



FM 3-90-1

OFFENSE AND DEFENSE

VOLUME 1

MARCH 2013

DISTRIBUTION RESTRICTION:

Approved for public release; distribution is unlimited.

HEADQUARTERS, DEPARTMENT OF THE ARMY

This publication is available at Army Knowledge Online
(<https://armypubs.us.army.mil/doctrine/index.html>).

To receive publishing updates, please subscribe at
http://www.apd.army.mil/AdminPubs/new_subscribe.asp.

Offense and Defense

Volume 1

Contents

	Page
PREFACE	viii
INTRODUCTION	ix
PART ONE OFFENSIVE TASKS	
Chapter 1 BASICS OF THE OFFENSE	1-1
Characteristics of Offensive Tasks.....	1-1
Offensive Tasks.....	1-1
Common Offensive Control Measures.....	1-2
Forms of Maneuver.....	1-2
Common Offensive Planning Considerations.....	1-22
Transition.....	1-42
Chapter 2 MOVEMENT TO CONTACT	2-1
General Considerations for a Movement to Contact.....	2-1
Organization of Forces for a Movement to Contact.....	2-2
Control Measures for a Movement to Contact.....	2-4
Planning a Movement to Contact.....	2-5
Preparing for a Movement to Contact.....	2-7
Executing a Movement to Contact.....	2-7
Search and Attack.....	2-12
Cordon and Search.....	2-15
Chapter 3 ATTACK	3-1
General Considerations for an Attack.....	3-1
Organization of Forces for an Attack.....	3-1
Control Measures For an Attack.....	3-3
Planning an Attack.....	3-4
Preparing for an Attack.....	3-9

Distribution Restriction: Approved for public release; distribution is unlimited.

***This publication supersedes FM 3-90, dated 4 July 2001.**

Contents

	Executing an Attack	3-12
	Special Purpose Attacks	3-23
Chapter 4	EXPLOITATION.....	4-1
	General Considerations of an Exploitation	4-1
	Organization of Forces for an Exploitation.....	4-2
	Control Measures for an Exploitation.....	4-4
	Planning an Exploitation	4-5
	Executing an Exploitation.....	4-9
Chapter 5	PURSUIT	5-1
	General Considerations for a Pursuit.....	5-1
	Organization of Forces for a Pursuit	5-2
	Control Measures for a Pursuit	5-4
	Planning a Pursuit.....	5-5
	Executing a Pursuit	5-6
	Pursuit During Other Than Major Combat Operations.....	5-9
PART TWO DEFENSIVE TASKS		
Chapter 6	BASICS OF THE DEFENSE	6-1
	General Considerations of the Defense.....	6-1
	Characteristics of the Defense.....	6-1
	Defensive Tasks.....	6-2
	Common Defensive Control Measures	6-3
	Common Defensive Planning Considerations	6-3
	Forms of the Defense	6-21
	Transitions.....	6-29
Chapter 7	THE AREA DEFENSE.....	7-1
	General Considerations for an Area Defense.....	7-1
	Organization of Forces for an Area Defense	7-1
	Control Measures for an Area Defense	7-4
	Planning an Area Defense	7-5
	Preparing an Area Defense	7-10
	Executing an Area Defense	7-12
Chapter 8	MOBILE DEFENSE	8-1
	General Considerations for a Mobile Defense.....	8-1
	Organization of Forces for a Mobile Defense	8-2
	Control Measures For a Mobile Defense	8-3
	Planning a Mobile Defense	8-4
	Preparing a Mobile Defense	8-5
	Executing a Mobile Defense	8-6
Chapter 9	THE RETROGRADE	9-1
	General Considerations for the Retrograde.....	9-1
	Delay	9-1
	Withdrawal	9-12
	Retirement.....	9-16
	Unique Retrograde Situations.....	9-19

Appendix A	BASIC TACTICAL CONTROL MEASURES	A-1
	Common Control Measures.....	A-1
Appendix B	TACTICAL MISSION TASKS	B-1
	GLOSSARY	Glossary-1
	REFERENCES	References-1
	INDEX	Index-1

Figures

Figure 1-1. Single envelopment.....	1-4
Figure 1-2. Double envelopment.....	1-4
Figure 1-3. Example envelopment control measures.....	1-5
Figure 1-4. Turning movement: turning force conducting the decisive operation	1-7
Figure 1-5. Control measures for a turning movement	1-8
Figure 1-6. Infiltration lane.....	1-11
Figure 1-7. Linkup point 8.....	1-12
Figure 1-8. Penetration: relative combat power	1-15
Figure 1-9. Penetration: minimum graphic control measures	1-16
Figure 1-10. The penetration	1-18
Figure 1-11. Widening the breach to secure the flanks.....	1-19
Figure 1-12. Seizing the objective	1-20
Figure 1-13. Frontal attack	1-20
Figure 1-14. Flank attack.....	1-22
Figure 1-15. Armored brigade combat team in battalion column	1-26
Figure 1-16. Line formation	1-27
Figure 1-17. Armored brigade combat team in echelon left formation	1-27
Figure 1-18. Armored brigade combat team in echelon right formation.....	1-28
Figure 1-19. Box formation	1-28
Figure 1-20. Diamond formation.....	1-28
Figure 1-21. Wedge formation.....	1-29
Figure 1-22. Armored brigade combat team in vee formation.....	1-30
Figure 2-1. Force organized for a movement to contact	2-2
Figure 2-2. Movement to contact control measures	2-5
Figure 2-3. A column advance guard attacking to destroy a contained enemy force	2-7
Figure 2-4. Search and attack control measures	2-13
Figure 2-5. Company search and attack	2-14
Figure 3-1. Minimum attack control measures	3-3
Figure 3-2. Movement from the assembly area to the line of departure	3-11
Figure 3-3. Probable line of deployment and assault positions.....	3-17
Figure 3-4. Attack of an objective: the breach.....	3-19
Figure 3-5. Attack of an objective: the assault	3-19

Contents

Figure 3-6. Ambush tactical mission graphic	3-23
Figure 3-7. Linear ambush	3-25
Figure 3-8. L-shaped ambush	3-25
Figure 3-9. Area ambush	3-25
Figure 3-10. Projected major counterattacks	3-27
Figure 3-11. Five phases of a raid	3-30
Figure 3-12. Spoiling attack	3-31
Figure 4-1. Control measures for a major exploitation	4-4
Figure 4-2. Control measures for a local exploitation	4-5
Figure 4-3. Brigade exploitation: battalions in column formation	4-6
Figure 4-4. Division exploitation: brigades abreast, no reserve	4-7
Figure 4-5. Brigade exploitation: two battalions forward, one in reserve	4-7
Figure 4-6. Exploitation control measures for a combined arms battalion in a vee formation	4-8
Figure 5-1. Frontal pursuit	5-2
Figure 5-2. Combination pursuit	5-3
Figure 5-3. Pursuit control measures	5-5
Figure 6-1. Perimeter defense	6-22
Figure 6-2. All company teams on the perimeter	6-23
Figure 6-3. Two battalion task forces on the perimeter, company teams positioned in depth	6-23
Figure 6-4. Two battalion task forces on the perimeter, one in reserve	6-24
Figure 6-5. Engagement area control measures	6-25
Figure 6-6. Slope terminology	6-27
Figure 6-7. Oblique defilade	6-28
Figure 7-1. Typical control measures for an area defense	7-4
Figure 7-2. Organization of forces for an area defense-contiguous area of operations	7-5
Figure 7-3. Organization of forces for an area defense-noncontiguous area of operations	7-5
Figure 7-4. Division conducting a defense in depth with subordinate brigades deployed in noncontiguous areas of operations with enemy avenues of approach depicted	7-7
Figure 7-5. Brigade conducting a forward defense in a contiguous area of operations	7-8
Figure 7-6. Division counterattack	7-9
Figure 7-7. Area defense using static and dynamic elements	7-12
Figure 7-8. Battle handover line	7-14
Figure 8-1. Mobile defense	8-2
Figure 8-2. Army organization of forces for a mobile defense	8-2
Figure 8-3. Mobile defense control measures	8-4
Figure 8-4. Mobile defense before commitment of striking force	8-7
Figure 8-5. Mobile defense after commitment of striking force	8-8
Figure 9-1. Delay tactical mission graphic	9-3

Figure 9-2. Control measures for a delay.....	9-4
Figure 9-3. Delay forward of a specified line for a specified time.....	9-5
Figure 9-4. Delay from alternate positions	9-7
Figure 9-5. Delay from subsequent positions.....	9-7
Figure 9-6. Detachment left in contact	9-14
Figure 9-7. Withdrawal control measures.....	9-14
Figure 9-8. Types of withdrawals	9-15
Figure 9-9. Retirement tactical mission graphic	9-17
Figure 9-10. Organization of forces for a retirement operation	9-17
Figure 9-11. Stay-behind force.....	9-21
Figure A-1. Example airspace coordination area	A-2
Figure A-2. Example air corridor and air control points.....	A-3
Figure A-3. Assembly area examples	A-5
Figure A-4. Checkpoint 13.....	A-5
Figure A-5. Contact point 8.....	A-5
Figure A-6. Critical friendly zone	A-6
Figure A-7. Example battalion engagement area.....	A-7
Figure A-8. Example sector of fire.....	A-8
Figure A-9. Target reference point 032	A-8
Figure A-10. Trigger line examples	A-9
Figure A-11. 1 st Brigade combat team coordinated fire line.....	A-10
Figure A-12. III Corps fire support coordination line.....	A-10
Figure A-13. 1CD free-fire area.....	A-11
Figure A-14. Example no fire area	A-11
Figure A-15. Example restrictive fire area.....	A-11
Figure A-16. Example restrictive fire line.....	A-12
Figure A-17. Fire support target symbols.....	A-12
Figure A-18. Example forward line of own troops	A-13
Figure A-19. Line of contact	A-13
Figure A-20. Example movement corridor.....	A-14
Figure A-21. Named area of interest Augusta.....	A-14
Figure A-22. Obstacle control measure graphics.....	A-15
Figure A-23. Phase lines with other control measures.....	A-18
Figure A-24. Position area for artillery.....	A-18
Figure A-25. Example routes.....	A-19
Figure A-26. Example target area of interest	A-19
Figure A-27. Attack by fire position Brandon.....	A-20
Figure A-28. Attack positions used with other common offensive control measures.....	A-21
Figure A-29. Battle handover line in a rearward passage of lines.....	A-22
Figure A-30. Final coordination line, limit of advance, and line of departure used with other offensive control measures.....	A-23

Contents

Figure A-31. Point of departure 7.....	A-24
Figure A-32. Rally point 14	A-24
Figure A-33. Support by fire position	A-24
Figure A-34. Task force battle position	A-25
Figure A-35. Area of operations and battle position control measures used in combination	A-26
Figure A-36. Five kinds of battle positions	A-26
Figure A-37. Strong point defense	A-27
Figure A-38. Direct fire control measures	A-27
Figure A-39. Final protective fire	A-28
Figure A-40. Forward edge of the battle area.....	A-28
Figure B-1. Attack by fire tactical mission graphic.....	B-3
Figure B-2. Breach tactical mission graphic.....	B-3
Figure B-3. Bypass tactical mission graphic.....	B-4
Figure B-4. Task force conducting a fix and bypass.....	B-4
Figure B-5. Clear tactical mission graphic	B-5
Figure B-6. Follow and assume tactical mission graphic.....	B-7
Figure B-7. Follow and support tactical mission graphic	B-8
Figure B-8. Occupy tactical mission graphic.....	B-9
Figure B-9. Retain tactical mission graphic.....	B-9
Figure B-10. Secure tactical mission graphic.....	B-9
Figure B-11. Seize tactical mission graphic.....	B-10
Figure B-12. Support by fire tactical mission graphic	B-10
Figure B-13. Block tactical mission graphic	B-10
Figure B-14. Block obstacle effect graphic	B-11
Figure B-15. Canalize tactical mission graphic.....	B-11
Figure B-16. Canalizing terrain enhanced by obstacles used with an engagement area.....	B-11
Figure B-17. Contain tactical mission graphic.....	B-12
Figure B-18. Destroy tactical mission graphic.....	B-12
Figure B-19. Disrupt tactical mission graphic.....	B-12
Figure B-20. Disrupt obstacle intent graphic.....	B-12
Figure B-21. Fix tactical mission graphic	B-13
Figure B-22. Fix obstacle intent graphic	B-13
Figure B-23. Interdict tactical mission graphic	B-13
Figure B-24. Isolate tactical mission graphic	B-14
Figure B-25. Neutralize tactical mission graphic.....	B-14
Figure B-26. Suppress tactical mission task graphic.....	B-14
Figure B-27. Turn tactical mission graphic.....	B-15
Figure B-28. Turn obstacle effect.....	B-15

Tables

Table 3-1. Advantages and disadvantages of limited-visibility attacks	3-6
Table 9-1. Advantages and disadvantages of delay techniques	9-6
Table B-1. Actions by friendly forces and effects on enemy forces	B-1
Table B-2. Elements of operations and subordinate tasks	B-2
Table B-3. Tactical shaping operations and tasks	B-2

Preface

Field Manual (FM) 3-90 Volume 1 contributes to the Army and joint community by providing guidance on the conduct of the offense and defense. It describes both combat-tested tactics and procedures that have been modified to exploit emerging Army and joint offensive and defensive capabilities. FM 3-90-1 expounds on the doctrinal fundamentals established in Army Doctrine Reference Publication (ADRP) 3-90. ADRP 3-90 must be read before reading FM 3-90-1, since that is where doctrine for the conduct of offensive and defensive tasks and the art and science of tactics is found. FM 3-90-1 addresses the basic tactics associated with the conduct of offensive and defensive tasks.

The principal audience for FM 3-90-1 is all members of the profession of arms. Commanders and staffs of Army headquarters serving as a joint task force or multinational headquarters should also refer to applicable joint or multinational doctrine concerning the range of military operations and joint or multinational forces. Trainers and educators throughout the Army will also use this publication.

FM 3-90-1 focuses on the organization of forces, minimum essential control measures, and general planning, preparation, and execution considerations for each primary offensive and defensive task. It is the common reference for all students of the art and science of tactics, both in the field and the Army school system. The offensive and defensive considerations in this publication apply to small tactical units, such as companies and battalions, even though most of the figures in this publication use the division and the brigade combat team (BCT) echelons to illustrate points in the text. Echelon-specific field manuals and Army techniques publications address the specifics of how each tactical echelon employs these tactical concepts.

FM 3-90-1 implements standardization agreement (STANAG) Allied Tactical Publication-3.2.1.

Commanders, staffs, and subordinates ensure their decisions and actions comply with applicable U.S., international, and, in some cases, host-nation laws and regulations. Commanders at all levels ensure their Soldiers operate in accordance with the law of war and the rules of engagement. (See FM 27-10.)

FM 3-90-1 uses joint terms where applicable. Most terms with joint or Army definitions are in both the glossary and the text. Terms for which FM 3-90-1 is the proponent publication (the authority) are marked with an asterisk (*) in the glossary. Definitions for which FM 3-90-1 is the proponent publication are boldfaced in the text. For other definitions shown in the text, the term is italicized and the number of the proponent publication follows the definition.

FM 3-90-1 applies to the Active Army, the Army National Guard (ARNG)/the Army National Guard of the United States (ARNGUS), and the United States Army Reserve (USAR) unless otherwise stated.

The United States Army Combined Arms Center is the proponent for this publication. The preparing agency is the Combined Arms Doctrine Directorate, United States Army Combined Arms Center. Send written comments and recommendations on a DA Form 2028 (Recommended Changes to Publications and Blank Forms) to Commander, U.S. Army Combined Arms Center and Fort Leavenworth, ATTN: ATZL-MCK-D (FM 3-90-1), 300 McPherson Avenue, Fort Leavenworth, KS 66027-2337; by e-mail to usarmy.leavenworth.mccoe.mbx.cadd-org-mailbox@mail.mil; or submit an electronic DA Form 2028.

Introduction

To understand FM 3-90-1, the reader must understand the doctrinal fundamentals contained in Army Doctrine Publications (ADP) 3-0 and 3-90 and Army Doctrine Reference Publications (ADRP) 3-0 and 3-90. The reader should understand how the activities described in ADPs 3-07 and 3-28 and ADRP 3-07 carry over and impact the conduct of offensive and defensive primary tasks and vice versa. The reader should understand the operations (plan, prepare, execute, and assess) process and how that process relates to the Army's military decisionmaking process and troop-leading procedures described in ADP 5-0 and ADRP 5-0. The reader should also understand the intelligence preparation of the battlefield (IPB) process found in ADRP 2-0 and the targeting process described in ADRP 3-09.

The combined arms tactics contained in this volume are based on the Army's historical lessons learned. However, enemies and adversaries read U.S. doctrine and tactics to learn how to best counter the U.S. combined arms team. The Army of the future must prove itself as capable of quickly adapting to new and unexpected situations as it has in the past. Implementing change in the midst of combat is a difficult process. Commanders must ensure the rapid dissemination of new tactics, techniques, and procedures developed to counter or take advantage of new circumstances regardless of the source of the solutions, from junior Soldiers on patrol to staff officers in Army command headquarters.

There have been several changes in the organization and contents of this publication when compared with its predecessor, the 2001 edition of FM 3-90, *Tactics*. Chapter 1, *The Art of Tactics*, and the common tactical concept half of chapter 2 of the previous edition are now found in ADRP 3-90. The graphic control measures discussion in the previous version's chapter 2 is now appendix A of FM 3-90-1. The Army branch discussion from the previous version's appendix A has been deleted as redundant with information contained in Department of the Army 600-series pamphlets. The Army tactical echelon discussion from the previous version's appendix A has been moved to chapter 2 of ADRP 3-90 and expanded on down to the fire team level. Appendix C, *Airborne and Air Assault Operations*, of the 2001 version of FM 3-90 has been deleted. The Army contributions to the joint task of forcible entry by vertical envelopment are now addressed in airborne and air assault doctrine. Appendix D, *Encirclement Operations*, is now a tactical enabling task addressed in FM 3-90-2. Appendix E, *Rear Area and Base Security*, is now addressed in the protection series of publications (ADP 3-37 and ADRP 3-37).

This volume contains nine chapters divided into two parts and two appendices. The text of FM 3-90-1 focuses on combined arms tactics used to employ available means to win in combat (the conduct of offensive and defensive tasks) and constitutes the Army's collective view of how units conduct prompt and sustained tactical offensive and defensive actions on land. Those tactics require judgment in application. FM 3-90-1 provides a common discussion of how commanders from the battalion task force level through the division echelon conduct tactical offensive and defensive tasks and their supporting tactical enabling tasks. The tactics and considerations discussed in this publication focus on the Army core competencies of employing combined arms in lethal combat operations. These offensive and defensive combined arms tactics and considerations apply to the conduct of decisive action across the range of military operations, but they cannot be used in isolation. Their application must be tempered by the obligation to protect the civilian population within the area of operations in the conduct of the stability element of decisive action. This publication is not prescriptive, but it is authoritative.

- Part One contains five chapters and addresses the conduct of offensive tasks.
- Part Two contains four chapters addresses the conduct of defensive tasks.
- The two appendices address in control measures that apply to the conduct of offensive and defensive tasks and Army tactical mission tasks.

Each chapter is built around organizational considerations, control measures, planning, preparation, and execution considerations for the tasks to be accomplished. These considerations are largely grouped by warfighting or joint function. Chapter 1 contains general information on the offense. Chapter 6 contains

general information on the defense. Information contained in these chapters is not repeated in other chapters to avoid redundancy. For example, chapter 1 addresses the sustainment function in the offense. That information applies to all four primary offensive tasks, so it is not repeated in chapters 2-5.

This publication discusses the conduct of the primary offensive tasks in chapters 2-5 and the primary defensive tasks in chapters 7-9 in a five-step sequence:

- Gain and maintain enemy contact.
- Disrupt the enemy.
- Fix the enemy.
- Maneuver.
- Follow through.

This sequence is for discussion purposes only and is not the only way of conducting operations. The reader should understand that these sequences overlap during the conduct of operations, if they can even be distinguished from each other. Normally the first three of these steps are shaping operations, while the maneuver step is the decisive operation. The follow through step is normally a sequel or a branch to the plan based on the revised situation, but in certain circumstances it can be the decisive operation. The execution of this follow through determines if the force can exploit success, or if it should transition to another task to include a change in focus from offensive or defensive tasks to a focus on the conduct of stability tasks.

The tactics, techniques, and procedures discussed in this publication are only examples of a way to conduct a specific offensive or defensive task. Collectively they provide a set of tools that commanders employ in accordance with the exact tactical situation that they face at any one given time. The tactical situation is defined as the mission variables of mission, enemy, terrain and weather, troops and support available, time available, and civil considerations (METT-TC).

The existing rules of engagement in a specific situation will control the actual application of the tactics, techniques, and procedures discussed in this publication. Readers of FM 3-90-1 should be aware that rules of engagement are constantly evolving. Criteria for allowing weapon systems employment during the conduct of major operations are significantly different than the criteria used during the conduct of irregular warfare or peace operations. Commanders must understand where they currently are on the range of military operations continuum and be able to switch quickly between different places along that continuum to protect their units and Soldiers while still accomplishing their mission. A commander should seek legal guidance concerning currently applicable U.S. and multinational rules and policies regarding the employment of lethal and non-lethal weapons before directing their employment.

This volume contains few historical references. Such references are important in illustrating the impact of combat on Soldiers and the art of command. Successful commanders, staff officers, and Soldiers of all ranks study military history. This study should include the experiences of other armies and precedents from classical, medieval, and recent historical periods, in addition to Army and Marine Corps recent experiences in Iraq and Afghanistan. Military professionals should also study politics and diplomacy, economics, and ways of influencing others—the other instruments of national power. While history never exactly repeats itself, on many occasions it closely parallels previous developments. In addition, war remains a human endeavor. What motivated or influenced Soldiers in the past will probably motivate or influence today's Soldiers to one degree or another, once adjustments are made to account for technological and social changes.

The introductory table on page xiii outlines different modifications in doctrinal terminology reflected in Volumes 1 and 2 of FM 3-90.

Introductory table. Modified Army terms

Term	Remarks
base defense force	Adopts the joint definition.
combat arms	Doctrinal term no longer used, but term still used in Army regulations.
combat support	Retained based on common English usage. No longer formally defined.
consolidation	FM 3-90-1 modifies the definition.
contact point	Adopts the joint definition.
destroy	FM 3-90-1 modifies the definition.
exfiltrate	FM 3-90-1 modifies the definition.
key terrain	Adopts the joint definition.
line formation	FM 3-90-1 modifies the definition.
passage of lines	Adopts the joint definition.
procedures	Adopts the DOD definition.
reconnaissance operations	Retained based on common English usage. No longer formally defined.
relief in place	Adopts the joint definition.
tactician	Retained based on common English usage. No longer formally defined.
techniques	Adopts the joint definition.

This page intentionally left blank.

PART ONE

Offensive Tasks

Chapter 1

Basics of the Offense

Offensive actions are combat operations conducted to defeat and destroy enemy forces and seize terrain, resources, and population centers. They impose the commander's will on the enemy. A commander may also conduct offensive actions to deprive the enemy of resources, seize decisive terrain, deceive or divert the enemy, develop intelligence, or hold an enemy in position. This chapter discusses the basics of the offense. The basics discussed in this chapter apply to the conduct of all offensive tasks.

1-1. The commander seizes, retains, and exploits the initiative when conducting offensive tasks. Specific operations may orient on a specific enemy force or terrain feature as a means of affecting the enemy. Even when conducting primarily defensive tasks, wresting the initiative from the enemy requires the conduct of offensive actions.

CHARACTERISTICS OF OFFENSIVE TASKS

1-2. Offensive tasks are characterized by surprise, concentration, tempo, and audacity. Effective offensive action capitalizes on accurate and timely intelligence and other relevant information regarding enemy forces, weather, and terrain. The commander maneuvers forces to advantageous positions before contact. Protection tasks, such as security operations, operations security, and information protection prevent or inhibit the enemy from acquiring accurate information about friendly forces. Contact with enemy forces before the decisive operation is deliberate, designed to shape the optimum situation for the decisive operation. The *decisive operation* is the operation that directly accomplishes the mission (ADRP 3-0). The decisive operation is a sudden, shattering action that capitalizes on subordinate initiative and a common operational picture (COP) to expand throughout the area of operations (AO). The commander executes violently without hesitation to break the enemy's will or destroy the enemy. (See ADRP 3-90 for a discussion of these characteristics.)

Characteristics of offensive tasks

- Surprise
- Concentration
- Tempo
- Audacity

OFFENSIVE TASKS

1-3. An *offensive task* is a task conducted to defeat and destroy enemy forces and seize terrain, resources, and population centers (ADRP 3-0). The four primary offensive tasks are movement to contact, attack, exploitation, and pursuit.

Army offensive tasks

- Movement to contact
- Attack
- Exploitation
- Pursuit

MOVEMENT TO CONTACT

1-4. *Movement to contact* is an offensive task designed to develop the situation and establish or regain contact (ADRP 3-90). It also creates favorable conditions for subsequent tactical actions. The commander conducts a movement to contact when the enemy situation is vague or not specific enough to conduct an attack. Forces executing this task seek to make contact with the smallest friendly force feasible. A movement to contact may result in a meeting engagement. Once contact is made with an enemy force, the commander has five options: attack, defend, bypass, delay, or withdraw. Search and attack and cordon and search are subordinate tasks of movement to contact. Chapter 2 discusses movement to contact. FM 3-90-2 discusses the approach march.

ATTACK

1-5. An *attack* is an offensive task that destroys or defeats enemy forces, seizes and secures terrain, or both (ADRP 3-90). Attacks incorporate coordinated movement supported by fires. They may be either decisive or shaping operations. Attacks may be characterized as hasty or deliberate, depending on the time available for assessing the situation, planning, and preparing. However, based on mission variable analysis, the commander may decide to conduct an attack using only fires. An attack differs from a movement to contact because, in an attack, the commander knows part of the enemy's disposition. This knowledge enables the commander to better synchronize the attack and employ combat power more effectively in an attack than in a movement to contact.

1-6. Subordinate forms of the attack have special purposes and include the ambush, counterattack, demonstration, feint, raid, and spoiling attack. The commander's intent and the mission variables of mission, enemy, terrain and weather, troops and support available, time available, and civil considerations (METT-TC) determine which of these forms of attack are employed. The commander can conduct each of these forms of attack, except for a raid, as either a hasty or a deliberate operation. Chapter 3 discusses the attack and these subordinate forms.

Forms of the attack

- Ambush
- Counterattack
- Demonstration
- Feint
- Raid
- Spoiling attack

EXPLOITATION

1-7. *Exploitation* is an offensive task that usually follows the conduct of a successful attack and is designed to disorganize the enemy in depth (ADRP 3-90). Exploitations seek to disintegrate enemy forces to the point where they have no alternative but surrender or take flight. Exploitations take advantage of tactical opportunities. Division and higher headquarters normally plan exploitations as branches or sequels to the current operation. Chapter 4 discusses exploitation.

PURSUIT

1-8. A *pursuit* is an offensive task designed to catch or cut off a hostile force attempting to escape, with the aim of destroying it (ADRP 3-90). A pursuit normally follows a successful exploitation. However, any offensive task can transition into a pursuit, if enemy resistance has broken down and the enemy is fleeing the battlefield. Pursuits entail rapid movement and decentralized control. Chapter 5 discusses the pursuit.

COMMON OFFENSIVE CONTROL MEASURES

1-9. Appendix A discusses common control measures. Those control measures closely associated with a subordinate offensive task, form of maneuver, or form of attack are discussed as part of the discussion of those tasks or forms.

FORMS OF MANEUVER

1-10. *Forms of maneuver* are distinct tactical combinations of fire and movement with a unique set of doctrinal characteristics that differ primarily in the relationship between the maneuvering force and the

enemy (ADRP 3-90). There are six forms of maneuver: envelopment, turning movement, frontal attack, penetration, infiltration, and flank attack. Combined arms organizations accomplish their mission by synchronizing the contributions of all warfighting functions to execute these forms of maneuver. *Combined arms* is the synchronized and simultaneous application of arms to achieve an effect greater than if each arm was used separately or sequentially (ADRP 3-0). The commander generally chooses one form on which to build a course of action (COA). The higher commander rarely specifies the specific form of offensive maneuver. However, that higher commander's guidance and intent, along with the mission and any implied tasks, may impose constraints such as time, security, and direction of attack that narrow the forms of offensive maneuver to one alternative. Additionally, the AO's characteristics and the enemy's dispositions also help the commander determine the form of maneuver. A single operation may contain several forms of maneuver, such as a frontal attack to clear a security area followed by a penetration to create a gap in enemy defenses. Then, the commander might use an envelopment to destroy the enemy's first line of defense.

Forms of maneuver

- Envelopment
- Turning movement
- Frontal attack
- Penetration
- Infiltration
- Flank attack

ENVELOPMENT

1-11. ***Envelopment is a form of maneuver in which an attacking force seeks to avoid the principal enemy defenses by seizing objectives behind those defenses that allow the targeted enemy force to be destroyed in their current positions.*** At the tactical level, envelopments focus on seizing terrain, destroying specific enemy forces, and interdicting enemy withdrawal routes. The commander's decisive operation focuses on attacking an assailable flank. It avoids the enemy's strength—the enemy's front—where the effects of enemy fires and obstacles are the greatest. Generally, a commander prefers to conduct envelopment instead of a penetration or a frontal attack because the attacking force tends to suffer fewer casualties while having the most opportunities to destroy the enemy. Envelopment also produces great psychological shock to the enemy. If no assailable flank is available, the attacking force creates one through the conduct of a penetration. The four varieties of envelopment are the single envelopment, double envelopment, encirclement, and vertical envelopment. (See figure 1-1 and 1-2 on page 1-4.) ***A single envelopment results from maneuvering around one assailable flank of a designated enemy force. A double envelopment results from simultaneous maneuvering around both flanks of a designated enemy force. Encirclement operations are operations where one force loses its freedom of maneuver because an opposing force is able to isolate it by controlling all ground lines of communication and reinforcement. Vertical envelopments are tactical maneuvers in which troops, either air-dropped or airlanded, attack the rear and flanks of a force, in effect cutting off or encircling the force. (JP 3-18). (For a discussion of encirclement operations, see FM 3-90-2.)***

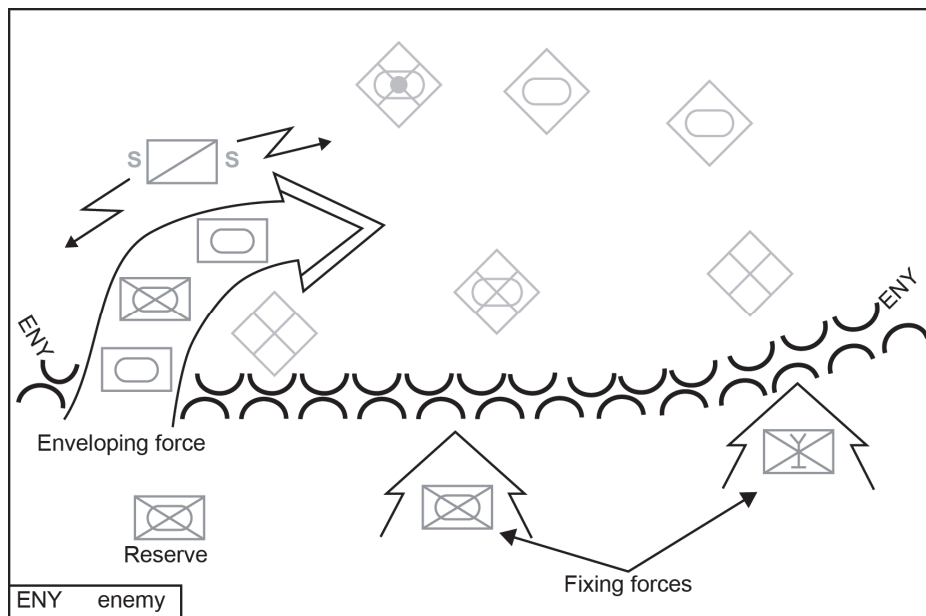

Figure 1-1. Single envelopment

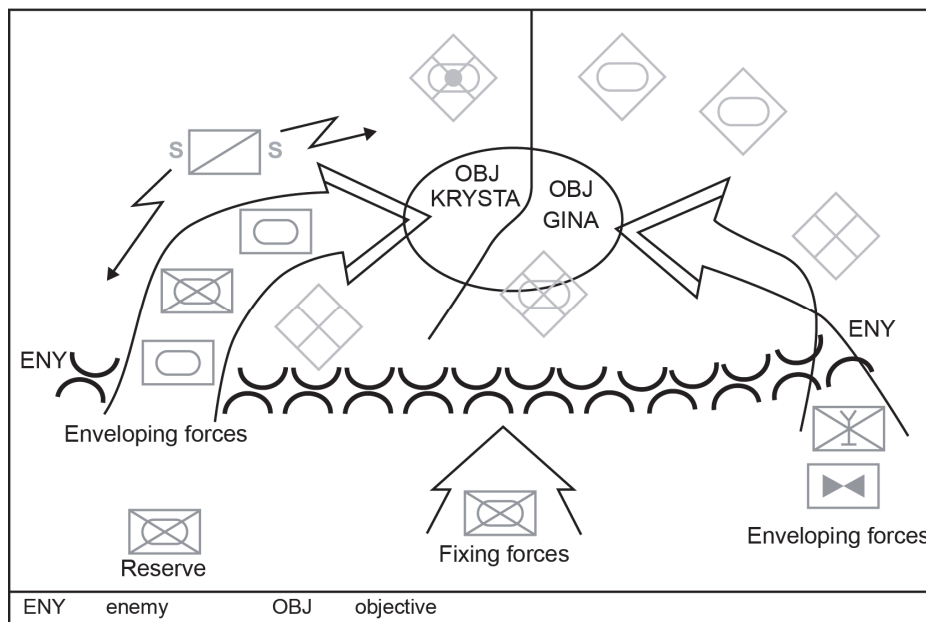

Figure 1-2. Double envelopment

1-12. Single and double envelopments force the enemy to fight in two or more directions simultaneously to meet the converging efforts of the attack. A double envelopment generally requires a preponderance of force and can be difficult to control. A force seeking to execute a double envelopment must also have a substantial mobility advantage over the defender. A unit performs a double envelopment by conducting a frontal attack as a shaping operation in the center to fix the enemy in place while enveloping both hostile flanks. Because of the forces required, normally only divisions and larger organizations have the resources to execute a double envelopment.

Organization of Forces

1-13. The commander envisioning a single envelopment organizes the friendly force to perform two primary tasks: fixing the enemy force in its current location and conducting the envelopment. The commander also allocates forces to conduct necessary shaping operations, such as reconnaissance, security, reserve, and sustaining tasks. The force conducting the envelopment normally conducts the decisive operation by attacking an assailable enemy flank and avoiding the enemy's main strength en route to the objective. The fixing force conducting the shaping operations normally conducts a frontal attack to fix enemy forces in their current positions to prevent their escape and reduce their capability to react against the enveloping force. A commander executing a double envelopment organizes the friendly forces to conduct two enveloping operations and allocates the minimum combat power to shaping operations required to conduct the fix tasks in addition to reconnaissance, security, reserve, and sustaining tasks. The commander typically designates the more important of the two enveloping forces as the main effort for resources. The *main effort* is a designated subordinate unit whose mission at a given point in time is most critical to overall mission success (ADRP 3-0).

Control Measures

1-14. The commander, at a minimum, designates AOs for each unit participating in the envelopment by using boundaries. The commander also designates phase lines (PLs), support by fire and attack by fire positions, contact points, and appropriate fire coordination measures, such as a restrictive fire line or boundary between converging forces, and any other control measures necessary to control the envelopment. Figure 1-3 is an example of control measures used when conducting a single envelopment.

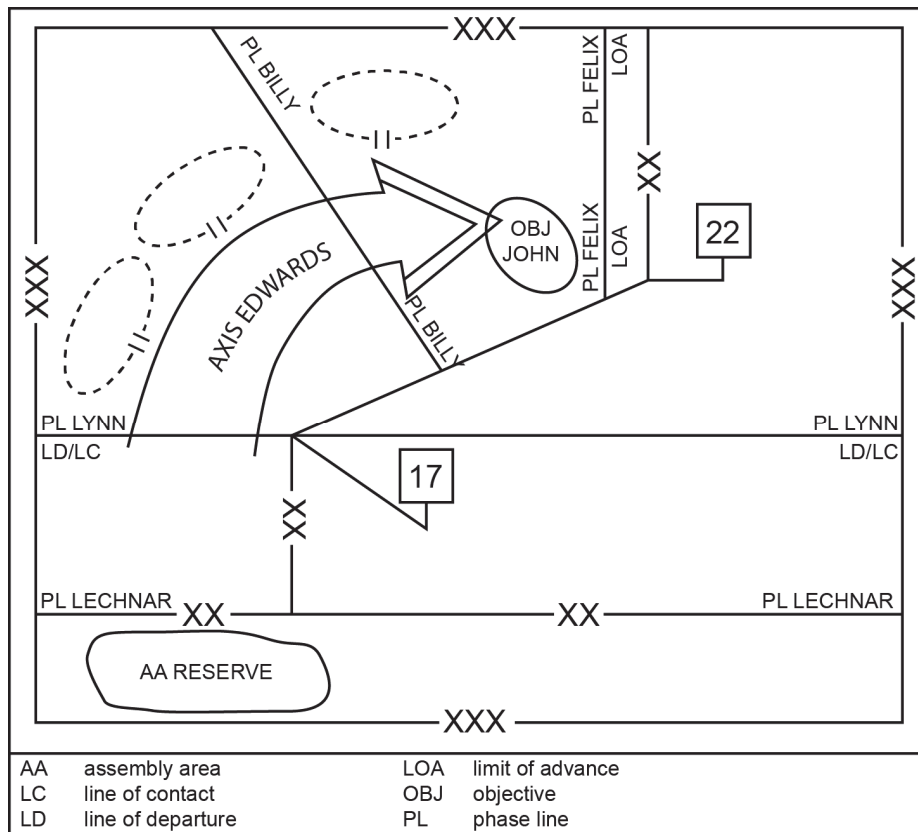

Figure 1-3. Example envelopment control measures

Planning an Envelopment

1-15. Successful envelopment planning depends on knowing and understanding the enemy and its capabilities. The commander seeks to maneuver the enveloping force around or over the enemy's main defenses to secure objectives on the enemy's flank or rear. From those objectives the enveloping force can use its positional advantage to employ superior combat power against a defending enemy oriented in the wrong direction. The commander uses intelligence assets and personnel to determine the disposition and capabilities of enemy forces to detect and react to their operations.

1-16. The commander plans for the force conducting the envelopment to remain within supporting distance of the fixing force. (If the enveloping force is going outside of supporting distance, it is probably conducting a turning movement, not envelopment.)

1-17. Sustaining the enveloping force requires deliberate planning because only intermittent ground lines of communication (LOCs) between the echelon support area and the enveloping force may exist. A *line of communications* is a route, either land, water, and/or air, that connects an operating military force with a base of operations and along which supplies and military forces move (JP 2-01.3).

1-18. The commander plans how to exploit the envelopment's success as the enemy is encircled or how to transition to a pursuit to complete the destruction of the enemy force. These plans are developed as branches and sequels to the envelopment operation.

Executing an Envelopment

1-19. A successful envelopment depends largely on the degree of surprise the commander achieves against the opponent or the presence of overwhelming combat power. The envelopment's probability of success also increases when the commander's forces have superior tactical mobility, possess air and information superiority, and shaping operations fix the bulk of the enemy's forces in their current positions. The commander uses reconnaissance and surveillance assets to provide continuous intelligence and combat information to identify changes in enemy COAs throughout the execution of the envelopment.

1-20. Normally, a unit orients the majority of its combat power toward where it expects to engage enemy forces, while placing less combat power on its own flanks. Thus the flanks of most units are more vulnerable to attack. The attacking commander creates an assailable flank using whatever means necessary. The enveloping force then moves rapidly to exploit the situation before the enemy strengthens an assailable flank by preparing positions in depth and by holding mobile forces in reserve. When faced with the threat of envelopment, the enemy commander might move reserves to meet the enveloping force. Thus, rapid movement around the enemy's flank is essential to prevent the enemy from occupying previously prepared positions. Ground and air assets conducting vigorous shaping operations attempt to prevent the enemy commander from reconstituting reserves from other portions of the enemy front.

1-21. The enemy may attempt to cut off the enveloping force and extend its flank beyond the area that the enveloping force is attempting to attack through. If the encircling force attempts to outflank such a hostile extension, it may become overextended by moving outside of supporting distance from the fixing force. Therefore, it is usually better for the encircling force to take advantage of the enemy's extension and subsequent weakness by penetrating a thinly held area of the enemy's front rather than overextending itself in an attempt to completely outflank the enemy's position.

1-22. The enemy may attempt a frontal counterattack in response to an attempted envelopment. In this case, the fixing force defends itself or conducts a delay while the enveloping force continues the envelopment.

1-23. After the initial envelopment of one flank—which places the enemy at a disadvantage—the commander has many options. The commander may choose to establish favorable conditions for passing to a double envelopment by using reserves, or the commander may exploit success by generating additional combat power along the same axis. Alternatively, the commander can destroy or defeat the enveloped enemy force in place, or transition to another type of operation, such as an exploitation or pursuit.

TURNING MOVEMENT

1-24. A *turning movement* is a form of maneuver in which the attacking force seeks to avoid the enemy's principle defensive positions by seizing objectives behind the enemy's current positions thereby causing the enemy force to move out of their current positions or divert major forces to meet the threat. However, a commander can employ a vertical envelopment using airborne or air assault forces to effect a turning movement. An *air assault* is the movement of friendly assault forces (combat, combat support, and combat service support) by rotary wing aircraft to engage and destroy enemy forces or to seize and hold key terrain (JP 3-18). It can also be conducted using waterborne or amphibious means. (JP 3-02 discusses amphibious operations.) A commander uses this form of offensive maneuver to seize vital areas in the enemy's support area before the main enemy force can withdraw or receive support or reinforcements. (See figure 1-4 for a graphic depiction of a turning movement.) Commanders frequently transition this form of offensive maneuver from the attack into an exploitation or pursuit. A turning movement differs from envelopment because the force conducting a turning movement seeks to make the enemy forces displace from their current locations, whereas an enveloping force seeks to engage the enemy forces in their current locations from an unexpected direction.

Organization of Forces

1-25. The commander directing a turning movement task organizes available resources to conduct three main tasks: conduct a turning movement, conduct shaping operations, and conduct reserve operations. Each of these task-organized forces conducts security and reconnaissance operations as part of its tactical enabling operations. Normally the force conducting the turning movement conducts the echelon's decisive operation given the appropriate mission variables of METT-TC. A turning movement is particularly suited for division-sized or larger forces possessing a high degree of tactical mobility. It is not until a commander has access to the resources of these echelons that the commander normally has the combat power to resource a turning force that can operate outside supporting range of the main body to allow the turning force to force enemy units out of their current positions. The commander bases the task organization of these forces on the mission variables of METT-TC and the concept of operations for the turning movement.

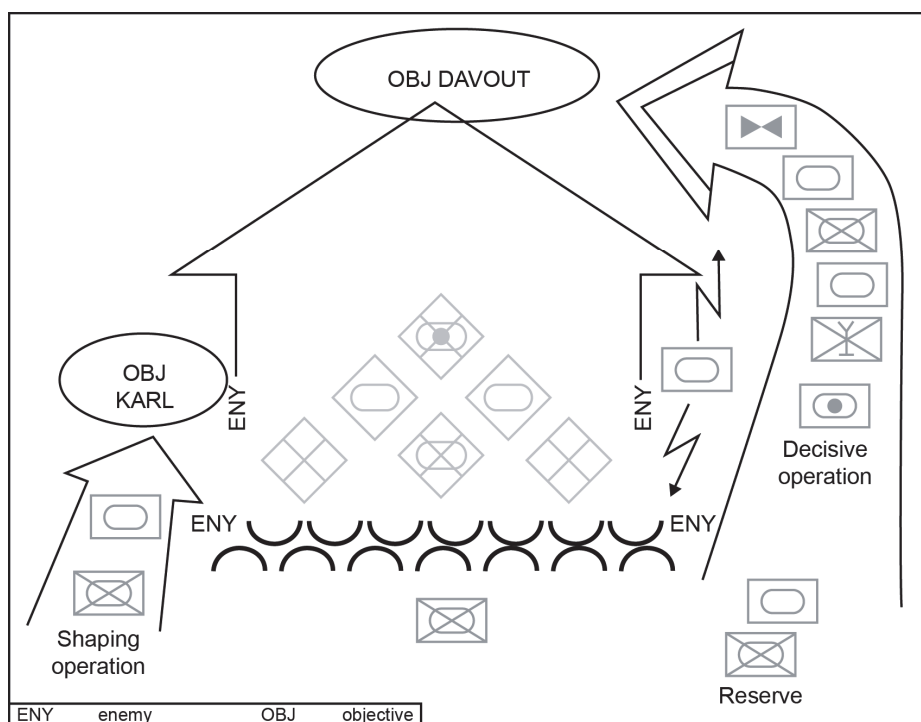

Figure 1-4. Turning movement: turning force conducting the decisive operation

1-26. The maneuver of the turning force is what causes enemy forces to leave their positions. A turning force normally conducts the majority of its operations outside of the supporting range of the main body and possibly outside its supporting distance. Thus, the turning force must contain sufficient maneuver, functional, and multifunctional capabilities to operate independently of the main body for a specific period.

1-27. The commander task organizes the main body to ensure the success of the turning force. The main body conducts operations, such as attacks designed to divert the enemy’s attention away from the area where the turning force conducts its operations. The operations of the main body can be either the echelon’s decisive or shaping operations. The commander organizes the reserve to exploit success by either the turning force or the main body. The reserve also provides the commander insurance against unexpected enemy actions.

Control Measures

1-28. The commander designates the AOs for each unit participating in the turning movement by establishing boundaries. The commander also designates additional control measures as necessary to synchronize the subordinate force operations. These additional control measures include phase lines, contact points, objectives, limits of advance, and appropriate fire coordination measures. Figure 1-5 depicts these control measures used to synchronize a turning movement that employs an airborne division as the turning force.

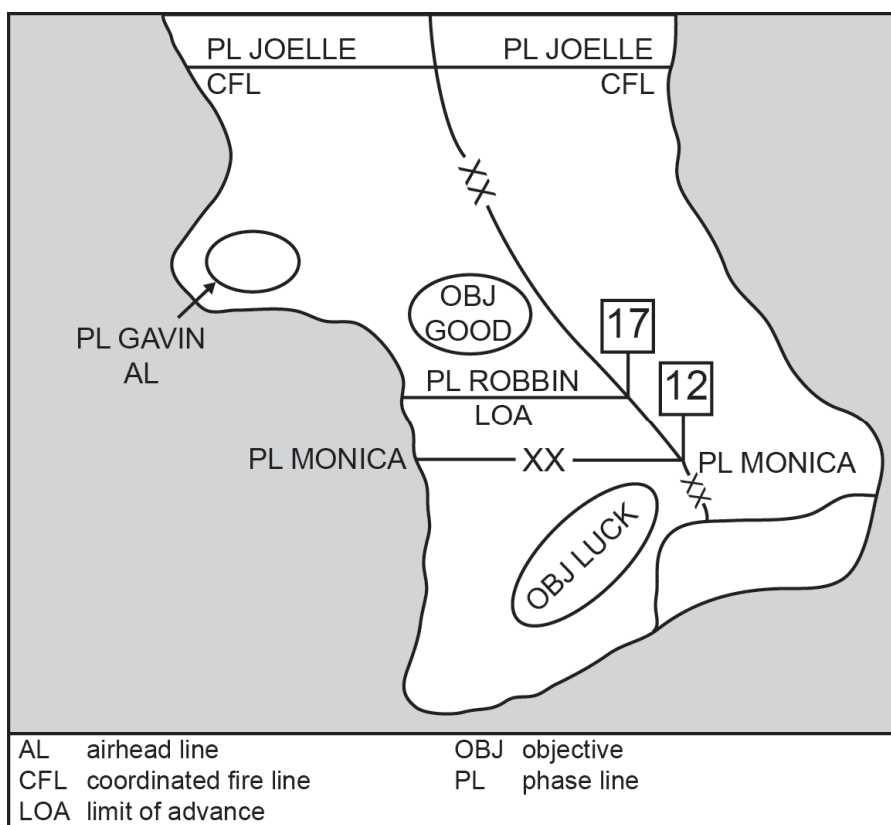

Figure 1-5. Control measures for a turning movement

Planning a Turning Movement

1-29. Selecting the geographic objective of the turning movement is of major importance to the success of the operation. The commander’s scheme of maneuver in a turning movement may vary, depending on the specific situation and the mission variables of METT-TC. In addition to common offensive planning

considerations addressed in paragraphs 1-96 to 1-204, the commander conducting a turning movement pays special attention to planning branches and sequels to the turning movement, including—

- Defensive actions conducted by the turning force.
- Link-up operations between the turning force and the main body.
- Retrograde operations for the turning force.

Essential to the planning of the branches and sequels is the linkage between the branch or sequel and specific decision points supported by situation development.

1-30. After developing the tactical plan, the commander plans how the turning force maneuvers to its objective. The commander develops the turning force's movement, loading, and staging plans if outside transportation assets are required. The commander can plan to occupy key terrain that will threaten the enemy's survival or remain mobile and seek ways to exploit the turning force's success. Before initiating the operation, the commander plans how the turning force can exploit success.

1-31. In a turning movement that envisions an early linkup with the main body, the turning force normally plans to defend only that terrain required to protect itself. Once reinforcement or linkup with the main body occurs, the commander plans how to use the turning force to continue the attack or relieve it so it can prepare for subsequent missions.

1-32. The distances between forces and the existence of intermittent LOCs magnify the problems inherent in providing sustainment to a maneuver force during a turning movement. Therefore, in the planning of a turning movement, the commander emphasizes resupply, equipment maintenance, casualty evacuation, graves registration, prisoner of war handling, and dealing with the indigenous civilian population to address these likely problems. Prepackaging company- and battalion-sized resupply sets can ease the execution of sustaining operations during periods when sustainment units must push supplies to the combat units. A *sustaining operation* is an operation at any echelon that enables the decisive operation or shaping operation by generating or maintaining combat power (ADRP 3-0).

1-33. Planners must consider the provision of all supplies and equipment required for mission accomplishment as an integral part of tactical planning. The commander plans and organizes unit sustainment operations to support a rapid tempo of highly mobile and widely dispersed operations. Traditional doctrinal supporting distances and responsibilities do not always apply to turning movements. Sustainment planners recognize this and adjust their plans using available resources. Subordinate units will carry into the operation only those supplies required to meet their immediate needs. Excess supplies and equipment can burden the turning force. Staffs establish and maintain required supply levels in the objective area by phasing supplies into the objective area on an accompanying, follow-up (automatic and on-call), and routine basis. Medical evacuation, resupply, and reinforcement airlifts may be necessary to sustain the force's combat operations. Ammunition and petroleum, oils, and lubricants (POL) normally constitute the major tonnage items.

Executing a Turning Movement

1-34. The primary prerequisites of a successful turning movement are moving the turning force to the objective area without incurring unacceptable losses and providing the force with the required combat power and sustainment. A commander can reduce personnel and equipment losses by operating under conditions of friendly air and information superiority, suppressing enemy fires, and having a mobility advantage over the enemy.

1-35. Major sources of firepower to suppress enemy fires are fixed-wing aircraft, attack helicopters, jammers, and Multiple Launch Rocket Systems (MLRSs) that cover the entire route taken by the turning force. Other sources of firepower include accompanying artillery units and naval surface fire support.

1-36. When threatened with a turning movement, the enemy commander is in a dilemma. The enemy's original defense is misplaced. The enemy commander must move forces from their original position in meeting the new threat. Often the commander must commit available reserves against the new threat. The enemy commander exposes those forces to friendly fires as the commander weakens the defense and moves those forces. The enemy commander must now engage friendly forces on ground that commander has not chosen or prepared. Whenever possible, the commander conducting a turning movement tries to reach the

decisive location without encountering the enemy. Techniques to accomplish this include outflanking the enemy or using airborne, air assault, and amphibious means to avoid prepared enemy positions. Once friendly forces find a way deep into the enemy's support areas, the turning force moves rapidly to exploit the situation. It seeks to achieve its mission before the enemy can reposition uncommitted forces to react. Rapid movement is essential to prevent the enemy from occupying previously prepared positions in the enemy's support area. Vigorous shaping operations prevent the enemy from reconstituting reserves from other portions of the enemy front.

1-37. The enemy may counterattack in an attempt to cut off and destroy or block the turning force and prevent the successful completion of the turning movement. In this case, the turning force's security elements conduct an area defense in depth or engage in delaying actions while the rest of the turning force continues its mission. Alternatively, the enemy may try to withdraw forces to a position where their LOCs are not threatened.

INFILTRATION

1-38. An *infiltration* is a form of maneuver in which an attacking force conducts undetected movement through or into an area occupied by enemy forces to occupy a position of advantage behind those enemy positions while exposing only small elements to enemy defensive fires. Historically, the scope of the mission for the infiltrating force has been limited. Infiltration is also a march technique used within friendly territory to move forces in small groups at extended or irregular intervals. (See FM 3-90-2 for a discussion of infiltration as a movement technique.)

1-39. Infiltration occurs by land, water, air, or a combination of means. Moving and assembling forces covertly through enemy positions takes a considerable amount of time. To successfully infiltrate, the force must avoid detection and engagement. Since this requirement limits the size and strength of the infiltrating force—and infiltrated forces alone can rarely defeat an enemy force—infiltration is normally used in conjunction with and in support of the other forms of offensive maneuver.

1-40. The commander orders an infiltration to move all or a portion of a unit through gaps in the enemy's defenses to—

- Reconnoiter known or templated enemy positions and conduct surveillance of named areas of interest and targeted areas of interest.
- Attack enemy-held positions from an unexpected direction.
- Occupy a support by fire position to support the decisive operation.
- Secure key terrain.
- Conduct ambushes and raids to destroy vital facilities and disrupt the enemy's defensive structure by attacking enemy reserves, fire support and air defense systems, communication nodes, and sustainment.
- Conduct a covert breach of an obstacle or obstacle complex.

1-41. Special operations forces and light infantry units up to brigade size are best suited to conduct an infiltration. In some circumstances, armored and Stryker-equipped forces operating in small units can conduct an infiltration. However, as the proliferation of technology leads to increased situational understanding, this should increase the ability of these forces to avoid enemy contact and move undetected through enemy positions. In the future a commander may conduct an infiltration with armored and Stryker-equipped forces in coordination with precision fires as a prelude to an attack.

Organization of Forces

1-42. Normally, to be successful, the infiltrating force must avoid detection at least until it reaches its objective rally point. Thus, the infiltrating force's size, strength, and composition are usually limited. The infiltrating unit commander organizes the main body into one or more infiltrating elements. The largest-sized element possible, compatible with the requirement for stealth and ease of movement, conducts the infiltration. This increases the commander's control, speeds the execution of the infiltration, and provides responsive combat power. The commander determines the exact size and number of infiltrating elements, based on the situation.

1-43. The commander considers the following factors when determining how to organize available forces. Smaller infiltrating elements are not as easy to detect as larger elements and can get through smaller defensive gaps. Even the detection of one or two small elements by the enemy may not prevent the unit from accomplishing its mission. Larger infiltrating elements are easier to detect, and their discovery is more apt to endanger the success of the mission. Also, they require larger gaps to move through. A unit with many smaller infiltrating elements requires more time to complete the infiltration and needs more linkup points than a similar sized unit with only a few infiltrating elements. Many, smaller infiltrating elements are also harder to control than fewer, larger elements.

1-44. If resources allow, the commander designates security forces that move ahead of, to the flanks of, and to the rear of each infiltrating element's main body. These security forces can be given either a screen or a guard mission. (FM 3-90-2 discusses screen and guard missions.) The commander determines the sizes and orientations of security elements based on the situation. Each infiltrating element is responsible for its own reconnaissance effort.

1-45. Sustainment of an infiltrating force normally depends on the force's basic load of supplies and those medical and maintenance assets accompanying the infiltrating force. After completing the mission, the commander reopens LOCs to conduct normal sustainment operations.

Control Measures

1-46. Control measures for an infiltration include, as a minimum—

- An AO for the infiltrating unit.
- One or more infiltration lanes.
- A line of departure (LD) or point of departure (PD).
- Movement routes with their associated start points (SPs) and release points (RPs), or a direction or axis of attack.
- Linkup or rally points, including objective rally points.
- Assault positions.
- One or more objectives.
- A limit of advance (LOA).

The commander can impose other measures to control the infiltration including checkpoints, PLs, and assault positions on the flank or rear of enemy positions. If it is not necessary for the entire infiltrating unit to reassemble to accomplish its mission, the objective may be broken into smaller objectives. Each infiltrating element would then move directly to its objective to conduct operations. The following paragraphs describe using an infiltration lane and a linkup point.

1-47. **An infiltration lane is a control measure that coordinates forward and lateral movement of infiltrating units and fixes fire planning responsibilities.** The commander selects infiltration lanes that avoid the enemy, provide cover and concealment, and facilitate navigation. Figure 1-6 depicts the graphic for an infiltration lane. Each unit assigned an infiltration lane picks its own routes within the lane and switches routes as necessary. The left and right limits of the infiltration lane act as lateral boundaries for the unit conducting the infiltration. Attacks by rotary- or fixed-wing aircraft, indirect fires, or munitions effects that impact the lane must be coordinated with the infiltrating unit. Units leaving their assigned lane run the risk of being hit by friendly fires. Company-sized units are normally assigned a single infiltration lane, although they can use more than one lane. Larger organizations, battalion and above, are always assigned more than one infiltration lane.

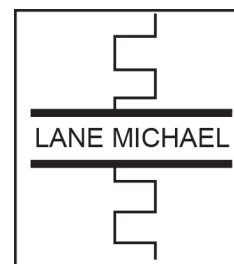

Figure 1-6. Infiltration lane

1-48. **A linkup point is where two infiltrating elements in the same or different infiltration lanes are scheduled to meet to consolidate before proceeding on with their missions.** Figure 1-7 on page 1-12 depicts linkup point 8. A linkup point is normally positioned behind or along one flank of the enemy's positions. It should be large enough for all infiltrating elements to assemble, and it should offer cover and concealment for these elements. It should be an easily identifiable point on the ground. The commander

should position linkup points on defensible terrain located away from normal enemy troop movement routes.

Planning an Infiltration

1-49. The activities and functions associated with the process of planning an infiltration are the same as with any other offensive task. That planning takes advantage of that unit's stealth capabilities to surprise the enemy. The planning process synchronizes the warfighting functions that support the infiltrating unit, especially precise, high-resolution intelligence. Without precise, detailed intelligence, infiltration maneuvers become high-risk probing operations that can be costly and time-consuming. Careful planning, full reconnaissance and surveillance integration, detailed analysis, and aggressive operations security can permit an infiltrating force to avoid an enemy force, minimize direct contact, and maximize surprise according to the commander's intent.

1-50. After identifying gaps or weaknesses in the enemy's defensive positions, the commander assigns infiltration lanes, contact points, and objectives to subordinate units. These objectives afford the infiltrating force positions of greatest advantage over the enemy and are not required to be to the geographic rear of the targeted enemy force. Each subordinate unit commander picks one or more routes within the assigned lane and establishes additional contact points, rally points, assault points, and other control measures as required. The commander wants each of the routes within an infiltration lane to be far enough apart to prevent an infiltrating element on one route from seeing other infiltrating elements, but close enough so that an infiltrating element could switch quickly to another route if required by the situation. The commander wants each route to provide infiltrating elements cover and concealment while avoiding known enemy and civilian locations and movement routes to the maximum extent possible. If possible, the subordinate unit commander selects the exact routes during the preparation phase after reconnoitering each infiltration lane. That subordinate decides whether the unit will infiltrate as a whole, in smaller elements, or even as two-man buddy teams, depending on the enemy density and strength.

1-51. The commander may use single or multiple infiltration lanes depending on the infiltrating force's size, the amount of detailed information on enemy dispositions and terrain accessible, time allowed, and number of lanes available. A single infiltration lane—

- Facilitates navigation, control, and reassembly.
- Requires the existence or creation of only one gap in the enemy's position.
- Reduces the area for which detailed intelligence is required.

1-52. Multiple infiltration lanes—

- Require the existence or creation of more gaps in the enemy's security area.
- Reduce the possibility of compromising the entire force.
- Increase difficulty with maintaining control.

1-53. The sizes and numbers of infiltrating elements are major considerations for the commander when deciding whether to use a single lane or multiple infiltration lanes. If the infiltration takes place using multiple elements, contingency plans must address the following situations:

- A lead element, possibly the advance guard, makes contact, but the trail elements have not started infiltrating.
- A lead element infiltrates successfully, but compromises one or more trailing elements.
- A compromised linkup point.

1-54. The commander uses available technology to assist in planning the infiltration and avoiding unintended enemy and civilian contact during the infiltration. This can be as simple as all units using the same infiltrating lane being on the same frequency to facilitate the avoidance of enemy contact. An accurate depiction of enemy systems and locations, tied to rapid terrain analysis, can graphically depict dead spots in the enemy's battlefield surveillance. The commander can then plan how to expand those existing dead spots into infiltration lanes through a precision attack on selected enemy elements and systems.

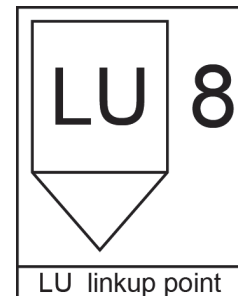

Figure 1-7. Linkup point 8

1-55. The plan also addresses the following considerations:

- Availability of supporting fires, including rotary- and fixed-wing aircraft and non-lethal fires—especially electronic warfare, throughout the operation, during infiltration and the attack on the objective.
- Linkup or extraction of the infiltrating unit after mission completion.
- Sustainment of the infiltrating force during the operation, to include casualty evacuation.
- Military deception operations, such as actions by other units designed to divert enemy attention from the area selected for the infiltration.
- Linkup of the various infiltrating elements.
- Mission command or control procedures, to include recognition signals.
- Positioning of combat vehicles to support the infiltrating elements.
- Using limited visibility and rough terrain to mask movement and reduce the chance of detection.
- Infiltration of the largest elements possible to maintain control.
- Rehearsals.
- Specially required preparations, such as modifying the unit's SOP regarding the Soldier's combat load for the mission. When infiltrating on foot, units carry only required equipment. For example, in close terrain and in the absence of an armor threat, heavy anti-armor missile systems may be a liability.
- Abort criteria.
- Critical friendly zones.

1-56. Planned recognition signals and linkup procedures for the infiltration should be simple and quick. If there has not been any firing or any other noises, signals should not violate noise and light discipline. However, if there have already been assaults, artillery, and small-arms fire, signals, such as whistles and flares, can be used as linkup aids. A lack of time and the short distance involved in many infiltration operations may make conducting formal linkup procedures unnecessary.

Preparing an Infiltration

1-57. Once the commander selects the objective, infiltration lanes, and linkup or rally points, the commander directs reconnaissance and surveillance operations to update and confirm the details on which the plan is based. Friendly reconnaissance and surveillance assets identify enemy sensors and surveillance systems. The commander then revises the plan to reflect current conditions within the AO.

Executing an Infiltration

1-58. Moving undetected during an infiltration requires a considerable amount of time. The infiltrating unit moves from its assembly area (AA) or current position through the start point and then continues moving along the infiltration route to a release point. If buddy teams or small elements are conducting the infiltration, the unit uses a series of linkup points to reassemble into a coherent unit. Units can use a variety of navigation aids, such as a global positioning system (GPS), to remain within the planned infiltration lane, which minimizes their chances of detection by the enemy. At the same time, they report their progress and status using communications systems that provide this information automatically to all command nodes which require this information.

1-59. If the complete unit is conducting the infiltration, the forward security force begins its movement first, followed by the main body. The distance between the forward security force and the main body depends on the mission variables of METT-TC. The advance guard must be far enough ahead of the main body so that it can either deploy or move to another route if the forward security force discovers the enemy. The forward security force in an infiltration must have enough time to move in a stealthy and secure manner. Enemy units should not be able to move undetected in the gap between the forward security force and the main body.

1-60. As the infiltrating unit moves, the advance guard reports to the commander regarding the cover and concealment of each route, enemy activity, location of danger areas and linkup points, enemy activity on the objective, and other combat information. The unit attempts to avoid enemy and civilian contact;

however, contact does not always mean the mission is compromised. The infiltrating unit engages targets first with indirect fires to avoid revealing its presence and exact location. These fires include the conduct of inform and influence activities and cyber electromagnetic tasks designed to blind enemy reconnaissance and surveillance assets and prevent the enemy from coordinating an effective response to the infiltration.

1-61. If necessary, the forward security force conducts actions on contact while the main body moves to another route, reconstitutes a forward security force, and continues the mission. If the main body makes contact unexpectedly, it either overruns the enemy force, if the enemy has little combat power, or bypasses the encountered enemy force and continues the mission. During the infiltration, the unit ignores ineffective enemy fire and continues to move. The commander may use suppressive fires against the enemy to cover the sounds of the infiltration or to divert the enemy's attention to areas other than where the infiltration lanes are located.

1-62. The infiltrating unit's elements move to an AA or an objective rally point to consolidate their combat power, refine the plan, and conduct any last-minute coordination before continuing the mission. The unit then conducts those tasks needed to accomplish its mission, which could be an attack, raid, ambush, seizing key terrain, capturing prisoners, or collecting specific combat information.

1-63. A commander may need to abort an infiltration operation if the mission variables of METT-TC change so drastically during the infiltration that the infiltrating force is no longer capable of accomplishing its mission. Examples of changes that might trigger such an action include—

- Significant portions of the infiltrating force's combat power are lost through navigation errors, enemy action, accidents, or maintenance failures.
- Movement or significant reinforcement of a force-oriented objective.
- Detection of the infiltration by the enemy.
- Changes in the tactical situation that make the mission no longer appropriate, such as the initiation of an enemy attack.

The criteria for aborting the operation are developed in the planning process. The decision to abort the infiltration is transmitted to all appropriate headquarters for their action and information.

PENETRATION

1-64. A **penetration** is a form of maneuver in which an attacking force seeks to rupture enemy defenses on a narrow front to disrupt the defensive system. Destroying the continuity of that defense allows the enemy's subsequent isolation and defeat in detail by exploiting friendly forces. The penetration extends from the enemy's security area through main defensive positions into the enemy support area. A commander employs a penetration when there is no assailable flank, enemy defenses are overextended and weak spots are detected in the enemy's positions, or time pressures do not permit envelopment.

Organization of Forces

1-65. Penetrating a well-organized position requires overwhelming combat power in the area of penetration and combat superiority to continue the momentum of the attack. (See figure 1-8.) The commander designates a breach, support, and assault force. These elements should be designated for each defensive position the force is required to penetrate. The commander should not withhold combat power from the initial penetration to conduct additional penetration unless there is so much combat power available that the success of the initial penetration is ensured.

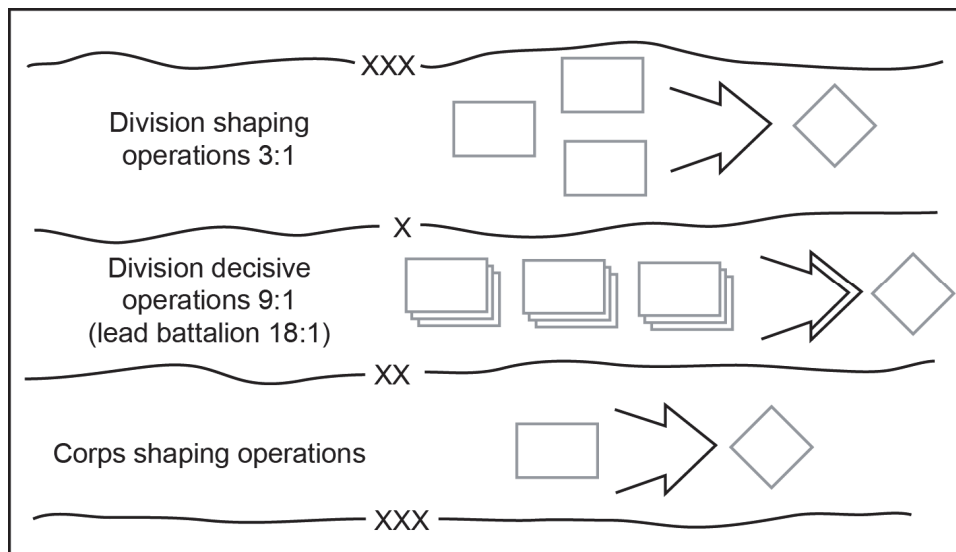

Figure 1-8. Penetration: relative combat power

1-66. The commander resources a reserve to address expected or unexpected contingencies, such as an enemy counterattack, to avoid diverting the assault element from attacking the final objective of the penetration. The commander designates additional units missions of follow-and-support or follow-and-assume to ensure rapid exploitation of initial success. The commander designates forces to fix enemy reserves in their current locations and isolate enemy forces within the area selected for penetration.

Control Measures

1-67. A commander assigns, as a minimum, an AO to every maneuver unit, a LD or line of contact (LC); time of the attack or time of assault; phase lines; objective; and a LOA to control and synchronize the attack. (A commander can use a battle handover line instead of a LOA if the commander knows where the likely commitment of a follow-and-assume force will occur.) The lateral boundaries of the unit making the decisive operation are narrowly drawn to help establish the overwhelming combat power necessary at the area of penetration. The commander locates the LOA beyond the enemy's main defensive position to ensure completing the breach. If the operation results in opportunities to exploit success and pursue a beaten enemy, the commander adjusts existing boundaries to accommodate the new situation. (See figure 1-9 on page 1-16.)

1-68. A commander uses the graphics associated with breaching operations, such as points of breach and lanes, on the small-scale maps used to control the maneuver of subordinate forces at each point where they penetrate the enemy's defenses.

1-69. Other control measures available to the commander include checkpoints, support by fire and attack by fire positions, probable line of deployment, fire support coordination measures, attack position, assault position, and time of assault. Within the unit's AO, a commander can use either an axis of advance or a direction of attack to further control maneuver.

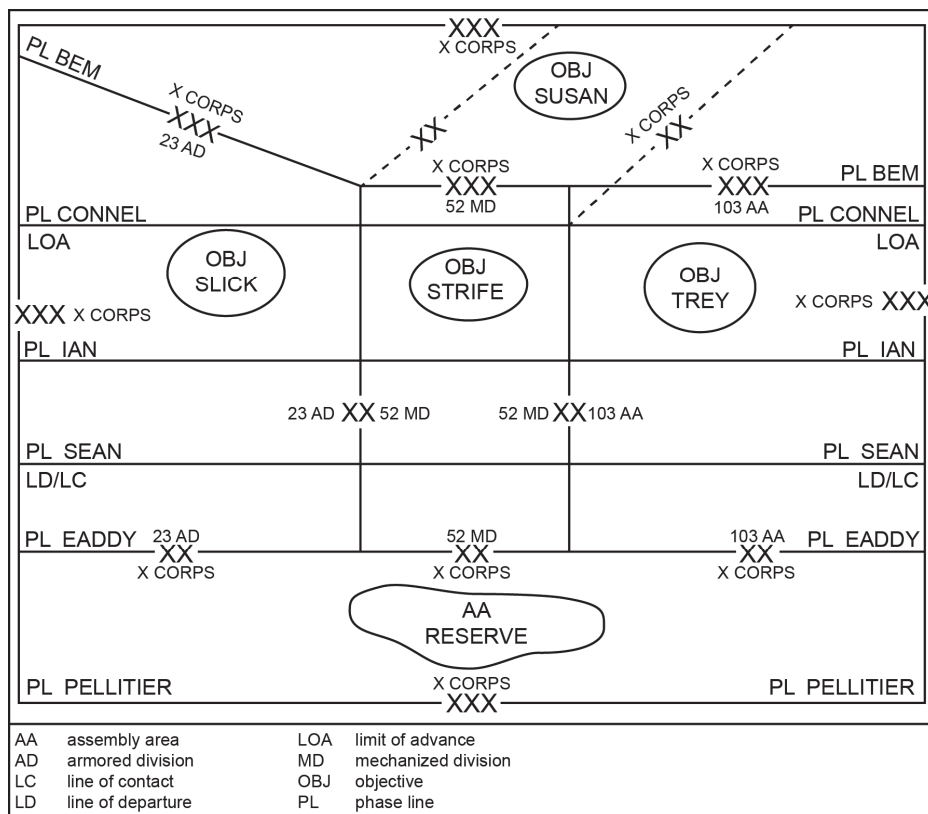

Figure 1-9. Penetration: minimum graphic control measures

Planning a Penetration

1-70. The success of the penetration depends primarily on a coordinated and synchronized plan—violently executed at a high tempo—against comparatively weak enemy defenses. However, the terrain behind the area selected to penetrate must allow the penetration to proceed from the breach to a decisive objective.

1-71. The depth of the enemy position and the relative strength of attacking echelons determine the width of the penetration. The availability of artillery, air support, and other combat multipliers for the attacking force helps the commander determine relative combat power. A wider gap allows friendly forces to drive deeper, making it more difficult for the enemy to close the gap. The deeper the penetration, the easier it is for a unit to seize its objective and roll up the enemy's flanks exposed by the breach and the less likely it is that the enemy will be in a position to restore the enemy's front by falling back.

1-72. Plans for penetrating a defensive position include isolating, suppressing, and destroying by fire enemy forces in the area selected for the penetration. These plans should also address how to isolate the area of penetration from support or reinforcement by enemy forces located outside the area. This consideration includes how to fix enemy reserves and long-range weapons in their current locations. Positioning friendly assets so that the commander can mass the effects of their combat power to accomplish these results without giving away the location of the penetration is also a critical part of the plan.

1-73. The commander plans to place the majority of forces and assets in positions where the effects of their combat power can be felt in the area selected for penetration. The commander's plan for the penetration normally has three phases:

- Breaching the enemy's main defensive positions.
- Widening the gap created to secure the penetration's flanks.
- Seizing the objective and subsequently exploiting the success of the penetration.

1-74. Planning the sequence of these phases depends on the specific situation. In some situations, if there are weaknesses or gaps in the enemy's front, it is possible for armored forces to breach the enemy's defenses and proceed straight to the objective. Simultaneously, light infantry units could conduct local envelopment and exploitation operations. In other situations, the commander uses light infantry forces to create the breach, holding armored or Stryker-equipped forces initially in reserve to exploit gaps in the enemy's defenses created by those light forces.

1-75. The commander plans shaping operations outside the area of penetration to contain the enemy on the flanks of the penetration and fix enemy reserves in their current locations. Synchronizing the effects of rotary- and fixed-wing aircraft, artillery fires, and obscuration smoke to delay or disrupt repositioning forces is an example of such shaping operations. These shaping operations will involve the maintenance of operations security and the conduct of military deception operations. The commander usually attempts to penetrate the enemy's defensive positions along enemy unit boundaries because defenses tend to be less effective along a boundary.

1-76. The commander's plans should address penetrating through the enemy's defensive positions in enough depth so the enemy is unable to reestablish a viable defense on more rearward positions. Until this event takes place, the commander does not want to divert the strength of attacking units to widening the gap to secure the flanks of the penetration. However, plans do address contingencies, such as hostile counterattacks against the penetration's flanks. The plan should provide assistance to attacking elements as they close with the enemy and support the attack until the enemy's power of resistance is broken.

Executing a Penetration

1-77. After the initial breach of the enemy's main line of resistance, the sequence of the remaining two phases is determined by the situation. If the enemy is in a weak position, it may be possible for the lead attacking force to seize the penetration's final objective while simultaneously widening the initial breach.

Breaching the Enemy's Main Defensive Positions

1-78. The commander launches the actual penetration on a relatively narrow front. (See figure 1-10 on page 1-18.) The commander narrows the AO of the unit or units conducting the decisive operation—the penetration—by adjusting unit lateral boundaries to the exact point or points where the commander wants to penetrate the enemy's defenses. This allows the force conducting the penetration to focus overwhelming combat power at that location. The commander assigns the assault force a close-in objective. The support force locates where it can support by fire both the breach and the assault forces. The reconnaissance squadron conducts a shaping operation by occupying support by fire position BOB. Local reserves, in this case the 2nd Combined Arms Battalion (CAB) given a follow and assume mission, are held in readiness to conduct a forward passage through or around units whose attacks have slowed or stopped.

1-79. Shaping operations focused on the remainder of the hostile front fix enemy forces in their current positions and prevent them from disengaging to reinforce enemy units opposing the decisive operation. The commander tracks the battle's progress to ensure that subordinate forces penetrate entirely through the enemy's main defensive positions and not just the enemy's security area.

1-80. The enemy normally tries to slow down or stop the breach to gain time to react to the changing situation. Therefore, the attacking commander rapidly exploits and reinforces success. The attacker masses resources and additional units as necessary to ensure completing the penetration through the enemy's defensive positions. The attacker also employs electronic warfare and military deception operations to desynchronize the enemy's reaction to the friendly breach.

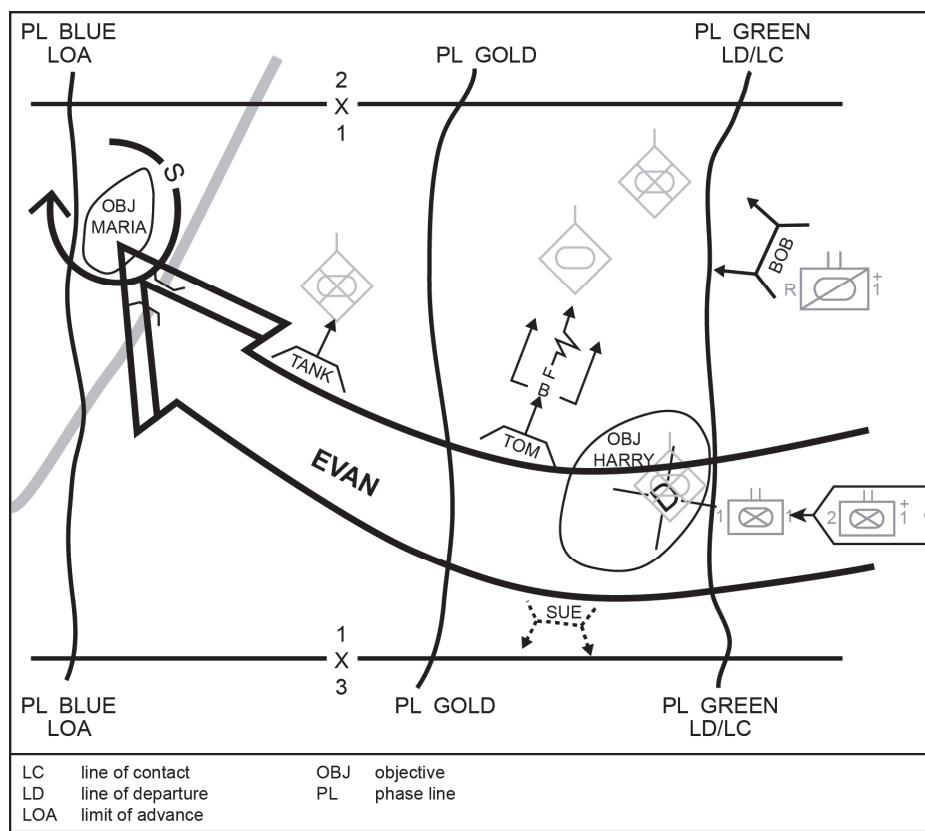

Figure 1-10. The penetration

Widening the Breach to Secure the Flanks

1-81. Once the attacking force penetrates the main defenses, it begins to widen the penetration of the enemy's defensive positions by conducting a series of shallow envelopments or attacks by fire to roll back its shoulders. (See figure 1-11.) The task of widening the initial gap of the penetration is normally assigned to a follow-and-support force. In the example in figure 1-11, this is the 2nd CAB. That task can also be assigned to the reserve as a contingency mission. If the commander commits the reserve to accomplish that task, a reserve must be reconstituted from another part of the force. Alternatively, the commander may assume the risk of not having a reserve for the time necessary to accomplish this task. The commander makes plans to meet enemy counterattacks by shifting fires or committing reserves or follow-and-assume forces. Units can use obstacles on the flanks of the penetration as a combat multiplier to assist in defeating any local enemy counterattack and to provide additional security for the force.

Seizing the Objective and Subsequent Exploitation

1-82. The decisive operation after completing the penetration is the seizing of the objective, destroying the continuity of the enemy's defensive position. This may entail the destruction of a specific enemy force. Frequently that objective is so far from the area of penetration that the unit or units initially conducting the penetration cannot seize it without a pause. In that case, the commander plans to pass the reserve or follow-and-assume forces through the initial attacking force early, leaving exploitation beyond the objective to higher echelons. While the exact force mix depends on the mission variables of METT-TC, armored, mechanized, and aviation forces are generally suited for subsequent exploitation. However, in the scenario depicted in figure 1-12 on page 1-20 the initially attacking 2nd CAB is able to secure the objective.

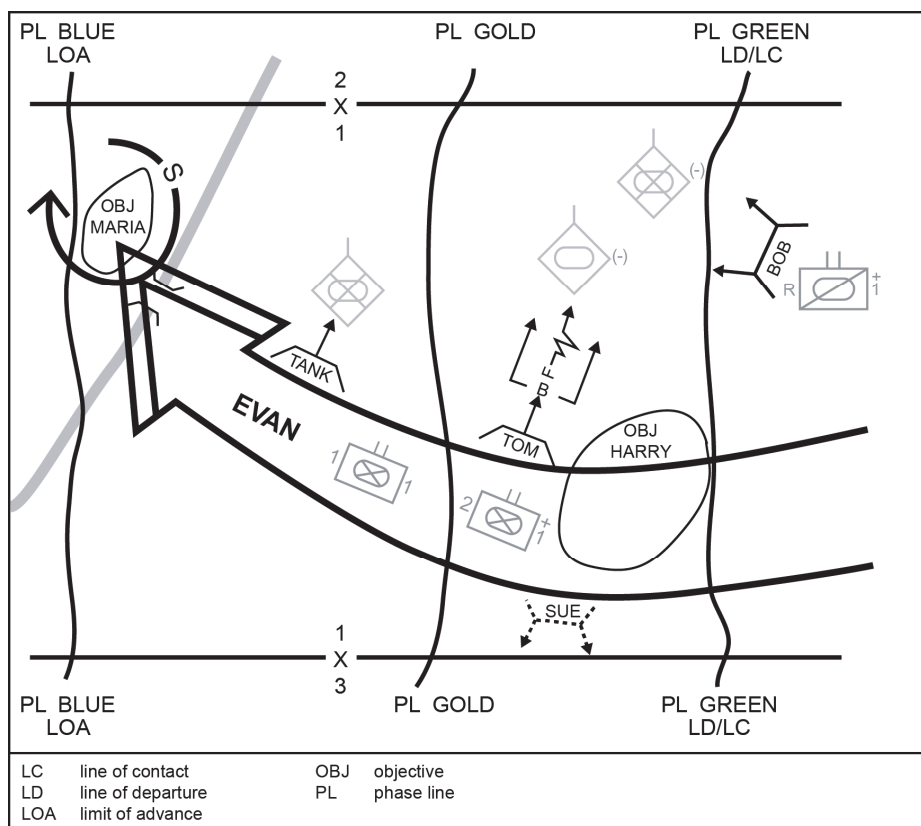

Figure 1-11. Widening the breach to secure the flanks

1-83. In large commands, forces may initiate an attack by simultaneously launching two or more convergent penetrations against weak localities on the hostile front. Often this method of attack helps isolate an extremely strong, hostile defense. The commander assigns shaping operations to initially contain any strong localities. When the multiple attacks have advanced sufficiently, the force reduces bypassed enemy forces and unites the penetrating attacks into a single decisive operation.

FRONTAL ATTACK

1-84. A *frontal attack* is a form of maneuver in which an attacking force seeks to destroy a weaker enemy force or fix a larger enemy force in place over a broad front. At the tactical level, an attacking force can use a frontal attack to rapidly overrun a weak enemy force. A commander commonly uses a frontal attack as a shaping operation in conjunction with other forms of maneuver. A commander normally employs a frontal attack to—

- Clear enemy security forces.
- Overwhelm a shattered enemy during an exploitation or pursuit.
- Fix enemy forces in place as part of a shaping operation.
- Conduct a reconnaissance in force.

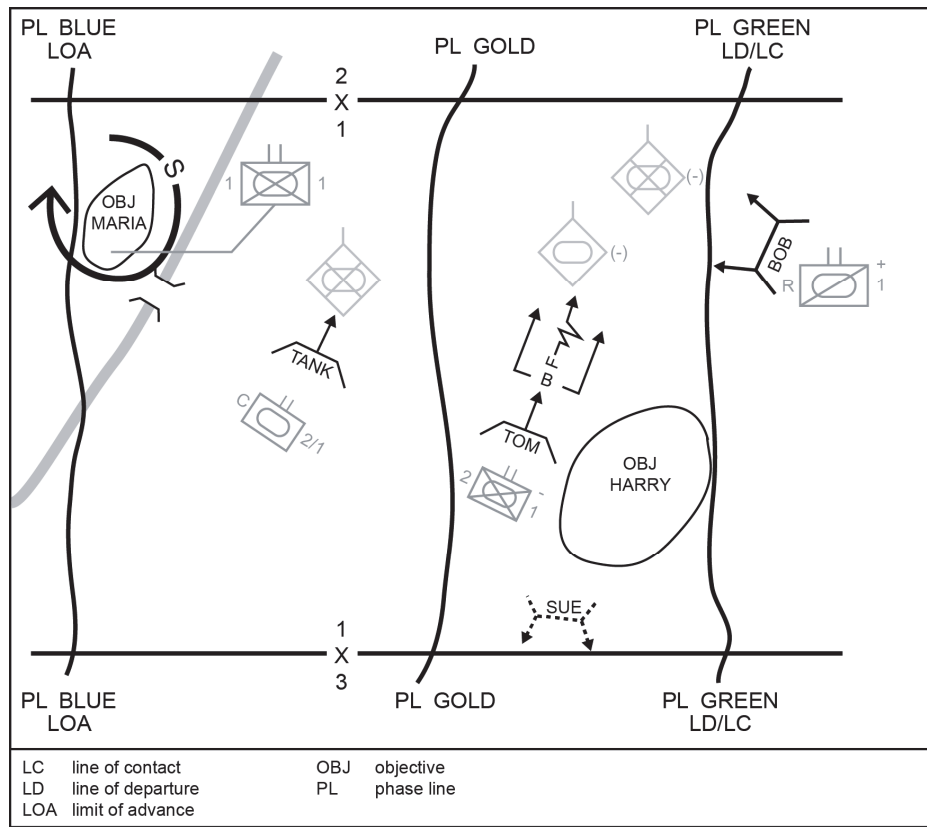

Figure 1-12. Seizing the objective

Figure 1-13 depicts a frontal attack.

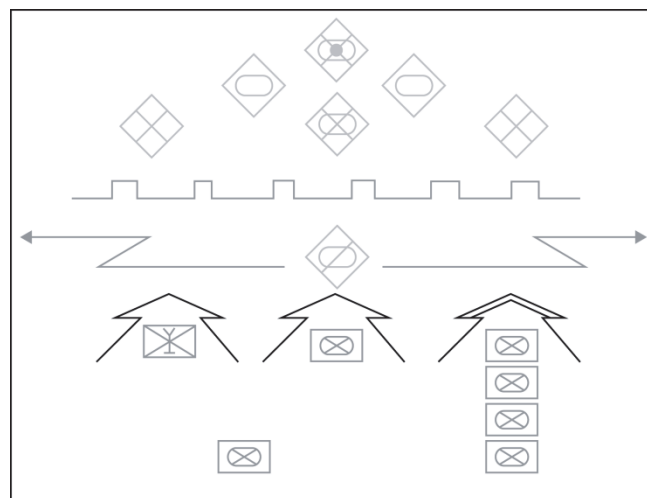

Figure 1-13. Frontal attack

1-85. It is also necessary to conduct a frontal attack when assailable flanks do not exist. Where a penetration is a sharp attack designed to rupture the enemy position, the commander designs a frontal attack to maintain continuous pressure along the entire front until either a breach occurs or the attacking forces succeed in pushing the enemy back. Frontal attacks conducted without overwhelming combat power are

seldom decisive. Consequently, the commander's choice to conduct a frontal attack in situations where the commander does not have overwhelming combat power is rarely justified unless the time gained is vital to the operation's success.

Organization of Forces

1-86. There is no unique organization of forces associated with this form of maneuver. A commander conducting a frontal attack organizes the unit into an element to conduct reconnaissance and security operations, a main body, and a reserve. The mission variables of METT-TC dictate the specific task organization of the unit.

Control Measures

1-87. A commander conducting a frontal attack may not require any additional control measures beyond those established to control the overall mission. This includes an AO, defined by unit boundaries, and an objective, at a minimum. The commander can also use any other control measure necessary to control the attack, including—

- Attack positions.
- Line of departure.
- Phase lines.
- Assault positions.
- Limit of advance.
- Direction of attack or axis of advance for every maneuver unit.

A unit conducting a frontal attack normally has a wider AO than a unit conducting a penetration.

Planning a Frontal Attack

1-88. It is seldom possible for a commander to exert sufficient pressure to overwhelm an enemy using a frontal attack, since it strikes the enemy along a significant portion of the enemy's front. The attacking force's primary objective is to maintain pressure and help fix the enemy force. The commander's planning effort should reflect these two considerations. When considering employing a frontal attack in a shaping operation, the commander should also consider other means for holding the enemy in position, such as feints and demonstrations employing indirect fires to preclude excessive losses.

Executing a Frontal Attack

1-89. The unit conducting a frontal attack advances on a broad front, normally with its subordinate ground maneuver elements abreast (except for the reserve). This clears the enemy's security area of enemy security forces and intelligence, reconnaissance, surveillance, and target acquisition assets while advancing the friendly force into the enemy's main defenses. Once the unit makes enemy contact, the attacking force's subordinate elements rapidly develop the situation and report enemy dispositions immediately to the commander, so the commander can direct the exploitation of enemy weaknesses. The attacking force fixes enemy forces in their current locations and seeks to gain positional advantage to destroy them using fire and movement.

1-90. If the attacking unit discovers a gap in the enemy's defenses, the commander seeks to exploit that weakness and disrupt the integrity of the enemy's defense. After assessing the situation to make sure that it is not a trap, the commander can employ the reserve to exploit the opportunity. The commander synchronizes the exploitation with the actions of other maneuver and functional and multifunctional support and sustainment units to prevent counterattacking enemy forces from isolating and destroying successful subordinate elements of the attacking friendly force.

1-91. When a unit conducting a frontal attack can no longer advance, it adopts a defensive posture. The commander may require it to assist the forward passage of lines of other units. It continues to perform reconnaissance of enemy positions to locate gaps or assailable flanks.

FLANK ATTACK

1-92. A **flank attack** is a form of offensive maneuver directed at the flank of an enemy. (See figure 1-14.) A flank is the right or left side of a military formation and is not oriented toward the enemy. It is usually not as strong in terms of forces or fires as is the front of a military formation. A flank may be created by the attacker through the use of fires or by a successful penetration. A flanking attack is similar to an envelopment but generally conducted on a shallower axis. It is designed to defeat the enemy force while minimizing the effect of the enemy's frontally-oriented combat power. Flanking attacks are normally conducted with the main effort directed at the flank of the enemy. Usually, a supporting effort engages the enemy's front by fire and maneuver while the main effort maneuvers to attack the enemy's flank. This supporting effort diverts the enemy's attention from the threatened flank. It is often used for a hasty attack or meeting engagement where speed and simplicity are paramount to maintaining battle tempo and, ultimately, the initiative.

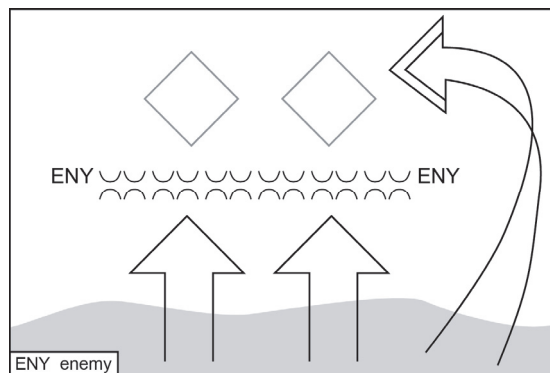

Figure 1-14. Flank attack

1-93. The primary difference between a flank attack and an envelopment is one of depth. A flank attack is an envelopment delivered squarely on the enemy's flank. Conversely, an envelopment is an attack delivered beyond the enemy's flank and into the enemy's support areas, but short of the depth associated with a turning movement.

1-94. Just as there is a relationship between unit size and the ability of a friendly force to execute a turning movement instead of an envelopment, this relationship extends downward between an envelopment and a flank attack. Corps and divisions are the most likely echelons to conduct turning movements. Divisions and brigade combat teams (BCTs) are the echelons most likely to conduct envelopments—single or double. Smaller-sized tactical units, such as maneuver battalions, companies, and platoons, are more likely to conduct flank attacks than larger tactical units. This is largely a result of troop-to-space ratios and sustainment and mission command constraints.

1-95. For these reasons, the organization of forces, control measures, and conduct—planning, preparation, execution, and assessment—considerations associated with a flank attack are similar to those addressed in the envelopment discussion in paragraphs 1-11 to 1-23. The primary difference between these forms of maneuver is which portion of the enemy position is attacked.

COMMON OFFENSIVE PLANNING CONSIDERATIONS

1-96. Understanding, visualizing, describing, and directing are aspects of leadership common to all commanders. The tactical commander begins with a designated AO, identified mission, and available forces. The commander develops and issues planning guidance based on the commander's visualization in terms of the physical means to accomplish the mission.

1-97. The offense is basic to combat operations. Only a resolute offense, conducted at a high tempo and to great depth, attains the enemy's total destruction. The offense has a number of indisputable advantages. The attacker's principal advantage is possession of the initiative. Having the initiative allows a commander to select the time, place, and specific tactics, techniques, and procedures used by the attacking force. The attacker has the time and opportunity to develop a plan and to concentrate the effects of subordinate forces and thoroughly prepare conditions for success when the commander has the initiative. The commander strikes the enemy in unexpected ways at unexpected times and places. The commander focuses on attacking the right combination of targets, not necessarily the biggest or the closest. These attacks are rapidly executed, violently executed, unpredictable in nature, and they disorient the enemy. They enhance the commander's capability to impose the commander's will on the enemy and thus to achieve decisive victory.

1-98. The commander maintains momentum by rapidly following up attacks to prevent enemy recovery. The attacking commander denies the enemy commander any opportunity to adjust to friendly actions in spite of the enemy's desperate attempts to do so. The commander changes the attacking force's means and methods before the enemy can adapt to those in current use. The tempo of friendly operations must be fast enough to prevent effective counteraction. The commander synchronizes unrelenting pressure by adjusting combinations to meet the offensive's ever-changing demands. The attacking force maintains relentless pressure and exploits gains to make temporary battlefield success permanent.

1-99. Each battle or engagement, even those occurring simultaneously as a part of the same campaign, has its own unique peculiarities, determined by the actual conditions of the situation. The widespread application of highly accurate and lethal weapons, high degree of tactical mobility, dynamic nature, rapid situational changes, and the noncontiguous and large spatial scope of unit AOs all characterize contemporary combined arms warfare. The commander first able to see the battlefield, understand the implications of existing friendly and enemy dispositions, and take effective action to impose the commander's will on the situation will enjoy tactical success. The planning considerations for the offense in paragraphs 1-101 through 1-204 below also apply to the defense with situationally appropriate modifications.

1-100. The following discussion uses those physical means—Soldiers, organizations, and equipment—that constitute the six warfighting functions defined in ADRP 3-0 as the framework for discussing planning considerations that apply to all primary and subordinate offensive tasks.

MISSION COMMAND

1-101. Commanders, assisted by their staffs, integrate numerous processes and activities within the headquarters and across the force as they exercise mission command. The commander's mission and intent determine the scheme of maneuver and the allocation of available resources. Paragraphs 1-102 through 1-115 highlight the importance of the operations process and team development during the conduct of offensive tasks. The other mission command warfighting function tasks occur, but they do not require emphasis here. (See mission command doctrine for a discussion of the other mission command warfighting function tasks.)

Operations Process

1-102. Commanders drive the operations process through their activities of understanding, visualizing, describing, directing, leading, and assessing the conduct of the primary offensive task. If few resources are available, the commander reduces the scope of the initial mission. For example, a commander could tell subordinates to clear their AOs of all enemy platoon-sized and larger forces instead of clearing their areas of operations of all enemy forces, if those subordinates lack the time or forces needed to accomplish the latter task.

1-103. All offensive planning addresses the mission variables of METT-TC, with special emphasis on—

- Missions and objectives, to include task and purpose, for each subordinate element.
- Commander's intent.
- Enemy positions, obstacles, strengths, and capabilities.
- AOs for the use of each subordinate element with associated control measures.
- Time the operation is to begin.
- Scheme of maneuver.
- Targeting guidance and high-payoff targets.
- Special tasks required to accomplish the mission.
- Risk.
- Options for accomplishing the mission.

Planning also addresses the prevention of unnecessary damage to property and disruption of the civilian population within the area of operations.

1-104. The commander and staff translate the unit's mission into specific objectives for all subordinates, to include the reserve. These objectives can involve any type or form of operations. If the type of operation assigned has associated forms, the commander may specify which form to use, but should minimize restrictions on subordinate freedom of action. ADRP 5-0 addresses the military decisionmaking process.

1-105. Synchronizing the six warfighting functions through prior planning and preparation increases a unit's effectiveness when executing operations. However, the fluid nature of combat requires the commander to guide the actions of subordinates during the execution phase. Commanders determine where they can best sense the flow of the operation to influence critical events through the redirecting the effects of committed forces, changing priorities or support, or employing echelon reserves. This normally means that the commander is well forward in the echelon's combat formation, usually with the force designated to conduct the decisive operation. Once the unit conducting the decisive operations makes contact with the enemy, the commander quickly moves to the area of contact, assesses the situation, and directs appropriate aggressive actions to direct the continuation of offensive tasks.

1-106. The commander anticipates any requirements to shift the main effort during the offensive to press the battle and keep the enemy off balance. The commander develops decision points to support these changes using both human and technical means to validate decision points.

1-107. In addition to assigning objectives and identifying decision points, commanders at all echelons consider how to exploit advantages that arise during operations and the seizure of intermediate and final objectives. The commander exploits success by aggressively executing the plan, taking advantage of junior leader initiative, and employing trained units capable of rapidly executing standard drills. The echelon reserve also provides a flexible capability to exploit unforeseen advantages.

1-108. The commander always seeks to surprise opponents throughout the operation. Military deception and the choice of an unexpected direction or time for conducting offensive tasks can result in the enemy being surprised. Surprise delays enemy reactions, overloads and confuses enemy command and control (C2), induces psychological shock, and reduces the coherence of the enemy's defenses. Tactical surprise is more difficult to achieve once hostilities begin, but it is still possible. The commander achieves tactical surprise by attacking in bad weather and over seemingly impassible terrain, conducting feints and demonstrations, making rapid changes in tempo, and employing sound operations security (OPSEC) measures.

1-109. The commander retains the capability to rapidly concentrate force effects, such as fires, throughout the extent of the AO during the conduct of offensive tasks. This capability is also critical to the commander when subordinate forces cross linear obstacles. Lanes and gaps resulting from combined arms breaching operations or occurring naturally typically are choke points. There is a tendency for each subordinate element to move out independently as it completes its passage through the choke point. This independent movement detracts from the ability of the whole force to rapidly concentrate combat power on the far side of an obstacle.

1-110. The commander briefs the plan and the plans of adjacent units and higher echelons to unit leaders and the unit's Soldiers. This helps units and individual Soldiers moving into unexpected locations to direct their efforts toward accomplishing the mission. This exchange of information occurs in all operations.

1-111. The commander maintains communications and a free flow of information between all units throughout the offense. The commander plans how to position and reposition information systems to maintain a common operational picture throughout the operation. That common operational picture requires timely and frequent updates of relevant information from the lowest tactical echelons upwards, particularly information on the disposition and activities of friendly and enemy forces, if it is going to aid the commander in maintaining situational awareness. The commander plans how to expand the communications coverage to accommodate increased distances as the unit advances. Accordingly, the commander provides for redundant communication means—including wire, radio, visible and ultraviolet light, heat, smoke, audible sound, messengers, and event-oriented communications, such as the casualty-producing device that initiates an ambush.

1-112. A unit with advanced information systems and automated decision aids enjoys reduced engagement times and an enhanced planning process. This improves the unit commander's ability to control the tempo of the battle and stay within the enemy's decisionmaking cycle. Greatly improved knowledge of the enemy

and friendly situations facilitates the tactical employment of precision fires and decisive maneuver at extended ranges. These digital systems also enhance the commander's freedom to move to those battlefield locations that best enable the commander's ability to influence the battle or engagement at the critical time and place.

Team Development Between Commanders

1-113. Generally, commanders rely on others to follow and execute their intent. Turning their visualization of the offense into reality takes the combined efforts of many teams inside and outside the organization. Commanders build solid, effective teams by developing and training them. As part of the commander's task of team development, the commander has the authority to organize assigned or attached forces to best accomplish the mission based on the commander's concept of operations. The commander task organizes subordinate units as necessary, assigns responsibilities, establishes or delegates appropriate command and support relationships, and establishes coordinating instructions. Sound organization provides for unity of effort, centralized planning, and decentralized execution. Unity of effort is necessary for effectiveness and efficiency. Centralized planning is essential for controlling and coordinating the efforts of the forces. When organizing Army forces with multinational forces, simplicity and clarity are critical.

1-114. Subordinates work hard and fight tenaciously when they are well trained and sense that they are part of a first-rate team. Collective confidence comes from succeeding under challenging and stressful conditions, beginning in training before deployment. A sense of belonging derives from experiencing technical and tactical proficiency—first as individuals and later collectively. That proficiency expresses itself in the confidence team members have in their peers and their leaders. Many times that sense of belonging is enhanced by the conduct of social activities. Those social activities have to be tailored to the audience. What will motivate and inspire young Soldiers and junior noncommissioned officers may not have the same impact on field grade officers and senior noncommissioned officers. Ultimately, cohesive teams are the desired result. Effective organizations work as teams in synchronized ways to complete tasks and missions.

1-115. Successful delegation of authority involves convincing subordinates that they are empowered and have the freedom to act independently. This only comes from the subordinates' experience with the commander. Empowered subordinates understand that they bear more than the responsibility to get the job done. They have the authority to operate as they see fit, within the limits of commander's intent, missions, task organization, and available resources. This helps them lead their people with determination.

MOVEMENT AND MANEUVER

1-116. The commander maneuvers to avoid enemy strengths and to create opportunities to increase the effects of friendly fires. The commander secures surprise by making unexpected maneuvers, rapidly changing the tempo of ongoing operations, avoiding observation, and using deceptive techniques and procedures. The commander seeks to overwhelm the enemy with one or more unexpected blows before the enemy has time to react in an organized fashion. This occurs when the attacking force is able to engage the defending enemy force from positions that place the attacking force in a position of advantage with respect to the defending enemy force, such as engaging the enemy from a flanking position. Echelon security forces prevent the enemy from discovering friendly dispositions, capabilities, and intentions, or interfering with the preparations for the attack. Finally, the commander maneuvers to close with and destroy the enemy by close combat and shock effect. *Close combat* is warfare carried out on land in a direct-fire fight, supported by direct and indirect fires and other assets (ADRP 3-0). Close combat defeats or destroys enemy forces, or seizes and retains ground. Close combat encompasses all actions that place friendly forces in immediate contact with the enemy where the commander uses direct fire and movement in combination to defeat or destroy enemy forces or seize and retain ground.

1-117. A commander can overwhelm an enemy by the early seizing and retaining of key and decisive terrain that provides dominating observation, cover and concealment, and better fields of fire to facilitate the maneuver of friendly forces. *Key terrain* is any locality, or area, the seizure or retention of which affords a marked advantage to either combatant (JP 2-01.3). **Decisive terrain, when present, is key terrain whose seizure and retention is mandatory for successful mission accomplishment.** If decisive terrain is present, the commander designates it to communicate its importance in the commander's concept of

operations, first to the echelon staff and later to subordinate commanders. The friendly force must control decisive terrain to successfully accomplish its mission.

Combat Formations

1-118. A *combat formation* is an ordered arrangement of forces for a specific purpose and describes the general configuration of a unit on the ground (ADRP 3-90). A commander can use seven different combat formations depending on the mission variables of METT-TC: column, line, echelon (left or right), box, diamond, wedge, and vee. Terrain characteristics and visibility determine the actual arrangement and location of the unit's personnel and vehicles within a given formation.

1-119. Combat formations allow a unit to move on the battlefield in a posture suited to the senior commander's intent and mission. A unit may employ a series of combat formations during the course of an attack; each has its advantages and disadvantages. Subordinate units within a combat formation can also employ their own combat formations, consistent with their particular situation. The commander considers the advantages and disadvantages of each formation in the areas of mission command, maintenance, firepower orientation, ability to mass fires, and flexibility when determining the appropriate formation for a given situation. All combat formations use one or more of the three movement techniques: traveling, traveling overwatch, and bounding overwatch. (FM 3-90-2 describes these three movement techniques.)

1-120. The commander's use of standard formations allows the unit to rapidly shift from one formation to another, giving additional flexibility when adjusting to changes in the mission variables of METT-TC. (This results from a commander rehearsing subordinates so that they can change formations using standard responses to changing situations, such as actions on contact.) By designating the combat formation planned for use, the commander—

- Establishes the geographic relationship between units.
- Indicates probable reactions once the enemy makes contact with the formation.
- Indicates the level of security desired.
- Establishes the preponderant orientation of subordinate weapon systems.
- Postures friendly forces for the attack.

The number of maneuver units available makes some formations, such as the box and the diamond, impractical for modular armored and infantry brigade combat teams, unless they are task organized with additional maneuver forces.

Column

1-121. The *column formation* is a combat formation in which elements are placed one behind another. The unit moves in column formation when the commander does not anticipate early contact, the objective is distant, and speed and control are critical. (Figure 1-15 illustrates an armored brigade combat team [ABCT] in battalion column.) The location of fire support units within the column reflects the column's length and the range fans of those fire support systems. Normally, the lead element uses a traveling overwatch technique while the following units are in traveling formation. Employing a column formation—

- Provides the best formation to move large forces quickly, especially with limited routes and limited visibility.
- Makes enemy contact with a small part of the total force while facilitating control and allowing the commander to quickly mass forces.

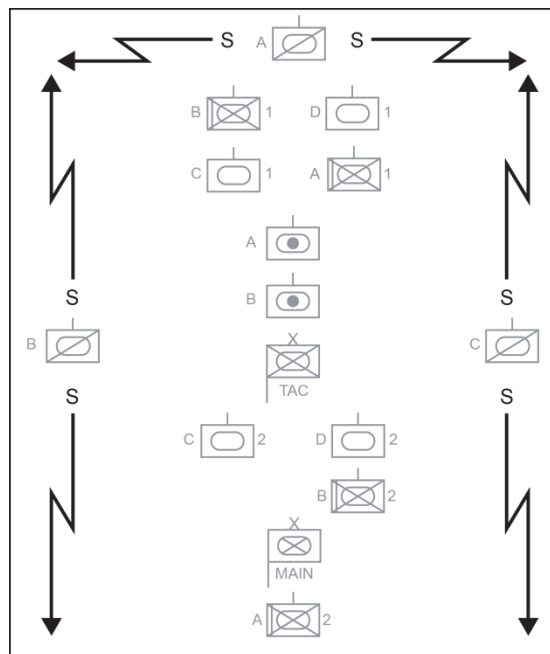

Figure 1-15. Armored brigade combat team in battalion column

- Provides a base for easy transition to other formations.
- Works in restricted terrain.

1-122. A disadvantage of using the column formation is that the majority of the column's firepower can only be immediately applied on the column's flanks. The length of the column impacts movement and terrain management. Additionally, there are the possibilities of inadvertently bypassing enemy units or positions and exposing the unit's flanks or running head on into an enemy deployed perpendicular to the column's direction of movement.

Line

1-123. In a *line formation*, the unit's subordinate ground maneuver elements move abreast of each other. (See figure 1-16.) A commander employs this formation when assaulting an objective because it concentrates firepower to the front in the direction of movement. A line formation also—

- Facilitates speed and shock in closing with an enemy.
- Allows the coverage of wide frontages.
- Facilitates the occupation of attack by fire or support by fire positions.

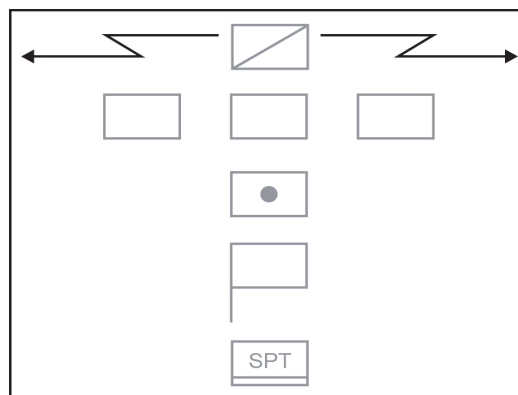

Figure 1-16. Line formation

1-124. There are also disadvantages of a line formation:

- Provides less flexibility of maneuver than other formations since it does not distribute units in depth.
- Linear deployment allows a unit deployed on line to bring only limited firepower to bear on either flank.
- Provides limited or no reserve.
- Limits overwatch forces.
- Limits control of a unit using a line formation in restricted terrain or under conditions of limited visibility.

Echelon

1-125. An *echelon formation* is a unit formation with subordinate elements arranged on an angle to the left or to the right of the direction of attack (echelon left, echelon right). This formation provides for firepower forward and to the flank of the direction of the echelon. It facilitates control in open areas. It provides minimal security to the opposite flank of the direction of the echeloning. A commander who has knowledge of potential enemy locations can use an echelon formation to deploy subordinate ground maneuver units diagonally left or right. (See figure 1-17 and figure 1-18 on page 1-28.) Units operating on the flank of a larger formation commonly use this formation. An echelon formation—

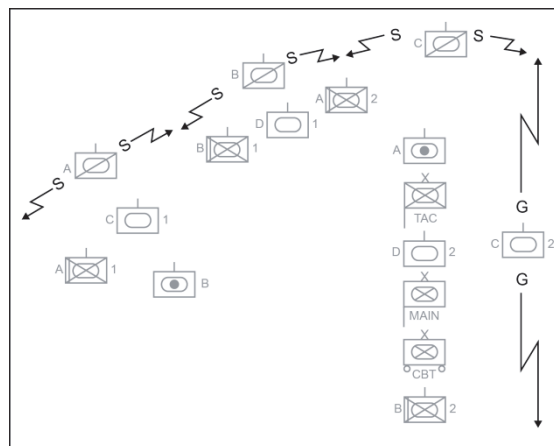

Figure 1-17. Armored brigade combat team in echelon left formation

- Facilitates control in open terrain.
- Allows the concentration of the unit's firepower forward and to the flank in the direction of echelon.

- Allows forces not in contact to maneuver against known enemy forces, because all elements will not simultaneously make contact.

1-126. There are two primary disadvantages of the echelon formation. First, it is more difficult to maintain control over the unit in restricted terrain than a column formation. Second, it lacks security or firepower on the opposite side of the echelon.

Box

1-127. The **box formation** is a unit formation with subordinate elements arranged in a box or square, or two elements up and two elements back. It is a flexible formation that provides equal firepower in all directions. It is generally used when the enemy location is known. This formation can cause 50 percent of the force to be decisively engaged at the same time, therefore limiting the combat power available to maneuver against an enemy. The box formation arranges the unit with two forward and two trail maneuver elements. (See figure 1-19.) A unit with only three maneuver elements, such as an ABCT or an infantry brigade combat team (IBCT) cannot adopt the box formation unless it is reinforced. The subordinate elements of the box usually move in a column formation with flank security. It is often used when executing an approach march, exploitation, or pursuit when the commander has only general knowledge about the enemy. Employing a box formation—

- Allows the unit to change quickly and easily to any other formation.
- Facilitates rapid movement, yet still provides all-around security.
- Provides firepower to the front and flanks.
- Maintains control more easily than a line formation.

1-128. The primary disadvantages of a box formation are that it requires sufficient maneuver space for dispersion and the availability of multiple routes. At the battalion and company level there also exists the possibility of enemy units massing on one element at a time as the other elements' direct fires are masked by other friendly forces.

Diamond Formation

1-129. A **diamond formation** is a variation of the box combat formation with one maneuver unit leading, maneuver units positioned on each flank, and the remaining maneuver unit to the rear. (See figure 1-20.) The subordinate elements

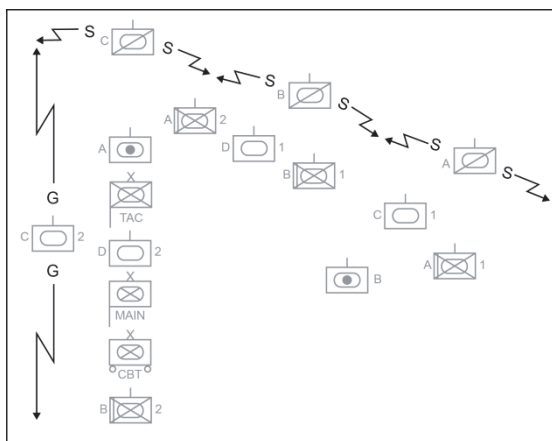

Figure 1-18. Armored brigade combat team in echelon right formation

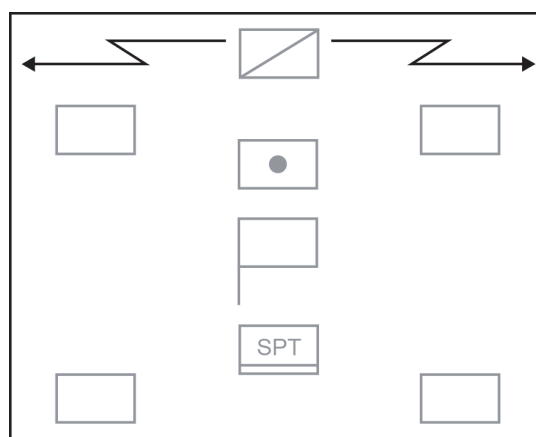

Figure 1-19. Box formation

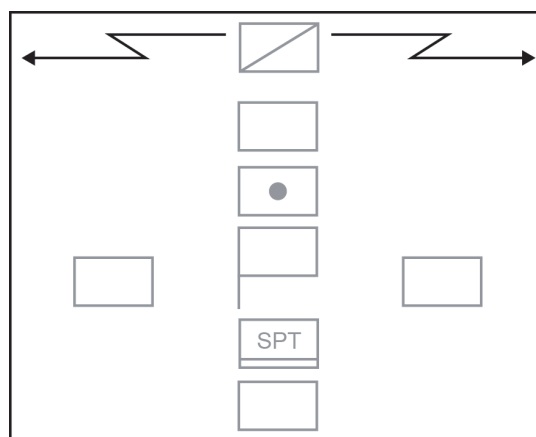

Figure 1-20. Diamond formation

of the diamond usually move in a column formation with flank security. It is most effective during approach marches, exploitations, or pursuits when the commander has only general knowledge about the enemy. Employing a diamond formation—

- Allows the commander to maneuver either left or right immediately, without first repositioning, regardless of which subordinate element makes contact with the enemy. (This is the chief advantage of and the difference between a diamond and a box formation.)
- Facilitates making enemy contact with the smallest possible force, yet provides all-around security.
- Provides firepower to the front and flanks.
- Changes easily and quickly to another formation.
- Facilitates speed of movement while remaining easy to control.
- Provides an uncommitted force for use as a reserve.

1-130. The primary disadvantages of this formation are that it—

- Requires sufficient space for dispersion laterally and in depth.
- Requires four subordinate maneuver elements.
- Requires the availability of multiple routes.

Wedge

1-131. The wedge formation arranges forces to attack an enemy appearing to the front and flanks. (See figure 1-21.) A unit with only three subordinate maneuver elements can adopt the wedge formation. The commander uses the wedge when contact with the enemy is possible or expected, but the enemy’s location and dispositions are vague. It is the preferred formation for a movement to contact in an organization with three subordinate maneuver units because it initiates contact with one unit while retaining two other subordinate uncommitted units positioned to maneuver and further develop the situation. Within the wedge, subordinate units employ the formation best suited to the terrain, visibility, and likelihood of contact. Employing a wedge formation—

- Provides maximum fire-power forward and allows a large portion of the unit’s firepower to be used on the flanks.
- Allows rapid crossing of open terrain when enemy contact is not expected.
- Facilitates control.
- Allows for rapid changes in the orientation of the force.
- Facilitates the rapid change to a line, vee, echelon, or column formation.

1-132. The primary disadvantages to the wedge formation are that it—

- Requires sufficient space for dispersion laterally and in depth.
- Requires the availability of multiple routes.
- Lacks ease of control in restricted terrain or poor visibility.

Vee

1-133. The vee formation disposes the unit with two maneuver elements abreast and one or more units trailing. (See figure 1-22 on page 1-30.) This arrangement is well suited for an advance against a known threat to the front. The commander may use this formation when expecting enemy contact and the enemy’s location and disposition is known. Employing a vee formation—

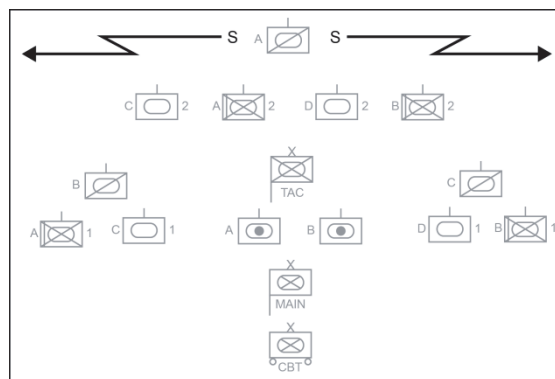

Figure 1-21. Wedge formation

- Provides maximum firepower forward and good firepower to the flanks, but the firepower on the flanks is less than that provided by the wedge.
- Facilitates a continued maneuver after contact is made and a rapid transition to the assault.
- Allows the unit to change quickly to a line, wedge, or column formation.

1-134. The primary disadvantages to this formation are that it—

- Makes reorientation of the direction of movement, such as a 90-degree turn, more difficult than using a wedge.
- Makes control in restricted terrain and under limited-visibility conditions difficult.
- Requires sufficient space for dispersion laterally and in depth.

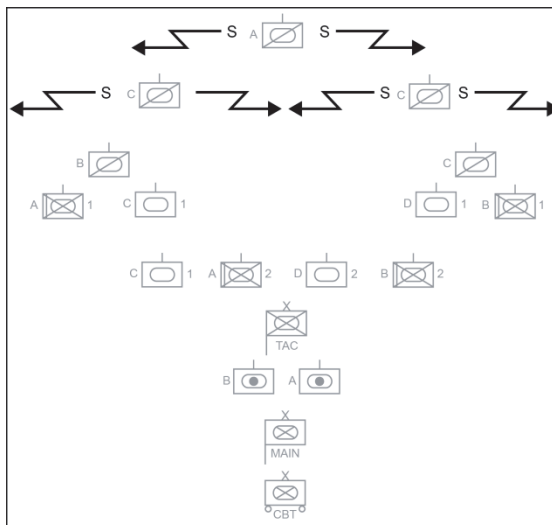

Figure 1-22. Armored brigade combat team in vee formation

Limited-Visibility Conditions

1-135. The capability to fight at night and under limited-visibility conditions is an important aspect of conducting maneuver. The conduct of operations during conditions of limited visibility operations should be actively considered given the U.S. military's current advantage in night vision devices. The commander conducts field training exercises under limited-visibility conditions to ensure that the unit has this capability. A commander conducts offensive actions at night or under limited-visibility conditions when a daylight operation continues into the night. Offensive actions conducted in these conditions can achieve surprise, gain terrain required for further operations, and negate enemy visual target acquisition capabilities while taking advantage of the friendly force's night-fighting capabilities.

1-136. All operations conducted in limited visibility or adverse weather require more planning and preparation time than normal. They require designating reference points and establishing navigation aids, such as GPS waypoints. The commander ensures that the night-vision and navigation systems required to maneuver under these conditions are available and functional. The commander rehearses these operations before execution to ensure complete integration and synchronization of the plan. Rehearsals also ensure that the Soldiers in subordinate units have the necessary skills to accomplish the mission. Any problem areas require resolution before beginning the operation.

1-137. Night operations degrade the capabilities of Soldiers and units. Cognitive abilities degrade more rapidly than physical strength and endurance. Night-vision devices degrade the user's depth perception. This degradation in performance occurs after as little as 18 hours of sustained work. (Additional information concerning the impact of extended operations on Soldiers and units can be found in FM 6-22.5.) The plan should allow time for both Soldiers and units to recuperate after conducting a night attack before being committed to other operations. The weight that Soldiers must carry also directly affects their endurance. The commander carefully determines the fighting load of the Soldiers in subordinate units, taking into account the mission variables of METT-TC. The fighting load of Soldiers conducting night operations should be limited. The equipment carried by Soldiers for extended periods should never exceed one-third of their body weight.

Soldiers' Load

1-138. The load that Soldiers carry is an important planning consideration. How much Soldiers carry, how far, and in what configuration are critical mission considerations requiring command emphasis and inspection. Historical experience and research shows that Soldiers can carry 30 percent of their body weight and retain much of their agility, stamina, alertness, and mobility. For the average Soldier, who

weighs 160 pounds, this means carrying 48 pounds. Success and survival in the offense demand that Soldiers retain these capabilities. If an attacking unit's Soldiers cannot move with stealth, agility, and alertness, the success of the mission is at risk. For each pound over 30 percent of body weight, the Soldier loses function. When the load exceeds 45 percent of body weight, or 72 pounds for the average Soldier, that individual's functional ability drops rapidly, and chances of becoming a casualty increase. Commanders must ensure that Soldiers carry no more than 30 percent of their body weight when in contact, or when contact is expected. At other times, the Soldier's load should not exceed 72 pounds. Sometimes, conditions dictate that the Soldier's load must exceed this recommended weight. However, the commander and subordinate leaders must realize how that excess weight impacts unit effectiveness.

Assured Mobility

1-139. Assured mobility is a framework of processes, actions, and capabilities that assure the ability of a force to deploy, move, and maneuver where and when desired, without interruption or delay, to achieve the mission. The assured mobility fundamentals predict, detect, prevent, avoid, neutralize, and protect support the assured mobility framework. This framework is one means of enabling a force to achieve the commander's intent. Assured mobility emphasizes the conduct of proactive mobility, countermobility, and protection tasks in an integrated manner so as to increase the probability of mission accomplishment. While focused primarily on the movement and maneuver warfighting function, the assured mobility concept links to each warfighting function and both enables and is enabled by those functions. (See ATTP 3-90.4.)

Predict

1-140. Commanders and staffs must accurately predict potential obstacles to force mobility by analyzing the enemy's capabilities and tactics, techniques, and procedures. This involves understanding how the enemy will evolve in reaction to friendly force countermeasures. It also involves understanding how the effects of terrain and the effects of the population, such as vehicular traffic and dislocated civilians, will impact force mobility. This helps build the mobility portion of the common operational picture and facilitates decisionmaking.

Detect

1-141. Commanders and staffs use intelligence products and information collection assets to identify the location of natural and man-made obstacles and potential means the enemy can use to create obstacles. Commanders employ available information collection assets to detect enemy obstacle preparations and also identify areas where there are no or only limited obstacles to ground movement and maneuver. This knowledge can be obtained through sustained surveillance of an area. Commanders identify both actual and potential obstacles and propose solutions and alternate COAs to minimize or eliminate their potential impact.

Prevent

1-142. Commanders and staffs apply this fundamental by preventing civilian interference with operations and denying the enemy's ability to influence friendly mobility. This is accomplished by forces acting proactively to elicit local populace support, or at least non-interference, and to eliminate enemy countermobility capabilities before those capabilities can emplace or activate obstacles, and by mitigating the factors that result in natural obstacles to friendly force movement and maneuver. This may include the employment of information-related capabilities to decrease uncertainty among the population to build support for or acceptance of operations.

1-143. Prevention may also consist of aggressive action to destroy enemy assets and capabilities before they can be used to create obstacles. For example, this involved assigning high target priorities to Soviet UMZ (universal mine-layer) truck-mounted scatterable mine systems when planning for major combat operations during the Cold War. In recent operations this includes disrupting terrorist bomb-making cells by all available means, such as cutting off their funding, eliminating safe house where the bombs can be constructed, jamming frequencies to prevent remote detonators from being triggered, and either capturing or killing members of these cells. Forces also apply this fundamental by conducting countermobility operations to shape enemy movement and maneuver that may affect friendly movement and maneuver.

This includes denying the enemy the ability and opportunity to attack critical infrastructure that supports mobility, such as airfields, roads, and bridges; or that could result in an obstacle; or have an obstacle effect if destroyed, such as dams and industrial chemical production and storage facilities.

Avoid

1-144. If prevention fails, the commander will move or maneuver forces to avoid impediments to mobility, if this is viable within the scheme of maneuver. If friendly information collection efforts and intelligence analysis can tell the commander where the enemy has not been, this frees up the unit to maneuver rapidly through those areas, even if they are not the most favorable movement routes.

Neutralize

1-145. Commanders and staffs plan to neutralize, reduce, or overcome obstacles and impediments as soon as possible to allow unrestricted movement of forces. The specific tactics, techniques, and procedures employed will depend of the mission variables of METT-TC, rules of engagement, and where along the joint range of military operations the unit finds itself. For example, a small unit involved in major operations encountering surface-laid mines on a road in an urban area might attempt to destroy the mines in place using organic methods, such as aimed rifle or machinegun fire, after only minimal checks to reduce the danger to local civilians and accepting collateral damage to civilian buildings before proceeding on with its mission. That same unit encountering the same situation during the conduct of a peace keeping operation would more likely secure the site, evacuate civilians from the area, and call for an explosive ordnance disposal team to disarm the mines in place to preclude any collateral damage.

Protect

1-146. Commanders and staffs plan and implement survivability and other protection measures that will prevent observation of the maneuvering force and thereby reduce the enemy's ability to engage or otherwise interfere with that force. This includes the use of combat formations and movement techniques. It may involve the use of electronic warfare systems—such as counter-radio controlled improvised explosive device electronic warfare (CREW) systems, mine plows and rollers, and modifications to the rules of engagements. This may also include the conduct of countermobility missions to deny the enemy the capability to maneuver in certain directions and thereby provide additional protection to friendly maneuvering forces. It can also be as simple as altering patrol routes.

1-147. While engineers are the principal staff integrators for assured mobility, other staff sections play critical roles in ensuring the effective application and integration of mobility, countermobility, and protection tasks. In the case of amphibious operations, this would include naval forces that are responsible for assured mobility from amphibious shipping to beach and landing zone exits. These critical roles include providing information on threats to the routes. The senior engineer staff officer's role within assured mobility is similar to the role of the assistant chief of staff, intelligence (G-2) or the intelligence staff officer's (S-2) integrating role in the intelligence preparation of the battlefield process. Ultimately, assured mobility is the commander's responsibility. (See engineer doctrine on assured mobility for more information.)

Mobility

1-148. *Mobility* is a quality or capability of military forces which permits them to move from place to place while retaining the ability to fulfill their primary mission (JP 3-17). *Mobility operations* are those combined arms activities that mitigate the effects of natural and man-made obstacles to enable freedom of movement and maneuver (ATTP 3-90.4). They include obstacle reduction by maneuver and engineer units to reduce or negate the effects of existing or reinforcing obstacles. The objective is to maintain freedom of movement for maneuver units, weapon systems, and critical supplies. Mobility operations include these six primary tasks:

- Breaching operations.
- Clearing operations (areas and routes).
- Gap-crossing operations.

- Combat roads and trails.
- Forward airfields and landing zones.
- Traffic operations.

1-149. Mobility is necessary for the conduct of successful offensive tasks. Its major focus is to enable friendly forces to move and maneuver freely on the battlefield. The commander seeks the capability to move, exploit, and pursue the enemy across a wide front. When attacking, the commander concentrates the effects of combat power at selected locations. This may require the unit to improve or construct combat trails through areas where routes do not exist. The surprise achieved by attacking through an area believed to be impassable may justify the effort and time expended in constructing these trails. The force bypasses existing obstacles and minefields identified before starting the offensive task instead of breaching them whenever possible. Units mark bypassed minefields whenever the mission variables of METT-TC allow.

1-150. Maintaining the momentum of the offense requires the attacking force to quickly pass through obstacles as it encounters them. There is a deliberate effort to capture bridges, beach and port exits, and other enemy reserved obstacles intact. The use of amphibious, air assault, and airborne forces is an effective technique to accomplish this goal. The preferred method of fighting through a defended obstacle is employing a hasty (in-stride) breach, because it avoids the loss of time and momentum associated with conducting a deliberate breach. The commander plans how and where subordinate forces conduct breaching operations. Commanders plan breaching operations using a reverse planning sequence from the objective back to the assembly area.

1-151. Rivers and other gaps remain major obstacles despite advances in high-mobility weapon systems and extensive aviation support. Wet gap crossings are among the most critical, complex, and vulnerable combined arms operations. A crossing is conducted as a hasty crossing and as a continuation of the attack whenever possible because the time needed to prepare for a gap crossing allows the enemy more time to strengthen the defense. The size of the gap, as well as the enemy and friendly situations, will dictate the specific tactics, techniques, and procedures used in conducting the crossing. Functional engineer brigades contain the majority of tactical bridging assets. Military police and chemical, biological, radiological, and nuclear (CBRN) assets may also be required.

1-152. Clearing operations are conducted to eliminate the enemy's obstacle effort or residual obstacles within an assigned area or along a specified route. A clearing operation is a mobility operation, and, as with most mobility operations, it is typically performed by a combined arms force built around an engineer-based clearing force. A clearing operation could be conducted as a single mission to open or reopen a route or area, or it may be conducted on a recurring basis in support of efforts to defeat a sustained threat to a critical route. (See Maneuver Support Center of Excellence doctrine, tactics, and procedures for more information on clearing operations. This includes discussions of route clearance and its role within the improvised explosive device [IED] defeat framework.)

Countermobility

1-153. *Countermobility operations* are those combined arms activities that use or enhance the effects of natural and man-made obstacles to deny an adversary freedom of movement and maneuver (FM 3-34). Countermobility operations help isolate the battlefield and protect the attacking force from enemy counterattack, even though force mobility in offensive actions normally has first priority. Obstacles provide security for friendly forces as the fight progresses into the depth of the enemy's defenses. They provide flank protection and deny the enemy counterattack routes. They assist friendly forces in defeating the enemy in detail and can be vital in reducing the amount of forces required to secure a given area. Further, they can permit the concentration of forces by allowing a relatively small force to defend a large AO. The commander ensures the use of obstacles is integrated with fires and fully synchronized with the concept of operations to avoid hindering the attacking force's mobility.

1-154. During visualization, the commander identifies avenues of approach that offer natural flank protection to an attacking force, such as rivers or ridgelines. Staff running estimates support this process. Flanks are protected by destroying bridges, emplacing minefields, and by using scatterable mines to interdict roads and trails. Swamps, canals, lakes, forests, and escarpments are natural terrain features that can be quickly reinforced for flank security.

1-155. Countermobility operations during the offense must stress rapid emplacement and flexibility. Engineer support must keep pace with advancing maneuver forces and be prepared to emplace obstacles alongside them. Obstacles are employed to maximize the effects of restrictive terrain, such as choke points, or deny the usefulness of key terrain, since time and resources will not permit developing the terrain's full defensive potential. The commander first considers likely enemy reactions and then plans how to block enemy avenues of approach or withdrawal with obstacles. The commander also plans the use of obstacles to contain bypassed enemy elements and prevent the enemy from withdrawing. The plan includes obstacles to use on identification of the enemy's counterattack. Speed and interdiction capabilities are vital characteristics of the obstacles employed. The commander directs the planning for air- and artillery-delivered munitions on enemy counterattack routes. The fire support system delivers these munitions in front of or on top of enemy lead elements once they commit to one of the routes. Rapid cratering devices and surface minefields provide other excellent capabilities.

1-156. Control of mines and obstacles and accurate reporting to all units are vital. Obstacles will hinder both friendly and enemy maneuver. Control of obstacle initiation is necessary to prevent the premature activation of minefields and obstacles. (See Maneuver Support Center of Excellence doctrine, tactics, techniques, and procedures for information on obstacle integration and mine warfare.)

INTELLIGENCE

1-157. The task generate intelligence knowledge is a continuous, user-defined task driven by the commander. It begins before mission receipt and provides the relevant knowledge required regarding the operational environment for the conduct of operations. The information and intelligence obtained are refined into knowledge for use in intelligence preparation of the battlefield (IPB) and mission analysis. Information is obtained through intelligence reach, research, data mining, database access, academic studies, products, or materials, intelligence archives, open-source intelligence (OSINT), and other information sources.

1-158. A commander uses the products of the IPB process to identify any aspect within the AO or area of interest that will affect how the friendly force accomplishes the mission. An *area of interest* is that area of concern to the commander, including the area of influence, areas adjacent thereto, and extending into enemy territory. This area also includes areas occupied by enemy forces who could jeopardize the accomplishment of the mission (JP 3-0).

1-159. The entire staff, led by the echelon intelligence staff, uses the IPB process to identify any aspects of the area of operations or area of interest that will affect enemy, friendly, and third party operations. The IPB process is collaborative in nature and requires information from all staff elements and some subordinate units. All staff and subordinate elements use the results and products of the IPB process for planning. FM 2-01.3 describes the IPB process.

1-160. The commander uses available reconnaissance and surveillance assets to study the terrain and confirm or deny the enemy's strengths, dispositions, and likely intentions, especially where and in what strength the enemy will defend. Indications of the location and composition of obstacles and the positioning of engineer assets may be key in determining where and when the enemy will defend. These assets also gather information concerning the civilian population within the AO to confirm or deny their numbers, locations, and likely intentions, especially with regard to staying in shelters or fleeing from combat operations.

1-161. By studying the terrain, the commander tries to determine the principal heavy and light avenues of approach to the objective. The commander also tries to determine the most advantageous area for the enemy's main defense, routes that the enemy may use to conduct counterattacks, and other factors, such as observation and fields of fire, avenues of approach, key terrain, obstacles, and cover and concealment (OAKOC). The attacking unit must continuously conduct reconnaissance and surveillance for intelligence collection during the battle because it is unlikely that the commander has complete knowledge of the enemy's intentions and actions.

1-162. The echelon intelligence and operations officers, in coordination with the rest of the staff, develop a synchronized and integrated reconnaissance and surveillance plan that satisfies the commander's maneuver,

targeting, and information requirements. A commander's information requirements are dictated by the mission variables of METT-TC, but commonly include—

- Locations, composition, equipment, strengths, and weaknesses of the enemy force, to include high-priority targets and enemy reconnaissance and surveillance capabilities.
- Locations of obstacles, prepared fighting positions, enemy engineer units, earth moving equipment, breaching assets, and barrier material.
- Probable locations of enemy reconnaissance objectives.
- Locations of possible enemy assembly areas.
- Locations of enemy indirect-fire weapon systems and units.
- Locations of gaps, assailable flanks, and other enemy weaknesses.
- Locations of areas for friendly and enemy air assault and parachute assault operations.
- Locations of enemy air defense gun and missile units and air defense radars.
- Locations of enemy electronic warfare units.
- Effects of weather and terrain on current and projected operations.
- Areas, structures, capabilities, organizations, people, and events (ASCOPE) related information about civilians located within the unit's area of operations.
- Likely withdrawal routes for enemy forces.
- Anticipated timetable schedules for the enemy's most likely COA and other probable COAs.
- Locations of enemy command and control and intelligence nodes and reconnaissance and surveillance systems and the frequencies used by the information systems linking these systems.
- Locations of enemy sustainment assets.

If friendly reconnaissance and surveillance assets cannot answer the commander's information requirements, the echelon intelligence staff can send a request for information to higher and adjacent units, the commander can commit additional resources, or the commander can decide to execute the offense with the current information.

1-163. The IPB process contributes to the protection warfighting function by developing products that help the commander protect subordinate forces, including identification of key terrain features, man-made and natural obstacles, trafficability and cross-country mobility analysis, line of sight overlays, and situation templates. Line of sight overlays help protect the force. If an enemy cannot observe the friendly force, the enemy cannot engage the friendly force with direct-fire weapons. Situation templates also help protect the force. If a commander knows how fast an enemy force can respond to the unit's offensive actions, unit operations can be sequenced, so they occur at times and places where the enemy cannot respond effectively. This occurs through determining enemy artillery range fans, movement times between enemy reserve assembly area locations and advancing friendly forces, and other related intelligence items.

FIRES

1-164. The targeting process ensures the coordinated use of indirect fires, air and missile defense, and joint fires to gain and maintain fire superiority throughout all offensive actions. (The joint community regards air and missile defense as a protection function.) The commander uses a variety of methods and assets to achieve the desired effects on targeted enemy forces and thereby to enable friendly maneuver.

Army Indirect Fires and Joint Fires

1-165. Using preparation fires, counterfire, suppression fires, and electronic warfare assets provides the commander with numerous options for gaining and maintaining fire superiority. The commander uses long-range artillery systems (cannon and rocket, naval surface fire support, and air support—rotary and fixed wing) to engage the enemy throughout the depth of the enemy's defensive positions.

1-166. A U.S. Air Force (USAF) tactical air control party (TACP) is co-located with the fires cell at the BCT and fires brigade main command posts. The USAF air liaison officer (ALO) leading the TACP is the BCT and fires brigade commanders' principal advisor on air support. The ALO leverages the expertise of the TACP with linkages to higher echelon TACPs to plan, prepare, execute, and assess air support for

brigade operations. The ALO also maintains situational understanding of the total air support picture. The brigade's aligned TACP is resourced to support brigade operations from that unit's tactical command post as well as the main command post. The TACP's joint terminal attack controllers may be assisted by joint fires observers. Joint fires observers may assist joint terminal attack controllers in the conduct of type 2 or 3 close air support (CAS).

1-167. Fire support planning is the continuing process of analyzing, allocating, and scheduling fires. It determines how fires are used, what types of targets to attack, what collection assets are used to acquire and track those targets, what assets are used to attack the target, and what assets verify effects on the target. This planning does not stop at the objective or LOA. The commander gives attention to flanks and potential enemy hide positions. Coordination among echelon fire cells and the proper use of fire support coordination measures are critical to prevent fratricide. A commander plans to employ available fires to delay or neutralize repositioning enemy forces to include enemy reserves. Fires are planned to support the unit's reconnaissance and breaching or penetration efforts. They are also used to suppress, neutralize, or destroy those enemy forces and systems that can most affect the unit's closure on the objective. Triggers for the initiation, shifting, and lifting of preparatory fires are established that reflect the mission variables of METT-TC.

1-168. The fire support coordinator (FSCOORD) or chief of fires (depending on the echelon) integrates fires into the unit's scheme of maneuver for the commander. The FSCOORD or chief of fires supports the unit's maneuver by planning preparation fires, harassing fires, interdiction fires, suppressive fires, and destruction fires, and deception fires. These fires can be time- or event-driven. The FSCOORD or chief of fires plans fires on known and likely enemy positions, which may include templated enemy positions. Successful massing of indirect fires and fixed-wing attacks requires a fire cell that is proficient in the tracking of friendly indirect fire asset positions and movements and knows the maximum ordinate requirements. It also requires a TACP proficient in the timely execution of close air support. Fire planning reconciles top-down planning and bottom-up refinement.

1-169. As the attacking force moves forward, preparatory fires sequentially neutralize, suppress, or destroy enemy positions. However, the commander must weigh the probable effects of preparation fires against achieving a greater degree of surprise against the enemy, especially under conditions of limited visibility, in determining whether to fire an artillery preparation. The commander may decide to employ terminally guided munitions to destroy select high-payoff targets or use these munitions in mass against part of the enemy defense to facilitate a breach and negate the requirement for long-duration preparation fires using area fire munitions.

1-170. The commander may choose to make the initial assault without using preparation fires to achieve tactical surprise. However, fires are always planned to support each unit's operations, so that they are available if needed. Preparation fires are normally high-volume fires delivered over a short period of time to maximize surprise and shock effect. These preparatory fires also include the conduct of electronic warfare operations. They can continue while ground maneuver elements are moving. This consideration applies to the conduct of all offensive tasks.

1-171. Artillery and mortars must occupy positions that are well forward and still within supporting range of the flanks of maneuver forces to provide responsive indirect fires. The commander considers the effect that movement by echelon or battery has on the amount of fire support provided. The commander should support the unit's decisive operation with priority of fires. The main effort before the initiation of the decisive operation will have priority of fires, if the operation contains phases. The commander places coordinated fire lines (CFLs) as close as possible to friendly maneuver forces and plans on-order CFLs on phase lines so that they can be quickly shifted as the force moves. This allows the expeditious engagement of targets beyond the CFL by the maximum number of available systems. Critical friendly zones (CFZs) are established to protect critical actions, such as support-by-fire positions and breaching efforts.

1-172. The effective assignment of Army forward observers, joint forward observers, and target acquisition assets to quick-fire or exclusive nets also provides responsive fires. Quick-fire nets allow the lead observers to associate directly with specific field artillery or mortar fire units. These kinds of communication arrangements enhance responsiveness through streamlined net structures and focused priorities. Communications planning should also include the need for communication nets for the clearing of targets for rotary- and fixed-wing attacks.

1-173. The commander employs information capabilities to support the offense. As the friendly force moves through the enemy's security area and closes into the enemy's main defensive positions, electronic warfare jamming resources concentrate on neutralizing enemy fire control, target acquisition, and intelligence-gathering systems. The commander uses military deception to prevent the enemy from determining the location and objective of the friendly decisive operation. In addition, intelligence sensors continue to provide intelligence and guidance to both friendly jammers and lethal indirect fire weapon systems, so attacking units can destroy enemy command and control nodes, reconnaissance and surveillance assets, artillery, and other high-value targets. The commander synchronizes the timing and conduct of these offensive actions so they achieve maximum effectiveness.

Air and Missile Defense

1-174. A ground force's primary air defense systems are joint fighter aircraft, such as today's F-22 and F-18s, conducting offensive counter-air operations operated by the joint force air component commander (JFACC). During offensive actions, the commander directs the positioning of available organic or supporting radars in those locations where they can best initially support the unit's attack. The selection of those positions reflects a risk assessment designed to preclude their early loss to enemy action. The air defense airspace management (ADAM) element in the unit staff ensures that it has communications with the appropriate air and missile defense (AMD) organization's command post. That AMD command post will provide additional information to the supported unit to expand the fidelity of the air picture, to include information on the engagement of air threats by JFACC and Army Patriot air defense systems and short range air defense. The attacking unit concentrates on conducting passive air defense measures during its offensive actions. If attacked by enemy aerial systems in assembly areas, attack positions, or while moving, the unit disperses and conducts small arms air defense. The commander at each echelon establishes air defense priorities based on the concept of operations, scheme of maneuver, air situation, and the air defense priorities established by higher headquarters. If the commander has Army air defense systems in direct support of the attack, their coverage is generally weighted toward the unit's decisive operation or main effort and establishes a protective corridor over the terrain traversed by the subordinate unit or units conducting that operation. Command of all air defense assets requires complete and timely communications to ensure proper weapon status for the protection of friendly air support assets.

1-175. Passive air defense measures are an essential part of air and missile defense planning at all levels. All units conduct passive actions in conjunction with their missions. Passive actions reduce the effectiveness of the enemy air threat.

1-176. Targets selected to support echelon tactical air defense efforts include the following—

- Enemy unmanned aircraft systems.
- Enemy rotary- and fixed-wing aircraft.
- Facilities supporting enemy air operations, such as airfields, launch sites, logistics support facilities, technical support facilities, forward arming and refueling points, navigation aids, and aerial command and control sites or communications nodes.

These facilities are normally engaged by maneuver and fire support elements and not air defense artillery units. (See FM 3-01 for additional information on the use of active and passive air defense measures.)

SUSTAINMENT

1-177. The objective of sustainment in offensive actions is to assist the tactical commander in maintaining the momentum. The commander wants to take advantage of windows of opportunity and execute offensive tasks with minimum advance warning time. Therefore, sustainment—logistics, personnel, and health service support—planners and operators must anticipate these events and maintain the flexibility to support the offensive plan accordingly. A key to success in the offense is the ability to anticipate the requirement to push support forward, specifically in regard to ammunition, fuel, replacements, and water. Sustainment commanders must act, rather than react, to support requirements. The existence of habitual support relationships facilitates this ability to anticipate.

Logistics

1-178. Logistics maintains momentum of the attack by delivering supplies as far forward as possible. The commander can use throughput distribution and preplanned and preconfigured packages of essential items to help maintain offensive momentum and tempo. The commander examines the unit's basic load to determine its adequacy to support the operation. The commander determines the combat load, the supplies carried by individual Soldiers and combat vehicles. The unit's logistics load consists of what remains of the unit's basic load once the combat load is subtracted. Unit tactical vehicles carry the logistics load. The commander also determines the supplies required for likely contingencies. The commander determines the amount of cross-loading of supplies required by the situation to prevent all of one type of supply from being destroyed by the loss of a single system.

1-179. Logistics units and material remain close to the maneuver force to ensure short turnaround time for supplies and services. This includes uploading as much critical materiel—such as POL and ammunition—as possible and coordinating to preclude attempted occupation of a piece of terrain by more than one unit. The commander makes decisions regarding the risk that logistics preparations for the attack will be detected by enemy forces and give indications of the unit's tactical plans.

1-180. The availability of adequate supplies and transportation to sustain the operation becomes more critical as it progresses. Supply LOCs are strained, and requirements for repair and replacement of weapon systems increase. Requirements for POL increase because of the distance the combat vehicles of the maneuver force are likely to travel. Sustainment units in direct support of maneuver units must be as mobile as the forces they support. One way to provide continuous support is to task organize elements of sustainment units or complete sustainment units with their supported maneuver formations as required by the mission variables of METT-TC. ABCTs and IBCTs contain organic brigade support battalions and forward support companies for this reason.

1-181. The variety and complexity of offensive actions requires the commander to establish a flexible and tailorable transportation system. There may be a wide dispersion of forces and lengthening of LOCs. Required capabilities include movement control, in-transit visibility of supplies being carried, terminal operations, and mode operations.

1-182. Field maintenance assets move as far forward as consistent with the tactical situation to repair inoperable and damaged equipment and to return it to battle as quickly as possible. Crews continue to perform their preventive maintenance checks and services as modified for the climate and terrain in which they find themselves. Battle damage assessment and repair may be critical to sustaining offensive actions. Crews as well as maintenance and recovery teams conduct battle damage assessment and repair to rapidly return disabled equipment for battlefield service by expediently fixing, bypassing, or using field expedient components. Battle damage assessment and repair restores the minimum essential combat capabilities necessary to support a specific combat mission or to enable the equipment to self-recover.

1-183. Establishing aerial resupply and forward logistics bases may be necessary to sustain maneuver operations such as exploitation and pursuit conducted at great distances from the unit's sustaining base. The unit or support activity at the airlift's point of origin is responsible for obtaining the required packing, shipping, and sling-load equipment. It prepares the load for aerial transport, prepares the pickup zone, and conducts air-loading operations. The unit located at the airlift destination is responsible for preparing the landing zone to accommodate aerial resupply and for receiving the load.

1-184. Raids conducted by ground maneuver forces within the depths of the enemy's support areas tend to be audacious, rapid, and of short duration. Logistics support is minimal; units carry as much POL and ammunition as possible, taking advantage of any captured enemy supplies. Once the raiding force crosses its LD, only limited, emergency aerial resupply of critical supplies and medical evacuation are feasible because of the absence of a secure LOC. The commander must thoroughly plan for aerial resupply of the raiding force since it entails greater risk than normal operations. Under these conditions, units destroy damaged equipment that is unable to maintain the pace of the operation.

Health Service Support

1-185. The burden on medical resources increases due to the intensity of offensive actions and the increased distances over which support is required as the force advances. The commander reallocates medical resources as the tactical situation changes. Medical units can anticipate large numbers of casualties in a short period of time due to the capabilities of modern conventional weapons and the employment of weapons of mass destruction. These mass casualty situations can exceed the capabilities of organic and direct support medical assets to effectively treat the numbers of casualties being sustained. To prevent this from occurring, planners should anticipate this possibility and coordinate with area support medical units to help absorb the acute rise in battlefield injuries. Careful planning and coordination will ensure that the standard of medical care for injured Soldiers is not compromised. Effective management of mass casualty situations is dependent on established and rehearsed mass casualty plans and detailed medical planning. There are a number of other variables which can ensure the success of a unit's mass casualty response plan. These include, but are not limited to—

- Coordination and synchronization of additional medical support and or augmentation, such as medical evacuation support, forward resuscitative surgical intervention provided by forward surgical teams, and established Class VIII resupply.
- Quickly locating the injured and clearing them from the battlefield.
- Providing effective emergency medical treatment for the injured.
- Accurate triage and rapid medical evacuation of the injured to medical treatment facilities at the next higher role of care.

PROTECTION

1-186. The fluidity and rapid tempo of the offense pose challenges in the protection of friendly assets. The forward movement of subordinate units is critical to the commander's maintaining the initiative necessary for successful offensive actions. The commander denies the enemy a chance to plan, prepare, and execute an effective response to friendly offensive actions through maintaining a high tempo. This is a key way to ensure the survivability of the force. Techniques for maintaining a high offensive tempo include using multiple routes, dispersion, highly mobile forces, piecemeal destruction of isolated enemy forces, scheduled rotation and relief of forces before they culminate, and the wise use of terrain. The exact techniques employed in a specific situation must reflect the mission variables of METT-TC.

1-187. The commander protects subordinate forces to deny the enemy the capability to interfere with their ongoing operations. That protection also meets the commander's legal and moral obligations to the organization's Soldiers. To help protect the force, the commander ensures that all protection tasks are addressed during the unit's planning, preparation, and execution, while also constantly assessing the effectiveness of those protection tasks. Paragraphs 1-188 through 1-206 highlight areas of special emphasis within the protection warfighting function during the conduct of offensive tasks. (See ADRP 3-37 and medical doctrine for a complete discussion of all protection tasks.)

Personnel Recovery

1-188. Unit commanders and staff, subordinate leaders, and individual Soldiers are trained how to react to an isolating incident. This training includes the Code of Conduct and survival, evasion, resistance, and escape training. It stresses the five personnel recovery execution tasks: report, locate, support, recover, and reintegrate. Unit commanders ensure that assigned and attached personnel are familiar with the command's personnel recovery guidance and the isolated Soldier guidance for each mission. Unit commanders also should ensure that assigned and attached personnel are familiar with the key personnel recovery questions: "How do I know when I am isolated?" "What do I do about that isolation?" and "How can I assist in my own recovery?"

1-189. A quick response to an isolating incident is important in the successful resolution of a personnel recovery incident for four reasons. First, isolated personnel are less likely to move or be moved very far from their last known location, thus reducing the size of the search area. Second, prompt medical attention reduces the probability that injuries suffered by isolated personnel will result in the loss of life or limb. Third, a quick response keeps the enemy from reacting in a coordinated manner. Finally, by responding

quickly, the impacts of hunger or thirst, environmental factors, such as cold and wet weather, endemic diseases, and dangerous animals and insects on isolated personnel will be reduced.

Information Protection

1-190. The unit assistant chief of staff, signal (G-6) or signal staff officer (S-6) continues to refine the unit's information protection plan during the offense. The unit mission command cell works with the protection cell to provide staff supervision of the implementation of information system intrusion and attack detection devices. This is accomplished by monitoring perimeter protection tools and devices to identify activities that constitute violations of the information protection plan and security policy. Selected events are monitored to detect unauthorized access and inadvertent modification or destruction of data.

1-191. Network managers react to counter the effects of an incident on the network. Reaction to a network or information system intrusion incorporates restoring essential information services, as well as initiating attack response processes. Disaster recovery requires stopping the breach and restoring the network. (See Signal Center of Excellence doctrine, tactics, and procedures for additional information.)

Friendly Fire Incident Avoidance

1-192. Confirmation briefs and rehearsals are primary tools for identifying and reducing fratricide risk during the preparation phase of offensive actions. The following are considerations for their use:

- Confirmation briefs and rehearsals ensure subordinates know where fratricide risks exist and how to reduce or eliminate them.
- Brief backs ensure subordinates understand the commander's intent. (They often reveal areas of confusion, complexity, or planning errors.)
- The types of risks identified depend on the type of rehearsal conducted.
- Rehearsals should extend to all levels of command and involve all key players.

1-193. The following factors may reveal friendly fire incident risks during rehearsals:

- Number and type of rehearsals.
- Training and proficiency levels of units and individuals.
- The habitual relationships between units conducting the operation.
- The physical readiness (endurance) of the troops conducting the operation.

1-194. During execution, in stride risk assessment and reaction can overcome unforeseen fratricide risk situations. The following are factors to consider when assessing fratricide risks—

- Intervisibility between adjacent units.
- Amount of battlefield obscuration.
- Ability to positively identify targets.
- Similarities and differences in equipment and uniforms between friendly and enemy forces.
- Vehicle density on the battlefield.
- The tempo of the battle.

1-195. Maintaining an awareness of the COP at all levels and at all times as an operation progresses is another key to fratricide reduction. To aid leaders and Soldiers in this process, units develop and employ effective techniques and standard operating procedures (SOPs) including—

- Monitoring the next higher echelon's radio net.
- Radio cross-talk between units.
- COP updates.
- Accurate position reporting and navigation.
- Training, use, and exchange of liaison officers.

Operational Area Security and Antiterrorism

1-196. The operational area security and antiterrorism activities of the unit are discussed in ADRP 3-37. The staff of the unit's protection cell provides staff oversight of area security and antiterrorism activities in the unit's support area and prepares subordinate units located within that area to conduct these activities. Subordinate forces conduct local security activities in their defensive positions, assembly areas, and attack positions that provide security and antiterrorism protection to those forces.

1-197. Engineer units operating in the echelon support area (usually conducting general engineering or survivability tasks) also have the potential to serve as a response force to level II threats within that support area. These engineer units require time to assemble because they are normally dispersed when conducting engineer missions on an area basis. They require augmentation in the areas of fire support and antitank capabilities before commitment.

Survivability

1-198. *Survivability* includes all aspects of protecting personnel, weapons, and supplies while simultaneously deceiving the enemy (JP 3-34). The commander normally considers the impact of constructing protective emplacements for artillery and sustainment concentrations as part of the planning process. Units do not employ protective positions in the offense as extensively as they do in the defense. However, the commander may require the hardening of key mission command facilities, especially those with detectable electronic signatures. Maneuver units construct as many fighting positions as possible whenever they halt or pause during the conduct of offensive tasks. They improve existing terrain by cutting reverse-slope firing shelves or slots when possible. (See Maneuver Support Center of Excellence tactics, techniques, and procedures publications for more information on constructing protective positions.) Forces conducting offensive actions will continue to use camouflage, cover, and concealment. (See ATTP 3-34.39 for additional information on those topics.)

1-199. While survivability is an important engineer task, all units have an inherent responsibility to improve their positions, whether they are located in fighting positions or a base. Survivability consists of four areas designed to focus efforts in mitigating friendly losses to hostile actions or environments: mobility; situational understanding; hardening; and camouflage, concealment, and military deception.

Force Health Protection

1-200. The unit surgeon continues to refine the unit's medical support plan throughout all phases of offensive actions. The surgeon staff section works with the protection cell to provide staff supervision of the implementation of force health protection actions by subordinate units. Medical personnel actively monitor the unit's AO for disease; they conduct preventive services—such as immunizations and prophylaxes; and they help when Soldiers get exposed to hazards. Medical personnel provide assistance and subject matter expertise to control excessive occupational and environmental health exposure to hazards such as noise, toxic industrial materials, waste streams, and climate extremes. They establish medical, occupational, and environmental health screening as required. Through field sanitation team training and water assessments, medical personnel educate Soldiers and noncombatants on disease and non-battle injury prevention.

Chemical, Biological, Radiological, and Nuclear Defense Operations

1-201. CBRN defense consists of active and passive measures which contribute to the overall success of CBRN defense. CBRN active defense consists of measures taken to stop a CBRN attack. CBRN passive defense minimizes the vulnerability to the effects of CBRN attacks. The commander integrates CBRN defensive considerations into all types of mission planning. Implementing many CBRN passive defensive measures may slow the tempo, degrade combat power, and may also increase logistics requirements. CBRN reconnaissance and surveillance consumes resources, especially time. Personnel in protective equipment find it more difficult to work or fight. The principles of all CBRN defense activities are contamination avoidance, protection, and decontamination. (See FM 3-11 for additional information on CBRN defensive considerations.)

Safety

1-202. Units implement their safety plans during offensive actions. The unit safety officer observes safety-related issues and ensures units translate the plan into action by traveling throughout the unit AO. Commanders emphasize safety during hazardous operations, such as aviation and wet gap crossing operations, ensuring that units do not take unnecessary risks.

Operations Security

1-203. The echelon's OPSEC program and any military deception or survivability efforts should conceal the location of the friendly objective, the decisive operation, the disposition of forces, and the timing of the offense task from the enemy or mislead the enemy regarding this information. These measures prevent the enemy from launching effective spoiling attacks. (See JP 3-13 for additional information on OPSEC, military deception, and information protection.)

Explosive Ordnance Disposal

1-204. Explosive ordnance disposal (EOD) elements supporting the unit provide the capability to neutralize hazards from conventional unexploded ordnance (UXO), high-yield explosives and associated materials, and IEDs and booby traps containing both conventional explosives and chemical, biological, radiological, nuclear, and high-yield explosives (CBRNE) that present a threat to the unit's offensive actions. These elements may dispose of hazardous foreign or U.S. ammunition, UXO, individual mines, booby-trapped mines, and chemical mines. Breaching and clearance of minefields is primarily an engineer responsibility. The EOD force serves as a combat multiplier by neutralizing UXO and booby traps that restrict unit freedom of movement and deny access to or threaten supplies, facilities, and other critical assets within the unit AO. (See FM 4-30.51 for additional information on UXO procedures.)

Internment and Resettlement Operations

1-205. During the conduct of all offensive tasks the unit can expect to accumulate a sizeable number of detainees. Their classification will vary according to the operational environment. The unit protection cell must work with the sustainment cell so that the necessary resources are made available to construct and operate internment facilities for the number of detainees projected to be acquired during the conduct of the mission. The actual number of detainees has to be monitored closely to avoid devoting too many or too few resources to the performance of internment operations.

1-206. Individual Soldiers have to be reminded of the proper handling of detainees during their initial capture by small units. It is at these dispersed locations where Soldiers are under extreme stress that detainee abuse is most likely to occur. Military police Soldiers trained in internment and resettlement will probably not be at these capture sites. (See military police doctrine for additional information on internment and resettlement.)

TRANSITION

1-207. A transition occurs when the commander makes the assessment that the unit must change its focus from one element of military operations to another. The following paragraphs explain why a commander primarily conducting offensive tasks operations would transition to a focus on the conduct of defensive tasks and describe techniques that a commander can use to ease the transition.

1-208. A commander halts an offense only when it results in complete victory and the end of hostilities, reaches a culminating point, or the commander receives a change in mission from a higher commander. This change in mission may be a result of the interrelationship of the other instruments of national power, such as a political decision.

1-209. All offensive actions that do not achieve complete victory reach a culminating point when the balance of strength shifts from the attacking force to its opponent. Usually, offensive actions lose momentum when friendly forces encounter heavily defended areas that cannot be bypassed. They also reach a culminating point when the resupply of fuel, ammunition, and other supplies fails to keep up with expenditures, Soldiers become physically exhausted, casualties and equipment losses mount, and repairs

and replacements do not keep pace with damage and losses. Because of enemy surprise movements, offensive actions also stall when reserves are not available to continue the advance; the defender receives reinforcements, or the defender counterattacks with fresh troops. Several of these causes may combine to halt an offense. In some cases, the unit can regain its momentum, but this only happens after difficult fighting or an operational pause.

1-210. The commander plans a pause to replenish combat power and phases the operation accordingly, if the attacker cannot anticipate securing decisive objectives before subordinate forces reach their culminating points. Simultaneously, the commander attempts to prevent the enemy from knowing when the friendly forces become overextended.

TRANSITION TO A FOCUS ON THE CONDUCT OF DEFENSIVE TASKS

1-211. Once offensive actions begin, the attacking commander tries to sense when subordinates reach, or are about to reach, their respective culminating points. Before they reach this point, the commander must transition to a focus on the defensive element of decisive action. The commander has more freedom to choose where and when to halt the attack, if the commander can sense that subordinate forces are approaching culmination. The commander can plan future activities to aid the defense, minimize vulnerability to attack, and facilitate renewal of the offense as the force transitions to branches or sequels of the ongoing operation. For example, to prevent overburdening the extended LOCs resulting from the advances beyond eight hours of travel from the echelon support area, some of the commander's subordinate units may move into battle positions before the entire unit terminates its offensive actions to start preparing for the ensuing defensive-centric operation.

1-212. A lull in combat operations often accompanies a transition. The commander cannot forget about the stability component of decisive action because the civilian populations of the unit's AO tend to come out of their hiding positions and request assistance from friendly forces during these lulls. The commander must consider how to minimize the interference of these civilians with the force's military operations while protecting these civilians from future hostile actions in accordance with international law. The commander must also consider the threat they pose to the force and its operations, if enemy intelligence agents or saboteurs are part of the civilian population.

1-213. A commander anticipating the termination of unit offensive actions prepares orders that include the time or circumstances under which the current offense transitions to a defensive-centric operation, the missions and locations of subordinate units, and control measures. As the unit transitions from an offensive focus to a defensive focus, the commander—

- Maintains contact and surveillance of the enemy, using a combination of reconnaissance units and surveillance assets to develop the information required to plan future actions.
- Establishes a security area and local security measures.
- Redeploys artillery assets to ensure the support of security forces.
- Redeploys forces on probable future employment.
- Maintains or regains contact with adjacent units in a contiguous AO and ensures that units remain capable of mutual support in a noncontiguous AO.
- Transitions the engineer effort by shifting the emphasis from mobility to countermobility and survivability.
- Consolidates and reorganizes.
- Explains the rationale for transitioning from the offense to the unit's Soldiers.

1-214. The commander conducts any required reorganization and resupply concurrently with other transition activities. This requires a transition in the sustainment effort with a shift in emphasis from ensuring the force's ability to move forward (POL and forward repair of maintenance and combat losses) to ensuring the force's ability to defend on its chosen location (forward stockage of construction, barrier, and obstacle material, and ammunition). A transition is often a time when units can perform equipment maintenance. Additional assets may also be available for casualty evacuation and medical treatment because of a reduction in the tempo.

1-215. The commander should not wait too long to transition from the offense to the defense as subordinate forces approach their culminating points. Without prior planning, transitioning to defensive actions after reaching a culminating point is extremely difficult for several reasons. Defensive preparations are hasty, and forces are not adequately disposed for defense. Defensive reorganization requires more time than the enemy will probably allow. Usually, attacking forces are dispersed, extended in depth, and in a weakened condition. Moreover, the shift to defense requires a psychological adjustment. Soldiers who have become accustomed to advancing must now halt and fight defensively—sometimes desperately—on new and often unfavorable terms.

1-216. A commander can use two techniques when transitioning to a defensive-centric operation. The first technique is for the leading elements to commit forces and push forward to claim enough ground to establish a security area anchored on defensible terrain. The main force moves forward or rearward as necessary to occupy key terrain and institutes a hasty defense that progresses into a deliberate defense as time and resources allow. The second technique is to establish a security area generally along the unit's final positions, moving the main body rearward to defensible terrain. The security force thins out and the remaining force deploys to organize the defense. In both methods, the security area should be deep enough to keep the main force out of the range of enemy medium artillery and rocket systems.

1-217. In the first technique, the security area often lacks depth because the force lacks sufficient combat power to seize required terrain. In the second technique, enemy forces will probably accurately template the forward trace of friendly units and engage with artillery and other fire support systems. These actions often result in the loss of additional friendly Soldiers and equipment and the expenditure of more resources.

1-218. If a commander determines that it is necessary to terminate an offensive task and conduct a retrograde, subordinate units typically conduct an area defense from their current locations until their activities can be synchronized to conduct the retrograde operation. The amount of effort expended in establishing the area defense depends on the specific mission variables of METT-TC.

TRANSITION TO A FOCUS ON THE CONDUCT OF STABILITY TASKS

1-219. At some point in time the unit will probably transition from one phase of the major operations or campaign plan to another and begin executing a sequel to its previous offensive order. The end of offensive tasks may not be the decisive act. The conduct of stability tasks may be the decisive operation in the major operation or campaign. The transition to a focus on the conduct of stability tasks from the conduct of offensive tasks cannot be an afterthought. Setting the conditions for the conduct of stability tasks may have significant impact on the planning and execution of offensive-centric actions.

1-220. It is likely that a significant reorganization of the unit will occur to introduce those capabilities required by the changes in the mission variables of METT-TC. Depending on the specific operational environment the unit finds itself in, the appropriate official departmental publications dealing with other operations and tasks should be referenced to refresh previous training and education in those subjects. The mission command and protection functions remain important because it is likely that some Soldiers will want to relax discipline and safety standards as the stress of active offensive actions disappears.

1-221. During major combat operations, the commander transitions to a stability-centric element of decisive action, if the unit's offensive actions are successful in destroying or defeating the enemy and the situation makes a focus on the conduct of defensive tasks inappropriate. As in other operations, the commander's concept of operations and intent drive the design of and planning for stability tasks. Generally, a tactical commander will focus on meeting the immediate essential service and civil security needs of the civilian inhabitants of the area of operations in coordination with any existing host nation government and non-governmental organizations before addressing the other three primary stability tasks. Also, the commander will probably change the rules of engagement, and these rules must be transmitted down to the squad and individual Soldier level.

1-222. When involved in other operations, such as peace operations, irregular warfare, and military engagement, unit offensive actions normally are closely related to the movement to contact tasks of search and attack (see paragraphs 2-66 to 2-80) or cordon and search (see paragraph 2-81). The conduct of offensive tasks in these other operations will normally employ restrictive rules of engagement throughout

the mission regardless of the element of decisive action dominant at any specific moment. In the conduct of these operations, the emphasis on the stability element is much more dominant than the defensive element.

This page intentionally left blank.

Chapter 2

Movement to Contact

When necessary, commanders order subordinates to conduct a movement to contact regardless of which element of decisive action is currently dominant—offense, defense, or stability. Commanders conduct a movement to contact to create favorable conditions for subsequent tactical tasks. A commander conducts a movement to contact when the tactical situation is not clear, or when the enemy has broken contact. A properly executed movement to contact develops the combat situation and maintains the commander's freedom of action after contact is gained. This flexibility is essential in maintaining the initiative. All of the tactical concepts, control measures, and planning considerations introduced in ADRP 3-90 apply to the conduct of a movement to contact. The attack preparation considerations introduced in chapter 3 of this publication also apply.

GENERAL CONSIDERATIONS FOR A MOVEMENT TO CONTACT

2-1. A movement to contact employs purposeful and aggressive movement, decentralized control, and the hasty deployment of combined arms formations from the march to conduct offensive, defensive, or stability tasks. The fundamentals of a movement to contact are—

- Focus all efforts on finding the enemy.
- Make initial contact with the smallest force possible, consistent with protecting the force.
- Make initial contact with small, mobile, self-contained forces to avoid decisive engagement of the main body on ground chosen by the enemy. (This allows the commander maximum flexibility to develop the situation.)
- Task-organize the force and use movement formations to deploy and attack rapidly in any direction.
- Keep subordinate forces within supporting distances to facilitate a flexible response.
- Maintain contact regardless of the course of action (COA) adopted once contact is gained.

Close air support, air interdiction, and counterair operations are essential to the success of large-scale movements to contact. Local air superiority or, as a minimum, air parity is vital to the operation's success.

2-2. The Army's improved intelligence capabilities reduce the need for corps and divisions to conduct a movement to contact since modernized units normally have a general idea of the location of significant enemy forces. However, enemy use of complex terrain, such as jungle, urban, and extensive forests, operations security, and military deception operations designed to degrade the accuracy of the friendly common operational picture (COP) will continue to require small tactical units to conduct a movement to contact. Likewise, if opposing a peer competitor having a sophisticated command and control warfare or electronic warfare system capable of seriously disrupting or degrading U.S. national-level intelligence and surveillance systems, large tactical units may be required to conduct movements to contact.

2-3. A **meeting engagement** is a combat action that occurs when a moving force, incompletely deployed for battle, engages an enemy at an unexpected time and place. The enemy force encountered may be either stationary or moving. For a meeting engagement to occur, both forces do not have to be surprised by their meeting. The force making unexpected contact is the one conducting a meeting engagement. Such encounters often occur in small-unit operations when reconnaissance has been ineffective.

2-4. In a meeting engagement the force that reacts first to the unexpected contact generally gains an advantage over its enemy. However, a meeting engagement may also occur when the opponents are aware of each other and both decide to attack immediately to obtain a tactical advantage or seize key or decisive terrain. A meeting engagement may also occur when one force attempts to deploy into a hasty defense while the other force attacks before its opponent can organize an effective defense. Acquisition systems may discover the enemy before the security force can gain contact. No matter how the force makes contact, seizing the initiative is the overriding imperative. Prompt execution of battle drills at platoon level and below, and standard actions on contact for larger units, can give that initiative to the friendly force.

ORGANIZATION OF FORCES FOR A MOVEMENT TO CONTACT

2-5. A movement to contact is organized (as a minimum) with a forward security force—either a covering force or an advance guard—and a main body. A portion of the main body composes the commander’s sustaining base. Based on the mission variables (mission, enemy, terrain and weather, troops and support available, time available, and civil considerations) of METT-TC, the commander may increase the unit’s security by resourcing an offensive covering force and an advance guard for each column, as well as flank and rear security (normally a screen or guard). (See figure 2-1.) FM 3-90-2 discusses security operations.

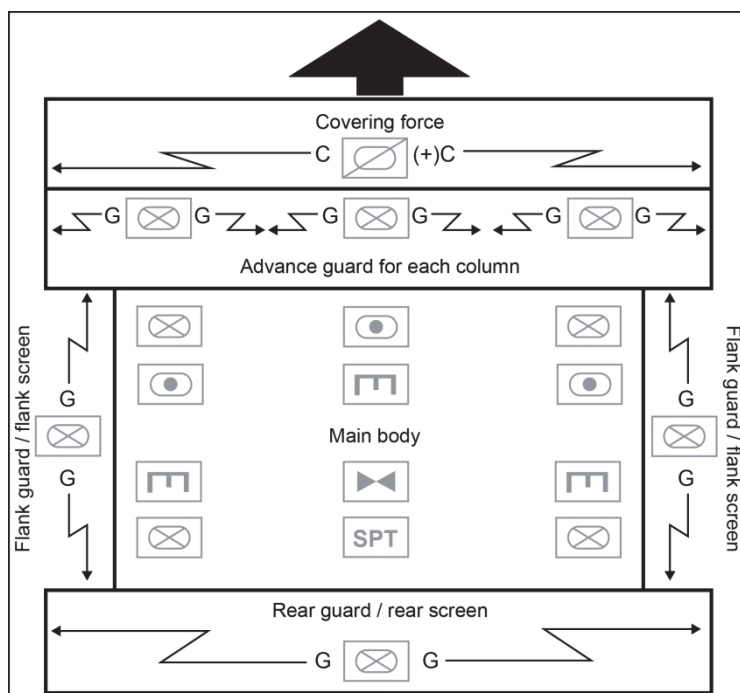

Figure 2-1. Force organized for a movement to contact

2-6. A movement to contact mission requires the commander not to have contact with the enemy main body. However, the commander may still know the location of at least some enemy reserve and follow-on forces. If the corps or division commander has enough intelligence information to target enemy uncommitted forces, reserves, or sustaining operations activities, the commander normally designates forces, such as long-range artillery systems, attack helicopters, extended range unmanned aircraft, and fixed-wing aircraft to engage known enemy elements regardless of their geographical location within the area of operations (AO). At all times the forward security element and the main body perform reconnaissance.

Security Forces

2-7. A commander conducting a movement to contact typically organizes the security element into a covering force to protect the movement of the main body and to develop the situation before committing the main body. This security element is normally the unit's initial main effort. A covering force is task-organized to accomplish specific tasks independent of the main body such as conduct mobility and selected countermobility operations in accordance with the mission variables of METT-TC. This covering force reports directly to the establishing commander.

2-8. If a force conducting a movement to contact is unable to resource a covering force for independent security operations, it may use an advance guard in the place of a covering force. An advance guard is a task-organized combined arms unit or detachment that precedes a column formation to protect the main body from ground observation or surprise by the enemy. This typically occurs when a brigade or battalion conducts a movement to contact. In cases where the higher echelon (corps or division) creates a covering force, subordinate elements can establish an advance guard behind the covering force and ahead of the main body. This normally occurs when subordinate units are advancing in multiple parallel columns. In this case, each main body column usually organizes its own advance guard.

2-9. The advance guard operates forward of the main body to ensure its uninterrupted advance by reducing obstacles to create passage lanes, repair roads and bridges, or locate bypasses. The advance guard also protects the main body from surprise attack and fixes the enemy to protect the deployment of the main body when it is committed to action. The elements composing the advance guard should have equal or preferably superior mobility to that of the main body. For this reason, combined arms units containing a mixture of mechanized or Stryker equipped infantry, armor, and reconnaissance or cavalry elements are most suitable for use in an advance guard. Engineer assets should also constitute a portion of the advance guard, but the main body can also provide other support. However, there are some environments, such as jungles and swamps, where providing the advance guard with mobility superior to that of the main body is impossible.

2-10. The advance guard moves as quickly and as aggressively as possible, but, unlike the covering force, remains within supporting range of the main body's weapon systems. It forces the enemy to withdraw or destroys small enemy groups before they can disrupt the advance of the main body. When the advance guard encounters large enemy forces or heavily defended areas, it takes prompt and aggressive action to develop the situation and, within its capability, defeat the enemy. Its commander reports the location, strength, disposition, and composition of the enemy and tries to find the enemy's flanks and gaps or other weaknesses in its position. The main body may then join the attack. The force commander usually specifies how far in front of the main body of the force the advance guard is to operate. The commander reduces those distances in close terrain and under low-visibility conditions.

2-11. When the command's rear or flanks are not protected by adjacent or following units, it must provide its own flank and rear security. The command can accomplish this by establishing a screen or a guard on its flanks or to its rear. The flank columns of the main body normally provide these flank security elements; for example, the left flank brigade would provide the left flank screen for a division-level movement to contact. The rear guard normally comes from one of the subordinate elements of the corps or division and reports directly to the corps or division headquarters. A corps may conduct a flank cover if there is a clearly identified, significant threat from the flank. A flank cover requires significant resources that are unavailable to the main body. Combat aviation units may establish a flank screen, if the mission variables of METT-TC allow it; however, this increases the risk to the main body. (See FM 3-90-2 for more specific information concerning the conduct of the various reconnaissance and security tasks.)

Main Body

2-12. The main body consists of forces not detailed to security duties. It is normally the element that will conduct the decisive operation within the conduct of the movement to contact. The combat elements of the main body prepare to respond to enemy contact with the unit's security forces. For example, attack helicopter units organic to combat aviation brigades supporting a division or corps conducting a movement to contact normally remain under division and corps control until contact is made. If the situation allows, the commander can assign a follow and support mission to a subordinate unit. This allows that subordinate

unit to relieve security forces from such tasks as observing bypassed enemy forces, handling displaced civilians, and clearing routes. This prevents security forces from being diverted from their primary mission.

2-13. The commander designates a portion of the main body for use as the reserve. The size of the reserve is based upon the mission variables of METT-TC and the amount of uncertainty concerning the enemy. The more vague the enemy situation, the larger the size of the reserve. The reserve typically constitutes approximately one-fourth to one-third of the force. On contact with the enemy, the reserve provides flexibility to react to unforeseen circumstances and allows the unit to quickly resume its movement.

2-14. When a movement to contact is conducted at the corps or division echelon, the corps and division commanders conducting a movement-to-contact will not normally have a command relationship with sustainment assets beyond that found in their attached brigades. Instead, those sustainment assets are assigned to the Army Material Command and attached to or placed under the operational control of the Army's theater sustainment command or some type of joint sustainment command. They have a support relationship with the corps or division. The division or corps headquarters staff coordinate with the supporting sustainment organization so that the theater sustainment command or sustainment brigade supporting the tactical unit adjusts the supporting sustainment unit's internal organization to meet the tactical commander's needs. The corps or division echelon staff informs the commander of any shortfall in available sustainment support so that the movement to contact concept of operations and tactical plan can be modified to meet sustainment realities. This mainly occurs when the tactical unit conducting a movement to contact is not conducting the decisive operation or main effort of its higher headquarters.

2-15. Brigade combat team (BCT) commanders tailor their units' organic sustainment assets to the mission. They decentralize the execution of the sustainment, but that support must be continuously available to the main body. This includes using preplanned logistics packages (LOGPACs). **A logistics package is a grouping of multiple classes of supply and supply vehicles under the control of a single convoy commander.** Daily LOGPACs contain a standardized allocation of supplies. Special LOGPACs can also be dispatched as needed.

2-16. The commander frequently finds that main supply routes (MSRs) become extended as the operation proceeds. Aerial resupply may also be necessary to support large-scale movement to contacts or to maintain the momentum of the main body. Combat trains containing fuel, ammunition, medical, and maintenance assets move with their habitually associated supported battalion or company team. Fuel and ammunition stocks remain loaded on tactical vehicles in the combat trains, so they can instantly move when necessary. Battalion field trains move with a higher support echelon, such as the brigade support battalion, in the main body of each BCT. Aviation units use forward arming and refuel points (FARPs) to reduce aircraft turnaround time.

CONTROL MEASURES FOR A MOVEMENT TO CONTACT

2-17. A commander uses the minimal number and type of control measures possible in a movement to contact because of the uncertain enemy situation. These measures include designation of an AO with left, right, front, and rear boundaries, or a separate AO bounded by a continuous boundary (noncontiguous operations). The commander further divides the AO into subordinate unit AOs to facilitate subordinate unit actions.

2-18. The operation usually starts from a line of departure (LD) at the time specified in the operation order (OPORD). The commander controls the movement to contact by using phase lines, contact points, and checkpoints as required. (See figure 2-2.) The commander controls the depth of the movement to contact by using a limit of advance (LOA) or a forward boundary. Figure 2-2 shows an LOA and not a forward boundary. The commander could designate one or more objectives to limit the extent of the movement to contact and orient the force. However, these are often terrain-oriented and used only to guide movement. Although a movement to contact may result in taking a terrain objective, the primary focus should be on the enemy force. If the commander has enough information to locate significant enemy forces, then the commander should plan some other type of offensive action.

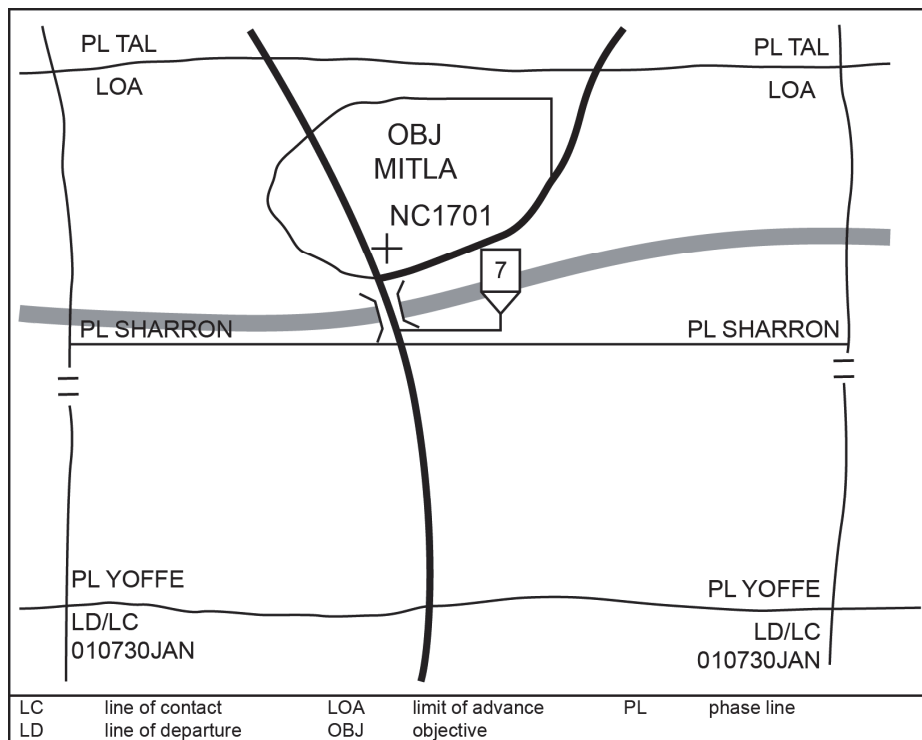

Figure 2-2. Movement to contact control measures

2-19. Corps, division, or BCT commanders use boundaries to separate the various organizational elements and clearly establish responsibilities between different organizations. Battalion commanders use these control measures along with mission orders, coupled with battle drills and formation discipline, to synchronize the movement to contact. Company teams are not normally assigned their own areas of operations during the conduct of a movement to contact.

2-20. The commander can designate a series of phase lines that can successively become the new rear boundary of the forward security elements as that force advances. Each rear boundary becomes the forward boundary of the main body and shifts as the security force moves forward. The rear boundary of the main body designates the limit of responsibility of the rear security element. This line also shifts as the main body moves forward. (See FM 3-90-2 for a discussion of security force boundaries.)

2-21. Commanders may use an axis of advance in limited visibility. However, there is the risk of enemy forces outside the axis not being detected, and thus being inadvertently bypassed.

PLANNING A MOVEMENT TO CONTACT

2-22. The commander executes the intelligence annex to the OPORD to determine the enemy's location and intent while conducting security operations to protect the main body. This includes the use of available fixed-wing aircraft. This allows the main body to focus its planning and preparation, to include rehearsals, on the conduct of hasty attacks, bypass maneuvers, and hasty defenses. The plan addresses not only actions anticipated by the commander based on available intelligence information, but also the conduct of meeting engagements at anticipated times and locations where they might occur. The commander tasks the forward security force with conducting route reconnaissance of routes the main body will traverse.

2-23. The commander seeks to gain contact by using the smallest elements possible. These elements are normally ground scouts or aerial scouts performing reconnaissance, but may also be unmanned aircraft systems (UASs) or other reconnaissance and surveillance assets. The commander may task organize the unit's scouts to provide them with additional combat power to allow them to develop the situation. The

unit's planned movement formation should contribute to the goal of making initial contact with the smallest force possible. It should also provide for efficient movement of the force and adequate reserves. The commander can choose to have all or part of the force conduct an approach march as part of the movement to contact to provide that efficient movement. An approach march can facilitate the commander's decisions by allowing freedom of action and movement of the main body. (See FM 3-90-2 for a discussion of an approach march.)

2-24. The frontage assigned to a unit in a movement to contact must allow it to apply sufficient combat power to maintain the momentum of the operation. Reducing the frontage normally gives the unit adequate combat power to develop the situation on contact while maintaining the required momentum. Both the covering force and advance guard commanders should have uncommitted forces available to develop the situation without requiring the deployment of the main body.

2-25. The commander relies primarily on fire assets to weight the lead element's combat power, but the commander also provides it with the additional combat multipliers it needs to accomplish the mission. The fires system helps develop fire superiority when organized correctly to fire immediate suppression missions to help maneuver forces get within direct-fire range of the enemy.

2-26. The reconnaissance effort may proceed faster in a movement to contact than in a zone reconnaissance because the emphasis is on making contact with the enemy. However, the commander must recognize that by increasing the speed of the reconnaissance effort, there is an increased risk associated with the operation.

2-27. Bypass criteria should be clearly stated and depend on the mission variables of METT-TC. For example, an armored or Stryker BCT commander in an open desert environment could declare that no mounted enemy force larger than a platoon can be bypassed. All other forces will be cleared from the brigade's axis of advance. Any force that bypasses an enemy unit must maintain contact with it until handing it off to another friendly element, usually a force assigned a follow and support mission.

2-28. The echelon intelligence officer (G-2 or S-2), assisted by the engineer and air defense staff representatives, must carefully analyze the terrain to include air avenues of approach. The echelon intelligence officer identifies the enemy's most dangerous COA in the war gaming portion of the military decisionmaking process. Because of the force's vulnerability, the G-2 must not underestimate the enemy during a movement to contact. A thorough intelligence preparation of the battlefield (IPB)—by developing the modified combined obstacle overlay to include intervisibility overlays and other products, such as the event templates—enhances the force's security by indicating danger areas where the force is most likely to make contact with the enemy. It also helps to determine movement times between phase lines and other locations. Potential danger areas are likely enemy defensive locations, engagement areas, observation posts (OPs), and obstacles. The fires system targets these areas, and they become on-order priority targets placed into effect and cancelled as the lead element can confirm or deny enemy presence. The intelligence annex of the movement to contact order must address coverage of these danger areas. If reconnaissance and surveillance forces cannot clear these areas, more deliberate movement techniques are required.

2-29. The commander develops decision points to support changes in the force's movement formation or a change from an approach march to a combat formation. Using both human and technical means to validate decision points, the commander must determine the acceptable degree of risk, based on the mission. The commander's confidence in the products of the IPB process and the acceptable risk determine the unit's combat formation and scheme of maneuver. In a high-risk environment, it is usually better to increase the distance between forward elements and the main body than to slow the speed of advance.

2-30. Corps and divisions can execute shaping operations in support of their subordinate BCTs as part of a movement to contact, although, by definition, a force conducts a movement to contact when the enemy situation is vague or totally unknown. This occurs when the necessary information regarding enemy reserves and follow-on forces is available, but information regarding those enemy forces in close proximity to the friendly force is not available. As in any other type of operation, the commander plans to focus operations on finding the enemy and then delaying, disrupting, and destroying each enemy force element as much as possible before it arrives into direct-fire range. This allows BCT maneuver forces to prepare to engage enemy units on their arrival.

2-31. In a movement to contact, the commander can opt not to designate a decisive operation until forces make contact with the enemy, unless there is a specific reason to designate it. In this case, the commander retains resources under direct control to reinforce the decisive operation. The commander may designate the decisive operation during the initial stages of a movement to contact because of the presence of a key piece of terrain or an avenue of approach.

PREPARING FOR A MOVEMENT TO CONTACT

2-32. The preparations for the conduct of a movement to contact are the same as those for an attack. (See the appropriate section of chapter 3 for additional information on this subject.)

EXECUTING A MOVEMENT TO CONTACT

2-33. Each element of the force synchronizes its actions with adjacent and supporting units, maintaining contact and coordination as prescribed in orders and unit standard operating procedures (SOPs). The advance guard maintains contact with the covering force (if one is established). The lead elements of the main body maintain contact with the advance guard. The rear guard and flank security elements maintain contact with and orient on the main body's movement. These security forces prevent unnecessary delay of the main body and prevent the deployment of the main body as long as possible. Reconnaissance elements operate to the front and flanks of each column's advance guard and maintain contact with the covering force. The commander may instruct each column's advance guard to eliminate small pockets of resistance bypassed by forward security force. (See figure 2-3.)

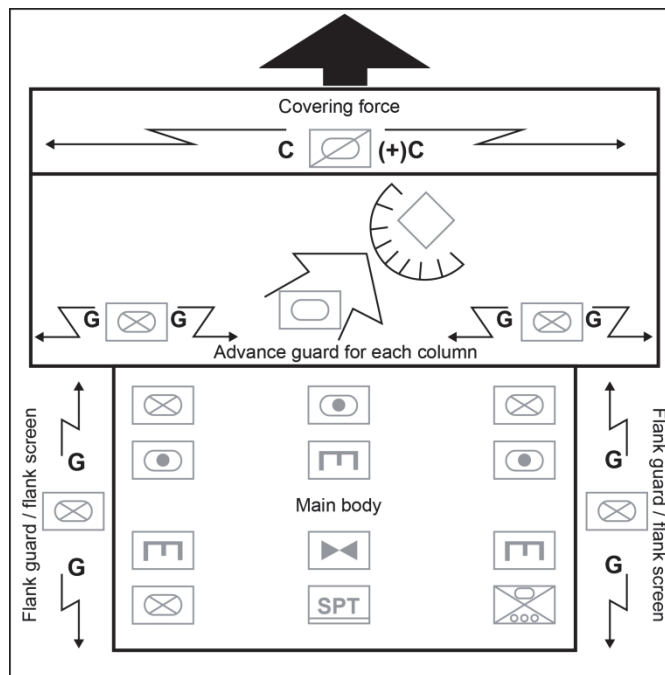

Figure 2-3. A column advance guard attacking to destroy a contained enemy force

2-34. The commander of the advance guard chooses a combat formation, based on the mission variables of METT-TC, to make contact with the smallest possible force while providing flexibility for maneuver. Whatever combat formation the commander chooses, the unit must be able to deploy appropriately once the enemy's location is determined. The commander ensures that the route or axis of advance traveled by the main body is free of enemy forces. The main body may move continuously (using traveling and traveling overwatch) or by bounds (using bounding overwatch). It moves by bounds when contact with the enemy is imminent and the terrain is favorable. Some indirect-fire assets, such as a mortar platoon or artillery battery and combat observation and lasing teams (COLTs), may be positioned with the advance guard. The COLTs

can help overwatch the advance guard movement, and indirect fires focus on suppressing enemy weapons, obscuring enemy observation posts, and screening friendly movement.

2-35. The main body keeps enough distance between itself and its forward security elements to maintain flexibility for maneuver. This distance varies with the level of command, the terrain, and the availability of information about the enemy. The main body may execute an approach march for all or part of the movement to contact to efficiently use the available road network or reduce the time needed to move from one location to another. Command posts and trains travel along high-mobility routes within the AO and occupy hasty positions as necessary.

2-36. Behind these forward security elements, the main body advances over multiple parallel routes with numerous lateral branches to remain flexible and reduce the time needed to initiate maneuver. (While it is preferred for a battalion to use multiple routes, battalions and smaller units can move on just one route.) In a movement to contact, the main body's march dispositions must allow maximum flexibility for maneuvering during movement and when establishing contact with the enemy force.

2-37. The commander's fire support systems tend to focus on suppression missions to disrupt enemy forces as they are encountered and smoke missions to obscure or screen exposed friendly forces when conducting a movement to contact. The commander schedules the movements of fire support systems in synchronization with the movement of the rest of the force. Fire support systems that cannot match the cross-country mobility of ground maneuver units cause them to slow their rate of advance. If these units do not slow down, they run the risk of outrunning their fire support. The commander synchronizes the employment of close air support to prevent the enemy from regaining balance while the commander's ground fire support assets are repositioning. The main body updates its priority target list during a movement to contact operation.

2-38. Similar considerations apply to air and missile defense when the enemy possesses these capabilities. The unit conducting a movement to contact remains aware of the air and missile defense umbrella provided by Sentinel Radars and Army Air and Missile Defense Command Patriot systems, and the combat air patrol provided by Air Force, Navy, and Marine Corps fighter aircraft.

2-39. The unit's tempo, momentum, tactical dispersal, and attention to electromagnetic emission control complicate the enemy's ability to detect and target the main body until contact is made. Once the force makes contact and concentrates its effects against detected enemy forces, it becomes vulnerable to strikes by enemy conventional weapons and weapons of mass destruction (WMD). It must concentrate its combat effects rapidly in a meeting engagement and disperse again as soon as it overcomes resistance to avoid enemy counteractions, if the movement to contact is to continue. However, the results of that meeting engagement and the mission variables of METT-TC will determine the specific COA selected.

2-40. Movement should be as rapid as the terrain, the mobility of the force, and the enemy situation permit. Open terrain provides maneuver space on either side of the line of march and facilitates high-speed movement. It also allows for greater dispersal and usually permits more separation between forward security elements and the main body than restricted terrain allows. The commander should never commit the main body to canalizing terrain before these forward security elements have advanced far enough to ensure that the main body will not become fixed within that terrain. The enemy may have also established fire support control measures that allow the enemy to employ non-observed harassing and interdiction fires to interdict friendly forces traversing these choke points. As the enemy situation becomes known, the commander may shorten the distance between elements to decrease reaction time or deploy the force to prepare for contact.

2-41. At battalion and company levels, a moving force moves along covered or concealed routes from one covered or concealed position to another, using terrain to minimize its vulnerability to enemy weapons. Further, an overwatching force should cover the moving force. (FM 3-90-2 describes movement techniques, such as traveling overwatch.) Regardless of the specific movement technique employed, subordinate elements need to provide mutual support and be knowledgeable about their counterpart's sectors of fire.

2-42. The force must attempt to cross any obstacles it encounters without loss of momentum by conducting hasty (in-stride) breaches. The commander uses forward security forces in an attempt to seize

intact bridges whenever possible. Lead security elements bypass or breach obstacles as quickly as possible to maintain the momentum of the movement. If these lead elements cannot overcome obstacles, the commander directs subsequent elements of the main body to bypass the obstacle site and take the lead. Following forces can also reduce obstacles that hinder the unit's sustainment flow.

2-43. The commander moves well forward in the movement formation. Once the formation makes contact with the enemy, the commander can move quickly to the area of contact, analyze the situation, and direct aggressively. The unit's security elements conduct actions on contact to develop the situation once they find the enemy. Once they make contact with the enemy, a number of actions occur that have been divided into the following sequence. (Units equipped with a full set of digital information systems may be able to combine or skip one or more of the steps in that sequence. Those units will conduct maneuver and remain within supporting distance of each other with a significantly larger AO than units equipped with analog systems.) These actions normally constitute a major portion of the unit's shaping operations.

2-44. This publication discusses executing all four offensive tasks in a five-step sequence:

- Gain and maintain enemy contact.
- Disrupt the enemy.
- Fix the enemy.
- Maneuver.
- Follow through.

This sequence is for discussion purposes only and is not the only way of conducting these offensive tasks. The five steps used in this publication to illustrate the execution of offensive tasks actually tend to overlap each other during the conduct of offensive actions. Normally the first three of these steps are shaping operations or supporting efforts, while the maneuver step is the decisive operation or main effort. Follow through is normally a sequel or a branch to the plan based on the current situation.

SHAPING OPERATIONS

2-45. A *shaping operation* is an operation at any echelon that creates and preserves conditions for the success of the decisive operation through effects on the enemy, other actors, and the terrain (ADRP 3-0). If the result of any of these three steps is the complete development of the situation and the establishment or regaining of contact with the enemy main body, not just enemy security forces, then that step will have been the decisive operation of the movement to contact.

Gain and Maintain Enemy Contact

2-46. All reconnaissance and surveillance assets focus on determining the enemy's dispositions and providing the commander with current intelligence and relevant combat information; this ensures that the commander can commit friendly forces under optimal conditions. The commander uses all available sources of combat information to find the enemy's location and dispositions. Corps and divisions use the long-range surveillance units and detachments, unmanned aircraft systems, and technical systems found in the attached battlefield surveillance brigade (BFSB) in conjunction with data provided by special operations forces, joint, and multinational assets to gain contact with the enemy. BCTs and their subordinate battalions use their organic reconnaissance assets to gain that contact. This contact may be in any of seven forms: visual; physical; indirect fire; obstacles; aircraft; chemical, biological, radiological, nuclear, and high-yield explosive (CBRNE); and direct fire. Commanders use these systems to cue the conduct of aerial and ground reconnaissance by their attached BCTs and combat aviation brigades.

2-47. The enemy situation becomes clearer as the unit's forward security elements conduct actions on contact to rapidly develop the situation in accordance with the commander's plan and intent. By determining the strength, location, and disposition of enemy forces, these security elements allow the commander to focus the effects of the main body's combat power against the enemy main body. The overall force must remain flexible to exploit both intelligence and combat information. The security force should not allow the enemy force to break contact unless it receives an order from the commander. When a strong covering force has not preceded the advance guard, it should seize terrain that offers essential observation.

2-48. *Actions on contact* are a series of combat actions often conducted simultaneously taken on contact with the enemy to develop the situation (ADRP 3-90). Actions on contact are:

- Deploy and report.
- Evaluate and develop the situation.
- Choose a course of action.
- Execute selected course of action.
- Recommend a course of action to the higher commander.

2-49. Once the lead elements of a force conducting a movement to contact encounter the enemy, they conduct actions on contact. The unit treats obstacles like any other form of enemy contact, since it assumes that the obstacles are covered by fire. The unit carries out these actions on contact regardless of whether the enemy has detected its presence. The unit's security force often gains a tactical advantage over an enemy force by using tempo and initiative to conduct these actions on contact, allowing it to gain and maintain contact without becoming decisively engaged. How quickly the unit develops the situation is directly related to its security. This tempo is directly related to the unit's use of well-rehearsed SOPs and drills.

2-50. *Deploy and Report*. When a unit's security element encounters an enemy unit or obstacle, it deploys to a covered position that provides observation and fields of fire. If the security element is under enemy fire, it uses direct and indirect fire to suppress the enemy and restore freedom of maneuver. Simultaneously, the commander of the security element reports the contact using a spot report format to provide all available information on the situation to the next higher headquarters and update the common operational picture. This alerts the commander and allows the initiation of necessary actions. (FM 6-99.2 provides the format for a spot report.)

2-51. *Evaluate and Develop the Situation*. The unit's security force develops the situation rapidly within mission constraints by employing techniques ranging from stealthy, foot-mobile reconnaissance to reconnaissance by fire, which uses both direct and indirect fire weapons. After evaluating the situation, the commander continues the security mission with other elements not currently in contact with the enemy after evaluating the situation, if possible. This helps to develop the situation across the front and provides more maneuver space to execute further actions. As the situation develops and the enemy's dispositions, strength, and intentions become clearer, the security force submits additional reports.

2-52. *Choose a Course of Action*. After the security force makes contact, its commander gathers information, makes an assessment, and chooses a COA consistent with the higher commander's intent and within the unit's capability. The unit initiates direct and indirect fires to gain the initiative, if it is appropriate to engage the enemy. This allows the security force to resume its mission as soon as possible. The commander cannot allow small enemy forces to delay the movement of the security force. Usually, available intelligence and the concept of operations indicate the COA to follow. For obstacles not covered by fire, the unit can either seek a bypass or create the required number of lanes to support its maneuver or the maneuver of a supported unit. Once enemy contact is made, these COAs are normally to conduct an attack, bypass, defend, delay, or withdrawal. For obstacles covered by fire, the unit can either seek a bypass or conduct breaching operations as part of a hasty attack.

2-53. *Execute Selected Course of Action*. The security force commander should determine quickly whether to bypass the enemy or attack. The security force attacks if it has sufficient, immediately available combat power to overwhelm the enemy and the attack will not detract from mission accomplishment (see chapter 3). Such attacks are usually necessary to overcome enemy attempts to slow the movement of the security force. If this initial attack fails to defeat enemy defenses, the security force commander must consider other options, such as making a more deliberate attack or assuming the defense while continuing to find out as much as possible about the enemy's positions.

2-54. The security force may bypass the enemy if it does not have sufficient combat power or an attack would jeopardize mission accomplishment. It must request permission to bypass an enemy force, unless the operations order provides bypass criteria. The security force commander must report bypassed enemy forces to the next higher headquarters, which then assumes responsibility for their destruction or containment. Alternatively, the security force could keep a minimum force in contact with the bypassed

enemy so that the enemy cannot move freely around the battlefield. (See appendix B for a discussion of bypass as a tactical task.)

2-55. If the security force cannot conduct either a hasty attack or a bypass, it attempts to establish a defense (see chapter 6). In the defense, the security force maintains enemy contact, continues to perform reconnaissance, and prepares to support other forces. When the security force commander decides to defend, responsibility for further action rests with the higher commander. In the event other COAs would lead to decisive engagements or destruction, the security force conducts those activities necessary to assure self-preservation, such as delay or withdrawal (see chapter 9), but maintains enemy contact unless the higher commander orders otherwise.

2-56. *Recommend a Course of Action to the Higher Commander.* Once the security force commander selects a COA, keeping in mind the commander's intent, the security force commander reports it to the higher commander, who has the option of disapproving it based on its impact on the overall mission. To avoid delay, unit SOPs may provide automatic approval of certain actions. If the higher commander assumes responsibility for continuing to develop the situation, the security force supports the higher commander's actions, as ordered. The higher commander must be careful to avoid becoming overly focused on initial security engagements to the detriment of operations directed against the enemy main body.

Disrupt the Enemy

2-57. Once contact is made, the main body commander brings overwhelming fires onto the enemy to prevent the enemy from conducting either a spoiling attack or organizing a coherent defense. The security force commander maneuvers as quickly as possible to find gaps in the enemy's defenses. The commander uses reconnaissance and surveillance assets to gain as much information as possible about the enemy's dispositions, strengths, capabilities, and intentions. As more intelligence becomes available, the main body commander attacks to destroy or disrupt enemy command and control (C2) centers, fire control nodes, and communication nets. The main body commander conducts operations to prevent enemy reserves from moving to counter the commander's actions.

Fix the Enemy

2-58. The security force commander does not allow enemy security and main body forces to maneuver against the friendly main body. The organization, size, and combat power of the security force are the major factors that determine the size of the enemy force it can defeat or fix in place without deploying the main body.

2-59. The commander uses aerial maneuver and fire support assets to fix an enemy force in its current positions by directly attacking enemy maneuver elements and command systems, and emplacing situational obstacles. The typical priorities are to attack enemy forces in contact, enemy command and control and fire direction control facilities, enemy fire support assets, and moving enemy forces not yet in contact, such as follow-on forces and reserves. These priorities vary with the mission variables of METT-TC. Attack helicopters and close air support fixed-wing aircraft working in joint air attack teams (JAAT) are ideally suited to engage the enemy throughout the depth of the area of operations, if suppression of enemy air defenses can reduce aircraft risk to an acceptable degree.

2-60. The techniques a commander employs to fix the enemy when both forces are moving are different than those employed when the enemy force is stationary during the meeting engagement. In both situations, when the security force cannot overrun the enemy by conducting a hasty frontal attack, the commander must deploy a portion of the main body. When this occurs the unit is no longer conducting a movement to contact but an attack.

DECISIVE OPERATION OR MANEUVER

2-61. If the security force cannot overrun enemy security forces with a frontal attack to make contact with the enemy main body, the commander quickly maneuvers the friendly main body to conduct a penetration, flank attack, or envelopment of those enemy security forces. At this point, this makes the main body the

decisive operation of the movement to contact. This is one of the key reasons that commanders ensure that their main body is not engaged until the time and place of their choosing. When and where possible, this maneuver should be initiated at a tempo the enemy cannot match. (See chapter 3 for a discussion of attack.) The commander does this to overwhelm the enemy security force before it can react effectively or reinforce. The commander attempts to defeat enemy security forces in detail while still maintaining the momentum of the advance, until the unit makes contact with the enemy main body.

2-62. Main body elements deploy rapidly to the vicinity of the line of contact, if the commander initiates a frontal attack. Commanders of maneuvering units coordinate forward passage through friendly forces in contact as required. The intent is to deliver the assault before the enemy force can deploy or reinforce its engaged forces. The commander may order an attack from a march column for one of the main body's columns, while the rest of the main body deploys. The commander can also wait to attack until the bulk of the main body can be brought forward. The commander avoids piecemeal commitment, except when rapid action is essential and the unit has combat superiority at the vital point and can maintain it throughout the attack, or when compartmentalized terrain forces such a COA.

2-63. When trying to conduct an envelopment, the commander focuses on attacking the enemy's flanks and rear before the enemy can prepare to counter these actions. The commander uses the security force to fix the enemy while the main body maneuvers to look for an assailable flank or the commander uses the main body to fix the enemy while the security force finds the assailable flank.

2-64. If the enemy is not rapidly defeated, the commander has three main options: bypass, transition to a more deliberate attack, or conduct some type of defense. In all cases, the commander makes every effort to retain the initiative by conducting violent and resolute attacks and prevent the enemy from stabilizing the situation. Simultaneously the commander must maintain momentum by synchronizing the actions of friendly maneuver, functional and multifunctional support, and sustainment elements.

FOLLOW THROUGH

2-65. After a successful attack, the main body commander resumes the movement to contact if the location of the enemy main body is still unclear and the limit of advance has not been reached, or the commander transitions to the appropriate task—deliberate attack, a defense, or retrograde—for the existing tactical situation. (For more discussion of these types of operations, see the respective chapters in this publication.)

SEARCH AND ATTACK

2-66. ***Search and attack is a technique for conducting a movement to contact that shares many of the characteristics of an area security mission.*** A commander employs this form of a movement to contact when the enemy is operating as small, dispersed elements whose locations cannot be determined to targetable accuracy by methods other than a physical search, or when the task is to deny the enemy the ability to move within a given area. A search and attack is conducted primarily by dismounted infantry forces and often supported by armor, mechanized, and Stryker equipped forces. A search and attack normally occurs during the conduct of irregular warfare. However, it may also be necessary when conducting noncontiguous operations within major combat operations.

2-67. All units can conduct search and attack operations. However, a division will rarely conduct search and attack operations simultaneously throughout its AO. BCTs, maneuver battalions, and companies normally conduct search and attack operations. However, during World War II, Germany and Japan, with their allies, conducted division and even corps-sized search and attacks designed to secure major lines of communications in Russia, the Balkans, and China. BCTs assist their subordinate maneuver battalions conducting search and attack by ensuring the availability of indirect fires and other support.

ORGANIZATION OF FORCES FOR A SEARCH AND ATTACK

2-68. The commander can task organize a unit into reconnaissance, fixing, and finishing forces, each with a specific purpose and task to accomplish. Alternatively, all units can be involved in the reconnaissance effort with individual subordinate elements being tasked to perform the fixing and finishing functions based on the specifics of the situation.

2-69. The size of the reconnaissance force is based on the available intelligence about the size of enemy forces in the AO and the size of the AO in terms of both the geographical size and the size of the civilian population contained in that AO. The less known about the situation, the larger the reconnaissance force. The reconnaissance force typically consists of scout, infantry, aviation, and electronic warfare assets. The fixing force must have enough combat power to isolate the enemy forces once the reconnaissance force finds them. The finishing force is normally the main body of that echelon. It must have enough combat power to defeat those enemy forces expected to be located within the AO. The commander can direct subordinate units to retain their own finishing force, or the commander can retain direct control of the finishing force. The commander may rotate subordinate elements through the reconnaissance, fixing, and finishing roles. However, rotating roles may require a change in task organization and additional time for training and rehearsal.

CONTROL MEASURES FOR A SEARCH AND ATTACK

2-70. The commander establishes control measures that allow for decentralized actions and small-unit initiative to the greatest extent possible. The minimum control measures for a search and attack are an AO, target reference points (TRPs), objectives, checkpoints, and contact points. (See figure 2-4.) The use of TRPs facilitates responsive fire support once the reconnaissance force makes contact with the enemy. The commander uses objectives and checkpoints to guide the movement of subordinate elements. Coordination points indicate a specific location for coordinating fires and movement between adjacent units. The commander uses other control measures, such as phase lines and named areas of interest (NAIs), as necessary. (See appendix A for a discussion of these common control measures.)

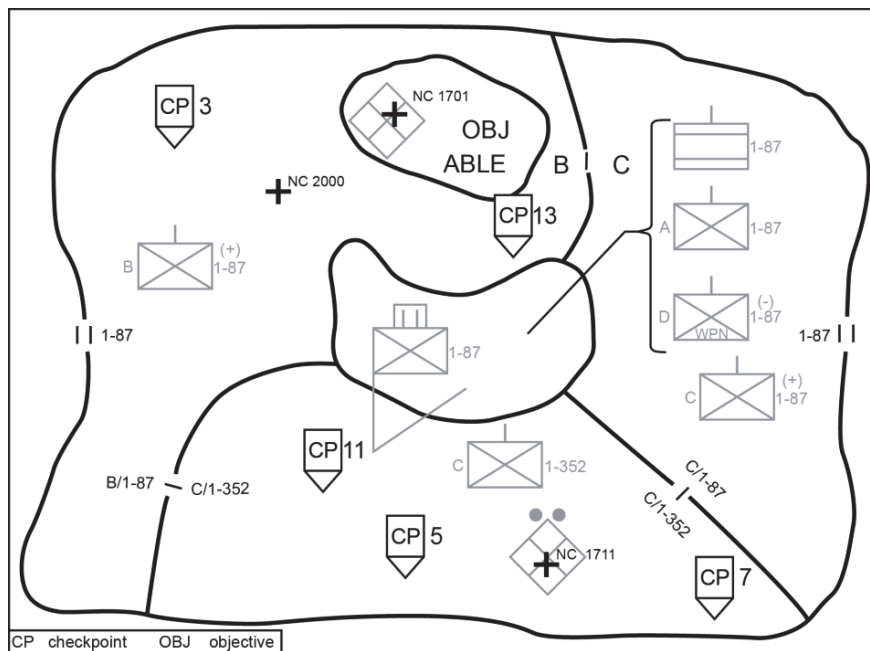

Figure 2-4. Search and attack control measures

PLANNING A SEARCH AND ATTACK

2-71. A commander conducts a search and attack for one or more of the following purposes:

- Destroy the enemy: render enemy units in the AO combat-ineffective.
- Deny the area: prevent the enemy from operating unhindered in a given area; for example, in any area the enemy is using for a base camp or for logistics support.

- Protect the force: prevent the enemy from massing to disrupt or destroy friendly military or civilian operations, equipment, property, and key facilities.
- Collect information: gain information about the enemy and the terrain to confirm the enemy COA predicted as a result of the IPB process.

2-72. The products of the IPB process are critical to conducting a search and attack. They focus the force's reconnaissance efforts on likely enemy locations.

2-73. The search and attack plan places the finishing force, as the decisive operation, where it can best maneuver to destroy enemy forces or essential facilities once located by reconnaissance assets. Typically, the finishing force occupies a central location in the AO. However, the mission variables of METT-TC may allow the commander to position the finishing force outside the search and attack area. The commander weights this decisive operation or main effort by using priority of fires and assigning priorities of support to available combat multipliers, such as engineer elements and helicopter lift support. The commander establishes control measures as necessary to consolidate units and concentrate the combat power of the force before the attack. Once the reconnaissance force locates the enemy, the fixing and finishing forces can fix and destroy it. The commander also develops a contingency plan in the event that the reconnaissance force is compromised.

2-74. Fire support plans must provide for flexible and rapidly delivered fires to achieve the commander's desired effects throughout the AO. The commander positions fire support assets so they can support subordinate elements throughout the AO. The commander must establish procedures for rapidly clearing fires. To clear fires rapidly, command posts and small-unit commanders must track and report the locations of all subordinate elements. Because of the uncertain enemy situation, the commander is careful to assign clear fire-support relationships.

EXECUTING A SEARCH AND ATTACK

2-75. Each subordinate element operating in its own AO is tasked to destroy the enemy within its capability. Units may enter the AO by infiltrating as an entire unit and then splitting out (see figure 2-5) or by infiltrating as smaller units via ground, air, or water. The commander should have in place previously established control measures and communications means between any closing elements to prevent fratricide and friendly fire incidents. The reconnaissance force conducts a zone reconnaissance to reconnoiter identified NAIs.

2-76. Once the reconnaissance force finds the enemy force, the fixing force develops the situation and executes one of two options based on the commander's guidance and the mission variables of METT-TC. The first option is to block identified routes that the detected enemy can use to escape or rush reinforcement over. The fixing force maintains contact with the enemy and positions its forces to isolate and fix the enemy before the finishing force attacks. The second option is to conduct an attack to fix the enemy in its current positions until the finishing force arrives. The fixing force attacks if attacking meets the commander's intent and if it can generate sufficient combat power against the detected enemy. Depending on the enemy's mobility and the likelihood of the reconnaissance force being compromised, the commander may need to position the fixing force before the reconnaissance force enters the AO.

2-77. Brigade combat teams (and possibly battalions) may establish fire-support bases as part of the operations of their fixing force to provide fire-support coverage throughout the area of operations during search and attack operations conducted in complex terrain. These positions should be mutually supporting and prepared for all-around defense. They are located in positions that facilitate aerial resupply. The development of these positions depends on the mission variables of METT-TC because their establishment

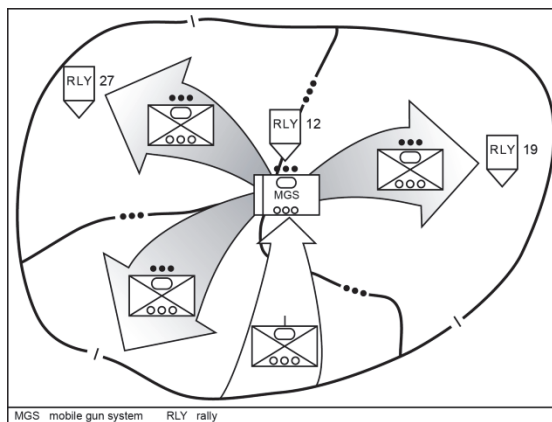

Figure 2-5. Company search and attack

requires diverting combat power to ensure protecting fire support and other assets located within such bases.

2-78. If conditions are not right to use the finishing force or main body to attack the detected enemy, the reconnaissance or the fixing force can continue to conduct reconnaissance and surveillance activities to further develop the situation. Whenever this occurs, the force maintaining surveillance must be careful to avoid detection and possible enemy ambushes.

2-79. The finishing force or main body may move behind the reconnaissance and fixing forces, or it may locate at a pickup zone and conduct air assault movement into a landing zone near the enemy, once the enemy is located. The finishing force or main body must be responsive enough to engage the enemy before the enemy can break contact with the reconnaissance force or the fixing force. The echelon intelligence officer provides the commander with an estimate of the time it will take the enemy to displace from its detected locations. The commander provides additional mobility assets, so the finishing force or main body can respond within that timeframe.

2-80. The commander uses the finishing force or main body to destroy the detected and fixed enemy during a search and attack by conducting hasty or deliberate attacks, maneuvering to block enemy escape routes while another unit conducts the attack, or employing indirect fire or close air support to destroy the enemy. The commander may have the finishing force or main body establish an area ambush and use the reconnaissance and fixing forces to drive the enemy into the ambushes.

CORDON AND SEARCH

2-81. ***Cordon and search is a technique of conducting a movement to contact that involves isolating a target area and searching suspected locations within that target area to capture or destroy possible enemy forces and contraband.*** Cordon and search operations take place throughout the range of military operations. Commanders conducting a cordon and search organize their units into four elements—command, security, search or assault, and support. The security element must be large enough to establish both an inner and an outer cordon around the target area of the search. In that regards, cordon and search operations are similar to encirclement operations. (Encirclement operations are discussed in FM 3-90-2.) Cordon and search is normally conducted at the maneuver battalion level and below. FM 3-06.20 establishes multi-Service tactics, techniques, and procedures for cordon and search operations.

This page intentionally left blank.

Chapter 3

Attack

When the commander decides to attack, or the opportunity to attack occurs during combat operations, the execution of that attack must mass the effects of overwhelming combat power against selected portions of the enemy force with a tempo and intensity that cannot be matched by the enemy. The resulting combat should not be a contest between near equals. Attackers must be determined to seek decision on the ground of their choosing through the deliberate synchronization and employment of the combined arms team.

GENERAL CONSIDERATIONS FOR AN ATTACK

3-1. Attacks take place along a continuum defined at one end by fragmentary orders that direct the execution of rapidly executed battle drills by forces immediately available. The other end of the continuum includes published, detailed orders with multiple branches and sequels, detailed knowledge of all aspects of enemy dispositions, a force that has been task organized specifically for the operation, and the conduct of extensive rehearsals. Most attacks fall between the ends of the continuum as opposed to either extreme. (ADRP 3-90 discusses this continuum between hasty and deliberate operations.)

3-2. This chapter addresses those considerations unique to the attack task. Those general offensive warfighting function considerations discussed in chapter 1 continue to apply. There are no unique sustainment and protection functional considerations that apply only to the attack.

ORGANIZATION OF FORCES FOR AN ATTACK

3-3. Once a commander determines the scheme of maneuver, the commander task organizes the force to give each unit enough combat power to accomplish its mission. The commander normally organizes the force into a security force, a main body, and a reserve, all supported by some type of sustainment organization. The commander should complete any changes in task organization in time to allow units to conduct rehearsals with their attached and supporting elements. The best place and time for an attacking force to task organize is when it is in an assembly area.

SECURITY FORCES

3-4. Under normal circumstances, a commander resources dedicated security forces during an attack only if the attack will uncover one or more flanks or the rear of the attacking force as it advances. In this case, the commander designates a flank or rear security force and assigns it a guard or screen mission, depending on the mission variables of mission, enemy, terrain and weather, troops and support available, time available, and civil considerations (METT-TC). Normally an attacking unit does not need extensive forward security forces; most attacks are launched from positions in contact with the enemy, which reduces the usefulness of a separate forward security force. An exception occurs when the attacking unit is transitioning from the defense to an attack and had previously established a security area as part of the defense.

MAIN BODY

3-5. The commander organizes the main body into combined arms formations to conduct the decisive operation and necessary shaping operations. The commander aims the decisive operation toward the decisive point which can consist of the immediate and decisive destruction of the enemy force, its will to

resist, seizure of a terrain objective, or the defeat of the enemy's plan. The scheme of maneuver identifies the focus of the decisive operation. All of the force's available resources operate in concert to assure the success of the decisive operation. The subordinate unit or units designated to conduct the decisive operation can change during the course of the attack. If the commander expects to conduct a breach operation during the attack, the commander designates an assault, breach, and support force.

3-6. If it is impractical to determine initially when or where the echelon's decisive operation will be, such as during a hasty attack, the commander retains flexibility by arranging forces in depth, holding out strong reserves, and maintaining centralized control of long-range fire support systems. As soon as the tactical situation clarifies enough to allow the commander to designate the decisive operation, the commander focuses available resources to support that decisive operation's achievement of its objective. Enemy actions, minor changes in the situation, or the lack of success by other elements cannot be allowed to divert either force or its effects from the decisive operation.

3-7. The commander may need to designate a unit or units to conduct shaping operations to create windows of opportunity for executing the decisive operation. The commander allocates the unit or units assigned to conduct shaping operations the minimal combat power necessary to accomplish their missions, since overwhelming combat power cannot be employed everywhere. Units conducting shaping operations usually have a wider area of operations (AO) than those conducting a decisive operation. If the commander has sufficient forces to conduct echelon shaping operations, the commander can assign the tasks of follow and assume or follow and support to subordinate units. (Appendix B defines these two tactical mission tasks.)

RESERVE

3-8. The commander uses the reserve to exploit success, defeat enemy counterattacks, or restore momentum to a stalled attack. Once committed, the reserve's actions normally become or reinforce the echelon's decisive operation, and the commander makes every effort to reconstitute another reserve from units made available by the revised situation. Often a commander's most difficult and important decision concerns the time, place, and circumstances for committing the reserve. The reserve is not a committed force; it is not used as a follow and support force or a follow and assume force.

3-9. In the attack, the combat power allocated to the reserve depends primarily on the level of uncertainty about the enemy, especially the strength of any expected enemy counterattacks. The commander only needs to resource a small reserve to respond to unanticipated enemy reactions when detailed information about the enemy exists. When the situation is relatively clear and enemy capabilities are limited, the reserve may consist of a small fraction of the command. When the situation is vague, the reserve may initially contain the majority of the commander's combat power.

3-10. In addition, the strength and composition of the reserve vary with the reserve's contemplated missions, the forces available, the form of offensive maneuver selected, the terrain, and the risk accepted. For example, in a hasty attack the reserve can contain up to one-third of the force's combat power. Alternatively, in a deliberate attack the commander sizes the reserve to defeat the enemy's projected available counterattack forces. The commander should not constitute the reserve by weakening the decisive operation. A reserve must have mobility equal to or greater than the most dangerous enemy ground threat, and be able to counter that threat.

3-11. In an attack the commander generally locates the reserve to the rear of the unit, placing the decisive operation in a location that provides maximum protection from hostile observation and fire. However, the reserve must be able to move quickly to areas where it is needed in different contingencies. This is most likely to occur if the enemy has strong counterattack forces. For armored and Stryker equipped reserve forces, the key factor is cross-country mobility or road networks. For light forces, the key factors are the existing road network, the availability of trucks and helicopters, or the availability of pickup zones (PZs) for use by supporting helicopters that enable the reserve to conduct air assault operations. The commander prioritizes the positioning of the reserve to reinforce the success of the decisive operation first, then to counter the worst-case enemy counterattack.

SUSTAINMENT

3-12. The commander resources sustaining operations to support the attacking force. A maneuver battalion commander and that individual's supporting brigade support battalion (BSB) commander organizes the maneuver battalion's supporting sustainment assets into combat and field trains. The Stryker brigade combat team (SBCT) sustainment organization is different in structure from that of armored brigade combat teams (ABCTs) and infantry brigade combat teams (IBCTs). Higher echelon commanders appoint someone to control sustaining operations within their echelon support areas. For example, this is often the BSB commander in an ABCT and the commander of a division's attached maneuver enhancement brigade (MEB). In an attack, the commander tries to position sustainment units well forward. From these forward locations they can sustain the attacking force and provide priority of support to the units conducting the decisive operation. As the attacking force advances, sustainment units and capabilities displace forward as required to shorten supply lines, using displacement techniques designed to ensure uninterrupted support to maneuver units. The size of the force a commander devotes to the echelon support area security mission depends on the threat in the attacking force's support area. A significant enemy threat requires the commander to resource a tactical combat force. (FM 3-90-2 discusses tactics associated with the conduct of area security operations.)

Note. An Army Maneuver Enhancement Brigade (MEB) should not be confused with a Marine Expeditionary Brigade. They are two very different organizations with vastly different capabilities.

CONTROL MEASURES FOR AN ATTACK

3-13. Units conducting offensive actions are assigned an AO within which to operate. Within the AO the commander normally designates the following control measures regardless of whether the attack takes place in a contiguous or noncontiguous environment:

- Areas of operations for subordinate units of battalion size or larger.
- A phase line as the line of departure (LD), which may also be the line of contact (LC).
- The time to initiate the operation.
- The objective.

If necessary, a commander can use either an axis of advance or a direction of attack to further control maneuver forces. (Figure 3-1 depicts minimum control measures for an attack.)

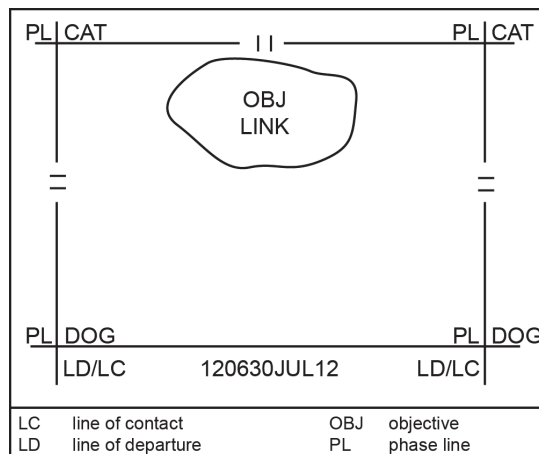

Figure 3-1. Minimum attack control measures

3-14. A commander can use any other control measures necessary to control the attack. Short of the LD or LC, the commander may designate assembly areas and attack positions where the unit prepares for offensive actions or waits for the establishment of the required conditions to initiate the attack. Beyond the LD or LC the commander may designate checkpoints, phase lines (PLs), probable lines of deployment (PLDs), assault positions, direct fire control measures, and indirect fire support coordination measures. Between the PLD and the objective a commander can use a final coordination line (FCL), assault positions, support by fire and attack by fire positions, and a time of assault to further control the final stage of the attack. Beyond the objective the commander can impose a limit of advance (LOA), if the commander does not want the unit to conduct exploitation or a pursuit. (Appendix A discusses these control measures.)

3-15. In an attack during limited-visibility conditions, the commander maintains control over the movement of all attacking elements. Typically, additional control measures are imposed beyond those used

in a daylight attack. These additional measures may include using a point of departure (PD) and a direction of attack.

PLANNING AN ATTACK

3-16. In an attack, friendly forces seek to place the enemy in a position where the enemy can easily be defeated or destroyed. The commander seeks to keep the enemy off-balance while continually reducing the enemy's options. In an attack the commander focuses movement and maneuver effects, supported by the other warfighting functions, on those enemy forces that seek to prevent the unit from accomplishing its mission and seizing its objective. Planning helps a commander synchronize the effects of combat power through the military decisionmaking process and troop leading procedures outlined in ADRP 5-0.

3-17. **Fire superiority is that degree of dominance in the fires of one force over another that permits that force to conduct maneuver at a given time and place without prohibitive interference by the enemy.** The commander plans to focus the effects of friendly systems to achieve fire superiority and allow friendly maneuver forces to breach the enemy's defensive network. The force must gain and maintain fire superiority at critical points during the attack. Having fire superiority allows the commander to maneuver forces without prohibitive losses. The commander gains fire superiority by using a variety of tactics, techniques, and procedures. This includes using counterfires and precision fires, suppressing enemy positions, and destroying key facilities and assets. Achieving fire superiority requires the commander to take advantage of—

- The range, precision, and lethality of available weapon systems.
- Temporary information superiority resulting from a blend of friendly information management; knowledge management; intelligence, reconnaissance, and surveillance operations; and joint information operations and Army inform and influence and cyber electromagnetic activities.
- Movement to place the enemy in a position of disadvantage where enemy weapon systems can be destroyed, one or more at a time, with little risk to friendly weapon systems.

MISSION COMMAND

3-18. The commander states the desired effect of fires on the enemy weapon systems, such as suppression or destruction, as part of the planning process. The commander assigns subordinate units their missions and imposes those control measures necessary to synchronize and maintain control over the operation.

3-19. Using the enemy situational and weapons templates previously developed, the commander determines the probable line of contact and enemy trigger lines. As the commander arrays subordinate elements to shape the battlefield, friendly weapon systems are matched against the enemy's to determine the PLD. Once the commander determines the PLD, the commander establishes how long it takes subordinates to move from the LD to the PLD and any support by fire positions the attack requires. The commander establishes when and where the force must maneuver into enemy direct-fire range.

3-20. In addition to accomplishing the mission, every attack plan must contain provisions for exploiting success or any advantages that may arise during the operation. The commander exploits success by aggressively executing the plan, promoting subordinate leader initiative, and using units that can rapidly execute battle drills.

MOVEMENT AND MANEUVER

3-21. In the plan of attack, the commander seeks to surprise the enemy by choosing an unexpected direction, time, type, or strength for the attack and by exploiting the success of military deception operations. Surprise delays enemy reactions, overloads and confuses enemy command and control, induces psychological shock in the enemy, and reduces the coherence of the enemy defense. The commander achieves tactical surprise by attacking in bad weather and over seemingly impassible terrain, conducting feints and demonstrations, maintaining a high tempo, destroying enemy forces, and employing sound operations security (OPSEC). For example, a unit in extremely hilly or mountainous terrain may consider transporting light infantry forces to the heights and have them maneuver down the terrain. The commander may plan different attack times for the decisive and shaping operations to mislead the enemy and allow the

shifting of supporting fires to successive attacking echelons. However, simultaneous attacks provide a means to maximize the effects of mass in the initial assault. They also prevent the enemy from concentrating defensive fires against successive attacks.

3-22. In planning, the commander and subordinate leaders focus on the routes, formations, and navigational aids they will use to traverse the ground from the LD or PD to the objective. Some terrain locations may require the attacking unit to change its combat formation, direction of movement, or movement technique when it reaches those locations. The unit can post guides at these critical locations to ensure control over the movement.

3-23. The commander attacks targets throughout the depth of the enemy's defense to keep the enemy off balance and limit enemy freedom of action. However, at the point of the decisive operation, the commander concentrates the effects of overwhelming combat power against the enemy to shatter the cohesion of the defense. The commander accomplishes this by applying combat power against the enemy at a level of violence and in a manner that the enemy cannot match. For example, the commander could concentrate an Army combined arms battalion's shock action and firepower against one enemy rifle platoon's hastily prepared defensive position.

3-24. Another aspect of concentration is the ability to rapidly concentrate force effects such as lethal fires and electronic warfare capabilities during movement. This is especially critical when crossing linear obstacles. Each subordinate element tends to move out independently when it completes passage through a choke point. This independent movement detracts from the ability of the whole force to rapidly concentrate combat power on the far side of the obstacle.

DAYLIGHT ATTACKS

3-25. Daylight attacks allow friendly forces to effectively use their equipment while facilitating control of their maneuver. They are the least stressful psychologically and physically on the attacking units. One major disadvantage is that the enemy force can effectively use its weapon systems to oppose the attack. Another disadvantage is that it does not take advantage of the Army's generally superior night vision capabilities.

LIMITED-VISIBILITY ATTACKS

3-26. The mission variables of METT-TC normally require an attack conducted during limited visibility to be more deliberate in nature than a daylight attack, except when it occurs as part of the follow-up to a daylight attack or as part of an exploitation or pursuit operation. The commander planning a night attack considers how limited visibility complicates controlling units, Soldiers, and fires. Limited visibility also complicates identifying and engaging targets, navigating and moving without detection, locating, treating, and evacuating casualties, and locating and bypassing or breaching obstacles.

3-27. Commanders attack in limited-visibility conditions to take advantage of American night-vision and navigational superiority against most potential enemy ground forces. Intensively trained forces equipped for this environment have significant advantages over an enemy who is unprepared for limited-visibility operations. When the friendly force's limited-visibility operations capabilities are significantly greater than the enemy's, limited-visibility attacks may become the normal type of attack. Table 3-1 on page 3-6 outlines the advantages and disadvantages of conducting limited-visibility attacks.

3-28. Highly-trained units equipped with modern night-vision devices conduct limited-visibility attacks similar to the way they conduct daylight attacks. Units without extensive night-vision devices can use the darkness to their advantage to conceal their movement, allowing them to get as close to the enemy positions as possible, if the enemy also does not have extensive night-vision capabilities. Troops that are well trained for limited-visibility operations and take full advantage of the superiority of their night-vision equipment gain significant tactical and psychological advantages when attacking the enemy at night or in other conditions of reduced visibility. The commander should understand the different night-vision capabilities of all elements participating in the attack, to include the enemy's night-vision capabilities, and make any adjustments necessary to the plan based on these differences. The commander should take advantage of superior night-fighting capabilities whenever possible.

Table 3-1. Advantages and disadvantages of limited-visibility attacks

Advantages of limited-visibility attacks	Disadvantages of limited-visibility attacks
<ul style="list-style-type: none"> • Defenses are more susceptible to infiltration. • Darkness can conceal the movement of large forces. • Physical and psychological factors favor the attacker, as shock, disorientation, and isolation are easier to achieve. • Air assets can operate more safely because air defenders with only optical sights have greater difficulty acquiring targets at night. • The element of surprise may increase because defenders are more susceptible to military deception techniques, such as dummy lights, noise, smoke, and fires. • The defender cannot employ reserves as quickly at night as the defender can during daylight conditions. • U.S. forces training in a limited visibility environment are superior to most potential opponents. 	<ul style="list-style-type: none"> • Control of maneuver forces in the absence of technical means is more difficult. • The defender can react easier to changing situations. • The attacker has difficulty determining the limits of obstacle systems. • Restrictive terrain is more difficult to traverse. • Light, smoke, noise, and fires can deceive the attacker. • The attacker loses momentum because attacks are conducted at a reduced speed to maintain the coherence of the unit. • Land navigation, without global positioning systems, is more difficult at night; units may become separated, cohesion can be lost, and support elements can move to the wrong positions. • The enemy can reposition or emplace obstacles during darkness without being detected by friendly reconnaissance, surveillance, and intelligence assets. • Attacking units are easier to ambush at night. • Adjusting indirect fire is difficult, even with night-vision devices or illumination. • Units require significantly larger quantities of signal ammunition such as smoke, tracers, flares, and illumination rounds. • Units have more difficulty locating and evacuating casualties. • The risk of fratricide may increase.

3-29. The organization of forces for a limited-visibility or night attack is the same as for any other attack. However, changing an existing task organization under limited-visibility conditions requires much more time and effort than it does during daylight. Small tactical organizations, such as combat crews and infantry squads, should be manned and equipped as close as possible to full strength, even if it means reducing the total number of these small tactical groups.

3-30. The presence or lack of illumination characterizes the conduct of limited-visibility attacks. Non-illuminated attacks offer the best chance of gaining surprise. Illumination, however, is normally planned for every limited-visibility attack, so that it can be readily available if required. The commander can choose to conduct a non-illuminated attack until subordinate forces make contact with the enemy. At that point, the objective can be illuminated. The enemy can also choose to employ illumination to increase the effectiveness of defensive efforts. Units generally conduct non-illuminated attacks, although they always plan for illumination. All leaders within the attacking unit must understand the time, conditions, and authority required to employ illumination.

3-31. Illuminated, supported attacks are almost like daylight attacks. They are most effective when speed is essential, time for reconnaissance is limited, or the enemy is weak and disorganized. If the commander employs illumination, it should continue until the force secures the objective. After the attacking force reaches its assault position, the commander should place illumination beyond the objective to silhouette objects on the objective. This helps the assaulting force see and fire at withdrawing or counterattacking enemy forces. The commander may also employ illumination in several locations to confuse the enemy about the exact place of attack.

3-32. The commander plans for limited-visibility operations in the same manner that the commander does for daylight operations, with emphasis on—

- Keeping the plan simple.
- Taking additional time for reconnaissance.
- Taking advantage of easily identifiable terrain features, such as roads and railroad tracks, when establishing control measures.
- Using intermediate objectives as necessary to control and maintain the correct movement direction during the attack.
- Concealing preparations.
- Scheduling initial rehearsals during daylight, with the final rehearsal at night.

The commander establishes control measures to facilitate visualizing, describing, and directing subordinate and supporting forces during limited visibility operations. Commanders should also take advantage of the technical capabilities of the equipment available, such as those projected for the Land Warrior system.

3-33. To simplify control problems, the commander may weight the support element over the assault force to reduce the number of friendly Soldiers moving on the objective in the darkness. The commander may also develop a plan that does not require the unit to change its movement azimuth after it crosses the LD or PD to simplify execution.

3-34. The commander must assume that the enemy possesses, in at least limited quantities, the same limited-visibility observation capabilities as friendly forces—absent positive information to the contrary—when conducting a limited-visibility attack. Using terrain to mask movement and deployment remains critical because limited visibility may create a false sense of protection from enemy observation. During movement, leaders reduce the distances between vehicles or individual Soldiers as necessary to allow one system or Soldier to observe the other. This decreases the time necessary to react to enemy contact. The attacking force strives to maintain its momentum; therefore, it does not preserve the alignment of units within the selected combat formation at the expense of additional time. However, the attacking force must adhere more closely to the plan of attack than under daylight conditions.

INTELLIGENCE

3-35. To employ the proper capabilities and tactics, the commander must have detailed knowledge of the enemy's organization, equipment, and tactics. The commander must understand the enemy's strengths and weaknesses. Ideally, this knowledge is available during the military decisionmaking process. The commander and staff develop enemy situational and weapons templates based on analysis of all available combat information and intelligence data. These templates must address both conventional and unconventional threats. These templates help to determine the feasibility of available courses of action (COAs) designed to achieve a position of advantage.

3-36. Before the attack, a unit conducts reconnaissance and surveillance activities to ascertain those information requirements addressed in paragraphs 1-157 to 1-163. Other information requirements can include—

- The location and depth of enemy reserves.
- The location and extent of contaminated areas.
- The location and extent of obstacles, possible breach sites, and enemy engagement areas.
- The location of areas where attacking units could become disoriented, such as rough or restrictive terrain.
- The most favorable routes of approach to the attack objective.
- Areas that the attacker can use for flanking fire and maneuver, such as support by fire and attack by fire positions.
- Suitability of planned friendly assault, support, artillery, and sustainment positions.
- Enemy deception operations.

Commanders and leaders at all echelons personally participate in this process.

3-37. The commander takes every opportunity to gain and refine combat information regarding the enemy. Available reconnaissance and surveillance assets are employed to gather combat information and process it

into intelligence. Information gathered during the planning phase of the plan, prepare, and execute cycle is especially useful in determining the viability of each COA developed. Generally, if a commander does not have good intelligence and, therefore, does not know where the overwhelming majority of the enemy's units and systems are located, the commander cannot conduct a deliberate attack. The attacking unit must conduct a movement to contact, conduct a hasty attack, or collect more combat information.

3-38. The two fundamental employment techniques for reconnaissance in the attack are reconnaissance-pull and reconnaissance-push. In reconnaissance-pull, the reconnaissance objective is to find weaknesses in enemy dispositions that can be exploited by the main force. Reconnaissance is launched over a broad area that allows the reconnaissance elements to identify enemy weaknesses to exploit and enemy strengths to avoid. Once these are identified, the commander exploits the situation by choosing a COA that allows the decisive operation to attack enemy weaknesses and penetrate gaps in the enemy's defense. The commander can then commit forces to widen the gap and envelop the enemy. The reconnaissance elements continue to move, seeking paths of least resistance and pulling the main body deep into the enemy's rear.

3-39. In reconnaissance-push, the reconnaissance objective is to identify the obstacles and enemy forces the attack forces must overcome to assault the objective in a previously chosen location in accordance with a COA selected before the reconnaissance. Once friendly reconnaissance elements gain contact with the enemy, they develop the situation within their capabilities. If the objective is an enemy force, the reconnaissance element orients on it to maintain contact and determine as much as possible about its dispositions.

3-40. The commander ensures that reconnaissance and surveillance of the enemy's defensive positions and any terrain critical to the scheme of maneuver continue throughout the attack. If the enemy units attempt to modify their defenses, those actions will be detected. In turn, this allows the commander to adjust the scheme of maneuver as the enemy situation becomes clearer. The commander can use human and technological means, acting separately or in combination, to provide the required degree of reconnaissance and surveillance.

3-41. A commander's capability to gain information about the enemy and the AO's environment varies by echelon. Army brigade combat teams (BCTs) are the lowest tactical echelons with organic analysis capabilities. However, continuing improvements in intelligence dissemination capabilities and greater tactical internet bandwidth availability means that intelligence products developed by higher echelons will be more available at low tactical levels—battalion and company level—in the future than they are today.

3-42. All intelligence disciplines can be found in the theater army's intelligence brigade. The Army's battlefield surveillance brigade (BFSB) contains a military intelligence collection capability that includes unmanned aircraft system (UAS) sensors, signals intelligence, human intelligence, and counterintelligence. The BFSB's reconnaissance and surveillance squadron provides ground reconnaissance and surveillance capabilities. BCTs also contain organic UASs, signals intelligence, human intelligence, counterintelligence, and ground reconnaissance capabilities although the organic reconnaissance and surveillance assets of a BCT are less capable than those found in the BFSB. Maneuver battalions and companies have their own reconnaissance capabilities. Non-maneuver battalions and companies can conduct reconnaissance patrols as necessary to enhance their local security or to gain or improve their understanding of the mission variables of METT-TC around their locations. (FM 3-90-2 contains the basic tactics associated with the conduct of reconnaissance operations.)

FIRES

3-43. The planning process synchronizes the unit's maneuver with the provision of fire support. It must identify critical times and places where the commander needs the maximum effects from fire-support assets. That planning must take into account existing limitations on the employment of fires, such as rules of engagement and positive identification requirements, presence of special operations forces (SOF) within the AO, desired conditions of subsequent phases, and requirements for collateral damage assessments. The commander combines maneuver with fires to mass effects, achieve surprise, destroy enemy forces, and obtain decisive results. The commander's guidance gives specified attack criteria for supporting fires assets, thus focusing the planning and execution efforts on those critical times and events. The specified

attack criteria are a compilation of the commander's guidance, desired effects, and high-payoff targets and attack priorities. The amount of time available to plan the operation constrains the commander's ability to synchronize fire-support operations that employ well-matched effects of all available assets against high-payoff targets.

3-44. The goal of the commander's attack criteria is to focus fires on seizing the initiative. The commander emphasizes simple and rapidly integrated fire support plans. This is done using quick-fire planning techniques and good standard operating procedures (SOPs). The commander integrates fire assets as far forward as possible in the movement formation to facilitate early emplacement. One example of this integration would be the use of a UAS forward site team from a combat aviation brigade temporarily attached to a fires brigade or a BFSB to identify targets for destruction. Fires concentrate (mass) on forward enemy elements to enable maneuver efforts to close with the enemy positions. Fires can isolate forward enemy elements by using long-range fires, air support, and electronic warfare.

3-45. Fires facilitate the attacking unit's maneuver by destroying or neutralizing strong enemy forces and positions. Fire systems must take full advantage of available preparation time to achieve these demanding effects criteria. Fire plans feature the following characteristics:

- Targets that are confirmed or denied by reconnaissance and surveillance efforts.
- Designation of target sensor-to-shooter communication links.
- Possible use of preparation and deception fires to shape the enemy's defense.
- Air support to destroy high-payoff targets on the objective and then shift to reinforcing enemy units, artillery assets, and command and control nodes.
- Proactive suppression of enemy air-defense efforts.
- Preparation fires that shift just as the maneuver force arrives on the objective.
- Suppression and obscuration fire plan to support breaching operations.
- Pre-positioned ammunition backed by prepackaged munitions stocks capable of rapid delivery.
- Integration of nonlethal effects, such as electronic attack and military information support operations, into the attack guidance matrix.
- Integration of primary and backup observers to engage high-priority targets.
- Fire support coordination measures, accounting for danger close and other technical constraints, to allow maneuver forces to get as close as possible to the objective before lifting fires.
- Signals for lifting and shifting fires on the objective, primarily by combat net radio and by visual signals as a backup means.

These later fire support coordination measures should also facilitate the massing of fires, including close air support (CAS) and air interdiction using kill box procedures, against high-payoff targets throughout the AO. (See FM 3-09.34 for more information on the employment of a kill box.)

PREPARING FOR AN ATTACK

3-46. Even in fluid situations, attacks are best organized and coordinated in assembly areas. If the commander decides that rapid action is essential to retain a tactical advantage, that individual may opt not to use an assembly area. Detailed advance planning—combined with digital communications, SOPs, and battle drills—may reduce negative impacts of such a decision.

3-47. Unless already in an assembly area, the attacking unit moves into one during the preparation phase. The unit moves with as much secrecy as possible, normally at night and along routes that prevent or degrade the enemy's capabilities to observe or detect the movement. It avoids congesting its assembly area and occupies it for the minimum possible time. While in the assembly area, each unit is responsible for its own protection activities, such as local ground security.

3-48. Units moving to assembly areas send out their quartering parties and link up with their guides at the designated locations. (FM 3-90-2 discusses these aspects of troop movement.) While subordinate units move to and occupy assembly areas, the commander completes the process of planning and coordinating the attack.

3-49. The attacking unit should continue its troop leading procedures and priorities of work to the extent the situation and mission allow before moving to attack positions. These preparations include but are not necessarily limited to—

- Protecting the force.
- Conducting task organization.
- Performing reconnaissance.
- Refining the plan.
- Briefing the troops.
- Conducting rehearsals, to include test firing of weapons and breach and gap crossings, if these operations are envisioned to occur during the attack. (The type of rehearsal and techniques used will vary based on the mission variables of METT-TC.)
- Moving logistics and medical support forward.
- Promoting adequate rest for both leaders and Soldiers.
- Positioning the force for subsequent action.

As part of troop leading procedures, leaders at all levels should conduct a personal reconnaissance of the actual terrain when this will not compromise operations security or result in excessive risk to the unit's leadership. Modern information systems can enable leaders to conduct a virtual reconnaissance when a physical reconnaissance is not practical. If a limited-visibility attack is planned, they should also reconnoiter the terrain at night.

3-50. A thorough reconnaissance of the objective, its foreground, and other enemy positions is a critical part of attack preparations. The commander exploits all available reconnaissance and surveillance assets to provide the necessary information. This includes requesting joint surveillance feeds of enemy movements from higher echelons or imagery of enemy obstacles. Reconnaissance forces infiltrate through the enemy security area to conduct an area reconnaissance. They can employ precision munitions and conventional indirect fires to destroy detected enemy outposts while remaining undetected. They locate and attempt to infiltrate the enemy's main defensive positions to confirm enemy unit dispositions. When properly task-organized, forces conducting reconnaissance may also be given a mission to conduct covert breaches in the enemy's obstacle complexes to facilitate rapid movement of the decisive or shaping operation.

3-51. During this phase, the commander positions artillery target-acquisition radars to provide support throughout the AO. BCT and higher headquarters establish quick-fire channels between sensors, such as counterbattery radars, and firing units assigned a counterfire mission, to rapidly silence enemy indirect fire systems. These channels do not change command relationships or priority of fires.

3-52. The commander exercises and refines the maneuver and fire plans during rehearsals which are an important part of ensuring the plan's coordination and synchronization. As part of the rehearsal process, the commander reviews the anticipated battle sequence with subordinate leaders to ensure all units understand the plan, the relationship between fire and movement, and the synchronization of critical events. These critical events include:

- Moving from the assembly area to the line of departure.
- Maneuvering from the line of departure to the probable line of deployment.
- Occupying support by fire positions.
- Conducting the breach or gap crossing.
- Assaulting the objective.
- Consolidating on the objective.
- Exploiting success or pursuing a withdrawing enemy.
- Actions of echelon reserves.

The unit should conduct rehearsals under as many types of adverse conditions as possible (under time and other constraints) to identify and prepare the unit to cope with problems. At lower tactical echelons, the rehearsal includes battle drills, such as creating lanes through minefields.

3-53. From their assembly areas, attacking units move to their respective LDs. (See figure 3-2.) Units move from assembly areas to the LD in the same way as for any other tactical movement. (FM 3-90-2 discusses troop movement.) The number of columns a unit employs in its movement depends on the availability of suitable routes and the friendly and enemy situation. The tactical situation and the order in which the commander wants subordinate units to arrive at their attack positions primarily govern the march formation. Using an LD facilitates the simultaneous initiation of the attack at the prescribed time by all attacking units.

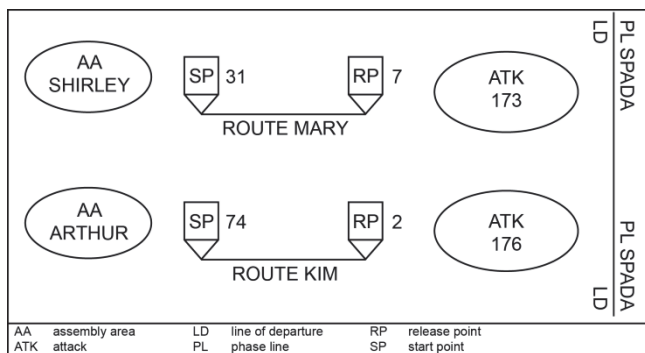

Figure 3-2. Movement from the assembly area to the line of departure

3-54. Light infantry units should move by tactical vehicles to the maximum extent possible to avoid prematurely exhausting their Soldiers. However, light infantry forces should not travel too far forward in tactical vehicles. The enemy can detect the noise and other battlefield signatures associated with using tactical vehicles at a greater distance than dismounted infantry Soldiers can be detected, and the enemy will probably respond to the presence of tactical vehicles with direct- and indirect-fire systems. The commander must weigh the need for security against the time required to conduct a foot march and its resulting effects on Soldiers.

3-55. Units move rapidly through their attack positions and across the LD, which should be controlled by friendly forces. A unit uses its designated attack position only by exception, such as when it must refuel before to crossing the LD to ensure sufficient fuel to reach the objective or the conditions required to ensure the success of the planned maneuver are not yet established. A unit does not occupy its attack positions for more than 10 to 15 minutes without initiating actions to protect itself and increase its survivability, such as deploying local security and camouflage nets and starting the construction of fighting and survivability positions. If necessary, a unit can use guides to assist in occupying the attack position.

3-56. For units attacking on foot using infiltration and stealth, a commander may designate a point of departure for the attacking units instead of an LD. Armored and Stryker-equipped units normally use gaps or lanes through the friendly positions to allow them to deploy into combat formations before they cross the LD.

3-57. Preliminary operations for an attack may include using preparatory fires and the relief of units in contact by executing a relief in place (RIP) or a forward passage of lines. The relief of units may be desirable to continue the momentum of the attack with fresh troops, change the direction of the attack, exploit a weakness in the enemy position with reserve forces, or initiate an offensive on a stabilized front. (FM 3-90-2 addresses the basic tactics associated with the conduct of a RIP and a forward passage of lines.)

3-58. The commander uses available artillery, mortar, CAS, air interdiction, electronic warfare, and military information support operations (MISO) to conduct preparation fires. Preparation fires are developed from the top down, with bottom-up refinement. The subordinate commander most affected by the effects of these preparatory fires must strongly emphasize the bottom-up refinement process. Preparatory fires can accomplish the following functions:

- Destroy the enemy.
- Suppress, neutralize, or disrupt high-value or high-priority targets.
- Gain fire superiority.
- Suppress enemy forces in their defensive positions.

- Facilitate the attacking force's maneuver.
- Deceive the enemy.

3-59. If the attacking forces are in contact with the enemy's security zone, preparatory fires may initially destroy or disrupt only the enemy's reconnaissance and security forces and positions. In either case, counterfires conducted as part of preparatory fires serve to degrade the enemy's fire-support systems and assist in achieving fire superiority.

3-60. The commander ensures that attacking maneuver forces have the functional and multifunctional support and sustainment assets necessary to conduct the operation and maintain the attack's momentum as part of the preparation process. That support and sustainment effort must anticipate future maneuvers to ensure the uninterrupted advance of the maneuver force.

EXECUTING AN ATTACK

3-61. An attack consists of a series of advances and assaults by attacking units until they accomplish their mission. (This may be the seizure or securing of a final geographic objective, or the destruction, defeat, or disruption of a designated enemy force in accordance with the higher commander's intent.) Commanders at all levels must use their initiative to rapidly shift their decisive operation or main effort between units as necessary to take advantage of opportunities and momentum to ensure the enemy's rapid destruction. Attacking units move as quickly as possible, following reconnaissance elements through gaps in the enemy's defenses. They shift their strength to reinforce success and carry the battle deep into the enemy's rear. A commander does not delay the attack to preserve the alignment of subordinate units or to adhere closely to the preconceived plan of attack.

3-62. The commander must avoid becoming so committed to the initial plan that opportunities are neglected. The commander is mentally prepared to abandon failed attacks and to exploit any unanticipated successes or enemy errors by designating another unit to conduct the decisive operation in response to the changing situation.

3-63. When maneuvering the force, the commander strives to retain freedom of action while protecting the force. Although a detailed plan to defeat the enemy may exist, the commander continually seeks any opportunity to attack to defeat, destroy, or reduce the enemy's combat power or shatter the enemy's cohesion and will to fight. The commander avoids dogged adherence to a plan no longer appropriate to current battlefield conditions. The difference between success and failure in combat often depends on the commander's ability to make the plan fit existing circumstances rather than trying to make circumstances fit the plan.

SHAPING OPERATIONS

3-64. The five step discussion of offensive actions introduced in chapter 2 is used in this chapter, although there are others ways of discussing the execution phase. Just as in chapter 2, the first three steps are usually shaping operations or supporting efforts. These steps are presented here for discussion purposes only and often overlap during the actual execution of attacks.

Gain and Maintain Enemy Contact

3-65. Gaining and maintaining contact with an enemy determined to break that contact is vital to the success of offensive actions. A defending enemy generally establishes a security area around those forces manning the main line of defense to make early contact with attacking forces to determine their capabilities, intent, and chosen COA, and to delay their approach. The enemy commander uses that security area to strip away friendly reconnaissance forces and hide enemy dispositions, capabilities, and intent. The enemy commander's goal is to compel the attacking force to conduct a movement to contact against defending enemy forces that know the exact location of the attacking force.

3-66. A commander employs combat power to overwhelm enemy forces in accordance with the commander's situational understanding. However, echelons below division do not normally have the detection, tracking, and weapon systems necessary to conduct decisive or shaping operations directed

against enemy forces not currently committed to close combat. The way a unit gains and maintains contact depends on whether the unit is in contact with the enemy's security area or the enemy's main line of resistance and the echelon of the unit in the nested layers of reconnaissance and security. For example, the intent of a corps' reconnaissance effort is to determine the dispositions, composition, direction of movement, and rate of movement of a defending enemy's significant forces. An ABCT, acting as a covering force or advance guard, can fight through most security areas, develop the situation, confirm information provided by technical means, and force the enemy to reveal more information than could be acquired solely through using intelligence sensors. This additional information includes locating the enemy's tactical and possibly operational reserves. At a lower level, a battalion constituting the advance guard of the main body of a brigade combat team can use its scout platoon to conduct a zone reconnaissance that focuses on acquiring updates of enemy positions and obstacles.

3-67. The commander's ability to sense the enemy's actions by gaining and maintaining contact with all significant parts of the enemy force, to include tracking enemy reserves, fire support, and follow-on forces, increases the security of the attacking force. The commander seeks to detect the enemy's attempts to shift major elements of defending enemy forces or launch a counterattack. Additionally, by sending out a force to conduct area reconnaissance with an on-order mission to be prepared to conduct a security mission, the commander can prevent enemy reconnaissance assets from detecting the friendly force's major movements and increase the enemy's risk. The risks to the enemy force increase when friendly forces impede or deny enemy reconnaissance and surveillance assets success. Combining these factors results in providing the attacking commander with additional time to take advantage of the changing situation. Moving within the enemy's decision cycle allows the commander to take advantage of successes by transitioning to the exploitation and pursuit to complete the enemy's destruction.

3-68. The capabilities of digital information systems offer additional techniques a commander can use to gain and maintain enemy contact. The improved common operational picture provided by those systems enhances the commander's situational understanding and ensures rapid, clear communication of orders and intent, thereby reducing the confusion and friction of battle. This is especially true when the data on those information systems providing that common operational picture is rapidly updated from the lowest tactical echelons. The disposition and activities of friendly and enemy forces and third-party agencies are important elements of information. Advanced Service and joint intelligence systems feeding those information systems enable the commander and echelon staff to detect and track enemy forces throughout a given AO without having subordinate forces make physical contact with the enemy. The commander's ability to see and understand the situation before the enemy can allows the friendly force to act first and rapidly maneuver out of contact with the enemy at a high tempo. This allows the commander to position subordinate forces where they can overwhelm selected elements of the enemy force to disrupt and destroy the enemy's combined arms team. Such attacks—delivered simultaneously with precision by air, ground, and naval systems throughout the width, height, and depth of the battlefield—stun the enemy forces and rapidly lead to their defeat.

Disrupt the Enemy

3-69. Disrupting one or more parts of the enemy's combined arms team weakens the entire enemy force and allows the friendly commander to attack selected portions of the remaining enemy force in an asymmetrical manner. The assessment and decisions regarding what to disrupt, when to disrupt, and to what end are critical. For example, the goal of disrupting the enemy's fire-support system is to allow friendly forces to maneuver and mass the effects of their weapon systems against the enemy without being engaged by the enemy's indirect-fire weapons. Attacking forces can accomplish this by attacking enemy forward observers, fire-direction centers, command posts, artillery, rocket systems, or ammunition. Each set of targets requires a different amount of resources. The probability of success, the effectiveness of the attack, and the time necessary to achieve the desired target effects varies with each set of targets.

3-70. Once any type of contact—even sensor contact—is made with the enemy, the commander seeks to use the element of surprise to conduct shaping operations that strike at the enemy and disrupt both the enemy's combined arms team and the enemy commander's ability to plan operations and control enemy forces. Once the attacking commander begins this disruption process, it continues throughout the attack.

The commander uses any existing technological advantage over the enemy in the following areas to aid the disruption process:

- Joint information operations core, supporting, and related capabilities and Army inform and influence and cyber electromagnetic activities.
- Lethal firepower effects.
- Range of direct-fire weapons.
- Protection.
- Battlefield mobility and countermobility.
- Information management.
- Mission command systems.

3-71. Disrupting the enemy enables the commander to seize, retain, and exploit the initiative, maintain freedom of action, impose the commander's will on the enemy, set the terms, and select the place for battle. That disruption also allows the commander to exploit enemy vulnerabilities and react to changing situations and unexpected developments more rapidly than the enemy. This disruption effort usually occurs at divisional echelons and above because lower echelons lack the necessary reconnaissance, target acquisition, intelligence analysis, and target attack assets to engage enemy forces not committed to close combat.

3-72. The commander plans the shaping operations to occur at the place and time necessary to establish the conditions for the decisive operation. Targets of a shaping operation may include enemy command and control facilities, reconnaissance and surveillance assets, fire-support systems, reserves, and logistics support nodes. If a commander executes a shaping operation too early, the enemy has time to recover and respond before friendly forces conducting the decisive operation can complete their maneuver.

3-73. The commander plans to use harassment, suppressive, or interdiction fires against positions likely to contain high-payoff targets to disrupt enemy reactions to the attacking unit's advance. These fires deny the enemy unrestricted use of the terrain and can prevent enemy reserves from entering the fight before the attacking friendly unit seizes the objective. Additional benefits may result from these fires over time, including increased psychological pressure on enemy personnel and a reduction in their mental and physical capabilities by disrupting their sleep and rest patterns.

3-74. Surprise denies the enemy the opportunity to focus and synchronize combat power against the attacking force. It prevents the enemy from massing defending enemy forces or fires at a critical, possibly decisive, place and time. In place of cohesive resistance, surprise can produce confusion, fear, and piecemeal resistance. Factors that contribute to surprise include the tempo and intensity in executing the attack plan and employing unexpected factors, such as selecting a less than optimal COA, varying operational tactics and methods, conducting military deception operations, and ensuring OPSEC.

Fix the Enemy

3-75. A primary purpose in fixing the enemy is to isolate the objective of the force conducting the echelon's decisive operation to prevent the enemy from maneuvering to reinforce the unit targeted for destruction. Since war is a contest between thinking opponents, the enemy will oppose the friendly commander's attempts to fix the enemy's forces. Every friendly move causes the enemy to attempt to counter that move. The commander does everything possible to limit the options available to the opposing commander. Fixing an enemy into a given position or a COA and controlling the enemy's movements limit enemy options and reduce the amount of uncertainty on the battlefield.

3-76. Reducing uncertainty allows the friendly force to use maneuver to mass the effects of overwhelming combat power against a portion of the enemy. It gives the commander more time to modify the attack plan as necessary and synchronize the employment of friendly forces. It allows the commander to mass forces in one place by using economy of force measures in other areas. The commander may also try to fix an enemy unit, such as the enemy reserve or follow-on force, to prevent it from repositioning or maneuvering against the force conducting the decisive operation.

3-77. Fixing the enemy must be done with the minimum amount of force. The commander normally allocates the bulk of friendly combat power to the force conducting the decisive operation, so fixing operations are, by necessity, shaping operations that illustrate economy of force as a principle of war. Therefore, the commander must carefully consider which enemy elements to fix and target only those that can significantly affect the operation's outcome. The longer the requirement to fix these forces, the more resources the commander needs to accomplish the mission. Generally, an enemy force only needs to be fixed until it cannot respond to the actions of the unit conducting the decisive operation in time to affect the outcome. This may require a commander to slow down the rate of march of an enemy unit to prevent it from influencing the outcome of the engagement or battle.

3-78. One method of isolating the objective is to conduct a shaping operation using lethal and nonlethal effects. Lethal effects may range from sniper fire to a joint fire plan designed to totally destroy a selected portion of the enemy force. Nonlethal effects, such as electronic warfare, can prevent the enemy from receiving orders or vital intelligence and combat information.

3-79. Severing enemy lines of communication over prolonged periods of time by using interdiction measures is another way to fix the enemy. These measures can range from air interdiction that destroys bridges and rail switching yards to ambushes conducted by infiltrating combat patrols.

3-80. Another method of fixing the enemy is to tie obstacles into the existing terrain to canalize and slow the movement of enemy reserves. At lower tactical echelons, scatterable minefields (employed in accordance with the rules of engagement) can seal the objectives from possible enemy reinforcement or counterattacks and block or disrupt enemy actions to the flanks. Military deception operations and activities, such as demonstrations and false preparatory fires, can fix the enemy. Using extensive smoke screens and vehicle mock-ups in a military deception effort can also assist in fixing an enemy force.

DECISIVE OPERATIONS

3-81. The commander maneuvers subordinate forces to gain positional advantage that enables the friendly force to seize, retain, and exploit the initiative. The attacking force seeks to avoid the enemy's defensive strength. The commander employs tactics that defeat the enemy by attacking through a point of relative weakness, such as a flank or the rear.

3-82. Offensive maneuver seeks to achieve a decisive massing of effects at the decisive point, or at several decisive points if adequate combat power is available. The commander exploits maneuver by—

- Taking maximum advantage of dead space and covered and concealed routes to close with the enemy.
- Using advantages in the effective ranges of weapon systems.
- Repositioning friendly forces rapidly.
- Navigating accurately cross-country.
- Obtaining situational understanding of friendly and enemy locations.
- Taking effective security measures.
- Synchronizing the application of all elements of combat power at a time and place on the battlefield to maximize their effects.

3-83. The key to success is to strike hard and fast, overwhelm a portion of the enemy force, and then quickly transition to the next objective or phase, thus maintaining the momentum of the attack without reducing the pressure on the enemy. The commander must retain freedom of maneuver with multiple COAs throughout the operation and responsive sustainment. Additionally, the commander must make every effort to locate and track enemy reserve and follow-on forces, which prevents friendly forces from being attacked unexpectedly by significant enemy forces. This allows the commander time to delay, disrupt, or destroy these enemy forces before they can interfere with the attack.

3-84. Depending on the mission variables of METT-TC, artillery and mortars may advance with the attacking formation or move forward by bounds. The echelon fire support coordinators (FSCOORDs) position direct support and reinforcing artillery in coordination with their maneuver commanders. The force field artillery headquarters, normally a fires brigade headquarters, coordinates position areas for general

support and general support-reinforcing artillery units through the fires cells organic to the corps, division, and brigade headquarters. The commander considers the maneuver of fire support assets along with maneuver forces to ensure that proper fire support is available at all times.

3-85. The maneuver process normally follows this sequence:

- Movement from the LD to the PLD.
- Actions at the PLD, assault position, or FCL.
- Breaching operations.
- Actions on the objective.

The movement from the assembly area to the LD that precedes many attacks is troop movement and is discussed in FM 3-90-2.

MOVEMENT FROM THE LINE OF DEPARTURE TO THE PROBABLE LINE OF DEPLOYMENT

3-86. The unit transitions from troop movement to maneuver once it crosses the LD. It moves aggressively and as quickly as the terrain and enemy situation allow. It moves forward using appropriate movement techniques assisted by the fires of supporting units. Fire and movement are closely integrated and coordinated. Effective suppressive fires facilitate friendly movement, and friendly movement facilitates more effective fires. Whenever possible, the attacking unit uses avenues of approach that avoid strong enemy defensive positions, takes advantage of all available cover and concealment, and places the unit on the flanks and rear of the defending enemy. Where cover and concealment are not available, the unit uses obscurants to conceal its movement. Any delays in establishing obscurants and suppressive fires before crossing the PLD may require the attacking unit to occupy its assault positions.

3-87. Artillery and other ground-based fires assets move as necessary to ensure that the attacking unit remains within supporting range. The commander's analysis of the time it takes the maneuver unit to move from the LD to the PLD and the distances involved ensures that artillery systems are prepared to provide support before maneuver units move inside the effective range of enemy direct-fire weapon systems. The commander keeps attacking artillery forces out of enemy artillery range as long as possible. The existence of enemy artillery systems that have a longer range than fielded U.S. artillery systems complicates this process. The commander uses fires delivered from fixed- and rotary-wing systems and the autonomous operation capabilities of modernized artillery systems to help counter any enemy range advantage.

3-88. If the commander expects to make enemy contact at or shortly beyond the LD, the unit deploys so as to maintain maximum firepower against the enemy's known positions. The commander selects the combat formation that best balances firepower, tempo, security, and control in the specific situation. The commander has the option of deploying a security force in front of the attacking unit. The commander may also employ a flank or rear security force if required by the enemy situation. The commander may not want to change formations during the attack because of potential loss of momentum resulting from such changes. If the commander finds it necessary to transition from one combat formation to another, that transition should be based on thoroughly trained drills. Once enemy contact is expected, the force transitions to the bounding overwatch technique of movement. (FM 3-90-2 addresses movement techniques.)

3-89. Between the LD and the PLD, the attacker seizes intermediate objectives only to eliminate enemy positions or bring additional suppressive fires to bear. Artillery, rocket, electronic warfare (EW), and aerial assets engage targets of opportunity. The commander uses CAS and artillery to destroy enemy security forces. As the unit approaches suspected enemy positions or danger areas, the commander directs subordinate forces to occupy pre-designated support by fire positions. Lethal fires, suppression, and obscurants enable attacking forces to occupy these positions. The commander uses direct-fires from these positions to suppress enemy forces while other portions of the unit continue their advance toward the objective.

3-90. The commander engages known enemy forces with the maximum possible combat power to overwhelm them as quickly as possible. An attacking unit that encounters small enemy units on the way to the objective either quickly overruns or bypasses them, if they meet the bypass criteria. The attacking unit then reports the location of bypassed enemy elements to its higher headquarters and maintains contact until

they can be handed off to follow and support forces. The commander uses minimal force to maintain that contact to avoid significantly weakening the force conducting the unit's decisive operation.

ACTIONS AT THE PROBABLE LINE OF DEPLOYMENT, ASSAULT POSITION, OR FINAL COORDINATION LINE

3-91. The attacking unit maintains the pace of its advance as it approaches its PLD. (See figure 3-3.) The commander divides the attacking unit into one or more assault and support forces either before or upon reaching the PLD. At the PLD infantry Soldiers dismount from their combat vehicles, if necessary. All forces supporting the assault force should be set in their support by fire positions before the assault force crosses the PLD. The commander synchronizes the occupation of these support by fire positions with the maneuver of the supported attacking unit to limit the vulnerability of the forces occupying these positions. The commander uses unit tactical SOPs, battle drills, prearranged signals, engagement areas (EAs), and target reference points (TRPs) to control the direct fires from these supporting positions. A commander normally employs restrictive fire lines between converging forces.

3-92. The PLD can be co-located with the assault position. (See figure 3-3.) The commander ensures that the final preparations of the breach force in an assault position do not delay its maneuver to the breach point as soon as the conditions are set. Whenever possible, the assault force rapidly passes through the assault position. It may have to halt in the assault position while fires are lifted and shifted. In this case, if the enemy anticipates the assault, the assault force deploys into covered positions, screens its positions with smoke, and waits for the order to assault. As long as the assault force remains in the assault position, support forces continue their suppressive fires on the objective.

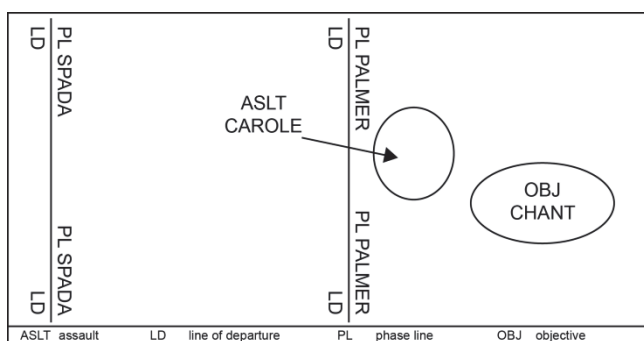

Figure 3-3. Probable line of deployment and assault positions

3-93. Once the support force sets the conditions, the breach force reduces, proofs, and marks the required number of lanes through the enemy's tactical obstacles to support the maneuver of the assault force. To avoid confusion, the commander clearly identifies the conditions that allow the breach force to proceed. From the PLD, the assault force maneuvers against or around the enemy to take advantage of the support force's efforts to suppress the targeted enemy positions. The support force employs direct and indirect fires against the selected enemy positions to destroy, suppress, obscure, or neutralize enemy weapons and cover the assault force's movement. The assault force must closely follow these supporting fires to gain ground that offers positional advantage. This COA normally results in the fewest casualties.

3-94. The key to forward movement when the assault force is under enemy direct fire is to return effective fire, which prevents the enemy from firing effectively at the moving assault force. Destructive or suppressive fires are most effective when fired by the stationary support force. These fires prevent the enemy from firing effectively at the moving assault force. Once the support force is in position and the assault force is prepared to move, the support force places a heavy volume of fires on the enemy forces to destroy, neutralize, or suppress them. The ability of the support force to move to advantageous terrain is critical to accomplishing its purpose of ensuring the assault force's success. Once it suppresses the enemy position, it reduces its rate of fire to sustainable levels to conserve ammunition as the assault force closes on the objective to ensure that it has enough to support the assault. When the assault force nears its objective, the support force increases its rate of fire to ensure the continued suppression of the enemy. This allows the assault force to assault the position before the enemy can react. Either on signal or when the assault begins, the support force ceases fire, shifts its fire to another target area, or walks its fire across the objective in front of the assault force.

3-95. The commander uses smoke to help conceal units and individual weapons. It degrades enemy laser designators, range finders, and directed energy weapons. When planning to employ smoke, the commander remembers that smoke can have the same effects on friendly and enemy forces. During the assault, the commander uses obscuration to blind the enemy and screen friendly movement onto the objective if possible. Obscuration is placed in front of enemy positions, on the far side of obstacles, and in areas that restrict maneuver. The commander may use a smoke haze over the echelon support area to limit enemy observation. The neutralization of enemy thermal viewers requires the use of multispectral smoke.

ACTIONS ON THE OBJECTIVE

3-96. The commander employs overwhelming and simultaneous fire, movement, and shock action during the final assault. This violent assault destroys, defeats, or drives the enemy from the objective area. Small units conduct the final assault while operating under the control of the appropriate echelon command post. Armored forces have the option of conducting this final assault in either a mounted or dismounted configuration.

3-97. The commander employs all fire support means to destroy and suppress the enemy and sustain the momentum of the attack. By carefully synchronizing the effects of indirect-fire systems and available CAS, the commander improves the likelihood of success. The commander plans fires in series or groups to support maneuver against enemy forces on or near the geographical objective. As the commander shifts artillery fires and obscurants from the objective to other targets, the assault element moves rapidly across the objective. The support elements must maintain suppressive fires to isolate the objective and prevent the enemy from reinforcing or counterattacking. They also destroy escaping enemy forces and systems. The commander employs joint information operations and Army information tasks, such as electronic warfare, to attack enemy command and control information systems as part of this effort.

3-98. Supporting artillery may need to displace forward during the attack to ensure maximum support is available for the assault. However, changes in position are limited because they reduce the volume of available fires. The commander balances the need to maintain that amount of artillery support against the enemy's counterfire capabilities with the need to provide continued coverage as the attacking unit continues to move forward. Supporting artillery, rocket, and mortar assets move into their new positions one subordinate unit at a time, by echelon, to maintain support throughout the attack. The commander can use any available CAS to provide supporting fires while artillery batteries displace.

3-99. Small enemy units moving toward the penetrated area can disrupt the synchronization of this final assault. As small units and weapon systems crews become engaged, they tend to focus on their immediate opponent rather than the overall situation. Loss of situational understanding, combined with the enemy's more detailed knowledge of the terrain, allows small enemy forces to inflict a great deal of damage on the attacking force. The attacking unit's leaders must understand the flow of combat and retain the capability to engage these enemy forces before they can alter the outcome of the assault. The commander can commit the echelon reserve to maintain the attack momentum and keep relentless pressure on the enemy. This also hinders enemy attempts to stabilize the situation.

3-100. Against a well-prepared, integrated enemy defense, the commander must isolate and destroy portions of the enemy defense in sequence. (See figures 3-4 and 3-5.) Friendly forces must isolate, suppress, obscure, and bypass selected enemy positions. For example, smoke delivered by field artillery and mortars in front of the objective—between the force and the enemy—screens friendly movement and obscures the enemy's weapon systems. Fires placed on and beyond the flanks of the objective isolate the enemy's position. These fires include smoke, high explosives, improved conventional munitions, and precision-guided munitions delivered by a mix of field artillery, fixed-wing aviation assets, and attack helicopters conducting close combat attack. In addition, the commander may employ short-duration scatterable mines in conjunction with terminally guided munitions to help isolate and impair the enemy's ability to counterattack. (Their use must not impede the commander's conduct of exploitation and pursuit operations.) Jamming can be used to cut information system links between the enemy's maneuver force and its supporting artillery. The commander can also use available CAS to accomplish these tasks.

3-101. The commander masses overwhelming combat power in sequence against isolated centers of resistance. The assault element commander can task organize the element to assault one portion of the objective at a time. For example, within the assault company of a battalion-level attack, two platoons may suppress while one platoon seizes a portion of the company objective. This initial platoon, having seized a foothold, then suppresses to allow a second platoon to continue the assault. The third platoon may have a third portion of the objective assigned to it to seize in turn. The enemy may attempt to reinforce its defending forces or counterattack during the friendly force's attack. Once the attacking force reaches the far side of the objective, selected elements clear remaining pockets of resistance while the bulk of the assault force prepares for a possible enemy counterattack. After the assault force reaches the objective, the support force leaves its support by fire position and rejoins the assault force or moves to a blocking position to counter possible enemy counterattacks.

Mounted Assault

3-102. In determining whether to conduct a mounted or dismounted attack, the commander considers the primary mission variables of the terrain, obstacles, and the strength of enemy anti-armor defenses. Mounted assaults accelerate the execution of the operation by allowing the greatest speed and shock action and providing the best protection against small arms and indirect fires while conserving the strength of the infantry Soldiers conducting the assault.

3-103. When facing weak, hastily prepared, disorganized resistance, or when attacking with overwhelming combat power, an armored or Stryker-equipped force commander can conduct a mounted assault. The commander conducting a mounted assault concentrates all supporting fires to destroy and neutralize the enemy and fix local reserves. Tanks, infantry fighting vehicles, and amphibious assault carriers use their cannons and machineguns to engage targets for as long as possible. As the fires from one type of weapon are lifted or shifted, other weapons increase their rate of fire. The assault force advances close to its objective under the cover of these supporting fires.

3-104. The assault force attacks using shock action and firepower to rapidly overrun the enemy position as soon as the commander shifts supporting fires beyond the objective. Mechanized infantry elements move as close as possible to the objective while remaining mounted in their combat vehicles. When the danger to the mounted infantry elements exceeds the protection offered by their combat vehicle, the commander gives the order for infantry elements to dismount from their carriers.

3-105. The following technique for securing an objective applies to an armored or Stryker equipped force assigned the mission of rapidly clearing an objective against an enemy that does not have a robust anti-armor capability. First, the force overruns the objective. Then, the accompanying mechanized infantry Soldiers dismount from their combat vehicles on the far side of the objective and sweep the objective from the far side back to the near side to clear any remaining pockets of resistance. The ability of armored and Stryker forces to closely follow friendly mortar and artillery fires, as they shift across the objective, is a

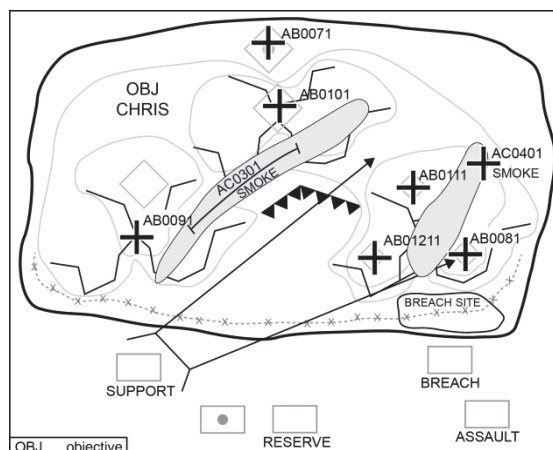

Figure 3-4. Attack of an objective: the breach

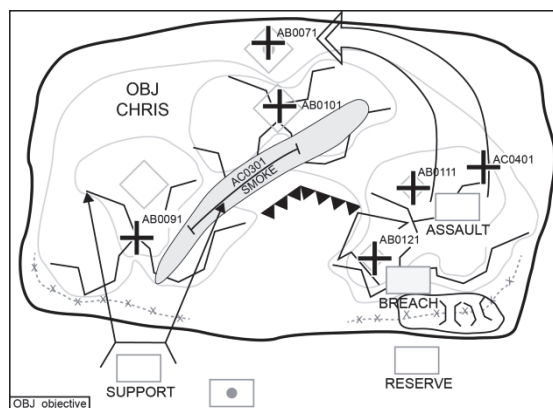

Figure 3-5. Attack of an objective: the assault

major advantage. The commander secures the objective immediately after supporting fires are shifted to deny the enemy time to move from protective to firing positions.

Dismounted Assault

3-106. An armored or Stryker equipped force commander usually conducts a dismounted assault when any of the following conditions apply:

- Terrain favors dismounted operations.
- The enemy is in prepared positions.
- The enemy has a strong anti-armor capability.
- Tanks are not available to lead the assault even though the mission variables of METT-TC favor their employment.
- Obstacles prevent maneuver across the objective.
- Stealth is required to close on the objective.
- A mounted assault stalls on or short of the objective.

The commander determines if, when, and where any mechanized infantry forces will dismount from their combat vehicles based on analysis of the mission variables of METT-TC and the degree of acceptable risk.

3-107. An attacking force should consider advancing beyond the geographical boundaries of enemy defensive positions whenever possible before stopping to consolidate and reorganize when attacking enemies with considerable artillery and mortar capabilities. This is because enemies with these indirect fire capabilities are likely to have developed preplanned targets on those positions for rapid engagement in case of their loss and to support enemy counterattacks.

Consolidation

3-108. Once an attacking force takes an enemy position, it consolidates on that position if doing so is tactically necessary or advantageous. **Consolidation is organizing and strengthening a newly captured position so that it can be used against the enemy.** Normally, the attacking unit tries to exploit its success; however, in some situations the unit may have to pause to consolidate its gains. Consolidation may vary from a rapid repositioning of forces and security elements on the objective, to a reorganization of the attacking force, to the organization and detailed improvement of the position for defense. Actions taken to consolidate gains include—

- Conducting reconnaissance.
- Establishing security.
- Eliminating enemy pockets of resistance.
- Positioning forces to enable them to conduct a hasty defense by blocking possible enemy counterattacks.
- Adjusting the fire planning.
- Preparing for potential additional missions.

3-109. Immediately after the assault, the commander must maintain contact with those enemy forces that have abandoned the objective. If the attacking force has destroyed all enemy forces on the objective, the commander takes those actions necessary to regain contact with the enemy. Patrols are sent in any direction required to maintain or regain contact with the enemy within the unit's AO. Higher echelon commanders reposition their intelligence collection assets and adjust their missions as necessary to maintain that contact.

3-110. The commander also dispatches patrols to ensure contact with any adjacent friendly units. A unit is normally responsible for establishing contact with the units to its front and right as defined by the direction to the enemy. The unit commander also establishes contact with friendly units to the left and rear, unless those units are preparing to establish contact. Otherwise, a dangerous gap could occur, which the enemy could exploit during a counterattack.

3-111. As soon as the attacking force occupies the objective it establishes security. Each subordinate element establishes observation posts (OPs) that monitor likely enemy avenues of approach and conduct

other security operations. Units must remain aware that the enemy will have defensive fires planned on these formerly occupied positions, including headquarters bunkers and supply caches.

3-112. Once subordinate units seize the objective, they clear it of enemy forces. They then occupy firing positions to prepare for an enemy counterattack. Normally, an attacking unit does not occupy vacated enemy positions because the enemy is familiar with and normally targets them. Therefore, the attacking unit should position itself away from established enemy positions, usually on the next defensible piece of terrain. This positioning is also important because the unit needs to orient on different avenues of approach and in a different direction. The commander positions armored and antitank systems in overwatch to cover likely enemy mounted avenues of approach. Mechanized infantry forces normally dismount and orient along likely dismounted and mounted avenues of approach. Mortars, command posts, and sustainment assets move forward to assist in the consolidation.

3-113. The commander should preplan the location and future missions of each element. Artillery and other fire support systems mass fires on enemy assembly areas and troops forming for counterattacks. The commander may alert the reserve to protect the flanks of the attacking units, hold ground seized by them, or counter an enemy counterattack. The commander may use antitank minefields or other obstacles to cover likely enemy avenues of approach. As the unit has time and resources, it improves these obstacles and defensive positions.

3-114. The commander normally designates TRPs, final protective fires, engagement areas, and other direct- and indirect-fire control measures as part of the consolidation process. Once in position, subordinate elements modify preplanned measures and improve defensive capabilities as required. As local security is being established, the commander directs subordinate elements to conduct mounted or dismounted patrols along likely enemy avenues of approach. The echelon scout or cavalry unit deploys beyond these local security patrols to conduct its reconnaissance or security mission.

Reorganization

3-115. **Reorganization includes all measures taken by the commander to maintain unit combat effectiveness or return it to a specified level of combat capability.** Commanders of all types of units at each echelon conduct reorganization. Any reorganization actions not completed when conducting the attack are accomplished during consolidation. These actions include—

- Redistributing or cross-leveling supplies, ammunition, and equipment as necessary.
- Matching operational weapon systems with crews.
- Forming composite units by joining two or more attrited units to form a single, mission-capable unit.
- Replacing key personnel lost before or during the battle.
- Reporting unit location and status to keep the next higher commander informed; digitized units can do this automatically.
- Recovering, treating, and evacuating casualties, prisoners of war, and damaged equipment in accordance with its SOP.
- Resupplying basic loads of ammunition, fuel, and repair parts.
- Integrating replacement Soldiers and systems into the unit.
- Revising communication plans as required.
- Placing the unit's command posts in position to conduct further operations and control the consolidation.
- Reestablishing unit cohesion.
- Conducting essential training, such as training replacements on the unit's SOP.

FOLLOW THROUGH

3-116. After seizing the objective, the commander has two alternatives: exploit success and continue the attack or terminate the offense. After seizing an objective, the most likely on-order mission is to continue the attack. By continuing the attack the commander seeks to achieve a breakthrough that can be turned into

an exploitation or a pursuit. A **breakthrough** is a rupturing of the enemy's forward defense that occurs as a result of a penetration. A breakthrough permits the passage of an exploitation force. At BCT echelon and below, the unit maintains contact and attempts to exploit its success. Normally, an intermediate tactical commander, such as a division or corps commander, makes the decision regarding whether to initiate a general—as opposed to local—exploitation or pursuit or terminate offensive actions.

3-117. During consolidation, the unit commander and staff continue troop leading procedures in preparation for any on-order missions. They use available combat information and intelligence products to adjust contingency plans. The commander redirects the unit's intelligence collection effort to support the next mission.

3-118. Fire support assets move quickly to take advantage of the natural reduction in support requirements that occurs when a position is taken. Field artillery units reposition to where they can support a renewed attack when ammunition supply and enemy action permit. Attacks by rotary- and fixed-wing manned and unmanned aircraft can provide support while artillery systems reposition. Road conditions, such as destroyed bridges or large numbers of dislocated civilians, and the unit's cross-country mobility will affect the exact time of repositioning.

3-119. The commander attempts to exploit the deterioration of the enemy position by administering quick and powerful blows before the enemy can reconstitute an effective defense. The commander's employment of precision-guided munitions, combined with the action of large, armored or Stryker formations and air support, may achieve decisive results.

3-120. Ordinarily, a defending enemy force will attempt to hold a position until nightfall to be able to complete its withdrawal under the cover of darkness. The attacking unit maintains relentless pressure, continuing the attack at night. Through these attacks, the unit maintains contact with the enemy, keeps the enemy off balance, and makes the enemy force's withdrawal from action extremely difficult. If the enemy tries to delay, the unit continues its attack, concentrating its efforts on enveloping or encircling the retrograding enemy force, if the enemy is too strong to overrun. An attack aggressively pushed through the hostile front may isolate major elements and force the enemy force to evacuate the entire defensive position before it can construct a viable fall-back position.

3-121. When conducting a successful penetration, attacking units penetrate deeply into the hostile position to attack enemy reserves, artillery, command and control nodes, and lines of communication. Either the assault or a support unit attacks the enemy's newly exposed flanks to widen the gap. The commander sends forces through the gap that have a high degree of tactical mobility to exploit the penetration, attack the enemy from the rear, and prevent the enemy's escape. At this time, the commander's force multipliers—such as fixed-wing aviation assets—concentrate on supporting the ground force exploiting the penetration.

3-122. The commander plans logical sequels to the attack as part of the follow through. Attacking forces plan for exploitation. Exploiting forces plan for the pursuit of a defeated enemy. Furthermore, the commander must use subordinate forces without overextending their sustainment capabilities. The commander must plan to have fresh units pass around or through forward units to sustain the momentum of the attack. These fresh units may be assigned the task of follow and support or follow and assume in an effort to maintain the attack's tempo. (Appendix B discusses both tactical mission tasks.) A commander of any unit conducting any offensive task envisions how, under what conditions, where, and when that unit will need to transition to the defense, based on possible enemy countermoves and other events.

3-123. If the attacking unit transitions to a pursuit or exploitation, it may have to bypass enemy units to maintain the tempo. Units bypass enemy forces according to previously established bypass criteria. As a minimum, the bypassed force remains under observation or fixed in place by other units.

3-124. If the enemy succeeds in withdrawing major forces from action, the commander intensifies reconnaissance to obtain the information necessary to decide on a COA. Aggressive action may prevent the enemy from reconstituting an effective defense in a rearward position. The commander may have to delay the renewal of the attack until completing additional reconnaissance, so a tactically sound plan can be formulated if the enemy succeeds in occupying new defensive positions.

SPECIAL PURPOSE ATTACKS

3-125. The commander can launch an attack to achieve various results or for special purposes. These subordinate attack tasks include the—

- Ambush.
- Counterattack.
- Demonstration.
- Feint.
- Raid.
- Spoiling attack.

3-126. The commander's intent and mission variables of METT-TC determine the specific attack form. As subordinate attack tasks, they share many of the planning, preparation, and execution considerations of the attack. This section discusses the unique considerations of each subordinate attack task. Demonstrations and feints, while forms of attack, are also associated with the conduct of military deception operations. (See JP 3-13.)

AMBUSH

3-127. An **ambush is an attack by fire or other destructive means from concealed positions on a moving or temporarily halted enemy**. An ambush stops, denies, or destroys enemy forces by maximizing the element of surprise. Ambushes can employ direct fire systems as well as other destructive means, such as command-detonated mines, indirect fires, and supporting nonlethal effects. They may include an assault to close with and destroy enemy forces. In an ambush, ground objectives do not have to be seized and held.

3-128. The three forms of an ambush are the point ambush, the area ambush, and the anti-armor ambush. In a point ambush, a unit deploys to attack a single kill zone. In an area ambush, a unit deploys into two or more related point ambushes. A unit smaller than a platoon does not normally conduct an area ambush. Anti-armor ambushes focus on moving or temporarily halted enemy armored vehicles.

3-129. Ambushes are categorized as hasty or deliberate but take place along a continuum. A hasty ambush is an immediate reaction to an unexpected opportunity conducted using SOPs and battle drill. A deliberate ambush is planned as a specific action against a specific target. Detailed information about the target; such as size, organization, and direction of movement, and times the target will reach or pass certain points on its route, may be available. All forces may conduct an ambush. There are no ambush specific control measures. (Figure 3-6 shows the ambush tactical mission graphic.) Doctrine also categorizes ambushes as near or far ambushes, based on the proximity of the friendly force to the enemy.

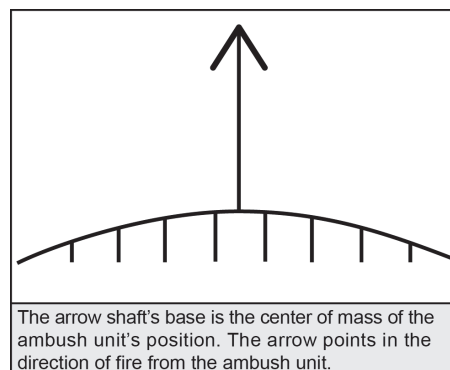

Figure 3-6. Ambush tactical mission graphic

3-130. The normal goal of an ambush is the death or capture of all enemy personnel located within the kill zone. Another goal could be to destroy certain designated vehicles, such as all missile transporter-erector launchers. Ideally, the ambush force can destroy the ambushed enemy so quickly that enemy personnel within the kill zone cannot to report the engagement while the ambush force accomplishes its mission.

Organization of Forces

3-131. A typical ambush is organized into three elements: assault, support, and security. The assault element fires into the kill zone. Its goal is to destroy the enemy force. When used, the assault force attacks into and clears the kill zone and may be assigned additional tasks, to include searching for items of intelligence value, capturing prisoners, and completing the destruction of enemy equipment to preclude its

immediate reuse. The support element supports the assault element by firing into and around the kill zone, and it provides the ambush's primary killing power. The support element attempts to destroy the majority of enemy combat power before the assault element moves into the objective or kill zone. The security element isolates the kill zone, provides early warning of the arrival of any enemy relief force, and provides security for the assault and support elements. It secures the objective rally point and blocks enemy avenues of approach into and out of the ambush site, which prevents the enemy from entering or leaving.

Planning an Ambush

3-132. During terrain analysis, leaders identify at least four different locations: the ambush site, the kill zone, security positions, and rally points. As far as possible, so-called "ideal" ambush sites should be avoided because alert enemies avoid them if possible and increase their vigilance and security when they must be entered. Therefore, surprise is difficult to achieve. Instead, unlikely sites should be chosen when possible. Other planning considerations for an ambush include—

- A “no-later-than” time to establish the ambush.
- A tentative ambush formation or, for an area ambush, element locations.
- Insertion and exit routes.
- A forward passage of lines and movement to the ambush site in tactical formation.
- Actions if the ambush is prematurely detected.
- A scheme of maneuver that maximizes engagement of the enemy's flank or rear, provides early warning of target approach, includes assault element actions in the kill zone, and details how the ambush element displaces from the ambush site.
- Actions at the objective.
- Obstacles to augment the effects of the friendly fire.
- A fire support plan that integrates the direct fire and obstacle plans, which results in the enemy's isolation, inflicts maximum damage, and also supports forces in the rally point.
- The criteria for initiating the ambush; for example, units only engage enemy formations of the same or smaller size and withhold fire until the target moves into the kill zone.
- Any required changes to the ambushing unit's fire distribution SOP.
- Rear security measures.

3-133. A point ambush usually employs a linear or an L-shaped formation. The names of these formations describe deployment of the support element around the kill zone. **The kill zone is that part of an ambush site where fires are concentrated to isolate, fix, and destroy the enemy.** The ambush formation is important because it determines whether a point ambush can deliver the heavy volume of fire necessary to isolate and destroy the target. The commander determines the formation to use based on the advantages and disadvantages of each formation in relation to the mission variables of METT-TC.

3-134. The assault and support elements generally deploy parallel to the target's route of movement—the long axis of the kill zone—which subjects the target to flanking fire in the line formation. (See figure 3-7.) The security element positions itself where it can best provide security to the assault and support elements. The size of the target that can be trapped in the kill zone is limited by the size of the area that can be covered by the support element's weapons. Natural, man-made, and military obstacles—reinforced with tactical obstacles integrated with direct and indirect fires—trap the target in the kill zone. A disadvantage of the line formation is that the target may be so dispersed that it is larger than the kill zone.

3-135. The linear ambush formation is effective in close terrain, which restricts the target's movement, and in open terrain where one flank is blocked by existing or reinforcing obstacles. The commander may place similar obstacles between the assault and support elements and the kill zone to protect the ambush force from the target's counter-ambush drills. When the ambush force deploys in a line formation, it leaves access lanes through these protective obstacles so that it can assault the target. An advantage of the line formation is that it is relatively easy to control under all conditions of visibility.

3-136. The L-shaped formation is a variation of the line formation. (See figure 3-8.) The long leg of the “L” (assault element) is parallel to the kill zone and provides flanking fire. An advantage of the “L”

formation is that the short leg (support element) is at the end of the kill zone and at a right angle to it and blocks the enemy's forward movement. It also provides enfilading fire that interlocks with fire from the other leg. The commander can employ an L-shaped formation on a straight stretch of trail, road, stream, or at a sharp bend.

3-137. An area ambush is most effective when enemy movement is largely restricted to trails or roads. The area should offer several suitable point ambush sites. The commander selects a central ambush site around which the commander can organize outlying ambushes. Once the site is selected, the commander must determine the enemy's possible avenues of approach and escape routes. Outlying point ambush sites are assigned to subordinates to cover these avenues. Once they occupy these sites, they report all enemy traffic going toward or away from the central ambush site to the commander. These outlying ambushes allow the enemy to pass through their kill zones until the commander initiates the central ambush. Once the central ambush begins, the out-lying ambushes prevent enemy troops from escaping or entering the area. (See figure 3-9.)

3-138. The ambush unit commander normally specifies the signals required to control the ambush. Changes to the meaning of audible and visual signals are made frequently to avoid setting patterns that the enemy can recognize. Otherwise, the enemy might recognize a signal and react in time to avoid the full effects of the ambush. For example, if a white star cluster is always used to signal withdrawal in a night ambush, an alert enemy might fire one and cause the ambush force to withdraw prematurely. The subordinate elements of the ambush unit must receive communications—in the form of signals—that relay the following information:

- Target approaching, normally given by a member of the security team to warn the ambush commander and the ambush elements of the target's progress.
- Initiate the ambush, given by the ambush unit commander. (This signal should be a mass casualty-producing signal initiated by a reliable weapon system or explosive, such as a main gun)

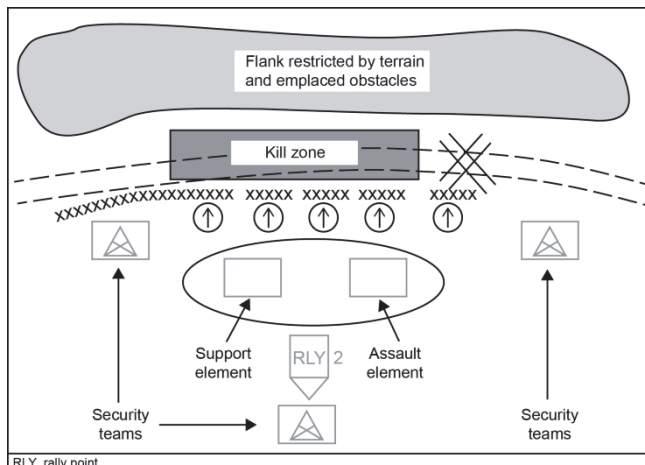

Figure 3-7. Linear ambush

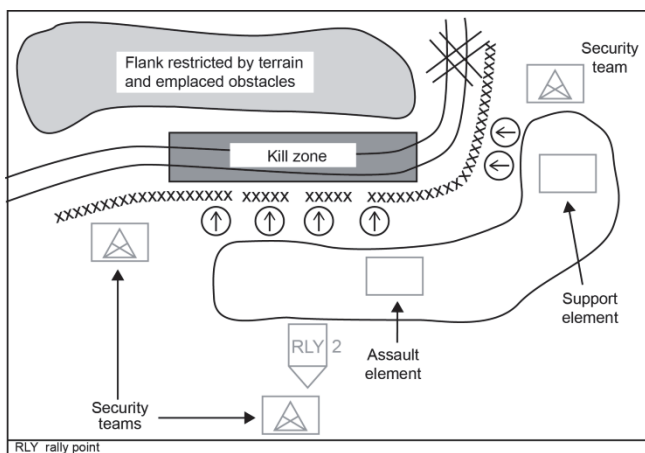

Figure 3-8. L-shaped ambush

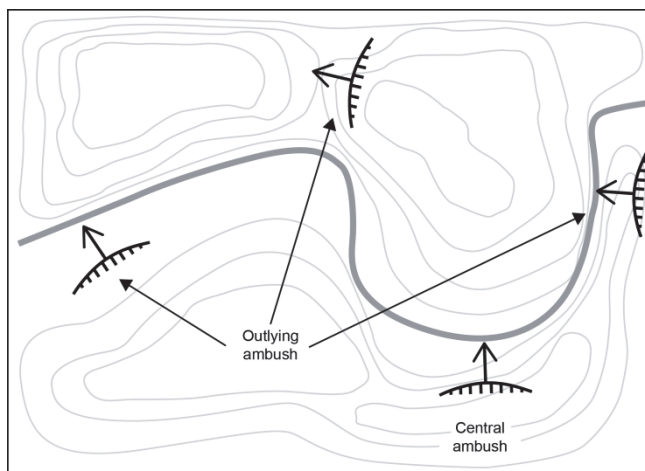

Figure 3-9. Area ambush

round from a tank or infantry carrier, the detonation of mines or explosives, or other direct fire crew-served weapons that fire from a closed bolt.)

- Lift or shift fire, given when the target is to be assaulted; all fires must stop or be shifted at once so that the assault element can attack before the target can react.
- Assault, given when the assault force is to move into the kill zone and complete its activities.
- Cease fire, given to cease all fires.
- Withdraw from the kill zone or ambush site, given when the ambush is completed or an enemy relief force is approaching.

3-139. The commander uses a variety of signals to communicate this information, such as radio transmissions, voice commands, vehicle horns, whistles, or pyrotechnics. All signals must have at least one backup. For example, if the signal to shift fire fails, the assault element should not attack the target unless it receives the backup signal. Signals sent out before initiation of the ambush should not expose the ambush to detection by the enemy. The commander reviews SOP signals to see if they need to be revised or augmented to meet specific situational requirements.

Preparation for an Ambush

3-140. The keys to a successful ambush are surprise, coordinated fires, and control. Surprise allows the ambush force to seize control of the situation. If total surprise is not possible, it must be so nearly complete that the target does not expect the ambush until it is too late to react effectively. Thorough planning, preparation, and execution help achieve surprise.

3-141. The commander conducts a leader's reconnaissance with key personnel to confirm or modify the plan. This reconnaissance should be covert to remain undetected and preclude alerting the enemy. If necessary, the commander modifies the ambush plan and immediately disseminates those changes to subordinate leaders and other affected organizations. The commander must maintain close control during movement to, occupation of, and withdrawal from the ambush site. Control is most critical when the ambush unit is approaching the target. Leaders enforce camouflage, noise, and light discipline. All elements of the ambush force reconnoiter their routes of withdrawal to the selected rally point. When possible, all Soldiers reconnoiter the routes they will use.

3-142. The ambush unit's security element remains at full alert and uses all available observation devices to detect the enemy's approach to the ambush site. Each Soldier's duties within each element are rotated as necessary to maintain alertness.

3-143. The commander positions all weapons, including mines and demolitions, to obtain the maximum effectiveness against the target in the kill zone. All fires, including those of supporting artillery and mortars, are coordinated. The support element isolates the kill zone, prevents the target's escape or reinforcement, and delivers a large volume of highly concentrated surprise fire into the kill zone. This fire must inflict maximum damage so the assault element can quickly assault and destroy the target.

Execution of an Ambush

3-144. Fire discipline is a key part of any ambush. Soldiers withhold fire until the ambush commander gives the signal to initiate the ambush. That signal should be fire from the most deadly and reliable weapon in the ambush. Once initiated, the ambush unit delivers its fires at the maximum rate possible given the need for accuracy. Otherwise, the assault could be delayed, giving the target time to react and increasing the possibility of fratricide. Accurate fires help achieve surprise as well as destroy the target. When it is necessary to assault the target, the lifting or shifting of fires must be precise. The assault element does not conduct its assault until enemy fires or resistance has been negated or eliminated.

3-145. If the ambush fails and the enemy pursues the ambush force, it may have to withdraw by bounds. It should use smoke to help conceal its withdrawal. Activating limited-duration minefields along the withdrawal routes after the passage of the withdrawing ambush force can help stop or delay enemy pursuit. The commander positions the support element to assist in the withdrawal of the assault element.

3-146. On the commander's order, the ambush force withdraws to the rally point, reorganizes, and starts its return march. At a previously established location, it halts and disseminates any combat information obtained as a result of the ambush to all elements of the ambush force. However, if information systems are able to disseminate this information, the force does not need to halt.

3-147. Once the ambush force returns from conducting the ambush, the commander or a representative debriefs the ambush force to help identify enemy patterns of response, activities, and procedures, both inside and outside the ambush area. Patterns should be analyzed and reported to all appropriate organizations through intelligence channels. The commander adjusts the tactics, techniques, and procedures employed by the unit to account for these patterns. (For additional information on the conduct of ambushes see the Maneuver Center of Excellence Army techniques publication for the infantry rifle platoon and squad.)

COUNTERATTACK

3-148. A **counterattack** is an attack by part or all of a defending force against an enemy attacking force, for such specific purposes as regaining ground lost or cutting off or destroying enemy advance units, and with the general objective of denying to the enemy the attainment of the enemy's purpose in attacking. In sustained defensive actions, it is undertaken to restore the battle position and is directed at limited objectives. The commander directs a counterattack—normally conducted from a defensive posture—to defeat or destroy enemy forces, exploit an enemy weakness, such as an exposed flank, or to regain control of terrain and facilities after an enemy success. A unit conducts a counterattack to seize the initiative from the enemy through offensive action. A counterattacking force maneuvers to isolate and destroy a designated enemy force. It can attack by fire into an engagement area to defeat or destroy an enemy force, restore the original position, or block an enemy penetration. Once launched, the counterattack normally becomes the commander's decisive operation. (See figure 3-10.)

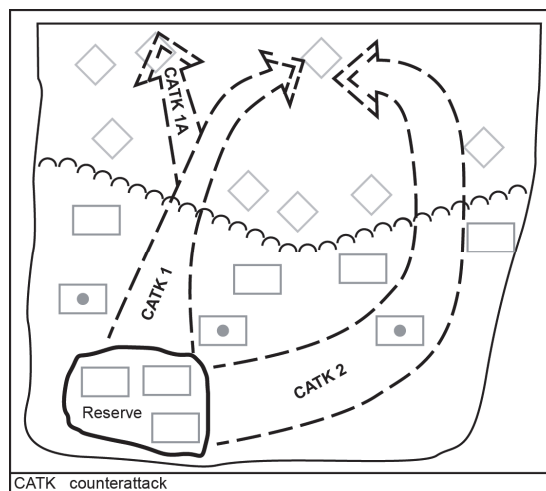

Figure 3-10. Projected major counterattacks

Once launched, the counterattack normally becomes the commander's decisive operation. (See figure 3-10.)

3-149. The commander plans and conducts a counterattack to attack the enemy when and where the enemy is most vulnerable, which is when the enemy is attempting to overcome friendly defensive positions. Normally, the commander attempts to retain a reserve or striking force to conduct a decisive counterattack once the enemy main force commits to the attack. The commander assigns objectives to counterattacking forces when they are intended to assault the enemy. The commander normally assigns attack by fire positions when counterattacking using primarily direct and indirect fires.

3-150. The two levels of counterattacks are major and local counterattacks. In both cases, waiting for the enemy to act first may reveal the enemy's main effort and create an assailable flank to exploit. A defending unit conducts a major counterattack to seize the initiative from the enemy through offensive action after an enemy launches an attack. A commander also conducts major counterattacks to defeat or block an enemy penetration that endangers the integrity of the entire defense, or to attrit the enemy by the defeat or destruction of an isolated portion of the attacking enemy.

Organization of Forces

3-151. The commander of a major counterattack force typically organizes available combined arms assets into security, reconnaissance, main body, and reserve forces. Those defending forces already in contact with the enemy are used to fix or contain those same enemy forces. The commander may use a force committed to the counterattack, such as the striking force in a mobile defense, the reserve, another

echelon's reserve, or designate any other force deemed appropriate to be the counterattack force. The commander completes changes in task organization in time to allow units to conduct rehearsals with their attached or supporting elements.

3-152. A commander conducts a local counterattack with whatever forces are immediately available to retake positions lost to enemy action or to exploit a target of opportunity. The forces often consist of the reserves of subordinates and defending forces that survive after completing their withdrawal from lost positions. While it is unlikely that the commander changes the task organization of the forces conducting a local counterattack, the commander organizes the force into a security force and a main body. The commander may be able to designate an element to conduct reconnaissance.

3-153. The counterattack force is a committed force from the beginning of the defense if the commander's defensive scheme hinges on a counterattack to destroy, dislocate, disintegrate, or isolate the attacking enemy force, such as the strike force in a mobile defense. In this case, the commander should designate another force as the reserve.

Planning a Counterattack

3-154. The commander plans to counterattack the enemy force when it is vulnerable. As the enemy force advances, the defense may create gaps between enemy units, exposing the flanks and rear of elements of the attacking force. Immediately after an enemy force occupies a defended position, it is often disorganized and ill prepared to meet a sudden counterattack. Opportunities for effective counterattacks are usually brief; the commander must assess the situation rapidly, and the force must execute the counterattack swiftly. The commander assigns objectives or attack by fire positions to counterattacking forces, depending on whether the counterattacking force is intended to close with and assault the enemy.

3-155. Major counterattack plans are normally developed as a branch or sequel to the main defensive plan. A major counterattack may achieve surprise when it strikes the enemy from an unanticipated direction. For that reason the force directed to conduct a major counterattack, such as the strike force in a mobile defense, should be involved in developing those plans as well as any plans to exploit potential success. Local counterattacks may or may not be the result of previous deliberate planning.

Preparing a Counterattack

3-156. The keys to a successful counterattack are surprise, control, and coordinated fires. Surprise allows the counterattacking force to seize control of the situation. If total surprise is not possible, it must be so nearly complete that the targeted enemy force does not expect the attack until it is too late to react effectively. Thorough planning and preparation help achieve surprise. The commander adjusts the positioning of reconnaissance and surveillance assets and the taskings given those assets so as to determine the location and targets for the counterattack.

3-157. Control of a counterattack begins with the commander's plan. The commander conducts a leader's reconnaissance with key personnel to confirm or modify the counterattack plan. If necessary, the commander modifies the plan and disseminates those changes to subordinate leaders and other affected organizations. Each element of the counterattack force reconnoiters its planned axis of advance and the routes it will take, if possible. The commander maintains close control during movement to and occupation of hide positions and this reconnaissance process so the enemy does not detect the counterattack force before initiating the counterattack. Leaders enforce camouflage, noise, and light discipline.

3-158. The commander coordinates fires by adjusting the planned positions of weapon systems to obtain maximum effectiveness against targets in the planned engagement area. The commander coordinates all fires, including those of supporting artillery and mortars. The commander uses these fires to isolate the targeted enemy force in the planned engagement area while preventing the target's escape or reinforcement. These fires must inflict maximum damage quickly before the enemy can respond to the counterattack.

Executing a Counterattack

3-159. A commander should not counterattack unless there is a reasonable chance of success. The commander attempts to retain a reserve to counterattack the enemy force after it reveals its main effort by

committing the majority of its combat power. If the commander orders the reserve to conduct a planned counterattack, the reserve becomes a committed force and the commander should take measures to designate or reconstitute a new reserve.

3-160. The commander conducts the counterattack in the same manner in which any other attack is conducted. The commander shifts priorities of support and fire and designates targets to be engaged by electronic warfare systems. The counterattack force also performs those activities discussed in paragraphs 3-61 to 3-124.

3-161. Subordinate commanders initiate local counterattacks with the forces on hand when it fits within the higher commander's intent. The conduct of a local counterattack should be swift and violent. Commanders exploit enemy disorganization, such as the confusion that temporarily exists in an attacking force after it seizes a defended position. A rapidly mounted local counterattack may yield better results than a more deliberate counterattack executed by a higher echelon because of the speed at which it can be launched.

3-162. In the face of a strong enemy penetration, a commander may conduct local counterattacks to retain or seize positions on the shoulders of the enemy's penetration. This prevents the enemy from widening the penetration while forces from other defending units engage the penetrating enemy forces. Holding the shoulders can also prevent the sacrifice of positional depth because the limited gap in the defensive position prevents an attacking enemy force from fully exploiting its success.

DEMONSTRATIONS AND FEINTS

3-163. In military deception, a *demonstration* is a show of force in an area where a decision is not sought that is made to deceive an adversary. It is similar to a feint but no actual contact with the adversary is intended (JP 3-13.4). A *feint* in military deception is an offensive action involving contact with the adversary conducted for the purpose of deceiving the adversary as to the location and/or time of the actual main offensive action (JP 3-13.4). A commander uses demonstrations and feints in conjunction with other military deception activities. They generally attempt to deceive the enemy and induce the enemy commander to move reserves and shift fire support assets to locations where they cannot immediately impact the friendly decisive operation or take other actions not conducive to the enemy's best interests during the defense. Both forms are always shaping operations. The commander must synchronize the conduct of these forms of attack with higher and lower echelon plans and operations to prevent inadvertently placing another unit at risk.

3-164. The principal difference between these forms of attack is that in a feint the commander assigns the force an objective limited in size, scope, or some other measure. Forces conducting a feint make direct fire contact with the enemy but avoid decisive engagement. Forces conducting a demonstration do not seek contact with the enemy. The planning, preparing, and executing considerations for demonstrations and feints are the same as for the other forms of attack.

RAID

3-165. A *raid* is an operation to temporarily seize an area in order to secure information, confuse an adversary, capture personnel or equipment, or to destroy a capability culminating in a planned withdrawal (JP 3-0). Raids are usually small, involving battalion-sized or smaller forces. Raids are normally conducted in five phases, as shown in figure 3-11 on page 3-30. In the first phase the raiding force inserts or infiltrates into the objective area. In the second phase the objective area is then sealed off from outside support or reinforcement, to include enemy air assets. In phase three any enemy forces at or near the objective are overcome in a violently executed surprise attack using all available firepower for shock effect. In phase four the force seizes the objective and accomplishes its assigned task quickly before any surviving enemy in the objective area can recover or be reinforced. Lastly in phase five the raiding force withdraws from the objective area and is extracted usually using a different route than what was used for movement to the objective. Operations designed to rescue and recover individuals and equipment in danger of capture are normally conducted as raids.

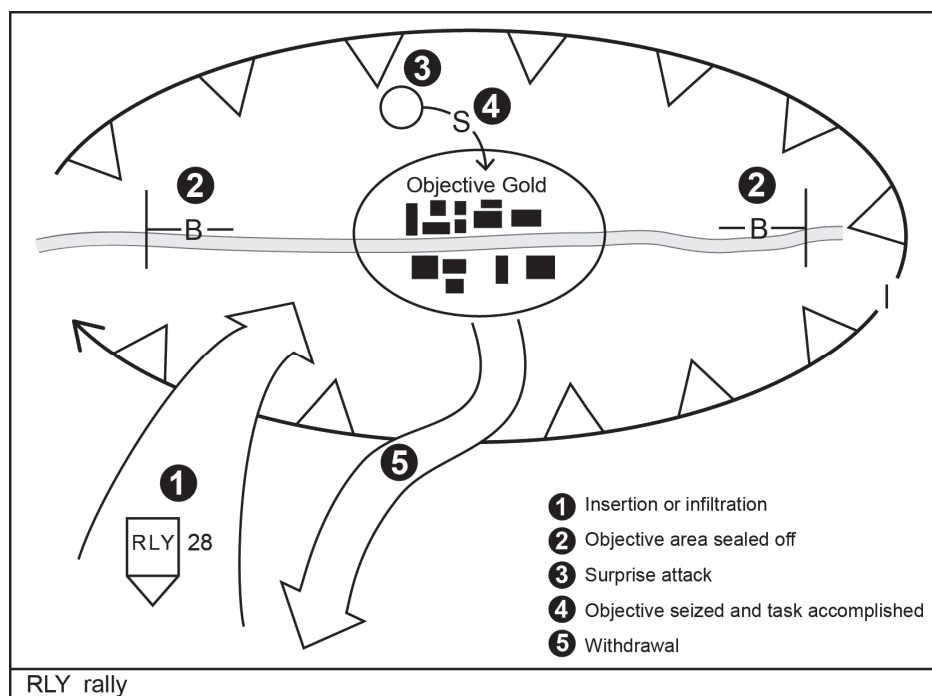

Figure 3-11. Five phases of a raid

3-166. A simplified raid chain of command is an essential organizational requirement. A raid usually requires a force carefully tailored to neutralize specific enemy forces operating in the vicinity of the objective and to perform whatever additional functions are required to accomplish the objective of the raid. These additional functions can consist of the demolition of bridges over major water obstacles or the recovery of an attack helicopter pilot shot down forward of the forward line of own troops (FLOT). The commander incorporates any necessary support specialists during the initial planning stage of the operation.

3-167. When a unit's commander and staff plan a raid, they develop COAs that meet ethical, legal, political, and technical feasibility criteria. Planners require precise, time-sensitive, all-source intelligence. The planning process determines how mission command, sustainment, target acquisition and target servicing will occur during the raid. Techniques and procedures for conducting operations across the FLOT are also developed, given the specific mission variables of METT-TC expected to exist during the conduct of the raid. The commander and staff develop as many alternative COAs as time and the situation permit. They carefully weigh each alternative. In addition to those planning considerations associated with other offensive actions, they must determine the risks associated with conducting the mission and possible repercussions.

3-168. All elements involved in a raid fully rehearse their functions, if time permits. The key elements in determining the level of detail and the opportunities for rehearsal before mission execution are time, OPSEC, and military deception requirements. (See Maneuver Center of Excellence Army techniques publications discussing the infantry rifle company, platoon, and squad for additional information on the conduct of raids.)

SPOILING ATTACK

3-169. A *spoiling attack* is a tactical maneuver employed to seriously impair a hostile attack while the enemy is in the process of forming or assembling for an attack. The objective of a spoiling attack is to disrupt the enemy's offensive capabilities and timelines while destroying targeted enemy personnel and equipment, not to seize terrain and other physical objectives. (See figure 3-12.) A commander conducts a spoiling attack whenever possible during the conduct of friendly defensive tasks to strike an enemy force

while it is in assembly areas or attack positions preparing for its own offensive operation or is temporarily stopped. A spoiling attack usually employs armored, attack helicopter, or fire support elements to attack enemy assembly positions in front of the friendly commander's main line of resistance or battle positions.

3-170. A commander conducts a spoiling attack to—

- Disrupt the enemy's offensive preparations.
- Destroy key assets that the enemy requires to attack, such as fire support systems, fuel and ammunition stocks, and bridging equipment.
- Gain additional time for the defending force to prepare its positions.
- Reduce the enemy's current advantage in the correlation of forces.

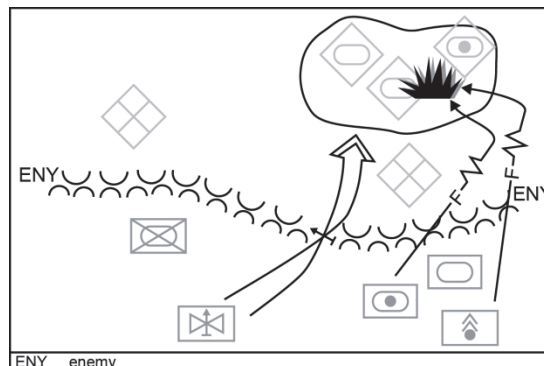

Figure 3-12. Spoiling attack

The commander synchronizes the conduct of the spoiling attack with other defensive actions.

3-171. The commander can employ reserve forces in a spoiling attack to throw the enemy's offensive preparations off stride. The commander assumes the risk of not having a reserve or designates another force as the echelon reserve in this case. The following considerations affect the spoiling attack:

- The commander may want to limit the size of the force used in executing the spoiling attack.
- Spoiling attacks are not conducted if the loss or destruction of the friendly attacking force would jeopardize the commander's ability to accomplish the defensive mission.
- The mobility of the force available for the spoiling attack should be equal to or greater than that of the targeted enemy force.
- Operations by artillery or aviation systems to prevent enemy elements not in contact from interfering with the spoiling attack are necessary to ensure the success of the operation.

3-172. There are two conditions that must be met to conduct a successful and survivable spoiling attack:

- The spoiling attack's objective must be obtainable before the enemy is able to respond to the attack in a synchronized and coordinated manner.
- The commander must prevent the force conducting the spoiling attack from becoming overextended.

If the spoiling attack fails to meet both conditions, it will likely fail, with grave consequences to the defense.

This page intentionally left blank.

Chapter 4

Exploitation

An exploitation takes full advantage of offensive success, following up initial gains, and making permanent the temporary effects already achieved. Commanders at all echelons exploit successful offensive actions. Attacks that succeed in annihilating a defending enemy are rare. Failure to aggressively exploit success at every turn may give the enemy time to reconstitute an effective defense by shifting forces or by regaining the initiative through a counterattack. Therefore, every offensive action not restricted by higher authority or lack of resources should be followed without delay by bold exploitation. The commander designs the exploitation to maintain pressure on the enemy, compound and take advantage of the enemy's disorganization, shatter the enemy's will to resist, and seize decisive or key terrain.

GENERAL CONSIDERATIONS OF AN EXPLOITATION

4-1. Exploitation is the primary means of translating tactical success into operational advantage. It reinforces enemy force disorganization and confusion in the enemy's command and control (C2) system caused by tactical defeat. It is an integral part of the concept of the offense. The psychological effect of tactical defeat creates confusion and apprehension throughout the enemy C2 structure and reduces the enemy's ability to react. Exploitation takes advantage of this reduction in enemy capabilities to make permanent what would be only a temporary tactical effect if exploitation were not conducted. Exploitation may be decisive.

4-2. Exploitation can occur regardless of the operational theme or point along the range of operations in which the exploitation occurs. All units, regardless of their size, conduct exploitation, although the discussion in this chapter tends to focus on the activities of large units during conduct of major combat operations. Small tactical units also conduct exploitations. For example, during counterinsurgency operations, a company could conduct a raid on an particular civilian residence during the night to exploit the information and intelligence gathered during its conduct of a cordon and search operation that occurred earlier in the day. In this example, effective search procedures, tactical site exploitation, tactical questioning, and the use of reconnaissance and surveillance assets are keys to the company being able to effectively conduct exploitation.

4-3. Those plan, prepare, execute, and assess concepts discussed in ADRP 5-0 apply during an exploitation. The commander modifies these concepts as necessary to reflect the specific existing mission variables of mission, enemy, terrain and weather, troops and support available, time available, and civil considerations (METT-TC). The five step sequence for executing offensive actions described in the introduction of this publication is used to discuss the execution of an exploitation. The first three steps are shaping operations and the last two constitute the decisive operation.

4-4. Local exploitation by the committed force follows a successful attack. A unit conducts a local exploitation when it capitalizes on whatever tactical opportunities it creates in the course of accomplishing its offensive mission. Whenever possible, the lead attacking unit transitions directly to the exploitation after accomplishing its mission in a local exploitation. If this is not feasible, the commander can pass fresh forces (follow and assume) into the lead. The commander acts quickly to capitalize on local successes. Although such local exploitations may appear insignificant, their cumulative effects can be decisive. Subordinate commanders, working within their higher commander's intent, use their initiative to launch exploitations. When initiating a local exploitation, the commander informs higher headquarters. This

prevents disruption of the higher echelon's battle or campaign and allows the higher headquarters to assess the possibility of general collapse and to initiate pursuit operations.

4-5. Conduct of a major exploitation is a specific contingency mission assigned to a large unit in anticipation of offensive success by another unit of equivalent size. Divisions and brigade combat teams (BCTs) are the echelons that typically conduct a major exploitation, although a corps can conduct a major exploitation as part of a multi-corps operation.

ORGANIZATION OF FORCES FOR AN EXPLOITATION

4-6. The forces conducting an attack are also the forces that initially exploit that attack's success. Typically, the commander does not assign a subordinate unit the mission of exploitation before starting a movement to contact or an attack. The commander reorganizes internally to reflect the existing mission variables of METT-TC when the opportunity to exploit success occurs. The commander then uses fragmentary orders (FRAGORDs) to conduct actions on contact. (See chapter 2 for a discussion of actions on contact.) If a commander needs additional resources to support the exploitation, they are requested from the appropriate headquarters. The additional resources may include reconnaissance and surveillance assets to help identify targets for attack, as well as attack helicopters and controlled munitions, such as the Army tactical missile system rockets, to attack identified targets. Each exploitation force should be large enough to defend itself from those enemy forces it expects to encounter. It should also be a reasonably self-sufficient combined arms force capable of operations beyond the supporting range of the main body.

4-7. The units that create an opportunity to exploit should not be expected to continue the exploitation to an extended depth. If the commander plans to exploit with a specific subordinate unit, the commander specifies the degree of damage or risk to that force the commander is willing to accept during the operation. If the initially attacking units incur significant losses of combat power, the commander replaces them as soon as possible. When the exploiting force's combat power weakens because of fatigue, disorganization, or attrition, or when it must hold ground or resupply, the commander should continue the exploitation with a fresh force. In both cases, the replacement force should have a high degree of tactical mobility, so it can conduct the exploitation.

4-8. The exploitation may be more effective if the commander can commit additional forces and assign them the task of either *follow and support* or *follow and assume*. The commander assigns follow and support missions to units designated to assist exploiting forces by relieving them of tasks that would slow their advances. The lead unit and any follow and assume or follow and support units exchange liaison teams to facilitate the transfer of responsibilities. Units designated to follow and assume conduct a forward passage of lines and replace the initial exploiting forces when they approach their culminating point. Normally, the next higher commander retains control of the forces performing the tasks of follow and support or follow and assume. (Appendix B expands the discussion of these tasks.) When possible, units assigned these tasks should possess mobility equal to that of the exploiting unit or receive additional engineers and transportation assets to provide the necessary mobility. Once organized, they are committed forces and should receive habitually associated artillery, air defense, engineer, and other functional and multifunctional support and sustainment forces in accordance with the mission variables of METT-TC. In an exploitation operation projected to cross significant distances, the commander may attach elements of a follow and support unit to the exploiting force to ensure unity of command and effort.

4-9. Since the force conducting an exploitation operation typically covers a wider front than an attacking force, fire support assets may find their supported elements operating outside normal supporting ranges. They must displace forward to ensure the continued provision of fires on and beyond enemy formations, which may cause some difficulty in supporting the exploiting force's flank elements. To provide the required support, these fire support units, as well as independently operating assets, can be attached to subordinate elements of the exploiting force. Otherwise, the commander can move additional reinforcing fire support elements forward to fill the void. The commander can use available air interdiction and close air support (CAS) by fixed-wing aircraft to augment or replace Army fire support assets during exploitation.

4-10. The joint air and missile defense (AMD) coverage for the initial attack is likely to remain effective throughout the exploitation. However, when a tactical commander accepts the risks involved and extends

subordinate formations and assets to cover more area, the AMD coverage probably becomes less effective. The commander needs to consider the risks associated with moving out from under the AMD umbrella provided by the Army air and missile defense command (AAMDC) or Army air defense artillery brigade supporting the joint force commander. The commander can request adjustments in that coverage to conform to the unit's tactical maneuvers. Counterair operations conducted by Air Force and Navy assets and anti-air warfare conducted by Marine Corps assets may provide the desired degree of AMD protection.

4-11. The exploitation mission demands a force with a significant mobility advantage over the enemy. This mobility advantage may be provided by forces with tracked or wheeled armored combat vehicles. Attack helicopters and air assault assets may constitute a portion of the exploiting force's combat power. They are extremely useful in seizing defiles, crossing obstacles, and otherwise capitalizing on their mobility to attack and cut off disorganized enemy elements. They can also seize or control key terrain such as important river-crossing sites or vital enemy transportation nodes along the exploiting force's route of advance into and through the enemy's support areas. The commander integrates combat engineers into the exploiting force to help breach obstacles, keep ground forces maneuvering, and provide countermobility protection to the flanks. Typical problems that degrade an exploiting force's mobility are minefields and other obstacles. The commander also uses engineers to keep the force's supply routes open.

4-12. The commander retains only those reserves necessary to ensure flexibility of operation, continued momentum in the advance, and likely enemy responses to the exploitation. (Chapter 3 discusses employment considerations for the reserve.)

RECONNAISSANCE AND SECURITY

4-13. When a commander initiates an exploitation operation, the exact enemy situation may not be clear. The commander orders one or more subordinates to conduct reconnaissance to gain and maintain enemy contact. Those forces conducting reconnaissance also provide a degree of security. The reconnaissance effort is complemented with sensors and surveillance assets and intelligence products produced by adjacent, higher, and lower echelons to maintain the commander's situational understanding of the strength, dispositions, capabilities, and intentions of all significant enemy elements within the area of interest. The commander normally emphasizes reconnaissance more than security operations when conducting exploitation. Nevertheless, since forces exploiting success tend to move independently, the overall commander addresses the total force's security needs.

4-14. The commander assigns the appropriate security missions to appropriate subordinates in the same way they are for a movement to contact. (See chapter 2.) An exploiting corps or division commander typically organizes the forward-most security element into a covering force to protect the main body's movement and develop the situation before the commander commits the main body. These security elements respond directly to the overall commander.

4-15. If an exploiting force is unable to resource a covering force for independent operations, it may use an advance guard in place of a covering force. This is typical for a BCT conducting exploitation on its own. In some cases when the higher echelon (corps or division) creates a covering force, a BCT subordinate to that corps or division may still push out its own advance guard behind the covering force. This normally occurs when subordinate exploiting units advance in multiple parallel columns.

SUSTAINMENT

4-16. Functional and multifunctional sustainment arrangements must be extremely flexible during exploitation operations. In the conduct of major exploitation operations directed against uncommitted enemy forces or in exploitation operations directed along diverging lines of advance, the tactical commander commonly attaches functional and multifunctional sustainment units to the exploiting maneuver force. This changes the normal support relationship between the two forces to a command relationship for the duration of the operation. At a minimum that command relationship should be operational control (OPCON) for positioning, movement, and defense since the sustainment unit will be a tenant unit within the tactical commander's area of operations (AO). Alternatively, the supporting sustainment assets can follow the exploiting force in an echeloned manner along main supply routes (MSRs). Transportation and supplies to sustain the force become increasingly important as the exploitation

progresses. As supply lines lengthen, the condition of lines of communications and the conduct of route and convoy security can become problems. The largest possible stocks of fuel, spare parts, and ammunition should accompany the force so that it does not lose momentum because of a lack of support.

4-17. The exploitation effort may be limited more by vehicle mechanical failures and the need for fuel than by combat losses or a lack of ammunition. Therefore, at the low tactical level a field maintenance team from the brigade support battalion (BSB) should accompany each exploiting company to assess problems and repair disabled vehicles quickly or evacuate them to maintenance collection points for repair or evacuation by the BSB's field maintenance company. The commander may use utility and cargo helicopters to move critical supplies forward during the exploitation.

CONTROL MEASURES FOR AN EXPLOITATION

4-18. Exploitation uses fewer control measures than many other operations because of the uncertain enemy situation and the need to provide subordinate commanders with the maximum flexibility to take advantage of fleeting opportunities. (See figure 4-1 for an example of control measures for a major exploitation. See figure 4-2 for an example of control measures for a local exploitation.) Planners develop control measures as part of the planning process. The commander issues these control measures as part of the attack order to facilitate mission command when the force transitions to exploitation.

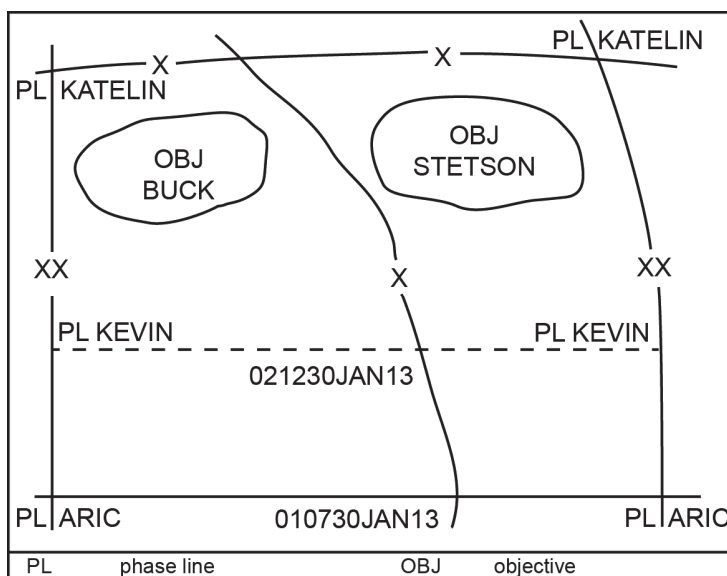

Figure 4-1. Control measures for a major exploitation

4-19. A unit conducting exploitation normally operates in the same AO it was assigned for the attack. The exploiting unit assigns subordinate units their own AOs. Boundaries between subordinate units may change often to take advantage of opportunities. Since an exploiting unit deploys reconnaissance and security forces, the commander must rapidly adjust boundaries as the exploiting force advances. The commander designates obstacle-restricted areas to prevent friendly obstacles from hindering the movement of the exploiting force. The commander designates obstacle zones on the flanks of the exploiting force's mobility corridors to enhance security. The commander uses phase lines and subsequent objectives to control the conduct of the exploitation. The commander uses objectives to orient the movement of exploiting forces. Although exploitation may result in taking a terrain objective, the primary focus should be on completing the destruction of the enemy force. The commander may establish a limit of advance if a culminating point can be anticipated or some other restriction, such as political considerations regarding an international border, requires its establishment.

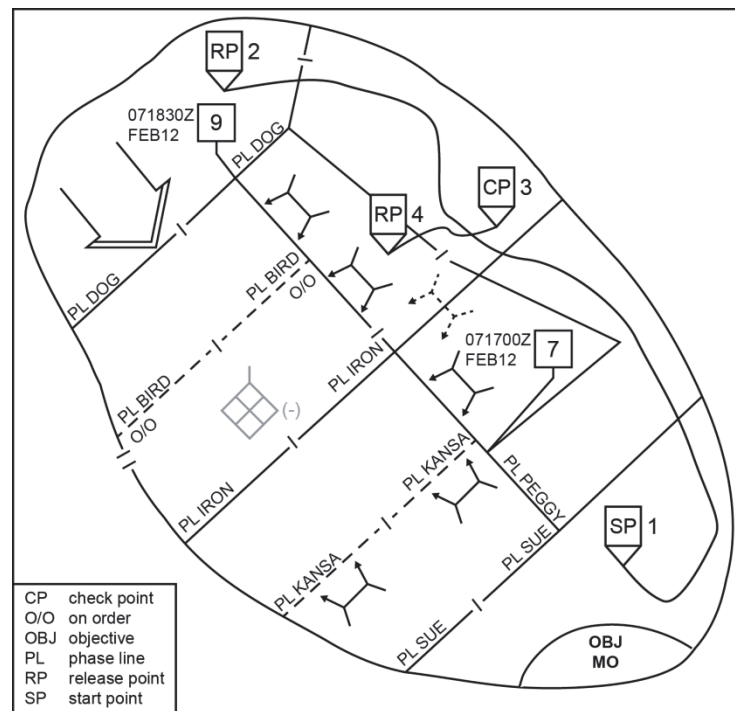

Figure 4-2. Control measures for a local exploitation

4-20. A commander normally employs permissive fire support coordination measures during exploitation. A coordinated fire line (CFL) ensures rapid response. Movement of the CFL is particularly important to provide adequate support as the force continues to advance. Even if the culmination of the exploitation is not anticipated, establishing a forward boundary is important to facilitate operations beyond that boundary by a higher headquarters. The commander can use additional control measures, such as targets and checkpoints, as required.

PLANNING AN EXPLOITATION

4-21. The commander's ability to deny the enemy options by proactive use of the warfighting functions is critical to a successful exploitation. This is done by arranging the warfighting functions within the opponent's time and space relationship in accordance with the mission variables of METT-TC. This applies whether conducting a local or a major exploitation.

4-22. The commander must plan for decentralized execution during the conduct of an exploitation. The commander's intent is especially important because subordinates must be able to exercise initiative in a rapidly changing situation. The commander must state the purpose of the exploitation, which may be to force the retrograde of enemy forces from an area, encircle enemy forces so they cannot withdraw, or destroy enemy artillery and other fire support systems. The intent must describe the desired end state. That intent will also determine the force's decisive and shaping operations and guide the designation of the main effort.

4-23. A clear commander's intent provides subordinates with guidance on integrating their operations into the overall operations of the higher headquarters. Subordinates act quickly to seize all opportunities to damage the enemy or accelerate the tempo of operations. Commanders place minimal restrictions on subordinates. These may include clear instructions regarding the seizure of key terrain and the size of enemy forces that may be bypassed. Reliable, secure communications between the exploiting force, the follow and support force, and the commander facilitate coordination that can maximize the impact of the

exploitation. However, all subordinates should have a clear picture of the desired end state to conduct operations that support it, even if communications are lost.

4-24. Exploitation planning begins during the preparation phase of all offensive actions. To avoid losing critical time during the transition from a movement to contact or an attack to exploitation, the commander tentatively identifies forces, objectives, and AOs for subordinate units before the offensive task begins. The defeat of these enemy forces and the seizure of these objectives deny the enemy routes of escape, result in the encirclement of selected enemy forces, and destroy enemy command and control nodes and the enemy's sustainment facilities. When the opportunity to exploit occurs, BCT and higher-echelon commanders initiate the exploitation either as a branch of or a sequel to the existing operation. Commanders may direct that lower tactical commanders immediately exploit the local successes of their units. However, the commander avoids driving the enemy back towards the enemy's sustaining base.

4-25. During exploitation planning and execution, the commander balances the force conducting the exploitation's need for speed and momentum against its need for security as it begins to move beyond supporting range of the rest of the force. The commander must be careful not to allow a force conducting exploitation to move outside of supporting distance of the main body. Determining the supporting distance requires some knowledge of the enemy's remaining capabilities. Generally, the commander should approach exploitation planning with a sense of guarded optimism. It is an excellent opportunity to shatter enemy cohesion and gain a position of advantage over the enemy. However, the commander cannot allow the exploiting force to fall into an enemy trap where it could be drawn into a salient and destroyed in detail.

4-26. The exploitation may take the form of a movement to contact with a series of hasty attacks. The commander usually issues a series of FRAGORDs that designate—

- Movement formation.
- The position of each major element within the formation of the force conducting the exploitation.
- Any required modifications to task organization.
- Bypass criteria.
- Revised or new control measures that assist with the maneuver, such as objectives, boundary changes, a limit of advance (LOA), and fire support coordination measures (FSCMs).

4-27. Forces conducting exploitation normally maneuver on a wide front and on at least two axes. The forces on each axis are capable of independent action, depending on the mobility of the force, the road net, and other aspects of the terrain. In some cases, rather than assigning subordinates their own AOs, the commander may designate a movement formation for the entire unit to concentrate all combat power against a specific enemy element. In this case, the commander normally adopts a variation of the column, line, or vee formation. (Chapter 1 discusses combat formations.) (Figure 4-3 shows an armored brigade combat team [ABCT] conducting exploitation with its battalions in column.) Movement on parallel routes is preferred; however, the terrain and the enemy situation may cause the force to advance in a column formation. Generally, using a column in the exploitation emphasizes flexibility at the expense of placing maximum firepower forward.

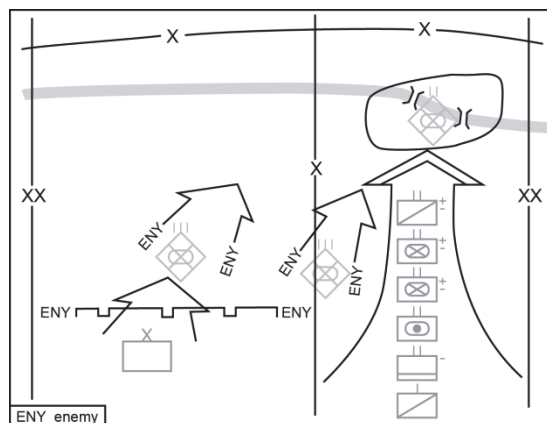

Figure 4-3. Brigade exploitation: battalions in column formation

Generally, using a column in the exploitation emphasizes flexibility at the expense of placing maximum firepower forward.

4-28. In exceptional circumstances, when the enemy is clearly incapable of effectively resisting, the commander can choose temporarily not to retain a reserve but to commit all forces to the exploitation. The commander may employ a line formation with two or more elements abreast without a reserve when the approach to the objective must be made on as wide a front as possible. For example, a commander could use this formation when attempting to secure crossing sites over a major river. (See figure 4-4 on page 4-7.)

The commander could also employ this formation against sporadic and weakening resistance when the enemy lacks a significant counterattack capability or when the counterattack can be blocked by means other than employing the reserve. Despite the lack of a constituted reserve, other actions, such as the effective employment of massed indirect fires, can provide the commander with the flexibility usually provided by the reserve for influencing actions during exploitation.

4-29. A vee formation with two or more elements abreast and a reserve allows the unit to advance on a reasonably wide front with the bulk of the unit's direct firepower oriented forward. This configuration helps when creating gaps in the enemy's defenses. While the bulk of the unit is committed, the reserve is available to exploit the success of the attacking elements, or counter enemy threats as they develop. (See figure 4-5 and figure 4-6 on page 4-8.)

4-30. Because of the need to rapidly transition from an attack to exploitation, exploitation fire planning must take place as part of the planning for the attack. The commander establishes links between military intelligence, reconnaissance, attack aviation, field artillery, electronic warfare, and supporting fixed-wing aviation assets to expedite the detection and delivery of effects against situationally dependent high-priority targets. The commander selects those targets regardless of their location within the enemy's defensive area to support the exploitation. During the exploitation, there is little time to revise target lists. Target considerations are similar to those of a movement to contact. In addition, the exploitation requires a flexible, responsive, and redundant fire control net that must be planned in advance. Coordination with the echelon intelligence officer is critical as the situation develops into exploitation. The exploiting force templates known enemy locations within its AO as danger areas and targets them.

4-31. The fire support plan includes allocating support for meeting engagements or hasty attacks that occur during the exploitation. The fire support coordinator (FSCOORD) plans targets beyond the projected locations of the exploiting maneuver forces to shield them from enemy counterattacks. The FSCOORD then addresses how to provide fire support to the force in its movement to the LOA and targets locations beyond the LOA to interdict the enemy's lines of communication (LOCs).

4-32. The commander plans for artillery and mortar displacement as an integral part of the exploitation. These indirect fire assets must displace at a faster pace than during normal offensive actions, while maintaining the capability to provide accurate and lethal fires. The commander can normally plan on subordinate forces using less ammunition during an exploitation than in an attack because fleeing enemy forces are normally not in prepared positions, and thus are more vulnerable. The commander should also consider using close air support in the exploitation, especially to support those units moving beyond supporting range of the main body. Airborne forward air controllers can help identify and track high-payoff targets forward of the exploiting force.

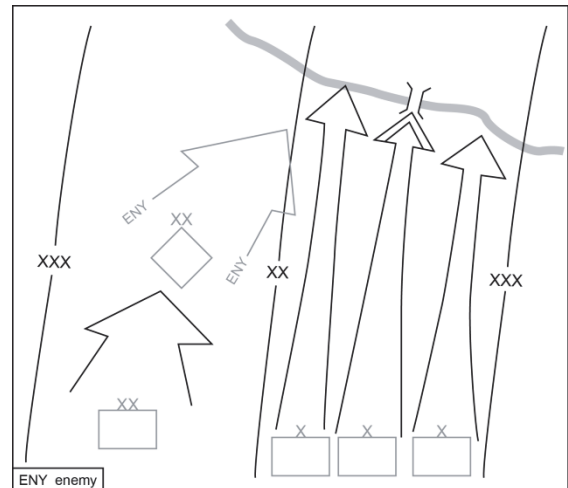

Figure 4-4. Division exploitation: brigades abreast, no reserve

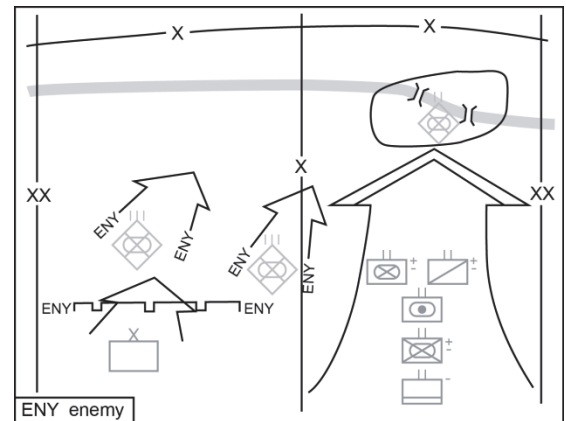

Figure 4-5. Brigade exploitation: two battalions forward, one in reserve

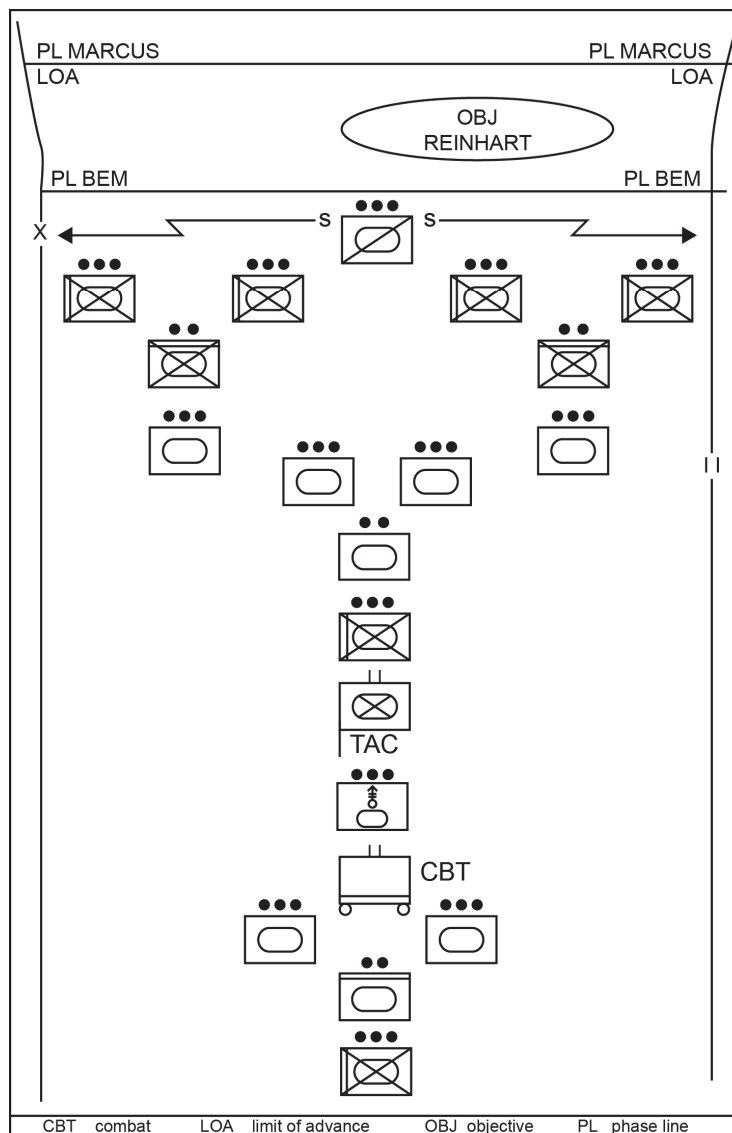

Figure 4-6. Exploitation control measures for a combined arms battalion in a vee formation

4-33. The commander plans situational obstacles for each phase of the operation. For example, in accordance with the rules of engagement, the commander places scatterable minefields in those areas that could be used by an enemy counterattack force as friendly forces move forward.

4-34. The enemy may be willing to commit aircraft against a friendly exploitation that endangers the viability of the enemy's defense, buying the enemy time to prepare a defense while weakening the friendly force. Enemy forces may have the ability to employ unmanned aircraft systems in reconnaissance and attack roles. The tactical commander plans a decision point to request through command channels that the joint force commander reposition joint air and missile defense assets to provide priority of protection to that part of the commander's decisive operation that moves out from under the existing air and missile defense umbrella. Ideally, that existing defensive umbrella protects the commander's tactical lines of communication from enemy air attack, thereby allowing supporting functional and multifunctional sustainment elements to keep pace with the operation. The commander must plan how to rapidly resupply air and missile defense missiles as they are used and protect launch locations from interference from enemy

ground attack. The commander must also allow for adjustments in the priority of protection assigned to different elements during the exploitation.

4-35. The commander must anticipate the exploitation and ensure that the sustainment plan supports the force all the way to the LOA. Planning for sustainment in the exploitation includes designating future main supply routes (MSRs), logistics release points, maintenance collection points, casualty collection points, medical treatment facilities, ambulance exchange points, and prisoner of war collection points. In sustaining the exploitation, petroleum, oil, and lubricants (POL) consumption and vehicle maintenance are primary concerns of sustainment planners. A significant factor is that an exploiting force tends to travel on a broad front, which may necessitate designating one or more lateral MSRs to handle the dispersion. Sustainment operators must be prepared to bound their sustainment assets farther forward and move them more often than in an attack. Commanders consider in their planning the amount of military logistics and health support needed by the civilian population of the AO beyond what the civilian sector can provide for itself during an exploitation. It is the commander's decision, after being informed by the staff, as to how much the provision of such support should be allowed to impact on the conduct of the exploitation.

4-36. Selecting a flexible MSR is critical because it must be able to respond to changes in the direction of the exploitation. Maintaining the MSR is a responsibility of the force engineers. During planning, the commander must specifically address the control of sustainment unit positioning and convoys. The tactical commander calls supporting as well as organic sustainment units forward and redirects them as needed. Low tactical echelon commanders may have to plan for guides to assist the movement of these sustainment assets around bypassed enemy positions and obstacles. The commander may assign some maneuver elements from the reserve an "on-order" mission to conduct echelon support area security to help protect echelon sustainment and other supporting elements or secure the MSR. The commander must also ensure adequate plans exist for controlling displaced civilians on the battlefield, so that they do not interfere with follow-on maneuver and support assets. This is a critical stability task that impacts exploitation operations.

EXECUTING AN EXPLOITATION

4-37. An exploitation may be initiated on order or on reaching prescribed objectives or phase lines. Local and major exploitations require physical and mental aggressiveness to combat the friction of limited visibility, fatigue, bad weather, fratricide dangers, and the exhaustion associated with extended operations. An exploitation requires bold and aggressive reconnaissance, prompt use of firepower, and rapid employment of previously uncommitted units. Exploiting forces maneuver swiftly toward their objectives, sever enemy escape routes, and strike at enemy command posts, communications nodes, reserves, artillery, and functional and multifunctional support units to prevent the enemy from reorganizing an effective defense. Exploiting forces should be able to change direction on short notice. The commander supports exploiting forces with tactical air support, attack aviation, artillery fires, and electronic warfare. Units participating in exploitation apply the doctrine, tactics, techniques, and procedures appropriate for a unit of their size conducting a movement to contact and an attack.

4-38. To maintain sufficient forces to conduct exploitation, the commander must ensure that subordinates focus on the commander's intent. They should not dissipate their combat power by seeking minor tactical successes or reducing inconsequential enemy forces. The aim is to reach the final objective with the maximum possible strength as rapidly as possible. The commander must provide exploiting forces with mobile sustainment, including air resupply, to move emergency lifts of POL and ammunition.

4-39. The transition from attack to exploitation may be so gradual that it is hardly distinguishable; it may also be abrupt. The abrupt transition may occur when a force uses large numbers of precision munitions, achieves surprise, or overwhelms a much weaker enemy force. Normally, the commander orders an exploitation after the force seizes or secures its objective. With adequate support, the commander can launch the exploitation with the initial assault or at any time after that, depending on the effects of the fires and the commander's desires.

4-40. Since the exploitation takes advantage of previous success, forces previously allocated toward attacking enemy forces normally continue their ongoing activities. These activities include—

- Attrition or defeat of enemy reserves before their commitment.
- Destruction of enemy countermobility assets before their employment on a friendly avenue of advance for the exploiting force.
- Disruption of enemy units attempting to reestablish a coherent defense.
- Disruption of enemy sustaining operations.

This assumes the commander has accurate and timely intelligence to target these enemy actions.

4-41. Generally, as one part of the attacking force finishes clearing an objective, the commander orders the remaining elements to exploit that success. To accomplish this with minimal confusion, the commander must know where each subordinate and supporting element is and what combat formation each has adopted. If the commander has previously trained and rehearsed the force to change rapidly from one combat formation to another, to change missions, and to change the direction of advance, the commander can time the execution of such changes to maintain the initiative over an enemy.

4-42. The commander can also initiate exploitation upon the realization that the enemy force is having difficulty maintaining its position or cohesion. Updated intelligence is crucial to the commander, since it is difficult to accurately predict the exact conditions required to transition from an attack to exploitation. Therefore, the commander and subordinates watch the enemy's defenses for indications of disintegration that may signal the opportunity to transition to exploitation. Such indicators include the following:

- The threat or use of weapons of mass destruction by enemy forces, despite the probable U.S. retaliation, may signal impending enemy collapse.
- Enemy reconnaissance intensifies.
- Rearward movement increases, especially by fire support and reserves.
- The enemy prepares to demolish or destroy facilities, installations, equipment, and supply stockpiles.
- Various units intermix their vehicles and personnel in combat formations or march columns.
- The number of prisoners captured increases significantly.
- Enemy fire decreases in intensity and effectiveness.
- Fires increase in one or more individual sectors of the front that do not appear to be synchronized with the developing situation and at a time when the amount of defensive fires appears to be decreasing.
- Enemy resistance decreases considerably, or the enemy lacks any type of organized defense.
- The amount of abandoned enemy war materiel encountered increases significantly.
- Reports confirm the capture or absence of enemy leaders.
- Friendly forces overrun enemy artillery, C2 facilities, and supply points.
- Enemy units disintegrate and friendly companies and battalions can defeat enemy battalion- and brigade-sized units, respectively.

In any case, the commander ruthlessly exploits vulnerable enemy forces after weighing and accommodating the risks.

4-43. The commander has two general methods to exploit the unit's battlefield success. The commander rapidly implements the method chosen. The first method is to exploit with committed forces. In this method, forces are committed to exploit their own success. This is extremely common at low tactical echelons, such as the battalion and below, at all points along the range of operations. This method is generally indicated when the attacking unit has accomplished its mission with minimum loss and is the force most readily available to continue the advance. It may become necessary to reorganize and resupply these forces while they are still moving to maintain the momentum of the exploitation.

4-44. The second method is to exploit with forces other than the unit that achieved the initial battlefield success. This other force may be the echelon reserve or specifically designated follow-and-support or follow-and-assume forces. In this method, this other force is committed by passing around, over, or through the forces that achieved the initial success. This method is generally indicated when the attacking echelon still has essential tasks to accomplish, is still actively engaged with enemy forces, or will require

reorganization before it can continue the advance. This commonly occurs in exploitations by brigades and larger units.

GAIN AND MAINTAIN ENEMY CONTACT

4-45. The exploiting force must gain and maintain contact with the enemy. This is a critical aspect of local and major exploitations, since the enemy may be trying to break contact and distance itself from the friendly force to give enemy units time to recover. After a successful attack, the exploiting force must perform aggressive reconnaissance to both its front and flanks. The commander's intent determines how much contact is required to maintain pressure on the enemy, compound the enemy's disorganization, shatter the enemy's will, and seize key or decisive terrain. As discussed in chapter 3, this reconnaissance effort must start almost immediately after an attacking unit seizes its objective. If the commander has dedicated reconnaissance assets, they are used to maintain enemy contact, observe the enemy's movements, and search for weakly defended enemy positions. If those assets are not available, other maneuver units perform those reconnaissance tasks. While maintaining contact with the enemy, the reconnaissance force tries to locate enemy reserves, uncommitted forces, and blocking positions. This effort helps the exploiting force avoid being led into ambushes as the enemy seeks to recover the initiative by counterattacking.

4-46. When the previously assigned offensive mission is accomplished, units at all echelons push out their reconnaissance and security forces to discover whether the opportunity exists to initiate exploitation. At BCT and battalion echelons, these reconnaissance and security forces must gain and maintain enemy contact while remaining within the supporting range of their parent brigade or battalion.

4-47. The commander uses air reconnaissance to augment ground reconnaissance. The commander can employ aerial sensors, such as manned and unmanned aircraft systems, in advance of ground maneuver reconnaissance. This allows aerial observation of named and targeted areas of interest that facilitate the unit's movement and cue the attack of high-payoff targets. Armed manned and unmanned aircraft can locate enemy positions and engage the enemy to disrupt the enemy's movement and preparations. Aviation assets maintain constant contact and pressure on the enemy.

DISRUPT THE ENEMY

4-48. The commander's decision to exploit presumes that the enemy has already been somewhat disrupted. The commander exploits to maintain or increase this disruption by preventing the enemy from reconstituting an effective defense. At the division and corps levels, the commander combines the effects of operations against enemy reserves and uncommitted forces with the rapid maneuver of ground maneuver forces to maintain this disruption. Attack helicopters can maneuver in front of exploiting ground maneuver forces to destroy high-payoff targets. The commander integrates fixed-wing aircraft into the fire plan for attacking these targets. Rapid advances by the exploiting force keep the enemy force off balance and degrade enemy intelligence and surveillance capabilities, thus providing some security from attack. The commander uses all available resources to maintain pressure on the enemy, using both overwhelming combat power and asymmetric weapon systems. The commander never allows the enemy an opportunity to recover from the initial blow. The exploiting force's fire support system must deliver massed fires quickly to respond to any contingencies that arise during the exploitation.

FIX THE ENEMY

4-49. As part of its shaping operations, an exploiting force has three goals in fixing an enemy force. First, it tries to break down the enemy's combined arms organization by fixing enemy units in positions out of supporting distance of each other. This allows the exploiting force to defeat the enemy in detail. Second, the commander attacks out-of-contact enemy forces before they can adversely affect the exploitation. By attacking these enemy forces, the commander seeks to fix them in their current positions or force them to move to locations where they can be harmlessly contained until the exploiting force or a follow and support force can engage and defeat them. Third, it achieves a specific targeting effect—such as causing 15-percent casualties—that disrupts the enemy commander's plan.

DECISIVE OPERATION

4-50. During an exploitation, the exploiting force maneuvers to maintain pressure on the enemy. Swift raids, thrusts, and envelopments prevent enemy reorganization. The commander can use any armored, Stryker, and mobile light infantry forces, such as airborne or air assault elements, to secure terrain objectives or choke points critical to the advance and to cut enemy lines of escape. The commander takes advantage of vertical envelopment capabilities to secure objectives critical to the advance and to cut enemy lines of escape. The exploiting force clears only enough of its AO to permit its advance. It cuts through enemy logistics units and lines of communications to seize objectives vital to the enemy's defense. It attacks from the march to overrun weak enemy formations. In accordance with the bypass criteria, the exploiting force can contain and bypass those enemy pockets of resistance too small to jeopardize the mission while its commander reports these enemy forces to adjacent units, following units, and higher headquarters.

4-51. If an enemy unit is too strong for the leading elements of the exploiting force to overrun and destroy, succeeding elements of the force conduct a hasty attack based on the combat information provided by its leading elements. Such enemy forces are rarely attacked frontally. In almost all cases, the commander uses another form of maneuver to produce faster and better results with fewer casualties. While the exploiting force is seeking one or more assailable flanks, available fire support systems continue to engage the enemy to divert attention from the attempted envelopment and destroy as much enemy combat power as possible.

4-52. The exploiting force may face prepared belts of defensive positions in depth when it is exploiting the initial success of the attack. Therefore, the exploiting force must move rapidly to attack and destroy the enemy before enemy defending forces can settle into subsequent or supplemental positions. The faster the exploiting force moves, the less likely it is that succeeding defensive lines will be fully prepared and the less effort it will take to penetrate each successive defensive position. The exploiting force attacks and maneuvers as many times as necessary until it breaks completely through the enemy's defenses.

4-53. The commander's primary concern when initiating an exploitation resulting from a successful attack is to shift the force into the appropriate combat formation and task-organize it with additional capabilities and resources to take advantage of a short window of opportunity. The commander must control the formation as it moves and prevent its overextension. The commander must anticipate the enemy's reactions to friendly actions. The real danger to the exploiting force is not the immediate enemy, but the enemy not yet engaged. Overextension is a risk inherent in exploitation. While commanders avoid overextension, they must also guard against being overcautious.

4-54. During an exploitation, the commander often surrounds or bypasses enemy units. Surrender appeals and ultimatums are particularly effective when directed against enemy units that have been surrounded, isolated, or bypassed. JP 3-13.2 and FM 3-53 detail ways for communicating with the enemy.

4-55. While the exploiting force is conducting its operations, the follow and support force, if available—

- Widens or secures the shoulders of a penetration.
- Destroys bypassed enemy units.
- Relieves supported units that have halted to contain enemy forces.
- Blocks the movement of enemy reinforcements.
- Opens and secures lines of communications.
- Guards prisoners, key areas, seized enemy bases and installations, and lines of communication.
- Controls dislocated civilians.

FOLLOW THROUGH

4-56. Once the exploitation begins, friendly forces quickly move to attack enemy forces. The exploitation continues around the clock, so the enemy cannot escape the relentless offensive pressure. The exploiting force retains terrain only as necessary to accomplish its mission. The commander must be careful not to dissipate combat power to achieve minor tactical successes or to reduce small enemy forces. Once the exploiting force reaches the LOA, the commander quickly shifts attention to reconnaissance and surveillance, counter mobility, and protection because of the possibility of an enemy counterattack.

4-57. At some point a unit conducting an exploitation reaches a culminating point or transitions to a pursuit. Culmination can occur for a variety of reasons, such as friendly losses or the enemy's commitment of a reserve. The commander, when making an assessment that the force is approaching culmination, should transition to another type of operation. For example, a pursuit enables the commander to complete the enemy's destruction.

This page intentionally left blank.

Chapter 5

Pursuit

A pursuit differs from the exploitation in that its primary function is to complete the destruction of the targeted enemy force. Army doctrine regards a pursuit as an offensive task. Pursuit operations begin when an enemy force attempts to conduct retrograde operations. At that point, it becomes most vulnerable to the loss of internal cohesion and complete destruction. An aggressively executed pursuit leaves the enemy trapped, unprepared, and unable to defend, faced with the options of surrendering or complete destruction. Pursuits include the rapid shifting of units, continuous day and night movements, hasty attacks, containment of bypassed enemy forces, large numbers of prisoners, and a willingness to forego some synchronization to maintain contact with and pressure on a fleeing enemy. Pursuits require swift maneuver and attacks by forces to strike the enemy's most vulnerable areas. A successful pursuit requires flexible forces, initiative by commanders at all echelons, and a high tempo during execution.

GENERAL CONSIDERATIONS FOR A PURSUIT

5-1. The enemy may conduct a retrograde when successful friendly offensive actions have shattered the enemy's defense. In addition, the enemy may deliberately conduct a retrograde when—

- Reacting to a threat of envelopment.
- Adjusting battlefield dispositions to meet changing situations.
- Attempting to draw the friendly force into fire sacks, kill zones, or engagement areas.
- Planning to employ weapons of mass destruction.

5-2. Modern military information systems give brigade combat teams (BCTs) the ability to leverage external Service, joint, and interagency intelligence assets to determine if the enemy is conducting a retrograde. When faced with enemy attempts to break contact, BCTs and maneuver battalions act to maintain contact until a division or corps commander directs them to initiate a pursuit operation.

5-3. Unlike an exploitation, which may focus on seizing key or decisive terrain instead of the enemy force, the pursuit always focuses on completing the destruction of fleeing enemy forces by destroying their ability and will to resist. This is seldom accomplished by directly pushing back the hostile forces on their lines of communication (LOCs). The commander in a pursuit tries to combine direct pressure against the retreating forces with an enveloping or encircling maneuver to place friendly troops across the enemy's lines of retreat. This fixes the enemy in positions where the enemy force can be defeated in detail. If it becomes apparent that enemy resistance has broken down entirely and the enemy is fleeing the battlefield, any other offensive task can transition to a pursuit.

5-4. Conducting a pursuit is a prudent risk. Once the pursuit begins, the commander maintains contact with the enemy and pursues retreating enemy forces without further orders. The commander maintains the pursuit as long as the enemy appears disorganized and friendly forces continue to advance. Like exploitation, pursuit tests the audacity and endurance of Soldiers and leaders. In both operations, the attacker risks becoming disorganized. Extraordinary physical and mental effort is necessary to sustain the pursuit, transition to other operations, and translate tactical success into operational or strategic victory.

5-5. The commander must be aware of any approaching culmination point. Enemy forces are usually falling back on their supply bases, and potentially on fresh units, while friendly forces become less effective as they expend resources faster than they can be replaced. Reasons to stop the pursuit include the

presence of fresh enemy forces, greatly increased resistance, fatigue, dwindling supplies, diversion of friendly units to security missions, increased need to conduct immediate civil security and civil control tasks, and the need to contain bypassed enemy units. The unit staff should have developed a decision support template that depicts decision points, timelines associated with the movement of forces and the flow of the operation, and other key items of information required before the unit reaches that culmination point.

5-6. Those plan, prepare, and execute concepts introduced previously continue to apply during a pursuit. The assessment concepts described in ADRP 5-0 also apply. The commander modifies them as necessary to account for the specific existing mission variables of mission, enemy, terrain and weather, troops and support available, time available, and civil considerations (METT-TC).

ORGANIZATION OF FORCES FOR A PURSUIT

5-7. Normally, the commander does not organize specifically for pursuit operations ahead of time, although the unit staff may plan for a pursuit mission as a branch or sequel to the current order. Therefore, the commander must be flexible to react when the situation presents itself. Subordinate elements are made as self-sufficient as resources will permit. The commander's maneuver and sustainment forces continue their ongoing activities, while the commander readjusts priorities to better support the pursuit. The commander requests and acquires additional support from higher headquarters in accordance with the mission variables of METT-TC. For most pursuits, the commander assigns subordinate forces security, direct-pressure, encircling, follow and support, and reserve missions. The commander can assign available airborne or air assault units the encircling mission because of their ability to conduct vertical envelopments. Given sufficient resources, there can be more than one force assigned the encirclement mission. The subordinate unit assigned the follow and support mission polices the battlefield to prevent the dissipation of the combat power of the unit assigned the direct-pressure mission. Appendix B addresses the duties of a follow and support force. The reserve allows the commander to take advantage of unforeseen opportunities or respond to enemy counterattacks.

5-8. There are two options in conducting a pursuit; each involves assigning a subordinate the mission of maintaining direct-pressure on the rearward moving enemy force. The first is a frontal pursuit that employs only direct-pressure. The second is a combination that uses one subordinate element to maintain direct-pressure and one or more other subordinate forces to encircling the retrograding enemy. The combination pursuit is generally more effective. Either the subordinate applying direct-pressure or the subordinate conducting the encirclement can be conducting the decisive operation in a combination pursuit.

FRONTAL PURSUIT

5-9. In a frontal pursuit, the commander employs only a single force to maintain direct-pressure on the retrograding enemy by conducting operations along the same retrograde routes used by that enemy. (See figure 5-1.) The commander chooses this option in two situations. The first is when a subordinate force with a sufficient mobility advantage to get behind a retrograding enemy force cannot be created. The second is when the commander cannot provide enough resources to the force conducting the encirclement to allow that force to survive and sustain itself until linkup with the direct-pressure force can be achieved. Either situation can occur because of restrictive terrain or because an enemy withdraws in a disciplined, cohesive formation and still has significant available combat power.

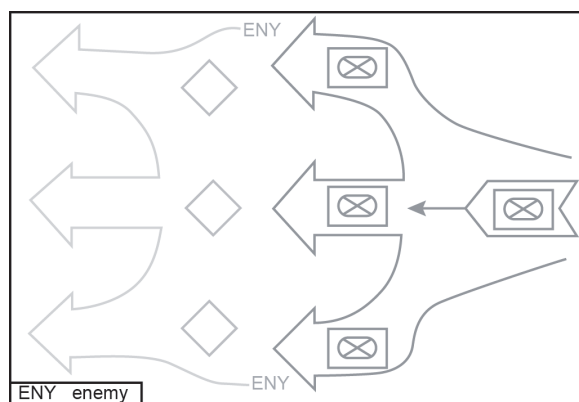

Figure 5-1. Frontal pursuit

COMBINATION PURSUIT

5-10. In the pursuit, the most decisive effects result from combining a direct pressure force and an encircling force. **The direct pressure force is a force employed in a pursuit operation that orients on the enemy main body to prevent enemy disengagement or defensive reconstitution prior to envelopment by the encircling force. It normally conducts a series of attacks to slow the enemy's retirement by forcing the enemy to stand and fight.** (See figure 5-2.) In the combination pursuit, the force providing direct-pressure initiates a frontal pursuit immediately on discovering the enemy's initiation of a retrograde operation. This slows the tempo of the enemy's withdrawal (or fixes the enemy force in its current position if possible), and may destroy the enemy's rear security force. The direct-pressure force's actions help to set the conditions necessary for the success of the force conducting the encircling operation by maintaining constant pressure.

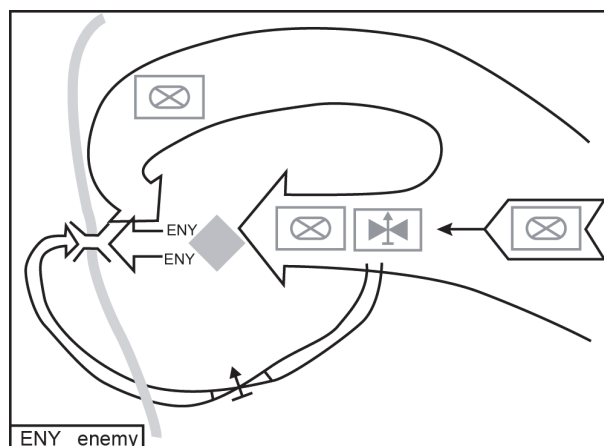

Figure 5-2. Combination pursuit

The encircling force is, in pursuit operations, the force which maneuvers to the rear or flank of the enemy to block the enemy's escape so that the enemy can be destroyed between the direct pressure force and encircling force. This force advances or flies along routes parallel to the enemy's line of retreat. If the encircling force cannot outdistance the enemy to cut the enemy off, the encircling force may also attack the flank of a retreating enemy. The force conducting the encircling operation conducts an envelopment or a turning movement to position itself where it can block the enemy's escape and trap the enemy between the two forces, which leads to complete annihilation of the enemy.

5-11. The force providing direct-pressure conducts hasty attacks to maintain contact and apply unrelenting pressure until it destroys the enemy force. The force applying direct-pressure prevents enemy disengagement and subsequent reconstitution of the enemy's defense and inflicts maximum casualties. It forces the enemy to deploy frequently in an attempt to delay the advance of the force applying direct-pressure and restricts the enemy's ability to disengage and rapidly move away. The force applying direct-pressure must be at least as mobile as the enemy. Armored and Stryker units are ideally suited to this role in open terrain, but the commander can employ light infantry forces, if the enemy is also foot-mobile and the terrain prevents the use of more tactically mobile forces. The force applying direct-pressure organizes itself to conduct a movement to contact and must be able to conduct a series of hasty attacks. It must be powerful enough to defeat enemy rear guard actions and maintain pressure on the enemy's main body.

5-12. The force conducting the encirclement is the force that maneuvers to the rear or flank of the enemy to block the enemy's escape, so that the enemy can be destroyed between the force applying direct pressure and the force conducting the encirclement. The force conducting the encirclement advances or flies along routes parallel to the enemy's line of retreat. If the force conducting the encirclement cannot outdistance the enemy to cut the retrograding enemy off, that encircling force may also attack the flank of a retreating enemy. The mobility of the force conducting the encirclement must be equal—preferably superior—to the withdrawing enemy. If there is no inherent mobility differential, the commander must create one. This differential can also result from the force applying direct-pressure to force the enemy to deploy. The commander can also enhance, and sometimes create, this mobility advantage by conducting countermobility operations against the enemy, specifically targeting locations, such as choke points or bridges, that will hinder the fleeing enemy's withdrawal. Armored, air assault, and airborne forces are well suited for this encircling mission. Attack helicopters are also effective when used as part of this encircling force. The force conducting the encirclement must be strong enough to defend itself from the enemy's main body and slow or fix the enemy until the friendly force applying direct-pressure force can combine with the encircling force to destroy the enemy. It must be capable of mounting a hasty defense without placing itself

at risk of annihilation. The force conducting the encirclement must be self-contained, since it normally operates out of supporting range of friendly indirect-fire systems. Therefore, it frequently has additional supporting artillery attached. The primary mission of this encircling force is to prevent the enemy's escape by trapping the enemy between the encircling force and the direct-pressure force. The commander can assign other missions to the force conducting the encirclement, such as—

- Destroying enemy weapons of mass destruction and their delivery means.
- Linking up with airborne or air assault forces in their airheads.
- Reporting terrain conditions and other combat information beyond that normally addressed in the unit standing operating procedures.

The commander can assign the encirclement mission, wholly or in part, to available airborne or air assault units because their vertical envelopment capabilities allow friendly forces to be inserted deeper into enemy-controlled territory than ground units. The time required to plan amphibious and airborne operations and stage air- and sealift platforms airlift impacts the usefulness of airborne forces in small-scale pursuit operations.

5-13. Forces assigned direct-pressure and encircling missions require engineer support to create lanes through obstacles, which enables them to move rapidly and continuously. The commander should place combat engineers well forward in unit movement formations to quickly breach any obstacles that cannot be bypassed. Engineers accompanying the encircling force must also be prepared to conduct countermobility and survivability tasks.

CONTROL MEASURES FOR A PURSUIT

5-14. The commander uses control measures to retain tactical options to converge on the most important axis or to redirect the pursuit effort on a new axis. These control measures should be flexible and capable of rapid adjustments to reflect changing conditions. In assigning control measures for a pursuit, subordinate commanders are given as much freedom of action as possible, consistent with security and maintenance of command integrity. This flexibility is also necessary when engaging advancing enemy reserves or counterattack forces.

5-15. The commander employs centralized planning and decentralized execution during a pursuit. The commander balances the need to prevent fratricide and friendly fire incidents with the need to allow subordinates to take advantage of fleeting opportunities in a pursuit with rapidly moving forces and a rapidly changing situation. The commander designates an area of operations (AO) for each maneuver unit involved in the pursuit. The commander establishes few control measures for the direct-pressure force other than phase lines and checkpoints during a pursuit. The commander uses phase lines to designate a forward and rearward boundary for the direct-pressure force. The forward boundary relieves the direct-pressure force of any responsibility beyond the forward boundary. It also gives the higher headquarters flexibility to coordinate with the encircling force and address enemy elements located beyond that forward boundary. The rear boundary becomes the boundary between the direct-pressure force and the follow and support force.

5-16. If the force conducting the encirclement is a ground element, the control measures are almost identical to those used during an envelopment. The commander must designate a route, an axis of advance, or an AO adjacent to that of the force providing direct-pressure on the retrograding enemy to allow the force conducting the encirclement force to move parallel to and eventually get ahead of the fleeing enemy force. The commander can designate a terrain objective as a guide for the encircling force. (See objective HAWKE in figure 5-3.) However, the commander may change this objective rapidly and frequently, based on the progress of the encircling force and the enemy. The objective should be a terrain feature that provides the encircling force good, defensible terrain that the enemy cannot easily bypass. The commander often selects choke points, such as defiles and bridges, as objectives for the encircling force.

5-17. The commander establishes a boundary or a restrictive fire line between the force conducting the encirclement and the force exerting direct-pressure before the encircling force reaches its objective. Other fire support coordination measures (FSCMs) around the area currently occupied by the force conducting the encirclement are established to relieve it of unnecessary fire support coordination responsibilities. The

overall commander directs security operations beyond the encircling force, allowing it to engage the withdrawing enemy without devoting resources to flank and rear security. The overall commander establishes additional control measures to control the convergence of both elements of the friendly force, such as restrictive fire lines, phase lines, and contact points.

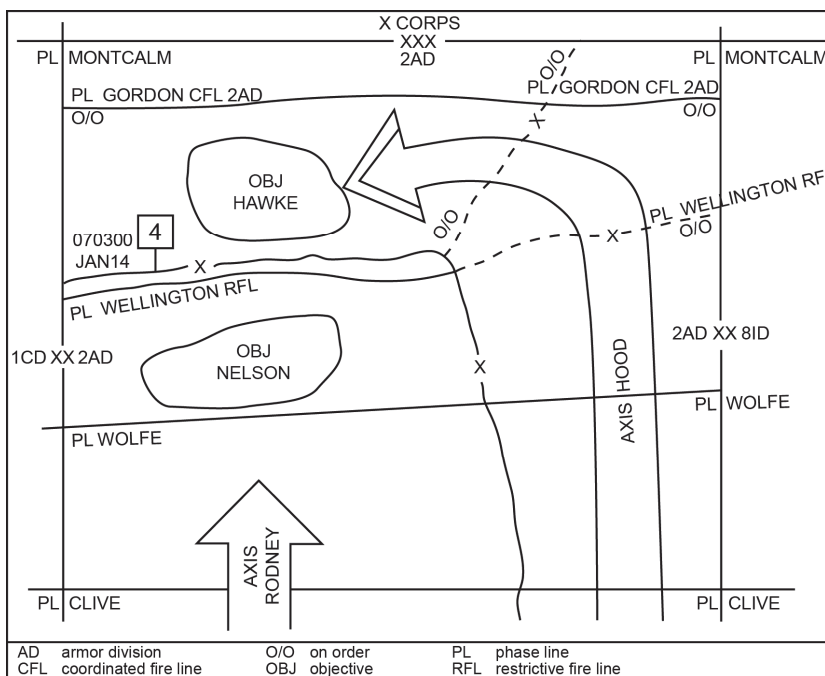

Figure 5-3. Pursuit control measures

PLANNING A PURSUIT

5-18. The commander anticipates an enemy retrograde operation as either a branch or a sequel to the plan. The plan should identify possible direct-pressure, encircling, follow and support, and reserve forces and issue on-order or be-prepared missions to these forces. The commander should employ the maximum number of available maneuver forces in the pursuit. The commander bases the details of the plan on the enemy's anticipated actions, the combat formation of the attacking troops, and the amount of planning time available. The commander also considers—

- Possible routes the enemy might use to conduct retrograde operations.
- Availability of reconnaissance and surveillance assets to detect enemy forces and acquire targets in depth.
- Scheme of movement and maneuver. (While combat forces will maneuver during the conduct of a pursuit, some echelon sustainment elements will be moving.)
- Availability and condition of pursuit routes.
- Availability of forces to keep the pressure on the enemy force until its destruction is complete.
- Critical terrain features.
- Use of reconnaissance and security forces.
- Allocation of precision-guided munitions and aviation support.
- Availability of functional and multifunctional support and sustainment resources.

Pursuit planning must address the possibility of defending temporarily during operational pauses while making preparations to continue the pursuit or to consolidate gains. However, the use of an operational pause generally results in the abandonment of the pursuit because the enemy is able to use that time to organize a coherent defense.

5-19. The commander must specifically address how to detect the enemy retrograde operations; otherwise, the enemy may succeed in breaking contact. The commander relies on active reconnaissance, an understanding of enemy tactics, and knowledge of the current tactical situation. The commander must watch for signs that indicate the enemy is preparing to conduct a retrograde, such as when the enemy—

- Lacks the capability to maintain the current position or cohesion.
- Conducts limited local counterattacks.
- Intensifies reconnaissance and intelligence efforts.
- Increases the amount of rearward movements and changes the type of elements conducting them, especially by fire support and reserves.
- Prepares facilities, installations, equipment, and supply stock-piles for demolition and destruction.
- Decreases fire in intensity and effectiveness through the AO.
- Increases fires in one or more individual sectors of the front, which does not appear to be in accordance with the developing situation, and at a time when the amount of defensive fires seems to be decreasing.

The presence or absence of any of these signs may not necessarily indicate the start of a retrograde operation. The enemy could be attempting to draw friendly forces into an ambush or setting up a counterattack as part of the defense. The decision of when to start a pursuit is part of the art of tactics.

5-20. When the commander initiates a pursuit, the commander often creates the force conducting the encirclement from uncommitted or reserve elements. Normally, these forces do not have allocated fire support assets. The commander must plan how to redistribute fire support assets to properly support these encircling forces. Attack helicopters and close air support are well suited to support the force conducting the encirclement.

5-21. Engineer mobility and countermobility assets are instrumental in sustaining the rate of advance and hindering the enemy's withdrawal. Engineers prepare the route of advance and support the lateral dispersion of units transitioning to the pursuit and the movement of the reserve. During the pursuit, the commander must plan for engineers to provide assault bridging and emergency road repairs to sustain the tempo of the pursuit. The commander also plans to use engineer assets to block any bypassed enemy's withdrawal routes by using antitank and command-operated mines, demolitions, and obstacles.

5-22. Sustainment units should plan for increased demand for fuel and maintenance as the tempo of operations increases. In the pursuit, priority for sustainment normally goes to units having the greatest success. Sustainment planners need to anticipate success since the depth of the pursuit depends on the capability of sustainment assets to support the operation. The sustainment elements supporting the pursuing force should be as mobile as possible. Sustainment planners are particularly concerned with supporting the encircling force, such as providing casualty evacuation over possibly unsecured LOCs. The commander may need aerial resupply or heavily guarded convoys to support this force. Security for sustainment convoys and LOCs are major planning considerations.

5-23. The commander uses all available sustainment assets to provide essential support to the force pursuing the enemy. The pursuit plan must result in a force prepared to conduct wide-ranging operations using all available maneuver assets throughout the AO to complete the destruction and morale collapse of the enemy force.

EXECUTING A PURSUIT

5-24. The goal of a pursuit is to destroy the withdrawing enemy. This generally occurs because of trapping the enemy between the forces conducting direct-pressure and encirclement operations or a major geographic barrier—such as an unfordable river—followed by the enemy's defeat in detail. The commander's timeliness in deciding to initiate a pursuit is critical to its success. If the enemy begins a retrograde undetected, the enemy avoids the constant pressure that results in disrupting that operation. The commander expects the enemy forces to conduct retrograde operations at times advantageous to them—usually at night or during bad weather.

5-25. A pursuit is often conducted as a series of encirclements in which successive portions of the fleeing enemy are intercepted, cut off from outside support, and captured or destroyed. (FM 3-90-2 addresses the tactics associated with the conduct of encirclement operations.) The force exerting direct pressure on the retrograding enemy conducts a series of hasty attacks to destroy that enemy's rear security force, maintain constant pressure on the enemy's main body, and slow the enemy's withdrawal. At every opportunity, the force exerting direct pressure fixes, disrupts, and destroys enemy elements, provided such actions do not interfere with its primary mission of maintaining constant pressure on the enemy's main body. The force exerting direct pressure can bypass large enemy forces, if it can hand them off to follow and support units, or if they do not pose a significant risk to the capability of the force applying direct-pressure to maintain that direct pressure on the retrograding enemy main body.

5-26. As soon as the commander designates a unit to conduct the encirclement and directs its actions, the force moves as swiftly as possible by the most advantageous routes to cut off the enemy's retreat. If that unit cannot move farther and faster than the enemy to achieve the encirclement, it attacks the enemy's main body on one of its flanks. When this occurs, the overall commander should constitute and dispatch a new element to conduct an encirclement of the retrograding enemy force.

SHAPING OPERATIONS

5-27. This chapter discusses the execution of a pursuit. It uses the five steps introduced in chapter 4 for illustrative purposes only. In practice these steps will overlap. The first three steps are normally shaping operations. Maneuver completes the destruction of the retrograding enemy and is the decisive operation in a pursuit. Follow through involves either a branch or a sequel to the pursuit.

Gain and Maintain Enemy Contact

5-28. At the first indication of an enemy retrograde, the BCT or lower-echelon commander who discovers the enemy's rearward movement acts to maintain contact with the enemy across a wide area without waiting for orders from higher headquarters. This ensures that the enemy does not break contact and conduct an orderly retirement. These forces in contact constitute the nucleus of the direct-pressure force. As the situation permits, they reform into a movement column with reconnaissance and security elements in the lead and, if necessary, to the flank.

5-29. During a pursuit, the intelligence effort is intensive. Reconnaissance and surveillance elements concentrate on all routes the enemy could use when conducting a retrograde operation. These elements provide information on the disposition of retreating enemy formations and on the forward movement of reserves as the pursuit develops. The tactical situation during a pursuit may become obscure because of its potential depth. Much of the combat information needed during a pursuit is located behind the fleeing enemy force. Therefore, air reconnaissance, backed by technical intelligence systems, is vital to the overall reconnaissance effort. It can determine—

- The beginning of the rearward movement of enemy sustainment forces.
- The composition of retrograding forces and their direction of movement.
- The composition and direction of enemy reserve forces moving forward.
- The nature of obstacles and intermediate defensive positions.

Information about fresh enemy reserves and prepared positions is vital at the stage when a pursuit force may be approaching a culminating point; it may be the basis for terminating the pursuit.

5-30. The primary mission of the encircling force's reconnaissance and surveillance assets is to find routes for the encircling force to allow it to move behind withdrawing enemy units and establish blocking positions. This mission may force these assets to operate outside the supporting range of the main body, as they try to maneuver behind the retrograding enemy force. The encircling force avoids combat, when possible, until it reaches its assigned objective area. However, en route to its objective, it overruns any small enemy positions while bypassing larger enemy units. Forward security elements of the encircling force conduct activities to prevent the enemy from interfering with the forward movement of the encircling force's main body. These security elements move rapidly along all available roads or routes and overrun or bypass small enemy pockets of resistance. If they encounter strongly held enemy positions, they attempt to

find routes around or through these positions. The encircling force can then avoid these enemy positions and occupy blocking positions before withdrawing enemy forces can reach them. If necessary, the encircling force organizes a hasty defense behind the enemy to block the enemy's retreat.

Disrupt the Enemy

5-31. Keeping the enemy from reconstituting an effective defense is critical to success. Constant pressure by direct-pressure forces and echelon fire support systems disrupts and weakens the enemy. The commander uses fires to keep pressure on the enemy. The enemy commander must not be allowed to freely adjust dispositions to counter the actions of the friendly force. Artillery fire and air strikes harass and disrupt the enemy's attempts to move engaged forces to the rear or bring previously uncommitted forces into action. In a pursuit, decisive operations may include the ground maneuver of the direct-pressure or the encircling force. Fire support targets in a pursuit include fires on enemy columns and troop or vehicle concentrations at road junctions, defiles, bridges, and river crossings. They may also be used to repulse enemy counterattacks, destroy or delay enemy reserves, and destroy the enemy's fire support systems. The commander conducts electronic warfare against the enemy's command and control (C2) system as an integral part of this disruption process, concentrating on destroying or degrading the enemy's capability to reconstitute and synchronize an effective defense.

Fix the Enemy

5-32. Using movement and fire or the threat of fires, the commander fixes a withdrawing enemy. If the direct-pressure force disrupts the enemy's C2 system, the enemy's ability to counter friendly efforts is significantly degraded, and the goal of fixing the enemy is much easier to accomplish.

5-33. The enemy force will attempt to use its reserves to restore the integrity of the defense or prevent the withdrawing enemy force from being overrun. Fixing enemy reserves is essential to the pursuit's success and is normally the focus of echelon shaping operations. The direct-pressure force fixes enemy reserves in place or slows them down so that they remain outside supporting distance until the withdrawing enemy force is completely annihilated.

DECISIVE OPERATION

5-34. During the conduct of pursuit operations, the overall commander of the pursuit normally combines the actions of a subordinate conducting a frontal pursuit to provide direct pressure on the retrograding enemy with the actions of a second subordinate attempting to encircle that same retrograding enemy. The force providing direct pressure advances in a column formation as quickly as possible. After a successful penetration of a defending enemy, existing gaps between the different elements of the force and the apply direct-pressure force are likely to increase. Aware of the vulnerability of open flanks in this situation, the overall commander must deploy other elements with a reserve mission where they can respond to flank dangers. The overall commander does not expect a uniform rate of advance on all axes. Some columns may move rapidly, while others are still engaged in penetrating the enemy's rear guard defensive positions or meeting enemy counterattacks.

5-35. The actions of the force applying direct pressure should facilitate the commitment of another force moving parallel to the rearward-moving enemy and attempting to encircle that enemy. The depth of the pursuit depends on the size of the forces involved. It takes a division-level or higher commander to make the decision to initiate a pursuit because of the resources necessary to conduct a pursuit. The commander directing the initiation of a pursuit informs that individual's higher commander of this intention. This allows even greater resources to be devoted to the pursuit and avoids desynchronizing the higher headquarters' major operation or campaign.

5-36. The force providing direct pressure normally tasks its forward subordinate element to provide an advance guard to prevent the enemy from ambushing its main body and to overrun or bypass small enemy forces. This advance guard moves on multiple avenues of advance. If it encounters enemy units beyond its capacity to defeat, it conducts actions on contact to develop the situation. The commander of the force providing direct pressure uses combat information provided by these actions on contact to guide the main body of the force providing direct pressure to a position of advantage where it can seriously degrade or

destroy the retrograding enemy force. These actions of the force providing direct pressure may or may not be in conjunction with the actions of any encircling force.

5-37. The overall pursuit commander does everything possible to place a force behind a retrograding enemy to encircle and trap the bulk of that enemy force between the encircling force and the force providing direct pressure. The force providing direct pressure maintains enough pressure on the retrograding enemy force so that the encircling force can envelop it. To envelop the enemy, the force providing the direct-pressure force must be strong enough to overcome any enemy rear guard before the enemy's main body can complete its retrograde and reestablish a coherent defense. Once in its objectives, the force conducting the encirclement defends or attacks as necessary, responding to the enemy's actions and those of the force providing direct pressure to complete the enemy's geographic isolation.

5-38. A pursuing force must not give an enemy force time to reorganize for an all-around defense after it is encircled. If the enemy forms a perimeter, the pursuing commander must repeatedly split it into smaller elements until the encircled enemy force is destroyed. If time is not critical, the commander can keep the encirclement closed, defeat enemy breakout attempts, and weaken the enemy by fires alone. The commander can greatly accelerate the collapse of a large, encircled enemy force by using psychological operations, precision-guided weapons, and improved conventional munitions in mass. (FM 3-90-2 describes the tactics associated with the reduction of an encircled enemy force.) If the resulting encirclement does not destroy the retrograding enemy force, the commander conducts additional pursuit operations until the enemy is destroyed.

FOLLOW THROUGH

5-39. Once the commander initiates a pursuit, it is continued until a higher commander terminates the pursuit. Conditions under which a higher commander may terminate a pursuit include the following:

- The pursuing force annihilates or captures the enemy and resistance ceases.
- The pursuing force fixes the enemy for follow-on forces.
- The higher commander makes an assessment that the pursuing force is about to reach a culminating point.

5-40. A commander often transitions from a pursuit into other types of offensive and defensive actions. If the enemy attempts to reorganize, forces conducting a pursuit execute hasty attacks. They conduct an exploitation to capitalize on the success of these attacks and then move back into pursuit. Forces conducting a pursuit may also transition into a defense, if the pursuing force reaches a culminating point. This usually occurs when the enemy introduces strong reinforcements to prepare for a counteroffensive. If the pursuit is totally successful and the enemy is destroyed, the pursuing force may need to transition to a focus on the conduct of stability tasks. (See ADRP 3-07.)

PURSUIT DURING OTHER THAN MAJOR COMBAT OPERATIONS

5-41. The transition to retrograde operations by unconventional enemies may make it more difficult for tactical units to engage, capture, or kill enemy fighters during the conduct of pursuit operations in other than major combat operations. Successful pursuit of unconventional enemies in these situations relies on maintaining contact through surveillance assets, patrols, and host nation security forces. Since dispersing unconventional forces usually use preplanned routes of withdrawal, or if pressed simply scatter and try to blend into the local civilian population to rally later at a pre-designated point, any pursuit must be undertaken immediately both on the ground and in the air. Boundaries should not prevent the pursuit of unconventional forces into an adjacent unit's area of operations. Operations orders or other means of coordination should provide for this contingency.

5-42. Tactical leaders must recognize the potential for unconventional enemies to conduct a baited ambush during their retrograde operations. Critical to mitigating risk to friendly forces during a pursuit is maintaining one of the eight forms of contact—direct; indirect; nonhostile or civilian; obstacle; chemical, biological, radiological, and nuclear (CBRN); aerial; visual; and electronic—and positioning of adjacent units. These adjacent units may include aviation, host nation security forces, surveillance assets, other ground forces, and quick response forces (QRFs).

5-43. Unconventional enemies may establish base camps and conduct cross-border operations from countries adjacent to the host country. They take advantage of an international boundary to launch operations or to evade pursuit. Commanders operating in border areas must respect the sanctity of international boundaries. However, they can conduct combat operations against the insurgent force once the unconventional enemy force crosses back over the border. Ambush patrols and area ambushes are excellent means of dealing with unconventional enemy forces who try to use an international border as a sanctuary.

5-44. Unconventional enemies should know that every ambush they execute may result in rapid, violent, and relentless pursuit by friendly forces. Such action, executed automatically as a matter of first priority, is most important to the overall effort to reduce the effectiveness and frequency of ambushes by unconventional enemies. First, it ensures an early relief of the ambushed unit; second, it increases the possibility of friendly forces making contact with the ambush party before it disperses; third, it reduces the time available to the unconventional enemy to destroy the ambushed forces and to loot vehicles; and, finally, successful pursuit operations will improve the morale of friendly units while having a corresponding opposite effect upon unconventional enemy forces. Commanders must initiate pursuits of ambush forces with the least possible delay, with only that degree of caution required to prevent falling into a larger ambush.

PART TWO

Defensive Tasks

Chapter 6

Basics of the Defense

Defensive actions alone normally cannot achieve a decision. Their purpose is to create conditions for a counteroffensive that allows Army forces to regain the initiative. Other reasons for conducting defensive actions include—

- Retaining decisive terrain or denying a vital area to the enemy.
- Attriting or fixing the enemy as a prelude to offensive actions.
- Surprise action by the enemy.
- Increasing the enemy's vulnerability by forcing the enemy to concentrate subordinate forces.

GENERAL CONSIDERATIONS OF THE DEFENSE

6-1. A defensive task is a task conducted to defeat an enemy attack, gain time, economize forces, and develop conditions favorable for offensive or stability tasks (ADRP 3-0). While the offense element of decisive action is more decisive, the defense is the stronger element. The defense's inherent strengths include the defender's ability to occupy positions before the attack and use the available time to prepare the defenses. The defending force ends its defensive preparations only when it retrogrades or begins to fight. Even during the fight, the defending force takes the opportunities afforded by lulls in the action to improve its positions and repair combat damage. The defender does not wait passively to be attacked. The defender aggressively seeks ways of attriting and weakening attacking enemy forces before the initiation of close combat. The defender maneuvers to place the enemy in a position of disadvantage and attacks the enemy at every opportunity, using fires, electronic warfare, and joint assets, such as close air support. The static and mobile elements of the defense combine to deprive the enemy of the initiative. The defender contains the enemy while seeking every opportunity to transition to the offense.

CHARACTERISTICS OF THE DEFENSE

6-2. Successful defenses share the following characteristics: disruption, flexibility, maneuver, massing effects, operations in depth, preparation, and security. (See ADRP 3-90 for a discussion of these characteristics.)

Characteristics of the defense

- Disruption
- Flexibility
- Maneuver
- Massing effects
- Operations in depth
- Preparation
- Security

DEFENSIVE TASKS

6-3. There are three basic defensive tasks: the area defense, the mobile defense, and the retrograde. These three tasks have significantly different concepts and pose significantly different problems. Therefore, each defensive task must be dealt with differently when planning and executing the defense. Although the names of these defensive tasks convey the overall aim of a selected operation, each typically contains elements of the other and combines static and mobile elements.

Defensive tasks

- Area defense
- Mobile defense
- Retrograde

6-4. Although on the defense, the commander remains alert for opportunities to attack the enemy whenever resources permit. Within a defensive posture, the defending commander may conduct a spoiling attack or a counterattack, if permitted to do so by the mission variables of mission, enemy, terrain and weather, troops and support available, time available, and civil considerations (METT-TC.) (Chapter 3 discusses these two forms of attack.)

AREA DEFENSE

6-5. The *area defense* is a defensive task that concentrates on denying enemy forces access to designated terrain for a specific time rather than destroying the enemy outright (ADRP 3-90). The focus of the area defense is on retaining terrain where the bulk of the defending force positions itself in mutually supporting, prepared positions. Units maintain their positions and control the terrain between these positions. The decisive operation focuses on fires into engagement areas (EAs), possibly supplemented by a counterattack. The reserve may or may not take part in the decisive operation. The commander can use the reserve to reinforce fires, add depth, block, or restore the position by counterattack, seize the initiative, and destroy enemy forces. Units at all echelons can conduct an area defense. Units at all echelons may use an area defense in conjunction with pursuit to transition from the defense- or offense-centric operations to stability-centric operations. (Chapter 7 discusses the conduct of an area defense.)

MOBILE DEFENSE

6-6. The *mobile defense* is a defensive task that concentrates on the destruction or defeat of the enemy through a decisive attack by a striking force (ADRP 3-90). (The Marine Corps has a different definition for the mobile defense, see chapter 8.) The mobile defense focuses on defeating or destroying the enemy by allowing enemy forces to advance to a point where they are exposed to a decisive counterattack by the striking force. The *striking force* is a dedicated counterattack force in a mobile defense constituted with the bulk of available combat power (ADRP 3-90). A fixing force supplements the striking force. The commander uses the fixing force to hold attacking enemy forces in position, to help channel attacking enemy forces into ambush areas, and to retain areas from which to launch the striking force.

6-7. A mobile defense requires an area of operations (AO) of considerable depth. The commander must be able to shape the battlefield, causing an enemy force to overextend its lines of communication (LOCs), expose its flanks, and dissipate its combat power. Likewise, the commander must be able to move friendly forces around and behind the enemy force targeted to be cut off and destroyed. Divisions and larger formations normally execute mobile defenses. However, brigade combat teams (BCTs) and maneuver battalions may participate as part of the fixing force or the striking force. (Chapter 8 discusses the mobile defense.)

RETROGRADE

6-8. The *retrograde* is a defensive task that involves organized movement away from the enemy (ADRP 3-90). The enemy may force these operations, or a commander may execute them voluntarily. The higher commander of the force executing the retrograde must approve the operation before its initiation in either case. The retrograde is a transitional operation; it is not conducted in isolation. It is part of a larger maneuver scheme designed to regain the initiative and defeat the enemy. (Chapter 9 further discusses the retrograde.)

COMMON DEFENSIVE CONTROL MEASURES

6-9. The commander controls the defense by using control measures to provide the flexibility needed to respond to changes in the situation and allow the defending commander to rapidly concentrate combat power at the decisive point. Defensive control measures within a commander's AO include designating the security area, the battle handover line (BHL), the main battle area (MBA) with its associated forward edge of the battle area (FEBA), and the echelon support area. The commander uses battle positions and additional direct fire control and fire support coordination measures (FSCMs) in addition to those control measures referenced in the offensive task discussion of this publication and discussed in appendix A to further synchronize the employment of combat power. The commander designates disengagement lines to trigger the displacement of subordinate forces. These common defensive control measures are also discussed in appendix A.

COMMON DEFENSIVE PLANNING CONSIDERATIONS

6-10. The defense is more effective when there is adequate time to thoroughly plan and prepare defensive positions. Lack of preparation time may cause the commander to maintain a larger-than-normal reserve force or accept greater risks than usual. All units must be capable of mounting a defense with minimal preparation, but a strong defense takes time to organize and prepare. If the enemy attack does not take place at the predicted time, the commander uses the additional time to improve the unit's defensive positions. The defending commander can increase the effectiveness of the security area, establish additional alternate and supplementary positions, refine the defensive plan to include branches and sequels, conduct defensive rehearsals, and maintain vehicles and personnel. To gain time to organize a defense, the commander may order the security force to conduct a delay while the main body disengages and moves to more advantageous positions. The security force must know how long it needs to delay the enemy for the main body to prepare its defense and be task organized to conduct a delay. (FM 3-90-2 discusses tactics associated with the conduct of a delay.)

6-11. At the attack's onset, the defending commander yields the initiative to the enemy. However, the defending commander exploits the advantages of prepared, mutually supporting positions organized for all-around defense and knowledge of the terrain to slow the enemy's momentum. The defending force maintains its security and disrupts the enemy's attack at every opportunity. The defending commander hinders enemy offensive preparations by using long-range fires to reduce the force of the enemy's initial blows and start the process of wresting the initiative from the enemy. The defending force draws the enemy into engagement areas where the defenders can initiate combat on their own terms. The commander surprises the enemy with concentrated and integrated fires that violently erupt on exposed enemy formations from concealed and protected positions. The defending commander then counterattacks the enemy, repeatedly imposing unexpected blows. The commander exploits small tactical success and opportunities to stop the attacker's momentum.

6-12. The defending force does not have to kill every enemy soldier, squad, or combat system to be successful. It only has to destroy the enemy's ability to synchronize a combined arms team or the enemy soldiers' will to fight. Those events signal a transition period that affords the defending commander the opportunity to seize the initiative and return to the offense.

6-13. The common defensive planning considerations addressed in paragraphs 6-14 through 6-114 apply to the conduct of all defensive tasks. In the defense, synchronizing the effects of the warfighting functions with information and leadership allows a commander to apply overwhelming combat power against selected advancing enemy forces to unhinge the enemy commander's plan and destroy the enemy's combined arms team. Defensive synchronization is normally the result of detailed planning and preparation among the various units participating in an operation. While these activities may be separated in time and space, they are synchronized if their combined consequences are felt at decisive times and places. All defenses are a mix of static and dynamic actions. As an operation evolves, the commander knows that there will probably be a requirement to shift decisive and shaping operations to press the engagement and keep the enemy off balance. Synchronized prior planning and preparation bolster the commander's combat power, increasing the effectiveness of the defense. The commander must remain cognizant of the

possibility of dislocated civilians attempting to move through defensive positions in an effort to escape approaching enemy forces throughout the defense.

MISSION COMMAND

6-14. A defensive mission generally imposes few restrictions on the defending commander. It allows freedom of maneuver within assigned boundaries, but requires the commander to prevent enemy penetration of the rear boundary. Defending an AO is a typical mission for battalion and higher-echelon units. This mission allows the commander to distribute forces to suit the terrain and plan an engagement that integrates direct and indirect fires. The commander ensures that subordinate unit defensive plans are compatible and that control measures, such as contact points and phase lines, are sufficient for flank coordination when assigning AOs. The defensive plan must address what happens when it succeeds and the opportunity exists to transition from defense to offense.

6-15. Defensive tasks are often difficult to conduct because they may occur against an enemy who has the initiative and usually has superior combat power. The commander must have a clear understanding of the battlefield situation to mass subordinate and supporting forces to disengage committed forces. The commander takes advantage of war gaming that takes place in the military decisionmaking process to derive decision points. The commander bases these decision points on enemy and friendly actions, such as shifting fires, moving between battle positions, and rearming part or all of the defending force. The commander may require additional signal support, such as retransmission teams, to sustain primary communication, such as joint network node signal assets and tactical radio communications across the wide frontages characteristic of many operations.

6-16. Because the enemy has the initiative, the commander may have to frequently shift shaping operations or supporting efforts to contain the enemy's attack until the defending force can seize the initiative. This may require the commander to adjust subordinate unit AOs, repeatedly commit and reconstitute the reserve, and modify the original plan.

6-17. The defending commander may change task organization to respond to the existing or projected situation, such as forming a detachment left in contact before conducting a withdraw. Whenever possible, the commander ensures that changes in task organization take place between units that have previously trained or operated together to take advantage of established interpersonal relationships. The commanders of such recently reorganized units place special attention on ensuring that each element directs its efforts toward accomplishing the overall unit's mission. This requires them to ensure synchronizing objectives, control measures, movement routes, defensive positions, and specifically assigned tasks are understood. It also requires using standard operating procedures by each element of the task-organized unit. Failure to synchronize task-organized elements has often resulted in mission failure during training and actual operations.

6-18. To break through the MBA, the enemy often attacks along the boundaries of defending units, when they can be identified. Therefore, it is extremely important for commanders at every echelon to ensure that the plan for their part of the defense is properly coordinated, not only within their units, but also with flanking and supporting units. Commanders coordinate through personal visits to subordinate commanders on the ground when possible. The staff rapidly transmits coordination decisions to all concerned. The following planning aspects require attention in the coordination process:

- Understanding the superior commander's intent and concept of operations.
- Understanding the tactics to be applied by flanking and supporting units.
- Selecting boundary locations that do not increase the coordination problem.
- Planning for mutual support.
- Surveillance and target acquisition plans.
- Location and composition of security forces.
- Obstacle and demolition plans.
- Fire plans, to include employing antitank systems, illumination, and smoke.
- Air defense coverage areas.

- Employing the reserve in conjunction with information operations and fire support systems, such as artillery and aviation.
- Boundaries and other control measures.
- Communications.

6-19. Because mission command facilities tend to be more stationary in the defense than in the offense, the commander should place them in hardened areas or protective terrain and reduce their electronic signature. They must remain capable of rapidly relocating to respond to battlefield developments.

6-20. The fact that the defending unit is typically relinquishing terrain along with its associated civilian inhabitants makes dealing with those civilians more difficult in the defense than it is in the offense. However, it is important that the defending unit prevent the uncoordinated movement of displaced civilians within the AO. Such uncoordinated movements can hamper the execution of the unit's defense by hindering the repositioning of defending forces in response to the changing tactical situation, the sustainment of defending forces, and the evacuation of casualties. It is also important that the defending unit meet its legal obligations to the civilian inhabitants of its area of operations.

MOVEMENT AND MANEUVER

6-21. The commander's intent is to defeat the enemy force's attack by overwhelming it with repeated, unexpected blows before it conducts its final assault on friendly defensive positions. As the enemy attack fails, the enemy must attempt to withdraw or transition to a defense in the face of friendly counterattacks. If the enemy succeeds in overrunning a key defensive position, the defending force counterattacks to overwhelm the enemy before the enemy either organizes that position for defense or exploits success.

Exploit the Advantages of Terrain

6-22. The defending commander exploits the advantages of occupying the terrain where the battle will occur. The defending force engages the attacker from locations that give the defending force an advantage. These locations include defiles, rivers, thick woods, swamps, cliffs, canals, built-up areas, and reverse slopes. Defensive positions in the MBA should make use of existing and reinforcing obstacles. The commander may choose to shape the battlefield by defending in one area to deny terrain to the enemy while delaying in another area to deceive the enemy commander into believing that the attacking enemy force has achieved success.

6-23. The defending commander uses key terrain to impede the enemy's movement. The defending commander selects terrain that allows massing friendly fires but forces the enemy to commit forces piecemeal into friendly engagement areas. This exposes portions of the enemy force for destruction without giving up the advantages of fighting from protected positions. Examples of key terrain include terrain that permits the defending force to cover a major obstacle system by fire, and important road junctions and choke points that impact troop movements, such as the movement of reserves and lines of communications.

6-24. The commander determines the probable force ratios the defenders will face and establishes positions accordingly. The terrain determines how quickly the enemy can close on defensive positions and how much time is available to employ combat multipliers, such as indirect fires. Once the commander arrives at acceptable force ratios—or the degree of risk that must be taken is clear—the commander allocates available forces and begins planning EAs.

6-25. On each enemy avenue of approach, the commander determines where to destroy the enemy. The commander arrays forces allocated to that avenue of approach around this point to establish an EA using obstacles and fires to canalize enemy forces into it. The commander takes actions to increase the kill probabilities of various weapon systems at different ranges. This includes establishing range markers for direct fire weapons, confirming the zero on weapons, or clearing obstacles that might snag the cables over which travel the commands of wire-guided munitions.

6-26. Generally, defending forces have the advantage of preparing the terrain by reinforcing natural obstacles, fortifying positions, and rehearsing operations. First, they prepare the ground to force the piecemeal commitment of enemy forces and their subsequent defeat in detail. Second, they prepare the

ground to force the enemy to fight where the enemy does not want to fight, such as in open areas dominated by terrain that offers adequate cover and concealment for the occupying friendly forces. The defending force tries to guide or entice the enemy into these prepared engagement areas. Units employ and continuously strengthen obstacles and fortifications to improve the natural defensive strength of a position, which has a direct bearing on the distribution of forces, frontages, and depth of the defense. (FM 90-7 provides guidance on integrating obstacles into engagement and defensive positions.)

6-27. Terrain features that favors the defense include—

- A series of parallel ridges across the line of hostile advance.
- Unfordable streams, swamps, lakes, and other obstacles on the front and flanks.
- High ground with good observation and long-range fields of fire.
- Concealed movement routes immediately behind defensive positions.
- A limited road network in front of the line of contact to confine the enemy to predictable avenues of approach.
- A good road network behind the line of contact that allows the commander to reposition forces as the battle progresses.

6-28. The opposite of the terrain conditions listed above degrades a force's ability to conduct defensive tasks. For example, terrain with a limited road net that canalizes the defending force allows the enemy to predict its movement and take steps to interdict that movement.

6-29. In accordance with the mission variables of METT-TC, units can conduct survivability moves between their primary, alternate, and supplementary positions. A *survivability move* is a move that involves rapidly displacing a unit, command post, or facility in response to direct and indirect fires, the approach of an enemy unit, a natural phenomenon or as a proactive measure based on intelligence, meteorological data and risk analysis of enemy capabilities and intentions (including weapons of mass destruction) (ADRP 3-90).

Maintain Security

6-30. Commanders use security operations to confuse the enemy about the location of the commander's main battle positions, prevent enemy observation of preparations and positions, and keep the enemy from delivering observed fire on friendly positions. Commanders also try to force the attacking enemy to deploy prematurely. They can offset the attacker's inherent advantage of initiative regarding the time, place, plan, direction, strength, and composition of the attack by forcing the enemy to attack blind into prepared defenses. Commanders counter enemy ground reconnaissance activities through both active and passive measures. The commander must not permit enemy reconnaissance and surveillance assets to determine the precise location and strength of defensive positions, obstacles, engagement areas, and reserves. First, the defending force conducts reconnaissance to gain and maintain contact with the enemy. Second, each echelon normally establishes a security area forward of its MBA. The *security area* is that area that begins at the forward area of the battlefield and extends as far to the front and flanks as security forces are deployed. Forces in the security area furnish information on the enemy and delay, deceive, and disrupt the enemy and conduct counterreconnaissance (ADRP 3-90). All units conduct aggressive security operations within their AO, including the echelon support area, to seek out and repel or kill enemy reconnaissance and other forces. Units implement operations security (OPSEC) and other information protection measures to deny the enemy information about friendly dispositions. (See FM 3-90-2 for more information on the tactics associated with the conduct of security tasks.)

Disrupt the Enemy Attack at Every Opportunity

6-31. The defending force conducts operations throughout the depth of the enemy's formation in time and space to destroy key enemy units and assets, particularly their artillery and reserves, or disrupt their timely introduction into battle at the point of engagement. This allows the defending force to regain the initiative. It conducts spoiling attacks to disrupt enemy's troop concentrations and attack preparations. The defending force counterattacks enemy successes rapidly with its reserve, the forces at hand, or a striking force before the enemy can exploit success. It conducts electronic warfare to assist this process.

Mass the Effects of Combat Power

6-32. The defending force must mass its combat power to overwhelm the enemy and regain the initiative. The commander uses economy of force measures in areas that do not involve the decisive operation to mass forces in the decisive area. This decisive point can be a geographical objective or an enemy force. In an area defense, defending units use engagement areas to concentrate overwhelming combat power from mutually supporting positions. In a mobile defense, the commander uses the striking force to generate overwhelming combat power at the decisive point. Another way the commander can apply the effects of mass is through committing the reserve.

6-33. Typically a commander will begin engaging advancing enemy forces at the maximum effective range of available weapon systems. The defender then employs an increasing volume of fire by engaging with shorter-range systems as the attacking enemy continues to close on the defender's positions while continuing to engage the attacker with longer-range systems. The commander attrits and defeats the enemy as far forward of friendly defensive positions as is possible. This allows the defender to engage the enemy for longer periods which normally allows for more kills forward of the defender's positions. This method of engagement is normally employed against enemy formations of similar or larger size than the defender. The major disadvantage of this method is that once the defender employs direct-fire systems, the enemy will probably detect the firing positions of those systems. This allows the enemy to engage the defender with fires. At the low tactical level it may make flank shots against enemy armored systems more difficult to obtain at longer ranges.

6-34. One method of massing combat power initiates fires with fixed-wing aircraft and Army long-range indirect fires as the enemy comes within range. Rotary-wing close combat attack may occur at great distance from or near the forward line of own troops (FLOT), depending upon the enemy's air defense capability. Electronic attack begins at the point the commander believes it to be most effective to disrupt the enemy's command and control. Direct fire weapon systems such as tanks and long range antitank missiles begin to engage at those systems' maximum effective range. As the enemy continues to advance, defending light mortars, machineguns, and medium-range anti-tank systems engage. As the range continues to close, defenders employ individual rifles, grenade launchers, and short-range anti-tank weapons. If the attacking enemy is not defeated and continues to close with defenders that do not displace, eventually the attacker will face defending Soldiers employing pistols, grenades, bayonets, pioneer tools, and combatatives in addition to other previously used weapons. At some point in the process fixed-wing, rotary-wing, and tilt-rotor aircraft weapons will no longer be able to engage the front ranks of the attacking enemy force because of the unacceptable danger of hitting friendly forces and the crowded nature of the airspace over the defensive position. However, that point can be very close. There are historical cases where an enemy has been within 25 meters of a defending force and was still engaged by fixed-wing aircraft. In extreme cases, airburst artillery and mortar fires have been called in on friendly positions to successfully defeat an enemy attack when adequate overhead protective cover was available for friendly forces and the unit was in danger of being overrun.

6-35. Another method of massing combat power uses the simultaneous employment of all direct-fire weapons. This method will result in more kills on first engagement, but at a much closer range. However, the mass and momentum of the attacking enemy may still carry the force into friendly positions. This method is ideal for use in situations where parts of the attacking enemy are isolated from the direct-fire support of their fellows, such as what occurs when employing a reverse-slope defense or in defensive situations where the attacking enemy element is considerably smaller in size or has significantly less lethal capabilities than the defending force and the majority of that attacking force can be enticed to enter into an engagement area.

Armored and Stryker Forces

6-36. When most of a defending force consists of units equipped with armored combat vehicles, the commander can conduct a defense designed to take advantage of the tactical mobility and protection offered by them. Combat vehicles provide defending forces with the capability to maneuver to delay the advance of a strong enemy force and then immediately change from a mobile to a static defense or counterattack. Forces equipped with armored combat vehicles are well suited for use as security and MBA

forces. They are more suited for operations within a chemical, biological, radiological, or nuclear (CBRN)-contaminated environment than dismounted infantry forces because of their built-in CBRN overpressure protection.

Infantry Forces

6-37. When facing enemy light forces, the commander deploys and uses defending infantry forces in the same manner as defending armored and Stryker forces are used against enemy heavy and motorized forces. Light infantry forces facing a heavy enemy are primarily used in static roles within the MBA or in security roles within the echelon support area. When facing heavy enemy forces, light infantry forces are most effective when fighting from prepared defenses or in close terrain, such as swamps, woods, hilly and mountainous areas, and urban areas, where they can take advantage of their foot mobility and short-range infantry and anti-armor weapons.

6-38. The commander uses an air assault unit in the same manner as other light forces once it deploys into its landing zones (LZs). (See the Maneuver Center of Excellence tactics publication on air assault operations for additional information.) However, there may be problems in extracting an air assault force, particularly if it is in direct contact with the enemy. Because of its mobility and potential reaction speed, an air assault force is often well-suited for a reserve role during the conduct of the defense. Its tasks might include—

- Rapid reinforcement of a threatened position.
- Occupation of a blocking position, possibly in conjunction with existing defensive positions.
- Echelon support area security operations, such as containment of an enemy airborne or helicopter assault.
- Reinforcement of encircled friendly forces.
- Flank protection.

Rotary- and Fixed-Wing Aviation and Unmanned Aircraft Systems

6-39. Aviation assets are particularly valuable in the defense because of their speed, mobility, and versatility. Their tasks can include—

- Conducting reconnaissance and security operations.
- Conducting shaping operations to establish the necessary conditions for decisive operations by other forces through attriting, disrupting, and delaying the enemy.
- Conducting counterattacks and spoiling attacks.
- Controlling ground for limited periods where a commander does not wish to irrevocably commit ground forces (for example, forward of an executed obstacle).
- Blocking enemy penetrations.
- Closing gaps in a defense plan before the arrival of ground maneuver forces.
- Facilitating the disengagement of ground forces.
- Countering enemy activities in the echelon support area, in particular enemy airborne or air assault forces.
- Resupplying defending forces with Class IV barrier material or facilitating casualty evacuation.
- Assisting in the countermobility effort.
- Providing long-range biological surveillance.

Ensure Mutual Support

6-40. Mutual support exists when positions and units support each other by direct, indirect, lethal, and nonlethal fire, thus preventing the enemy from attacking one position without being subjected to fire from one or more adjacent positions. Mutual support increases the strength of all defensive positions, prevents defeat in detail, and helps prevent infiltration between positions. Tactical positions achieve the maximum degree of mutual support between them when they are located to observe or monitor the ground between them or conduct patrols to prevent any enemy infiltration. At night or during periods of limited visibility,

the commander may position small tactical units closer together to retain the advantages of mutual support. Unit leaders must coordinate the nature and extent of their mutual support.

Mobility

6-41. During the defense, mobility tasks include maintaining routes, coordinating gaps in existing obstacles, and supporting counterattacks. Engineers also open helicopter landing zones and tactical landing strips for fixed-wing aircraft. Maintaining and improving routes and creating bypass or alternate routes at critical points are major engineering tasks because movement routes are subjected to fires from enemy artillery and air support systems. These enemy fires may necessitate deploying engineer equipment, such as assault bridging and bulldozers, forward. The commander can also evacuate dislocated civilians or restrict their movements to routes not required by friendly forces to avoid detracting from the mobility of the defending force. The commander can do this provided the action is coordinated with the host nation or the appropriate civil-military operations agency and fulfills the commander's responsibilities to displaced civilians under international law.

6-42. The commander's priority of mobility support is first to routes used by counterattacking forces, then to routes used by main body forces displacing to subsequent positions. This mainly involves reducing obstacles and improving or constructing combat roads and trails to allow tactical support vehicles to accompany moving combat vehicles. The commander coordinates carefully to ensure units leave lanes or gaps in obstacles for repositioning main body units and committing the counterattack force. CBRN reconnaissance systems also contribute to the force's mobility in a contaminated environment.

Counter-mobility

6-43. In the defense, the commander normally concentrates engineer efforts on countering the enemy's mobility. A defending force typically requires large quantities of Class IV and V material and specialized equipment to construct fighting and survivability positions and obstacles. With limited assets, the commander must establish priorities among counter-mobility, mobility, and survivability efforts. The commander ensures that the unit staff synchronizes these efforts with the unit's sustainment plans.

6-44. The commander may plan to canalize the enemy force into a salient. In this case, the commander takes advantage of the enemy force's forward orientation by fixing the enemy and then delivering a blow to the enemy's flank or rear. As the enemy's attacking force assumes a defensive posture, the defending commander rapidly coordinates and concentrates all defending fires against unprepared and unsupported segments of the attacking enemy force. The unit may deliver these fires simultaneously or sequentially.

6-45. When planning obstacles, commanders and staffs consider not only current operations but also future operations. The commander should design obstacles for current operations so they do not hinder future operations. Any commander authorized to employ obstacles can designate certain obstacles to shape the battlefield as high-priority reserve obstacles. The commander assigns responsibility for preparation to a subordinate unit but retains authority for ordering their completion. One example of a reserve obstacle is a highway bridge over a major river. Such obstacles receive the highest priority in preparation and, if ordered, execution by the designated subordinate unit.

6-46. A commander integrates reinforcing obstacles with existing obstacles to improve the natural restrictive nature of the terrain to halt or slow enemy movement, canalize enemy movement into engagement areas, and protect friendly positions and maneuver. The commander may choose to employ scatterable mines, if allowed by the rules of engagement. Obstacles must be integrated with fires to be effective. This requires the ability to deliver effective fires well beyond the obstacle's location. When possible, units conceal obstacles from hostile observation. They coordinate obstacle plans with adjacent units and conform to the obstacle zone or belts of superior echelons.

6-47. Effective obstacles block, turn, or force the enemy to attempt to breach them. The defending commander tries to predict enemy points of breach based on terrain and probable enemy objectives. The defending force develops means to counter enemy breach attempts, such as pre-coordinated fires. The attacker will try to conceal the time and location of the breach. The defending commander's plan addresses

how to counter such a breach, to include reestablishing the obstacle by using scatterable mines and other techniques.

6-48. Improvement to the defensive is continuous. Given time and resources, the defending force constructs additional obstacle systems in-depth, paying special attention to its assailable flanks and rear. The rear is especially vulnerable if there are noncontiguous areas of operations or nontraditional threats. Obstacle systems can provide additional protection from enemy attacks by forcing the enemy to spend time and resources to breach or bypass them. This gives the defending force more time to engage enemy forces attempting to execute breach or bypass operations.

6-49. The commander designates the unit responsible for establishing and securing each obstacle. The commander may retain execution authority for some obstacles or restrict the use of some types of obstacles to allow other battlefield activities to occur. The commander allows subordinate commanders some flexibility in selecting the exact positioning of obstacles. However, all units must know which gaps or lanes—through obstacles and crossing sites—to keep open for movements, as well as the firing and self-destruct times of scatterable mines to prevent delays in movement. Commanders must be specific and clear in their orders for executing reserve obstacles and closing lanes. As each lane closes, the closing unit reports the lane's closure to the higher, subordinate, and adjacent headquarters to preclude displacing units from moving into areas with unmarked or abandoned obstacles.

6-50. Tactical and protective obstacles are constructed primarily at company level and below. Small-unit commanders ensure that observation and fires cover all obstacles to hinder breaching. Deliberate protective obstacles are common around fixed sites. Protective obstacles are a key component of survivability operations. They are tied in with final protective fires (FPF)s and provide the friendly force with close-in protection. Commanders at all echelons track defensive preparations, such as establishing Class IV and V supply points and start or completion times of obstacle belts and groups. The commander plans how the unit will restore obstacles the enemy has breached. The commander uses artillery, air, or ground systems to reseed minefields. (Maneuver Support Center of Excellence tactics and procedures publications provide additional information about obstacles and obstacle integration.)

Enemy Airborne and Air Assault

6-51. Defeating an enemy airborne or air assault attack begins with a good intelligence preparation of the battlefield (IPB) process to determine the enemy's capabilities to conduct vertical envelopment and identify enemy airfields, pickup zones, drop zones, and landing zones. Armed with an appreciation of the enemy's capability to conduct vertical envelopment, the commander takes steps to counter the attackers before they launch, during their movement to the drop zone, or at the landing zone. After prioritizing the risk of each potential drop zone or landing zone to the operation, the commander establishes systematic surveillance of these areas to alert defending forces of attempted enemy insertions. Units also sight their weapons to cover the most probable drop and landing zones. The fire support plan includes these zones in its target list for conventional munitions and scatterable mines and reflects current rules of engagement and host nation restrictions. Units and engineers emplace obstacles in these locations and block avenues of approach from such areas to critical friendly installations and activities as part of their countermobility and echelon support area survivability efforts.

6-52. Once enemy forces succeed in landing, the key to a successful defense is speed in containing and counterattacking the inserted enemy force before it becomes organized and reinforced. Field artillery and attack helicopters conducting close combat attacks must attack quickly to take advantage of the concentration of targets in the insertion area. Affected base and base cluster defense forces and available response forces keep the enemy force under observation, calling in and designating targets for available fire support systems. The commander rapidly musters and commits available maneuver forces to take advantage of enemy light air assault or airborne forces' vulnerabilities to attack by armored vehicles while they remain concentrated in the insertion area. If more enemy troops land and consolidate, local base and base cluster defense forces and the response force try to fix the enemy force to allow a tactical combat force (TCF) to counterattack. If the enemy force is too large for the TCF to reduce, the commander may need to commit the reserve.

Smoke and Obscuration

6-53. The commander uses smoke to disrupt the enemy's assault or movement formations and deny the enemy's use of target acquisition optics, visual navigation aids, air avenues of approach, landing zones, and drop zones. Smoke creates gaps in enemy formations, separating or isolating attacking units, and disrupting their planned movements. Bispectral obscuration can blind attackers who lack thermal viewers or other enhanced optical systems. It prevents overwatching enemy elements from observing and engaging the defender, while defending forces with advanced optical systems can acquire and engage the enemy within the smoke. The commander can use smoke to facilitate friendly target acquisition by highlighting enemy systems against a light background while degrading the enemy's optics. Smoke used to mask obstacles located in low-level flight corridors and on landing and drop zones can prevent an enemy from using them or greatly increase the enemy's risk.

6-54. The commander uses smoke-generation capabilities to mark targets and screen and obscure friendly positions. Modern bispectral obscurants provide protection from thermal as well as visual viewing devices. The commander must carefully employ obscurants with regard to enemy systems and friendly capabilities. Improper use can create an advantage for the enemy. The effectiveness of smoke depends on weather conditions and the quantity of smoke employed. The commander coordinates the use of smoke generators, artillery or mortar smoke, and smoke pot employment. The capabilities of each of these smoke-producing systems are most effective when used together to achieve synergistic effects. Using smoke can also enhance military deception operations and cover friendly movements. (FM 3-11.50 provides details on planning, preparing, and executing battlefield obscuration.)

Limited Visibility Adjustments

6-55. Defending during periods of limited visibility or nighttime conditions is normal. The ability of the attacker to create conditions of smoke—including thermal neutralizing smoke—and the smoke and dust associated with a battle also means that the defending commander must be able to rapidly modify the defense to one effective during limited visibility. In fact, the commander should assume limited visibility rather than full visibility during defensive planning.

6-56. There are two general limit visibility conditions: those which mechanical aids, such as thermal sights, can overcome or partially overcome, and those which such mechanical aids cannot overcome. The first category includes darkness. The second category includes dense battlefield dust, smoke, heavy rain, snow, fog, or any other conditions which cannot be at least partially overcome by artificial illumination, image intensification, radar, or other sensors. In this case, defending units may need to move closer to the avenues of approach they are guarding. Sensors may still be of some value in these conditions.

6-57. Night vision technology continues to change defensive tactics, techniques, and procedures in limited-visibility environments. Night vision devices have greatly increased capabilities to see, engage, and move for both defenders and attackers. While night-vision devices in U.S. units have continued to proliferate and improve over the years, their fields of view and depth perception remain limited when compared to normal vision during daylight. Limited-visibility conditions cause psychological impacts, a need to employ tighter formations, and cross-country navigation difficulties.

6-58. The attacking enemy can be expected to create or take advantage of limited visibility conditions. Normally, a defending commander can expect an attacker to take advantage of limited visibility conditions to:

- Conduct reconnaissance operations to locate the defender's weapons, defensive obstacles, and positions.
- Breach or reduce defensive obstacles.
- Move elements through gaps in the defender's coverage caused by reduced weapon ranges.

6-59. The defensive plan should include the following to help overcome potential limited-visibility problems:

- Long-range detection equipment, such as radar, sensors, and thermal imaging devices, focused on well-defined avenues of approach.
- Deployed weapons systems and some units along avenues of approach that follow terrain features potentially used by an enemy for orientation in darkness, such as wood lines and water courses.
- Increased numbers of infantry, scouts, observation posts, combat patrols, and anti-armor teams deployed forward on secondary avenues of approach and between subordinate unit defensive positions to detect and slow enemy movement, especially enemy infiltration attempts, and protect obstacles against enemy breaching attempts.
- Emplaced point obstacles and early warning devices along likely night approaches to slow the advancing enemy or to alert defenders to enemy presence.
- Planned and rehearsed weapon system and unit displacements and the massing of fires on projected enemy approaches. (Defending units moving over previously reconnoitered routes should be able to move faster than an enemy force moving through unfamiliar terrain.)
- Planned illumination on or behind likely engagement areas to silhouette enemy forces while leaving defenders in shadows and darkness. (While this illumination should not be needed with thermal sights, it is useful with other sights.)
- Adjustments to the organization of the defense for limited visibility should commence before dark and be completely reversed to their daylight configuration before dawn.

INTELLIGENCE

6-60. During the planning process, the commander uses intelligence products to identify probable enemy objectives and approaches. From those probable objectives and approaches, named areas of interest (NAIs) and targeted areas of interest (TAIs) can be developed. The commander studies patterns of enemy operations and the enemy's vulnerability to counterattack, interdiction, electronic warfare, air attacks, and canalization by obstacles. The commander must also examine the enemy's capability to conduct air attacks, insert forces behind friendly units, and employ nuclear, biological, and chemical weapons. The commander must determine how soon follow-on enemy forces can join the fight when defending against an enemy attacking in echelons.

6-61. The commander uses available reconnaissance, surveillance, and engineer assets to study the terrain. By studying the terrain, the commander tries to determine the principal enemy and friendly heavy, light, and air avenues of approach. The commander determines the most advantageous area for the enemy's main attack, as well as other mission variables of observation and fields of fire, avenues of approach, key terrain, obstacles, and cover and concealment (OAKOC). (See ATTP 3-34.80 for a detailed discussion of OAKOC.)

6-62. Just as in the offense, the echelon intelligence and operations officers, in coordination with the rest of the staff, develop a synchronized and integrated information collection plan that satisfies the commander's maneuver, targeting, and information requirements. These requirements in the defense are remarkably similar to those found in paragraph 1-162, although the commander's exact information requirements in the defense are dictated by the mission variables of METT-TC.

6-63. Commanders integrate information collection activities as part of the overall plan that addresses the continuation of collection and analysis efforts throughout the operation because it is unlikely that the commander has complete knowledge of the enemy's intentions, capabilities, and dispositions. (Maneuver Support Center of Excellence tactics and procedures publications discuss the specialized tasks associated with CBRN and engineer reconnaissance.)

6-64. The commander's ability to see the enemy is critical to the conduct of all defensive tasks. Defensive plans must address the sustainment, replacement, and reconstitution of reconnaissance and surveillance assets throughout the preparation and execution of the defense.

FIRES

6-65. In the defense, the commander uses the fires warfighting function to neutralize, suppress, or destroy enemy forces, to delay or disrupt the enemy's ability to execute a given course of action (COA), and to enhance the effects of massed direct fires. Thus fire support systems support both the commander's decisive and shaping operations.

Army Indirect Fires and Joint Fires

6-66. The defending force is more effective if it can locate and attack enemy forces while the enemy is stationary and concentrated in assembly areas or advancing along lines of communications, as opposed to when the attacking enemy force is deployed in combat formations within the MBA. To accomplish this, the defending force must employ available indirect and joint fires throughout its area of operations. It must be closely linked to target acquisition means, including reconnaissance and surveillance assets. The information in paragraphs 1-166 through 1-168 on the USAF tactical air control party (TACP), fire support planning, and role of the fire support coordinator (FSCOORD) or chief of fires applies to the defense.

6-67. As defensive plans develop, the commander must visualize how to synchronize, coordinate, and distribute the effects of indirect and direct fire at the decisive time and place. Permissive FSCM are placed as close as possible to friendly positions to enable the rapid engagement of attacking enemy forces by indirect and joint fires. Commanders coordinate the massing of fires effects on enemy targets, concentrated at obstacles and other choke points, before they can disperse. Proper distribution of fires ensures the massing of overwhelming combat power at these points and ensures that high-payoff targets are destroyed or neutralized without wasting assets through repetitive engagements by multiple friendly systems.

6-68. Indirect fires have the greatest impact on the enemy when they are synchronized with direct fires and the use of obstacles, defensive positions, and counterattack plans. The commander must integrate the defensive fire and obstacle plans from the beginning. Indirect fires complement the effects of obstacles and can disrupt enemy attempts to breach or bypass these obstacles. All elements in the fire support chain—from joint fires observers and platoon forward observers in fire support teams to the fires cell including the supporting tactical air control party and the supporting fires units—must understand the commander's intent, the scheme of maneuver, and the obstacle plan.

6-69. There are various fire support considerations for each phase of a battle. As part of shaping operations or supporting efforts during defense preparations, a commander tries to disrupt the enemy's attack preparations by—

- Conducting harassing fires on choke points and likely enemy assembly areas.
- Employing air support on known, suspected, and likely enemy locations.
- Attriting enemy resources by continuously engaging high-payoff targets.
- Conducting electronic warfare to degrade the enemy's ability to command and control forces.
- Employing counterfires to engage and destroy enemy artillery and mortar systems attempting to deliver suppressive fires.
- Providing fires in support of the unit's security operations, such as a unit conducting the tactical mission task of counterreconnaissance.

6-70. It may be better to wait to execute a counterfire mission until the fighting begins in the MBA. However, when defending forces enjoy qualitative advantages in fire support, the advantages accruing from a counterfire battle usually outweigh the risks to the defending force. The defender's ability to mass fires quickly and then rapidly reposition forces is a major factor in disrupting the enemy and establishing the conditions for successful decisive operations.

6-71. The commander employs fires to support the security force, using precision and other munitions to destroy enemy reconnaissance and other high-payoff targets. This also helps to deceive the enemy about the location of the MBA. The commander supports the security force by planning the delivery of fires at appropriate times and places throughout the AO to slow and canalize the enemy force as it approaches the security area. This allows the security force to engage the enemy on more favorable terms. To prevent fratricide and friendly fire incidents, the commander places no fire areas over security force elements.

Finally, the commander uses fires to support the withdrawal of the security force once the security force's shaping mission is complete and the defending unit is prepared to conduct MBA operations.

6-72. Air support can play an important part in delaying enemy forces following or attempting to bypass rearward-moving defending forces. Air operations contribute to overcoming the enemy's initial advantage of freedom of action. Often, only aircraft are available to initially oppose an enemy penetration until ground forces can redeploy. Commanders use close air support (CAS) and air interdiction to disrupt an enemy advance. CAS can operate with Army helicopters and artillery assets to form a joint air attack team (JAAT). The commander also incorporates artillery fires with electronic warfare and joint systems to suppress enemy air defenses while CAS hits a target. Air interdiction can delay, destroy, or neutralize enemy follow-on forces, thereby providing the commander with additional time to prepare defensive positions.

6-73. Once the engagement moves into the MBA, fire support assets continue to target enemy combat units to force them to deploy. At the same time, fire support assets inflict casualties, disrupt the cohesion of the enemy's attack, and impede the enemy's ability to mass combat power. Fire support assets continue to attack enemy follow-on forces before they can be committed to the MBA. Fire support assets attack enemy command and control (C2) facilities and logistics sites in depth to isolate the attacking enemy. The commander takes advantage of the range and flexibility of fire support weapons to mass fires at critical points, such as obstacles and engagement areas, to slow and canalize the enemy to provide better targets for direct fire systems. Fire support systems cover barriers, gaps, and open areas within the MBA. The commander assigns tasks to these fire support systems, including closing obstacle gaps or reseeding previously breached obstacles in accordance with the rules of engagement. Other tasks include—

- Massing fires to suppress enemy direct and indirect fire systems to facilitate defensive maneuver, especially the counterattack and disengagement.
- Neutralizing or isolating enemy forces that have penetrated the defensive area and impeding the movement of enemy reserves.
- Attacking enemy artillery and forward air defense elements.
- Using jamming to degrade or destroy the enemy's ability to transmit data and information.
- Reallocating fire support assets, after identifying the enemy's main effort, to reinforce fires in the most vulnerable areas.
- Separating attacking enemy combat vehicles from light infantry, disrupting the enemy's combined arms team.

6-74. In response to shallow enemy penetrations, artillery commanders normally reposition their systems laterally, away from the point(s) of enemy penetration. This allows the defender's artillery systems to provide fire support throughout the area of penetration.

Air and Missile Defense

6-75. Army air defense artillery forces, operating interdependently with other elements of the joint and multinational team at strategic, operational, and tactical levels, will provide air and missile defense and contribute to situational understanding, airspace management, and early warning to deter or defeat enemy aerial threats, protect the force and high value assets, and enable the force's freedom to operate. This mission is normally executed within a joint theater-wide structure and requires integration and close coordination between Army air defense artillery forces and other counterair forces.

6-76. Freedom of movement and freedom from aerial attack are as essential to successful defensive actions as they are to successful offensive actions. In an environment where air and missile threats exist, the defending ground force operates within a joint counterair operation designed to attain the desired degree of air superiority required by the joint force commander to accomplish the mission. The joint force commander normally seeks to gain and maintain air superiority as quickly as possible to allow all friendly forces, not just ground forces, to operate without prohibitive interference from enemy air and missile threats. This counterair mission integrates both offensive and defensive activities by all joint force components.

6-77. Generally, commanders use offensive counterair operations to dominate enemy airspace and prevent the launch of threats. (Offensive counterair operations include the suppression of enemy air defenses.) Defensive counterair operations defeat enemy air and missile threats attempting to penetrate or attack through friendly airspace. Commanders integrate joint forces to exploit the mutually beneficial effects of offensive and defensive actions to destroy, neutralize, or minimize air and missile threats. (See JP 3-01 for additional information on joint counterair operations.)

6-78. Air and missile defense fire control is part of the joint kill chain and is directed by the area air defense commander thru a sector air defense center or regional air defense center. The Army air and missile defense command or air defense artillery brigade provides air defense artillery fire control officers to the sector or regional air defense center. Air and missile defense fires are coordinated and cleared on the ground and through the airspace to enable rapid and timely engagement of threats while preventing fratricide. However, the defending ground force staffs coordinate to ensure that as much of their defended asset list as possible is located within the footprint fan of these air and missile defense systems.

6-79. Air and missile defense supports the conduct of defensive tasks involving engaging targets throughout the area of operations with air and missile defense fires and defensive counterair operations. In the defense, general fire support considerations for supporting the concept of operations include—

- Plan for target acquisition and sensors to provide coverage of NAIs, TAIs, and critical assets.
- Provide fires in support of defensive counterair operations to prevent enemy aerial attacks.
- Provide integrated air and missile defense fires in synchronization with maneuver and electronic warfare countermeasures in the conduct of decisive and shaping operations.
- Provide fires to support counterattacks.
- Provide fires in support of decisive, shaping, and sustaining operations.

Active Air and Missile Defense

6-80. *Active air defense* is direct defensive action taken to destroy, nullify, or reduce the effectiveness of hostile air and missile threats against friendly forces and assets. (JP 3-01). It includes the use of aircraft, air defense weapons, electronic warfare, and other available weapons. Active missile defense requires early detection of missiles in flight to permit cueing, acquisition, tracking, classification, identification, and destruction as soon as possible after launch. The area air defense commander exercises control of active air defense operations by integration of air defense artillery systems and forces into the command's information systems. The Army forces (ARFOR) commander retains command of Army active defense forces. They conduct operations within their areas of operations per area air defense commander-developed, joint force commander-approved rules of engagement, defended asset list, and airspace control measures to protect their forces and the joint force commander air and missile defense priorities. *Airspace control* is a process used to increase operational effectiveness by promoting the safe, efficient, and flexible use of airspace (JP 3-52).

6-81. Army air and missile defense (AMD) units will not normally be positioned to provide AMD support to security forces in the defending unit's security area. They may be able to range portions of the MBA to provide some general support. Generally, defending ground forces depend on offensive and defensive counterair warfare operations conducted by joint force air component commander (JFACC) (who is also the area air defense commander) controlled fixed-wing aircraft and Army Patriot batteries for defense against enemy aircraft and missiles. Defending ground units employ small arms air defense against enemy aircraft attacking their positions and enemy unmanned aircraft systems.

Passive Air Defense

6-82. *Passive air defense* is all measures, other than active air defenses, taken to minimize the effects of hostile air and missile threats against friendly forces and assets (JP 3-01). These measures include camouflage, concealment, military deception, dispersion, reconstitution, redundancy, detection and warning systems, and the use of protective construction. Passive defense improves survivability by reducing the likelihood of being detected and targeted from the air and by mitigating the potential effects of air surveillance and attack. Passive missile defense measures include detecting air and missile launches,

predicting impact points, providing threat identification, and disseminating early warning. It includes measures initiated to reduce vulnerability and to minimize the effect of damage caused by missile attack.

SUSTAINMENT

6-83. The commander addresses several unique sustainment considerations in the defensive plan. Priorities for replenishment are normally ammunition and materials to construct obstacles and defensive positions. There is normally a reduced need for bulk fuel. There may be an increased demand for decontaminants and CBRN collective and personal protective equipment. The commander considers stockpiling or caching ammunition and limited amounts of petroleum products in centrally located positions within the main battle area. The commander plans to destroy those stocks if necessary as part of denial operations. The supply of obstacle materials in a defense can be a significant problem that requires detailed coordination and long lead times. The commander should not overlook the transportation and manpower required in obtaining, moving, and uncrating barrier material and associated obstacle creating munitions, such as demolition charges and mines.

6-84. The commander ensures that the echelon sustainment officers (G-4/S-4, G-1/S-1, and the G-8) and the commanders of the sustainment units supporting the defending force understand the commander's tactical intent. They can then establish support priorities in accordance with the commander's intent and plan sustainment operations to ensure the supportability of the operations. The commander also addresses sustainment during branches and sequels to the defense plan, such as a counterattack into the flank of an adjacent unit.

6-85. Maneuver units top off regularly with supplies in case an enemy breakthrough disrupts the replenishment flow. At the battalion and BCT level the commander ensures that sustainment operators deliver combat-configured loads to maneuver units on a scheduled basis. Combat-configured loads are packages of potable and nonpotable water, CBRN defense supplies, barrier materials, ammunition, petroleum, oil, and lubricants (POL), medical supplies, and repair parts tailored to a specific size unit. This eliminates the need to request supplies and reduces the chance that a lapse in communications will interrupt the supply flow and jeopardize the integrity of the defense. The commander resupplies the supported maneuver unit using this push system until it requests otherwise. The commander can use utility and cargo helicopters to deliver supplies directly from the echelon support area to the defending unit. Commanders use information systems to accurately tailor these combat-configured push packages to the demands of the supported maneuver units.

6-86. As a technique, the defending force conducts resupply during periods of limited visibility if the commander does not expect the enemy to conduct a limited-visibility attack. This reduces the chance for enemy interference with the resupply process but also lengthens the amount of time it takes to complete the process. Resupply occurs during daylight hours if the commander expects the enemy to conduct a limited visibility attack. The commander may be required to infiltrate resupply vehicles to reduce detection chances when the enemy possesses a significant air, satellite, or unmanned aircraft capability. The commander may also use smoke to help conceal logistics operations.

6-87. Terrain management is a critical consideration in the echelon support area. The commander positions each sustainment unit where it can best fulfill its support tasks while using minimal resources to maintain security in conjunction with other units located in the echelon support area. In contiguous operations, the commander positions echelon sustainment facilities farther away from the forward edge of the battle area (FEBA) in a defense than in the offense to avoid interfering with the movement of units between battle positions or the forward movement of counterattack forces. These facilities are located far enough behind friendly lines that likely enemy advances will not compel the relocation of critical sustainment capabilities at inopportune times. However, those sustainment capabilities supporting the unit must be close enough to provide responsive support. In noncontiguous operations, the commander positions sustainment facilities in bases and base clusters within the perimeters of ground maneuver units to provide security and avoid interrupting their sustainment functions. The commander distributes similar functional sustainment units throughout the defensive area in both environments. This distribution allows the commander to designate one sustainment unit to pick up the workload of a displacing second sustainment unit until the second sustainment unit is once again operational.

6-88. The defending commander provides maintenance support as far forward as possible at maintenance collection points to reduce the need to evacuate equipment. The thrust of the maintenance effort is to fix as far forward as possible those systems that can be quickly returned to the unit in combat-ready condition. The commander must ensure that multifunctional forward logistics elements contain the maximum variety of maintenance personnel with appropriate equipment, such as repair sets, kits, and outfits, to rapidly repair weapon systems.

6-89. Medical support associated with the defense anticipates significant casualties just as in the offense. The commander plans to augment the available ambulances if a mass-casualty situation develops. Units should always plan for mass casualties and have an evacuation plan, including ambulance exchange points and air evacuation, which accounts for the use of both standard and nonstandard air and ground platforms.

6-90. The conduct of troop movements and resupply convoys is critical to a successful defense. Staffs balance terrain management, movement planning, and traffic-circulation control priorities. They plan multiple routes throughout the AO and closely control their use. The commander may allocate mobility resources to maintain main supply routes to support units and supplies moving forward and to evacuate personnel and equipment to the rear. Military police ease these movements, prevent congestion, and respond to maneuver plan changes. Commanders plan for dislocated civilians and the effect that they have on friendly military operations. Civil affairs units and personnel assist commanders in planning populace and resource control measures. Host nation and international organizations minimize the impact of disaster or conflict on displaced civilians. The commander coordinates air and ground movements supporting the commander's scheme of maneuver with any other affected Services. Commanders also coordinate such movements with any affected organic and external Army aviation, fire support, air defense units, and ground maneuver units.

6-91. During the preparatory phase of the defense, sustainment operators normally pre-position supply stocks, particularly ammunition and barrier materials, in the battle positions of defending forces. They also establish maintenance and casualty collection points. Sustainment operators must address these and other sustainment preparations in the planning process to avoid compromising the operation. These sustainment preparations can also be included in military deception plans.

PROTECTION

6-92. Unit survivability is critical to defensive success no matter what defensive task is performed. Protection preserves subordinate unit capabilities so that the commander can use those capabilities to apply maximum combat power at the desired times and places. Criticality, vulnerability, and recuperability are some of the most significant considerations for the commander in determining protection priorities. The commander uses available decision support tools and analysis to assess the unit's critical assets and key vulnerabilities. The commander plans and prepares for enemy attacks by predicting where the next attack will occur and applies measures to mitigate the attack. These enemy attacks may be from conventional, irregular, or terrorist forces and drive changes in local unit protection or individual protective measures. Incident management plans and environmental considerations integrate the protection tasks and their associated systems. The protection tasks discussed below have additional defense-specific planning considerations not previously addressed in chapter 1. (See ADRP 3-37 and medical doctrine for a detailed discussion of all protection tasks.)

Area Security, Antiterrorism, and Physical Security

6-93. The enemy will employ a mix of long-range fires, aircraft, cannons, missiles, and rockets, as well as ground maneuver and special purpose forces, to attack defending maneuver elements, mission command nodes, lines of communications, sustainment sites, and civilian population centers in an attempt to disrupt the unit's defense. Commanders pay attention to area and local security and antiterrorism operations throughout the conduct of the defense. This is especially true when the defending unit conducts noncontiguous operations.

6-94. In the defense, commanders protect forces and critical assets by conducting area security operations. Forces conducting area security in the defense can deter, detect, or defeat enemy reconnaissance while creating standoff distances from enemy direct- and indirect-fire systems. Commanders use area security

operations to protect the rapid movement of combat trains or protect cached commodities in addition to their respective echelon support areas.

6-95. Units employ all-around security at all times, although they deploy the bulk of their combat power against likely enemy avenues of approach. Units maintain security because the battlefield offers many opportunities for small enemy elements to move undetected.

6-96. The commander clearly defines responsibilities for the security of units within the echelon support area. The individual designated as responsible for a given echelon support area (for example, the commander of a maneuver enhancement brigade for the division support area) is responsible for defensive planning and risk mitigation in that area. That individual can designate the commanders of tenant units (except medical corps officers) as base and base cluster commanders. Those base and base cluster commanders are responsible for the local security of their respective bases and base clusters. The commander responsible for the echelon support area can also designate protection standards and defensive readiness conditions for tenant units and units transiting through the area. Higher protection standards may impact the ability of those supporting sustainment units to perform their primary mission in support of the operations of maneuver and other forces. The commander coordinates to mitigate the effects of security operations on the primary functions of units located within the echelon support area.

6-97. The success of unit defensive actions may depend on protecting the echelon support area from enemy attacks. Commanders must address the early detection and immediate destruction of enemy forces attempting to operate in the echelon support area or interdict lines of communications between that support area and maneuver forces. Enemy attacks in the echelon support area can range in size from individual saboteurs to enemy airborne or air assault insertions targeted against key facilities and capabilities. These enemy activities, especially at smaller unit levels, may even precede the onset of large-scale hostilities and will be almost indistinguishable from terrorist acts.

6-98. Planners determine how military police elements supporting the defending unit will enhance unit protection capabilities by conducting operational area security (reconnaissance, surveillance, base security, protective services, secure routes and convoys, and implement physical security measures) inside and outside the echelon support area. Military police also perform response-force operations to defeat Level II threats against bases and base clusters located in that support area. They will maintain contact with Level III threats in the echelon support area until a tactical combat force can respond. (See JP 3-10 [figure I-1] for a discussion of the threat levels.)

Survivability

6-99. Since the attacking enemy force usually has the initiative in terms of where and when it will attack, a defending commander must take a wide range of actions to protect the force from losses due to enemy actions. The survivability effort for the defense must enable units to concentrate firepower from fixed positions. To avoid detection and destruction by the enemy, units should move frequently and establish survivability positions quickly. To provide flexibility, units may need primary, alternate, and supplementary positions. This is particularly true of units defending key or decisive terrain. Units enhance their survivability through the use of concealment, military deception, dispersion, and field fortifications. The commander should avoid predictable defensive preparations because an enemy will tend to attack lightly defended areas.

6-100. When preparing area and mobile defenses, the engineers supporting the defensive effort help maneuver and supporting units prepare fighting and survivability positions. Commanders locate these positions throughout the defending unit's area of operations from the security area, through the MBA, to the echelon support area. Requirements beyond the capabilities of BCT engineer units are passed to a division or corps current operations cell to an attached maneuver enhancement brigade (MEB) or any functional engineer brigade supporting the division or corps. These engineers also prepare any strongpoints required by the division or corps concept of operations.

6-101. In accordance with the mission variables of METT-TC, units can conduct survivability moves. They may move between their primary, alternate, and supplementary positions.

6-102. Survivability tasks include using engineer equipment to assist in preparing and constructing trenches, command post shelters, and artillery firing, radar, and combat vehicle fighting positions. The commander provides guidance on the level of protection—such as hull defilade or overhead cover, system priorities, and early use of specialized engineer systems that can construct survivability positions. The commander's priority in engineer survivability planning during defensive actions is determining the most appropriate locations and standards for the construction of survivability positions. This includes such things as determining overhead cover standards, such as capable of resisting penetration by 82 mm mortar or 152 howitzer shells. (Maneuver Support Center of Excellence tactics and procedures publications provide additional information concerning the construction and maintenance of survivability positions.)

6-103. The commander protects supply stocks against blast, shrapnel, incendiaries, and CBRN contamination. Supplies loaded on tactical vehicles can be protected against almost anything but a direct hit by constructing berms large enough to accommodate the vehicle and deep enough to keep supplies below ground level. The echelon engineer officer can advise sustainment operators about storage area site selection that reduces the requirements for engineer survivability support without reducing the degree of protection provided.

6-104. The defending unit's subordinate maneuver elements occupy their AOs as soon as possible, so they can have as much time as possible to prepare defensive positions and enhance the defensive characteristics of the terrain within those AOs. This includes the construction of fighting and survivability positions.

6-105. Units employ three principles to enhance the concealment of their defensive positions—siting, discipline, and construction.

- Siting means selecting the most advantageous position in which to hide a man, an object, or an activity. This is often the shadows provided by wood lines, wadies, and buildings.
- Strict concealment discipline by units and individual Soldiers is required for success in any concealment effort. Units avoid activities that change the appearance of an area or reveal the presence of military equipment. Laxness and carelessness will reveal a position. Tracks, spoil, and debris are the most common signs of military activity that indicate concealed objects. Commanders ensure that new tracks follow existing paths, roads, fences, or natural lines in the terrain pattern. Commanders do not end exposed routes at a position, but extend them to another logical termination. Units brush out, camouflage, or cover their tracks, if practical. Units cover or place spoil and debris on positions and equipment to blend with the surroundings. Units add artificial camouflage when the terrain and natural vegetation are inadequate for concealment.
- Construction involves adding natural materials to blend with the surrounding terrain.

The commander uses the same principles for concealment from aerial observation as for concealment from ground observation.

6-106. In addition to hiding equipment, units can avoid detection by using mud for glassy surfaces and unfilled sandbags over windshields. Camouflage is one of the basic weapons of war. Soldiers must understand the importance, the principles, and the techniques of camouflage. All personnel must ensure the effectiveness of all camouflage measures and maintain strict camouflage discipline. (See ATTP 3-34.39 for additional information on the use of camouflage and concealment.)

6-107. Major defensive positions, sustainment sites, command posts, and other facilities may require special camouflage. Camouflage measures that provide this protection include constructing dummy positions and decoys. The commander carefully plans the use of such measures within the framework of real positions and ongoing and future operations. There are three fundamental methods of concealing individual weapons, units, installations and activities—hiding, blending, and disguising.

- Hiding is the complete concealment of an object by some form of physical screen. For example, sod placed over mines hides the mines; the overhead canopy of trees hides the objects beneath from aerial observation; tunnels hide objects located within them; a building roof and walls, camouflage net, or tarpaulin hides objects beneath it; a defilade position hides objects from ground observation. In some cases, the screen may be invisible. In other instances, the screen may be visible, but it hides the activity behind it.
- Blending is arranging or applying camouflage materials on, over, and around the object so that it appears to be part of the background. Examples include applying face paint to the exposed areas of skin, and adding burlap, paint, and live vegetation to helmets and clothing to closely resemble or blend into the background. Units can apply the same technique for equipment or structures.
- Using clever disguises can often mislead the enemy about the friendly force's identity, strength, and intention, and may draw enemy fire from real assets. Therefore, the simulation of objects, pieces of equipment, or activities may have military significance. Inflatable tanks, tents, and buildings can look like the real thing to an aerial observer.

6-108. Damage limiting measures are also employed as part of unit survivability measures. These measures attempt to limit damage, if the enemy detects the position. Through damage limiting, the enemy is forced to destroy friendly equipment one piece at a time. Enemy forces should never be able to put a unit out of action with just a single attack. The commander uses dispersion to limit the damage done by an enemy attack. Dispersed troops and vehicles force the attacker to concentrate on a single small target that may be missed. The wider the dispersion of unit personnel and equipment, the greater the potential for limiting damage. The commander positions forces and installations to avoid congestion, but does not disperse them to the extent that there is a risk of defeat in detail by an enemy employing conventional munitions or weapons of mass destruction.

6-109. Units also use cover to limit the amount of damage and casualties that they can receive because of an enemy attack. Folds in the earth, natural depressions, trees, buildings, and walls offer cover; individuals and units seek them out and use them habitually. If the commander deploys in flat terrain lacking cover, digging in or sandbagging can offer some protection. The unit employs smoke if it is moving and cannot use natural cover or cannot build fortifications. Smoke makes target acquisition much more difficult for the attacker. The unit must do everything it can to avoid an attack in the first place as part of its survivability measures, but if it is attacked, it uses cover and dispersion to limit the amount of damage.

Force Health Protection

6-110. Defensive actions can result in prolonged occupation of static positions and corresponding exposure of personnel and equipment to weather and other environmental affects that can quickly degrade readiness. Commanders enforce environmental disciplines, such as hydration, protective clothing, and maintenance. Defensive actions also may entail sustained enemy bombardments resulting in dramatic affects on the mental and behavioral health of unit personnel. Soldiers can become combat ineffective from heavy indirect fire even if exposure is for short durations. Commanders deliberately emplace systems for combat stress identification and treatment to reduce the return-to-duty time of affected personnel.

CHEMICAL, BIOLOGICAL RADIOLOGICAL, AND NUCLEAR DEFENSE

6-111. Because defending units are often in fixed positions, they increase their vulnerability to CBRN threats and hazards. The commander specifies the degree of acceptable risk and establishes priorities for CBRN assets. The commander positions forces and installations to avoid congestion, but does not disperse them to the extent that there is a risk of defeat in detail by an enemy employing conventional munitions.

6-112. Units develop, train, and rehearse a CBRN passive defense plan to protect personnel and equipment from CBRN hazards. Mission-oriented protective posture (MOPP) analysis results in initial individual protective equipment levels, and decontaminants are positioned accordingly. Higher headquarters often establish the MOPP level. Force health personnel maintain situational awareness and surveillance of personnel strength information for indications of force contamination, epidemics, or other anomalies apparent in force health trend data. The commander ensures that the unit can conduct operational and

thorough decontamination of military personnel and equipment. The commander is responsible for CBRN passive defense training to prepare the unit to respond properly to CBRN threats.

6-113. The commander should employ CBRN reconnaissance and surveillance elements along movement routes and at potential choke points. Proper use of these assets enables the commander to reduce casualties and complete the mission.

6-114. CBRN personnel contribute to the overall protection of defending units located in defensive positions. CBRN personnel conduct CBRN vulnerability assessments that provide a list of recommended preventive measures for commanders to consider before and after units move into their defensive positions. These assessments provide a list of preventive measures that can range from emplacing smoke pots and generators to provide obscuration to neutralize enemy sensors, to establishing collective protection and personnel and equipment decontamination sites. (For more information on CBRN operations, see FM 3-11 and FM 100-30.)

FORMS OF THE DEFENSE

6-115. Subordinate forms of the defense have special purposes and have their own unique planning considerations. The following section addresses these purposes and the unique considerations associated with—

- Defense of a linear obstacle.
- Perimeter defense.
- Reverse slope defense.

DEFENSE OF A LINEAR OBSTACLE

6-116. A commander may conduct either an area or mobile defense along or behind a linear obstacle. Commanders normally prefer an area defense because it accepts less risk by not allowing the enemy to cross the obstacle. Linear obstacles such as mountain ranges or river lines generally favor a forward defense. The defending force seeks to defeat any enemy attempt to seize a bridgehead across the linear obstacle. Local defending units immediately and violently counterattack any enemy bridgeheads to destroy enemy forces located within the bridgehead, while higher echelons attempt to isolate enemy bridgehead sites. If the enemy seizes a bridgehead and strikes out rapidly, it could quickly penetrate the defending force. This requires the commander to conduct either a delay or a withdrawal.

6-117. It is extremely difficult to deploy in strength along the entire length of a linear obstacle. The defending commander must conduct economy of force measures in some areas. Within an area defense, the commander's use of a defense in depth accepts the possibility that the enemy may force a crossing at a given point. The depth of the defense should prevent the enemy from rapidly exploiting its success. It also defuses the enemy's combat power by forcing the enemy to contain bypassed friendly defensive positions in addition to continuing to attack positions in greater depth. Once the enemy force secures several bridgeheads, the defending force moves to contain them. The defending force commander may choose not to counterattack until the commander can mass overwhelming combat power. The defending commander will probably choose to eliminate the bridgeheads sequentially in this case. However, the defender risks allowing the enemy to establish and fortify bridgehead crossing sites sufficiently to prevent the counterattack force from eliminating them.

6-118. The mobile defense gives the enemy an opportunity to cross the obstacle with a portion of the attacking enemy force. The commander conducting a mobile defense along a linear obstacle normally employs minimal forces along the obstacle as the fixing force. This generally allows the enemy to cross in at least one location. Once the enemy has partially crossed and the obstacle divides enemy forces, the commander conducts shaping operations to isolate the enemy bridgehead. Once the bridgehead is isolated, the defending commander launches a decisive attack by the striking force to destroy that isolated enemy bridgehead. The defending commander may also choose this technique when the enemy is likely to use weapons of mass destruction.

6-119. Alternatively, in a mobile defense the commander may take advantage of terrain or smoke to hide a striking force until the enemy's forward elements pass this force. Until committed, the striking force maintains a perimeter defense. This technique closely resembles the use of stay-behind forces. Similarly, the commander may order units inadvertently bypassed by the enemy not to break out immediately, so that the defenders may capitalize on their position to destroy the enemy.

PERIMETER DEFENSE

6-120. The commander can employ the perimeter defense as an option when conducting an area or mobile defense. The commander uses it in many other circumstances, such as when subordinate units bypass enemy forces or in the conduct of base and base cluster defense in the echelon support area.

6-121. A perimeter defense is oriented in all directions. The prerequisites for a successful perimeter defense are aggressive patrolling and security operations outside the perimeter. The unit within the perimeter can perform these activities, or another force, such as the territorial defense forces of a host nation, can perform them. The unit can organize a perimeter defense to accomplish a specific mission, such as protecting a fire base, or providing immediate self-protection, such as during resupply operations when all-around security is required. The commander establishes a perimeter when the unit must hold critical terrain, such as a strong point, or when it must defend itself in areas where the defense is not tied in with adjacent units. This occurs when the unit is operating behind enemy lines, or when it is securing an isolated objective, such as a bridge, mountain pass, or airfield. A unit may also form a perimeter when it has been bypassed and isolated by the enemy, and it must defend in place, or it is located in the friendly echelon support within the confines of a base or base cluster. (See figure 6-1.) However, divisions and corps can also organize a perimeter defense when necessary.

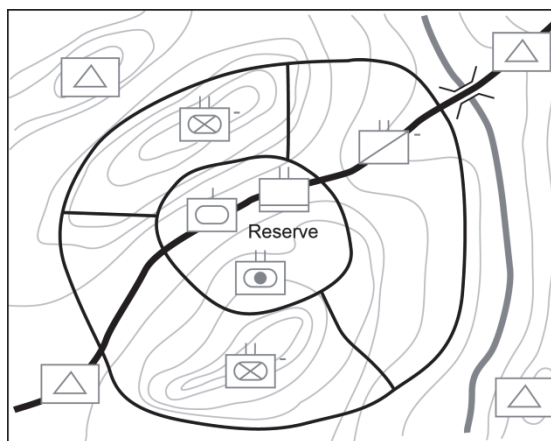

Figure 6-1. Perimeter defense

6-122. A major characteristic of a perimeter defense is a secure inner area with most of the combat power located on the perimeter. Another characteristic is the ease of access for resupply operations. The commander coordinates direct and indirect fire plans to prevent accidentally engaging neighboring friendly units and noncombatants. Normally, the reserve centrally locates to react to a penetration of the perimeter at any point.

6-123. Perimeters vary in shape depending on the terrain and situation. If the commander determines the most probable direction of enemy attack, that part of the perimeter covering that approach may be reinforced with additional resources. The perimeter shape conforms to the terrain features that best use friendly observation and fields of fire. The commander can increase the effectiveness of the perimeter by tying it into a natural obstacle, such as a river, which allows the defending unit to concentrate its combat power in more threatened areas.

Organization of Forces

6-124. The commander may employ all defending forces forward along the perimeter or establish a defense in depth within the perimeter. The commander employs patrols, raids, ambushes, air attacks, and supporting fires to harass and destroy enemy forces before they make contact with the perimeter, thus providing defense in depth with both techniques.

6-125. In the first technique, the commander places all subordinate units in positions along the perimeter. The commander divides the perimeter into subordinate unit AOs with boundaries and contact points. (See figure 6-2.) This reduces the possibility of fratricide and friendly fire incidents within the perimeter and maximizes combat power on the perimeter.

6-126. Constructing an outer and inner perimeter creates some depth in the defense in the second technique. Using an infantry brigade combat team (IBCT) assembly area as an example, the commander places two companies in each battalion along the outer perimeter reinforced with detachments from the battalion weapons company and one company in reserve along the inner perimeter. (See figure 6-3.) This configuration gives depth to each battalion's positions and facilitates control. It also gives one company from each battalion the mission to support frontline platoons. The reconnaissance battalion would have its resources manning positions outside the perimeter. Alternatively, the commander could elect to assign the outer perimeter to the two maneuver battalions and have the reconnaissance battalion resource an inner perimeter, retaining a larger, more tactically mobile central reserve. (See figure 6-4 on page 6-24.)

6-127. The commander positions forces within the perimeter to decrease the possibility of an enemy simultaneously suppressing the inner and outer perimeter forces with the same fires. Friendly forces within the perimeter provide mutual support.

In open terrain, the commander covers gaps on the outer perimeter between units with fires. The commander does not allow gaps between defensive fighting positions when the unit is in restrictive terrain with restricted fields of fire and observation. This may mean that a unit defends along a narrower frontage than on more open terrain. The commander may also have to employ all subordinate units on the line formed by the perimeter. The commander ensures that outer perimeter positions have rearward protection from inner perimeter weapons if an inner perimeter is established.

6-128. The commander normally assigns combat vehicles supporting the defense firing positions on the perimeter to cover the most likely mounted avenues of approach. Vehicle commanders select and prepare alternate and supplemental firing positions and routes to and from them. If the perimeter has several mounted avenues of approach leading to it, the commander may elect to hold these combat vehicles in hide positions until the enemy approaches. Units prepare routes, firing positions, and range cards in advance for all positions. Small-unit leaders must ensure that vehicles do not destroy communication wires when they displace from one position to another. Those same leaders make sure that jamming devices protecting their vehicles from radio controlled command detonated mines and boobytraps during movement are completely shut off before returning to assembly areas, defensive positions, and forward operating bases to prevent the jamming of friendly communications systems.

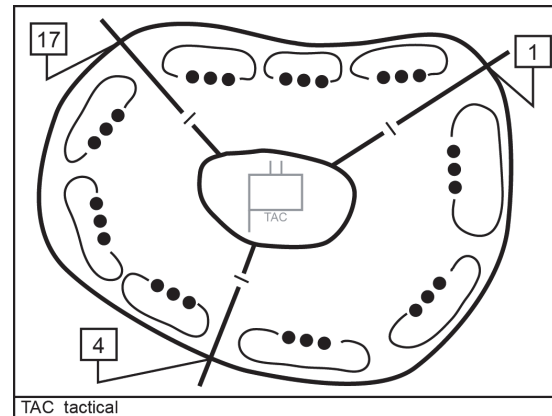

Figure 6-2. All company teams on the perimeter

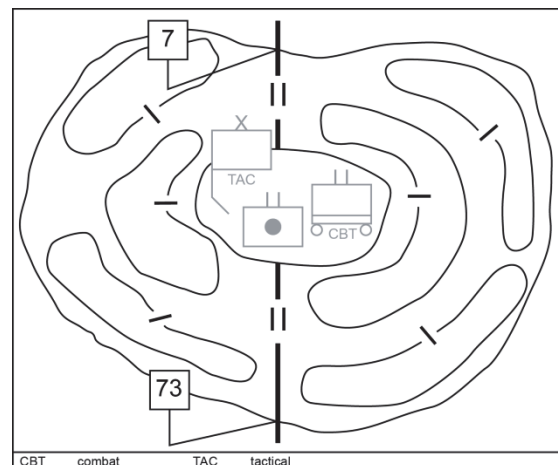

Figure 6-3. Two battalion task forces on the perimeter, company teams positioned in depth.

6-129. The need to hold or protect terrain features—such as bridges, airfields, or landing zones—from enemy observation and fires may restrict the positioning of units within a perimeter. These factors, as well as the inability to achieve depth, make a perimeter defense vulnerable to penetration by heavy enemy forces. The commander reduces these vulnerabilities by—

- Developing reconnaissance and surveillance plans that provide early warning.
- Positioning anti-armor systems on restrictive terrain to concentrate fires on armor approaches.
- Providing as much depth as the diameter of the perimeter to allow the proper placement of security elements and the reserve and the designation of secondary sectors of fire for anti-armor weapons.
- Constructing obstacles to fix or block the enemy, so friendly units can effectively engage them.
- Using smoke and military deception.

6-130. If isolation from other friendly units drives the commander to form a perimeter, such as when conducting echelon support area security, functional and multifunctional support and sustainment elements from other units may seek to take advantage of that perimeter's protection. These elements are given defensive missions within the base formed by the perimeter based on their capabilities. The commander coordinates and integrates any fire support provided from outside the perimeter into the overall defensive plan. This extra fire support conserves the ammunition of units within the perimeter.

6-131. The commander normally employs reconnaissance assets, such as a scout platoon, outside the perimeter to provide early warning. The commander may augment perimeter security with squad-sized or smaller observation posts forward of the perimeter that are provided and controlled by units on the perimeter. These security elements are positioned to observe avenues of approach. Patrols cover areas that cannot be observed by stationary elements. Any security forces operating outside the perimeter must coordinate their passage of lines into and out of the perimeter with the appropriate perimeter units.

6-132. The reserve may be a designated unit or a provisional force organized from available personnel and equipment. The reserve forms a second line of defense behind the perimeter forces. Ideally, the reserve is mobile enough to react to enemy action along any part of the perimeter. The commander positions the reserve to block the most dangerous avenue of approach and assigns on-order positions on other critical avenues. The commander may task combat vehicles initially occupying firing positions on the perimeter with the mission of reinforcing the reserve.

Control Measures

6-133. The commander in a perimeter defense designates the trace of the perimeter, battle positions, contact points, and lateral and forward boundaries. The commander can use EAs, target reference points, final protective fires, and principal direction of fire as fire control measures. The commander designates checkpoints, contact points, passage points, and passage routes for use by local reconnaissance, surveillance, and security elements operating outside the boundary of the perimeter. (See figure 6-5.)

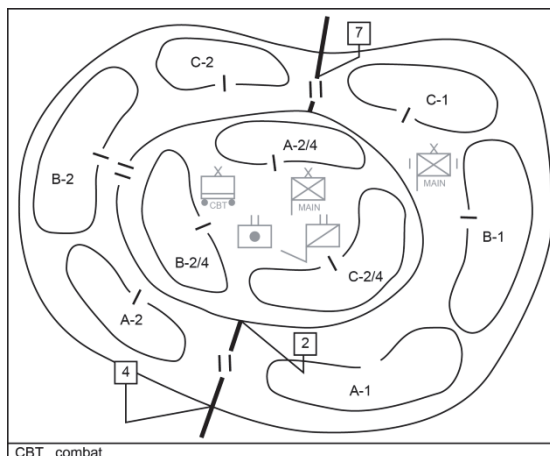

Figure 6-4. Two battalion task forces on the perimeter, one in reserve.

Planning a Perimeter Defense

6-134. The defending commander positions defending forces and plans fire and movement, so they can respond to the widest possible range of enemy actions. The defending commander, assisted by the staff, prepares plans, including counterattack plans. The commander rehearses, evaluates, and revises these plans as needed. The availability of landing and drop zones protected from enemy observation and fire is a major consideration when selecting and organizing the perimeter defense. The commander must emphasize supply economy and protect existing supply stocks, since aerial resupply is vulnerable to weather and enemy fires. The commander considers the following fundamentals when planning a perimeter defense.

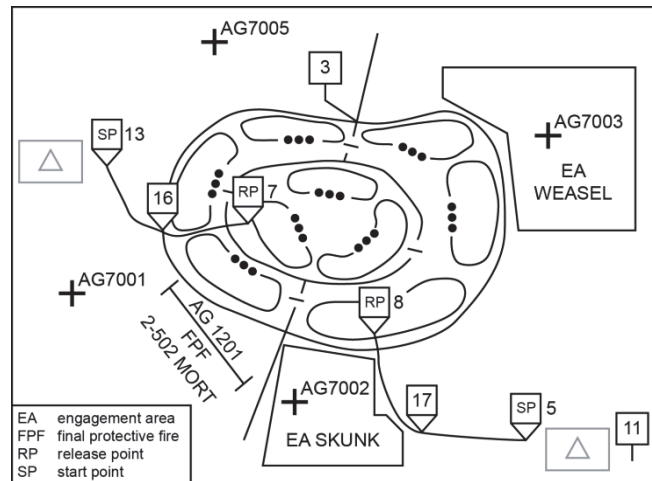

Figure 6-5. Engagement area control measures

Use of Terrain

6-135. Proper evaluation and organization of the area are essential to maximize the effectiveness of a force conducting perimeter defense. Commanders consider —

- Natural defensive characteristics of the terrain.
- Using artificial obstacles to enhance the natural defensive characteristics of the terrain.
- Existing roads, railways, and waterways used for military LOCs and civilian commerce.
- Controlling land areas surrounding the perimeter to a range beyond that of enemy mortars and rockets and also controlling water approaches.

Security

6-136. Early warnings of pending enemy actions ensure the commander time to react to any threat. Combat outposts, patrols, sensors, target acquisition radars, and aerial surveillance provide early warning. Civilian informants and the actions of indigenous people near the position are excellent indicators of pending enemy actions. Security measures vary with the enemy threat, forces available, and the other mission variables of METT-TC; however, all-round security is essential.

Mutual Support

6-137. The commander positions defending forces to ensure mutual employment of defensive resources, such as crew-served weapons, observation, and maneuver elements. Mutual support between defensive elements requires careful planning, positioning, and coordination because of the circular aspects of the perimeter defense. The commander uses surveillance, obstacles, prearranged indirect fires, and maneuver elements to exploit or reinforce fires to control any gaps in the perimeter. Defensive plans provide for using all available support, including field artillery systems firing danger close, attack helicopters conducting close combat attack, and close air support.

All-Around Defense

6-138. In defensive planning, the commander has to be prepared to defend against an enemy attack from any direction. The commander employs flexible plans and positions the reserve to react to any threat. The commander commits maneuver elements and supporting weapons to detect, engage, and destroy the

attacking enemy force. The commander assigns defensive positions to all personnel within the perimeter and sectors of fire.

Defense in Depth

6-139. Alternate and supplementary positions, combat outposts, and mutually supporting strong points forward of the perimeter extend the depth of the defense. The commander plans fires throughout the defensive area up to the maximum range of weapons. The commander may place portable obstacles around critical locations within the perimeter during periods of reduced visibility to disrupt the enemy's plan and add depth to the defense.

Responsiveness

6-140. Attacks against a perimeter may range from long-range sniper, mortar, or artillery and rocket fire to attacks by demolition teams or major forces. The enemy has the advantage of deciding when, where, and with what force to attack. The commander prepares plans, to include counterattack plans, and rehearses, assesses, and revises them as necessary. The defensive plan contains procedures for timely responses by fire support teams and maneuver forces.

Maximum Use of Offensive Action

6-141. Since the objective of the perimeter defense is to maintain a secure position, the commander uses offensive actions to engage enemy forces outside the base. On initial occupation of the perimeter, friendly forces take offensive actions to destroy enemy forces in the immediate area. Once the perimeter area is clear, a relatively smaller force can defend the perimeter, thereby releasing other forces for their primary operations. The commander employs patrols, raids, ambushes, aerial attacks, and supporting fires to harass and destroy enemy forces to prevent their threatening the perimeter. The commander maintains constant communications and a common operational picture with subordinates within the perimeter. The commander directs them to conduct appropriate actions to remove threats located within their AOs and sectors of fire.

Executing a Perimeter Defense

6-142. Attacks against a perimeter may range from long-range sniper, mortar, or rocket fire attacks by suicide demolition squads, and attacks by major enemy ground and air forces. Mortars, artillery, tanks, and anti-armor missile systems from within the perimeter engage the enemy at long ranges. As the attack comes within small arms range, other weapons on the perimeter engage the enemy. If the assault continues, the force employs its available FPFs. If the enemy penetrates the perimeter, the reserve blocks the penetration or counterattacks to restore the perimeter. After committing the initial reserve, the commander must reconstitute another reserve to meet other threats. This force normally comes from an unengaged unit on another portion of the perimeter. If the commander uses an unengaged force to constitute a new reserve, the commander must retain sufficient forces to defend the vacated sector, unless the situation forces the commander to assume that degree of risk.

6-143. Sustainment elements may provide support from within the perimeter or from outside locations, depending on the mission and the status of the unit providing the defensive perimeter, type of transport available, weather, and terrain. Units in contested areas without secure ground lines of communications are often sustained by air.

REVERSE SLOPE DEFENSE

6-144. The commander organizes a reverse slope defense on the portion of a terrain feature or slope with a topographical crest that masks the main defensive positions from enemy observation and direct fire. All or part of the defending force may employ this technique. It is generally useful at lower tactical levels, such as battalion and below.

6-145. The commander bases a successful reverse slope defense on denying the enemy the topographical crest. Although the defender may not occupy the crest in strength, controlling the crest by fire is essential for success. This situation reduces the effects of indirect fire (mortar, artillery, and close-air support) and draws the battle into small arms range. Commanders use the reverse slope defense to provide the defending force an opportunity to gain surprise. The commander's goal is to make the enemy commit forces against the forward slope of the defense, causing enemy forces to attack in an uncoordinated fashion across the exposed topographical crest. Firing from covered and concealed positions throughout the battle area, the defending force maintains a distinct advantage over the exposed enemy forces and canalizes them through unfamiliar terrain into kill zones. (Figure 6-6 shows the terminology associated with the reverse slope defense.)

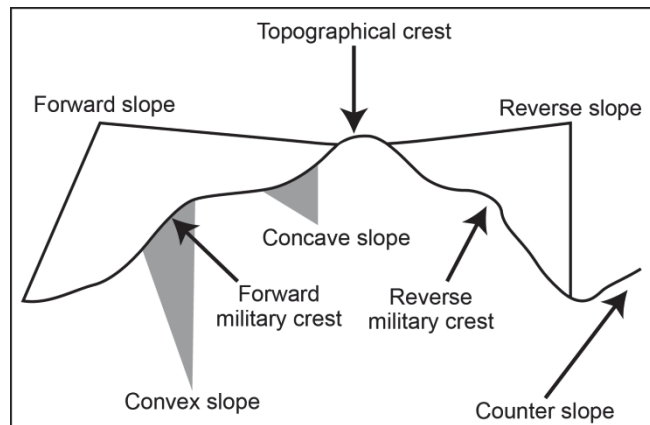

Figure 6-6. Slope terminology

6-146. The commander chooses to conduct a reverse slope defense when—

- The crest and forward slope are untenable because the enemy enjoys a quantitative or qualitative advantage in firepower at that point.
- His weapons cannot depress enough to engage.
- The crest and forward slope offer little or no cover and concealment.
- The forward slope has been lost or has not been seized.
- Units on the flanks can adequately cover the forward slope.
- Variance in the force's tactical pattern is advisable to deceive or surprise the enemy.
- The commander is forced to assume a hasty defense while in contact with or close to the enemy.

6-147. The reverse slope defense may deceive the enemy regarding the true location and organization of the main defensive positions. This defense protects the main defensive positions from preparation fires and causes the enemy to deploy into assault formations prematurely. The forward crest of the main defensive positions limits the enemy's observation. It reduces the effectiveness of enemy indirect fires and CAS and renders the enemy's direct fire weapons ineffective. The defending force may surprise enemy forces as they crest the high ground, engaging them with massed fires. Units on the reverse slope have more freedom of movement until the crest is lost.

6-148. Using the reverse slope defense has several disadvantages:

- The effective range of direct fire weapons may be limited.
- Once security elements withdraw, the enemy can advance largely unimpeded until attacking elements crest the high ground in front of the main defensive positions.
- The enemy has the advantage of attacking downhill.
- Maintaining observation of the enemy is difficult.
- In some cases obstacles can only be covered from positions on the forward slope.

Organization of Forces

6-149. The commander places over-watching elements forward of the topographic crest and on the flanks of the position in a valley or depression. Another variation available to the commander is to organize a system of reverse slope defenses firing to the oblique defilade, each covering the other. A commander uses an oblique defilade to protect defending systems from enemy frontal and flanking fires and from fires coming from above. For example, in figure 6-7 on page 6-28, the units defending cannot engage half of the

hill to their direct front because of line of sight restrictions caused by small forests, but they can cover each other using oblique defilade.

6-150. The commander positions reconnaissance and security elements where they can observe the forward slope, the terrain forward of it, and other approaches to the defending position. Security elements destroy enemy reconnaissance assets, delay the enemy, disorganize the enemy's attack, and deceive the enemy regarding the exact location of the main defense. The commander should position reconnaissance and surveillance assets in observation posts (OPs) located near or forward of the topographical crest to provide long-range observation of both the enemy's flanks and front. Forces manning these OPs, which can be provided by the commander's reserve, may vary in size from a two-man team to a rifle squad or a multiple combat vehicle section in each position. The commander should employ sufficient forces to provide observation and a security screen for the MBA on ground that should be retained. During darkness and periods of reduced visibility, the commander should increase the numbers and sizes of these detachments to provide security against infiltration or unexpected attack. Aggressive night combat patrols and ambushes are an essential part of the security process.

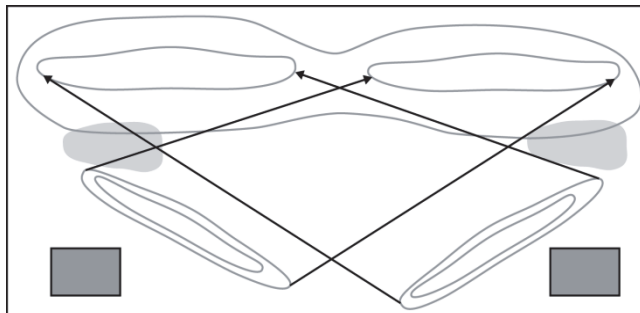

Figure 6-7. Oblique defilade

6-151. In order to achieve surprise and limit the enemy's ability to maneuver, the commander organizes the main defensive positions to mass fires on the enemy as the attacking enemy force crosses the topographical crest. In a reverse slope defense, the key position denies enemy penetration and supports forward elements by fire. The defending force maintains observation and fires over the entire forward slope as long as possible to destroy enemy forces, thus preventing the enemy from massing for a final assault. From defensive positions on the reverse slope, the close-in battle builds in intensity. The defending force does not fire its direct fire weapons, which are located throughout the MBA (on adjacent slope positions, counterslope positions, or reverse slope positions), until suitable targets appear. At the same time, the force shifts the effects of its indirect fires to those areas forward of the crest and forward military slope.

6-152. When possible, other units on complementary terrain support units in reverse slope positions. This is especially desirable when those supporting units can observe and place fires on the crest and forward slope. In a defense on a counterslope (reverse forward slope), fires must cover the area immediately in front of the reverse slope positions to the topographical crest. The commander organizes defensive positions to permit fires on enemy approaches around and over the crest and on the forward slopes of adjacent terrain features, if applicable. The key factors that affect the organization of these areas are mutually supporting covered and concealed positions, numerous existing and reinforcing obstacles, the ability to bring devastating fires from all available weapons onto the crest, and a counterattack force. Depending on the terrain, the most desirable location for the reserve may be on the counterslope or the reverse military crest of the counterslope.

Control Measures

6-153. Defensive control measures introduced in previous chapters continue to apply. The commander places EAs and obstacles on the reverse slope. The topographical crest normally marks the far edge of the EA. The defender must dominate that crest by fires to prevent the enemy from successfully engaging it.

Executing a Reverse Slope Defense

6-154. When executing a reverse slope defense, the commander places special emphasis on—

- The proper organization of the forward slope to provide observation across the entire front and security to the main battle positions.
- A fire support plan to prevent the enemy's occupation and use of the topographical crest.

- A counterattack plan that specifies measures necessary to clear the crest or regain it from the enemy control.
- Fire support to destroy, disrupt, and attrit enemy forces on the forward slope.

6-155. The commander normally places final protective fires along the topographical crest and employs them as the enemy reaches the first row of defiladed obstacles. The commander uses the reserve to counterattack and expel the enemy from the topographical crest, if massed indirect fires do not defeat the attack. In a reverse slope defense, the commander can employ the designated reserve to conduct echelon support area security operations, prepare withdrawal routes, provide flank security, and conduct other actions with the understanding that this increases the time required to reassemble the reserve and prepare it to support the defense.

6-156. The reverse slope defense pursues offensive opportunities through surprise and deceptive actions. It is uniquely suited to infantry forces in mountainous terrain. When conducting a reverse slope defense, surprise results from defending in a manner for which the enemy is unprepared. Once this defense is employed successfully to halt an enemy attack, it may have limited further value because the effect of surprise will be difficult to attain. (For additional information on the use of a reverse slope defense, see small-unit tactics and procedures publications from the Maneuver Center of Excellence.)

TRANSITIONS

6-157. If a defense is successful, the commander anticipates and attempts to transition to the offense. If the defense is unsuccessful, the commander needs to transition from a defensive posture into retrograde operations. Transition from one type of operation to another requires mental as well as physical agility on the part of all those involved as well as accurate situational assessment capabilities.

6-158. The commander deliberately plans for offensive or retrograde operations, assisting the transition process and allowing the commander to set the conditions necessary for a successful transition. Such planning addresses the need to control the tempo of operations, maintain contact with both enemy and friendly forces, and keep the enemy off balance. It establishes the procedures and priorities by which a unit prepares for the next mission. In accordance with the mission variables of METT-TC, it establishes the required organization of forces and control measures necessary for success.

6-159. Prior contingency planning decreases the time needed to adjust the tempo of combat operations when a unit transitions from a focus on the conduct of defensive tasks to offensive tasks. It does this by allowing subordinate units to simultaneously plan and prepare for subsequent operations. Preparations typically include resupplying unit basic loads and repositioning or reallocating supporting systems. (Chapters 1 thru 5 address the planning, preparation, and execution of all offensive tasks.)

6-160. The commander's contingency planning also reduces the amount of time and confusion when a unit is unsuccessful in its defensive efforts and must transition to retrograde operations. The commander designates units to conduct denial operations and to evacuate casualties and inoperative equipment. The commander uses retrograde operations to preserve the force as a combat-capable formation until the commander can establish those conditions necessary for a successful defense. (FM 3-90-2 discusses the task of retrograde.)

TRANSITION TO A FOCUS ON OFFENSIVE TASKS

6-161. A defending commander transitions to a focus on the offensive element of decisive action by anticipating when and where the enemy force will reach its culminating point or require an operational pause before it can continue. At those moments, the combat power ratios most favor the defending force. The enemy force will do everything it can to keep the friendly force from knowing when it is becoming overextended. Indicators that the enemy is becoming overextended include when—

- Enemy forces begin to transition to the defense—this defense may be by forces in or out of contact with friendly forces.
- Enemy forces suffer heavy losses.
- Enemy forces start to deploy before encountering friendly forces.

- Enemy forces are defeated in most engagements.
- Enemy forces are committed piecemeal in continued enemy attacks.
- Enemy reserve forces are identified among attacking forces.
- Examination of captured or killed enemy soldiers and captured or destroyed enemy equipment and supplies shows that the enemy force is unable to adequately sustain itself.
- A noticeable reduction in the tempo of enemy operations.
- Local counterattacks meet with unexpected success.

The commander must be careful not to be successfully targeted by enemy information operations designed to tempt the commander to abandon the advantages of fighting from prepared defensive positions.

6-162. In a mobile defense, transitioning to the offense generally follows the striking force's counterattack. In an area defense, the commander designates a portion of the defending force to conduct the attack. This force usually includes the echelon's available reserves.

6-163. As the commander transitions the force from the defense to the offense, the commander—

- Establishes a line of departure (LD). This may require the conduct of local, small-scale attacks to seize terrain necessary for the conduct of offensive tasks or destroy enemy forces that could threaten the larger offensive action.
- Maintains contact with the enemy, using combinations of available reconnaissance and surveillance assets to develop the information required to plan future operations and avoid being deceived by enemy military deception operations.
- Redeploys the combined arms team based on the probable future employment of each element of that team. For example, fire support assets tend to move forward so that additional enemy forces and terrain are encompassed within their range fans.
- Maintains or regains contact with adjacent units in a contiguous AO and ensures that subordinate units remain capable of mutual support in a noncontiguous AO.
- Transitions the focus of engineer efforts from countermobility and survivability to mobility.
- Provides the commander's intent for transitioning from the defense to the offense to subordinate commanders and Soldiers.
- Submits defended asset lists to influence the positioning of these air and missile defense assets by the joint force area air defense commander.

6-164. The commander conducts any required reorganization and resupply concurrently with other transition activities. This requires a transition in the sustainment effort, with a shift in emphasis from ensuring a capability to defend from a chosen location to an emphasis on ensuring the force's ability to advance and maneuver. For example, in the defense, the sustainment effort may have focused on the forward stockage of Class IV and V items and the rapid evacuation of combat-damaged systems. In the offense, the sustainment effort may need to focus on providing POL and forward repair of maintenance and combat losses. A transition is often a time in which deferred equipment maintenance can be performed. Additional assets may also be available on a temporary basis for casualty evacuation and medical treatment because of a reduction in the tempo of operations.

6-165. The commander should not wait too long to transition from the defense to the offense as the enemy force approaches its culminating point. Enemy forces will be dispersed, extended in depth, and weakened. At that time, any enemy defensive preparations will be hasty and enemy forces will not be adequately disposed for defense. The commander wants the enemy in this posture when the force transitions to the offense. The commander does not want to give the enemy force time to prepare for the defense. Additionally, the psychological shock on enemy soldiers will be greater if they suddenly find themselves desperately defending on new and often unfavorable terms while the commander's own Soldiers will enjoy a psychological boost by going on the offense.

6-166. A commander can use two basic techniques when transitioning to the offense. The first, and generally preferred, technique is to attack using forces not previously committed to the defense. This is because defending MBA units may still be decisively engaged. These attacking forces may come from the

reserve or consist of reinforcements. Since these forces have not recently been actively involved in combat, they are more likely to—

- Be at authorized strength levels.
- Enjoy a higher combat system operationally ready rate.
- Have leaders and Soldiers who are more likely to be rested and thus capable of prolonged, continuous operations.
- Have a complete basic load of supplies.
- Have the time and energy to plan and prepare for offensive action.
- Be able to maneuver out of physical contact with the enemy.

6-167. A drawback to the use of this technique is the requirement to conduct a forward passage of lines. Additionally, enemy reconnaissance and surveillance assets are likely to detect the arrival of significant reinforcements.

6-168. Another consideration of using units not in contact occurs when they are operating in noncontiguous AOs. The commander rapidly masses overwhelming combat power in the decisive operation. This might require the commander to adopt economy of force measures in some AOs while temporarily abandoning others in order to concentrate sufficient combat power. (See chapters 1 and 3 for offensive planning, preparing, and executing considerations.)

6-169. The second technique is to conduct offensive actions using the currently defending forces. This technique generally has the advantage of being more rapidly executed and thus more likely to catch the enemy by surprise. Speed of execution in this technique results from not having to conduct an approach or tactical road march from reserve assembly areas or, in the case of reinforcements, move from other AOs and reception, staging, organization, and integration locations. Speed also results from not having to conduct a forward passage of lines and perform the liaison necessary to establish a common operational picture that includes knowledge of the enemy force's patterns of operation. The primary disadvantage of this technique is that the attacking force generally lacks stamina and must be quickly replaced, if friendly offensive actions are not to culminate quickly.

6-170. If units in contact participate in the attack, the commander must retain sufficient forces in contact to fix the enemy. The commander concentrates the attack by reinforcing select subordinate units so they can execute the attack and, if necessary, maintain the existing defense. The commander can also adjust the defensive boundaries of subordinate units so entire units can withdraw and concentrate for the attack.

TRANSITION TO THE RETROGRADE

6-171. A defending commander transitions from an area or mobile defense to the retrograde for those reasons outlined in paragraph 9-1. A retrograde usually involves a combination of delay, withdrawal, and retirement operations. These operations may occur simultaneously or sequentially. As in other operations, the commander's concept of operations and intent drive planning for retrograde operations. Each form of retrograde operation has its unique planning considerations, but considerations common to all retrograde operations are risk, the need for synchronization, and rear operations. The planning, preparing, and executing considerations associated with retrograde operations are found in chapter 9, but a number of key considerations receive special emphasis during the transition from the defense to the retrograde.

6-172. The transition to retrograde operations must be accompanied by efforts designed to—

- Reduce the enemy's strength and combat power.
- Provide friendly reinforcements.
- Concentrate forces elsewhere for the attack.
- Prepare stronger defenses elsewhere within the AO.
- Lure or force part or all of the enemy force into areas where it can be counterattacked.

6-173. The complexity and fluidity of retrograde operations and the absolute need to synchronize the entire operation dictates the need for detailed, centralized planning and decentralized execution. Planning for

retrograde operations begins with the preparation of plans for the follow-on mission and is driven by the commander's concept of operations and intent.

6-174. The nature of retrograde operations involves an inherent risk of degrading the defending force's morale. Therefore, maintaining offensive spirit is essential among subordinate leaders and Soldiers. Rearward movements may be seen as a defeat, or as an action that could result in isolation of the force. The commander remains well forward and visible. The commander ensures that subordinate leaders and Soldiers understand the purpose and intent of the operation and their role in accomplishing the mission. Thorough planning, effective control, and aggressive leadership will minimize risk during the retrograde or enhance the probability of success.

6-175. The commander's intelligence requirements dramatically increase as forces begin their movement to other locations, and the combat capabilities of units in contact are subsequently reduced. The commander develops a synchronized and integrated intelligence collection plan to identify and locate enemy attempts to pursue, outflank, and isolate the defending force as it transitions to the retrograde. As the commander transitions to the retrograde, the commander makes every effort to conserve combat power. The commander considers the need to—

- Balance the risk of conserving combat power while remaining disposed to the intent of the defensive mission.
- Disengage and withdraw units with the least tactical mobility and nonessential elements before the retrograde of the main body.
- Use mobile forces to cover the retrograde of less mobile forces.
- Use the minimum essential combat power necessary to provide security for the retrograde of the main body.

TRANSITION TO A FOCUS ON STABILITY TASKS

6-176. Transition to a focus on the conduct of stability tasks is conditional, but should be planned in advance. A defending commander may transition to the stability element of decisive action if the defense retained decisive terrain, denied vital areas to the enemy, and so successfully attrited the attacking enemy that offensive actions are superfluous. As in other operations, the commander's concept of operations and intent drive the design of and planning for stability tasks. Generally, a tactical commander will focus on meeting the immediate essential service and civil security needs of the civilian inhabitants of the area of operations in coordination with any existing host nation government and non-governmental organizations before addressing the other three primary stability tasks. Support requirements may change dramatically. The commander will probably change the rules of engagement, and the commander must transmit these rules down to the squad and individual Soldier level.

6-177. When the focus transitions from defensive to stability tasks, the unit will probably begin executing a sequel to its previous defensive order. The commander will probably reorganize the unit to introduce those capabilities required by changes in the mission variables of METT-TC. Depending on the specific operational environment, commanders and staffs should reference the appropriate official departmental publications dealing with other operations and tasks, such as ADRP 3-07 or FM 3-24, to refresh previous training and education in those subjects. If commanders and staffs are unfamiliar with the civil considerations of their AO, they should refer to area histories, cultural and economic studies, and similar reference materials. The mission command and protection functions remain important to prevent Soldiers from relaxing discipline and safety standards as the stress of active defensive actions disappears.

6-178. When involved in other operations, such as peace operations, irregular warfare, and military engagement, unit defensive actions are closely related to the perimeter defense. (Area security considerations are addressed in FM 3-90-2.) Defensive tasks conducted during these other missions will normally employ restrictive rules of engagement throughout the mission, regardless of the primary element of decisive action prevailing at any specific moment.

Chapter 7

The Area Defense

An area defense capitalizes on the strength inherent in a closely integrated defensive organization on the ground. The conduct of an area defense facilitates the consolidation and reconstitution of forces in order to transition to a focus on another element of decisive action, such as stability. The commander may assign subordinate units the task of conducting an area defense as part of their mission. Subordinate echelons defend within their assigned areas of operations (AOs) as part of the larger-echelon's operation.

GENERAL CONSIDERATIONS FOR AN AREA DEFENSE

7-1. A commander conducts an area defense when the following conditions occur:

- When directed to defend or retain specified terrain.
- When the commander cannot resource a striking force.
- The forces available have less mobility than the enemy.
- The terrain affords natural lines of resistance and limits the enemy to a few well-defined avenues of approach, thereby restricting the enemy's maneuver.
- There is enough time to organize the position.
- Terrain constraints and lack of friendly air superiority limit the striking force's options in a mobile defense to a few probable employment options.
- Conditions require the preservation of forces when transitioning from a focus on the conduct of offensive tasks to stability tasks and when offensive actions are superfluous to the mission.

7-2. The commander conducting an area defense combines static and mobile actions to accomplish the mission. Static actions usually consist of fires from prepared positions. Mobile actions include using the fires provided by units in prepared positions as a base for counterattacks and repositioning units between defensive positions or forward operating bases when the operation is focused on the conduct of stability tasks. The commander can use the reserve and uncommitted forces to conduct counterattacks and spoiling attacks to desynchronize the enemy forces or prevent them from massing.

ORGANIZATION OF FORCES FOR AN AREA DEFENSE

7-3. The commander organizes the defending force to accomplish intelligence, security, main battle area (MBA), reserve, and sustainment missions. The commander has the option of defending forward or defending in depth. When the commander defends forward within an AO, the force is organized so that most of the available combat power is committed early in the defensive effort. To accomplish this, the commander may deploy forces forward or plan counterattacks well forward in the MBA or even beyond the MBA. If the commander has the option of conducting a defense in depth, security forces and forward MBA elements are used to identify, define, and control the depth of the enemy's main effort while holding off secondary thrusts. This allows the commander to conserve combat power, strengthen the reserve, and better resource the counterattack.

RECONNAISSANCE AND SURVEILLANCE

7-4. The commander directs reconnaissance and surveillance assets to determine the locations, strengths, and probable intentions of the attacking enemy force before and throughout the defense. The commander places a high priority on early identification of the enemy's main effort. The commander may need to

complement surveillance with combat actions that test enemy intentions. Fighting for information can have two benefits—it can force the enemy to reveal intentions and disrupt enemy preparations.

7-5. In the defense, reconnaissance and surveillance operations overlap the unit's planning and preparing phases. Leaders performing reconnaissance and surveillance tasks must understand that they often deploy before the commander fully develops the plan. These leaders must be responsive to changes in orientation and mission. The commander ensures that the staff fully plans, prepares, and assesses the execution of the intelligence portion of the overall plan.

SECURITY

7-6. The commander balances the need to create a strong security force to shape the battle with the resulting diversion of combat power from the main body's decisive operation. The commander usually allocates security forces to provide early warning and protect those forces, systems, and locations necessary to conduct the decisive operation from unexpected enemy contact. On a battlefield where forces are contiguous with one another, the location of security forces is usually in front of the main defensive positions. On a noncontiguous battlefield they are located on avenues of approach between the protected force and known or suspected enemy locations.

7-7. Maneuver battalion and brigade combat team (BCT) security forces normally conduct screen or guard missions. At division level and above, the commander may use a covering force. A division commander may elect to have the security force conduct a guard mission, if a corps covering force exists. Because an area security mission usually ties in closely with flank units, flank security forces are needed if there are gaps on the unit's flanks, which occurs during noncontiguous operations, or if gaps develop during the operation. A flank screen or guard is critical if an enemy avenue of approach into the defended area from the flanks could be uncovered during the defense. A commander does not normally assign a force the mission of conducting rear guard or rear cover during contiguous operations, since it is unlikely that the force's support area will become uncovered during the defense. The commander resources echelon support area security forces, to include a tactical combat force (TCF) or accepts the risk to the sustainment effort of not performing this function.

MAIN BATTLE AREA

7-8. The commander builds the decisive operation around identified decisive points, such as key terrain or high-payoff targets. The commander's decisive operation in an area defense focuses on retaining terrain by using fires from mutually supporting, prepared positions supplemented by one or more counterattacks and the repositioning of forces from one location to another. The commander's decisive operation normally involves close combat since an area defense emphasizes terrain retention.

7-9. The commander normally positions the echelon's main body—the bulk of combat power—within the MBA where the commander wants to conduct the decisive operation. The commander organizes the main body to halt, defeat, and ultimately destroy attacking enemy forces. The majority of the main body deploys into prepared defensive positions within the MBA. However, mobile elements of the force are ready to deploy where and when needed.

RESERVE

7-10. The commander's defensive plan should be able to succeed without using the reserve. However, the most likely mission of the reserve is to conduct a counterattack in accordance with previously prepared plans. Lower-echelon commanders use their reserves primarily to conduct local counterattacks to restore the integrity of their defense or to exploit opportunities. A senior commander uses the reserve to seize the initiative from the enemy when the opportunity presents itself. For example, a corps commander may target the effects of the corps reserve against enemy fire support and follow-on forces to produce that effect.

7-11. The reserve is not a committed force. The commander can assign it a wide variety of tasks on its commitment, and it must be prepared to perform other missions. In certain situations, it may become necessary to commit the reserve to restore the integrity of the defense by blocking an enemy penetration or reinforcing fires into an engagement area (EA). These secondary tasks include—

- Reinforcing the defense of committed forces.
- Blocking or containing enemy forces that penetrate friendly defensive positions.
- Relieving depleted units and providing for continuous operations.
- Reacting to threats directed against the friendly force's sustainment effort. (This includes acting as the echelon TCF when a separate TCF cannot be resourced.)
- Extending the flanks of a defending unit to prevent its envelopment.
- Covering a retrograde movement.

7-12. Defending commanders usually have difficulties establishing and resourcing reserve forces because they are normally facing an enemy with superior combat power. Nevertheless, commanders at each echelon down to the battalion retain reserves as a means of ensuring mission accomplishment and for exploiting opportunities through offensive action. (Maneuver company commanders may retain a reserve based on the mission variables.) Commanders do not place artillery and other fire support systems in reserve. (Such systems committed to echelon support operations are not in reserve.) Each echelon's reserve must have the mobility and striking power required to quickly isolate and defeat breakthroughs and flanking attempts. It must be able to seize and exploit fleeting opportunities in a powerful manner to throw the enemy's overall offensive off balance. The commander must resource the reserve, so it can repeatedly attack, regroup, move, and attack again.

7-13. The size of the reserve is relative to the commander's uncertainty about the enemy's capabilities and intentions. The more uncertainty that exists, the larger the reserve. The reverse is also true. If the commander knows the enemy's size, dispositions, capabilities, and intentions, only a comparatively small reserve is required.

7-14. In some situations, the commander may not be able to resource a separate reserve. Therefore, the commander may constitute all or a portion of the reserve from the security force, after it conducts a rearward passage of lines through MBA units. If the security force is the reserve for an area defense, the commander must withdraw it, so it has sufficient time to occupy its reserve position, perform the necessary degree of reconstitution, and prepare plans for its reserve role. However, this is not the preferred option. Before battle handover, the senior commander must state the acceptable risk to the security force or the disengagement criteria in quantifiable terms, such as friendly strength levels, time, or event. In this case, after completing the rearward passage, the security force moves to an assembly area to prepare for its subsequent operations. This area should be free from enemy interference and clear of MBA units, main supply routes (MSRs), and the movements of other portions of the reserve.

7-15. Once committed, the reserve's operations usually become the echelon's decisive operation. However, the commander can commit the reserve to shaping operations to allow the ongoing decisive operation to achieve success. It no longer constitutes the force reserve on its commitment in either case, so the commander should designate another uncommitted force as the reserve. If the commander does not have that flexibility, the commander holds the reserve for commitment at a decisive moment and accepts the associated risk.

SUSTAINMENT

7-16. The sustainment mission in an area defense requires a careful balance between establishing forward supply stocks of petroleum, oil, and lubricants (POL); barrier material; and ammunition in adequate amounts to support defending units and not having so many supplies located in forward locations that they cannot be rapidly moved in conformance with enemy advances. Any suitable POL, barrier material, construction equipment, and laborers that can be lawfully obtained from the civil infrastructure reduce the defending unit's transportation requirements. Proper forecasting of supply and support requirements is important to the success of the area defense. (Commanders and staffs carefully determine the quantities of supplies to be obtained locally to avoid introducing unnecessary instability in the local economy.) Likewise, maintenance and medical support, with their associated repair parts and medical supplies, must also be forward deployed. Those systems and Soldiers that cannot be quickly returned to the battle should be rapidly evacuated from forward defensive positions to avoid unduly burdening maintenance and medical elements. (See paragraphs 6-83 through 6-91 for additional defensive sustainment considerations.)

CONTROL MEASURES FOR AN AREA DEFENSE

7-17. The commander organizes an area defense by designating the MBA and assigning AOs, battle positions (BPs), or forward operating bases (FOBs) to subordinate units located within the MBA. The commander creates a security area in front of the MBA or around a base of operations. When possible, the boundaries of the subordinate elements of the security force coincide with those of the major defending units in the MBA. The security area should be deep enough to make the enemy displace as much of the enemy's supporting forces as possible, such as cannon artillery, sensors, and air defense artillery gun systems, before carrying the attack into the MBA. The commander also designates an echelon support area. (See FM 3-90-2 for a discussion of security operations.)

7-18. Area defense maneuver graphic control measures may include EAs, the forward edge of the battle area (FEBA), the battle handover line (BHL), strong points, target reference points (TRPs), named areas of interest (NAIs), targeted areas of interest (TAIs), decision points, and various other fire control and counter-mobility control measures. Tactical mission tasks assigned as part of the mission can also be control measures. (Figure 7-1 depicts the most common control measures. Appendix A defines these defensive control measures.)

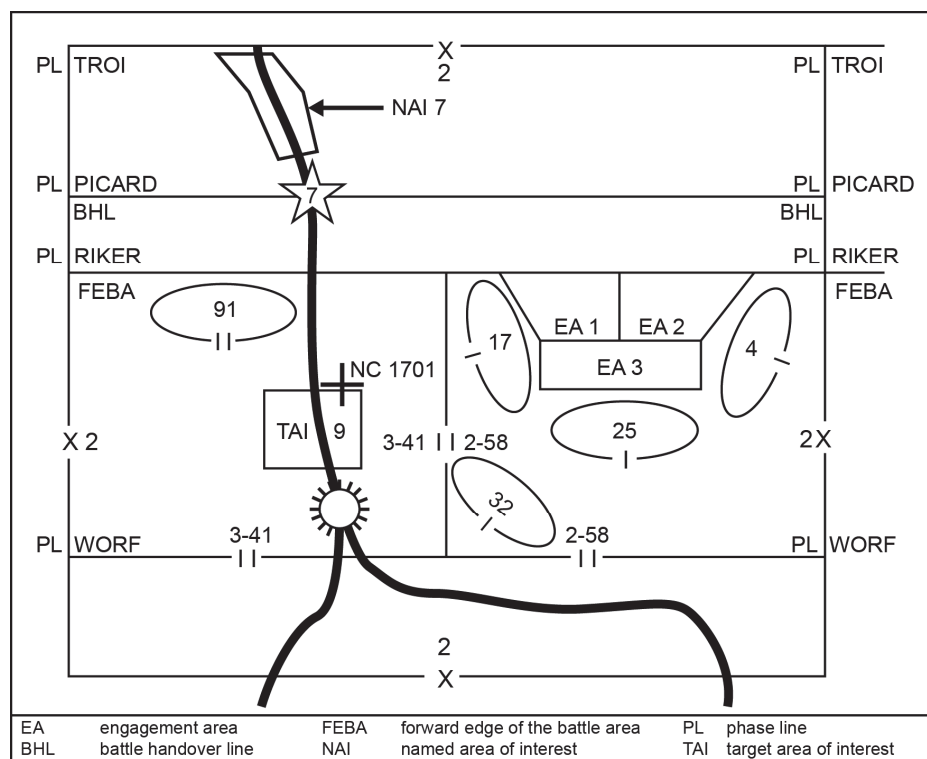

Figure 7-1. Typical control measures for an area defense

7-19. If the commander assigns a battle position (BP) and an AO to a subordinate, the commander gives the subordinate commander specific guidance on the initial positioning of forces. The commander ensures the synchronization of subordinate units' defensive plans, and that control measures, such as contact points and phase lines, are sufficient to ensure the continued control of subordinates. The commander is responsible for fire and movement planning between the positions of subordinate units. If subordinate unit commanders prepare their defensive plans in isolation, one or more assailable flanks between subordinate units could easily develop. (The tactics associated with conducting a passage of lines are addressed in FM 3-90-2.)

PLANNING AN AREA DEFENSE

7-20. The key to a successful area defense is the integration and synchronization of all available assets. The commander achieves this when the combined arms team is at the decisive time and place. (The general defensive planning considerations addressed in chapter 6 apply to the area defense.) The commander assigns missions, allocates forces, and apportions functional and multifunctional support and sustainment resources within the construct of decisive, shaping, and sustaining operations. The commander decides where to concentrate the effort and where to take risks. The commander can rapidly redirect attack aviation and artillery systems initially allocated to shaping operations to support decisive operations at the appropriate time. Commanders organize forces differently for contiguous and noncontiguous areas of operations. **A contiguous area of operations is where all subordinate forces' areas of operations share one or more common boundaries. A noncontiguous area of operations is where one or more of the commander's subordinate force's areas of operation do not share a common boundary.** (See figures 7-2 and 7-3 for graphical depictions of the organization of forces for an area defense in a contiguous AO and in a noncontiguous AO.)

7-21. The commander describes the concept of operations in sufficient detail so that the staff and subordinate commanders understand precisely how the commander intends to fight the battle. The commander ensures the coordination of maneuver and supporting actions among subordinates. (ADRP 5-0 discusses the military decisionmaking process.)

7-22. The commander's keys to a successful area defense are—

- Capability to concentrate effects.
- Depth of the defensive area.
- Security.
- Ability to take full advantage of the terrain, such as intervisibility lines.
- Flexibility of defensive actions.
- Timely resumption of offensive actions.

7-23. The crux of the commander's defensive challenge is to gain time to ensure a synchronized, effective defense. The commander organizes the defensive effort based on an analysis of the mission variables and the higher commander's concept. When conducting an area defense while transitioning to a focus on the conduct of stability tasks, the commander may also transition to the joint operational variables—political, military, economic, social, information, and infrastructure to which the Army adds physical environment and time (PMESII-PT). (ADRP 3-0 discusses PMESII-PT in more detail.) The commander decides where to concentrate efforts and how to economize forces. The commander forces the enemy units to enter established EAs. To succeed in its area defense mission, the unit must also counteract the enemy's initiative. The commander should take advantage of available offensive opportunities that do not risk the integrity of the defense, such as a spoiling attack or counterattack.

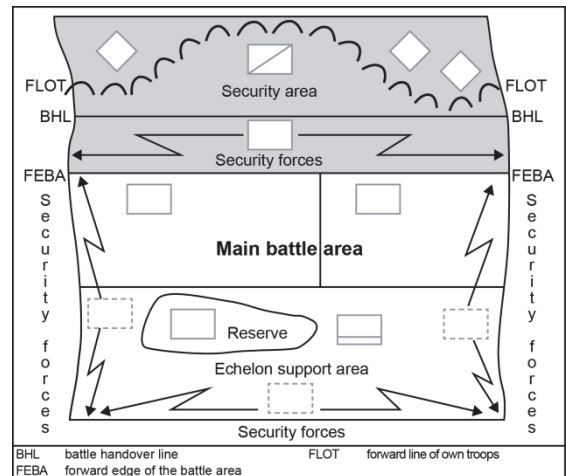

Figure 7-2. Organization of forces for an area defense-contiguous area of operations

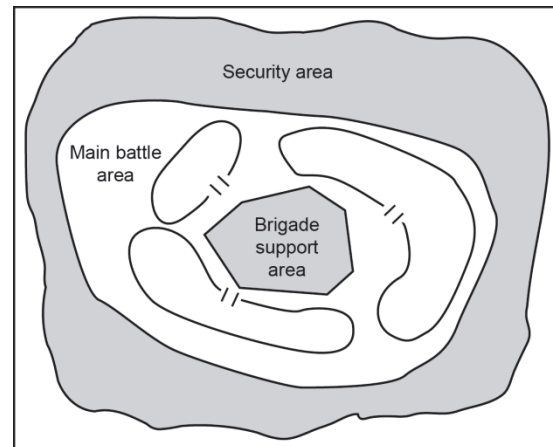

Figure 7-3. Organization of forces for an area defense-noncontiguous area of operations

7-24. In planning an area defense, the commander may choose between two forms of defensive maneuver. The defending unit can organize either a defense in depth or a forward defense. A higher commander may dictate the form of maneuver or impose restrictions that eliminate a subordinate commander's form of maneuver. These restrictions can include time, security concerns, and retention of specific terrain. These two deployment choices are not totally exclusionary. Part of a defending commander's unit can conduct a forward defense, while the other part conducts a defense in depth.

7-25. In determining the form of maneuver, the commander decides where the defensible terrain is located within the assigned AO based on its terrain characteristics and that individual's estimate of the enemy's chosen course of action (COA). Those terrain characteristics include terrain relief patterns, avenues of approach into and within the AO, the location of any key or decisive terrain, and existing obstacles and choke points, to include rivers and fording sites. The other mission variables of mission, enemy, terrain and weather, troops and support available, time available, and civil considerations (METT-TC) also influence the commander's decision.

POSITION SELECTION

7-26. A statement anecdotally attributed to Frederick the Great and Robert E. Lee, among others, is that the commander who attempts to defend everything, defends nothing. Therefore, the commander carefully designs the defense plan to ensure the defending force can halt the enemy attack and develop an opportunity to seize the initiative and undertake offensive actions. The cohesion of the defending force has a significant impact on the overall effectiveness of the defense. The commander must be prepared to adjust the defensive dispositions to meet changes in the enemy's dispositions to maintain that cohesion, if the defense is to remain viable.

7-27. The area defense concept requires that units in defensive positions accomplish their mission independently or in combination by defeating the enemy by fire, absorbing the strength of the attack within the position, or destroying the enemy with a local counterattack. The commander combines the advantages of fighting from prepared positions, obstacles, planned fires, and local counterattacks to isolate and overwhelm selected enemy formations. The commander must be prepared to rapidly shift the nature and location of the main effort throughout the AO. The commander may have to reposition defending units within their defensive positions or reposition between terrain features to mass overwhelming fires against the attacking enemy. The commander's defensive plan designates axes of advance and routes for the commitment or movement of reserves, or the forward or rearward passage of one unit through another. It should identify air axes for aerial maneuver by attack helicopters, air assault units, or fixed-wing aircraft. The operations process identifies decision points associated with the initiation of these counterattacks, repositioning of forces, and other actions. This capability to dynamically reposition is dependent on the defending force having superior tactical mobility. Without tactical mobility, defending forces stay in their prepared positions and accept the possibility of becoming decisively engaged.

7-28. The commander assigning the defensive mission defines the area to defend. A commander defending on a broad front is forced to accept gaps and conduct noncontiguous operations. The forward line of own troops (FLOT) will not be contiguous. Defending shallow areas of operations reduces flexibility and requires the commander to fight well forward. Narrow frontages and deep areas of operations increase the elasticity of an area defense by increasing the commander's maneuver options.

7-29. The ideal area defense is one where effective mutual support exists throughout the width and depth of the defender's tactical positions. The commander organizes and occupies these positions based on their natural defensive strength; their retention ensures the integrity of the defense whether the defending commander employs a defense in an AO, defends by BP, or employs a combination of both. The defending unit maintains tactical integrity within each defensive area. A unit conducting an area defense normally addresses the security requirements of each flank by assigning responsibility to a subordinate element or organizing a security force to specifically accomplish that mission.

DEFENSE IN DEPTH

7-30. A defense in depth is normally the commander's preferred option. Forces defending in depth absorb the momentum of the enemy's attack by forcing the enemy to attack repeatedly through mutually

supporting positions in depth. Construction of these positions requires significant engineer and other resources dedicated to survivability and countermobility. Depth gives the commander's fire support assets time to deliver devastating effects and affords the defending commander multiple opportunities to concentrate the effects of overwhelming combat power against the attacking enemy. Depth also provides more reaction time for the defending force to appropriately respond to the attack. The commander continues to gather additional information about the attacking enemy's intentions and capabilities between the time combat starts and the time the enemy commits to a COA. This reduces the risk of the enemy force quickly penetrating the main line of defense along an unexpected direction.

7-31. The commander also employs a defense in depth when the enemy has the capability to employ large quantities of precision-guided munitions or weapons of mass destruction. A defense in depth results in friendly units and facilities being dispersed throughout the defensive AO. The commander takes area damage-control measures to reduce the effects of weapons of mass destruction on the friendly force and denies the enemy lucrative targets. The degree of dispersal adopted by defending forces is both a function of the enemy's capabilities and the friendly forces' capability to rapidly concentrate overwhelming combat power at decisive points.

7-32. The commander positions defending units in successive layers of battle positions along likely enemy avenues of approach when conducting a defense in depth. (See figure 7-4.) The commander usually decides to conduct a defense in depth when—

- The mission is not restrictive and allows the commander to fight throughout the depth of the battlefield.
- The terrain does not favor a defense well forward, and there is better defensible terrain deeper within the AO.
- The AO is deep compared to its width, and there is significant depth available.
- The cover and concealment on or near the FEBA is limited.
- The enemy has several times the combat power of the defender.

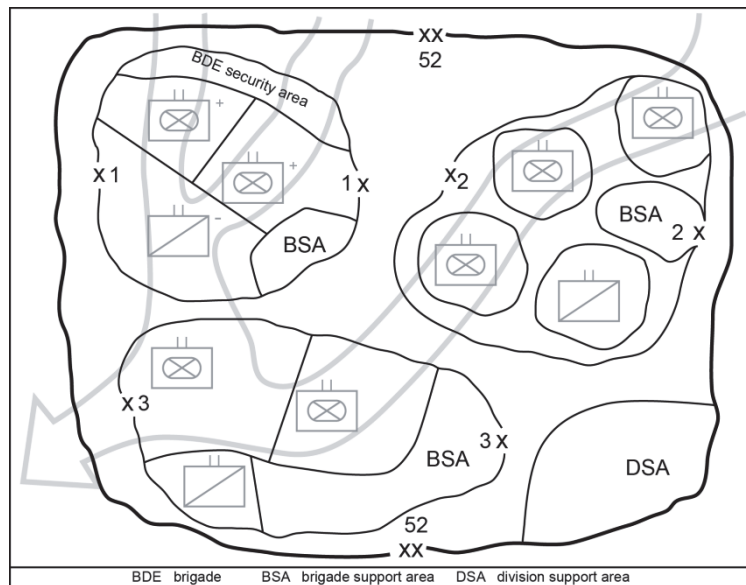

Figure 7-4. Division conducting a defense in depth with subordinate brigades deployed in noncontiguous areas of operations with enemy avenues of approach depicted

7-33. Large units, such as a division or corps, employing a defense in depth can conduct an area defense on a wider frontage than they can if they adopt a forward defense because a forward defense has no time or space to reposition forces. A defense in depth allows the commander to use security and forces in the forward part of the MBA to identify the enemy's decisive operation and control the depth of the enemy's penetration into the MBA. By their defensive actions, these forces provide the commander with time to react to enemy actions and allow the defending commander to take offensive steps that eliminate enemy options, such as conducting a counterattack into the flank of an enemy force.

FORWARD DEFENSE

7-34. The commander conducts the decisive operation from forward defensive positions near the FEBA in a forward defense. (See figure 7-5 on page 7-8.) The commander concentrates a significant portion of

available combat power into EAs along the FEBA. The intent is to prevent significant enemy penetration into the defensive area. The commander conducting a forward defense fights to retain these positions along the FEBA and violently counterattacks any enemy penetration. However, if the enemy penetrates the main defensive positions, the defender's lack of depth may allow the enemy to rapidly exploit success.

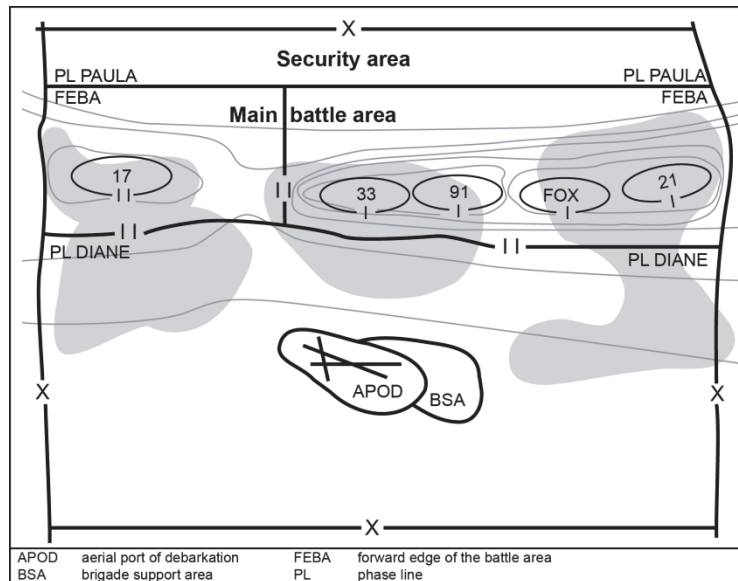

Figure 7-5. Brigade conducting a forward defense in a contiguous area of operations

7-35. In general, the commander uses a forward defense when a higher commander directs the commander to retain forward terrain for political, military, economic, and other reasons. Alternatively, a commander may choose to conduct a forward defense when the terrain in that part of the AO—including natural obstacles—favors the defending force because—

- The best defensive positions are located along the FEBA.
- Strong natural obstacles are located near the FEBA.
- Natural EAs occur near the FEBA.
- Cover and concealment in the rear portion of the AO are limited.

POSITIONING THE RESERVE

7-36. Whatever the commander's choice—forward or in depth—once the enemy commits forces, the defending commander has the ability to seize the initiative by counterattacking over familiar ground to destroy a halted, disorganized enemy, while the counterattacking force is protected by overwatching fires from friendly positions. Whenever possible, the commander should direct these counterattacks against the enemy's rear or flanks. The commander's reserve is a key component of the counterattack.

7-37. When deciding where to place the reserve, the commander decides whether to orient the reserve on its most likely mission or its most important mission. The commander and staff expend significant effort during the planning process to ensure the commander can effectively use the reserve when needed. The commander may locate the reserve within the AO where it can employ the road network to rapidly displace throughout the AO in response to a number of opportunities or contingencies. The commander must consider terrain, MSR of forward units, enemy avenues of approach, and probable enemy penetrations when determining the exact location for the reserve. The commander may choose to initially position the reserve in a forward location to deceive the enemy and obscure subordinate unit boundaries, especially those of dissimilar units such as armor and light infantry.

7-38. In restrictive terrain that lacks routes for movement, the commander can task organize the reserve into small elements and position them where they can react quickly to local combat developments. This

dispersion provides increased protection but reduces the ability of the reserve to mass fires. Covered lateral and forward high-speed deployment routes should be available. The reserve must have movement priority along those routes. The commander must ensure the maintenance of communication between these dispersed elements. This may require establishing retransmission nodes for combat net radios. In open terrain, the commander maintains a centrally located reserve positioned somewhat farther from the FLOT. The commander considers the enemy's potential to employ weapons of mass destruction and conduct air interdiction when deciding where to position the reserve.

7-39. Whenever possible, the commander positions the reserve beyond the enemy's direct fire range. This is easier to achieve at higher echelons than at lower echelons. The reserve takes defensive measures to prevent being acquired and attacked by enemy indirect fire systems. These include camouflage, local security, and control of electronic emissions.

7-40. The commander also plans how to reconstitute a reserve on commitment of the original reserve. The commander most easily designates subordinate unit reserves as the new echelon reserve. If the higher headquarters has not committed its reserve, the commander has more flexibility and can take greater risk in employing the reserve.

SPOILING ATTACKS AND COUNTERATTACKS

7-41. A spoiling attack preempts or seriously impairs the enemy's ability to launch an attack, while a counterattack prevents the enemy from exploiting successes. The forces conducting either form of attack must be large and strong enough to develop the situation, defend themselves against those enemy forces that they expect to encounter, and force the enemy to react, placing the enemy's attack plan at risk.

7-42. The commander considers the enemy situation and estimates the time and distance factors of any follow-on enemy forces in planning either a spoiling attack or a counterattack by the reserve and other forces. Then the commander determines which units will attack, where they will be after the attack, and what interdiction is necessary to isolate the targeted enemy element. (See figure 7-6.) Counterattacking forces plan to avoid enemy strength when possible. The most effective attacks seize strong positions that permit the counterattacking force to deliver fire on an exposed enemy unit's flanks and rear. If it is tasked to stay and defend against enemy follow-on forces, the counterattacking force must establish a viable defensive position before any following enemy units can make contact.

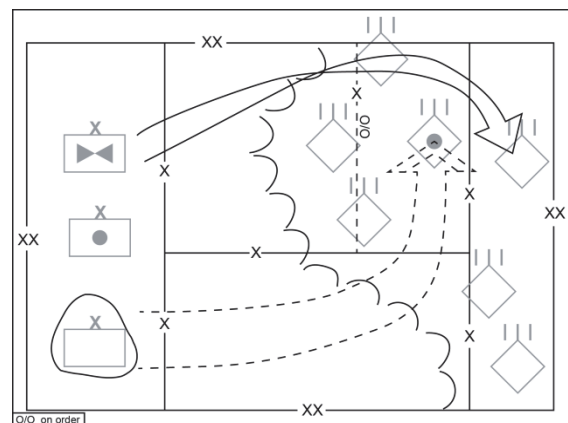

Figure 7-6. Division counterattack

7-43. Counterattack plans include assumptions regarding the size and shape of the anticipated penetration or enemy formation, the strength and composition of the enemy force, and the status of the reserve and forces in the MBA. Other factors that affect the counterattack include the capability to contain the enemy, shaping operations to support the attack, and the strength and responsiveness of the reserve at the time of the counterattack.

7-44. The commander's staff prepares counterattack plans and then allocates subordinate headquarters sufficient time to make their plans. The control measures for a counterattack are the same ones discussed in chapter 3 for the attack. If possible, the commander distributes counterattack plans along with the base defense plan. Reserve unit commanders conduct detailed counterattack planning that includes conducting reconnaissance, selecting multiple routes, determining time and space factors, rehearsing, coordinating with appropriate elements of the forward defending force, and fire planning. The commander adjusts counterattack plans as necessary based on the lessons learned during rehearsals.

7-45. Enemy movement into an NAI helps the commander determine the enemy's scheme of maneuver and possible objectives. The commander uses decision points and NAIs throughout the AO to trigger the counterattack. The commander identifies TAIs for attack to support area defensive actions.

CIVIL CONSIDERATIONS IN THE AREA DEFENSE

7-46. The unit's defensive plans must address how the preparations for, and the conduct of, the area defense impact the civilian population of the AO. This includes the conduct of noncombatant evacuation operations for U.S. civilians and other authorized groups. The commander's legal obligations to that civilian population must be met. Ideally, the host nation government will have the capability to conduct the five primary stability tasks. To the extent that a host nation government is unable to conduct the immediate subordinate stability tasks, the defending unit will have to attempt to make up the shortfall.

PREPARING AN AREA DEFENSE

7-47. Commanders planning an area defense focus their preparations on planning those additional reconnaissance and surveillance operations required to answer the commander's critical information requirements, refining the plan, increasing coordination and synchronization, and conducting shaping actions within the force's capability and operations security guidelines. If the commander decides that a deliberate defense must be conducted but knows that the enemy will attack before the defending force is prepared, the commander may have to commit substantial forces to security operations or conduct a spoiling attack. This buys time and space to prepare for a deliberate defense.

7-48. A unit normally transitions to the defense after it completes the deployment process of force projection, completes its offensive actions, or is in an assembly area. The commander issues a warning order stating the mission and identifying any special considerations. The unit staff conducts detailed planning while the rest of the unit completes its current mission. The staff coordinates for the pre-positioning of ammunition and barrier material in a secure area near the unit's defensive positions before starting the operation.

7-49. Before occupying any position, leaders at all echelons conduct some type of reconnaissance. This reconnaissance effort is as detailed as the mission variables of METT-TC permit. It may consist of a simple map reconnaissance or a more detailed leaders' reconnaissance that determines the initial layout of the new position. Leaders also take advantage of digital enablers, such as the Distributed Common Ground System and geospatial intelligence (GEOINT), to increase their understanding of their area of operations.

7-50. The defending unit occupies its defensive positions as soon as practical after receiving the mission. It conducts reconnaissance of the defensive area and establishes a forward security area before occupying defensive positions. The unit may pre-position supplies such as ammunition and barrier materiel once it establishes security. The unit can accomplish many defensive tasks simultaneously; the mission variables of METT-TC are the deciding consideration in establishing priorities of work. Those priorities may be—

- Establishing local security and deploying a security force.
- Identifying EAs where the commander wants to engage and destroy the enemy.
- Planning fire control measures, such as TRPs, trigger lines, and final protective fires to support the EAs.
- Positioning key weapon systems to engage into the EAs and TRPs and develop range cards and sector sketches.
- Positioning observers who can see both targets and trigger lines.
- Positioning obstacle groups to support weapon systems.
- Designating and clearing fields of fire.
- Preparing primary fighting positions based on the anticipated fighting conditions, such as the time of day and weather conditions.
- Emplacing obstacles and surveying indirect fire targets to support these obstacles.
- Providing concealment and camouflage for fighting and survivability positions as they are constructed.

- Positioning any available critical friendly zones over friendly positions by establishing sensor coverage and quickfire links between the sensor and shooter.
- Installing night and limited-visibility aids, such as thermal hot spots and chemical lights on TRPs during daylight.
- Updating range cards and sector sketches as required.
- Preparing alternate fighting positions.
- Designating and preparing supplementary positions.
- Designating hide positions and rehearsing movements to and from fighting positions. (Units may place their combat and tactical vehicles in hide positions at any time while preparing the defensive position.)
- Positioning the reserve.
- Establishing contact points with any adjacent units so that the defensive efforts of both units can be tied together.
- Emplacing communications assets in order to support the unit's primary, alternate, contingency, and emergency communications for each primary, supplemental, and alternative position.
- Improving mobility on counterattack routes.
- Prestocking ammunition in revetments or bunkers where it can survive the enemy's preparatory fires.
- Rehearsing movements under daylight and limited-visibility conditions.
- Establishing sleep and rest plans.
- Continuing to improve the defense.

7-51. Survivability positions enhance the strength of a defensive position by providing Soldiers and weapon systems with some degree of cover from enemy fires. Units initiate construction of survivability positions in accordance with their priority of work and continue to build and improve them until the last possible moment. The degree of overhead cover provided varies with the location of the sheltered troops and enemy capabilities. As time and resources allow, the defending unit improves communication routes throughout its defensive positions to ease movement of supplies and forces, particularly the reserve. It quickly establishes tactical communications among its various subordinate elements to reduce its electromagnetic signature.

7-52. The defending unit rehearses how to move from its hide positions to its primary positions and how it will occupy alternate and supplementary positions to continue to engage the enemy, if the enemy's attack progresses into the unit's defensive positions. These rehearsals establish the time necessary to conduct these movements under different environmental conditions. It modifies existing plans based on the results of rehearsals and changes in the mission variables of METT-TC. The commander takes steps to ensure that the routes taken during these rehearsals do not show obvious signs of heavy use. These steps can include the conduct of only dismounted rehearsals, only moving one vehicle per platoon, and taking steps to eliminate signs of movement such as sweeping snow back over the tracks made during the rehearsal.

7-53. The commander ensures close coordination among subordinates. During the preparation phase, subordinate commanders are taken to a vantage point in the MBA to rehearse the battle and plan coordination among their units if such a site is available. This helps in transmitting the commander's intent and in establishing common control measures for subordinate units.

7-54. The location, composition, and movement of the reserve are essential elements of friendly information. Enemy reconnaissance efforts focus on finding the reserve and reporting when and where it is committed. Avoiding detection by the enemy is vital to the success of the reserve.

7-55. The commander integrates the sustainment rehearsal into the maneuver rehearsal to verify that routes for support do not cross or conflict with routes used by reserve forces or other maneuver elements. The commander should balance the use of ammunition caches against the defending unit's ability to guard them. The commander should also ensure that alternate MSR are adequate to accommodate contingency plans and that changing MSR can be accomplished effectively.

7-56. The commander ensures that available combat multipliers are completely integrated with the unit's intended maneuver. This includes the use of camouflage, military deception, and smoke to confuse enemy reconnaissance assets. After issuing the order and receiving backbriefs from subordinate commanders and other leaders, the commander verifies that they have a common understanding of the plan and can execute it with minimal guidance.

EXECUTING AN AREA DEFENSE

7-57. A defending unit within the MBA uses a variety of tactics, techniques, and procedures to accomplish the mission. At one end of the defensive continuum is a totally static defense oriented on terrain retention. This defense depends on the use of firepower from fixed positions to deny the enemy terrain. At the other end is a dynamic defense focused on the enemy. That defense depends on maneuver to disrupt and destroy the enemy force.

7-58. A commander combines the static element to control, stop, or canalize the attacking enemy force and the dynamic element to strike and defeat that force. A successful area defense uses forces in relatively fixed positions to create the opportunity for the reserve to strike at the enemy from an unanticipated direction and strength. (See figure 7-7.) The defending force repeatedly lures the enemy into EAs where it kills selected portions of the enemy force.

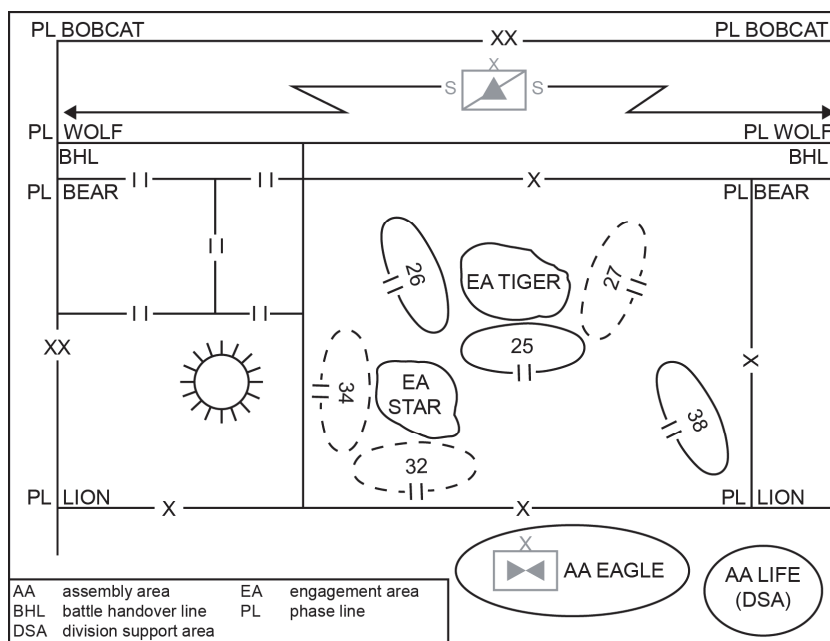

Figure 7-7. Area defense using static and dynamic elements

7-59. In an area defense, defending forces fight mainly from prepared, protected positions to concentrate combat power against attempted enemy breakthroughs and flanking movements. The commander uses mobile forces to cover gaps between defensive positions, reinforce those positions as necessary, and counterattack to seal penetrations or block enemy attempts at flanking movements.

7-60. Conducting shaping operations in an area defense is similar to shaping operations in the offense. The mission variables of METT-TC determine how closely the commander synchronizes shaping operations with the decisive operation. The commander conducts shaping operations designed to regain the initiative by limiting the attacker's options and disrupting the enemy's plan. Shaping operations prevent enemy forces from massing and create windows of opportunity for the conduct of a decisive offensive task, allowing the defending force to defeat the attacking enemy in detail. The commander also employs shaping operations to disrupt enemy operations by attacking command posts at critical stages in the battle or by striking and eliminating key elements, such as river crossing equipment and supplies in a region that

contains numerous unfordable rivers. Reconnaissance and security operations are normally components of the echelon's shaping operations.

7-61. As in the offensive chapters of this publication, this chapter divides execution into five steps for discussion purposes. These steps are:

- Gain and maintain enemy contact.
- Disrupt the enemy.
- Fix the enemy.
- Maneuver.
- Follow through (counterattack).

7-62. This does not mean that these steps occur sequentially; they may occur simultaneously. The first three of these steps are almost always shaping operations. Depending on the circumstances, either of the last two steps may be the echelon's decisive operation.

GAIN AND MAINTAIN ENEMY CONTACT

7-63. Gaining and maintaining enemy contact in the face of the enemy's determined efforts to destroy friendly reconnaissance and surveillance assets is vital to the success of defensive actions. As the enemy's attack begins, the defending unit's first concerns are to identify committed enemy units' positions and capabilities, determine the enemy's intent and direction of attack, and gain time to react. Initially, the commander accomplishes these goals in the security area. The sources of this type of intelligence include reconnaissance and security forces, intelligence units, special operations forces, and aviation elements. Battalions and companies are increasingly able to access combat information provided by technical means belonging to higher echelons, such as unmanned aircraft systems and signals intelligence, to provide the required reaction time. The commander ensures the distribution of a common operational picture throughout the force during the battle as a basis for subordinate commanders' actions. The commander uses the information available, in conjunction with military judgment, to determine the point at which the enemy commits to a COA.

7-64. The security force seeks to strip enemy reconnaissance forces and hide the defending force's dispositions, capabilities, and intent at the same time as friendly reconnaissance and surveillance assets help to determine the enemy's chosen COA. Ideally, the engagement in the security area should force the enemy to conduct a movement to contact against a prepared defense.

7-65. A single force in the security area can perform both reconnaissance and security functions. The security force uses every opportunity for limited offensive action to delay and harass the enemy and to gain information. As the security element displaces, the commander makes preparations to pass it through or around the MBA force as quickly as possible by using multiple passage points, gaps, or lanes along the FEBA. This usually occurs in one location at a time until the security force has completely withdrawn. However, the security force may pass in sequence based on enemy pressure. Transfer of responsibility occurs forward of the FEBA at the BHL. (See figure 7-8 on page 7-14.) Taking advantage of previous liaison and plans, the security force makes any required last-minute coordination with MBA forces at contact points to ensure its rapid passage through the MBA force.

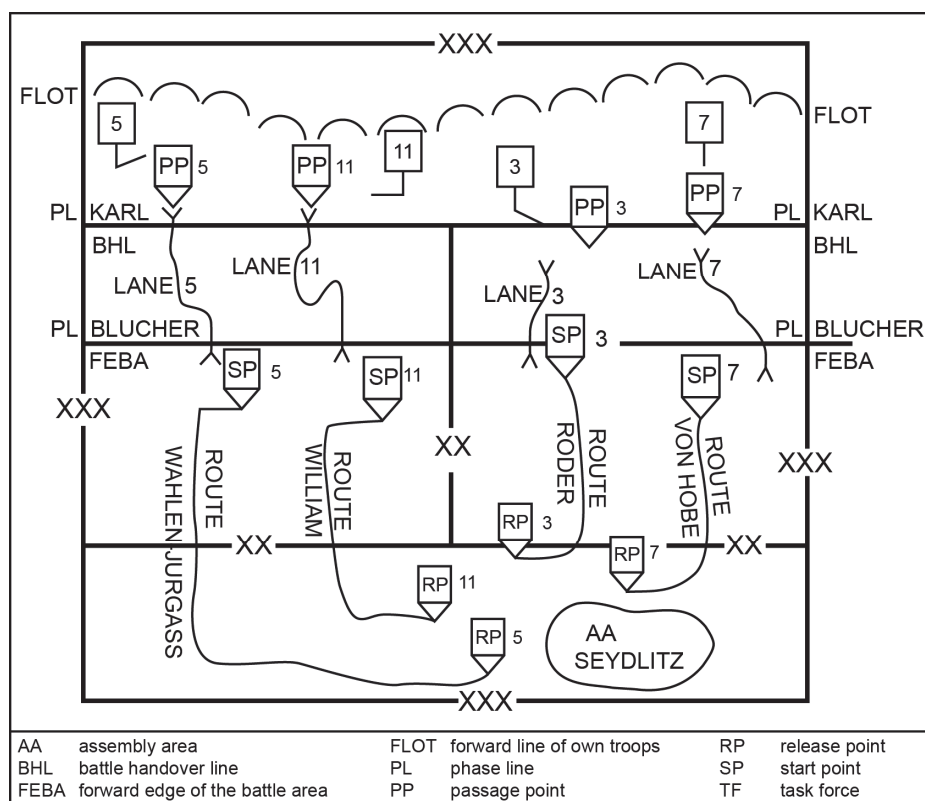

Figure 7-8. Battle handover line

7-66. The entire security force should not withdraw automatically as soon as the first enemy units reach the FEBA. The commander can leave in place security elements located in areas where the enemy has not advanced. The security force adjusts to the enemy's advance and continues to conduct security operations as far forward as possible. It continues to resist the enemy's shaping operations, such as the enemy's reconnaissance effort, thereby upsetting the enemy's coordination and allowing the MBA commander to fight one engagement or battle at a time. Doing this increases the chances for success even if the enemy attack penetrates the MBA in one or more areas. In some cases, the security force can attack the enemy force from its rear, engage high-payoff targets, or drive between echelons to isolate leading enemy units.

7-67. As the enemy force approaches the MBA, the commander may order reconnaissance and surveillance assets within the security force to displace to one or both sides of the enemy penetration and continue to maintain surveillance. By observing and providing access to enemy flanks, reconnaissance and surveillance elements can facilitate the conduct of friendly counterattacks. However, to prevent the encirclement of these assets, the commander may plan to monitor those areas where the enemy has not advanced into the MBA solely by technical means.

7-68. Commanders coordinate the battle handover between the security force and MBA forces as quickly and efficiently as possible to minimize their vulnerability to enemy fire. The security force commander must retain freedom to maneuver until the initiation of the passage of lines. The commander's fire support assets help cover the withdrawal of security forces. Functional and multifunctional support and sustainment elements of the security force leave the security area as early as possible to avoid hampering the movement of maneuver forces. Normally, battalion-sized units of the security force hand off the battle to the brigade combat teams through which they pass. (See FM 3-90-2 for a discussion of the tactics associated with the conduct of a rearward passage of lines.)

7-69. The commander must consider the security force's next mission before battle handover between the security force and the MBA force. Factors that may affect this decision are the status of the security force,

its subsequent mission preparation requirements, and the size and nature of the reserve required by the situation. The commander may decide to employ it immediately as the reserve, which would release the initial reserve for other tasks. Alternately, the commander may decide to use the security force to conduct additional security operations on the flanks of MBA forces as the battle progresses. However, it may be some time before the security force is ready for commitment. Therefore, the commander is more likely to wait until the security force has been reconstituted and the initial reserve committed before designating the former security force as the reserve.

7-70. The commander should base the location of the security force's assembly area on its follow-on mission. The commander locates those assembly areas to rapidly support ongoing operations yet keep withdrawn security units from interfering with ongoing decisive and shaping operations. After passage, the security force normally moves to these locations to prepare for subsequent operations. At a minimum, the commander must rearm and refuel the security force. Additional sustainment concerns include casualty evacuation, maintenance requirements, and resupply.

DISRUPT THE ENEMY

7-71. The commander executes shaping operations, to include the conduct of military deception operations, to disrupt the enemy regardless of the enemy's location within the AO. After making contact with the enemy, the commander seeks to disrupt the enemy's plan, the enemy's ability to control forces, and the enemy's combined arms team. Ideally, the results of the commander's shaping operations should force a disorganized enemy, whose ability to synchronize its elements has been degraded, to conduct a movement to contact against prepared defenses. Once the process of disrupting the attacking enemy begins, it continues throughout the conduct of the defense.

7-72. The commander initiates shaping operations simultaneously with the preparation of MBA positions. These shaping operations typically focus on enemy high-payoff targets, such as command and control nodes, engineer, fire support, and air defense assets for destruction or disruption. They can also force the enemy to use avenues of approach covered by friendly EAs. These shaping operations destroy the enemy's cohesion and disrupt the tempo of the enemy's approach to the MBA. This, in turn, disrupts the timely introduction of enemy follow-on forces into the engagement. For example, electronic warfare directed against the enemy's command and control nodes and air defense assets increases the enemy's vulnerability to other shaping operations while simultaneously slowing the enemy's reaction to these shaping operations. (See FM 3-36 for a discussion of electronic warfare.) Follow-on engagements focus on degrading the enemy's fire support and engineer assets, thereby disrupting the movement of enemy approaching units.

7-73. Other targets for shaping operations include enemy reconnaissance and intelligence assets. Destroying these assets allows the commander to repeatedly force enemy units to deploy into combat formations on ground of the commander's choosing, thus contributing to the disruption and desynchronization of the enemy's plan. The timing of these shaping operations is important. The enemy cannot be allowed to recover from their effects before the decisive operation. The commander may also execute offensive actions to further disrupt the enemy, such as spoiling attacks, raids, ambushes, feints, or demonstrations.

FIX THE ENEMY

7-74. The commander does everything possible to limit the options available to the enemy when conducting an area defense. In addition to disrupting the enemy, the commander conducts shaping operations to constrain the enemy into a specific COA, control enemy movements, or fix the enemy in a given location. These actions limit the enemy's options. While executing these operations, the commander continues to find, delay, or attrit enemy follow-on and reserve forces to keep them from entering the MBA.

7-75. The commander has several options to help fix an attacking enemy force. The commander can design shaping operations—such as securing the flanks and point of a penetration—to fix the enemy and allow friendly forces to execute decisive maneuver elsewhere. Combat outposts and strong points can also deny enemy movement to or through a given location. (See chapter 6.) A properly executed military deception operation can constrain the enemy to a given COA.

7-76. The commander uses obstacles covered by fire to fix, turn, block, or disrupt to limit the enemy's available options. Properly executed obstacles are a result of the synthesis of top-down and bottom-up obstacle planning and emplacement. Blocking forces can also affect enemy movement. A blocking force may achieve its mission from a variety of positions depending on the mission variables of METT-TC.

MANEUVER

7-77. In an area defense, the decisive operation occurs in the MBA. This is where the effects of shaping operations, coupled with sustaining operations, combine with the decisive operations of the MBA force to defeat the enemy. The commander's goal is to prevent the enemy's further advance by using a combination of fires from prepared positions, obstacles, and mobile reserves.

7-78. Generating massed effects is especially critical to the commander conducting the defense of a large area against an enemy with a significant advantage in combat power. The attacker has the ability to select the point and time of the attack. Therefore, the attacking enemy can mass forces at a specific point, thus dramatically influencing the ratio of forces at the point of attack. An enemy three-to-one advantage in overall combat power can easily turn into a local six-to-one or higher ratio. The defending commander must quickly determine the intent of the enemy commander and the effects of terrain. This allows defending units and their weapon systems to concentrate the effects of combat power against the enemy at those points and restore a more favorable force ratio.

7-79. Forces in the MBA assume responsibility for the battle at the BHL. As the security force approaches the FEBA, it may be necessary to increase the intensity of fire support from the MBA to allow the security force to break contact. Both direct and indirect fire assets from MBA forces provide support to cover the withdrawal of the security force and to close passage lanes through obstacle complexes. The commander may also employ smoke to assist the security force with breaking contact with the enemy. The security force's withdrawal through the forward positions of the MBA must be carefully planned and coordinated. The commander must guard gaps in obstacles left for the withdrawal of the security force and arrange for closing them after the passage of the security force.

7-80. After the attacking enemy force reaches the MBA, it tries to find weak points and attempts to force a passage, possibly by a series of probing attacks. As the attack develops, defending units engage the enemy's lead forces. The enemy advance may slow because of canalization and the increased density of forces resulting from limited maneuver space, presenting good targets for defensive fire and air support. The maximum effects of simultaneous and sequential fires are brought to bear at this stage of the battle.

7-81. The commander's subordinate elements maneuver using massed direct and indirect fire and movement to gain positional advantage over the assaulting enemy force. The commander also directs the engineer obstacle and sustainment effort by the assignment of priorities. The commander must reposition forces to meet the enemy where the enemy actually is rather than where the commander projected that the enemy would be. The commander directs operations and supports subordinate elements by providing the necessary functional and multifunctional support and sustainment assets. The commander controls the commitment of the echelon reserve and, at division echelon and above, engages enemy follow-on forces with long-range rockets and air support. If enemy follow-on forces can be delayed, the enemy's attack may be defeated in detail, one echelon at a time. If the defending unit can force the enemy to commit follow-on forces sooner than planned, it can disrupt the enemy's timetable, which can lead to the creation of exploitable gaps between the committed and subsequent echelons.

7-82. Gaps between defensive positions may be necessary, but the commander does not leave them where the enemy's probable main effort will be. They are kept under surveillance, covered by fire or, where possible, blocked by barriers or repositioned friendly forces. The commander clearly defines the responsibility for dealing with each enemy penetration. The commander leverages the use of choke points and obstacles to prevent enemy penetration. If the enemy succeeds in penetrating the MBA, the commander blocks the penetration immediately and destroys this enemy force as soon as possible, using the mobile reserve. The commander may extend actions within the depth of the AO to counter enemy penetrations that cannot be stopped farther forward.

7-83. The commander does not allow the attacking enemy to consolidate, unless it fits the scheme of maneuver. The commander conducts a local counterattack with all available local resources to prevent the enemy from consolidating gains. The lowest possible echelon conducts this local counterattack; however, the commander must be aware of the problem of piecemeal commitment. A unit does not abandon a position unless it fits within the higher commander's intent, or that higher commander grants permission to do so. If the defending force is unable to repulse the enemy, it tries to contain the enemy penetration until it can attack in concert with major counterattacking forces. The commander coordinates counterattacks with the efforts of the fire support system.

7-84. Although the commander plans for the counterattack in defensive planning, the plan may not correspond exactly with the existing situation when the counterattack is launched. As the situation develops, the commander reassesses the plan based on a revised situational understanding that results from an updated common operational picture as new intelligence and combat information becomes available to answer the following questions:

- Is a counterattack feasible, or should the commander use the reserve to contain enemy successes?
- When and where should the defending forces counterattack?
- In the case of enemy penetrations, what should the defending forces counterattack, and what should they block or contain?
- Is there enough time to complete the counterattack before the arrival of enemy follow-on forces?
- Can the counterattack be conducted using only available fires or must ground maneuver forces be committed?

7-85. When counterattacking, the commander employs all available resources necessary to ensure success. The reserve's counterattack usually becomes the echelon's decisive operation on its commitment, so the commander avoids its premature or piecemeal commitment. One of the commander's most critical decisions is committing the reserve. The commander may reinforce the reserve force before its commitment to give it greater capability to counter enemy action. The commander does not counterattack as an automatic reaction to an enemy penetration, nor does the commander commit the reserve solely because the enemy has reached a certain phase line or other location. The commander may employ fire support assets and local counterattacks by forces already defending to destroy, disrupt, or attrit enemy penetrations, thus avoiding the need to commit the reserve. When possible, the commander launches the counterattack when the enemy presents a flank or rear, overextends, or the enemy's momentum dissipates. Once the flanks of the enemy's main effort are identified, the commander can target counterattacks to isolate and destroy enemy forces within the MBA.

7-86. Sometimes the commander may determine that the reserve is unable to conduct a successful counterattack. In this case, the commander uses available resources to block, contain, or delay the enemy to gain time to employ higher-echelon reserves. In these cases, the commander and staff must plan how to integrate reinforcing companies and battalions into the defensive scheme, adjust boundaries, and place battle positions. The commander plans the routes these units will use, and what adjustments will be necessary in existing mission command arrangements. The commander can speed the process of positioning and moving reinforcements or the reserve by designating routes, allocating mobility assets, and providing traffic-control personnel and guides at contact points to lead and brief them on the situation. Maneuver battalion scouts, military police, and reconnaissance units are typically the assets used to provide traffic control during the movement of these reserves because they have the combat power to protect themselves from small enemy forces that may be encountered in this type of situation.

FOLLOW THROUGH (COUNTERATTACK)

7-87. The purpose of defensive actions is to retain terrain and create conditions for a counteroffensive that regains the initiative. The area defense does this by causing the enemy to sustain unacceptable losses short of any decisive objectives. A successful area defense allows the commander to transition to an attack. An area defense could also result in a stalemate with both forces left in contact. Finally, it could result in the defender being overcome by the enemy attack and needing to transition to a retrograde operation. Any

decision to withdraw must take into account the current situation in adjacent defensive areas. Only the commander who ordered the defense can designate a new FEBA or authorize a retrograde operation.

7-88. During this follow-through period, time is critical. Unless the commander has a large, uncommitted reserve prepared to quickly exploit or reverse the situation, the commander must reset the defense as well as maintain contact with the enemy. Time is also critical to the enemy, because the enemy will use it to reorganize, establish a security area, and fortify positions.

7-89. There is a difference between local counterattacks designed to restore the defense and a decisive operation designed to wrest the initiative from the enemy force and then defeat it. To conduct a decisive counterattack, the defending force must bring the enemy attack to or past its culminating point before it results in an unacceptable level of degradation to the defending force. To do this, the defending force must disrupt the enemy's ability to mass, causing the enemy to disperse its combat power into small groups or attrit enemy forces to gain a favorable combat power ratio. The defending force must continue to disrupt the enemy's ability to introduce follow-on forces and attack the defender's sustainment system. In the defense, the commander must prepare to quickly take advantage of fleeting opportunities, seize the initiative, and assume the offense. Ideally, the commander already has a counterattack plan appropriate to the existing situation. The commander must rapidly reorganize and refit selected units, move them to attack positions, and attack. Alternatively, the commander must conduct an attack using those units already in contact with the enemy, which is normally the least favorable COA.

7-90. It is extremely difficult for the enemy to fight a defensive battle in response to a friendly counterattack after the enemy reaches a culminating point for the following reasons:

- Defensive preparations are hasty.
- Forces are not adequately organized for defense.
- Reorganizing for a defense requires more time than the friendly commander allows.
- The enemy force is dispersed, extended in depth, and weakened.
- Enemy attacks rarely culminate on ground ideally suited for defense.
- Physical fatigue.

7-91. The shift to a defense requires enemy soldiers to make a psychological adjustment. Enemy soldiers who have become accustomed to advancing, and thus winning, must now halt deep in the defending force's territory and fight defensively, sometimes desperately, on new and often unfavorable terms. If the enemy commander decides to conduct retrograde operations to more defensible ground, enemy soldiers will tend to find it even harder to adjust psychologically. The commander conducts prior planning to develop decision points and control measures, such as retrograde routes, objectives, and target reference points to exploit the opportunities offered in this situation.

7-92. If the defensive battle leads to a stalemate with both forces left in contact, the defending force commander seeks to retain the initiative and set the conditions for the next encounter. The commander prepares the defending unit to move rapidly to a subsequent defensive position during a lull in the battle because it is risky to defend from the same position twice. The enemy will know the location of the defending force's position and subject it to supporting fires unless the defending force moves. The defending unit should normally stay in place and continue to fight unless it can suppress the enemy's approaching forces or take other actions to distract the enemy. This is because of the risk to a unit when it moves out of its prepared positions while still under enemy pressure.

7-93. If the defending unit is unable to maintain the integrity of its defense, it must transition to a retrograde operation or risk destruction. The commander must analyze how to execute this transition and prepare contingency plans. If the situation requires a retrograde movement, the commander conducts the operation according to the retrograde fundamentals and principles addressed in chapter 9. In the retrograde, if the defending force can trade space for time without sustaining unacceptable losses, the commander can usually reestablish the conditions required for a successful defense.

Chapter 8

Mobile Defense

A mobile defense focuses on destroying the attacking force by permitting the enemy to advance into a position that exposes the enemy to counterattack and envelopment. The commander retains the majority of available combat power in a striking force for the decisive operation, a major counterattack. The commander commits the minimum possible combat power to the fixing force that conducts shaping operations to control the depth and breadth of the enemy's advance. The fixing force also retains the terrain required to conduct the striking force's decisive counterattack. The area defense, on the other hand, focuses on retaining terrain by absorbing the enemy into an interlocked series of positions, where the enemy is destroyed largely by fires.

NOTE: The Army and Marine Corps concept and terminology for the conduct of a mobile defense are different. The Marine Corps does not use the fixing and striking force terminology. The Marine Corps discussion of a mobile defense addresses allocating minimum forces to a positional defense while allocating maximum combat power to counterattack forces.

GENERAL CONSIDERATIONS FOR A MOBILE DEFENSE

8-1. The mission variables of mission, enemy, terrain and weather, troops and support available, time available, and civil considerations (METT-TC) may dictate that a unit conducts a mobile defense when defending against an enemy force with greater combat power but less mobility. The following circumstances favor the conduct of a mobile defense—

- The defender possesses equal or greater mobility than the enemy.
- The frontage assigned exceeds the defender's capability to establish an effective area or positional defense.
- The depth of the area of operations (AO) allows the attacking enemy force to be drawn into an unfavorable position where it can be attacked.
- Time for preparing defensive positions is limited.
- Sufficient armored, Styer, aviation, and long-range artillery forces and joint fires are available to allow rapid concentration of combat power.
- The enemy may employ weapons of mass destruction because this type of defense reduces the vulnerability of the force to attack and preserves its freedom of action.
- The mission does not require denying the enemy specific terrain.
- The AO lacks well-defined avenues of approach and consists largely of flat, open terrain.

8-2. Commanders conducting a mobile defense anticipate enemy penetration into defended areas and use obstacles and defensive positions to shape and control such penetrations. They also use local counterattacks to either draw the enemy into entering planned penetration areas or to deceive the enemy commander as to the nature of the defense. Among other risks associated with the conduct of a mobile defense are—

- The fixing force may be isolated and defeated in detail because of the need to resource the striking force to the detriment of the fixing force.
- Operations in noncontiguous AOs associated with conducting a mobile defense can lead to defeat in detail.
- Enemy operations may impair the ability of the striking force to react at critical points.
- The enemy may not move into the area intended by the defending commander.

- The attacking enemy force retains at least some momentum as it approaches the desired engagement areas (EAs).
- The defending force may not gain an accurate picture of the enemy's locations and dispositions required by the striking force to launch decisive operations in time to react.
- The decentralized operations required by the mobile defense increase the potential for friendly fire incidents.

8-3. Future technology associated with mission command systems should improve the ability of the friendly force to gain and maintain a common operational picture, which reduces the risk associated with this type of defense. Figure 8-1 depicts Army units conducting a mobile defense.

ORGANIZATION OF FORCES FOR A MOBILE DEFENSE

8-4. Units smaller than a division do not normally conduct a mobile defense because of their limited capabilities to fight multiple engagements throughout the width, depth, and height of the AO while simultaneously resourcing striking, fixing, and reserve forces. Typically, the striking force in a mobile defense may consist of one-half to two-thirds of the defender's combat power. Army brigade combat teams (BCTs) and smaller units generally conduct an area defense or a delay as part of the fixing force as the commander shapes the enemy's penetration, or they attack as part of the striking force. Alternatively, they can constitute a portion of the reserve.

8-5. Army commanders organize the main body into two principal groups—the fixing force and the striking force. In the mobile defense, reconnaissance and security, reserve, and sustaining forces accomplish the same tasks as in an area defense. The commander completes any required adjustments in task organization before committing subordinate units to combat. (See figure 8-2.)

8-6. Organized by the commander with the minimum combat power needed to accomplish its mission, the fixing force turns, blocks, and delays the attacking enemy force. It tries to shape the enemy penetration or contain the enemy's advance. Typically, it has most of the countermobility assets of the defending unit. The fixing force may conduct defensive actions over considerable depth within the main battle area (MBA). However, it must be prepared to stop and hold terrain on short notice to assist the striking force on its commitment. The operations of the fixing force establish the conditions for a decisive attack by the striking force at a favorable tactical location. The fixing force executes its portion of the battle essentially as a combination of an area defense and a delaying action. The actions of the fixing force are shaping operations.

8-7. The striking force decisively engages the enemy as attacking enemy forces become exposed in their attempts to overcome the fixing force. The term "striking force" is used rather than reserve because the term "reserve" indicates an uncommitted force. The striking force is a committed force and has the resources to conduct a decisive counterattack as part of the mobile defense. It is the commander's decisive operation.

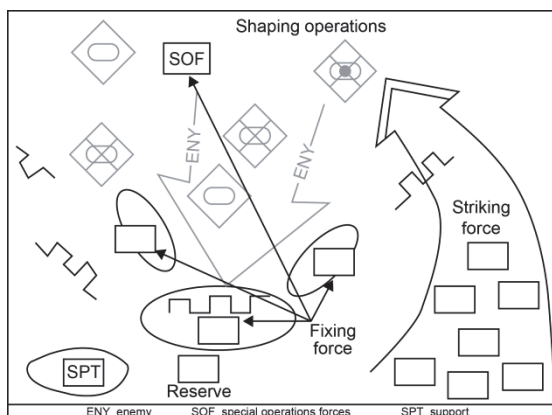

Figure 8-1. Mobile defense

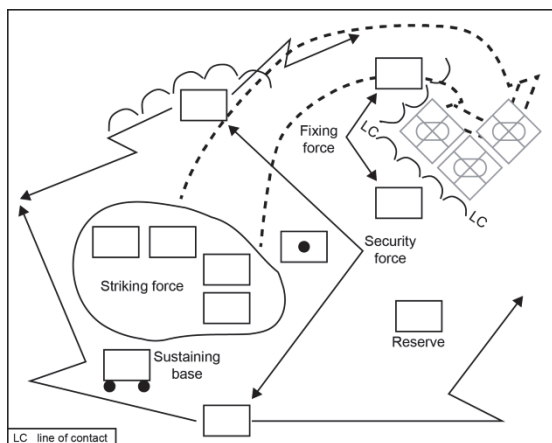

Figure 8-2. Army organization of forces for a mobile defense

8-8. The striking force contains the maximum combat power available to the commander at the time of its counterattack. The striking force is a combined arms force that has greater combat power and mobility than the force it seeks to defeat or destroy. The commander considers the effects of surprise when determining the relative combat power of the striking force and its targeted enemy unit. The striking force is normally fully task organized with all functional and multifunctional support and sustainment assets before its actual commitment. The commander positions engineer mobility-enhancing assets with the lead elements of the striking force.

8-9. The striking force is the key to a successful mobile defense. All of its contingencies relate to its attack. If the opportunity does not exist to decisively commit the striking force, the defender repositions forces to establish the conditions for success. The striking force must have mobility equal to or greater than that of its targeted enemy unit. It can obtain this mobility through proper task organization, countermobility operations to slow and disrupt enemy movements, and mobility operations to facilitate the rapid shifting of friendly formations. The striking force requires access to multiple routes because an attacking enemy normally goes to great length to deny the defending force freedom of action.

8-10. The commander responsible for orchestrating the overall mobile defense should retain control of the striking force unless communication difficulties make this impossible. Normally this is the overall defending force commander. The commander's most critical decisions are when, where, and under what conditions the commander should commit the striking force. The commander normally accompanies the striking force.

8-11. Resourcing a reserve in a mobile defense is difficult and requires the commander to assume risk. The commander generally uses the reserve to support the fixing force. However, if the reserve is available to the striking force, it exploits the success of the striking force.

CONTROL MEASURES FOR A MOBILE DEFENSE

8-12. A commander conducting a mobile defense uses control measures to synchronize the operation. These control measures include designating the AOs of the fixing and striking forces with their associated boundaries, battle positions, and phase lines. The commander designates a line of departure or a line of contact as part of the graphic control measures for the striking force. The commander may designate an axis of advance for the striking force. The commander can designate attack by fire or support by fire positions. The commander uses EAs, target reference points, targeted areas of interest, and final protective fires as necessary. The commander designates named areas of interest (NAI) to focus the efforts of reconnaissance and surveillance assets. This allows the commander to determine the enemy's chosen course of action (COA). The commander designates checkpoints, contact points, passage points, passage routes, and passage lanes for use by reconnaissance and surveillance assets, security units, and the striking force. (See figure 8-3 on page 8-4.)

8-13. The commander must provide the striking force commander with control measures to focus the striking force at the decisive time and place and to deconflict fires with the fixing force. As a minimum, the striking force commander needs to know the anticipated objective decision points that could lead to the commitment of the striking force, limit of advance, and boundaries of the striking force's AO. If the overall commander imposes either an axis of attack or a direction of attack as a control measure, that higher commander restricts the striking force commander's freedom of maneuver. However, such restrictions may be necessary to avoid contact with enemy forces that could distract the striking force from accomplishing its primary mission. The commander may have to determine and transmit these control measures rapidly while the commander, staff, and subordinates move to take advantage of an opportunity to commit the striking force in a decisive counterattack. They should also help the commander recover the defense's integrity, if the striking force is not successful in its attack. (Appendix A explains these control measures.)

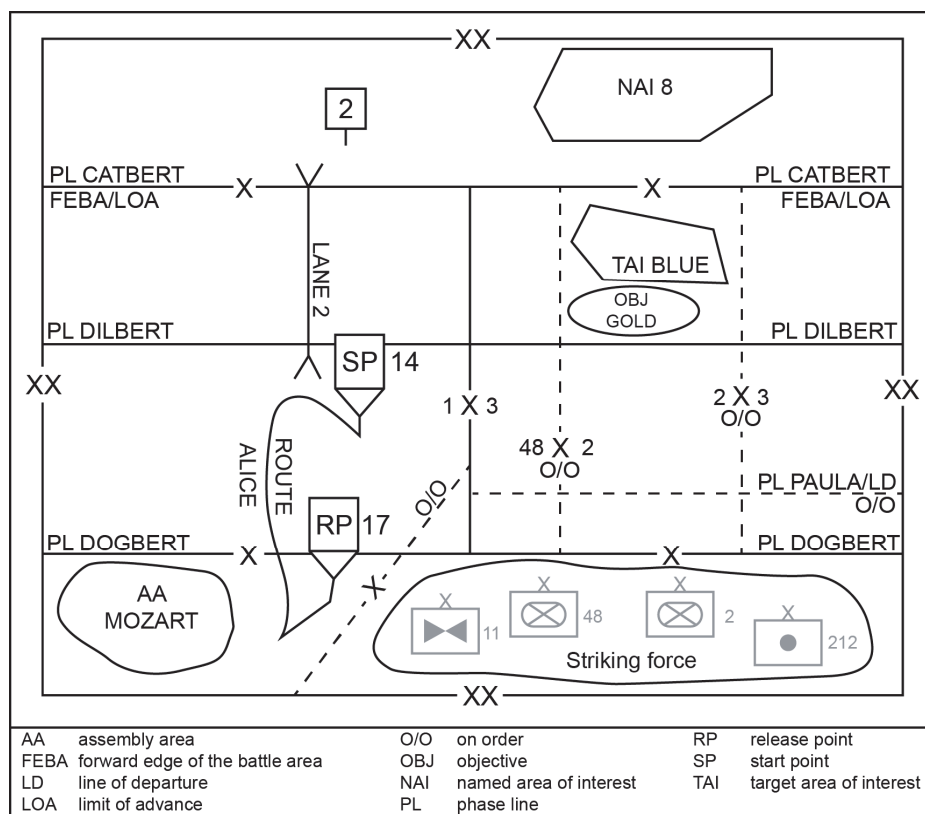

Figure 8-3. Mobile defense control measures

PLANNING A MOBILE DEFENSE

8-14. The key to a successful mobile defense is the integration and synchronization of all available assets to maximize the combat power of the defending unit, particularly the striking force. The commander achieves integration and synchronization when employing their combined effects at decisive times and places. (The general defensive planning considerations addressed in chapter 6 apply to the mobile defense.)

8-15. Just as in an area defense, in a mobile defense the unit's plans must address how the preparations for, and the conduct of, the mobile defense impact the civilian population of the AO. This is even more important during a mobile defense than it is during an area defense because the scope of maneuver and tempo of operations tends to be much larger. Civilian attempts to avoid advancing enemy formations and locations where combat occurs will impede the ground maneuver of defending units unless steps are taken to account for their presence and provide alternative routes for these dislocated civilians to use. Commanders communicate these routes to the civilian population by a wide variety of means to ensure they receive the information. Ideally, host nation civilian or military organizations will provide civilian traffic regulation and immediate essential services along those civilian evacuation routes (along with the other four primary stability tasks). However, if the host nation cannot perform these tasks, the defending unit will have to perform them. Screening of civilians by units is necessary in this case to preclude enemy agents from using these routes to infiltrate friendly defensive positions. At all times, commanders must meet legal obligations to local civilian populations.

MOVEMENT AND MANEUVER

8-16. The commander's ability to maintain the mobility advantage of the force is an important aspect of the mobile defense. This mobility advantage may result from or be enhanced by countermobility actions

directed against the attacking enemy force. In the mobile defense plan, the commander ensures that subordinate forces—including reserves and the striking force—can move freely around the battlefield, while at the same time restricting the enemy's mobility, slowing the enemy's momentum, and guiding or forcing the enemy into areas that favor the defense.

8-17. Most of the commander's countermobility assets support the operations of the fixing force. Most of the commander's mobility assets support the operations of the striking force. Situational obstacles provide a tremendous advantage to the defender in the conduct of a mobile defense. These obstacles are a combat multiplier because they enable economy of force measures. The commander uses situational obstacles to exploit enemy vulnerabilities, exploit success, separate enemy follow-on forces, and provide flank protection.

FIRES

8-18. The effectiveness of a mobile defense is based on the carefully planned fires of all weapons. The striking force conducts the commander's decisive operation in a mobile defense. It requires continuous and concentrated fire support. The commander weights the decisive operation, in part, by allocating field artillery and other fire support weapon systems to it. The commander rapidly shifts indirect fire support from the fixing force to the striking force. These fire support systems do not have to move with the striking force, if it remains within supporting range.

8-19. If the striking force's planned maneuver places it outside the supporting range of the defending commander's fire support systems, the commander must either plan to move fire support assets to locations where they can support the striking force or incorporate them into the striking force. Fire support assets, especially when employing precision munitions, can partially compensate for a lack of maneuver forces in the striking force. The commander takes precautions to prevent fratricide as the striking force approaches the fixing force's EAs by establishing restrictive fire lines (RFLs), while supporting air and artillery assets interdict enemy movements.

SUSTAINMENT

8-20. When planning for the mobile defense's sustaining operations, sustainment planners must look beyond the fixing force's shaping operations to support the striking force's decisive counterattack. The greater the distance the striking force must cover when moving from its assembly area (AA) to its final objective, the greater the amount of supplies needed to support that move. Once committed, units in the striking force require priority of fuel, ammunition, and maintenance support over comparable units in the fixing force. Commanders establish casualty treatment and evacuation procedures for both the fixing force and the striking force. The fixing force will likely suffer a higher percentage of casualties than the striking force as it absorbs the enemy's attack. When the striking force must move a considerable distance from its sustaining base, the commander should consider establishing an intermediate staging base (ISB). Before establishing an ISB, the commander must weigh the benefits of establishing the base against the cost in terms of combat power or effort diverted from the support mission to secure the ISB. (See FM 3-35 for additional information on ISBs.)

PREPARING A MOBILE DEFENSE

8-21. Preparations for conducting a mobile defense include developing the fixing force's defensive positions and EAs. The commander aggressively uses reconnaissance assets to track enemy units as they approach. Engineers participate in conducting route and area reconnaissance to find and classify existing routes. They improve existing routes and open new routes for use during the battle.

8-22. The striking force assembles in one or more areas depending on the width of the AO, the terrain, enemy capabilities, and the commander's intent. Before the enemy attack begins, the striking force may deploy some or all of its elements forward in the MBA to—

- Deceive the enemy regarding the purpose of the force.
- Occupy dummy battle positions.

- Create a false impression of unit boundaries, which is important when operating with a mix of armored, Stryker, and infantry forces or multinational forces.
- Conduct reconnaissance of routes between the striking force's AAs and potential EAs.

8-23. The enemy attempts to discover the strength, composition, and location of the units that constitute the fixing force and the striking force. The commander uses protective measures, such as security forces and operations security, to deny the enemy this information and degrade the collection capabilities of enemy reconnaissance and surveillance assets. The commander routinely repositions to mislead the enemy and to protect the force. In addition, the commander incorporates information protection and other defensive measures into plans and preparations. The commander attempts to portray an area defense to the enemy while hiding the striking force.

EXECUTING A MOBILE DEFENSE

8-24. This publication divides the execution of a mobile defense into five steps for discussion purposes. The length and nature of each step, if it occurs at all, varies from situation to situation according to the mission variables of METT-TC. These steps are gain and maintain enemy contact, disrupt the enemy, fix the enemy, maneuver, and follow through. The first three are normally shaping operations within a mobile defense. The maneuver step is normally the mobile defense's decisive operation, while the follow through step is normally a branch or sequel operation.

8-25. A commander executing a mobile defense must have the flexibility to yield terrain and shape the enemy penetration. The commander may even entice the enemy by appearing to uncover an objective of strategic or operational value to the enemy. The striking force maneuvers to conduct the decisive operation—the counterattack—once the results of the actions of the fixing force shape the situation to meet the commander's intent.

GAIN AND MAINTAIN ENEMY CONTACT

8-26. The commander conducting a mobile defense focuses on discovering the enemy's strength and exact locations to facilitate the effectiveness of the striking force. The security force (guard or cover) or the fixing force confirms the enemy's COA and the main avenues of approach used by the enemy. The commander normally tasks other reconnaissance and surveillance assets to determine the location of enemy reserves and follow-on forces. Early detection of the enemy's decisive operation provides the commander with reaction time to adjust the fixing force's positions and shape the enemy penetration, which, in turn, provides the time necessary to commit the striking force. The striking force commander requires as close to real-time updates of the enemy situation as possible to ensure that the striking force engages the enemy at the right location and time.

8-27. While conducting delaying operations (see FM 3-90-2), the security force determines what routes the enemy is using, where the enemy is strong or weak, and where gaps in and between enemy formations exist. This information aids the commander in seizing the initiative by identifying opportunities. Further, it helps direct the striking force along the path of least resistance, as it maneuvers to employ its combat power at the critical time and place.

DISRUPT THE ENEMY

8-28. In a mobile defense, the commander conducts shaping operations designed to shape the enemy's penetration into the MBA and disrupt the enemy's introduction of fresh forces—reserves and follow-on echelons—into the fight. These shaping operations help establish the preconditions for committing the striking force by isolating the object of the striking force and destroying the enemy's key command and control (C2) nodes, logistics resupply units, and reserves. Whenever possible, the commander sequences these shaping operations, to include electronic warfare, so that their effects coincide with the commitment of the striking force. To generate a tempo that temporarily paralyzes enemy C2, the commander may increase the intensity of these shaping operations dramatically on the commitment of the striking force. The commander continues to conduct shaping operations once the striking force commits to prevent enemy forces from outside the objective area from interfering with the decisive counterattack.

FIX THE ENEMY

8-29. Fixing the enemy is the second half of shaping operations and establishes the conditions necessary for decisive operations by the striking force. Typically, the commander of the defending force allows the enemy force to penetrate the MBA before the striking force attacks. (See figure 8-4.) The fixing force may employ a combination of area defense, delay, and strong point techniques to shape the enemy penetration. The intent of the fixing force is not necessarily to defeat the enemy but to shape the penetration to facilitate a decisive counterattack by the striking force. The commander ensures that the missions and task organization of subordinate units within the fixing force are consistent with the concept for shaping the enemy penetration. Defensive positions within the fixing force may not be contiguous since the fixing force contains only the minimum-essential combat power to accomplish its mission.

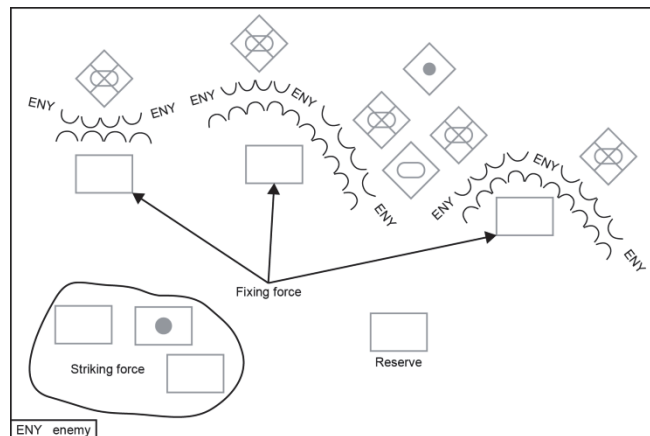

Figure 8-4. Mobile defense before commitment of striking force

8-30. The fixing force's extensive use of obstacles supports this shaping effort and helps it gain an overall mobility advantage over the enemy. The commander may want to yield ground quickly to make the attacking enemy commander think that the attacking enemy force has been successful or to entice the attacking enemy force to move to a decisive point where the striking force can attack. Normally, in a mobile defense, the commander retains ground only to facilitate the commitment of the striking force.

8-31. When conducting a mobile defense, the commander may need to commit the reserve to reinforce the fixing force and help shape the battlefield. The commander positions the reserve so that it effectively reacts to the most likely contingency and the enemy's most dangerous COA. Without a reserve, the commander assumes significant risk in attempting to shape the enemy penetration. Circumstances may also force the commander to employ elements of the striking force to assist the fixing force. If that occurs, the commander uses available long-range fire support assets and attack helicopters. They are the best choice because of their ability to rapidly disengage and shift their effects to support the rest of the striking force on its commitment.

MANEUVER

8-32. The commander's situational understanding is critical in establishing the conditions that initiate the striking force's movement and in determining the general area that serves as a focus for the counterattack. Situational understanding includes identifying those points in time and space where the counterattack proves decisive. A force-oriented objective or an EA usually indicates the decisive point. The staff synchronizes the unit's activities in time and space to sufficiently mass the effects of the striking force at the right time and place.

8-33. The actions of the striking force are the echelon's decisive operation on its commitment. The commander's reconnaissance and surveillance assets focus entirely on tracking the enemy's advance. The striking force commander continuously receives intelligence and combat information updates that allow that commander to adjust the counterattack as necessary to defeat the targeted enemy. Once the enemy force starts its attack, any forward-deployed elements of the striking force withdraw to assembly areas or attack positions and prepare for their commitment.

8-34. The defending commander launches the striking force in a counterattack when its offensive power, relative to that of the targeted attacking enemy element, is the greatest. (See figure 8-5.) Piecemeal commitment of the striking force in support of local objectives jeopardizes the success of the overall operation. The striking force must execute the counterattack rapidly and violently, employing all combat power necessary to ensure success. The striking force may be committed at a different time than anticipated and in an entirely different area than planned. Thus, it must be able to respond to unexpected developments rapidly and decisively.

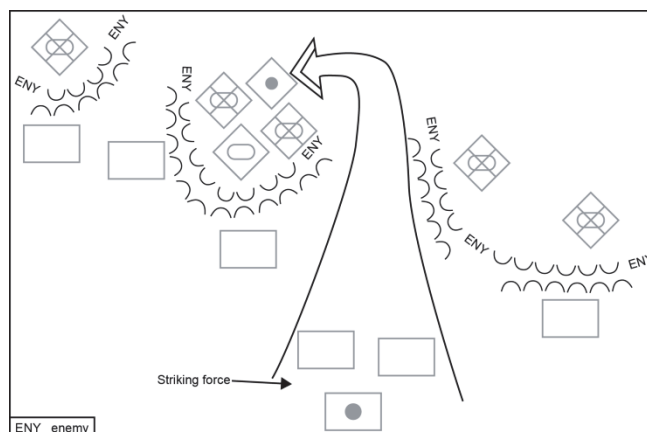

Figure 8-5. Mobile defense after commitment of striking force

8-35. Because the striking force normally attacks a moving enemy, it generally assumes a combat formation with a covering force, an advance guard, a main body, and either a follow-and-support or a follow-and-assume force. The striking force takes advantage of obstacles, such as rivers or obstacle zones, that block the enemy's movement. The strike force commander designates flank responsibilities and may even allocate a force against a particularly vulnerable flank. However, the striking force moves quickly and takes risks on its flanks, using its speed of movement and superior situational understanding to provide security.

8-36. The striking force attacks in a formation that provides maximum combat power forward to devastate the enemy force and achieve decisive results. The striking force takes advantage of its mobility and fire power to seize the initiative by overwhelming the enemy force with swift, violent blows that cripple the enemy's command and control system, disrupt attacking enemy formations, and destroy enemy combat systems. The commander ensures that fire support and fixing force efforts capture the enemy's attention and posture the enemy for attack by the striking force. During the counterattack, the strike force commander may have one element of the striking force occupy support by fire positions to suppress the enemy, while another striking force element prepares to assault the objective. Armored, Stryker, and infantry forces may make this assault. (Chapter 3 discusses the actual conduct of an assault on an objective.)

8-37. Engineers should be well forward to enhance the mobility of the striking force. These lead engineers search for existing obstacles and clear the route as much as possible within their capabilities. Follow-on engineers expand breaches, improve routes, and replace assault bridges with more permanent structures. Engineers with flank units focus on countermobility to protect the striking force's flanks.

FOLLOW THROUGH

8-38. Commanders use defensive actions to create the opportunity to transition to the offense. In a mobile defense, that transitional opportunity generally results from the success of the striking force's attack. The commander exploits success and attempts to establish conditions for a pursuit, if the result of the commander's assessment of the striking force's attack shows that there are opportunities for future offensive actions. (Chapters 4 and 5 discuss exploitation and pursuit.) If the mobile defense is unsuccessful and the enemy retains the initiative, the commander must either reestablish a viable defense or conduct retrograde operations. (Retrograde operations are the topic of chapter 9.)

Chapter 9

The Retrograde

The Army categorizes the retrograde as one of three primary defensive tasks. The enemy may force these operations or a commander may execute them voluntarily. In either case, the higher commander of the force executing the operation must approve the retrograde. Retrograde operations are transitional operations; they are not considered in isolation.

GENERAL CONSIDERATIONS FOR THE RETROGRADE

9-1. ***Retrograde movement*** is any movement of a command to the rear, or away from the enemy. It may be forced by the enemy or may be made voluntarily. Such movements may be classified as **withdrawal, retirement, or delaying actions**. The commander executes retrogrades to—

- Disengage from operations.
- Gain time without fighting a decisive engagement.
- Resist, exhaust, and damage an enemy in situations that do not favor a defense.
- Draw the enemy into an unfavorable situation or extend the enemy's lines of communication (LOCs).
- Preserve the force or avoid combat under undesirable conditions, such as continuing an operation that no longer promises success.
- Reposition forces to more favorable locations or conform to movements of other friendly troops.
- Position the force for use elsewhere in other missions.
- Simplify sustainment of the force by shortening LOCs.
- Position the force where it can safely conduct reconstitution.
- Adjust the defensive scheme to secure more favorable terrain.
- Deceive the enemy.

9-2. The three retrograde tasks are delay, withdrawal, and retirement. In each task, a force moves to the rear, using combinations of combat formations and marches. (Chapter 1 discusses combat formations; FM 3-90-2 discusses troop movement.) The commander may use all three tasks singularly or in combination with other offensive or defensive tasks.

Retrograde tasks

- Delay
- Withdrawal
- Retirement

9-3. Retrogrades can negatively affect the participating Soldiers' attitudes more than any other type of operation because they may view the retrograde as a defeat. A commander must not allow retrograde operations to reduce or destroy unit morale. Leaders must maintain unit aggressiveness. By planning and efficiently executing the retrograde and ensuring that Soldiers understand the purpose and duration of the operation, the commander can counter any negative effects of the operation on unit morale. After completing a retrograde operation, the commander may reconstitute the force. (See Sustainment Center of Excellence publications that contain the principles of reconstitution for more information.)

DELAY

9-4. A *delaying operation* is an operation in which a force under pressure trades space for time by slowing down the enemy's momentum and inflicting maximum damage on the enemy without, in principle, becoming decisively engaged (JP 3-04). The delay is one of the most demanding of all ground combat

operations. A delay wears down the enemy so that friendly forces can regain the initiative through offensive action, buy time to establish an effective defense, or determine enemy intentions as part of a security operation. Normally in a delay, inflicting casualties on the enemy is secondary to gaining time. For example, a flank security force conducts a delay operation to provide time for the protected force to establish a viable defense along its threatened flank. Except when directed to prevent enemy penetration of a phase line (PL) for a specific duration, a force conducting a delay normally does not become decisively engaged.

9-5. A delay operation can occur when the commander does not have enough friendly forces to attack or defend. It may also occur, based on a unit's mission, in conjunction with a higher commander's intent. The decision to conduct a delay may not be based on the unit's combat power, but on the other mission variables of mission, enemy, terrain and weather, troops and support available, time available, and civil considerations (METT-TC). For example, during security operations, the commander may conduct a delay as a shaping operation to draw the enemy into an area where the attacking enemy force is vulnerable to a counterattack. Another example is a delay instituted as an economy of force effort to allow the commander to conduct offensive actions elsewhere.

9-6. The ability of a force to trade space for time requires depth within the area of operations (AO) assigned to the delaying force. The amount of depth required depends on several factors, including the—

- Amount of time to be gained.
- Relative combat power of friendly and enemy forces.
- Relative mobility of the forces.
- Nature of the terrain.
- Ability to shape the AO with obstacles and fires.
- Degree of acceptable risk.

Ordinarily, the greater the available depth, the lower the risk involved to the delaying force and the greater the chance for success.

9-7. A delay succeeds by forcing the enemy to repeatedly concentrate forces to fight through a series of defensive positions. A delaying force must offer a continued threat of serious opposition, forcing the enemy to repeatedly deploy and maneuver. Delaying forces displace to subsequent positions before the enemy is able to concentrate sufficient resources to decisively engage and defeat delaying forces in their current position. The length of time a force can remain in a position without facing the danger of becoming decisively engaged is primarily a function of relative combat power and the mission variables of METT-TC, such as terrain and weather.

ORGANIZATION OF FORCES

9-8. The commander normally organizes the delaying force into a main body, a security force, and a reserve. The security force usually conducts a screen forward of the initial delay positions. For a division or corps conducting a delay, the security force may be an armored brigade combat team (ABCT), a Stryker brigade combat team (SBCT), or a task force based around a battlefield surveillance brigade's (BFSB's) reconnaissance squadron. For a brigade combat team (BCT) conducting a delay, the security force may consist of the BCT reconnaissance squadron, a battalion-sized task force, or another element tasked to conduct security operations.

9-9. The main body, which contains the majority of the delaying force's combat power, may use alternate or subsequent positions to conduct the delay. The commander usually deploys the main body as a complete unit into a forward position when conducting a delay from subsequent positions. The commander divides the main body into two parts, roughly equal in combat power, to occupy each set of positions when conducting a delay from alternate positions.

9-10. The commander normally retains a reserve to contain enemy penetrations between positions, to reinforce fires into an engagement area (EA), or to help a unit disengage from the enemy. All of these missions require that the reserve has the mobility and strength to strike with such force that an enemy has no option but to react to it.

9-11. The extended frontages and ranges common to retrograde operations make the provision of fire support difficult and limit the commander's ability to mass fires. Therefore, retrograde forces, especially delay forces, often have more than the normal allocation of fire support assets. The commander's risk of losing supporting artillery systems and their ammunition also increases when conducting retrograde operations. Therefore, the commander balances the decision to commit fire support systems forward against anticipated requirements in subsequent battle stages. In particular, the commander protects towed artillery systems from being overrun by a mobile enemy. The commander can use available rotary- and fixed-wing aircraft to augment or replace artillery systems.

9-12. Functional and multifunctional support and sustainment assets are widely dispersed and often attached to the units they support because of the width of the AOs normally assigned in a delay. Engineer priorities are normally countermobility first, then mobility. However, restrictive terrain that impedes friendly movement may require the commander to reverse priorities. Close coordination is necessary so that engineer obstacles are covered by fire and do not impede the planned withdrawal routes of delaying forces or the commitment of a counterattacking reserve force. The delaying force should have a greater-than-normal allocation of fire support systems to include Service and joint aviation to allow the delay force to break contact if necessary.

9-13. The requirement to maintain continuous support during the delay requires sustainment organizations to echelon their assets throughout the area where the retrograde will take place. This echeloning, coupled with the wide dispersion of combat forces that is inherent in a delay, complicates the conduct of the delay.

CONTROL MEASURES

9-14. The delay consists of a series of independent small-unit actions that occur simultaneously across the front. Subordinate commanders must have freedom of action. The tactical mission graphic for the delay appears in figure 9-1. It is not a control measure. Tactical mission graphics are used by planners developing different courses of action. The control measures used in the delay are the same as those introduced in chapter 8. Common graphics used in a delay include AOs, PLs, battle positions (BPs), coordination points, checkpoints, EAs, trigger lines, target reference points (TRPs), and disengagement lines. (See figure 9-2 on page 9-4.) The commander designates contact points in front of, between, and behind units to assist coordination, ensure continuity of the delay, and draw attention to enemy avenues of approach into unit flanks. (FM 3-90-2 addresses the use of passage points within its discussion of the tactics associated with the conduct of a passage of lines.)

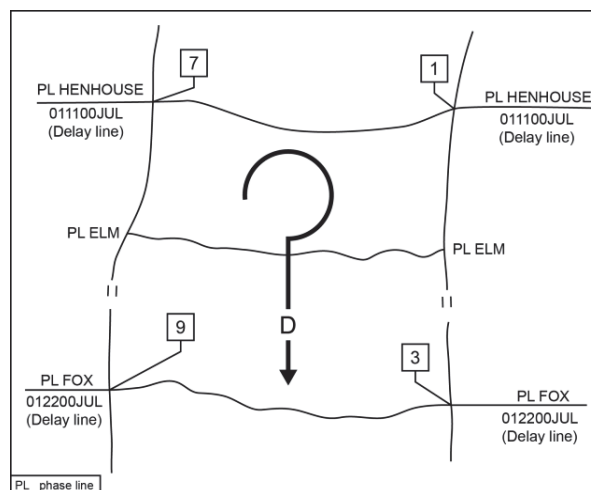

Figure 9-1. Delay tactical mission graphic

9-15. In planning for a delaying action, the commander assigns an AO to each committed unit down through the company or troop level. The commander assigns each likely enemy avenue of approach to only one subordinate unit when designating subordinate units' AOs. When the commander draws the boundaries of these subordinate AOs, terrain that controls fire and observation into those areas is included.

9-16. The commander designates additional PLs beyond those established by the higher commander as necessary to control the unit's movement during the delay. A *delay line* is a **phase line where the date and time before which the enemy is not allowed to cross the phase line is depicted as part of the graphic control measure**. Designating delay lines is a command decision that imposes a high degree of risk on the delaying unit. The delaying unit must do everything in its power—including accepting decisive engagement—to prevent the enemy from crossing that line before the time indicated. A delay line may also be event driven. For example, a commander can order a delaying unit to prevent penetration of the delay line until supporting engineers complete construction of a rearward obstacle belt.

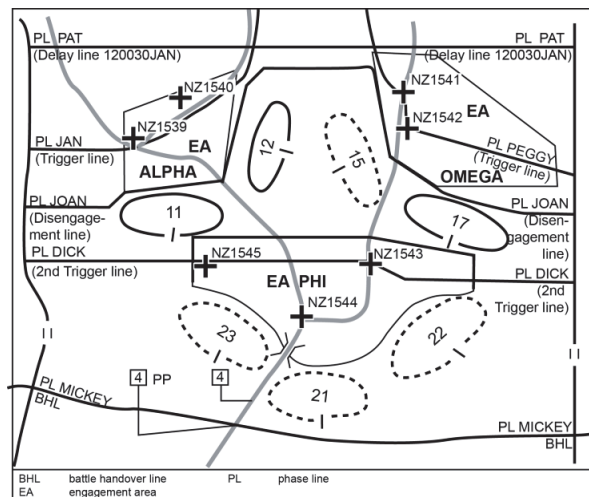

Figure 9-2. Control measures for a delay

PLAN

9-17. Unit commanders and their Soldiers must understand and exercise the basic defensive tactics outlined in chapter 6 to conduct a successful delay. However, these defensive basics have unique considerations, and the significance of these considerations varies depending on the mission variables of METT-TC. In a delay, units operate on extended frontages at great risk from advancing enemy forces. The tactical situation constantly changes with opportunities for maneuver existing for only extremely short periods. Subordinate commanders must have the flexibility to take immediate action to retain the integrity of their forces. This helps retain their freedom of maneuver and inflict maximum destruction on the enemy.

9-18. The commander identifies ground and air avenues for enemy attacks and friendly counterattacks. When avenues of approach diverge or pass from one AO to another, adjacent units must coordinate with each other. Using the intelligence preparation of the battlefield process, the commander designates initial and subsequent delay positions on key terrain that covers likely enemy avenues of approach throughout the depth of the AO allocated to the delay mission.

9-19. The commander of the delaying force must maintain a mobility advantage over the attacker to successfully conduct a delay. Robust engineering and fire support are critical to this effort. The commander maintains this advantage by fully utilizing the mobility inherent in the combat and tactical systems available to the delaying force. In addition, the commander takes other steps to enhance friendly mobility and degrade the enemy's mobility, such as building combat trails between delaying positions and preparing bridges over major rivers for demolition. The delaying force should be capable of constructing large numbers of obstacles and delivering long-range fires. For example, while the enemy travels in movement formations that allow the enemy force to quickly press its attack, the delaying force's aim is to engage the enemy as early and often as possible. This forces the enemy out of those formations through a multiple series of time-consuming deployments into assault formations.

9-20. Air defense of a delaying force has three main considerations—the protection of the force while it is in position, the protection of any forces left in contact, and the protection of the force as it moves to the rear. Priority should be toward maintaining the mobility of the force. Air defense assets remain mobile yet able to engage aerial targets with little advance warning. These assets should work in teams, able to move to the rear in alternating bounds. This ensures that dedicated air defense assets will always be in position, with the flexibility needed to keep pace with the operations. These firing points are not obvious positions that an enemy would target as part of preparatory or supporting fires. Early warning of enemy air attack is provided over combat net radios using the command net at the brigade echelon and below.

9-21. Flanks and gaps between units are always areas of concern. In a linear deployment, the enemy can bypass or outflank the delaying force, if coordination between adjacent friendly units is weak, or if one unit

creates a gap by moving rearward too rapidly. Therefore, the commander normally designates BPs to guard approaches into the AO. Adjacent units of different commands must exchange liaisons.

9-22. Displacement criteria should specify at what point—either event or time-driven—the delaying force should begin its displacement. The commander should calculate enemy closure rates for the terrain and compare them to friendly displacement rates between positions. By comparing time and distance factors, the commander can calculate the movement time. By applying the enemy’s probable rates of advance and formations to the avenues of approach, the commander can decide what obstacles to use and where to emplace them (covering them by fires). This comparison also helps the commander determine if and where decisive engagement is likely or required to achieve the delay objective. Careful consideration of the mission variables of METT-TC, especially terrain analysis, is an inherent part of delay planning.

PARAMETERS OF THE DELAY ORDER

9-23. The commander must specify certain parameters in an order for a delay mission. First, the commander must direct one of two alternatives: delay within the AO or delay forward of a specified line or terrain feature for a specified time. That time is usually based on another unit completing its activities, such as establishing rearward defensive positions. A mission of delay within the AO implies that force integrity is a prime consideration. In this case, the delaying force delays the enemy as long as possible while avoiding decisive engagement. Generally, this force displaces once predetermined criteria have been met, such as when the enemy force reaches a disengagement line. The control measures are the same for both alternatives, except that during a delay forward of a specified line for a specified time, the commander annotates the PL with the specified time. (See figure 9-3.) If the commander establishes a delay line, mission accomplishment outweighs preservation of the force’s integrity. It may require that the force hold a given position until ordered to displace.

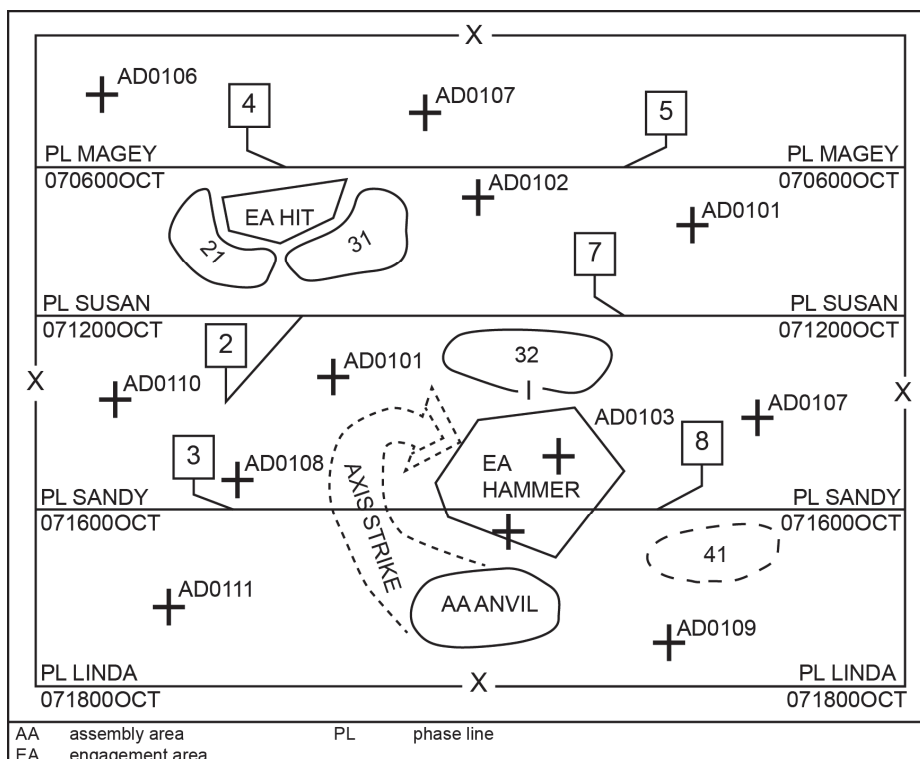

Figure 9-3. Delay forward of a specified line for a specified time

9-24. The second parameter is that the order must specify the acceptable risk. Acceptable risk ranges from accepting decisive engagement in an attempt to hold terrain for a given time to maintaining the integrity of the delaying force. The depth of the AO available for the delay, the time needed by higher headquarters,

and subsequent missions for the delaying force determine the amount of acceptable risk. A delay mission that does not specify times, control of key terrain, or other guidance and control measures implies a lower degree of risk.

9-25. Third, the order must specify whether the delaying force may use the entire AO or must delay from specific BPs. A delay using the entire AO is preferable, but a delay from specific positions may be required to coordinate two or more units in the delay. To enhance mission command and to coordinate the battle across a broad front, the commander can assign units down to platoon-level specific BPs. However, the commander may assign them missions to delay within their AO, if that best supports the scheme of maneuver.

ALTERNATE AND SUBSEQUENT POSITIONS

9-26. The commander normally assigns subordinate units contiguous AOs that are deeper than they are wide. The commander uses obstacles, fires, and movement throughout the depth of each assigned AO. The delaying unit may be forced to fight from a single set of positions, if the commander plans the delay to only last a short time or the AO’s depth is limited. If the commander expects the delay to last for a longer period, or if sufficient depth is available, the delaying unit may delay from either alternate or successive positions.

9-27. In both techniques, delaying forces normally reconnoiter subsequent positions before occupying them and, if possible, post guides on one or two subsequent positions. Additionally, in executing both techniques, it is critical that the delaying force maintains contact with the enemy between delay positions. (The advantages and disadvantages of the two techniques are summarized in Table 9-1.)

Table 9-1. Advantages and disadvantages of delay techniques

<i>Method of delay</i>	<i>Use when</i>	<i>Advantages</i>	<i>Disadvantages</i>
Delay from subsequent positions	<ul style="list-style-type: none"> • Area of operations is wide. • Forces available do not allow themselves to be split. 	<ul style="list-style-type: none"> • Masses fires of all available combat elements. 	<ul style="list-style-type: none"> • Limited depth to the delay positions. • Less available time to prepare each position. • Less flexibility.
Delay from alternate positions	<ul style="list-style-type: none"> • Area of operations is narrow. • Forces are adequate to be split between different positions. 	<ul style="list-style-type: none"> • Allows positioning in depth. • Allows more time for equipment and Soldier maintenance. • Increases flexibility. 	<ul style="list-style-type: none"> • Requires continuous coordination. • Requires passage of lines. • Engages only part of the force at one time.

9-28. A commander normally prefers to use alternate positions when adequate forces are available and the AO has sufficient depth. In a delay from alternate positions, two or more units in a single AO occupy delaying positions in depth. (See figure 9-4.) As the first unit engages the enemy, the second occupies the next position in depth and prepares to assume responsibility for the operation. The first force disengages and passes around or through the second force. It then moves to the next position and prepares to reengage the enemy while the second force takes up the fight. Alternate positions are normally used when the delaying force operates on a narrow front. A delay from alternate positions is particularly useful on the most dangerous avenues of approach because it offers greater security than a delay from successive positions. However, it requires more forces and continuous maneuver coordination. Additionally, the delaying forces risk losing contact with the enemy between delay positions.

9-29. The commander uses a delay from subsequent positions when the assigned AO is so wide that available forces cannot occupy more than a single tier of positions. (See figure 9-5.) In a delay from subsequent positions, all delaying units are committed to each of the series of battle positions (BPs) or across the AO on the same PL. Most of the delaying force is located well forward. The mission dictates the delay from one BP or PL to the next. The commander staggers the movement of delaying elements so that not all elements are moving at the same time.

EFFECTS OF TERRAIN

9-30. The commander always takes advantage of the terrain when planning how to position forces and conduct operations. The commander selects terrain that favors friendly actions and hampers enemy actions. The terrain dictates where a delaying force can orient on a moving enemy force and ambush it. During a delay, compartmentalized terrain facilitates shorter displacements initiated at closer range to the enemy. The commander conducting operations in compartmentalized terrain selects locations that restrict the enemy's movement and prevent the enemy force from fully exploiting its combat superiority. On the other hand, flat or open terrain requires earlier displacements at greater distances to stay in front of the advancing enemy. In open terrain, the most important consideration in selecting a position is a good, long-range field of fire. **A *field of fire* is the area that a weapon or group of weapons may cover effectively from a given position.**

9-31. In restricted terrain, where a light force conducts the primary action, positions may be close together, except when conducting a delay using air assault techniques. In open terrain, delay positions are often far apart. In selecting positions, the commander considers natural and artificial obstacles, particularly when the enemy has numerous armored combat systems.

9-32. The commander identifies routes that reinforcements, artillery units, command posts (CPs), and sustainment elements will use and keeps them under the commander's control and free of obstacles. Alternate routes should be available, so that a friendly force can bypass choke points if they are closed or contaminated.

9-33. Disengaging from the enemy while displacing from one position to the next is difficult. The unit's disengagement plans include the following:

- The maneuver concept of operations for tactical elements after disengagement, which includes the movement routes for each small unit.
- Fires to suppress the enemy and cover the unit's movement.
- Electronic warfare activities to disrupt enemy command and control (C2) at critical moments.
- Screening smoke to conceal the unit's movement, conduct a military deception operation, or cover passage points.
- Contact and passage points if moving through friendly lines.
- Disengagement start times.

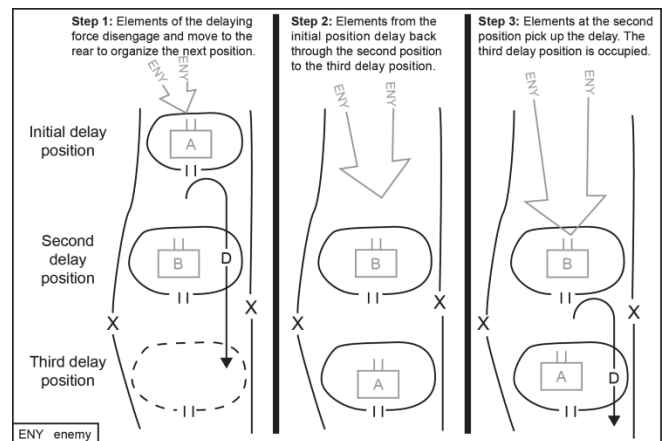

Figure 9-4. Delay from alternate positions

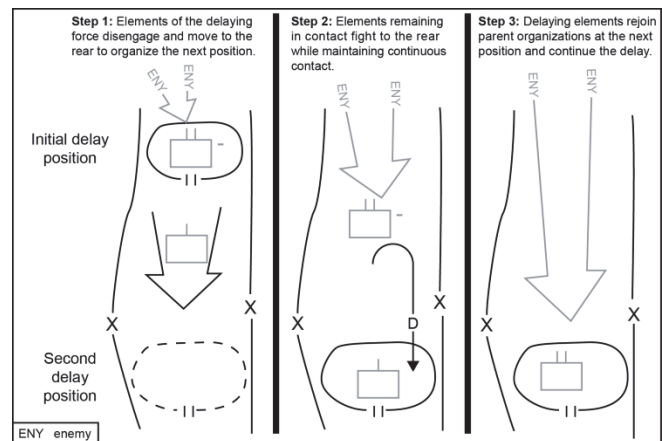

Figure 9-5. Delay from subsequent positions

- The earliest time for functional and multifunctional support and sustainment elements to move.
- Designating units responsible for closing lanes through obstacles and executing reserve obstacles.

MOVEMENT AND MANEUVER

9-34. A delay is one of the most difficult defensive tasks to execute. The primary reason is that the delaying force must engage the enemy sufficiently to slow the attacking enemy force's movement, yet not become decisively engaged. Also, the delaying unit must maintain continuous coordination with any flank units as it displaces rearward.

9-35. There are many similarities in the tactics and techniques of a mobile defense and a delay. However, units conducting a delay normally do not become decisively engaged except to prevent the enemy from prematurely crossing a delay line or to risk a part of the force to prevent the whole delaying force from being jeopardized.

9-36. Armored and Stryker-equipped forces—equipped with tanks, Bradley fighting vehicles, and various Stryker variants supported by indirect fires—are highly suitable for delay operations in most terrain. Their organic firepower allows them to engage the enemy effectively at long ranges, and their mobility allows them to move quickly between successive positions or to a flank. Their combat vehicles provide protection that simplifies battlefield movement. These same characteristics also allow armored and Stryker-equipped reserve forces to rapidly launch counterattacks to extract delaying forces from untenable situations.

9-37. Infantry forces are especially suited to conduct delays in broken, close, and built-up terrain. They take advantage of such terrain, reinforced by the extensive use of situational obstacles, to hinder the mobility of enemy combat systems and supporting tactical vehicles. They can also participate in stay-behind operations. (See paragraphs 9-117 through 9-121.) This type of terrain offers cover for the movement of friendly light infantry forces and favors using ambushes against the enemy. Because of the restrictions on organic motorized transportation assets and the limited protection available to light infantry units, the commander must specifically plan for their displacement. While all light infantry forces can move rapidly by air by assault, cargo helicopter, or tilt-wing aircraft, a delay offers little opportunity for airborne forces to use their unique capability.

9-38. The commander may employ air assault forces in a manner similar to that of other light infantry units in a delay. However, they possess additional useful capabilities in a delay operation. Because of typically habitual teaming with helicopter units, they can rapidly deploy, redeploy, and disperse in open terrain if the weather is suitable and the necessary landing and pickup zones exist. The combination of light infantry, attack and assault helicopters, and fire support systems found in air assault units allows the delaying commander to rapidly concentrate combat power at key locations to attrit the enemy through repeated ambushes. The combined arms nature of air assault units also makes them extremely useful for conducting security and reserve operations over large geographical areas against heavy and light enemy forces. However, their extraction is a high-risk activity when pressured by a heavy enemy or in the presence of a significant air defense threat.

9-39. The mobility, lethality, and long range of Army attack helicopter and joint fixed-wing aviation firepower make these assets invaluable to a force conducting a delay. The commander can also use them to conduct counterattacks and spoiling attacks as part of a combined arms team. Other uses of Army aviation in a delay include the rapid rearward movement of sustainment assets, the deployment of light infantry forces, and reconnaissance.

9-40. Normally, countermobility is the most important engineer task, unless the delaying force must cross one or more major obstacles, in which case the major engineer task is mobility, specifically breach operations. The commander must set realistic and specific priorities for the engineer effort. The commander monitors its progress to prevent it from dissipating countermobility efforts throughout the area. The commander employs engineers in depth. This is crucial when the commander conducts noncontiguous operations or when the enemy attacks deep into the support area of a force conducting contiguous operations, or when the enemy has the ability to employ weapons of mass destruction. The maneuver element provides security for the engineers, so that they can concentrate their efforts on engineer tasks.

9-41. Because of the importance of mobility and countermobility tasks, a unit conducting a delay probably has few engineer assets to devote to the survivability function. Units should maximize the use of smoke when and where weather conditions allow to provide concealment for movement and assembly. Smoke curtains, blankets, and haze may protect withdrawing columns, critical points, and routes. The commander takes precautions to ensure that the smoke does not provide a screen for the enemy's advance. (See FM 3-11.50.)

INTELLIGENCE

9-42. When conducting a delay operation, the commander may not get the most effective use of supporting intelligence assets. The commander echelons organic and supporting reconnaissance and surveillance systems rearward to maintain at least partial coverage of the AO during the delay. This increases the need to ensure the effective management of collection assets. However, the commander must rely on a downward flow of intelligence from higher echelons and combat information, such as unmanned aircraft systems and joint surveillance target attack radar system data, to make up for the degradation in collection capabilities that occurs when systems displace.

9-43. Initially, intelligence assets attempt to determine if the enemy recognizes the delay. Subsequently, they focus on how the enemy reacts to the delay. Intelligence analysis attempts to predict enemy course of action and surveillance, and reconnaissance systems monitor enemy attempts to envelop the flanks or strike the rear of the rearward-moving friendly force. They also focus on actions of any enemy airborne, air assault, and attack aviation units that may try to interdict the movement of the friendly force. The delaying commander must detect the enemy's advance early to adjust the scheme of maneuver and concentrate sufficient combat power to effectively delay the enemy.

MISSION COMMAND

9-44. Centralized planning and decentralized execution characterize mission command in a delay operation. Communications are essential to the success of this type of operation, and the commander builds redundancy into the communications architecture. Digital information systems help ensure that redundancy by providing a common operating picture and a distributed database. This allows one CP to temporarily assume the duties of another CP if the latter is destroyed.

9-45. The echelon main CP is normally the first CP within an echelon to displace during a delay, leaving the tactical CP to control the delay, until it can be reestablished in a secure location. The main CP may displace by echelon, leaving a residual mission command capability in the original location.

PREPARE

9-46. The defensive preparations outlined in chapter 6 also apply when conducting a delay. Resources—including the time available—determine the extent of preparations. The commander assigns a high priority to reconnaissance. Additionally, the preparation of subsequent positions receives a higher priority than it does in either a mobile or an area defense. It is not always possible to complete all preparations before starting the delay operation. Consequently, delaying units continue to prepare and adapt plans as the situation develops.

9-47. In the delay, the commander uses BPs in a manner similar to the defense. However, when organizing BPs, the commander places more emphasis on width than depth, as well as reconnaissance and preparing routes for displacing. Within each BP, most of the available firepower is oriented toward the expected enemy avenue of approach. However, the commander must provide adequate flank and rear security, since the delaying unit must furnish its own security. Each crew and squad learns the routes from its primary positions to alternate, supplementary, and sequential positions. In preparing a BP, a commander conducting a delay places less emphasis on installing protective obstacles, final protective fires (FPFs), and ammunition stockpiling than would occur in either an area or a mobile defense. BPs are sometimes referred to as delay positions during the conduct of a delay.

EXECUTE

9-48. The complex nature of a delay requires the subordinate elements of a delaying force to execute different, yet complementary, actions. In a single delaying operation, attacks, area defenses, mobile defenses, and other actions may occur in any sequence or simultaneously. For example, the commander may elect to assign one delaying element the task of holding a key road intersection for a period of time, so a reserve force can strike the enemy's flank. Therefore, the enemy must deploy into a hasty defense, which delays any further enemy attacks.

9-49. The commander deploys the security force well forward of the initial delay position to give early warning of any enemy approach. When the security force detects and reports an approach, the commander reconciles these reports against decision support and event templates to confirm the enemy's probable course of action. Based on an analysis of ongoing events and a projection of how the battle will unfold, the commander can direct one subordinate element to maneuver in a manner designed to draw the advancing enemy into a position of disadvantage.

9-50. The security force fixes, defeats, and destroys the enemy's reconnaissance and security elements without risking decisive engagement. It directs fires at the approaching enemy force as far forward of the delay positions as possible. Engaging a moving enemy at long ranges tends to inflict far more casualties on an attacking enemy than the enemy can inflict on the delaying force; it also slows the enemy force's tempo of operations. The more a delaying force can blind an enemy force through the elimination of that force's reconnaissance assets, the more likely the enemy force is to hesitate and move with caution.

9-51. Once the security force makes contact with the enemy, it maintains contact. As the enemy approaches, it moves by bounds back to the flanks of the defending units, keeping the enemy under constant observation. This prevents the enemy from finding gaps between delaying units and attacking the exposed flanks of delaying units. The security force uses covered, concealed, and coordinated routes to avoid enemy and friendly fires.

9-52. Recovering security assets may be more difficult, if the security force needs to pass through the range fan of friendly tanks and other direct-fire weapons in its movement. Recovery should be to the flanks of delay positions and not through friendly EAs and TRPs, unless the tactical situation makes such movement absolutely necessary. Security forces move so that they do not reveal the locations of other friendly elements.

9-53. The main body uses a variety of tactics to execute the delay. These include ambushes, counterattacks, spoiling attacks, artillery raids, jamming, and close air support. The commander of the delay force preserves the force's freedom to maneuver by engaging the enemy with sufficient force to temporarily stop its advance. The delay force uses obstacles and defensive positions in depth to slow and canalize the enemy and exploit the mobility of its combat systems to confuse and defeat the enemy. Once a delay starts, units displace rapidly between positions. Whenever possible, the commander grasps any fleeting opportunity to seize the initiative, even if only temporarily. By aggressively contesting the enemy's initiative through offensive action, the delaying force avoids passive patterns that favor the attacking enemy. The delaying force may conduct strong counterattacks from unexpected directions to temporarily confuse the enemy commander. Attacking an enemy throws the enemy off stride, disorganizes the enemy force, confuses the enemy commander's picture of the fight, and helps prolong the delay. In turn, this confusion may affect the enemy's tempo and momentum. It also affects the movement of enemy reserves and other follow-on forces. However, the delaying force seeks to avoid decisive engagement.

9-54. In a delay, the commander uses fire support assets to delay enemy forces, inflict casualties on them, and assist the friendly force in gaining a mobility advantage over them. Indirect fires continue throughout the delay. The commander's fire support assets can disrupt the enemy's follow-on forces and restrict the immediate battle to the enemy's committed forces. Air interdiction using kill boxes, close air support, and attack helicopters can engage enemy forces before they come within range of the supporting field artillery systems. The commander should weigh the effects required, however, since rotary-wing attack aviation is a limited resource and close air support (CAS) aircraft are a fleeting resource. The commander's objective is the massing of fires, to include the killing power of the unit in contact. However, this should not delay integration of CAS aircraft, given limited loiter times.

9-55. Artillery and mortar systems support the direct-fire fight to prevent the enemy from conducting a combined arms attack on the delay position. As the advancing enemy force encounters each obstacle, friendly fire support systems engage it. These fires should cause enemy armored forces to button up and slow down. Artillery and mortar systems use fires to separate enemy formations by striking the enemy force when it concentrates near choke points and in EAs. Integrating fires and obstacles makes it difficult for the enemy to traverse EAs. The delaying force breaks the enemy's momentum by forcing deployment and by inflicting casualties. Fires assist delaying forces by—

- Assisting in disengaging maneuver forces.
- Suppressing the enemy.
- Degrading the enemy's ability to move and communicate.
- Obscuring the enemy's overwatching support by fire positions and degrading enemy intelligence and target acquisition systems.
- Reinforcing or closing breaches or lanes in obstacles.
- Executing FPFs.
- Screening friendly displacements and disengagements by using smoke. (This also degrades the enemy's terminal guidance of precision-guided munitions.)
- Destroying high-payoff targets.
- Supporting limited counterattacks.

9-56. As the advancing enemy force approaches the delay position, it crosses one or more trigger lines and moves into EAs within the range of the delaying force's anti-armor missiles, tank cannons, and small arms. The commander holds the delaying force's direct fire, until the enemy is positioned where the fire plan and scheme of maneuver require their use. The commander controls these fires from the delaying force in the same manner as in any defense. The more damage the delaying force can inflict on the enemy, the longer it can stay in position.

9-57. As the enemy force presses its attack and maneuvers against the delaying force, the commander constantly assesses the action to guide the displacements of the delay force to anticipate possible decisive engagement while accomplishing its mission. When the enemy commander begins to think that the enemy force is successfully maneuvering against a friendly position, the enemy force is engaged by indirect fires while the delaying force disappears behind a cloud of smoke, dust, and exploding munitions. Intense FPFs and fires aimed at and behind recently evacuated friendly delay positions allow the delaying force to disengage from an attacking enemy.

9-58. Division and brigade commanders generally decentralize execution of a delay to battalion and lower levels. Those senior commanders must rely on their subordinates to execute the mission and request help when needed. The commander establishes the acceptable risk and displacement criteria. Subordinates displace once they meet the previously established delay criteria. This displacement may be a preplanned event or time dependent. The senior commander monitors the delay and intervenes when the displacement of one unit threatens the survival of another.

9-59. The delaying force relies heavily on artillery fires and air support to suppress the enemy, so the force can disengage, move, and occupy new positions. If a subordinate element cannot maintain separation from the enemy, the commander can shift additional combat multipliers and other resources to that particular AO to counter the enemy's success. As one subordinate element displaces, the delaying commander may order other subordinate elements to change their orientation to cover the move. Each displacing element travels along its designated route, using demolitions as required and requesting additional fire support if the enemy is able to maintain contact.

9-60. Passing through obstacle lanes during displacement between positions poses significant risks to the delaying force. The unit passing through a linear obstacle becomes more vulnerable to enemy attack because of the danger of the delaying force becoming congested on the far side of the obstacle. Obstacle lanes also increase the time required for a passing unit to transit through an area. The commander prevents the enemy from engaging the passing unit until it can redeploy into a tactical formation.

9-61. The commander retains the reserve for the decisive moment. As with aviation, the reserve should not be committed early in the delay unless its integrity is threatened. Typically, the commander commits the

reserve to help a unit disengage and regain its ability to maneuver or to prevent the enemy from exploiting an advantage. The reserve normally uses a support by fire position for this task. If the commander commits the reserve too early, the commander's ability to influence the battle is greatly reduced unless the commander can reconstitute a new reserve. It is possible to commit the reserve several times throughout the battle, but only when it can be extracted, re-designated, or otherwise reconstituted quickly.

9-62. In the delay, the commander locates the force's sustainment elements outside of enemy artillery range but close enough to provide adequate support. Artillery ammunition stocks must be capable of sustaining the quantity of fire support required in the delay. Maintenance operations focus on evacuating rather than returning damaged vehicles to combat. Unless vehicles can be fixed quickly on the spot, the unit should evacuate them to the echelon support area because vehicles left behind must be destroyed to prevent their capture.

TERMINATION OF A DELAY

9-63. A delay operation terminates when the delaying force conducts a rearward passage of lines through a defending force, the delaying force reaches defensible terrain and transitions to the defense, the advancing enemy force reaches a culminating point, or the delaying force goes on the offense after being reinforced. If the advancing enemy force reaches a culmination point, the delaying force may maintain contact in current positions, withdraw to perform another mission, or transition to the offense. In all cases, the senior commander must plan for the expected outcome of the delay. If the commander expects a friendly counterattack, the commander plans for the forward passage of the counterattack force, conserves resources to ensure relative combat superiority, and provides for the smooth handover of appropriate AOs.

WITHDRAWAL

9-64. Joint doctrine defines a *withdrawal operation* as a planned retrograde operation in which a force in contact disengages from an enemy force and moves in a direction away from the enemy (JP 1-02). The commander may or may not conduct a withdrawal under enemy pressure. Subordinate units may withdraw without the entire force withdrawing. A unit conducts a withdrawal for a variety of reasons, which are listed at the beginning of this chapter. In addition, a withdrawal may precede a retirement operation.

9-65. Although the commander avoids withdrawing from action under enemy pressure, this is not always possible. The commander may conduct a withdrawal when the situation requires rapid action to save the command from disaster. This usually occurs after a tactical reverse or after a unit reaches its culminating point. When an aggressive enemy becomes aware of a friendly force's withdrawal or its intention to withdraw, the attacking enemy commander attempts to exploit the withdrawal, using all available capabilities to try to turn the friendly force's withdrawal into a rout. The attacking enemy may have ground and air superiority and continuously attempt to pursue, encircle, and destroy the withdrawing force. The attacking enemy commander will try to use a combination of direct pressure and enveloping forces and fires to isolate the withdrawing friendly force for later destruction.

9-66. Withdrawals are inherently dangerous because they involve moving units to the rear and away from what is usually a stronger enemy force. The heavier the previous fighting and the closer the contact with the enemy, the more difficult the withdrawal. Operations security (OPSEC) is extremely important. A unit usually confines its rearward movement to times and conditions when the advancing enemy force cannot observe the activity, so that the enemy cannot easily detect the operation. To help preserve secrecy and freedom of action, for example, the commander must consider visibility conditions and times when enemy reconnaissance satellites can observe friendly movements. Operations security is especially critical during the initial stages of a delay when most of the functional and multifunctional support and sustainment elements displace.

9-67. A unit withdraws to an assembly area or a new defensive position. Alternatively, it can withdraw indirectly to either area through one or more intermediate positions. When preparing the new position, the commander balances the need for security with the need to get an early start on the defensive effort.

ORGANIZATION OF FORCES FOR A WITHDRAWAL

9-68. The commander typically organizes the withdrawing unit into a security force, a main body, and a reserve. The commander also organizes a detachment left in contact (DLIC) and stay-behind forces if the scheme of maneuver requires them. Commanders avoid changing task organization unless subordinates have sufficient planning time. However, circumstances may dictate rapid task organization changes immediately before the withdrawal, such as when the unit must conduct an immediate withdrawal to prevent encirclement.

9-69. The security force maintains contact with the enemy until ordered to disengage or until another force takes over. It simulates the continued presence of the main body, which requires additional allocation of combat multipliers beyond those normally allocated to a force of its size. The greater its mobility and range advantages over the enemy, the easier for the security force to successfully cover the main body's withdrawal. The commander organizes the majority of available combat power to the security force as a rear guard or a rear-covering force; the most probable threat to a withdrawing force is a pursuing enemy. However, the commander must maintain all-around security of the withdrawing force. When the enemy can infiltrate or insert forces ahead of the withdrawing force, the commander may establish an advance guard to clear the route or AO. The commander designates a flank guard or screen, as the situation requires.

9-70. When a security zone exists between the two main opposing forces, the existing security force can transition on order to a rear guard or rear-covering force. It then conducts delay operations until the commander orders it to disengage and break contact with the enemy. When the withdrawing force is in close contact with the enemy, a security zone does not normally exist. Withdrawals under these conditions require that security forces adopt different techniques. One technique is to establish a DLIC to provide a way to sequentially break contact with the enemy.

9-71. **A *detachment left in contact* is an element left in contact as part of the previously designated (usually rear) security force while the main body conducts its withdrawal.** Its primary purpose is to remain behind to deceive the enemy into believing the parent unit is still in position while most of the unit withdraws. It simulates—as nearly as possible—the continued presence of the main body until it is too late for the enemy to react by conducting activities such as electronic transmissions or attacks. The DLIC must have specific instructions about what to do when the enemy attacks and when and under what circumstances to delay or withdraw. If the DLIC must disengage from the enemy, it uses the same techniques as in the delay. If required, the commander provides this detachment additional recovery, evacuation, and transportation assets to use after disengagement to speed its rearward movement.

9-72. Two methods exist to resource the DLIC. The first is for each major subordinate element of the withdrawing force to leave a sub-element in place. For example, in a BCT withdrawal, each maneuver battalion leaves a task-organized company team in contact. Typically, these teams fall under a senior DLIC commander designated by the BCT commander. Alternatively, one major subordinate command of the withdrawing force can stay behind as the DLIC. For example, in figure 9-6 on page 9-14 a BCT with three maneuver battalions leaves one task-organized battalion as the DLIC, which then expands its security responsibilities to cover the width of the BCT's AO.

9-73. Often, when a DLIC is used, the commander creates an additional security force behind the existing main defensive positions to assist in the withdrawal process. The commander can create an additional force from the withdrawing unit or from an assisting unit. The DLIC can delay to this additional security force and join it, or delay back, conduct battle handover, and then conduct a rearward passage of lines. In either case, the additional security force becomes the rear guard.

9-74. The main body of the withdrawing force consists of all elements remaining after the commander resources a security force and the reserve. The commander in a withdrawal generally finds it difficult to resource a reserve, but makes every attempt to do so. When the complete formation withdraws under pressure, the reserve may take limited offensive action, such as spoiling attacks, to disorganize, disrupt, and delay the enemy. It can counter penetrations between positions, reinforce threatened areas, and protect withdrawal routes. Reserves may also extricate encircled or heavily engaged forces.

CONTROL MEASURES

9-75. Withdrawing forces must apply combat power to protect themselves while simultaneously moving combat power away from the enemy. This requires careful coordination among all forces. Throughout the operation, the commander must tightly control rearward movement and maintain the ability to concentrate decisive combat power at key times and places. As shown in figure 9-7, the control measures used in the withdrawal are the same as those in a delay or a defense. The routes used by each unit in the withdrawal and the block movement times are also withdrawal control measures.

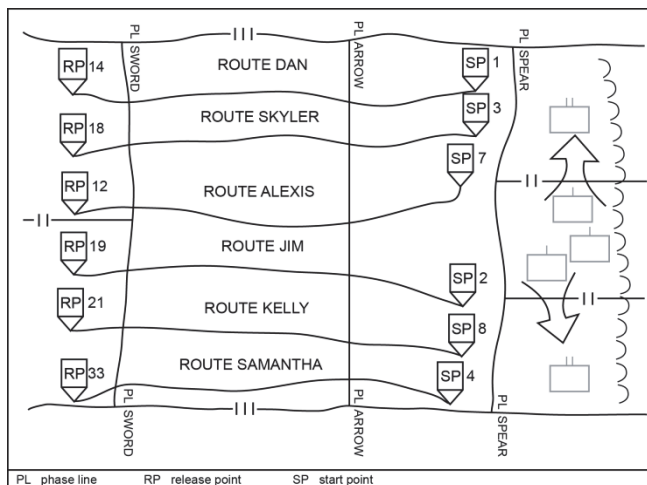

Figure 9-6. Detachment left in contact

PLANNING A WITHDRAWAL

9-76. The commander plans and coordinates a withdrawal in the same manner as a delay. Some mission variables of METT-TC apply differently because of the differences between a delay and a withdrawal. A withdrawal always begins under the threat of enemy interference. Because the force is most vulnerable if the enemy attacks, the commander always plans for a withdrawal under pressure. The commander then develops contingencies for a withdrawal without pressure. In both cases, the commander’s main considerations are to—

- Plan a deliberate break from the enemy.
- Displace the main body rapidly, free of enemy interference.
- Safeguard the withdrawal routes.
- Retain sufficient maneuver and functional and multifunctional support and sustainment capabilities throughout the operation to support forces in contact with the enemy.

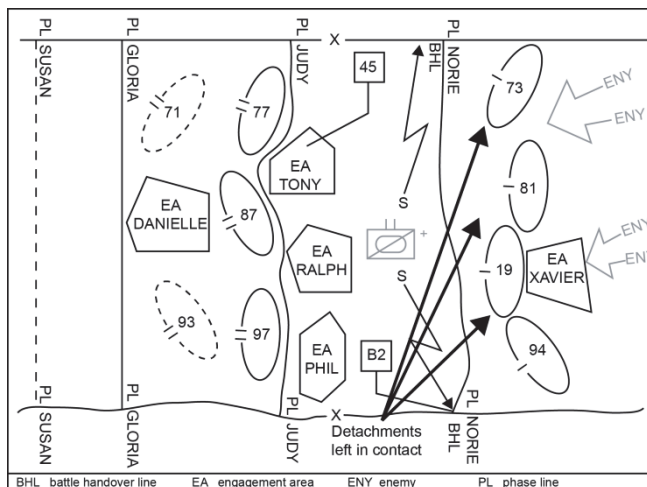

Figure 9-7. Withdrawal control measures

9-77. A withdrawal may be assisted or unassisted. It may or may not take place under enemy pressure. These two factors combined produce the four variations shown in figure 9-8. That figure also depicts the tactical mission graphic for a withdrawal and a withdrawal under enemy pressure. The withdrawal plan considers which variation the force currently faces. Each variation requires a different blend of the three retrograde options.

9-78. A commander prefers to conduct a withdrawal while not under pressure and without assistance. Actions by the enemy, as well as the additional coordination needed because of the presence of an assisting unit, complicate the operation.

9-79. A withdrawing force can receive assistance from another force in the form of—

- Additional security for the area through which the withdrawing force will pass.
- Information concerning withdrawal routes.
- Forces to secure choke points or key terrain along withdrawal routes.
- Elements to assist in movement control, such as traffic control points.
- Required maneuver and functional and multifunctional support and sustainment, which can involve conducting a counterattack to assist the withdrawing unit in disengaging from the enemy.

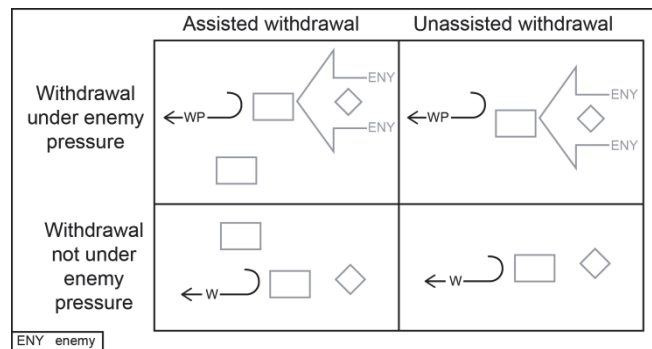

Figure 9-8. Types of withdrawal

9-80. In a withdrawal under enemy pressure, all units withdraw simultaneously when available routes allow, using delaying tactics to fight their way to the rear. In the usual case, when simultaneous withdrawal of all forces is not practical, the commander decides the order of withdrawal. Several factors influence this decision:

- Subsequent missions.
- Availability of transportation assets and routes.
- Disposition of friendly and enemy forces.
- Level and nature of enemy pressure.
- Degree of urgency associated with the withdrawal.

The commander must make three interrelated key decisions: when to start the movement of selected functional and multifunctional support and sustainment elements, when forward elements should start thinning out, and when the security force should start its disengagement operations. The commander avoids premature actions that lead the enemy to believe a withdrawal is being contemplated. Commanders must anticipate enemy means of interference and plan for employing security forces, attack helicopters conducting close combat attack, and close air support.

9-81. The commander conducting a withdrawal without enemy pressure can plan when to begin the withdrawal. The commander has the option of taking prudent risks to increase the displacement capabilities of the withdrawing force. For example, the main body may be ordered to conduct a tactical road march instead of moving in tactical formations. The commander can plan for stay-behind forces as part of the operation. (The stay-behind discussion starts on page 9-21.)

PREPARING A WITHDRAWAL

9-82. Before withdrawing, the main body dispatches quartering parties to help it occupy the new position. (FM 3-90-2 details the responsibilities of a quartering party.)

9-83. In an unassisted withdrawal, the withdrawing unit establishes its own security force and reserve. It reconnoiters and secures the routes it will use in its rearward movement while sustaining itself during the withdrawal. The withdrawing unit must disengage from the enemy.

9-84. By concealing supplies along movement routes, sustainment operators can simplify support requirements and reduce the enemy's ability to interfere with logistics operations. This allows sustainment units to withdraw earlier than they otherwise could. The commander carefully considers whether to place supplies in caches. Once cached, supplies are difficult to recover if the operation does not go as planned. Other than medical items, the withdrawing unit evacuates or destroys all supplies that it is unable to evacuate to prevent their capture. The commander establishes destruction criteria, which is time- or event-driven, for each class of supply.

EXECUTING A WITHDRAWAL

9-85. Typically, when under enemy pressure, the less heavily engaged elements of the withdrawing force withdraw first. The more heavily engaged units generally withdraw under the cover of a security force using support provided by available fire support and electronic warfare assets. They take advantage of obstacles to assist in breaking contact with the enemy. The commander conducts night movements and uses obscuration smoke to screen friendly movement while reducing both the accuracy of enemy direct-fire systems and the enemy's ability to observe friendly movements. The security force continues to use alternate and successive positions until the entire force breaks contact with the enemy.

9-86. The security force may remain in position and maintain a military deception. The main body moves rearward to intermediate or final positions as rapidly as possible. After the main body withdraws a safe distance, the security force begins its rearward movement. Once the security force begins moving, it assumes the duties of a rear guard. Even if the enemy does not pursue the withdrawing force, the security force continues to act as the rear guard unless the commander assigns that mission to another element. However, if not pursued by the enemy, the security force may remain in a march column. (FM 3-90-2 provides a definition of a march column.)

9-87. On order, the main body moves rapidly on multiple routes to reconnoitered positions. It may occupy a series of intermediate positions before completing the withdrawal. Usually functional and multifunctional support and sustainment units, along with their convoy escorts, move first and precede combat units in the withdrawal movement formation. The commander maintains the disciplined use of routes during a withdrawal. Despite confusion and enemy pressure, subordinate units must follow specified routes and movement times.

9-88. When the main body withdraws, its reserve remains well forward to assist the security force and other units by employing supporting direct and indirect fires and counterattacks. The reserve can launch spoiling attacks to disorganize and delay the enemy and extricate encircled or heavily engaged forces.

9-89. If the security force and the reserve cannot prevent the enemy from closing on the main body, the commander must commit some or all of the main body to prevent the enemy from further interfering with the withdrawal. The main body delays or defends, if the security force fails to slow the enemy. In this event, the withdrawal resumes at the earliest possible time. If the enemy blocks movement to the rear, the commander shifts to alternate routes to bypass the interdicted area. Alternatively, the withdrawing force can attack through the enemy.

TERMINATING A WITHDRAWAL

9-90. Once the withdrawing force successfully disengages from the enemy, it has two options. It can rejoin the overall defense under more favorable conditions or transition into a retirement and continue to move away from the enemy and toward its next mission.

RETIREMENT

9-91. A *retirement* is an operation in which a force out of contact moves away from the enemy (ADRP 3-90). Figure 9-9 shows the tactical mission graphic for a retirement. A retiring unit organizes for combat, but it does not anticipate interference from enemy ground forces. Typically, another unit's security force covers the movement of one formation as the unit conducts a retirement. However, mobile enemy forces, unconventional forces, air strikes, air assault operations, or long-range fires may attempt to interdict the retiring unit. The commander must plan for enemy actions and organize the unit to fight in self-defense. The commander usually conducts retirement operations to reposition forces for future operations or to accommodate the current concept of operations.

9-92. When a withdrawal from action precedes a retirement, the actual retirement begins after the unit breaks contact and organizes into its march formation organization. (While a force withdrawing without enemy pressure can also use march columns, the difference between the two situations is the probability of enemy interference.) Units conduct retirements as tactical road marches where security and speed are the most important considerations.

9-93. The retiring unit generally moves toward an assembly area, which should support the preparations for the unit's next mission. When determining the routes the retiring force takes to the assembly area, the commander considers the unit's capability to support defensive actions, if combat occurs during the retirement.

9-94. The initial action in a retirement is to move sustainment units and supplies to the rear. At the designated time, the retiring unit executes a withdrawal from action and forms into a march formation. The unit can first move into an assembly area, if this step is necessary, before moving into a march formation to reestablish mission command or resupply. Once it forms a march formation, the force is prepared to initiate the retirement. During the initial phase, the force retires in multiple small columns. As the distance from the enemy increases, smaller columns can consolidate into larger ones for ease of movement control. Road nets and the potential for hostile interference influence how and when this consolidation occurs.

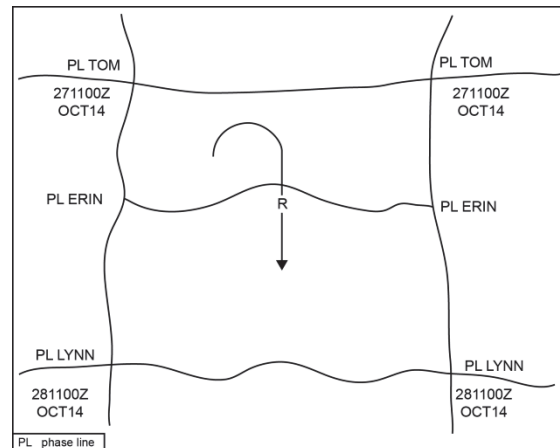

Figure 9-9. Retirement tactical mission graphic

ORGANIZATION OF FORCES

9-95. The commander normally designates security elements and a main body in a retirement. (See figure 9-10.) The formation and number of columns employed during a retirement depend on the number of available routes and the potential for enemy interference. The commander typically moves major elements to the rear simultaneously. However, a limited road net or a flank threat may require echelonment of the movement in terms of time and ground locations.

9-96. The terrain and the enemy threat dictate whether the retiring force establishes a single rear security force, which is usually a rear guard, or whether each column forms a separate rear security force. These security forces protect the rearward moving columns from surprise, harassment, and attack by any pursuing enemy force. Their size and composition depend on the strength and imminence of the enemy threat. These security elements generally remain in march columns, unless there is a potential for enemy interference. If the enemy establishes contact, the rear security element conducts a delay.

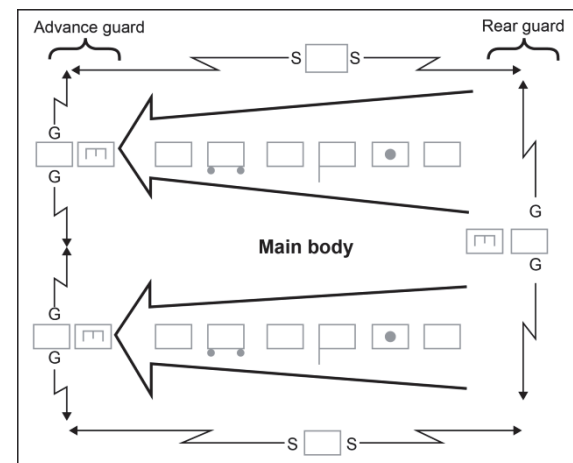

Figure 9-10. Organization of forces for a retirement operation

9-97. The retiring march columns normally require an advance guard augmented by engineers focused on mobility. Engineers with the rear guard are focused on countermobility. The commander assigns a flank security element to prevent potential enemy interference with the retiring force's extended columns. The commander may designate flank security responsibilities to subordinate march units.

9-98. The main body organizes in a manner opposite that of an approach march. (FM 3-90-2 explains the approach march.) The movement of functional and multifunctional support and sustainment units should precede the movement of combat forces. When necessary, elements of the main body can reinforce the rear guard or any other security element. Because fire support elements and attack helicopter elements of the main body can respond most rapidly, they are usually the first elements tasked for this mission.

CONTROL MEASURES

9-99. The control measures used in a retirement are the same as those in a delay and a withdrawal. As in a withdrawal, thorough planning and strict adherence to routes and movement times facilitate an orderly retirement. Typically, the commander controls movement using movement times, routes, and checkpoints. (FM 3-90-2 discusses these movement control measures.)

SUSTAINMENT

9-100. During retrograde operations, sustainment units echelon their movements to maintain adequate support to the committed force. They maintain maximum dispersion consistent with control and local security. Their goal is to provide uninterrupted support and maximum protection during the time it takes to conduct the retrograde operation. By echeloning support, the commander reduces the amount of time each sustainment unit spends moving, preventing it from performing its primary support tasks. High-priority assets may require added protection to prevent their loss or capture. To reduce congestion and interference with the operations of combat and functional and multifunctional support units, the commander should displace supporting sustainment assets as early as possible, normally during periods of limited visibility. The early displacement of sustainment units can also prevent revealing friendly future operations to the enemy.

9-101. The commander anticipates the effects of retrograde movements on sustainment elements to ensure adequate support for the operation and the prompt evacuation of casualties. Retrograde movements generally result in increased distances between sustainment and combat units, which makes providing this support more difficult. Retrograde operations generally require more Class III, and possibly more Class V, supplies than during the conduct of other defensive tasks. These supplies must be available for emergency issue. These two factors combine to increase the demand for transportation assets and space on main supply routes. This, in turn, increases the need for movement management and pre-positioned services and supplies. Sustainment units carry and cache necessary fuel and ammunition stocks as required by the specific situation.

9-102. The sustainment provided must be mobile to cope with demands of the fluid tactical situation that typically occurs during a retrograde operation. The commander prevents unnecessary supplies from accumulating in areas that will be abandoned. Only essential medical and logistics support should be located in the area involved in the retrograde operation.

9-103. The commander establishes maintenance, recovery, and evacuation priorities and destruction criteria for inoperable equipment in paragraph 4 of the operations order. Maintenance requirements generally overwhelm the organic capabilities of forward units during a retrograde operation. Forward units place as much maintenance, recovery, and evacuation assets forward as possible to augment or relieve combat elements of the burden of repairing unserviceable equipment. Recovery and evacuation vehicles position themselves at critical locations to keep disabled vehicles from blocking movement routes. Forward units evacuate systems that cannot be repaired within established timelines. They use all available means to accomplish this, including equipment transporters and armored vehicles with inoperative weapon systems. When recovery and evacuation are impossible, units destroy inoperable equipment to prevent capture. When possible, units destroy the same vital components in each type of system to prevent the enemy from rapidly exploiting captured friendly systems through battlefield cannibalization.

9-104. The commander assigns transportation priorities for the movement of combat troops and their supplies, the movement of obstacle materials to impede the enemy, and the evacuation of casualties and repairable equipment. The commander keeps main supply routes open and decontaminated as necessary. Units control the back-haul of transportation assets before the retrograde begins, reducing the amount of transportation needed to support the operation.

9-105. Generally, the commander uses many separate supply routes rather than just a few main supply routes. Some routes remain open for traffic moving to the front while the bulk of functional and multifunctional support and sustainment units displace farther rearward. Commanders designate and reserve routes for evacuating displaced civilians. Commanders avoid designating routes that cross or otherwise interfere with the unit's main supply routes as much as possible.

9-106. The senior military person present determines when to request medical evacuation and assigns precedence of evacuation. This decision is based on the advice of the senior medical person at the scene, the patient's condition, and the tactical situation. Assignment of medical evacuation precedence is necessary. The precedence provides the supporting medical unit and controlling headquarters with information that is used in determining priorities for committing their evacuation assets. For this reason, correct assignment of precedence cannot be overemphasized; over classification remains a continuing problem. Patients are evacuated as quickly as possible, consistent with available resources and pending missions. Medical elements supporting the retrograding force must provide rapid evacuation of casualties to medical facilities. Medical evacuation requirements are especially demanding in the large AOs common to the retrograde. Commanders may augment the ground ambulance capabilities of supporting forward medical units.

9-107. Military police elements of the retrograde force are involved primarily in maneuver and mobility support operations to support and preserve the commander's freedom of movement. The commander may augment supporting military police forces to establish traffic control points and route and convoy security. Military police also provide support through the execution of internment and resettlement operations.

UNIQUE RETROGRADE SITUATIONS

9-108. Conditions that require conducting denial and stay-behind operations can arise during retrograde operations. These two operations have their own unique planning and execution considerations.

DENIAL OPERATIONS

9-109. **Denial operations are actions to hinder or deny the enemy the use of space, personnel, supplies, or facilities.** They may include destroying, removing, and contaminating those supplies and facilities or erecting obstacles. Sometimes, an enemy unit will capture friendly equipment and supplies. This situation often occurs during the conduct of defensive tasks. As a result, the defending commander may be required to conduct denial operations. The principles of denial include the following:

- The commander denies the enemy the use of military equipment and supplies.
- Steps taken to deny equipment and supplies to the enemy do not, if possible, preclude their later use by friendly forces.
- The commander orders the destruction of military equipment and supplies only when friendly forces cannot prevent them from falling into enemy hands.
- The user is responsible for denying the enemy the use of the user's military equipment and supplies by means of its destruction, removal, or contamination.
- Deliberately destroying medical equipment and supplies and making food and water unfit for consumption is unlawful under the terms of the Geneva Conventions.

In denial operations, the definition of a unit's military equipment and supplies could expand to include military installations and any civilian equipment and supplies used by the friendly force. Under the law of war, the destruction of civilian property is only permitted where required by immediate military necessity. The determination of whether there is sufficient necessity to justify destruction is a complex decision that requires consideration of moral, political, and legal considerations. Additionally, civil instability increased by the destruction of civilian property, material, and equipment could have adverse effects on the outcomes of the different elements of decisive action.

9-110. The commander who orders the denial operation must consider the potential value of the military equipment and supplies to an enemy when determining the priorities and the extent of the denial operation. Examples of high priorities for denial include—

- Classified equipment, material, and documents.
- Petroleum, oils, and lubricants (POL).
- Sophisticated weapon systems or electronic equipment.
- Heavy weapons and associated ammunition.
- Communications equipment.

- Ferrying and bridging equipment.
- Air, sea, and land transport systems.

Any other military supplies, equipment, or facilities that may be of use to an enemy are a lesser priority for denial operations.

9-111. The commander issues detailed instructions to deny military equipment and supplies to prevent the enemy from directly using them. Denial must also prevent an enemy from repairing a system through the cannibalization of several systems. The unit must destroy the same parts in each type of system.

9-112. Denial differs from countermobility operations because the commander designs denial operations to deprive the enemy of some or all of the short-term benefits of capturing an area. The impact of denial operations on civilian inhabitants and the environment of the area act as a moral and a legal constraint on their use by U.S. forces. The commander involves the staff judge advocate and civil affairs operations staff officer in planning denial operations.

9-113. The commander ensures that executing the denial plan does not adversely affect the unit's future operations. This includes carefully considering the force's demolition policy in relation to the purpose of the rearward movement and the contemplated subsequent actions of the force. Widespread demolitions during a retrograde may become a greater hindrance to a friendly force moving back into the area than to the enemy during the friendly retrograde. For example, destroying the transportation infrastructure increases friendly logistics difficulties once the area is recaptured. Removing or destroying militarily significant supplies and equipment, such as fuel, obstacle materials, and rail cars, from an area requires friendly forces to bring similar assets with them when they reoccupy the area.

9-114. The commander can expand a denial operation to prevent the enemy from exploiting resources, such as fuel, minerals, and the indigenous population; routes of communication, such as river locks, railroad switching yards, road interchanges, and bridges; and facilities, such as telephone exchanges, radio and television stations, and the industrial plants of a region. The defending force can assist civil authorities in evacuating the civilian population. The defending force either removes the resources, supplies, and facilities from the area being abandoned to the enemy or destroys them in place. Such denial operations may be either total or limited.

9-115. Total denial operations can produce long-term political, economic, military, and environmental effects. Total denial operations have operational-level, and possibly strategic-level, impact. Total denial operations consume large quantities of transportation and engineer resources and require considerable time to plan and execute.

9-116. Limited or partial denial operations are particularly suitable if the defending force expects to regain control of the area within a short time. The removal or destruction of only a few key components can reduce a facility to limited utility, yet it allows for the facility's quick restoration of all functions once it is returned to friendly control. American forces only destroy discrete targets of significant military value. Limited denial operations normally do not affect the advance of properly supported enemy combat formations possessing cross-country mobility. However, they can seriously impede an enemy's road-bound and rail-bound logistics support if executed with skill and imagination according to an overall plan.

STAY-BEHIND OPERATIONS

9-117. A *stay-behind operation* is an operation in which the commander leaves a unit in position to conduct a specified mission while the remainder of the forces withdraw or retire from an area. The force should consist of enough combat, functional and multifunctional support, and sustainment elements to protect and sustain its fighting capability for the duration of the mission. A stay-behind force may also result from enemy actions that bypass friendly forces.

9-118. The main purpose of a stay-behind force is to destroy, disrupt, and deceive the enemy. This force has a high-risk mission because of the danger that it will be located, encircled, and destroyed by the enemy. Resupply and casualty evacuation are also extremely difficult. A commander considers assigning this mission only after a thorough analysis of the mission variables of METT-TC. The stay-behind force attacks enemy combat forces and command nodes, functional and multifunctional support, and sustainment

elements from unexpected directions. (See figure 9-11.) These attacks may cause enemy follow-on forces to be more cautious and to slow down to clear possible attack and ambush sites. The commander may require the stay-behind force to conduct a breakout from encirclement and linkup operations after it completes its mission. (FM 3-90-2 discusses the conduct of a breakout from an encirclement.)

9-119. A light infantry, stay-behind force surprises an enemy by conducting a series of raids and ambushes. The light infantry force can be inserted via infiltration, air assault, or parachute; it can also be a bypassed force. Attacks in the enemy support area by friendly armored forces can cover a larger area than attacks by light infantry forces.

9-120. Stay-behind operations eventually require the force to reenter friendly lines or link up with other elements, often in more than one location. The commander must carefully coordinate this reentry to prevent friendly fire incidents. The return routes for the stay-behind force are the best-covered and concealed routes available. Commanders place guarded gaps or lanes near obstacles along these routes that cannot be bypassed.

9-121. A stay-behind operation is not a suicide mission. The commander conducts this operation only when there is confidence that the stay-behind force will rejoin the main body, extract itself in alternative ways, or the main body will fight its way forward to link up with the stay-behind force.

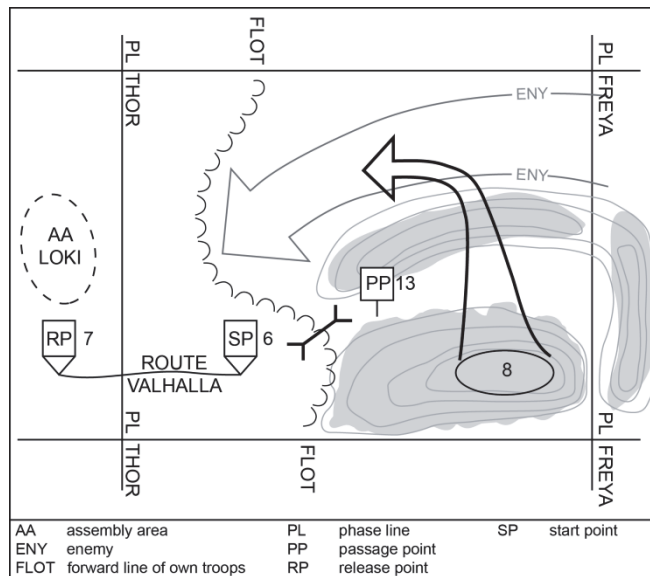

Figure 9-11. Stay-behind force

This page intentionally left blank.

Appendix A

Basic Tactical Control Measures

This appendix explains basic tactical control measures common to the conduct of offensive and defensive tasks. These control measures apply to both automated and hand-drawn graphic displays and overlays. This appendix portrays common control measures for use on situation maps, overlays, and annotated aerial photographs. They are also the standard for all simulations, to include those used in live, virtual, and constructive environments.

GENERAL CONSIDERATIONS FOR CONTROL MEASURES

A-1. Units conducting tactical operations must have clearly defined tasks and responsibilities. The commander uses control measures to impose restrictions that prevent units from impeding one another and establish specific responsibilities. Control measures can be permissive (which allows something to happen) or restrictive (which limits how something is done). Control measures may be graphical, such as boundaries, or procedural, such as target engagement priorities. A commander should establish only the minimum control measures necessary to provide essential coordination and deconfliction between units. Control measures must not unduly restrict subordinates in accomplishing their missions. The commander removes restrictive control measures as soon as possible. Control measures can become more restrictive as forces transition from an emphasis on the conduct of offensive and defensive tasks to an emphasis on the conduct of the primary stability or defense support of civil authorities tasks. ADRP 1-02 discusses the rules for drawing control measures on overlays and maps.

A-2. Well-conceived control measures facilitate the conduct of current and future operations. The commander adjusts control measures as necessary to maintain synchronization and ensure mission accomplishment as the tactical situation evolves. The commander balances the risk of introducing additional friction into the operation with the benefits gained by changing them.

A-3. Control measures apply to all forces. The commander ensures that all higher-echelon control measures, such as phase lines (PLs) and checkpoints, are incorporated into the unit's graphic control measures. The commander references only the control measures established by the higher headquarters when making reports to that headquarters. The commander may or may not chose to establish a standard naming convention for control measures in the unit standard operating procedures (SOPs). Examples of such naming conventions would be reserving car model names for phase lines and female names for objectives. This publication does not use a standard naming convention.

COMMON CONTROL MEASURES

A-4. Paragraphs A-5 through A-70 discuss control measures common to the conduct of all offensive and defensive tasks. Paragraphs A-71 through A-88 discuss control measures common to the conduct of offensive tasks. Finally, paragraphs A-89 through A-106 discuss control measures common to the conduct of defensive tasks.

AIRSPACE COORDINATING MEASURES

A-5. The joint force commander designates an airspace control authority to develop, coordinate, and publish airspace control procedures for operating the airspace control system in the joint operations area. The airspace control authority establishes an airspace control plan that provides specific planning guidance and procedures for the airspace control system for the joint operational area. The airspace control order implements the airspace control plan by providing the details of the approved requests for airspace

coordinating measures (ACMs). It is published either as part of the air tasking order or as a separate document. (See JP 3-52.) These ACMs are measures employed to facilitate the efficient use of airspace to accomplish missions and simultaneously provide safeguards for friendly forces. Airspace elements establish ACMs to accomplish one or more functions:

- Establish reserved airspace for specific airspace users.
- Restrict the actions of some airspace users.
- Create airspace in which units can use weapons with minimal risk of friendly fire incidents. (Friendly fire incidents include death by fratricide, injury, and property damage.)
- Control actions of specific airspace users.
- Require airspace users to accomplish specific actions.

A-6. JP 3-52 provides additional information on each of the following joint ACMs:

- Coordinating altitude.
- Low-level transit routes.
- Minimum-risk routes
- Restricted operations areas.
- Special-use airspace.
- High-density airspace control zones.
- Standard use Army aviation flight routes.

Figure A-1 shows how some of these joint ACMs are used to create an airspace coordination area.

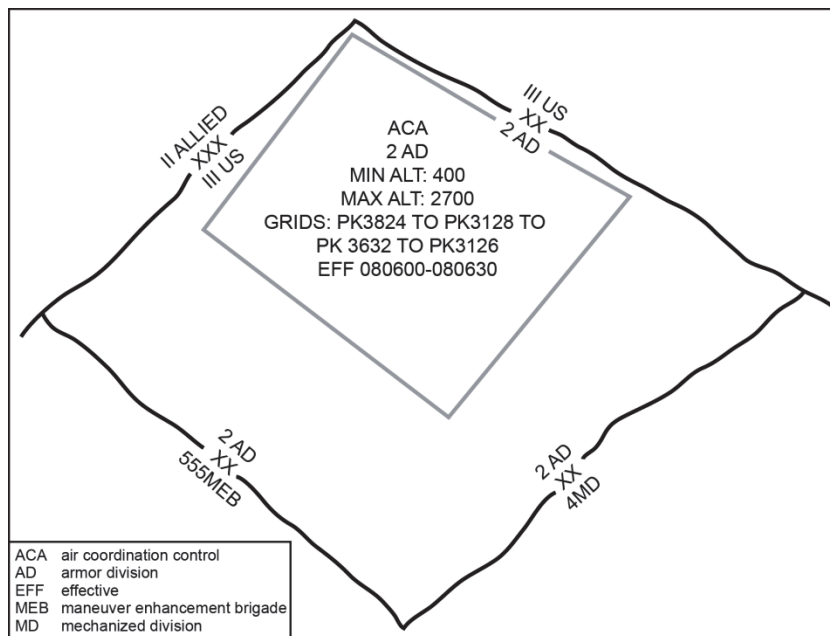

Figure A-1. Example airspace coordination area

A-7. The Army, in addition to the seven joint ACMs listed in paragraph A-6, has developed additional standardized ACMs. For Army forces, these measures assign responsibility, ensure conformity with the tactical plan, describe and illustrate the concept of operations, maintain separation of forces, concentrate effort, coordinate fires with maneuver, and assist in the control of forces. Army forces can graphically depict the integration, coordination, regulation, and identification of Army airspace users with ground forces in a given area of operations when they incorporate airspace coordinating measures with these standardized Army ACMs. These Army ACMs are:

- Air corridor.
- Axis of advance.
- Air control point.
- Battle position.
- Engagement area.
- Communications checkpoint.
- Attack by fire position.
- Observation post.

Figure A-2 provides an example air corridor with its associated air control points. FM 3-52 provides additional information on these Army ACMs.

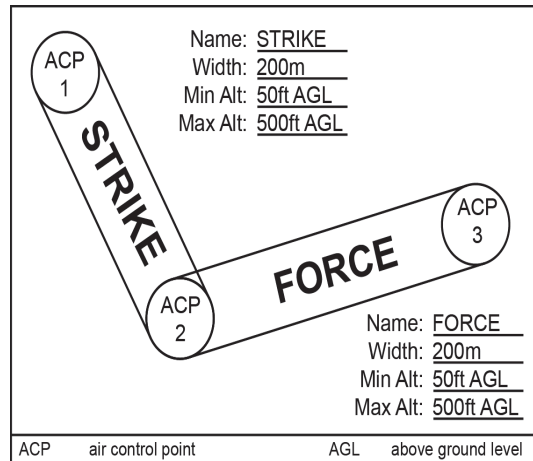

Figure A-2. Example air corridor and air control points

AREA OF OPERATIONS

A-8. An area of operations (AO) is both a basic tactical concept and the basic control measure for all types of operations. An *area of operations* is an operational area defined by the joint force commander for land and maritime forces that should be large enough to accomplish their missions and protect their forces (JP 3-0). The joint force land component commander, Army Service component command (ASCC) commander, or Army (ARFOR) commander will in turn assign subordinates their own AOs. Those subordinates will further assign their subordinates AOs down to the battalion or even company echelon based on the mission variables of mission, enemy, terrain and weather, troops and support available, time available, and civil considerations (METT-TC). A unit assigned an AO, although the owning unit, may not change control measures imposed by a higher headquarters within its AO. However, it may establish additional control measures to coordinate and synchronize its operations.

A-9. Assigning an AO to a subordinate headquarters maximizes decentralized execution by empowering subordinate commanders to use their own initiative to accomplish their missions. This encourages the use of mission command. (See ADRP 6-0 for a discussion of mission command.) At the same time it adds the responsibilities listed in paragraph A-12 to the lower headquarters. Conversely, failure to designate subordinate AOs maximizes centralized execution and limits subordinates' tactical options. The latter choice should be made only when mandated by the mission variables of METT-TC. For example, a brigade combat team (BCT) commander responsible for blocking an enemy advance along a single avenue of approach may assign subordinate battalions battle positions to support a BCT engagement area (EA) instead of subdividing the BCT AO and the avenue of approach into battalion AOs.

A-10. A higher headquarters designates an AO using boundaries. A divisional commander normally assigns AOs to subordinate maneuver units, such as BCTs or maneuver enhancement brigades. However, the commander may also assign an AO to subordinate functional and multifunctional support or sustainment units even though owning an AO is not a task for which these types of units are designed. For example, they lack joint enablers like a tactical air control party. (This non-doctrinal mission for these later types of units is most likely to occur during the conduct of the irregular warfare.) An assigned AO both restricts and facilitates the movement of units and use of fires. It restricts units not assigned responsibility for the AO from moving through the AO. It also restricts outside units from firing into or allowing the effects of their fires to affect the AO. Both of these restrictions can be relaxed through coordination with the owning unit. An assigned AO facilitates the movement and fires of the unit assigned responsibility for, or owning, it. The assigned AO must encompass enough terrain for the commander to accomplish the mission and protect friendly forces.

A-11. Commanders consider a unit's area of influence when assigning it an area of operations. An *area of influence* is a geographical area wherein a commander is directly capable of influencing operations by maneuver or fire support systems normally under the commander's command or control (JP 3-0). A unit's area of operations should not be substantially larger than its area of influence. Ideally, the entire AO is encompassed by the area of influence. An area of operations that is too large for a unit to control can allow

sanctuaries for enemy forces to develop and may limit the unit's flexibility of operations. If the commander's area of influence is smaller than the assigned AO, the commander must consider options for extending the size of that area of influence. These options include the following techniques:

- Changing the geographical dispositions of unit current systems to increase the size of the area of influence and ensure coverage of key areas, installations, and systems.
- Requesting additional assets.
- Requesting boundary adjustments to reduce the size of the AO.
- Accepting the increased risk associated with being unable to provide security throughout the AO.
- Moving the area of influence by phases to sequentially encompass the entire AO.

A-12. All units assigned an AO have the following responsibilities within the boundaries of that AO:

- Terrain management.
- Intelligence collection.
- Civil affairs activities.
- Air and ground movement control.
- Clearance of fires.
- Security.
- Personnel recovery.
- Environmental considerations.

(See ADRP 3-90 for a discussion of these responsibilities.)

ASSEMBLY AREAS

A-13. An **assembly area** is an area a unit occupies to prepare for an operation. Ideally, an assembly area (AA) provides—

- Concealment from air and ground observation.
- Adequate entrances, exits, and internal routes.
- Space for dispersion; each AA is separated by enough distance from other AAs to preclude mutual interference.
- Cover from direct fire.
- Good drainage and soil conditions that can sustain unit vehicles and individual Soldier movements.
- Terrain masking of electromagnetic signatures.
- Terrain allowing observation of ground and air avenues into the AA.
- Sanctuary from enemy medium-range artillery fires because it is located outside the enemy's range.

A-14. The commander assigns each unit its own AA. In figure A-3 on page A-5, the example of multiple units occupying one AA is a graphical shortcut taken when the map scale would make depiction of multiple assembly areas unreadable. In reality, the commander would subdivide AA Thomas into two smaller AAs, one for each unit. A unit AA is normally within the AO of another unit. An AA is usually treated as a noncontiguous AO. This means that a unit has the same responsibilities within its assigned AA as it has for any other AO.

A-15. The proper location of AAs contributes significantly to both security and flexibility. The location should facilitate future operations, so movement to subsequent positions can take place smoothly and quickly by concealed routes. Because of their smaller signature, infantry units can use AAs closer to the enemy than armored units without excessive risk of enemy detection. The tactical mobility of armored and Stryker units allows them to occupy AAs at a greater distance from the line of departure (LD) than infantry units.

BOUNDARIES

A-16. A *boundary* is a line that delineates surface areas for the purpose of facilitating coordination and deconfliction of operations between adjacent units, formations, or areas (JP 3-0). A **forward boundary** is a boundary of an echelon that is primarily designated to divide responsibilities between it and its next higher echelon. A **lateral boundary** is a boundary that extends from the rear boundary to the unit's forward boundary. A **rear boundary** is a boundary that defines the rearward limits of a unit's area. It usually also defines the start of the next echelon's support area. The commander uses graphic control measures to define the limits of an AO and, as such, establishes ground forces' responsibilities. The ACMs control the vertical dimension. The commander bases the boundaries of subordinate units on clearly defined terrain features. This requirement is less important if all units in the AO have precision navigation capabilities. Boundaries should not split responsibilities for roads, rivers, or railways. Responsibility for an avenue of approach and key terrain should also belong to only one unit. The commander adjusts boundaries as necessary in response to the evolving tactical situation. Any areas not delegated to a subordinate remain the responsibility of the commander.

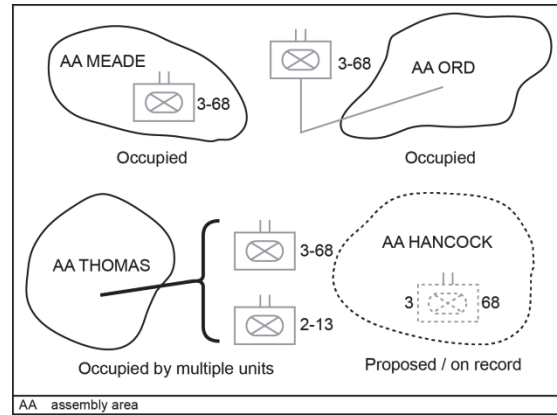

Figure A-3. Assembly area examples

A-17. After military characteristics of the terrain are accounted for within the context of the unit's mission, existing political boundaries, such as city limits and provincial borders, are important considerations in developing friendly unit graphical control measures and assigning subordinate unit AOs. Military boundaries that conflict or do not align with existing political boundaries require additional effort when trying to deconflict, manage, or organize the use of indigenous capabilities. However, during the conduct of protracted operations within an AO, subordinate unit AOs should be periodically adjusted to avoid the inadvertent creation of sanctuaries that an enemy could exploit.

CHECKPOINT

A-18. A *checkpoint* is a predetermined point on the ground used to control movement, tactical maneuver, and orientation (ADRP 1-02). Units can also use a checkpoint as a fire control measure in lieu of the preferred control measure, a target reference point. Checkpoints are useful for orientation. Units may use checkpoints to supplement or as substitutes for PLs. They are also used in the conduct of sustainment operations. Figure A-4 depicts checkpoint 13.

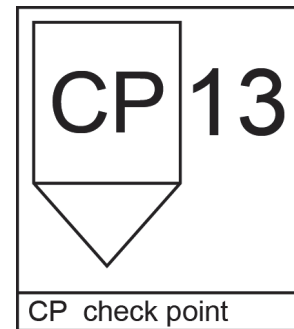

Figure A-4. Checkpoint 13

CONTACT POINT

A-19. In land warfare, a *contact point* is a point on the terrain, easily identifiable, where two or more ground units are required to make physical contact (JP 3-50). A commander establishes a contact point where a PL crosses a lateral boundary or on other identifiable terrain as a technique to ensure coordination between two units. The commander provides a date-time group to indicate when to make that physical contact. Figure A-5 depicts contact point 8.

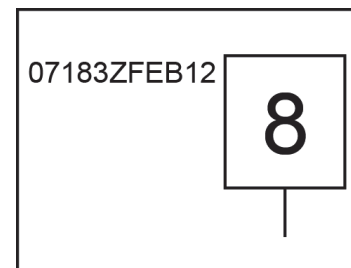

Figure A-5. Contact point 8

A-20. The mutual higher commander of two moving units normally designates the location of contact points and times of contact. When one unit is stationary, its commander normally designates the location

of the contact point and the meeting time, and transmits this information to the commander of the moving unit.

CRITICAL FRIENDLY ZONE

A-21. A *critical friendly zone* is an area, usually a friendly unit or location, which the maneuver commander designates as critical to the protection of an asset whose loss would seriously jeopardize the mission (ADRP 1-02). A critical friendly zone (CFZ) is one of four different types of zones used with field artillery target acquisition radars. Typical CFZs include maneuver assembly areas, command posts, forward arming and refueling points, friendly breaching sites, and other troop concentrations. The exact size and shape of the CFZ reflects the technical characteristics of the sensor coverage and varies in accordance with the terrain. Figure A-6 shows a CFZ for a BCT. The designation of a CFZ requires the availability of target acquisition radars to cover the designated area and fire support weapon systems to conduct counterfire. (JP 3-09 defines *counterfire* as fire intended to destroy or neutralize enemy weapons. Includes counterbattery and countermortar fire.) The supporting field artillery unit's automated fire support system is tied to that sensor to place the location of a weapon firing into the CFZ ahead of all other targets in priority for counterfire. This results in an immediate call for fire unless the system operator manually overrides the automated request for fire. The other three types of radar zones are call-for-fire zone, artillery target intelligence zone, and censor zone. (For additional information on the employment of all four of these radar zones, see FM 3-09.12.)

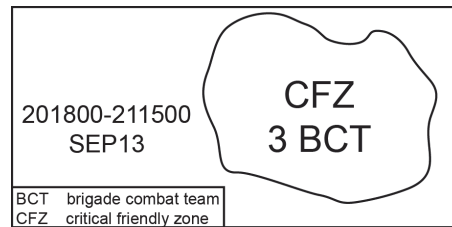

Figure A-6. Critical friendly zone

DIRECT FIRE CONTROL MEASURES

A-22. The small-unit commander communicates to subordinates the manner, method, and time to initiate, shift, and mass fires, and when to disengage by using direct fire control measures. The commander should control unit fires to direct the engagement of enemy systems to gain the greatest effect. The commander uses intelligence preparation of the battlefield (IPB) products and reconnaissance to determine the most advantageous way to use direct fire control measures to mass the effects on the enemy and reduce friendly fire incidents from direct fire systems. The commander must understand the characteristics of weapon systems and available munitions (such as the danger to unprotected Soldiers when tanks fire discarding sabot ammunition over their heads or near them). Direct fire control measures defined in this publication include engagement criteria, engagement priorities, sectors of fire, and target reference points (TRPs). Maneuver platoon and company publications address other direct fire control measures, such as frontal, cross, or depth fire patterns and simultaneous, alternating, or observed techniques of fire.

Engagement Area

A-23. An **engagement area** is an area where the commander intends to contain and destroy an enemy force with the massed effects of all available weapons and supporting systems. This includes organic direct fire systems and supporting systems, such as close air support. Figure A-7 depicts several EAs used within the context of a battalion defense. The commander determines the size and shape of the EA by the relatively unobstructed line-of-sight from the weapon systems in their firing positions and the maximum range of those weapons. The commander designates EAs to cover each enemy avenue of approach into unit positions. The commander also can use them to designate known or suspected enemy locations. The commander selects EAs and then arrays available forces and weapon systems in positions to concentrate overwhelming effects into these areas. The commander routinely subdivides EA into smaller EAs for subordinates using one or more target reference points or by prominent terrain features. The commander assigns sectors of fires to subordinates to prevent friendly fire incidents, but responsibility for an avenue of approach or key terrain is never split. These sectors normally do not affect friendly maneuver. Commanders of units up to battalion task force size normally use this control measure. (See FM 90-7 for a discussion of EA development.)

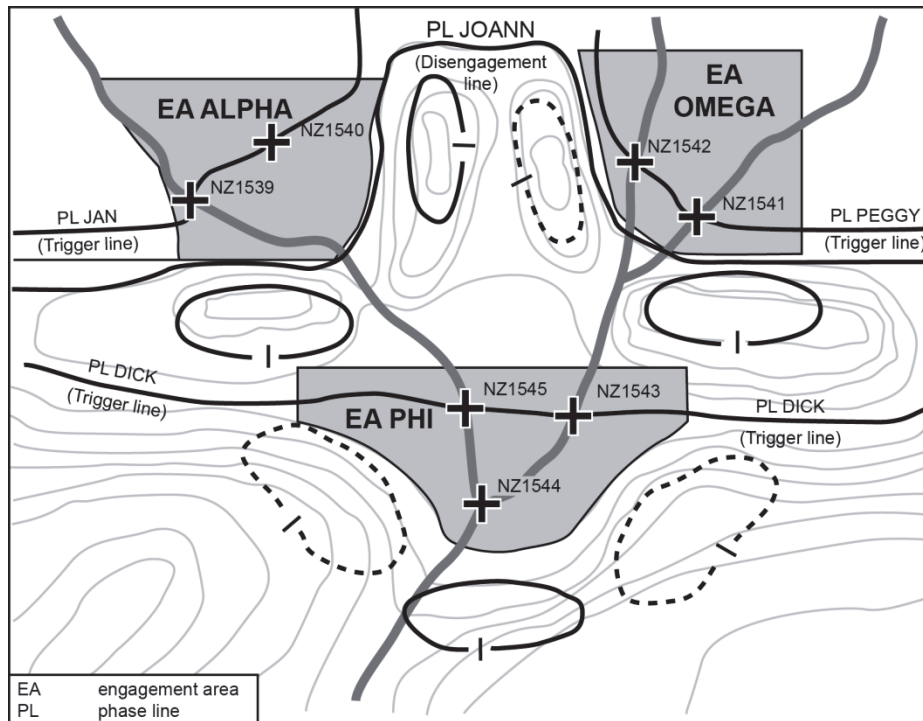

Figure A-7. Example battalion engagement area

Engagement Criteria

A-24. **Engagement criteria** are protocols that specify those circumstances for initiating engagement with an enemy force. They may be restrictive or permissive. For example, a company commander could tell the 1st Platoon to wait until three enemy tanks reach a target reference point within its EA before initiating fire. Another example is a battalion commander telling a company commander not to engage an approaching enemy unit until it commits itself to an avenue of approach. The commander establishes engagement criteria in the direct fire plan. Commanders and leaders of small tactical units use engagement criteria in conjunction with engagement priorities and other direct fire control measures to mass fires and control fire distribution.

Engagement Priority

A-25. **Engagement priority** specifies the order in which the unit engages enemy systems or functions. The commander assigns engagement priorities based on the type or level of threat at different ranges to match organic weapon systems capabilities against enemy vulnerabilities. Engagement priorities are situationally dependent. The commander uses engagement priorities to distribute fires rapidly and effectively. Subordinate elements can have different engagement priorities. For example, the commander establishes engagement priorities so that M2 Bradley fighting vehicles engage enemy infantry fighting vehicles or armored personnel carriers, while M1 Abrams tanks engage enemy tanks. Normally, units engage the most dangerous targets first, followed by targets in depth or specialized systems, such as engineer vehicles.

Sector of Fire

A-26. A **sector of fire** is that area assigned to a unit, a crew-served weapon, or an individual weapon within which it will engage targets as they appear in accordance with established engagement priorities. (See figure A-8 on page A-8.) Battalions and smaller echelons primarily use this direct fire control measure. Each sector of fire can extend from a firing position to the maximum engagement range of

the weapon, or it can be an enclosed area at a distance from the firing position. The commander should assign each subordinate unit or available weapon system a primary sector of fire and a secondary sector of fire to increase the capability of concentrating fire in certain areas. The primary sector of fire is that area in which the assigned unit, individual, or crew-served weapon is initially responsible for engaging and destroying enemy targets located in that sector in accordance with established priorities for engagement. Fire shifts to the secondary sector, on order, when there are no targets in the primary sector, or when the commander needs to cover the movement of another friendly element. This secondary sector of fire should correspond to another element's primary sector of fire to obtain mutual support. Subordinate commanders may impose additional fire control measures as required.

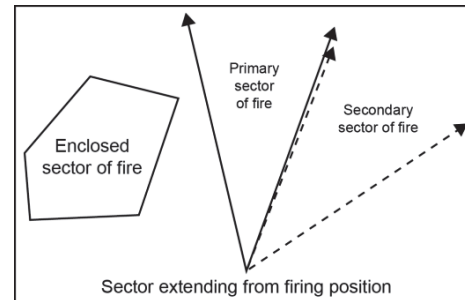

Figure A-8. Example sector of fire

Target Reference Point

A-27. A *target reference point* is An easily recognizable point on the ground (either natural or man-made) used to initiate, distribute, and control fires (ADRP 1-02). Target reference points (TRPs) can also designate the center of an area where the commander plans to distribute or converge the fires of all his weapons rapidly. They are used by task force and below, and can further delineate sectors of fire within an engagement area. TRPs are designated using the standard target symbol and numbers issued by the fire support officer. Once designated, TRPs may also constitute indirect fire targets. A TRP may be a natural terrain feature, a man-made artifact, such as a building, or a marker emplaced by the unit. Maneuver leaders at battalion and below designate TRPs to define unit or individual sectors of fire and observation, usually within an EA. A TRP can also designate the center of an area where the commander plans to rapidly distribute or converge fires. A task force commander designates TRPs for subordinate company teams. Company commanders designate TRPs for their platoons, sections, and, in some cases, individual weapons. Platoon leaders or subordinate leaders may designate additional TRPs for their elements as necessary to control direct and indirect fires. The echelon fire support officer can also designate TRPs as indirect fire targets by using the standard target symbol and target numbering identification (two letters and four numbers). (See FM 3-60 for additional information on indirect fire target numbering.) The TRP is designated using numeric-only marking only if the TRP is not also used as an indirect fire target. Figure A-9 depicts the symbol for TRP 032, a direct-fire only target reference point. The rest of the TRPs in the figures in this publication are both direct- and indirect fire targets and thus designated using indirect fire symbology.

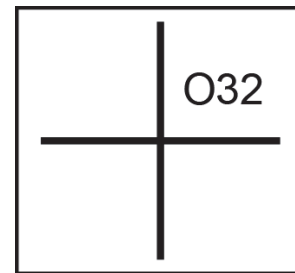

Figure A-9. Target reference point 032

Trigger Line

A-28. A *trigger line* is A phase line located on identifiable terrain that crosses the engagement area—used to initiate and mass fires into an engagement area at a predetermined range for all or like weapon systems (ADRP 1-02). It is located on identifiable terrain—like all phase lines—that crosses an EA, a direction of attack, or an axis of advance. The commander can designate one trigger line for all weapon systems or separate trigger lines for each weapon or type of weapon system. The commander specifies the engagement criteria for this specific situation. The criteria may be either time- or event-driven, such as a certain number or certain types of vehicles to cross the trigger line before initiating engagement. The commander can use a time-based fires delivery methodology or a geography based fires delivery. The commander may reserve the authority to initiate engagement by firing the commander's own individual weapon or giving the command to fire.

A-29. The commander designates a PL as the trigger line for available supporting fire support systems. The commander bases the location of the trigger line on the mission variables of METT-TC, including such variables as the time of flight for artillery shells, positioning of the guns, and the existence of quick-fire links. Its location varies from situation to situation. Its position reflects the distance an enemy force is likely to traverse in the time it takes from when fires are requested to when artillery rounds impact, at a given enemy's movement speed. (See figure A-10.) This gives time for supporting fire support systems to respond to the initial call for fire. For example, in a desert environment—for enemy forces traveling at speed X, a battalion task force commander's fire support trigger line is approximately four kilometers beyond the point where the commander wants to engage the enemy with indirect fires when M109A6 howitzers are in direct support. It is approximately six kilometers when M109A3 howitzers are in direct support. The shorter distance reflects the generally more rapid response capabilities of the M109A6.

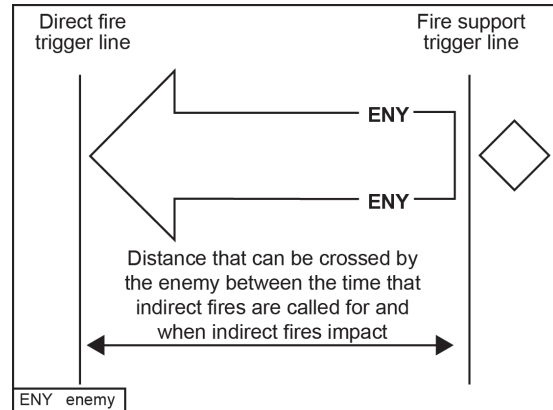

Figure A-10. Trigger line examples

A-30. The commander can establish another trigger line for the unit's most accurate long-range weapon system in the vicinity of the area where the fire support impacts to capitalize on the asymmetric attack. However, dust and debris resulting from the artillery fire may prevent direct-fire systems from engaging the enemy. The commander establishes other trigger lines and TRPs for shorter-range systems. The commander may give guidance to extremely proficient crews to engage the enemy at longer than normal ranges or give them different engagement priorities than the rest of the force, such as giving priority to engaging air defense or engineer-breaching systems.

A-31. When the enemy reaches these closer trigger lines, the commander establishes a decision point to help force a determination on whether the commander wants available longer-range systems to continue to fire in depth or to concentrate unit fires on a single point. Many factors impact this decision, most of which concern the enemy and how the enemy maneuvers and the effects of the defending force's fires.

FIRE SUPPORT COORDINATION MEASURES

A-32. Commanders assigned an AO employ fire support coordination measures (FSCMs) to facilitate rapid target engagement and simultaneously provide safeguards for friendly forces. FSCMs are either permissive or restrictive. Boundaries are the basic FSCM. The fire support coordinator recommends FSCMs to the commander based on the commander's guidance, location of friendly forces, scheme of maneuver, and anticipated enemy actions. Once established, they are entered into or posted on all the command's displays and databases. (ADRP 3-09 explains the use of all FSCMs in more detail).

Permissive Fire Support Coordination Measures

A-33. The primary purpose of permissive measures is to facilitate the attack of targets. Once they are established, further coordination is not required to engage targets affected by the measures. Permissive FSCMs include a coordinated fire line (CFL), a fire support coordination line (FSCL), and a free-fire area (FFA).

Coordinated Fire Line

A-34. A *coordinated fire line* is a line beyond which conventional and indirect surface fire support means may fire at any time within the boundaries of the establishing headquarters without additional coordination. The purpose of the coordinated fire line is to expedite the surface-to-surface attack of targets beyond the coordinated fire line without coordination with the ground commander in whose area the targets are located (JP 3-09). BCTs or divisions usually establish a CFL, although a maneuver battalion may establish one. It

is located as close as possible to the establishing unit without interfering with maneuver forces to open up the area beyond the CFL to fires. A higher echelon may consolidate subordinate unit CFLs. If this occurs, any changes to the subordinate CFLs are coordinated with the subordinate headquarters. (See figure A-11.)

Fire Support Coordination Line

A-35. The *fire support coordination line* is a fire support coordination measure that is established and adjusted by appropriate land or amphibious force commanders within their boundaries in consultation with superior, subordinate, supporting, and affected commanders. Fire support coordination lines facilitate the expeditious attack of surface targets of opportunity beyond the coordinating measure. A fire support coordination line does not divide an area of operations by defining a boundary between close and deep operations or a zone for close air support. The fire support coordination line applies to all fires of air, land, and sea-based weapon systems using any type of ammunition. Forces attacking targets beyond a fire support coordination line must inform all affected commanders in sufficient time to allow necessary reaction to avoid fratricide. Supporting elements attacking targets beyond the fire support coordination line must ensure that the attack will not produce adverse effects on, or to the rear of, the line. Short of a fire support coordination line, all air-to-ground and surface-to-surface attack operations are controlled by the appropriate land or amphibious force commander. The fire support coordination line should follow well-defined terrain features. Coordination of attacks beyond the fire support coordination line is especially critical to commanders of air, land, and special operations forces. In exceptional circumstances, the inability to conduct this coordination will not preclude the attack of targets beyond the fire support coordination line. However, failure to do so may increase the risk of fratricide and could waste limited resources (JP 3-09). (See figure A-12.)

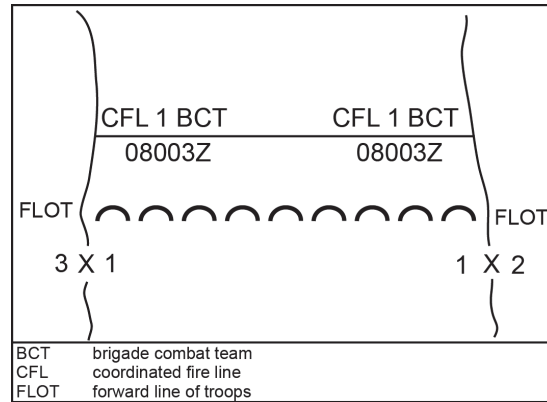

Figure A-11. 1st Brigade combat team coordinated fire line

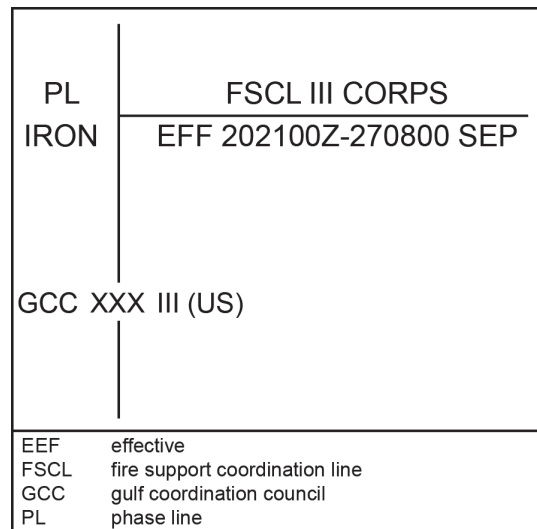

Figure A-12. III Corps fire support coordination line

A-36. The commander designating a FSCL remains responsible for establishing the priority, effects, and timing of fires impacting beyond the FSCL. Coordination for attacks beyond the FSCL is through the air tasking order. The appropriate land or amphibious commander controls attacks short of the FSCL. Army commanders use the tactical air control system or the Army air-ground system to control the execution of close air support (CAS). By establishing a FSCL close-in, yet at sufficient depth so as to not limit high tempo maneuver, land and amphibious force commanders ease the coordination requirements for engagement operations within their AOs by forces not under their control, such as naval surface fire support or air interdiction.

Free-Fire Area

A-37. A *free-fire area* is a specific area into which any weapon system may fire without additional coordination with the establishing headquarters (JP 3-09). Normally, division or higher headquarters establish a FFA on identifiable terrain. (See figure A-13.)

Restrictive Fire Support Coordination Measures

A-38. A restrictive FSCM prevents fires into or beyond the control measure without detailed coordination. The primary purpose of restrictive measures is to provide safeguards for friendly forces. Restrictive FSCM include an airspace coordination area, a no-fire area (NFA), a restrictive fire area (RFA), and a restrictive fire line (RFL). Establishing a restrictive measure imposes certain requirements for specific coordination before the engagement of those targets affected by the measure. (See FM 3-52 for a description of an airspace coordination area.)

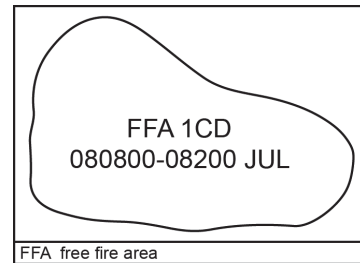

Figure A-13. 1CD free-fire area

No-Fire Area

A-39. A *no-fire area* is an area designated by the appropriate commander into which fires or their effects are prohibited (JP 3-09.3). (See figure A-14.) A commander uses a NFA to protect independently operating elements, such as forward observers and special operations forces. The commander can also use it to protect friendly forces in the echelon support area and for humanitarian reasons, such as preventing the inadvertent engagement of displaced civilian concentrations, or to protect sensitive areas, such as cultural monuments. This rule has two exceptions:

- The establishing headquarters may approve fires within the NFA on a case-by-case mission basis.
- When an enemy force within a NFA engages a friendly force, the friendly force may engage a positively identified enemy force to defend itself.

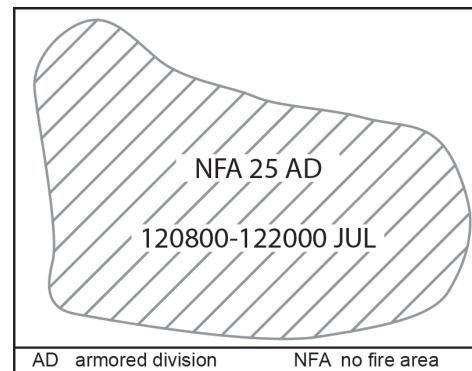

Figure A-14. Example no fire area

Restrictive Fire Area

A-40. A *restrictive fire area* is an area in which specific restrictions are imposed and into which fires that exceed those restrictions will not be delivered without coordination with the establishing headquarters (JP 3-09). (See figure A-15.) The purpose of the RFA is to regulate fires into an area according to the stated restrictions, such as no unguided conventional or dud-producing munitions. Maneuver battalion or larger ground forces normally establish RFAs. On occasion, a company operating independently may establish a RFA. Usually, it is located on identifiable terrain, by grid or by a radius (in meters) from a center point. The restrictions on a RFA may be shown on a map or overlay, or reference can be made to an operation order that contains the restrictions.

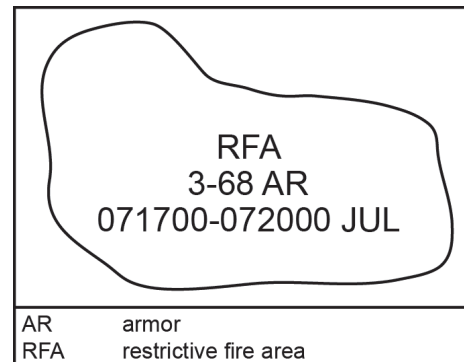

Figure A-15. Example restrictive fire area

Restrictive Fire Line

A-41. A *restrictive fire line* is a line established between converging friendly surface forces that prohibits fires or their effects across that line (JP 3-09). Both or only one of those converging forces may be moving. Fires and their effects can cross a RFL when the event has been coordinated with the establishing and affected organizations. The purpose of the line is to prevent interference between converging friendly forces, such as what occurs during a linkup operation. The next higher common commander of the converging forces establishes the RFL. Located on identifiable terrain, it is usually located closer to the

stationary force—if there is one—than to the moving force. Alternatively, the commander can use a RFL to protect sensitive areas, such as cultural monuments. (See figure A-16.)

Fire Support Targets

A-42. In the fire support context, a *target* is an area designated and numbered for future firing (JP 3-60). There are control measures for point targets, circular targets, rectangular targets, and linear targets. Figure A-17 depicts these symbols.

The commander designates fire support targets using a two-letter and four-digit code established in field artillery doctrine. The commander may group two or more targets for simultaneous engagement. This is called a “group of targets.” A group of targets is graphically shown by circling the targets and identifying the group with a group designator. This group designator consists of the two letters assigned to the block of target numbers assigned to a unit with a number inserted between the two letters. The commander may also attack individual targets and groups of targets in series or in a predetermined sequence. When this occurs, it is referred to as a “series of targets”. Graphically, a series of targets is shown as individual targets or groups of targets within a prescribed area. The series is assigned a code name or nickname. The fact that a series or group of targets has been designated does not preclude the attack of individual targets within the series or group. It also does not preclude the attack of one or more groups of targets within the series.

A-43. Doctrine classifies each fire support target as either a planned target or a target of opportunity. Targets of opportunity are not planned in advance and are engaged as they present themselves in accordance with established engagement criteria and rules of engagement. Planned targets are ones on which fires are prearranged, although the degree of this prearrangement may vary.

A-44. Individually planned fire support targets may be further subdivided into scheduled and on-call fires. Scheduled targets are planned targets on which field artillery and other fire support assets deliver their fires in accordance with a pre-established time schedule and sequence. On-call targets are planned targets engaged in response to a request for fires rather than in accordance with an established time schedule. An on-call target requires less reaction time than a target of opportunity. The degree of prearrangement for the on-call target influences the reaction time from request to execution—the greater the prearrangement, the faster the reaction time. Priority targets are an example of on-call targets that have short reaction times, since each priority target has a fire unit placed on it when it is not engaged in other fire missions. The final protective fires (FPFs) of A Battery, 1st Battalion 16th Field Artillery in figure A-17 above is an example of a priority target. (See ADRP 3-09 for additional information regarding fire support.)

A-45. Time-sensitive targets are not area targets designated and numbered for future firing. A *time-sensitive target* is a joint force commander designated target requiring immediate response because it is a highly lucrative, fleeting target of opportunity or it poses (or will soon pose) a danger to friendly forces (JP 3-60).

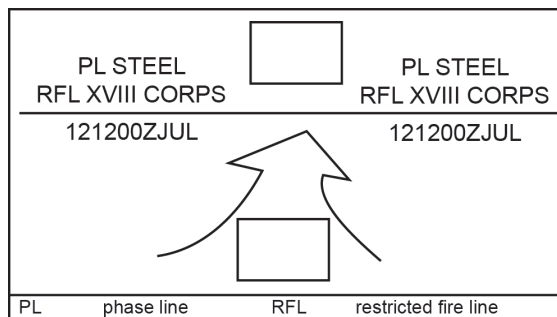

Figure A-16. Example restrictive fire line

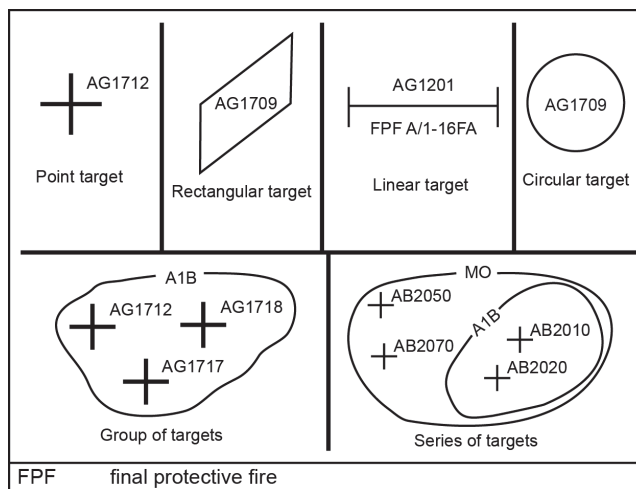

Figure A-17. Fire support target symbols

FORWARD LINE OF OWN TROOPS

A-46. The *forward line of own troops* is a line which indicates the most forward positions of friendly forces in any kind of military operation at a specific time (JP 3-03). The forward line of own troops (FLOT) normally identifies the forward location of covering and screening forces. In the defense, it may be beyond, at, or short of the forward edge of the battle area (FEBA), depending on the tactical situation. It does not include small, long-range reconnaissance assets and similar stay-behind forces. Friendly forces forward of the FLOT may have a restrictive fire coordination measure, such as an RFA, placed around them to preclude friendly fire incidents. Figure A-18 depicts the symbol for the FLOT.

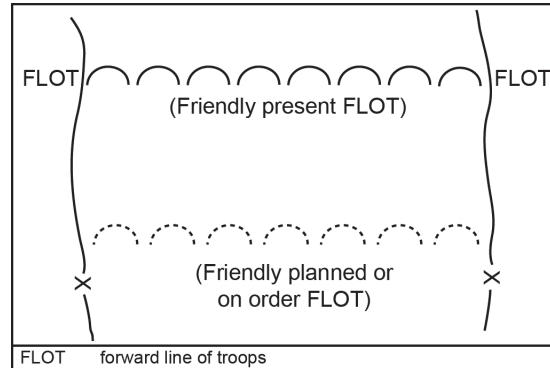

Figure A-18. Example forward line of own troops

LINE OF CONTACT

A-47. The *line of contact* is a general trace delineating the location where friendly and enemy forces are engaged. The commander designates the enemy side of the line of contact (LC) by the abbreviation "ENY." In the defense, a LC is often synonymous with the FLOT. In the offense, a LC is often combined with the LD. Chapter 4 discusses the LD. Figure A-19 depicts the symbol for the LC.

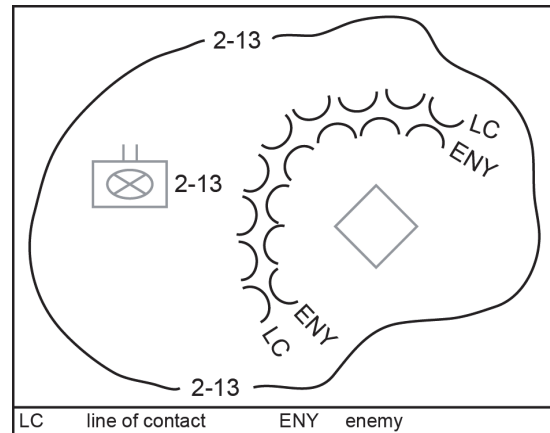

Figure A-19. Line of contact

MOVEMENT CORRIDOR

A-48. A *movement corridor* is a designated area established to protect and enable ground movement along a route (FM 3-90.31). Units establish a movement corridor to set the conditions to protect and enable movement of traffic along a designated surface route. Units conduct synchronized operations within the movement corridor such as reconnaissance, security, mobility, and information engagement for forces that require additional mission command, protection, and support to enable their movement. A movement corridor may be established to facilitate the movement of a single element or be established for a longer period of time to facilitate the movement of a number of elements along a given route. The owner of an AO may establish a movement corridor within that AO along an established main supply route or a route designated for a unit's movement. The movement corridor would typically include the airspace above it to allow the establishing unit to conduct aerial reconnaissance and fires. Figure A-20 on page A-14 depicts a movement corridor.

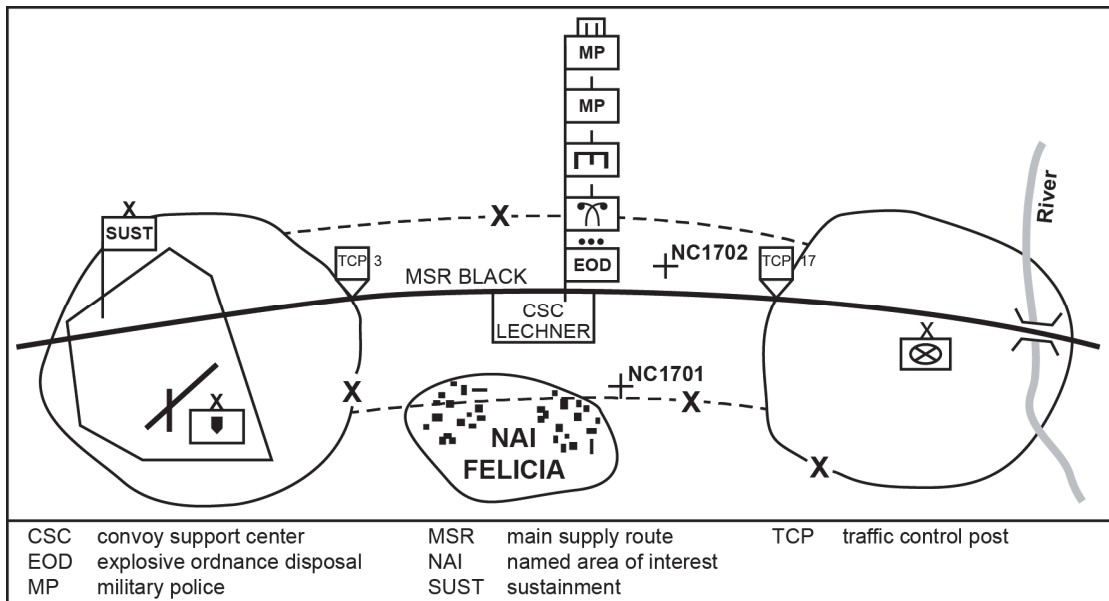

Figure A-20. Example movement corridor

NAMED AREA OF INTEREST

A-49. A *named area of interest* is the geographical area where information that will satisfy a specific information requirement can be collected (ADRP 1-02). Named areas of interest (NAIs) are usually selected to capture indications of enemy courses of action but also may be related to battlefield and environmental conditions. In this later case, the NAI may actually be a person, group, or portion of cyberspace. The commander tailors the shape of the NAI symbol to the actual area the commander wants observed, rather than using a prescribed shape. It is possible to redesignate a NAI as a targeted area of interest or a target area of interest (TAI) on confirmation of enemy activity within the area, allowing a commander to mass the effects of combat power on that area. Figure A-21 depicts NAI Augusta.

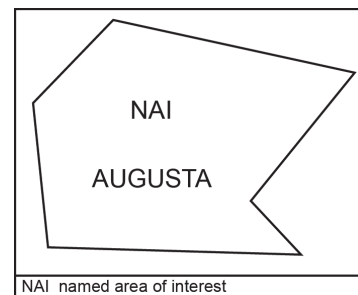

Figure A-21. Named area of interest Augusta

OBSTACLE CONTROL MEASURES

A-50. An *obstacle* is any natural or man-made obstruction designed or employed to disrupt, fix, turn, or block the movement of an opposing force, and to impose additional losses in personnel, time, and equipment on the opposing force (JP 3-15). Obstacles can be natural or man-made, or a combination of both. Forces emplace tactical and protective obstacles that reinforce terrain restrictions and existing obstacles, and integrate them with fires to affect enemy movement or maneuver and shape engagements. **Obstacle control measures are specific measures that simplify the granting of obstacle-emplacing authority while providing obstacle control.** They consist of—

- Zones.
- Belts.
- Groups.
- Restrictions.

Figure A-22 summarizes these control measures. A commander assigned an AO can only emplace protective obstacles unless authorized by that individual's higher echelon commander.

Obstacle control measure	Emplacement authority		Graphic	Example	
	From	To			
Zone	CORPS DIV	DIV BDE	Letter designation Effect graphic optional		
Belt	CORPS DIV BDE	BDE ¹ BDE ¹ TF	Number designation Effect graphic optional		
Group	DIV BDE TF	BDE ² TF ² CO TRP	Letter designation Effect symbol is the graphic		
Obstacle restricted area (ORA)	Any		52ID 120900- 162400SEP		
<p>1 - Rarely done by corps and divisions, but possible.</p> <p>2 - Done only when directed and integrated with corps or division fire plans.</p>					
Graphic effects symbols					Distrupt Fix Turn Block

Figure A-22. Obstacle control measure graphics

A-51. Analysis of the higher headquarters' mission and commander's intent identifies information that may impact the mission. The components of this analysis are intent, AOs, military deception, directed and implied tasks, limitations, available assets, risk, and emplacement timelines and risk. Among the directed obstacle tasks are the planning, preparation, and execution of reserve obstacles. Reserve obstacles allow the force to retain control over the mobility along a given avenue of approach. FM 90-7 discusses engagement area development and obstacle integration.

Obstacle Zones

A-52. An *obstacle zone* is a division-level command and control measure, normally done graphically, to designate specific land areas where lower echelons are allowed to employ tactical obstacles (JP 3-15). Corps and division commanders use them to grant obstacle-emplacement authority to brigades (including other major subordinate units). Obstacle zones are permissive, allowing a BCT to place reinforcing obstacles to support their scheme of maneuver without interfering with future operations.

A-53. If the obstacle zone encompasses the entire BCT AO, another graphic is unnecessary. Commanders may designate the entire AO as an obstacle zone, with the unit boundaries defining the geographical limits of the zone. Obstacle zones do not cross BCT boundaries. Commanders assign obstacle zones to a single subordinate unit to ensure unity of effort, just as they would when assigning defensive AOs or battle positions. This keeps tactical obstacle responsibility along the same lines as control of direct and indirect fires. This does not normally create vulnerabilities on the boundary between units since the commander bases the assignment of both subordinate AOs and obstacle zones on defined avenues of approach.

A-54. A commander does not normally assign an obstacle effect (block, fix, turn, or disrupt) to an obstacle zone. This allows subordinate commanders flexibility in using obstacles. The commander should establish construction and resourcing priorities between different obstacle zones.

Obstacle Belts

A-55. An *obstacle belt* is a brigade-level command and control measure, normally given graphically, to show where within an obstacle zone the ground tactical commander plans to limit friendly obstacle employment and focus the defense (JP 3-15). It assigns an intent to the obstacle plan and provides the necessary guidance on the overall effect of obstacles within a belt. Commanders plan obstacle belts within assigned obstacle zones to grant obstacle-emplacement authority to their major subordinate units. Obstacle belts also focus obstacles to support the brigade scheme of maneuver and ensure that obstacles do not interfere with the maneuver of any higher headquarters.

A-56. Obstacle belts are restrictive, but also direct a subordinate unit to construct one or more obstacles to create an effect in the area. They do not specify the type or number of obstacles. Obstacle belts do not cross unit boundaries for the same reasons discussed in obstacle zones. A single unit is responsible for a belt; however, a commander may assign more than one belt to a unit.

A-57. A BCT commander normally assigns an obstacle effect and priority to each obstacle belt. As with the obstacle zone, the target and relative location are apparent. Adding a specific obstacle effect gives purpose and direction to subordinate battalion obstacle planning. When BCT commanders assign an obstacle effect, they ensure that obstacles within the belt complement the BCT fire plan.

A-58. A corps, division, or brigade commander may authorize emplacement authority for certain types of protective obstacles outside of obstacle zones or belts. Normally, the commander authorizes company team and base commanders to emplace protective obstacles within 500 meters of their positions, depending on the mission variables of METT-TC. The commander usually limits the types of obstacles a unit may use for protective obstacles that are outside of obstacle-control measures. For example, the commander may allow only wire- and command-detonated mines outside of control measures for protective obstacles. Furthermore, the commander may require that minefields be fenced on all sides to prevent friendly fire incidents, after obtaining legal guidance concerning current rules and policies on mine emplacement.

Obstacle Groups

A-59. **Obstacle groups are one or more individual obstacles grouped to provide a specific obstacle effect.** Task forces use obstacle groups to ensure that company teams emplace individual obstacles supporting the task force's scheme of maneuver. In rare cases, brigades, divisions, or even corps may use obstacle groups for specific tactical obstacles. Also, units integrate obstacle groups with their direct- and indirect-fire plans. Brigade and maneuver battalion commanders can plan their placement anywhere in the obstacle zones or belts, respectively.

A-60. Unlike obstacle zones or belts, obstacle groups are not areas but relative locations for actual obstacles. Commanders normally show obstacle groups using the obstacle-effect graphics. When detailed planning is possible (to include detailed on-the-ground reconnaissance), commanders may show obstacle groups using individual obstacle graphics.

A-61. The company team commander and the engineer can adjust obstacles in the group if the intent and link to the fire plan remain intact. Company team commanders make minor changes to obstacles and fire-control measures based on terrain realities. For example, a commander may move a fixing obstacle group and direct-fire TRPs a hundred meters to avoid having them masked by rolling terrain. However, a major change to the obstacle group location requires the approval of the commander who ordered the obstacle group emplacement.

Individual Obstacles

A-62. Each type of individual obstacle, such as abatis, antitank ditches, booby traps, mines and minefields, roadblocks, craters, and wire obstacles has its associated graphic. Once a unit constructs an individual obstacle, the obstacle's location is recorded and reported through the chain of command. Commanders must report individual obstacles in sufficient detail so that any unit moving through the area can bypass or reduce the obstacle without excessive risk. Each headquarters is responsible to ensure exact obstacle locations are disseminated throughout its organization. Individual obstacle graphics are rarely shown on maps above the battalion echelon and are not depicted in this publication. (Maneuver Support Center of Excellence publications describe individual obstacles and establish their associated symbols.)

Obstacle Restrictions

A-63. Commanders may use obstacle restrictions to provide additional obstacle control and to limit the specific types of obstacles used, such as restricting the use of buried mines. These restrictions ensure that subordinates do not use obstacles with characteristics that impair future operations. These restrictions also allow commanders to focus the use of limited resources for the decisive operation by restricting their use elsewhere. An *obstacle restricted area* is a command and control measure used to limit the type or number of obstacles within an area (JP 3-15). The commander with emplacement authority uses obstacle restricted areas (ORAs) to restrict obstacle placement. The ORA graphic depicts the impacted area, the unit imposing the restriction, and the restrictions in effect.

PHASE LINE

A-64. A *phase line* is a line utilized for control and coordination of military operations, usually an easily identified feature in the operational area (JP 3-09). (See figure A-23 on page A-18.) A commander establishes PLs to control the maneuver of the units. Phase lines are not boundaries unless designated as such and do not establish any specific responsibilities between units, unless the operations order so specifies. When possible, the commander places them along easily recognizable terrain features—such as roads, railroad tracks, rivers, and ridgelines—to ensure easy identification. As with boundaries, this is less important if all units are equipped with precision navigation devices, such as global positioning systems (GPS). Some PLs have additional designations for specific purposes, such as a LD or a probable line of deployment (PLD).

POSITION AREA FOR ARTILLERY

A-65. A *position area for artillery* is an area assigned to an artillery unit where individual artillery systems can maneuver to increase their survivability. A **position area for artillery is not an area of operations for the artillery unit occupying it.** The commander assigns position areas for artillery (PAAs) for terrain management purposes. Establishing a PAA lets other subordinate units know they should avoid occupying that same terrain, thus avoiding enemy counterfire. While the exact size of a PAA depends on the mission variables of METT-TC, a Paladin platoon normally requires a PAA encompassing over four square kilometers, and a Multiple Launch Rocket System (MLRS) platoon requires nine square kilometers. (See figure A-24 on page A-18.)

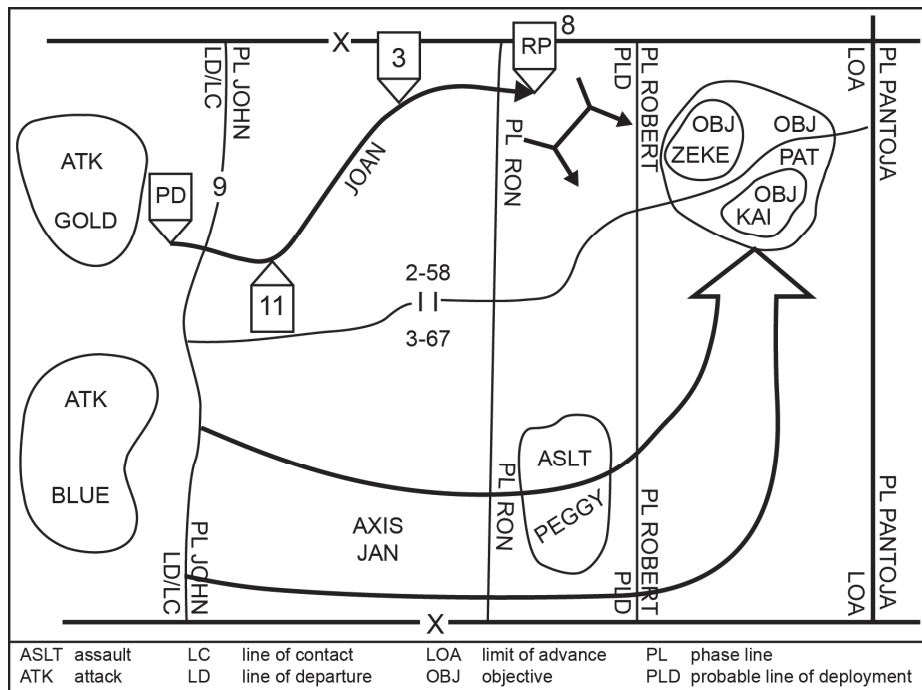

Figure A-23. Phase lines with other control measures

A-66. The maneuver echelon operations officer (G-3 or S-3) of the unit that owns the terrain establishes the PAA. The occupying artillery unit does not have the same authority and responsibilities toward the PAA that are associated with a unit assigned an AO. For example, other units can move through a PAA without clearing that movement with the artillery unit. The artillery unit occupying a PAA establishes liaison with the unit that owns the AO where the PAA is located. The echelon fire support officer usually conducts this liaison in accordance with standard command and support relationships. (For a discussion of common command and support relationships, see ADP 3-0. For a discussion of artillery missions, see ADRP 3-09.)

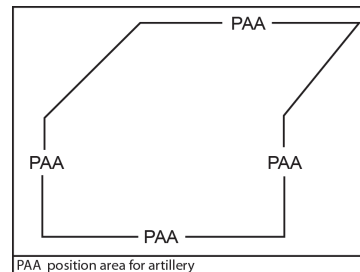

Figure A-24. Position area for artillery

A-67. The decision to establish a PAA affects airspace control for rotary-, fixed-wing, and tilt-rotor aircraft integration. A PAA is a base upon which to establish future grid-target lines for lateral deconfliction and areas for rotary-, fixed-wing, and tilt rotor aircraft to avoid, depending on high- or low-angle artillery fires.

ROUTE

A-68. A route is the prescribed course to be traveled from a specific point of origin to a specific destination. (See Route Iron in figure A-25.) Routes can have different functions. Those functions can be added as adjectives to specify different types of routes. Examples of such routes include a passing route and a main supply route (MSR). The commander can further designate MSRs as open, supervised, dispatch, reserved, or prohibited. The commander can assign names, numbers, or alphanumeric designations to routes within the AO. (See FM 3-34.170 for additional information concerning route classification and marking.)

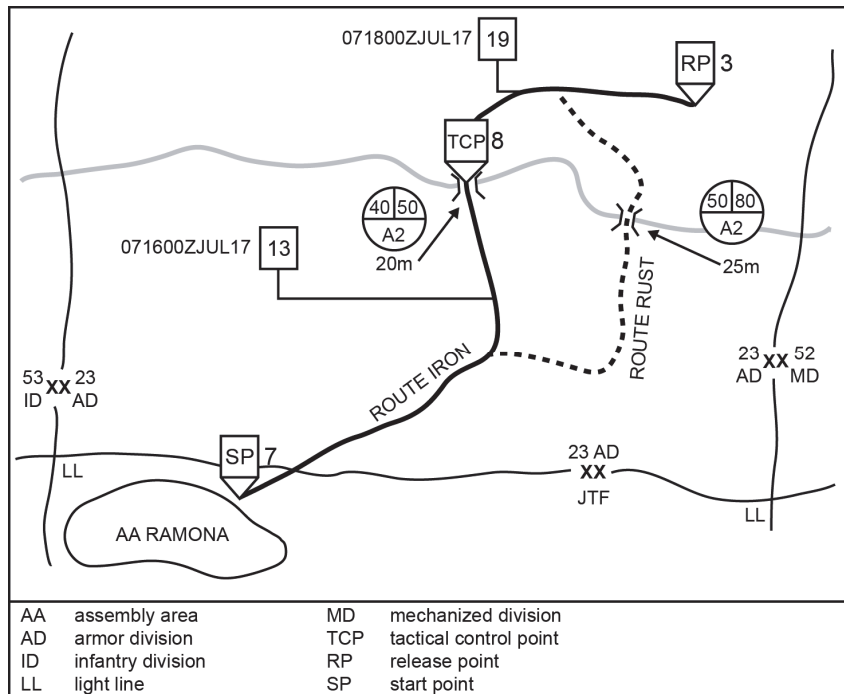

Figure A-25. Example routes

TARGET AREA OF INTEREST

A-69. A *target area of interest* is the geographical area where high-value targets can be acquired and engaged by friendly forces. Not all target areas of interest will form part of the friendly course of action; only target areas of interest associated with high priority targets are of interest to the staff. These are identified during staff planning and wargaming. Target areas of interest differ from engagement areas in degree. Engagement areas plan for the use of all available weapons; target areas of interest might be engaged by a single weapon. (JP 2-01.3) Not all target areas of interest will form part of the friendly course of action; only target areas of interest associated with high priority targets are of interest to the staff. The commander designates a target area of interest where subordinate friendly weapon systems can best attack high-payoff targets. The unit staff develops these target areas of interest during the targeting process, based on the currently available products resulting from the IPB process. These target areas of interest are further refined during wargaming and finally approved by the commander during course of action approval. The shape of a target area of interest reflects the type of target and the weapon system intended to engage that target. They are normally cued by surveillance assets, which include unmanned aircraft system (UAS), combat observation and lasing teams (COLTs), long-range surveillance teams, fixed-wing reconnaissance aircraft using a variety of sensors, and special operations forces. A commander can designate a target area of interest for any organic or supporting systems, including close air support. Target areas of interest differ from engagement areas in degree. Commanders plan EAs for the use of all available weapons, while TAIs might be engaged by only a single weapon system. Figure A-26 depicts TAI Whitetail.

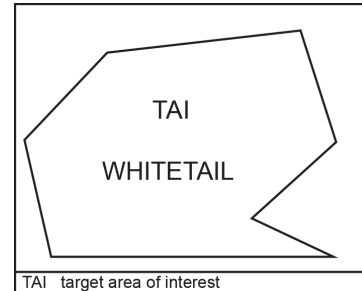

Figure A-26. Example target area of interest

A-70. The Army term *targeted area of interest* is the geographical area or point along a mobility corridor where successful interdiction will cause the enemy to abandon a particular course of action or require the enemy to use specialized engineer support to continue. It is where the enemy force can be acquired and engaged by friendly forces (ADRP 1-02).

COMMON OFFENSIVE CONTROL MEASURES

A-71. This section defines in alphabetical order those common offensive control measures commanders use to synchronize the effects of combat power. The commander uses the minimum control measures required to successfully complete the mission while providing subordinates the flexibility needed to respond to changes in the situation.

Assault Position

A-72. An *assault position* is a covered and concealed position short of the objective from which final preparations are made to assault the objective. (ADRP 3-90). These final preparations can involve tactical considerations, such as a short halt to coordinate the final assault, reorganize to adjust to combat losses, or make necessary adjustments in the attacking force's dispositions. These preparations can also involve technical items, such as engineers conducting their final prepare-to-fire checks on obstacle clearing systems and the crews of plow- and roller-equipped tanks removing their locking pins. An assault position may be located near either a final coordination line (FCL) or a probable line of deployment (PLD). (Paragraphs A-79 and A-84 define a FCL and a PLD respectively.)

Assault Time

A-73. The *assault time* establishes the moment to attack the initial objectives throughout the geographical scope of the operation (ADRP 3-90). It is imposed by the higher headquarters in operations to achieve simultaneous results from several different units. It synchronizes the moment the enemy feels the effects of friendly combat power. It is similar to the time-on-target control method for fire mission processing used by the field artillery. A commander uses it instead of a time of attack (see paragraph A-87) because of the different distances that elements of the commander's force must traverse, known obstacles, and differences in each unit's tactical mobility.

Attack by Fire Position

A-74. An *attack by fire position* designates the general position from which a unit conducts the tactical task of attack by fire (ADRP 3-90). (Appendix B defines the tactical mission task of attack by fire.) The purpose of these positions is to mass the effects of direct fire systems for one or multiple locations toward the enemy. An attack by fire position does not indicate the specific site. Attack by fire positions are rarely applicable to units larger than company size. Figure A-27 depicts attack by fire position BRANDON.

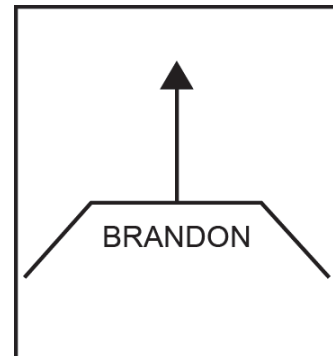

Figure A-27. Attack by fire position Brandon

Attack Position

A-75. The *attack position* is the last position an attacking force occupies or passes through before crossing the line of departure (ADRP 3-90). An attack position facilitates the deployment and last-minute coordination of the attacking force before it crosses the LD. It is located on the friendly side of the LD and offers cover and concealment for the attacking force. It is used primarily at battalion level and below. Whenever possible, units move through the attack position without stopping. An attacking unit occupies an attack position for a variety of reasons, including, for example, when the unit is waiting for specific results from preparation fires or when it is necessary to conduct additional coordination, such as a forward passage of lines. If the attacking unit occupies the attack position, it stays there for the shortest amount of time possible to avoid offering the enemy a lucrative target. (Figure A-28 shows attack positions BLUE and GOLD used in conjunction with other common offensive control measures.)

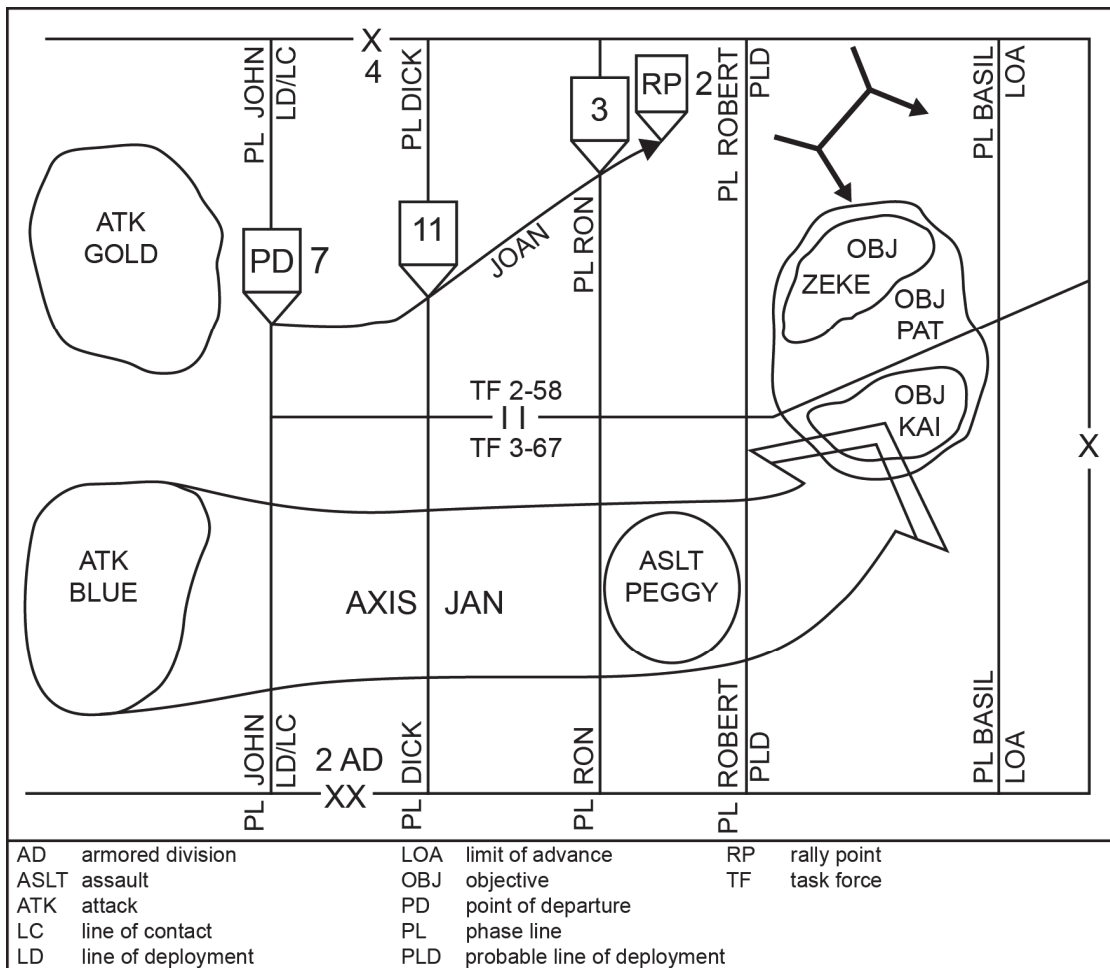

Figure A-28. Attack positions used with other common offensive control measures

Axis of Advance

A-76. An *axis of advance* designates the general area through which the bulk of a unit’s combat power must move (ADRP 3-90). When developing the axis of advance, the commander also establishes bypass criteria. *Bypass criteria* are measures during the conduct of an offensive operation established by higher headquarters that specify the conditions and size under which enemy units and contact may be avoided (ADRP 3-90). There are three primary reasons why a commander uses an axis of advance:

- First, to direct the bypass of locations that could delay the progress of the advancing force, such as known contaminated areas.
- Second, to indicate that the force is not required to clear the AO as it advances. The force will be required to clear the axis in accordance with specified bypass criteria.
- The third primary reason is to indicate to a unit involved in offensive encirclement, exploitation, or pursuit operations the need to move rapidly toward an objective.

When using an axis of advance there is always the risk that enemy forces outside the axis not being detected and being inadvertently bypassed. Figure A-28 depicts axis of advance JAN.

Battle Handover Line

A-77. The *battle handover line* is a designated phase line on the ground where responsibility transitions from the stationary force to the moving force and vice versa (ADRP 3-90). The common higher

commander of the two forces establishes the battle handover line (BHL) after consulting both commanders. The stationary commander determines the location of the line. The BHL is forward of the forward edge of the FEBA in the defense or the FLOT in the offense. The commander draws it where elements of the passing unit can be effectively supported by the direct fires of the forward combat elements of the stationary unit until passage of lines is complete. The area between the BHL and the stationary force belongs to the stationary force commander. The stationary force commander may employ security forces, obstacles, and fires in the area. Figure A-29 depicts a BHL used in conjunction with other control measures for a rearward passage of lines.

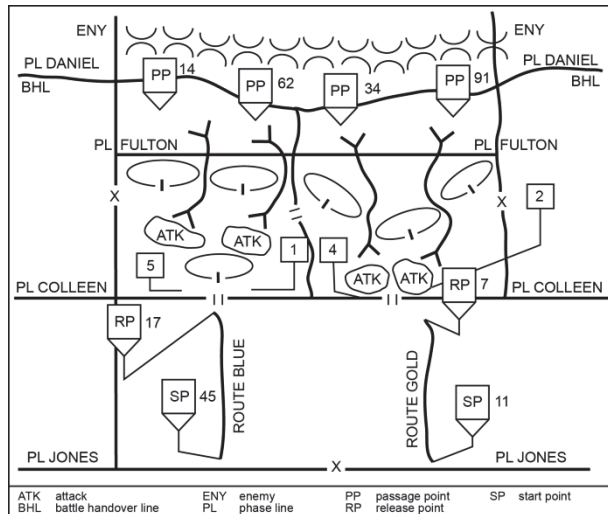

Figure A-29. Battle handover line in a rearward passage of lines

Direction of Attack

A-78. The *direction of attack* is a specific direction or assigned route a force uses and does not deviate from when attacking (ADRP 3-90). It is a restrictive control measure. The commander's use of a direction of attack maximizes control over the subordinate unit movement, and is often used during night attacks, infiltrations, and when attacking through smoke. The commander establishes a direction of attack through a variety of means, such as target reference points, checkpoints, GPS way points, and using sensors, such as ground surveillance radar to track the attack force and target acquisition radars to track the impact of artillery shells. Target reference points placed on recognizable terrain provide the commander with the capability to rapidly shift fires and reorient subordinate maneuver forces. When using a direction of attack, the commander designates a point of departure (PD). (Figure A-28 on page A-21 depicts direction of attack JOAN.)

Final Coordination Line

A-79. The *final coordination line* is a phase line close to the enemy position used to coordinate the lifting or shifting of supporting fires with the final deployment of maneuver elements (ADRP 3-90). Final adjustments to supporting fires necessary to reflect the actual versus the planned tactical situation take place before crossing this line. It should be easily recognizable on the ground. The FCL is not a fire support coordination measure. (Figure A-30 shows PL ROBERT as the FCL for the 4th Brigade.)

Limit of Advance

A-80. The *limit of advance* is a phase line used to control forward progress of the attack. The attacking unit does not advance any of its elements or assets beyond the limit of advance, but the attacking unit can push its security forces to that limit (ADRP 3-90). A commander usually selects a linear terrain feature, perpendicular to the direction of attack, on the far side of the objective as the limit of advance (LOA) because such a terrain feature is easily identifiable. The commander employs a LOA to prevent overextending the attacking force and reduce the possibility of fratricide and friendly fire incidents by fires supporting the attack. The commander positions a LOA far enough beyond the objective to allow the unit to defend the objective. A LOA prevents units from exploiting success and launching a pursuit; therefore, commanders should only use LOAs if they do not want their units to conduct an exploitation or pursuit. A forward boundary is always a LOA, but a LOA is not necessarily a forward boundary. In fact, a LOA and the unit's forward boundary should rarely coincide because of the resulting limitations that a forward boundary places on supporting fires beyond the forward boundary. Figure A-30 shows PL BASIL used as 4th Brigade's LOA.

Line of Departure

A-81. The *line of departure* is a phase line crossed at a prescribed time by troops initiating an offensive operation (ADRP 3-90). The purpose of the LD is to coordinate the advance of the attacking force, so that its elements strike the enemy in the order and at the time desired. The LD also marks where the unit transitions from movement to maneuver. The commander can also use it to facilitate the coordination of fires. Generally, it should be perpendicular to the direction the attacking force will take on its way to the objective. Friendly forces should control the LD. The commander analyzes the terrain before designating a LD. Different units have different movement rates on leaving their AAs based on their inherent mobility characteristics and the terrain being crossed. The commander considers these different characteristics when establishing the LD to prevent these differences from affecting the synchronization of the operation. When possible, the commander selects the LD so that the terrain the attack unit traverses before crossing the LD provides sufficient cover for the attacking unit's final deployment into a combat formation before crossing the LD. In many cases the LD is also the LC because the unit in contact is conducting the attack from its current positions. Figure A-30 depicts PL JOHN as a combined LD and LC.

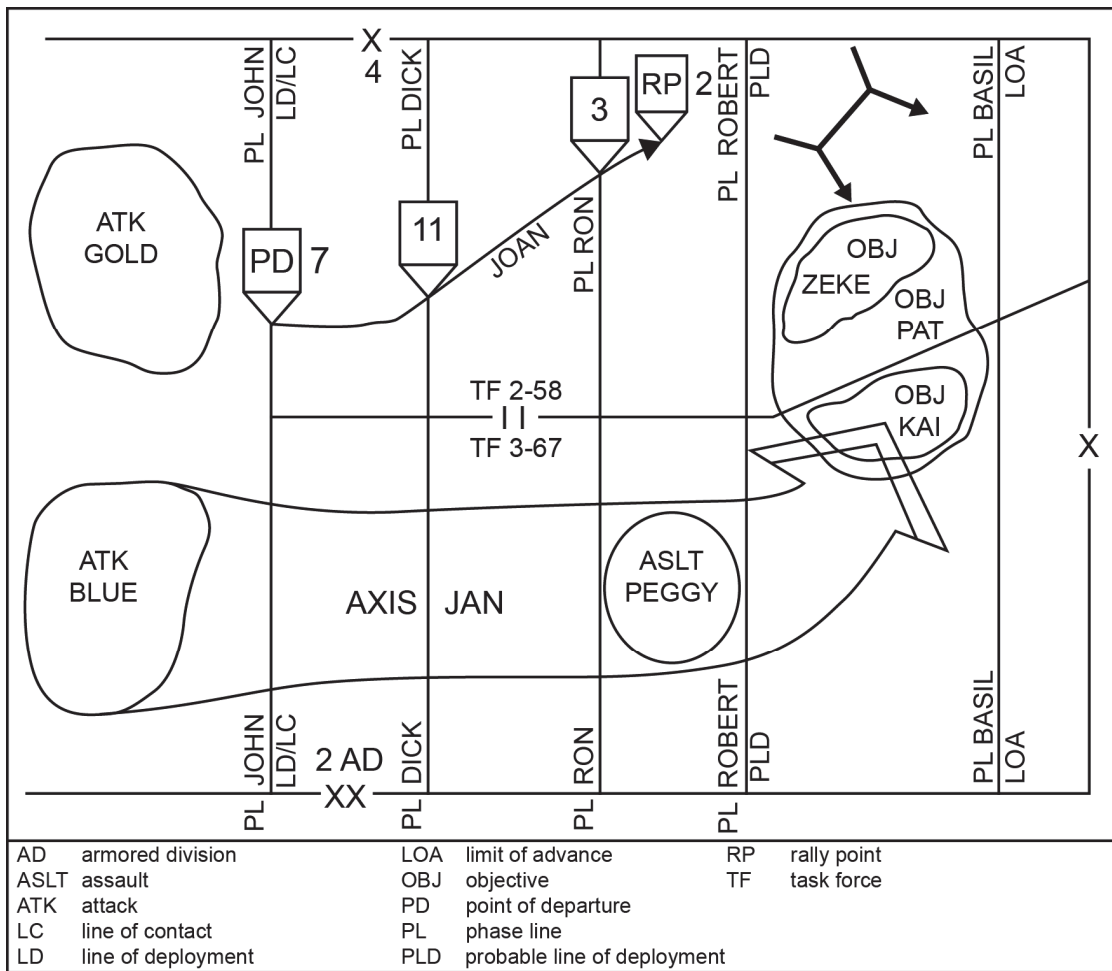

Figure A-30. Final coordination line, limit of advance, and line of departure used with other offensive control measures

Objective

A-82. An *objective* is a location on the ground used to orient operations, phase operations, facilitate changes of direction, and provide for unity of effort (ADRP 3-90). An objective can be either terrain- or

force-oriented. Terrain objectives should be easily identifiable on the ground to facilitate their recognition. The commander determines force-oriented objectives based on known enemy positions. The commander normally assigns subordinate commanders only their final objectives, but can assign intermediate objectives as necessary. Figure A-30 on page A23 depicts objective PAT. Objective PAT is further broken down into two subordinate objectives, objective KAI and objective ZEKE.

Point of Departure

A-83. The *point of departure* is the point where the unit crosses the LD and begins moving along a direction of attack (ADRP 3-90). Units conducting reconnaissance and security patrols and other operations in a low-visibility environment commonly use a PD as a control measure. Like an LD, it marks the point where the unit transitions from movement to maneuver under conditions of limited visibility. Figure A-31 depicts PD 7.

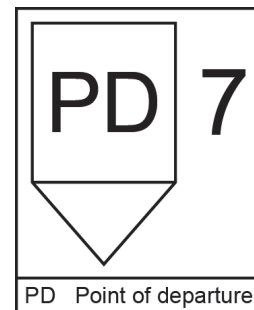

Figure A-31. Point of departure 7

Probable Line of Deployment

A-84. A *probable line of deployment* is a phase line that designates the location where the commander intends to deploy the unit into assault formation before beginning the assault (ADRP 3-90). The PLD is used primarily at battalion level and below when the unit does not cross the LD in its assault formation. It is usually a linear terrain feature perpendicular to the direction of attack and recognizable under conditions of limited visibility. The PLD should be located outside the range where the enemy can place the attacking force under effective direct fire. It has no use except as it relates to the enemy. In figure A-30 on page A-23, PL ROBERT could also be designated as the PLD.

Rally Point

A-85. A *rally point* is an easily identifiable point on the ground at which aircrews and passengers can assemble and reorganize following an incident requiring a forced landing. Alternatively, it is also an easily identifiable point on the ground at which units can reassemble and reorganize if they become dispersed (ADRP 1-02). Forces conducting a patrol or an infiltration commonly use this control measure. The *objective rally point* is a rally point established on an easily identifiable point on the ground where all elements of the infiltrating unit assemble and prepare to attack the objective (ADRP 3-90). It is typically near the infiltrating unit's objective; however, there is no standard distance from the objective to the objective rally point. It should be far enough away from the objective so that the enemy will not detect the infiltrating unit's attack preparations. Figure A-32 depicts rally point 14.

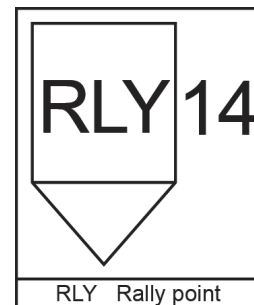

Figure A-32. Rally point 14

Support by Fire Position

A-86. A *support by fire position* designates the general position from which a unit conducts the tactical mission task of support by fire (ADRP 3-90). (Appendix B defines the tactical mission task of support by fire.) The purpose of these positions is to increase the supported force's freedom of maneuver by placing direct fires on an objective that is going to be assaulted by a friendly force. Support by fire positions are located within the maximum friendly direct-fire range of the enemy positions. The commander selects them so that the moving assault force does not mask its supporting fires. For this reason, support by fire positions are normally located on the flank of the assault force, elevated above the objective if possible. Support by fire positions are rarely applicable to units larger than company size. The support by fire position graphic depicted in figure A-33 indicates the general location and direction from which the unit provides fires; it does not indicate a specific site.

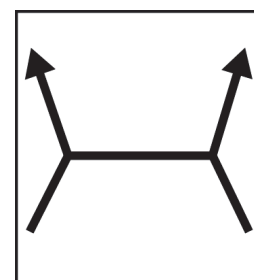

Figure A-33. Support by fire position

Time of Attack

A-87. The *time of attack* is the moment the leading elements of the main body cross the line of departure, or in a night attack, the point of departure. (ADRP 3-90). A commander uses it when conducting simultaneous operations where a shaping operation must accomplish its mission to set the conditions for the success of the decisive operation. When determining time of attack, the commander considers the time subordinates require to—

- Conduct necessary reconnaissance, prepare plans, and issue orders.
- Synchronize plans between all subordinate units.
- Complete attack preparations, such as pre-combat inspections.
- Move to the LD or PD.

A-88. Orders normally designate the time of attack as H-hour. This is normally when the main body crosses the LD. However, H-hour can also designate the time to implement a phase of an operation, such as an airborne or air assault phase. The headquarters planning the operation specifies the term's exact meaning. This is usually a part of the unit's standard operating procedures (SOPs).

COMMON DEFENSIVE CONTROL MEASURES

A-89. The commander controls the defense by using control measures to provide the flexibility needed to respond to changes in the situation and allow the defending commander to rapidly concentrate combat power at the decisive point. Defensive control measures within a commander's AO include designating the security area, the battle handover line (BHL), the main battle area (MBA) with its associated FEBA, and the echelon support area. (FM 3-90-2 discusses tactics associated with the conduct of security tasks.) (Paragraph A-104 defines the FEBA.) The commander can use battle positions and additional direct fire control and FSCMs in addition to those control measures discussed earlier in appendix A to further synchronize the employment of combat power. The commander designates disengagement lines to trigger the displacement of subordinate forces. These common defensive control measures are discussed in alphabetical order below.

Battle Positions

A-90. A *battle position* is a defensive location oriented on a likely enemy avenue of approach (ADRP 3-90). The battle position is an intent graphic that depicts the location and general orientation of the majority of the defending forces. A commander's use of a battle position does not direct the position of the subordinate's entire force within its bounds since it is not an AO. (See figure A-34.) Units as large as battalion task forces and as small as squads or sections use battle positions. They may occupy the topographical crest of a hill, a forward slope, a reverse slope, or a combination of these areas. The commander selects positions based on terrain, enemy capabilities, and friendly capabilities. A commander can assign all or some subordinates battle positions within the AO. (See figure A-35 on page A-26.)

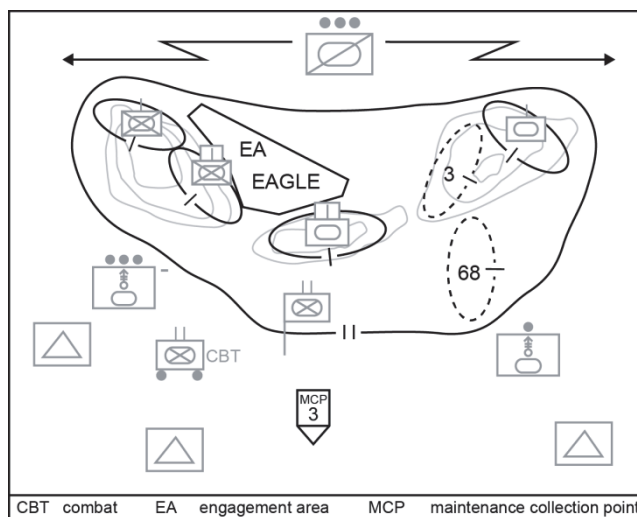

Figure A-34. Task force battle position

A-91. The commander may assign subordinates battle positions in situations when there is a need to retain a greater degree of control over the maneuver of subordinate units than that provided through only using an AO, as the commander controls maneuver outside the general location of the battle position. Multiple battle positions may be assigned to a single unit, which allows that unit to maneuver between battle positions. The

commander specifies mission and engagement criteria to the unit assigned to a battle position. Security, functional and multifunctional support, and sustainment forces typically operate outside a unit's battle position.

A-92. Units occupy or depart battle positions as part of the overall plan. The commander assigning a unit to a battle position should specify when and under what conditions the unit displaces from the position, since they are not normally held at all costs. If a unit is ordered to defend a battle position, its commander has the option of moving off the battle position. If that unit is directed to retain a battle position, its commander needs to know the specific conditions that must exist before the unit can displace.

A-93. There are five kinds of battle positions—primary, alternate, supplementary, subsequent, and strong point. (See figure A-36.) When assigning battle positions, the commander always designates the primary battle position. The commander designates and prepares alternate, supplementary, and subsequent positions as time and other resources permit and if the terrain or situation requires them.

A-94. The *primary position* is the position that covers the enemy's most likely avenue of approach into the area of operations (ADRP 3-90). It is the best position from which to accomplish the mission, such as cover an EA.

A-95. An *alternate position* is a defensive position that the commander assigns to a unit or weapon for occupation when the primary position becomes untenable or unsuitable for carrying out the assigned task (ADRP 3-90). It covers the same area as the primary position. The commander locates alternate positions so the occupant can continue to fulfill the original task, such as covering the same avenue of approach or EA as the primary position. These positions increase the defender's survivability by allowing the defender to engage the enemy from multiple positions. For example, a unit moves to its alternate positions when the enemy brings suppressive fires on the primary position.

A-96. A *supplementary position* is a defensive position located within a unit's assigned area of operations that provides the best sectors of fire and defensive terrain along an avenue of approach that is not the primary avenue where the enemy is expected to attack (ADRP 3-90). For example, an avenue of approach into a unit's AO from one of its flanks normally requires establishing supplementary positions to allow a unit or weapon system to engage enemy forces traveling along that avenue.

A-97. A *subsequent position* is a position that a unit expects to move to during the course of battle (ADRP 3-90). A defending unit may have a series of subsequent positions. Subsequent positions can also have primary, alternate, and supplementary positions associated with them.

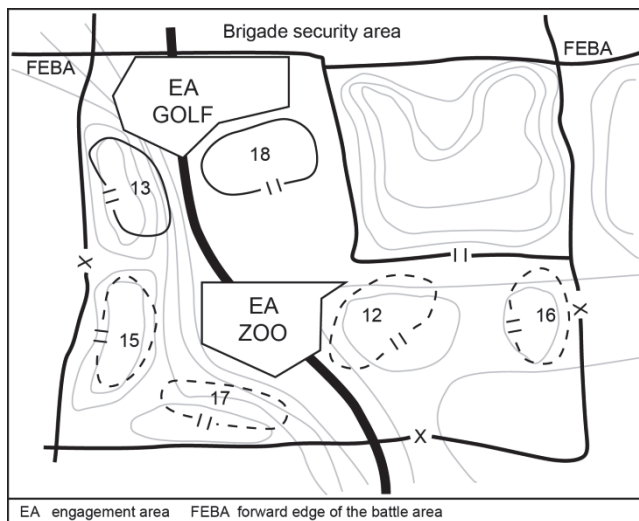

Figure A-35. Area of operations and battle position control measures used in combination

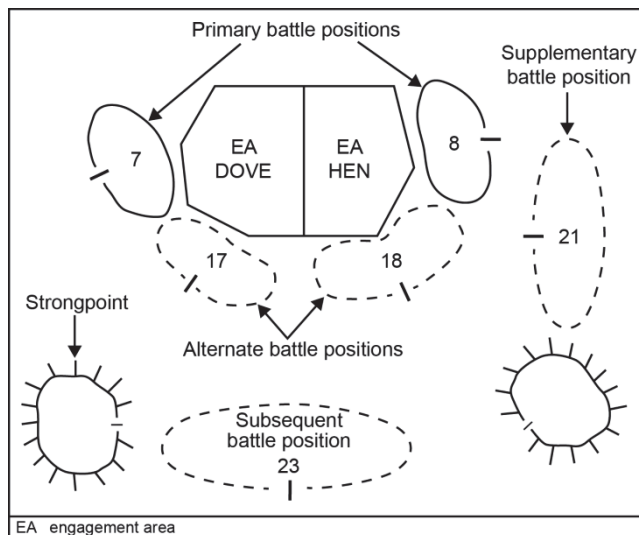

Figure A-36. Five kinds of battle positions

A-98. A *strong point* is a heavily fortified battle position tied to a natural or reinforcing obstacle to create an anchor for the defense or to deny the enemy decisive or key terrain (ADRP 3-90). The commander prepares a strong point for all-around defense. (See figure A-37.) The commander positions strong points on key or decisive terrain. The unit occupying the strong point prepares positions for its weapon systems, vehicles, Soldiers, and supplies. The commander also establishes a strong point when anticipating that enemy actions will isolate a defending force retaining terrain critical to the defense.

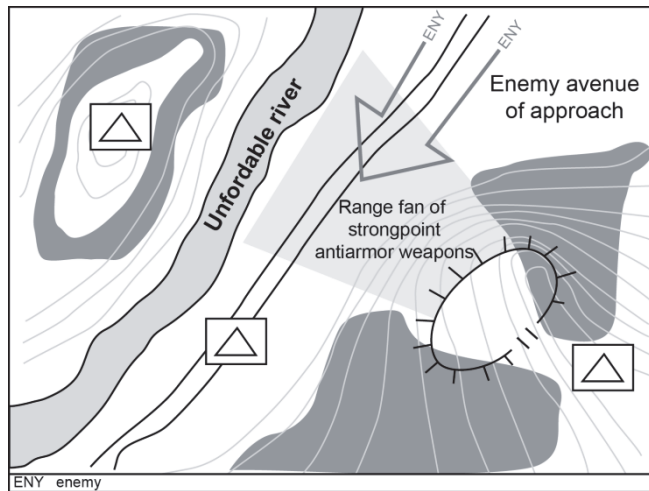

Figure A-37. Strong point defense

A-99. Before assigning a strong point mission, the commander ensures that the strong point force has sufficient time and resources to construct the position, which requires significant engineer support. A minimally effective strong point typically requires a one-day effort from an engineer unit the same size as the unit defending the strong point. Normally, companies and battalions occupy strong points, although brigades may construct them. The commander does not normally establish strong points for units smaller than company size. This is because a platoon or squad cannot secure a perimeter large enough to encompass all required assets and supplies.

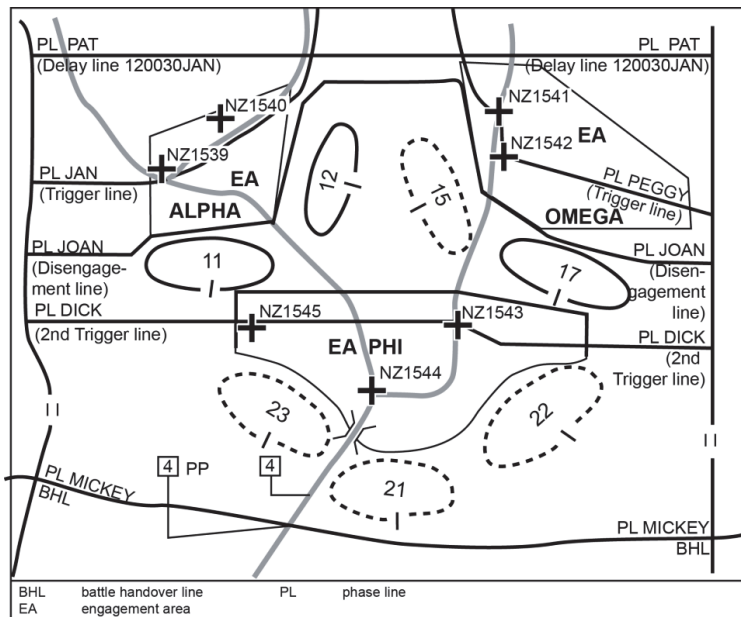

Figure A-38. Direct fire control measures

Direct Fire Control Measures

A-100. The commander engages the enemy force with all available defensive fires when it enters the defending unit’s engagement area. These direct fire control measures, such as TRPs, trigger lines, and EAs, are discussed in this appendix under the heading of “common offensive control measures” in paragraphs A-27, A-28, and A-23. (See figure A-38.)

Disengagement Line

A-101. A *disengagement line* is a phase line located on identifiable terrain that, when crossed by the enemy, signals to defending elements that it is time to displace to their next position (ADRP 3-90). Phase Line JOAN is a disengagement line in figure A-39. The commander uses these lines in the delay and the defense when the commander does not want the defending unit to become decisively engaged. The commander establishes criteria for the disengagement, such as number of enemy vehicles by type, friendly losses, or enemy movement to flanking locations. Commanders may designate multiple disengagement lines, one for each system in the defense.

Fire Support Coordination Measures

A-102. The commander tries to engage the enemy at extended ranges and attrit the enemy force as the enemy's attack advances. To control indirect fires in the defense, the commander uses those common FSCM introduced in paragraphs A-32 through A-45. The commander can also employ final protective fires.

A-103. *Final protective fire* is an immediately available preplanned barrier of fires designed to impede enemy movement across defensive lines or areas (JP 1-02). Both direct- and indirect- fire weapons can provide FPFs. The commander can only assign each firing battery or platoon a single FPF. A FPF is a priority target for an element or system, and those fire units are laid on that target when they are not engaged in other fire missions. When the enemy force initiates its final assault into a defensive position, the defending unit initiates its FPFs to kill enemy infantry soldiers and suppress enemy armored vehicles. (Figure A-39 depicts an FPF.)

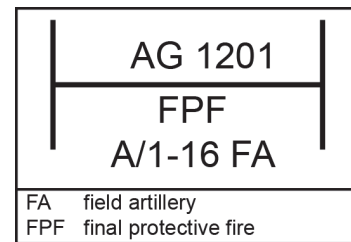

Figure A-39. Final protective fire

Forward Edge of the Battle Area

A-104. The *forward edge of the battle area* is the foremost limit of a series of areas in which ground combat units are deployed, excluding the areas in which the covering or screening forces are operating, designated to coordinate fire support, the positioning of forces, or the maneuver of units (JP 3-09.3). The Army only uses a FEBA during the conduct of defensive tasks. The FEBA is not a boundary, but it conveys the commander's intent. It marks the foremost limits of the areas in which the preponderance of ground combat units deploy, excluding the areas in which security forces are operating. MBA forces can temporarily move forward of the FEBA to expedite the retrograde operations of security forces. The commander designates a FEBA to coordinate fire support and to assist in the maneuver of subordinate forces. A phase line designating the forward-most point of the MBA indicates the FEBA. The FEBA shows the senior commander's planned limit for the effects of direct fires. Defending units must address this area in their scheme of maneuver and exchange information regarding tactical plans at coordination points. (Figure A-40 graphically depicts the current FEBA and a proposed FEBA.)

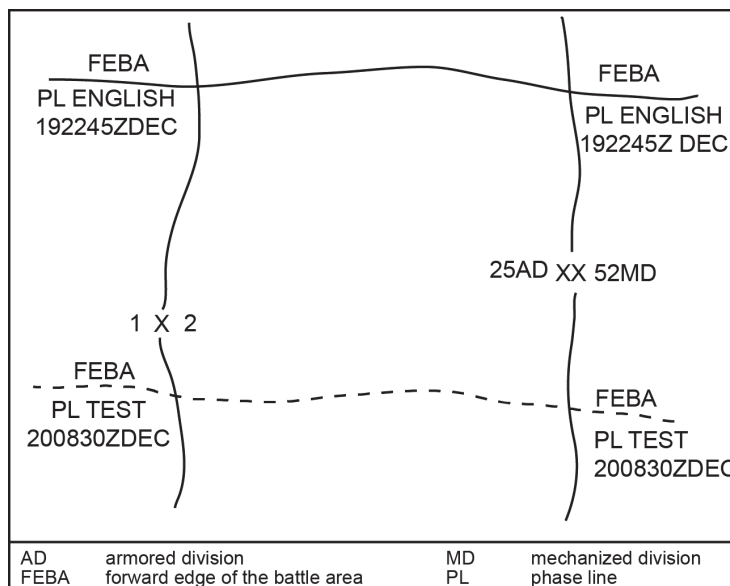

Figure A-40. Forward edge of the battle area

Main Battle Area

A-105. The *main battle area* is the area where the commander intends to deploy the bulk of the unit's combat power and conduct decisive operations to defeat an attacking enemy (ADRP 3-90). The defending commander's major advantage is the ability to select the ground on which the battle takes place. The defender positions subordinate forces in mutually supporting positions in depth to absorb enemy penetrations or canalize them into prepared EAs, defeating the enemy's attack by concentrating the effects of overwhelming combat power. The natural defensive strength of the position determines the distribution

of forces in relation to both frontage and depth. In addition, defending units typically employ field fortifications and obstacles to improve the terrain's natural defensive strength. The MBA also includes the area where the defending force creates an opportunity to deliver a decisive counterattack to defeat or destroy the enemy.

A-106. The MBA extends from the FEBA to the unit's rear boundary. The commander locates subordinate unit boundaries along identifiable terrain features and extends them out beyond the FLOT by establishing forward boundaries. Unit boundaries should not split avenues of approach or key terrain. The commander selects the MBA based on the products of the IPB process and the commander's own analysis using the mission variables of METT-TC. The IPB process indicates how the enemy force will probably use the available avenues of approach.

This page intentionally left blank.

Appendix B

Tactical Mission Tasks

The tactical mission tasks in this appendix describe the results or effects the commander wants to achieve—the *what* and *why* of a mission statement not previously addressed in this publication. A mission statement contains the *who*, *what*, *when*, *where*, and *why* associated with a specific operation. The *what* and *why* of a mission statement are not the same thing and both are needed. The *what* is an effect that is normally measurable. The *why* of a mission statement provides the mission’s purpose. These tasks have specific military definitions that are different from those found in a dictionary. In some cases, the discussion includes more than just a definition; it includes results or effects in relation to the enemy, terrain, or friendly forces not associated with any specific type or form of an operation. Tasks that identify a friendly action rarely provide sufficient clarity for a mission statement.

B-1. A **tactical mission task** is the specific activity performed by a unit while executing a form of tactical operation or form of maneuver. It may be expressed in terms of either actions by a friendly force or effects on an enemy force. As shown in tables B-1, B-2, and B-3, there is no definitive list of words or terms to describe the *what* and the *why* of a mission statement. The commander is not limited to the tactical mission tasks listed in this appendix in specifying desired subordinate actions in an operations order or operations plan. Many of the words and terms used to describe the *what* and *why* of a mission statement do not have special connotations beyond their common English language meanings. However, both the commander and the subordinate must have a common understanding of the *what* and *why* of the operation. Tasks involving only actions by friendly forces rarely provide sufficient clarity for a mission statement, thus the addition of a solid purpose coupled with the task adds understanding and clarity. The commander ensures that the missions assigned to subordinate units are consistent with the scheme of maneuver and the resources allocated to those subordinates. For example, a defending unit requires far greater effort (resources) to destroy an enemy force than to defeat it. Likewise, an attacking unit requires more combat power to clear the enemy from a given area than to contain that enemy in that same area.

Table B-1. Actions by friendly forces and effects on enemy forces

<i>Actions by friendly forces</i>	<i>Effects on enemy forces</i>
Attack by fire	Block
Breach	Canalize
Bypass	Contain
Clear	Defeat
Control	Destroy
Counterreconnaissance	Disrupt
Disengagement	Fix
Exfiltrate	Isolate
Follow and assume	Neutralize
Follow and support	Suppress
Occupy	Turn
Retain	
Secure	
Seize	
Support by fire	

Table B-2. Elements of operations and subordinate tasks

<i>Elements of operations</i>	
<i>Offensive tasks</i>	<i>Defensive tasks</i>
Movement to contact: <ul style="list-style-type: none"> • Search and attack • Cordon and search 	Area defense
Attack: <ul style="list-style-type: none"> • Ambush • Demonstration • Feint • Raid • Spoiling attack 	Mobile defense
Exploitation	Retrograde operations <ul style="list-style-type: none"> • Delay • Withdrawal • Retirement
Pursuit	
Forms of offensive maneuver <ul style="list-style-type: none"> • Envelopment • Frontal attack • Infiltration • Penetration • Turning movement 	

Table B-3. Tactical shaping operations and tasks

<i>Tactical shaping tasks</i>
Passage of lines
Reconnaissance operations <ul style="list-style-type: none"> • Zone • Area • Route • Reconnaissance in force
Relief in place
Security operations: <ul style="list-style-type: none"> • Screen • Guard • Cover • Area (includes route and convoy) • Local
Troop movements: <ul style="list-style-type: none"> • Administrative movement • Approach march • Road march

B-2. Many of the tactical mission tasks in this appendix or introduced previously in this publication have a tactical mission graphic associated with them. Commanders and staff officers use tactical mission graphics in conjunction with course of action development.

ACTIONS BY FRIENDLY FORCES

B-3. The following tactical mission tasks address actions by friendly forces. They are the action, the *what*, the commander wants the friendly force to perform. Most of these actions have associated tactical mission graphics that are used in course of action development and sketches as part of the military decisionmaking process.

ATTACK BY FIRE

B-4. **Attack by fire** is a tactical mission task in which a commander uses direct fires, supported by indirect fires, to engage an enemy force without closing with the enemy to destroy, suppress, fix, or deceive that enemy. A commander assigning this task to a subordinate must also state the desired effect on the enemy, such as neutralize, fix, or disrupt. A commander normally employs this task when the mission does not dictate or support close combat and occupation of a geographical objective by another friendly force. The commander may assign the force conducting an attack by fire a battle position with either a sector of fire or an engagement area (EA), or the commander may assign it an axis of advance and a force-oriented objective. The enemy may be stationary or moving. Figure B-1 shows the tactical mission graphic for attack by fire. The arrow points at the targeted force or objective, and the commander places the base of the arrow in the general area from which the commander wants to deliver the attack.

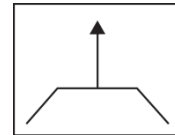

Figure B-1.
Attack by fire
tactical
mission
graphic

B-5. An attack by fire closely resembles the task of support by fire. The chief difference is that one unit conducts the support by fire task to support another unit so it can maneuver against the enemy. The attack by fire task includes—

- Assigning sectors of fire or EAs to each subordinate weapon system to include the enemy's defensive positions or avenues of approach.
- Designating control measures to allow massing, distributing, and shifting of direct and indirect fires.
- Designating battle positions, area of operations (AO), or axis of advance to allow the friendly force to engage the enemy.
- Providing for security and all-around defense, including control measures to ensure tie-in of subordinate elements and maximum use of hide positions.
- Using operations security (OPSEC) to deceive the enemy about movement, occupation, and intent of the operation.
- Reconnoitering, preparing, and securing movement routes and firing positions before the movement of the main body, and stocking Class V items.
- Providing movement instructions to the initial battle positions.

BREACH

B-6. **Breach** is a tactical mission task in which the unit employs all available means to break through or establish a passage through an enemy defense, obstacle, minefield, or fortification. A commander attempts to bypass and avoid obstacles and enemy defensive positions to the maximum extent possible to maintain tempo and momentum. Breaching enemy defenses and obstacle systems is normally the last choice. A breach is a synchronized combined arms operation under the control of the maneuver commander. (Figure B-2 shows the control graphic for a breach.) The area located between the arms of the graphic shows the general location for the breach. The length of the arms extend to include the entire depth of the area that must be breached. Breaching operations may be required to support an attack anywhere along the continuum from a deliberate to a hasty attack. Regardless of where the attack falls along the continuum, the breaching tenets—intelligence, breaching fundamentals, breaching organization, mass, and synchronization—apply when conducting breaching operations in support of an attack. (ATTP 3-90.4 gives detailed information concerning breaching operations.)

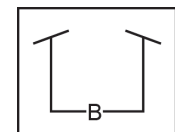

Figure B-2.
Breach
tactical
mission
graphic

BYPASS

B-7. *Bypass* is a tactical mission task in which the commander directs the unit to maneuver around an obstacle, position, or enemy force to maintain the momentum of the operation while deliberately avoiding combat with an enemy force. A commander orders a bypass and directs combat power toward mission accomplishment. A bypass can take place in offensive or defensive actions. (Figure B-3 shows the tactical mission graphic for a bypass.) The arms of the graphic go on both sides of the location or unit that will be bypassed.

B-8. The commander bases the bypass decision on—

- The requirement to maintain momentum and aggressive action.
- Knowledge of enemy strength, intent, or mission.
- The degree to which the bypassed enemy can interfere with the advance.
- The general state of the enemy force; for example, if enemy resistance is crumbling, the friendly force can take greater risks.
- Any bypass criteria established by a higher headquarters.

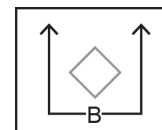

Figure B-3.
Bypass
tactical
mission
graphic

B-9. The force conducting the bypass immediately reports any bypassed obstacles and enemy forces to its higher headquarters. The force normally keeps the bypassed enemy under observation until relieved by another force, unless it is part of a raid. A senior commander does not normally delegate authority to bypass below the battalion task force level. Bypass criteria are established to limit the size of the enemy force that can be bypassed without the authority of the next higher commander. Before approving the bypass, the commander ensures that the bypassing force checks the bypass route for enemy presence and trafficability. The bypassing force prevents the bypassed enemy force from interfering with the moving friendly force.

B-10. The two bypass techniques that the force can employ are—

- Avoiding the enemy totally.
- Fixing the enemy in place with fires and then conducting the bypass.

B-11. If the force cannot avoid the enemy, the bypassing force must fix the enemy with part of its maneuver elements and bypass with the balance of the force. (See figure B-4.) Generally, a commander will not attempt to bypass an enemy force if more than a third of the unit's combat power is required to fix the enemy. The commander assigns one subordinate unit the mission of fixing the enemy in this situation, reinforcing the fixing force as required by the mission variables of mission, enemy, terrain and weather, troops and support available, time available, and civil considerations (METT-TC.) The fixing force coordinates with the unit assigned to relieve the fixing force as soon as possible and provides the

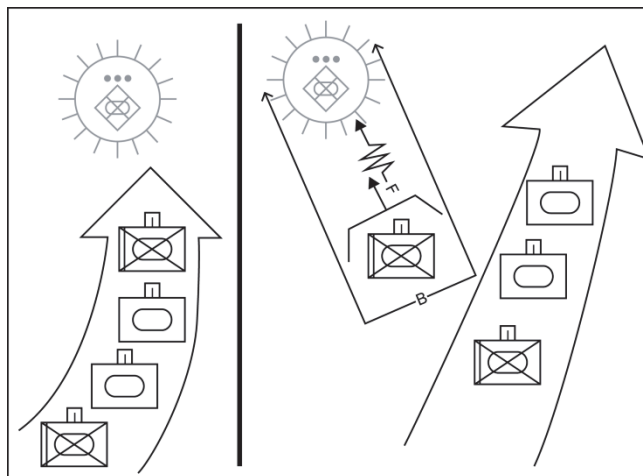

Figure B-4. Task force conducting a fix and bypass

The relieving unit is normally another unit assigned a follow-and-support task. Once relieved, the force fixing the enemy either rejoins its parent organization or becomes part of the following element and comes under its control.

B-12. Occasionally the commander may direct the fixing force to break contact with the enemy after the bypassing force completes the bypass. This occurs when the bypassing force has no requirement to maintain an uninterrupted logistics flow, such as in a raid. In this case, the fixing force fixes the enemy by employing defensive and limited offensive actions in synchronization with all available fire support until ordered to rejoin the bypassing force.

Clear

B-13. **Clear** is a tactical mission task that requires the commander to remove all enemy forces and eliminate organized resistance within an assigned area. The force does this by destroying, capturing, or forcing the withdrawal of enemy forces, so they cannot interfere with the friendly unit's mission. In all cases, this task requires a thorough reconnaissance to discover the enemy's locations. After discovering the enemy's location, the clearing force maneuvers against the enemy force. (Figure B-5 shows the tactical mission graphic for clear.) The bar connecting the arrows designates the desired limit of advance for the clearing force. The bar also establishes the width of the area to clear.

B-14. This task requires significant time and other resources. In the mission statement, a commander can modify the objective associated with this task to destroying, capturing, or forcing the withdrawal of only enemy forces larger than a stated size. In this case, the clearing force keeps smaller enemy forces under observation, while the rest of the friendly force bypasses them.

B-15. Clear is also a mobility task that involves the total elimination of an obstacle that is usually performed by follow-on engineers and is not done under fire. Clearing operations are conducted to completely eliminate the enemy's obstacle effort or residual obstacles affecting the operational area. (See FM 3-34.210 for more information on mobility clearing operations.)

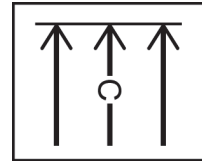

Figure B-5. Clear tactical mission graphic

CONTROL

B-16. **Control** is a tactical mission task that requires the commander to maintain physical influence over a specified area to prevent its use by an enemy or to create conditions necessary for successful friendly operations. That influence can result from friendly forces occupying the specified area or dominating that area by their weapon systems. Control of an area does not require the complete clearance of all enemy soldiers from the specified area. The tactical mission task of control differs from that of secure because secure does not allow enemy fires to impact on the secured area. The enemy can engage targets within the controlled area but cannot move ground forces through that area.

B-17. Control may also mean a command relationship or a function commanders exercise through their mission command systems. (See ADRPs 3-0 and 6-0.)

COUNTERRECONNAISSANCE

B-18. **Counterreconnaissance** is a tactical mission task that encompasses all measures taken by a commander to counter enemy reconnaissance and surveillance efforts. Counterreconnaissance is not a distinct mission, but a component of all forms of security operations. It prevents hostile observation of a force or area. Counterreconnaissance is an element of all security operations and most local security measures. It involves both active and passive elements and includes combat action to destroy or repel enemy reconnaissance units and surveillance assets.

B-19. Destroying enemy ground reconnaissance assets while denying the enemy information through other collection systems allows friendly force commanders to operate against an enemy who is operating blindly. The enemy commander's inability to see the battlefield eventually desynchronizes the enemy commander's actions and renders that commander's force vulnerable to aggressive action by friendly forces. (See chapter 12 for additional information on counterreconnaissance.)

DISENGAGE

B-20. **Disengage** is a tactical mission task where a commander has the unit break contact with the enemy to allow the conduct of another mission or to avoid decisive engagement. It involves moving to a location where the enemy cannot engage the friendly force with either direct fires or observed indirect fires. Disengaging from the enemy while displacing from one position to the next is a difficult procedure. A disengagement plan includes—

- The maneuver concept of operations for tactical elements after disengagement, along with the movement routes for each subordinate unit.
- Fires to suppress the enemy and cover the unit's movement.
- Screening smoke to conceal the unit's movement, as part of a military deception operation, or to cover passage points.
- Contact and passage points if moving through friendly lines. (See FM 3-90-2.)
- The time disengagement starts.
- The earliest time that functional and multifunctional support and sustainment elements move.

B-21. The senior headquarters conducts operations to support the disengaging forces and relieve pressure on units in contact with the enemy. For example, if a division is conducting a delay, the division commander uses attached aviation assets to help a brigade combat team (BCT) disengage from the close fight. Simultaneously, the division uses its long-range artillery, rocket, and electronic warfare (EW) systems to destroy or disrupt enemy follow-on echelons to prevent them from interfering with the disengagement. The intent is to create conditions that allow the unit to disengage while avoiding decisive combat.

B-22. To facilitate disengagement, the commander suppresses the enemy in contact by bombarding the enemy force with large volumes of both direct and indirect fires provided by forces other than the disengaging unit. In open terrain, the unit generally moves its short-range systems first. In close terrain, it generally moves its long-range systems first to support by fire positions. The time involved to move a system to its next position also affects when that system moves. Small-unit leaders usually direct this movement because of the limited range of combat net radios and the fact that the tactical situation varies across a unit's front. The process repeats as necessary. Once disengagement starts, units must complete it rapidly. The commander can employ supporting units or reserves to protect the disengaging unit's flanks and assist in freeing any closely engaged elements. The unit then moves to its next position using the appropriate movement techniques. (See FM 3-90-2.)

B-23. If enemy combat systems have not closed within direct-fire range of the friendly disengaging unit, all its elements may be able to move simultaneously under the cover of intense fires and smoke. Speed of execution and continued coordination are essential to the success of this task.

EXFILTRATE

B-24. **Exfiltrate is a tactical mission task where a commander removes Soldiers or units from areas under enemy control by stealth, deception, surprise, or clandestine means.** Friendly forces exfiltrate when they have been encircled by enemy forces and cannot conduct a breakout or be relieved by other friendly forces. Forces returning from a raid, an infiltration, or a patrol behind enemy lines can also conduct an exfiltration. The commander exfiltrates an encircled force to preserve a portion of the force; it is preferable to the capture of the entire force. A force exfiltrates only after destroying or incapacitating all equipment, except medical, that it must leave behind. Only as a last resort, when the alternative is the capture of the entire force, does a force conducting an exfiltration leave its casualties in place with supplies, chaplain support, and medical personnel.

B-25. Exfiltration is most feasible through rough or difficult terrain in areas lightly covered by enemy observation and fire. These conditions often allow undetected movement of small elements, when movement of the entire force would present more risk. Exfiltration requires resourcefulness, a high degree of discipline, expert land navigation skills, and motivation. It is unlikely that the entire force will be able to exfiltrate, since part of it may have to create a diversion. Good, small-unit leadership is essential in this type of operation.

B-26. The exfiltrating force first establishes its rally points and exfiltration lanes. It coordinates its linkup plans with other friendly units. The commander designates exfiltration lanes as restrictive fire areas (RFAs) or no-fire areas (NFAs). The exfiltrating force uses preparatory fires to cover its movement and to expend stockpiled ammunition. Based on reconnaissance and available intelligence, the exfiltrating force subdivides into small groups and exfiltrates during periods of limited visibility, passing through or around enemy defensive positions. If detected, it tries to bypass the enemy. Exfiltration may be more difficult with

combat and tactical vehicles because the noise they make and the limitations they impose on exfiltration routes make detection more likely.

FOLLOW AND ASSUME

B-27. *Follow and assume* is a tactical mission task in which a second committed force follows a force conducting an offensive task and is prepared to continue the mission if the lead force is fixed, attrited, or unable to continue. The follow-and-assume force is not a reserve but is committed to accomplish specific tasks. Figure B-6 shows the tactical mission graphic for follow and assume. The commander places the box part of the graphic around the symbol of the unit being assigned this task.

B-28. Tasks for a follow-and-assume force include—

- Preparing to execute all missions of the followed unit.
- Maintaining contact with the trail elements of the leading force.
- Preparing to conduct a forward passage of lines through the force it is following.
- Monitoring all combat information and intelligence being provided to and from the force it is following.
- Avoiding engaging enemy forces bypassed by the force it is following.

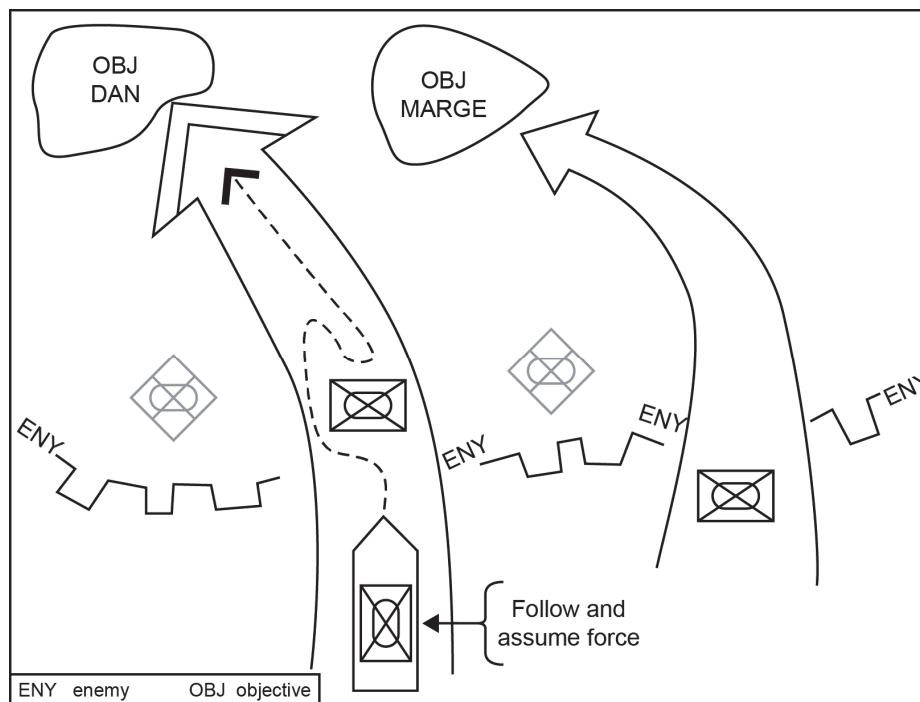

Figure B-6. Follow and assume tactical mission graphic

B-29. A commander assigns a follow-and-assume mission to ensure that the attacking force maintains the momentum of its offensive action. The follow-and-assume force ensures that it can immediately execute a forward passage of lines and assume the mission of the lead force.

B-30. The commander assigning a unit the task of follow and assume has two options in establishing the relationship between the lead and trail units. The commander normally retains command of both units and requires that all requests for support from the supported unit to the supporting unit pass through the commander's headquarters. Alternatively, in situations where the commander will not be able to maintain control over both units, the supporting unit is placed in a standard command relationship with the supported unit, such as attached or operational control. An example of this occurs when both units are trying to encircle a retrograding enemy force and the commander remains with the direct-pressure force.

FOLLOW AND SUPPORT

B-31. **Follow and support** is a tactical mission task in which a committed force follows and supports a lead force conducting an offensive task. The follow-and-support force is not a reserve but is a force committed to specific tasks. (Figure B-7 shows the tactical mission graphic for follow and support.) The commander places the box part of the graphic around the symbol of the unit being assigned this task.

B-32. Tasks for a follow-and-support force include—

- Destroying bypassed enemy units when the lead unit does not clear the AO as it advances.
- Blocking movement of enemy reinforcements.
- Relieving in place any direct-pressure or encircling force halted to contain the enemy.
- Securing lines of communication.
- Clearing obstacles.
- Guarding prisoners, key areas, and installations.
- Recovering friendly battle losses.
- Securing key terrain.
- Controlling dislocated civilians.

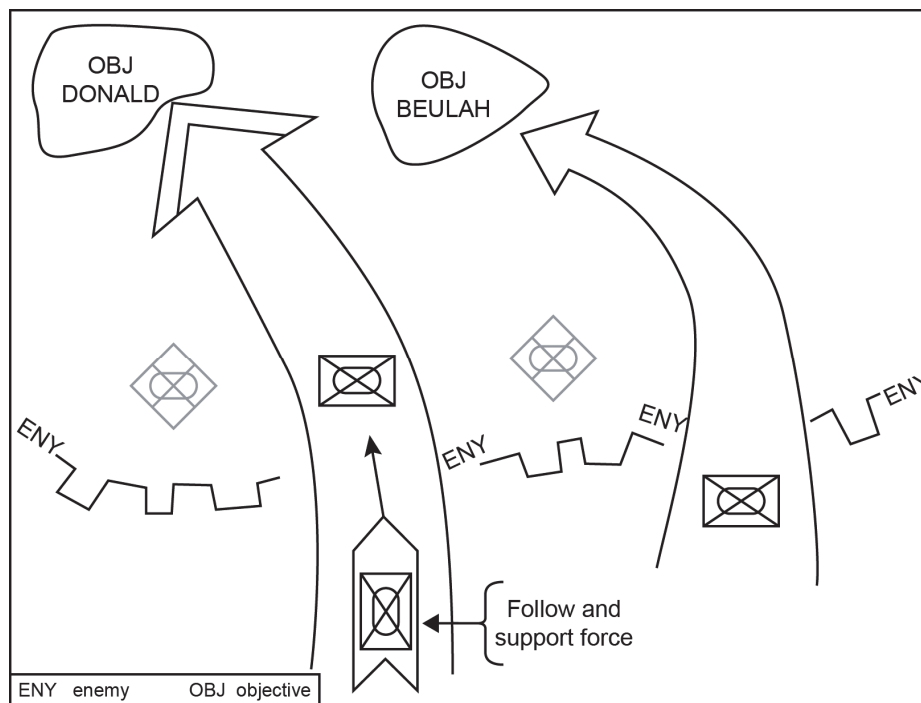

Figure B-7. Follow and support tactical mission graphic

B-33. A commander assigns a unit the task of follow and support to keep the supported force from having to commit its combat power to tasks other than the decisive operation, which would slow the offensive operation's momentum and tempo. The follow-and-support force accomplishes its tasks to prevent the enemy, obstacles, and other factors from interfering with offensive actions, especially along the lines of communications.

B-34. The commander assigning the follow-and-support task has two options in establishing the relationship between the supported and the supporting units. The commander can place the follow-and-support unit in a standard command relationship with the supported unit, such as attached or operational control. Alternatively, the commander can retain command of the follow-and-support force and require that all tasking requests from the supported unit go through the commander's headquarters.

OCCUPY

B-35. *Occupy* is a tactical mission task that involves moving a friendly force into an area so that it can control that area. Both the force's movement to and occupation of the area occur without enemy opposition. A unit can control an area without occupying it, but not vice versa. That is the difference between the tactical mission tasks of occupy and control. (Figure B-8 shows the occupy tactical mission graphic. The X on the tactical mission graphic has no significance, but the graphic should encompass the entire area that the commander desires to occupy.) Units typically occupy assembly areas, objectives, and defensive positions.

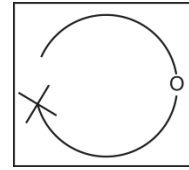

Figure B-8.
Occupy tactical mission graphic

REDUCE

B-36. *Reduce* is a tactical mission task that involves the destruction of an encircled or bypassed enemy force. There is no tactical mission graphic for this task. This task can occur at any location on the battlefield. (FM 3-90-2 discusses the reduction of an encircled enemy.) *Reduce* is also a mobility task that involves creating and marking sufficient lanes through, over, or around an obstacle to negate its intended effect (ATTP 3-90.4).

RETAIN

B-37. *Retain* is a tactical mission task in which the commander ensures that a terrain feature controlled by a friendly force remains free of enemy occupation or use. The commander assigning this task specifies the area to retain and the duration of the retention, which is time- or event-driven. While a unit is conducting this task, it expects the enemy to attack and prepares to become decisively engaged. A unit tasked to retain a specific piece of terrain does not necessarily have to occupy it. (Figure B-9 shows the tactical mission graphic for retain. The direction of the arrow has no significance, but the graphic includes the entire area the commander wants to retain.)

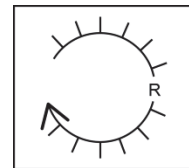

Figure B-9.
Retain tactical mission graphic

SECURE

B-38. *Secure* is a tactical mission task that involves preventing a unit, facility, or geographical location from being damaged or destroyed as a result of enemy action. This task normally involves conducting area security operations. (See FM 3-90 Volume 2.) A force given the mission of securing a unit, facility, or geographical location, such as a route or base, not only prevents enemy forces from over-running or occupying the secured location, but also prevents enemy direct fires and observed indirect fires from impacting the secured location, unit, or facility. This is the primary difference between control and secure. The control tactical mission task allows enemy direct and indirect fires to affect the location being controlled. A unit does not have to physically occupy the area immediately around the unit, facility, or geographical location it is securing, if it can prevent the enemy from occupying or firing at that location by other means. The commander states the mission duration in terms of time or event when assigning a mission to secure a given unit, facility, or geographical location. (Figure B-10 shows the tactical mission graphic for secure. The direction of the arrow has no significance, but the graphic includes the entire area the commander wants to secure.)

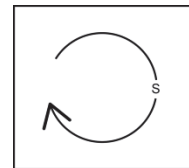

Figure B-10.
Secure tactical mission graphic

SEIZE

B-39. **Seize** is a tactical mission task that involves taking possession of a designated area by using overwhelming force. (Figure B-11 shows the tactical mission graphic for seize.) An enemy force can no longer place direct fire on an objective that has been seized. The arrow points to the location or objective to seize. This task differs from secure because it requires offensive action to obtain control of the designated area or objective. It differs from the task of occupy because it involves overcoming anticipated enemy opposition. Once a force seizes a physical objective, it clears the terrain within that objective by killing, capturing, or forcing the withdrawal of all enemy forces.

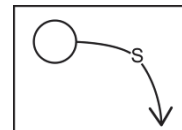

Figure B-11.
Seize tactical mission graphic

SUPPORT BY FIRE

B-40. **Support by fire** is a tactical mission task in which a maneuver force moves to a position where it can engage the enemy by direct fire in support of another maneuvering force. The primary objective of the support force is normally to fix and suppress the enemy so that the enemy cannot effectively fire on the maneuvering force. The secondary objective is to destroy the enemy if the enemy tries to reposition. The commander specifies the desired effect on the enemy when assigning this task.

B-41. A unit conducting the task of support by fire does not maneuver to capture enemy forces or terrain. The commander gives this task to another unit as part of a larger maneuver. When assigning a support by fire mission, the commander designates the enemy, when to attack, the general location from which to operate, the friendly force to support, and the purpose of the task, such as fix or suppress. (Figure B-12 shows the tactical mission graphic for support by fire.) The ends of the arrows point in the general direction of the targeted unit or location. The base of the area indicates the general area from which to deliver fires.

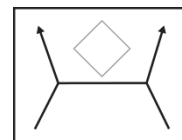

Figure B-12.
Support by fire tactical mission graphic

B-42. Once the commander gives an element the task of support by fire, it should occupy support by fire positions that have cover and concealment, good observation, and clear fields of fire. Elements occupying support by fire positions should—

- Check the security of the position.
- Search for targets.
- Orient weapons on likely or suspected enemy positions.
- Assume fighting positions that provide some degree of protection. Armored and Stryker equipped forces occupy hull-down firing positions, while infantry forces use trees, natural berms, buildings, and similar existing terrain features.
- Assign observation sectors to each Soldier or weapon system in the support by fire element.
- Use available thermal sights to locate heat sources not visible to the naked eye, such as vehicles concealed in tree lines or other wooded areas or personnel serving at observation posts (OPs).

B-43. Support by fire closely resembles the task of attack by fire. The difference is that support by fire supports another force so that it can maneuver against the enemy, while an attack by fire does not support the maneuver of another friendly force.

EFFECTS ON ENEMY FORCE

B-44. The following tactical mission tasks address effects on enemy forces. They are the *what* or *why* of a mission statement. Most of these effects have associated tactical mission graphics that are used in course of action development and sketches as part of the military decisionmaking process.

BLOCK

B-45. **Block** is a tactical mission task that denies the enemy access to an area or prevents the enemy's advance in a direction or along an avenue of approach. A blocking task normally requires the friendly force to block the enemy force for a certain

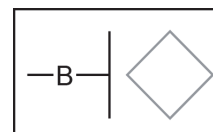

Figure B-13. Block
tactical mission graphic

time, or until a specific event has occurred. The line perpendicular to the enemy's line of advance indicates the limit of enemy advance. A blocking unit may have to hold terrain and become decisively engaged. (Figure B-13 illustrates the tactical mission graphic for a blocking task.)

B-46. **Block** is also an obstacle effect that integrates fire planning and obstacle efforts to stop an attacker along a specific avenue of approach or prevent the attacking force from passing through an engagement area. The vertical line in the obstacle effect graphic indicates the limit of enemy advance. It also indicates where the obstacle ties in to restricted terrain. (Figure B-14 illustrates the block obstacle effect graphic.) A force may employ blocking obstacles to assist in the task. Blocking obstacles are complex, employed in depth, and integrated with fires to prevent the enemy from proceeding along an avenue of approach, or to proceed only at unacceptable cost. When employed, blocking obstacles serve as a limit, not allowing the enemy beyond that point. Obstacles alone cannot accomplish a blocking task. (FM 90-7 describes the block engineer obstacle effect.)

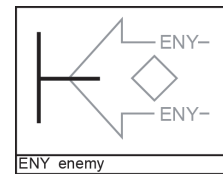

Figure B-14. Block obstacle effect graphic

B-47. Block as a tactical mission task differs from the tactical mission task of fix because a blocked enemy force can move in any direction other than the obstructed one, while a fixed enemy force cannot move in any direction.

CANALIZE

B-48. **Canalize** is a tactical mission task in which the commander restricts enemy movement to a narrow zone by exploiting terrain coupled with the use of obstacles, fires, or friendly maneuver. (See figure B-15.) Figure B-16 shows how successful canalization results in moving the enemy formation or individual Soldiers and weapon systems into a predetermined position where they are vulnerable to piecemeal destruction.

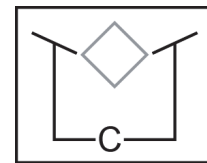

Figure B-15. Canalize tactical mission graphic

CONTAIN

B-49. **Contain** is a tactical mission task that requires the commander to stop, hold, or surround enemy forces or to cause them to center their activity on a given front and prevent them from withdrawing any part of their forces for use elsewhere. Containment allows an enemy force to reposition itself within the designated geographical area, while fixing an enemy does not. Geographic terms or time may express the limits of the containment. The contain graphic encompasses the entire area in which the commander desires to contain the enemy during the development of alternative courses of action. (Figure B-17 on page B-12 shows the tactical control graphic for contain.)

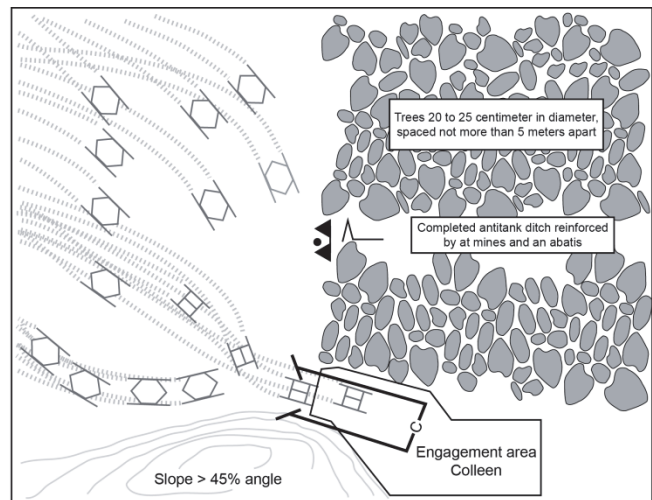

Figure B-16. Canalizing terrain enhanced by obstacles used with an engagement area

DEFEAT

B-50. **Defeat** is a tactical mission task that occurs when an enemy force has temporarily or permanently lost the physical means or the will to fight. The defeated force's commander is unwilling or unable to pursue that individual's adopted course of action, thereby yielding to the friendly commander's will and can no longer interfere to a significant degree with the actions of friendly forces. Defeat can result from the use of force or the threat of its use.

B-51. A commander can generate different effects against an enemy to defeat that force:

- Physical. The enemy loses the physical means to continue fighting. The enemy force no longer has the personnel, weapon systems, equipment, or supplies to carry out its mission.
- Psychological. The enemy loses the will to fight. Enemy commanders and their soldiers become mentally exhausted, and their morale is so low that they can no longer accomplish their missions.

These effects typically occur because of catastrophic losses inflicted over a very short time or from sustained attrition. An opponent who is not ideologically motivated may be defeated psychologically on observing preparations for the delivery of clearly overwhelming combat power on the position that opponent occupies. Defeat manifests itself in some sort of physical action, such as mass surrenders, abandonment of significant quantities of equipment and supplies, or retrograde operations.

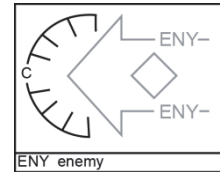

Figure B-17. Contain tactical mission graphic

DESTROY

B-52. *Destroy* is a tactical mission task that occurs when an enemy force has temporarily or permanently lost the physical means or the will to fight. The defeated force's commander is unwilling or unable to pursue that individual's adopted course of action, thereby yielding to the friendly commander's will and can no longer interfere to a significant degree with the actions of friendly forces. Defeat can result from the use of force or the threat of its use. The amount of damage needed to render a unit combat-ineffective depends on the unit's type, discipline, and morale. Destroying armored or dug-in targets with area fire weapons requires considerable ammunition and time, so forces do not normally attempt it unless they have terminally guided munitions. (Figure B-18 shows the tactical mission graphic for destroy.)

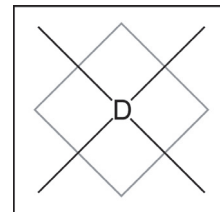

Figure B-18. Destroy tactical mission graphic

DISRUPT

B-53. *Disrupt* is a tactical mission task in which a commander integrates direct and indirect fires, terrain, and obstacles to upset an enemy's formation or tempo, interrupt the enemy's timetable, or cause enemy forces to commit prematurely or attack in a piecemeal fashion. This increases the enemy's vulnerability to friendly fires. It may temporarily knock a unit out of the battle. Disruption is never an end; it is the means to an end. (Figure B-19 shows the tactical mission graphic for disrupt. The center arrow points toward the targeted enemy unit.)

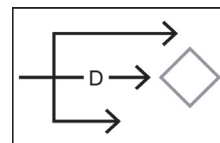

Figure B-19. Disrupt tactical mission graphic

B-54. The maneuver force attempting to disrupt an enemy must attack the defending enemy with enough combat power to achieve the desired results with one mass attack or sustain the attack until it achieves the desired results. It may involve attacking the enemy force while it is still in its assembly areas or in an approach march before it can deploy into a combat formation. The commander determines the degree of acceptable risk based on anticipated friendly losses, the location of the attack, the number of attacks, and other risk management factors.

B-55. *Disrupt* is also an obstacle effect that focuses fire planning and obstacle effort to cause the enemy force to break up its formation and tempo, interrupt its timetable, commit breaching assets prematurely, and attack in a piecemeal effort. It also helps to deceive the enemy concerning the location of friendly defensive positions, to separate combat echelons, or to separate combat forces from their logistic support. As shown in figure B-20, the short arrow(s) in the obstacle-effect graphic indicates where obstacles impact the enemy's ability to maneuver. The longer arrow(s) indicate where the commander allows the enemy to bypass the obstacle

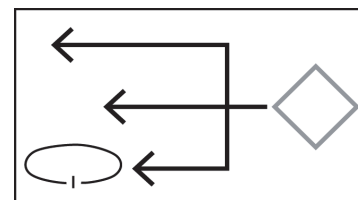

Figure B-20. Disrupt obstacle intent graphic

effect, so the defending force can attack the enemy with fires. The arrows indicate the direction of enemy attack. A defending commander normally uses the disrupt obstacle effect forward of EAs. Obstacles alone cannot disrupt an enemy unit. (FM 90-7 describes the disrupt engineer obstacle effect.)

FIX

B-56. **Fix is a tactical mission task where a commander prevents the enemy force from moving any part of that force from a specific location for a specific period.** This may occur by engaging the enemy force to prevent its withdrawal for use elsewhere, or by using military deception, such as transmitting false orders. The commander uses fix in offensive and defensive actions; it is always a shaping operation. (Figure B-21 shows the tactical mission graphic for fix.) The commander points the arrow toward the desired enemy unit to fix. The broken part of the arrow indicates the desired location for that event to occur.

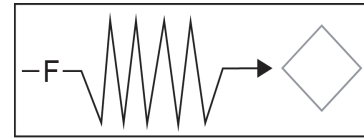

Figure B-21. Fix tactical mission graphic

B-57. Fixing an enemy force does not mean destroying it. The friendly force has to prevent the enemy from moving in any direction. This task usually has a time constraint, such as “fix the enemy reserve force until OBJECTIVE FALON, the decisive operation, is secured.” The tactical mission task of fix differs from that of block in that a fixed enemy force cannot move from a given location, but a blocked enemy force can move in any direction other than the one obstructed.

B-58. **Fix is also an obstacle effect that focuses fire planning and obstacle effort to slow an attacker’s movement within a specified area, normally an engagement area.** The primary use of this effect is to give the friendly unit time to acquire, target, and destroy the attacking enemy with direct and indirect fires throughout the depth of an EA or avenue of approach. The irregular part of the arrow in the obstacle-intent graphic indicates the location where the enemy’s rate of advance will be slowed by complex obstacles. The arrow indicates the direction of enemy advance. (See Figure B-22.) (FM 90-7 describes the fix engineer obstacle effect.)

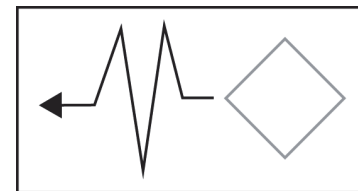

Figure B-22. Fix obstacle intent graphic

INTERDICTION

B-59. **Interdict is a tactical mission task where the commander prevents, disrupts, or delays the enemy’s use of an area or route.** Interdiction is a shaping operation conducted to complement and reinforce other ongoing offensive or defensive tasks. (Figure B-23 shows the tactical mission graphic for interdict.) The two arrows should cross on the unit or location targeted for interdiction. An interdiction tasking must specify how long to interdict, defined as a length of time or some event that must occur before the interdiction is lifted, or the exact effect desired from the interdiction.

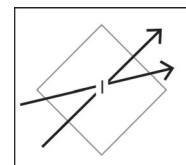

Figure B-23. Interdict tactical mission graphic

B-60. The depth at which the attacking force conducts the interdiction generally determines the friendly force’s freedom of action. Increasing the depth of operations reduces the danger of fratricide to air and surface forces, reduces the coordination required, and allows increasingly flexible operations. Aerial forces, such as attack helicopters and fixed-wing aircraft, can attack the enemy to interdict the enemy’s movement throughout the AO.

B-61. The depth at which interdiction takes place also determines the speed with which its effects are observed. Normally, ground maneuver units first focus on targets close to the forward of line own troops (FLOT). Interdiction efforts there have immediate impact on enemy forces near the interdiction target but do not affect the enemy’s ability to mass force effects. Attacks at greater distances from the FLOT have a delayed impact on close combat but eventually degrade the enemy’s ability to mass effects.

B-62. The friendly force’s capability to interdict may have a devastating impact on the enemy’s plans and ability to respond to friendly actions. For example, interdiction efforts that result in the enemy’s maneuver

being delayed or disrupted enhance the friendly force’s ability to achieve tactical advantages. Delaying or disrupting enemy resupply efforts limits the enemy’s ability to sustain intense, high-tempo offensive or defensive actions and restricts enemy mobility.

B-63. Interdicting the movement of enemy units can be extremely effective in assisting their encirclement and eventual destruction. Fixed enemy ground forces—or those trapped by the loss of their mobility—provide lucrative targets. The commander plans to interdict withdrawing enemy forces to enhance the pursuit. While interdiction can contribute to success by hampering reinforcement and resupply, it can also contribute by trapping enemy forces or canalizing their maneuvers, leading to their destruction in detail.

ISOLATE

B-64. *Isolate* is a tactical mission task that requires a unit to seal off—both physically and psychologically—an enemy from sources of support, deny the enemy freedom of movement, and prevent the isolated enemy force from having contact with other enemy forces. A commander does not allow an isolated enemy force sanctuary within its present position but continues to conduct offensive actions against the enemy force. (Figure B-24 shows the tactical mission graphic for isolate. The position or direction of the arrow has no significance, but the graphic surrounds the targeted enemy unit.)

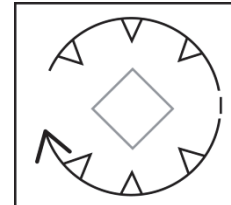

Figure B-24.
Isolate tactical mission graphic

NEUTRALIZE

B-65. *Neutralize* is a tactical mission task that results in rendering enemy personnel or materiel incapable of interfering with a particular operation. (Figure B-25 shows the neutralize tactical mission graphic.) The two lines cross over the symbol of the unit or facility targeted for neutralization. When assigning a task to neutralize, the commander specifies the enemy force or materiel to neutralize and the duration, which is time- or event-driven. The neutralized target may become effective again when casualties are replaced, damage is repaired, or effort resulting in the neutralization is lifted. The commander normally uses a combination of lethal and nonlethal effects to neutralize enemy personnel or materiel. The assets required to neutralize a target vary according to the type and size of the target and the weapon and munitions combination used.

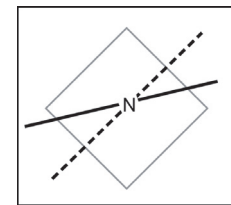

Figure B-25.
Neutralize tactical mission graphic

SUPPRESS

B-66. *Suppress* is a tactical mission task that results in the temporary degradation of the performance of a force or weapon system below the level needed to accomplish its mission. It occurs when a commander employs direct or indirect lethal and nonlethal effects, such as artillery, electronic warfare, or smoke on enemy personnel, weapons, and equipment to prevent or degrade enemy fires, sensors, and visual observation of friendly forces. Unlike the neutralization task, the original target regains its effectiveness without needing to reconstitute, once the effects of the systems involved in the suppression effort lift or shift to another target. (Figure B-26 shows the suppress tactical mission task graphic.)

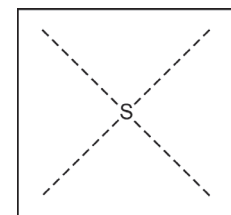

Figure B-26.
Suppress tactical mission task graphic

TURN

B-67. **Turn** is a tactical mission task that involves forcing an enemy element from one avenue of approach or mobility corridor to another. The commander relates obstacles, fires, and terrain to improve the friendly tactical situation while degrading the enemy's situation. For example, in the offense, a commander might want to turn an enemy force being pursued to place it in a position where the enemy force can be destroyed. In the defense, a commander might want to turn an attacking enemy force to allow the friendly force to conduct a counterattack into the enemy's flank. (Figure B-27 shows the turn tactical mission graphic. The place where the arrow breaks indicates the general location of the obstacle complex that will force the enemy to move from one avenue of approach to another.)

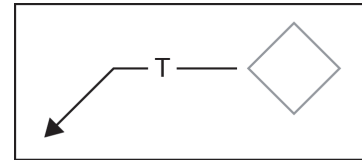

Figure B-27. Turn tactical mission graphic

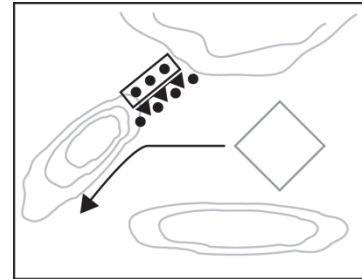

Figure B-28. Turn obstacle effect

B-68. **Turn** is also a tactical obstacle effect that integrates fire planning and obstacle effort to divert an enemy formation from one avenue of approach to an adjacent avenue of approach or into an engagement area. Its development requires well-defined mobility corridors and avenues of approach. To achieve this effect, the obstacles have a subtle orientation relative to the enemy's approach as shown in figure B-28. The obstacles and their associated fires allow bypasses in the direction desired by the friendly scheme of maneuver. Finally, the obstacles tie into restrictive terrain at the initial point of the turn. A commander normally uses the turn effect on the flanks of an EA. The direction of the arrow indicates the desired direction of turn. (See FM 90-7 for more information on tactical obstacle effects.)

This page intentionally left blank.

Glossary

The glossary lists acronyms and terms with Army, multi-Service, or joint definitions, and other selected terms. Where Army and joint definitions are different, (*Army*) follows the term. Terms for which FM 3-90 is the proponent publication (the authority) are marked with an asterisk (*). The proponent publication for other terms is listed in parentheses after the definition.

SECTION I – ACRONYMS AND ABBREVIATIONS

AA	assembly area
AAMDC	Army air and missile defense command
ABCT	armored brigade combat team
ACM	airspace coordinating measure
ADAM	air defense airspace management
ADP	Army doctrine publication
ADRP	Army doctrine reference publication
ALO	air liaison officer
AMD	air and missile defense
AO	area of operations
ARFOR	Army forces
ASCC	Army Service component command
ASCOPE	areas, structures, capabilities, organizations, people, and events
ATTP	Army tactics, techniques, and procedures
BCT	brigade combat team
BFSB	battlefield surveillance brigade
BHL	battle handover line
BP	battle position
BSB	brigade support battalion
C2	command and control
CAB	combined arms battalion
CAS	close air support
CBRN	chemical, biological radiological, and nuclear
CBRNE	chemical, biological, radiological, nuclear, and high-yield explosives
CFL	coordinated fire line
CFZ	critical friendly zone
CI	counterintelligence
COA	course of action
COLT	combat observation and lasing team
COP	common operational picture
CP	command post
CREW	counter-radio controlled improvised explosive device electronic warfare systems

Glossary

DLIC	detachment left in contact
DOD	Department of Defense
EA	engagement area
EOD	explosive ordnance disposal
ENY	enemy
EW	electronic warfare
FARP	forward arming and refuel point
FCL	final coordination line
FEBA	forward edge of the battle area
FFA	free-fire area
FLOT	forward line of own troops
FM	field manual
FOB	forward operating base
FPF	final protective fire
FRAGORD	fragmentary order
FSCL	fire support coordination line
FSCM	fire support coordination measure
FSCOORD	fire support coordinator
G-1	assistant chief of staff, personnel
G-2	assistant chief of staff, intelligence
G-3	assistant chief of staff, operations
G-4	assistant chief of staff, logistics
G-6	assistant chief of staff, signal
G-8	assistant chief of staff, resource management
GEOINT	geospatial intelligence
GPS	global positioning system
IBCT	infantry brigade combat team
IED	improvised explosive device
IPB	intelligence preparation of the battlefield
ISB	intermediate staging base
JAAT	joint air attack team
JFACC	joint force air component commander
JP	joint publication
LC	line of contact
LD	line of departure
LOA	limit of advance
LOC	line of communication
LOGPAC	logistics package
LZ	landing zone
MBA	main battle area
MEB	maneuver enhancement brigade

METT-TC	mission, enemy, terrain and weather, troops and support available, time available, and civil considerations
MISO	military information support operations
MLRS	Multiple Launch Rocket System
MOPP	mission-oriented protective posture
MSR	main supply route
NAI	named area of interest
NFA	no-fire area
OAKOC	observation and fields of fire, avenues of approach, key terrain, obstacles, and cover and concealment
OP	observation post
OPCON	operational control
OPORD	operations order
OPSEC	operations security
ORA	obstacle restricted area
ORSA	operations research/systems analysis
OSINT	open-source intelligence
PAA	position area for artillery
PD	point of departure
PL	phase line
PLD	probable line of deployment
PMESII-PT	political, military, economic, social, information, infrastructure, physical environment, and time
POL	petroleum, oils, and lubricants
PZ	pickup zone
QRF	quick response force
RFA	restrictive fire area
RFL	restrictive fire line
RIP	relief in place
RP	release point
S-1	personnel staff officer
S-2	intelligence staff officer
S-3	operations staff officer
S-4	logistics staff officer
S-6	signal staff officer
S-9	civil-military operations officer
SBCT	Stryker brigade combat team
SOF	special operations forces
SOP	standard operating procedure
SP	start point
TACP	tactical air control party
TAI	target area of interest

TCF	tactical combat force
TRP	target reference point
UAS	unmanned aircraft system
U.S.	United States
USAF	U.S. Air Force
UXO	unexploded ordnance
WMD	weapons of mass destruction

SECTION II – TERMS

actions on contact

A series of combat actions often conducted simultaneously taken on contact with the enemy to develop the situation. (ADRP 3-90)

active air defense

Direct defensive action taken to destroy, nullify, or reduce the effectiveness of hostile air and missile threats against friendly forces and assets. (JP 3-01)

air assault

The movement of friendly assault forces (combat, combat support, and combat service support) by rotary-wing aircraft to engage and destroy enemy forces or to seize and hold key terrain. (JP 3-18)

airspace control

A process used to increase operational effectiveness by promoting the safe, efficient, and flexible use of airspace. (JP 3-52)

alternate position

A defensive position that the commander assigns to a unit or weapon for occupation when the primary position becomes untenable or unsuitable for carrying out the assigned task. (ADRP 3-90)

***ambush**

An attack by fire or other destructive means from concealed positions on a moving or temporarily halted enemy.

area defense

A defensive task that concentrates on denying enemy forces access to designated terrain for a specific time rather than destroying the enemy outright. (ADRP 3-90)

area of influence

A geographical area wherein a commander is directly capable of influencing operations by maneuver or fire support systems normally under the commander's command or control. (JP 3-0)

area of interest

That area of concern to the commander, including the area of influence, areas adjacent thereto, and extending into enemy territory. This area also includes areas occupied by enemy forces who could jeopardize the accomplishment of the mission. (JP 3-0)

area of operations

An operational area defined by the joint force commander for land and maritime forces that should be large enough to accomplish their missions and protect their forces. (JP 3-0)

assault position

A covered and concealed position short of the objective from which final preparations are made to assault the objective. (ADRP 3-90)

assault time

The moment to attack the initial objectives throughout the geographical scope of the operation. (ADRP 3-90)

***assembly area**

An area a unit occupies to prepare for an operation.

attack

An offensive task that destroys or defeats enemy forces, seizes and secures terrain, or both. (ADRP 3-90)

***attack by fire**

A tactical mission task in which a commander uses direct fires, supported by indirect fires, to engage an enemy force without closing with the enemy to destroy, suppress, fix, or deceive that enemy.

attack by fire position

The general position from which a unit conducts the tactical task of attack by fire. (ADRP 3-90)

attack position

(Army) The last position an attacking force occupies or passes through before crossing the line of departure. (ADRP 3-90)

axis of advance

(Army) The general area through which the bulk of a unit's combat power must move. (ADRP 3-90)

battle handover line

A designated phase line on the ground where responsibility transitions from the stationary force to the moving force and vice versa. (ADRP 3-90)

battle position

A defensive location oriented on a likely enemy avenue of approach. (ADRP 3-90)

***block**

A tactical mission task that denies the enemy access to an area or prevents the enemy's advance in a direction or along an avenue of approach. Block is also an obstacle effect that integrates fire planning and obstacle efforts to stop an attacker along a specific avenue of approach or prevent the attacking force from passing through an engagement area.

boundary

A line that delineates surface areas for the purpose of facilitating coordination and deconfliction of operations between adjacent units, formations, or areas. (JP 3-0)

***box formation**

A unit formation with subordinate elements arranged in a box or square, or two elements up and two elements back. It is a flexible formation that provides equal firepower in all directions. It is generally used when the enemy location is known. This formation can cause 50 percent of the force to be decisively engaged at the same time, therefore limiting the combat power available to maneuver against an enemy.

***breach**

A tactical mission task in which the unit employs all available means to break through or establish a passage through an enemy defense, obstacle, minefield, or fortification.

***breakthrough**

A rupturing of the enemy's forward defenses that occurs as a result of a penetration. A breakthrough permits the passage of an exploitation force.

***bypass**

A tactical mission task in which the commander directs the unit to maneuver around an obstacle, position, or enemy force to maintain the momentum of the operation while deliberately avoiding combat with an enemy force.

Glossary

bypass criteria

Measures during the conduct of an offensive operation established by higher headquarters that specify the conditions and size under which enemy units and contact may be avoided. (ADRP 3-90)

***canalize**

(Army) A tactical mission task in which the commander restricts enemy movement to a narrow zone by exploiting terrain coupled with the use of obstacles, fires, or friendly maneuver.

checkpoint

A predetermined point on the ground used to control movement, tactical maneuver, and orientation. (ADRP 1-02)

***clear**

A tactical mission task that requires the commander to remove all enemy forces and eliminate organized resistance within an assigned area.

close combat

Warfare carried out on land in a direct-fire fight, supported by direct and indirect fires and other assets. (ADRP 3-0)

***column formation**

The column formation is a combat formation in which elements are placed one behind the other.

combat formation

A combat formation is an ordered arrangement of forces for a specific purpose and describes the general configuration of a unit on the ground. (ADRP 3-90)

combined arms

The synchronized and simultaneous application of arms to achieve an effect greater than if each arm was used separately or sequentially. (ADRP 3-0)

concept of operations

A verbal or graphic statement that clearly and concisely expresses what the joint force commander intends to accomplish and how it will be done using available resources. (JP 5-0)

***consolidation**

Organizing and strengthening a newly captured position so that it can be used against the enemy.

contact point

In land warfare, a point on the terrain, easily identifiable, where two or more ground units are required to make physical contact. (JP 3-50)

***contain**

(Army) A tactical mission task that requires the commander to stop, hold, or surround enemy forces or to cause them to center their activity on a given front and prevent them from withdrawing any part of their forces for use elsewhere.

***contiguous area of operations**

Where all of a commander's subordinate forces' areas of operations share one or more common boundaries.

***control**

(Army) A tactical mission task that requires the commander to maintain physical influence over a specified area to prevent its use by an enemy or to create conditions necessary for successful friendly operations.

coordinated fire line

A line beyond which conventional and indirect surface fire support means may fire at any time within the boundaries of the establishing headquarters without additional coordination. The purpose of the coordinated fire line is to expedite the surface-to-surface attack of targets beyond the coordinated fire line without coordination with the ground commander in whose area the targets are located. (JP 3-09)

***cordon and search**

A technique of conducting a movement to contact that involves isolating a target area and searching suspected locations within that target area to capture or destroy possible enemy forces and contraband.

counterattack

Attack by part or all of a defending force against an enemy attacking force, for such specific purposes as regaining ground lost, or cutting off or destroying enemy advance units, and with the general objective of denying to the enemy the attainment of the enemy's purpose in attacking. In sustained defensive operations, it is undertaken to restore the battle position and is directed at limited objectives. (ADRP 1-02)

counterfire

Fire intended to destroy or neutralize enemy weapons. Includes counterbattery and countermortar fire. (JP 3-09)

countermobility operations

Those combined arms activities that use or enhance the effects of natural and man-made obstacles to deny an adversary freedom of movement and maneuver. (FM 3-34)

***counterreconnaissance**

(Army) A tactical mission task that encompasses all measures taken by a commander to counter enemy reconnaissance and surveillance efforts. Counterreconnaissance is not a distinct mission, but a component of all forms of security operations.

critical friendly zone

An area, usually a friendly unit or location, which the maneuver commander designates as critical to the protection of an asset whose loss would seriously jeopardize the mission. (ADRP 1-02)

decisive operation

The operation that directly accomplishes the mission. (ADRP 3-0)

***decisive terrain**

Key terrain whose seizure and retention is mandatory for successful mission accomplishment.

***defeat**

A tactical mission task that occurs when an enemy force has temporarily or permanently lost the physical means or the will to fight. The defeated force's commander is unwilling or unable to pursue that individual's adopted course of action, thereby yielding to the friendly commander's will and can no longer interfere to a significant degree with the actions of friendly forces. Defeat can result from the use of force or the threat of its use.

defensive task

A task conducted to defeat an enemy attack, gain time, economize forces, and develop conditions favorable for offensive or stability tasks. (ADRP 3-0)

***delay line**

A phase line where the date and time before which the enemy is not allowed to cross the phase line is depicted as part of the graphic control measure.

delaying operation

An operation in which a force under pressure trades space for time by slowing down the enemy's momentum and inflicting maximum damage on the enemy without, in principle, becoming decisively engaged. (JP 3-04)

demonstration

In military deception, a show of force in an area where a decision is not sought that is made to deceive an adversary. It is similar to a feint but no actual contact with the adversary is intended. (JP 3-13.4)

***denial operations**

Actions to hinder or deny the enemy the use of space, personnel, supplies, or facilities.

***destroy**

A tactical mission task that occurs when an enemy force has temporarily or permanently lost the physical means or the will to fight. The defeated force's commander is unwilling or unable to pursue that individual's adopted course of action, thereby yielding to the friendly commander's will and can no longer interfere to a significant degree with the actions of friendly forces. Defeat can result from the use of force or the threat of its use.

***detachment left in contact**

An element left in contact as part of the previously designated (usually rear) security force while the main body conducts its withdrawal.

***diamond formation**

A diamond formation is a variation of the box combat formation with one maneuver unit leading, maneuver units positioned on each flank, and the remaining maneuver unit to the rear.

***direct pressure force**

A force employed in a pursuit operation that orients on the enemy main body to prevent enemy disengagement or defensive reconstitution prior to envelopment by the encircling force. It normally conducts a series of attacks to slow the enemy's retirement by forcing the enemy to stand and fight.

direction of attack

A specific direction or assigned route a force uses and does not deviate from when attacking. (ADRP 3-90)

***disengage**

A tactical mission task where a commander has the unit break contact with the enemy to allow the conduct of another mission or to avoid decisive engagement.

disengagement line

A phase line located on identifiable terrain that, when crossed by the enemy, signals to defending elements that it is time to displace to their next positions. (ADRP 3-90)

***disrupt**

1. A tactical mission task in which a commander integrates direct and indirect fires, terrain, and obstacles to upset an enemy's formation or tempo, interrupt the enemy's timetable, or cause enemy forces to commit prematurely or attack in a piecemeal fashion. 2. An obstacle effect that focuses fire planning and obstacle effort to cause the enemy force to break up its formation and tempo, interrupt its timetable, commit breaching assets prematurely, and attack in a piecemeal effort. (FM 90-7)

***double envelopment**

This results from simultaneous maneuvering around both flanks of a designated enemy force.

***echelon formation**

A unit formation with subordinate elements arranged on an angle to the left or to the right of the direction of attack (echelon left, echelon right). This formation provides for firepower forward and to the flank of the direction of the echelon. It facilitates control in open areas. It provides minimal security to the opposite flank of the direction of the echeloning.

encirclement operations

Operations where one force loses its freedom of maneuver because an opposing force is able to isolate it by controlling all ground lines of communication and reinforcement. (ADRP 3-90)

***encircling force**

In pursuit operations, the force which maneuvers to the rear or flank of the enemy to block the enemy's escape so that the enemy can be destroyed between the direct pressure force and encircling force. This force advances or flies along routes parallel to the enemy's line of retreat. If the encircling force cannot outdistance the enemy to cut the enemy off, the encircling force may also attack the flank of a retreating enemy.

***engagement area**

Where the commander intends to contain and destroy an enemy force with the massed effects of all available weapons and supporting systems.

***engagement criteria**

Protocols that specify those circumstances for initiating engagement with an enemy force.

***engagement priority**

The order in which the unit engages enemy systems or functions.

***envelopment**

A form of maneuver in which an attacking force seeks to avoid the principal enemy defenses by seizing objectives behind those defenses that allow the targeted enemy force to be destroyed in their current positions.

***exfiltrate**

A tactical mission task where a commander removes Soldiers or units from areas under enemy control by stealth, deception, surprise, or clandestine means.

exploitation

An offensive task that usually follows a successful attack and is designed to disorganize the enemy in depth. (ADRP 3-90)

feint

In military deception, an offensive action involving contact with the adversary conducted for the purpose of deceiving the adversary as to the location and/or time of the actual main offensive action. (JP 3-13.4)

***field of fire**

The area that a weapon or group of weapons may cover effectively from a given position.

final coordination line

A phase line close to the enemy position used to coordinate the lifting or shifting of supporting fires with the final deployment of maneuver elements. (ADRP 3-90)

final protective fire

An immediately available preplanned barrier of fires designed to impede enemy movement across defensive lines or areas. (JP 1-02)

***fire superiority**

That degree of dominance in the fires of one force over another that permits that force to conduct maneuver at a given time and place without prohibitive interference by the enemy.

fire support coordination line

A fire support coordination measure that is established and adjusted by appropriate land or amphibious force commanders within their boundaries in consultation with superior, subordinate, supporting, and affected commanders. Fire support coordination lines facilitate the expeditious attack of surface targets of opportunity beyond the coordinating measure. A fire support coordination line does not divide an area of operations by defining a boundary between close and deep operations or a zone for close air support. The fire support coordination line applies to all fires of air, land, and sea-based weapon systems using any type of ammunition. Forces attacking targets beyond a fire support coordination line must inform all affected commanders in sufficient time to allow necessary reaction to avoid fratricide. Supporting elements attacking targets beyond the fire support coordination line must

ensure that the attack will not produce adverse effects on, or to the rear of, the line. Short of a fire support coordination line, all air-to-ground and surface-to-surface attack operations are controlled by the appropriate land or amphibious force commander. The fire support coordination line should follow well-defined terrain features. Coordination of attacks beyond the fire support coordination line is especially critical to commanders of air, land, and special operations forces. In exceptional circumstances, the inability to conduct this coordination will not preclude the attack of targets beyond the fire support coordination line. However, failure to do so may increase the risk of fratricide and could waste limited resources. (JP 3-09)

***fix**

A tactical mission task where a commander prevents the enemy force from moving any part of that force from a specific location for a specific period. Fix is also an obstacle effect that focuses fire planning and obstacle effort to slow an attacker's movement within a specified area, normally an engagement area.

***flank attack**

A form of offensive maneuver directed at the flank of an enemy.

***follow and assume**

A tactical mission task in which a second committed force follows a force conducting an offensive task and is prepared to continue the mission if the lead force is fixed, attrited, or unable to continue.

***follow and support**

A tactical mission task in which a committed force follows and supports a lead force conducting an offensive task.

forms of maneuver

Distinct tactical combinations of fire and movement with a unique set of doctrinal characteristics that differ primarily in the relationship between the maneuvering force and the enemy. (ADRP 3-90)

***forward boundary**

A boundary of an echelon that is primarily designated to divide responsibilities between it and its next higher echelon.

forward edge of the battle area

The foremost limit of a series of areas in which ground combat units are deployed, excluding the areas in which the covering or screening forces are operating, designated to coordinate fire support, the positioning of forces, or the maneuver of units. (JP 3-09.3)

forward line of own troops

A line which indicates the most forward positions of friendly forces in any kind of military operation at a specific time. (JP 3-03)

free-fire area

A specific area into which any weapon system may fire without additional coordination with the establishing headquarters. (JP 3-09)

***frontal attack**

A form of maneuver in which an attacking force seeks to destroy a weaker enemy force or fix a larger enemy force in place over a broad front.

***infiltration**

(Army) A form of maneuver in which an attacking force conducts undetected movement through or into an area occupied by enemy forces to occupy a position of advantage behind those enemy positions while exposing only small elements to enemy defensive fires.

***infiltration lane**

A control measure that coordinates forward and lateral movement of infiltrating units and fixes fire planning responsibilities.

***interdict**

A tactical mission task where the commander prevents, disrupts, or delays the enemy's use of an area or route.

***isolate**

A tactical mission task that requires a unit to seal off—both physically and psychologically—an enemy from sources of support, deny the enemy freedom of movement, and prevent the isolated enemy force from having contact with other enemy forces.

key terrain

Any locality, or area, the seizure or retention of which affords a marked advantage to either combatant. (JP 2-01.3)

***kill zone**

That part of an ambush site where fires are concentrated to isolate, fix, and destroy the enemy.

***lateral boundary**

A boundary that extends from the rear boundary to the unit's forward boundary.

limit of advance

A phase line used to control forward progress of the attack. The attacking unit does not advance any of its elements or assets beyond the limit of advance, but the attacking unit can push its security forces to that limit. (ADRP 3-90)

line formation

When the unit's subordinate ground maneuver elements move abreast of each other.

line of communications

A route, either land, water, and/or air, that connects an operating military force with a base of operations and along which supplies and military forces move. (JP 2-01.3)

***line of contact**

A general trace delineating the location where friendly and enemy forces are engaged.

line of departure

(Army) A phase line crossed at a prescribed time by troops initiating an offensive operation. (ADRP 3-90)

***linkup point**

A point where two infiltrating elements in the same or different infiltration lanes are scheduled to meet to consolidate before proceeding on with their missions.

***logistics package**

A grouping of multiple classes of supply and supply vehicles under the control of a single convoy commander.

main effort

A designated subordinate unit whose mission at a given point in time is most critical to overall mission success. (ADRP 3-0)

main battle area

The area where the commander intends to deploy the bulk of the unit's combat power and conduct decisive operations to defeat an attacking enemy. (ADRP-3-90)

***meeting engagement**

A combat action that occurs when a moving force, incompletely deployed for battle, engages an enemy at an unexpected time and place.

mobile defense

A defensive task that concentrates on the destruction or defeat of the enemy through a decisive attack by a striking force. (ADRP 3-90)

Glossary

mobility

A quality or capability of military forces which permits them to move from place to place while retaining the ability to fulfill their primary mission. (JP 3-17)

mobility operations

Those combined arms activities that mitigate the effects of natural and man-made obstacles to enable freedom of movement and maneuver. (ATTP 3-90.4)

movement corridor

A designated area established to protect and enable ground movement along a route. (FM 3-90.31)

movement to contact

(Army) An offensive task designed to develop the situation and establish or regain contact. (ADRP 3-90)

named area of interest

(Army) The geographical area where information that will satisfy a specific information requirement can be collected. (ADRP 1-02)

***neutralize**

(Army) A tactical mission task that results in rendering enemy personnel or materiel incapable of interfering with a particular operation.

***noncontiguous area of operations**

Where one or more of the commander's subordinate force's areas of operation do not share a common boundary.

no-fire area

An area designated by the appropriate commander into which fires or their effects are prohibited. (JP 3-09.3)

objective

(Army) A location on the ground used to orient operations, phase operations, facilitate changes of direction, and provide for unity of effort. (ADRP 3-90)

objective rally point

A rally point established on an easily identifiable point on the ground where all elements of the infiltrating unit assemble and prepare to attack the objective. (ADRP 3-90)

obstacle

Any natural or man-made obstruction designed or employed to disrupt, fix, turn, or block the movement of an opposing force, and to impose additional losses in personnel, time, and equipment on the opposing force. (JP 3-15)

obstacle belt

A brigade-level command and control measure, normally given graphically, to show where within an obstacle zone the ground tactical commander plans to limit friendly obstacle employment and focus the defense. (JP 3-15)

***obstacle control measures**

Specific measures that simplify the granting of obstacle-emplacing authority while providing obstacle control.

***obstacle groups**

One or more individual obstacles grouped to provide a specific obstacle effect.

obstacle restricted areas

A command and control measure used to limit the type or number of obstacles within an area. (JP 3-15)

obstacle zone

A division-level command and control measure, normally done graphically, to designate specific land areas where lower echelons are allowed to employ tactical obstacles. (JP 3-15)

***occupy**

A tactical mission task that involves moving a friendly force into an area so that it can control that area. Both the force's movement to and occupation of the area occur without enemy opposition.

offensive tasks

Tasks conducted to defeat and destroy enemy forces and seize terrain, resources, and population centers. (ADRP 3-0)

passive air defense

All measures, other than active air defense, taken to minimize the effectiveness of hostile air and missile threats against friendly forces and assets. (JP 3-01)

***penetration**

(Army) A form of maneuver in which an attacking force seeks to rupture enemy defenses on a narrow front to disrupt the defensive system.

phase line

A line utilized for control and coordination of military operations, usually an easily identified feature in the operational area. (JP 3-09)

point of departure

The point where the unit crosses the line of departure and begins moving along a direction of attack. (ADRP 3-90)

***position area for artillery**

An area assigned to an artillery unit where individual artillery systems can maneuver to increase their survivability. A position area for artillery is not an area of operations for the artillery unit occupying it.

primary position

The position that covers the enemy's most likely avenue of approach into the area of operations. (ADRP 3-90)

probable line of deployment

A phase line that designates the location where the commander intends to deploy the unit into assault formation before beginning the assault. (ADRP 3-90)

pursuit

An offensive task designed to catch or cut off a hostile force attempting to escape, with the aim of destroying it. (ADRP 3-90)

raid

An operation to temporarily seize an area in order to secure information, confuse an adversary, capture personnel or equipment, or to destroy a capability culminating with a planned withdrawal. (JP 3-0)

rally point

1. An easily identifiable point on the ground at which aircrews and passengers can assemble and reorganize following an incident requiring a forced landing. 2. An easily identifiable point on the ground at which units can reassemble and reorganize if they become dispersed. (ADRP 1-02)

***rear boundary**

A boundary that defines the rearward limits of a unit's area. It usually also defines the start of the next echelon's support area.

Glossary

***reduce**

1. A tactical mission task that involves the destruction of an encircled or bypassed enemy force. 2. A mobility task to create and mark lanes through, over, or around an obstacle to allow the attacking force to accomplish its mission. (ATTP 3-90.4)

***reorganization**

All measures taken by the commander to maintain unit combat effectiveness or return it to a specified level of combat capability.

restrictive fire area

An area in which specific restrictions are imposed and into which fires that exceed those restrictions will not be delivered without coordination with the establishing headquarters. (JP 3-09)

restrictive fire line

A line established between converging friendly surface forces that prohibits fires or their effects across that line. (JP 3-09)

***retain**

A tactical mission task in which the commander ensures that a terrain feature controlled by a friendly force remains free of enemy occupation or use.

retirement

An operation in which a force out of contact moves away from the enemy. (ADRP 3-90)

retrograde

(Army) A defensive task that involves organized movement away from the enemy. (ADRP 3-90)

***retrograde movement**

Any movement of a command to the rear, or away from the enemy. It may be forced by the enemy or may be made voluntarily. Such movements may be classified as withdrawal, retirement, or delaying actions.

***route**

The prescribed course to be traveled from a specific point of origin to a specific destination.

***search and attack**

A technique for conducting a movement to contact that shares many of the characteristics of an area security mission.

***sector of fire**

That area assigned to a unit, a crew-served weapon, or an individual weapon within which it will engage targets as they appear in accordance with established engagement priorities.

***secure**

A tactical mission task that involves preventing a unit, facility, or geographical location from being damaged or destroyed as a result of enemy action.

security area

That area that begins at the forward area of the battlefield and extends as far to the front and flanks as security forces are deployed. Forces in the security area furnish information on the enemy and delay, deceive, and disrupt the enemy and conduct counterreconnaissance. (ADRP 3-90)

***seize**

(Army) A tactical mission task that involves taking possession of a designated area by using overwhelming force.

shaping operation

An operation at any echelon that creates and preserves conditions for success of the decisive operation through effects on the enemy, other actors, and the terrain. (ADRP 3-0)

***single envelopment**

A form of maneuver that results from maneuvering around one assailable flank of a designated enemy force.

***spoiling attack**

A tactical maneuver employed to seriously impair a hostile attack while the enemy is in the process of forming or assembling for an attack.

***stay-behind operation**

An operation in which the commander leaves a unit in position to conduct a specified mission while the remainder of the forces withdraw or retire from an area.

striking force

A dedicated counterattack force in a mobile defense constituted with the bulk of available combat power. (ADRP 3-90)

strong point

A heavily fortified battle position tied to a natural or reinforcing obstacle to create an anchor for the defense or to deny the enemy decisive or key terrain. (ADRP 3-90)

subsequent position

A position that a unit expects to move to during the course of battle. (ADRP 3-90)

supplementary position

A defensive position located within a unit's assigned area of operations that provides the best sectors of fire and defensive terrain along an avenue of approach that is not the primary avenue where the enemy is expected to attack. (ADRP 3-90)

***support by fire**

A tactical mission task in which a maneuver force moves to a position where it can engage the enemy by direct fire in support of another maneuvering force.

support by fire position

The general position from which a unit conducts the tactical mission task of support by fire. (ADRP 3-90)

***suppress**

(Army) A tactical mission task that results in the temporary degradation of the performance of a force or weapon system below the level needed to accomplish its mission.

survivability

All aspects of protecting personnel, weapons, and supplies while simultaneously deceiving the enemy. (JP 3-34)

survivability move

A move that involves rapidly displacing a unit, command post, or facility in response to direct and indirect fires, the approach of an enemy unit, a natural phenomenon, or as a proactive measure based on intelligence, meteorological data, and risk analysis of enemy capabilities and intentions (including weapons of mass destruction). (ADRP 3-90)

sustaining operation

An operation at any echelon that enables the decisive operation or shaping operation by generating or maintaining combat power. (ADRP 3-0)

Glossary

***tactical mission task**

The specific activity performed by a unit while executing a form of tactical operation or form of maneuver. It may be expressed in terms of either actions by a friendly force or effects on an enemy force.

target

An area designated and numbered for future firing. (JP 3-60)

target area of interest

The geographical area where high-value targets can be acquired and engaged by friendly forces. Not all target areas of interest will form part of the friendly course of action; only target areas of interest associated with high priority targets are of interest to the staff. These are identified during staff planning and wargaming. Target areas of interest differ from engagement areas in degree. Engagement areas plan for the use of all available weapons; target areas of interest might be engaged by a single weapon. (JP 2-01.3)

target reference point

An easily recognizable point on the ground (either natural or man-made) used to initiate, distribute, and control fires. (ADRP 1-02)

targeted area of interest

The geographical area or point along a mobility corridor where successful interdiction will cause the enemy to abandon a particular course of action or requires the enemy to use specialized engineer support to continue. It is where the enemy force can be acquired and engaged by friendly forces. (ADRP 1-02)

time of attack

The moment the leading elements of the main body cross the line of departure, or in a night attack, the point of departure. (ADRP 3-90)

time-sensitive target

A joint force commander designated target requiring immediate response because it is a highly lucrative, fleeting target of opportunity or it poses (or will soon pose) a danger to friendly forces. (JP 3-60)

trigger line

A phase line located on identifiable terrain that crosses the engagement area—used to initiate and mass fires into an engagement area at a predetermined range for all or like weapon systems. (ADRP 1-02)

***turn**

1. A tactical mission task that involves forcing an enemy element from one avenue of approach or mobility corridor to another. 2. A tactical obstacle effect that integrates fire planning and obstacle effort to divert an enemy formation from one avenue of approach to an adjacent avenue of approach or into an engagement area.

***turning movement**

(Army) A form of maneuver in which the attacking force seeks to avoid the enemy's principle defensive positions by seizing objectives behind the enemy's current positions thereby causing the enemy force to move out of their current positions or divert major forces to meet the threat.

vertical envelopment

A tactical maneuver in which troops, either air-dropped or airlanded, attack the rear and flanks of a force, in effect cutting off or encircling the force. (JP 3-18)

withdrawal operation

A planned retrograde operation in which a force in contact disengages from an enemy force and moves in a direction away from the enemy. (JP 1-02)

References

Field manuals and selected joint publications are listed by new number followed by old number.

REQUIRED PUBLICATIONS

These documents must be available to intended users of this publication.

ADRP 1-02. *Operational Terms and Military Symbols*. 31 August 2012.

JP 1-02. *Department of Defense Dictionary of Military and Associated Terms*. 8 November 2010.

RELATED PUBLICATIONS

These documents contain relevant supplemental information.

JOINT AND DEPARTMENT OF DEFENSE PUBLICATIONS

Most joint publications are available online: <http://www.dtic.mil/doctrine/new_pubs/jointpub.htm>.

JP 2-01.3. *Joint Intelligence Preparation of the Operational Environment*. 16 June 2009.

JP 3-0. *Joint Operations*. 11 August 2011.

JP 3-01. *Countering Air and Missile Threats*. 23 March 2012.

JP 3-02. *Amphibious Operations*. 10 August 2009.

JP 3-03. *Joint Interdiction*. 14 October 2011.

JP 3-04. *Joint Shipboard Helicopter and Tiltrotor Aircraft Operations*. 06 December 2012.

JP 3-09. *Joint Fire Support*. 30 June 2010.

JP 3-09.3. *Close Air Support*. 8 July 2009.

JP 3-10. *Joint Security Operations in Theater*. 3 February 2010.

JP 3-13. *Information Operations*. 27 November 2012.

JP 3-13.2. *Military Information Support Operations*. 07 January 2010.

JP 3-13.4. *Military Deception*. 26 January 2012.

JP 3-15. *Barriers, Obstacles, and Mine Warfare for Joint Operations*. 17 June 2011.

JP 3-17. *Air Mobility Operations*. 2 October 2009.

JP 3-18. *Joint Forcible Entry Operations*. 27 November 2012.

JP 3-34. *Joint Engineer Operations*. 30 June 2011.

JP 3-50. *Personnel Recovery*. 20 December 2011.

JP 3-52. *Joint Airspace Control*. 20 May 2010.

JP 3-60. *Joint Targeting*. 31 January 2013.

JP 3-61. *Public Affairs*. 25 August 2010.

ARMY PUBLICATIONS

Most Army doctrinal publications are available online: <<http://www.apd.army.mil/>>. Army regulations are produced only in electronic media and available at the same link.

ADP 3-0. *Unified Land Operations*. 10 December 2011.

ADP 3-37. *Protection*. 31 August 2012.

ADP 3-90. *Offense and Defense*. 31 August 2012.

ADP 5-0. *The Operations Process*. 17 March 2012.

References

- ADRP 2-0. *Intelligence*. 31 August 2012.
- ADRP 3-0. *Unified Land Operations*. 16 May 2012.
- ADRP 3-07. *Stability*. 31 August 2012.
- ADRP 3-09. *Fires*. 31 August 2012.
- ADRP 3-37. *Protection*. 31 August 2012.
- ADRP 3-90. *Offense and Defense*. 31 August 2012.
- ADRP 5-0. *The Operations Process*. 17 May 2012.
- ADRP 6-0. *Mission Command*. 17 May 2012.
- ATTP 3-34.39. *Camouflage, Concealment, and Decoys*. 26 November 2010.
- ATTP 3-34.80. *Geospatial Engineering*. 29 July 2010.
- ATTP 3-90.4. *Combined Arms Mobility Operations*. 10 August 2011.
- FM 2-01.3. *Intelligence Preparation of the Battlefield/Battlespace*. 15 October 2009.
- FM 3-01. *U.S. Army Air and Missile Defense Operations*. 25 November 2009.
- FM 3-06. *Urban Operations*. 26 October 2006.
- FM 3-06.20. *Multi-Service Tactics, Techniques, and Procedures for Cordon and Search Operations*. 25 April 2006.
- FM 3-09.12. *Tactics, Techniques, and Procedures for Field Artillery Target Acquisition*. 21 June 2002.
- FM 3-09.34. *Multi-Service Tactics, Techniques, and Procedures for Kill Box Employment*. 4 August 2009.
- FM 3-11. *Multi-Service Doctrine for Chemical, Biological, Radiological, and Nuclear Operations*. 1 July 2011.
- FM 3-11.50. *Battlefield Obscuration*. 31 December 2008.
- FM 3-24. *Counterinsurgency*. 15 December 2006.
- FM 3-34. *Engineer Operations*. 4 August 2011.
- FM 3-34.170. *Engineer Reconnaissance*. 25 March 2008.
- FM 3-34.210. *Explosive Hazards Operations*. 27 March 2007.
- FM 3-35. *Army Deployment and Redeployment*. 21 April 2010.
- FM 3-36. *Electronic Warfare*. 9 November 2012.
- FM 3-39. *Military Police Operations*. 16 February 2010.
- FM 3-52. *Airspace Control*. 8 February 2013.
- FM 3-53. *Military Information Support Operations*. 4 January 2013.
- FM 3-60. *The Targeting Process*. 26 November 2010.
- FM 3-90-2. *Reconnaissance, Security, and Tactical Enabling Tasks*. 22 March 2013.
- FM 3-90.31. *Tactics, Techniques, and Procedures for Fire Support for the Combined Arms Commander*. 1 October 2002.
- FM 3-90.119. *Combined Arms Improvised Explosive Device Defeat Operations*. 21 September 2007.
- FM 4-30.51. *Unexploded Ordnance (UXO) Procedures*. 13 July 2006.
- FM 6-02.40. *Visual Information Operations*. 10 March 2009.
- FM 6-22.5. *Combat and Operational Stress Control Manual for Leaders and Soldiers*. 18 March 2009.
- FM 6-99.2. *U.S. Army Report and Message Formats*. 30 April 2007.
- FM 27-10. *The Law of Land Warfare*. 18 July 1956.
- FM 90-7. *Combined Arms Obstacle Integration*. 29 September 1994.
- FM 100-30. *Nuclear Operations*. 29 October 1996.

NORTH ATLANTIC TREATY ORGANIZATION PUBLICATION

Allied Tactical Publication-3.2.1. *Allied Land Tactics*. 9 November 2009.

<https://nsa.nato.int/protected/unclass/ap/ATP-3.2.1.pdf>

PRESCRIBED FORMS

None.

REFERENCED FORMS

DA forms are available on the Army Publishing Directorate website <<http://www.apd.army.mil/>>.

DA Form 2028. *Recommended Changes to Publications and Blank Forms*.

This page intentionally left blank.

Index

Entries are by paragraph number.

A

actions at the probable line of deployment, assault position, or final coordination line, 3-91–3-95

actions by friendly forces, B-3–B-43

actions on contact, defined, 2-48

actions on the objective, 3-96–3-115

active air and missile defense, in the defense, 6-80–6-81

air and missile defense, 1-174–1-176

in the defense, 6-75–6-82

air assault, defined, 1-24

airspace coordinating measures, A-5–A-7

all-around defense, perimeter defense, 6-138

alternate and subsequent positions, delay, 9-26–9-29

alternate position, defined, A-95

ambush, 3-127–3-147

defined, 3-127

execution, 3-144–3-147

organization of forces for an, 3-131

planning, 3-132–3-139

preparation for, 3-140–3-143

area defense, 7-1–7-93

civil considerations, 7-46

control measures, 7-17–7-19

defense in depth, 7-30–7-33

defined, 6-5

disrupt the enemy, 7-71–7-73

executing, 7-57–7-93

fix the enemy, 7-74–7-76

follow through (counterattack), 7-87–7-93

forward defense, 7-34–7-35

gain and maintain enemy contact, 7-63–7-70

general considerations for an, 7-1–7-2

main battle area, 7-8–7-9

maneuver, 7-77–7-86

organization of forces, 7-3–7-16

planning, 7-20–7-46

position selection, 7-26–7-29

positioning the reserve, 7-36–7-40

preparing, 7-47–7-56

reconnaissance and surveillance, 7-4–7-5

reserve, 7-10–7-15

security, 7-6–7-7

sustainment, 7-16

area of influence, A-11

area of interest, defined, 1-158

area of operations, A-8–A-12

defined, A-8

area security, antiterrorism, and physical security, in the defense, 6-93–6-98

armored and Stryker forces, in the defense, 6-36

Army indirect fires and joint fires, 1-165–1-173

in the defense, 6-66–6-74

assault position, defined, A-72

assault time, defined, A-73

assembly area, defined, A-13

assembly areas, A-13–A-15

assured mobility, 1-39

attack, 3-1–3-172, 1-5–1-6

control measures, 3-13–3-15

defined, 1-5

executing an, 3-61–5-124

general considerations for an, 3-1–3-2

main body, 3-5–3-7

mission command, 3-18–3-20

movement and maneuver in, 3-21–3-24

organization of forces, 3-3–3-12

planning, 3-16–3-17

preparing for an, 3-46–3-60

reserve, 3-8–3-11

security forces, 3-4

shaping operations, 3-64

sustainment, 3-12

attack by fire, B-4–B-5

defined, B-4

attack by fire position, defined, A-74

attack position, defined, A-75

avoid, 1-144

axis of advance, defined, A-76

B

basic tactical control measures, A-1–A-106

basics, of the defense, 6-1–6-178

of the offense, 1-1–1-222

battle handover line, defined, A-77

battle position, defined, A-90

battle positions, A-90–A-99

block, B-45–B-47

block obstacle effect, defined, B-46

block tactical mission task, defined, B-45

boundaries, A-16–A-17

boundary, defined, A-16

box, 1-127–1-128

box formation, defined, 1-127

breach, defined, B-6

breaching the enemy's main defensive positions, 1-78–1-80

breakthrough, defined, 3-116

bypass, B-7–B-12

defined, B-7

C

canalize, defined, B-48

characteristics, of offensive tasks, 1-2

of the defense, 6-2

checkpoint, defined, A-18

chemical, biological, and nuclear defense operations, 1-201

chemical, biological, radiological, and nuclear defense, 6-111–6-114

choose a course of action, in a movement to contact, 2-52

civil considerations, area defense, 7-46

clear, B-13–B-15

defined, B-13

close combat, defined, 1-116

Entries are by paragraph number.

- column, 1-121–1-122
- column formation, defined, 1-121
- combat formation, defined, 1-118
- combat formations, 1-118–1-134
- combination pursuit, 5-10–5-13
- common, control measures, A-4–A-106
- defensive control measures, A-89–A-106
 - defensive planning
 - considerations, 6-10–6-13
 - offensive control measures, A-71–A-88
 - offensive control measures, 1-9
 - offensive planning
 - considerations, 1-96–1-206
- consolidation, 3-108–3-114
- defined, 3-108
- contact point, A-19–A-20
- defined, A-19
- contain, defined, B-49
- control, B-16–B-17
- defined, B-16
- control measures, area defense, 7-17–7-19
- attack, 3-13–3-15
 - basic tactical, A-1–A-106
 - common, A-4–A-106
 - delay, 9-14–9-16
 - envelopment, 1-14
 - exploitation, 4-18–4-20
 - for a search and attack, 2-70
 - frontal attack, 1-87
 - general considerations for, A-1–A-3
 - infiltration, 1-46–1-48
 - mobile defense, 8-12–8-13
 - movement to contact, 2-17–2-21
 - penetration, 1-67–1-69
 - perimeter defense, 6-133
 - pursuit, 5-14–5-17
 - retirement, 9-99
 - reverse slope defense, 6-153
 - turning movement, 1-28
 - withdrawal, 9-75
- coordinated fire line, defined, A-34
- cordon and search, defined, 2-81
- counterattack, 3-148–3-163
- defined, 3-148
 - executing, 3-159–3-162
 - organization of forces, 3-151–3-153
 - planning, 3-154–3-155
 - preparing, 3-156–3-158
- countermobility, 1-153–1-156
- in the defense, 6-43–6-50
- countermobility operations, defined, 1-153
- counterreconnaissance, B-18–B-19
- defined, B-18
- critical friendly zone, defined, A-21
- D**
- daylight attacks, 3-25
- decisive operation, defined, 1-2
- exploitation, 4-50–4-55
 - pursuit, 5-34–5-38
- decisive operation or maneuver, 2-61–2-64
- decisive operations, in an attack, 3-81–3-85
- decisive terrain, defined, 1-117
- defeat, B-50–B-51
- defined, B-50
- defense, active air and missile
- defense in the, 6-80–6-81
 - air and missile defense in the, 6-75–6-82
 - area security, antiterrorism, and physical security in the, 6-93–6-98
 - armored and Stryker forces, 6-36
 - basics of the, 6-1–6-178
 - characteristics of the, 6-2
 - chemical, biological, radiological, and nuclear defense in the, 6-111–6-114
 - countermobility, 6-43–6-50
 - disrupt the enemy attack at every opportunity, 6-31
 - enemy airborne and air assault in the, 6-51–6-52
 - ensure mutual support in the, 6-40
 - exploit the advantages of terrain, 6-22–6-29
 - fires in the, 6-65–6-82
 - force health protection in the, 6-110
 - forms of the, 6-115–6-156
 - general considerations of the, 6-1
 - infantry forces in the, 6-37–6-38
 - Intelligence in the, 6-60–6-64
 - limited visibility adjustments in the, 6-55–6-59
 - linear obstacle, 6-116–6-119
 - maintain security in the, 6-30
 - mass the effects of combat power, 6-32–6-35
 - mission command in the, 6-14–6-20
 - mobility, 6-41–6-42
 - movement and maneuver in the, 6-21–6-59
 - passive air defense in the, 6-82
 - protection in the, 6-92–6-114
 - rotary and fixed wing aviation and unmanned aircraft systems, 6-39–6-52
 - smoke and obscurity in the, 6-53–6-54
 - survivability in the, 6-99–6-109
 - sustainment in the, 6-83–6-91
- defense in depth, area defense, 7-30–7-33
- perimeter defense, 6-139
- defensive control measures, common, A-89–A-106
- defensive planning
- considerations, common, 6-10–6-13
 - Army indirect fires and joint fires, 6-66–6-74
- defensive task, defined, 6-1
- defensive tasks, 6-1–9-121, 6-3–6-8
- delay, 9-4–9-63
- alternate and subsequent positions, 9-26–9-29
 - control measures, 9-14–9-16
 - effects of terrain, 9-30–9-33
 - execute, 9-48–9-62
 - intelligence, 9-42–9-43
 - mission command, 9-44–9-45
 - movement and maneuver, 9-34–9-41
 - organization of forces, 9-8–9-13
 - plan, 9-17–9-22
 - prepare, 9-46–9-47
 - termination, 9-63
- delay line, defined, 9-16
- delay order, parameters, 9-23–9-25
- delaying operation, defined, 9-4
- demonstration, defined, 3-163
- demonstrations and feints, 3-163–3-164
- denial operations, 9-109–9-116
- defined, 9-109
- deploy and report, in a movement to contact, 2-50
- destroy, defined, B-52
- detachment left in contact, defined, 9-71

detect, 1-141
diamond formation, 1-129–1-130
 defined, 1-129
direct fire control measures, A-22–
 A-31, A-100
direct pressure force, defined,
 5-10
direction of attack, defined, A-78
disengage, B-20–B-23
 defined, B-20
disengagement line, defined,
 A-101
dismounted assault, 3-106–3-107
disrupt, B-53–B-55
disrupt obstacle effect, B-55
disrupt tactical mission task,
 defined, B-53
disrupt the enemy, area defense,
 7-71–7-73
 attack, 3-69–3-74
 exploitation, 4-48
 mobile defense, 8-28
 movement to contact, 2-57
 pursuit, 5-31
disrupt the enemy attack, 6-31
double envelopment, defined,
 1-11

E

echelon, 1-125–1-126
echelon formation, defined, 1-125
effects of terrain, delay, 9-30–9-33
effects on enemy force, B-44–
 B-68
encirclement operations, defined,
 1-11
encircling force, defined, 5-10
enemy airborne and air assault, in
 the defense, 6-51–6-52
engagement area, defined, A-23
engagement criteria, defined,
 A-24
engagement priority, defined,
 A-25
ensure mutual support, in the
 defense, 6-40
envelopment, 1-11–1-23
 control measures, 1-14
 defined, 1-11
 executing, 1-19–1-23
 organization of forces, 1-13
 planning, 1-15–1-18
evaluate and develop the
 situation, in a movement to
 contact, 2-51

execute selected course of action,
 2-53
executing, ambush, 3-144–3-147
 area defense, 7-57–7-93
 attack, 3-61–5-124
 counterattack, 3-159–3-162
 delay, 9-48–9-62
 envelopment, 1-19–1-23
 exploitation, 4-37–4-44
 frontal attack, 1-89–1-91
 infiltration, 1-58–1-63
 mobile defense, 8-24–8-25
 movement to contact, 2-33–
 2-65
 penetration, 1-77–1-83
 perimeter defense, 6-142–
 6-143
 pursuit, 5-24–5-40
 reverse slope defense, 6-154–
 6-156
 search and attack, 2-75–2-80
 turning movement, 1-34–1-37
 withdrawal, 9-85–9-89
exfiltrate, B-24–B-26
 defined, B-24
exploit the advantages of terrain,
 in the defense, 6-22–6-29
exploitation, 4-1–4-57
 control measures, 4-18–4-20
 decisive operation, 4-50–4-55
 defined, 1-7
 disrupt the enemy, 4-48
 executing, 4-37–4-44
 fix the enemy, 4-49
 follow through, 4-56–4-57
 gain and maintain enemy
 contact, 4-45–4-47
 general considerations of, 4-1–
 4-5
 organization of forces, 4-6–
 4-12
 planning, 4-21–4-36
 reconnaissance and security,
 4-13–4-15
 sustainment, 4-16–4-17
explosive ordnance disposal,
 1-204

F

feint, defined, 3-163
field of fire, defined, 9-30
final coordination line, defined,
 A-79
final protective fire, defined, A-103
fire superiority, defined, 3-17
fire support coordination line,
 A-35–A-36
 defined, A-35

fire support coordination
 measures, A-102–A-103, A-32–
 A-45
fire support targets, A-42–A-45
fires, 1-164–1-176
 attack, 3-43–3-45
 defense, 6-65–6-82
 mobile defense, 8-18–8-19
fix, B-56–B-58
fix obstacle effect, defined, B-58
fix tactical mission task, defined,
 B-56
fix the enemy, area defense,
 7-74–7-76
 attack, 3-75–3-80
 exploitation, 4-49
 mobile defense, 8-29–8-31
 movement to contact, 2-58–
 2-60
 pursuit, 5-32–5-33
flank attack, 1-92–1-95
flanking attack, defined, 1-92
follow and assume, B-27–B-30
 defined, B-27
follow and support, B-31–B-34
 defined, B-31
follow through, 3-116–3-124
 area defense, 7-87–7-93
 exploitation, 4-56–4-57
 mobile defense, 8-38
 movement to contact, 2-65
 pursuit, 5-39–5-40
force health protection, 1-200
 in the defense, 6-110
forms, defense, 6-115–6-156
 maneuver, 1-10–1-95
forms of maneuver, defined, 1-10
forward boundary, defined, A-16
forward defense, area defense,
 7-34–7-35
forward edge of the battle area,
 defined, A-104
forward line of own troops,
 defined, A-46
free fire area, defined, A-37
friendly fire incident avoidance,
 1-192–1-195
frontal attack, 1-84–1-91
 control measures, 1-87
 defined, 1-84
 executing, 1-89–1-91
 organization of forces, 1-86
 planning, 1-88
frontal pursuit, 5-9

Entries are by paragraph number.

G

gain and maintain enemy contact,
 area defense, 7-63-7-70
 attack, 3-65-3-68
 exploitation, 4-45-4-47
 mobile defense, 8-26-8-27
 movement to contact, 2-46-
 2-56
 pursuit, 5-28-5-30

general considerations, area
 defense, 7-1-7-2
 attack, 3-1-3-2
 control measures, A-1-A-3
 defense, 6-1
 exploitation, 4-1-4-5
 mobile defense, 8-1-8-3
 movement to contact, 2-1-2-4
 pursuit, 5-1-5-6
 retrograde, 9-1-9-3

H

health service support, 1-185

individual obstacles, A-62

infantry forces, in the defense,
 6-37-6-38

I

infiltration, 1-38-1-63
 control measures, 1-46-1-48
 defined, 1-38
 executing, 1-58-1-63
 organization of forces, 1-42-
 1-45
 planning, 1-49-1-56
 preparing, 1-57

infiltration lane, defined, 1-47

information protection, 1-190-
 1-191

intelligence, 1-157-1-163
 attack, 3-35-3-42
 defense, 6-60-6-64
 delay, 9-42-9-43

interdict, B-59-B-63
 defined, B-59

internment and resettlement
 operations, 1-205-1-206

isolate, defined, B-64

J-K

key terrain, defined, 1-117

kill zone, defined, 3-133

lateral boundary, defined, A-16

L

limit of advance, defined, A-80

limited visibility adjustments,
 defense, 6-55-6-59

limited-visibility attacks, 3-26-3-34

limited-visibility conditions, 1-135-
 1-137

line, 1-123-1-124

line formation, defined, 1-123

line of communications, defined,
 1-17

line of contact, defined, A-47

line of departure, defined, A-81

linkup point, defined, 1-48

logistics, 1-178-1-184

logistics package, defined, 2-15

M

main battle area, A-105-A-106
 area defense, 7-8-7-9
 defined, A-105

main body, attack, 3-5-3-7
 movement to contact, 2-12-
 2-16

maintain security, in the defense,
 6-30

maneuver, area defense, 7-77-
 7-86
 mobile defense, 8-32-8-37

mass the effects of combat power,
 in the defense, 6-32-6-35

maximum use of offensive action,
 perimeter defense, 6-148

meeting engagement, defined, 2-3

mission command, attack, 3-18-
 3-20
 defense, 6-14-6-20
 delay, 9-44-9-45
 offense, 1-101-1-115

mobile defense, 6-6-6-7, 8-1-
 8-38
 control measures, 8-12-8-13
 defined, 6-6
 disrupt the enemy, 8-28
 executing, 8-24-8-25
 fires, 8-18-8-19
 fix the enemy, 8-29-8-31
 follow through, 8-38
 gain and maintain enemy
 contact, 8-26-8-27
 general considerations for a,
 8-1-8-3
 maneuver, 8-32-8-37
 movement and maneuver,
 8-16-8-17
 organization of forces, 8-4-
 8-11
 planning, 8-14-8-15
 preparing, 8-21-8-23
 sustainment, 8-20

mobility, 1-148-1-152
 defined, 1-148
 in the defense, 6-41-6-42

mobility operations, defined, 1-148

mounted assault, 3-102-3-105

movement and maneuver, 1-116-
 1-156
 attack, 3-21-3-24
 defense, 6-21-6-59
 delay, 9-34-9-41
 mobile defense, 8-16-8-17

movement corridor, defined, A-48

movement from the line of
 departure to the probable line of
 deployment, 3-86-3-90

movement to contact, 2-1-2-81
 control measures, 2-17-2-21
 defined, 1-4
 executing, 2-33-2-65
 general considerations for a,
 2-1-2-4
 main body, 2-12-2-16
 organization of forces, 2-5-
 2-16
 planning, 2-22-2-31
 preparing, 2-32
 security forces, 2-7-2-11

mutual support, perimeter
 defense, 6-137

N

named area of interest, defined,
 A-49

neutralize, 1-145
 defined, B-65

no-fire area, defined, A-39

O

objective, defined, A-82

obstacle, defined, A-50

obstacle belt, defined, A-55

obstacle belts, A-55-A-58

obstacle control measures, A-50-
 A-63
 defined, A-50

obstacle groups, A-59-A-61
 defined, A-59

obstacle restricted area, defined,
 A-63

obstacle restrictions, A-63

obstacle zone, defined, A-52

obstacle zones, A-52-A-54

occupy, defined, B-35

offensive control measures,
 common, A-71-A-88

offensive task, defined, 1-3
 offensive tasks, 1-1–5-44
 operational area security and antiterrorism, 1-196–1-197
 operations process, 1-102–1-112
 operations security, 1-203
 organization of forces, ambush, 3-131
 area defense, 7-3–7-16
 attack, 3-3–3-12
 counterattack, 3-151–3-153
 delay, 9-8–9-13
 envelopment, 1-13
 exploitation, 4-6–4-12
 frontal attack, 1-86
 infiltration, 1-42–1-45
 mobile defense, 8-4–8-11
 movement to contact, 2-5–2-16
 penetration, 1-65–1-66
 perimeter defense, 6-124–6-132
 pursuit, 5-7–5-8
 retirement, 9-95–9-98
 reverse slope defense, 6-149–6-152
 search and attack, 2-68–2-69
 turning movement, 1-25–1-27
 withdrawal, 9-68–9-74

P

parameters, of the delay order, 9-23–9-25
 passive air defense, in the defense, 6-82
 penetration, 1-64–1-83
 control measures, 1-67–1-69
 defined, 1-64
 executing a, 1-77–1-83
 organization of forces, 1-65–1-66
 planning, 1-70–1-76
 perimeter defense, 6-120–6-143
 all-around defense, 6-138
 control measures, 6-133
 defense in depth, 6-139
 executing, 6-142–6-143
 maximum use of offensive action, 6-148
 mutual support, 6-137
 organization of forces, 6-124–6-132
 planning, 6-134–6-141
 responsiveness, 6-140
 security, 6-136
 use of terrain, 6-135
 permissive fire support coordination measures, A-33–A-37
 personnel recovery, 1-188–1-189

phase line, defined, A-64
 planning, ambush, 3-132–3-139
 area defense, 7-20–7-46
 attack, 3-16–3-17
 counterattack, 3-154–3-155
 delay, 9-17–9-22
 envelopment, 1-15–1-18
 exploitation, 4-21–4-36
 frontal attack, 1-88
 infiltration, 1-49–1-56
 mobile defense, 8-14–8-15
 movement to contact, 2-22–2-31
 penetration, 1-70–1-76
 perimeter defense, 6-134–6-141
 pursuit, 5-18–5-23
 search and attack, 2-71–2-74
 turning movement, 1-29–1-33
 withdrawal, 9-76–9-81
 point of departure, defined, A-83
 position area for artillery, A-65–A-67
 defined, A-65
 position selection, area defense, 7-26–7-29
 positioning the reserve, area defense, 7-36–7-40
 predict, 1-140
 preparing, ambush, 3-140–3-143
 area defense, 7-47–7-56
 attack, 3-46–3-60
 counterattack, 3-156–3-158
 delay, 9-46–9-47
 infiltration, 1-57
 mobile defense, 8-21–8-23
 movement to contact, 2-32
 withdrawal, 9-82–9-84
 prevent, 1-142–1-143
 primary position, defined, A-94
 probable line of deployment, defined, A-84
 protect, 1-146–1-147
 protection, 1-186–1-187
 in the defense, 6-92–6-114
 pursuit, 5-1–5-44
 control measures, 5-14–5-17
 decisive operation, 5-34–5-38
 defined, 1-8
 disrupt the enemy, 5-31
 during other than major operations, 5-41–5-44
 executing, 5-24–5-40
 fix the enemy, 5-32–5-33
 follow through, 5-39–5-40
 gain and maintain enemy contact, 7-28–7-30

general considerations of a, 5-1–5-6
 organization of forces for a, 5-7–5-8
 planning, 5-18–5-23
 shaping operations, 5-27–5-33

Q-R

raid, 3-165–3-168
 defined, 3-165
 rally point, defined, A-85
 rear boundary, defined, A-16
 recommend a course of action to the higher commander, 2-56
 reconnaissance and security, exploitation, 4-13–4-15
 reconnaissance and surveillance, area defense, 7-4–7-5
 reduce, defined, B-36
 reorganization, defined, 3-115
 reserve, area defense, 7-10–7-15
 attack, 3-8–3-11
 responsiveness, perimeter defense, 6-140
 restrictive fire area, defined, A-40
 restrictive fire line, defined, A-41
 restrictive fire support coordination measures, A-38–A-45
 retain, defined, B-37
 retirement, 9-91–9-107
 control measures, 9-99
 defined, 9-91
 organization of forces, 9-95–9-98
 sustainment, 9-100–9-107
 retrograde, 9-1–9-121
 defined, 6-8
 general considerations for the, 9-1–9-3
 retrograde movement, defined, 9-1
 reverse slope defense, 6-144–6-156
 control measures, 6-153
 executing, 6-154–6-156
 organization of forces, 6-149–6-152
 rotary and fixed wing aviation and unmanned aircraft systems, in the defense, 6-39–6-52
 route, defined, A-68

S

safety, 1-202
 search and attack, 2-66–2-80
 control measures, 2-70

Entries are by paragraph number.

- search and attack (*continued*)
 executing, 2-75–2-80
 organization of forces, 2-68–2-69
 planning, 2-71–2-74
 sector of fire, defined, A-26
 secure, defined, B-38
 security, area defense, 7-6–7-7
 perimeter defense, 6-136
 security area, defined, 6-30
 security forces, attack, 3-4
 movement to contact, 2-7–2-11
 seize, defined, B-39
 seizing the objective and subsequent exploitation, 1-82–1-83
 shaping operation, defined, 2-45
 shaping operations, for an attack, 3-64
 in a movement to contact, 2-25–2-61
 pursuit, 5-27–5-33
 single envelopment, defined, 1-11
 smoke and obscuration, in the defense, 6-53–6-54
 Soldiers' load, 1-138
 special purpose attacks, 3-125–3-172
 spoiling attack, 3-169–3-172
 defined, 3-169
 spoiling attacks and counterattacks, 7-41-7-45
 stay behind operation, defined, 9-117
 stay behind operations, 9-117–9-121
 striking force, defined, 6-6
 strong point, A-98–A-99
 defined, A-98
 subsequent position, defined, A-97
 supplementary position, defined, A-96
 support by fire, B-40–B-43
 defined, B-40
 support by fire position, defined, A-86
 suppress, defined, B-66
 survivability, 1-198–1-199
 defined, 1-198
 in the defense, 6-99–6-109
 survivability move, defined, 6-29
 sustaining operation, defined, 1-32
 sustainment, 1-177–1-185
 area defense, 7-16
 attack, 3-12
 exploitation, 4-16–4-17
 in the defense, 6-83–6-91
 mobile defense, 8-20
 retirement, 9-100–9-107
- T**
- tactical mission tasks, B-1–B-68
 target, defined, A-42
 target area of interest, A-69–A-70
 defined, A-69
 target reference point, defined, A-27
 targeted area of interest, defined, A-70
 team development between commanders, 1-113–1-115
 terminating, delay, 9-63
 withdrawal, 9-90
 time of attack, defined, A-87
 time-sensitive target, A-45
 transition, 1-207–1-222
 to a focus on defensive tasks, 1-211–1-218
 to a focus on offensive tasks, 6-161–6-170
 to a focus on stability tasks, 1-219–1-222
 to a focus on stability tasks, 6-176–6-178
 to the retrograde, 6-171–6-175
 transitions, 6-157–6-178
 trigger line, A-28–A-31
 defined, A-28
 turn, B-67–B-68
 turn obstacle effect, B-68
 turn tactical mission task, B-67
 turning movement, 1-24–1-37
 control measures, 1-28
 defined, 1-24
 executing, 1-34–1-37
 organization of forces, 1-25–1-27
 planning, 1-29–1-33
- U**
- unique retrograde situations, 9-108–9-121
 use of terrain, perimeter defense, 6-135
- V**
- vee, 1-133–1-134
 vertical envelopments, defined, 1-11
- W-X-Y-Z**
- wedge, 1-131–1-32
 widening the breach to secure the flanks, 1-81
 withdrawal, 9-64–9-90
 control measures, 9-75
 executing, 9-85–9-89
 organization of forces, 9-68–9-74
 planning, 9-76–9-81
 preparing, 9-82–9-84
 terminating, 9-90
 withdrawal operation, defined, 9-64

FM 3-90-1
22 March 2013

By Order of the Secretary of the Army:

RAYMOND T. ODIERNO
General, United States Army
Chief of Staff

Official:



JOYCE E. MORROW
Administrative Assistant to the
Secretary of the Army
1234903

DISTRIBUTION:
DISTRIBUTION:

Active Army, Army National Guard, and United States Army Reserve: To be distributed in accordance with the initial distribution number (IDN) 115848, requirements for FM 3-90-1.

