

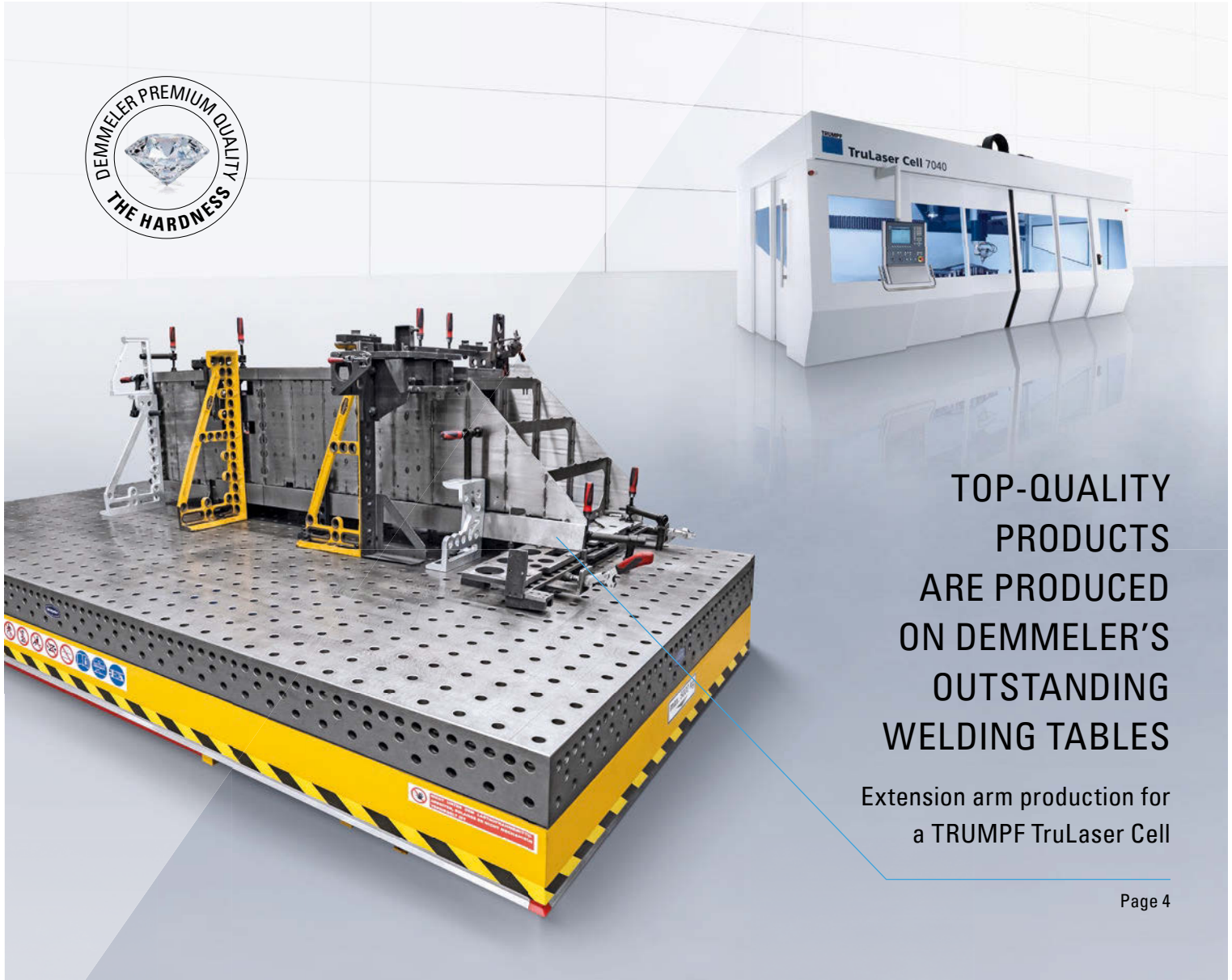

THE welding table  
THE ORIGINAL

# weldingnews 2019/2



TOP-QUALITY  
PRODUCTS  
ARE PRODUCED  
ON DEMMELEER'S  
OUTSTANDING  
WELDING TABLES

Extension arm production for  
a TRUMPF TruLaser Cell

Page 4



THE OPTIMUM 3D WELDING TABLE FOR  
EVERY APPLICATION. Page 6



YOUR INDIVIDUAL FREEDOM  
WHEN CLAMPING Page 16



THE ULTIMATE IN FLEXIBILITY DURING  
WELDING AND ASSEMBLY Page 18



TRADE FAIR DATES 2019 |



**HANNOVER**  
16.09. – 21.09.2019  
Hall 15, Booth C11



**STUTTGART**  
05. – 08.11.2019  
Hall 1, Booth 1607

Ladies and gentlemen,  
business partners and customers,

We are continuously investing in development and process optimisation in order to ensure that we can meet the growing demands for outstanding product quality coupled with short delivery times and fair market prices long into the future.

True to the motto HIGH PERFORMANCE 2019+, our new DEMMELER logistics centre is now fully up and running. Our many faithful regular customers: Thousands of craft operations, medium-sized companies and major corporations all around the globe enjoy outstanding success every day thanks to our top-quality welding tables, tools and manipulators.

And for us, it is the human operator with the specialist knowledge that is always the focus of our attention. It is our ambition to provide operators with optimum working conditions and help them achieve outstanding efficiency over many decades. Our patented DEMMELER Ergonomix series of manipulators not only boasts a space-saving footprint but also has a unique 180° swivel range. Thanks to this, the work piece can always be moved to the optimum position for welding or assembly reliably and quickly. These operations are reproducible and therefore compatible with Industry 4.0 requirements thanks to our optional teach controller.

The DEMMELER original 3D welding tables and tools excel thanks to their exceptional flexibility and outstanding quality even in tough working conditions in the steel construction sector. Lightweight yet extremely stable aluminium-titanium clamping and locating angles can be optimally clamped for long-term use and without indents using our unique DEMMELER PPC bolts with polygons.

We hope you will enjoy discovering our **weldingnews** and look forward to welcoming you to our autumn exhibitions.

Kind regards  
Johannes Demmeler  
Executive Partner



HIGH  
PERFOR  
MANCE  
2019<sup>+</sup>

PRODUCTION AND LOGISTICS AREA AT THE HEIMERTINGEN  
SITE NOW OVER 20,000 M<sup>2</sup>

D28 D16 D22

Click and scroll through the entire range of DEMMELER  
3D clamping systems and manipulators ...



Web site  
and general  
catalogue available  
in 14 languages

As the inventor of the modular 3D welding table and clamping systems, we shape our development and innovation around the modular clamping and manipulation of components. We have developed and redesigned countless products. Our general catalogue comprises **620 pages** and offers a complete overview of our entire product line with many interesting example applications. We are happy to send you the printed or digital catalogue.



Extension arm production for a TRUMPF TruLaser Cell on a DEMMELEER 3D welding table with scissor lift.

Top-quality products are produced on DEMMELEER's outstanding welding tables.



**DEMMELEER 3D welding table (PE) D28 with scissor lift**

- Work ergonomically and with maximum flexibility
- Continuously variable height adjustment with the DEMMELEER scissor lift
- 4000 x 2000 mm DEMMELEER 3D welding table (PE) D28 for unlimited clamping capabilities. Worktop with D28 system bores in a 100 x 100 mm grid. 3-row bore pattern on the table side plates.



Scissor lift with continuously variable height adjustment. Available in the standard table sizes. Including hand control.

Quality products that enjoy an excellent reputation around the world are manufactured in Ditzingen, Swabia. Applications for TRUMPF machine tools and lasers are used in a wide variety of industries, from the automobile industry to steel and sheet metal processing, aviation and aerospace to orthopaedics and medical technology.

**MINIMAL DIMENSIONAL TOLERANCES FOR HIGH-TECH PRODUCTS**

Precision is an essential characteristic of all TRUMPF products. Which is why TRUMPF counts on DEMMELER products in its manufacturing operations. Thanks to the sophisticated system and the comprehensive accessories, which are versatile in use and are easy to change over, manufacturing operations at TRUMPF would be inconceivable without DEMMELER welding tables. The minimal dimensional tolerances of the DEMMELER welding tables throughout their service life and the efficient manufacturing possibilities of the versatile systems are fundamental requirements for high-quality production at competitive global market conditions.

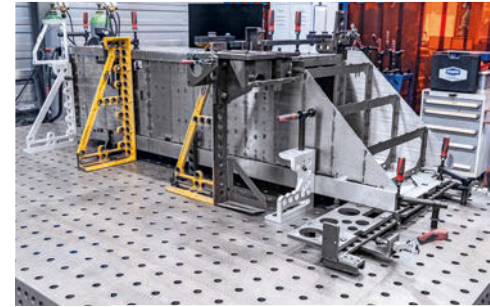
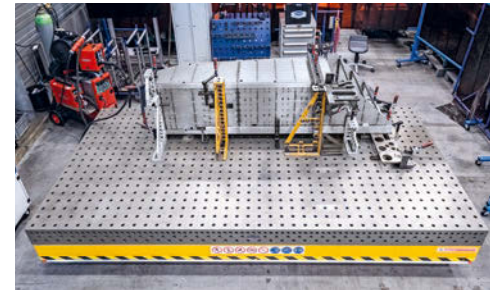

Production of the extension arm with Y-axis for the TRUMPF 3D laser cutting system, TruLaser Cell 7040. The Z-axis with the cutting head is attached to this

**DEMMELER's extensive and sophisticated range of clamping tools**

- Permits unlimited clamping capabilities
- Clamping and locating angles for use as tall stop
- Screw clamps for fast, powerful and accurate work piece clamping
- The original DEMMELER PPC bolt – for self-centring, force-locked and low-wear clamping



**Screw clamp 180° with spindle**  
Item no.: D28-07005-000

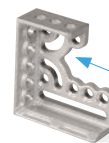

**Clamping and locating angle aluminium-titanium 300**  
Item no.: P28-03002-002/-003



**Original DEMMELER polygon bolts, short**  
Item no.: D28-06025-000

## The optimum 3D welding table for every application. Innovative details for even more efficiency.

Ø 28

Ø 16



**D28 D22** **Clever toolbox**  
with a double drawer for all system parts and plenty of space for difficult angles

### SYSTEM SIZES AND PRODUCT ADVANTAGES OF THE 3D CLAMPING SYSTEM FROM DEMMELER!

Optimum positioning of the work piece not only makes work more accurate but also much more effective. In addition to hardness, system tables from DEMMELER have clear advantages compared to conventional tables. These include intelligent system grids, axis designations with fine scaling, additional drill holes and protective countersinks for optimum protection of tools and table surfaces.

#### FOR DELICATE APPLICATIONS

**D16** PROFIPlusLINE (PL)  
- Diagonal grid 50 x 50 mm  
- 3-row bore pattern on the table side plates, 50 mm grid in the top, middle and bottom row

**D16** PROFIEcoLINE (PE)  
- Grid 50 x 50 mm  
- 3-row bore pattern on the table side plates, 50 mm grid in the top, middle and bottom row



#### FOR LIGHT AND MEDIUM-DUTY APPLICATIONS

**D22** PROFIPremiumLINE (PP)  
- Grid 50 x 50 mm  
- 3-row bore pattern on the table side plates, 50 x 50 mm diagonal grid

**D22** PROFIPlusLINE (PL)  
- Diagonal grid 100 x 100 mm  
- 2-row bore pattern on the table side plates, 50 mm grid

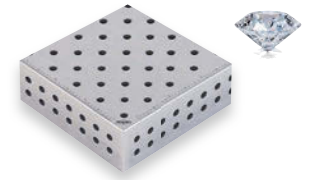

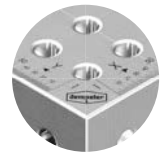

Precision scaling



Protective countersink



Additional bores



Foot sleeve

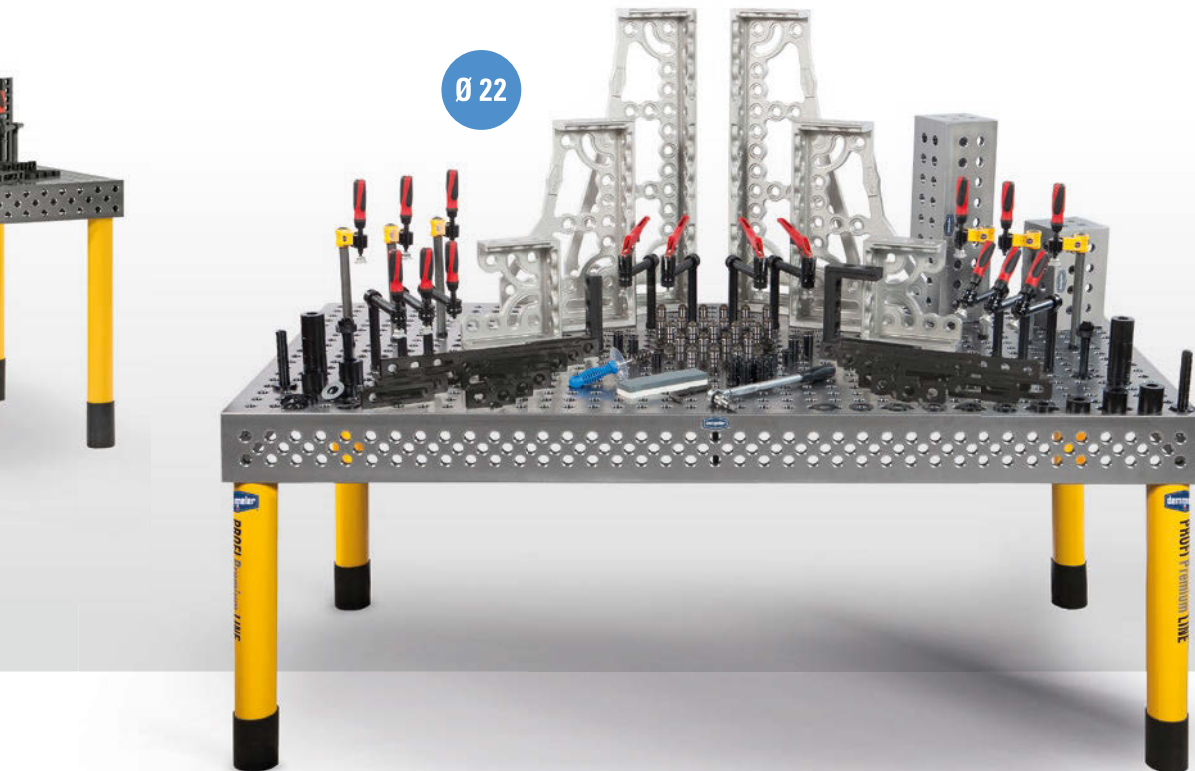

Original 3D welding tables from DEMMELE stand out due to their extreme robustness and durability. With the specially optimised DEMONT hardening process, you get the best surface properties with a hardness of up to 860 Vickers - making them even more wear-free and durable.

FOR EVERYDAY AND LARGE WELDING CONSTRUCTION

**D28** PROFIPremiumLINE (PP)

- Grid 50 x 50 mm
- 3-hole drilling pattern in the table side plates, 50 mm grid in the top and bottom rows with additional 100 mm grid in the middle



**D28** PROFIPlusLINE (PL)

- Diagonal grid 100 x 100 mm
- 3-hole drilling pattern in the table side plates, 50 mm grid in the top and bottom rows with additional 100 mm grid in the middle



**D28** PROFIEcoLINE (PE)

- Grid 100 x 100 mm
- 3-hole drilling pattern in the table side plates, 50 mm grid in the top and bottom rows with additional 100 mm grid in the middle



**D28** HobbyLINE (H)

- Grid 100 x 100 mm
- Worktop approx. 25 mm high with system bores in a 100 mm x 100 mm grid



### PROFIplusLINE (PP) 28 3D welding table

For large welded constructions:

# DEMMELER 3D WELDING TABLE PROFIplusLINE (PL) 28

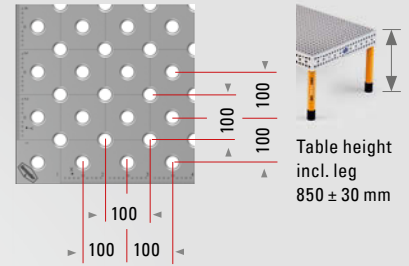
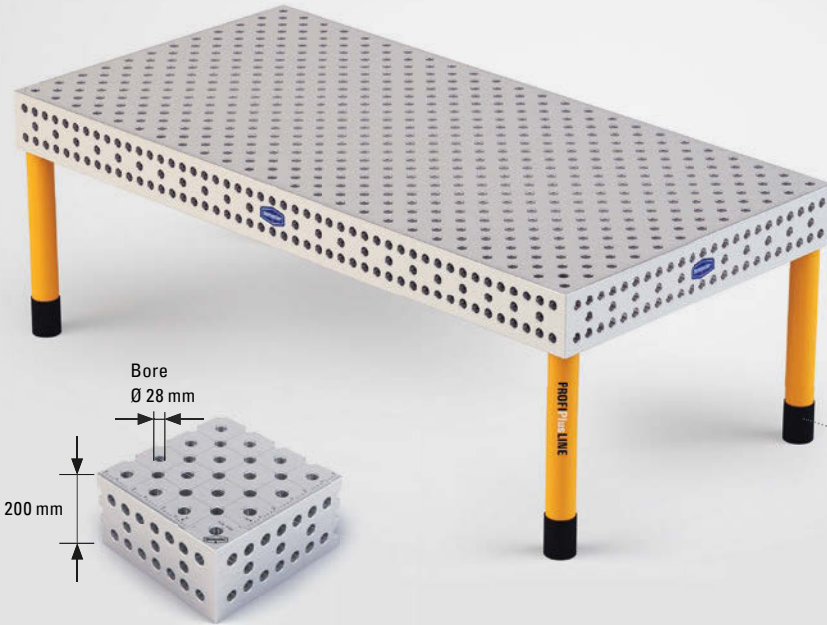

- Worktop with D28 system bores in a 100 mm x 100 mm double grid
- 3-hole drilling pattern in the table side plates, 50-mm grid in the top and bottom rows with an additional 100-mm grid in the middle
- Table sizes optionally available in hardened version, DEMONT 760 M and DEMONT 860 M, (up to 860 Vickers)
- Precision scaling with millimetre graduation
- Coordinate marking of the bores in the X and Y-direction

**Pivoting leg** with stable M 30 x 2 threaded spindle, finely adjustable ± 30 mm  
**Leg sleeve** prevents pinching the welding hose and protects the threaded spindle against dirt.

**HARDNESS**  
DEMONT 760 M

**HARDNESS**  
DEMONT 860 M

TABLE SIZE L X W	TABLE WITH STANDARD LEG	DEMONT 760 M HARDENED	DEMONT 860 M HARDENED
1000 x 1000 mm	PL28-01001-001	PL28-01001-011	PL28-01001-021
1200 x 800 mm	PL28-11019-001	PL28-11019-011	PL28-11019-021
1500 x 1000 mm	PL28-01011-001	PL28-01011-011	PL28-01011-021
1200 x 1200 mm	PL28-01056-001	PL28-01056-011	PL28-01056-021
1500 x 1500 mm	PL28-01031-001	PL28-01031-011	PL28-01031-021
2000 x 1000 mm	PL28-01002-001	PL28-01002-011	PL28-01002-021
2000 x 2000 mm	PL28-01006-001	PL28-01006-011	PL28-01006-021
2400 x 1200 mm	PL28-01003-001	PL28-01003-011	PL28-01003-021
3000 x 1500 mm	PL28-01004-001	PL28-01004-011	PL28-01004-021
4000 x 2000 mm	PL28-01005-001	PL28-01005-011	PL28-01005-021
4800 x 2400 mm	PL28-11085-001	PL28-11085-011	PL28-11085-021

Special sizes available upon request! On request the table is also available in a stainless steel version!

Errors and changes reserved.  
Offer is non-binding.

DIFFERENT LEG VARIETIES  
ARE AVAILABLE UPON  
REQUEST.





Accessory sets PROFIPlusLINE (PL) 28

	D 710	D 720	D 730		
	4	4	4	PE28-03001-000	Clamping and locating angle 175 x 175 x 50 mm
	2	4		D28-03001-005	Clamping and locating angle 175 x 75 x 50 mm
	2	1		PL28-03002-000	Clamping and locating angle right 300 x 275 mm
	2	1		PL28-03002-001	Clamping and locating angle left 300 x 275 mm
			1	PL28-03003-000	Clamping and locating angle right 600 x 375 mm
			1	PL28-03003-001	Clamping and locating angle left 600 x 375 mm
	2	2	4	PE28-03008-000	Clamping and locating angle 275 x 175 x 50 mm
	4	2	4	D28-05001-000	Universal stop /size 225 x 50 x 25 mm
	4	2		D28-05003-000	Stop strip L 500 - 500 x 100 x 25 mm
		2		D28-05003-001	Stop strip L 800 - 800 x 100 x 25 mm
	2	4	4	D28-05009-000	Universal stop L 300 - 300 x 50 x 25 mm
		2		D28-05013-000	Locating disk Ø 75 - 25-50 mm
		2		D28-05013-001	Locating disk Ø 100 - 25-75 mm
		2		D28-05013-010	Angle-setting template
	4	4	4	D28-05015-000	Displacement stop 150, 50 x 25 mm
	12	20	24	D28-06001-000	PC-bolt, short
			2	D28-06002-000	PC-bolt, long
	6	10	12	D28-06009-000	Stop and positioning bolt Ø 28
		2	2	D28-07001-000	Compensating swing clamp 150 mm with spindle
	4	2	2	D28-07002-000	Compensating swing clamp 200 mm with spindle
		4	4	D28-07005-000	Screw clamp 180° with spindle, vertical tube 220 mm
		4	4	D28-07005-014	Screw clamp 180° with spindle, vertical tube 350 mm
			4	D28-07005-015	Screw clamp 180° with quick-action clamping cylinder
		2	4	D28-07008-000	Variable screw clamp 90° with adjusting screw
	4	4	4	D28-07009-000	Variable screw clamp 45° with adjusting screw
			4	D28-07009-011	Variable screw clamp 45° with spindle, clamping tube 350 mm
		2	2	D28-09001-000	11-Piece spacer set Ø 50 x 225 mm
			2	D28-09001-005	Spacer set with thread Ø 50
			8	D28-09003-000	Prism holder steel, burnished Ø 58 mm
	1	1	1	D28-10002-000	Round brush Ø 28
		1	1	D00-10007-000	Bench stone
			1	D00-10009-000	Ground connector D16   D22   D28
	1	1	1	D00-10016-001	Extraction tool - 250 x 40 mm, AF 14

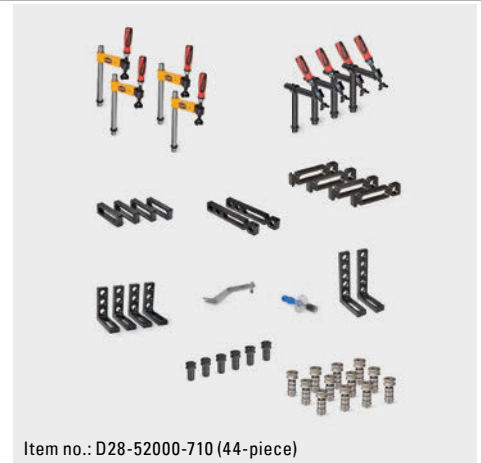

Item no.: D28-52000-710 (44-piece)

PROFIPlusLINE (PL) 28 Set D 710

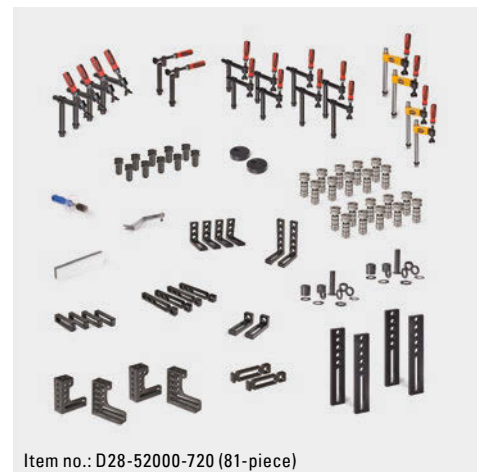

Item no.: D28-52000-720 (81-piece)

PROFIPlusLINE (PL) 28 Set D 720



Item no.: D28-52000-730 (120-piece)

PROFIPlusLINE (PL) 28 Set D 730



PPC bolt surcharge

Set D710	D28-52000-711
Set D720	D28-52000-721
Set D730	D28-52000-731

You can individually assemble or supplement your sets with the large selection of DEMMELER accessories. The DEMMELER general catalogue is available at [www.demmeler.com](http://www.demmeler.com).

### PROFIEcoLINE (PE) 28 3D welding table

For large welded constructions:

# DEMMELER 3D WELDING TABLE PROFIEcoLINE (PE) 28

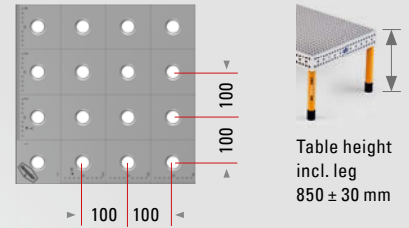

- Worktop with D28 system bores in a 100 mm x 100 mm grid
- 3 drilling pattern in the table side plates, 50 mm grid in the top row with additional 100 mm grid in the middle and bottom rows
- Table sizes optionally available in hardened version, DEMONT 760 M and DEMONT 860 M, (up to 860 Vickers)
- Precision scaling with millimetre graduation
- Coordinate marking of the bores in the X and Y-direction

**Pivoting leg** with stable M 30 x 2 threaded spindle, finely adjustable ± 30 mm  
**Leg sleeve** prevents pinching the welding hose and protects the threaded spindle against dirt.

**HARDNESS**  
DEMONT 760 M

**HARDNESS**  
DEMONT 860 M

TABLE SIZE L X W	TABLE WITH STANDARD LEG	DEMONT 760 M HARDENED	DEMONT 860 M HARDENED
1000 x 1000 mm	PE28-01001-001	PE28-01001-011	PE28-01001-021
1200 x 800 mm	PE28-11019-001	PE28-11019-011	PE28-11019-021
1500 x 1000 mm	PE28-01011-001	PE28-01011-011	PE28-01011-021
1200 x 1200 mm	PE28-01056-001	PE28-01056-011	PE28-01056-021
1500 x 1500 mm	PE28-01031-001	PE28-01031-011	PE28-01031-021
2000 x 1000 mm	PE28-01002-001	PE28-01002-011	PE28-01002-021
2000 x 2000 mm	PE28-01006-001	PE28-01006-011	PE28-01006-021
2400 x 1200 mm	PE28-01003-001	PE28-01003-011	PE28-01003-021
3000 x 1500 mm	PE28-01004-001	PE28-01004-011	PE28-01004-021
4000 x 2000 mm	PE28-01005-001	PE28-01005-011	PE28-01005-021
4800 x 2400 mm	PE28-11085-001	PE28-11085-011	PE28-11085-021

Special sizes available upon request! On request the table is also available in a stainless steel version!

Errors and changes reserved. Offer is non-binding.

DIFFERENT LEG VARIETIES ARE AVAILABLE UPON REQUEST.



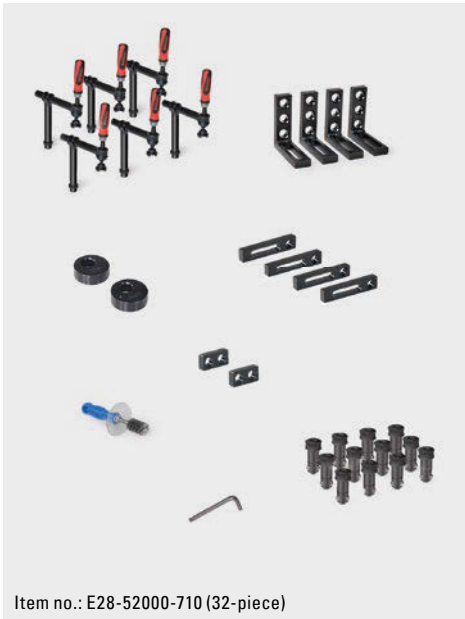

Item no.: E28-52000-710 (32-piece)

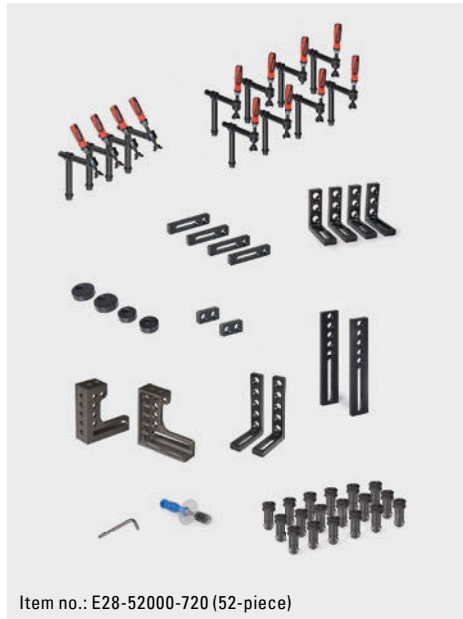

Item no.: E28-52000-720 (52-piece)

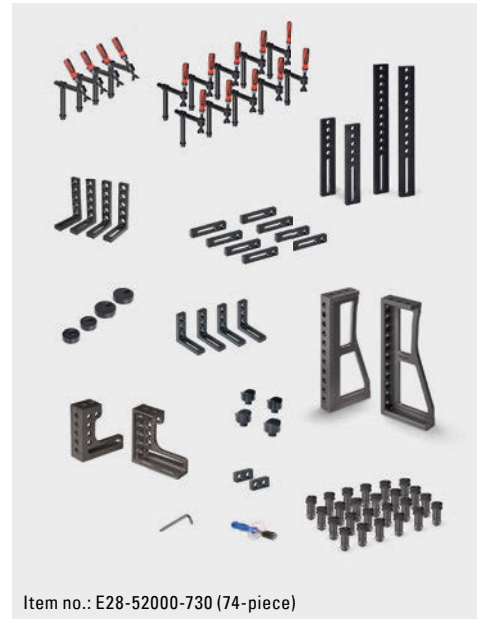

Item no.: E28-52000-730 (74-piece)

ProfiEcoLINE (PE) 28 Set E 710

ProfiEcoLINE (PE) 28 Set E 720

ProfiEcoLINE (PE) 28 Set E 730

	E 710	E 720	E 730		
	4	4	4	PE28-03001-000	ECO clamping and locating angle 175 x 175 x 50 mm
		1	1	PL28-03002-000	Clamping and locating angle right 300 x 275 mm
		1	1	PL28-03002-001	Clamping and locating angle left 300 x 275 mm
			1	PE28-03003-000	PE clamping and locating angle right 600 x 275 x 80 mm
			1	PE28-03003-001	PE clamping and locating angle left 600 x 275 x 80 mm
		2	4	PE28-03008-000	ECO clamping and locating angle 275 x 175 x 50 mm
	4	4	8	E28-05001-000	ECO Universal stop /size 225 x 50 x 25 mm
		2	2	E28-05002-000	ECO Universal stop /size 100 x 50 x 25 mm
		2	2	E28-05003-000	ECO Stop strip L 500 - 500 x 100 x 25 mm
		2	2	E28-05003-001	ECO Stop strip L 800 - 800 x 100 x 25 mm
		2	2	E28-05013-000	ECO locating disk 25-50 mm
	2	2	2	E28-05013-001	ECO locating disk 25-75 mm
	12	18	24	E28-06001-000	ECOLine bolt / short Ø 28 x 95 mm
	6	8	10	E28-07005-000	ECO screw clamp 180° with spindle
		4	4	E28-07009-000	ECO variable screw clamp 45° with spindle
			4	E28-09003-000	ECO prism holder Ø 58 mm
	1	1	1	E28-10002-000	ECO round brush Ø 28 mm
	1	1	1	E28-10008-000	ECO ball-head Allen key AF 8

You can individually assemble or supplement your sets with the large selection of DEMMELER accessories. The DEMMELER general catalogue is available at [www.demmeler.com](http://www.demmeler.com).

Also suitable for aluminium



**THE PERFECT CONNECTION**

- PPC clamping bolt / short
- Very quick to clamp and unclamp
- Force-locking through full-area contact
- Easy on materials
- Extremely robust
- Limit clamping range 41-47

Item no.: D28-06025-000  
PPC bolt, short

ECOLine bolts in the sets can be exchanged for PPC clamping bolts on request.

**PPC bolt, short, surcharge**

- Set E 710 E28-52000-712
- Set E 720 E28-52000-722
- Set E 730 E28-52000-732

### PROFIPlusLINE (PP) 16 3D welding table

For delicate applications:

## DEMMELER 3D WELDING TABLE PROFIPlusLINE (PL) 16

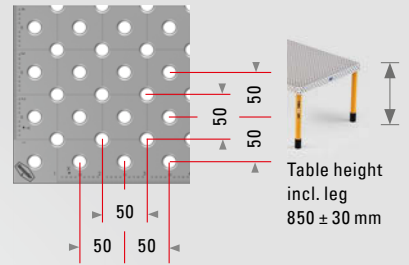
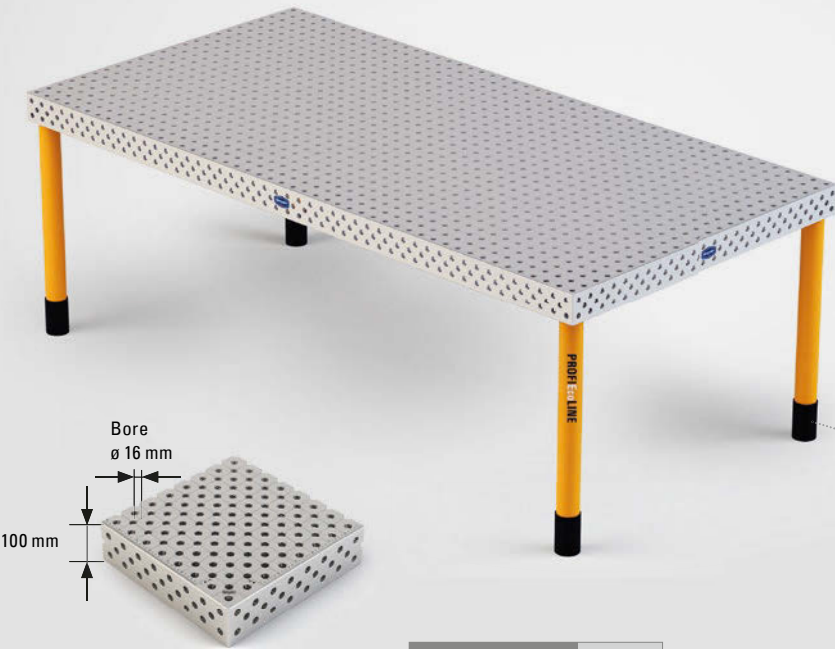

- Worktop with D16 system bores in a 50 x 50 mm double grid
- 3-row bore pattern on the table side plates, 50 mm grid in the top, middle and bottom row
- Table sizes optionally available in hardened version, DEMONT 760 M (up to 760 Vickers)
- Precision scaling with millimetre graduation
- Coordinate marking of the bores in the X and Y-direction

**Pendulum foot** with stable M 24 x 2 threaded spindle, finely adjustable ± 30 mm **foot sleeve** prevents the welding hose from getting trapped and protects the threaded spindle from dirt.

**HARDNESS**  
DEMONT 760 M



TABLE SIZE L X W	TABLE WITH STANDARD LEG	DEMONT 760 M HARDENED
1000 x 500 mm	PL16-01000-001	PL16-01000-011
1000 x 1000 mm	PL16-01001-001	PL16-01001-011
1200 x 800 mm	PL16-11019-001	PL16-11019-011
1200 x 1200 mm	PL16-01056-001	PL16-01056-011
1500 x 1000 mm	PL16-01017-001	PL16-01017-011
1500 x 1500 mm	PL16-01011-001	PL16-01011-011
2000 x 1000 mm	PL16-01002-001	PL16-01002-011
2400 x 1200 mm	PL16-01003-001	PL16-01003-011
3000 x 1500 mm <sup>1</sup>	PL16-01004-001	PL16-01004-011

<sup>1</sup>Consists of 2x 1500 x 1500 x 100 mm.

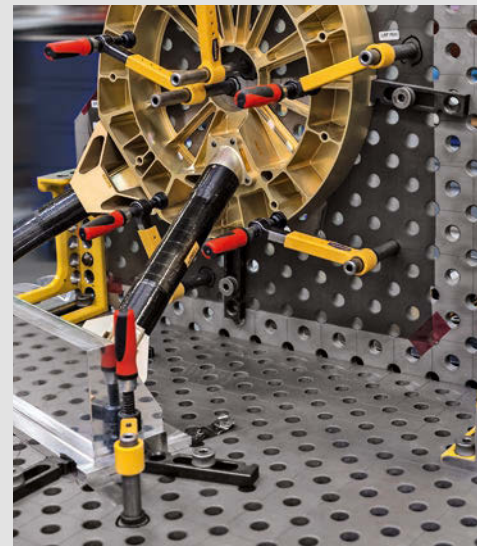

Special sizes available upon request! The table is also available in other materials (e.g. stainless steel) on request!

DIFFERENT LEG VARIETIES ARE AVAILABLE UPON REQUEST.

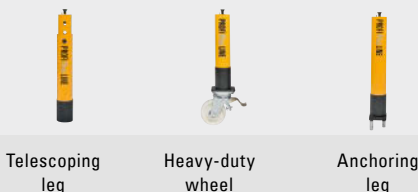

Errors and changes reserved. Offer is non-binding.

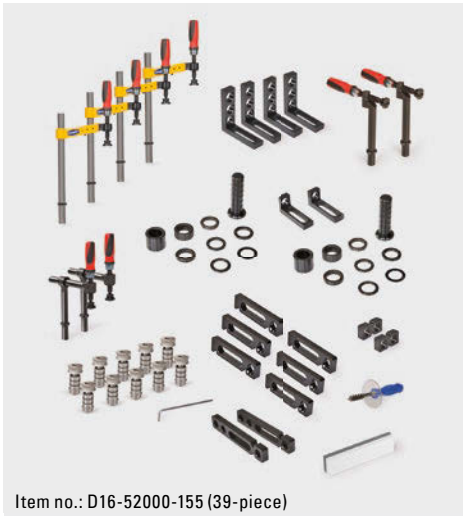

Item no.: D16-52000-155 (39-piece)

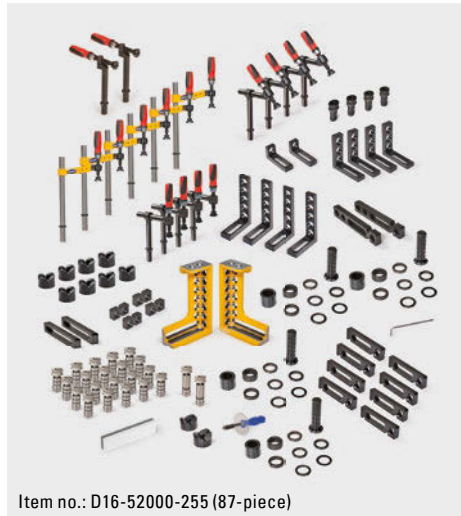

Item no.: D16-52000-255 (87-piece)

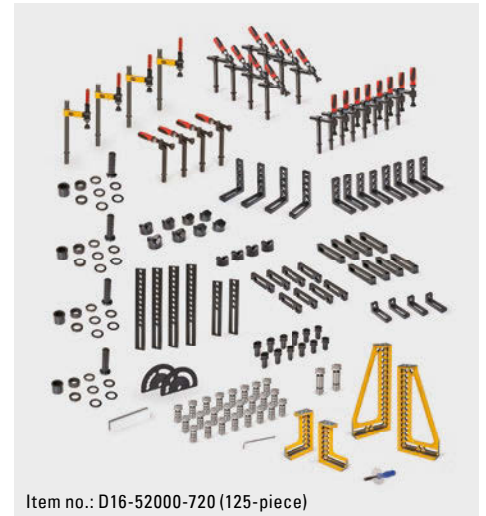

Item no.: D16-52000-720 (125-piece)

PROFIPlusLINE (PL) 16 SET D 155

PROFIPlusLINE (PL) 16 SET D 255

PROFIPlusLINE (PL) 16 SET D 720

	D 155	D 255	D 720		
	4	4	8	D16-03001-000	Clamping and locating angle 90 x 90 x 25 mm
	2	2	4	D16-03001-002	Clamping and locating angle 90 x 37.5 x 25 mm
	2	4		D16-05002-000	Universal stop / small / L55
	1	1		D16-03002-000	Clamping and locating angle right 200 x 137.5 x 50 mm
	1	1		D16-03002-001	Clamping and locating angle left 200 x 137.5 x 50 mm
		1		D16-03003-000	Clamping and locating angle right 400 x 187.5 x 50 mm
		1		D16-03003-001	Clamping and locating angle left 400 x 187.5 x 50 mm
	4	4		D16-03008-000	Clamping and locating angle 140 x 90 x 25 mm
	6	8	8	D16-05001-004	Universal stop with scale 115 x 25 x 12 mm
		2		D16-05003-000	Stop strip L 250, 250 x 50 x 12 mm
		4		D16-05003-001	Stop strip L 400, 400 x 50 x 12 mm
	2	2		D16-05009-000	Universal stop / L 165
		2		D16-05013-010	Angle-setting template
	2	8		D16-05015-000	Displacement stop 150 x 25 x 12 mm
	10	20	24	D16-06001-000	PC bolt, short Ø 16
	2	2		D16-06002-000	PC bolt, long Ø 16
	4	12		D16-06009-000	Stop and positioning bolt Ø 16
		4		D16-07001-001	Compensating swing clamp with quick-action clamping cylinder
	4	6		D16-07001-000	Compensating swing clamp 180° with spindle
	2	4	8	D16-07005-000	Screw clamp 180° with spindle
	2	2	4	D16-07008-000	Variable screw clamp 90° with adjusting screw
		4	8	D16-07009-000	Variable screw clamp 45° with adjusting screw - vertical tube 130 mm
	2	4	4	D16-09001-000	9-Piece spacer set Ø 25 x 60 mm
		2	8	D16-09003-000	Prism holder steel, burnished Ø 80 mm
		8	4	D16-09004-000	Prism holder steel, burnished Ø 58 mm
	1	1	1	D16-10002-000	Round brush Ø 16
	1	1	1	D00-10007-000	Bench stone
	1	1	1	D16-10008-000	Hexagonal wrench AF 8



Item no.:  
D16-03002-000  
(right)

Item no.:  
D16-03002-001  
(left)

**CAN BE USED INDIVIDUALLY**

- Clamping and locating angle casting 200
- Continuous adjustment and locking
- Three full clamping sides with system bores
- Special casting: ultimate stability and ductility
- For use e.g. as a tall stop or table extension
- With grid lines and precision scaling
- Approx. 137.5 x 75 x 200 x 50 mm
- Weight approx. 1.7 kg

You can individually assemble or supplement your sets with the large selection of DEMMELER accessories. The DEMMELER general catalogue is available at [www.demmeler.com](http://www.demmeler.com).

### PROFIEcoLINE (PE) 16 3D welding table

For delicate applications:

## DEMMELER 3D WELDING TABLE PROFIEcoLINE (PE) 16

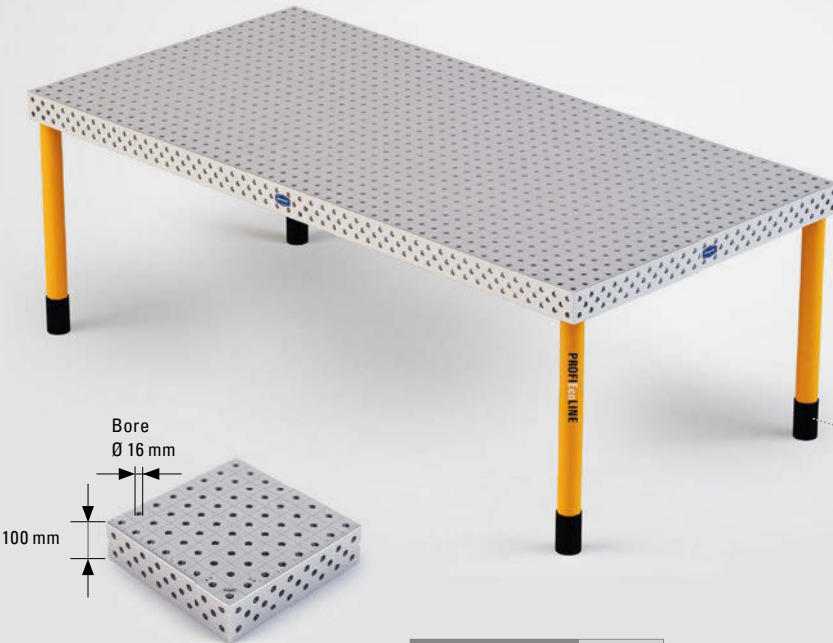
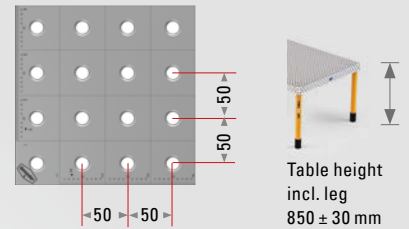

- Worktop with D16 system bores in a 50 x 50 mm grid
- 3-row bore pattern on the table side plates, 50 mm grid in the top, middle and bottom row
- Table sizes optionally available in hardened version, DEMONT 760 M (up to 760 Vickers)
- Precision scaling with millimetre graduation
- Coordinate marking of the bores in the X and Y-direction

**Pendulum foot** with stable M 24 x 2 threaded spindle, finely adjustable ± 30 mm **foot sleeve** prevents the welding hose from getting trapped and protects the threaded spindle from dirt.

**HARDNESS**  
DEMONT 760 M



TABLE SIZE L X W	TABLE WITH STANDARD LEG	DEMONT 760 M HARDENED
1000 x 500 mm	PE16-01000-001	PE16-01000-011
1000 x 1000 mm	PE16-01001-001	PE16-01001-011
1200 x 800 mm	PE16-11019-001	PE16-11019-011
1500 x 1000 mm	PE16-01017-001	PE16-01017-011
1200 x 1200 mm	PE16-01056-001	PE16-01056-011
1500 x 1500 mm	PE16-01011-001	PE16-01011-011
2000 x 1000 mm	PE16-01002-001	PE16-01002-011
2400 x 1200 mm	PE16-01003-001	PE16-01003-011
3000 x 1500 mm <sup>1</sup>	PE16-01004-001	PE16-01004-011

<sup>1</sup>Consists of 2x 1500 x 1500 x 100 mm.

Special sizes available upon request! The table is also available in other materials (e.g. stainless steel) on request!



DIFFERENT LEG VARIETIES ARE AVAILABLE UPON REQUEST.



Telescoping leg



Heavy-duty wheel



Anchoring leg

Errors and changes reserved. Offer is non-binding.

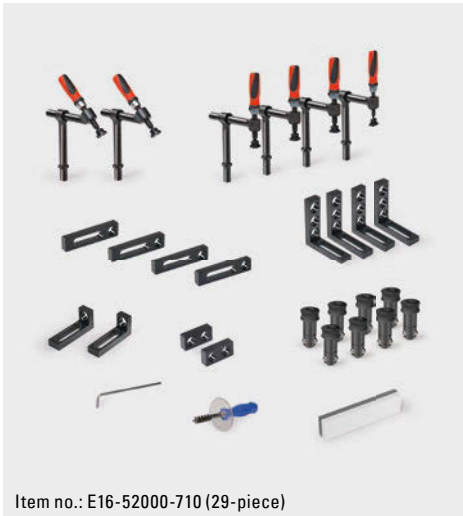

Item no.: E16-52000-710 (29-piece)

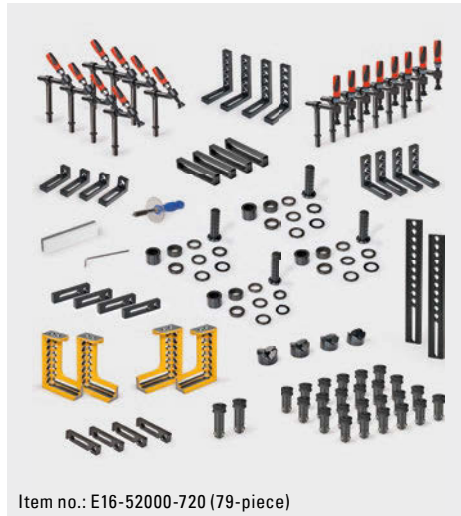

Item no.: E16-52000-720 (79-piece)



Item no.: E16-52000-730 (114-piece)

PROFIEcoLINE (PE) 16 Set E 710

PROFIEcoLINE (PE) 16 Set E 720

PROFIEcoLINE (PE) 16 Set E 730

	E 710	E 720	E 730		
	4	4		E16-03008-000	ECO clamping and locating angle 140 x 90 x 25 mm
	4	4	10	E16-03001-000	ECO clamping and locating angle 90 x 90 x 25 mm
	2	4	4	E16-03001-002	ECO clamping and locating angle 90 x 37.5 x 25 mm
		2	1	E16-03002-000	ECO clamping and locating angle right 200 x 137.5 x 50 mm
		2	1	E16-03002-001	ECO clamping and locating angle left 200 x 137.5 x 50 mm
	2		4	E16-05002-000	ECO universal stop small L55
	4	4	12	E16-05001-000	ECO universal stop / large L115
	4	2		D16-09001-000	Spacer set 9 pieces
		4	2	E16-05015-000	ECO displacement-stop L150
			4	D16-05003-000	Stop strip 250 mm
		2	2	D16-05003-001	Stop strip 400 mm
	4	8	8	D16-07005-000	Screw clamp 180° with spindle
	2	8	8	D16-07009-000	Variable screw clamp 45° with adjusting screw
		4	8	D16-09003-000	Prism holder Ø 80 mm
	1	1	1	D16-10002-000	Round brush Ø 16 mm
	1	1	1	D00-10007-000	Bench stone
	1	1	1	E16-10008-000	Hexagonal wrench AF 5
			4	D16-06003-000	Connection bolt / short
		2	4	E16-06002-000	ECOLine bolt, long
	8	24	32	E16-06001-000	ECOLine bolt, short
			1	D16-11001-002	Accessory cart D16



Item no.:  
D16-03007-000  
(right)

Item no.:  
D16-03007-003  
(left)

**CONTINUOUS TILT  
OF 0° - 225°**

- Universal pivot and tilt angle with hydromechanical clamping:  
>> Completely maintenance-free  
>> Holding force up to 160 Nm torque with system 16
- Can be combined with other system components
- Horizontal and vertical use possible
- approx. 225 x 50 mm
- Weight approx. 3 kg

**ECOLine clamping bolts in the sets can be exchanged for PC clamping bolts on request.**

**PC clamping bolt, short, surcharge**

- Set E 710 E16-52000-711
- Set E 720 E16-52000-721
- Set E 730 E16-52000-731



You can individually assemble or supplement your sets with the large selection of DEMMELER accessories. The DEMMELER general catalogue is available at [www.demmeler.com](http://www.demmeler.com).

**NEW DESIGN**

# HIGH PERFORMANCE – perfect handling with the **DEMMELE** performance screw clamp

Continuous swivelling. Rotation through 360°. Simplifies all-round operation!

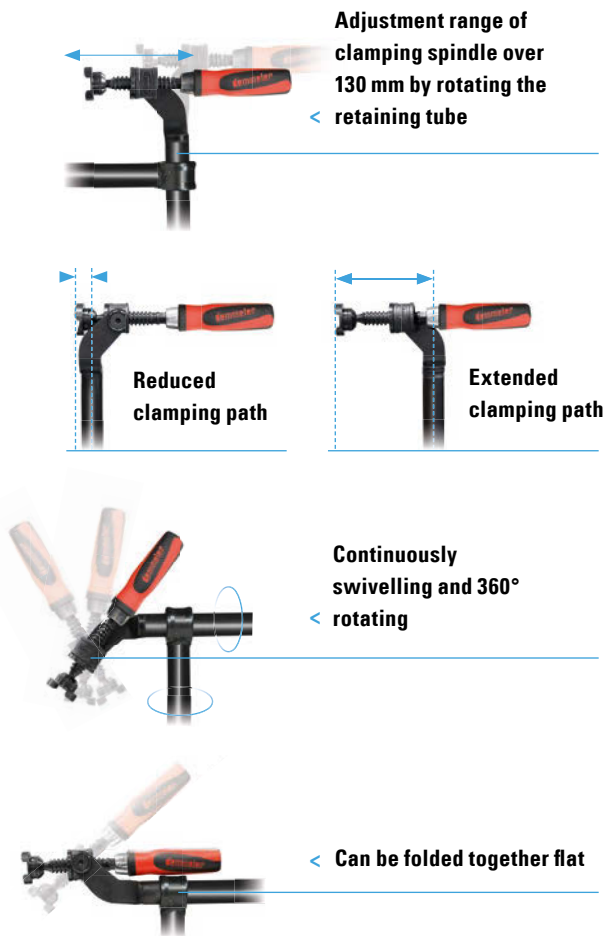

## D28 Performance screw clamp with spindle

- Universally usable for the horizontal/vertical and oblique clamping of work pieces
- Continuously swivelling and 360° rotating
- Adjustment range of clamping spindle over 130 mm by rotating the retaining tube without having to move the clamp (previous version: 68 mm)
- Can be folded together flat (less storage space required)
- With three exchangeable actuation modes (spindle, short boring spindle and quick-action clamping cylinder)
- Max. horizontal length 240 mm, C 300 mm
- Weight approx. 2.2 kg

Item no.: D28-07009-033





Flexible down to the details. Thanks to the modular system, the screw clamp adapts perfectly to different clamping situations. The continuous swivelling and rotation capability through  $\pm 360^\circ$  permits the horizontal/vertical and oblique clamping of round and rectangular work pieces. The clamping pad with V-block, which is supplied as standard, always ensures self-centring clamping at the work piece. The V-block prevents slipping and tipping. Depending on the shape and characteristics of the item to be clamped, other support and pressure pieces are available for high-speed changeovers.

**Other accessories and clamps can be found at [www.demmeler.com](http://www.demmeler.com).**

## Typical potential applications



**Confined spaces.** The DEMMELER performance screw clamp permits simple clamping even in hard-to-access locations. At the same time, the clamping pad with V-block ensures central force distribution.



**High-precision clamping.** The performance screw clamp also always provides a firm grip when work pieces are clamped obliquely. With continuous swivelling and  $360^\circ$  rotation, it is suitable for every clamping situation.

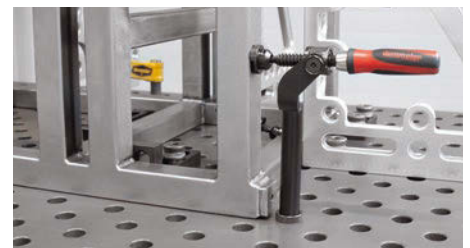

**Extended adjustment range.** Thanks to the new shape, it is possible to clamp nearby work pieces as well as pieces at a greater distance to the next system bore without difficulty.



Unique Swivelling range up to 180 degrees.

## The ultimate in flexibility during welding and assembly.

Limited space. Unlimited possibilities. Outstanding flexibility during welding or assembly work thanks to swivel range of up to 180° as standard.

A special characteristic of the DEMMELER Ergonomix M product family is the large swivel range of up to 180°. This has the crucial advantage with many work pieces of being able to process them fully in one clamping cycle without turning them over. The excellent price-performance ratio of the DEMMELER products is the key feature.



Request our current manipulator brochure as well.



Using the teach controller, it is possible to store multiple different work piece programs and call them when needed.

## Equipment for the Ergonomix M 2000 and optimum extension capabilities

### 1 Controller

Series equipment

- with pendant control panel 2
- with foot switch 3

### 4 Teach controller

Item no. Z00-01001-008

### 5 Laser scanner

Item no. Z00-01010-001

### 6 Rotary feedthroughs

for querying the state of fixtures, electrical:  
Item no. Z00-01004-005  
for pneumatic clamping fixtures:  
Item no. Z00-01004-008  
for hydraulic clamping fixtures:  
Item no. Z00-01004-009

### 7 Ground connector

max. 400 A at 60% ED:  
Item no. Z00-01000-002  
max. 700 A at 60% ED:  
Item no. Z00-01000-009

- Series equipment
- Special equipment



## Basic model Ergonomix M 2000

Description		M 2000 / V1250	M 2000 / V2500
Bearing load (w/o worktop)	[kg]	2000	2000
D=max. interference area at 180° (w/o worktop)	[mm]	1000	1000
At height	[mm]	650	650
Max. rotation speed	[RPM]	1.4	1.4
Min. rotation speed	[RPM]	0.75	0.2
Torque	[Nm]	1250	2500
Tilt angle	[°]	180	180
Moment of tilt	[Nm]	8000	8000
A=min. height (w/o worktop)	[mm]	490	490
B=max. Height at 180° swivel angle	[mm]	970	970
C=max. Height at 90° swivel angle	[mm]	1480	1480
Pendant control panel		✓	✓
10-speed control		✓	✓
Motors / rotary axis		1	2
Item no.		M02-02000-006	M02-02000-007

Specifications without worktop. Other equipment details on request.

Errors and changes reserved. Offer is non-binding.

## Optional clamping solutions: Worktops and 3D worktables

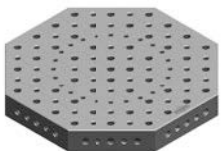

### 3D worktable Okto (suitable for Ergonomix M2000)

- 3D worktable Okto with D28 system bores in 100 x 100 mm grid and M24 thread in diagonal grid
- Includes cover plate on the underside as collision protection
- Dimensions: SW 800, H 100 mm, weight: 155 kg

Item no.: D28-01013-032

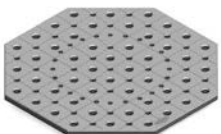

### Clamping and adapter plates (suitable for Ergonomix M2000)

- Clamping and adapter plate with D28 system bores in 100 x 100 mm grid and M24 thread in diagonal grid
- Includes cover plate on the underside as collision protection
- Dimensions: SW 800, H 25 mm, weight: 120 kg

Item no.: D28-02001-221





**Convenient online ordering:  
DEMMELER Webshop**

Discover our entire product range for clamping systems, tools and accessories on our webpage and conveniently submit your order online.



**Subscribe to our new YouTube Channel  
that showcases many products and example applications.**

**FAX ORDER FORM – FAX NO.: +49 8335 9859-27**

Quantity	Item no.	Article designation	Unit price	Total price



**„Original 3D clamping systems  
and welding tables“**  
Our general catalogue comprises 620 pages  
and offers a complete overview of our entire  
product line with many interesting example  
applications.

Please send me the general catalogue.

Your address / company stamp / signature

Would you like more information about our products?  
We will gladly send you a free  
product brochure. Please use check marks.



Manipulators



NC rotary tables



Tool changing  
system

PDFs of the brochures  
are also available  
for download at  
[www.demmeler.com](http://www.demmeler.com)



OUR PERFORMANCE  
makes THE DIFFERENCE

DEMMELER Maschinenbau GmbH & Co. KG  
Alpenstraße 10, 87751 Heimertingen/Germany  
Tel.: +49 8335 9859-0  
Fax: +49 8335 9859-27  
Email: [sales@demmeler.com](mailto:sales@demmeler.com)  
Website: [www.demmeler.com](http://www.demmeler.com)

Your authorised dealer: