

# UniSee Guided Installation

Executive Summary rev 2.0

## Who is the Reseller

Name of Project (Per Reseller):

Reseller Name:

City/State:

Project Contact:

Title: PM

Sales Mgr

Purchasing

Email:

Phone:

## Shipping To

Destination Contact Name:

Email:

Phone:

## Installation Location

Company Name and Address:

Estimated Delivery Date:

Estimated installation Date:

(30-days or less require authorization)

## Tell Us About The System

The Facility is: Replacing/Upgrading

Expanding

New Construction

Type of wall: Sheetrock

Brick/stone

On Stand

Other

List locations, configuration & Controller e.g., Lobby-3x2 UPW210, Control RM-10x4 NGP410...

## Other Information

Who is the Barco Sales Manager Associated with this purchase?

Provide Other Voluntary Information Beneficial to the Project:

# PRE-INSTALLATION REQUIREMENTS – BARCO UNISEE WALL

## Table of Contents

Introduction	2
Responsibilities	2
UniSee Guided Installation	2
UniSee wall installation Requirements	3
⚠ Re-Seller/Integrator Mandatory Requirements	3
Online Training	3
Installation Tool list	5
Dead-On-Arrival (DOA) check	6
After installation support	7
Return shipment preparation	7
General Requirements and Recommendations	8
Site Conditions and material handling	8
Access to the installation site	9
Environmental Conditions (Temperature, humidity, etc.)	9
Luminance	10
Health and Safety	10
Wall mounting Requirements – Wall Preparation	11
UniSee UNI-8002 Panel Specs	12
Strut channel approach suggestion	12
Wall Requirements – Recessed wall considerations	13
Wall Requirements – Trim/cladding considerations	13
Ethernet network requirements	13
Power and Grounding requirements	14
UniSee Panel power specs	15
External Power Supply (Optional)	15
UniSee Connect (BCMC Wall Controller)	16
Image source and video cabling requirements	17
Video cable path considerations	17
Checklist for Pre-Installation Requirements	18

## Introduction

This document describes the general technical requirements before the installation as well as the conditions of use of a Barco video wall system based on the UniSee display.

**The key for a successful installation is having the site and the team well prepared, so the requirements listed on this document are to be followed.** A failure to do so can result in delay, loss of warranty and can lead to additional costs that will be invoiced to the purchaser.

**IMPORTANT:** For partner registration at Barco (create a myBarco account) and get access to product/training content, please go to <http://www.barco.com/en/register>

## Responsibilities

The **Barco Project Manager** is responsible:

- To inform the customer about the pre-installation requirements for the system that has been purchased.
- To check whether the customer fully appreciates the scope and importance of them.

The **Customer Project Manager** is responsible:

- To thoroughly check these pre-installation conditions.
- To make sure that these conditions have been implemented before the start of the installation.
- To return the signed Checklist Form at the end of this document to Barco at least two weeks before the start of the installation.

## UniSee Guided Installation

Recommended on-site guidance for Barco partners on their first UniSee installation. The goal is to ensure the installation success by teaching the integrator team on the step by step procedure during the contracted period, as a complement to the Online Training preparation.

Barco offers guided installation packages to cover the most typical installations. In the event you need a customized quote, feel free to contact us.

More details can be found on the **UniSee Guided Installation quote**.

# UniSee wall installation Requirements

## ⚠ Re-Seller/Integrator Mandatory Requirements

### Online Training

- Train the installing team (at least two persons) on the online training available at Barco website (MyBarco login required):



[Barco Certified Specialist - UniSee Installation](#)



[Product Registration & BCM6 Software E-learning](#)

- **On-line trainees should prepare and set up their “My Barco” accounts up ahead of time (2 business days).** This will allow some time for our internal training team to provide the proper approval and time for processing their requests.
- Make sure to use the two provided links above. This is critical to accessing the correct eLearning modules in Barco University.
- Recommended Browser for accessing eLearning content in Barco University is Chrome; Microsoft IE/Edge can have restrictions that may prevent the content from working. If they have a problem accessing any part of the Barco Website or Barco U it is most likely with the local computer and/or browser, we cannot fix this.
- All courses must be completed entirely, no skipping modules or jumping forward on videos. If the module detects any part is avoided it will not allow for completion.
- Direct links for the Barco US Team made videos on Unistrut preparation and alignment:
  - [Preparing the Unistrut channels](#)
  - [Installing the crosses](#)
- The certificates from the trained people must be sent to Barco Project Management contact a minimum of two weeks in advance for schedule/mobilization confirmation.

- To get the certificates please follow the following steps:
  - Being logged into your myBarco account
  - On the Training page – click on “Visit your personal plan”

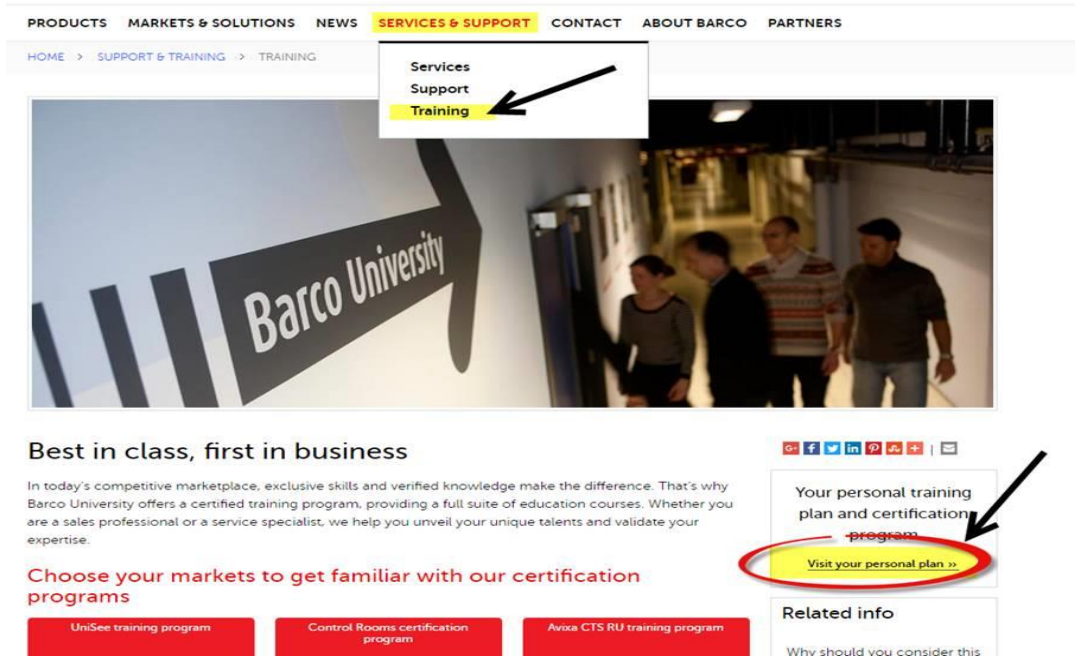

- In your My Learning Assignments: You will see the “End-of-Course survey”

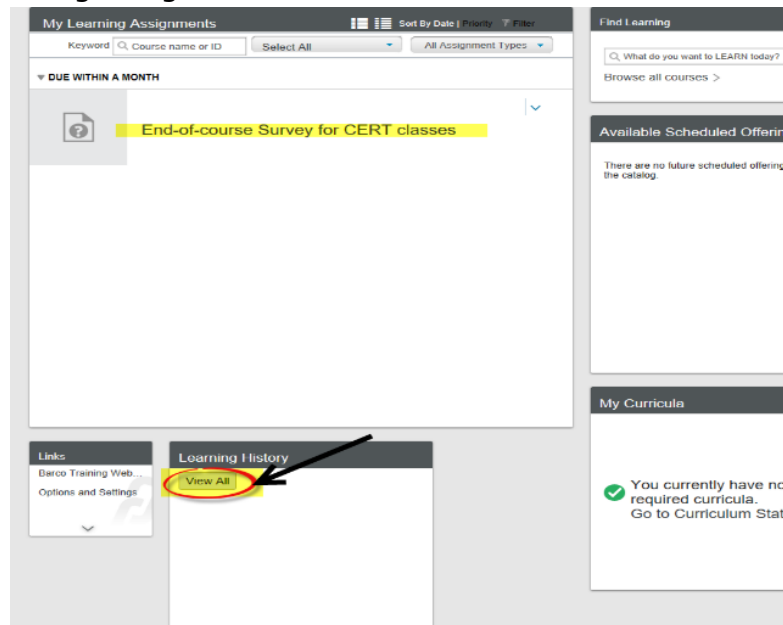

- In your History: click on “View All” in Learning History
- See all your class(es) with a printer icon next to it.

## Installation Tool list

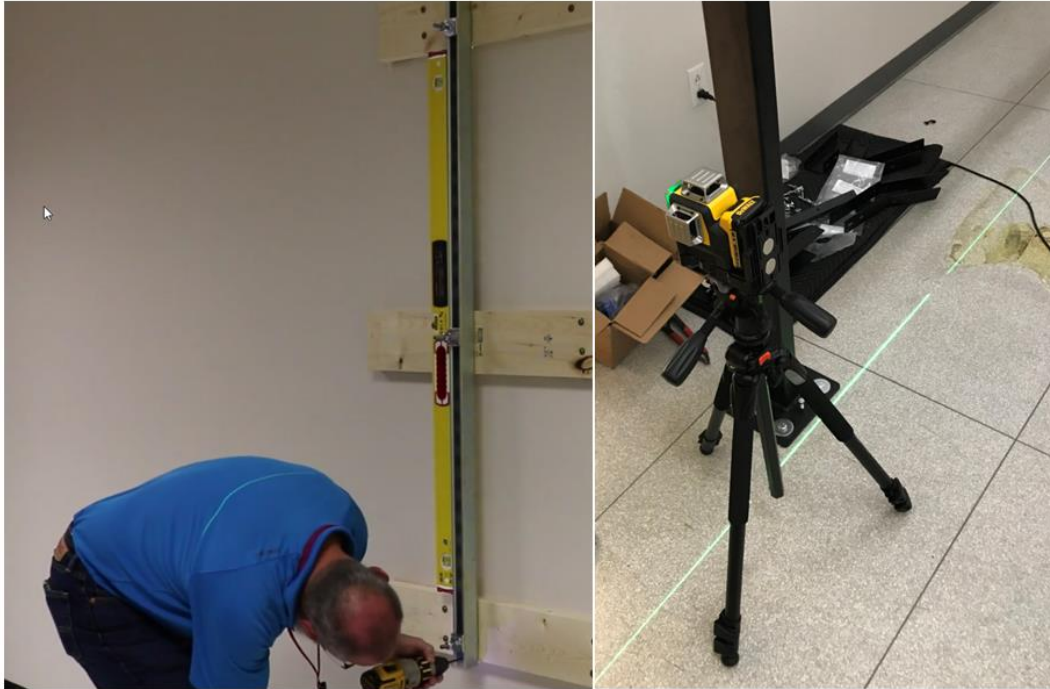

- Self-leveling cross line (vertical/horizontal) or rotating green laser on a tripod. Reference model **DeWalt DW089LG**
- Pencil or a small marker
- Torx (star) key size 20, 25, 30 (do not use Allen keys for risk of damage!)
- Wrench key size 13, 17, 24 millimeters
- Measurement tape
- Drilling machine
- 48 inch (>1 meter) electronic digital level
- Adjustable wrench
- Torque key
- Allen key sizes 4, 5 and 6 millimeters
- Diagonal cutter
- 6-inch tongue and groove pliers

⚠ Please also foresee the proper high lift devices on place and safety training to work on heights: ladders/scissor lift/scaffold etc.

## Dead-On-Arrival (DOA) check

Each UniSee panel must be checked for transportation damages before installation while still in the box. Any DOA claim after unpacking the screen will be void.

The DOA Test procedure documentation can be found in the UniSee Accessory kit and inside the LCM packaging. It is also thoroughly explained within the online [Barco Certified Specialist - UniSee Installation](#) training course.

Please also check the following links on the DOA test procedure:

[DOA check UniSee View](#)

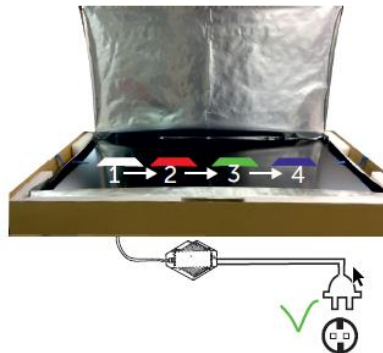

[DOA Instruction Video](#)

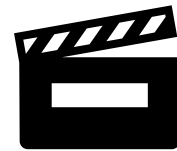



Figure 1 – Damaged UniSee panel under DOA test.

## After installation support

Any post-installation activity or technical support needs to go via the Service Helpdesk at Barco:

 Telephone: +1 866-992-2726, Option 1  
E-mail: [service.controlrooms.usa@barco.com](mailto:service.controlrooms.usa@barco.com)

## Return shipment preparation

In case of an RMA or return shipment need, the LCM panel must be handled as carefully as a new display. So, pack the same way as you received, means using all foam parts, bags, and cardboard.

- Close the DOA inspection cut-outs at the box using tape.
- UniSee panels have to be shipped in an upright position at a pallet (see the arrows at the box).
- It comes with challenges for only shipping one or two displays:
  - Strap together with empty boxes to stabilize the shipment.
  - Strike through the label of those empty boxes.
  - Combine stacks of at least four boxes width as per scheme on Figure 2.



Figure 2 - UniSee panel box and packaging guidelines.

- Check for resistance against tilting or side sliding.



## General Requirements and Recommendations

### Site Conditions and material handling

- All construction, reconstruction, decoration activities must be completed before the installation of the system to prevent excessive dust on and in the devices and to prevent possible mechanical damage.
- Any return trip due to the site not being ready will be billable and subject to reschedule availability.
- The purchaser is responsible for the safekeeping of the materials. Materials should be maintained in an environmentally controlled room close to the installation area.
- Keep the UniSee parts on their original pallets until installation time. In case it is not possible, keep the boxes on the upright position according to the arrow indication on the box.
- Do not open the internal boxes → Please refer to the Packing List if needed.



Figure 3 - UniSee panels pallet example.

## Access to the installation site

- The building must be accessible during the extended straight time, 6 AM – 12 PM, five days per week. Alternative time slots need to be agreed upon with the Barco Project Manager.
- From the delivery point to the installation site, all doors and passages require a minimum width and height that depends on the size of the systems. The delivered volume information is available on the Packing List document.
- A responsible, single point of contact must be available during the installation for practical arrangements and safety reasons.
- The customer is requested to grant access to Barco personnel, and subcontractors, if that applies, to first aid and medical attention facilities as required.
- Barco's personnel might use a computer in the installation site to log or retrieve information related to the installation or performance of the display wall system and to communicate with the Barco offices as required. Barco requests access to a telephone line and the Internet at and near the installation site.

## Environmental Conditions (Temperature, humidity, etc.)

- The temperature and humidity conditions in the room must be within specification during installation and maintained afterward. **Airflow behind the display wall for heat exchange is required.**
- The displays require a temperature between 62-81°F (17-27°C) for optimum performance and humidity between 20-70% RH (non-condensing).
- The displays operate between 50-104°F (10-40°C). The thermal dissipation of the units has to be taken into consideration.
- The displays can be stored between -4 to 140°F (-20 to 60°C) and humidity below 90 % RH, non-condensing.

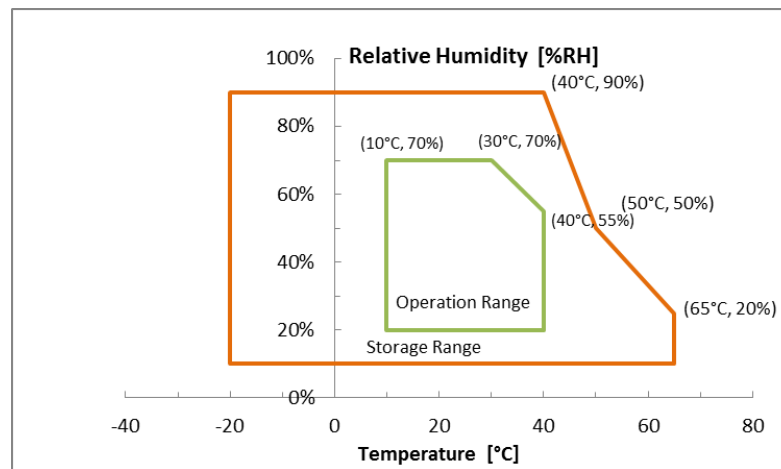

**Figure 4 - Storage and operation range chart.**

- 3hrs before installation the screens have to acclimatize to the room conditions if they were stored in an environment with a temperature difference of more than 10°C/50°F with the installation environment. During this period, the screens remain packed but unbundled.
- Dust-free site condition during the whole installation. Barco advises a dust class of ISO 14644-1 level 8 or better in the room.

## Luminance

- Light falling directly on the screen will negatively influence the resulting contrast level. The design of the lighting should avoid as much as possible light falling directly on to the screen. The light condition on the screen will determine the real performance of the displays system.
- Bright colors for the ceiling, the walls and floor surrounding the screen have to be avoided. Do not use reflecting materials for the roof, the walls and floor surrounding the screen.
- Ample lighting in the room is required during installation.

## Health and Safety

- All local Health and Safety considerations need to be made available at the sign of this document.

## Wall mounting Requirements – Wall Preparation

- The installation room must be sufficiently high and have enough floor space, and maintenance area must be available when installing the display wall.
- Enough space ( $\geq 120\text{mm}$ ) must be provided above the display wall as on all sides (please refer to Figure 6).

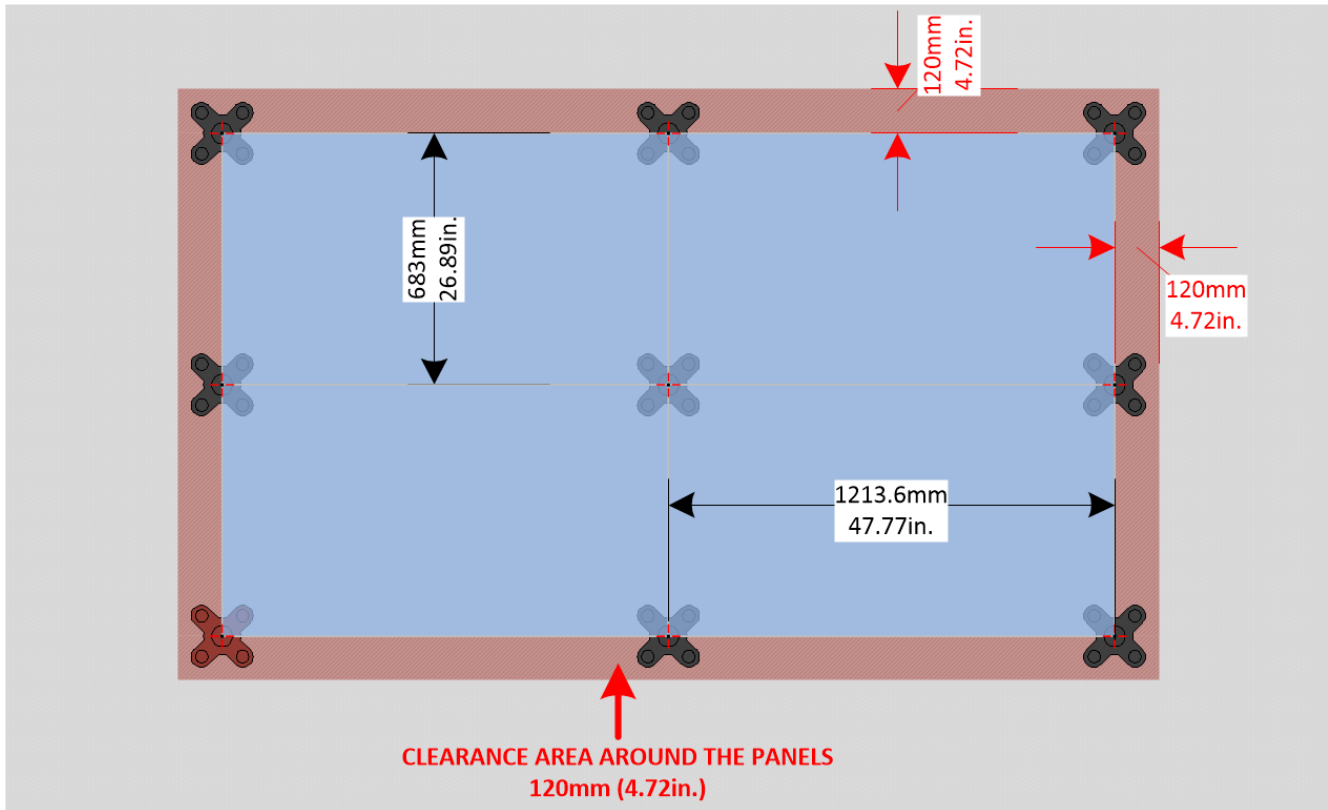

Figure 5 - 2x2 UniSee wall reference dimensions.

- Wall should be straight and capable of carrying the weight of the video wall.
- The integrator/customer is responsible for drilling holes into the building wall.
- The M10 anchor's bolts (suitable for the specific type of floor/wall) and threaded rods are not included in the delivery and are to be selected and delivered by the customer. Each of the anchors must be able to withstand a pullout force of 0.5kN.
- **IMPORTANT:** In case of drywall, it has to be reinforced with  $\frac{3}{4}$  inch thick wood backing attached to the drywall structure studs.

## UniSee UNI-8002 Panel Specs

<b>Dimensions</b>	1213.5 x 683 x 102.4 mm   47.8" x 26.9" x 4.03" (internal SMPS)
<b>Active screen area</b>	1212.5 x 682 mm   47.7" x 26.8" (55")
<b>Weight</b>	LCM NET: 15 kg   33.1 lbs. LCD (LCM+ one power supply +input board): 17kg LCD + Smart mount (complete module): 32kg → 40kg for loading calculation reference.
<b>Depth</b>	50,4mm (LCM only) 167mm (Does not include wall reinforcement or Unistrut channel profiles that may be applied)
<b>Pull-out strength wall anchors</b>	$F_x=0,05\text{kN}$ $F_y=0,38\text{kN}$ $F_z=0,06\text{kN}$
<b>Bezel width</b>	NA (bezel-less)

### Strut channel approach suggestion

Using strut channel profiles to fasten the M10 threaded rods to strut nuts is a more practical and cost-effective way to secure the UniSee frame to a wall and ensure the best mechanical alignment is possible.



Figure 6 – Wall mounting installation with Strut channel profiles.

**IMPORTANT:** UniSee is a METRIC system so requires metric Unistrut M10 threaded rods and channel nuts. More information on that can be found on the [Installing Unistrut for UniSee](#) video (myBarco) and the **UniSee wall mounting with strut system** reference document.

## Wall Requirements – Recessed wall considerations

- A recessed wall must also consider the following:
  - Minimum of 120mm (4.72 inches) clearance around the screens and proper panel ventilation on the back side for heat exchange (please check environmental and power requirements);
  - System depth: the nominal system depth from the reference wall to screen front side is 168mm (6 5/8” inches). That may increase in case strut channel profiles are used (please see the **UniSee wall mounting with strut system reference** document);

## Wall Requirements – Trim/cladding considerations

- Trim around the UniSee videowall can only be mounted after completion of the installation. All precaution should be taken to avoid any damage during the mounting of the final trim. The purchaser bears the responsibility for any damage or degeneration during this operation;
- The trim must be quickly removed all around the video wall for service purposes;
- Please consult Barco UniSee Ecosystem website on <https://www.barco.com/en/page/UniSee-ecosystem> for extra information on trim solutions.



## Ethernet network requirements

Table 1 - Ethernet connections on the customer network for Barco supplied devices.

QTY	DEVICE	STATIC IP
01	BCMC (Internal server for video wall control and diagnostics)	optional

- The Barco UniSee panels and BCMC appliance are intended to be implemented as an isolated LAN for video management. However a separate "client" network port is available on the BCMC appliance to allow connection to the customer's corporate network if desired or required.

**IMPORTANT:** A network administrator must be available during the installation to advise the network connection and to take care of the required network authorizations.

## Power and Grounding requirements

- The electrical network must be available and functional before the start of the installation. Power outlets for installation purposes are required as well.
- Earth current loops in the installation must be avoided. The neutral power conductor of the electrical net and the grounding conductor must be separated.
- Each display has specific power requirements (see technical specification). The number of displays starting up at the same time must be limited to avoid tripping of the fuse at startup.
- The a/c power and system need to be grounded by a qualified electrician, ordered by the integrator/customer. The material for grounding is not included in delivery:

Per column, the green-yellow cable with annular cable lug (M6) and the spring washer/star washer needs to be provided on site:

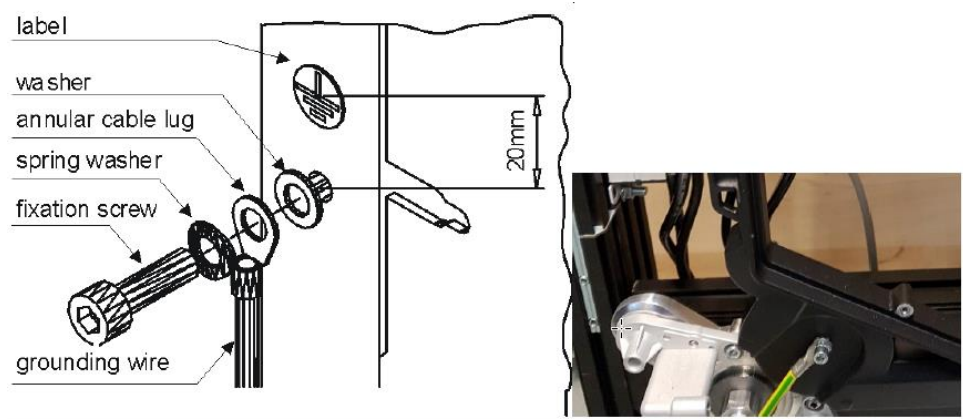

**Figure 7 - Grounding recommendation per video wall column.**

- All circuits have to use the same ground level (also indirectly connected equipment).

## UniSee Panel power specs

POWER SPECS PER UNI-8002 DISPLAY	LUMINANCE REFERENCE	INTERNAL POWER SUPPLY	EXTERNAL POWER SUPPLY
Power consumption (W)	800 nits	190	175
	350 nits	100	92
Heat Dissipation (BTU/h)	800 nits	650	600
	350 nits	342	314

## External Power Supply (Optional)

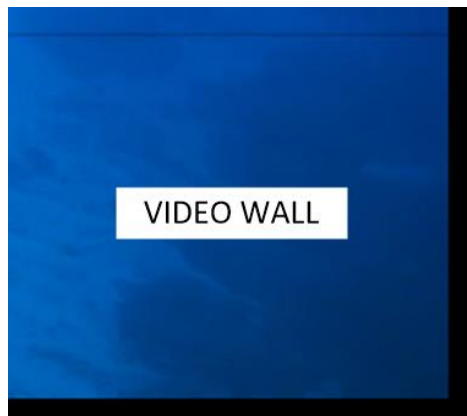

REMOTE POWER SUPPLY MODULE  
(INSTALLED IN A 19 INCH RACK)



POWER CABLE ADAPTER

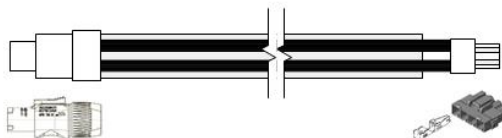

REMOTE POWER CABLE (10, 20, 50 OR 100M)

**Figure 8 – Remote power supply option.**

Each 19" rack module reference **R9849349 - EXT-1200 EXT POWER SUPPLY BLCK** can feed up to 6 LCD monitors. Two to four power supply bricks can be installed in a power supply module depending on the redundancy scheme.

Remote power supply cables are available on the following lengths: 10, 20, 50 or 100 meters.

**IMPORTANT:** Barco warranty is void in case the remote power cabling is cut and reconnected. The remaining cable length should be arranged in an "8" loop shape to prevent "coil effect" and consequent heating.



## UniSee Connect (BCMC Wall Controller)

The BCMC device is used for the UniSee video wall setup, control, and diagnostics over the network. It creates an INTERNAL LAN for the displays, isolated from the customer (CLIENT) network.

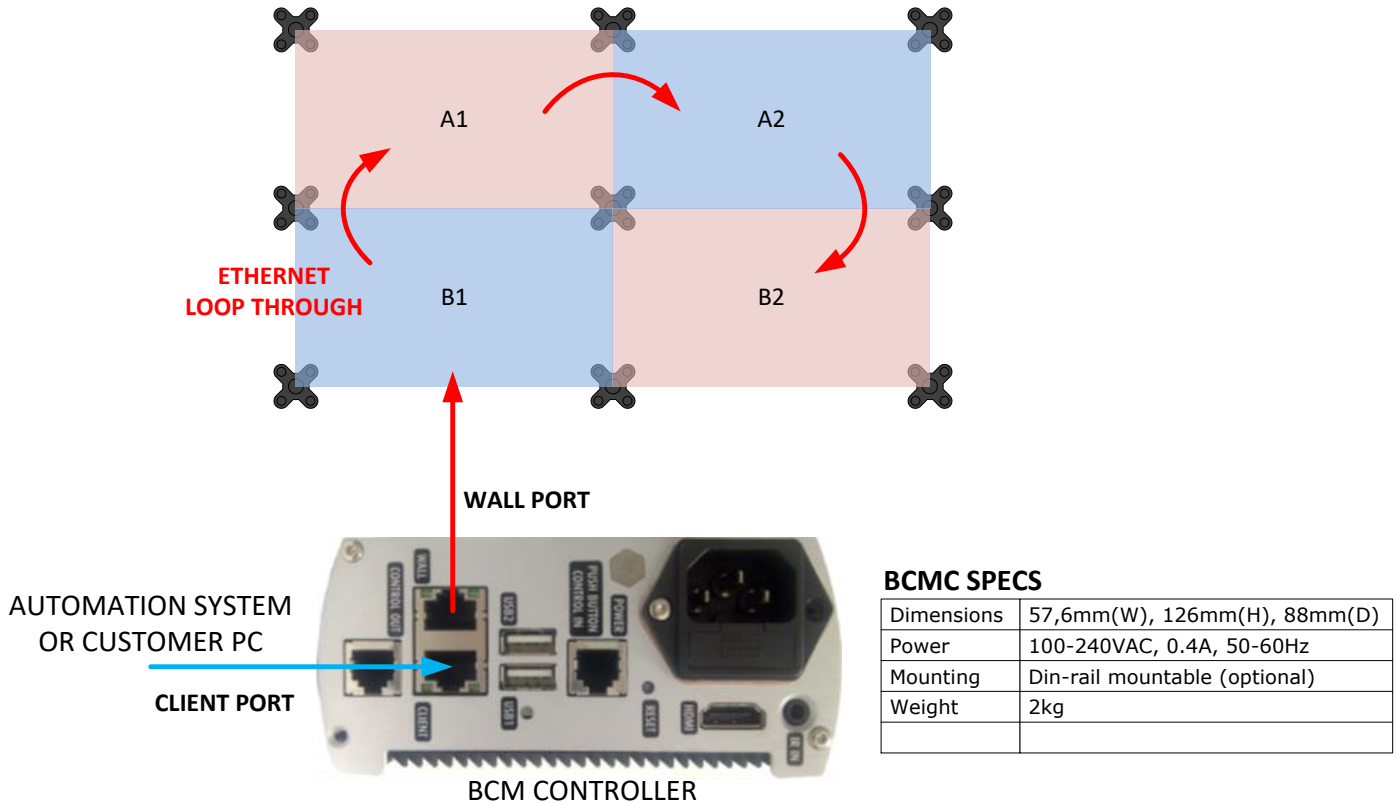

Figure 9 - BCM setup example in a 2x2 wall.

Up to 16 (8 recommended for better performance) displays can be connected in a loop-through arrangement: always connect the LAN OUT (LAN2) of the previous display with the LAN IN (LAN1) of the following display.

An alternative approach is one to one network connection from a switch configured to create an isolated VLAN with no restrictions.

**IMPORTANT:** To use the BCM6 interface, the video wall must be registered first through the procedure indicated on the [Product Registration & BCM6 Software E-learning](#).

## Image source and video cabling requirements

The UniSee input module and UniSee panel currently support the following video connections:



Figure 10 - Input module ports.

<b>Native panel resolution</b>	1920x1080	
<b>DisplayPort</b>	2 DP1.2 with HDCP 1.4 inputs 1 DP1.2 output	
<b>HDMI</b>	2 HDMI 1.4a with HDCP 1.4 inputs	
<b>USB</b>	2 (only for power)	
<b>Ethernet port</b>	2. 1 GB Ethernet input (LAN 1), LAN 2: configured as LAN OUT for loop-through cabling, not available for input (visualized via the missing fill color).	
<b>HDCP</b>	<b>HDMI:</b>	- direct source connections (one to one) only.
	<b>DisplayPort:</b>	- direct sources connections or - loop through (HDCP repeater) up to 7 display in total
<b>Máx. supported resolution</b>	4k@30Hz (2x2HD@30Hz) for DP1.1 connection or HDMI 1.4 4k@60Hz (2x2HD@60Hz) for DP1.2 connection	

- The display has loop-through of the active input (HDMI, DisplayPort) to the DisplayPort output, which allows connecting multiple sets of displays in a daisy chain.
- As soon as the input (HDMI, DisplayPort) is selected the active input, this input has a loop-through connection to the DP output.

### Video cable path considerations

- Use a shielded signal interface cables with a ferrite core to maintain standard compliance for the product;
- If applicable, use a High-Speed HDMI™ or a DisplayPort 1.2 cable;
- Barco cannot test and validate any 3rd party cable or video processing interface on the market.

## Checklist for Pre-Installation Requirements

Please place a check in the OK column or provide comments in the Remarks section, then email this form signed at least two weeks before the installation date to the Barco project manager in charge.

Requirement type	OK	Remarks
Installation team Training/Previous experience		
Installation tools kit and lifting devices		
Barco material on place		
Health and Safety local requirements and procedures		
Site conditions (luminance, temperature, humidity, dust free) and workspace for installation activities		
Wall preparation		
Unistrut parts purchased and available on site		
Power and grounding		
Barco Connect – BCMC (Power and network)		
Image source and video cabling		

At this moment, we confirm that the requirements for the installation of the visualization system – as specified in this document - will be entirely fulfilled by the installation date.

Date	Name	Company	Signature

