



Enterprise and Data Center Preferred Parts for Network Infrastructure

North America

WESCO®

PANDUIT®

Network Infrastructure

Today's networks support ever-expanding converged applications for voice, data, and video, as well as functions such as intelligent lighting, security, safety systems, and more. Panduit® provides the industry's most comprehensive and holistic portfolio of products and services that enable sustainable, energy-efficient enterprises. Innovative design features provide easy installation, reduced maintenance costs, and improved network reliability and flexibility. This catalog features the most common offering for a physical infrastructure deployment in your Enterprise, Telecommunications Room or Data Center.



Table of Contents

Copper Cable	3	Cabinets and Thermal Management	13 – 15
RJ45 Patch Cords	3 – 4	Racks, Shelves and Accessories	16
RJ45 Jack Module	4	Cable Managers	16
High Speed Copper Trunks and Assemblies.....	4 – 5	Power Distribution Units (PDUs)	17
Patch Panels, Kits and Accessories	5	Wyr-Grid® Overhead Cable Tray System.....	18
Fiber Trunks and Assemblies	6 – 7	FiberRunner® 6x4 Cable Routing System.....	19
Fiber HD Flex™ Fiber Cabling System	8 – 9	Faceplates	20
Fiber Enclosures	9	Surface Mount Box	20
Fiber Cassettes.....	9	Surface Raceway.....	20
Adapter Modules and Fiber Adaptor Panels (FAPs).....	10	Zone Enclosures	21
Fiber Patch Cords and Pigtails	10 – 11	Grounding	21
Fiber Patch Panels and Accessories.....	11	Labeling	22
Fiber Optic Cable	12	Cable Ties and Bundling	22
Fiber Build Up Kits	12	Security Devices	23
Fiber Connectors	12	Tools.....	23

Copper Cable

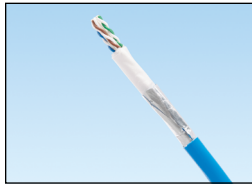

PUP6AM04BU-UG

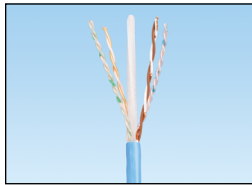

PUP6004BU-W

Panduit Part Number	Wesco Part Number	Description	Min. Order Qty. (MOQ)*	Min. Order Incrmt. (MOI)*	UOM
Unshielded					
PUP6AM04BU-UG	07498322034	Category 6A, 4-pair, 23 AWG, U/UTP, plenum, (CMP), Blue.	5000	1000	Ft.
PUR6A04BU-UG	07498308164	Category 6A, 4-pair, 23 AWG, U/UTP, riser, (CMR) Blue.	9000	1000	Ft.
PUP6ASD04BU-UG	07498324110	Category 6A, 4-pair, small diameter, 26 AWG, U/UTP, plenum (CMP), Blue.	9000	1000	Ft.
PUR6ASD04BU-CG	07498324100	Category 6A, 4-pair, small diameter, 26 AWG, U/UTP, riser, (CMR), Blue.	9000	1000	Ft.
PUP6004BU-W	07498366903	Enhanced Category 6, 4-pair, 23 AWG, U/UTP, plenum (CMP), Blue.	12000	1000	Ft.
PUR6004BU-W	07498366931	Enhanced Category 6, 4-pair, 23 AWG, U/UTP, riser (CMR), Blue.	12000	1000	Ft.
PUP5504BU-UY	07498305789	Premium Category 5e, 4-pair, 24 AWG, U/UTP, plenum (CMP), Blue.	13000	1000	Ft.
PUR5504BU-UY	07498305833	Premium Category 5e, 4-pair, 24 AWG, U/UTP, riser (CMR), Blue.	13000	1000	Ft.
Outside Plant (OSP) Cable					
PUO6C04BL-U	07498304300	Category 6, 4-pair, 23 AWG, U/UTP, outside plant (OSP), Black.	9000	1000	Ft.

*MOQ needs to be met prior to MOI. Contact Panduit Customer Service for additional information.

RJ45 Patch Cords



UTP6ASD*



UTP6ASD*



UTPSP*

Panduit Part Number	Wesco Part Number	Description	Std. Pkg. Qty.	Std. Ctn. Qty.
Category 6A 28 AWG				
UTP28X3	07498399456	Category 6A 28 AWG UTP patch cord, 3 ft., Off White.	1	10
UTP28X5	07498399955	Category 6A 28 AWG UTP patch cord, 5 ft., Off White.	1	10
UTP28X7	07498399959	Category 6A 28 AWG UTP patch cord, 7 ft., Off White.	1	10
UTP28X10	07498399966	Category 6A 28 AWG UTP patch cord, 10 ft., Off White.	1	10
UTP28X3BU	07498399619	Category 6A 28 AWG UTP patch cord, 3 ft., Blue.	1	10
UTP28X5BU	07498399981	Category 6A 28 AWG UTP patch cord, 5 ft., Blue.	1	10
UTP28X7BU	07498304900	Category 6A 28 AWG UTP patch cord, 7 ft., Blue.	1	10
UTP28X10BU	07498302877	Category 6A 28 AWG UTP patch cord, 10 ft., Blue.	1	10
Category 6A 26 AWG				
UTP6ASD3	07498330915	Category 6A 26 AWG UTP patch cord, 3 ft., Off White.	1	10
UTP6ASD5	07498330943	Category 6A 26 AWG UTP patch cord, 5 ft., Off White.	1	10
UTP6ASD7	07498330923	Category 6A 26 AWG UTP patch cord, 7 ft., Off White.	1	10
UTP6ASD10	07498330978	Category 6A 26 AWG UTP patch cord, 10 ft., Off White.	1	10
UTP6ASD3BU	07498330917	Category 6A 26 AWG UTP patch cord, 3 ft., Blue	1	10
UTP6ASD5BU	07498330946	Category 6A 26 AWG UTP patch cord, 5 ft., Blue	1	10
UTP6ASD7BU	07498330933	Category 6A 26 AWG UTP patch cord, 7 ft., Blue	1	10
UTP6ASD10BU	07498330980	Category 6A 26 AWG UTP patch cord, 10 ft., Blue.	1	10
Category 6 28 AWG				
UTP28SP3	07498365195	Category 6 28 AWG UTP patch cord, 3 ft., Off White.	1	10
UTP28SP5	07498365217	Category 6 28 AWG UTP patch cord, 5 ft., Off White.	1	10
UTP28SP7	07498365235	Category 6 28 AWG UTP patch cord, 7 ft., Off White.	1	10
UTP28SP10	07498365274	Category 6 28 AWG UTP patch cord, 10 ft., Off White.	1	10
UTP28SP3BU	07498365197	Category 6 28 AWG UTP patch cord, 3 ft., Blue.	1	10
UTP28SP5BU	07498365219	Category 6 28 AWG UTP patch cord, 5 ft., Blue.	1	10
UTP28SP7BU	07498365247	Category 6 28 AWG UTP patch cord, 7 ft., Blue.	1	10
UTP28SP10BU	07498365294	Category 6 28 AWG UTP patch cord, 10 ft., Blue.	1	10
Category 6				
UTPSP3Y	07498317043	Category 6 UTP patch cord, 3 ft., Off White.	1	10
UTPSP5Y	07498317091	Category 6 UTP patch cord, 5 ft., Off White.	1	10
UTPSP7Y	07498317127	Category 6 UTP patch cord, 7 ft., Off White.	1	10
UTPSP10Y	07498316891	Category 6 UTP patch cord, 10 ft., Off White.	1	10
UTPSP3BUY	07498317045	Category 6 UTP patch cord, 3 ft., Blue.	1	10
UTPSP5BUY	07498317093	Category 6 UTP patch cord, 5 ft., Blue.	1	10
UTPSP7BUY	07498317129	Category 6 UTP patch cord, 7 ft., Blue.	1	10
UTPSP10BUY	07498316893	Category 6 UTP patch cord, 10 ft., Blue.	1	10

Bulk packaging available: Add -Q for pack of 25.

(continued on page 4)

RJ45 Patch Cords (continued)

Panduit Part Number	Wesco Part Number	Description	Std. Pkg. Qty.	Std. Ctn. Qty.
Category 5e 28 AWG				
UTP28CH3	07498341769	Category 5e 28 AWG UTP patch cord, 3 ft., Off White.	1	10
UTP28CH5	07498341772	Category 5e 28 AWG UTP patch cord, 5 ft., Off White.	1	10
UTP28CH7	07498341774	Category 5e 28 AWG UTP patch cord, 7 ft., Off White.	1	10
UTP28CH10	07498341784	Category 5e 28 AWG UTP patch cord, 10 ft., Off White.	1	10
UTP28CH3BU	07498341777	Category 5e 28 AWG UTP patch cord, 3 ft., Blue.	1	10
UTP28CH5BU	07498341779	Category 5e 28 AWG UTP patch cord, 5 ft., Blue.	1	10
UTP28CH7BU	07498341781	Category 5e 28 AWG UTP patch cord, 7 ft., Blue.	1	10
UTP28CH10BU	07498341792	Category 5e 28 AWG UTP patch cord, 10 ft., Blue.	1	10
Category 5e				
UTPCH3Y	07498316539	Category 5e UTP patch cord, 3 ft., Off White.	1	10
UTPCH5Y	07498316569	Category 5e UTP patch cord, 5 ft., Off White.	1	10
UTPCH7Y	07498316605	Category 5e UTP patch cord, 7 ft., Off White.	1	10
UTPCH10Y	07498306234	Category 5e UTP patch cord, 10 ft., Off White.	1	10
UTPCH3BUY	07498316541	Category 5e UTP patch cord, 3 ft., Blue.	1	10
UTPCH5BUY	07498316571	Category 5e UTP patch cord, 5 ft., Blue.	1	10
UTPCH7BUY	07498316607	Category 5e UTP patch cord, 7 ft., Blue.	1	10
UTPCH10BUY	07498306237	Category 5e UTP patch cord, 10 ft., Blue.	1	10

RJ45 Jack Module



CJ6X88TGBL



CJ688TGBU

Panduit Part Number	Wesco Part Number	Description	Std. Pkg. Qty.	Std. Ctn. Qty.
Unshielded				
CJ6X88TGBL	07498363436	Category 6A RJ45 UTP Mini-Com® Jack, Black.	1	50
CJ6X88TGBU	07498363434	Category 6A RJ45 UTP Mini-Com® Jack, Blue.	1	50
CJ6X88TGIW	07498363619	Category 6A RJ45 UTP Mini-Com® Jack, International White.	1	50
CJ688TGBL	07498339544	Category 6 RJ45 UTP Mini-Com® Jack, Black.	1	50
CJ688TGBU	07498339546	Category 6 RJ45 UTP Mini-Com® Jack, Blue.	1	50
CJ688TGIW	07498339550	Category 6 RJ45 UTP Mini-Com® Jack, International White.	1	50
CJ5E88TGBL	07498339522	Category 5e RJ45 UTP Mini-Com® Jack, Black.	1	50
CJ5E88TGBU	07498339524	Category 5e RJ45 UTP Mini-Com® Jack, Blue.	1	50
CJ5E88TGIW	07498339528	Category 5e RJ45 UTP Mini-Com® Jack, International White.	1	50

Contact Panduit Customer Service for other colors.
Bulk packages available: Add -24 for pack of 24 or -C for pack of 100.

High Speed Copper Trunks and Assemblies

Selection Guide for QuickNet™ Cable Assembly Semi-Custom Part Numbers

Example: QXPBCBCBXX10 - QuickNet™ Cable Assembly, Cat 6A (SD), Plenum, Blue Jacks/Cable, UTP, Cassette-Cassette, 10 Feet.

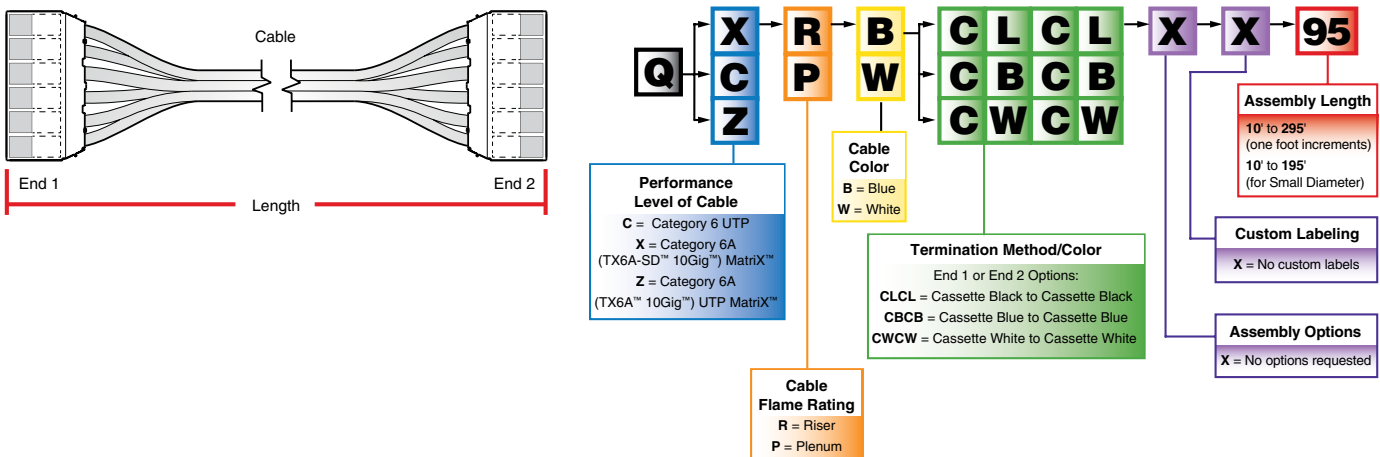

Above part number: Category 6A SD UTP MaTriX Riser White Cable, Cassette (Black Jack Module) – Cassette (White Jack Module), Custom Assembly Label, 92 ft.

*Custom cable assembly labels are available up to eighteen characters; individual cable labels are available up to fifteen characters.
 **For cable assemblies constructed of Category 6A (TX6A-SD 10Gig) UTP MaTriX Copper Cable, the maximum length is 196 ft. (60m).

High Speed Copper Trunks and Assemblies (continued)



PHQ4SFPXA*MBL



PQSFPXA1MBU

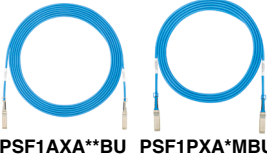

PSF1AXA**BU PSF1PXA*MBU

Panduit Part Number	Wesco Part Number	Description	Std. Pkg. Qty.	Std. Ctn. Qty.
QSFP+ to Four SFP+ Breakout Copper Cable Assemblies				
PHQ4SFPXA1MBL	07498364292	QSFP+ to SFP+ Breakout Copper Cable Assembly, 30 AWG, Black, 1m.	1	10
Standard lengths include 1, 2, and 3 meters. Contact Panduit Customer Service for additional lengths.				
QSFP+ 40Gig™ Copper Cable Assemblies				
PQSFPXA1MBU	07498333102	QSFP+ 40Gig™ Copper Cable Assembly, 30 AWG, Blue, 1m.	1	10
Standard lengths include 1, 3, 5, and 7 meters. Contact Panduit Customer Service for additional lengths.				
Extended Reach 10Gig™ SFP+ Direct Attach Active Copper Cable Assemblies				
PSF1AXA3MBU	07498366332	10Gig™ SFP+ Direct Attach Active Copper Cable Assembly, Blue, 3m.	1	10
Standard lengths include 3, 5, 7, and 10 meters. Contact Panduit Customer Service for additional lengths and colors.				
10Gig™ SFP+ Direct Attach Passive Copper Cable Assemblies				
PSF1PXA0.5MBU	07498319830	10Gig™ SFP+ Direct Attach Passive Copper Cable Assembly, 0.5m, Blue.	1	10
Standard lengths include 0.5, 1, 1.5, 2, 2.5, and 3 meters. Contact Panduit Customer Service for additional lengths and colors.				

Patch Panels, Kits, and Accessories



CPP24FMWBLY



CPP48HDWBLY



CPPA48HDWBLY



DP48688TGY



QAPP24BL



QAPP48HDBL



QPPBBL



SRB19BLY



SRB19BLY SRB19D5BL SRB19D7BL

Panduit Part Number	Wesco Part Number	Description	Std. Pkg. Qty.	Std. Ctn. Qty.
Modular				
CPP24FMWBLY	07498303654	24-port patch panel, flush mount.	1	10
CPPA24FMWBLY	07498303663	24-port angled patch panel, flush mount.	1	10
CPPLA48WBLY	07498303690	48-port angled patch panel with labels, with six CFFPL4 faceplates.	1	10
CPPA48FMWBLY	07498303665	48-port angled patch panel, flush mount.	1	10
CPP48HDWBLY	07498303659	48-port, high density patch panel, 1 RU.	1	10
CPPA48HDWBLY	07498303666	48-port, high density angled patch panel, 1 RU.	1	10
Data-Patch™ Patch Panels				
DP246X88TGY	07498303707	24-port, flat, 1 RU, Category 6A RJ45 UTP Data-Patch™ Patch Panel, Black.	1	10
DP486X88TGY	07498303711	48-port, flat, 2 RU, Category 6A RJ45 UTP Data-Patch™ Patch Panel, Black.	1	10
DP24688TGY	07498303706	24-port, flat, 1 RU, Category 6 RJ45 UTP Data-Patch™ Patch Panel, Black.	1	10
DP48688TGY	07498303710	48-port, flat, 2 RU, Category 6 RJ45 UTP Data-Patch™ Patch Panel, Black.	1	10
DP245E88TGY	07498303705	24-port, flat, 1 RU, Category 5e RJ45 UTP Data-Patch™ Patch Panel, Black.	1	10
DP485E88TGY	07498303709	48-port, flat, 2 RU, Category 5e RJ45 UTP Data-Patch™ Patch Panel, Black.	1	10
QuickNet™ Patch Panels				
QAPP24BL	07498300502	24-port, angled patch panel which accepts QuickNet™ Pre-Terminated Cassettes and Patch Panel Adapters.	1	10
QAPP48HDBL	07498300504	48-port, angled patch panel which accepts QuickNet™ Pre-Terminated Cassettes and Patch Panel Adapters.	1	10
QPP24BL	07498300501	24-port, patch panel which accepts QuickNet™ Pre-Terminated Cassettes and Patch Panel Adapters.	1	10
QPP48HDBL	07498300503	48-port, patch panel which accepts QuickNet™ Pre-Terminated Cassettes and Patch Panel Adapters.	1	10
QPP48HDVNSBL	07498301766	48-port, patch panel which accepts QuickNet™ Pre-Terminated Cassettes and Patch Panel Adapters. Numbering sequence is top to bottom across patch panel.	1	10
QuickNet™ Accessories				
QPPBBL	07498302330	QuickNet™ Patch Panel Blank.	1	10
QPPABL	07498399604	QuickNet™ Patch Panel Adapter which accepts Mini-Com® Modules for UTP, fiber optic, and audio/visual applications.	1	10
Strain Relief				
SRB19BLY	07498305964	Strain relief bar.	1	10
SRB19D5BL	07498322284	Quick release bracket kit for strain relief bars.	1	10
SRB19D7BL	07498312588	Deep strain relief bar, extends 5".	1	10
	07498312589	Deep strain relief bar, extends 7".	1	10

Fiber Assemblies

Multimode Trunks

Example: FXUY7E7EAAF015 – OM3 24-Fiber Indoor Small Diameter Trunk Plenum, Female PanMPO™ Connector to Female PanMPO™ Connector, Method A, Std. IL, Pulling Eye end A – 15 Feet.

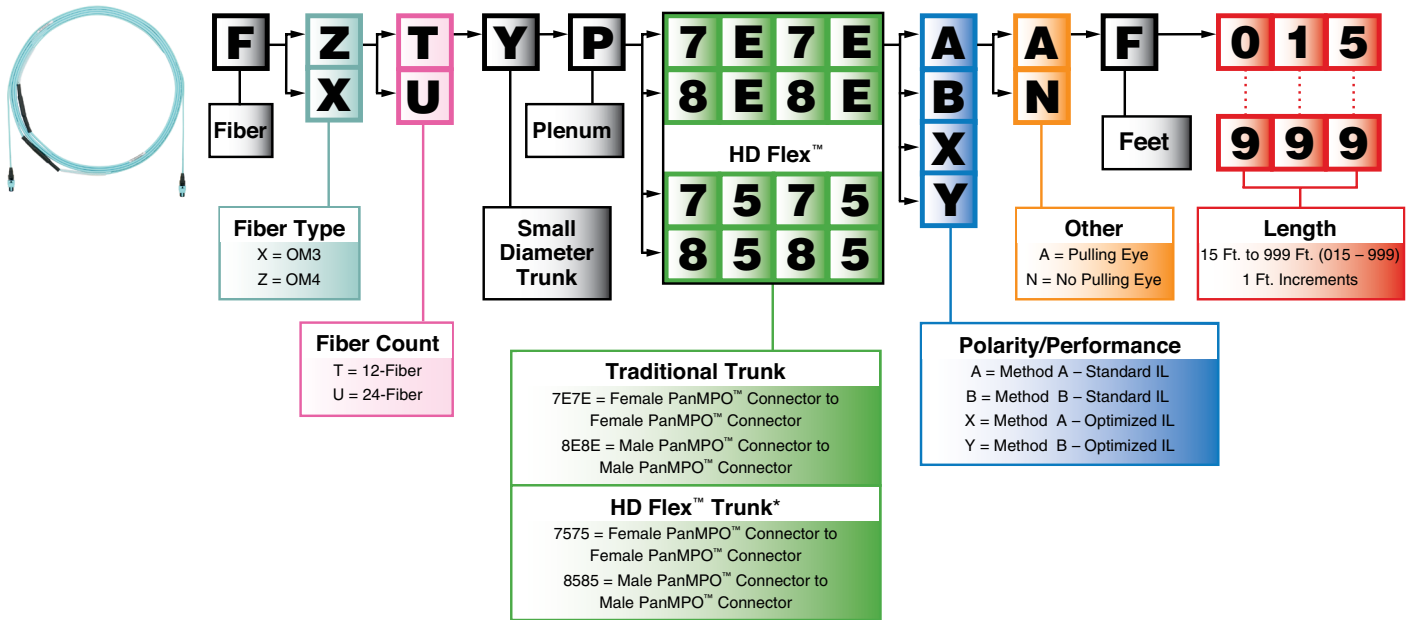

Singlemode Trunks

Example: F9TYP5E5EAAF015 – OS2 12 Fiber Small Diameter Indoor Trunk Plenum, MPO Female to MPO Female, Method A, Std. IL, Pulling Eye – 15 Feet.

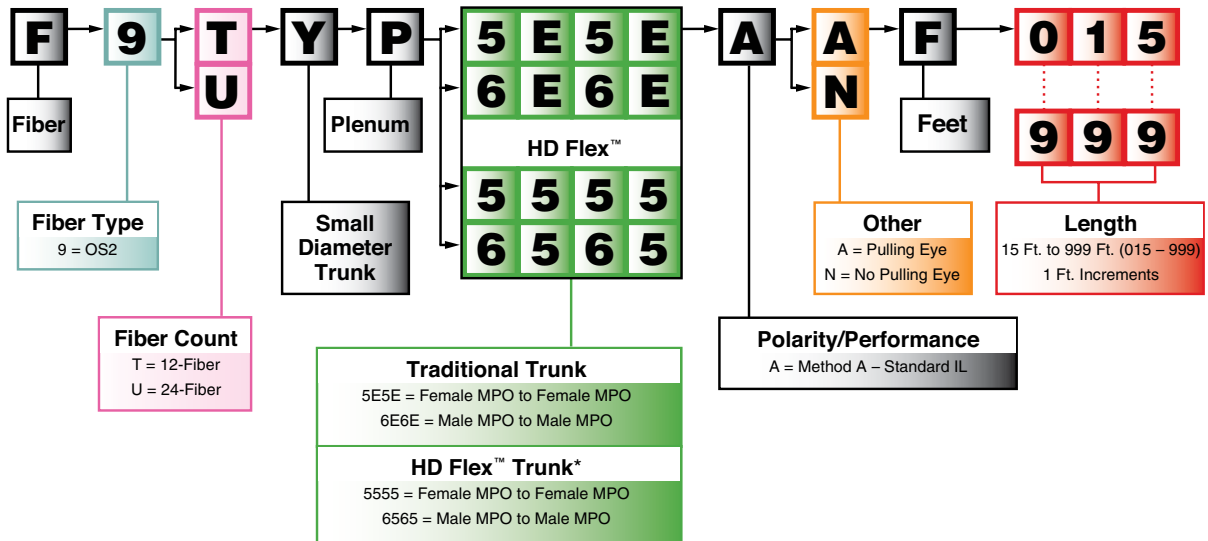

*HD Flex™ Trunks include the HD Flex™ Clip.

Fiber Assemblies (continued)

Multimode Interconnects

Example: FXTRP7N7NANF001 – OM3 12 Fiber Interconnect Plenum, Female PanMPO™ Connector to Female PanMPO™ Connector, Method A, Std. IL, no Pulling Eye – 1 Foot.

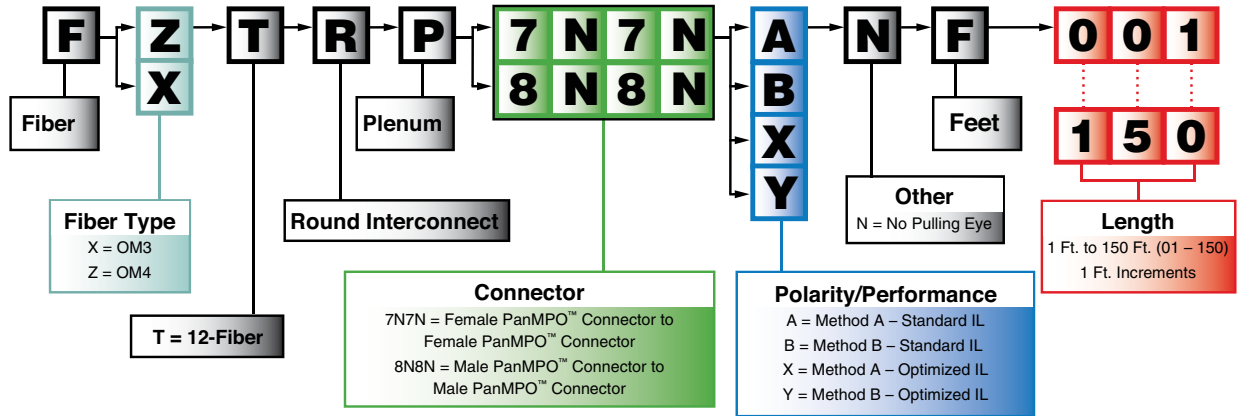





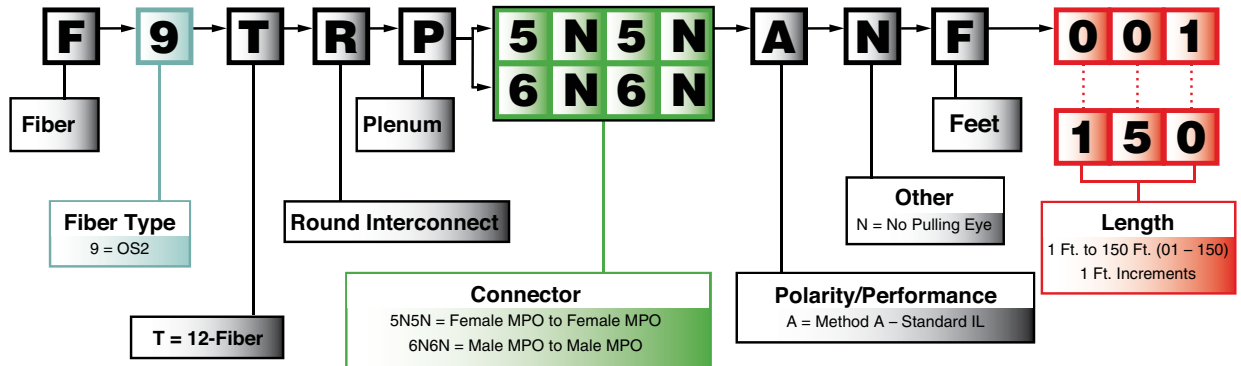

Singlemode Interconnects

Example: F9TRP5N5NANF003 – OS2 12 Fiber Interconnect Plenum, MPO Female to MPO Female, Method A Std. IL, no Pulling Eye – 3 Feet.



Note: Interconnects are patch cords with MPO's on both ends.

HD Flex™ Fiber Cabling System

Panduit Part Number	Wesco Part Number	Description	Std. Pkg. Qty.	Std. Ctn. Qty.
HD Flex™ Enclosures				
	FLEX1U06	61305614296	1 RU 6-port HD Flex™ Enclosure.	1 —
	FLEX1U12	61305614297	1 RU 12-port HD Flex™ Enclosure.	1 —
	FLEX2U06	61305614299	2 RU 6-port HD Flex™ Enclosure.	1 —
	FLEX2U12	61305614300	2 RU 12-port HD Flex™ Enclosure.	1 —
	FLEX4U06	61305614599	4 RU 6-port HD Flex™ Enclosure.	1 —
	FLEX4U12	61305614600	4 RU 12-port HD Flex™ Enclosure.	1 —
HD Flex™ Patch Panels				
	FLEX1UPN06	61305610843	1 RU 6-port HD Flex™ Patch Panel.	1 —
	FLEX1UPN12	61305610844	1 RU 12-port HD Flex™ Patch Panel.	1 —
	FLEX2UPN06	61305610847	2 RU 6-port HD Flex™ Patch Panel.	1 —
	FLEX2UPN12	61305610848	2 RU 12-port HD Flex™ Patch Panel.	1 —
	FLEX4UPN06	61305610851	4 RU 6-port HD Flex™ Patch Panel.	1 —
	FLEX4UPN12	61305610852	4 RU 12-port HD Flex™ Patch Panel.	1 —
HD Flex™ Fiber Optic Cassettes and Adapters				
	FHC39N-08-10AN	07498313872	OS2 breakout cassette with 1 MPO to 4 duplex LC (parallel to duplex optics), standard loss with method A polarity.	1 10
	FHC3XO-08-10AN	Contact Wesco	OM3 breakout cassette with 1 MPO to 4 duplex LC (parallel to duplex optics), optimized loss with method A polarity.	1 10
	FHC3ZO-08-10BN	07498313834	OM4 breakout cassette with 1 MPO to 4 duplex LC (parallel to duplex optics), optimized loss with method B polarity.	1 10
	FHC9N-12-10AS	07498313614	OS2 cassette with 1 MPO to 6 duplex LC, standard loss with method A polarity.	1 10
	FHCXO-12-10AS	07498313397	OM3 cassette with 1 MPO to 6 duplex LC, optimized loss with method A polarity.	1 10
	FHCZO-12-10BN	07498313801	OM4 cassette with 1 MPO to 6 duplex LC, optimized loss with method B polarity.	1 10
	FHS9N-12-10P	07498303992	LC splice cassette preloaded with 12 OS2 LC pigtails (250µm) and Standard IL; 6-port duplex LC adapters in blue with zirconia sleeves.	1 10
	FHSXO-12-10P	07498303989	LC splice cassette preloaded with 12 OM3 LC pigtails (250µm) and Optimized IL, 6-port duplex LC adapters in aqua with zirconia sleeves.	1 10
	FHSZO-12-10R	07498303994	LC splice cassette preloaded with 12-fiber ribbon OM4 pigtail and Optimized IL, 6-port duplex LC adapters in aqua with zirconia sleeves.	1 10
	FHMP-6-ABL	07498311978	6 MPO type A adapters (key-up to key-down), Black.	1 10
	FHS9N-12-10N	07498303857	6 LC duplex singlemode adapters in Blue with zirconia sleeves.	1 10
	FHSXN-12-10N	07498303892	6 LC duplex multimode adapters in Aqua with zirconia sleeves.	1 10
	FHC9N-24-10AS	61305617403	OS2 HD Flex™ Cassette, 12-port duplex LC to (2) 12-fiber MPOs, Method A.	1 10
	FHCXO-24-10BN	61305617405	OM3 HD Flex™ Cassette, 12-port duplex LC to (2) 12-fiber MPOs, optimized loss, Method B.	1 10
	FHCZA-24-10BN	6130561741	OM4 HD Flex™ Cassette, 12-port duplex LC to (2) 12-fiber MPOs, ultra low loss, Method B.	1 10
	FHCZO-24F-10BN	61305617400	OM4 HD Flex™ Cassette, 12-port duplex LC to (1) 1-24-fiber MPO, optimized loss, Method B.	1 10
	FHCZO-24-10BN	61305617408	OM4 HD Flex™ Cassette, 12-port duplex LC to (2) 12-fiber MPOs, optimized loss, Method B.	1 10
HD Flex™ Cable Managers				
	FLEX-FCM1UA	61305616995	1 RU HD Flex™ Front Cable Manager.	1 —
	FLEX-FCM2UA	61305616997	2 RU HD Flex™ Front Cable Manager.	1 —
	FLEX-FCM4UA	61305616998	4 RU HD Flex™ Front Cable Manager.	1 —
	FLEX-RCM1U	Contact Wesco	1 RU HD Flex™ Rear Cable Manager.	1 —
	FLEX-RCM2U	Contact Wesco	2 RU HD Flex™ Rear Cable Manager.	1 —
	FLEX-RCM4U	Contact Wesco	4 RU HD Flex™ Rear Cable Manager	1 —

HD Flex™ Fiber Cabling System (continued)

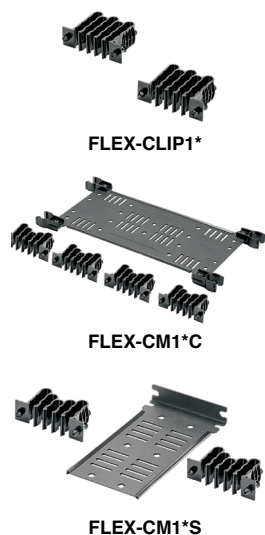

Panduit Part Number	Wesco Part Number	Description	Std. Pkg. Qty.	Std. Ctn. Qty.
HD Flex™ Zero RU Bracket				
FLEX-0RUBR06	61305616981	6-port HD Flex™ Zero RU Bracket and Cassette Holder.	1	—
FLEX-0RUBR12	61305616982	12-port HD Flex™ Zero RU Bracket and Cassette Holder.	1	—
FLEX-0RUCH06	61305616993	6-port HD Flex™ Zero RU Cassette Holder.	1	—
FLEX-0RUCH12	61305616994	12-port HD Flex™ Zero RU Cassette Holder.	1	—
HD Flex™ Accessories				
FLEX-PLATE1	Contact Wesco	Enclosure trunk slack plate – 1 RU.	1	—
FLEX-PLATE2	Contact Wesco	Enclosure trunk slack plate – 2 RU.	1	—
FLEX-CLIP12	07498382511	Trunk transition clip (qty. 2); 12-position.	1	10
FLEX-CLIP18	07498382510	Trunk transition clip (qty. 2); 18-position.	1	10
FLEX-CM12C	07498398034	Rear cable manager for use with PatchRunner™ Cable Manager (PEV12).	1	—
FLEX-CM18C	07498398042	Rear cable manager for use with PatchRunner™ Cable Manager (PEV12).	1	—
FLEX-CM12S	07498397886	Universal rear cable manager 12-position transition manager (qty. 2) with screw mount bracket.	1	—
FLEX-CM18S	07498397916	Universal rear cable manager.	1	—

Fiber Enclosures



Panduit Part Number	Wesco Part Number	Description	Std. Pkg. Qty.	Std. Ctn. Qty.
FRME1	07498385921	1 RU enclosure; holds three FAPs/cassettes, with two slack spools, and sliding tray. Tilts down.	1	1
FCE1U	07498300873	1 RU enclosure; holds up to four FAPs/cassettes/splice modules with a sliding tray. Tilts down.	1	1
FRME1U	07498307901	1 RU enclosure; holds up to three FAPs/cassettes; with a sliding tray.	1	1
FRME2	07498385484	2 RU enclosure; holds up to six FAPs/cassettes; with a sliding tray.	1	1
FRME4	07498385486	4 RU enclosure; holds up to twelve FAPs/cassettes; with a sliding tray.	1	1
FWME2	07498385836	Wall mount fiber enclosure with two FAP openings and two slack spools.	1	1
FAPB	07498362506	Blank fiber adapter panel – reserves space for future use.	1	1

Fiber Cassettes



Panduit Part Number	Wesco Part Number	Description	Std. Pkg. Qty.	Std. Ctn. Qty.
FQ9N-12-10AS	07498396046	12-fiber QuickNet™ SFQ Cassette, OS2 (9/125µm), standard loss, duplex LC to MTP; Method A.	1	10
FQXN-12-10AS	07498396047	12-fiber QuickNet™ SFQ Cassette, OM3 (50/125µm), standard loss; duplex LC to MTP; Method A.	1	10
FQZN-12-10AS	07498396048	12-fiber QuickNet™ SFQ Cassette, OM4 (50/125µm), duplex LC to MTP; standard loss, Method A.	1	10
FC29N-12-10AS	07498395148	OS2 12-fiber total, standard loss, LC duplex adapter cassettes, standard Method A.	1	10
FC2XN-12-10AS	07498395144	OM3 12-fiber total, standard loss, LC duplex adapter cassettes, standard Method A.	1	10
FC2ZN-12-10AS	07498395142	OM4 12-fiber total, standard loss, LC duplex adapter cassettes, standard Method A.	1	10
FC29N-24-10AS	07498395133	OS2 24-fiber total, standard loss, LC duplex adapter cassettes, standard Method A.	1	10
FC2XN-24-10AS	07498395130	OM3 24-fiber total, standard loss, LC duplex adapter cassettes, standard Method A.	1	10
FC2ZN-24-10AS	07498395128	OM4 24-fiber total, standard loss, LC duplex adapter cassettes, standard Method A.	1	10

For OM3/OM4 cassettes, change “N” to “O” for optimized performance and for flipped, change “AS” to “AF”. See fiber patch panels and accessories on page 11.

Adapter Modules and Fiber Adaptor Panels (FAPs)

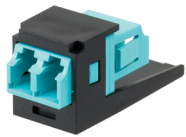

CMDAQCZBL

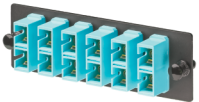

FAP6WAQDSCZ

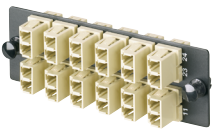

FAP12WEIDL

Panduit Part Number	Wesco Part Number	Description	Std. Pkg. Qty.	Std. Ctn. Qty.
Fiber Adapter Modules				
CMDSAQLCZBL	07498353999	OM3/OM4 duplex LC Sr./Sr. Mini-Com™ Module Adapter, Aqua/Black, zirconia split sleeve.	1	10
Fiber Adapter Panels (FAP)				
FAP12WAQDLCZ	07498361036	OM3/OM4 FAP loaded with twelve LC duplex fiber adapters (Aqua) zirconia ceramic split sleeves.	1	10
FAP12WBUDLCZ	07498345410	OS2 FAP loaded with twelve LC duplex fiber adapters (Blue) zirconia ceramic split sleeves.	1	10
FAP6WBUDLCZ	07498339537	OS2 FAP loaded with six LC duplex fiber adapters (Blue) zirconia ceramic split sleeves.	1	10
FAP6WAQDLCZ	07498337657	OM3/OM4 FAP loaded with six LC duplex fiber adapters (Aqua) zirconia ceramic split sleeves.	1	10
FAP6WBUDSCZ	07498385496	OS2 FAP loaded with six SC duplex fiber adapters (Blue) zirconia ceramic split sleeves.	1	10
FAP12WEIDL	07498345409	LC OM1 FAP loaded with twelve LC duplex multimode fiber optic adapters (Electric Ivory) with phosphor bronze split sleeves.	1	10
FAP6WEIDL	07498339535	LC OM1 FAP loaded with six LC duplex multimode fiber optic adapters (Electric Ivory) with phosphor bronze split sleeves.	1	10
CFAPPBL1	07498378857	Flat fiber patch panel. Holds up to four FAP or FMP adapter panels.	1	10
QuickNet™ SFQ Series MPO Fiber Adapter Panel (FAP)				
FQMAP65BL	07498339232	QuickNet™ Fiber Optic Migration Adapter Panel – 6 MPO key-up/key-down adapters.	1	10

Fiber Patch Cords and Pigtails



F92ERLNLNSNM***



FX2ERLNLNSNM***



F92ERQ1Q1SNM***



FX2ERQ1Q1SNM***

Panduit Part Number	Wesco Part Number	Description	Std. Pkg. Qty.	Std. Ctn. Qty.
Patch Cords				
F92ERLNLNSNM002	07498392138	OS2 2 fiber 1.6mm patch cord riser, LC duplex to LC duplex Std. IL – 2 meters.	1	10
F92ERLNLNSNM003	07498392141	OS2 2 fiber 1.6mm patch cord riser, LC duplex to LC duplex Std. IL – 3 meters.	1	10
FX2ERLNLNSNM001	07498392193	OM3 2 fiber 1.6mm patch cord riser, LC duplex to LC duplex Std. IL – 1 meters.	1	10
FX2ERLNLNSNM002	07498392254	OM3 2 fiber 1.6mm patch cord riser, LC duplex to LC duplex Std. IL – 2 meters.	1	10
FX2ERLNLNSNM003	07498392255	OM3 2 fiber 1.6mm patch cord riser, LC duplex to LC duplex Std. IL – 3 meters.	1	10
F923RSNSNSNM001	07498382520	OS2 2 fiber 3mm patch cord riser, SC duplex to SC duplex Std. IL – 1 meter.	1	10
F92ERLNSNSNM001	07498373796	OS2 2 fiber 3mm patch cord riser, LC duplex to SC duplex Std. IL – 1 meter.	1	10
F92ERQ1Q1SNM001	07498307536	OS2 2 fiber 1.6mm patch cord riser, LC push-pull to LC push-pull Std. IL – 1 meter.	1	10
FX2ERQ1Q1ONM001	07498303270	OM3 2 fiber 1.6mm patch cord riser, LC push-pull to LC push-pull optimized IL – 1 meter.	1	10
FX2ERQ1Q1SNM001	07498399635	OM3 2 fiber 1.6mm patch cord riser, LC push-pull to LC push-pull Std IL – 1 meter.	1	10
FZ2ERQ1Q1ONM001	07498304722	OM4 2 fiber 1.6mm patch cord riser, LC push-pull to LC push-pull optimized IL – 1 meter.	1	10
FZ2ERQ1Q1SNM001	07498399457	OM4 2 fiber 1.6mm patch cord riser, LC push-pull to LC push-pull Std. IL – 1 meter.	1	10

Length in meters. 1, 2, 3, 5, and 10 meter lengths. Contact Panduit Customer Service for additional lengths.

Fiber Patch Cords and Pigtails (continued)



FX1BN*NNNSNM001



FZ1BN*NNNSNM001

Panduit Part Number	Wesco Part Number	Description	Std. Pkg. Qty.	Std. Ctn. Qty.
Pigtails				
F91BN1NNNSNM001	07498392187	OS2 1 fiber 900µm buffered patch cord, LC to pigtail Std. IL – 1 meter.	1	10
F91BN3NNNSNM001	07498392181	OS2 1 fiber 900µm buffered patch cord, SC to pigtail Std. IL – 1 meter.	1	10
FX1BN1NNNSNM001	07498392337	OM3 1 fiber 900µm buffered patch cord, LC to pigtail Std. IL – 1 meter.	1	10
FX1BN3NNNSNM001	07498392340	OM3 1 fiber 900µm buffered patch cord, SC to pigtail Std. IL – 1 meter.	1	10
FZ1BN1NNNSNM001	07498392328	OM4 1 fiber 900µm buffered patch cord, LC to pigtail Std. IL – 1 meter.	1	10
FZ1BN3NNNSNM001	07498392325	OM4 1 fiber 900µm buffered patch cord, SC to pigtail Std. IL – 1 meter.	1	10

Fiber Patch Panels and Accessories



QAPP48HDBL



QPPBBL



FQCRCM



FMT1

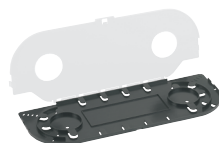

FOSMF

Panduit Part Number	Wesco Part Number	Description	Std. Pkg. Qty.	Std. Ctn. Qty.
QAPP48HDBL	07498300504	48-port, angled patch panel which accepts QuickNet™ Pre-Terminated Cassettes and Patch Panel Adapters.	1	10
QPP24BL	07498300501	24-port, patch panel which accepts QuickNet™ Pre-Terminated Cassettes and Patch Panel Adapters.	1	10
QPPBBL	07498302330	QuickNet™ Patch Panel Blank reserves space for future use and promotes proper airflow and cooling. Use QPPLC24 for label/label cover.	1	10

Straight and angled 24-port and 48-port patch panels are available.

QuickNet™ Cassette Cable Manager and Patch Field Protection Cover

FQCRCM	07498320729	QuickNet™ Cassette Rear Cable Manager.	1	10
FPFPC1	07498339910	1 RU fiber patch field protection cover.	1	10

Opticom® Trays and Drawers

FMT1	07498385475	Mount with CFAPPBL1 fiber adapter patch panel to hold up to four QuickNet™ Cassettes, FAP, and FMP adapter panels.	1	—
FMD1	07498385477	Holds up to 4 FAP or FMP adapter panels. Sliding drawer.	1	—
FMS1	07498334542	Spools and manages fiber slack in Opticom® 1 RU Rack Mount Fiber Enclosures.	1	10

Opticom® QuickNet™ Splice Module

FOSMF	07498300896	Fiber optic splice module holds and protects up to 24 fusion splices.	1	10
-------	-------------	---	---	----

Fiber Optic Cable



Panduit Part Number	Wesco Part Number	Description	UOM	MOQ*
Distribution Cable				
FODPX12Y	07498304832	12-fiber OM3 multimode OFNP (plenum) rated distribution cable.	Ft.	—
FODPX24Y	07498304833	24-fiber OM3 multimode OFNP (plenum) rated distribution cable.	Ft.	—
Interlocking Armor Distribution				
FOPPX12Y	07498304881	12 fiber OM3 multimode OFCP (plenum) rated distribution cable with interlocking armor.	Ft.	—
FSP924Y	07498305097	24 fiber OS2 singlemode OFCP (plenum) rated distribution cable with interlocking armor.	Ft.	—
Indoor/Outdoor Central Tube Cable				
FOCRZ12Y	07498320697	12-fiber OM4 ONFR (riser) rated indoor/outdoor central tube cable.	Ft.	—
FOCRX12Y	07498304830	12-fiber OM3 ONFR (riser) rated indoor/outdoor central tube cable.	Ft.	—
FSCR912Y	07498304924	12-fiber OS2 singlemode ONFR (riser) rated indoor/outdoor central tube cable.	Ft.	—

*See Panduit's Safety Stock Program for a full list of in-stock fiber cables.

Fiber Build Up Kits



Panduit Part Number	Wesco Part Number	Description	Std. Pkg. Qty.	Std. Ctn. Qty.
Fiber Build Up Kits				
FO12CB	07498376434	Build up 250µm fiber to 900µm loose buffered coating size; for twelve fibers.	1	1
FO6CB	07498376433	Build up 250µm fiber to 900µm loose buffered coating size; for six fibers.	1	1

Fiber Connectors

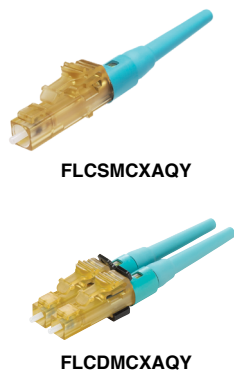

Panduit Part Number	Wesco Part Number	Description	Std. Pkg. Qty.	Std. Ctn. Qty.
OptiCam™ Pre-Polished Connectors				
FLCDMCAQY	07498304742	LC 50/125µm OM3/OM4 multimode duplex connector, Aqua boot.	1	10
FLCSCXAQY	07498304748	LC 50/125µm OM3/OM4 multimode simplex connector, Aqua boot.	1	10
FLCSCBUY	07498317597	LC 9/125µm singlemode simplex fiber optic connector for 900µm.	1	10
FLCDSBUY	07498317596	LC 9/125µm singlemode duplex fiber optic connector for 900µm.	1	10
Field Polished Connectors				
FLCSMBLY	07498312717	LC 50/125µm OM2/OM3/OM4 simplex connector, Aqua boot.	1	10
FLCSCBUY	07498304753	LC 9/125µm OS2 singlemode simplex connector for 900µm.	1	10
FSCMCAQ	07498321457	SC 50/125µm OM2/OM3/OM4 duplex connector, Aqua boot.	1	10
FSCSBU	07498383819	SC 9/125µm OS2 singlemode simplex connector, Blue boot.	1	10

Cabinets and Thermal Management



S-Type Cabinets



SN15F



SPDUBRK

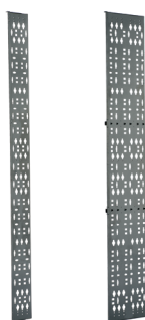

S2BRK6 S2BRK12

Panduit Part Number	Wesco Part Number	Description	Std. Pkg. Qty.	Std. Ctn. Qty.
Net-Access™ S-Type Cabinets				
S6212B	07498366921	Single hinge perforated front door, split perforated rear doors, solid side panels (2), casters, PDU brackets (1 set), 42 RU, cage nut rails (2 sets). Color: Black. Dimensions: 79.8"H x 23.6"W x 42.0"D (2026mm x 600mm x 1070mm).	1	—
S6512B	07498366945	Single hinge perforated front door, split perforated rear doors, solid side panels (2), casters, PDU brackets (1 set), 45 RU, cage nut rails (2 sets). Color: Black. Dimensions: 85.0"H x 23.6"W x 42.0"D (2160mm x 600mm x 1070mm).	1	—
S6522B	07498366950	Single hinge perforated front door, split perforated rear doors, solid side panels (2), casters, PDU brackets (1 set), 45 RU, cage nut rails (2 sets). Color: Black. Dimensions: 85.0"H x 23.6"W x 48.0"D (2160mm x 600mm x 1200mm).	1	—
S6522B9	07498360559	Single hinge perforated front door, split perforated rear doors, solid side panels (2), PDU brackets (1 set), 45 RU, cage nut rails (2 sets). Color: Black. Dimensions: 85.0"H x 23.6"W x 48.0"D (2160mm x 600mm x 1200mm).	1	—
S7222B	07498366961	Single hinge perforated front door, split perforated rear doors, solid side panels (2), casters, PDU brackets (1 set), 42 RU, cage nut rails (2 sets). Color: Black. Dimensions: 79.8"H x 27.6"W x 48.0"D (2026mm x 700mm x 1200mm).	1	—
S7222BF	07498334578	Single hinge perforated front door, split perforated rear doors, solid side panels (2), casters, cage nut rails (2 sets), 42 RU, and cable management fingers (1 set). Color: Black. Dimensions: 79.8"H x 27.6"W x 48.0"D (2026mm x 700mm x 1200mm).	1	—
S7529B	07498366964	Single hinge perforated front door, split perforated rear doors, casters, PDU brackets (1 set), 45 RU, cage nut rails (2 sets). Color: Black. Dimensions: 85.0"H x 27.6"W x 48.0"D (2160mm x 700mm x 1200mm).	1	—
S8512BF	07498367012	Single hinge perforated front door, split perforated rear doors, solid side panels (2), casters, PDU brackets (1 set), 45 RU, cage nut rails (2 sets). Cable management fingers (1 set). Color: Black. Dimensions: 85.0"H x 31.5"W x 42.0"D (2160mm x 800mm x 1070mm).	1	—
S8522B	07498366982	Single hinge perforated front door, split perforated rear doors, solid side panels (2), casters, PDU brackets (1 set), 45 RU, cage nut rails (2 sets). Color: Black. Dimensions: 85.0"H x 31.5"W x 48.0"D (2160mm x 800mm x 1200mm).	1	—

Contact Panduit Customer Service for other colors and sizes.

Net-Access™ S-Type Cabinet Accessories

SN15F	07498367102	Finger kit, 100mm (3.9") depth that attaches to posts on 42 RU through 48 RU cabinets. Color: Black.	1	—
SPDUBRK	07498397307	PDU brackets, sold as 1 set. Color: Black.	1	—
S2BRK6	07498367095	Combination PDU/cable management bracket, 152mm (6") wide full length for 42 RU through 48 RU cabinet.	1	—
S2BRK12	07498367096	Combination PDU/cable management bracket, 305mm (12") wide full length for 42 RU through 48 RU cabinet.	1	—

(continued on page 14)

Cabinets and Thermal Management (continued)



N-Type Cabinets



NVPDUB



NCSTR4



NVBP



E6412B2



E6212B1

Panduit Part Number	Wesco Part Number	Description	Std. Pkg. Qty.	Std. Ctn. Qty.
Net-Access™ N-Type Cabinets				
N8212B	07498396780	Dual hinge perforated front door, split perforated rear doors, solid side panels (2), #12-24 threaded rails (2 sets), 42 RU, with 2 sets of high density cable management fingers (SN25F). Color: Black. Dimensions: 78.8"H x 31.5"W x 42.0"D (2000mm x 800mm x 1070mm).	1	—
N8512B	07498367030	Dual hinge perforated front door, split perforated rear doors, solid side panels (2), #12-24 threaded rails (2 sets), 45 RU, with 2 sets of high density cable management fingers (SN25F). Color: Black. Dimensions: 84.0"H x 31.5"W x 42.0"D (2134mm x 800mm x 1070mm).	1	—
N8512BC	07498367032	Dual hinge perforated front door, split perforated rear doors, solid side panels (2), cage nut rails (2 sets), 45 RU, with 2 sets of high density cable management fingers (SN25F). Color: Black. Dimensions: 84.0"H x 31.5"W x 42.0"D (2134mm x 800mm x 1070mm).	1	—
N8519B	07498367031	Dual hinge perforated front door, split perforated rear doors, #12-24 threaded rails (2 sets), 45 RU, with 2 sets of high density cable management fingers (SN25F). Color: Black. Dimensions: 84.0"H x 31.5"W x 42.0"D (2134mm x 800mm x 1070mm).	1	—
N8519BC	07498367033	Dual hinge perforated front door, split perforated rear doors, cage nut rails (2 sets), 45 RU, with 2 sets of high density cable management fingers (SN25F). Color: Black. Dimensions: 84.0"H x 31.5"W x 42.0"D (2134mm x 800mm x 1070mm).	1	—
N8522B	07498396759	Dual hinge perforated front door, split perforated rear doors, solid side panels (2), #12-24 threaded rails (2 sets), 45 RU, with 2 sets of high density cable management fingers (SN25F). Color: Black. Dimensions: 84.0"H x 31.5"W x 48.0"D (2134mm x 800mm x 1200mm).	1	—
N8522BC	07498367045	Dual hinge perforated front door, split perforated rear doors, solid side panels (2), cage nut rails (2 sets), 45 RU, with 2 sets of high density cable management fingers (SN25F). Color: Black. Dimensions: 84.0"H x 31.5"W x 48.0"D (2134mm x 800mm x 1200mm).	1	—

Contact Panduit Customer Service for other colors and sizes.

Net-Access™ N-Type Cabinet Accessories

NVPDUB	07498367150	PDU brackets, sold as 1 set. Color: Black.	1	—
NCSTR4	07498367151	Caster kit. 2 fixed casters for front of cabinet, 2 swivel casters for rear of cabinet, 4 mounting plates and 24 screws. Casters add 24mm (1") to height of cabinet.	1	—
NVBP	07498304618	Vertical blanking panels with pass-through holes for 42 RU through 48 RU cabinets.	1	—

Enterprise Cabinets

E6412B2	07498334886	Enterprise cabinet, 24 RU, single hinge perforated front and rear doors with keyed locks, (2) solid single piece side panels with ¼ turn locks, and casters. Fully assembled, Black. Dimensions: 46.7"H x 23.5"W x 42.0"D (1187mm x 600mm x 1070mm)	1	—
E6212B1	07498334874	Enterprise cabinet, 12 RU, single hinge perforated front and rear doors with keyed locks, (2) solid single piece side panels with ¼ turn locks, and casters. Fully assembled, Black. Dimensions: 25.7"H x 23.5"W x 42.0"D (654mm x 600mm x 1070mm).	1	—

(continued on page 15)

Cabinets and Thermal Management (continued)



CDE1



CNLTD52A2



CNLTD72A3



DIRBB2007S21W



DIRLC2214M21W



CTGN3X5



CTGN3X5



TLBP1R-V

Panduit Part Number	Wesco Part Number	Description	Std. Pkg. Qty.	Std. Ctn. Qty.
Net-Direct™ Air Inlet Ducting				
CDE1	07498319487	1 RU that resides below the switch provides cold aisle airflow to Cisco^ 4948, 4928, and 4924. Optimized for use in server cabinet applications, Black.	1	—
CDE2	07498331874	2 RU that resides in-line and below switch provides cold aisle airflow to Cisco^ Nexus N2K-C2148T-1GE, N2K-C2248TP-1GE, and N2K-C2232PP-10GE fabric extenders and Cisco^ WS-C4948E-F, WS-C4948E-F-S, and WS-C4948E-F-E. Optimized for use in server cabinet applications, Black.	1	—
CNLTD142A3	07498365943	Designed for Cisco^ Nexus 7009 switch. Consists of 3 RU top and 3 RU bottom inlet ducts and a side duct, Black.	1	—
CNLTD21B2	07498337266	Designed for Cisco^ Catalyst 4900M switch. Consists of one 2 RU inlet duct and a side duct, Black.	1	—
CNLTD52A2	07498337268	Designed for Cisco^ Catalyst 6504-E switch. Consists of 2 RU top and 2 RU bottom inlet ducts and a side duct, Black.	1	—
CNLTD72A3	07498337271	Designed for Cisco^ MDS 9506 switch. Consists of 3 RU top and 3 RU bottom inlet ducts and a side duct, Black.	1	—
DIFBA2002S00S	07498302464	Designed for Cisco^ Nexus 9396 switch, Black.	1	—
DIFBA3003S00S	07498302465	Designed for Cisco^ Nexus 93128 switch, Black.	1	—
DIRBB2007S21W	07498398138	Designed for Cisco^ Nexus 7004 switch. Consists of one 2 RU inlet duct and a side duct, Black.	1	—
DIRLC2214M21W	07498392078	Designed for Cisco^ Catalyst 6509-E switch. Consists of 2 RU top and 2 RU bottom inlet ducts and a side duct, Black.	1	—
DIRLC25S23W	07498307650	Designed for Cisco^ Catalyst 6880 switch. Consists of 3 RU top and 5 RU side duct, Black.	1	—
DIRLC3210S17W	07498307234	Designed for Cisco^ Catalyst 6807-XL switch. Consists of 3 RU top and 2 RU bottom duct and side duct, Black.	1	—
Net-Access™ Air Sealing Accessories				
CTCN3X5	07498395552	Used to seal off 3.5" x 5" cabinet top openings. Can also be used to add the CTGN3X5 to openings where the snap-on cover has been removed. For use with Net-Access™ Cabinets, Black.	1	10
CTGN3X5	07498395554	Cool Boot® Fitting, used to seal off 3" x 5" cabinet top openings when cables are routed through the top of a cabinet, Black.	1	10
TLBP1R-V	07498332296	1 RU tool-less blanking panel, round hole 19" (483mm) width for tapped rails.	5	—
TLBP1S-V	07498332297	1 RU tool-less blanking panel, square hole 19" (483mm) width for 3/8" cage nut holes (may be used with or without cage nuts installed).	5	—
TLBP2S-V	07498332295	2 RU tool-less blanking panel, square hole 19" (483mm) width for 3/8" cage nut holes (may be used with or without cage nuts installed).	5	—
FLBSIM-51	07498396960	Full-length blanking shade blanks out 4-51 consecutive rack units on standard 19" (483mm) wide vertical mounting rails.	1	—
RFG6X8SMY	07498310814	Cool Boot® Bottom of Cabinet Raised Floor Air Sealing Grommet overall size of 6" x 8" (152.4mm x 203.2mm) allows for 4.2" x 6.2" (106.7mm x 157.5mm) capacity. Color: Navy Blue.	1	10

^Cisco, Catalyst, and Cisco Nexus are registered trademarks of Cisco Systems, Inc. and/or its affiliates in the United States and certain other countries.

Racks, Shelves and Accessories



R4PCN

Panduit Part Number	Wesco Part Number	Description	Std. Pkg. Qty.	Std. Ctn. Qty.
Racks				
R2P	07498332051	2 post rack, 45 RU, with #12-24 threaded rails, RU spaces numbered bottom up.	1	1
R4P	07498308904	4 post rack, 45 RU, 30" deep, with #12-24 threaded rails, RU spaces numbered bottom up, adjustable front and rear rails.	1	1
R4PCN	07498308906	4 post rack, 45 RU, 30" deep, with cage nut rails, RU spaces numbered bottom up, adjustable front and rear rails.	1	1
Rack Accessories				
RSHLF	07498308180	1 RU 19"W x 30"D 4 post rack vented shelf, adjustable mounting along the depth of the shelf.	1	—
SRM19FM1	07498383844	1 RU 19"W x 15"D 2 post rack front mount shelf.	1	—
DPFP1	07498350373	1 RU 19"W horizontal rack filler panel.	1	10
CMBRC5	07498397403	5 RU 3.3"D bend radius control finger set, one-piece unit with five bend radius control fingers, for use with active equipment.	1	10
CMLT19	07498379675	4 RU lower trough with 1.3" bend radius; mounts to the bottom of a standard 19" EIA rack, includes hardware kit.	1	—
CMUT19	07498379677	2 RU upper trough with 1.3" bend radius, mounts to the top of a standard 19" EIA rack, includes hardware kit.	1	—
R2PPDUB	07498340279	Power Distribution Unit (PDU) brackets for 2 and 4 post racks, set of 2 brackets.	1	—
RFAKIT	07498333270	Rack anchor kit for concrete floor, set of four.	1	10

Cable Managers



WMPVHC45E



PRV8



WMPSE



WBH2

Panduit Part Number	Wesco Part Number	Description	Std. Pkg. Qty.	Std. Ctn. Qty.
Vertical Managers				
WMPV45E	07498365617	NetRunner™ Vertical Cable Manager, front and rear, 45 RU, 4"W x 5"D front and rear channels, includes covers.	1	—
WMPVF45E	07498365618	NetRunner™ Vertical Cable Manager, front only, 45 RU, 4"W x 5"D channel, includes covers.	1	—
WMPVHC45E	07498365619	NetRunner™ Vertical Cable Manager, front and rear, 45 RU, 6"W x 6"D front and rear channels, includes covers.	1	—
PRV6	07498345416	PatchRunner™ Vertical Cable Manager, front and rear, 45 RU, 6"W x 10"D front channel and 6"W x 6"D rear channel.	1	—
PRVF6	07498345419	PatchRunner™ Vertical Cable Manager, front only, 45 RU, 6"W x 10"D channel.	1	—
PRV8	07498345415	PatchRunner™ Vertical Cable Manager, front and rear, 45 RU, 8"W x 10"D front channel and 8"W x 6"D rear channel.	1	—
PRV12	07498345414	PatchRunner™ Vertical Cable Manager front and rear, 45 RU, 12"W x 10"D front channel and 12"W x 6"D rear channel.	1	—
Doors				
PRD6	07498345413	PatchRunner™ 6 Inch (152mm) Dual Hinge Door for 45 RU.	1	—
PRD8	07498345412	PatchRunner™ 8 Inch (203mm) Dual Hinge Door for 45 RU.	1	—
PRD12	07498345414	PatchRunner™ 12 Inch (305mm) Dual Hinge Door for 45 RU.	1	—
Horizontal Managers				
WMPSE	07498337798	PatchLink™ Horizontal Cable Manager with hinged cover, front and rear, 1 RU.	1	—
WMPFSE	07498337799	PatchLink™ Horizontal Cable Manager with hinged cover, front only, 1 RU.	1	—
WMP1E	07498337649	PatchLink™ Horizontal Cable Manager with hinged cover, front and rear, 2 RU.	1	—
WMPF1E	07498337797	PatchLink™ Horizontal Cable Manager with hinged cover, front only, 2 RU.	1	—
NM2	07498300940	NetManager™ Horizontal Cable Manager with hinged cover, front and rear, 2 RU.	1	—
NM4	07498300944	NetManager™ Horizontal Cable Manager with hinged cover, front and rear, 4 RU.	1	—
NMF2	07498300941	NetManager™ Horizontal Cable Manager with hinged cover, front only, 2 RU.	1	—
NMF4	07498300945	NetManager™ Horizontal Cable Manager with hinged cover, front only, 4 RU.	1	—
Hinged Wall Bracket				
WBH2	07498348918	2 RU 6"D hinged wall mount bracket, accepts 19" patch panels, horizontal managers, and equipment.	1	—

Power Distribution Units (PDUs)



Panduit Part Number	Wesco Part Number	Amps	Volts	Receptacles		Plug	Breaker		Std. Pkg. Qty.
				Type	Qty.		Type	Qty.	
Basic and Basic with Local Meter Horizontal Rack PDUs, Single Phase, NEMKO Certified									
CMRPSH15	07498384474	15A	120V	NEMA 5-15R	10	NEMA 5-15P	15A Thermal	1	1
CMRPSH20	07498384473	20A	120V	NEMA 5-20R	10	NEMA 5-20P	20A Thermal	1	1
CMRPSH20CM	07498300931	20A	120V	NEMA 5-20R	10	NEMA L5-20P	20A Thermal	1	1
CMRPSH20CMTL	07498332990	20A	120V	NEMA 5-20R	10	NEMA L5-20P Twist Lock	20A Thermal	1	1
CMRPSH20STL	07498357135	20A	120V	NEMA 5-20R	10	NEMA L5-20P Twist Lock	20A Thermal	1	1
H1B1B1M2M10AKA0	07498394708	30A	120V	NEMA 5-20R	10	NEMA L5-30P	20A Single Pole	2	1
HB1B1L4BT10M1	07498357302	30A	208V	IEC C-13	10	NEMA L6-30P Twist Lock	15A Thermal	4	1
Basic and Basic with Local Meter Vertical Rack PDUs, Single Phase, NEMKO Certified									
CMRPSV15SIL	07498357127	15A	120V	NEMA 5-15R Inline	20	NEMA 5-15P	15A Thermal	1	1
CMRPSV20	07498384471	20A	120V	NEMA 5-20R	10	NEMA 5-20P	20A Thermal	1	1
CMRPSV20SILTL	07498357141	20A	120V	NEMA 5-20R Inline	20	NEMA L5-20P Twist Lock	20A Thermal	1	1
V1B2B1L2N24ALA0	07498394700	30A	208V	NEMA 6-20R	24	NEMA L6-30P	—	—	1
V1B2B1M2M24AKA0	07498394707	30A	120V	NEMA 5-20R	24	NEMA L5-30P	20A Single Pole	2	1
V1M2B1L2N30AHA0	07498369847	30A	208V	IEC C-13/ IEC C-19	24/6	NEMA L6-30P	—	—	1
V1M2B1M2M24AKA0	07498392784	30A	120V	NEMA 5-20R	24	NEMA L5-30P	20A Single Pole	2	1
SmartZone™ Network-Enabled M Series Horizontal Rack PDU with (1) 10/100 RJ45 Ethernet Port and (2) RJ45 Remote Environmental Ports, Single Phase, NEMKO Certified									
P1N1B1L2N08ATA0	7498387598	30A	208V	IEC C-13 / IEC C-19	6/2	NEMA L6-30P	—	—	1
P1N1B1M2M10AKA0	7498387787	30A	120V	NEMA 5-20R	10	NEMA L5-30P	—	—	1
SmartZone™ Network-Enabled M Series Vertical Rack PDU with (1) 10/100 RJ45 Ethernet Port and (2) RJ45 Remote Environmental Ports, Single Phase, NEMKO Certified									
Q1N1B1C0A24AKA0	7498387597	20A	120V	NEMA 5-20R	24	NEMA L5-20P Twist Lock	—	—	1
Q1N1B1F0A30AHA0	7498387594	20A	208V	IEC C-13/ IEC C-19	24/6	NEMA L6-20P Twist Lock	—	—	1
Q1N2B1L2N30AHA0	7498388107	30A	208V	IEC C-13/ IEC C-19	24/6	NEMA L6-30P	—	—	1
Q1N2B2C3N30AHA0	7498388114	60A	208V	IEC C-13/ IEC C-19	24/6	IEC 60309 – 6H 2P+E	—	—	1
Q1N1B1D0A24AKA0	7498387596	20A	120V	NEMA 5-20R	24	NEMA L5-20P Twist Lock	—	—	1

Wyr-Grid® Overhead Cable Tray Routing System



WG12BL10



WGINTBRC4BL



WGSW4BL



WGINTSPLBL



WGSPL1218BL

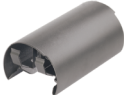

WGRTMWFBL



WGSWF4BL



WGTBS12BL



WGWMTB12BL

Panduit Part Number	Wesco Part Number	Description	Std. Pkg. Qty.	Std. Ctn. Qty.
Wyr-Grid® Pathway				
WG12BL10	07498396773	12" wide x 118.35" (3006.2mm) long pathway section used to carry cables horizontally throughout the system.	10	—
Wyr-Grid® Sidewalls				
WGINTBRC4BL	07498332451	Wyr-Grid® 4" (102mm) high Snap-On Intersection Bend Radius Control provides 3" (76mm) bend radius control.	1	—
WGSW4BL	07498387880	Wyr-Grid® 4" (102mm) high Snap-On Sidewalls.	1	40
Wyr-Grid® Splice Connectors				
WGINTSPLBL	07498331888	Intersection splice connector quickly joins Wyr-Grid® Pathways at all intersections.	1	10
WGSPL1218BL	07498331889	Straight splice connector quickly joins two 8" (203mm) 12" (305mm) or 18" (457mm) wide Wyr-Grid® Pathways together.	1	10
Wyr-Grid® Waterfalls				
WGBTMWFBL	07498332207	Bottom waterfall provides 1.38" (35mm) bend radius control for cables transitioning down into the racks or cabinets from within the Wyr-Grid® Pathway.	1	10
WGSWF4BL	07498397108	The side waterfall provides 3" (76mm) bend radius control for cables transitioning down into the racks or cabinets from the side of the Wyr-Grid® Pathway.	1	5
Wyr-Grid® Brackets				
WGTBS12BL	07498361191	Bracket used to support 12" (305mm) wide Wyr-Grid® Pathway from the ceiling using a pair of 1/2" or 12mm threaded rod drops.	1	5
WGWMTB12BL	07498332208	Bracket used to support the end of the 12" (305mm) Wyr-Grid® Pathway against the wall. Mounting hardware for attaching to wall not included.	1	5

Contact Panduit Customer Service for other pathway widths, 8" (203mm), 18" (457mm), 24" (610mm), and 30" (762mm). For pathway, order number of feet required, in multiples of standard 10' length increments.

FiberRunner® 6x4 Cable Routing System



Panduit Part Number	Wesco Part Number	Description	Std. Pkg. Qty.	Std. Ctn. Qty.
---------------------	-------------------	-------------	----------------	----------------

FiberRunner® 6" x 4" (150mm x 100mm) Channel and Cover

FR6X4YL6	07498378399	Channel, 6'.	6'	36'
FRHC6YL6	07498378403	Hinged, snap-on channel cover, 6'.	6'	36'
FRSHC6YL6	07498385092	Split hinged snap-on channel cover, 6'.	6'	36'

FiberRunner® 6" x 4" (150mm x 100mm) Fittings

FRBC6X4YL	07498379418	QuikLock™ Coupler.	1	5
FREC6X4YL	07498378435	End cap.	1	5
FRFVC6X4YL	07498378439	4-way cross fitting.	1	5
FRFVCSC6YL	07498379938	4-way cross split cover.	1	5
FRH456X4YL	07498381576	Horizontal 45° angle fitting.	1	5
FRH45SC6YL	07498381578	Horizontal 45° angle split cover.	1	5
FRIV456X4YL	07498378456	Inside Vertical 45° fitting and cover.	1	5
FRIVRA6X4YL	07498378446	Inside Vertical 90° fitting and cover.	1	5
FROV456X4YL	07498378464	Outside Vertical 45° angle fitting.	1	5
FROV45SC6YL	07498379942	Outside Vertical 45° angle split cover.	1	5
FROVRA6X4YL	07498378451	Outside Vertical 90° angle fitting.	1	5
FROVRASC6YL	07498379940	Outside Vertical 90° angle split cover.	1	5
FRR6X4YL	07498378419	Horizontal right angle fitting.	1	5
FRRASC6YL	07498379936	Horizontal right angle split cover.	1	5
FRT6X4YL	07498378415	Horizontal tee fitting.	1	5
FRTSC6YL	07498379934	Horizontal tee split cover.	1	5
FRRF64YL	07498378430	Reducer from 6" x 4" FiberRunner® to 4" x 4" Fiber-Duct™ Fitting and Cover.	1	5
FRADC6X4YL	07498379945	Adapter from 6" x 4" FiberRunner® to 6" x 4" FiberGuide*.	1	5

*FiberGuide is a registered trademark of TE Connectivity.

FiberRunner® Spillouts

FRSPJ2X2YL	07498306616	Assembles onto 4x4, 6x4, 12x4, or 24x4 FiberRunner® Channel, spilling over the side into a 2x2 vertical exit.	1	—
FRSPJC26YL	07498307260	Used to fully enclose 6x4 channel in conjunction with the spill-over junction FRSPJ2X2YL.	1	5
FRVT6X4YL	07498378425	Vertical tee with hinged door.	1	5
FIDT4X4BL	07498378926	Used to route cable into one or two pieces of 1.5" (38mm) diameter split corrugated tubing. Black color only.	1	5
FTR4X4YL	07498378927	3-sided vertical tee trumpet spillout.	1	5

For other colors replace YL (Yellow) with BL (Black).

FiberRunner® Brackets

F2PCLB58	07498385498	Two-piece bracket attaches to 3/8" (9.5mm) wide x 1 1/2" (38.1mm) or 3/8" (9.5mm) wide x 2" (50.8mm) ladder rack rail.	1	10
FR6TRBN58	07498379919	New 5/8" threaded rod QuikLock™ Bracket for 4" x 4" and 6" x 4" FiberRunner®.	1	10
FRTBWG12BL	07498333216	FiberRunner® Threaded Rod Trapeze Bracket for Wyr-Grid® 12" width.	1	10

Contact Panduit Customer Service for other colors and sizes, 24x4, 12x4, 4x4, and 2x2. For channel and channel cover, order number of feet required, in multiples of standard 6' length increments.

Faceplates



CFFPL4BL



CFP4

CFPE2

Panduit Part Number	Wesco Part Number	Description	Std. Pkg. Qty.	Std. Ctn. Qty.
Furniture Faceplates				
CFFP4BL	07498358460	Furniture faceplate, 4-port, standard, Black.	1	10
CFFPL4BL	07498377678	Furniture faceplate with labeling, 4-port, standard, Black.	1	10
CFFPHM4BL	07498375670	Furniture faceplate, 4-port, Herman Miler, Black.	1	10
Classic Faceplates				
CFP2EI	07498368759	Classic faceplate single gang, 2-port, Electric Ivory.	1	10
CFP2IW	07498368758	Classic faceplate single gang, 2-port, Off White.	1	10
CFP2WH	07498368761	Classic faceplate single gang, 2-port, White.	1	10
CFP4EI	07498368765	Classic faceplate single gang, 4-port, Electric Ivory.	1	10
CFP4IW	07498368764	Classic faceplate single gang, 4-port, Off White.	1	10
CFP4WH	07498368767	Classic faceplate single gang, 4-port, White.	1	10
CFPL2EIY	07498303362	Classic faceplate single gang with label, 2-port, Electric Ivory.	1	10
CFPL2IWY	07498303365	Classic faceplate single gang with label, 2-port, Off White.	1	10
CFPL2WHY	07498303368	Classic faceplate single gang with label, 2-port, White.	1	10
CFPL4EIY	07498303379	Classic faceplate single gang with label, 4-port, Electric Ivory.	1	10
CFPL4IWY	07498303382	Classic faceplate single gang with label, 4-port, Off White.	1	10
CFPL4WHY	07498303386	Classic faceplate single gang with label, 4-port, White.	1	10
Executive Faceplates				
CFPE2EIY	07498303326	Executive faceplate single gang, 2-port, Electric Ivory.	1	10
CFPE2IWY	07498303329	Executive faceplate single gang, 2-port, Off White.	1	10
CFPE2WHY	07498303331	Executive faceplate single gang, 2-port, White.	1	10
CFPE4EIY	07498303337	Executive faceplate single gang, 4-port, Electric Ivory.	1	10
CFPE4IWY	07498303340	Executive faceplate single gang, 4-port, Off White.	1	10
CFPE4WHY	07498303342	Executive faceplate single gang, 4-port, White.	1	10

Surface Mount Box



CBX2IW-A

Panduit Part Number	Wesco Part Number	Description	Std. Pkg. Qty.	Std. Ctn. Qty.
CBX1IW-A	07498375376	Surface mount box, 1-port, Off White.	1	10
CBX1WH-A	07498375377	Surface mount box, 1-port, White.	1	10
CBX2IW-A	07498303202	Surface mount box, 2-port, Off White.	1	10
CBX2WH-A	07498303203	Surface mount box, 2-port, White.	1	10
CBX4IW-A	07498303208	Surface mount box, 4-port, Off White.	1	10
CBX4WH-A	07498303209	Surface mount box, 4-port, White.	1	10
CBXF6IW-A	07498303233	Surface mount box, 6-port, multimedia, Off White.	1	10

Contact Panduit Customer Service for other colors.

Surface Raceway



LD^IW-A



OFC^IW-X



JB1IW-A

Panduit Part Number	Wesco Part Number	Description	Std. Pkg. Qty.	Std. Ctn. Qty.
LD Profile Raceway				
LD3IW6-A	07498358826	LD3, low voltage 1-piece single channel raceway with adhesive.	6 Ft.	120 Ft.
LD5IW6-A	07498358827	LD5, low voltage 1-piece single channel raceway with adhesive.	6 Ft.	120 Ft.
LD10IW6-A	07498358828	LD10 low voltage 1-piece single channel raceway with adhesive.	6 Ft.	120 Ft.
LD Profile Raceway Fittings				
DCF^IW-X	07498326244	Drop ceiling/entrance end fitting for use with LD raceway.	10	50
OCF^IW-X	07498326263	Outside corner fitting for use with LD raceway.	10	50
ECF^IW-E	07498326251	End cap fitting for use with LD raceway.	10	50
RAF^IW-E	07498326269	Right angle fitting for use with LD raceway.	10	50
Junction Boxes Used with LD Profile Raceway				
JB1IW-A	07498358285	Single gang one-piece outlet box with adhesive backing.	1	10
JBX3510IW-A	07498335394	Single gang two-piece snap together outlet box with adhesive backing.	1	10
JBP1DIW	07498364077	Single gang power rated two-piece deep outlet box.	1	10
JBP2DIW	07498370293	Double gang power rated two-piece deep outlet box.	1	10

*Raceway listed in 6 foot lengths. Other lengths available include: 8 and 10 foot.

^Insert LD raceway size: 3, 5, 10

Zone Enclosures

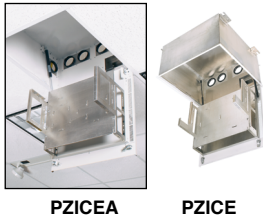

Panduit Part Number	Wesco Part Number	Description	Std. Pkg. Qty.	Std. Ctn. Qty.
PZICEA	07498300908	PanZone® Active In-Ceiling Enclosure with hinged door gas-assist air cylinders. Accepts up to 2 RU of active equipment and up to 6 RU of passive equipment, includes mounting brackets and integrated horizontal slack manager, AC power provisions, fan assembly, air dam, and electrical junction box.	1	—
PZICE	07498300907	PanZone® Passive In-Ceiling Enclosure with hinged door gas-assist air cylinders. Accepts up to 8 RU of passive equipment, includes mounting brackets and integrated horizontal slack manager.	1	—

Grounding

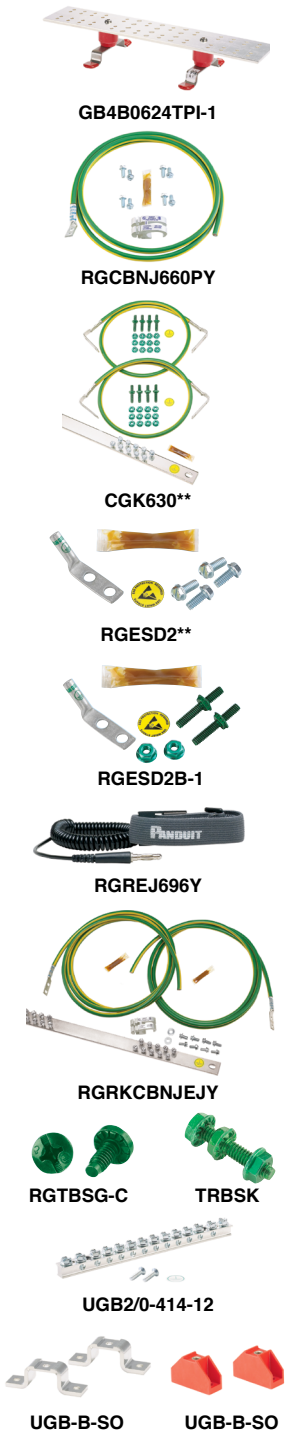

Panduit Part Number	Wesco Part Number	Description	Std. Pkg. Qty.	Std. Ctn. Qty.
Rack Grounding Kits				
CNBK	07498309730	Bonding cage nut kit.	1	—
GB2B0306TPI-1	07498365927	Grounding busbar, BICSI 1/4" x 2" x 12" (6.4mm x 51mm x 305mm).	1	—
GB4B0624TPI-1	07498334541	Grounding busbar, BICSI 1/4" x 4" x 20" (6.4mm x 102mm x 508mm).	1	—
GB4B0612TPI-1	07498334540	Grounding busbar, BICSI 1/4" x 4" x 12" (6.4mm x 102mm x 305mm).	1	—
GB2B0304TPI-1	07498365926	Grounding busbar, BICSI 1/4" x 2" x 10" (6.4mm x 51mm x 254mm).	1	—
GPQC10-1/0	07498309846	Access floor grounding clamp, 7/8" (22.2mm) square, 1 – 1 1/8" (25.4 – 28.6mm) round.	1	—
RGCBNJ660P22	07498379863	Jumper kits, Common Bonding Network (CBN), #6 AWG (16mm ²) jumper, 60" (1.52m) length.	1	—
RGCBNJ660PY	07498360851	Jumper kits, Common Bonding Network (CBN), #6 AWG (16mm ²) jumper, 60" (1.52m) length.	1	—
RGRKCBNJY	07498360870	Jumper kit, rack grounding retrofit equipment.	1	—
RGRB19U	07498366041	Grounding busbar kits, 19" (483mm) length, 20 mounting holes, 5/8" (15.9mm) hole spacing.	1	—
RGRB19Y	07498360866	Grounding busbar kits, 19" (483mm) length, 14 mounting holes, 1/2" (12.7mm) hole spacing.	1	—
RGS134-1Y	07498360871	Grounding strip kits, one, 78.65" (2m) x 0.67" (17mm) x 0.05" (1.27mm) strip.	1	—
Cabinet Grounding Kits				
CGR630U	07498365786	Complete grounding kit for new installations on cabinets with 42 RUs, threaded #12-24 or M6 rail fasteners and rail depth up to 30" (0.75m).	1	—
CGR630UB	Contact Wesco	Complete grounding kit for new installations on cabinets with 42 RUs, cage nut rail fasteners and rail depth up to 30" (0.75m).	1	—
RGESD2-1	07498339606	Two-hole ESD port with 5/8" hole spacing; provided with an ESD protection sticker, 0.16 oz. (5cc) of antioxidant, and two each #12-24 x 1/2" and M6 x 12mm thread-forming screws.	1	20
RGESD2B-1	07498365369	Two-hole ESD port with 5/8" hole spacing; provided with an ESD protection sticker, 0.16 oz. (5cc) of antioxidant, two cage nut bonding studs and two #12-24 bonding nuts.	1	20
RGESDWS	07498302307	Adjustable fabric ESD wrist strap with 6' coil cord, banana plug, 1 meg ohm resistor and 4mm snap.	1	—
RGREJ696Y	07498360869	Grounding jumper; #6 AWG (16mm ²); 96" (2.44m) length.	1	10
RGRKCBNJEJY	07498360599	Rack grounding kit to ground the rack and one piece of equipment; includes one RGRB19U busbar, one HTCT250-2-1 HTAP, and two RGREJ696Y grounding jumpers.	1	10
RGTBSG-C	07498369697	Green thread-forming bonding screw, #12-24 x 1/2".	100	—
TRBSK	07498300845	Bonding stud kit for threaded #12-24 rail fasteners.	1	4
UGB2/0-414-12	07498340223	Universal ground bar accepts #14 – #4 AWG wire in 12 wire ports and up to a 2/0 AWG main equipment grounding conductor with a compression or mechanical connector; 8.28" (210.3mm) length, 0.62" (15.7mm) width, 0.48" (12.2mm) height.	1	10
UGB-B-SO	07498340219	Universal ground bar bonding stand-offs; includes two stand-offs and hardware; 2.34" (59.3mm) length, 0.63" (15.9mm) width, 0.75" (19.1mm) height.	1	10
UGB-IN-SO	07498340218	Universal ground bar isolation stand-offs; includes two stand-offs and hardware; 1.57" (40mm) length, 0.59" (15.0mm) width, 0.98" (25.0mm) height.	1	10

Labeling



LS8EQ-KIT

Panduit Part Number	Wesco Part Number	Description	Std. Pkg. Qty.	Std. Ctn. Qty.
LS8EQ-KIT	07498308901	Panduit® PanTher™ Hand-Held Label Printing System in kit. Includes LS8EQ printer with QWERTY keypad, one cassette of S100X150VAC self-laminating labels, six AA alkaline batteries, LS8E-ACS, LS8-CASE, LS8-PCKIT, LS8-IB, LS8-WS, quick reference card and operator's manual. USE FOR LABELS THAT MUST BE PRINTED ON THE JOB SITE.	1	1
PTR-CLN	07498376640	Printer cleaning kit – contains (1) cleaning pen, (8) cleaning solution soaked wipes, (8) foam swabs pre-saturated with cleaning solution, MSDS, and cleaning instructions.	1	—
LJSL5-Y3-2.5	07498382453	Laser/inkjet, self-laminating label, adhesive polyester, 1.00" W x 1.33" H, 0.47" print-on area, Clear/White, 52 per package.	1	10
NWSLC-2Y	07498345850	Yellow cable identification sleeve for 2mm simplex fiber cable, 1" length, 100 per pack.	100	1000
R100X125V1T	07498321935	Turn-Tell® Thermal Transfer Vinyl Label, 1.00" W X 1.25" H, 0.38" print-on area, Clear/White, 3" Core 12 – 10 AWG wire/cable, Category 3 UTP cable.	2500	10000
S100X150YAJ	07498346392	Laser/inkjet, self-laminating label, polyester, 1.00" W x 1.50" L, 0.50" print-on area, Clear/White.	1	10
S100X150VAC	07498335303	P1 cassette, self-laminating label, vinyl, 1.00" W x 1.50" H, 0.50" print-on area, Clear/White.	1	10
S100X150VATY	07498343951	Thermal transfer, self-laminating label, vinyl, 1.00" W x 1.50" H, 0.50" print-on area, Clear/White.	5000	—
PROG-EM2GO	07498308924	Easy-Mark™ Labeling Software for PC, supplied on USB flash drive. For pre-printing communications labels on laser/inkjet printer.	1	—

Cable Ties and Bundling

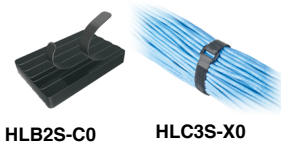

HLB2S-C0 HLC3S-X0



HLM-15R0



HLS1.5S-X0
HLS3S-X0



HLSP1.5S-X0



HLT2I-X0

Panduit Part Number	Wesco Part Number	Description	Std. Pkg. Qty.	Std. Ctn. Qty.
HLS-75R0	07498372446	Hook and loop roll, 75'L (22.9m), 0.75"W (19.1mm), Black.	1	10
HLS-15R0	07498352340	Hook and loop roll, 15'L (4.6m), 0.75"W (19.1mm), Black.	1	10
HLB2S-C0	07498309014	Hook and loop stacked strip cable tie, 7.0" (178mm) length, 0.75" (19.1mm) width, nylon loop, polyethylene hook, Black.	1	10
HLC3S-X0	07498352338	Hook and loop cinch cable tie, 12.0" (305mm) length, 0.75" (19.1mm) width, nylon hook and loop, nylon cinch ring, Black.	10	100
HLM-15R0	07498362694	Hook and loop miniature roll cable tie, 15' (4.6m) length, 0.33" (8.4mm) width, nylon loop, polyethylene hook, Black.	1	10
HLS1.5S-X0	07498353936	Hook and loop strip cable tie, 6.0" (152mm) length, 0.75" (19.1mm) width, nylon loop, polyethylene hook, Black.	10	100
HLS3S-X0	07498353937	Hook and loop strip cable tie, 12.0" (305mm) length, 0.75" (19.1mm) width, nylon loop, polyethylene hook, Black.	10	100
HLSP1.5S-X0	07498375473	Hook and Loop cable tie, UL Listed, strip style, 6.0", Standard cross section, Black.	10	100
HLT2I-X0	07498352341	Hook and loop cable loop tie, 8.0" (203mm) length, 0.50" (12.7mm) width, nylon loop, polyethylene hook, Black.	10	100
HLTP2I-X0	07498375057	Hook and loop cable tie, UL Listed, 8.0", Intermediate cross section, Black.	10	100
TTS-35RX0	07498337844	Hook and loop roll, 10 roll pack, low profile, 35'L (10.7m), 0.75"W (19.1mm), Black.	1	10
PLT3I-C	07498354054	Cable tie, 11.4"L (290mm), Intermediate, nylon, Natural.	100	1000
PLT3S-C2	07498354791	Cable tie, 11.5"L (292mm) Standard, nylon, Red.	100	1000
PLT8LH-C0	07498338350	Cable tie, 27.6"L (701mm), Light-Heavy, weather resistant, Black.	100	2000
PLT4S-M30	07498356621	Cable tie, 14.5"L (368mm), Standard, heat stabilized, Black.	1000	10000
PLT3S-M2	07498356479	Cable tie, 11.5"L (292mm) Standard, nylon, Red.	1000	10000
PLT4I-M	07498354071	Cable tie, 14.5"L (368mm), Intermediate, nylon, Natural.	1000	10000

< [Previous Page](#) | [Table of Contents](#) | [Next Page](#) >

Security Devices



PSL-LCAB-BU



PSL-DCJB



PSL-DCPLS

Panduit Part Number	Wesco Part Number	Description	Std. Pkg. Qty.	Std. Ctn. Qty.
PSL-LCAB-BU	07498319476	LC duplex adapter blackout device, ten devices (Blue) and one removal tool (Black).	1	20
PSL-DCJB-BL	07498357799	Jack module blackout device, ten block-outs (Black) and one removal tool (Black).	1	20
PSL-DCJB-BU	07498357801	Jack module blackout device, ten block-outs (Blue) and one removal tool (Black).	1	20
PSL-DCJB	07498333847	Jack module blackout device, ten block-outs (Red) and one removal tool (Black).	1	20
PSL-DCPLX-BL	07498331998	RJ45 plug lock-in device, ten devices (Black) and one installation/removal tool (Black).	1	20
PSL-DCPLRX-BU	07498331991	Recessed RJ45 plug lock-in device, ten devices (Blue) and one installation/removal tool (Black).	1	20
PSL-DCPLS	07498308959	Super recessed RJ45 plug lock-in device, ten devices (Red) and one installation/removal tool (Black).	1	20

Tools



EGJT



TGJT



FCAMKIT

Panduit Part Number	Wesco Part Number	Description	Std. Pkg. Qty.	Std. Ctn. Qty.
EGJT	07498365906	TG jack termination tool.	1	—
TGJT	07498379866	TG jack termination tool, for high-volume installations.	1	—
CJAST	07498397455	Copper cable jacket stripper.	1	1
CWST	07498382126	Copper wire snips.	1	1
PDT110	07498339020	110 punchdown tool.	1	1
CBOT24K	07498308821	Cable bundle organizing tool.	1	10
FIELDKIT	07498371791	Field polish fiber optic termination kit for all field polish connectors.	1	—
FCAMKIT	07498371788	OptiCam™ Termination Kit for pre-polished connectors.	1	1



WESCO®

PANDUIT®