



ILL70CB



ILL71CB



ILL72CB



ILL70ABAWN

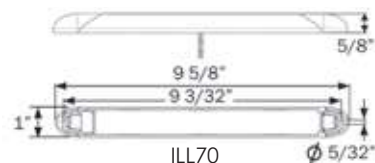

ILL70

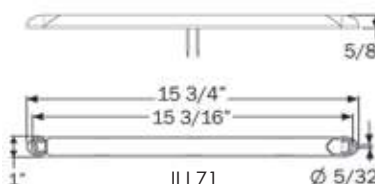

ILL71

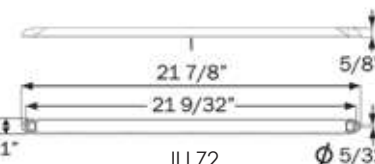

ILL72

**MATERIALS**

Polycarbonate lens and housing

**VOLT/AMP**

ILL70: 12.8VDC - .150A

ILL71: 12.8VDC - .300A

ILL72: 12.8VDC - .480A

**WT/DIMS**

ILL70: .154 lb. / 9.625" x 1" x .625"

ILL71: .187 lb. / 15.75" x 1" x .625"

ILL72: .210 lb. / 21.875" x 1" x .625"

**WARRANTY**

Lifetime LED Warranty

## ILL70/71/72 SERIES Opti-Brite™ LED Interior Strip Lights for Surface Mount

- Low profile, slimline lights – only 1" wide by 5/8" thick
- Hard wired design includes both lead and ground wires
- Select from 9-inch, 16-inch and 22-inch strip lights and 11" and 18" awning lights
- Sealed, waterproof

BULK P/N	POLYPACK P/N	DESCRIPTION	QTY
<b>9" WHITE LED STRIP LIGHT - 9 DIODES</b>			
ILL70CB	ILL70CBP	Strip light	20/10
ILL70CSB	ILL70CSBP	Strip light with on/off switch	10
<b>11" WHITE LED AWNING LIGHT - 9 DIODES</b>			
ILL70CBAWN	ILL70CBAWN	No switch, chrome housing	10
ILL70CBBAWN	ILL70CBBAWN	No switch, black housing	10
ILL70CBSAWN	ILL70CBSAWN	On/off switch, black housing	10
ILL70CCSAWN	ILL70CCSAWN	On/off switch, chrome housing	10
<b>11" AMBER LED AWNING LIGHT - 9 DIODES</b>			
ILL70ABAWN	ILL70ABAWN	No switch, chrome housing	10
ILL70ABBAWN	ILL70ABBAWN	No switch, black housing	10
<b>Raw lumen output: 189 lm</b> <b>Effective lumen output: 171 lm</b>			
<b>16" WHITE LED STRIP LIGHT - 18 DIODES</b>			
ILL71CB	ILL71CBP	Strip light	20/10
ILL71CSB	ILL71CSBP	Strip light with on/off switch	10
ILL71CPG	ILL71CPGP	Strip light, .180 male bullets	10
<b>18" WHITE LED AWNING LIGHT - 18 DIODES</b>			
ILL71CBAWN	ILL71CBAWN	No switch, chrome housing	10
<b>Raw lumen output: 370 lm</b> <b>Effective lumen output: 342 lm</b>			
<b>22" WHITE LED STRIP LIGHT - 27 DIODES</b>			
ILL72CB	ILL72CBP	Strip light	20/10
<b>Raw lumen output: 567 lm</b> <b>Effective lumen output: 513 lm</b>			

## ILL85 SERIES LED Exterior Step/Area Light

- Illuminate step well or pavement at base of steps or ramps
- Meets ADA lighting standard
- Surface mount, 3.662" mounting centers
- Hard wired design includes both lead and ground wires
- Operating voltage 8-30VDC, for use with 12VDC or 24VDC systems
- Polycarbonate construction with polished chrome finish
- Mounting gasket included

BULK P/N	POLYPACK P/N	DESCRIPTION	QTY
<b>STEP/AREA LIGHT - 10 DIODES</b>			
ILL85CB	ILL85CBP	Step/area light	10

<b>MATERIALS</b>	Polycarbonate lens and housing
<b>VOLT/AMP</b>	12.8VDC - .107A
<b>WT/DIMS</b>	.154 lb. / 4.25" x 1.24" x 1.69"
<b>WARRANTY</b>	Lifetime LED Warranty



ILL85CB

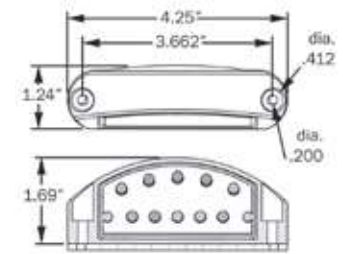

## ILL86 SERIES LED Exterior Step/Area Light

- Illuminate step well or pavement at base of steps or ramps
- Meets ADA lighting standard
- Surface mount, 2.92" mounting centers
- Hard wired design includes both lead and ground wires
- Die cast aluminum housing coated for protection against corrosion and UV exposure; polycarbonate lens

BULK P/N	POLYPACK P/N	DESCRIPTION	QTY
<b>STEP/AREA LIGHT - 5 DIODES</b>			
ILL86CB	ILL86CBP	Step/area light, white finish	10
ILL86BCB	ILL86BCBP	Step/area light, black finish	10

<b>MATERIALS</b>	Die cast aluminum housing, polycarbonate lens
<b>VOLT/AMP</b>	12.8VDC - .25A
<b>WT/DIMS</b>	.154 lb. / 4" x 2.5" x 1.313"
<b>WARRANTY</b>	Lifetime LED Warranty



ILL86CB

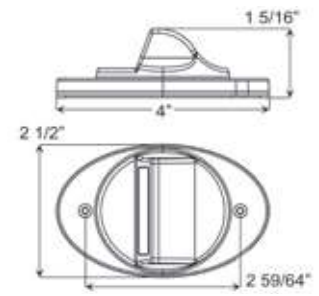



ILL91CB

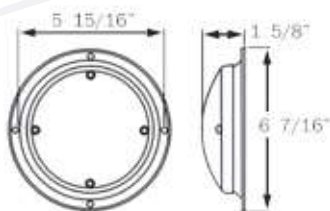

## ILL91 SERIES 6" LED Interior Dome Light

- Surface mount steel base, chrome plated
- Hard wired design includes both lead and ground wires
- Two diodes provide low amp draw, bright white light

BULK P/N	POLYPACK P/N	DESCRIPTION	QTY
<b>DOMES LIGHT - 6 DIODES</b>			
ILL91CB	ILL91CBP	Dome light	50
ILL91CPG	ILL91CPGP	Dome light, .180 male bullets	50
<b>Raw lumen output: 600 lm</b>			
<b>Effective lumen output: 540 lm</b>			

<b>MATERIALS</b>	Polycarbonate lens and housing
<b>VOLT/AMP</b>	12.8VDC - .35A
<b>WT/DIMS</b>	.154 lb. / 6.438" x 6.438" x 1.625"
<b>WARRANTY</b>	Lifetime LED Warranty



LM112CB



LM315BB



LM835CB

## LM SERIES LED Utility, Courtesy & Accent Lights

- LM112CB is recess mount waterproof light for use above or below water level. Single diode. Plastic housing.
- LM315BB is semi-recess mount courtesy light
- LM835CB is eight-diode recess mount accent light with clear lens and chrome trim ring; screw mount
- All models are hard wired with ground wire

BULK P/N	POLYPACK P/N	DESCRIPTION	QTY
<b>WATERPROOF UTILITY LIGHT - 1 DIODE</b>			
LM112CB	LM112CBP	Waterproof mini utility light	50
<b>COURTESY LIGHT - 3 DIODES</b>			
LM315BB	LM315BBP	Courtesy light, black	50
<b>ACCENT LIGHT - 8 DIODE</b>			
LM835CB	LM835CBP	Recess mount accent light	50

<b>MATERIALS</b>	Polycarbonate lens and housing
<b>VOLT/AMP</b>	LM112CB: 12.8VDC - .013A LM315BB: 12.8VDC - .007A LM835CB: 12.8VDC - .087A
<b>WT/DIMS</b>	LM112CB: .154 lb. / 1.25" x 1.25" x 1.25" LM315BB: .187 lb. / 2.25" x 2.25" x 1.625" LM835CB: .210 lb. / 3.75" x 3.75" x 0.75"
<b>WARRANTY</b>	Lifetime LED Warranty

## ULL25 SERIES COB LED Utility Strip Light



- Waterproof
- Slim design - only 5/8" wide and 3/16" thick
- Design includes both lead and ground wire
- Ultrawhite – color temperature 6500K

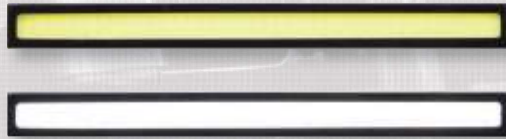

BULK P/N	POLYPACK P/N	DESCRIPTION	QTY
<b>STRIP LIGHT - 76 COB</b>			
ULL25CB	ULL25CBP	12V COB strip light	50
ULL25CTB	ULL25CTBP	12V COB strip light with mounting tape	50
<b>Raw lumen output: 380 lm</b>			
<b>Effective lumen output: 220 lm</b>			

<b>MATERIALS</b>	Polycarbonate lens and housing
<b>VOLT/AMP</b>	12.8VDC - .30A
<b>WT/DIMS</b>	.25 lb. / 6.829" x .616" x 0.14"
<b>WARRANTY</b>	Lifetime LED Warranty





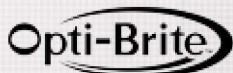

## TLL30 SERIES Opti-Brite™ LED Work Light

- Compact design – only 3.25" diameter
- Die cast aluminum housing with powder coat finish
- Stainless steel hardware
- 16-gauge, 20" lead and ground wire; IP69K rating



TLL30FB

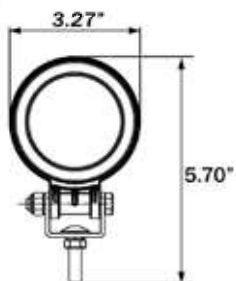

BULK P/N	POLYPACK P/N	DESCRIPTION	QTY
<b>FLOOD BEAM - 4 DIODES</b>			
TLL30FB	TLL30FBP	Flood beam	1t

**Raw lumen output: 960 lm**  
**Effective lumen output: 670 lm**

<b>MATERIALS</b>	Polycarbonate lens, aluminum housing
<b>VOLT/AMP</b>	12.8VDC - 0.75A, 24.0VDC - 0.37A
<b>WT/DIMS</b>	1.468 lbs. / 3.27" x 5.70" x 2.36"
<b>WARRANTY</b>	Lifetime LED Warranty

### IP69K RATING

Highest designation available for water ingress testing, offering increased reliability and service life when subjected to severe environmental conditions or cleaning methods.

## TLL44/45 SERIES Opti-Brite™ LED Work Lights

- Heavy duty design with powder coated, die cast aluminum housing and polycarbonate lens
- Low profile design – only 2 inches deep
- Dual power: use with 12VDC and 24VDC systems
- Stainless steel mounting hardware
- 14-gauge, 10" lead and ground wire

BULK P/N	POLYPACK P/N	DESCRIPTION	QTY
<b>ROUND LED WORK LIGHT - 6 DIODES</b>			
TLL44FB	TLL44FBP	Flood beam	2
<b>RETAIL</b>			
TLL144FSL		Flood beam, window box	3

**Raw lumen output: 1200 lm**  
**Effective lumen output: 720 lm**

<b>MATERIALS</b>	Polycarbonate lens, aluminum housing
<b>VOLT/AMP</b>	12.8VDC - 1.1A, 24.0VDC - 0.48A
<b>WT/DIMS</b>	0.98 lbs. / 4" x 6.281" x 2.375"
<b>WARRANTY</b>	Lifetime LED Warranty

BULK P/N	POLYPACK P/N	DESCRIPTION	QTY
<b>ROUND LED WORK LIGHT - 8 DIODES</b>			
TLL45FB	TLL45FBP	Flood beam	3
<b>Raw lumen output: 1600 lm</b> <b>Effective lumen output: 897 lm</b>			

<b>MATERIALS</b>	Polycarbonate lens, aluminum housing
<b>VOLT/AMP</b>	12.8VDC - 1.38A, 24.0VDC - 0.65A
<b>WT/DIMS</b>	1.389 lbs. / 4.5" x 7" x 2"
<b>WARRANTY</b>	Lifetime LED Warranty



TLL144FSL

Opti-Brite



TLL44FB

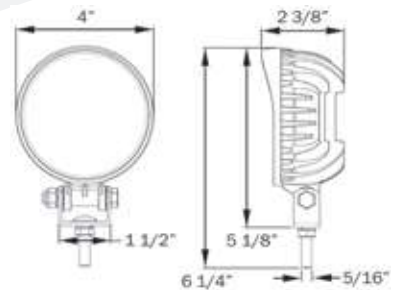

TLL45FB

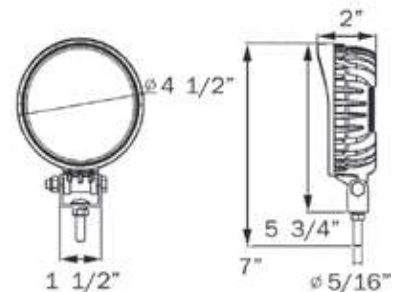

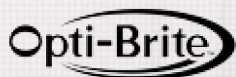

TLL46CFB



TLL46TB

## TLL46 SERIES Opti-Brite™ LED Work Lights

- Heavy duty design with powder coated, die cast aluminum housing and polycarbonate lens
- Low profile design – less than 2.5 inches deep
- Dual power: use with 12VDC and 24VDC systems
- Stainless steel mounting hardware
- 14-gauge, 10” lead and ground wire

BULK P/N	POLYPACK P/N	DESCRIPTION	QTY
<b>FLOOD BEAM - 9 DIODES</b>			
TLL46CFB	TLL46CFBP	Flood beam	3
TLL46CFPG	-	Flood beam, .156 female barrel on ground, .156 male bullet on power	3
<b>Raw lumen output: 1800 lm</b>			
<b>Effective lumen output: 1042 lm</b>			

<b>MATERIALS</b>	Polycarbonate lens, aluminum housing
<b>VOLT/AMP</b>	12.8VDC - 1.70A, 24.0VDC - 1.0A
<b>WT/DIMS</b>	1.764 lbs. / 5" x 7" x 2.375"
<b>WARRANTY</b>	Lifetime LED Warranty

BULK P/N	POLYPACK P/N	DESCRIPTION	QTY
<b>TRAPEZOID BEAM - 9 DIODES</b>			
TLL46TB	TLL46TBP	Trapezoid beam	3
<b>Raw lumen output: 1800 lm</b>			
<b>Effective lumen output: 707 lm</b>			

<b>MATERIALS</b>	Polycarbonate lens, aluminum housing
<b>VOLT/AMP</b>	12.8VDC - 1.50A, 24.0VDC - 0.73A
<b>WT/DIMS</b>	1.764 lbs. / 5" x 7" x 2.375"
<b>WARRANTY</b>	Lifetime LED Warranty

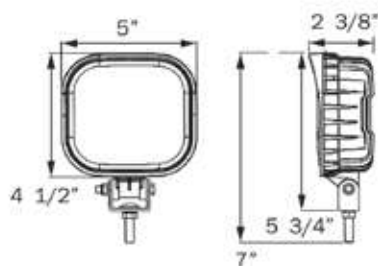

### IP69K RATING

Highest designation available for water ingress testing, offering increased reliability and service life when subjected to severe environmental conditions or cleaning methods.



## TLL48 SERIES Opti-Brite™ LED Work Light

- Heavy duty design with powder coated, die cast aluminum housing and polycarbonate lens
- Low profile design – less than 2.5 inches deep
- Dual power: use with 12VDC and 24VDC systems
- Stainless steel mounting hardware
- 14-gauge, 10" lead and ground wire; IP69K rating

BULK P/N	POLYPACK P/N	DESCRIPTION	QTY
<b>FLOOD BEAM - 6 DIODES</b>			
TLL48FB	TLL48FBP	Flood beam	5
<b>Raw lumen output: 1200 lm</b>			
<b>Effective lumen output: 617 lm</b>			
<b>MATERIALS</b>	Polycarbonate lens, aluminum housing		
<b>VOLT/AMP</b>	12.8VDC - 1.52A, 24.0VDC - 0.65A		
<b>WT/DIMS</b>	1.14 lbs. / 4.15" x 6.375" x 2.14"		
<b>WARRANTY</b>	Lifetime LED Warranty		



TLL48FB

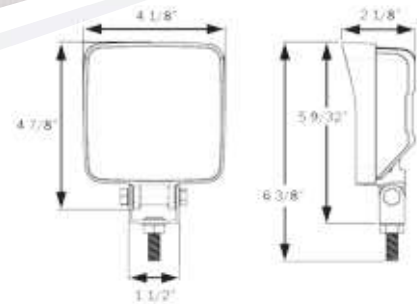

## TLL50 SERIES Opti-Brite™ LED Work Light

- Lightweight, compact LED work light
- Corrosion proof housing and polycarbonate lens
- Dual power: use with 12VDC and 24VDC systems
- 22-gauge, 10" lead and ground wire
- IP69K rating

BULK P/N	POLYPACK P/N	DESCRIPTION	QTY
<b>FLOOD BEAM - 9 DIODES</b>			
TLL50FB	TLL50FBP	Flood beam	3
<b>RETAIL</b>			
TLL150FSL		Flood beam, window box	1
<b>Raw lumen output: 324 lm</b>			
<b>Effective lumen output: 252 lm</b>			



TLL50FB

<b>MATERIALS</b>	Polycarbonate lens and housing, stainless steel hardware
<b>VOLT/AMP</b>	12.8VDC - 1.50A, 24.0VDC - 0.73A
<b>WT/DIMS</b>	1 lbs. / 4.938" x 6.938" x 2.375"
<b>WARRANTY</b>	Lifetime LED Warranty

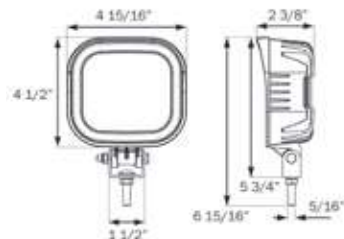

TLL150FSL



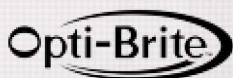

TLL51FB

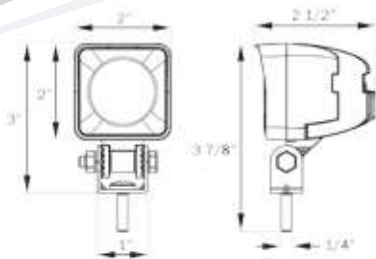

## TLL51 SERIES Opti-Brite™ LED Work Light

- Heavy duty design with powder coated, die cast aluminum housing and polycarbonate lens
- Compact design – only 2 inches square
- Dual power: use with 12VDC and 24VDC systems
- Stainless steel mounting hardware
- 14-gauge, 10" lead and ground wire; IP69K rating

BULK P/N	POLYPACK P/N	DESCRIPTION	QTY
----------	--------------	-------------	-----

### FLOOD BEAM - 1 DIODE

TLL51FB	TLL51FBP	Flood beam	10
TLL51FRPG	-	Flood beam, .180 male bullet on power, ring terminal on ground	10

**Raw lumen output: 800 lm**  
**Effective lumen output: 549 lm**

<b>MATERIALS</b>	Polycarbonate lens, aluminum housing
<b>VOLT/AMP</b>	12.8VDC - 0.91A, 24.0VDC - 0.42A
<b>WT/DIMS</b>	0.37 lbs. / 2" x 3" x 2.5"
<b>WARRANTY</b>	Lifetime LED Warranty



TLL52FWB

TLL52FB



TLL152FSL

## TLL52 SERIES Opti-Brite™ LED Work Light

- Heavy duty design with powder coated, die cast aluminum housing and polycarbonate lens
- Compact design – only 2.75 inches square
- Dual power: use with 12VDC and 24VDC systems
- Stainless steel mounting hardware
- 14-gauge, 10" lead and ground wire; IP69K rating

BULK P/N	POLYPACK P/N	DESCRIPTION	QTY
----------	--------------	-------------	-----

### FLOOD BEAM - 3 DIODES

TLL52FB	TLL52FBP	Flood beam, black housing	10
TLL52FWB	TLL52FWBP	Flood beam, white housing	10

### RETAIL

TLL152FSL		Flood beam, window box	1
-----------	--	------------------------	---

**Raw lumen output: 600 lm**  
**Effective lumen output: 325 lm**

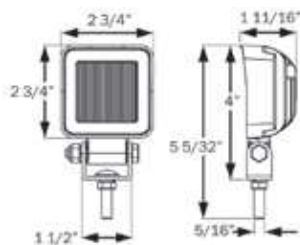

<b>MATERIALS</b>	Polycarbonate lens and housing, stainless steel hardware
<b>VOLT/AMP</b>	12.8VDC - 1.50A, 24.0VDC - 0.73A
<b>WT/DIMS</b>	.38 lbs. / 2.75" x 5.171" x 1.687"
<b>WARRANTY</b>	Lifetime LED Warranty

## TLL52 ABS SERIES Opti-Brite™ LED Work Light

- Corrosion proof housing and polycarbonate lens
- Compact design – only 2 inches square
- Dual power: use with 12VDC and 24VDC systems
- Stainless steel mounting hardware
- 14-gauge, 10" lead and ground wire; IP69K rating

BULK P/N	POLYPACK P/N	DESCRIPTION	QTY
<b>FLOOD BEAM - 3 DIODES</b>			
TLL52FPBB	TLL52FPBBP	Flood beam, blue housing	10
<b>Raw lumen output: 550 lm</b>			
<b>Effective lumen output: 389 lm</b>			

<b>MATERIALS</b>	Polycarbonate lens, nylon housing
<b>VOLT/AMP</b>	12.8VDC - .06A, 24.0VDC - 0.3A
<b>WT/DIMS</b>	0.37 lbs. / 2" x 3" x 2.5"
<b>WARRANTY</b>	Lifetime LED Warranty

Opti-Brite



TLL52FPBB

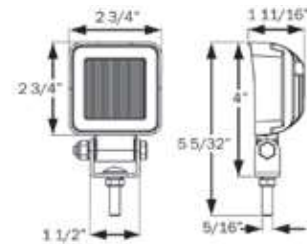

## TLL54 SERIES Opti-Brite™ LED Work Light

- Heavy duty design with powder coated, die cast aluminum housing and polycarbonate lens
- Low profile design – less than 2.5 inches deep
- Dual power: use with 12VDC and 24VDC systems
- Stainless steel mounting hardware
- 14-gauge, 10" lead and ground wire; IP69K rating

BULK P/N	POLYPACK P/N	DESCRIPTION	QTY
<b>SPOT BEAM - 9 DIODES</b>			
TLL54TB	TLL54TBP	Spot beam	5
<b>Raw lumen output: 1800 lm</b>			
<b>Effective lumen output: 900 lm</b>			

<b>MATERIALS</b>	Polycarbonate lens, aluminum housing
<b>VOLT/AMP</b>	12.8VDC - 1.50A, 24.0VDC - 0.73A
<b>WT/DIMS</b>	1.51 lbs. / 5" x 7" x 2.375"
<b>WARRANTY</b>	Lifetime LED Warranty

Opti-Brite



TLL54TB

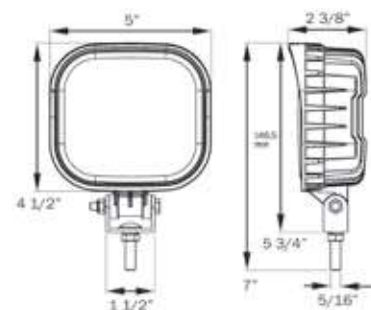

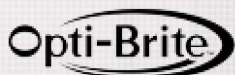

TLL55FB

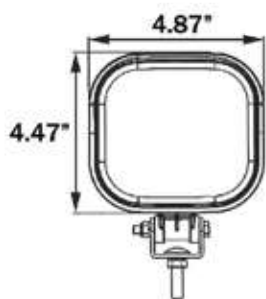

## TLL55 SERIES Opti-Brite™ LED Work Light

- Contoured lens for wide angle beam
- Die cast aluminum housing with powder coat finish
- Stainless steel hardware
- 14-gauge, 10" lead and ground wire; IP69K rating

BULK P/N	POLYPACK P/N	DESCRIPTION	QTY
<b>FLOOD BEAM - 9 DIODES</b>			
TLL55FB	TLL55FBP	Flood beam	1
<b>Raw lumen output: 2160 lm</b>			
<b>Effective lumen output: 1512 lm</b>			

<b>MATERIALS</b>	Polycarbonate lens, aluminum housing
<b>VOLT/AMP</b>	12.8VDC - 1.50A, 24.0VDC - 0.73A
<b>WT/DIMS</b>	1.35 lbs. / 4.87" x 6.90" x 2.03"
<b>WARRANTY</b>	Lifetime LED Warranty



TLL56FB

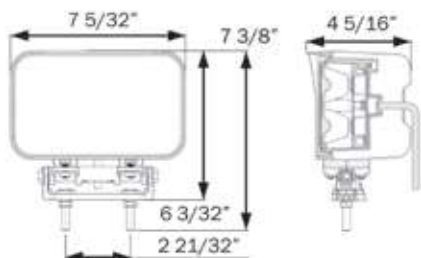

## TLL56/57 SERIES Opti-Brite™ LED Work Lights

- Heavy duty design with powder coated, die cast aluminum housing and polycarbonate lens
- Effective lumen output 4000 lumens
- Dual power: use with 12VDC and 24VDC systems
- Stainless steel mounting hardware
- 16-gauge, 20" lead and ground wire; IP69K rating

BULK P/N	POLYPACK P/N	DESCRIPTION	QTY
<b>FLOOD BEAM - 8 DIODES</b>			
TLL56FB	TLL56FBP	Flood beam	2
TLL57FB	TLL57FBP	Flood beam, shock mount	2
<b>Raw lumen output: 5600 lm</b>			
<b>Effective lumen output: 4000 lm</b>			

<b>MATERIALS</b>	Polycarbonate lens, aluminum housing
<b>VOLT/AMP</b>	12.8VDC - 5.0A, 24.0VDC - 2.5A
<b>WT/DIMS</b>	3.53 lbs. / 7.161" x 9" x 4.313"
<b>WARRANTY</b>	Lifetime LED Warranty



## TLL60 SERIES Opti-Brite™ LED Work Light

- Heavy duty design with powder coated, die cast aluminum housing and polycarbonate lens
- Rectangular design – 6 inches wide by 2 inches high
- Dual power: use with 12VDC and 24VDC systems
- Stainless steel mounting hardware
- 14-gauge, 10" lead and ground wire; IP69K rating

BULK P/N	POLYPACK P/N	DESCRIPTION	QTY
<b>FLOOD BEAM - 6 DIODES</b>			
TLL60FB	TLL60FBP	Flood beam	5
<b>Raw lumen output: 1200 lm</b>			
<b>Effective lumen output: 720 lm</b>			
<b>MATERIALS</b>	Polycarbonate lens, aluminum housing		
<b>VOLT/AMP</b>	12.8VDC - 1.1A, 24.0VDC - 0.48A		
<b>WT/DIMS</b>	0.95 lbs. / 6" x 4.5" x 2.4"		
<b>WARRANTY</b>	Lifetime LED Warranty		



TLL60FB

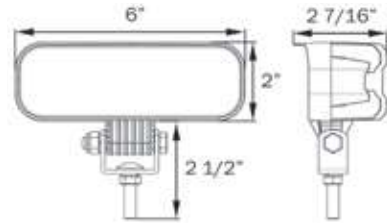

## TLL64 SERIES Opti-Brite™ LED Work Light

- Heavy duty design with powder coated, die cast aluminum housing and polycarbonate lens
- Ultrabright output in standard size light – 1939 lumens
- Dual power: use with 12VDC and 24VDC systems
- Stainless steel mounting hardware
- 14-gauge, 10" lead and ground wire; IP69K rating

BULK P/N	POLYPACK P/N	DESCRIPTION	QTY
<b>FLOOD BEAM - 4 DIODES</b>			
TLL64FB	TLL64FBP	Flood beam	2
<b>Raw lumen output: 3200 lm</b>			
<b>Effective lumen output: 1939 lm</b>			
<b>MATERIALS</b>	Polycarbonate lens, aluminum housing		
<b>VOLT/AMP</b>	12.8VDC - 3.16A, 24.0VDC - 1.41A		
<b>WT/DIMS</b>	1.41 lbs. / 4.187" x 6.5" x 3"		
<b>WARRANTY</b>	Lifetime LED Warranty		



TLL64FB

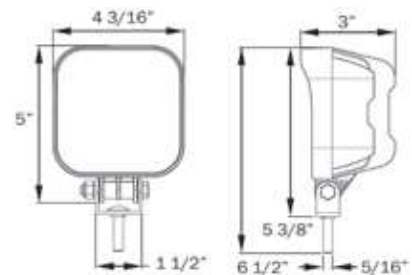





TLL70FB

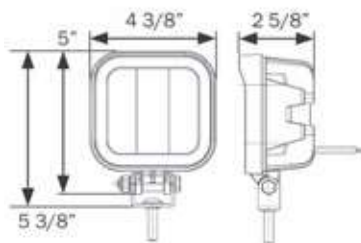

## TLL70 SERIES Opti-Brite™ LED Work Light

- Contoured lens for wide angle beam
- Heavy duty design with powder coated, die cast aluminum housing and polycarbonate lens
- Ultrabright output in standard size light – 2500 lumens
- Dual power: use with 12VDC and 24VDC systems
- Stainless steel mounting hardware
- 14-gauge, 10" lead and ground wire; IP69K rating

BULK P/N	POLYPACK P/N	DESCRIPTION	QTY
<b>FLOOD BEAM - 6 DIODES</b>			
TLL70FB	TLL70FBP	Flood beam	2

**Raw lumen output: 3950 lm**  
**Effective lumen output: 2500 lm**

<b>MATERIALS</b>	Polycarbonate lens, aluminum housing
<b>VOLT/AMP</b>	12.8VDC - 2.8A, 24.0VDC - 1.43A
<b>WT/DIMS</b>	1.41 lbs. / 5" x 4.375" x 2.625"
<b>WARRANTY</b>	Lifetime LED Warranty



TLL71FB

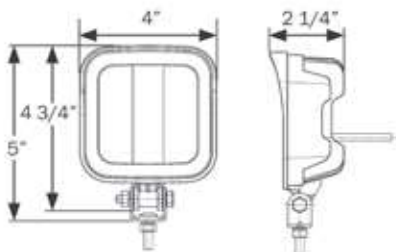

## TLL71 SERIES Opti-Brite™ LED Work Light

- Contoured lens for wide angle beam
- Heavy duty design with powder coated, die cast aluminum housing and polycarbonate lens
- Dual power: use with 12VDC and 24VDC systems
- Stainless steel mounting hardware
- 14-gauge, 10" lead and ground wire; IP69K rating

BULK P/N	POLYPACK P/N	DESCRIPTION	QTY
<b>FLOOD BEAM - 9 DIODES</b>			
TLL71FB	TLL71FBP	Flood beam	2

**Raw lumen output: 1560 lm**  
**Effective lumen output: 938 lm**

<b>MATERIALS</b>	Polycarbonate lens, aluminum housing
<b>VOLT/AMP</b>	12.8VDC - 1.43A, 24.0VDC - 0.66A
<b>WT/DIMS</b>	1.41 lbs. / 4.75" x 4" x 2.25"
<b>WARRANTY</b>	Lifetime LED Warranty

## TLL72 SERIES Opti-Brite™ LED Work Light

- Contoured lens for wide angle beam
- Heavy duty design with powder coated, die cast aluminum housing and polycarbonate lens
- Dual power: use with 12VDC and 24VDC systems
- Stainless steel mounting hardware
- 14-gauge, 10" lead and ground wire; IP69K rating



TLL72FB

BULK P/N	POLYPACK P/N	DESCRIPTION	QTY
<b>FLOOD BEAM - 9 DIODES</b>			
TLL72FB	TLL72FBP	Flood beam	2

**Raw lumen output:** 1610 lm  
**Effective lumen output:** 980 lm

<b>MATERIALS</b>	Polycarbonate lens, aluminum housing
<b>VOLT/AMP</b>	12.8VDC - 1.48A, 24.0VDC - 0.7A
<b>WT/DIMS</b>	1.5 lbs. / 5.375" x 5" x 2.25"
<b>WARRANTY</b>	Lifetime LED Warranty

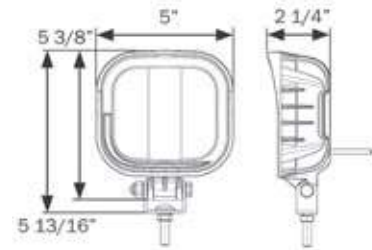

## TLL73 SERIES Opti-Brite™ LED Work Light

- Heavy duty design with powder coated, die cast aluminum housing and polycarbonate lens
- Dual power: use with 12VDC and 24VDC systems
- Stainless steel mounting hardware; built in handle
- 14-gauge, 10" lead and ground wire; IP69K rating



TLL73FB

BULK P/N	POLYPACK P/N	DESCRIPTION	QTY
<b>FLOOD BEAM - 9 DIODES</b>			
TLL73FB	TLL73FBP	Flood beam	2

**Raw lumen output:** 1610 lm  
**Effective lumen output:** 980 lm

<b>MATERIALS</b>	Polycarbonate lens, aluminum housing
<b>VOLT/AMP</b>	12.8VDC - 1.48A, 24.0VDC - 0.7A
<b>WT/DIMS</b>	1.61 lbs. / 7.5" x 5" x 3.25"
<b>WARRANTY</b>	Lifetime LED Warranty

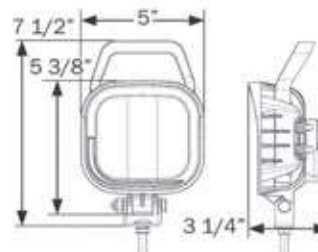



## TLL80 SERIES Opti-Brite™ LED Mini Flood Light



TLL80FB

- Coated die cast aluminum housing, polycarbonate lens
- Compact design – only 3 inches wide by 2 inches high
- Bright white SMD diodes for bright, dependable light

BULK P/N	POLYPACK P/N	DESCRIPTION	QTY
<b>FLOOD BEAM - 6 DIODES</b>			
TLL80FB	TLL80FBP	Flood beam, black housing	5
TLL80WFB	TLL80WFBP	Flood beam, white housing	5

Raw lumen output: 270 lm

Effective lumen output: 150 lm

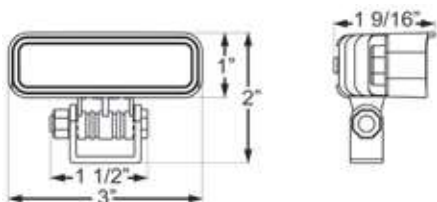

<b>MATERIALS</b>	Polycarbonate lens, aluminum housing
<b>VOLT/AMP</b>	12.8VDC - .19A
<b>WT/DIMS</b>	.7 lbs. / 3" x 2" x 1.563"
<b>WARRANTY</b>	Lifetime LED Warranty



## DLL25/50 SERIES LED Docking/Utility Lights

DLL50CB



DLL50WC

- Wide, low beam ideal for docking or loading applications
- Die cast aluminum housing coated for protection against corrosion and UV exposure; durable polycarbonate lens
- Sealed lens, gasket at wire entry; IP44 rating
- Dual power: use with 12VDC and 24VDC systems
- Stainless steel mounting hardware
- 20-gauge lead and ground wire with tinned ends

BULK P/N	POLYPACK P/N	DESCRIPTION	QTY
<b>DOCKING/UTILITY LIGHTS - 2 DIODES</b>			
DLL50CB	DLL50CBP	Black housing	10
<b>RETAIL</b>			
TLL25FS		Black housing, clam	3
DLL50CC		Pair of lights, black housing, box	3
DLL50WC		Pair of lights, white housing, box	3

Raw lumen output: 440 lm  
Effective lumen output: 396 lm

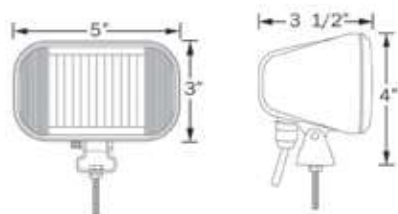

<b>MATERIALS</b>	Polycarbonate lens, aluminum housing
<b>VOLT/AMP</b>	12.8/24.0VDC - 0.683A
<b>WT/DIMS</b>	DLL50CB: 1.23 lbs. / 5" x 4" x 3.5" DLL50CC/WC: 3.00 lbs. / 5" x 4" x 3.5"
<b>WARRANTY</b>	Lifetime LED Warranty



## ST45 SERIES 4" Round Sealed Lights

- Sonically sealed, waterproof
- Shock-proof socket guarantees long bulb life
- Accepts standard PL-3 plug
- Kits include grommet and plug



ST45RB



ST45AB



ST46RB

SEALED STOP/TURN/TAILO  
PARKING/TURN SIGNALS

BULK P/N	POLYPACK P/N	DESCRIPTION	QTY
<b>RED STOP/TURN/TAILO LIGHTS</b>			
ST45RB	ST45RBP	Light with PL-3 connection	50
ST44RB	ST44RBP	Kit: ST45RB, A45GB & A45PB	10
ST45RGB	ST45RGBP	Light with male pin connection	50
ST46RB	ST46RBP	Light with reflex lens, PL-3 connection	50
<b>YELLOW PARKING/TURN SIGNALS</b>			
ST45AB	ST45ABP	Light	50
ST44AB	ST44ABP	Kit: ST45AB, A45GB & A45PB	10
<b>ACCESSORIES</b>			
A45GB	A45GBP	Grommet	50
A45PB	A45PBP	Pigtail, 3-wire	100
A47PB	A47PBP	Right angle pigtail, 3-wire	100
BK45BB	BK45BBP	Black steel bracket	10
<b>RETAIL</b>			
ST45RK		Kit: ST45RB, A45GB & A45PB, clam	6
ST45RS		Light only, clam	6

<b>FMVSS</b>	ST45RB: S T I P 2 ST45AB: I P P 2 ST46RB: S T I P 2 A
<b>MATERIALS</b>	Polycarbonate lens and housing
<b>VOLT/AMP</b>	12.8VDC - 2.4A Stop/Turn, 0.49A Tail/Parking
<b>WT/DIMS</b>	ST45/46: .221 lbs. / 4.25" x 4.25" x 2.063"
<b>WARRANTY</b>	Three Year Warranty



ST45RGB male pin connection detail

HOLE CUT-OUT: 4.5"

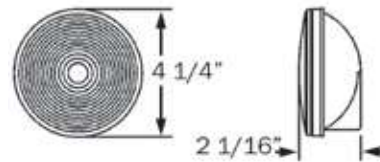

ST45AB/RB & 46RB





## ST47 Series

### 4" Flange Mount Stop/Turn/Tail Light

**PATENTED TECHNOLOGY**

- Sonically sealed, waterproof
- ST47RLB includes locking connection designed to retain straight PL-3 plugs found on existing wire harnesses
- Shock-proof socket guarantees long bulb life



ST47RB



ST47RLB

SEALED STOP/TURN/TAILO  
PARKING/TURN SIGNALS

BULK P/N	POLYPACK P/N	DESCRIPTION	QTY
<b>RED STOP/TURN/TAIL LIGHT</b>			
ST47RB	ST47RBP	Flange mount, PL-3 connection, gray	50
ST47RKB	ST47RKBP	Kit: ST47RB & A45PB	10
ST47RLB	ST47RLBP	Flange mount, locking PL-3 connection, black	50

<b>FMVSS</b>	S T I P 2
<b>MATERIALS</b>	Polycarbonate lens and housing
<b>VOLT/AMP</b>	12.8VDC - 2.4A Stop/Turn, .49A Tail
<b>WT/DIMS</b>	.617 lbs. / 5.50" x 5.50" x 2"
<b>WARRANTY</b>	Three Year Warranty

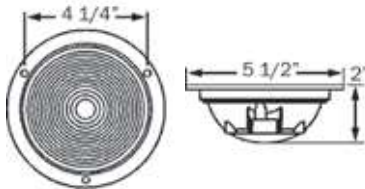

HOLE CUT-OUT: 4.5"



Locking Connection

## ST70/75 SERIES 6" Oval Sealed Lights

- Sonically sealed, waterproof
- Shock-proof socket guarantees long bulb life
- Accepts standard PL-3 plug
- Kits include grommet and plug

BULK P/N	POLYPACK P/N	DESCRIPTION	QTY
<b>RED STOP/TURN/TAIL LIGHTS</b>			
ST70RB	ST70RBP	Light	50
ST74RB	ST74RBP	Kit: ST70RB, A70GB & A45PB	50
ST70RBTK	ST70RBTKP	ST70RB light sealed to bracket	30
ST64RB	ST64RBP	Kit: ST70RB, A70GB & A47PB (plug attached to light)	50
ST65RB	ST65RBP	Kit: ST70RB, A70GB & A47PB	50
<b>YELLOW SIGNAL LIGHTS</b>			
ST70AB	ST70ABP	Parking/turn signal	50
ST74AB	ST74ABP	Kit: ST70AB, A70GB & A45PB	50
ST75AB	ST75ABP	Mid-ship turn signal/side marker	50
ST77AB	ST77ABP	Kit: ST75AB, A70GB & A45PB	50
<b>ACCESSORIES</b>			
A70GB	A70GBP	Grommet	50
A45PB	A45PBP	Pigtail, 3-wire	100
A47PB	A47PBP	Right angle pigtail, 3-wire	100
BK70BB	BK70BBP	Black steel bracket	10
<b>RETAIL</b>			
ST70RK		Kit: ST70RB, A70GB & A45PB, clam	6
ST70RS		Light only, clam	6

<b>FMVSS</b>	ST70RB: S T I P 2 ST70AB: I P P 2 ST75AB: E P 2 A
<b>MATERIALS</b>	Polycarbonate lens and housing
<b>VOLT/AMP</b>	12.8VDC - 2.4A Stop/Turn, 0.50A Tail/Parking
<b>WT/DIMS</b>	ST70: .265 lb. / 6.5" x 2.313" x 2.375" ST75: .221 lbs. / 6.5" x 2.313" x 2.75"
<b>WARRANTY</b>	Three Year Warranty

**optronics**



ST70RB



ST70RBTK



ST70AB



ST75AB

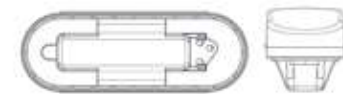
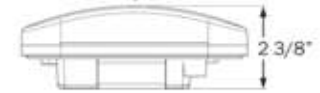

ST70

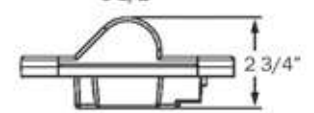
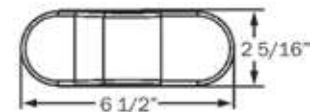

ST75AB

HOLE CUT-OUT: 6.85" X 2.5" (1.25" R)

SEALED STOP/TURN/TAIL & PARKING/TURN SIGNALS



## ST33 SERIES Rectangular Sealed Lights

- Sonically sealed, waterproof
- Shock-proof socket guarantees long bulb life
- Accepts standard PL-3 plug
- Kits include grommet and plug



ST33RB



ST33AB

SEALED STOP/TURN/TAILO  
PARKING/TURN SIGNALS

BULK P/N	POLYPACK P/N	DESCRIPTION	QTY
<b>RED STOP/TURN/TAILO LIGHTS</b>			
ST33RB	ST33RBP	Light	10
ST34RB	ST34RBP	Kit: ST33RB, A33GB & A47PB	50
<b>YELLOW PARKING/TURN LIGHTS</b>			
ST33AB	ST33ABP	Light	10
<b>ACCESSORIES</b>			
A33GB	A33GBP	Grommet	50
A45PB	A45PBP	Pigtail, 3-wire	100
A47PB	A47PBP	Right angle pigtail, 3-wire	100

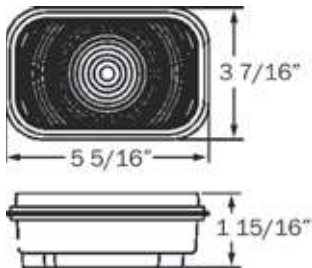

HOLE CUT-OUT: 5.453" X 3.578" (1" R)

<b>FMVSS</b>	ST33RB: S T I P 2 ST33AB: I P P 2
<b>MATERIALS</b>	Polycarbonate lens and housing
<b>VOLT/AMP</b>	12.8VDC - 2.19A Stop/Turn, 0.49A Tail/Parking
<b>WT/DIMS</b>	.265 lb. / 5.313" x 3.438" x 1.938"
<b>WARRANTY</b>	Three Year Warranty

## ST40/42 SERIES Flush Mount Stop/Turn/Tail Lights



- Flush mount with acrylic lens, steel housing, gasket
- Replaceable lens and bulb
- Shock-proof socket guarantees long bulb life
- Hard wired



ST40RB



A42GB

BULK P/N	POLYPACK P/N	DESCRIPTION	QTY
<b>RED STOP/TURN/TAIL LIGHTS</b>			
ST40RB	ST40RBP	Light, self grounding	50
ST42RB	ST42RBP	Light with reflex, ground wire	50
ST42RPG	ST42RPGP	Light with reflex, ground wire, .180 male bullets	50
<b>ACCESSORIES</b>			
A40SRB	A40SRBP	Snap-in lens retention ring	100
A40RB	A40RBP	Red lens	25
A42GB	A42GBP	Gasket for flange	100
A43RB	A43RB	Red lens with reflex	25
A2057B	A2057BP	2057 bulb	50
<b>RETAIL</b>			
ST40RS		Light, clam	6

COMBINATION  
TAIL LIGHTS & KITS

<b>FMVSS</b>	ST40: S T I ST42: A I S T
<b>MATERIALS</b>	Acrylic lens, steel housing
<b>VOLT/AMP</b>	12.8VDC - 2.4A Stop/Turn, 0.49A Tail/Parking
<b>WT/DIMS</b>	.221 lbs. / 5.375" x 5.375" x 1.563"
<b>WARRANTY</b>	Three Year Warranty

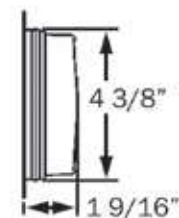
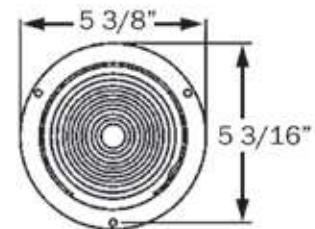

HOLE CUT-OUT: 4.5"





## ST90 SERIES 7" Transit Lights for Surface Mount

- Screw-on lens, easy to change bulb
- Surface mount on 6-1/4" centers
- Grounds through mounting hardware
- Acrylic lens, steel base plate

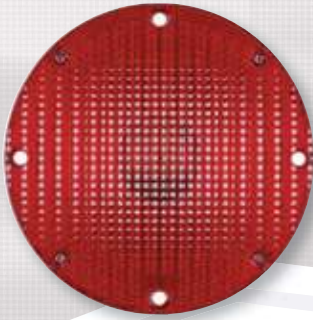

ST90RB

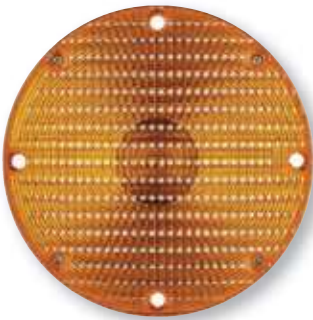

ST90AB

COMBINATION  
TAIL LIGHTS & KITS

BULK P/N	POLYPACK P/N	DESCRIPTION	QTY
<b>RED STOP/TAIL LIGHTS</b>			
ST90RB	ST90RBP	Light, 1157 bulb	5
<b>YELLOW TURN SIGNAL</b>			
ST90AB	ST90ABP	Light, 1156 bulb	5
<b>ACCESSORIES</b>			
A90RB	A90RBP	Red lens	5
A90AB	A90ABP	Yellow lens	5
A1157B	A1157BP	1157 replacement bulb	50
A1156B	A1156BP	1156 replacement bulb	50

<b>FMVSS</b>	Red: S T I, Yellow: I
<b>MATERIALS</b>	Acrylic lens and steel housing
<b>VOLT/AMP</b>	12.8VDC - 2.4A Stop, 0.5A Tail/Parking
<b>WT/DIMS</b>	1.146 lbs. / 7.125" x 7.125" x 2.188"
<b>WARRANTY</b>	Three Year Warranty

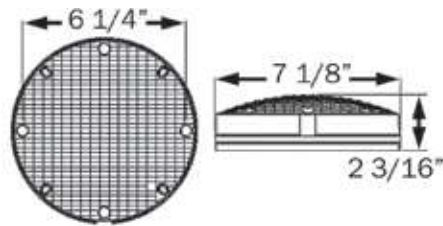

## ST92 SERIES 7" Transit Warning Lights for Surface Mount

- School bus warning lamps
- Screw-on lens, easy to change halogen bulb
- Hard wired, includes lead and ground wire
- Acrylic lens, steel base plate

BULK P/N	POLYPACK P/N	DESCRIPTION	QTY
<b>RED WARNING LIGHT</b>			
ST92RB	ST92RBP	Warning light	5
<b>YELLOW WARNING LIGHT</b>			
ST92AB	ST92ABP	Warning light	5
<b>ACCESSORIES</b>			
A94VB	A94VBP	Black visor	25
<b>RETAIL</b>			
A700		12V H3 55W replacement bulb, clam	12

FMVSS	W W2
MATERIALS	Acrylic lens and steel housing
VOLT/AMP	12.8VDC - 4.6A
WT/DIMS	1.146 lbs. / 7.063" x 7.063" x 2.25"
WARRANTY	Three Year Warranty

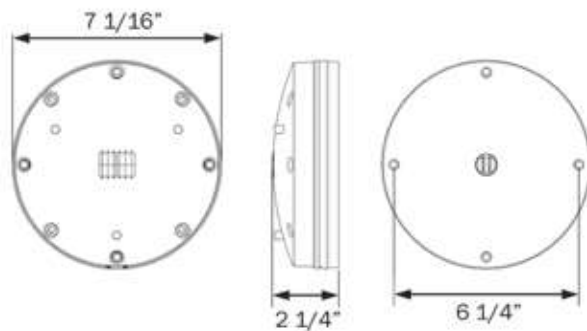

**optronics**



ST92RB



ST92AB



A94VB

COMBINATION  
TAIL LIGHTS & KITS



## ST51/52/53 SERIES Pedestal Mount Lights

- Snap-on lens, easy to change bulb
- ST51/52 mount with single post and are self grounding; ST53 with dual post mounts on 2" centers and includes ground wire



ST51RB



ST52AA



ST52RB



ST53AAB

BULK P/N	POLYPACK P/N	DESCRIPTION	QTY
<b>RED - SINGLE FACE</b>			
ST51RB	ST51RBP	Red, single face	10
<b>YELLOW - DUAL FACE</b>			
-	ST52AAP	Yellow, dual face	10
ST53AAB	ST53AABP	Square, yellow dual face with side marker/reflex, 1156 bulb	10
<b>RED/YELLOW DUAL FACE</b>			
ST52RB	ST52RBP	Dual face yellow/red stop/turn/tail light	10
<b>ACCESSORIES</b>			
A52RB	A52RBP	Red lens, round	25
A52AB	A52ABP	Yellow lens, round	25
A2057B	A2057BP	2057 replacement bulb	50
<b>RETAIL</b>			
ST51RS		Red stop/turn/tail light, clam	6
ST52AA		Dual yellow/yellow parking/turn, clam	6
ST52RA		Dual yellow/red stop/turn/tail light, clam	6

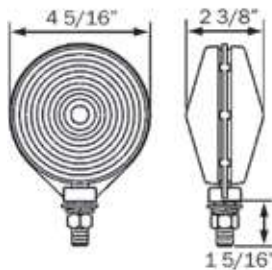

ST51/52

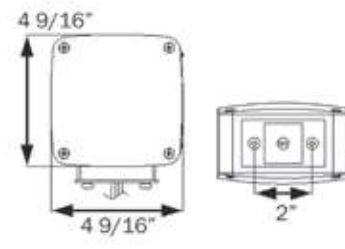

ST53AAB

COMBINATION  
TAIL LIGHTS & KITS



## ST24/25 SERIES Stud Mount Stop/Turn/Tail Lights

- Snap-on lens, easy to change bulb
- Stud mount on 2" centers
- Grounds through mounting hardware
- Acrylic lens, corrosion proof plastic housing
- Driver side light includes license illuminator

BULK P/N	POLYPACK P/N	DESCRIPTION	QTY
<b>STOP/TURN/TAIL LIGHTS</b>			
ST24RB	ST24RBP	Passenger side light	50
ST25RB	ST25RBP	Driver side light with license illuminator	50
<b>ACCESSORIES</b>			
A24RB	A24RBP	Red lens	25
A2057B	A2057BP	2057 replacement bulb	50

<b>FMVSS</b>	ST24RB: S T I P, ST25RB: S T I P L
<b>MATERIALS</b>	Acrylic lens and plastic housing
<b>VOLT/AMP</b>	12.8VDC - 2.5A Stop/Turn, 1.0A Tail
<b>WT/DIMS</b>	.309 lb. / 4.313" x 4.313" x 3.375"
<b>WARRANTY</b>	Three Year Warranty

**optronics**

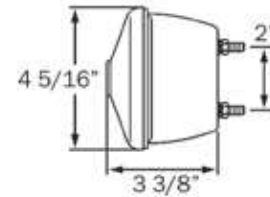

COMBINATION  
TAIL LIGHTS & KITS

## ST20/21 SERIES Surface Mount Stop/Turn/Tail Lights

- Screw-on lens, easy to change bulb
- Surface mount on 2" centers
- Grounds through mounting hardware
- Acrylic lens, steel housing
- Driver side light includes license illuminator

BULK P/N	POLYPACK P/N	DESCRIPTION	QTY
<b>RETAIL</b>			
ST20RS		Passenger side, clam	6
ST21RS		Driver side, clam	6
A20R		Red lens, slipover blister	12
<b>ACCESSORIES</b>			
A1157B	A1157BP	1157 replacement bulb	50

<b>FMVSS</b>	ST20RS: S T I, ST21RS: S T I L
<b>MATERIALS</b>	Acrylic lens and steel housing
<b>VOLT/AMP</b>	12.8VDC - 2.3A Stop/Turn, 0.90A Tail
<b>WT/DIMS</b>	.551 lb. / 3.875" x 3.875" x 3.063"
<b>WARRANTY</b>	Three Year Warranty

**optronics**

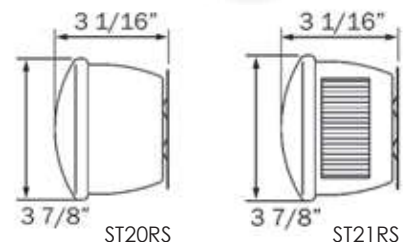



## ST8/9 SERIES Universal Mount Combination Tail Lights



ST9RB





ST8RB

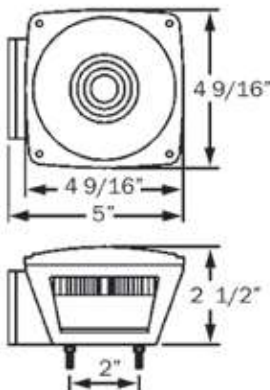

TL8RK



- Screw-on lens, easy to change bulbs
- Stud mount on 2" centers
- Grounds through mounting studs
- Shock-proof socket guarantees long bulb life
- Acrylic lens, corrosion proof plastic housing
- Passenger side light is 6-function: stop, turn, tail, rear reflex, side marker, and side reflex
- Driver side light also includes license illuminator
- Bulk models are designed with Plug-n-go connections for quick connect wiring
- Retail models are hard wired, self grounding

BULK P/N	POLYPACK P/N	DESCRIPTION	QTY
<b>STOP/TURN/TAIL LIGHTS</b>			
ST8RB	ST8RBP	Passenger side light	50
ST9RB	ST9RBP	Driver side light with license illuminator	50
ST8RHB	-	Passenger side light, hard wired	50
ST9RHB	-	Driver side light, hard wired	50
TL27BK	-	Kit: ST8RB, ST9RB, (2) MC36AB amber marker lights with reflex, LP10SB license plate bracket; 20-ft harness, box	1
TL29BK	-	Kit: ST8RB, ST9RB, (2) MC36AB amber marker lights with reflex, LP10SB license plate bracket; 25-ft harness, box	1
<b>ACCESSORIES</b>			
A8RB	A8RBP	Tail light lens	50
A9RB	A9RBP	Side marker light lens	50
A1157B	A1157BP	1157 replacement bulb	50
<b>RETAIL</b>			
ST8RS		Passenger side light, clam	6
ST9RS		Driver side with license illuminator, clam	6
TL8RK		Kit: ST8RB, ST9RB, license plate bracket, 20-ft harness, mounting hardware, clam	2
A8RK		Tail and side marker lens set, clam	12
A8R		Tail light lens, clam	12
A9R		Side marker light lens, clam	12
<b>FMVSS</b>	ST8RB: A S T, A P2, ST9RB: A S T, A P2, L		
<b>MATERIALS</b>	Acrylic lens and plastic housing		
<b>VOLT/AMP</b>	12.8VDC - 2.5A Stop/Turn, 1.0A Tail		
<b>WT/DIMS</b>	.309 lb. / 4.563" x 4.563" x 2.875"		
<b>WARRANTY</b>	Three Year Warranty		

COMBINATION  
TAIL LIGHTS & KITS

## ST6/7 SERIES

### Submersible Universal Mount Combination Tail Lights

- Submersible design suitable for many applications
- Screw-on lens, easy to change bulbs
- Stud mount on 2" centers
- Grounds through mounting studs
- Shock-proof socket guarantees long bulb life
- Acrylic lens, corrosion proof plastic housing
- Passenger side light is 6-function: stop, turn, tail, rear reflex, side marker, and side reflex
- Driver side light also includes license illuminator



ST7RB



ST6RB



TL5RK



BULK P/N	POLYPACK P/N	DESCRIPTION	QTY
<b>STOP/TURN/TAIL LIGHTS</b>			
ST6RB	ST6RBP	Passenger side light	50
ST7RB	ST7RBP	Driver side light with license illuminator	50
ST6RPG	ST6RPGP	Passenger side light, 2-way plug	50
ST7RPG	ST7RPGP	Driver side light with license illuminator, 2-way plug	50
<b>ACCESSORIES</b>			
A8RB	A8RBP	Tail light lens	50
A9RB	A9RBP	Side marker light lens	25
A1157B	A1157BP	1157 replacement bulb	50
<b>RETAIL</b>			
ST6RS		Passenger side light, clam	6
ST7RS		Driver side with license illuminator, clam	6
TL5RK		Deluxe kit: ST6RB, ST7RB, (2) MC36AB amber marker lights with reflex, LP10SB license plate bracket, 25-ft harness, mounting hardware, clam	2
TL9RK		Kit: ST6RB, ST7RB, LP10SB license plate bracket, 25-ft harness, mounting hardware, clam	2
A8RK		Tail and side marker lens set, clam	12
A8R		Tail light lens, clam	12
A9R		Side marker light lens, clam	12
<b>FMVSS</b>	ST6RB: A S T, A P2, ST7RB: A S T, A P2, L		
<b>MATERIALS</b>	Acrylic lens and plastic housing		
<b>VOLT/AMP</b>	12.8VDC - 2.5A Stop/Turn, 1.0A Tail		
<b>WT/DIMS</b>	.309 lb. / 4.563" x 4.563" x 2.875"		
<b>WARRANTY</b>	Three Year Warranty		

COMBINATION TAIL LIGHTS & KITS

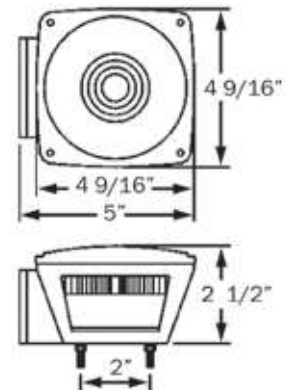





## ST2/3 SERIES

### Universal Mount Combination Tail Lights for Over 80" Applications



ST3RB



ST2RB

- Screw-on lens, easy to change bulbs
- Stud mount on 2" centers
- Grounds through mounting studs
- Shock-proof socket guarantees long bulb life
- Acrylic lens, corrosion proof plastic housing
- Passenger side light is 7-function: stop, turn, tail, rear clearance, rear reflex, side marker, and side reflex
- Driver side light also includes license illuminator
- Designed with Plug-n-go connections for quick connect wiring

COMBINATION  
TAIL LIGHTS & KITS

BULK P/N	POLYPACK P/N	DESCRIPTION	QTY
<b>STOP/TURN/TAIL LIGHTS</b>			
ST2RB	ST2RBP	Passenger side light	50
ST3RB	ST3RBP	Driver side light with license illuminator	50
<b>ACCESSORIES</b>			
A8RB	A8RBP	Tail light lens	50
A2RB	A2RBP	Side marker light lens	25
A1157B	A1157BP	1157 replacement bulb	50

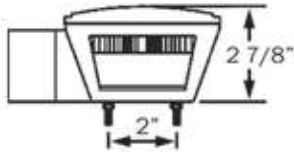
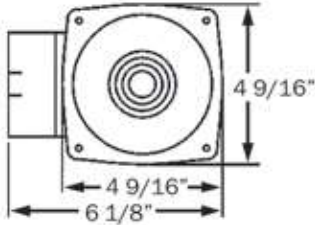

<b>FMVSS</b>	ST2RB: S T I A, P2 PC A, ST3RB: S T I A, P2 PC A, L
<b>MATERIALS</b>	Acrylic lens and plastic housing
<b>VOLT/AMP</b>	12.8VDC - 2.5A Stop/Turn, 1.0A Tail
<b>WT/DIMS</b>	.441 lb. / 6.125" x 4.563" x 2.875"
<b>WARRANTY</b>	Three Year Warranty



## ST4/5 SERIES

### Submersible Universal Mount Combination Tail Lights for Over 80" Applications

- Submersible design suitable for many applications
- Screw-on lens, easy to change bulbs
- Stud mount on 2" centers
- Grounds through mounting studs
- Shock-proof socket guarantees long bulb life
- Acrylic lens, corrosion proof plastic housing
- Passenger side light is 7-function: stop, turn, tail, rear clearance, rear reflex, side marker, and side reflex
- Driver side light also includes license illuminator

**optronics**



ST5RB



ST4RB

BULK P/N	POLYPACK P/N	DESCRIPTION	QTY
<b>STOP/TURN/TAIL LIGHTS</b>			
ST4RB	ST4RBP	Passenger side light	50
ST5RB	ST5RBP	Driver side light with license illuminator	50
<b>ACCESSORIES</b>			
A8RB	A8RBP	Tail light lens	50
A2RB	A2RBP	Side marker light lens	25
A1157B	A1157BP	1157 replacement bulb	50
<b>RETAIL</b>			
ST4RS		Passenger side light, clam	6
ST5RS		Driver side with license illuminator, clam	6
TL60RK		Set: ST4RB, ST5RB, mounting hardware, clam	2
A8R		Tail light lens, clam	12

<b>FMVSS</b>	ST6RB: S T I A, A P2, ST7RB: S T I A, A P2, L
<b>MATERIALS</b>	Acrylic lens and plastic housing
<b>VOLT/AMP</b>	12.8VDC - 2.5A Stop/Turn, 1.0A Tail
<b>WT/DIMS</b>	.441 lb. / 6.125" x 4.563" x 2.875"
<b>WARRANTY</b>	Three Year Warranty



TL60RK

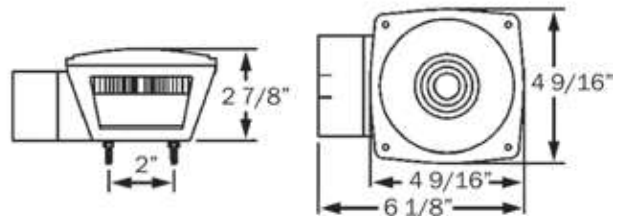

COMBINATION  
TAIL LIGHTS & KITS



## ST16/17 SERIES Waterproof Universal Mount Combination Tail Lights



ST17RB



ST16RB



TL16RK



TL15RK

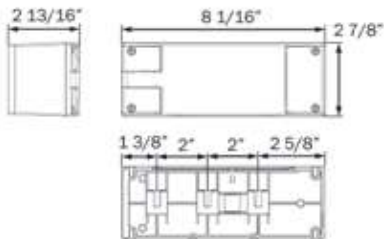

- Waterproof, low profile design for marine applications
- Replaceable lenses and bulbs
- Mount on 2" centers
- Includes separate ground wire with eyelet
- Acrylic lens, corrosion proof plastic housing
- Passenger side light is 7-function: stop, turn, tail, rear clearance, rear reflex, side marker, and side reflex
- Driver side light also includes license illuminator

BULK P/N	POLYPACK P/N	DESCRIPTION	QTY
<b>STOP/TURN/TAIL LIGHTS</b>			
ST16RB	ST16RBP	Passenger side light	20
ST17RB	ST17RBP	Driver side light with license illuminator	20
ST26RPG	ST26RPGP	Passenger side light, self grounding, 2-way plug	20
ST27RPG	ST27RPGP	Driver side light with license illuminator, self grounding, 2-way plug	20
<b>ACCESSORIES</b>			
A16RB	A16RBP	Tail light lens	50
A17RB	A17RBP	Side marker light lens	50
A2057B	A2057BP	2057 replacement bulb	50
<b>RETAIL</b>			
ST16RS		Passenger side light, clam	6
ST17RS		Driver side with license illuminator, clam	6
TL16RK		Deluxe kit: ST16RB, ST17RB, LP10SB license plate bracket, (2) MC91AB yellow marker lights with bases, (2) RE11AB yellow reflectors, 25-ft harness, stainless steel mounting hardware, clam	2
TL15RK		Kit: ST16RB, ST17RB, LP10SB license plate bracket, 25-ft harness, mounting hardware, clam	2
A16R		Tail light lens, clam	12
<b>FMVSS</b>	ST16RB: S T I A P2 PC; ST17RB: S T I A P2 PC, L		
<b>MATERIALS</b>	Acrylic lens and plastic housing		
<b>VOLT/AMP</b>	12.8VDC - 2.3A Stop/Turn, 0.9A Tail		
<b>WT/DIMS</b>	.661 lb. / 8.063" x 2.875" x 2.813"		
<b>WARRANTY</b>	Three Year Warranty		

COMBINATION  
TAIL LIGHTS & KITS

## ST36/37 SERIES Waterproof Universal Mount Combination Tail Lights

- Waterproof, low profile design for marine applications
- Screw-on lens, easy to change bulbs
- Mount on 2" centers
- Includes separate ground wire with eyelet
- Shock-proof socket guarantees long bulb life
- Acrylic lens, corrosion proof plastic housing
- Passenger side light is 7-function: stop, turn, tail, rear clearance, rear reflex, side marker, and side reflex
- Driver side light also includes license illuminator
- Stainless steel mounting hardware



ST37RB



ST36RB



TL36RK

BULK P/N	POLYPACK P/N	DESCRIPTION	QTY
----------	--------------	-------------	-----



### STOP/TURN/TAIL LIGHTS

ST36RB	ST36RBP	Passenger side light	20
ST37RB	ST37RBP	Driver side light with license illuminator	20
ST36RPG	ST36RPGP	Passenger side light, self grounding, 2-way plug	20
ST37RPG	ST37RPGP	Driver side light with license illuminator, self grounding, 2-way plug	20
ST66RPG	ST66RPGP	Passenger side light, 3-way plug	20
ST67RPG	ST67RPGP	Driver side light with license illuminator, 3-way plug	20

### ACCESSORIES

A39RB	A39RBP	Tail light lens	10
A37RB	A37RBP	Side marker light lens	50
A1157B	A1157BP	1157 replacement bulb	50

### RETAIL

ST36RS		Passenger side light, clam	6
ST37RS		Driver side with license illuminator, clam	6
TL36RK		Deluxe kit: ST36RB, ST37RB, LP10SB license plate bracket, (2) MC91AB yellow marker lights with bases, 25-ft harness, stainless steel mounting hardware, clam	2
A36R		Tail and marker light lenses, clam	12

<b>FMVSS</b>	ST36RB: S T I A P2, A P2; ST37RB: S T I A P2, A P2, L
<b>MATERIALS</b>	Acrylic lens and plastic housing
<b>VOLT/AMP</b>	12.8VDC - 2.3A Stop/Turn, 0.9A Tail
<b>WT/DIMS</b>	.992 lb. / 7.875" x 3.25" x 2.875"
<b>WARRANTY</b>	Three Year Warranty

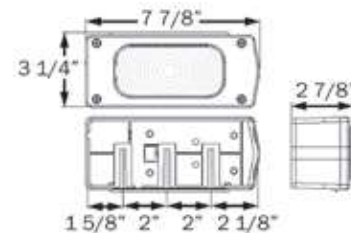

COMBINATION  
TAIL LIGHTS & KITS





## ST56/57 SERIES

### Submersible Universal Mount Combination Tail Lights for Over 80" Applications



ST57RS



ST56RS

- Waterproof design for marine applications
- Shock mount guarantees long bulb life
- Mount on 2" centers
- Includes separate ground wire with eyelet
- Acrylic lens, corrosion proof plastic housing
- Passenger side light is 7-function: stop, turn, tail, rear clearance, rear reflex, side marker, and side reflex
- Driver side light also includes license illuminator
- Stainless steel mounting hardware

COMBINATION  
TAIL LIGHTS & KITS

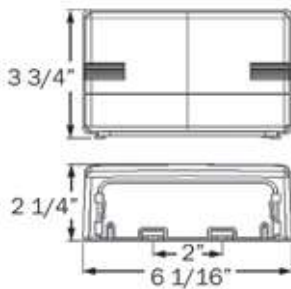

BULK P/N	POLYPACK P/N	DESCRIPTION	QTY
<b>RETAIL</b>			
ST56RS		Passenger side light, clam	6
ST57RS		Driver side with license illuminator, clam	6
<b>ACCESSORIES</b>			
A1157B	A1157BP	1157 replacement bulb	50
A194B	A194BP	194 replacement bulb	100

<b>FMVSS</b>	ST56RB: S2 T2 I6 PC A; ST57RB: S2 T2 I6 PC A, L
<b>MATERIALS</b>	Acrylic lens and plastic housing
<b>VOLT/AMP</b>	12.8VDC - 2.3A Stop/Turn, 0.9A Tail
<b>WT/DIMS</b>	.639 lb. / 6.063" x 3.75" x 2.25"
<b>WARRANTY</b>	Three Year Warranty



## ST60 SERIES

### Universal Mount Combination Tail Lights

- Stud mount stop/turn/tail light with back-up and license illuminator built in
- Screw-on lens, easy to change bulbs
- Grounds through mounting studs
- Shock-proof socket guarantees long bulb life
- Acrylic lens, corrosion proof plastic housing

BULK P/N	POLYPACK P/N	DESCRIPTION	QTY
<b>STOP/TURN/TAIL LIGHTS</b>			
ST60RB	ST60RBP	Combination tail light	20
<b>ACCESSORIES</b>			
A60RB	A60RBP	Tail light lens	25
A2057B	A2057BP	2057 replacement bulb	50
A1156B	A1156BP	1156 replacement bulb	50
<b>RETAIL</b>			
ST60RS		Combination tail light, clam	6
FMVSS	S T A I R		
MATERIALS	Acrylic lens and plastic housing		
VOLT/AMP	12.8VDC - 2.3A Stop/Turn, 0.9A Tail		
WT/DIMS	.992 lb. / 5.75" x 6.625" x 2.813"		
WARRANTY	Three Year Warranty		

**optronics**



ST60RB

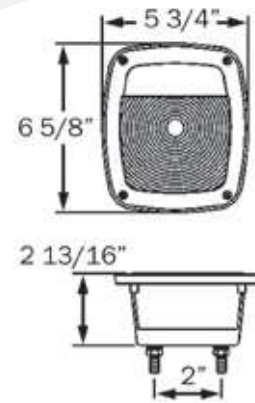

COMBINATION  
TAIL LIGHTS & KITS

## ST31 SERIES

### Weatherproof Surface Mount Light

- Snap-on lens, easy to change bulb
- Surface mount on 3-1/2" centers
- Hard wired, includes lead and ground wire
- Polycarbonate lens, steel base plate

BULK P/N	POLYPACK P/N	DESCRIPTION	QTY
<b>RED STOP/TURN/TAIL LIGHTS</b>			
ST31RB	ST31RBP	Light	50
<b>ACCESSORIES</b>			
A2057B	A2057BP	2057 replacement bulb	50
<b>RETAIL</b>			
ST31RS		Light, clam	12
FMVSS	S T I		
MATERIALS	Polycarbonate lens and steel housing		
VOLT/AMP	12.8VDC - 2.3A Stop/Turn, 0.90A Tail		
WT/DIMS	.309 lb. / 4.563" x 2.5" x 1.75"		
WARRANTY	Three Year Warranty		

**optronics**



ST31RB

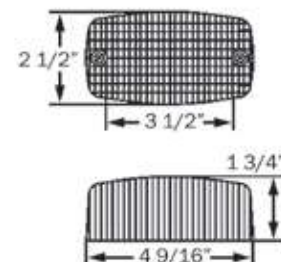



## TL22RK Magnetic Mount Towing Light Kit



TL22RK

- Magnetic mount towing light kit
- Pair of DOT compliant stop/turn/tail lights
- 20-ft wishbone style wiring harness and 4-ft trunk connector with 4-way flat plug
- Replaceable lens and bulb

BULK P/N	POLYPACK P/N	DESCRIPTION	QTY
<b>RETAIL</b>			
TL22RK		Towing light kit	2
<b>ACCESSORIES</b>			
A52RB	A52RBP	Tail light lens	25
A2057B	A2057BP	2057 replacement bulb	50



FMVSS	S T I
MATERIALS	Acrylic lens and plastic housing
VOLT/AMP	12.8VDC - 2.3A Stop/Turn, 0.9A Tail
WT/DIMS	3.53 lbs. / 7" x 4" x 2.125"
WARRANTY	Three Year Warranty

COMBINATION  
TAIL LIGHTS & KITS

## BU11CS Back-Up Light

- Single wire, grounds through mounting hardware
- Replaceable bulb (1156)

BULK P/N	POLYPACK P/N	DESCRIPTION	QTY
<b>RETAIL</b>			
BU11CS		Back-up light, chrome housing	12
FMVSS	R		
MATERIALS	Polycarbonate lens and plastic housing		
VOLT/AMP	12.8VDC - 0.4A		
WT/DIMS	.221 lbs. / 3.25" x 3.25" x 1.938"		
WARRANTY	Three Year Warranty		

**optronics**



BU11CS



## BU41 SERIES Flange Mount Back-Up Light

- Hard wired, includes both lead and ground wire
- Replaceable bulb (1056)

BULK P/N	POLYPACK P/N	DESCRIPTION	QTY
<b>BACK-UP LIGHT</b>			
BU41CB	BU41CBP	Back-up light	50
FMVSS	R		
MATERIALS	Acrylic lens, steel housing		
VOLT/AMP	12.8VDC - 1.182A		
WT/DIMS	.441 lbs. / 5.375" x 5.375" x 1.563"		
WARRANTY	Three Year Warranty		

**optronics**



BU41CB

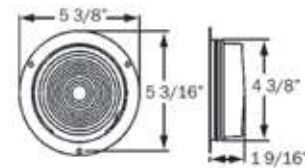

DOT COMPLIANT  
BACK-UP LIGHTS



## BU33/45/70 SERIES Sealed Back-Up Lights

- 4" round, 6" oval and rectangular models
- Sonically sealed, waterproof
- Flush mount design accepts standard two-way plug
- Shock proof socket guarantees long bulb life
- Kits include grommet and plug



BU45CB

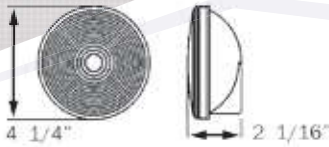

HOLE CUT-OUT: 4.5"



BU70CB

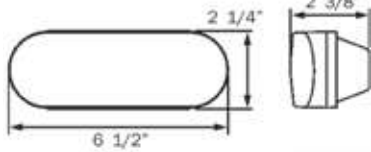

HOLE CUT-OUT: 6.85" x 2.5" (1.25" R)



BU33CRXLB

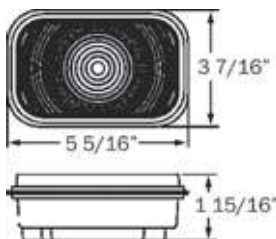

HOLE CUT-OUT: 5.453" x 3.578" (1" R)

DOT COMPLIANT  
BACK-UP LIGHTS

BULK P/N	POLYPACK P/N	DESCRIPTION	QTY
<b>4" ROUND BACK-UP LIGHTS</b>			
BU45CB	BU45CBP	Back-up light	50
BU44CB	BU44CBP	Kit: BU45CB, A45GB & A45CB	50
BU49CB	BU49CBP	Kit: BU45CB & A45GB	10
<b>6" OVAL BACK-UP LIGHTS</b>			
BU70CB	BU70CBP	Back-up light	50
BU74CB	BU74CBP	Kit: BU70CB, A70GB & A45CB	50
BU64CB	BU64CBP	Kit: BU70CB, A70GB & A49PB (pigtail attached to light)	50
BU65CB	BU65CBP	Kit: BU70CB, A70GB & A49PB	50
<b>RECTANGULAR BACK-UP LIGHTS</b>			
BU33CRXLB	BU33CRXLBP	Back-up light with red reflex	20
BU33CRX24LB	BU33CRX24LBP	Back-up light with red reflex, 24V	20
<b>ACCESSORIES</b>			
A45GB	A45GBP	4" round grommet	50
A70GB	A70GBP	6" oval grommet	50
A33GB	A33GBP	Rectangular grommet	50
A45CB	A45CBP	Straight two-wire pigtail	100
A49PB	A49PBP	Right angle two-wire pigtail	100

<b>FMVSS</b>	R
	BU33CRX: (2)RA
<b>MATERIALS</b>	Polycarbonate lens and housing
<b>VOLT/AMP</b>	BU45: 12.8VDC - 2.182A
	BU70: 12.8VDC - 0.4A
	BU33: 12.8VDC - 1.6A; 24.0VDC - .87A
<b>WT/DIMS</b>	BU45: .176 lbs. / 4.25" x 4.25" x 2.063"
	BU70: .265 lbs. / 6.5" x 2.25" x 2.375"
	BU33: .441 lbs. / 5.313" x 3.438" x 1.938"
<b>WARRANTY</b>	Three Year Warranty



## M1 SERIES Millennium Series® 6.5" Marker/Clearance Lights

- Replaceable lens and bulb
- Hard wired, includes separate ground wire
- Available with .180 male bullets or metripack connector
- Choose from light only or kit with chrome bezel

BULK P/N	POLYPACK P/N	DESCRIPTION	QTY
<b>YELLOW</b>			
00212351B	00212351P	12V, .180 bullets	20
00212331B	00212331P	12V Kit: .180 bullets, bezel	20
00212031B	00212031P	24V Kit: .180 bullets, bezel	20
00212362B	00212362P	12V, Metripack connector	20
00212342B	00212342P	12V Kit: Metripack connector, bezel	20
<b>RED</b>			
00212333B	00212333P	12V Kit: .180 bullets, bezel	20
<b>ACCESSORIES</b>			
00212317B	00212327P	Bezel	100/20
00212011B	00212005P	Socket with 193 bulb, .180 bullets	100/20

<b>FMVSS</b>	P2
<b>MATERIALS</b>	Polycarbonate lens, housing and bezel
<b>VOLT/AMP</b>	12.8VDC - 0.33A; 24.0VDC - 0.17A
<b>WARRANTY</b>	Three Year Warranty

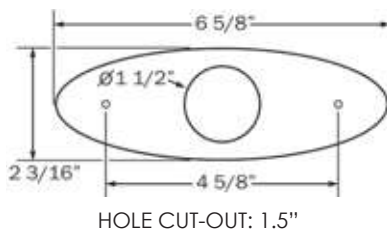

Panelite  
MILLENNIUM SERIES



M1 WITH BEZEL



M1 WITH BEZEL



MILLENNIUM SERIES  
MARKER/CLEARANCE LIGHTS



## M3 SERIES Millennium Series® 3" Marker/Clearance Lights

- Replaceable lens and bulb
- Hard wired, includes separate ground wire
- Molded .180 male bullets
- Choose from light only or kit with chrome bezel



M3 WITH BEZEL



M3 WITH BEZEL



M3 CLEAR LENS WITH BEZEL



BULK P/N	POLYPACK P/N	DESCRIPTION	QTY
<b>YELLOW</b>			
00212251B	00212251P	.180 bullets	20
00212231B	00212231P	Kit: .180 bullets, bezel	20
<b>RED</b>			
00212253B	00212253P	.180 bullets	20
00212233B	00212233P	Kit: .180 bullets, bezel	20
<b>CLEAR</b>			
00212239B	00212239P	Kit: .180 bullets, bezel	20
<b>ACCESSORIES</b>			
00212217B	00212227P	Bezel	500/20
00212011B	00212005P	Socket with 193 bulb, .180 bullets	100/20

<b>FMVSS</b>	P2
<b>MATERIALS</b>	Polycarbonate lens, housing and bezel
<b>VOLT/AMP</b>	12.8VDC - 0.33A
<b>WARRANTY</b>	Three Year Warranty

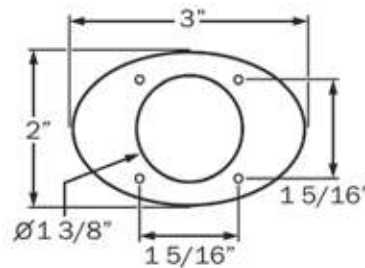

HOLE CUT-OUT: 1.375"

MILLENNIUM SERIES  
MARKER/CLEARANCE LIGHTS

## MC25/27 SERIES 2" & 2.5" Sealed Beehive Style Marker/Clearance Lights



- Sonically sealed, waterproof
- Clearance, side marker, or rear tracking light applications
- Accepts standard two-pin PL-10 plug



MC25AB



MC25RB

BULK P/N	POLYPACK P/N	DESCRIPTION	QTY
<b>YELLOW</b>			
MC25AB	MC25ABP	2" light	20
MC27AB	MC27ABP	2.5" light	20
<b>RED</b>			
MC25RB	MC25RBP	2" light	20
MC27RB	MC27RBP	2.5" light	20
<b>ACCESSORIES</b>			
A46PB	A46PBP	Straight PL-10 plug, 6" lead	100
A86PB	A86PBP	Straight PL-10 plug, 18" lead	100
A54GB	A54GBP	2" Flush mount grommet	100
A54GK	A54GKP	2" Kit: A54GB and A46PB	100
A55CB	A55CBP	2" Chrome trim ring	20
A55GB	A55GBP	2.5" Flush mount grommet (open back)	50
A56GB	A56GBP	2.5" Recess mount grommet (closed back)	100
A57GB	A57GBP	2.5" Recess mount grommet (open back)	50
A55GK	A55GKP	2.5" Kit: A55GB and A46PB	100
A57GK	A57GKP	2.5" Kit: A57GB and A46PB	100
A57CB	A57CBP	2.5" Chrome trim ring	20
BK5557GB	BK5557GBP	2"/2.5" Cam-on mounting bracket	50



MC27AB



MC27RB

SEALED MARKER/  
CLEARANCE LIGHTS

<b>FMVSS</b>	P2
<b>MATERIALS</b>	Polycarbonate lens and housing
<b>VOLT/AMP</b>	12.8VDC - 0.2A
<b>WT/DIMS</b>	MC25: .088 lbs. / 2" x 2" x 1.75" MC27: .110 lbs. / 2.5" x 2.5" x 2.313"
<b>WARRANTY</b>	Three Year Warranty

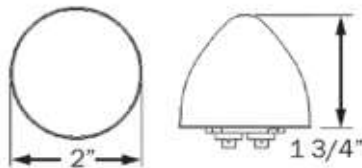

MC25 SERIES  
HOLE CUT-OUT: 2.313"

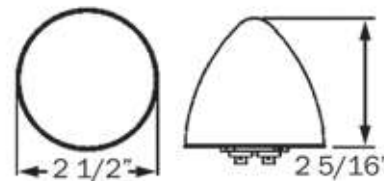

MC27 SERIES  
HOLE CUT-OUT: 2.75"





## MC52 SERIES 2" Round Sealed Recess Flange Mount Marker/Clearance Lights

- Sonically sealed, waterproof light for recess mount
- Accepts standard two-pin PL-10 plug
- Available in yellow and red models, with black or reflex flange
- Reflex flange model meets SAE "A" requirements for conspicuity



MC52AB



MC52RB



MC52AXB



MC52RXB

SEALED MARKER/  
CLEARANCE LIGHTS

BULK P/N	POLYPACK P/N	DESCRIPTION	QTY
<b>YELLOW</b>			
MC52AB	MC52ABP	Yellow, black flange	50
MC52AXB	MC52AXBP	Yellow, reflex lens and flange	50
<b>RED</b>			
MC52RB	MC52RBP	Red, black flange	50
MC52RXB	MC52RXBP	Red, reflex lens and flange	50
<b>ACCESSORIES</b>			
A46PB	A46BPB	Straight PL-10 plug, 6" lead	100
A86PB	A86BPB	Straight PL-10 plug, 18" lead	100
A3TRSSB	-	Stainless steel flange cover	100

<b>FMVSS</b>	Black flange: P2 Reflex flange: A P2
<b>MATERIALS</b>	Polycarbonate lens and housing
<b>VOLT/AMP</b>	12.8VDC - 0.2A
<b>WT/DIMS</b>	Black flange: .066 lbs. / 2.938" x 2.938" x .813" Reflex flange: .066 lbs. / 2.984" x 2.984" x .75"
<b>WARRANTY</b>	Three Year Warranty

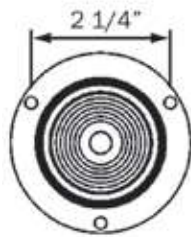

MC52 Black Flange

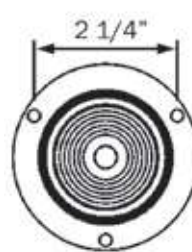

MC52 Reflex Flange

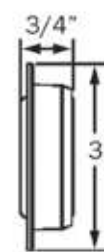

## MC53 & MC54 SERIES 2" Sealed Marker/Clearance Lights



- Sonically sealed, waterproof
- Accept standard two-pin PL-10 plugs
- Available in yellow, red, and yellow ABS models
- Available in recess and surface mount models

BULK P/N	POLYPACK P/N	DESCRIPTION	QTY
<b>YELLOW</b>			
MC53AB	MC53ABP	Recess mount	50
MC53ABSB	MC53ABSBP	Recess mount "ABS"	50
MC53AKB	MC53AKBP	Kit: MC53AB, A54GB and A46PB	50
MC54AB	MC54ABP	Flange surface mount	50
MC505ABSB	MC505ABSBP	Flange surface mount "ABS"	50
<b>RED</b>			
MC53RB	MC53RBP	Recess mount	50
MC53RKB	MC53RKBP	Kit: MC53RB, A54GB and A46PB	50
MC54RB	MC54RBP	Flange surface mount	50
<b>ACCESSORIES</b>			
A46PB	A46PBP	Straight PL-10 plug, 6" lead	100
A86PB	A86PBP	Straight PL-10 plug, 18" lead	100
A54GB	A54GBP	2" Flush mount grommet	100
A54GK	A54GKP	2" Kit: A54GB and A46PB	100
A55CB	A55CBP	2" Chrome trim ring	20
BK5557GB	BK5557GBP	Cam-on mounting bracket	50
<b>RETAIL</b>			
MC53AS		Yellow recess mount light, clam	12
MC53RS		Red recess mount light, clam	12

<b>FMVSS</b>	P2 PC
<b>MATERIALS</b>	Polycarbonate lens and housing
<b>VOLT/AMP</b>	12.8VDC - 0.2A
<b>WT/DIMS</b>	MC53: .066 lbs. / 2" x 2" x .688" MC54/505: .066 lbs. / 2.938" x 2.938" x .813"
<b>WARRANTY</b>	Three Year Warranty

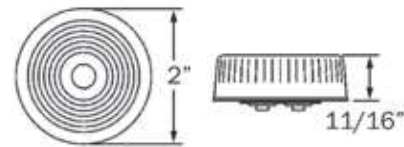

HOLE CUT-OUT: 2.313"

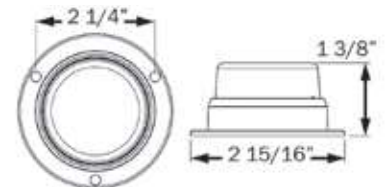

SURFACE MOUNT

SEALED MARKER/  
CLEARANCE LIGHTS



## MC55 & MC57 SERIES 2.5" Sealed Marker/Clearance Lights for Recess Mount



MC55AB

MC55RB



- Sonically sealed, waterproof design for recess mount
- Accept standard two-pin PL-10 plug
- MC55 series lights are PC rated
- MC57 series lights feature built-in reflex

SEALED MARKER/  
CLEARANCE LIGHTS

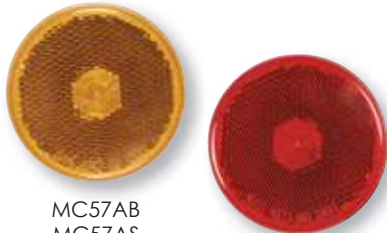

MC57AB  
MC57AS

MC57RB  
MC57RS

SAE A REFLEX  
P2 RATED

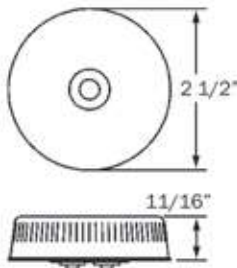

HOLE CUT-OUT: 2.75"

BULK P/N	POLYPACK P/N	DESCRIPTION	QTY
<b>YELLOW</b>			
MC55AB	MC55ABP	PC rated light	50
MC57AB	MC57ABP	P2 rated light with reflex	50
<b>RED</b>			
MC55RB	MC55RBP	PC rated light	50
MC57RB	MC57RBP	P2 rated light with reflex	50
<b>ACCESSORIES</b>			
A46PB	A46PBP	Straight PL-10 plug, 6" lead	100
A86PB	A86PBP	Straight PL-10 plug, 18" lead	100
A55GB	A55GBP	Flush mount grommet, open back	50
A56GB	A56GBP	Recess mount grommet, closed back	100
A57GB	A57GBP	Recess mount grommet, open back	50
A55GK	A55GKP	Kit: A55GB & A46PB	100
A57GK	A57GKP	Kit: A57GB & A46PB	100
A57CB	A57CBP	Chrome trim ring	20
BK5557GB	BK5557GBP	Cam-on mounting bracket	50
<b>RETAIL</b>			
MC57AS		Yellow light with reflex, clam	12
MC57RS		Red light with reflex, clam	12

<b>FMVSS</b>	MC55: P2 PC MC57: A P2
<b>MATERIALS</b>	Polycarbonate lens and housing
<b>VOLT/AMP</b>	12.8VDC - 0.2A
<b>WT/DIMS</b>	.066 lbs. / 2.5" x 2.5" x .688"
<b>WARRANTY</b>	Three Year Warranty



## MC56 & MC59 SERIES 2.5" Sealed Recess Flange Mount Marker/Clearance Lights

- Sonically sealed, waterproof light for recess mount
- Accepts standard two-pin PL-10 plug
- MC59 series lights include reflex meeting SAE "A" conspicuity requirement

BULK P/N	POLYPACK P/N	DESCRIPTION	QTY
<b>YELLOW</b>			
MC56AB	MC56ABP	Recess flange mount	50
MC59AFB	MC59AFBP	Recess flange mount, reflex lens	50
<b>RED</b>			
MC56RB	MC56RBP	Recess flange mount	50
MC59RFB	MC59RFBP	Recess flange mount, reflex lens	50
<b>ACCESSORIES</b>			
A46PB	A46PBP	Straight PL-10 plug, 6" lead	100
A86PB	A86PBP	Straight PL-10 plug, 18" lead	100

<b>FMVSS</b>	MC56: P2 MC59: A P2
<b>MATERIALS</b>	Polycarbonate lens and housing
<b>VOLT/AMP</b>	12.8VDC - 0.2A
<b>WT/DIMS</b>	.11 lb. / 3.438" x 3.438" x .938"
<b>WARRANTY</b>	Three Year Warranty

**optronics**



SEALED MARKER/  
CLEARANCE LIGHTS

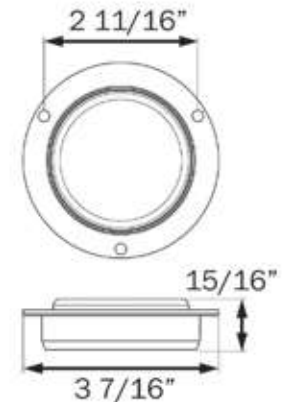

HOLE CUT-OUT: 2.75"



## MC61ABKB

### Sealed Marker/Clearance Light and Reflector in Elevated Bracket



MC61ABKB

- Sonically sealed, waterproof
- PC rated light fulfills front side marker requirement when properly mounted on a 15 degree angle
- Corrosion proof, surface mount wedge base
- Single wire design grounds through mounting hardware

SEALED MARKER/  
CLEARANCE LIGHTS

BULK P/N	POLYPACK P/N	DESCRIPTION	QTY
<b>LIGHT/REFLECTOR ASSEMBLY</b>			
MC61ABKB	MC61ABKBP	Light & reflector in bracket	20
<b>ACCESSORIES</b>			
BK61AB	-	Bracket with reflector	20

<b>FMVSS</b>	Light: P2 PC; Reflector: A
<b>MATERIALS</b>	Polycarbonate lens and housing; Acrylic reflector
<b>VOLT/AMP</b>	12.8VDC - 0.2A
<b>WT/DIMS</b>	.066 lbs. / 6.687" x 1.5" x 1.625"
<b>WARRANTY</b>	Three Year Warranty

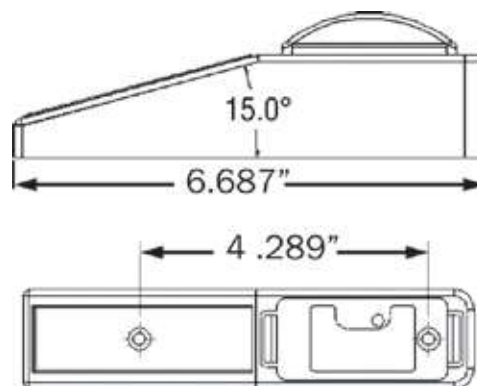

## MC65/67 & BA65 SERIES Sealed Fender Lights

- Sonically sealed, waterproof
- PC rated design includes two bulbs
- Multiple mounting and wiring options available
- Single wire design grounds through mounting hardware
- Two-wire design includes both lead and ground wires

BULK P/N	POLYPACK P/N	DESCRIPTION	QTY
<b>AMBER/RED FENDER LIGHT</b>			
MC65ARB	MC65ARBP	Light only	50
MC67ARB	MC67ARBP	Kit: MC65ARB & A65PB bracket/plug	50
<b>AMBER/RED FENDER LIGHT ASSEMBLIES</b>			
BA65ARLB	BA65ARLBP	Fender light assembly, left side: MC65AB & MC65RB in fender mount bracket	25
BA65ARRB	BA65ARRBP	Fender light assembly, right side: MC65AB & MC65RB in fender mount bracket	25
<b>ACCESSORIES</b>			
A67BB	A67BBP	Fender bracket, black	50
A67GB	A67GBP	Fender bracket, gray	50
A67CVB	A67CVBP	Curved fender bracket, gray	50
A65B	A65BP	Black bracket	50
A65P	A65PP	Single wire plug, .156 male bullet	50
A65PB	A65PBP	Kit: A65B black bracket & A65P plug	50
A66PB	A66PBP	Kit: Gray bracket & A65P plug	50
A67CB	A67CBP	Kit: Chrome bracket & A65P plug	50
A68PB	A68PBP	Kit: Black bracket & 2-wire plug	50

For more details on mounting and wiring accessories, see Accessories section at back of catalog.

<b>FMVSS</b>	MC65ARB: P2 BA65: P2 P3 PC2
<b>MATERIALS</b>	MC65: Polycarbonate lens and housing BA65: Polycarbonate lens and housing, plastic bracket
<b>VOLT/AMP</b>	MC65: 12.8VDC - 0.689A BA65: 12.8VDC - 0.8A
<b>WT/DIMS</b>	MC65: .066 lbs. / 3.938" x 1.25" x .875" BA65: .375 lbs. / 9.188" x 4.688" x 1.875"
<b>WARRANTY</b>	Three Year Warranty

**optronics**



MC65ARB



MC67ARB

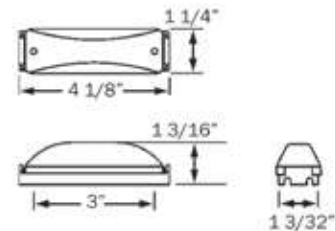

SEALED MARKER/  
CLEARANCE LIGHTS



BA65ARLB

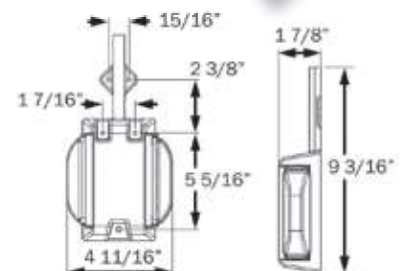





## MC65/67 SERIES Sealed Marker/Clearance Lights



- Sonically sealed, waterproof
- PC rated design includes two bulbs
- Multiple mounting and wiring options available
- Single wire design grounds through mounting hardware
- Two-wire design includes both lead and ground wires

MC65AB



MC65RB

MC67AB  
MC67AK



MC67RB  
MC67RK

SEALED MARKER/  
CLEARANCE LIGHTS

BULK P/N	POLYPACK P/N	DESCRIPTION	QTY
<b>YELLOW</b>			
MC65AB	MC65ABP	Light only	50
MC67AB	MC67ABP	Kit: MC65AB & A65PB	50
<b>RED</b>			
MC65RB	MC65RBP	Light only	50
MC67RB	MC67RBP	Kit: MC65RB & A65PB	50
<b>ACCESSORIES</b>			
A65B	A65BP	Black bracket	50
A65P	A65PP	Single wire plug, .156 male bullet	50
A65PB	A65PBP	Kit: A65B black bracket & A65P plug	50
A66PB	A66PBP	Kit: Gray bracket & A65P plug	50
A67CB	A67CBP	Kit: Chrome bracket & A65P plug	50
A68PB	A68PBP	Kit: Black bracket & 2-wire plug	50
For more details on mounting and wiring accessories, see Accessories section at back of catalog.			
<b>RETAIL</b>			
MC67AK		Yellow kit: MC65AB & A65PB, clam	12
MC67RK		Red kit: MC65RB & A65PB, clam	12

<b>FMVSS</b>	P2 P3 PC2
<b>MATERIALS</b>	Polycarbonate lens and housing
<b>VOLT/AMP</b>	12.8VDC - 0.4A
<b>WT/DIMS</b>	.066 lbs. / 3.938" x 1.25" x .875"
<b>WARRANTY</b>	Three Year Warranty

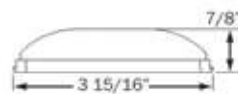

MC65

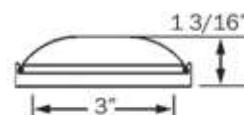
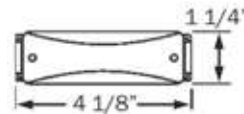

MC67



## MC91 SERIES Sealed Marker/Clearance Lights

- Sonically sealed, waterproof
- PC rated design
- Multiple mounting and wiring options available
- Single wire design grounds through mounting hardware
- Two-wire design includes both lead and ground wires



BULK P/N	POLYPACK P/N	DESCRIPTION	QTY
<b>YELLOW</b>			
A91AB	A91ABP	Light only	100
MC91AB	MC91ABP	Kit: A91AB, A91CB & A91LW	50
MC92AB	MC92ABP	Kit: A91AB, A91BB & A91LW	50
<b>RED</b>			
A91RB	A91RBP	Light only	100
MC92RB	MC92RBP	Kit: A91RB, A91BB & A91LW	50
<b>ACCESSORIES</b>			
A46PB	A46PBP	2-wire plug, 6" lead	100
A86PB	A86PBP	2-wire plug, 18" lead	100
A91LW	A91LWP	1-wire plug, 12" lead	100
A91BB	A91BBP	Black base, self grounding	100
A91BOB	A91BOBP	Black base, open back	100
A91CB	A91CBP	Chrome base, self grounding	100
A91OB	A91OBP	Chrome base, open back	100
A91GB	A91GBP	Grommet	100
<b>RETAIL</b>			
MC90AS		Yellow light only, clam	12
MC90RS		Red light only, clam	12
MC91AS		Yellow light kit: A91AB, A91CB chrome base, A91LW single wire plug, clam	12
MC91RS		Red light kit: A91RB, A91CB chrome base, A91LW single wire plug, clam	12
MC92AS		Yellow light kit: A91AB, A91BB black base, A91LW single wire plug, clam	12
MC92RS		Red light kit: A91RB, A91BB black base, A91LW single wire plug, clam	12

<b>FMVSS</b>	P2 PC
<b>MATERIALS</b>	Polycarbonate lens and housing
<b>VOLT/AMP</b>	12.8VDC - 0.2A
<b>WT/DIMS</b>	.066 lbs. / 2.5" x 1.188" x .875"
<b>WARRANTY</b>	Three Year Warranty



A91AB  
MC90AS



A91RB  
MC90RS



MC91AB  
MC91AS



MC91RS



MC92AB  
MC92AS



MC92RB  
MC92RS

SEALED MARKER/  
CLEARANCE LIGHTS

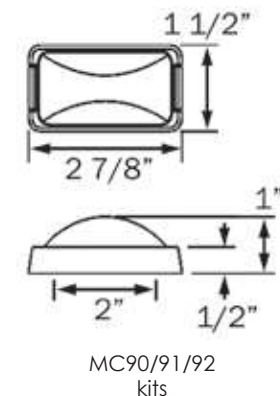
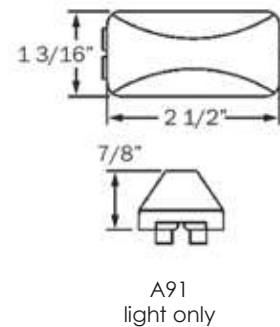



## MC11 SERIES Mini Marker/Clearance Lights

- Surface mount on 2-3/4" centers
- Single wire design grounds through mounting hardware
- Snap-on lens, replaceable bulb

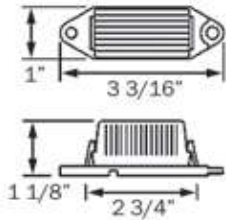

MC11AK

SURFACE MOUNT  
MARKER/CLEARANCE LIGHTS

BULK P/N	POLYPACK P/N	DESCRIPTION	QTY
<b>YELLOW</b>			
MC11AB	MC11ABP	Yellow, black base	50
<b>RED</b>			
MC11RB	MC11RBP	Red, black base	50
<b>ACCESSORIES</b>			
A11AB	A11ABP	Yellow replacement lens	50
A11RB	A11RBP	Red replacement lens	50
A194B	A194BP	194 replacement bulb	100
<b>RETAIL</b>			
MC11AS		Yellow light, clam	12
MC11RS		Red light, clam	12
MC11AK		(6) MC11AB, hardware, connectors, clam	6
UL11BS		Blue utility light, clam	12

FMVSS	P2 (except UL11BS)
MATERIALS	Acrylic lens, ABS housing
VOLT/AMP	12.8VDC - 0.4A
WT/DIMS	.044 lbs. / 3.188" x 1" x 1.125"
WARRANTY	Three Year Warranty



## MC30 SERIES Marker/Clearance Light with Reflex

- Surface mount on 2" centers
- Plug-n-go design for quick connection to power and ground
- Snap-on lens, replaceable bulb

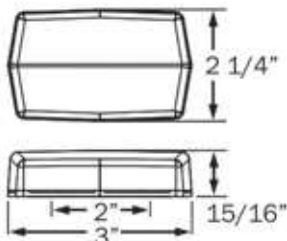

BULK P/N	POLYPACK P/N	DESCRIPTION	QTY
<b>YELLOW</b>			
MC30AB	MC30ABP	Yellow	20
<b>ACCESSORIES</b>			
A194B	A194BP	194 replacement bulb	100

FMVSS	A P2 PC
MATERIALS	Acrylic lens, ABS housing
VOLT/AMP	12.8VDC - 0.2A
WT/DIMS	.11 lb. / 3" x 2.25" x .938"
WARRANTY	Three Year Warranty



## MC21/22 SERIES Beehive Marker/Clearance Lights



- Surface mount on 3/4" centers
- Single wire design grounds through mounting hardware
- Snap-on lens, replaceable bulb



MC22RB

MC22AB

BULK P/N	POLYPACK P/N	DESCRIPTION	QTY
<b>YELLOW</b>			
MC22AB	MC22ABP	Yellow	50
<b>RED</b>			
MC22RB	MC22RBP	Red	50
<b>RETAIL</b>			
MC21AS		Yellow light, clam	12
MC21RS		Red light, clam	12

<b>FMVSS</b>	P2 PC
<b>MATERIALS</b>	Acrylic lens, steel bracket
<b>VOLT/AMP</b>	12.8VDC - 0.4A
<b>WT/DIMS</b>	MC22: .176 lbs. / 2.563" x 2.563" x 3.688"
	MC21: .176 lbs. / 2.563" x 2.563" x 4.063"
<b>WARRANTY</b>	Three Year Warranty



MC21RS

MC21AS

SURFACE MOUNT  
MARKER/CLEARANCE LIGHTS

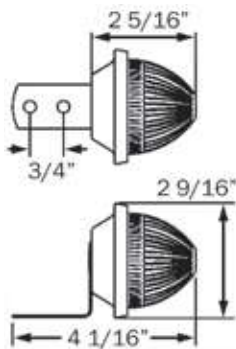

MC21

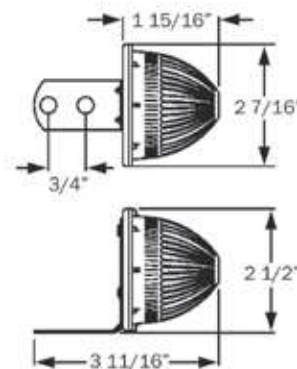

MC22



## MC31/32 SERIES Surface Mount Marker/Clearance Lights with Reflex

- Surface mount on 3" centers
- Lens with reflex eliminates need for separate reflector
- MC31 is single wire design, grounds through mounting hardware
- MC32 has twist-in socket with separate ground wire
- Snap-on lens, replaceable 194 bulb



MC31AB



MC31RB

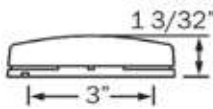
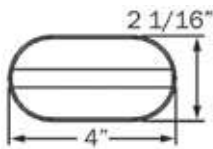

MC32AB



MC32RB

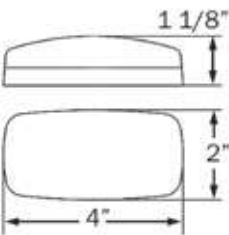

A32GB

SURFACE MOUNT  
MARKER/CLEARANCE LIGHTS

BULK P/N	POLYPACK P/N	DESCRIPTION	QTY
<b>YELLOW</b>			
MC31AB	MC31ABP	Oval, black base, single wire	50
MC31A15B2	-	MC31AB with .156 female barrels	50
MC32AB	MC32ABP	Oblong, white base, two-wire	100
MC32ABB	MC32ABBP	Oblong, black base, two-wire	100
<b>RED</b>			
MC31RB	MC31RBP	Oval, black base, single wire	50
MC31R15B2	-	MC31RB with .156 female barrels	50
MC32RB	MC32RBP	Oblong, white base, two-wire	100
MC32RBB	MC32RBBP	Oblong, black base, two-wire	100
<b>ACCESSORIES</b>			
A31AB	A31ABP	Yellow replacement lens, MC31	50
A31RB	A31RBP	Red replacement lens, MC31	50
A32AB	A32ABP	Yellow replacement lens, MC32	50/10
A32RB	A32RBP	Red replacement lens, MC32	50/10
A32GB	A32GBP	Mounting gasket, white	500
A194B	A194BP	194 replacement bulb	100
<b>RETAIL</b>			
MC31AS		MC31AB, clam	12
MC31RS		MC31RB, clam	12
MC32AS		MC32AB, clam	12
MC32ABS		MC32ABB, clam	12
MC32RS		MC32RB, clam	12
MC32RBS		MC32RBB, clam	12

<b>FMVSS</b>	A P2
<b>MATERIALS</b>	Acrylic lens, ABS housing
<b>VOLT/AMP</b>	12.8VDC - 0.2A
<b>WT/DIMS</b>	MC31: .088 lb. / 4" x 2.063" x 1.094" MC32: .11 lb. / 4" x 2" x 1.125"
<b>WARRANTY</b>	Three Year Warranty

## MC35/36 SERIES

### Surface Mount Marker/Clearance Lights with Reflex

- Surface mount lights; choose from ear mount or stud mount versions
- Lens with reflex eliminates need for separate reflector
- MC35 is ear mount version
- MC36 is stud mount version
- Single wire design grounds through mounting hardware
- Screw-on lens, replaceable bulb, black plastic base

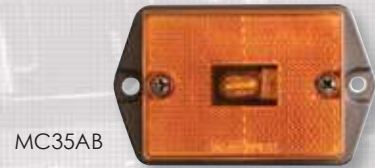

MC35AB



MC35RS



MC35AEB



MC36AB



MC36RB

BULK P/N	POLYPACK P/N	DESCRIPTION	QTY
<b>YELLOW</b>			
MC35AB	MC35ABP	Yellow ear mount	50
MC35AEB	MC35AEBP	Yellow ear mount, rectangular	200
MC36AB	MC36ABP	Yellow stud mount	50
<b>RED</b>			
MC36RB	MC36RBP	Red stud mount	50
<b>ACCESSORIES</b>			
A36AB	A36ABP	Yellow replacement lens	50
A36RB	A36RBP	Red replacement lens	50
A194B	A194BP	194 replacement bulb	100
<b>RETAIL</b>			
MC35AS		Yellow ear mount light, clam	12
MC36AS		Yellow stud mount light, clam	12
MC36RS		Red stud mount light, clam	12

<b>FMVSS</b>	A P2
<b>MATERIALS</b>	Acrylic lens, ABS housing
<b>VOLT/AMP</b>	12.8VDC - 0.2A
<b>WT/DIMS</b>	MC35: .132 lb. / 3.875" x 2.375" x 1.094" MC35AEB: .132 lb. / 3.75" x 2.063" x .938" MC36: .132 lb. / 2.75" x 2.125" x 1"
<b>WARRANTY</b>	Three Year Warranty

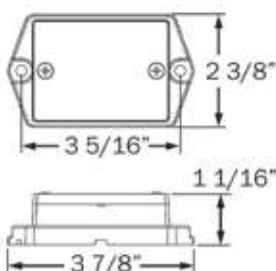

MC35

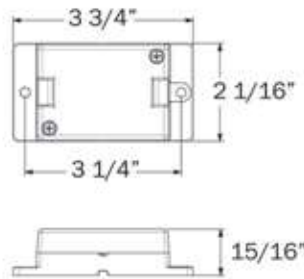

MC35AEB

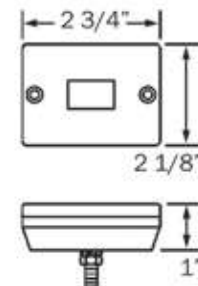

MC36

SURFACE MOUNT  
MARKER/CLEARANCE LIGHTS





## MC37 SERIES Stud Mount Marker/Clearance Light with Reflex



MC37AB

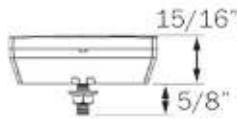
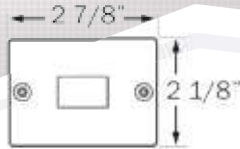

- Stud mount design; grounds through mounting stud
- Lens with reflex eliminates need for separate reflector
- Replaceable bulb
- Polycarbonate lens and housing

BULK P/N	POLYPACK P/N	DESCRIPTION	QTY
<b>YELLOW</b>			
MC37AB	MC37ABP	Yellow	50
<b>ACCESSORIES</b>			
A194B	A194BP	194 replacement bulb	100

<b>FMVSS</b>	A P2
<b>MATERIALS</b>	Polycarbonate lens and housing
<b>VOLT/AMP</b>	12.8VDC - 0.2A
<b>WT/DIMS</b>	.11 lb. / 2.875" x 2.125" x .938"
<b>WARRANTY</b>	Three Year Warranty

SURFACE MOUNT  
MARKER/CLEARANCE LIGHTS



## MC38 SERIES Surface Mount Marker/Clearance Lights with Reflex

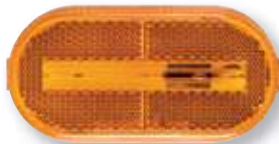

MC38AB



MC38RB

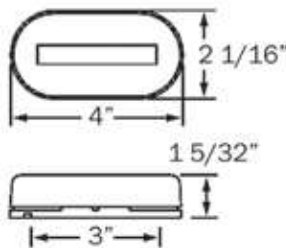

- Surface mount on 3" centers
- Lens with reflex eliminates need for separate reflector
- Single wire design grounds through mounting hardware
- Snap-on lens, replaceable bulb

BULK P/N	POLYPACK P/N	DESCRIPTION	QTY
<b>YELLOW</b>			
MC38AB	MC38ABP	Yellow	50
<b>RED</b>			
MC38RB	MC38RBP	Red	50
<b>ACCESSORIES</b>			
A38AB	A38ABP	Yellow replacement lens	50
A38RB	A38RBP	Red replacement lens	50
A194B	A194BP	194 replacement bulb	100

<b>FMVSS</b>	A P2
<b>MATERIALS</b>	Acrylic lens, ABS housing
<b>VOLT/AMP</b>	12.8VDC - 0.2A
<b>WT/DIMS</b>	.11 lb. / 4" x 2.063" x 1.156"
<b>WARRANTY</b>	Three Year Warranty

## MC42 SERIES

### Dual Bulb Marker/Clearance Lights

- Dual bulb, bullseye style lights with black base
- Snap-on lens and replaceable bulbs
- Surface mount on 3" centers
- Single wire design grounds through mounting hardware

BULK P/N	POLYPACK P/N	DESCRIPTION	QTY
<b>YELLOW</b>			
MC42AB	MC42ABP	Yellow	50
<b>RED</b>			
MC42RB	MC42RBP	Red	50
<b>ACCESSORIES</b>			
A42AB	A42ABP	Yellow replacement lens	10
A42RB	A42RBP	Red replacement lens	10
A194B	A194BP	194 replacement bulb	100
<b>RETAIL</b>			
MC42AS		Yellow light, clam	12
MC42RS		Red light, clam	12

<b>FMVSS</b>	P2
<b>MATERIALS</b>	Acrylic lens, ABS housing
<b>VOLT/AMP</b>	12.8VDC - 0.4A
<b>WT/DIMS</b>	.088 lb. / 4.094" x 2.125" x 1.125"
<b>WARRANTY</b>	Three Year Warranty



MC42AB



MC42RB

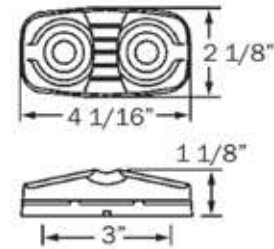

SURFACE MOUNT  
MARKER/CLEARANCE LIGHTS

## MC48 SERIES

### Marker/Clearance Lights with Reflex

- Flush mount on 3-3/8" centers
- Lens with reflex eliminates need for separate reflector
- Twist-in socket with replaceable bulb and ground wire

BULK P/N	POLYPACK P/N	DESCRIPTION	QTY
<b>YELLOW</b>			
MC48AB	MC48ABP	Yellow	50
MC48APG	MC48APGP	Yellow with .156 female barrels	50
<b>RED</b>			
MC48RPG	MC48RPGP	Red with .156 female barrels	50
<b>ACCESSORIES</b>			
A194B	A194BP	194 replacement bulb	100

<b>FMVSS</b>	AP2
<b>MATERIALS</b>	Acrylic lens, ABS housing
<b>VOLT/AMP</b>	12.8VDC - 0.2A
<b>WT/DIMS</b>	.132 lb. / 3.906" x 1.843" x 1.031"
<b>WARRANTY</b>	Three Year Warranty



MC48AB/APG



MC48RPG

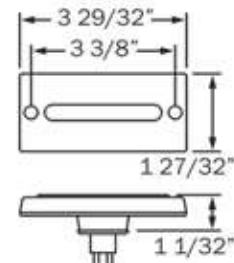



## MC44 & BA44 SERIES Surface Mount Marker/Clearance Lights with Reflex

- Surface mount on 3" centers
- Lens with reflex eliminates need for separate reflector
- Two-wire design includes both lead and ground wire
- Snap-on lens, replaceable bulb
- Fender light assembly includes one each MC44AB and MC44RB in black ABS bracket; female plug on power wire, grounding eyelet on ground wire



MC44AB



MC44RB



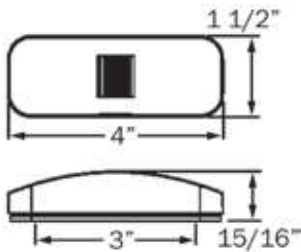

A44GB

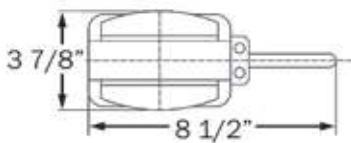

BA44FNL



BULK P/N	POLYPACK P/N	DESCRIPTION	QTY
<b>YELLOW</b>			
MC44AB	MC44ABP	Yellow, two-wire	50
MC44AB1	MC44AB1P	Yellow, single wire	50
<b>RED</b>			
MC44RB	MC44RBP	Red, two-wire	50
MC44RB1	MC44RB1P	Red, single wire	50
<b>YELLOW/RED FENDER LIGHT ASSEMBLY</b>			
BA44FNL	BA44FNLP	Left side	25
BA44FNR	BA44FNRP	Right side	25
<b>ACCESSORIES</b>			
MC441WB	-	Single wire base only	500
MC442WB	-	Two-wire base only	50
A44A500B	-	Yellow replacement lens, 500-pack	500
A44R500B	-	Red replacement lens, 500-pack	500
A44AB	A44ABP	Yellow replacement lens	10
A44RB	A44RBP	Red replacement lens	10
A194B	A194BP	194 replacement bulb	100
A44GTB	-	Mounting gasket, thick, white	1000
<b>RETAIL</b>			
MC44AS		Yellow light, clam	12
MC44RS		Red light, clam	12

<b>FMVSS</b>	A P2
<b>MATERIALS</b>	Acrylic lens, ABS housing
<b>VOLT/AMP</b>	MC44: 12.8VDC - 0.4A BA44: 12.8VDC - 0.8A
<b>WT/DIMS</b>	MC44: .066 lb. / 4" x 1.5" x .938" BA44: .353 lb. / 8.5" x 3.875" x 1.75"
<b>WARRANTY</b>	Three Year Warranty

SURFACE MOUNT  
MARKER/CLEARANCE LIGHTS



## MC58 SERIES 2.5" Marker/Clearance Lights

- Surface mount on 1-1/2" centers
- Single wire design grounds through mounting hardware
- Snap-on lens, replaceable bulb

BULK P/N	POLYPACK P/N	DESCRIPTION	QTY
<b>RED</b>			
MC58RB	MC58RBP	Red	50
<b>ACCESSORIES</b>			
A194B	A194BP	194 replacement bulb	100
<b>RETAIL</b>			
MC58AS		Yellow light, clam	12
MC58RS		Red light, clam	12
<b>FMVSS</b>	P2		
<b>MATERIALS</b>	Acrylic lens, ABS housing		
<b>VOLT/AMP</b>	12.8VDC - 0.2A		
<b>WT/DIMS</b>	.066 lbs. / 2.5" x 2.5" x 1.063"		
<b>WARRANTY</b>	Three Year Warranty		

**optronics**

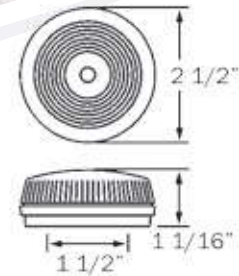

SURFACE MOUNT  
MARKER/CLEARANCE LIGHTS

## MC66 SERIES Surface Mount Dual Bulb Marker/Clearance Lights

- Surface mount on 3" centers
- Includes both lead and ground wires
- Snap-on lens, replaceable bulb



BULK P/N	POLYPACK P/N	DESCRIPTION	QTY
<b>YELLOW</b>			
MC66AB	MC66ABP	Yellow	50
MC66HAB	MC66HABP	Yellow, single wire, self grounding	50
<b>RED</b>			
MC66RB	MC66RBP	Red	50
<b>ACCESSORIES</b>			
A66AB	A66ABP	Yellow replacement lens	50
A66RB	A66RBP	Red replacement lens	50
A194B	A194BP	194 replacement bulb	100
<b>RETAIL</b>			
MC66AS		Yellow light, clam	12
MC66RS		Red light, clam	12
<b>FMVSS</b>	P2 PC		
<b>MATERIALS</b>	Acrylic lens, ABS housing		
<b>VOLT/AMP</b>	12.8VDC - 0.4A		
<b>WT/DIMS</b>	.132 lb. / 4" x 2.063" x 1.063"		
<b>WARRANTY</b>	Three Year Warranty		

**optronics**

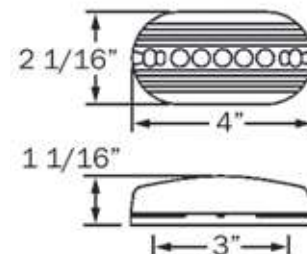



## MC68 SERIES Oblong Marker/Clearance Lights

- Surface mount on 2-3/4" centers
- Single wire design grounds through mounting hardware
- Snap-on lens, replaceable bulb



MC68AB



MC68RB

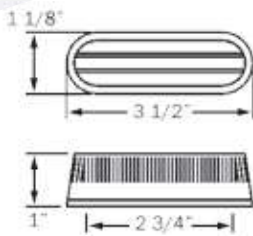

SURFACE MOUNT  
MARKER/CLEARANCE LIGHTS

BULK P/N	POLYPACK P/N	DESCRIPTION	QTY
<b>YELLOW</b>			
MC68AB	MC68ABP	Yellow, self grounding	50
<b>RED</b>			
MC68RB	MC68RBP	Red, self grounding	50
<b>ACCESSORIES</b>			
A68AB	A68ABP	Yellow replacement lens	10
A68RB	A68RBP	Red replacement lens	10
<b>RETAIL</b>			
MC68AS		Yellow light, clam	12
MC68RS		Red light, clam	12



FMVSS	P2
MATERIALS	Acrylic lens, ABS housing
VOLT/AMP	12.8VDC - 0.2A
WT/DIMS	.088 lb. / 3.5" x 1.125" x 1"
WARRANTY	Three Year Warranty



## MC70 SERIES Marker/Clearance Lights with Reflex

- Surface mount on 4-13/16" centers
- Lens with reflex eliminates need for separate reflector
- Weathertight plug included



MC70AB



MC70RB

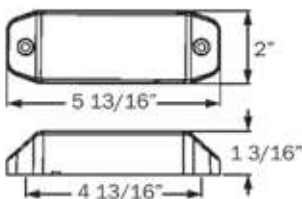

BULK P/N	POLYPACK P/N	DESCRIPTION	QTY
<b>YELLOW</b>			
MC70AB	MC70ABP	Yellow	20
<b>RED</b>			
MC70RB	MC70RBP	Red	20

FMVSS	A P2
MATERIALS	Acrylic lens, plastic housing
VOLT/AMP	12.8VDC - 0.422A
WT/DIMS	.132 lb. / 5.813" x 2" x 1.188"
WARRANTY	Three Year Warranty

## MC71 SERIES Marker/Clearance Lights

- Flush mount on 2" centers; chrome finish bezel
- Twist-in socket, includes both lead and ground wire
- Replaceable bulb

BULK P/N	POLYPACK P/N	DESCRIPTION	QTY
<b>RETAIL</b>			
MC71AS		Yellow light, clam	12
MC71RS		Red light, clam	12
<b>ACCESSORIES</b>			
A194B	A194BP	194 replacement bulb	100

<b>FMVSS</b>	P2
<b>MATERIALS</b>	Acrylic lens, ABS housing and bezel
<b>VOLT/AMP</b>	12.8VDC - 0.4A
<b>WT/DIMS</b>	.132 lb. / 3.75" x 2.25" x 0.5"
<b>WARRANTY</b>	Three Year Warranty

**optronics**



MC71AS



MC71RS

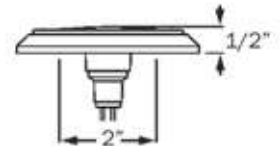
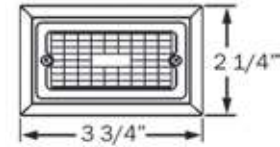

SURFACE MOUNT  
MARKER/CLEARANCE LIGHTS

## MC76 SERIES Marker/Clearance Light with Reflex

- Dual bulb light with built-in reflex
- Lens with reflex eliminates need for separate reflector
- Surface mount on 4-13/16" centers
- Hard wired, single wire design is self grounding

BULK P/N	POLYPACK P/N	DESCRIPTION	QTY
<b>YELLOW</b>			
MC76AB	MC76ABP	Yellow	50
<b>ACCESSORIES</b>			
A194B	A194BP	194 replacement bulb	100

<b>FMVSS</b>	A P2
<b>MATERIALS</b>	Acrylic lens, ABS housing
<b>VOLT/AMP</b>	12.8VDC - 1.0A
<b>WT/DIMS</b>	.132 lb. / 6" x 2.063" x 1"
<b>WARRANTY</b>	Three Year Warranty

**optronics**



MC76AB

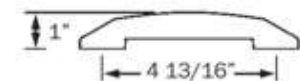
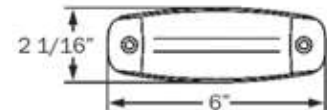





## MC81 SERIES Chrome Marker/Clearance Lights

- Surface mount on 3-7/8" centers
- Single wire design grounds through mounting hardware
- Replaceable lens and bulb





MC81AB

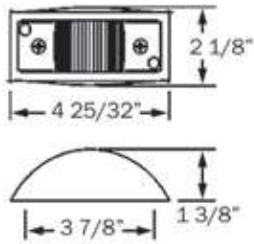

MC81RB



BULK P/N	POLYPACK P/N	DESCRIPTION	QTY
<b>YELLOW</b>			
MC81AB	MC81ABP	Yellow, self grounding	50
<b>RED</b>			
MC81RB	MC81RBP	Red, self grounding	50
<b>ACCESSORIES</b>			
A194B	A194BP	194 replacement bulb	100
<b>RETAIL</b>			
MC81AS		Yellow light, clam	12
MC81RS		Red light, clam	12

<b>FMVSS</b>	P2
<b>MATERIALS</b>	Acrylic lens, ABS housing
<b>VOLT/AMP</b>	12.8VDC - 0.2A
<b>WT/DIMS</b>	.176 lb. / 4.781" x 2.125" x 1.375"
<b>WARRANTY</b>	Three Year Warranty

SURFACE MOUNT  
MARKER/CLEARANCE LIGHTS



## MC82 SERIES Armored Marker/Clearance Lights

- Surface mount on 3-7/8" centers
- Single wire design grounds through mounting hardware
- Replaceable lens and bulb



MC82AB



MC82RB

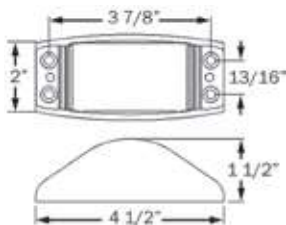

BULK P/N	POLYPACK P/N	DESCRIPTION	QTY
<b>YELLOW</b>			
MC82AB	MC82ABP	Yellow	20
<b>RED</b>			
MC82RB	MC82RBP	Red	20
<b>ACCESSORIES</b>			
A82AB	A82ABP	Yellow replacement lens	50
A82RB	A82RBP	Red replacement lens	50
A194B	A194BP	194 replacement bulb	100

<b>FMVSS</b>	P2 PC
<b>MATERIALS</b>	Acrylic lens, painted steel housing
<b>VOLT/AMP</b>	12.8VDC - 0.2A
<b>WT/DIMS</b>	.441 lb. / 4.5" x 2" x 1.5"
<b>WARRANTY</b>	Three Year Warranty

## MC85 SERIES Sealed Marker/Clearance Light

- Sonically sealed, waterproof
- Surface mount on 2-3/4" centers
- Hard wired, single wire design is self grounding

BULK P/N	POLYPACK P/N	DESCRIPTION	QTY
<b>YELLOW</b>			
MC85AB	MC85ABP	Yellow	50

<b>FMVSS</b>	P2 P3
<b>MATERIALS</b>	Polycarbonate lens and housing
<b>VOLT/AMP</b>	12.8VDC - 0.2A
<b>WT/DIMS</b>	.066 lb. / 3.188" x 1.063" x 1.063"
<b>WARRANTY</b>	Three Year Warranty



MC85AB

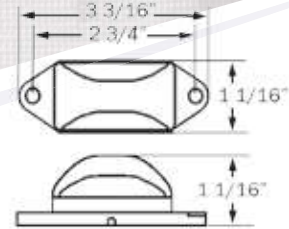

## MC95 SERIES Sealed Marker/Clearance Lights

- Sonically sealed, waterproof
- Stainless steel base
- Single wire design grounds through mounting hardware

BULK P/N	POLYPACK P/N	DESCRIPTION	QTY
<b>YELLOW</b>			
MC95AB	MC95ABP	Yellow	50
MC95APG	-	Yellow, .180 male bullet	50

<b>RED</b>			
MC95RB	MC95RBP	Red	50

<b>RETAIL</b>			
MC95AS		Yellow light, clam	12
MC95RS		Red light, clam	12

<b>FMVSS</b>	P2 P3
<b>MATERIALS</b>	Polycarbonate lens and housing, stainless steel base
<b>VOLT/AMP</b>	12.8VDC - 0.2A
<b>WT/DIMS</b>	.088 lb. / 2.063" x .688" x 1"
<b>WARRANTY</b>	Three Year Warranty



MC95AB



MC95RB

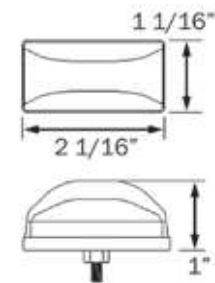

SURFACE MOUNT  
MARKER/CLEARANCE LIGHTS



## CB11WAB Yellow Cab/Clearance Light

- White base, mounts on 3" centers
- Replaceable lens and bulb (67 bulb)
- Includes both lead and ground wires



CB11WAB

BULK P/N	POLYPACK P/N	DESCRIPTION	QTY
<b>CAB/CLEARANCE LIGHT</b>			
CB11WAB	CB11WABP	Yellow, white base	50

FMVSS	P2 PC
MATERIALS	Acrylic lens, ABS housing
VOLT/AMP	12.8VDC - 0.569A
WT/DIMS	.265 lb. / 5.5" x 2.375" x 1.625"
WARRANTY	Three Year Warranty

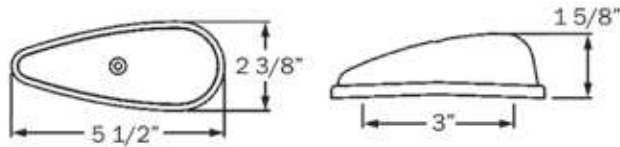

SURFACE MOUNT  
MARKER/CLEARANCE LIGHTS



## CB11AS/CB15AK Yellow Cab/Clearance Lights

- Black base, mounts on 3" centers
- Replaceable lens and bulb (67 bulb)
- Single wire design, self grounding



CB11AS



CB15AK

BULK P/N	POLYPACK P/N	DESCRIPTION	QTY
<b>RETAIL</b>			
CB11AS		Cab light, clam	12
CB15AK		5-pc cab light kit, clam	6

FMVSS	P2 PC
MATERIALS	Acrylic lens, ABS housing
VOLT/AMP	12.8VDC - 0.569A
WT/DIMS	CB11: .176 lb. / 5.5" x 2.375" x 1.625"
	CB15: 1.191 lbs. / 5.5" x 2.375" x 1.625"
WARRANTY	Three Year Warranty

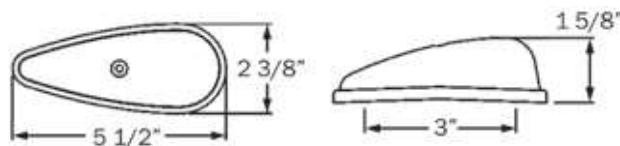



## CB20AB

### Yellow Cab/Clearance Light

- Surface mount on 1-1/2" centers, gasket included
- Sealed polycarbonate lens and housing
- Includes both lead and ground wires



CB20AB

BULK P/N	POLYPACK P/N	DESCRIPTION	QTY
<b>CAB/CLEARANCE LIGHT</b>			
CB20AB	CB20ABP	Yellow	50
<b>RETAIL</b>			
CB20AS		Yellow, clam	12



FMVSS	P2 PC
MATERIALS	Acrylic lens, ABS housing
VOLT/AMP	12.8VDC - 0.2A
WT/DIMS	.265 lb. / 3.5" x 2.75" x 1.688"
WARRANTY	Three Year Warranty

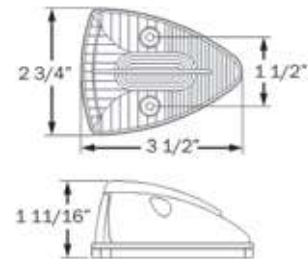

SURFACE MOUNT  
MARKER/CLEARANCE LIGHTS

## CB22 SERIES

### Cab/Clearance Lights



- Surface mount on 1-3/4" centers, gasket included
- Sealed polycarbonate lens and housing
- Twist-in socket with both lead and ground wires

BULK P/N	POLYPACK P/N	DESCRIPTION	QTY
<b>YELLOW</b>			
CB22AB	CB22ABP	Yellow	50
<b>RED</b>			
CB22RB	CB22RBP	Red	50
<b>ACCESSORIES</b>			
A194B	A194BP	194 replacement bulb	100
<b>RETAIL</b>			
CB22AS		Yellow, clam	12



FMVSS	P2 PC
MATERIALS	Polycarbonate lens and housing
VOLT/AMP	12.8VDC - 0.2A
WT/DIMS	.132 lb. / 3.875" x 3.125" x 1.625"
WARRANTY	Three Year Warranty



CB22AB



CB22RB

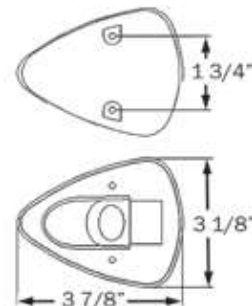



## MC77RB Identification Light Bar



MC77RB

- Steel base with white finish
- Surface mount on 7" centers
- Snap-on lens and replaceable bulb
- Single wire design, self grounding

BULK P/N	POLYPACK P/N	DESCRIPTION	QTY
----------	--------------	-------------	-----

### RED ID LIGHT BAR

MC77RB	MC77RBP	ID light bar	20
--------	---------	--------------	----

### ACCESSORIES

A68RB	A68RBP	Red replacement lens	10
-------	--------	----------------------	----

FMVSS	P2
MATERIALS	Acrylic lens, ABS housing, steel base
VOLT/AMP	12.8VDC - 1.0A (193 bulb)
WT/DIMS	.265 lb. / 15.563" x 1.188" x 1.313"
WARRANTY	Three Year Warranty

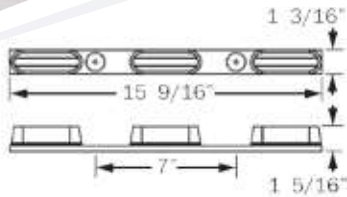

IDENTIFICATION  
LIGHT BARS



## MC93 SERIES Sealed Identification Light Bars

MC93AB



MC93RB

- Surface mount on 7-1/2" centers
- Sealed, waterproof lights
- Hard wired, power and ground

BULK P/N	POLYPACK P/N	DESCRIPTION	QTY
----------	--------------	-------------	-----

### YELLOW

MC93AB	MC93ABP	Yellow	20
--------	---------	--------	----

### RED

MC93RB	MC93RBP	Red	20
--------	---------	-----	----

MC93RPG	MC93RPGP	Red, .180 male bullet on power wire	20
---------	----------	-------------------------------------	----

MC93R2PG	MC93R2PGP	Red, .180 male bullets on both wires	20
----------	-----------	--------------------------------------	----

### ACCESSORIES

A91AB	A91ABP	Yellow replacement light	100
-------	--------	--------------------------	-----

A91RB	A91RBP	Red replacement light	100
-------	--------	-----------------------	-----

A93PB	A93PBP	Harness for light bar	100
-------	--------	-----------------------	-----

### RETAIL

MC93RK		Red ID light bar, clam	6
--------	---	------------------------	---

FMVSS	P2
MATERIALS	Polycarbonate lens and housing, ABS base
VOLT/AMP	12.8VDC - 1.0A
WT/DIMS	.397 lb. / 17" x 1.438" x 1.625"
WARRANTY	Three Year Warranty

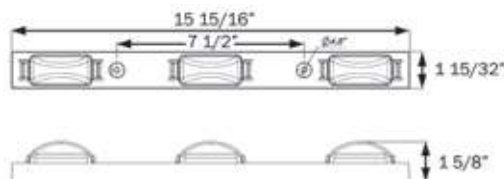

## MC94RB Identification Light Bar

- Stainless steel base
- Surface mount on 16-1/16" centers
- Sealed, waterproof lights
- Hard wired, power and ground



MC94RB

BULK P/N	POLYPACK P/N	DESCRIPTION	QTY
<b>RED ID LIGHT BAR</b>			
MC94RB	MC94RBP	ID light bar	20
<b>ACCESSORIES</b>			
A91RB	A91RBP	Red replacement light	100
A93PB	A93PBP	Harness for light bar	100

<b>FMVSS</b>	P2
<b>MATERIALS</b>	Polycarbonate lens and housing, stainless steel base
<b>VOLT/AMP</b>	12.8VDC - 1.0A
<b>WT/DIMS</b>	.441 lb. / 16.5" x 1.375" x 1.625"
<b>WARRANTY</b>	Three Year Warranty

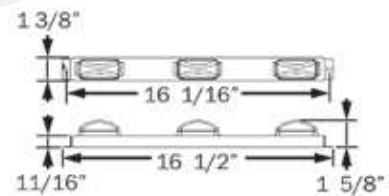

IDENTIFICATION LIGHT BARS

## MC97 SERIES Sealed Identification Light Bars

- Stainless steel base
- Surface mount on 8-1/2" centers
- Sealed, waterproof lights
- Single wire, self grounding



MC97RB

BULK P/N	POLYPACK P/N	DESCRIPTION	QTY
<b>RED ID LIGHT BARS</b>			
MC97RB	MC97RBP	Red	20
MC97R70PG	-	Red, .156 female plug, 70" lead	20
MC97RTTG	-	Red, .180 female plug	50
<b>CLEAR UTILITY LIGHT</b>			
UL97CPG	UL97CPGP	Clear	50
<b>ACCESSORIES</b>			
MC95RB	MC95RBP	Red replacement light	50
<b>RETAIL</b>			
MC97RK		Red ID light bar, clam	6

<b>FMVSS</b>	P2
<b>MATERIALS</b>	Polycarbonate lens and housing, stainless steel base
<b>VOLT/AMP</b>	12.8VDC - 1.0A
<b>WT/DIMS</b>	.441 lb. / 14.25" x 1.188" x 1.313"
<b>WARRANTY</b>	Three Year Warranty

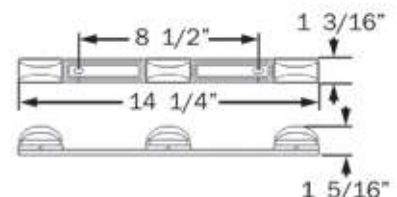





## MC99 SERIES Identification Light Bars

MC99AB





MC99RB

- Steel base with white finish
- Surface mount on 14-3/8" centers
- Snap-on lens, replaceable bulbs
- Single wire, self grounding

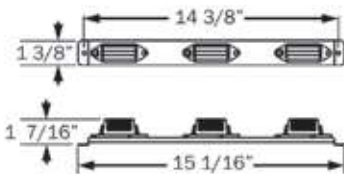
IDENTIFICATION  
LIGHT BARS



BULK P/N	POLYPACK P/N	DESCRIPTION	QTY
<b>YELLOW</b>			
MC99AB	MC99ABP	Yellow	20
<b>RED</b>			
MC99RB	MC99RBP	Red	20
<b>ACCESSORIES</b>			
A11AB	A11ABP	Yellow replacement lens	50
A11RB	A11RBP	Red replacement lens	50
A194B	A194BP	194 replacement bulb	100
<b>RETAIL</b>			
MC99AK		Yellow ID light bar, clam	6
MC99RK		Red ID light bar, clam	6

FMVSS	P2
MATERIALS	Acrylic lens, ABS housing, steel base
VOLT/AMP	12.8VDC - 1.0A
WT/DIMS	.353 lb. / 15.063" x 1.375" x 1.438"
WARRANTY	Three Year Warranty



## RB10A Magnet Mount Rotary Beacon



RB10A

- 12V rotary beacons for magnet mount
- 10-ft coil cord with power plug
- Replaceable bulb

BULK P/N	DESCRIPTION	QTY
<b>RETAIL</b>		
RB10A	Yellow rotary beacon, clam	6



MATERIALS	Acrylic lens
VOLT/AMP	12.8VDC - 1.45A
WT/DIMS	1.6 lb. / 4.75" x 4.75" x 5.25"
WARRANTY	Three Year Warranty

## LP11 SERIES Snap-In Mini License Plate Lights

- Chrome plated brass construction
- Easy snap-in mounting
- Replaceable bulb (67)
- Single wire, self grounding

BULK P/N	POLYPACK P/N	DESCRIPTION	QTY
<b>LICENSE LIGHTS</b>			
LP11CB	LP11CBP	License light	50
LP11CPG	LP11CPGP	License light, .180 male bullet	50
<b>RETAIL</b>			
LP11CS		License light, clam	12

FMVSS	(2) L
MATERIALS	Brass, chrome plated
VOLT/AMP	12.8VDC - 0.4A
WT/DIMS	.066 lb. / 1.5" x 1.5" x 2"
WARRANTY	Three Year Warranty

**optronics**



LP11CB

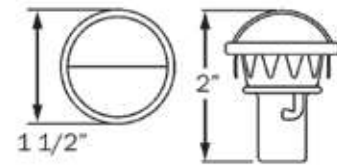

LICENSE/UTILITY LIGHTS

## LP21 SERIES Heavy Duty License Plate Lights

- Armored light made of durable chrome plated steel
- Surface mount on 2" centers
- Replaceable bulb (67)
- Single wire, self grounding

BULK P/N	POLYPACK P/N	DESCRIPTION	QTY
<b>LICENSE LIGHTS</b>			
LP21CB	LP21CBP	License light	50
<b>RETAIL</b>			
LP21CS		License light, clam	12

FMVSS	L
MATERIALS	Brass, chrome plated
VOLT/AMP	12.8VDC - 0.2A
WT/DIMS	.132 lb. / 2.5" x 1.813" x 2"
WARRANTY	Three Year Warranty

**optronics**



LP21CB

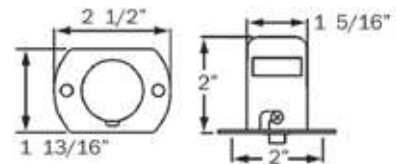



## LP31 SERIES Mini License Plate Light

- Surface mount on 2" centers
- Replaceable bulb
- Two-wire design includes both lead and ground wire



LP31CB



LPB31CPG

BULK P/N	POLYPACK P/N	DESCRIPTION	QTY
<b>LICENSE LIGHTS</b>			
LP31CB	LP31CBP	License light	50
LP31CPG	LP31CPGP	License light, .156 female barrels	50
LPB31CPG	LPB31CPGP	License light mounted on black plastic bracket, .156 female barrels	25
<b>ACCESSORIES</b>			
A194B	A194BP	194 replacement bulb	100
<b>RETAIL</b>			
LP31CS		License light, clam	12

<b>FMVSS</b>	(2) L
<b>MATERIALS</b>	Brass, chrome plated bezel; stainless steel bulb socket
<b>VOLT/AMP</b>	12.8VDC - 0.261A
<b>WT/DIMS</b>	.088 lb. / 2.563" x 1.25" x 1" (light only)
<b>WARRANTY</b>	Three Year Warranty

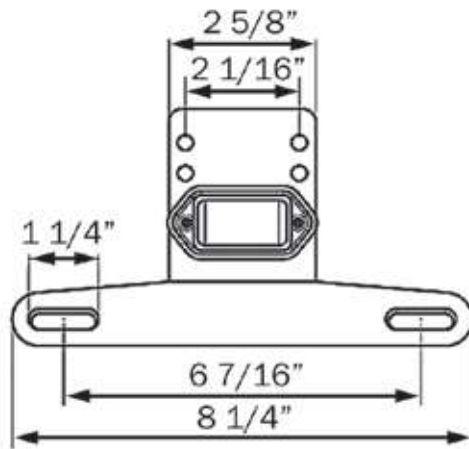

LPB31CPG

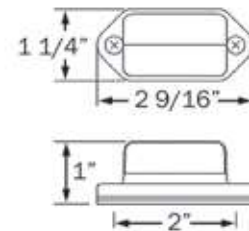
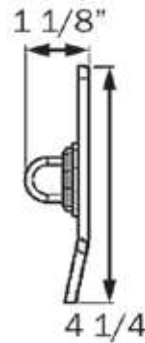

LP31CB



## LP41 SERIES Stud Mount License Plate Light

- Chrome plated cover, black base
- Stud mount on 1-3/4" centers
- Replaceable bulb
- Single wire, self grounding

BULK P/N	POLYPACK P/N	DESCRIPTION	QTY
<b>LICENSE LIGHTS</b>			
LP41CB	LP41CBP	License light	50
<b>ACCESSORIES</b>			
A194B	A194BP	194 replacement bulb	100
<b>RETAIL</b>			
LP41CS		License light, clam	12

FMVSS	L
MATERIALS	Brass, chrome plated
VOLT/AMP	12.8VDC - 0.2A
WT/DIMS	.11 lb. / 2.625" x 1.563" x 2.188"
WARRANTY	Three Year Warranty

**optronics**



LP41CB

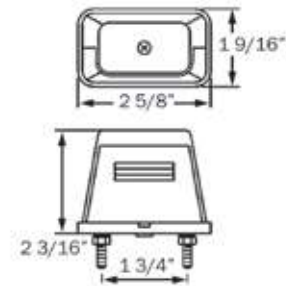

LICENSE/UTILITY LIGHTS

## LP51 SERIES Surface Mount License Plate Light

- Gray coated cover, stainless steel mounting base
- Stud mount on 3-1/4" centers
- Replaceable bulb
- Single wire, self grounding

BULK P/N	POLYPACK P/N	DESCRIPTION	QTY
<b>LICENSE LIGHTS</b>			
LP51CB	LP51CBP	License light	20
<b>ACCESSORIES</b>			
A194B	A194BP	194 replacement bulb	100

FMVSS	L
MATERIALS	Stainless steel mounting base, plastic cover
VOLT/AMP	12.8VDC - 0.2A
WT/DIMS	.309 lb. / 4" x 1.75" x 2.313"
WARRANTY	Three Year Warranty

**optronics**



LP51CB

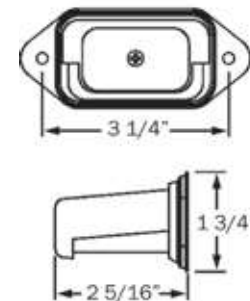



## LP52/54 SERIES License Plate Light with Bracket



LP52CB

- Light features gray coated cover, stainless steel mounting base; bracket is steel with black finish
- Surface mount on 3.5" centers, hardware included
- Replaceable bulb

BULK P/N	POLYPACK P/N	DESCRIPTION	QTY
<b>LICENSE LIGHTS</b>			
LP52CB	LP52CBP	License light, single wire	10
LP54CB	LP54CBP	License light, two-wire	10
<b>ACCESSORIES</b>			
LP52HP	LP52HPP	Mounting hardware	100
A194B	A194BP	194 replacement bulb	100

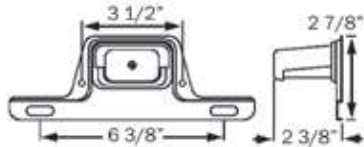

FMVSS	L
MATERIALS	Stainless steel mounting base, plastic cover, steel bracket
VOLT/AMP	12.8VDC - 0.2A
WT/DIMS	.309 lb. / 8.5" x 2.875" x 2.375"
WARRANTY	Three Year Warranty

LICENSE/UTILITY LIGHTS



## LP55 SERIES License Plate Light with Bracket



LP55CB

- Light features gray coated cover, stainless steel mounting base; bracket is black heavy duty plastic
- Surface mount on 6-7/16" centers
- Includes both lead and ground wires
- Replaceable bulb (67)

BULK P/N	POLYPACK P/N	DESCRIPTION	QTY
<b>LICENSE LIGHTS</b>			
LP55CB	LP55CBP	License light	10

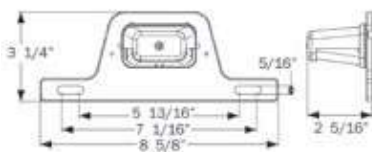

FMVSS	L
MATERIALS	Stainless steel mounting base, plastic cover, plastic bracket
VOLT/AMP	12.8VDC - 0.2A
WT/DIMS	.176 lb. / 8.625" x 3.25" x 2.313"
WARRANTY	Three Year Warranty

## LP56 SERIES Surface Mount License Plate Light

- Surface mount with included adhesive
- Replaceable bulb (67)
- Single wire, self grounding

BULK P/N	POLYPACK P/N	DESCRIPTION	QTY
<b>LICENSE LIGHTS</b>			
LP56CB	LP56CBP	License light	50

<b>FMVSS</b>	L
<b>MATERIALS</b>	Gray plastic housing
<b>VOLT/AMP</b>	12.8VDC - 0.2A
<b>WT/DIMS</b>	.11 lb. / 2.625" x 1.625" x 2"
<b>WARRANTY</b>	Three Year Warranty



LP56CB

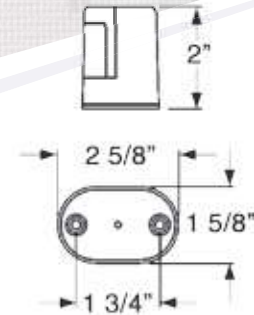

LICENSE/UTILITY LIGHTS

## LP65 SERIES Sealed License Plate Light

- Sonically sealed, waterproof
- Multiple mounting and wiring options

BULK P/N	POLYPACK P/N	DESCRIPTION	QTY
<b>LICENSE LIGHTS</b>			
LP65CB	LP65CBP	License light	50

<b>ACCESSORIES</b>			
A65B	A65BP	Black bracket	50
A65P	A65PP	Single wire plug, .156 male bullet	50
A65PB	A65PBP	Kit: A65B black bracket & A65P plug	50
A66PB	A66PBP	Kit: Gray bracket & A65P plug	50
A67CB	A67CBP	Kit: Chrome bracket & A65P plug	50
A68PB	A68PBP	Kit: Black bracket & 2-wire plug	50

For more details on mounting and wiring accessories, see Accessories section at back of catalog.

<b>FMVSS</b>	L
<b>MATERIALS</b>	Polycarbonate lens and housing
<b>VOLT/AMP</b>	12.8VDC - 0.656A
<b>WT/DIMS</b>	.066 lb. / 3.938" x 1.25" x 0.875"
<b>WARRANTY</b>	Three Year Warranty



LP65CB

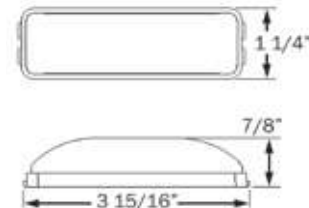







## LP71 SERIES Chrome License Plate Light

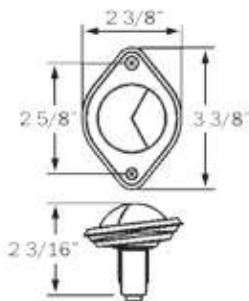

LP71CB

- Chrome-plated brass and steel housing
- Mount on 2-5/8" centers
- Replaceable bulb (67)
- Single wire, self grounding
- Two units required for legal license illumination



BULK P/N	POLYPACK P/N	DESCRIPTION	QTY
<b>LICENSE LIGHTS</b>			
LP71CB	LP71CBP	License light	25
<b>RETAIL</b>			
LP71CS		License light, clam	12

FMVSS	(2) L
MATERIALS	Brass and stainless steel housing
VOLT/AMP	12.8VDC - 0.2A
WT/DIMS	.058 lb. / 3.375" x 2.375" x 2.188"
WARRANTY	Three Year Warranty

LICENSE/UTILITY LIGHTS



## LP81 SERIES Surface Mount License Plate Light



LP81BB

- Surface mount on 3-7/16" centers
- Replaceable bulb
- Includes both lead and ground wires
- Available in standard black and optional gray color

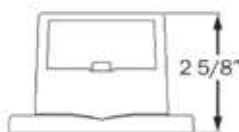
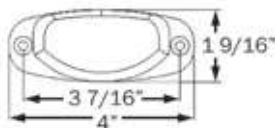

BULK P/N	POLYPACK P/N	DESCRIPTION	QTY
<b>LICENSE LIGHTS</b>			
LP81BB	LP81BBP	License light	50
LP81BPG	-	License light, .180 male plug on power, ground eyelet on ground	50
LP81GB	-	License light, gray housing	50
<b>ACCESSORIES</b>			
A194B	A194BP	194 replacement bulb	100

FMVSS	L
MATERIALS	Polycarbonate housing
VOLT/AMP	12.8VDC - 0.2A
WT/DIMS	.11 lb. / 4" x 1.563" x 2.625"
WARRANTY	Three Year Warranty

## LP97 SERIES Sealed License/Utility Light

- Sonically sealed, waterproof
- Terminal is two .156 female barrels

BULK P/N	POLYPACK P/N	DESCRIPTION	QTY
<b>LICENSE LIGHTS</b>			
LP97CB	LP97CBP	License light	50

FMVSS	L
MATERIALS	Polycarbonate lens and housing
VOLT/AMP	12.8VDC - 0.2A
WT/DIMS	.11 lb. / 3.375" x 1.25" x 2.375"
WARRANTY	Three Year Warranty



LP97CB

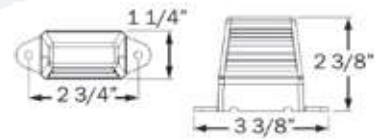

LICENSE/UTILITY LIGHTS

## LP95CBF Sealed Stud Mount License/Utility Light

- Sonically sealed, waterproof
- Design includes both lead and ground wires with .180 female barrels

BULK P/N	POLYPACK P/N	DESCRIPTION	QTY
<b>LICENSE/UTILITY LIGHTS</b>			
LP95CBF	-	License/utility light	50

MATERIALS	Polycarbonate lens and housing, stainless steel base
VOLT/AMP	12.8VDC - 0.2A
WT/DIMS	.066 lb. / 2.063" x .688" x 1"
WARRANTY	Three Year Warranty



LP95CBF

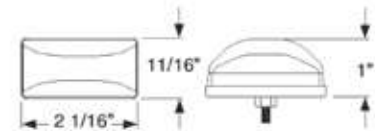



## LP85 SERIES Sealed License/Utility Light



LP85CB

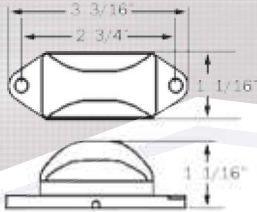

- Sonically sealed, waterproof
- Single wire design grounds through mounting hardware

BULK P/N	POLYPACK P/N	DESCRIPTION	QTY
<b>LICENSE/UTILITY LIGHTS</b>			
LP85CB	LP85CBP	License/utility light	50

<b>MATERIALS</b>	Polycarbonate lens and housing
<b>VOLT/AMP</b>	12.8VDC - 0.2A
<b>WT/DIMS</b>	.066 lb. / 3.188" x 1.063" x 1.063"
<b>WARRANTY</b>	Three Year Warranty



## LP91 SERIES Sealed License/Utility Light



LP91CB

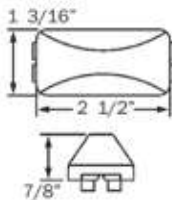

- Sonically sealed, waterproof
- Multiple mounting and wiring options

BULK P/N	POLYPACK P/N	DESCRIPTION	QTY
<b>LICENSE/UTILITY LIGHTS</b>			
LP91CB	LP91CBP	License/utility light	50
LP26SKB	LP26SKBP	Kit: LP91CB, LP25SGGB, gasket, .180 male bullets on power and ground	50

<b>LICENSE LIGHT BRACKET</b>			
LP25SB	LP25SBP	Vertical bracket, black coated	100

<b>ACCESSORIES</b>			
A46PB	A46PBP	2-wire plug, 6" lead	100
A86PB	A86PBP	2-wire plug, 18" lead	100
A91LW	A91LWP	1-wire plug, 12" lead	100
A91BB	A91BBP	Black base, self grounding	100
A91BOB	A91BOBP	Black base, open back	100
A91CB	A91CBP	Chrome base, self grounding	100
A91OB	A91OBP	Chrome base, open back	100
A91GB	A91GBP	Grommet	100



LP26SKB

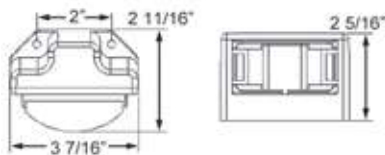

<b>MATERIALS</b>	Polycarbonate lens and housing
<b>VOLT/AMP</b>	12.8VDC - 0.2A
<b>WT/DIMS</b>	.066 lb. / 2.5" x 1.1885" x 0.875"
<b>WARRANTY</b>	Three Year Warranty



## UL94 SERIES

### Sealed Stud Mount License/Utility Light

- Sonically sealed, waterproof
- Polycarbonate housing, stainless steel base, clear lens
- Single wire design grounds through mounting hardware

BULK P/N	POLYPACK P/N	DESCRIPTION	QTY
<b>LICENSE/UTILITY LIGHT</b>			
UL94CB	UL94CBP	License/utility light	50

<b>MATERIALS</b>	Polycarbonate lens and housing, stainless steel base
<b>VOLT/AMP</b>	12.8VDC - 0.2A
<b>WT/DIMS</b>	.088 lb. / 2.125" x 1.125" x 1.063"
<b>WARRANTY</b>	Three Year Warranty



UL94CB

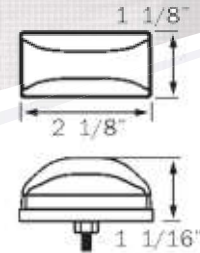

## UL95 SERIES

### Sealed Launch/Load Light

- Sonically sealed, waterproof
- Polycarbonate lens and housing
- Accepts standard two-pin PL-10 connector
- Multiple mounting and wiring options available

BULK P/N	POLYPACK P/N	DESCRIPTION	QTY
<b>LAUNCH/LOAD LIGHT</b>			
UL95CB	UL95CBP	Launch/load light	100

<b>ACCESSORIES</b>			
A46PB	A46PBP	2-wire plug, 6" lead	100
A86PB	A86PBP	2-wire plug, 18" lead	100
A91LW	A91LWP	1-wire plug, 12" lead	100
A91BB	A91BBP	Black base, self grounding	100
A91BOB	A91BOBP	Black base, open back	100
A91CB	A91CBP	Chrome base, self grounding	100
A91OB	A91OBP	Chrome base, open back	100
A91GB	A91GBP	Grommet	100

<b>MATERIALS</b>	Polycarbonate lens and housing
<b>VOLT/AMP</b>	12.8VDC - 0.4A
<b>WT/DIMS</b>	.066 lb. / 2.625" x 1.25" x 1.188"
<b>WARRANTY</b>	Three Year Warranty



UL95CB

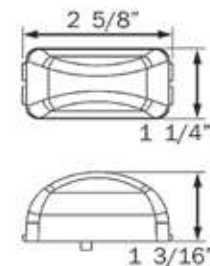



## UL97 SERIES Sealed Utility Light Bar



UL97CPCG

- Sonically sealed, waterproof
- Polycarbonate lens and housing, stainless steel base
- Single wire design grounds through mounting hardware
- Plug-n-go connector

BULK P/N	POLYPACK P/N	DESCRIPTION	QTY
<b>UTILITY LIGHT</b>			
UL97CPCG	UL97CPGP	Utility light bar	50

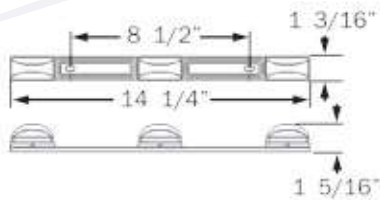

<b>MATERIALS</b>	Polycarbonate lens and housing, stainless steel base
<b>VOLT/AMP</b>	12.8VDC - 0.4A
<b>WT/DIMS</b>	.265 lb. / 14.25" x 1.188" x 1.313"
<b>WARRANTY</b>	Three Year Warranty

LICENSE/UTILITY LIGHTS



## UL71 SERIES Courtesy/Utility Light



UL71CS

- Chrome-plated ABS housing
- Twist-in bulb socket with lead and ground wires
- Replaceable bulb

BULK P/N	POLYPACK P/N	DESCRIPTION	QTY
<b>RETAIL</b>			
UL71CS		Utility light, clam	12
<b>ACCESSORIES</b>			
A194B	A194BP	194 replacement bulb	100

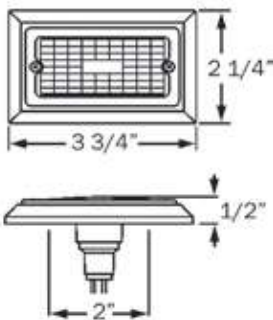

<b>MATERIALS</b>	Acrylic lens, ABS housing
<b>VOLT/AMP</b>	12.8VDC - 0.4A
<b>WT/DIMS</b>	.176 lb. / 3.75" x 2.25" x .5"
<b>WARRANTY</b>	Three Year Warranty

## UL53 SERIES 2" Sealed Utility Light

- Sonically sealed, waterproof
- Accepts standard two-pin PL-10 plug

BULK P/N	POLYPACK P/N	DESCRIPTION	QTY
<b>UTILITY LIGHT</b>			
UL53CB	UL53CBP	Utility light	100/50
<b>ACCESSORIES</b>			
A46PB	A46PBP	Straight plug, 6" lead	100
A86PB	A86PBP	Straight plug, 18" lead	100
A54GB	A54GBP	2" Flush mount grommet	100
A54GK	A54GKP	2" Kit: A54GB and A46PB	100
A55CB	A55CBP	2" Chrome trim ring	20
BK5557GB	BK5557GBP	Cam-on mounting bracket	50

<b>MATERIALS</b>	Polycarbonate lens and housing
<b>VOLT/AMP</b>	12.8VDC - 0.6A
<b>WT/DIMS</b>	.044 lb. / 2" x 2" x .688"
<b>WARRANTY</b>	Three Year Warranty

**optronics**



UL53CB

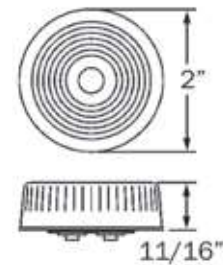

UTILITY/INTERIOR LIGHTS

## UL56 SERIES 2.5" Sealed Utility Light

- Sonically sealed, waterproof
- Accepts standard two-pin PL-10 plug
- Flush mount design with flange sealed to light

BULK P/N	POLYPACK P/N	DESCRIPTION	QTY
<b>UTILITY LIGHT</b>			
UL56CB	UL56CBP	Utility light	100/50
<b>ACCESSORIES</b>			
A46PB	A46PBP	Straight plug, 6" lead	100
A86PB	A86PBP	Straight plug, 18" lead	100

<b>MATERIALS</b>	Polycarbonate lens and housing
<b>VOLT/AMP</b>	12.8VDC - 0.6A
<b>WT/DIMS</b>	.044 lb. / 3.438" x 3.438" x .0938"
<b>WARRANTY</b>	Three Year Warranty

**optronics**



UL56CB

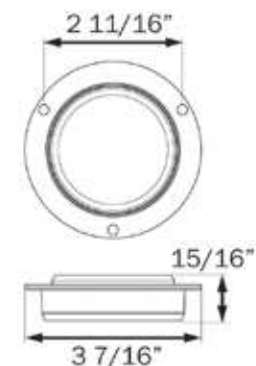







## IL21 SERIES Interior Dome Light

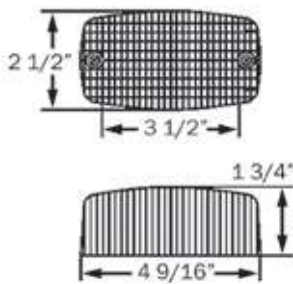

IL21CB

- Surface mount dome light with or without on/off switch
- Mounts on 3-1/2" centers
- Includes both lead and ground wire
- Replaceable bulb (1156)



BULK P/N	POLYPACK P/N	DESCRIPTION	QTY
<b>INTERIOR LIGHTS</b>			
IL21CB	IL21CBP	Interior light with switch, two-wire	50
IL21CPG	-	Interior light with switch, single wire with .180 male bullet	50
IL22CB	IL22CBP	Interior light without switch, two-wire	50
<b>RETAIL</b>			
IL21CS		Interior dome light with switch, clam	12

MATERIALS	Polycarbonate lens, steel base plate
VOLT/AMP	12.8VDC - 2.4A
WT/DIMS	.309 lb. / 4.563" x 2.5" x 1.75"
WARRANTY	Three Year Warranty

UTILITY/INTERIOR LIGHTS



## IL31CS Porch or Cabin Light



IL31CS

- Surface mount light with on/off switch
- Aluminum base, durable plastic lens
- Single wire design grounds through mounting hardware
- Replaceable bulb (1156)

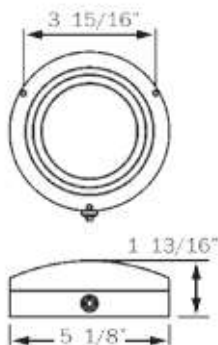

BULK P/N	POLYPACK P/N	DESCRIPTION	QTY
<b>RETAIL</b>			
IL31CS		Porch/cabin light, clam	6

MATERIALS	Plastic lens, aluminum housing
VOLT/AMP	12.8VDC - 2.2A
WT/DIMS	.375 lb. / 5.125" x 5.125" x 1.813"
WARRANTY	Three Year Warranty

## IL41 SERIES

### 4" Interior/Exterior Utility Light

- Flange mount light with steel housing and acrylic lens
- Includes both lead and ground wires
- Replaceable bulb (1142)

BULK P/N	POLYPACK P/N	DESCRIPTION	QTY
<b>INTERIOR/EXTERIOR LIGHT</b>			
IL41CB	IL41CBP	Interior light, two-wire	50

<b>MATERIALS</b>	Acrylic lens, steel housing
<b>VOLT/AMP</b>	12.8VDC - 1.5A
<b>WT/DIMS</b>	.441 lb. / 5.375" x 5.375" x 1.533"
<b>WARRANTY</b>	Three Year Warranty



IL41CB

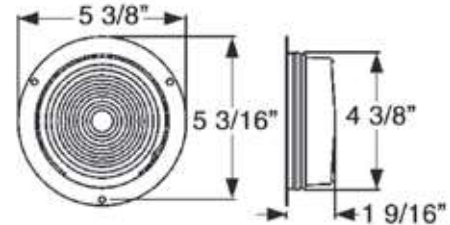

UTILITY/INTERIOR LIGHTS

## IL61 SERIES

### Dome Light with Switch

- Surface mount light with on/off switch
- Aluminum base, durable plastic lens
- Single wire design grounds through mounting hardware
- Replaceable bulb (1141)

BULK P/N	POLYPACK P/N	DESCRIPTION	QTY
<b>DOMELIGHT</b>			
IL61CB	IL61CBP	Dome light	50

<b>MATERIALS</b>	Plastic lens, aluminum housing
<b>VOLT/AMP</b>	12.8VDC - 0.4A
<b>WT/DIMS</b>	.221 lb. / 5.875" x 5.875" x 1.5"
<b>WARRANTY</b>	Three Year Warranty



IL61CB

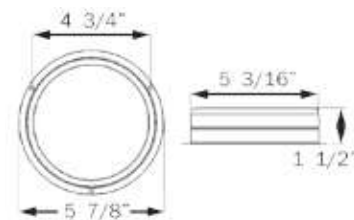



## IL91 SERIES 6" Steel Dome Light

- Surface mount steel base, chrome plated
- Includes both lead and ground wires
- Replaceable bulb (1141)



IL91CB

BULK P/N	POLYPACK P/N	DESCRIPTION	QTY
<b>DOMELIGHT</b>			
IL91CB	IL91CBP	Dome light	50

<b>MATERIALS</b>	Polycarbonate lens, steel housing
<b>VOLT/AMP</b>	12.8VDC - 0.4A
<b>WT/DIMS</b>	.485 lb. / 6.438" x 6.438" x 1.75"
<b>WARRANTY</b>	Three Year Warranty

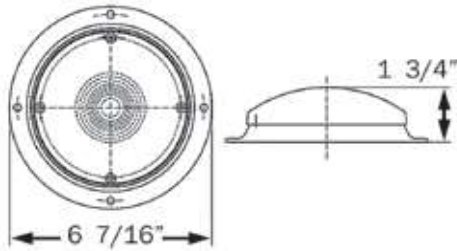

UTILITY/INTERIOR LIGHTS

## TL10 SERIES

### 5" Work Lights, Rubber Housings

- Utility/work/ag light with shock proof rubber housing
- #4411 sealed beam
- Include both lead and ground wires
- Steel bracket, 5/16" mounting post

BULK P/N	POLYPACK P/N	DESCRIPTION	QTY
<b>WORK/UTILITY/AG LIGHTS</b>			
TL10CB	TL10CBP	12V, 2-wire	25
TL10C24VB	TL10C24VBP	24V, 2-wire	25
TL11CPG	-	12V, self grounding, .180 male bullet	25
<b>RETAIL</b>			
TL10CS	12V Work/utility/ag light, clam		6
TL106CS	6V Work/utility/ag light, clam		6
TL10SS	12V Work/utility/ag light, stainless steel bracket, clam		6
TL12CS	12V Work/utility/ag light, recessed bulb, clam		6

<b>MATERIALS</b>	Rubber housing, glass lens, steel bracket
<b>VOLT/AMP</b>	12.8VDC - 2.8A
<b>WT/DIMS</b>	1.235 lbs. / 4.75" x 4.75" x 2.5"
<b>WARRANTY</b>	Three Year Warranty



TL10CB

WORK/AG LIGHTS

## TL35/46 SERIES

### 55W Rectangular Utility/Ag Lights

- Utility/ag light with heavy duty plastic housing
- 12V 55W H3 halogen bulb
- Include both lead and ground wires
- Adjustable, steel mounting bracket

BULK P/N	POLYPACK P/N	DESCRIPTION	QTY
<b>UTILITY/AG LIGHTS</b>			
TL35TB	-	3" x 5" lens, trapezoid beam	20
<b>RETAIL</b>			
TL35FS	3" x 5" lens, flood beam, clam		3
TL35TS	3" x 5" lens, trapezoid beam, clam		3
TL46FS	4" x 6" lens, flood beam, clam		3
TL46TS	4" x 6" lens, trapezoid beam, clam		3
A700	12V 55W H3 quartz halogen bulb, clam		12

<b>MATERIALS</b>	Plastic housing, glass lens, steel bracket
<b>VOLT/AMP</b>	12.8VDC - 4.5A
<b>WT/DIMS</b>	TL35: 1.5 lbs. / 6.5" x 4.375" x 3.75" TL46: 1.5 lbs. / 5.375" x 4.5" x 2.25"
<b>WARRANTY</b>	Three Year Warranty



TL35FS/TS



TL46FS/TS





## DL16 SERIES 55W Docking Lights



DL16CC

- Docking light with heavy duty plastic housing, glass lens
- 12V 55W H3 halogen bulb
- Includes both lead and ground wires with male bullets
- Stainless steel mounting bracket with rubber cover
- Kits include two lights, wiring, mounting hardware and switch



DL16WC

BULK P/N	POLYPACK P/N	DESCRIPTION	QTY
<b>RETAIL</b>			
DL16CC	Kit, black housing		3
DL16WC	Kit, white housing		3
A700	12V 55W H3 quartz halogen bulb, clam		12



<b>MATERIALS</b>	Plastic housing, glass lens, stainless steel bracket
<b>VOLT/AMP</b>	12.8VDC - 4.5A
<b>WT/DIMS</b>	0.663 lb. / 5.875" x 3" x 2.75"
<b>WARRANTY</b>	Three Year Warranty

HALOGEN LIGHTS



## DL55 SERIES 55W Marine Flood Lights



DL55CS

- Flood light with heavy duty plastic housing, glass lens
- 12V 55W H3 halogen bulb
- Includes both lead and ground wires
- Stainless steel mounting bracket

BULK P/N	POLYPACK P/N	DESCRIPTION	QTY
<b>RETAIL</b>			
DL55CS	55W marine flood light, clam		6
A700	12V 55W H3 quartz halogen bulb, clam		12



<b>MATERIALS</b>	Plastic housing, glass lens, stainless steel bracket
<b>VOLT/AMP</b>	12.8VDC - 4.5A
<b>WT/DIMS</b>	1.333 lb. / 6.25" x 4.25" x 3"
<b>WARRANTY</b>	Three Year Warranty

## QH16CTS & QH36CTS 55W Halogen Area Lights

- Area lights with post mount bases
- 12V 35W H3 halogen bulb
- Include both lead and ground wires
- QH36CTS has multi-directional bracket that adjusts both horizontally and vertically and stainless steel hardware

BULK P/N	POLYPACK P/N	DESCRIPTION	QTY
<b>AREA LIGHT</b>			
QH16CTS	QH16CTSP	Post mount area light	50
QH36CTS	QH36CTSP	Multi-directional post mount area light with stainless steel hardware	50
<b>RETAIL</b>			
A700	12V 55W H3 quartz halogen bulb, clam		12

<b>MATERIALS</b>	Plastic housing, glass lens
<b>VOLT/AMP</b>	12.8VDC - 4.5A
<b>WT/DIMS</b>	0.663 lb. / 5.875" x 3" x 2.75"
<b>WARRANTY</b>	Three Year Warranty

**optronics**



QH16CTS



QH36CTS

HALOGEN LIGHTS



## RVSTL0060/61 SERIES ONE™ LED Series RV Combination Tail Lights



RVSTL0060



RVSTL0061



RVSTLB0060



RVSTLB0061

- ONE™ LED Combination stop/turn/tail light with built-in reflex
- Driver side lights include LED license plate illuminator and mounting bracket
- Surface mount design with snap-on lens
- Available with white or black base
- Hard wired, ground wire included

BULK P/N	POLYPACK P/N	DESCRIPTION	QTY
<b>ONE™ LED RV COMBINATION TAIL LIGHTS</b>			
RVSTL0060	RVSTL0060P	Passenger side, white base	48
RVSTL0061	RVSTL0061P	Driver side, white base	48
RVSTLB0060	RVSTLB0060P	Passenger side, black base	48
RVSTLB0061	RVSTLB0061P	Driver side, black base	48
<b>ACCESSORIES</b>			
RV60BK	RV60BKP	Wedge base, white	100

<b>FMVSS</b>	A S2 T2 I6
<b>MATERIALS</b>	Acrylic lens and plastic housing
<b>VOLT/AMP</b>	RVSTL0060: 12.8VDC .34A Stop/Turn, .01A Tail RVSTL0061: 12.8VDC .43A Stop/Turn, .094A Tail
<b>WT/DIMS</b>	RVSTL0060 .456 lbs. / 8.688" x 3.188" x 2.25" RVSTL0061 .513 lbs. / 8.688" x 5" x 2.25"
<b>WARRANTY</b>	Lifetime LED Warranty

RV COMBINATION  
TAIL LIGHTS

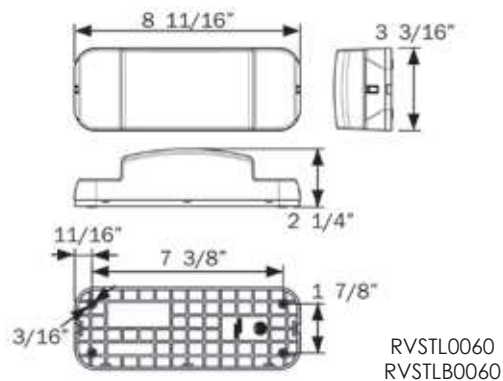
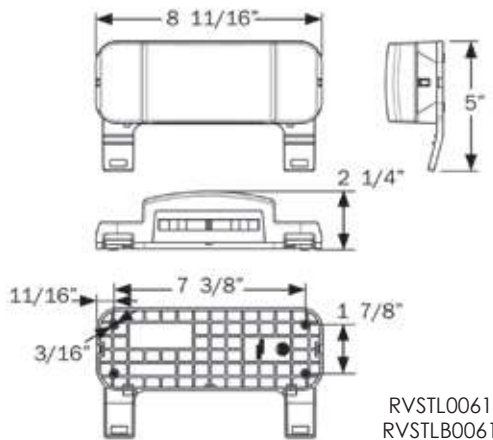

## RVSTL60/61 SERIES LED Low Profile RV Combination Tail Lights



- 9-LED combination stop/turn/tail light for surface mount
- Driver side lights include 3-LED license plate illuminator and mounting bracket
- Snap-on, replaceable lens
- Available with white or black base
- Hard wired, ground wire included



RVSTL60  
RVSTLB60



RVSTL61



RVSTLB61

BULK P/N	POLYPACK P/N	DESCRIPTION	QTY
----------	--------------	-------------	-----

### LED RV COMBINATION TAIL LIGHTS - 9 DIODES

RVSTL60	RVSTL60P	Passenger side, white base	48
RVSTL61	RVSTL61P	Driver side, white base	48
RVSTLB60	RVSTLB60P	Passenger side, black base	48
RVSTLB61	RVSTLB61P	Driver side, black base	48

### ACCESSORIES

RV60BK	RV60BKP	Wedge base mounting bezel, white	100
AST60B	AST60BP	Tail light lens, passenger side	10
AST61B	AST61BP	Tail light lens, driver side	10

### RETAIL

RVSTL60S	Passenger side, white base, clam		6
RVSTL61S	Driver side, white base, clam		6

<b>FMVSS</b>	A S2 T2 I6
<b>MATERIALS</b>	Acrylic lens and plastic housing
<b>VOLT/AMP</b>	12.8VDC - .243A Stop/Turn, .046A Tail
<b>WT/DIMS</b>	RVSTL60: .419 lb. / 8.625" x 3.188" x 2.25" RVSTL61: .419 lb. / 8.625" x 5" x 2.25"
<b>WARRANTY</b>	Lifetime LED Warranty

RV COMBINATION  
TAIL LIGHTS

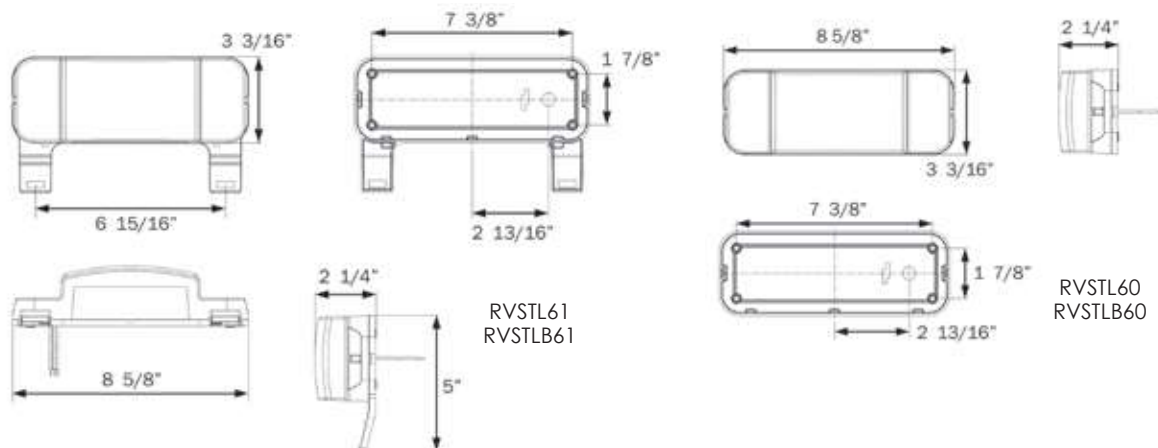





## RVST60/61 SERIES Low Profile RV Combination Tail Lights



RVST60  
RVSTB60



RVST61



RVSTB61



RV60BK

- Combination stop/turn/tail light for surface mount
- Driver side lights include license plate illuminator and mounting bracket
- Snap-on lens and replaceable bulb
- Available with white or black base
- Hard wired, ground wire included

BULK P/N	POLYPACK P/N	DESCRIPTION	QTY
<b>RV COMBINATION TAIL LIGHTS</b>			
RVST60	RVST60P	Passenger side RV tail light, white base	48
RVST61	RVST61P	Driver side RV tail light, white base	48
RVSTB60	RVSTB60P	Passenger side RV tail light, black base	48
RVSTB61	RVSTB61P	Driver side RV tail light, black base	48
<b>ACCESSORIES</b>			
AST60B	AST60BP	Tail light lens, RVST60	10
AST61B	AST61BP	Tail light lens, RVST61	10
RV60BK	RV60BKP	Wedge base mounting bezel, white	100
A1157B	A1157BP	1157 replacement bulb	50
<b>RETAIL</b>			
RVST60S	Passenger side, white base, clam		6
RVST61S	Driver side, white base, clam		6
<b>FMVSS</b>	A S2 T2 I6		
<b>MATERIALS</b>	Acrylic lens and plastic housing		
<b>VOLT/AMP</b>	12.8VDC - 2.65A Stop, 2.10A Tail		
<b>WT/DIMS</b>	RVST60: .419 lb. / 8.625" x 3.188" x 2.25"		
	RVST61: .419 lb. / 8.625" x 5" x 2.25"		
<b>WARRANTY</b>	Three Year Warranty		

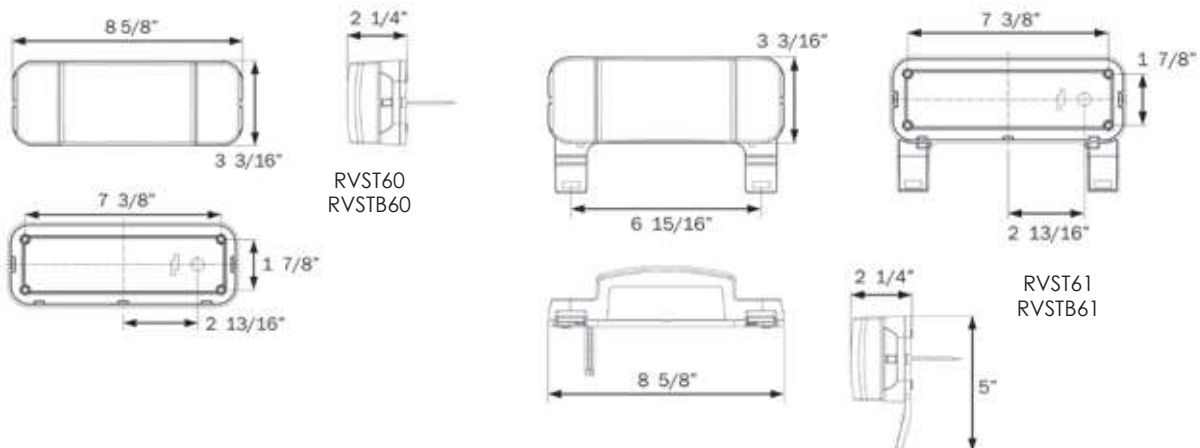

RV COMBINATION  
TAIL LIGHTS

## RVST50/51 SERIES RV Combination Tail Lights

- Combination stop/turn/tail light for surface mount
- Driver side lights include license plate illuminator and mounting bracket
- Snap-on lens and replaceable bulb
- Available with white or black base
- Hard wired, ground wire included



RVST50  
RVSTB50



RVST51



RVSTB51



RV50BK

BULK P/N	POLYPACK P/N	DESCRIPTION	QTY
<b>RV COMBINATION TAIL LIGHTS</b>			
RVST50	RVST50P	Passenger side RV tail light, white base	48
RVST51	RVST51P	Driver side RV tail light, white base	48
RVSTB50	RVSTB50P	Passenger side RV tail light, black base	48
RVSTB51	RVSTB51P	Driver side RV tail light, black base	48
<b>ACCESSORIES</b>			
AST50B	AST50BP	Tail light lens, RVST50	10
AST51B	AST51BP	Tail light lens, RVST51	10
RV50BK	RV50BKP	Wedge base mounting bezel, white	100
A2057B	A2057BP	2057 replacement bulb	50
<b>RETAIL</b>			
RVST50S	Passenger side, white base, clam		6
RVST51S	Driver side, white base, clam		6

<b>FMVSS</b>	RVST50: A I S T; RVST51: A I S T L
<b>MATERIALS</b>	Acrylic lens and plastic housing
<b>VOLT/AMP</b>	12.8VDC - 2.4A Stop, 0.4A Tail
<b>WT/DIMS</b>	RVST50: .419 lb. / 8.625" x 4.625" x 2.063" RVST51: .419 lb. / 8.625" x 6.313" x 2.063"
<b>WARRANTY</b>	Three Year Warranty

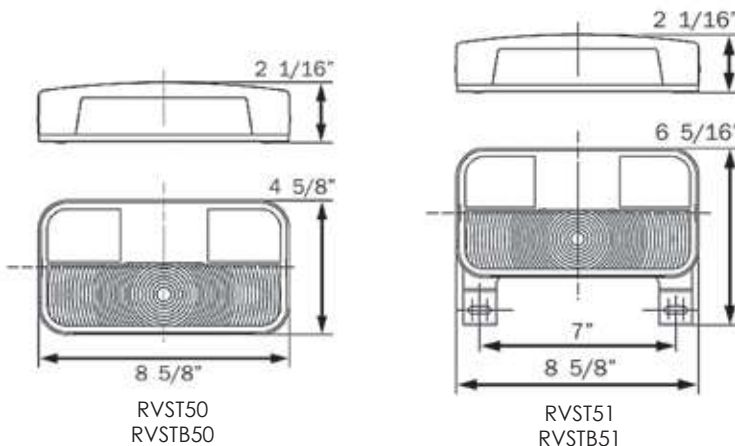

RV COMBINATION  
TAIL LIGHTS



## RVST55/56 SERIES RV Combination Tail Lights with Back-Up Lights



RVST55  
RVBST55



RVST56



RVBST56



RV50BK

- Combination stop/turn/tail/back-up light for surface mount
- Driver side lights include license plate illuminator and mounting bracket
- Snap-on lens and replaceable bulbs (2057 tail/1156 back-up)
- Hard wired, ground wire included

BULK P/N	POLYPACK P/N	DESCRIPTION	QTY
<b>RV COMBINATION TAIL LIGHTS</b>			
RVST55	RVST55P	Passenger side RV tail light, white base	48
RVST56	RVST56P	Driver side RV tail light, white base	48
RVBST55	RVBST55P	Passenger side RV tail light, black base	48
RVBST56	RVBST56P	Driver side RV tail light, black base	48
<b>ACCESSORIES</b>			
RV50BK	RV50BKP	Wedge base mounting bezel, white	100
A2057B	A2057BP	2057 replacement bulb	50
<b>RETAIL</b>			
RVST55S	Passenger side, white base, clam		6
RVST56S	Driver side, white base, clam		6

**FMVSS** RVST55: A I S T; RVST56: A I S T L  
**MATERIALS** Acrylic lens and plastic housing  
**VOLT/AMP** 12.8VDC - 2.2A Stop, 0.4A Tail, 2.1A Back-Up  
**WT/DIMS** RVST55: .419 lb. / 8.625" x 4.625" x 2.063"  
 RVST56: .419 lb. / 8.625" x 6.313" x 2.063"  
**WARRANTY** Three Year Warranty

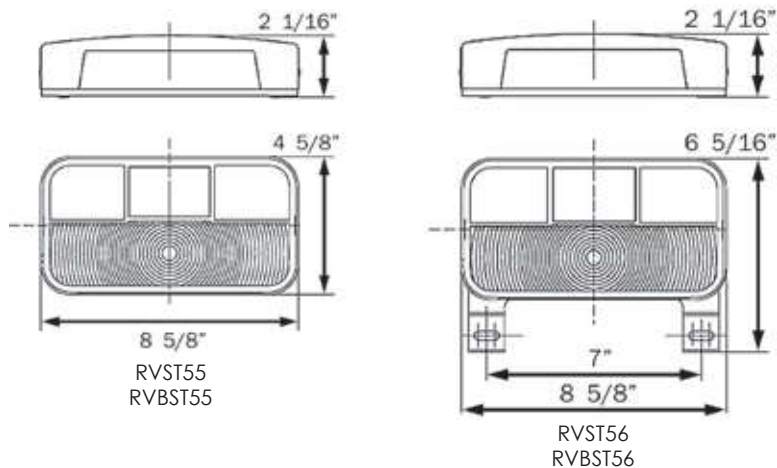

RV COMBINATION  
TAIL LIGHTS



## ILL70/71 SERIES Opti-Brite™ LED Awning Lights for Surface Mount

- Low profile awning mount lights with wedge base that directs light at a 45-degree angle
- Hard wired design includes both lead and ground wires
- Select from 11-inch and 18-inch models
- Available in amber and white LED
- Sealed, waterproof



ILL70CBAWN



ILL71CBAWN



ILL70ABAWN

BULK P/N	POLYPACK P/N	DESCRIPTION	QTY
<b>11" WHITE LED - 9 DIODES</b>			
ILL70CBAWN	ILL70CBAWNP	No switch, chrome housing	10
ILL70CBBAWN	ILL70CBBAWNP	No switch, black housing	10
ILL70CBSAWN	ILL70CBSAWNP	On/off switch, black housing	10
ILL70CCSAWN	ILL70CCSAWNP	On/off switch, chrome housing	10
<b>11" AMBER LED - 9 DIODES</b>			
ILL70ABAWN	ILL70ABAWNP	No switch, chrome housing	10
ILL70ABBAWN	ILL70ABBAWNP	No switch, black housing	10
<b>Raw lumen output: 189 lm</b>			
<b>Effective lumen output: 171 lm</b>			

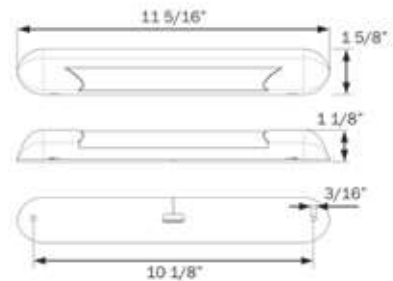

ILL70

BULK P/N	POLYPACK P/N	DESCRIPTION	QTY
<b>18" WHITE LED - 18 DIODES</b>			
ILL71CBAWN	ILL71CBAWNP	No switch, chrome housing	10
<b>Raw lumen output: 370 lm</b>			
<b>Effective lumen output: 342 lm</b>			

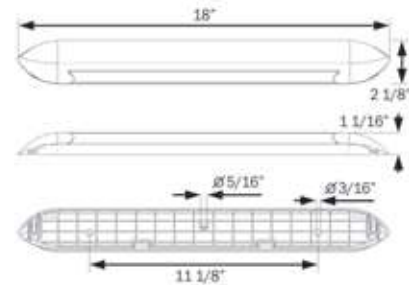

ILL71

<b>MATERIALS</b>	Polycarbonate lens and housing
<b>VOLT/AMP</b>	ILL70: 12.8VDC - .150A ILL71: 12.8VDC - .300A
<b>WT/DIMS</b>	ILL70: .154 lb. / 11.313" x 1.625" x 1.125" ILL71: .187 lb. / 18" x 2.125" x 1.063"
<b>WARRANTY</b>	Lifetime LED Warranty

**IP67 rating:** protected from dust and capable of withstanding water immersion, offering increased reliability and service life

RV PORCH/CABIN  
& SECURITY LIGHTS





## RVPLL8/9 SERIES Low Profile Porch/Utility Lights

- Surface mount LED porch/utility lights
- Available with yellow or clear lens
- Hard wired, includes separate ground wire



RVPLL8A



RVPLL8AB



RVPLL8C



RVPLL8CB



RVPLL9CC

BULK P/N	POLYPACK P/N	DESCRIPTION	QTY
<b>YELLOW PORCH LIGHTS</b>			
RVPLL8A	RVPLL8AP	White housing	50
RVPLL8AB	RVPLL8ABP	Black housing	50
<b>CLEAR UTILITY LIGHTS</b>			
RVPLL8C	RVPLL8CP	White housing	50
RVPLL8CB	RVPLL8CBP	Black housing	50
RVPLL9CC	RVPLL9CCP	Chrome housing	50

<b>CERTIFICATION</b>	CSA
<b>MATERIALS</b>	Acrylic lens and plastic housing
<b>VOLT/AMP</b>	12.8VDC .16A
<b>WT/DIMS</b>	.413 lbs. / 9.75" x 3.438" x 2.125"
<b>WARRANTY</b>	Lifetime LED Warranty

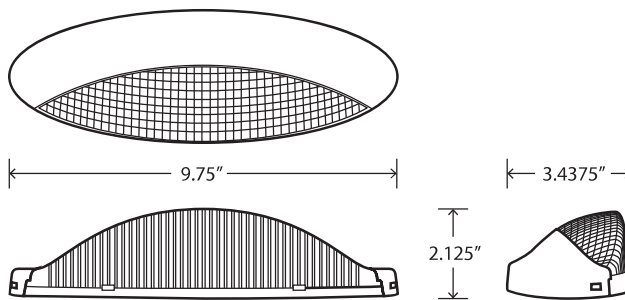

## RVPL1/3 SERIES Rectangular Porch/Utility Lights

- Surface mount porch/cabin lights (CSA/UL listed)
- White housing with snap-on lens and replaceable bulb (1141)
- Available with yellow or clear lens
- Hard wired with separate ground wire

BULK P/N	POLYPACK P/N	DESCRIPTION	QTY
<b>YELLOW PORCH LIGHTS</b>			
RVPL1A	RVPL1AP	Yellow porch light, no switch	50
RVPL3A	RVPL3AP	Yellow porch light with switch	50
<b>CLEAR UTILITY LIGHTS</b>			
RVPL1C	RVPL1CP	Clear utility light, no switch	50
RVPL3C	RVPL3CP	Clear utility light with switch	50
<b>ACCESSORIES</b>			
APL1AB	APL1ABP	Yellow replacement lens	10
APL1CB	APL1CBP	Clear replacement lens	10

<b>CERTIFICATION</b>	CSA / UL
<b>MATERIALS</b>	Acrylic lens and plastic housing
<b>VOLT/AMP</b>	12.8VDC - 1.4A
<b>WT/DIMS</b>	.419 lb. / 6.375" x 3.5" x 2.094"
<b>WARRANTY</b>	Three Year Warranty

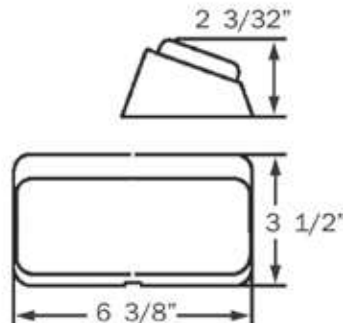

**Optronics**



RVPL1A



RVPL3A



RVPL1C



RVPL3C

RV PORCH/CABIN  
& SECURITY LIGHTS



## RVPL5/7 SERIES Oval Porch/Utility Lights

- Surface mount porch utility lights available with or without switch
- White or black housing with snap-on lens and replaceable bulb (1141)
- Available with yellow or clear lens
- Hard wired with separate ground wire



RVPL5A



RVPL5AB



RVPL7A



RVPL7AB



RVPL5C



RVPL5CB



RVPL7C



RVPL7CB

BULK P/N	POLYPACK P/N	DESCRIPTION	QTY
----------	--------------	-------------	-----

### YELLOW PORCH LIGHTS

RVPL5A	RVPL5AP	Yellow porch light, white housing, no switch	50
RVPL5AB	RVPL5ABP	Yellow porch light, black housing, no switch	50
RVPL7A	RVPL7AP	Yellow porch light, white housing, with switch	50
RVPL7AB	RVPL7ABP	Yellow porch light, black housing, with switch	50

### CLEAR UTILITY LIGHTS

RVPL5C	RVPL5CP	Clear utility light, white housing, no switch	50
RVPL5CB	RVPL5CBP	Clear utility light, black housing, no switch	50
RVPL7C	RVPL7CP	Clear utility light, white housing, with switch	50
RVPL7CB	RVPL7CBP	Clear utility light, black housing, with switch	50

### ACCESSORIES

APL5AB	APL5ABP	Yellow replacement lens	10
APL5CB	APL5CBP	Clear replacement lens	10

<b>CERTIFICATION</b>	CSA / UL
<b>MATERIALS</b>	Acrylic lens and plastic housing
<b>VOLT/AMP</b>	12.8VDC - 1.4A
<b>WT/DIMS</b>	.265 lb. / 6.25" x 3.438" x 1.875"
<b>WARRANTY</b>	Three Year Warranty

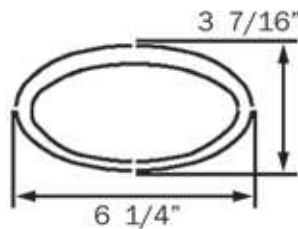
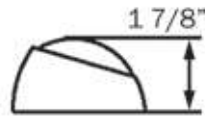

## RVPL8 SERIES

### Low Profile Porch/Utility Lights

- Surface mount porch utility lights
- Snap-on lens and replaceable bulb (12V 10W halogen)
- Available with yellow or clear lens
- Hard wired with separate ground wire



RVPL8AB



RVPL8C



RVPL8CB



RVPL9CC

BULK P/N	POLYPACK P/N	DESCRIPTION	QTY
<b>YELLOW PORCH LIGHTS</b>			
RVPL8AB	RVPL8ABP	Yellow porch light, black housing	50
<b>CLEAR UTILITY LIGHTS</b>			
RVPL8C	RVPL8CP	Clear utility light, white housing	50
RVPL8CB	RVPL8CBP	Clear utility light, black housing	50
RVPL9CC	RVPL9CCP	Clear utility light, chrome housing	50

<b>CERTIFICATION</b>	CSA
<b>MATERIALS</b>	Acrylic lens and plastic housing
<b>VOLT/AMP</b>	12.8VDC - 0.78A
<b>WT/DIMS</b>	.265 lb. / 10" x 3.5" x 2.125"
<b>WARRANTY</b>	Three Year Warranty

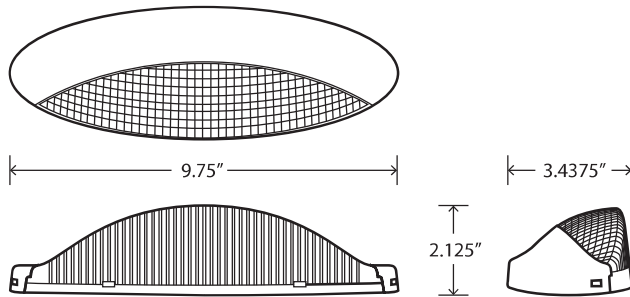

RV PORCH/CABIN  
& SECURITY LIGHTS





## RVSL21/31 SERIES Scare Lights



RVSL21

- Surface mount security lights with mounting gasket (CSA)
- Stainless steel or white housing with screw-on lens and replaceable bulb (1156)
- Hard wired with separate ground wire

BULK P/N	POLYPACK P/N	DESCRIPTION	QTY
<b>CLEAR SECURITY LIGHTS</b>			
RVSL21	RVSL21P	Scare light, stainless housing	25
RVSL31	RVSL31P	Scare light, white housing	25



RVSL31

<b>CERTIFICATION</b>	CSA
<b>MATERIALS</b>	Acrylic lens, metal housing
<b>VOLT/AMP</b>	12.8VDC - 1.4A
<b>WT/DIMS</b>	0.97 lb. / 8.656" x 8.656" x 1.969"
<b>WARRANTY</b>	Three Year Warranty

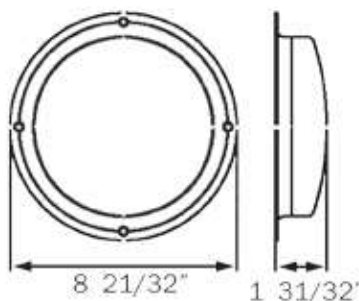

## RVILL39 LED Surface Mount Interior Ceiling Light



- Surface mount ceiling light with switch
- Effective lumen output 230 lm
- Replaceable white snap-on bezel
- Dual power: use with 12VDC and 24VDC systems
- 18-gauge, 6-inch lead and ground wire



RVILL39

BULK P/N	POLYPACK P/N	DESCRIPTION	QTY
<b>INTERIOR CEILING LIGHTS - 9 DIODES</b>			
RVILL39	RVILL39P	Interior light with switch	10

**Raw lumen output:** 280 lm  
**Effective lumen output:** 230 lm

<b>MATERIALS</b>	Clear PMMA lens, ABS bezel
<b>VOLT/AMP</b>	12.8VDC - 0.25A
<b>WT/DIMS</b>	.325 lb. / 7.188" x 5.188" x 1.438"
<b>WARRANTY</b>	Lifetime LED Warranty

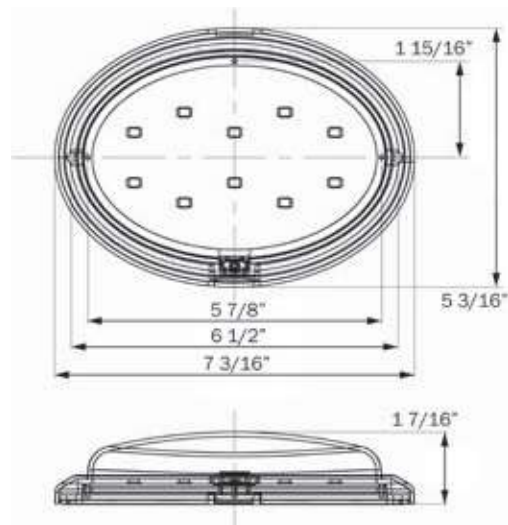

RV INTERIOR LIGHTS



## RVILL33/34 SERIES LED Interior RV Lights

- Surface mount interior lights with switch (CSA)
- Single or double lights with snap-on lens
- LED technology – uses 90% less energy
- Hard wired with separate ground wire



RVILL33



RVILL34

BULK P/N	POLYPACK P/N	DESCRIPTION	QTY
<b>LED INTERIOR LIGHTS</b>			
RVILL33	RVILL33P	Single, on/off switch, 9 diodes	50
RVILL34	RVILL34P	Double, on/off switch, 18 diodes	25
<b>ACCESSORIES</b>			
AIL32B	AIL32BP	Clear replacement lens for RVIF31/32	10

**RVILL33 lumen output (raw/effective):** 460 lm / 407 lm

**RVILL34 lumen output (raw/effective):** 920 lm / 815 lm

<b>CERTIFICATION</b>	CSA		
<b>MATERIALS</b>	Polycarbonate lens and plastic housing		
<b>VOLT/AMP</b>	RVILL33:	12.8VDC - 0.3A	
	RVILL34:	12.8VDC - 0.6A	
<b>WT/DIMS</b>	RVILL33:	.794 lb. / 6.377" x 4.173" x 1.787"	
	RVILL34:	1.587 lb. / 10.283" x 4.173" x 1.787"	
<b>WARRANTY</b>	Lifetime LED Warranty		

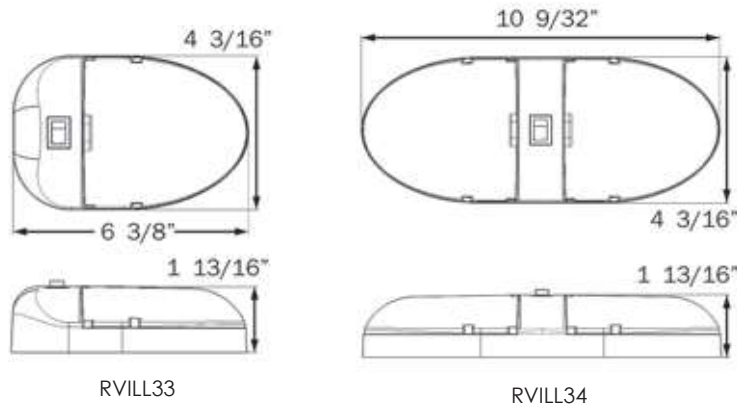

## RVIL35/36 SERIES Interior RV Lights



- Surface mount interior lights with switch (CSA)
- Single or double lights with snap-on lens and replaceable bulb
- Hard wired with separate ground wire



RVIL35



RVIL36

BULK P/N	POLYPACK P/N	DESCRIPTION	QTY
<b>INTERIOR RV LIGHTS</b>			
RVIL35	RVIL35P	Single, on/off switch	50
RVIL36	RVIL36P	Double, on/off switch	25
<b>ACCESSORIES</b>			
ARVIL35B	ARVIL35BP	Replacement lens	10
A921B	-	921 replacement bulb	50

<b>CERTIFICATION</b>	CSA
<b>MATERIALS</b>	Polycarbonate lens and plastic housing
<b>VOLT/AMP</b>	RVIL35: 12.8VDC - 1.3A RVIL36: 12.8VDC - 2.6A
<b>WT/DIMS</b>	RVIL35: .794 lb. / 6.375" x 4.125" x 1.75" RVIL36: 1.587 lb. / 10.25" x 4.125" x 1.75"
<b>WARRANTY</b>	Three Year Warranty

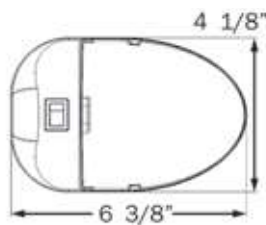

RVIL35

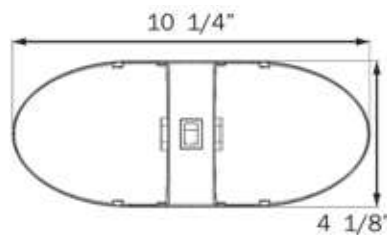

RVIL36

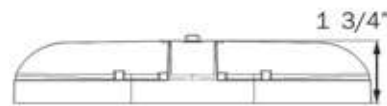
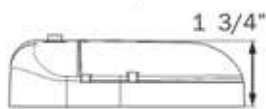





## RVIL21/22 SERIES RV Interior Lights

- Surface mount ceiling lights with switch (CSA)
- Single or double lights with snap-on lens and replaceable bulb
- Hard wired with separate ground wire



RVIL21



RVIL22

BULK P/N	POLYPACK P/N	DESCRIPTION	QTY
<b>RV INTERIOR LIGHTS</b>			
RVIL21	RVIL21P	Single, on/off switch	50
RVIL22	RVIL22P	Double, on/off switch	25
<b>ACCESSORIES</b>			
AIL21B	AIL21BP	Clear replacement lens	10
A921B	-	921 replacement bulb	50
<b>RETAIL</b>			
RVIL21S	Single, on/off switch, clam		6
RVIL22S	Double, on/off switch, clam		6

<b>CERTIFICATION</b>	CSA / UL
<b>MATERIALS</b>	Acrylic lens and plastic housing
<b>VOLT/AMP</b>	RVIL21: 12.8VDC - 0.5A RVIL22: 12.8VDC - 1.4A
<b>WT/DIMS</b>	RVIL21: .794 lb. / 7.078" x 4.25" x 1.969" RVIL22: 1.587 lb. / 12" x 4.25" x 1.844"
<b>WARRANTY</b>	Three Year Warranty

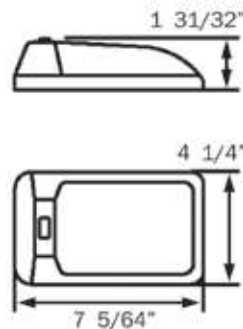

RVIL21

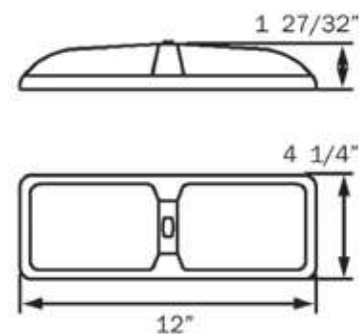

RVIL22

## RVFL51 SERIES Portable Interior Light



- Mount with clamp for portability
- Includes coil cord with male plug
- Combination reading light and fan with switch for each; replaceable bulb (912)



RVFL51

BULK P/N	POLYPACK P/N	DESCRIPTION	QTY
<b>PORTABLE LIGHT</b>			
RVFL51	RVFL51P	Reading light with fan, coil cord, male plug	24
<b>ACCESSORIES</b>			
RVC100	RVC100P	Bunk light adaptor with jack (CSA)	100
A921B	-	921 replacement bulb for RVIM46	50

<b>CERTIFICATION</b>	CSA
<b>MATERIALS</b>	Polycarbonate lens and plastic housing
<b>VOLT/AMP</b>	12.8VDC - 1.3A (fan and light)
<b>WT/DIMS</b>	RVFL51: 1.587 lb. / 8.5" x 5.625" x 2.875" RVC100: .6 lb. / 2.484" x 2.484" x 1.438"
<b>WARRANTY</b>	Three Year Warranty



RVC100



## COMPACT COURTESY LIGHTS



16802B



19102B

- Choose from surface mount and flush mount lights
- Hard wired, include lead and ground

BULK P/N	POLYPACK P/N	DESCRIPTION	QTY
COURTESY LIGHTS			
16802B	16802P	Black hooded light (bulb 194; .24A)	100
19102B	19102P	Flush mount light (bulb 194; .24A)	50

<b>CERTIFICATION</b>	CSA
<b>MATERIALS</b>	Plastic
<b>VOLT</b>	12.8VDC
<b>WT/DIMS</b>	16802B: .2 lb. / 2.75" x 1.75" x 1.5" 19102B: .2 lb. / 4.5" x 1.25"
<b>WARRANTY</b>	Three Year Warranty



## CHROME COURTESY LIGHTS



068NME



068WMTE

- Hooded lights with chrome finish, white lens
- Hard wired, include lead and ground

BULK P/N	POLYPACK P/N	DESCRIPTION	QTY
COURTESY LIGHTS			
068NME	068NMEP	Snap-in light	50
068WMTE	068WMTEP	Light with stainless steel mounting plate	50

<b>CERTIFICATION</b>	UL
<b>MATERIALS</b>	Metal (068WMTE - stainless steel plate), polycarbonate lens
<b>VOLT/AMP</b>	12.8VDC - 0.59A (bulb 67, 12V 4CP)
<b>WT/DIMS</b>	068NME: .2 lb. / 1.5" x 1.5" x 2" 068WMTE: .2 lb. / 2.75" x 1.625" x 2"
<b>WARRANTY</b>	Three Year Warranty

## WATERPROOF COURTESY LIGHT



- Submersible design with gaskets
- Hard wired, includes lead and ground

BULK P/N	POLYPACK P/N	DESCRIPTION	QTY
<b>COURTESY LIGHT</b>			
24074B	24074P	Rear mount light with nut	50



24074B

<b>CERTIFICATION</b>	CSA
<b>MATERIALS</b>	Plastic
<b>VOLT/AMP</b>	12.8VDC - 1.25A (bulb 194)
<b>WT/DIMS</b>	.2 lb. / 2" x 2" x 1.75"
<b>WARRANTY</b>	Three Year Warranty

## OVAL COURTESY LIGHTS



- Semi-recessed with clear lens
- Hard wired, includes lead and ground

BULK P/N	POLYPACK P/N	DESCRIPTION	QTY
<b>COURTESY LIGHTS</b>			
2407764B	2407764P	White finish	100
2407765B	2407765P	Dream white finish	50
2407771C	2407771CP	Black finish, chrome reflector	50



TOP TO BOTTOM:  
2407764B  
2407765B  
2407768B  
2407771C

<b>CERTIFICATION</b>	CSA
<b>MATERIALS</b>	Plastic
<b>VOLT/AMP</b>	12.8VDC - .17A (bulb 161, wedge base)
<b>WT/DIMS</b>	.2 lb. / 4" x 2.625" x 1.25"
<b>WARRANTY</b>	Three Year Warranty





## AURORA SERIES Bullet Light



04010040B

- Metal directional light with adjustable bracket and switch
- Surface mount with no exposed fasteners
- Hard wired, include lead and ground
- Bulb 922 wedge base incandescent

BULK P/N	POLYPACK P/N	DESCRIPTION	QTY
<b>BULLET LIGHTS</b>			
04010040B	04010040P	Brushed nickel, black switch	30

<b>CERTIFICATION</b>	CSA
<b>MATERIALS</b>	Metal housing
<b>VOLT/AMP</b>	12.8VDC - 0.98A (bulb 922 wedge base)
<b>WT/DIMS</b>	.5 lb. / 2.75" x 3.75" x 4.625"
<b>WARRANTY</b>	Three Year Warranty



## CO-PILOT LIGHTS Halogen and Incandescent



03001175B

- Map lights for sidewalls, drink trays and dashboards
- Switch is incorporated into light design
- Flexible 18" arm

BULK P/N	POLYPACK P/N	DESCRIPTION	QTY
<b>CO-PILOT LIGHTS</b>			
03001175B	03001175P	Halogen (5W bulb/0.35A)	10
03001150B	03001150P	Incandescent (1816 bulb/0.27A)	10

<b>CERTIFICATION</b>	UL
<b>MATERIALS</b>	Metal, black finish
<b>VOLT</b>	12.8VDC
<b>WT/DIMS</b>	.6 lb. / 18"
<b>WARRANTY</b>	Three Year Warranty

## **GALAXY LED SERIES** LED Directional Lights

- Recess mount lights with swivel globes and switches
- Removable snap-on trim ring, sold separately
- Hard wired, includes lead and ground

BULK P/N	POLYPACK P/N	DESCRIPTION	QTY
<b>LED DIRECTIONAL LIGHTS</b>			
240047171LB	-	LED Single fixture	50
240147171LB	-	LED Double fixture	20
24004TR71	24004TR71P	Trim ring for single fixture, black	50
24014TR71	24014TR71P	Trim ring for double fixture, black	50
<b>CERTIFICATION</b>	CSA		
<b>MATERIALS</b>	Plastic		
<b>VOLT/AMP</b>	Single: 12.8VDC - 0.020A Double: 12.8VDC - 0.054A		
<b>WT/DIMS</b>	Single: .15 lb. / 3.5" x 4.875" x 1.75" Double: .31 lb. / 3.5" x 9.625" x 1.75"		
<b>WARRANTY</b>	Lifetime LED Warranty		



240047171LB & 24004TR71



240147171LB & 24014TR71

## **GALAXY SERIES** Directional Lights

- Recess mount lights with swivel globes and switches
- Removable snap-on trim ring, sold separately
- Hard wired, includes lead and ground

BULK P/N	POLYPACK P/N	DESCRIPTION	QTY
<b>DIRECTIONAL LIGHTS</b>			
240047171B	240047171P	Single fixture	50
240147171B	240147171P	Double fixture	20
24004002B	-	Single fixture with reflector & 5W bulb	50
06001022B	06001022P	Single fixture with reflector	50
24004TR71	24004TR71P	Trim ring for single fixture, black	50
24014TR71	24014TR71P	Trim ring for double fixture, black	50
<b>CERTIFICATION</b>	CSA		
<b>MATERIALS</b>	Plastic		
<b>VOLT/AMP</b>	Single: 12.8VDC - 0.35A (bulb 168 wedge base) Double: 12.8VDC - 0.70A (bulb 168 wedge base)		
<b>WT/DIMS</b>	Single: .24 lb. / 3.5" x 4.875" x 1.75" Double: .47 lb. / 3.5" x 9.625" x 1.75"		
<b>WARRANTY</b>	Three Year Warranty		



240047171B & 24004TR71



240147171B & 24014TR71

RV DIRECTIONAL LIGHTS



825LED & 825TR02



826LED & 826TR02

## UNITEK LED SERIES LED Directional Lights

- Recess mount LED fixtures with multi-locking pivoting globes that activate lights
- Removable snap-on trim ring, sold separately
- Three-terminal hook-up for dome light application

BULK P/N	POLYPACK P/N	DESCRIPTION	QTY
LED DIRECTIONAL LIGHTS			
825LED	-	Single fixture, 9 diodes, black	50
826LED	826LEDP	Double fixture, 18 diodes, black	50
825TR02	825TR02P	Single trim ring, black	50
826TR02	826TR02P	Double trim ring, black	25
826TR12	816TR12P	Double trim ring, light gray	25
826TR90	-	Double trim ring, platinum silver	25

<b>CERTIFICATION</b>	UL
<b>MATERIALS</b>	Plastic
<b>VOLT/AMP</b>	12.8VDC - Single 0.35A , Double 0.70A
<b>WT/DIMS</b>	Single: .25 lb. / 4.125" x 3.5" x 1.5" Double: .48 lb. / 7" x 3.875" x 1.375"
<b>WARRANTY</b>	Lifetime LED Warranty



826L & 826TR02

## UNITEK SERIES Directional Light

- Recess mount fixture with multi-locking pivoting globes that activate lights
- Removable lenses allow easy bulb replacement
- Removable snap-on trim ring, sold separately
- Three-terminal hook-up for dome light application

BULK P/N	POLYPACK P/N	DESCRIPTION	QTY
DIRECTIONAL LIGHT			
826L	826LP	Double fixture, black	50
See complete listing of trim rings above			

<b>CERTIFICATION</b>	UL
<b>MATERIALS</b>	Plastic
<b>VOLT/AMP</b>	12.8VDC - 0.70A (bulb 168 wedge base)
<b>WT/DIMS</b>	.48 lb. / 7" x 3.875" x 1.375"
<b>WARRANTY</b>	Three Year Warranty

## ULTRATEK SERIES Directional Lights

- Flush mount fixtures with pivoting globes that activate lights
- Removable snap-on trim ring, sold separately
- Removable lens for easy bulb replacement
- Three-terminal hook-up for dome light application

BULK P/N	POLYPACK P/N	DESCRIPTION	QTY
<b>DIRECTIONAL LIGHTS</b>			
06001013B	06001013P	Single fixture, black	120
06001014B	06001014P	Double fixture, black	120
3802071BZL	3802071BZLP	Single trim ring, black	30
3801071BZL	3801071BZLP	Double trim ring, black	30

<b>CERTIFICATION</b>	CSA / NRTL/C / ANSI/UL		
<b>MATERIALS</b>	Plastic		
<b>VOLT/AMP</b>	Single:	12.8VDC - 0.37A (bulb 590 xenon 4cp)	
	Double:	12.8VDC - 0.74A (bulb 590 xenon 4cp)	
<b>WT/DIMS</b>	Single:	.27 lb. / 3.75" x 3.5" x 1.5"	
	Double:	.40 lb. / 5.875" x 3.5" x 1.5"	
<b>WARRANTY</b>	Three Year Warranty		



06001013B & 3802071BZL



06001014B & 3801071BZL

## AUTOTEK SERIES Directional Lights

- Low profile aircraft-style lights with switch
- Removable grids allow easy bulb replacement
- Snap-on trim ring covers mounting screws
- Three-terminal hook-up for dome light application

BULK P/N	POLYPACK P/N	DESCRIPTION	QTY
<b>DIRECTIONAL LIGHTS</b>			
725022B	725022P	Single fixture, black	25
726022B	726022P	Double fixture, black	20

<b>CERTIFICATION</b>	CSA / UL		
<b>MATERIALS</b>	Plastic		
<b>VOLT/AMP</b>	Single:	12.8VDC - 0.69A (bulb 906 T5 wedge base)	
	Double:	12.8VDC - 1.38A (bulb 906 T5 wedge base)	
<b>WT/DIMS</b>	Single:	.32 lb. / 4.625" x 3.5" x 2.25"	
	Double:	.52 lb. / 7.625" x 3.5" x 2.25"	
<b>WARRANTY</b>	Three Year Warranty		



725022B



726022B

RV DIRECTIONAL LIGHTS





## EUROPA SERIES Directional Lights



06001072B



06001026B  
06001015B  
06001061B

- Choose from single recess mount and single/double surface mount series with on/off switches
- Prismatic reflector globes for bright directional beams
- Easy bulb replacement (168 wedge base)

BULK P/N	POLYPACK P/N	DESCRIPTION	QTY
----------	--------------	-------------	-----

### RECESS MOUNT

06001072B	06001072P	Single fixture, black	20
-----------	-----------	-----------------------	----

### SURFACE MOUNT

06001026B	06001026P	Single fixture, black	20
-----------	-----------	-----------------------	----

06001015B	06001015P	Double fixture, black	20
-----------	-----------	-----------------------	----

06001061B	06001061P	Double fixture plus dome light, black	20
-----------	-----------	---------------------------------------	----

**CERTIFICATION** UL / CSA

**MATERIALS** Plastic

**VOLT/AMP** Single: 12.8VDC - 0.35A (bulb 168 wedge base)  
Double: 12.8VDC - 0.70A (bulb 168 wedge base)

**WT/DIMS** 06001072B/P: .18 lb. / 4.5" x 3.75" x 1.75"  
06001026B/P: .16 lb. / 4.125" x 2.937" x 1.625"  
06001015B/P: .28 lb. / 2.75" x 6.25" x 1.75"  
06001061B/P: .46 lb. / 8.375" x 2.75" x 1.75"

**WARRANTY** Three Year Warranty

RV DIRECTIONAL LIGHTS



## EUROPA SERIES Ultrabright Directional Lights



06001048B



06001037B

- High output for bright, directional reading light
- Easy bulb replacement (1003 bayonet base)
- Separate switches for each bulb

BULK P/N	POLYPACK P/N	DESCRIPTION	QTY
----------	--------------	-------------	-----

### ULTRA BRIGHT SURFACE MOUNT

06001048B	06001048P	Single fixture, black	20
-----------	-----------	-----------------------	----

06001037B	06001037P	Double fixture, black	20
-----------	-----------	-----------------------	----

**CERTIFICATION** UL

**MATERIALS** Plastic

**VOLT/AMP** Single: 12.8VDC - 0.94A (bulb 1003 bayonet base)  
Double: 12.8VDC - 0.94A (bulb 1003 bayonet base)

**WT/DIMS** Single: .25 lb. / 4" x 2.875" x 2.5"  
Double: .47 lb. / 6.125" x 2.75" x 2.625"

**WARRANTY** Three Year Warranty

## ODYSSEY SERIES Directional Light

- Recess mount light with press on/off feature at lens
- Removable snap-on trim ring, sold separately
- Hard wired, includes lead and ground



0601B & 060102B

BULK P/N	POLYPACK P/N	DESCRIPTION	QTY
<b>DIRECTIONAL LIGHTS</b>			
0601B	0601P	Light, black	200
060102B	060102P	Trim ring, black	50

<b>CERTIFICATION</b>	CSA / NRTL/C / ANSI/UL
<b>MATERIALS</b>	Plastic
<b>VOLT</b>	12.8VDC - 0.94A (bulb 906 T5 wedge base)
<b>WT/DIMS</b>	.26 lb. / 3.125" x 5" x 2"
<b>WARRANTY</b>	Three Year Warranty

## STARGAZER SERIES Directional Lights

- Recess mount fixtures with multi-locking, pivoting globes that activate lights
- Removable snap-on trim ring, sold separately
- Removable lens for easy bulb replacement
- Three-terminal hook-up for dome light application



06001001B & 06300004B

BULK P/N	POLYPACK P/N	DESCRIPTION	QTY
<b>DIRECTIONAL LIGHTS</b>			
06001001B	06001001P	Single fixture, black	50
06002001B	06002001P	Double fixture, black	48
06300004B	06300004P	Single trim ring, black	50
06300003B	06300003P	Double trim ring, black	25

<b>CERTIFICATION</b>	CSA / NRTL/C / ANSI/UL
<b>MATERIALS</b>	Plastic
<b>VOLT/AMP</b>	Single: 12.8VDC - 0.35A (bulb 168 wedge base) Double: 12.8VDC - 0.70A (bulb 168 wedge base)
<b>WT/DIMS</b>	Single: .25 lb. / 3.375" x 4" x 1.5" Double: .44 lb. / 7" x 3.875" x 1.5"
<b>WARRANTY</b>	Three Year Warranty



06002001B & 06300003B

RV DIRECTIONAL LIGHTS



## CENTURA SERIES



105500SP

105520B

- Simple design with aluminum base, acrylic lens and single or dual switch
- Slim design: only 2.5" wide and 1.13" thick
- Available in 5.5" and 12.5" lengths

BULK P/N	POLYPACK P/N	DESCRIPTION	QTY
<b>SURFACE MOUNT</b>			
105500SP	-	Single bulb, 5.5"	50
105520B	105520BP	Triple bulb, 12.5"	25
<b>MATERIALS</b>	Aluminum base, acrylic lens		
<b>VOLT/AMP</b>	5.5": 12.8VDC - 0.97A (bulb 211)		
	12.5": 12.8VDC - 2.91A (bulb 211-2)		
<b>WT/DIMS</b>	5.5": .20 lb. / 5.75" x 2.5" x 1.25"		
	12.5": .44 lb. / 12.75" x 2.5" x 1.25"		
<b>WARRANTY</b>	Three Year Warranty		



## SLIMLINE SERIES



18543910B



18543916B



18543936B

- Contemporary design with single or dual switch
- Low profile: 4" wide and only 1.5" thick
- Available in three lengths

BULK P/N	POLYPACK P/N	DESCRIPTION	QTY
<b>SURFACE MOUNT</b>			
18543910B	-	Single bulb, 4", no switch, white	25
18543916B	18543916BP	Single bulb, 5.5", switch, white	100
18543936B	-	Two bulb, 7.5", dual switch, white	20
<b>MATERIALS</b>	Plastic		
<b>VOLT/AMP</b>	Single: 12.8VDC - 1.0A (bulb 912)		
	Dual: 12.8VDC - 2.0A (bulb 912)		
<b>WT/DIMS</b>	4": .4 lb. / 4" x 4" x 1.5"		
	5.5": .6 lb. / 5.5" x 4" x 1.5"		
	7": .8 lb. / 7" x 4" x 1.5"		
<b>WARRANTY</b>	Three Year Warranty		

## 24113160B DOME LIGHT



- Halogen dome light with switch for general illumination
- Designed for overhead or bulkhead surface mount
- White plastic construction with frosted lens



24113160B

BULK P/N	POLYPACK P/N	DESCRIPTION	QTY
<b>DOMELIGHT</b>			
24113160B	24113160P	5.75" white dome light	30

<b>CERTIFICATION</b>	NRTL/C
<b>MATERIALS</b>	Plastic
<b>VOLT/AMP</b>	12.8VDC - 0.78A (bulb G4 bi-pin)
<b>WT/DIMS</b>	.4 lb. / 5.75" x 5.75" x 1.5"
<b>WARRANTY</b>	Three Year Warranty

## 357B DOME LIGHT



- 8.5" semi-recess mount light with one halogen and one incandescent bulb
- Chrome plated housing, Lexan lens, replaceable bulbs



357B

BULK P/N	POLYPACK P/N	DESCRIPTION	QTY
<b>DOMELIGHT</b>			
357B	357P	Dome light, chrome-plated	40

<b>MATERIALS</b>	Metal housing, Lexan lens
<b>VOLT/AMP</b>	12.8VDC - 2.79A (GH9 37.5W), 0.68A (906 T5 wedge)
<b>WT/DIMS</b>	1.25 lbs. / 8.75" x 8.75" x 1.875"
<b>WARRANTY</b>	Three Year Warranty





## 69000201B DOME LIGHT

- 6-3/8" surface mount light with gray base
- Two-wire, replaceable 1142 bulb



69000201B

BULK P/N	POLYPACK P/N	DESCRIPTION	QTY
<b>DOMELIGHT</b>			
69000201B	69000201P	Dome light, gray base	40
<b>VOLT/AMP</b>	12.8VDC - 1.44A (bulb 1142)		
<b>WT/DIMS</b>	.75 lb. / 6.25" x 6.25" x 2"		
<b>WARRANTY</b>	Three Year Warranty		



## 69000300B DOME LIGHT

- 5-3/4" surface mount light with red and white bulbs
- Dual switch, frosted lens, white housing



69000300B

BULK P/N	POLYPACK P/N	DESCRIPTION	QTY
<b>DOMELIGHT</b>			
69000300B	69000300P	Dome light, red/white bulbs	20
<b>VOLT/AMP</b>	12.8VDC - 1.00A (bulb 912)		
<b>WT/DIMS</b>	.48 lb. / 5.75" x 5.75" x 1.5"		
<b>WARRANTY</b>	Three Year Warranty		



## 193 SERIES DOME LIGHTS

- Semi-recessed design with domed clear lens
- Replaceable bulb (1003 bayonet)



193BSP



193G

BULK P/N	POLYPACK P/N	DESCRIPTION	QTY
<b>DOMELIGHT</b>			
193BSP	193BSPP	Dome light, black	10
193G	193P	Dome light, gray	10

<b>MATERIALS</b>	Steel housing, polycarbonate lens		
<b>VOLT/AMP</b>	12.8VDC - 0.94A (bulb 1003 bayonet)		
<b>WT/DIMS</b>	.25 lb. / 5.75" x 2.688" x 1.5"		
<b>WARRANTY</b>	Three Year Warranty		

## DOOR PULLS & SPRING LOADED HANDLES

- 11" door pulls with hinged end caps for easy installation
- Include steel reinforced mounting bases
- Spring loaded handle, may also be used as a clothes hanger; choose from three colors

BULK P/N	POLYPACK P/N	DESCRIPTION	QTY
<b>DOOR PULLS</b>			
01180071B	01180071P	Black	25
01180089B	01180089P	Fawn	25
01180090B	01180090BP	Platinum silver	25
<b>SPRING LOADED HANDLES</b>			
2500128B	2500128P	GM pewter	50
2500171B	2500171P	Black	50
2500189B	2500189P	Fawn	50

<b>MATERIALS</b>	Pulls: ABS, Handles: Steel base, ABS handle
<b>WT/DIMS</b>	Pulls: .31 lb. / 8.75" x 1.125" x 3" Handles: .18 lb. / 11" x 1.75" x 1"
<b>WARRANTY</b>	Three Year Warranty



01180071B  
01180089B  
01180090B



2500128B  
2500171B  
2500189B

## WALL PLATES

BULK P/N	POLYPACK P/N	DESCRIPTION	QTY
<b>WALL PLATES / ACCESSORIES</b>			
13000018B	13000018P	Standard 12V outlet, plastic	200
014BCRCW	014BCRCWP	Chrome 12V receptacle with cap	100
7850NFRC	7850NFRCP	Chrome 12V receptacle with cap & wires	250
RC	RCP	Rubber cap for 12V outlet	500



13000018B



## ASH TRAYS



BULK P/N	POLYPACK P/N	DESCRIPTION	QTY
<b>ASH TRAYS</b>			
510001B	510001P	Drop-in ashtray	50
530002B	530002P	Round drop-in ashtray	40
500302B	500302P	Black lighter	25



## BEVERAGE HOLDERS



09017101B

- Versatile beverage holder for cups, cans and mugs
- Two-tier design includes a handle recess for cups and mugs, and rubber flaps to secure cans and smaller cups
- Black finish on all



3202B

1502B

302B

BULK P/N	POLYPACK P/N	DESCRIPTION	QTY
<b>CUP HOLDERS</b>			
09017101B	09017101P	Dual purpose drop-in, handle cavity	50
3202B	3202P	3" two-tier drop-in	50
302B	302P	3" single tier drop-in	50
1502B	1502P	1.5" single tier drop-in	50
15202B	15202P	1.5" two-tier drop-in	50
2409171B	2409171BP	Adjustable, fold-down	100

## REPLACEMENT BULBS RV LIGHTING

BULK P/N	POLYPACK P/N	DESCRIPTION	QTY
<b>BULBS</b>			
30000000B	-	12" fluorescent, cool white	1
30031010B	-	18" fluorescent, cool white, Philips	24
30655010B	-	10W halogen	1

# VEHICLE CONSPICUITY TAPE

**Reflexite®**

- Alternating red/white pattern available in 11" red/7" white and 6" red/6" white patterns
- Solid white tape also available
- All tape is 2" wide, supplied in 150-ft rolls
- Choose from V92, V82 and V42 series tape
- Marked "DOT-C2" per NHTSA 9CFR571.108

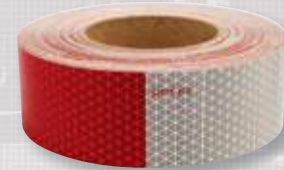

RTR150711B



RT150WBD



RE418T



RTR10150711CB



RTR10150WB



RTR03150711CB

BULK P/N	POLYPACK P/N	DESCRIPTION	QTY
<b>V92 CONSPICUITY TAPE - 5 YEAR</b>			
RTR15066B	RTR15066BP	6" red/6" white, continuous	1
RTR15066PB	RTR15066PBP	6" red/6" white, perforated	1
RTR150711B	RTR150711BP	11" red/7" white, continuous	1
RTR150711PB	RTR150711PBP	11" red/7" white, perforated	1
RT150W12B	RT150W12BP	Solid white, 12" sections on roll	1
RT150WBD	RT150WBDP	Solid white, continuous	1

**RETAIL**

RE418T		4-strip kit, 11" red/7" white	12
RE18T		8-strip kit, 11" red/7" white	12
RE10018T		10-strip kit, 11" red/7" white	1
RE2018T		20-strip kit, 11" red/7" white	5
RE21T		21-ft roll, 11" red/7" white	12

BULK P/N	POLYPACK P/N	DESCRIPTION	QTY
<b>V82 CONSPICUITY TAPE - 10 YEAR</b>			
RTR1015066CB	-	6" red/6" white, continuous	1
RTR10150711CB	-	11" red/7" white, continuous	1
RTR10150WB	-	Solid white, continuous	1

BULK P/N	POLYPACK P/N	DESCRIPTION	QTY
<b>V42 CONSPICUITY TAPE - 3 YEAR</b>			
RTR03150711CB	-	11" red/7" white, continuous	1

<b>FMVSS</b>	DOT-C2		
<b>WARRANTY</b>	V92:	Five Year Warranty	
	V82:	Ten Year Warranty	
	V42:	Three Year Warranty	

CONSPICUITY TAPE



# Reflexite®

## SCHOOL BUS CONSPICUITY TAPE



RT150Y2DB



RT150Y1DB



RT150Y2B



RT150Y1B

- Yellow tape available in 1" and 2" widths
- All tape is supplied in 150-ft rolls
- Choose from V92 and V82 series tape
- Meets ASTM D4956-05 (Type V), FMVSS 131 & 217, CSA D250 requirements

BULK P/N	POLYPACK P/N	DESCRIPTION	QTY
<b>V92 CONSPICUITY TAPE - 5 YEAR</b>			
RT150Y1DB	RT150Y1DBP	1" yellow, diamond pattern	1
RT150Y2DB	RT150Y2DBP	2" yellow, diamond pattern	1

BULK P/N	POLYPACK P/N	DESCRIPTION	QTY
<b>V82 CONSPICUITY TAPE - 10 YEAR</b>			
RT150Y1B	RT150Y1BP	1" yellow	1
RT150Y2B	RT150Y2BP	2" yellow	1

<b>FMVSS</b>	ASTM D4956-05 (Type V), FMVSS 131 & 217, CSA D250		
<b>WARRANTY</b>	V92:	Five Year Warranty	
	V82:	Ten Year Warranty	

# Reflexite®

## VEHICLE CONSPICUITY TAPE



RTRE150GB

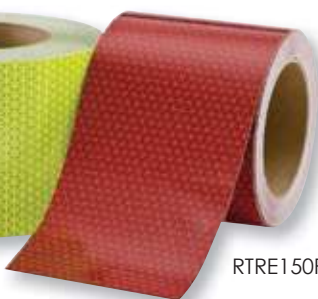

RTRE150RB



RTRE150OB

- Conformable sheeting for emergency vehicles
- Supplied in 6" wide, 150-ft rolls
- Choose from fluorescent lime, red and orange (other colors available upon request)
- Use red/lime sheeting to meet fire apparatus regulation NFPA 1901

BULK P/N	POLYPACK P/N	DESCRIPTION	QTY
<b>V98 CONFORMABLE SHEETING</b>			
RTRE150RB	RTRE150RBP	6" red, diamond pattern	1
RTRE150GB	RTRE150GBP	6" lime, diamond pattern	1
RTRE150OB	RTRE150OBP	6" orange, diamond pattern	1

<b>FMVSS</b>	NFPA 1901		
<b>WARRANTY</b>	Red/Orange:	Five Year Warranty	
	Lime:	Three Year Warranty	

CONSPICUITY TAPE

# RECTANGULAR REFLECTORS

- Select from multiple shapes, sizes and mounting methods; available in bulk, polypack and retail clams
- Acrylic construction; meet FMVSS "A" for reflex when properly applied

BULK P/N	POLYPACK P/N	DESCRIPTION	QTY
<b>REFLECTORS</b>			
RE10AB	RE10ABP	Rectangular, yellow, self adhesive	100
RE10RB	RE10RBP	Rectangular, red, self adhesive	100
RE11AB	RE11ABP	Oblong, yellow, self adhesive/screw mount	100
RE11RB	RE11RBP	Oblong, red, self adhesive/screw mount	100
RE15AB	RE15ABP	Thinline, yellow, adhesive/screw mount	100
RE15RB	RE15RBP	Thinline, red, adhesive/screw mount	100
<b>RETAIL - CLAM</b>			
RE10AK		Rectangular, yellow, self adhesive	12
RE10RK		Rectangular, red, self adhesive	12
RE12AK		Oblong, yellow, self adhesive/screw mount	12
RE12ARK		(2) each yellow and red RE11	12
RE15AK		Thinline, yellow, adhesive/screw mount	12
RE15RK		Thinline, red, adhesive/screw mount	12
RE52ARK		(2) each yellow and red RE52	12

<b>FMVSS</b>	A
<b>MATERIALS</b>	Acrylic
<b>WARRANTY</b>	Three Year Warranty

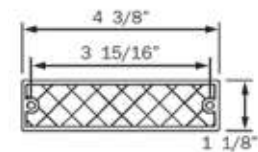
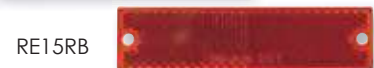
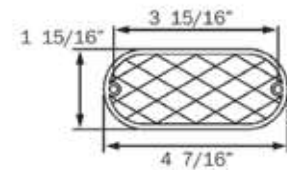
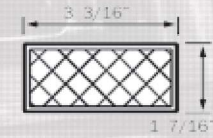

RE52ARK

4" W X 1.25" H X 0.75" D

# ROUND & OVAL REFLECTORS

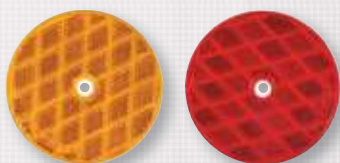

RE13AB

RE13RB

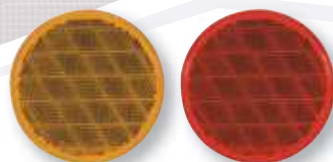
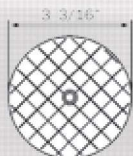

RE21AB

RE21RB



RE31AS

RE31RS

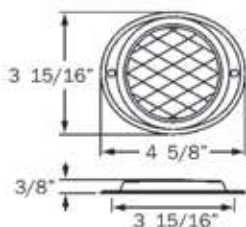

RE37AB

RE37RB

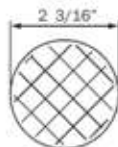

RE35AB

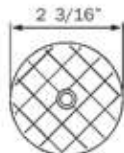

RE35RB

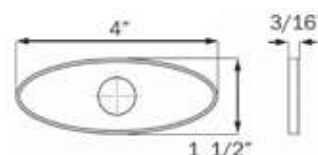

A11AXB / A11RXB



- Select from multiple shapes, sizes and mounting methods; available in bulk, polypack and retail clams
- Acrylic construction; meet FMVSS "A" for reflex when properly applied

BULK P/N	POLYPACK P/N	DESCRIPTION	QTY
<b>REFLECTORS</b>			
A11AXB	A11AXBP	Yellow reflector for 3/4" lights, self adhesive	100
A11RXB	A11RXBP	Red reflector for 3/4" lights, self adhesive	100
RE13AB	RE13ABP	3" round, yellow, center mount	50
RE13RB	RE13RBP	3" round, red, center mount	50
RE21AB	RE21ABP	3" round, yellow, self adhesive	50
RE21RB	RE21RBP	3" round, red, self adhesive	50
RE35AB	RE35ABP	2" round, yellow, center mount	100
RE35RB	RE35RBP	2" round, red, center mount	100
RE37AB	RE37ABP	2" round, yellow, self adhesive	100
RE37RB	RE37RBP	2" round, red, self adhesive	100
<b>RETAIL - CLAM</b>			
RE21AS		3" round, yellow, self adhesive	12
RE21RS		3" round, red, self adhesive	12
RE31AS		3" armored aluminum, yellow, screw mount	12
RE31RS		3" armored aluminum, red, screw mount	12

**FMVSS** A  
**MATERIALS** Acrylic  
**WARRANTY** Three Year Warranty



# 3/4" GROMMETS & BRACKETS

## Grommets and Brackets for 3/4" Round Sealed Lights

- PVC grommets for flush mount of 3/4" round lights
- Snap-in mounting flange for secure installation
- Stainless steel trim ring covers grommet
- License plate light brackets for use with LPL12CB

BULK P/N	POLYPACK P/N	DESCRIPTION	QTY
<b>GROMMETS &amp; BRACKETS</b>			
A10BB	A10BBP	Surface mount base, black	100
A10GB	A10GBP	Sealing grommet	100
A11GB	A11GBP	Standard grommet	100
A11DB	A11DBP	Adaptor cover 2" and 2.5" holes, accepts 3/4" lights	50
A12GB	A12GBP	Sealing grommet, for material thickness .070-.125"	100
A14GB	A14GBP	Sealing grommet, for material thickness .1250-.250"	100
A11PB	A11PBP	Snap-in mounting flange	100
<b>REFLECTORS/TRIM RINGS</b>			
A11AXB	A11AXBP	Yellow reflector, self adhesive	100
A11RXB	A11RXBP	Red reflector, self adhesive	100
A11SSB	A11SSBP	Stainless steel trim ring	100
<b>LICENSE PLATE LIGHT BRACKETS/ACCESSORIES</b>			
A11GLPB	A11GLPBP	License light bracket, gray	50
A11BLPB	A11BLPBP	License light bracket, black	50
A12B2LPB	A12B2LPBP	Vertical license light bracket	50
A12GLPB	A12GLPBP	Grommet for A12B2LPB bracket	50

P/N	MATERIALS	WT/DIMS
A10BB	ABS	
A10GB	PVC	
A11GB	PVC	.05 lb. / 1.083" x 1.083" x 0.456"
A11DB	ABS	.038 lb. / 3.563" x 3.563" x .375"
A12GB	PVC	.05 lb. / 1.094" x 1.094" x 0.465"
A14GB	PVC	.05 lb. / 1.094" x 1.094" x 0.465"
A11PB	Polycarbonate	.05 lb. / 1.156" x 1.156" x 0.75"
A11SSB	Stainless steel	.05 lb. / 1.313" x 1.313" x 0.125"
A11GLPB/BLPB	Polycarbonate	.08 lb. / 2.25" x 1.375" x 0.625"
A12GLPB	PVC	.12 lb. / 3.438" x 2.688" x 2.313"
A11AXB/RXB	Acrylic	.05 lb. / 4" x 1.5" x 0.188"



A10BB



A10GB

A11GB  
A12GB  
A14GB



A11DB



A11PB



A11SSB



A11GLPB



A12B2LPB bracket shown with light and A12GLPB grommet

MOUNTING & WIRING ACCESSORIES



## 2" GROMMETS & ACCESSORIES

### Grommets, Mounting Brackets and Trim Rings for 2" Round Lights

- PVC grommet for flush mount of 2" round lights provides shock mount to lengthen bulb life
- Choice of two surface mount brackets
- Trim rings for grommet or flange mount lights, screw mount



BULK P/N	POLYPACK P/N	DESCRIPTION	QTY
<b>MOUNTING ACCESSORIES</b>			
A53GB	A53GBP	Extra-flex flush mount grommet	100
A54GB	A54GBP	Flush mount grommet	100
A54GK	A54GKP	Kit: A54GB & A46PB PL-10 plug	100
BK5557GB	BK5557GBP	Cam-on mounting bracket	50
A55CB	A55CBP	Chrome trim ring, grommet mount	20
A3TRSSB	A3TRSSBP	Stainless steel trim ring, flange mount	100
BK53BB	BK53BBP	Branch deflector bracket, gray	50

<b>WIRING ACCESSORIES</b>			
A46PB	A46PBP	Two-pin plug with 6" lead, #10 terminal on ground	50

P/N	MATERIALS	WT/DIMS
A53GB	PVC	.05 lb. / 3" x 3" x 1"
A54GB	PVC	.05 lb. / 2.625" x 2.625" x 0.75"
BK5557GB	ABS	.05 lb. / 4" x 2.125" x 1"
A55CB	ABS	.05 lb. / 3.25" x 3.25" x 0.438"
A3TRSSB	Stainless steel	.05 lb. / 3.063" x 3.063" x 0.125"
BK53BB	ABS	.05 lb. / 5.375" x 2.75"

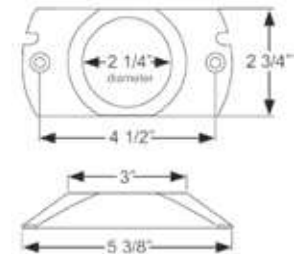
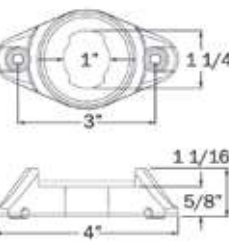
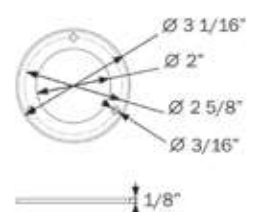
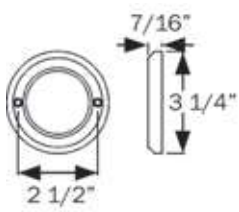

MOUNTING & WIRING ACCESSORIES

## 2.5" GROMMETS

### Mounting Grommets for 2.5" Round Sealed Lights

- PVC grommets for flush mount of 2.5" round lights
- Grommet provides shock mount to lengthen bulb life

BULK P/N	POLYPACK P/N	DESCRIPTION	QTY
<b>MOUNTING ACCESSORIES</b>			
A55GB	A55GBP	Open back, flush mount, black	50
A55GK	A55GKP	Kit: A55GB & A46PB PL-10 plug	100
A55GWB	A55GWBP	Open back, flush mount, white	50
A56GB	A56GBP	Closed back, recess mount, black	100
A57GB	A57GBP	Open back, recess mount, black	50
A57GK	A57GKP	Kit: A57GB & A46PB PL-10 plug	100
A58GB	A58GBP	Angled grommet, black	100

<b>WIRING ACCESSORIES</b>			
A46PB	A46PBP	PL-10 plug with 6" lead, #10 terminal on ground	100

P/N	MATERIALS	WT/DIMS
A55GB/GWB	PVC	.132 lb. / 3.5" x 3.5" x .938"
A56GB	PVC	.132 lb. / 3.25" x 3.25" x 1.125"
A57GB	PVC	.11 lb. / 3.25" x 3.25" x 1.125"
A58GB	PVC	.132 lb. / 3.438" x 3.438" x 0.875"



A55GB

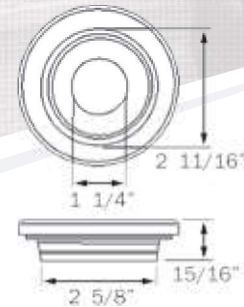

HOLE CUT-OUT: 3"



A56GB

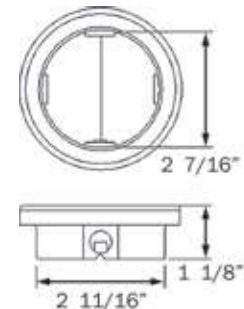

HOLE CUT-OUT: 2.75"



A57GB

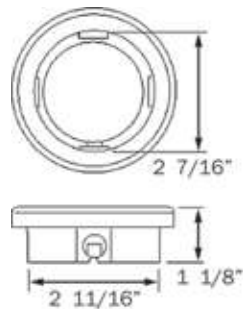

HOLE CUT-OUT: 2.75"



A58GB

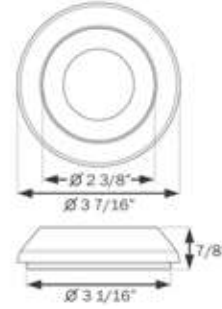

HOLE CUT-OUT: 2.75"

MOUNTING & WIRING ACCESSORIES

## 2.5" BRACKETS & TRIM RINGS

### Mounting Brackets and Ornamental Trim Rings for 2.5" Round Sealed Lights

- Choice of three brackets for surface mount of 2.5" round sealed lights
- Trim rings for grommet or flange mount lights, screw mount



BK55BB

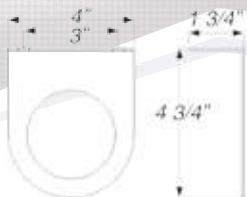

BK57BB

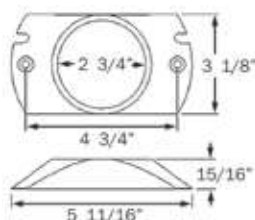

A25TRSSB

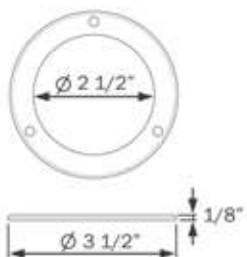

A57CB

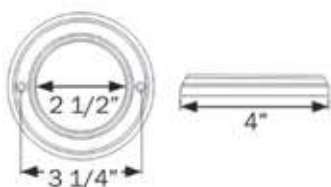

BK5557GB

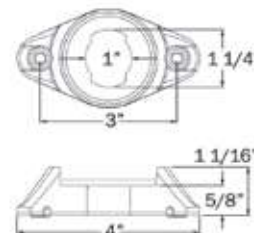

BULK P/N	POLYPACK P/N	DESCRIPTION	QTY
MOUNTING ACCESSORIES			
BK55BB	BK55BBP	Black steel bracket for use with grommet; no cut-out in trailer frame required	20
BK57BB	BK57BBP	Surface mount branch deflector bracket, gray plastic	50
BK5557GB	BK5557GBP	Cam-on mounting bracket with built-in branch deflector, suitable for use with PC rated lights	50
A25TRSSB	A25TRSSBP	Stainless steel trim ring, flange mount	50
A57CB	A57CBP	Chrome trim ring, grommet mount	20

P/N	MATERIALS	WT/DIMS
BK55BB	Steel	.375 lb. / 4" x 4.75" x 1.75"
BK57BB	Polycarbonate	.066 lb. / 5.688" x 3.125" x 0.938"
BK5557GB	Plastic	.066 lb. / 4" x 2.125" x 1"
A25TRSSB	Stainless steel	.04 lb. / 3.5" x 3.5" x 0.125"
A57CB	Plastic	.11 lb. / 4" x 4" x 0.415"



## MC65/A67 SERIES BRACKETS

### Mounting Brackets for MCL61 & MC/MCL65 Series Lights

- Corrosion proof brackets for surface mount of 61/65 series lights
- Single wire design grounds through mounting hardware
- Two-wire design includes both lead and ground wires
- A67 series brackets for use in exterior (top) fender applications with MC65ARB, MCL61ARB and MCL65ARB

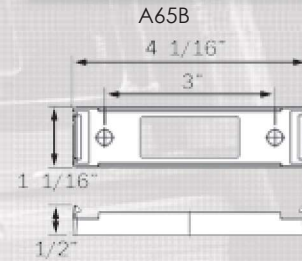

BULK P/N	POLYPACK P/N	DESCRIPTION	QTY
<b>SURFACE MOUNT BRACKETS</b>			
A65B	A65BP	Black bracket only	50
A65PB	A65PBP	Kit: A65B & A65P single wire plug	50
A65PBPG	A65PBPGP	Kit: A65B & A65P single wire plug with .180 molded male bullet	50
A65TB	A65TBP	Black bracket only, thick base	50
A66PB	A66PBP	Kit: Gray bracket & A65P single wire plug	50
A67CB	A67CBP	Kit: Chrome bracket & A65P, 12" lead	50
A67CBPG	A67CBPGP	Kit: Chrome bracket & single wire plug with .180 molded male bullet, 18" lead	50
A67P10G	A67P10GP	Kit: Chrome bracket & single wire plug with .180 molded male bullet, 10" lead	100
A68PB	A68PBP	Kit: A65B & A68P two-wire plug	50
A65PRXB	A65PRXBP	Kit: Black bracket with red reflector installed & single wire plug	50
<b>SURFACE MOUNT FENDER BRACKETS</b>			
A67BB	A67BBP	Black fender bracket with self grounding, single wire plug	50
A67GB	A67GBP	Gray fender bracket with self grounding, single wire plug	50
A67CVB	A67CVBP	Curved gray fender bracket with self grounding, single wire plug; curved to fit radius of trailer fender	50
<b>WIRING ACCESSORIES</b>			
A65P	A65PP	One-wire plug, grounds through mounting hardware	50
A68P	A68PP	Two-wire plug, includes lead and ground	50

P/N	MATERIALS
All brackets	Plastic

MOUNTING & WIRING ACCESSORIES



A91GB

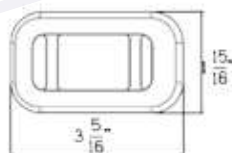
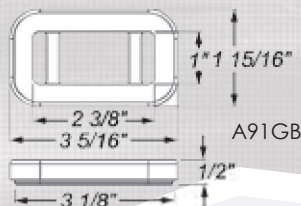
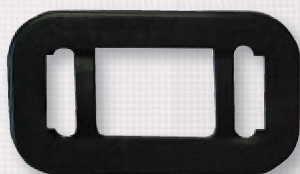

A91G15B1



## 91 SERIES GROMMETS

### Mounting Grommets for A91, AL90, AL191 and AL91 Series Lights

- PVC grommets for flush mount of 90/91 series lights
- Provide shock mount to lengthen life of light
- A91G15B1 allows light to be mounted at 15 degrees

BULK P/N	POLYPACK P/N	DESCRIPTION	QTY
<b>GROMMETS</b>			
A91GB	A91GBP	Black grommet, flush mount	100
A91GOB	A91GOBP	Black open back grommet	100
A91G15B1	A91G15B1P	Black 15 degree angled grommet	100
A91GZB	-	Black vertical mount grommet	50
<b>WIRING ACCESSORIES</b>			
A46PB	A46PBP	Two-wire plug, standard PL-10 connector	100

P/N	MATERIALS	WT/DIMS
A91GB/GOB	PVC	.066 lb. / 3.313" x 1.938" x 0.5"
A91G15B1	PVC	.066 lb. / 3.313" x 1.938" x 1.313"



A91CB

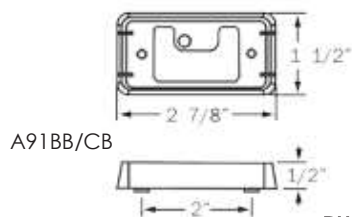

A91BOB

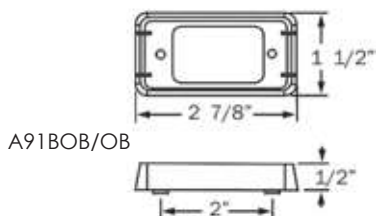

A91BOB/OB

## 91 SERIES BRACKETS

### Mounting Brackets for A91, AL90, AL191 and AL91 Series Lights

- Corrosion proof brackets for surface mount of 90/91 series lights
- Self grounding bases ground through mounting hardware and should be used with A91LW plug
- Open back bases should be used with A46PB two-wire plug

BULK P/N	POLYPACK P/N	DESCRIPTION	QTY
<b>SURFACE MOUNT BRACKETS</b>			
A91BB	A91BBP	Black base, self grounding	100
A91BOB	A91BOBP	Black base, open back	100
A91CB	A91CBP	Chrome base, self grounding	100
A91OB	A91OBP	Chrome base, open back	100
<b>WIRING ACCESSORIES</b>			
A91LW	A91LWP	Single wire plug, molded male bullet	100
A46PB	A46PBP	Two-wire plug, standard PL-10 connector	100

P/N	MATERIALS
All Brackets	Plastic

# 4" ROUND GROMMETS & BRACKETS

## Mounting Grommets & Brackets for Sealed 4" Round Lights

- PVC grommets for flush mount of 45 series lights; grommet provides shock mount to lengthen life of light
- Mounting flanges for flush mount of 45 series lights; lights snap into flange
- Steel bracket mounts to trailer frame; no panel cutout required. Use with A45GB grommet. Durable powder coated finish.



A45GB

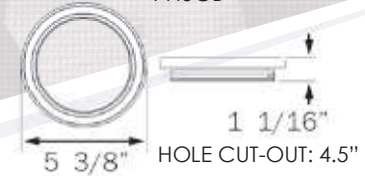

HOLE CUT-OUT: 4.5"

BULK P/N	POLYPACK P/N	DESCRIPTION	QTY
<b>GROMMETS</b>			
A45GB	A45GBP	PVC grommet, flush mount	50
A46GB	A46GBP	Extra-flex PVC grommet, flush mount	50
<b>BRACKETS</b>			
A45BB	A45BBP	Black plastic mounting flange	100
A45SB	A45SBP	Stainless steel mounting flange	20
BK45BB	BK45BBP	Steel mounting bracket, powder coated	10



A45SB

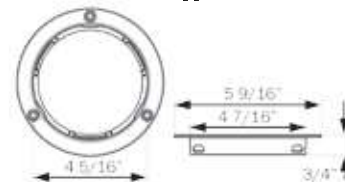

P/N	MATERIALS	WT/DIMS
A45GB	PVC	.176 lb. / 5.375" x 5.375" x 1.063"
A45BB	Plastic	.11 lb. / 5.5" x 5.5" x 1"
A45SB	Stainless steel	.19 lb. / 5.563" x 5.563" x 0.75"
A46GB	PVC	.05 lb. / 5.625" x 5.625" x 1.063"
BK45BB	Steel	.794 lb. / 6" x 5.813" x 1.375"



BK45BB

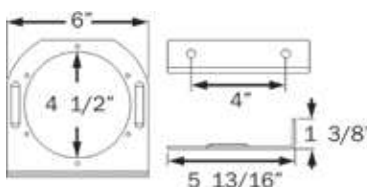

A46GB

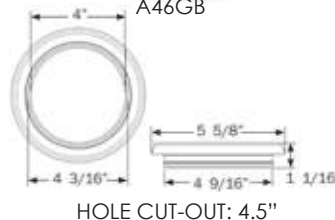

HOLE CUT-OUT: 4.5"



A45BB

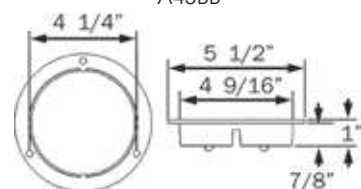

7/8"

MOUNTING & WIRING ACCESSORIES

## 4" ROUND TRIM RINGS

### Trim Rings for Sealed 4" Round Lights



A5TRSSB / A42FCB

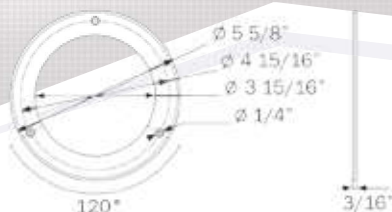

- Stainless steel models fit flange mount lights
- Chrome-plated plastic model fits grommet mount lights
- Trim rings mount using screws

BULK P/N	POLYPACK P/N	DESCRIPTION	QTY
TRIM RINGS			
A5TRSSB	A5TRSSBP	Stainless steel trim ring for flange mount lights	100
A42FCB	A42FCBP	Chromed metal trim ring for flange mount lights	100
A45CGB	A45CGBP	Chrome-plated plastic trim ring for grommet mount lights	20
A101TRSSB	A101TRSSBP	Stainless steel trim ring for STL/BUL101 flange mount lights	50



A45CGB

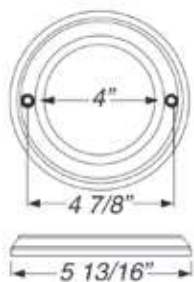

P/N	MATERIALS	WT/DIMS
A5TRSSB	Stainless steel	.132 lb. / 5.625" x 5.625" x 0.188"
A42FCB	Metal, chrome	.132 lb. / 5.625" x 5.625" x 0.188"
A45CGB	Plastic	.132 lb. / 5.813" x 5.813" x 0.5"
A101TRSSB	Stainless steel	.132 lb. / 5.625" x 5.625" x 0.188"



A101TRSSB

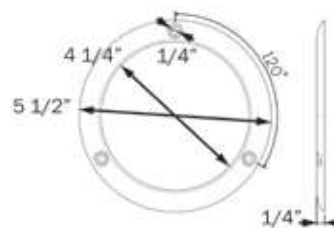

# 6" OVAL GROMMETS/BRACKETS

## Mounting Grommets & Brackets for Sealed 6" Oval Lights

- PVC grommets for flush mount of 70 series lights; grommet provides shock mount to lengthen life of light
- Steel brackets mount to trailer frame; no panel cutout required. Use with A70GB grommet or recess flange mount lights.

BULK P/N	POLYPACK P/N	DESCRIPTION	QTY
<b>GROMMETS</b>			
A70GB	A70GBP	PVC grommet, flush mount	50
A70GBD	A70GBDP	PVC grommet	50
A60GB	A60GBP	PVC grommet	50
<b>BRACKETS</b>			
BK70BB	BK70BBP	Steel mounting bracket, powder coated	10
A77SB	A77SBP	Steel mounting bracket, gray	20

P/N	MATERIALS	WT/DIMS
A70GB	PVC	.132 lb. / 7.625" x 3.375" x 1.125"
BK70BB	Steel	.728 lb. / 8.25" x 4" x 1.625"
A77SB	Steel	.132 lb. / 8.25" x 5.75" x 1.375"



A70GB

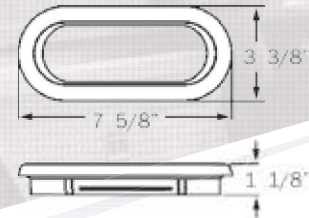

HOLE CUT-OUT: 6.85" x 2.5" (1.25" R)



BK70BB

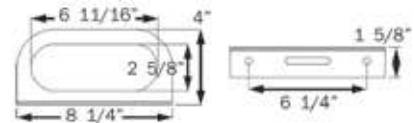

A77SB

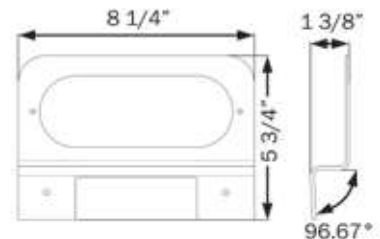

MOUNTING & WIRING ACCESSORIES





A7TRSSB

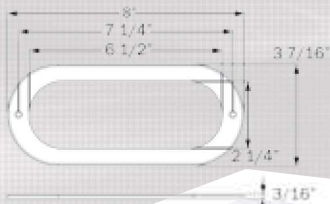

## 6" OVAL FLANGE COVERS

### Trim Rings for 6" Oval Sealed Flange Mount Lights

- Choose from stainless steel, chrome-plated plastic and red reflex models
- A7TRSSB mounts to STL75AMFB flange using screws
- A78CB1 and A78RXB snap onto flange/surface mount lights
- A78RXB fulfills rear reflex function, eliminating the need for a separate reflector



A78CB1

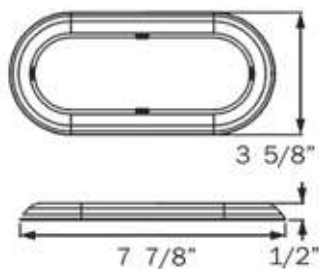

A78RXB

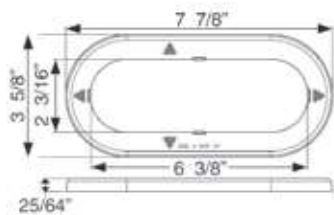

BULK P/N	POLYPACK P/N	DESCRIPTION	QTY
FLANGE COVERS			
A7TRSSB	A7TRSSBP	Stainless steel, screw mount (STL75AMFB)	100
A78CB1	A78CB1P	Chrome-plated plastic, snap-on	25
A78RXB	A78RXBP	Red reflex, snap-on	25
A111TRSSB	A111TRSSBP	Stainless steel screw mount trim ring for STL/BUL111 flange mount lights	50
A178TRSSB	A178TRSSBP	Stainless steel screw mount trim ring for STL178 flange mount lights	50

P/N	MATERIALS	WT/DIMS
A7TRSSB	Stainless steel	.066 lb. / 8" x 3.438" x 0.188"
A78CB1	ABS Plastic	.066 lb. / 7.875" x 3.625" x 0.5"
A78RXB	Acrylic	.066 lb. / 7.875" x 3.625" x 0.391"
A111TRSSB	Stainless steel	.066 lb. / 7.625" x 3.25" x 0.25"
A178TRSSB	Stainless steel	.066 lb. / 7.563" x 3.313" x 0.188"



A111TRSSB

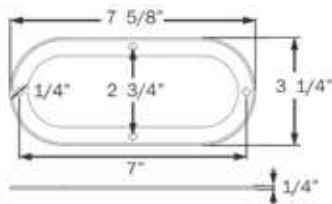

A178TRSSB

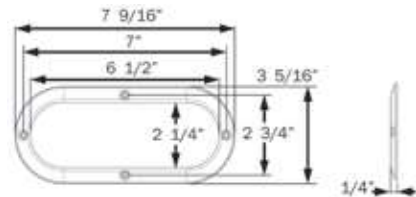

# MOUNTING ACCESSORIES

## Miscellaneous Mounting Grommets, Brackets & Accessories

- A33GB is PVC grommet for flush mount of 33/35 series lights; grommet provides shock mount to lengthen life of light
- BK42CB offers added protection for oblong, surface mount marker lights
- BK66DB offers added protection for MCL66 series lights
- A40SRB secures lens of ST series lights



A33GB

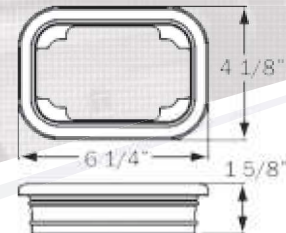

HOLE CUT-OUT: 5.453" x 3.578" (1" R)

BULK P/N	POLYPACK P/N	DESCRIPTION	QTY
<b>GROMMET - ST/STL33 SERIES</b>			
A33GB	A33GBP	PVC grommet, flush mount	50
<b>BRACKET - OBLONG M/C LIGHTS</b>			
BK42CB	BK42CBP	Steel mounting bracket, chrome plated	100
<b>BRACKET - MCL66 SERIES</b>			
BK66DB	BK66DBP	Heavy duty armored base for MCL66 series lights; die cast metal	50
<b>RETENTION RING - ST40 SERIES</b>			
A40SRB	A40SRBP	Snap ring for ST40 series lights	100



BK42CB

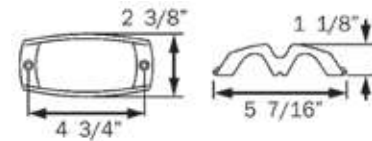

BK66DB

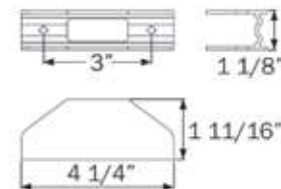

P/N	MATERIALS	WT/DIMS
A33GB	PVC	.353 lb. / 6.25" x 4.125" x 1.625"
BK42CB	Steel	.243 lb. / 5.438" x 2.375" x 1.125"
BK66DB	Aluminum	.132 lb. / 4.25" x 1.125" x 1.688"
A40SRB	Metal	.066 lb. / 5.125" x 0.125"

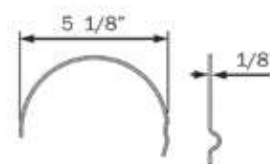

A40SRB

MOUNTING & WIRING ACCESSORIES

# MOUNTING ACCESSORIES

## Miscellaneous Mounting Bases & Bezels

- Chrome finish plastic mounting bases/bezels available for several light series; see details below
- Chrome finish plastic bezel for MCL48 and MCL73 dresses up light and covers mounting holes



A13C2B



A11SRB



A48CB



A94VB



A68SSB

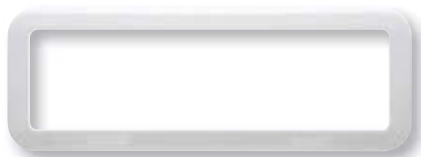

A06TR



A69CB



A79CB



A71CCABWN

BULK P/N	POLYPACK P/N	DESCRIPTION	QTY
BASES/BEZELS			
A06TR	A06TRP	White trim ring	50
A09BB	A09BBP	UCL09 trim ring, black	50
A09CB	A09CBP	UCL09 trim ring, chrome	50
A09WB	A09BBP	UCL09 trim ring, white	50
A11SSB	A11SSBP	Stainless steel trim ring for 3/4" lights	100
A13C2B	A13C2BP	MCL/UCL13 base/bezel, chrome	100
A13B2B	A13B2BP	MCL/UCL13 base/bezel, black	100
A15BB	A15BBP	MCL15 base/bezel, black	100
A15CB	A15CBP	MCL15 base/bezel, chrome	100
A21CHB	A21CHBP	ILL21 bezel, chrome	25
A48CB	A48CBP	MCL48 & MCL73 bezel, chrome	50
A68SSB	A68SSB	Stainless steel snap-on trim ring for STL68RB	20
A69CB	A69CBP	STL69 & MCL70 base/bezel, chrome	10
A69RXC	A69RXCBP	STL69RXC base/bezel, chrome	10
A71CBAWN	A71CBAWN	Chrome finish plastic base for ILL71CBAWN	10
A79CB	-	MCL78/88 and STL79/80/89/90 series base/bezel, chrome	10
A94VB	A94VP	Black steel visor for 7" warning lamps	25

P/N	MATERIALS	WT/DIMS
A06TR	ABS	.06 lb. / 11" x 4" x .25"
A09BB/CB/WB	ABS	.06 lb. / 3.421" x 3.421" x .287"
A11SRB	SS	.02 lb. / 1.5" x 1.5" x .125"
A13C2B/B2B	ABS	.088 lb. / 3.236" x 1.791" x .43"
A15BB/CB	ABS	.088 lb. / 3.938" x 1.374" x .5"
A21CHB	ABS	.088 lb. / 6.313" x 6.313" x .563"
A48CB	ABS	.088 lb. / 6" x 2.25" x 1.125"
A68SSB	SS	.088 lb. / 10.125" x 3" x .375"
A69CB	ABS	.176 lb. / 16.313" x 1.625" x 0.813"
A69RXC	ABS	.176 lb. / 16.313" x 1.875" x 0.813"
A71CBAWN	ABS	.176 lb. / 18" x 2" x 1"
A79CB	ABS	.176 lb. / 18.875" x 2" x 0.813"
A94VB	Steel	.81 lb. / 7.25" x 7.25" x 4"

# LICENSE PLATE BRACKETS

- Select from heavy duty metal and corrosion proof plastic
- Accept stud mount license plate lights

BULK P/N	POLYPACK P/N	DESCRIPTION	QTY
<b>BRACKETS</b>			
LP5SB	LP5SBP	Black heavy duty plastic	100
LP10SB	LP10SBP	Black heavy duty plastic	50
LP15SB	LP15SBP	Zinc plated steel	12
LP20SB	LP20SBP	Powder coated steel	25
LP31SB	LP31SBP	Black heavy duty plastic for low temps	50
BK31BB	BK31BBP	Black heavy duty plastic	50
<b>RETAIL</b>			
LP10S		Black heavy duty plastic, clam	12
LP15S		Zinc plated steel, clam	12

P/N	MATERIALS	WT/DIMS
LP5SB	Plastic	.17 lb. / 8.25" x 4.25" x .813"
LP10SB	Plastic	.17 lb. / 9.5" x 4.813"
LP15SB	Steel	.397 lb. / 8.438" x 3.625" x 1.5"
LP20SB	Steel	.132 lb. / 8.5" x 2.875"
LP31SB	Plastic - low temp	.17 lb. / 8.25" x 4.25" x .813"
BK31BB	Plastic	.17 lb. / 8.25" x 4.25" x .813"



LP5SB

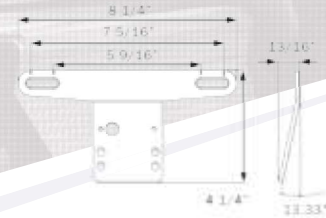

LP10SB

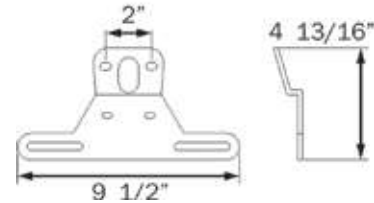

BK31BB  
LP31SB

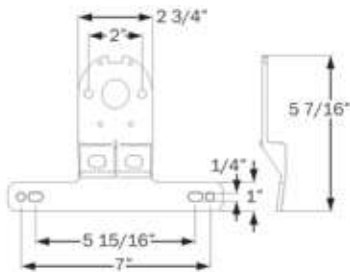

LP20SB

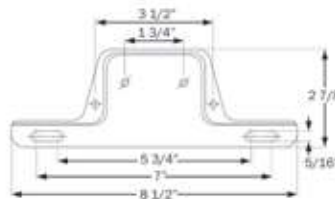

LP15SB

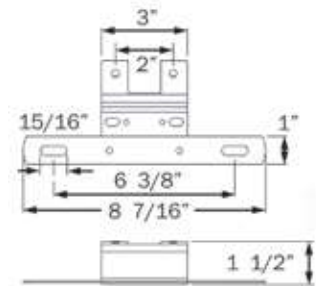

MOUNTING & WIRING ACCESSORIES





LP25SB

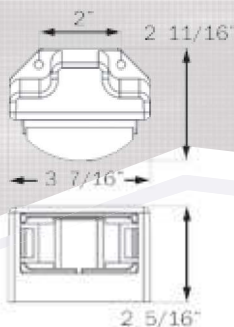

LP35BB

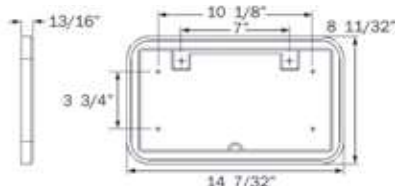

## LICENSE LIGHT BRACKETS & LICENSE PLATE HOLDER

- LP25SB surface mount bracket accepts LP91 and LPL91 series lights; mounting gasket sold separately
- LP35BB surface mount license plate holder is designed for mounting on flat surfaces

BULK P/N	POLYPACK P/N	DESCRIPTION	QTY
<b>LICENSE LIGHT BRACKETS</b>			
LP25SB	LP25SBP	Black bracket for LP/LPL91 lights	100
A25GB	A25GBP	Gasket for LP25SB	100
<b>LICENSE PLATE HOLDER</b>			
LP35BB	LP35BBP	Black license plate holder	25

P/N	MATERIALS	WT/DIMS
LP25SB/GGB	Polycarbonate	.066 lb. / 3.438" x 2.688" x 2.313"
LP35BB	Plastic	.122 lb. / 14.5" x 8.25"



DH55

## DOCUMENT HOLDER

- Twist-on cover with gasket protects documents from dirt and moisture while allowing convenient access
- Easy installation

BULK P/N	POLYPACK P/N	DESCRIPTION	QTY
<b>DOCUMENT HOLDER</b>			
DH55	DH55P	Document holder	10

P/N	MATERIALS	WT/DIMS
DH55	Polycarbonate	0.46 lb. / 5.5" x 5.5" x 2.125"

### 3-WIRE PIGTAILS

#### Wiring/Molded Plugs for Double Contact Sealed Lights

- A45PB & A47PB feature standard PL-3 plug with male pins, bare lead wires and #10 ring terminal on ground wire
- For use with stop/turn/tail, parking/turn and warning lights

BULK P/N	POLYPACK P/N	DESCRIPTION	QTY
<b>STANDARD PL-3</b>			
A45PB	A45PBP	Straight pigtail, 6"	100
A47PB	A47PBP	Right angle pigtail, 10"	100
A47PBB	A47PBBP	Straight pigtail, 10", no eyelet on ground	100
<b>WEATHERPROOF</b>			
A45PMB	A45PMBP	Weathertight plug to bare wire, 10"	50
AL45PWTB	AL45PWTBP	Weathertight plug with female PL-3, 10"	50
<b>RETAIL</b>			
A45PS		Straight pigtail, 6", clam	50
A47PS		Right angle pigtail, 10", clam	50
<b>WT</b>	All weigh approximately 0.044 lb. each		



A45PB

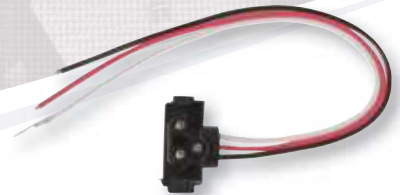

A47PB

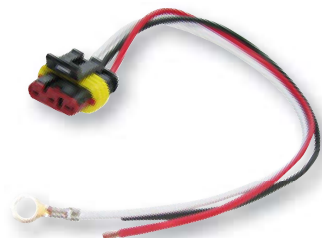
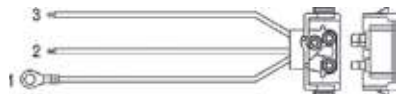

A45PMB

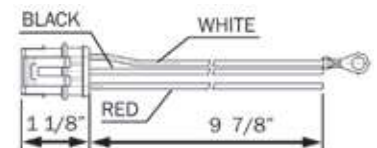

AL45PWTB



MOUNTING & WIRING ACCESSORIES



A42PMB

## 2-WIRE PIGTAILS

### Wiring/Molded Plugs for Single Contact Sealed Lights

- Standard two terminal plug with male pins, bare lead wire and #10 ring terminal on ground wire
- For use with back-up and utility lights



A45CB



A49PB



BULK P/N	POLYPACK P/N	DESCRIPTION	QTY
<b>TWO-WIRE PIGTAILS</b>			
A42PMB	A42PMBP	Weathertight pigtail, 10"	100
A45CB	A45CBP	Straight pigtail, 10"	100
A49PB	A49PBP	Right angle pigtail, 10"	100
A49PBB	A49PBBP	Right angle pigtail, 6", no eyelet on ground	100
<b>WT</b>		All weigh approximately 0.044 lb. each	

## 2-WIRE PIGTAILS

### Wiring/Molded Plugs for Sealed Marker/Clearance & Utility Lights

- Pigtails feature standard PL-10 plug with male pins; bare lead wires and #10 ring terminal on ground wire unless noted in description
- For use with sealed marker/clearance and utility lights



AL42PB



A46PB

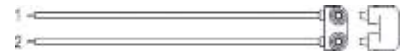

BULK P/N	POLYPACK P/N	DESCRIPTION	QTY
<b>TWO-WIRE PL-10 PLUGS</b>			
A12PB	A12PBP	12" adaptor, .180 male bullets to .180 female barrels	100
AL42PB	AL42PBP	MCL42 weathertight pigtail	100
AL42PG	AL42PGP	MCL42 weathertight pigtail, .180 bullets	100
A46PB	A46PBP	Straight pigtail, 6"	100
A46PBB	A46PBBP	Straight pigtail, 6", no eyelet on ground	100
A46PPG	A46PPGP	Straight pigtail, 6", male plug on power	100
A46P135B	-	Straight pigtail, 135", no ring terminal on ground wire	100
A46P75B	-	Straight pigtail, 75", no ring terminal on ground wire	100
A46P36B	-	Straight pigtail, 36", no ring terminal on ground wire	100
A86PB	A86PBP	Straight pigtail, 18"	100
<b>RETAIL</b>			
A46PS		Straight pigtail, 6", clam	12
<b>WT</b>	All weigh approximately 0.044 lb. each		

## ID LIGHT BAR HARNESS

### Wiring/Molded Plugs for 3-Pc Sealed Identification Light Bars

- Standard two terminal plugs with male pins; 65" bare lead wire and #10 ring terminal on 19" ground wire
- For use with identification light bars featuring sealed lights



A93PB

BULK P/N	POLYPACK P/N	DESCRIPTION	QTY
<b>ID LIGHT BAR HARNESS</b>			
A93PB	A93PBP	ID light bar harness	100
<b>WT</b>	0.4 lb.		

MOUNTING & WIRING ACCESSORIES





A91LW



## SINGLE WIRE PLUG

### Wiring/Molded Plug for Marker/Clearance & Utility Lights

- Standard molded .180 male plug with 12" lead wire
- For use with sealed marker/clearance and utility lights installed in self-grounding base

BULK P/N	POLYPACK P/N	DESCRIPTION	QTY
<b>SINGLE WIRE PLUG</b>			
A91LW	A91LWP	Single wire plug, 12"	100
A91LRW	A91LRWP	Single wire plug, 7", red	500
WT	0.044 lb.		



A65P



A68P

## SINGLE & TWO-WIRE PLUGS

### Wiring/Molded Plug for Thinline Marker/Clearance & Utility Lights

- Standard .156 male bullet on 6" lead wire
- Molded plug fits into surface mount bracket for MC/MCL/UL/UCL65 and MCL61 series lights
- Single wire plug grounds through mounting hardware
- Two-wire plug includes both lead and ground wire

BULK P/N	POLYPACK P/N	DESCRIPTION	QTY
<b>MOLDED PLUGS FOR THINLINE LIGHTS</b>			
A65P	A65PP	Single wire plug, 6"	50
A68P	A68PP	Two-wire plug, 6"	50
WT	Plugs weigh approximately 0.044 lb. each		

## TRUNK & TRAILER CONNECTORS

- A10TH5B tongue extension features 5-way flat plug with one female/four male pins on one end; on other end 5-way flat plug with one male/three female pins, female barrel on blue wire
- A4TC4WB and A6TC4WB trunk connectors feature 4-way flat plug with three female/one male pins
- A18TC replacement trailer connector has one female/ three male pins; A185TC has one female/four male pins
- A48TC replacement trunk connector has one male/three female pins



A48TC

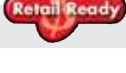

A18TC

BULK P/N	POLYPACK P/N	DESCRIPTION	QTY
<b>CONNECTORS</b>			
A10TH5B	A10TH5BP	5-way harness tongue extension, 10-ft	50
A4TC4WB	A4TC4WBP	4-way to bare wire, 4-ft	100
A6TC4WB	A6TC4WBP	4-way to bare wire, 6-ft	50
<b>RETAIL</b>			
A18TC		4-way trailer connector, 18", clam	12
A185TC		5-way trailer connector, 18", clam	12
A48TC		4-way trunk connector, 4-ft, clam	12

## 7-5 WAY ADAPTORS/PLUGS

Converts two vehicle 7-way round blade connector to 5-way flat pin connector





A57WB



A75TB



A7WCB

BULK P/N	POLYPACK P/N	DESCRIPTION	QTY
<b>7-5 WAY ADAPTORS</b>			
A57WB	A57WBP	5-flat to 7-round, 16" cable	25
A75TB	A75TBP	5-flat to 7-round, single piece	50
A7WCB	A7WCBP	7-way power plug, round	50
<b>RETAIL</b>			
A57WH		5-flat to 7-round, 16" cable, clam	6
A75TC		5-flat to 7-round, single piece, clam	12

## 4-WAY WISHBONE STYLE WIRING HARNESSSES

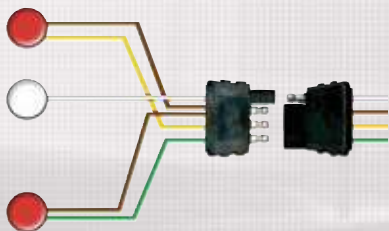

Split wishbone four-conductor harnesses

**WIRE DESCRIPTIONS:**

- WHITE - GROUND
- BROWN - TAIL LAMPS
- YELLOW - DRIVER SIDE STOP/TURN
- GREEN - PASSENGER SIDE STOP/TURN

BULK P/N	POLYPACK P/N	DESCRIPTION	QTY
<b>4-WAY HARNESSSES</b>			
A20WB	A20WBP	20-ft	50
A25WB	A25WBP	25-ft	50
A25R10WB	A25R10WBP	25-ft, #10 ring terminal on ground	50
A25W42B	A25W42BP	25-ft, 42" ground wire	50
A30WB	A30WBP	30-ft	50
A30W10B	A30W10BP	30-ft, 10-ft ground wire	50
A35WB	A35WBP	35-ft	25
A35R10WB	A35R10WBP	35-ft, #10 ring terminal on ground	25
A35W42B	A35W42BP	35-ft, 42" ground wire	50
A36WRB	A36WRBP	36-ft ribbon wiring harness	25
A40W42B	A40W42BP	40-ft with tubing, 42" ground wire	25
<b>RETAIL</b>			
A25WH		25-ft harness with 4-ft trunk connector, clam	6

## 5-WAY WISHBONE STYLE WIRING HARNESSSES

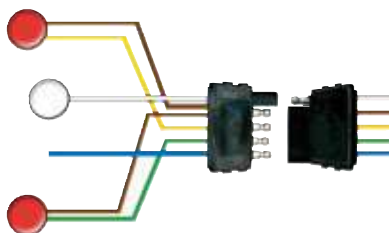

Split wishbone five-conductor harnesses have fifth wire for lights or brakes

**WIRE DESCRIPTIONS:**

- WHITE - GROUND
- BROWN - TAIL LAMPS
- YELLOW - DRIVER SIDE STOP/TURN
- GREEN - PASSENGER SIDE STOP/TURN
- BLUE - AUXILIARY USE

BULK P/N	POLYPACK P/N	DESCRIPTION	QTY
<b>5-WAY HARNESSSES</b>			
A25W5B	A25W5BP	25-ft, 30" ground, 5-ft blue wire	25
A30W5B	A30W5BP	30-ft, 30" ground, 5-ft blue wire	25
A30W5BLB	-	30-ft, 40" ground, 30-ft blue wire	25
A35W5B	A35W5BP	35-ft, 30" ground, 5-ft blue wire	25
A40W5B	A40W5BP	40-ft, 30" ground, 5-ft blue wire	25
<b>RETAIL</b>			
A255WH		25-ft harness with 4-ft trunk connector, clam	6

## REPLACEMENT BULBS

BULK P/N	POLYPACK P/N	DESCRIPTION	QTY
<b>BULBS</b>			
A2057B	A2057BP	2057, 14V 32/2CP, 1200/5000 hour rating	50
A1157B	A1157BP	1157, 14V 26.9/8.3W, 1200/5000 hour rating	100
A194B	A194BP	194 wedge base, 14V 4CP, 2500 hour rating	100
A921B	A921BP	921 wedge base, 14V 21CP, 500 hour rating	100
<b>RETAIL</b>			
A400		Set, (1) each: 2057, 1157, 194, 168; clam	12
A700		12V 55W H3 quartz halogen, clam	12

## ALEDRST Series LED Load Resistor

- Upgrade from incandescent turn signals to LED models for safer, cost-efficient lights
- Makes turn signal flash at proper flash rate
- 50W, 6 ohm in-line resistor

BULK P/N	POLYPACK P/N	DESCRIPTION	QTY
<b>LOAD RESISTOR</b>			
ALEDRST1B	ALEDRST1BP	LED load resistor with lead	50
ALEDRST2B	ALEDRST2BP	LED load resistor with lead and female PL-3 plug	50

VOLT/AMP	WARRANTY
12V / 50W	Three Year Warranty

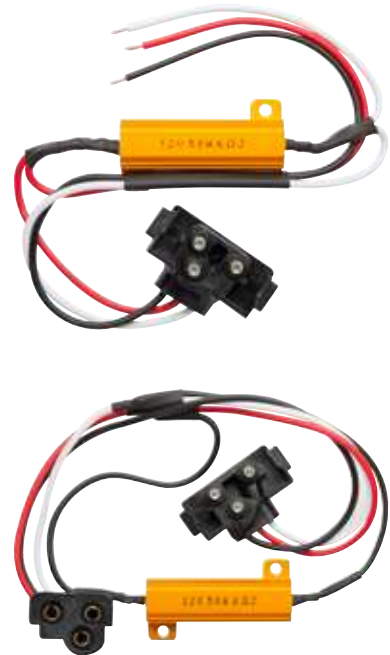

## BULK WIRE

BULK P/N	DESCRIPTION	QTY
<b>BULK WIRE</b>		
A0116AWGBLWSB	16AWG, Blue/White, 1,640-ft. spool	1
A0118AWGBRGRSB	18AWG Brown/Green, 1,640-ft. spool	1
A0118AWGBRBSB	18AWG, Brown, 2,985-ft. spool	1
A0118AWGBRYLWSB	18AWG, Brown/Yellow, 1,640-ft. spool	1
A0118AWGWHTSB	18AWG, White, 2,985-ft spool	1



## MOUNTING GASKETS

Closed cell foam gaskets provide weather tight seal to mounting surface

BULK P/N	POLYPACK P/N	DESCRIPTION	QTY
<b>GASKETS</b>			
A15GB	A15GBP	For MCL15 series, black	50
A13G2B	A13G2BP	For MCL/UCL13 series, black	200
A17GB	A17GBP	For MCL17 series, black	100
A25GB	A25GBP	For LP25SB license light bracket, black	100
A32GB	A32GBP	For MC32 series, white	500
A42GB	A42GBP	For ST40 & STL42 series, black	100
A44GTB	A44GTBP	Thick, for MC/MCL44 series, white	1000
A52GB	A52GBP	For MCL52 series, black	100
A66GB	A66GBP	For MCL66 series, black	100
A69GB	A69GBP	For MCL70/STL69 series, black	50
A73GB	A73GBP	For STL73 series, black	100

## MOUNTING HARDWARE

Hardware sets for mounting tail lights. See contents below. Components packaged separately.

BULK P/N	USE WITH	DESCRIPTION	QTY
<b>HARDWARE SETS</b>			
A830B	ST/STL16/17	(1) each: 1/4" 20 flange lock nut, 1/4" flat washer, 1/4" split lock washer; stainless	100
A839B	ST/STL16/17	(1) each: 1/4" 20 flange lock nut, 1/4" flat washer, 1/4" split lock washer; zinc plated	100



## FLASHER

BULK P/N	POLYPACK P/N	DESCRIPTION	QTY
<b>FLASHER</b>			
ALEDFB	ALEDFBP	LED flasher with connectors	10
<b>RETAIL</b>			
A LEDFS		LED flasher with connections, clam	12

## FEDERAL LIGHTING REGULATIONS FOR TRAILERS

**IMPORTANT NOTE:** Every lamp, reflex reflector, and conspicuity treatment must be permanently attached in the location specified below and must comply with all applicable requirements prescribed for it by FMVSS/CMVSS 108. The face of any device on the front/rear and sides should be, respectively perpendicular and parallel to the vehicle's centerline, unless it is photo-metrically certified at installation angle. No part of the vehicle shall prevent any device from meeting its prescribed requirements unless an auxiliary device meeting all prescribed requirements is installed. **IN CANADA:** Manufacturers and importers of vehicles must have the proper certification test records demonstrating compliance of lighting components with all prescribed requirements.



### BASIC EQUIPMENT REQUIRED ON ALL TRAILERS

DESCRIPTION				MANDATORY REQUIREMENTS			
Area	Equipment	SAE Lens Coding	Functional Purpose	Quantity	Color	Location	Height mm(in.) from the ground
1	Tail Lamps	(T)	Indicate vehicle's presence and width	Minimum 2	Red	On the rear - symmetrical as far apart as practicable	380-1830 (15-72)
	Stop Lamps	(S)	Indicate braking	Minimum 2	Red	On the rear - symmetrical as far apart as practicable	380-1830 (15-72)
	Rear Turn Signal Lamps	(I)	Indicate direction of turn	Minimum 2	Red or Yellow	On the rear - symmetrical as far apart as practicable	380-2110 (15-83)
	Rear Reflex Reflectors	(A)	Indicate vehicle's presence and width	Minimum 2	Red	On the rear - symmetrical as far apart as practicable facing rearward	380-1530 (15-60)
2	License Plate Lamp(s)	(L)	Illuminates license plate	Minimum 1	White	On the rear - above or at the sides of license plate	No requirement
3	Rear Side Marker Lamps	(P2, PC* or P3, PC2*) <small>*photometrically certified at installation angle</small>	Front and rear side marker lamps / side reflex reflectors indicate vehicle's presence and length	Minimum 2	Red	Each side at rear as far back as practicable	380-1530 (15-60) no max. for veh. under 2032mm (80") wide
	Rear Side Reflex Reflectors	(A)		Minimum 2	Red	Each side at rear as far back as practicable facing sideward	380-1530 (15-60)
4	a Front Side Marker Lamps	(P2, PC* or P3, PC2*) <small>*photometrically certified at installation angle</small>	Front and rear side marker lamps / side reflex reflectors indicate vehicle's presence and length	Minimum 2	Yellow	Each side at front as far forward as practicable	380 (15) minimum
	b Front Side Reflex Reflectors	(A)		Minimum 2	Yellow	Each side at front as far forward as practicable facing sideward	380-1530 (15-60)

### ADDITIONAL EQUIPMENT FOR TRAILERS EXCEEDING THE FOLLOWING PARAMETERS Length 9.1m (30 ft.) or longer

DESCRIPTION				MANDATORY REQUIREMENTS			
Area	Equipment	SAE Lens Coding	Functional Purpose	Quantity	Color	Location	Height mm(in.) from the ground
5	a Intermediate Side Marker Lamps	(P2 or P3)	Indicate presence of a long vehicle	Minimum 2	Yellow	Each side near center facing sideward	380 (15) minimum
	b Intermediate Side Reflex Reflectors	(A)	Indicate presence of a long vehicle	Minimum 2	Yellow	Each side near center facing sideward	380-1530 (15-60)

### Width 2032mm (80 in.) or wider

DESCRIPTION			MANDATORY REQUIREMENTS				
Area	Equipment	SAE Lens Coding	Functional Purpose	Quantity	Color	Location	Height
6	Rear Clearance Lamps	(P2, PC* or P3, PC2*) <small>*photometrically certified at installation angle</small>	Show vehicle's width MAY NOT be combined with tail lamps	Minimum 2	Red	At widest point - symmetrical on the rear or near the rear facing rearward	As high as practicable may be lower only if ID lamps are at the top
7	Rear Identification (ID) Lamps	(P2 or P3)	Indicate presence of a wide vehicle	Exactly 3	Red	On the rear - center horizontally spaced 150mm (6 in.) to 300mm (12 in.) apart facing rearward	At the top - may be lower if door header narrower than 25mm
8	Front Clearance Lamps	(P2, PC* or P3, PC2*) <small>*photometrically certified at installation angle</small>	Show vehicle's width	Minimum 2	Yellow	At widest point - symmetrical on the front or near the front facing forward	As high as practicable

### Width 2032mm (80 in.) or wider AND GVWR 4536 kg (10,000 lb.) or more

DESCRIPTION		MANDATORY REQUIREMENTS					
Area	Conspicuity Treatment	DOT Coding	Quantity	Color	Location	Height	Options
9	Rear Upper Body Markings	DOT-C DOT-C2 DOT-C3 DOT-C4	Exactly 2 pairs of 300mm long strips	White	On the rear upper corners facing rearward	At the top	Reflex reflectors may not be required if they are replaced in their required location with conspicuity treatment.  <b>Optional in Canada:</b> Rear lower body and side conspicuity treatment may also be solid white, solid yellow, or white and yellow.
10	Bumper Bar Marking		Continuous	Red/White	On the rear bumper bar's horizontal element full width - facing rearward	No requirement	
11	Rear Lower Body Marking		Continuous	Red/White (see options)	On the rear full width of the vehicle facing rearward	As horizontal as practicable and as close as practicable to the range of 375 to 1525mm from the ground	
12	Side Marking		(see location)	Red/White (see options)	Each side - facing sideward continuous, or evenly spaced over minimum of 50% of length starts and ends as close to the front and rear of the vehicle as practicable	As horizontal as practicable and as close as practicable to the range of 375 to 1525mm from the ground	

**NOTE:** The edge of red conspicuity tape shall not be closer than 75 mm to the edge of any amber lamp and the edge of white conspicuity tape shall not be closer than 75 mm to the edge of any lamp

**For more information contact:** Transport Canada: Motor Vehicle Safety Enforcement Branch  
National Highway Traffic Safety Administration: Office of Safety Performance Standards

# FMVSS LIGHTING REQUIREMENTS – TRAILERS

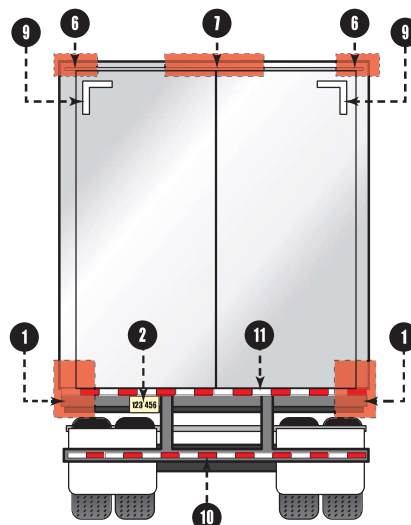
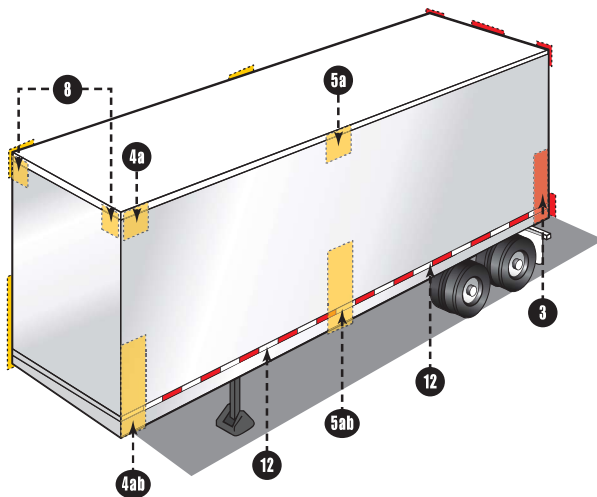
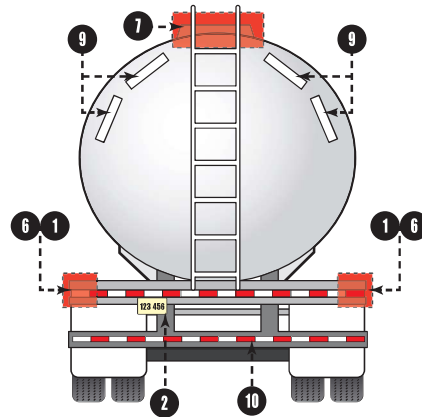
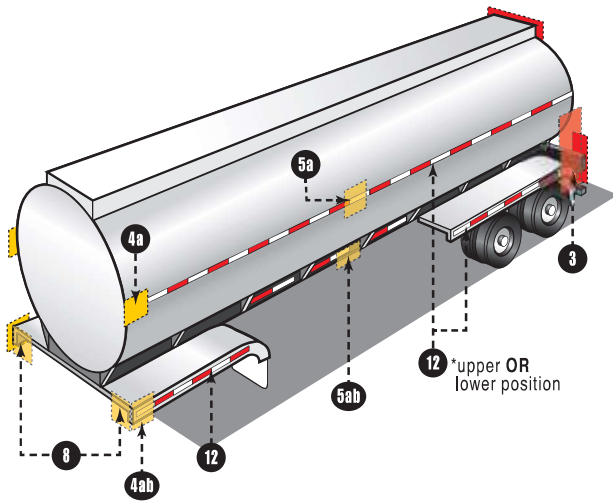
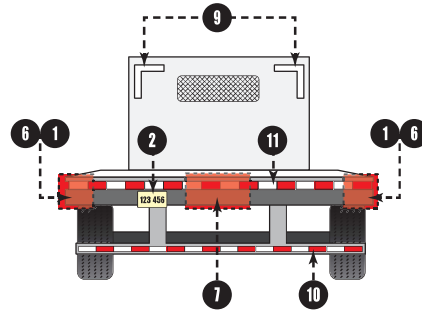
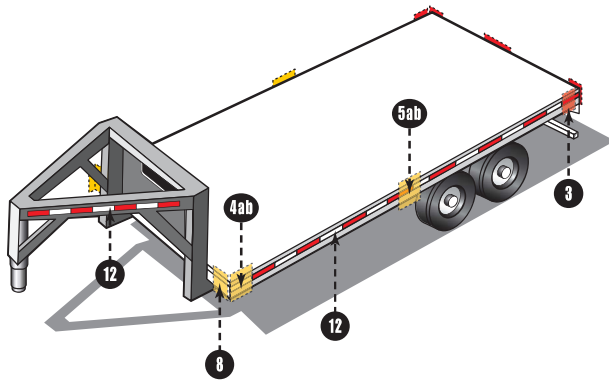
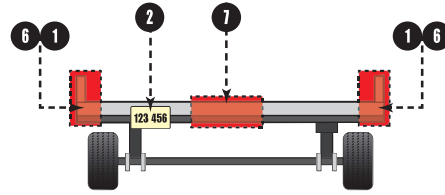
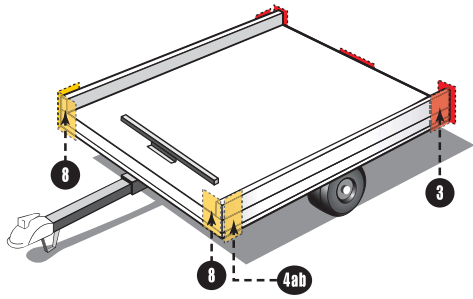



# FMVSS LIGHTING REQUIREMENTS – TRAILERS

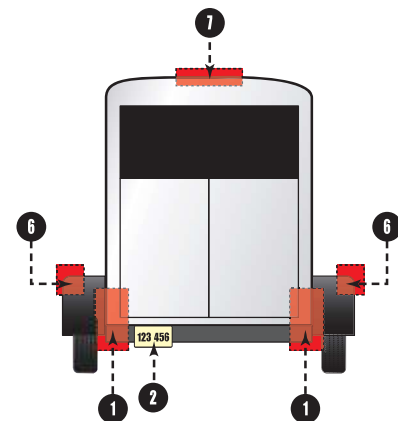
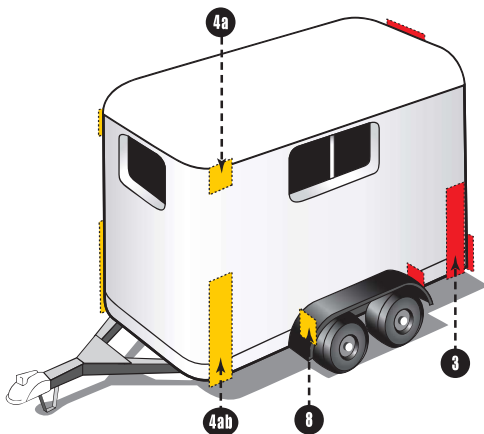
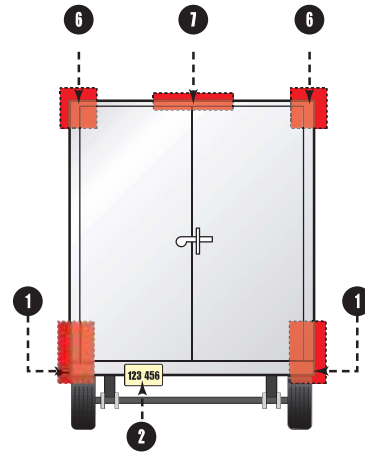
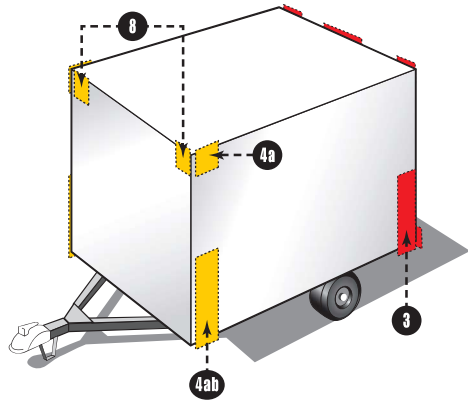
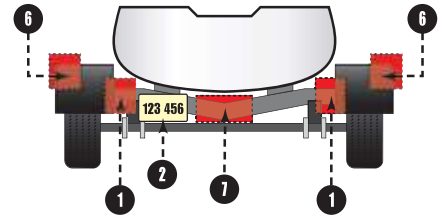
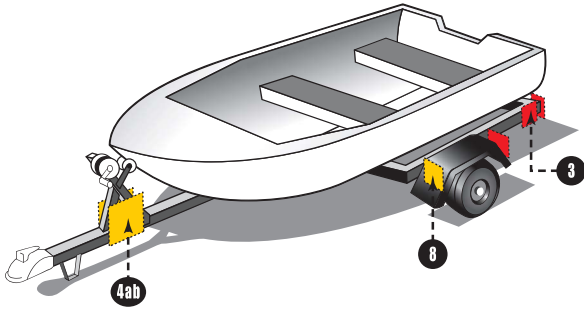
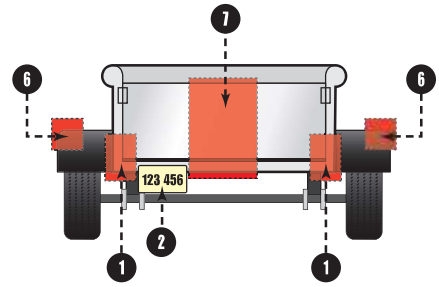
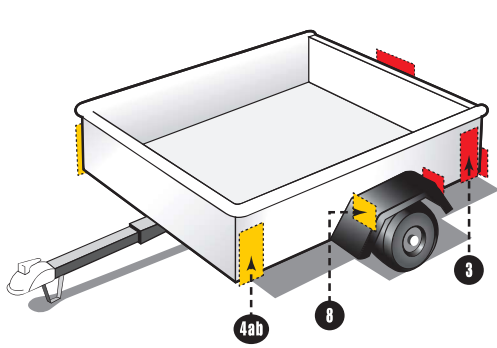



## FEDERAL LIGHTING REGULATIONS FOR TRUCKS, BUSES & MPVS

**IMPORTANT NOTE:** Every lamp, reflex reflector, and conspicuity treatment must be permanently attached in the location specified below and must comply with all applicable requirements prescribed for it by FMVSS/CMVSS 108. The face of any device on the front/rear and sides should be, respectively perpendicular and parallel to the vehicle's centerline, unless it is photo-metrically certified at installation angle. No part of the vehicle shall prevent any device from meeting its prescribed requirements unless an auxiliary device meeting all prescribed requirements is installed. **IN CANADA:** Manufacturers and importers of vehicles must have the proper certification test records demonstrating compliance of lighting components with all prescribed requirements.



### BASIC EQUIPMENT REQUIRED ON ALL TRUCKS, BUSES & MPVS

DESCRIPTION				MANDATORY REQUIREMENTS			
Area	Equipment	SAE Lens Coding	Functional Purpose	Quantity	Color	Location	Height mm(In.) from the ground
1	Headlamps - Lower Beam <small>US requires "DOT" labeling on lens US &amp; Canada - light source code required on lens</small>	(H, HR)	Forward road illumination	Minimum 2	White	On the front - symmetrical as far apart as practicable <small>if 4 lamp system - outboard or above upper beams</small>	560-1370 (22-54)
	Headlamps - Upper Beam <small>US requires "DOT" labeling on lens US &amp; Canada - light source code required on lens</small>	(H, HR)	Forward road illumination	Minimum 2	White	On the front - symmetrical as far apart as practicable <small>if 4 lamp system - inboard or below lower beams</small>	560-1370 (22-54)
	Parking Lamps <small>Vehicles less than 2032mm wide</small>	(P)	Indicate parked vehicle	Minimum 2	White or Yellow	On the front - symmetrical as far apart as practicable	380-1830 (15-72)
	Daytime Running Lamps (DRL) <small>Canada - required / US - option US requires "DRL" labeling on lens if not headlamp</small>	(Y2)	Indicate in use vehicle	Minimum 2	White or Yellow	On the front - symmetrical as far apart as practicable	380 (15) min. <small>Max. depends on type of DRL</small>
	Front Turn Signal/ Hazard Warning Lamps	(U)	Indicate direction of turn/ identify disabled vehicle	Minimum 2	Yellow	On the front - symmetrical as far apart as practicable	380-2110 (15-83)
2	Front Clearance Lamps <small>Vehicles 2032mm wide or wider *photometrically certified at installation angle</small>	(P2, PC* or P3, PC2*)	Show vehicle's width	Minimum 2	Yellow	At widest point - symmetrical on the front or near the front facing forward	As high as practicable
3	Front Identification Lamps (ID) <small>Vehicles 2032mm wide or wider</small>	(P2 or P3)	Indicate presence of a wide vehicle	Exactly 3	Yellow	On the front - center horizontally spaced 150mm (6 in.) to 300mm (12 in.) apart	As high as practicable or on top of the cab
4	a Front Side Marker Lamps <small>*photometrically certified at installation angle</small>	(P2, PC* or P3, PC2*)	Front and rear side marker lamps / side reflex reflector indicate vehicle's presence and length	Minimum 2	Yellow	Each side at front as far forward as practicable	380 (15) minimum
	b Front Side Reflex Reflectors	(A)		Minimum 2	Yellow	Each side at front as far forward as practicable facing sideward	380-1530 (15-60)
5	a Rear Side Marker Lamps** <small>*photometrically certified at installation angle</small>	(P2, PC* or P3, PC2*)		Minimum 2	Red	Each side at rear as far back as practicable	380 (15) minimum
	b Rear Side Reflex Reflectors** <small>**not required on Truck Tractors</small>	(A)		Minimum 2	Red	Each side at rear as far back as practicable facing sideward	380-1530 (15-60)
6	Rear Clearance Lamps <small>Vehicles 2032mm wide or wider Not required on Truck Tractors *photometrically certified at installation angle</small>	(P2, PC* or P3, PC2*)		Show vehicle's width MAY NOT be combined with tail lamps	Minimum 2	Red	At widest point - symmetrical on the rear or near the rear facing rearward
7	Rear Identification (ID) Lamps <small>Vehicles 2032mm wide or wider Not required on Truck Tractors</small>	(P2 or P3)	Indicate presence of a wide vehicle	Exactly 3	Red	On the rear - center horizontally spaced 150mm (6 in.) to 300mm (12 in.) apart facing rearward	At the top - may be lower if door header narrower than 25mm
8	Tail Lamps	(T)	Indicate vehicle's presence and width	Minimum 2	Red	On the rear - symmetrical as far apart as practicable	380-1830 (15-72)
	Stop Lamps	(S)	Indicate braking	Minimum 2	Red	On the rear - symmetrical as far apart as practicable	380-1830 (15-72)
	Rear Turn Signal/ Hazard Warning Lamps	(U)	Indicate direction of turn/ identify disabled vehicle	Minimum 2	Red or Yellow	On the rear - symmetrical as far apart as practicable	380-2110 (15-83)
	Rear Reflex Reflectors	(A)	Show vehicle's presence and width	Minimum 2	Red	On the rear - symmetrical as far apart as practicable	380-1530 (15-60)
9	Backup Lamp	(R)	Illuminates ground behind the vehicle and alert road users	Minimum 1	White	Rear	No requirement
10	License Plate Lamp(s)	(L)	Illuminates license plate	Minimum 1	White	On the rear - above or at the sides of license plate	No requirement
11	Center High Mounted Stop Lamp <small>Vehicles less than 2032mm wide and 4536kg</small>	(U3)	Indicates braking	1	Red	On the rear - centerline of the vehicle	860 (34) minimum

### ADDITIONAL EQUIPMENT FOR SPECIFIC VEHICLES VEHICLES 9.1m (30 ft.) LONG OR LONGER

DESCRIPTION				MANDATORY REQUIREMENTS			
Area	Equipment	SAE Lens Coding	Functional Purpose	Quantity	Color	Location	Height mm(In.) from the ground
12	a Intermediate Side Marker Lamps	(P2 or P3)	Indicate presence of a long vehicle	Minimum 2	Yellow	Each side near center	380 (15) minimum
	b Intermediate Side Reflex Reflectors	(A)	Indicate presence of a long vehicle	Minimum 2	Yellow	Each side near center facing sideward	380-1530 (15-60)

#### Truck Tractors

DESCRIPTION		MANDATORY REQUIREMENTS					
Area	Conspicuity Treatment	DOT Coding	Quantity	Color	Location	Height	Options
13	Rear Upper Body Markings	DOT-C DOT-C2 DOT-C3 DOT-C4	Exactly 2 pairs of 300mm long strips	White	Rear upper corners of cab facing rearward	As high as practicable excluding fairings	
14	Rear Marking		Exactly 2 sections of min. 600mm each	Red/White	Rear - facing rearward - on fenders, on mud flap brackets, or within 300mm below the top of mud flaps	As horizontal as practicable and not higher than 1525mm from the ground	If mud flaps not used - on the cab or frame mounted brackets

**NOTE:** The edge of red conspicuity tape shall not be closer than 75 mm to the edge of any amber lamp and the edge of white conspicuity tape shall not be closer than 75 mm to the edge of any lamp

**For more information contact:** Transport Canada: Motor Vehicle Safety Enforcement Branch  
National Highway Traffic Safety Administration: Office of Safety Performance Standards

# FMVSS LIGHTING REQUIREMENTS – TRUCKS/BUSES/MPV'S

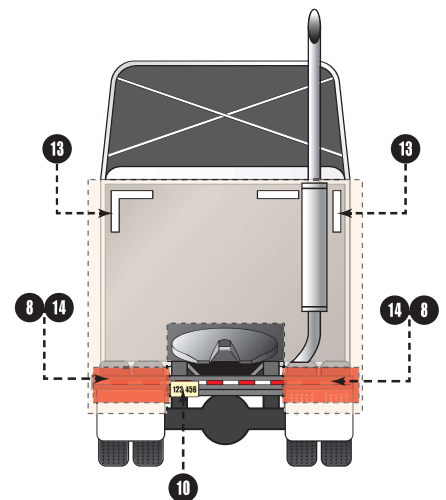
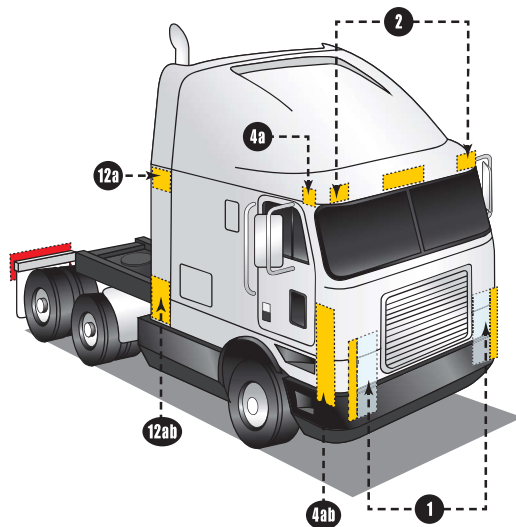
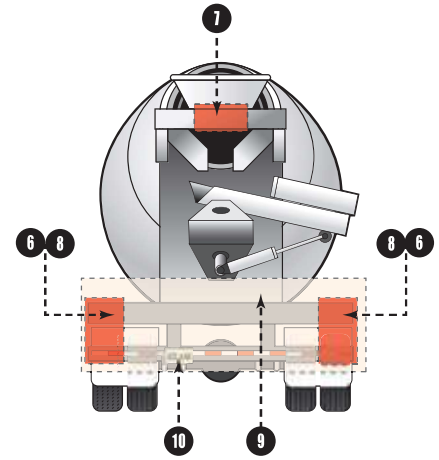
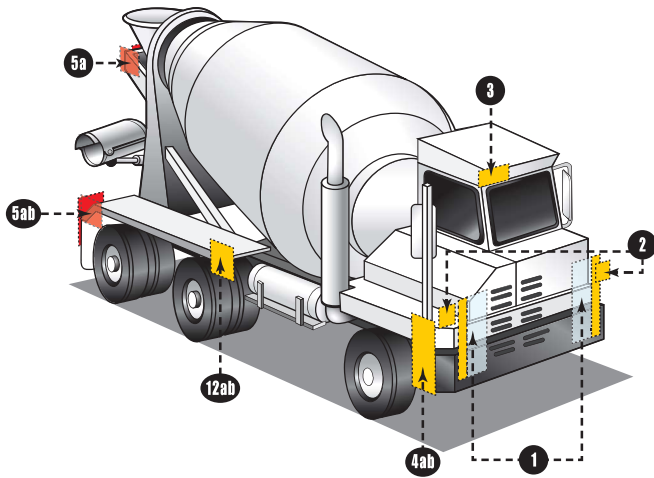
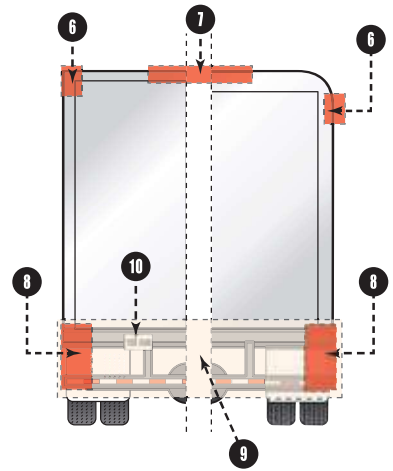
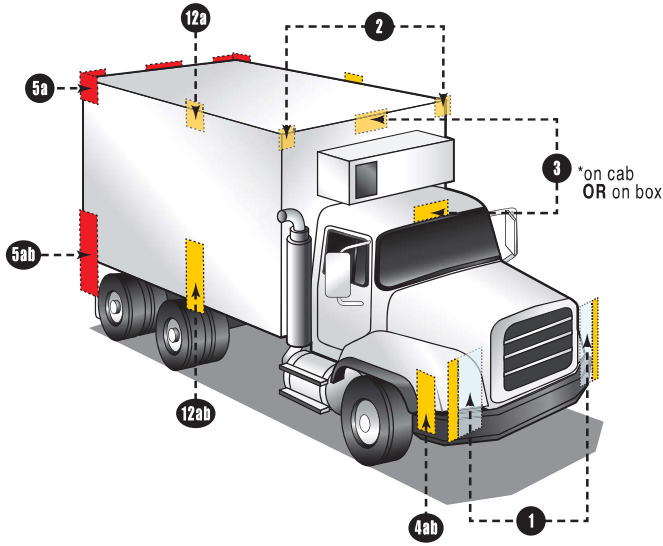



# FMVSS LIGHTING REQUIREMENTS – TRUCKS/BUSES/MPV'S

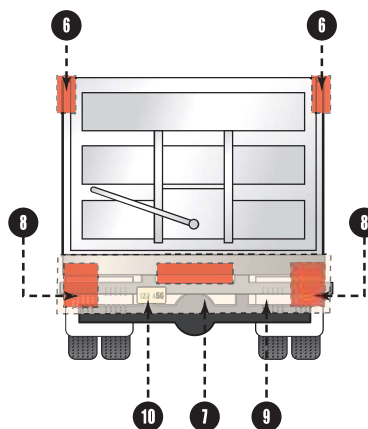
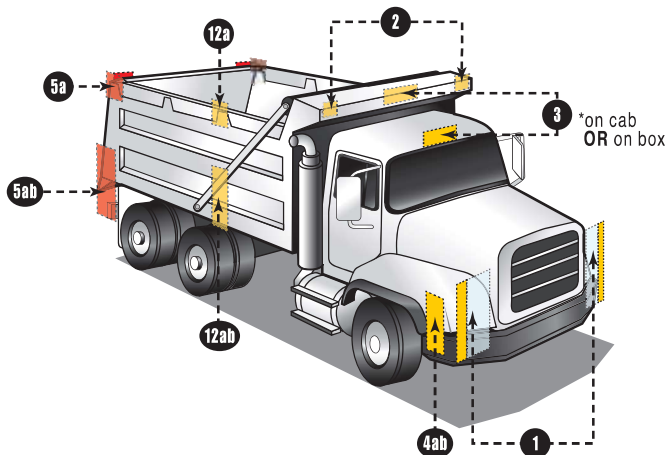
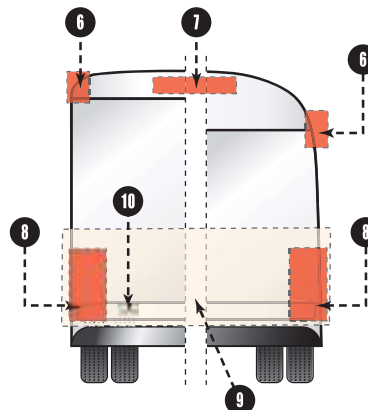
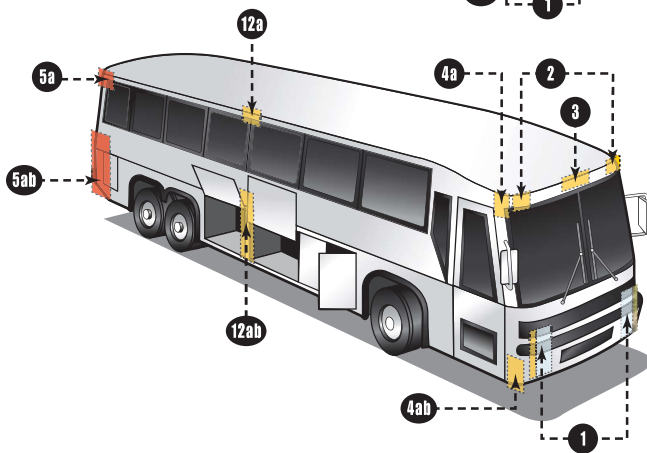
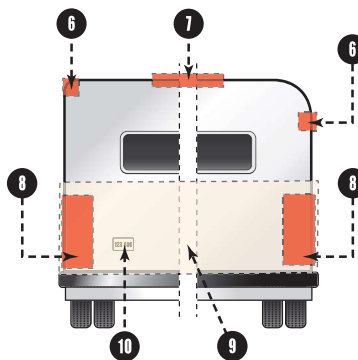
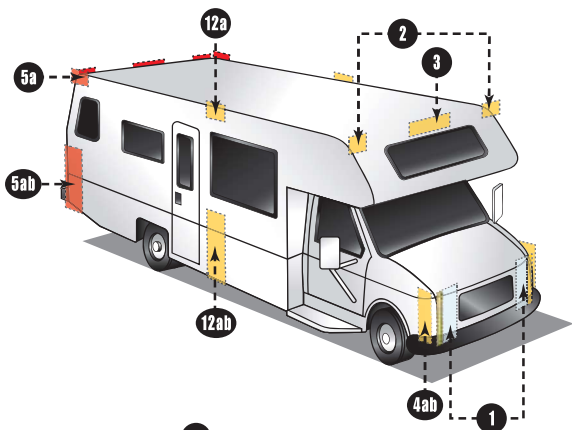
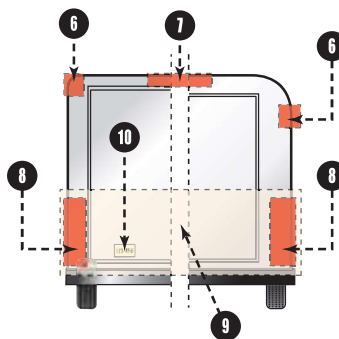
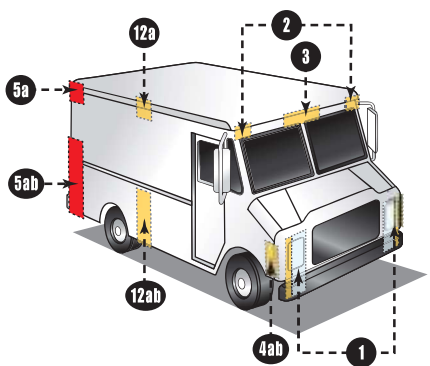

## Truck & Trailer Regulation – FMVSS 108 (49CFR 571.108)

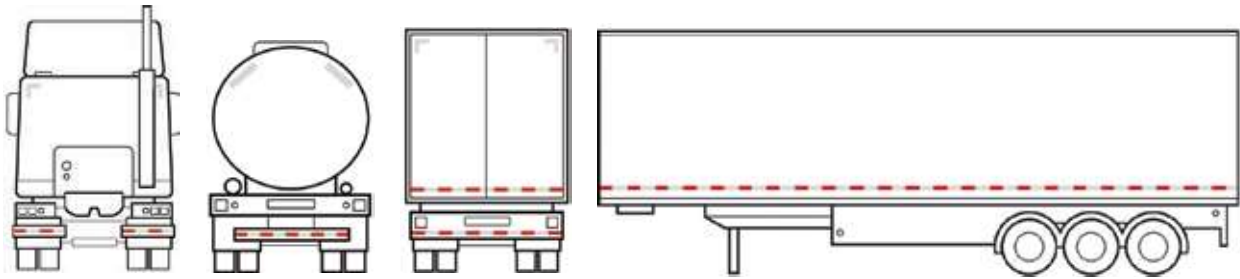

### APPLICATION LOCATIONS:

#### Rear Upper Body

12" WHITE strips placed in the upper rear corners

#### Rear Lower Body

- 2" wide RED/WHITE tape placed on rear full width of vehicle
- 2" wide RED/WHITE tape minimum 24" length on fender, mudflap brackets or within 12" below the top of mudflaps

#### Side Marking

2" wide RED/WHITE tape placed on each side of trailer continuous or evenly spaced over 50% of the vehicle

## School Bus Regulation – FMVSS 131 & 217

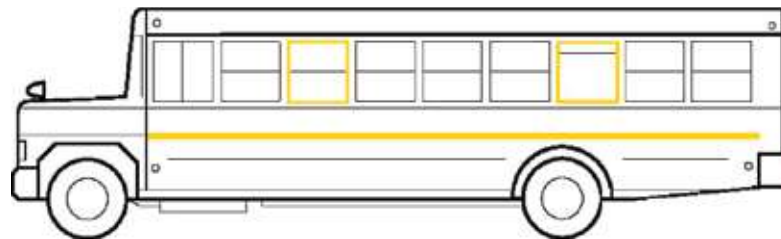
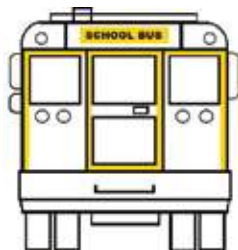

Each opening for a required emergency exit shall be outlined around its outside perimeter with a retroreflective tape with a minimum width of 1 inch and either red, white, or yellow in color, that when tested under the conditions specified in S6.1 of Standard No. 131 (49 CFR 571.131), meets the criteria specified.

### APPLICATION LOCATIONS:

- 1" strips used to mark side emergency exit windows
- 1" strips used to mark back emergency exit windows





00212005P .....189	00212351P .....189	06001048P .....256	11212709P .....75	357B .....259
00212011B .....189	00212355P .....76	06001061B .....256	11212710P .....75	357P .....259
00212031B .....189	00212356P .....76	06001061P .....256	11212711P .....75	3801071BZL .....255
00212031P .....189	00212357P .....76	06001072B .....256	13000018B .....261	3801071BZLP .....255
00212104B .....78	00212358P .....76	06001072P .....256	13000018P .....261	3802071BZL .....255
00212117B .....78	00212362B .....189	06002001B .....257	1502B .....262	3802071BZLP .....255
00212127P .....78	00212362P .....189	06002001P .....257	1502P .....262	500302B .....262
00212135P .....78	00212365P .....76	060102B .....257	15202B .....262	500302P .....262
00212137P .....78	00212367P .....76	060102P .....257	15202P .....262	510001B .....262
00212155P .....78	00212368P .....76	0601B .....257	16802B .....250	510001P .....262
00212157P .....78	00212376B .....76	0601P .....257	16802P .....250	530002B .....262
00212207B .....77	00212378B .....76	06300003B .....257	18543910B .....258	530002P .....262
00212209B .....77	00212386B .....76	06300003P .....257	18543916B .....258	69000201B .....260
00212213B .....77	00212700B .....79	06300004B .....257	18543916BP .....258	69000201P .....260
00212217B .....74	00212701B .....79	06300004P .....257	18543936B .....258	69000300B .....260
00212227P .....74	00212702B .....79	068NME.....250	19102B .....250	69000300P .....260
00212231B .....190	00212703B .....79	068NMEP .....250	19102P .....250	725022B .....255
00212231P .....190	00212704P .....79	068WMTE .....250	193BSP.....260	725022P .....255
00212233B .....190	00212705P .....79	068WMTEP .....250	193BSPP .....260	726022B .....255
00212233P .....190	00212706P .....79	09017101B .....262	193G .....260	726022P .....255
00212235P .....77	00212707P .....79	09017101P .....262	193P .....260	7850NFRC .....261
00212236P .....77	00212708P .....79	105500SP.....258	24004002B .....253	7850NFRCP .....261
00212237P .....77	00212709P .....79	105520B .....258	240047171B .....253	825LED .....254
00212238P .....77	00212710P .....79	105520BP .....258	240047171LB.....253	825TR02.....254
00212239B .....190	00212711P .....79	11212207B .....74	240047171P .....253	825TR02P.....254
00212239P .....190	00212712P .....79	11212209B .....74	24004TR71 .....253	826L.....254
00212251B .....190	00212717B .....75	11212235P .....74	24004TR71P.....253	826LED .....254
00212251P .....190	00212727P .....75	11212236P .....74	240147171B .....253	826LEDP .....254
00212253B .....190	01180071B .....261	11212237P .....74	240147171LB.....253	826LP.....254
00212253P .....190	01180071P .....261	11212238P .....74	240147171P .....253	826TR02.....254
00212254P .....77	01180089B .....261	11212255P .....74	24014TR71 .....253	826TR02P.....254
00212255P .....77	01180089P .....261	11212256P .....74	24014TR71P.....253	826TR12.....254
00212256P .....77	01180090B .....261	11212257P .....74	24074B .....251	826TR12P.....254
00212257P .....77	01180090BP .....261	11212258P .....74	24074P .....251	826TR90.....254
00212258P .....77	014BCRCW .....261	11212276B .....74	2407764B .....251	A0116AWGBLWSB ..287
00212263P .....77	014BCRCWP .....261	11212278B .....74	2407764P .....251	A0118AWGBRGRSB 287
00212276B .....77	03001150B .....252	11212307B .....73	2407765B .....251	A0118AWGBRSB .287
00212278B .....77	03001150P .....252	11212309B .....73	2407765P .....251	A0118AWGBRYLWSB287
00212307B .....76	03001175B .....252	11212335P .....73	2407771C.....251	A0118AWGWHTSB ..287
00212309B .....76	03001175P .....252	11212336P .....73	2407771CP .....251	A06TR .....278
00212316B .....76	04010040B .....252	11212337P .....73	2409171B .....262	A06TRP .....278
00212317B .....73	04010040P .....252	11212338P .....73	2409171BP .....262	A09BB .....278
00212327P .....73	06001001B .....257	11212355P .....73	24113160B .....259	A09BBP .....278
00212331B .....189	06001001P .....257	11212356P .....73	24113160P .....259	A09CB .....278
00212331P .....189	06001013B .....255	11212357P .....73	2500128B .....261	A09CBP .....278
00212333B .....189	06001013P .....255	11212358P .....73	2500128P .....261	A09WB .....278
00212333P .....189	06001014B .....255	11212376B .....73	2500171B .....261	A09WBP .....278
00212335P .....76	06001014P .....255	11212378B .....73	2500171P .....261	A101TRSSB .....274
00212336P .....76	06001015B .....256	11212700B .....75	2500189B .....261	A101TRSSBP .....274
00212337P .....76	06001015P .....256	11212701B .....75	2500189P .....261	A10BB .....267
00212338P .....76	06001022B .....253	11212702B .....75	30000000B .....262	A10BBP.....267
00212342B .....189	06001022P .....253	11212703B .....75	30031010B .....262	A10GB.....267
00212342P .....189	06001026B .....256	11212704P .....75	302B .....262	A10GBP.....267
00212345P .....76	06001026P .....256	11212705P .....75	302P .....262	A10TH5B.....285
00212346P .....76	06001037B .....256	11212706P .....75	30655010B .....262	A10TH5BP .....285
00212347P .....76	06001037P .....256	11212707P .....75	3202B .....262	A111TRSSB .....276
00212351B .....189	06001048B .....256	11212708P .....75	3202P .....262	A111TRSSBP .....276

A1157B.....287	A194B.....287	A36RB.....203	A45SBP.....273	A57WH.....285
A1157BP.....287	A194BP.....287	A36RBP.....203	A46GB.....273	A58GB.....269
A11AB.....200	A2057B.....287	A36WRB.....286	A46GBP.....273	A58GBP.....269
A11ABP.....200	A2057BP.....287	A36WRBP.....286	A46P135B.....283	A5TRSSB.....274
A11AXB.....266	A20R.....177	A37RB.....183	A46P36B.....283	A5TRSSBP.....274
A11AXBP.....266	A20WB.....286	A37RBP.....183	A46P75B.....283	A60GB.....275
A11BLPB.....267	A20WBP.....286	A38AB.....204	A46PB.....283	A60GBP.....275
A11BLPBP.....267	A21CHB.....148	A38ABP.....204	A46PBB.....283	A60RB.....185
A11DB.....267	A21CHBP.....148	A38RB.....204	A46PBBP.....283	A60RBP.....185
A11DBP.....267	A24RB.....177	A38RBP.....204	A46PBP.....283	A65B.....271
A11GB.....267	A24RBP.....177	A39RB.....183	A46PPG.....283	A65BP.....271
A11GBP.....267	A255WH.....286	A39RBP.....183	A46PPGP.....283	A65P.....284
A11GLPB.....267	A25GB.....288	A3TRSSB.....268	A46PS.....283	A65PB.....271
A11GLPBP.....267	A25GBP.....288	A3TRSSBP.....268	A47PB.....281	A65PBP.....271
A11PB.....267	A25R10WB.....286	A400.....287	A47PBB.....281	A65PBPG.....271
A11PBP.....267	A25R10WBP.....286	A40RB.....173	A47PBBP.....281	A65PBPGP.....271
A11RB.....200	A25TRSSB.....270	A40RBP.....173	A47PBP.....281	A65PP.....284
A11RBP.....200	A25TRSSBP.....270	A40SRB.....277	A47PS.....281	A65PRXB.....271
A11RXB.....266	A25W42B.....286	A40SRBP.....277	A48CB.....278	A65PRXBP.....271
A11RXBP.....266	A25W42BP.....286	A40W42B.....286	A48CBP.....278	A65TB.....271
A11SRB.....80	A25W5B.....286	A40W42BP.....286	A48TC.....285	A65TBP.....271
A11SRBP.....80	A25W5BP.....286	A40W5B.....286	A49PB.....282	A66AB.....207
A11SSB.....267	A25WB.....286	A40W5BP.....286	A49PBB.....282	A66ABP.....207
A11SSBP.....267	A25WBP.....286	A42AB.....205	A49PBBP.....282	A66GB.....288
A12B2LPB.....267	A25WH.....286	A42ABP.....205	A49PBP.....282	A66GBP.....288
A12B2LPBP.....267	A2RB.....180	A42FCB.....274	A4TC4WB.....285	A66PB.....271
A12GB.....267	A2RBP.....180	A42FCBP.....274	A4TC4WBP.....285	A66PBP.....271
A12GBP.....267	A30W10B.....286	A42GB.....288	A52AB.....176	A66RB.....207
A12GLPB.....267	A30W10BP.....286	A42GBP.....288	A52ABP.....176	A66RBP.....207
A12GLPBP.....267	A30W5B.....286	A42PMB.....282	A52GB.....288	A67BB.....271
A12PB.....283	A30W5BLB.....286	A42PMBP.....282	A52GBP.....288	A67BBP.....271
A12PBP.....283	A30W5BP.....286	A42RB.....205	A52RB.....176	A67CB.....271
A13B2B.....278	A30WB.....286	A42RBP.....205	A52RBP.....176	A67CBP.....271
A13B2BP.....278	A30WBP.....286	A43RB.....173	A53GB.....268	A67CBPG.....271
A13C2B.....278	A31AB.....202	A43RBP.....173	A53GBP.....268	A67CBPGP.....271
A13C2BP.....278	A31ABP.....202	A44A500B.....206	A54GB.....268	A67CVB.....271
A13G2B.....288	A31RB.....202	A44AB.....206	A54GBP.....268	A67CVBP.....271
A13G2BP.....288	A31RBP.....202	A44ABP.....206	A54GK.....268	A67GB.....271
A14GB.....267	A32AB.....202	A44GTB.....288	A54GKP.....268	A67GBP.....271
A14GBP.....267	A32ABP.....202	A44GTBP.....288	A55CB.....268	A67P10G.....271
A15BB.....278	A32GB.....288	A44R500B.....206	A55CBP.....268	A67P10GP.....271
A15BBP.....278	A32GBP.....288	A44RB.....206	A55CBP.....268	A68AB.....208
A15CB.....278	A32RBP.....202	A44RBP.....206	A55GB.....269	A68ABP.....208
A15CBP.....278	A32RBP.....202	A45BB.....273	A55GBP.....269	A68P.....284
A15GB.....288	A33GB.....277	A45BBP.....273	A55GK.....269	A68PB.....271
A15GBP.....288	A33GBP.....277	A45CB.....282	A55GKP.....269	A68PBP.....271
A16R.....182	A35R10WB.....286	A45CBP.....282	A55GWB.....269	A68PP.....284
A16RB.....182	A35R10WBP.....286	A45CGB.....274	A55GWBP.....269	A68RB.....208
A16RBP.....182	A35W42B.....286	A45CGBP.....274	A56GB.....269	A68RBP.....208
A178TRSSB.....276	A35W42BP.....286	A45GB.....273	A56GBP.....269	A68SSB.....278
A178TRSSBP.....276	A35W5B.....286	A45GBP.....273	A57CB.....270	A68SSBP.....278
A17GB.....288	A35W5BP.....286	A45PB.....281	A57CBP.....270	A69CB.....278
A17GBP.....288	A35WB.....286	A45PBP.....281	A57GB.....269	A69CBP.....278
A17RB.....182	A35WBP.....286	A45PMB.....281	A57GBP.....269	A69GB.....288
A17RBP.....182	A36AB.....203	A45PMBP.....281	A57GK.....269	A69GBP.....288
A185TC.....285	A36ABP.....203	A45PS.....281	A57GKP.....269	A69RXC.....278
A18TC.....285	A36R.....183	A45SB.....273	A57WB.....285	A69RXC.....278
			A57WBP.....285	A69RXCBP.....278

A6TC4WB.....285	A91LRW.....284	ALEDFS.....288	BU44CB.....188	BUL12CKBP.....66
A6TC4WBP.....285	A91LRWP.....284	ALEDRST1B.....287	BU44CBP.....188	BUL12CSB.....66
A700.....287	A91LW.....284	ALEDRST1BP.....287	BU45CB.....188	BUL12CSBP.....66
A70GB.....275	A91LWP.....284	ALEDRST2B.....287	BU45CBP.....188	BUL13CB.....138
A70GBD.....275	A91OB.....272	ALEDRST2BP.....287	BU49CB.....188	BUL13CBP.....138
A70GBDP.....275	A91OBP.....272	APL1AB.....241	BU49CBP.....188	BUL22CB.....68
A70GBP.....275	A91RB.....199	APL1ABP.....241	BU64CB.....188	BUL22CBP.....68
A71CBAWN.....278	A91RBP.....199	APL1CB.....241	BU64CBP.....188	BUL23C24B.....64
A71CBAWNPN.....278	A921B.....287	APL1CBP.....241	BU65CB.....188	BUL23C24BP.....64
A73GB.....288	A921BP.....287	APL5AB.....242	BU65CBP.....188	BUL23CB.....64
A73GBP.....288	A93PB.....283	APL5ABP.....242	BU70CB.....188	BUL23CBP.....64
A75TB.....285	A93PBP.....283	APL5CB.....242	BU70CBP.....188	BUL28CLPB.....140
A75TBP.....285	A94VB.....278	APL5CBP.....242	BU74CB.....188	BUL28CLPBP.....140
A75TC.....285	A94VBP.....278	ARVIL35B.....247	BU74CBP.....188	BUL35CB.....69
A77SB.....275	A9R.....178	ARVIL35BP.....247	BUL002CB.....67	BUL35CBP.....69
A77SBP.....275	A9RB.....178	AST50B.....237	BUL002CBP.....67	BUL43CB.....138
A78CB1.....276	A9RBP.....178	AST50BP.....237	BUL002CM3B.....67	BUL43CBK.....138
A78CB1P.....276	A1L21B.....248	AST51B.....237	BUL002CM3BP.....67	BUL43CBKP.....138
A78RXB.....276	A1L21BP.....248	AST51BP.....237	BUL003CB.....62	BUL43CBP.....138
A78RXBP.....276	A1L32B.....246	AST60B.....235	BUL003CBP.....62	BUL52CB.....68
A79CB.....278	A1L32BP.....246	AST60BP.....235	BUL003CKB.....62	BUL52CBP.....68
A7TRSSB.....276	AL16RB.....54	AST61B.....235	BUL003CKBP.....62	BUL53CB.....64
A7TRSSBP.....276	AL16RBP.....54	AST61BP.....235	BUL06CB.....61	BUL53CBP.....64
A7WCB.....285	AL17RB.....54	BA44FNL.....206	BUL06CBP.....61	BUL53CKB.....64
A7WCBP.....285	AL17RBP.....54	BA44FNLP.....206	BUL06CFB.....61	BUL53CKBP.....64
A82AB.....210	AL42PB.....283	BA44FNR.....206	BUL06CFBP.....61	BUL69CB.....139
A82ABP.....210	AL42PBP.....283	BA44FNRP.....206	BUL06CFMB.....61	BUL69CBMVC2B....139
A82RB.....210	AL42PG.....283	BA65ARLB.....197	BUL06CFMBP.....61	BUL69CBMVC2BP...139
A82RBP.....210	AL42PGP.....283	BA65ARLBP.....197	BUL06CKB.....61	BUL69CBP.....139
A830B.....288	AL45PWTB.....281	BA65ARRB.....197	BUL06CKBP.....61	BUL69CPG.....139
A839B.....288	AL45PWTBP.....281	BA65ARRBP.....197	BUL06CMB.....61	BUL69CPGP.....139
A86PB.....283	AL46AB.....120	BK31BB.....279	BUL06CMBP.....61	BUL72CB.....139
A86PBP.....283	AL46ABP.....120	BK31BBP.....279	BUL101CB.....60	BUL72CBGK.....139
A8R.....178	AL46RB.....120	BK42CB.....277	BUL101CBP.....60	BUL72CBGKP.....139
A8RB.....178	AL46RBP.....120	BK42CBP.....277	BUL101CKB.....60	BUL72CBP.....139
A8RBP.....178	AL82AB.....103	BK45BB.....273	BUL101CKBP.....60	BUL73CB.....140
A8RK.....178	AL82ABP.....103	BK45BBP.....273	BUL10CB.....68	BUL73CBP.....140
A90AB.....174	AL82RB.....103	BK53BB.....268	BUL10CBP.....68	BUL74CBK.....139
A90ABP.....174	AL82RBP.....103	BK53BBP.....268	BUL10CMB.....68	BUL74CBKP.....139
A90RB.....174	AL90AB.....104	BK5557GB.....268	BUL10CMBP.....68	BUL78C3MB.....140
A90RBP.....174	AL90ABP.....104	BK5557GBP.....268	BUL111CB.....65	BUL78C3MBP.....140
A91AB.....199	AL90AK.....104	BK55BB.....270	BUL111CBP.....65	BUL78CB.....140
A91ABP.....199	AL90AS.....104	BK55BBP.....270	BUL11CB.....63	BUL78CBP.....140
A91BB.....272	AL90RB.....104	BK57BB.....270	BUL11CBP.....63	BUL78CEZB.....140
A91BBP.....272	AL90RBP.....104	BK57BBP.....270	BUL11CBX.....63	BUL78CEZBP.....140
A91BOB.....272	AL90RCB.....104	BK61AB.....196	BUL11CBXP.....63	BUL90C24B.....69
A91BOBP.....272	AL90RCBP.....104	BK66DB.....277	BUL11CKB.....63	BUL90C24BP.....69
A91CB.....272	AL90RK.....104	BK66DBP.....277	BUL11CKBP.....63	BUL90CB.....69
A91CBP.....272	AL90RS.....104	BK70BB.....275	BUL11CM24B.....63	BUL90CBP.....69
A91G15B1.....272	AL91AB.....103	BK70BBP.....275	BUL11CM24BP.....63	CB11AS.....212
A91G15B1P.....272	AL91ABP.....103	BU11CS.....187	BUL11CMB.....63	CB11WAB.....212
A91GB.....272	AL91CAB.....103	BU33CRX24LB.....188	BUL11CMBP.....63	CB11WABP.....212
A91GBP.....272	AL91CABP.....103	BU33CRX24LBP....188	BUL12CB.....66	CB15AK.....212
A91GOB.....272	AL91RB.....103	BU33CRXLB.....188	BUL12CBP.....66	CB20AB.....213
A91GOBP.....272	AL91RBP.....103	BU33CRXLBP.....188	BUL12CFB.....66	CB20ABP.....213
A91GZB.....272	ALEDFB.....288	BU41CB.....187	BUL12CFBP.....66	CB20AS.....213
A91GZBP.....272	ALEDFBP.....288	BU41CBP.....187	BUL12CKB.....66	CB22AB.....213

CB22ABP .....213	ILL22CBP .....150	ILL72CB .....154	LP54CBP.....220	LPL43CBP .....135
CB22AS .....213	ILL22CHB .....150	ILL72CBP .....154	LP55CB.....220	LPL55CB .....135
CB22RB .....213	ILL22CHBP .....150	ILL85CB .....155	LP55CBP.....220	LPL55CBP .....135
CB22RBP .....213	ILL24CB .....150	ILL85CBP .....155	LP56CB.....221	LPL55CKB .....135
CBL22AB .....126	ILL24CBP .....150	ILL86BCB .....155	LP56CBP.....221	LPL55CKBP .....135
CBL22ABP .....126	ILL25CB .....149	ILL86BCBP .....155	LP5SB .....279	LPL55CPG .....135
CBL22AS .....126	ILL25CBP .....149	ILL86CB .....155	LP5SBP.....279	LPL55CPGP .....135
CBL22CAB .....126	ILL26CB .....149	ILL86CBP .....155	LP65CB.....221	LPL56CB .....135
CBL22CABP .....126	ILL26CBP .....149	ILL91CB .....156	LP65CBP.....221	LPL56CBP .....135
CBL22RB.....126	ILL28CMB .....147	ILL91CBP .....156	LP71CB.....222	LPL61C24B .....136
CBL22RBP .....126	ILL28CMBP .....147	ILL91CPG .....156	LP71CBP.....222	LPL61C24BP .....136
DH55 .....280	ILL28CMPG .....147	ILL91CPGP .....156	LP71CS .....222	LPL65CB .....136
DH55P .....280	ILL28CMPGP .....147	LM112CB.....156	LP81BB.....222	LPL65CBP .....136
DL16CC .....232	ILL30CBB .....151	LM112CBP .....156	LP81BBP .....222	LPL91CAB .....137
DL16WC.....232	ILL30CBBP .....151	LM315BB .....156	LP81BPG .....222	LPL91CABP .....137
DL55CS .....232	ILL31CB .....151	LM315BBP .....156	LP81GB.....222	LPL91CB .....137
DLL50CB.....168	ILL31CBP .....151	LM835CB.....156	LP85CB.....224	LPL91CBKB .....137
DLL50CBP .....168	ILL32CB .....151	LM835CBP .....156	LP85CBP.....224	LPL91CBKBP .....137
DLL50CC.....168	ILL32CBP .....151	LP10S .....279	LP91CB.....224	LPL91CBP .....137
DLL50WC .....168	ILL32CPG .....151	LP10SB.....279	LP91CBP.....224	LPL91CKALPB .....137
HLL88LB .....2	ILL33CB .....152	LP10SBP.....279	LP95CBF.....223	LPL91CKALPBP .....137
HLL88LBP .....2	ILL33CBP .....152	LP11CB.....217	LP97CB.....223	LPL91CKB .....137
HLL89HB .....2	ILL35CB .....151	LP11CBP.....217	LP97CBP.....223	LPL91CKBP .....137
HLL89HBP .....2	ILL36CB .....152	LP11CPG.....217	LPB31CPG .....218	LPL91CPG .....137
HLL90HLB.....3	ILL36CBP .....152	LP11CPGP .....217	LPB31CPGP .....218	LPL91CPGP .....137
HLL90HLBP .....3	ILL36CPG .....152	LP11CS .....217	LPL11CB .....132	MC11AB.....200
IL21CB .....228	ILL36CPGP .....152	LP15S .....279	LPL11CBP .....132	MC11ABP .....200
IL21CBP .....228	ILL39CB .....148	LP15SB.....279	LPL12CB .....133	MC11AK .....200
IL21CPG .....228	ILL39CBP .....148	LP15SBP.....279	LPL12CBP .....133	MC11AS.....200
IL21CS .....228	ILL45CB .....153	LP20SB.....279	LPL12CKF2B .....133	MC11RB .....200
IL22CB .....228	ILL45CBP .....153	LP20SBP.....279	LPL12CKF2BP .....133	MC11RBP .....200
IL22CBP .....228	ILL46CB .....153	LP21CB.....217	LPL12CKM2B.....133	MC11RS .....200
IL31CS .....228	ILL46CBP .....153	LP21CBP.....217	LPL12CKM2BP .....133	MC21AS.....201
IL41CB .....229	ILL70ABAWN.....239	LP21CS .....217	LPL12CKM5B.....133	MC21RS .....201
IL41CBP .....229	ILL70ABAWN .....239	LP25SB .....280	LPL12CKM5BP .....133	MC22AB.....201
IL61CB .....229	ILL70ABBAWN.....239	LP25SBP.....280	LPL12CKMB.....133	MC22ABP .....201
IL61CBP .....229	ILL70ABBAWN .....239	LP26SKB.....224	LPL12CKMBP .....133	MC22RB .....201
IL91CB .....230	ILL70CB .....154	LP26SKBP.....224	LPL12CPGB.....133	MC22RBP .....201
IL91CBP .....230	ILL70CBAWN.....239	LP31CB.....218	LPL12CPGBP.....133	MC25AB.....191
ILL01RB .....146	ILL70CBAWN .....239	LP31CBP.....218	LPL21CB .....134	MC25ABP .....191
ILL01RBP .....146	ILL70CBBAWN .....239	LP31CPG.....218	LPL21CBP .....134	MC25RB .....191
ILL06COB .....146	ILL70CBBAWN .....239	LP31CPGP .....218	LPL26SKB .....137	MC25RBP .....191
ILL06COBP .....146	ILL70CBP .....154	LP31CS .....218	LPL26SKBP .....137	MC27AB.....191
ILL06COPG .....146	ILL70CBSAWN.....239	LP31SB.....279	LPL31CB .....134	MC27ABP .....191
ILL06COPGP .....146	ILL70CBSAWN .....239	LP31SBP.....279	LPL31CBP .....134	MC27RB .....191
ILL07COB .....146	ILL70CCSBAWN .....239	LP35BB.....280	LPL31CEZB .....134	MC27RBP .....191
ILL07COBP .....146	ILL70CCSBAWN .....239	LP35BBP .....280	LPL31CEZBP .....134	MC30AB.....200
ILL08COB .....147	ILL70CSB.....154	LP41CB.....219	LPL31CPG .....134	MC30ABP .....200
ILL08COBP .....147	ILL70CSBP .....154	LP41CBP.....219	LPL31CPGP .....134	MC31A15B2.....202
ILL08COPG .....147	ILL71CB .....154	LP41CS.....219	LPL31CS .....134	MC31AB.....202
ILL08COPGP .....147	ILL71CBAWN.....239	LP51CB.....219	LPL31CSB .....134	MC31ABP .....202
ILL10CCB .....147	ILL71CBAWN .....239	LP51CBP.....219	LPL31CSBP .....134	MC31AS.....202
ILL10CCBP .....147	ILL71CBP .....154	LP52CB.....220	LPL41CB .....135	MC31R15B2.....202
ILL21CB .....148	ILL71CPG .....154	LP52CBP.....220	LPL41CBP .....135	MC31RB .....202
ILL21CBP .....148	ILL71CPGP .....154	LP52HP .....220	LPL42CBF .....135	MC31RBP .....202
ILL21CTPB.....148	ILL71CSB.....154	LP52HPP .....220	LPL42CBFP .....135	MC31RS .....202
ILL22CB .....150	ILL71CSBP .....154	LP54CB.....220	LPL43CB .....135	MC32AB.....202



MC32ABB .....202	MC52AXB .....192	MC66RBP .....207	MC93RPG .....214	MCL111RBP .....82
MC32ABBP .....202	MC52RB .....192	MC66RS .....207	MC93RPGP .....214	MCL111RKB .....82
MC32ABP .....202	MC52RBP .....192	MC67AB .....198	MC94RB .....215	MCL111RKBP .....82
MC32ABS .....202	MC52RXB .....192	MC67ABP .....198	MC94RBP .....215	MCL111RKFFPG .....82
MC32AS .....202	MC52RXBP .....192	MC67AK .....198	MC95AB .....211	MCL111RKFFPGP .....82
MC32RB .....202	MC53AB .....193	MC67ARB .....197	MC95ABP .....211	MCL111RKPG .....82
MC32RBB .....202	MC53ABP .....193	MC67ARBP .....197	MC95APG .....211	MCL111RKPGP .....82
MC32RBBP .....202	MC53ABSB .....193	MC67RB .....198	MC95AS .....211	MCL112AB .....83
MC32RBP .....202	MC53ABSBP .....193	MC67RBP .....198	MC95RB .....211	MCL112ABP .....83
MC32RBS .....202	MC53AKB .....193	MC67RK .....198	MC95RBP .....211	MCL112AKB .....83
MC32RS .....202	MC53AKBP .....193	MC68AB .....208	MC95RS .....211	MCL112AKBP .....83
MC35AB .....203	MC53AS .....193	MC68ABP .....208	MC97R70PG .....215	MCL112RB .....83
MC35ABP .....203	MC53RB .....193	MC68AS .....208	MC97RB .....215	MCL112RBP .....83
MC35AEB .....203	MC53RBP .....193	MC68RB .....208	MC97RBP .....215	MCL112RKB .....83
MC35AEBP .....203	MC53RKB .....193	MC68RBP .....208	MC97RK .....215	MCL112RKBP .....83
MC35AS .....203	MC53RKBP .....193	MC68RS .....208	MC97RTTG .....215	MCL11A24KB .....85
MC36AB .....203	MC53RS .....193	MC70AB .....208	MC99AB .....216	MCL11AB .....85
MC36ABP .....203	MC54AB .....193	MC70ABP .....208	MC99ABP .....216	MCL11ABP .....85
MC36AS .....203	MC54ABP .....193	MC70RB .....208	MC99AK .....216	MCL11AHPG .....85
MC36RB .....203	MC54RB .....193	MC70RBP .....208	MC99RB .....216	MCL11AK12B .....85
MC36RBP .....203	MC54RBP .....193	MC71AS .....209	MC99RBP .....216	MCL11AK12PG .....85
MC36RS .....203	MC55AB .....194	MC71RS .....209	MC99RK .....216	MCL11AKAB .....85
MC37AB .....204	MC55ABP .....194	MC76AB .....209	MCL10AB .....84	MCL11AKABP .....85
MC37ABP .....204	MC55RB .....194	MC76ABP .....209	MCL10ABP .....84	MCL11AKB .....85
MC38AB .....204	MC55RBP .....194	MC77RB .....214	MCL10AKB .....84	MCL11AKBF .....85
MC38ABP .....204	MC56AB .....195	MC77RBP .....214	MCL10AKBP .....84	MCL11AKBFP .....85
MC38RB .....204	MC56ABP .....195	MC81AB .....210	MCL10CAK14B .....84	MCL11AKBP .....85
MC38RBP .....204	MC56RB .....195	MC81ABP .....210	MCL10CAK14BP .....84	MCL11AKBSSP .....85
MC42AB .....205	MC56RBP .....195	MC81AS .....210	MCL10CRK14B .....84	MCL11AKPV4G .....85
MC42ABP .....205	MC57AB .....194	MC81RB .....210	MCL10CRK14BP .....84	MCL11AKPVG .....85
MC42AS .....205	MC57ABP .....194	MC81RBP .....210	MCL10RB .....84	MCL11APG .....85
MC42RB .....205	MC57AS .....194	MC81RS .....210	MCL10RBP .....84	MCL11APGP .....85
MC42RBP .....205	MC57RB .....194	MC82AB .....210	MCL10RKB .....84	MCL11CAB .....85
MC42RS .....205	MC57RBP .....194	MC82ABP .....210	MCL10RKBP .....84	MCL11CABP .....85
MC441WB .....206	MC57RS .....194	MC82RB .....210	MCL110AB .....81	MCL11CAKB .....85
MC442WB .....206	MC58AS .....207	MC82RBP .....210	MCL110ABP .....81	MCL11CAKBF .....85
MC44AB .....206	MC58RB .....207	MC85AB .....211	MCL110AKB .....81	MCL11CAKBP .....85
MC44AB1 .....206	MC58RBP .....207	MC85ABP .....211	MCL110AKBF .....81	MCL11CAKPG .....85
MC44AB1P .....206	MC58RS .....207	MC90AS .....199	MCL110AKBFP .....81	MCL11CRB .....85
MC44ABP .....206	MC59AFB .....195	MC90RS .....199	MCL110AKBP .....81	MCL11CRBP .....85
MC44AS .....206	MC59AFBP .....195	MC91AB .....199	MCL110AKPG .....81	MCL11CRKB .....85
MC44RB .....206	MC59RFB .....195	MC91ABP .....199	MCL110AKPGP .....81	MCL11CRKBF .....85
MC44RB1 .....206	MC59RFBP .....195	MC91AS .....199	MCL110RB .....81	MCL11CRKBP .....85
MC44RB1P .....206	MC61ABKB .....196	MC91RS .....199	MCL110RBP .....81	MCL11CRKPG .....85
MC44RBP .....206	MC61ABKBP .....196	MC92AB .....199	MCL110RKB .....81	MCL11R24KB .....85
MC44RS .....206	MC65AB .....198	MC92ABP .....199	MCL110RKBFP .....81	MCL11RB .....85
MC48AB .....205	MC65ABP .....198	MC92AS .....199	MCL110RKBFP .....81	MCL11RBP .....85
MC48ABP .....205	MC65ARB .....197	MC92RB .....199	MCL110RKBP .....81	MCL11RHFG .....85
MC48APG .....205	MC65ARB .....197	MC92RBP .....199	MCL110RKPG .....81	MCL11RK12B .....85
MC48APGP .....205	MC65RB .....198	MC92RS .....199	MCL110RKPGP .....81	MCL11RK12PG .....85
MC48RPG .....205	MC65RBP .....198	MC93AB .....214	MCL111AB .....82	MCL11RKAB .....85
MC48RPGP .....205	MC66AB .....207	MC93ABP .....214	MCL111ABP .....82	MCL11RKB .....85
MC505ABSB .....193	MC66ABP .....207	MC93R2PG .....214	MCL111AKB .....82	MCL11RKBFP .....85
MC505ABSBP .....193	MC66AS .....207	MC93R2PGP .....214	MCL111AKBP .....82	MCL11RKBFP .....85
MC52AB .....192	MC66HAB .....207	MC93RB .....214	MCL111AKPG .....82	MCL11RKBP .....85
MC52ABP .....192	MC66HABP .....207	MC93RBP .....214	MCL111AKPGP .....82	MCL11RKBSSP .....85
MC52AXB .....192	MC66RB .....207	MC93RK .....214	MCL111RB .....82	MCL11RKPV4G .....85

MCL11RKPVG .....85	MCL13APGP.....112	MCL15RKPG .....114	MCL31RB .....117	MCL49AB .....120
MCL11RPG .....85	MCL13AS .....112	MCL15RKPGP .....114	MCL31RBP .....117	MCL49ABP .....120
MCL11RPGP .....85	MCL13ATRS .....112	MCL15RPG .....114	MCL32AB .....117	MCL505ABSB .....91
MCL11SAB .....80	MCL13CA2B .....112	MCL15RPGP .....114	MCL32ABB .....117	MCL505ABSBP .....91
MCL11SABP .....80	MCL13CA2BP .....112	MCL165AB .....105	MCL32ABBP .....117	MCL505GABSB .....91
MCL11SAK1B .....80	MCL13CA3B .....112	MCL165ABP .....105	MCL32ABP .....117	MCL505GABSBP .....91
MCL11SAK1BP .....80	MCL13CA3BP .....112	MCL165RB .....105	MCL32ABS .....117	MCL50AB .....94
MCL11SAKB .....80	MCL13CR2B .....112	MCL165RBP .....105	MCL32AS .....117	MCL50ABP .....94
MCL11SAKBP .....80	MCL13CR2BP .....112	MCL166AB .....122	MCL32RB .....117	MCL50RB .....94
MCL11SRB .....80	MCL13CR3B .....112	MCL166ABP .....122	MCL32RBB .....117	MCL50RBP .....94
MCL11SRBP .....80	MCL13CR3BP .....112	MCL166RB .....122	MCL32RBBP .....117	MCL51AB .....99
MCL11SRK1B .....80	MCL13R2B .....112	MCL166RBP .....122	MCL32RBP .....117	MCL51ABP .....99
MCL11SRK1BP .....80	MCL13R2BP .....112	MCL17AB .....116	MCL32RBS .....117	MCL51RB .....99
MCL11SRKB .....80	MCL13R2MB .....112	MCL17ABP .....116	MCL32RS .....117	MCL51RBP .....99
MCL11SRKBP .....80	MCL13R2MBP .....112	MCL17APG .....116	MCL35A32G .....118	MCL527AB .....98
MCL121AK9PVG .....82	MCL13R2PG .....112	MCL17APGP .....116	MCL35A32GP .....118	MCL527ABP .....98
MCL121AK9PVGP .....82	MCL13R2PGP .....112	MCL17CAB .....116	MCL36AB .....118	MCL527AFB .....98
MCL121RK9PVG .....82	MCL13RS .....112	MCL17CABP .....116	MCL36ABP .....118	MCL527AFBP .....98
MCL121RK9PVGP .....82	MCL13RTRS .....112	MCL17CRB .....116	MCL36APG .....118	MCL527AK .....98
MCL12AB .....86	MCL14A12GB .....113	MCL17CRBP .....116	MCL36APGP .....118	MCL527AS .....98
MCL12ABP .....86	MCL14A12GBP .....113	MCL17RB .....116	MCL36AS .....118	MCL527RB .....98
MCL12AK .....86	MCL14AB .....113	MCL17RBP .....116	MCL36RB .....118	MCL527RBP .....98
MCL12AK156PG .....86	MCL14ABF .....113	MCL17RPG .....116	MCL36RBP .....118	MCL527RFB .....98
MCL12AKB .....86	MCL14ABFP .....113	MCL17RPGP .....116	MCL40AB .....119	MCL527RFBP .....98
MCL12AKBP .....86	MCL14ABP .....113	MCL180ARB .....110	MCL40AB1 .....119	MCL527RK .....98
MCL12AKPG .....86	MCL14AGB .....113	MCL180ARBP .....110	MCL40AB1P .....119	MCL527RS .....98
MCL12ARLB .....87	MCL14AGBP .....113	MCL190AB .....102	MCL40ABP .....119	MCL52AB .....95
MCL12ARLBP .....87	MCL14AGPB .....113	MCL190ABP .....102	MCL40APB .....119	MCL52ABP .....95
MCL12ARRB .....87	MCL14AGPBP .....113	MCL190RB .....102	MCL40APBP .....119	MCL52AHXB .....93
MCL12ARRBP .....87	MCL14CABF .....113	MCL190RBP .....102	MCL40AS .....119	MCL52AHXBP .....93
MCL12CA2RLB .....87	MCL14CABFP .....113	MCL1922RB .....131	MCL40RB .....119	MCL52AMB .....95
MCL12CA2RRB .....87	MCL14CRBF .....113	MCL1922RBP .....131	MCL40RB1 .....119	MCL52AMB .....95
MCL12RB .....86	MCL14CRBFP .....113	MCL19AB .....116	MCL40RB1P .....119	MCL52RB .....95
MCL12RBP .....86	MCL14RB .....113	MCL19ABP .....116	MCL40RBP .....119	MCL52RBP .....95
MCL12RK .....86	MCL14RBF .....113	MCL19CAB .....116	MCL40RS .....119	MCL52RHXB .....93
MCL12RK156PG .....86	MCL14RBFP .....113	MCL19CABP .....116	MCL44AB .....119	MCL52RHXP .....93
MCL12RK3B .....131	MCL14RBP .....113	MCL19CRB .....116	MCL44AB1 .....119	MCL52RMB .....95
MCL12RK3BP .....131	MCL14RGB .....113	MCL19CRBP .....116	MCL44AB1P .....119	MCL52RMBP .....95
MCL12RK3RMB .....131	MCL14RGBP .....113	MCL19RB .....116	MCL44ABP .....119	MCL54AB .....95
MCL12RKB .....86	MCL14RPG .....113	MCL19RBP .....116	MCL44RB .....119	MCL54ABP .....95
MCL12RKB .....86	MCL14RPGP .....113	MCL21AB .....88	MCL44RB1 .....119	MCL54RB .....95
MCL12RKBP .....86	MCL155AB .....89	MCL21ABP .....88	MCL44RB1P .....119	MCL54RBP .....95
MCL12RKPG .....86	MCL155ABP .....89	MCL21RB .....88	MCL44RBP .....119	MCL55A1224B .....90
MCL131A2B .....112	MCL155AFB .....89	MCL21RBP .....88	MCL45AB .....120	MCL55A1224BP .....90
MCL131A2BP .....112	MCL155AFBP .....89	MCL21RKPV4G .....85	MCL45ABP .....120	MCL55AB .....90
MCL131CA2B .....112	MCL155RB .....89	MCL22RK3B .....131	MCL45RB .....120	MCL55ABP .....90
MCL131CA2BP .....112	MCL155RBP .....89	MCL22RK4B .....131	MCL45RBP .....120	MCL55ACB .....90
MCL131CR2B .....112	MCL155RFB .....89	MCL23AB .....88	MCL46AB .....120	MCL55ACBP .....90
MCL131CR2BP .....112	MCL155RFBP .....89	MCL23ABP .....88	MCL46ABP .....120	MCL55AK .....90
MCL131R2B .....112	MCL157AB .....96	MCL23RB .....88	MCL46RB .....120	MCL55AKB .....90
MCL131R2BP .....112	MCL157ABP .....96	MCL23RBP .....88	MCL46RBP .....120	MCL55AKBP .....90
MCL13A2B .....112	MCL157RB .....96	MCL299AB .....115	MCL48AB .....121	MCL55FRB .....90
MCL13A2BP .....112	MCL157RBP .....96	MCL299ABP .....115	MCL48ABP .....121	MCL55FRBP .....90
MCL13A2MB .....112	MCL15AKPG .....114	MCL299RB .....115	MCL48AKB .....121	MCL55R1224B .....90
MCL13A2MBP .....112	MCL15AKPGP .....114	MCL299RBP .....115	MCL48AKBP .....121	MCL55R1224BP .....90
MCL13A2PG .....112	MCL15APG .....114	MCL31AB .....117	MCL48CAB .....121	MCL55RB .....90
MCL13A2PGP .....112	MCL15APGP .....114	MCL31ABP .....117	MCL48CABP .....121	MCL55RBP .....90

MCL55RCB .....90	MCL61ARBP.....109	MCL70RBP .....127	MCL93RPGP .....128	RE13AB.....266
MCL55RCBP .....90	MCL61AS .....107	MCL70RCB .....127	MCL95AB .....125	RE13ABP.....266
MCL55RK .....90	MCL61RB .....107	MCL70RCBP .....127	MCL95ABF .....125	RE13RB .....266
MCL55RKB .....90	MCL61RBP .....107	MCL70RS.....127	MCL95ABFP .....125	RE13RBP .....266
MCL55RKBP .....90	MCL61RK .....107	MCL71RB .....123	MCL95ABP .....125	RE15AB.....265
MCL56AB .....92	MCL61RS.....107	MCL71RBP .....123	MCL95AS .....125	RE15ABP.....265
MCL56ABP .....92	MCL63AB.....108	MCL73AB .....121	MCL95RB .....125	RE15AK.....265
MCL56AFB .....92	MCL63ABP.....108	MCL73ABP .....121	MCL95RBF.....125	RE15RB .....265
MCL56AFBP .....92	MCL63CAB .....108	MCL73RB .....121	MCL95RBF .....125	RE15RBP .....265
MCL56AK .....92	MCL63CABP .....108	MCL73RBP .....121	MCL95RBP .....125	RE15RK .....265
MCL56AS .....92	MCL63CRB .....108	MCL75AB .....106	MCL95RS.....125	RE18T.....263
MCL56RB .....92	MCL63CRBP .....108	MCL75ABP .....106	MCL96AB.....103	RE2018T.....263
MCL56RBP .....92	MCL63RB .....108	MCL75RB .....106	MCL96ABP .....103	RE21AB.....266
MCL56RFB.....92	MCL63RBP .....108	MCL75RBP .....106	MCL96RB .....103	RE21ABP.....266
MCL56RFBP .....92	MCL65A24B .....106	MCL76AB .....123	MCL96RBP .....103	RE21AS .....266
MCL56RK .....92	MCL65A24BP .....106	MCL76ABP .....123	MCL97RB .....129	RE21RB .....266
MCL56RS.....92	MCL65AB .....106	MCL76RB .....123	MCL97RBP .....129	RE21RBP .....266
MCL57A24B .....97	MCL65ABP .....106	MCL76RBP .....123	MCL97RK .....129	RE21RS .....266
MCL57A24BP .....97	MCL65ARB.....109	MCL77AB .....106	MCL97RPG .....129	RE21T.....263
MCL57AB .....97	MCL65ARBP .....109	MCL77ABP .....106	MCL97RPGP .....129	RE31AS .....266
MCL57ABP .....97	MCL65CAB .....106	MCL77RB .....106	MCL98RB .....130	RE31RS .....266
MCL57ACB .....97	MCL65CABP .....106	MCL77RBP .....106	MCL98RBP .....130	RE35AB.....266
MCL57ACBP .....97	MCL65CARB .....109	MCL78RB .....127	MCL98RK .....130	RE35ABP.....266
MCL57AK .....97	MCL65CARBP.....109	MCL78RBP .....127	MCL99A1B.....111	RE35RB .....266
MCL57AKB.....97	MCL65CRB .....106	MCL81AB .....124	MCL99A1BP.....111	RE35RBP .....266
MCL57AKBP.....97	MCL65CRBP .....106	MCL81ABP.....124	MCL99AB .....111	RE37AB.....266
MCL57R1224B .....97	MCL65R24B .....106	MCL81RB .....124	MCL99ABP.....111	RE37ABP.....266
MCL57R1224BP .....97	MCL65R24BP .....106	MCL81RBP .....124	MCL99AC1B.....111	RE37RB .....266
MCL57R24B .....97	MCL65RB .....106	MCL83RB .....128	MCL99AC1BP.....111	RE37RBP .....266
MCL57R24BP .....97	MCL65RBP .....106	MCL83RBP .....128	MCL99R1B .....111	RE418T.....263
MCL57RB .....97	MCL66A24B .....122	MCL83RCB .....128	MCL99R1BP .....111	RE52ARK .....265
MCL57RBP .....97	MCL66A24BP .....122	MCL83RCBP .....128	MCL99RB .....111	RT150W12B .....263
MCL57RCB .....97	MCL66AB.....122	MCL83RK .....128	MCL99RBP .....111	RT150W12BP .....263
MCL57RCBP .....97	MCL66ABP.....122	MCL84RB .....129	MCL99RC1B .....111	RT150WBD.....263
MCL57RK .....97	MCL66APG.....122	MCL84RBP .....129	MCL99RC1BP .....111	RT150WBDP .....263
MCL57RKB .....97	MCL66APGP.....122	MCL85AB .....124	QH16CTS.....233	RT150Y1B.....264
MCL57RKBP .....97	MCL66AS .....122	MCL85ABP .....124	QH16CTSP.....233	RT150Y1BP .....264
MCL58AB .....100	MCL66CAB .....122	MCL86AB .....125	QH36CTS.....233	RT150Y1DB .....264
MCL58ABP .....100	MCL66CABP .....122	MCL86ABP .....125	QH36CTSP.....233	RT150Y1DBP .....264
MCL58ACB .....100	MCL66CRB .....122	MCL86RB .....125	RB10A.....216	RT150Y2B.....264
MCL58ACBP .....100	MCL66CRBP .....122	MCL86RBP .....125	RBL10AS .....59	RT150Y2BP .....264
MCL58AMFB .....100	MCL66R24B .....122	MCL88RCB .....127	RBL10CA .....59	RT150Y2DB .....264
MCL58AMFBP .....100	MCL66R24BP .....122	MCL88RCBP .....127	RC .....261	RT150Y2DBP .....264
MCL58RB .....100	MCL66RB .....122	MCL90AS .....103	RCP .....261	RTR03150711CB.....263
MCL58RBP .....100	MCL66RBP .....122	MCL90RS .....103	RE10018T.....263	RTR1015066CB.....263
MCL58RMFB .....100	MCL66RPG .....122	MCL91AB .....103	RE10AB.....265	RTR10150711CB.....263
MCL58RMFBP .....100	MCL66RPGP .....122	MCL91ABP .....103	RE10ABP.....265	RTR10150WB .....263
MCL59AB .....101	MCL66RS.....122	MCL91AK.....103	RE10AK.....265	RTR15066B.....263
MCL59ABP .....101	MCL67AB.....106	MCL91RB .....103	RE10ORB .....265	RTR15066BP .....263
MCL59RB .....101	MCL67ABP.....106	MCL91RBP .....103	RE10RBP .....265	RTR15066PB .....263
MCL59RBP .....101	MCL67ARB.....109	MCL91RK .....103	RE10RK .....265	RTR15066PBP .....263
MCL61AB .....107	MCL67ARBP.....109	MCL922RB .....131	RE11AB.....265	RTR150711B.....263
MCL61ABP .....107	MCL67RB .....106	MCL922RBP .....131	RE11ABP.....265	RTR150711BP .....263
MCL61AK .....107	MCL67RBP .....106	MCL93RB .....128	RE11RB .....265	RTR150711PB .....263
MCL61AR26BK.....109	MCL70RB .....127	MCL93RBP .....128	RE11RBP .....265	RTR150711PBP .....263
MCL61AR26BKP.....109	MCL70RBF2.....127	MCL93RK .....128	RE12AK.....265	RTRE150GB .....264
MCL61ARB.....109	MCL70RBF2P .....127	MCL93RPG .....128	RE12ARK .....265	RTRE150GBP .....264

RTRE150OB .....264	RVPL8ABP .....243	RVSTLB0060.....234	ST36RPG.....183	ST60RS .....185
RTRE150OBP .....264	RVPL8C .....243	RVSTLB0060P.....234	ST36RPGP.....183	ST64RB .....171
RTRE150RB .....264	RVPL8CB .....243	RVSTLB0061 .....234	ST36RS .....183	ST64RBP .....171
RTRE150RBP .....264	RVPL8CBP .....243	RVSTLB0061P.....234	ST37RB .....183	ST65RB .....171
RV50BK.....237	RVPL8CP .....243	RVSTLB60.....235	ST37RBP .....183	ST65RBP .....171
RV50BKP .....237	RVPL9CC .....243	RVSTLB60P.....235	ST37RPG.....183	ST66RPG .....183
RV60BK.....234	RVPL9CCP .....243	RVSTLB61 .....235	ST37RPGP.....183	ST66RPGP.....183
RV60BKP .....234	RVPLL8A.....240	RVSTLB61P.....235	ST37RS .....183	ST67RPG.....183
RVBST55 .....238	RVPLL8AB.....240	SLL43AB1 .....70	ST3RB .....180	ST67RPGP.....183
RVBST55P .....238	RVPLL8ABP .....240	SLL43AB1P.....70	ST3RBP .....180	ST6RB .....179
RVBST56 .....238	RVPLL8AP.....240	SLL43AB2.....70	ST40RB .....173	ST6RBP .....179
RVBST56P .....238	RVPLL8C .....240	SLL43AB2P.....70	ST40RBP .....173	ST6RPG.....179
RVC100.....249	RVPLL8CB .....240	SLL43AKB1.....70	ST40RS .....173	ST6RPGP.....179
RVC100P.....249	RVPLL8CBP .....240	SLL43AKB1P .....70	ST42RB .....173	ST6RS .....179
RVFL51 .....249	RVPLL8CP .....240	SLL43AKB2.....70	ST42RBP .....173	ST70AB .....171
RVFL51P .....249	RVPLL9CC .....240	SLL43AKB2P .....70	ST42RPG.....173	ST70ABP .....171
RVIL21 .....248	RVPLL9CCP .....240	SLL72AB1 .....71	ST42RPGP.....173	ST70RB .....171
RVIL21P .....248	RVSL21 .....244	SLL72AB1P.....71	ST44AB .....169	ST70RBP .....171
RVIL21S.....248	RVSL21P .....244	SLL72AB2.....71	ST44ABP .....169	ST70RBTk .....171
RVIL22 .....248	RVSL31 .....244	SLL72AB2P.....71	ST44RB .....169	ST70RBTkP .....171
RVIL22P .....248	RVSL31P .....244	SLL72AKB1.....71	ST44RBP .....169	ST70RK .....171
RVIL22S.....248	RVST50 .....237	SLL72AKB1P .....71	ST45AB .....169	ST70RS .....171
RVIL35 .....247	RVST50P .....237	SLL72AKB2.....71	ST45ABP .....169	ST74AB .....171
RVIL35P .....247	RVST50S.....237	SLL72AKB2P .....71	ST45RB .....169	ST74ABP .....171
RVIL36 .....247	RVST51 .....237	SLL93AB.....72	ST45RBP .....169	ST74RB .....171
RVIL36P .....247	RVST51P .....237	SLL93ABP.....72	ST45RGB.....169	ST74RBP .....171
RVILL33.....246	RVST51S.....237	SLL93RB .....72	ST45RGBP.....169	ST75AB .....171
RVILL33P.....246	RVST55 .....238	SLL93RBP .....72	ST45RK .....169	ST75ABP .....171
RVILL34.....246	RVST55P .....238	ST16RB .....182	ST45RS .....169	ST77AB .....171
RVILL34P.....246	RVST55S.....238	ST16RBP .....182	ST46RB .....169	ST77ABP .....171
RVILL39.....245	RVST56 .....238	ST16RS .....182	ST46RBP .....169	ST7RB .....179
RVILL39P.....245	RVST56P .....238	ST17RB .....182	ST47RB .....170	ST7RBP .....179
RVPL1A .....241	RVST56S.....238	ST17RBP .....182	ST47RBP .....170	ST7RPG.....179
RVPL1AP .....241	RVST60 .....236	ST17RS .....182	ST47RKB.....170	ST7RPGP.....179
RVPL1C .....241	RVST60P .....236	ST20RS .....177	ST47RkBP.....170	ST7RS .....179
RVPL1CP .....241	RVST60S.....236	ST21RS .....177	ST47RLB .....170	ST8RB .....178
RVPL3A .....241	RVST61 .....236	ST24RB .....177	ST47RLBP .....170	ST8RBP .....178
RVPL3AP .....241	RVST61P .....236	ST24RBP .....177	ST4RB .....181	ST8RHB .....178
RVPL3C .....241	RVST61S.....236	ST25RB .....177	ST4RBP .....181	ST8RS .....178
RVPL3CP .....241	RVSTB50 .....237	ST25RBP .....177	ST4RS .....181	ST90AB .....174
RVPL5A .....242	RVSTB50P .....237	ST26RPG.....182	ST51RB .....176	ST90ABP .....174
RVPL5AB .....242	RVSTB51 .....237	ST26RPGP.....182	ST51RBP .....176	ST90RB .....174
RVPL5ABP .....242	RVSTB51P .....237	ST27RPG.....182	ST51RS .....176	ST90RBP .....174
RVPL5AP .....242	RVSTB60 .....236	ST27RPGP.....182	ST52AA.....176	ST92AB .....175
RVPL5C .....242	RVSTB60P .....236	ST2RB .....180	ST52AAP.....176	ST92ABP .....175
RVPL5CB.....242	RVSTB61 .....236	ST2RBP .....180	ST52RA .....176	ST92RB .....175
RVPL5CBP .....242	RVSTB61P .....236	ST31RB .....185	ST52RB .....176	ST92RBP .....175
RVPL5CP .....242	RVSTL0060.....234	ST31RBP .....185	ST52RBP .....176	ST9RB .....178
RVPL7A .....242	RVSTL0060P.....234	ST31RS .....185	ST53AAB.....176	ST9RBP .....178
RVPL7AB .....242	RVSTL0061 .....234	ST33AB .....172	ST53AABP.....176	ST9RHB .....178
RVPL7ABP .....242	RVSTL0061P.....234	ST33ABP .....172	ST56RS .....184	ST9RS .....178
RVPL7AP .....242	RVSTL60.....235	ST33RB .....172	ST57RS .....184	STL0016RB .....55
RVPL7C .....242	RVSTL60P.....235	ST33RBP .....172	ST5RB .....181	STL0016RBP .....55
RVPL7CB .....242	RVSTL60S .....235	ST34RB .....172	ST5RBP .....181	STL0016RS.....55
RVPL7CBP .....242	RVSTL61 .....235	ST34RBP .....172	ST5RS .....181	STL0017RB .....55
RVPL7CP .....242	RVSTL61P.....235	ST36RB .....183	ST60RB .....185	STL0017RBP .....55
RVPL8AB .....243	RVSTL61S.....235	ST36RBP .....183	ST60RBP .....185	STL0017RS.....55



STL002AB.....28	STL101RKBP .....8	STL13RH1BP.....14	STL22CCAB.....29	STL413RMBP.....15
STL002ABP.....28	STL101RMB.....8	STL13RH3B.....14	STL22CCABP.....29	STL42AB.....12
STL002RB.....28	STL101RMBP.....8	STL13RH3BP.....14	STL22CCRB.....29	STL42ABP.....12
STL002RBP.....28	STL108RB.....48	STL13RK.....14	STL22CCRBP.....29	STL42AMB.....12
STL002RFB.....28	STL108RBP.....48	STL13RKB.....14	STL22RB.....29	STL42AMB.....12
STL002RFBP.....28	STL109RB.....48	STL13RKB.....14	STL22RBH.....29	STL42RB.....12
STL002RK.....28	STL109RBP.....48	STL13RMB.....14	STL22RBHP.....29	STL42RBP.....12
STL002RK2B.....28	STL111AB.....20	STL13RMBP.....14	STL22RBP.....29	STL42RMB.....12
STL002RK2BP.....28	STL111ABP.....20	STL13RS.....14	STL22RCB.....29	STL42RMBK.....12
STL002RMB.....28	STL111ACB.....20	STL14RB.....53	STL22RCBP.....29	STL42RMBKP.....12
STL002RMBP.....28	STL111ACBP.....20	STL14RBP.....53	STL23A24B.....17	STL42RMBP.....12
STL002RS.....28	STL111RB.....20	STL153ARDBB.....42	STL23A24BP.....17	STL42RS.....12
STL003AB.....16	STL111RBP.....20	STL153ARDBBP.....42	STL23AB.....17	STL43A24B.....11
STL003ABP.....16	STL111RCB.....20	STL153ARPBB.....42	STL23ABP.....17	STL43A24BP.....11
STL003RB.....16	STL111RCBP.....20	STL153ARPBBP.....42	STL23CCRB.....17	STL43AB.....11
STL003RBP.....16	STL111RCFB.....21	STL15RB.....53	STL23CCRBP.....17	STL43ABP.....11
STL003RFB.....16	STL111RCFBP.....21	STL15RBP.....53	STL23R24B.....17	STL43ABX.....13
STL003RFBP.....16	STL111RCFMB.....21	STL161RB.....46	STL23R24BP.....17	STL43ABXP.....13
STL003RFLB.....16	STL111RCFMBP.....21	STL161RBP.....46	STL23RB.....17	STL43ABXS.....13
STL003RFLBP.....16	STL111RCMB.....20	STL161RLB.....46	STL23RBP.....17	STL43AKB.....11
STL003RFMB.....16	STL111RCMBP.....20	STL161RLBP.....46	STL26RB.....56	STL43AKBP.....11
STL003RFMBP.....16	STL111RFB.....21	STL16NTRB.....54	STL26RBP.....56	STL43R24B.....11
STL003RK.....16	STL111RFBP.....21	STL16NTRBP.....54	STL27RB.....56	STL43R24BP.....11
STL003RMB.....16	STL111RFMB.....21	STL16RB.....54	STL27RBP.....56	STL43RB.....11
STL003RMBP.....16	STL111RFMBP.....21	STL16RBP.....54	STL28RB.....52	STL43RBHX.....13
STL003RS.....16	STL111RHB.....20	STL16RS.....54	STL28RBP.....52	STL43RBHXP.....13
STL003SRFLB.....16	STL111RHBP.....20	STL175AMFB.....31	STL29RB.....52	STL43RBP.....11
STL003SRFLBP.....16	STL111RMB.....20	STL175AMFBP.....31	STL29RBP.....52	STL43RBX.....13
STL008RB.....51	STL111RMBP.....20	STL178RB.....22	STL2RB.....50	STL43RBXP.....13
STL008RBP.....51	STL112RB.....23	STL178RBP.....22	STL2RBP.....50	STL43RBXS.....13
STL008RPG.....51	STL112RBP.....23	STL178RCCFPB.....22	STL33RB.....35	STL43RK.....11
STL008RPGP.....51	STL113RB.....10	STL178RCCFPBP.....22	STL33RBP.....35	STL43RKB.....11
STL008RS.....51	STL113RBP.....10	STL178RCFPB.....22	STL33RFB.....35	STL43RKB.....11
STL009RB.....51	STL116RB.....53	STL178RCFPBP.....22	STL33RFBP.....35	STL43RMB.....11
STL009RBP.....51	STL116RBP.....53	STL178RFPB.....22	STL34RB.....35	STL43RMBP.....11
STL009RPG.....51	STL117RB.....53	STL178RFPBP.....22	STL34RBP.....35	STL512RB.....23
STL009RPGP.....51	STL117RBP.....53	STL179RB.....39	STL35AB.....36	STL512RBP.....23
STL009RS.....51	STL12RB.....26	STL179RBP.....39	STL35ABP.....36	STL512RCB.....23
STL101AB.....8	STL12RBP.....26	STL17NTRB.....54	STL35RB.....36	STL512RCBP.....23
STL101ABP.....8	STL12RK.....26	STL17NTRBP.....55	STL35RBP.....36	STL513RB.....10
STL101ACB.....8	STL12RK2B.....26	STL17RB.....54	STL36RB.....57	STL513RBP.....10
STL101ACBP.....8	STL12RKB.....26	STL17RBP.....54	STL36RBP.....57	STL513RCB.....10
STL101RB.....8	STL12RMB.....26	STL17RS.....54	STL36RPG.....57	STL513RCBP.....10
STL101RBP.....8	STL12RMBP.....26	STL190AB.....44	STL36RPGP.....57	STL52ARB.....43
STL101RCB.....8	STL12RS.....26	STL190ABP.....44	STL36RS.....57	STL52ARB.....43
STL101RCBP.....8	STL133RB.....34	STL190RB.....44	STL37RB.....57	STL53ARDB.....43
STL101RCFB.....9	STL133RBP.....34	STL190RBP.....44	STL37RBP.....57	STL53ARDBP.....43
STL101RCFBP.....9	STL13RB.....14	STL201RB.....5	STL37RPG.....57	STL53ARPB.....43
STL101RCFMB.....9	STL13RBP.....14	STL201RBP.....5	STL37RPGP.....57	STL53ARPB.....43
STL101RCFMBP.....9	STL13RFB.....14	STL201RFMB.....4	STL37RS.....57	STL53RCB.....11
STL101RCMB.....8	STL13RFBP.....14	STL201RFMBP.....4	STL37RB.....50	STL53RCBP.....11
STL101RCMBP.....8	STL13RFMB.....14	STL211RB.....6	STL3RBP.....50	STL543RB.....18
STL101RFB.....9	STL13RFMBP.....14	STL211RBP.....6	STL412RB.....27	STL543RBP.....18
STL101RFBP.....9	STL13RFS.....14	STL211RCB.....6	STL412RBP.....27	STL55AB.....19
STL101RFMB.....9	STL13RGB.....14	STL211RCBP.....6	STL413RB.....15	STL55ABP.....19
STL101RFMBP.....9	STL13RGBP.....14	STL22AB.....29	STL413RBP.....15	STL55RB.....19
STL101RKB.....8	STL13RH1B.....14	STL22ABP.....29	STL413RMB.....15	STL55RBP.....19

STL55RFMB .....19	STL72RMB .....24	STL9R3B .....49	TLL46TB .....160	UCL13CPGP .....142
STL55RFMBP .....19	STL72RMBP .....24	STL9R3BP .....49	TLL46TBP .....160	UCL160CB .....145
STL56RB .....58	STL72RS .....24	STL9RB .....49	TLL48FB .....161	UCL160CBP .....145
STL56RBP .....58	STL73RB .....27	STL9RBP .....49	TLL48FBP .....161	UCL178RFP2B .....141
STL572AB .....30	STL73RBP .....27	TL106CS .....231	TLL50FB .....161	UCL178RFP2BP .....141
STL572ABP .....30	STL73RK .....27	TL10C24VB .....231	TLL50FBP .....161	UCL19CB .....143
STL572RB .....30	STL73RKB .....27	TL10C24VBP .....231	TLL51FB .....162	UCL19CBP .....143
STL572RBP .....30	STL73RKBP .....27	TL10CB .....231	TLL51FBP .....162	UCL50CB .....143
STL57RB .....58	STL74RBK .....24	TL10CBP .....231	TLL51FRPG .....162	UCL50CBP .....143
STL57RBP .....58	STL74RBKP .....24	TL10CS .....231	TLL52FB .....162	UCL55CB .....144
STL60RB .....47	STL74RKB .....24	TL10SS .....231	TLL52FBP .....162	UCL55CBP .....144
STL60RBP .....47	STL74RKBP .....24	TL11CPG .....231	TLL52FPBB .....163	UCL60CB .....145
STL60RLB .....47	STL75AB .....33	TL12CS .....231	TLL52FPBBP .....163	UCL60CBB .....145
STL60RLBP .....47	STL75ABP .....33	TL15RK .....182	TLL52FWB .....162	UCL60CBBP .....145
STL61RB .....47	STL75AMB .....33	TL16RK .....182	TLL52FWBP .....162	UCL60CBP .....145
STL61RBP .....47	STL75AMBP .....33	TL22RK .....186	TLL54TB .....163	UCL60CSBB .....145
STL61RLB .....47	STL75AMFB .....32	TL27BK .....178	TLL54TBP .....163	UCL60CSBBP .....145
STL61RLBP .....47	STL75AMFBP .....32	TL29BK .....178	TLL55FB .....164	UCL60CSCB .....145
STL63CRB .....37	STL76RB .....41	TL35FS .....231	TLL55FBP .....164	UCL60CSNB .....145
STL63CRBP .....37	STL76RBP .....41	TL35TB .....231	TLL56FB .....164	UCL60CSNBP .....145
STL63RB .....37	STL78AB .....25	TL35TS .....231	TLL56FBP .....164	UCL60CSWNB .....145
STL63RBP .....37	STL78ABP .....25	TL36RK .....183	TLL56RK .....58	UCL60CSWNB .....145
STL68RB .....7	STL78RB .....25	TL46FS .....231	TLL57FB .....164	UCL65CB .....144
STL68RBP .....7	STL78RBP .....25	TL46TS .....231	TLL57FBP .....164	UCL65CBP .....144
STL68RPB .....7	STL78REZB .....25	TL5RK .....179	TLL60FB .....165	UL11BS .....200
STL68RPBP .....7	STL78REZBP .....25	TL60RK .....181	TLL60FBP .....165	UL53CB .....227
STL69CRPG .....38	STL78RK .....25	TL8RK .....178	TLL64FB .....165	UL53CBP .....227
STL69CRPGP .....38	STL78RLPB .....25	TL9RK .....179	TLL64FBP .....165	UL56CB .....227
STL69RB .....38	STL78RLPBP .....25	TLL0016RK .....55	TLL70FB .....166	UL56CBP .....227
STL69RBP .....38	STL78RPG .....25	TLL002RK .....28	TLL70FBP .....166	UL71CS .....226
STL69RCB .....38	STL78RPGP .....25	TLL008RK .....51	TLL71FB .....166	UL94CB .....225
STL69RCBMCV2B .....38	STL79RB .....40	TLL112RK .....20	TLL71FBP .....166	UL94CBP .....225
STL69RCBMCV2BP .....38	STL79RBP .....40	TLL12RK .....26	TLL72FB .....167	UL95CB .....225
STL69RCBP .....38	STL79RS .....40	TLL144FSL .....159	TLL72FBP .....167	UL95CBP .....225
STL69RK .....38	STL7RS .....49	TLL150FSL .....161	TLL73FB .....167	UL97CPG .....226
STL69RRXB .....38	STL80RB .....40	TLL152FSL .....162	TLL73FBP .....167	UL97CPGP .....226
STL69RRXBP .....38	STL80RBP .....40	TLL160RK .....54	TLL80FB .....168	ULL25CB .....157
STL69RRXCS .....38	STL82RCB .....24	TLL16RK .....54	TLL80FBP .....168	ULL25CBP .....157
STL69RS .....38	STL82RCBP .....24	TLL170RK .....53	TLL80WFB .....168	ULL25CTB .....157
STL6RS .....49	STL88RCB .....25	TLL190RK .....48	TLL80WFBP .....168	ULL25CTBP .....157
STL70AB .....30	STL88RCBP .....25	TLL21RK .....59	TLL90RK .....49	
STL70ABP .....30	STL88RCPG .....25	TLL22RK .....29	TLL9RK .....49	
STL70RB .....30	STL88RCPGP .....25	TLL25FS .....168	UCL09CB .....141	
STL70RBP .....30	STL89RCB .....40	TLL26RK .....56	UCL09CBB .....141	
STL71AMB .....32	STL89RCBP .....40	TLL28RK .....52	UCL09CBBP .....141	
STL71ABP .....32	STL8R3B .....49	TLL29RK .....52	UCL09CBP .....141	
STL72AB .....24	STL8R3BP .....49	TLL30FB .....158	UCL11CB .....142	
STL72ABP .....24	STL8RB .....49	TLL30FBP .....158	UCL11CBP .....142	
STL72AMB .....24	STL8RBP .....49	TLL31RK .....59	UCL11CKB .....142	
STL72AMB .....24	STL90A24B .....45	TLL36RK .....57	UCL11CKBP .....142	
STL72CAB .....24	STL90A24BP .....45	TLL44FB .....159	UCL11CKPG .....142	
STL72CABP .....24	STL90AB .....45	TLL44FBP .....159	UCL11CKPGP .....142	
STL72RB .....24	STL90ABP .....45	TLL45FB .....159	UCL13C2PG .....142	
STL72RBP .....24	STL90R24B .....45	TLL45FBP .....159	UCL13C2PGP .....142	
STL72RK .....24	STL90R24BP .....45	TLL46CFB .....160	UCL13CB2B .....142	
STL72RKB .....24	STL90RB .....45	TLL46CFBP .....160	UCL13CB2BP .....142	
STL72RKBP .....24	STL90RBP .....45	TLL46CFPG .....160	UCL13CPG .....142	

**BETTER VALUE  
BETTER OPTIONS  
BETTER LIGHTING**



For more information, scan this  
QR code with your mobile device

[www.optronicsinc.com](http://www.optronicsinc.com)