



1200V 6-Pack (3 Phase) Silicon Carbide Power Module

GE12050EEA3

V_{DS} : 1200 V I_{DS} : 475 A

Superior performance for high power, high frequency applications needing best-in-class power density

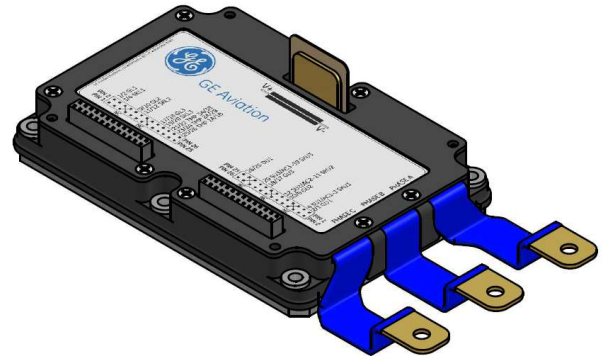

Features

- Highly reliable GE SiC MOSFET devices AEC-Q101 qualified to 200°C
- Low $R_{DS(ON)}$ (3.1 mΩ) (device only)
- Low stray inductance
- Ultra-low switching losses over entire operating range
- GE Power Overlay wire-bondless technology
- Body diode with minimal reverse recovery
- Integrated temperature sensing
- Dedicated DESAT Pin and Source-Kelvin Pin
- AlSiC Baseplate and Si_3N_4 AMB Substrate

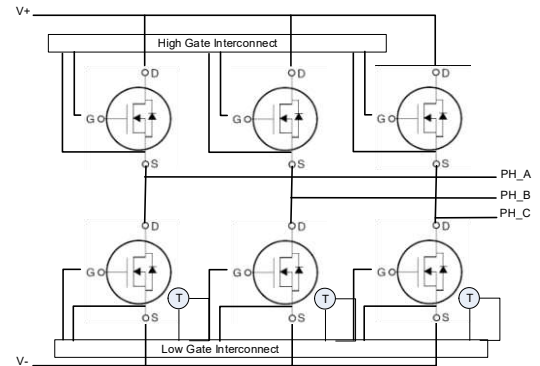

MOSFET DC Characteristics @ $T_J = 25^\circ C$ (unless otherwise specified)

Symbols	Parameters	Min.	Typ.	Max.	Unit	Test Conditions	Notes
I_{DS}	Continuous Drain Current			475	A	$V_{GS} = 20\text{ V}, T_c = 25^\circ C$	Per Switch
				333		$V_{GS} = 20\text{ V}, T_c = 100^\circ C$	
				272		$V_{GS} = 20\text{ V}, T_c = 125^\circ C$	
$I_{DS,pulse}$	Pulsed Drain Current			950	A	$T_c = 25^\circ C, t_p = 1\text{ ms}$	
V_{DSmax}	Drain - Source Breakdown Voltage	1200			V	$V_{GS} = 0\text{ V}, I_{DS} = 100\text{ }\mu A$	
V_{GSmax}	Maximum Gate - Source Voltage			-15/+23	V	$V_{DS} = 0\text{ V}$	
V_{GSop}	Recommended Gate - Source Voltage		-5/+20		V		
T_{Jmax}	Junction Temperature			175	$^\circ C$		
T_c	Case Temperature Range	-55		150	$^\circ C$		
T_{STG}	Storage Temperature Range	-55		150	$^\circ C$		
P_D	Power Dissipation			1250	W	$T_c = 25^\circ C$	Per Switch



(Continued) **MOSFET DC Characteristics @ $T_J = 25^\circ\text{C}$** (unless otherwise specified)

Symbols	Parameters	Min.	Typ.	Max.	Unit	Test Conditions	Notes
I_{DS}	Continuous Drain Current			475	A	$V_{GS} = 20\text{ V}, T_c = 25^\circ\text{C}$	Per Switch
$V_{GS(th)}$	Gate Threshold Voltage	2.5	2.8	4.5	V	$V_{GS} = V_{DS}, I_{DS} = 160\text{ mA}$	
I_{DSS}	Drain Leakage Current			0.10 1.6	mA	$V_{DS} = 1200\text{ V}, V_{GS} = 0\text{ V}, T_J = 25^\circ\text{C}$ $T_J = 175^\circ\text{C}$	
I_{GSS}	Gate-Source Leakage Current			160	nA	$V_{GS} = -15/+23\text{ V}$	
$R_{DS(on)}$	On State Resistance (Device Only)		3.1 5.6	4.4 6.8	m Ω	$V_{GS} = 20\text{ V}, I_{DS} = 475\text{ A}, T_J = 25^\circ\text{C}$ $T_J = 175^\circ\text{C}$	Per Switch
$R_{G(int)}$	Gate-Source series resistance		0.90		Ω	$V_{GS} = 0\text{ V}, f = 100\text{ kHz}, T_c = 25^\circ\text{C}$	

MOSFET Dynamic Characteristics per switch @ $T_J = 25^\circ\text{C}$ (unless otherwise specified)

Symbols	Parameters	Min.	Typ.	Max.	Unit	Test Conditions	Notes
C_{iss}	Input Capacitance		29.3		nF		
C_{oss}	Output Capacitance		1.60		nF	$V_{GS} = 0\text{ V}$ $V_{DS} = 600\text{ V}$	
C_{rss}	Reverse Transfer Capacitance		0.13		nF	$f = 100\text{ kHz}$	
E_{on}	Turn-On Switching Energy		4.3		mJ		
E_{off}	Turn-Off Switching Energy		5.7		mJ	$V_{GS} = -5\text{ V to }+20\text{ V}$ $V_{DS} = 600\text{ V}$	
t_r	Rise Time		21.9		ns	$I_{DS} = 475\text{ A}$	
t_f	Fall Time		38.9		ns	$R_{Gon} = R_{Goff} = 2.0\ \Omega$	
Q_G	Total Gate Charge		1248		nC	$V_{GS} = 0\text{ to }18\text{ V}$	
Q_{GD}	Gate-Drain Charge		536		nC	$V_{DS} = 900\text{ V}$	
Q_{GS}	Gate-Source Charge		176		nC	$I_{DS} = 240\text{ A}$	

Body Diode Characteristics per switch @ $T_J = 25^\circ\text{C}$ (unless otherwise specified)

Symbols	Parameters	Min.	Typ.	Max.	Unit	Test Conditions	Notes
I_{SD}	Pulsed body diode current			720	A	$V_{GS} = 0\text{ V}$	1.
V_{SD}	Diode Forward Voltage		4.69		V	$V_{GS} = 0\text{ V}, I_{SD} = 475\text{ A}, T_J = 25^\circ\text{C}$	

1. Use of body diode is recommended in pulse mode only

Thermal Characteristics

Symbols	Parameters	Min.	Typ.	Max.	Unit	Test Conditions	Notes
R_{th}	Thermal Resistance Junction-to-Case		0.10	0.12	$^\circ\text{C/W}$	JESD51-14	Per Switch



Temperature Sensor Characteristics

Symbols	Parameters	Min.	Typ.	Max.	Unit	Test Conditions	Notes
R_{RTD}	Rated Resistance of RTD		1k		ohm		2.
	Tolerance of Resistance		0.12		%		
	Accuracy		0.3		°C		
	Measuring Current	100		300	μA		
TCR	Temperature Coefficient		3850		ppm/K		
	Operating Temperature	-70		+500	°C		
	Insulation Resistance		100		Mohm	20°C	

2. RTD is mounted directly over center-most die allowing direct reading of T_j

Module packaging data

Symbols	Parameters	Min.	Typ.	Max.	Unit	Test Conditions	Notes
V_{Iso}	Case Isolation Voltage	4			kV	AC 50 Hz, 1 min, 25°C	
CTI	Comparative Tracking Index		600				
M_s	Mounting Torque			5.0 4.0	N-m	Power Terminals Baseplate	
$L_{V+/V-}$	Loop Inductance		4.0		nH		
	Module Mass		0.54		Kg		
	Clearance Distance		19		mm	Phase A to Phase B	
			19		mm	Phase B to Phase C	
			7		mm	V+ to V-	
			111		mm	V- to Phase A	
			36		mm	Phase B to Baseplate	
			25		mm	V+ to Baseplate	
	Creepage Distance		107		mm	Phase A to Phase B	
			113		mm	Phase B to Phase C	
			7		mm	V+ to V-	
			116		mm	V- to Phase A	
			70		mm	Phase B to Baseplate	
			31		mm	V+ to Baseplate	
M_{BP}	Base Plate Material		AlSiC				



Typical performance: **GE12050EEA3**

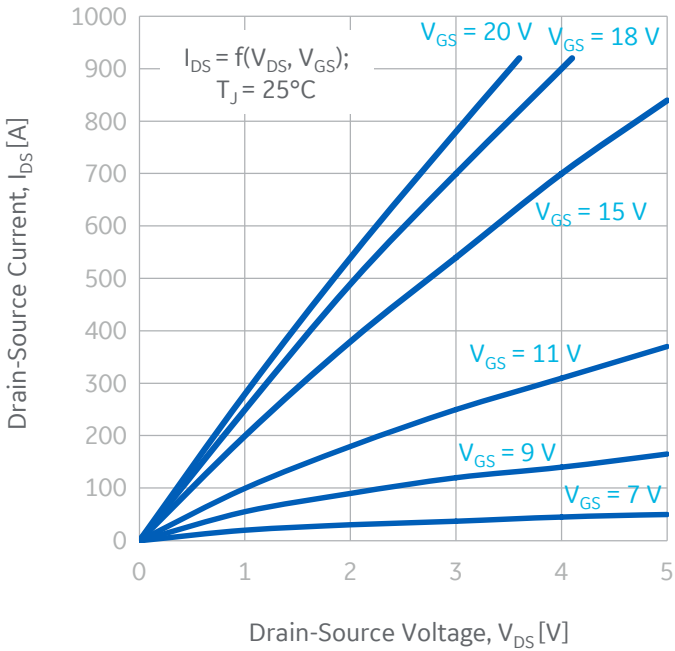

Figure 1: Output Characteristics (25°C)

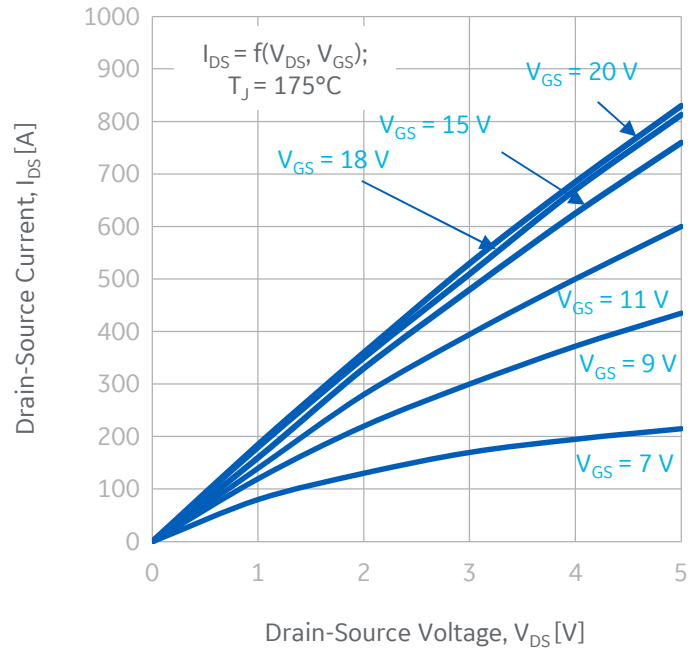

Figure 2: Output Characteristics (175°C)

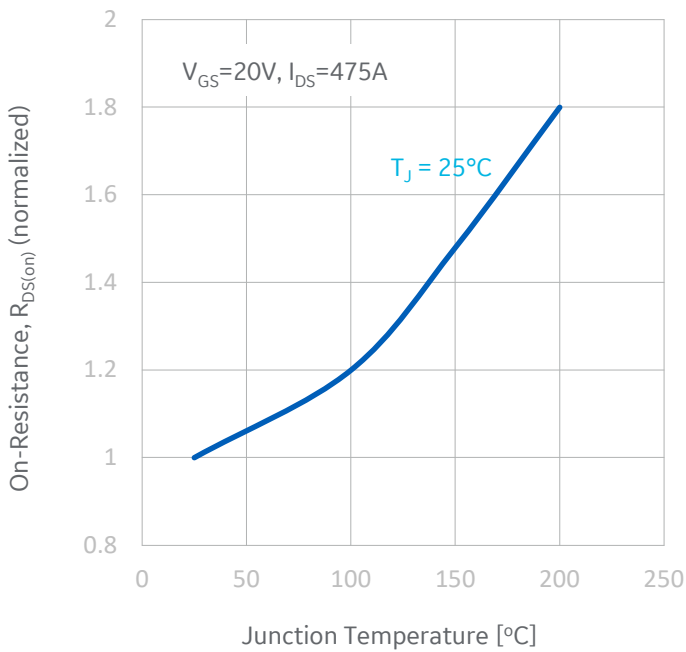

Figure 3: Normalized On-state Resistance vs. Temperature

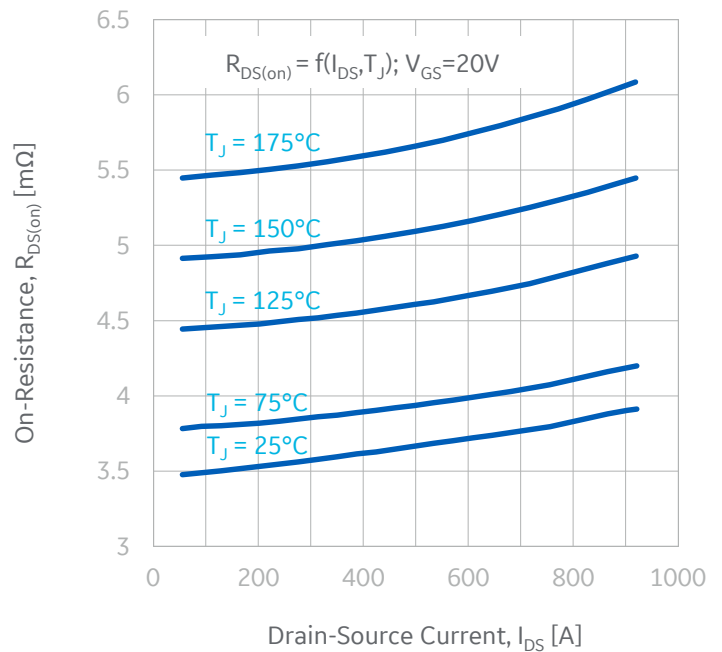

Figure 4: Module Drain-Source On-state Resistance



Typical performance: **GE12050EEA3**

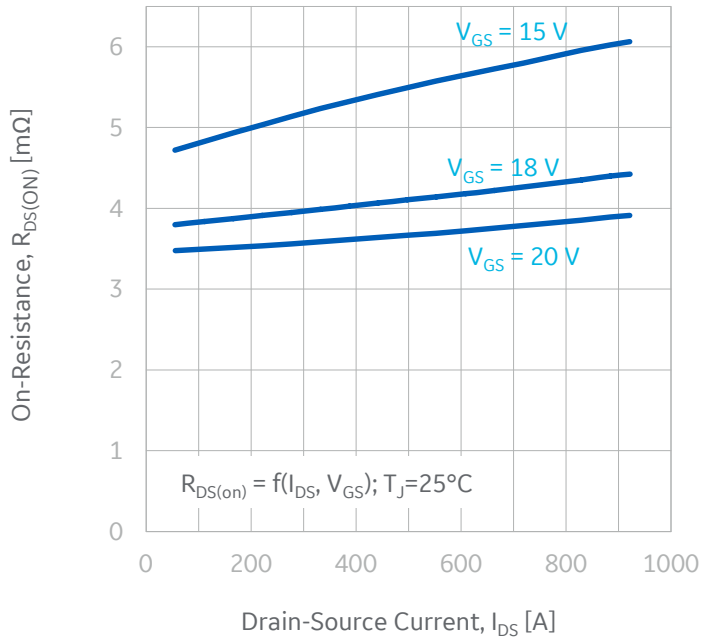

Figure 5: Module Drain-Source On-state Resistance

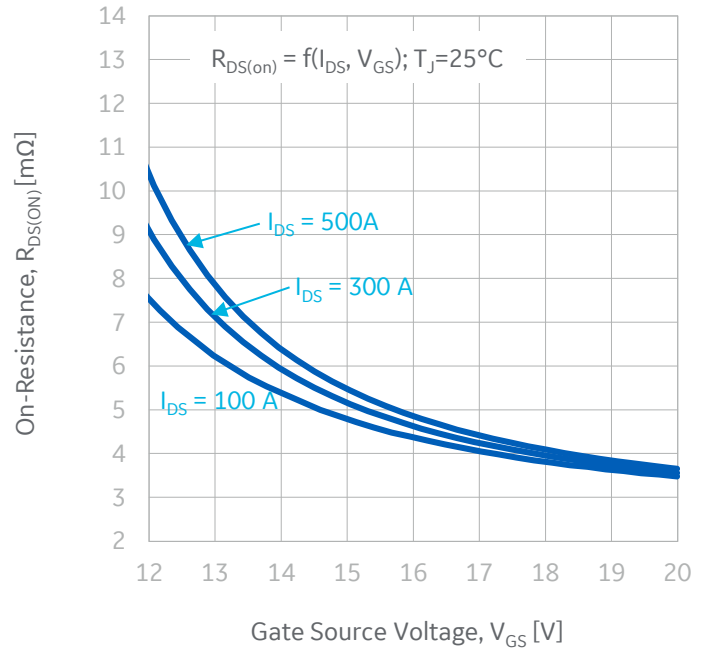

Figure 6: Drain-Source On-state Resistance vs. Gate Voltage

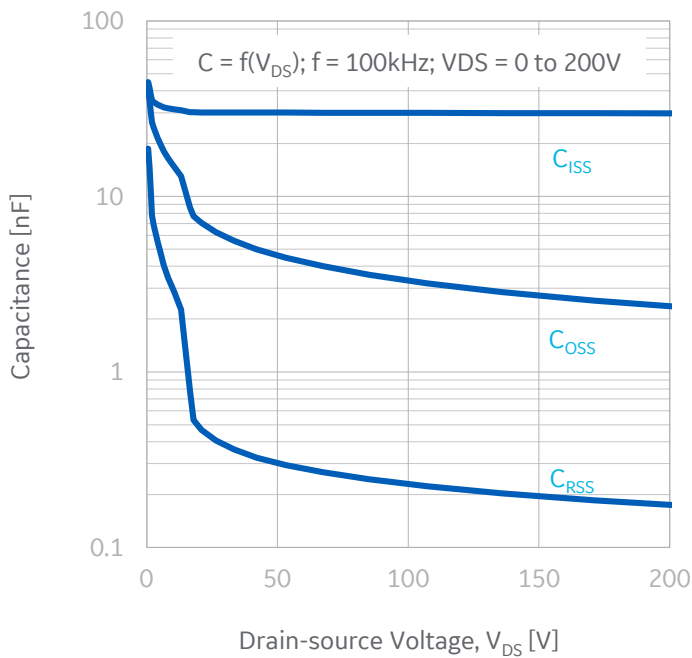

Figure 7: Junction Capacitances to 200 V

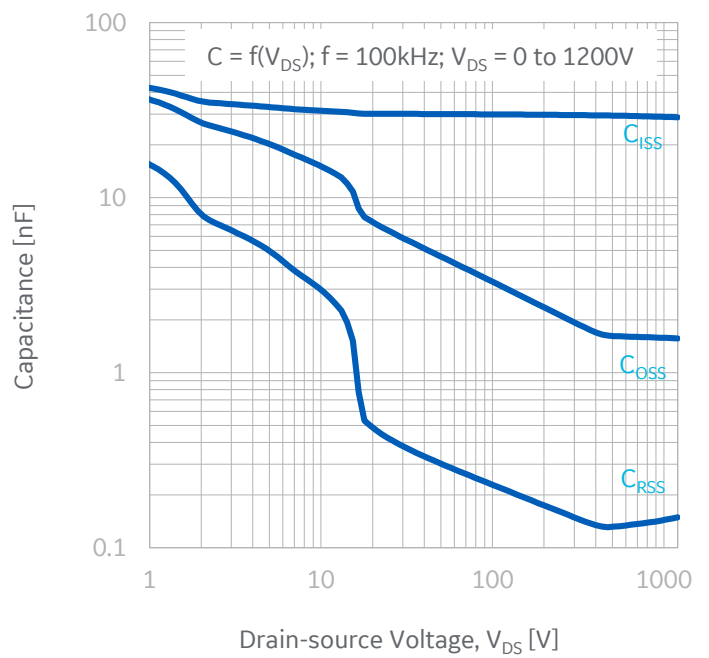

Figure 8: Junction Capacitances to 1200 V



Typical performance: **GE12050EEA3**

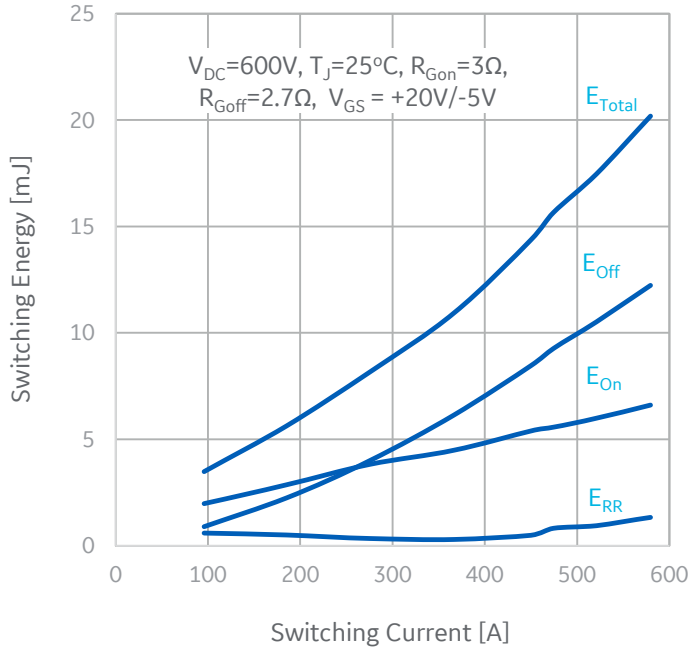

Figure 9: Switching Energy vs. Drain Current (600 V)

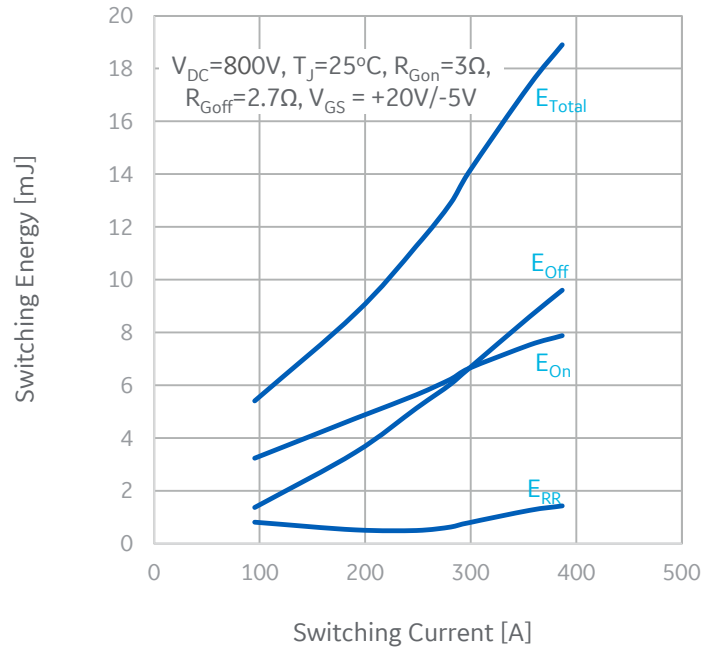

Figure 10: Switching Energy vs. Drain Current (800 V)

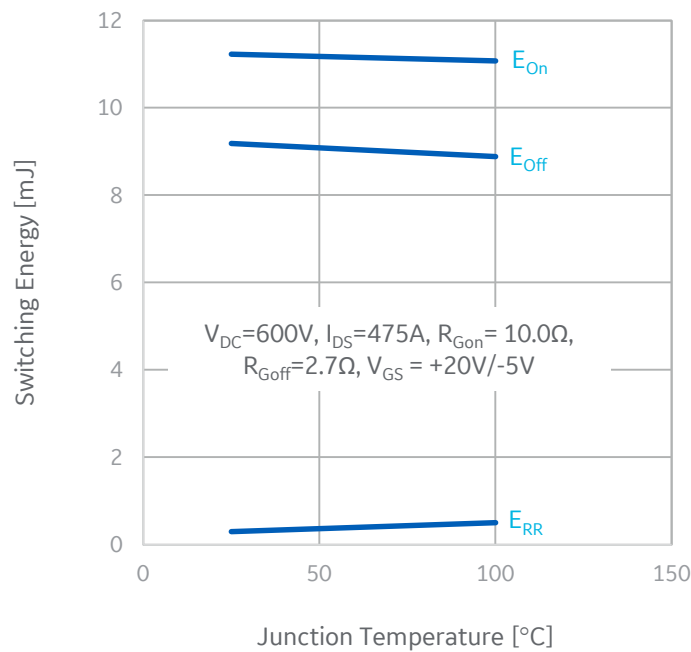

Figure 11: Switching Energy vs. Junction Temperature

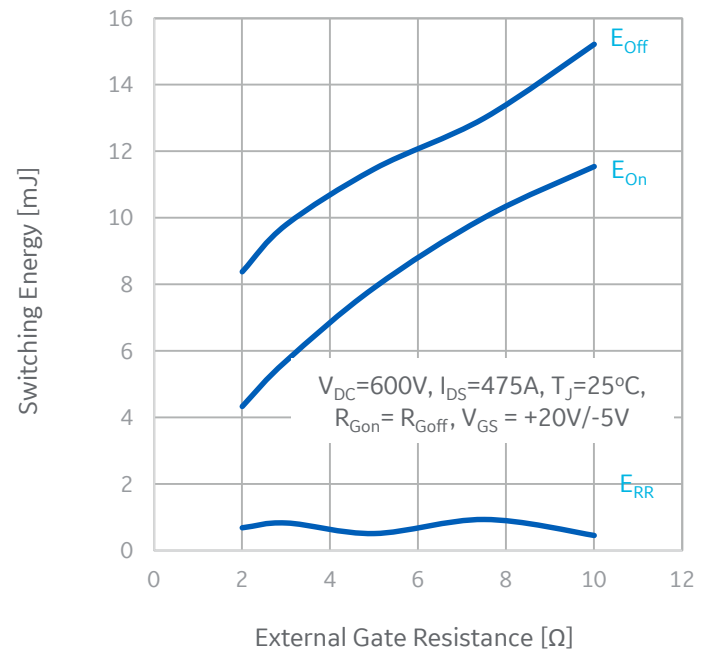

Figure 12: Switching Energy vs. Gate Resistance



Typical performance: **GE12050EEA3**

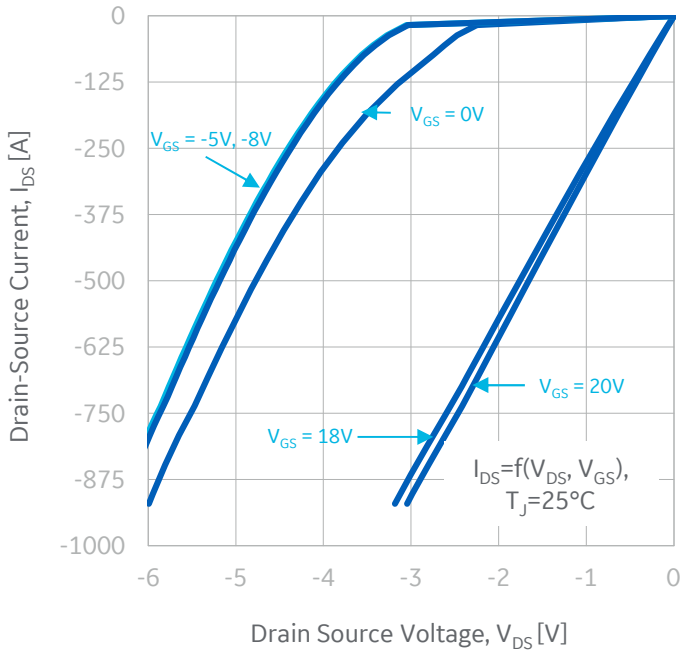

Figure 13: 3rd Quadrant Characteristics (25°C)

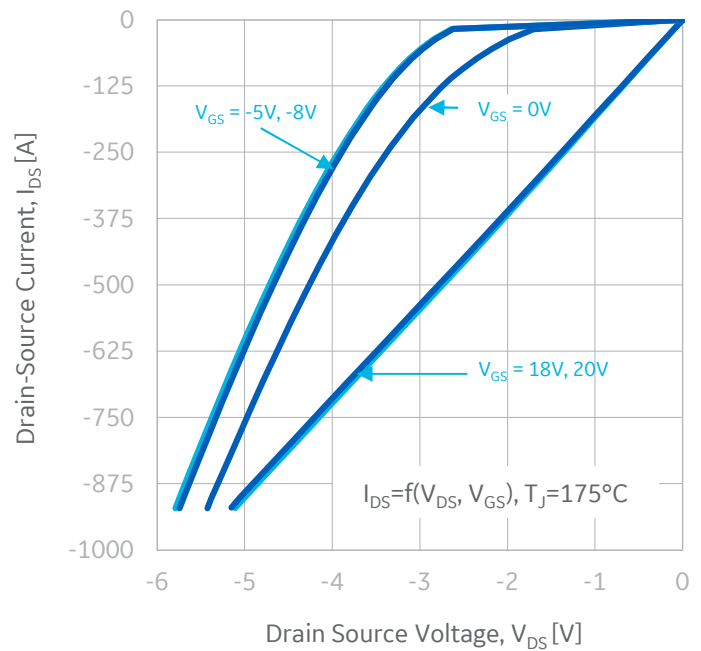

Figure 14: 3rd Quadrant Characteristics (175°C)

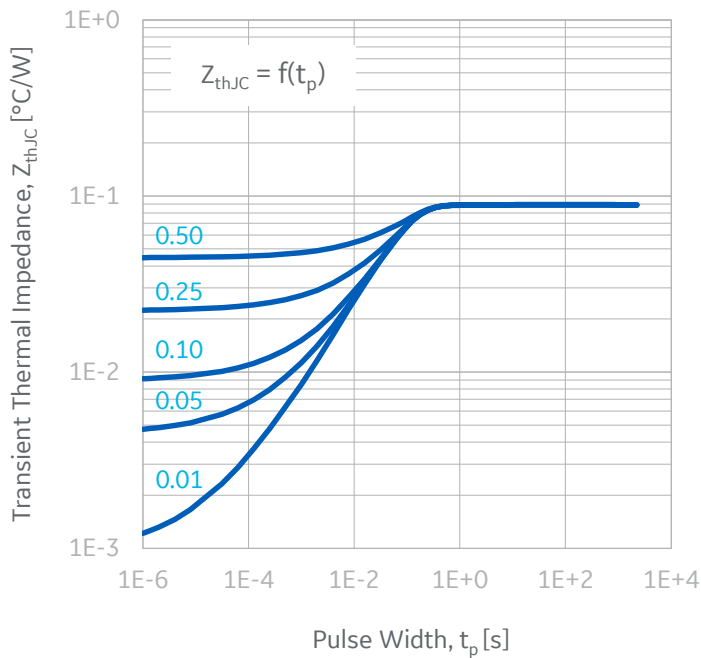

Figure 15: Transient Thermal Impedance

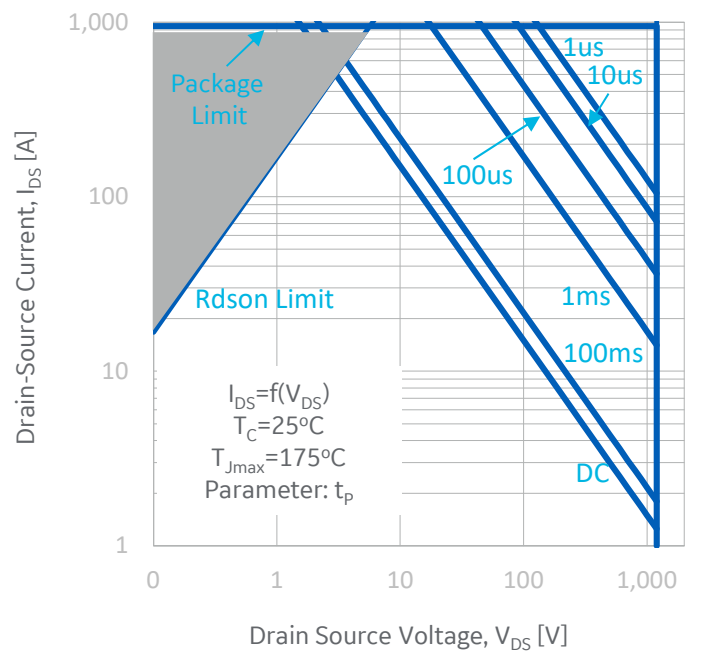

Figure 16: Forward-Bias Safe Operating Area



Typical performance: **GE12050EEA3**

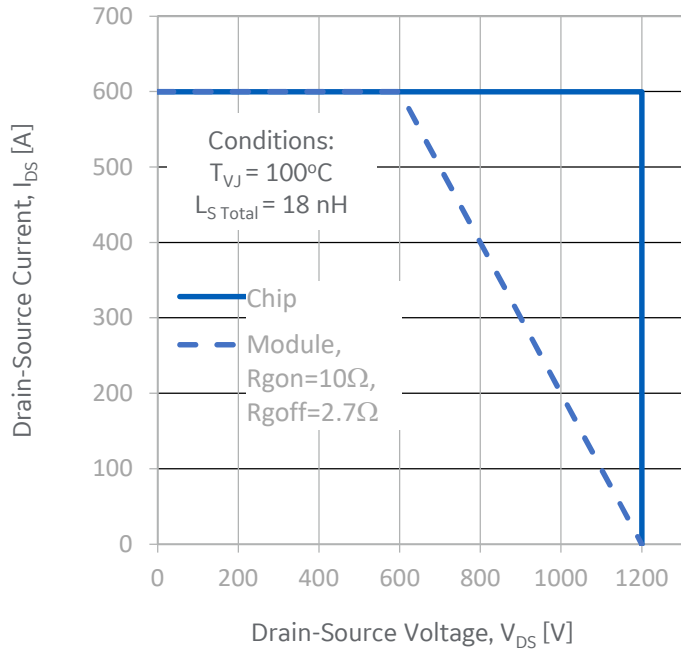

Figure 17: Reverse-Bias Safe Operating Area

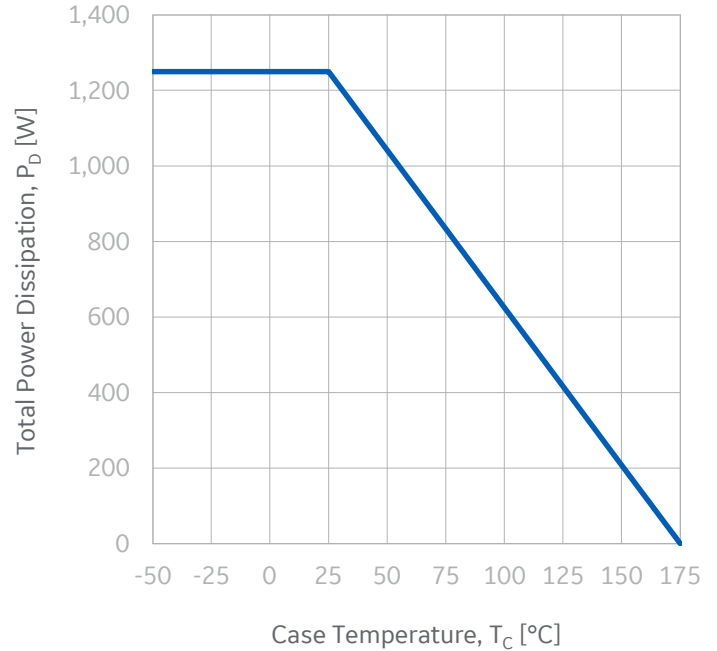
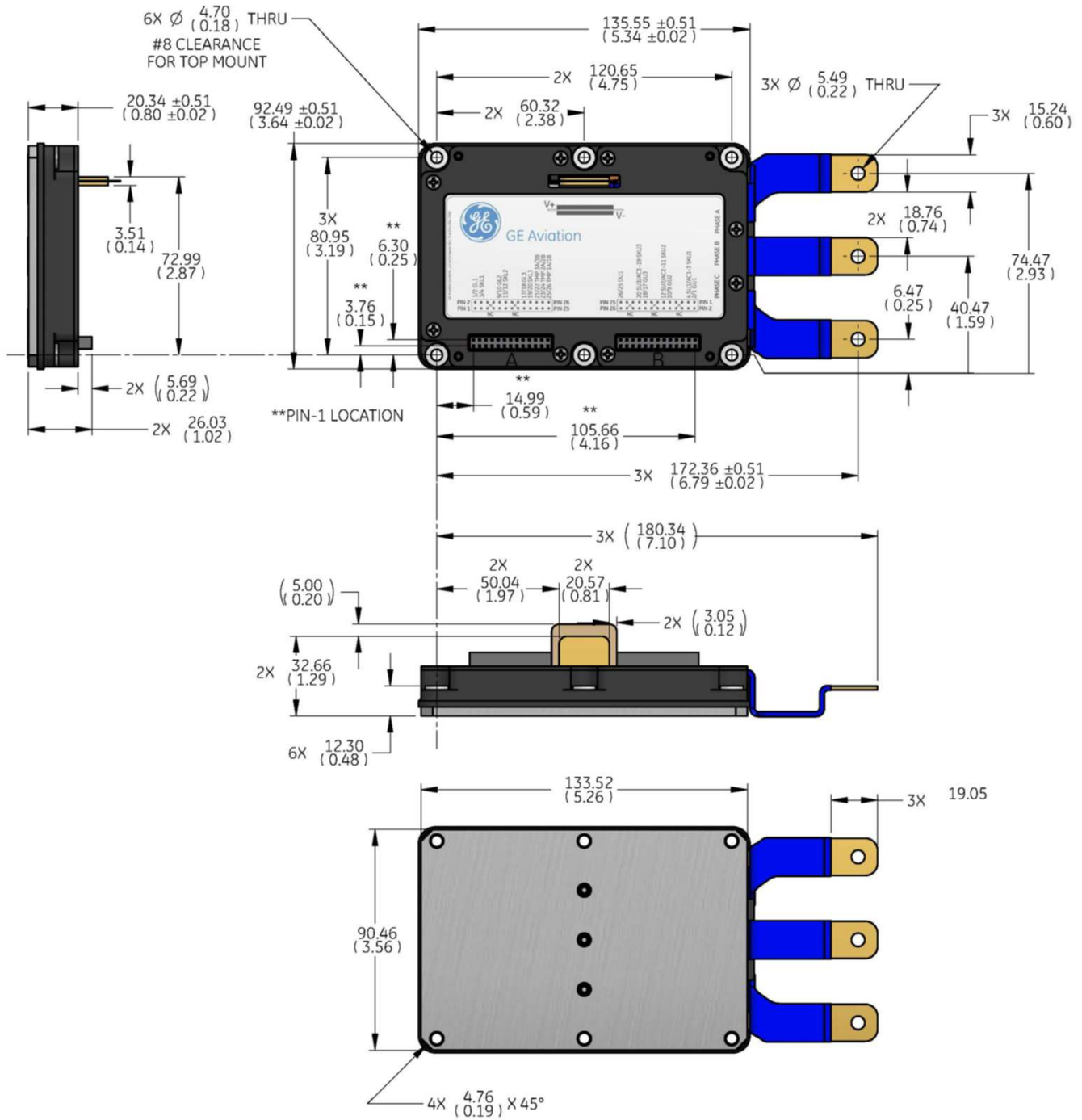

Figure 18: Maximum Power Dissipation vs. Case Temperature



Module dimensions (millimeters)





Electrical interface outline drawing

Lower Switch Interconnect

1	GL1
2	GL1
3	SKL1
4	SKL1
5	**
6	**
7	**
8	**
9	GL2
10	GL2
11	SKL2
12	SKL2
13	**
14	**
15	**
16	**
17	GL3
18	GL3
19	SKL3
20	SKL3
21	TMP3A
22	TMP3B
23	TMP2A
24	TMP2B
25	TMP1A
26	TMP1B

** = No Connection

Upper Switch Interconnect

1	GU1
2	GU1
3	SKU1
4	SU1/AC1
5	**
6	**
7	**
8	**
9	GU2
10	GU2
11	SKU2
12	SU2/AC2
13	**
14	**
15	**
16	**
17	GU3
18	GU3
19	SKU3
20	SU3/AC3
21	**
22	**
23	**
24	**
25	DU1
26	DU1

** = No Connection

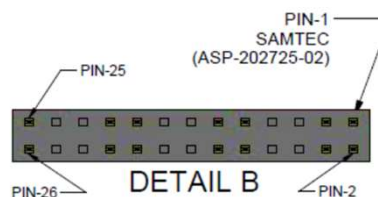
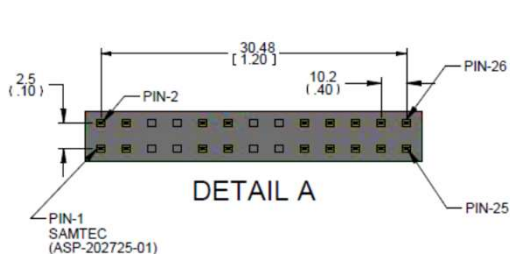

Disclaimer

The data presented in this document are for informational purposes only and shall in no event be regarded as a guarantee of conditions or characteristics. Any warranty or license for this product shall be specified and governed by the terms of a separate purchase agreement. General Electric Company does not assume any liability arising out of the application or use of this product; neither does it convey any license under its patent rights, nor the rights of others.

General Electric Company reserves the right to make changes in specifications and features shown herein to improve reliability, function, or design, or discontinue this product, at any time without notice or obligation. Contact your GE representative for the most current information.

Warning

This product is not authorized for use (1) in life support systems or (2) for applications implanted into the human body, without the express written approval of General Electric Company.

Questions or need help designing in GE SiC Power modules? Please contact:

SiC.Products@ge.com

GE Aerospace
2705 Gateway Dr.
Pompano Beach, FL 33069
(954) 984-2400

Document revisions

Rev 1.1 – Public Release – October 2022