

Multi-Power
Industrial Equipment

MODEL MP7500E 14 HP Generator

Owner's Manual



DO NOT RETURN TO STORE

**Questions? Problems?
Please call our customer help line:**

(877) 968-3733 M-F 8-5 CT

WARNING: AS A SAFETY PRECAUTION YOU MUST READ THIS OWNERS MANUAL TO AVOID THE RISK OF PROPERTY DAMAGE, BODILY INJURY OR DANGER.

Thank you for purchasing a Multi-Power MP7500E generator. This manual provides information regarding the operation and maintenance of this product. We have made every effort to ensure the accuracy of the information in this manual. Multi-Power reserves the right to change this product at any time without prior notice. This manual may not be reproduced without written consent from Multi-Power.

Please keep this manual available to all users during the entire life of the generator.



MODEL MP7500E 14 HP Generator

FEATURES

- *7500 Surge Watt Output*
- *7000 Rated Watt Output*
- *Powerful Enough to Run Essential Appliances During Power Outages*
- *120 and 240 Volt AC Outputs*
- *Low Oil Indicator*
- *Circuit Breaker for Overload Protection*
- *6.5 Gallon Fuel Tank Capacity*
- *Meets EPA Emission Standards*
- *DC Battery Charging Receptacle*
- *Digital Hour Meter*
- *Automatic Idle Reduction*

TABLE OF CONTENTS

GENERAL SAFETY PROCEDURES.....	4
PACKAGE CONTENTS.....	8
GENERATOR COMPONENTS.....	9
ASSEMBLY.....	10
Attach feet.....	10
Attach handles.....	11
Attach wheels.....	11
PREPARING THE GENERATOR FOR USE.....	13
Using the Generator for the First Time.....	13
Step 1- Add Oil.....	13
Step 2- Add Gasoline.....	14
Step 3- Ground the Generator.....	14
Subsequent Use of the Generator.....	15
Step 1- Check the Oil.....	15
Step 2- Check the Gas Level.....	16
Step 3- Ground the Generator.....	16
STARTING THE GENERATOR.....	17
USING THE GENERATOR.....	18
AC Usage.....	18
DC Usage.....	21
STOPPING THE GENERATOR.....	21
MAINTENANCE / CARE.....	22
Cleaning the Generator.....	22
Checking the Oil.....	22
Changing/ Adding Oil.....	23
Air Cleaner Maintenance.....	24
Fuel Filter Cup Cleaning.....	25
Spark Plug Maintenance.....	25
Emptying the Gas Tank.....	26
STORAGE / TRANSPORT PROCEDURES.....	26
SPECIFICATIONS.....	27
TROUBLESHOOTING.....	28
EXPLODED VIEW AND PARTS LIST.....	29
WIRING DIAGRAM.....	31
WARRANTY.....	33

Notice Regarding Emissions

Engines that are certified to comply with U.S. EPA emission regulations for SORE (Small Off Road Equipment), are certified to operate on regular unleaded gasoline, and may include the following emission control systems: (EM) Engine Modifications and (TWC) Three -Way Catalyst (if so equipped).

GENERAL SAFETY PROCEDURES

Please familiarize yourself with the following safety symbols and words:

The safety alert symbol  is used with one of the safety words (**DANGER**, **CAUTION**, or **WARNING**) to alert you to hazards. Please pay attention to these hazard notices both in this manual and on the generator.

DANGER: Indicates a hazard that will result in serious injury or death if instructions are not followed.

WARNING: Indicates a strong possibility of causing serious injury or death if instructions are not followed.

CAUTION: Indicates a possibility of personal injury or equipment damage if instructions are not followed.



If you have any questions regarding the hazard and safety notices listed in this manual or on the product, please call (877) 968-3733 M-F 8-5 CT before using the generator.

 DANGER: This generator produces poisonous carbon monoxide gas when running. This gas is both odorless and colorless. Even if you do not see or smell gas, carbon monoxide may still be present. Breathing this poison can lead to headaches, dizziness, drowsiness, and eventually death.

- Use outdoors ONLY in non-confined areas.
- Keep several feet of clearance on all sides to allow proper ventilation of the generator.

 WARNING: The exhaust from this product contains chemicals known to the State of California to cause cancer, birth defects, or other reproductive harm.

 WARNING: This generator may emit highly flammable and explosive gasoline vapors, which can cause severe burns or even death. A nearby open flame can lead to explosion even if not directly in contact with gas.

- Do not operate near open flame.
- Do not smoke near generator.
- Always operate on a firm, level surface.
- Always turn generator off before refueling. Allow generator to cool for at least 2 minutes before removing fuel cap. Loosen cap slowly to relieve pressure in tank.
- Do not overfill gas tank. Gas may expand during operation. Do not fill to the top of the tank.
- Always check for spilled gas before operating.
- Empty gasoline tank before storing or transporting the generator..
- Before transporting, turn fuel valve to off and disconnect spark plug.

⚠ WARNING: This generator produces powerful voltage, which can result in electrocution.

- ALWAYS ground the generator before using it (see the “Ground the Generator” portion of the “PREPARING THE GENERATOR FOR USE” section).
- Generator should only be plugged into electrical devices, either directly or with an extension cord. NEVER connect to a building electrical system without a qualified electrician. Such connections must comply with local electrical laws and codes. Failure to comply can create a backfeed, which may result in serious injury or death to utility workers.
- Use a ground fault circuit interrupter (GFCI) in highly conductive areas such as metal decking or steel work. GFCIs are available in-line with some extension cords.
- Do not use in rainy or wet conditions.
- Do not touch bare wires or receptacles (outlets).
- Do not allow children or non-qualified persons to operate.

⚠ WARNING: This generator produces heat when running. Temperatures near exhaust can exceed 150° F (65° C).

- Do not touch hot surfaces. Pay attention to warning labels on the generator denoting hot parts of the machine.
- Allow generator to cool several minutes after use before touching engine or areas which heat during use.

CAUTION: Misuse of this generator can damage it or shorten its life.

- Use generator only for its intended purposes.
- Operate only on dry, level surfaces.
- Allow generator to run for several minutes before connecting electrical devices.
- Shut off and disconnect any malfunctioning devices from generator.
- Do not exceed the Wattage capacity of the generator by plugging in more electrical devices than the unit can handle.
- Do not turn on electrical devices until *after* they are connected to the generator.
- Turn off all connected electrical devices before stopping the generator.

In addition to the above safety notices, please familiarize yourself with the safety and hazard markings on the generator.

WARNING! RISK OF EXPLOSION

- Stop generator before refueling.
- Check for spilled fuel.
- Do not operate near open flame.

WARNING! RISK OF ELECTRIC SHOCK

This generator produces high voltage

- Always ground properly before use.
- Do not connect to any building electrical system.
- Never use in rainy or wet conditions.
- Never touch bare wires or receptacles.
- Never allow children or non-qualified persons to operate.



WARNING

- This portable generator runs on gasoline. Constant direct exposure to exhaust fumes containing carbon monoxide is toxic and could be fatal.
- Go to fresh air immediately if you feel dizzy, weak, nauseous or have a headache.
- Never run a portable generator indoors including garages, basements, crawl spaces or any area without proper ventilation.
- When using a portable generator place outdoors in a dry area protected from rain, ice or snow. Place at least 30' from all activity.



IMPORTANT!
CONNECT GROUND TO EARTH BEFORE OPERATING.



OIL ALERT LAMP	HOURS METER	VOLT METER	
			
MODEL MP7500E			
RATED WATTAGE	7000W	RATED AMPERAGE	28A/8A
SURGE WATTAGE	7500W	RATED FREQUENCY	60Hz
RATED VOLTAGE	240V/120V	DC OUTPUT	12V
		PHASE	SINGLE



 CAUTION! HOT EXHAUST
 DO NOT TOUCH

 
CAUTION!
HIGH TEMPERATURE
DO NOT TOUCH







PACKAGE CONTENTS

Your generator comes with the items listed below. Please check to see that all of the following items are included with your generator.

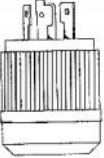
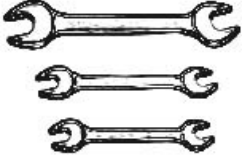
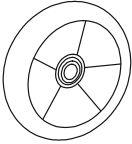

If you are missing components DO NOT RETURN TO STORE, please call (877) 968-3733 M-F 8-5 CT for customer service.

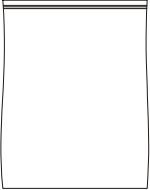
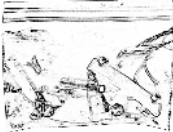
ITEM LIST

 <p>DC Cord</p>	 <p>Flat Head Screwdriver</p>	 <p>Rubber Foot (2 pcs)</p>
 <p>NEMA L14-30 plug</p>	 <p>Set of three wrenches for assembly</p>	 <p>Wheel (2 pcs)</p>
 <p>Instruction manual</p>	 <p>Vinyl Tool Pouch</p>	 <p>Wheel kit hardware</p>
 <p>Spark plug wrench</p>	 <p>Handle (2 pcs)</p>	

GENERATOR COMPONENTS

Please familiarize yourself with the locations and functions of the various components and controls of your generator.

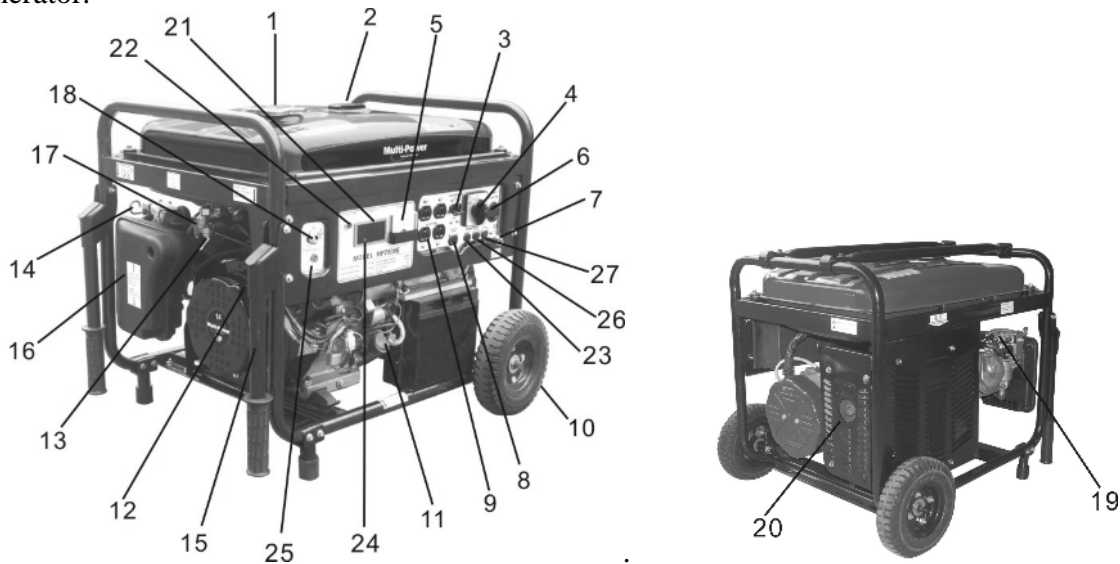

- (1) **Fuel Cap**- Access to the fuel tank for adding fuel.
- (2) **Fuel Gauge**- Indicates the amount of fuel in the tank.
- (3) **Circuit Breaker**- Set switch that protect the generator from electrical overload.
- (4) **Voltage Selector**-To switch between 120 and 240 Volt output.
- (5) **Voltage Meter** -Indicate output voltage.
- (6) **240/120 Volt AC Receptacle**- To connect electrical devices that run 120 and/or 240 Volt, 60 Hz, single phase, AC current.
- (7) **Ground Terminal**- Connect grounding wires here to properly ground unit.
- (8) **DC Output Receptacle**- For charging 12 V , 8.3A batteries
- (9) **120 Volt AC Duplex Receptacle**- To connect electrical devices that run 120 Volt, 60 Hz, single phase, AC current.
- (10) **Wheels**- For easy transport.
- (11) **Oil Fill and Dipstick**- Location for checking and filling engine oil.
- (12) **Recoil Starter**- Pull-cord for starting engine manually.
- (13) **Fuel Filter Cup**- Traps dirt and water from fuel before it enters the engine

- (14) **Choke Lever**- Adjusts the amount of air let into the engine.
- (15) **Handles**- For easy transport.
- (16) **Air Cleaner**- a removable, cleanable, sponge-like element that limits the amount of dirt pulled into the engine.
- (17) **Fuel Valve**- Allows fuel to enter engine.
- (18) **Engine Switch**- Used to start/stop engine.
- (19) **Spark Plug**- Provides proper engine ignition.
- (20) **Muffler**- Reduces engine noise.
- (21) **Hours Meter**- showing running time /Frequency/ oil adding reminder
- (22) **Low Oil Alert** - Red lights that turn on to indicate oil adding.
- (23) **Control Panel Fuse** - Protect DC output circuit.
- (24) **Hours Meter Reset Button** - To switch among running times,frequency and oil change reading.
- (25) **DC Circuit Reset Buttons**-Protect starting circuit.
- (26) **Fuel Control Solenoid** -for preventing fuel flow into engine after engine stops
- (27) **The Battery Charger Fuse** -Protecting DC charge circuit.

ASSEMBLY

In order to best protect the generator while in the package, this product comes with some components disassembled. Please complete the following assembly steps before proceeding to use the generator. For ease of assembly, we recommend attaching the components in the order listed in this manual.

If after reading this section, you are unsure about how to perform any of the steps, please call (877)968-3733 M-F 8-5 CT for customer service.

⚠ WARNING: This generator is heavy. Some assembly procedures may require two people.

Attach Feet

To attach the feet to the generator, perform the following steps:

1. Stack the two generator wheels on top of each other. Lift the end of the generator that has the recoil starter onto the stack of wheels (see figure 1). Be careful not to obstruct any holes on the generator.
2. Place one leg onto the frame as shown in figure 2. Line up the holes on the generator frame with the holes on the bracket portion of the leg. Tighten using two M6x40 bolts, two M6 nuts, and the included wrench.
3. Repeat step 2 for the other generator leg.



Figure 1- Stacking the wheels

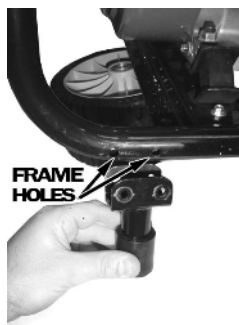

a



b

Figure 2- foot assembly

Attach Handles

The handles attach to the same end of the generator as the feet. To attach the handles to the generator, perform the following steps:

1. The handle assembly consists of the handle, bolt, two bushings, and a nut as shown in figure 3.

The new generator comes with the bolt, bushings, and nut attached to the frame. To attach the handle, first remove these pieces from the frame.

2. Place one bushing into each hole of the handle bracket. The head (large part) of the bushing should be on the inside of the bracket.
3. Line up the holes on the handle bracket, with bushings attached, the holes on the generator frame.
4. Secure the handle to the frame using the bolt and nut. Make this attachment so that the nut is on the inside of the frame.
5. Repeat steps 1-4 for the other handle.

At this point, gently remove the two wheels from underneath the generator.

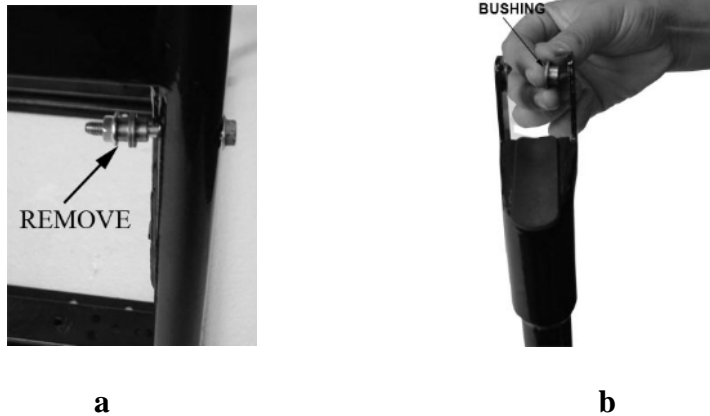

Figure 3- handle assembly

Attach Wheels

To attach the wheels to the generator, perform the following steps:

1. Find a wood block or similar item that is 3 inches thick or greater and rest the exhaust end of the generator on the block as shown in figure 4.
2. Take one wheel shaft, one spacer, and one M12 nut as shown. Place the spacer between the two holes on the frame bracket. Slide the wheel shaft, with the threaded part facing inward, through the frame and spacer. Secure using an M12 nut and the included wrench as shown in figure 5.
3. Slide the wheel onto the axle and secure in place using a large cotter pin as shown in figure 6. Spread the pin legs apart slightly to help secure the pin in place.
4. Repeat steps 2 and 3 for the other wheel.

At this point, the generator assembly is complete. Gently remove the generator from the wood block.



Figure 4- supporting the generator

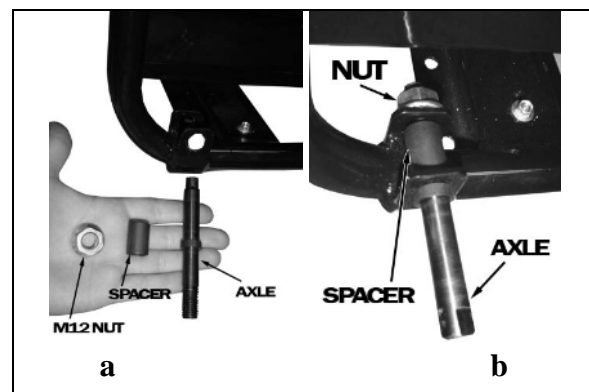
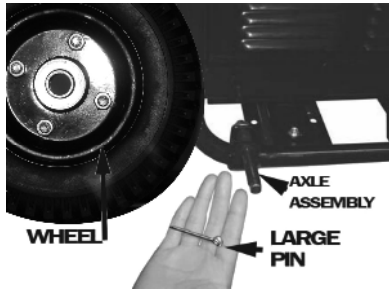
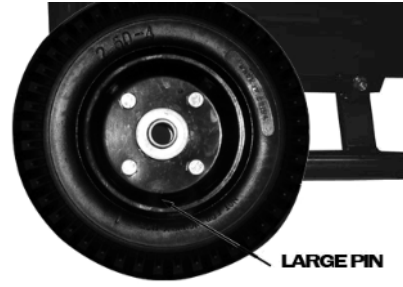

Figure 5 - axle assembly



a

Figure 6- wheel installation



b

PREPARING THE GENERATOR FOR USE

Using the Generator for the First Time



The following section describes steps you must follow to prepare your generator for first-time use. If after reading this section, you are unsure about how to perform any of the steps please call (877) 968-3733 M-F 8-5 CT for customer service. Failure to perform these steps properly can damage your generator or shorten its life.

If you are using the generator for the first time, there are a few steps you must take to prepare it for operation:

Step 1- Add oil

The generator requires engine oil to operate properly. The generator, when new from the package, contains *no* oil in the crankcase. You must add the proper amount of oil before operating the generator for the first time. This amount, which is equal to the oil capacity of the engine crankcase, can be found on the chart in figure 6. When filling the engine with oil in the future, please refer to this chart.

Figure 6- Generator Oil Capacity

Model number	MP3501	MP3502	MP5500DF	MP6000E	MP7500E
Engine oil capacity	20 fluid oz.	20 fluid oz.	37 fluid oz	37 fluid oz.	37 fluid oz.

For general use, we recommend SAE 10W/30 oil to fill the engine crankcase.

To add oil, follow these steps:

1. Make sure the generator is on a level surface.
2. Unscrew the oil filler/dipstick cap from the engine as shown in figure 7.
3. Using a funnel, add the appropriate amount of oil, as found in figure 6, into the crankcase.

NOTE: Even if you have measured out the appropriate amount of oil, some spillage is common when filling. You will know the crankcase is full when the oil level has reached the lower lip of the opening you have just poured the oil into (see figure 7).

4. Replace oil filler cap.

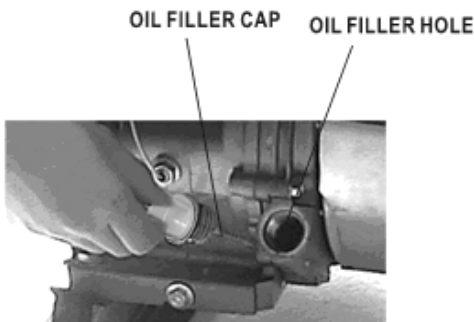

Figure 7- Unscrewing the oil cap



Figure 8- Adding oil

Step 2- Add Gasoline

⚠ WARNING: Gasoline and gas fumes are highly flammable.

- Do not fill tank near an open flame.
- Do not overfill. Always check for fuel spills.

To ensure that the generator runs smoothly use only FRESH, UNLEADED GAS WITH AN OCTANE RATING OF 87 OR HIGHER. To add gasoline:

1. Make sure the generator is on a level surface.
2. Unscrew gas cap and set aside (NOTE: the gas cap may be tight and hard to unscrew).
3. Slowly add unleaded gasoline to the fuel tank. Be careful not to overfill. Please refer to the chart in figure 9 to find the gas capacity of your generator model. The fuel gauge on the top of the generator indicates how much gasoline is in the generator gas tank. NOTE: Gas can expand. Do not fill the gas tank to the very top.
4. Replace fuel cap and wipe up any spilled gasoline with a dry cloth.

IMPORTANT:

- Never use an oil/gasoline mixture.
- Never use old gas.
- Avoid letting dirt or water into the fuel tank.
- Gas can age in the tank and make it hard to start up the generator in the future. Never store generator for extended periods of time with fuel in the tank.

Figure 9- Gas Tank Capacity

Model number	MP3501	MP3502	MP5500DF	MP6000E	MP7500E
Gas tank capacity	3.6L (0.95gallons)	15 L (3.96gallons)	25L (6.60gallons)	25L (6.60gallons)	25L (6.60gallons)

Step 3- Ground the Generator

⚠ WARNING: Failure to properly ground the generator can result in electrocution.

Ground the generator by tightening the grounding nut against a grounding wire (see figure 10). A generally acceptable grounding wire is a No. 12 AWG (American Wire Gauge) stranded copper wire. This grounding wire should be connected at the other end to a copper or brass grounding rod that is driven into the earth.

Grounding codes can vary by location. Please contact a local electrician to check the grounding regulations for your area.

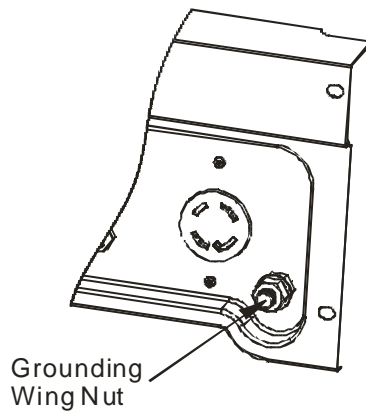

Figure 10- Grounding nut location

Subsequent Use of the Generator

If this is not your first time using the generator there are still steps you should take to prepare it for operation.

IMPORTANT: At this point you should be familiar with the procedures described in the first portion of this section entitled “Using the Generator for the First Time.” If you have not yet read this section, go back and read it now.

Step 1- Check the Oil

The generator is equipped with an automatic shutoff to protect it from damage due to low oil. Nonetheless, you should check the oil level of the engine before each use to ensure that the engine crankcase has a sufficient amount. To check the oil level:

1. Make sure the generator is on a level surface.
2. Unscrew the oil filler/dipstick cap.
3. With a dry cloth, wipe the oil off of the stick on the inside of the cap.
4. Insert the dipstick as if you were replacing the cap and then remove again. There should now be oil on the stick. If there is no oil on the stick, or oil only at the very end of the stick, you should add oil until the engine crankcase is filled (see “Changing/Adding Oil” portion of the “Maintenance” section).
5. Be sure to replace cap when finished checking oil.

NOTE: The oil capacity for your generator can be found in the “Specifications” section of this manual

Step 2 – Check the Gas Level

Before starting the generator, check to see that there is sufficient gasoline in the gas tank. The fuel gauge on top of the generator will indicate the gas level in the tank. Add gas if necessary according to the steps in the “Adding Gasoline” portion of the “Maintenance” section.

⚠ WARNING: Gasoline and gasoline fumes are highly flammable.

- **Do not fill tank near an open flame.**
- **Always allow engine to cool for several minutes before refueling.**
- **Do not overfill (check the “Specifications” section for the tank capacity of your generator). Always check for fuel spills.**

IMPORTANT:

- Use only UNLEADED gasoline with an octane rating of 87 or higher.
- Do not use old gas.
- Never use an oil/gasoline mixture.
- Avoid letting dirt or water into the fuel tank.
- Never store generator for extended periods of time with fuel in the tank.

Step 3- Ground the Generator

⚠ WARNING: Failure to properly ground the generator can result in electrocution.

Ground the generator by tightening the grounding nut against a grounding wire (see figure 11). A generally acceptable grounding wire is a No. 12 AWG (American Wire Gauge) stranded copper wire. This grounding wire should be connected at the other end to a copper or brass grounding rod that is driven into the earth.

Grounding codes can vary by location. Please contact a local electrician to check the grounding regulations for your area.

STARTING THE GENERATOR



Before starting the generator, make sure you have read and performed the steps in the “Preparing the Generator for Use” section of this manual. If you are unsure about how to perform any of the steps in this manual please call (877) 968-3733 M-F 8-5 CT for customer service.

⚠ CAUTION: Disconnect all electrical loads from the generator before attempting to start.

To start your generator, perform the following steps:

1. Make sure no electrical devices are connected to the generator. Such devices can make it difficult for the engine to start.
2. Check that the generator is properly grounded (see “Ground the Generator”).
3. Turn the fuel valve to the “on” position (see figure 11).
4. Move the choke lever to the “closed” position (see figure 13).
5. Turn on the key switch to “start” position, not more than 15 seconds for every time, if succeed, release the key, if fail, have a second try in the same way. (see figure 12)
6. If the engine doesn’t work when you start with key, please try to start with recoil starter. (see figure 12)
7. Pull on the recoil starter handle slowly until a slight resistance is felt (see figure 12). Then pull quickly to start the engine. Return cord gently into the machine. Never allow the cord to snap back.
8. If engine fails to start, repeat step 6. NOTE: After repeated failed attempts to start the engine, please consult the troubleshooting guide before attempting again. If problems persist please call **(877) 968-3733** M-F 8-5 CT.
9. Once the engine has started, move the choke lever about half way towards the “open” position. Wait 30 seconds and then move the choke lever all the way to the “open” position.
10. Allow the generator to run for several minutes before attempting to connect any electrical devices.

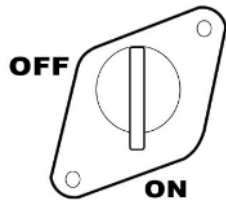

Figure 11- Fuel Valve in the “on” position

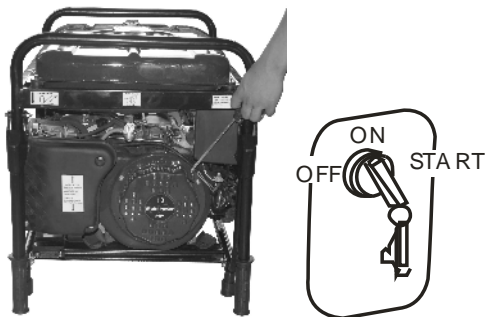

Figure 12- Start the generator

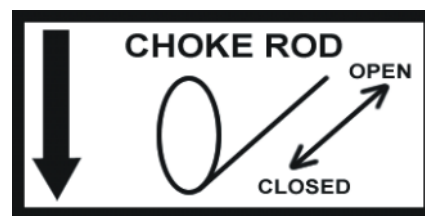

Figure 13- Pull choke out for closed position.
Push in for open position.

USING THE GENERATOR

Once you have allowed the engine to run for several minutes, you may connect electrical devices to the generator.

AC Usage

CAUTION: Please familiarize yourself with the markings on the panel before connecting electrical devices.

You may connect electrical devices running on AC current according to their wattage requirements. The chart in figure 14 shows the rated and surge wattage of your generator according to its model number.

CAUTION: Although the overall rated wattage of the machine is 7000 Watts, you never attempt to draw more than 2400 Watts(20 A) from any ONE of the 120 Volt receptacles.

The *rated wattage* corresponds to the maximum wattage the generator can output on a continuous basis.

The *surge wattage* corresponds to the maximum amount of power the generator can output for a short period of time. Many electrical devices such as refrigerators require short bursts of extra power, in addition to the rated wattage listed by the device, to stop and start their motors. The surge wattage ability of the generator covers this extra power requirement.

Model Number	Rated(Running) Wattage	Surge Wattage
MP3501	3000	3500
MP3502	3000	3500
MP5500DF	5000	5500
MP6000E	5500	6000
MP7500E	7000	7500

Figure1 4- generator wattage by model number.

The total running wattage requirement of the electrical devices connected to the generator should not exceed the rated wattage of the generator itself. To calculate the total wattage requirement of the electrical devices you wish to connect, find the rated (or running) wattage of each device. This number should be listed somewhere on the device or in its instruction manual. If you cannot find this wattage, you may calculate it by multiplying the Voltage requirement by the Amperage drawn:

$$\text{Watts} = \text{Volts} \times \text{Amperes}$$

If these specifications are not available, you may estimate the Watts required by your device using the chart in figure 15.

Once you have found the rated wattage requirement of each electrical device, add these numbers to find the total rated wattage you wish to draw from the generator. If this number exceeds the rated wattage of the generator, **DO NOT** connect all these devices. Select a combination of electrical devices, which has a total rated wattage lower than or equal to the rated wattage of the generator.

CAUTION- The generator can run at its surge wattage capacity for only a short time. Connect electrical devices requiring a rated (running) wattage equal to or less than the rated wattage of

the generator. Never connect devices requiring a rated wattage equal to the surge wattage of the generator.

tool or appliance	rated (running) Watts	additional surge Watts
electric water heater (40 gal)	4000	0
hot plate	2500	0
saw- radial arm	2000	2000
electric stove	1500	0
saw- circular	1500	1500
air compressor (1 HP)	1500	3000
window air conditioner	1200	1800
saw- miter	1200	1200
microwave	1000	0
well water pump	1000	1000
reciprocating saw	960	1040
sump pump	800	1200
refrigerator freezer	800	1200
furnace blower	800	1300
computer	800	0
electric drill	600	900
television	500	0
deep freezer	500	500
garage door opener	480	0
stereo	400	0
box fan	300	600
clock radio	300	0
security system	180	0
DVD player/ VCR	100	0
common light bulb	75	0

NOTE: The above wattage figures are estimates. Try to check the wattage listed on your electrical device before consulting this chart.

Figure 15- Estimated wattage requirements of common electrical devices.

Once you have determined what electrical devices you will be powering with the generator, connect these devices according to the following procedure:

1. Plug in each electrical device with the device turned off. **NOTE:** Be sure to attach appliances to the correct receptacle (outlet). Connect standard 120 Volt, single phase, 60 Hz loads **only** to the 120 Volt receptacles. Connect 240/120 Volt, single phase, 60Hz loads with a NEMA L14 -30 plug **only** to the 240/120 Volt receptacle See Figure 16 for a depiction of each of these receptacles.
2. Push the circuit breaker to the “on” position .
3. Move the voltage selector to the desired position. Move the switch to the left to use the standard 120 Volt receptacles. Move the switch to the right to use the 240/120 Volt NEMA receptacle.
4. The voltage meter will indicate accordingly as the Volt Selector is selected. It works when the receptacles receive power. In the case of the 240/120 Volt receptacle, it will indicate 240V \pm 20V. In the case of the 120/120 Volt receptacle, it indicates 120V \pm 10V.If the voltage meter does not indicate accordingly or indicate wrong, call our customer service number for instructions.

CAUTION: Do not connect 50Hz or 3-phase loads to the generator .



Figure 16- Receptacles available on the generator

CIRCUIT BREAKER

The circuit breakers help to prevent the generator from electrical overload. If your receptacle short circuits or becomes overloaded by an electrical device or devices with too great a wattage rating, the circuit protector may shut off power to the receptacle. If this happens, you will see the voltage meter changing from having voltage output to no voltage, and you will not be able to draw power from the overloaded receptacle. In the event of such an overload, disconnect all electrical devices from the generator and press the circuit breaker to “ON” position. If power still does not return to the receptacle, call our customer service line.

ATUOMATIC IDLE REDUCTION

When load $\geq 100W(0.83A)$, the generator will run from automatic idle reduction state to normal running state. The transition will be finished within 20 seconds.

When load $\leq 60W(0.5A)$, the generator may run from normal running state to automatic idle reduction state. The transition will be finished within 30 seconds.

SOME NOTES ABOUT POWER CORDS

Long or thin cords can drain the power provided to an electrical device by the generator. When using such cords, allow for a slightly higher rated wattage requirement by the electrical device. See Figure 17 for recommended cords based on the power requirement of the electrical device.

Device Requirements			Max. Cord Length (ft) by Wire Gauge				
Amps	Watts (120V)	Watts (240 V)	#8 wire	#10 wire	#12 wire	#14 wire	#16 wire
2.5	300	600	NR	1000	600	375	250
5	600	1200	NR	500	300	200	125
7.5	900	1800	NR	350	200	125	100
10	1200	2400	NR	250	150	100	50
15	1800	3600	NR	150	100	65	NR
20	2400	4800	175	125	75	50	NR
25	3000	6000	150	100	60	NR	NR
30	3600	7200	125	65	NR	NR	NR
40	4800	9600	90	NR	NR	NR	NR

*NR= not recommended

Figure 17- Maximum Extension Cord Lengths by Power Requirement

DC Usage

CAUTION: The DC receptacle is for charging 12 Volt 8.3A batteries ONLY. Do not connect any other device to this receptacle.

CAUTION: Only charge batteries when they are removed from the automobile. Never try to “jumpstart” a car using the generator.

To connect 12 Volt batteries to the DC receptacle:

1. Connect the positive end of charging wire to the positive terminal on the battery.
2. Connect the other end of charging wire to the negative terminal on the battery.
3. Start the generator.
4. Carefully connect the plug of charging wire to V shape DC receptacle on the generator.

STOPPING THE GENERATOR

To stop the generator:

1. Turn off, then unplug all connected electrical devices.
2. Allow the generator to run for several more minutes with no electrical devices connected. This helps stabilize the temperature of the generator.
3. Set the engine switch to the “off” position.
4. Turn the fuel valve to the “off” position.

⚠ WARNING: Allow the generator to cool for several minutes before touching areas that become hot during use.

CAUTION: Allowing gas to sit in the generator tank for long periods of time without use can make it difficult to start the generator in the future. Never store generator for extended periods of time with fuel in the tank.

MAINTENANCE / CARE

Proper routine maintenance of your generator will help prolong the life of your machine. Please perform maintenance checks and operations according to the schedule in figure 18.



If you have questions about any of the maintenance procedures listed in this manual, please call **(877) 968-3733** M-F 8-5 CT

CAUTION: Never perform maintenance operations while the generator is running.

Recommended Maintenance Schedule

		each use	first month then every 20 hrs	every 3 months or 50 hrs	every 6 months or 100 hrs	every year or 300 hrs
Engine oil	check level	x				
	replace		x	x		
Air cleaner	check	x				
	clean			x		
Fuel filter cup	clean				x	
Spark plug	check/ clean				x	
Gas tank	check gas level	x				
	clean					x

Figure 18- Recommended maintenance schedule

Cleaning the Generator

Always try to use your generator in a cool dry place. In the event the generator becomes dirty, clean the exterior with one or more of the following:

- a damp cloth
- a soft brush
- a vacuum
- pressurized air

Never clean the generator with a bucket of water or a hose. Water can get inside the working parts of the generator and cause a short circuit or corrosion.

Checking the Oil

The generator is equipped with an automatic shutoff and low oil indicator to protect it from running on low oil. Nonetheless, you should check the oil level of the generator before each use to ensure that the generator crankcase has a sufficient amount. To check the oil level:

1. Make sure the generator is on a level surface.
2. Unscrew the oil filler/dipstick cap (see figure 19).
3. With a dry cloth, wipe the oil off of the stick on the inside of the cap.
4. Insert the dipstick as if you were replacing the cap and then remove again. There should now be oil on the stick. If there is no oil on the stick, or oil only at the very end of the stick, you should add oil until the engine crankcase is filled. See "Changing/ Adding Oil" in this section.
5. Be sure to replace cap when finished checking oil.

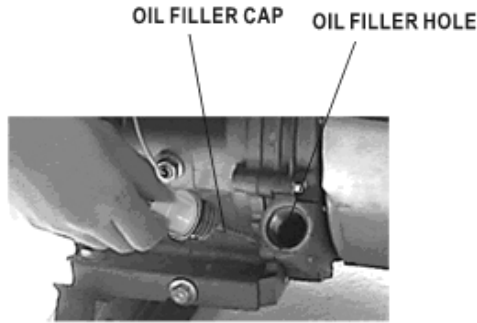

Figure 19- Checking the oil

Changing/ Adding Oil

You should check the oil level of the generator according to the maintenance schedule in figure 19. When the oil level is low you will need to add oil until the level is sufficient to run the generator. The oil capacity of your generator engine is listed in figure 20.

Model Number	MP3501	MP3502	MP5500DF	MP6000E	MP7500E
Engine oil capacity	20 fluid oz.	20 fluid oz.	37 fluid oz	37 fluid oz	37 fluid oz.

Figure 20- Engine Oil Capacity.

It is necessary to drain the oil from the crankcase every 3 months or Hours Meter shows “OFF”, or if it has become contaminated with water or dirt. Drain the oil from the generator according to the following steps:

1. Place a bucket underneath the generator to catch oil as it drains.
2. Using a 10 mm hex wrench, unscrew the oil drain plug, which is located on the crankcase underneath the oil filler/dipstick cap (see figure 21). Allow all the oil to drain from the generator.
3. Replace the oil drain plug and tighten with a 10 mm hex wrench.

To add oil to the crankcase, follow these steps:

1. Make sure the generator is on a level surface.
2. Unscrew the oil filler/dipstick cap from the engine as shown in figure 20 above.
3. Using a funnel, add high detergent motor oil to the crankcase. We recommend SAE 10W/30 motor oil for general use. When full, the oil level should come close to the top of the oil fill opening (see figure 22).

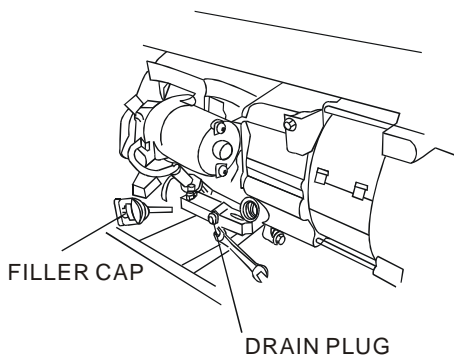

Figure 21- Draining oil



Figure 22- Adding oil

NOTE: Never dispose of used motor oil in the trash or down a drain. Please call your local recycling center or auto garage to arrange oil disposal.

Air Cleaner Maintenance

Routine maintenance of the air cleaner helps maintain proper air flow to the carburetor. Check that the air cleaner is free of excessive dirt.

1. Unhinge the clasps at the top and bottom of the air cleaner cover (see figure 2 3).
2. Remove the sponge-like elements from the casing.
3. Wipe the dirt from inside the empty air cleaner casing
4. Wash the sponge-like elements in household detergent and warm water. Allow to dry.
5. Replace the sponge-like elements in the air cleaner casing and replace the cover.



Figure 23- Removing the air cleaner casing.

Fuel Filter Cup Cleaning

The fuel filter cup is a small well underneath the fuel valve. It helps to trap dirt and water that may be in the fuel tank before it can enter the engine. To clean the fuel filter cup:

1. Turn the fuel valve to the “off” position.
2. Unscrew the fuel filter cup from the fuel valve using a wrench. Turn the valve toward you to unscrew (see figure 24).
3. Clean the cup of all sediment using a rag or brush.
4. Reinstall the fuel filter cup.

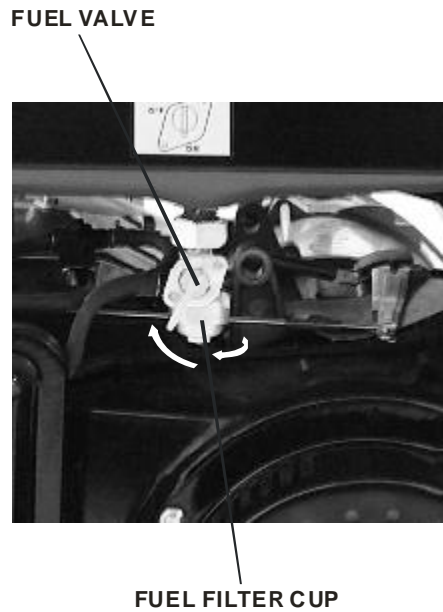

Figure 24- Removing the Fuel Filter Cup

Spark Plug Maintenance

The spark plug is important for proper engine operation. A good spark plug should be intact, free of deposits, and properly gapped. To inspect the spark plug:

1. Pull on the spark plug cap to remove it.
2. Unscrew the spark plug from the generator using the spark plug wrench included with this product (see figure 25).
3. Visually inspect the spark plug. If it is cracked or chipped, discard and replace with a new spark plug.
4. Measure the plug gap with a gauge (see figure 2 6). The gap should be 0.7-0.8mm (0.028-0.031in).
5. If you are re-using the spark plug, use a wire brush to clean any dirt from around the spark plug base and then re-gap the spark plug.
6. Screw the spark plug back into its place on the generator using the spark plug wrench. Place back the spark plug cap.

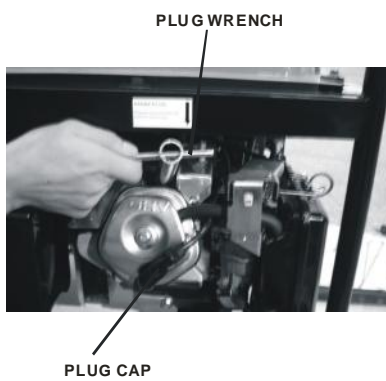

Figure 25- Removing the spark plug

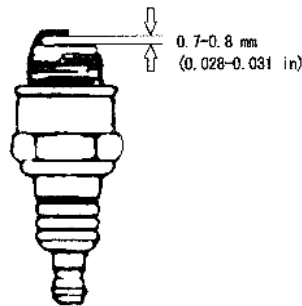

Figure 2 6- Measuring the spark plug gap

Emptying the Gas Tank

Before storing the generator for extended periods of time, you should drain the generator of gasoline. To drain the generator of gas:

1. Turn the fuel valve to the “off” position.
2. Remove the fuel filter cup (see “Fuel Filter Cup Cleaning” earlier in this section).
3. Empty the fuel filter cup of any fuel.
4. With a receptacle underneath the generator to catch the gas, turn the fuel valve to the “on” position. Drain all the gas from the generator.
5. Turn the fuel valve to the “off” position.
6. Replace the fuel filter cup.
7. Store the emptied gasoline in a suitable place.

⚠ CAUTION: Do not store fuel from one season to another.

STORAGE / TRANSPORT PROCEDURES

⚠ CAUTION: Never place any type of storage cover on the generator while it is still hot.

When transporting or storing the generator for extended periods of time:

- Empty the gas tank (see “Emptying the Gas Tank” in the “Maintenance” section).
- Disconnect the spark plug cap from the spark plug.
- Do not obstruct any ventilation openings.
- Keep the generator in a cool dry area.

SPECIFICATIONS

Generator

AC Output

	Model MP3501	Model MP3502	Model MP5500DF	Model MP6000E	Model MP7500E
Rated Wattage	3000 W	3000 W	5000 W	5500W	7000 W
Surge Wattage	3500 W	3500 W	5500 W	6000W	7500 W
Rated Voltage	120 V	240V/120V	240V/120V	240V/120V	240V/120V
Rated Amperage	25A	12.5A/25A	20.8A/41.6A	22.9A/45.8A	29A/58A
Rated Frequency	60 Hz	60 Hz	60 Hz	60 Hz	60 Hz
Phase	Single	Single	Single	Single	Single

DC Output

Voltage	12 V	12 V	12 V	12 V	12 V
Amperage	8.3 A	8.3 A	8.3 A	8.3 A	8.3 A

Dimensions(in):	length= 23 width=15.9 height= 16.3	length= 24 width= 17.7 height= 18.5	length= 27.6 width= 21.1 height= 22.1	length= 27.6 width= 21.1 height= 22.1	length= 27.6 width= 21.1 height= 22.1
Dry mass	77lbs	104 lbs	191lbs	191lbs	200lbs

Engine

	Model MP3501	Model MP3502	Model MP5500DF	Model MP6000E	Model MP7500E
Engine type	4-stroke OHV single cylinder with forced air cooling system				
Ignition system	non-contact transistor				
Displacement	196 cm ³	196 cm ³	389 cm ³	389 cm ³	420 cm ³
Fuel tank capacity:	3.6L (0.95 US gal)	15 L (3.96 US gal.)	25 L (6.60 US gal.)	25 L (6.60 US gal.)	25 L (6.60 US gal.)
Oil capacity	0.6 L (20 fl oz.)	0.6 L (20 fl oz.)	1.1 L (37 fl oz.)	1.1 L (37 fl oz.)	1.1 L (37 fl oz.)
Run time on 50% load	4hrs	15 hrs	12 hrs	11hrs	8hrs
Noise rating	69 dB	67dB	74dB	74dB	75 dB

TROUBLESHOOTING

IMPORTANT: If trouble persists please call our customer help line at **(877) 968-3733** M-F 8-5 Central Time.

Problem	Cause	Solution
Engine will not start	Engine switch is set to "off".	Set engine switch to "on".
	Fuel valve is turned to "closed".	Turn fuel valve to "open" position.
	Choke is open.	Close the choke
	Engine is out of gas.	Add gas.
	Engine is filled with contaminated or old gas	Change the gas in the engine.
	Spark plug is dirty.	Clean spark plug.
	Spark plug is broken.	Replace spark plug.
	Generator is not on level surface.	Move generator to a level surface to prevent low oil shutdown from triggering.
	Oil is low	Add or replace oil.
Engine runs but there is no electrical output	Circuit Breaker button is off.	Wait for 2 minutes and push the circuit breaker to the "on" position.
	Bad connecting wires/cables.	If you are using an extension cord, try a different one.
	Bad electrical device connected to generator.	Try connecting a different device.
Generator runs but does not support all electrical devices connected.	Generator is overloaded	Perform these steps: 1. Turn off all electrical devices. 2. Unplug all electrical devices. 3. Turn off generator. 4. Wait several minutes. 5. Restart generator. 6. Try connecting fewer electrical loads to the generator.
	Short in one of the connected devices.	Try disconnecting any faulty or short-circuited electrical loads.
	Air cleaner is dirty.	Clean or replace air cleaner.

EXPLODED VIEW AND PARTS LIST

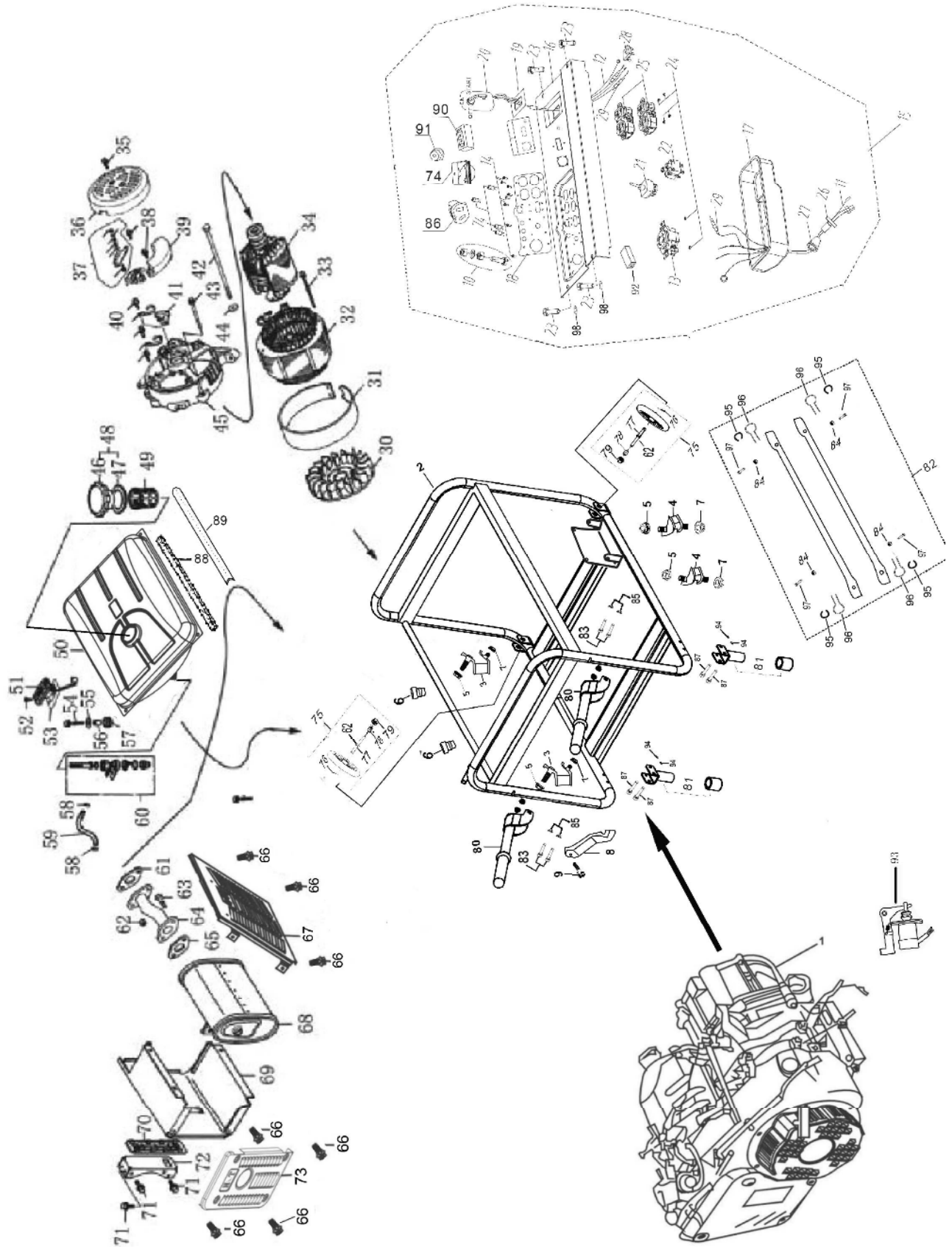

PARTS LIST

Item	Description	Qty	Item	Description	Qty
1	13hp gasoline engine	1	50	Gas tank	1
2	Tubular frame	1	51	Fuel gauge	1
3	Left rubber damper	2	52	Screw M5×10	2
4	Right rubber damper	2	53	Gasket	1
5	Nut M10	4	54	Bolt M6×25	4
6	Rubber frame pad	2	55	Upper tank damper	4
7	Nut M8	4	56	Bolt spacer	4
8	Air cleaner bracket	1	57	Lower tank damper	4
9	M6×14 screw	1	58	Fuel line clip	2
10	Earth terminal set	1	59	Fuel line $\phi 9 \times \phi 4.5 \times 170$	1
11	Wire harness Assy	1	60	Fuel valve assembly	1
12	Switch wire	1	61	Exhaust pipe gasket	1
13	Consent(30A)	1	62	Black gasket	2
14	Bolt M4×10	6	63	8mm nut	2
15	Control panel Assy	1	64	Exhaust pipe	1
16	Control panel	1	65	Exhaust pipe gasket	1
17	Control panel case	1	66	6×10 bolt	8
18	Panel switch mark,RH	1	67	Muffler guard	1
19	Panel switch mark,LH	1	68	Muffler	1
20	Ignition switch	1	69	Muffler shroud	1
21	Voltage Selector	1	70	Rubber seal	1
22	Circuit breaker(21A)	2	71	Bolt M8×16	4
23	Circuit bolt M6×25	4	72	Metal bracket	1
24	Nut M4	6	73	Muffler side cover	1
25	Duplex Receptacle	2	74	Voltage Meter	1
26	Boot, AC output wire	4	75	Wheel	2
27	Boot,main wire harness	1	76	Collar Pin	2
28	Diode Assy	2	77	Wheel Shaft	2
29	Fuse	2	78	Spacer	2
30	Generator fan	1	79	Flange Nut	2
31	Stator cover	1	80	Handle	2
32	Stator assy	1	81	Rubber Foot	2
33	Bolt M5×198	2	82	Protecting bar	2
34	Rotor	1	83	Bolt M6X50	2
35	Screw M5×12	2	84	Bolt	4
36	End cover	1	85	Nut M6	2
37	Voltage change Terminal	1	86	12V DC Receptacle	1
38	Screw M5×16	2	87	Bolt M6X40	4
39	Capacitor assembly	1	88	Stripe, fuel tank	1
40	Cable tie	1	89	Decorating Stripe, fuel tank	1
41	Brush assembly	1	90	Hours Meter	1
42	Bolt M10×250	1	91	Low Oil Alert	1
43	Bolt M6×160	4	92	Current sensor inductors, idle speed	1
44	Washer	1	93	Electromagnetic valve	1
45	Housing	1	94	Nut M6	4
46	Gas cap	1	95	Cushion	4
47	Gas cap washer	1	96	Lock,protecting bar	4
48	Gas cap assembly	1	97	Bolt M8X25	4

Item	Description	Qty	Item	Description	Qty
49	Fuel tank filter	1	98	Gasket,control pannel	4

EXPLODED VIEW FOR ENGINE

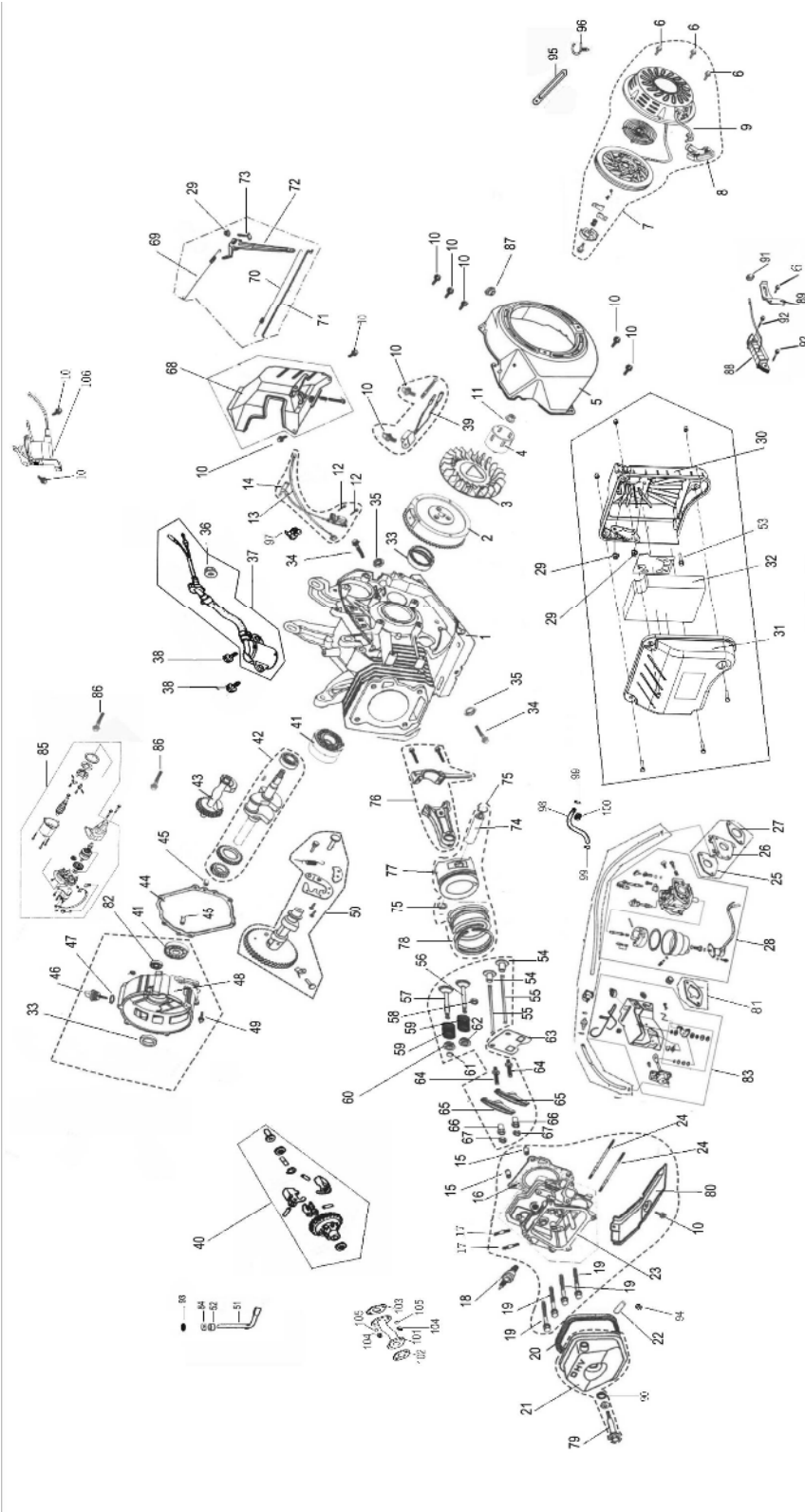

ENGINE PARTS LIST

NO.	Description	Qty	NO.	Description	Qty
1	Crankcase body	1	29	M6 Nut	3
2	Flywheel assembly	1	30	Air filter base	1
3	Cooling Fan	1	31	Air filter cover	1
4	Starting Cup	1	32	Air filter core assembly	1
5	Fan cover	1	33	Sealing washer	2
6	M6X10 Bolt	4	34	Bolt	2
7	Recoil starter cover	1	35	Washer	2
8	Handle	1	36	Nut	1
9	Recoil starting cord	1	37	Oil sensor	1
10	M6X12 Bolt	12	38	M6X16 Bolt	2
11	M16X1.5 Nut	1	39	Oil alert	1
12	M6X25 Bolt	2	40	Regulating gear assembly	1
13	Choke cord	1	41	Bearing 6207	2
14	Ignition winding assembly	1	42	Crankshaft assembly	1
15	12*20 Pin	2	43	Balance shaft	1
16	Cylinder gasket	1	44	Crankcase cover gasket	1
17	M8X35 Bolt	2	45	8X14 Pin	2
18	Spark plug F7TC	1	46	Oil dipstick	1
19	M10X80 Bolt	4	47	Seal	1
20	Cylinder cap gasket	1	48	Crankcase cover	1
21	Cylinder cap assembly	1	49	M8X40 Bolt	7
22	Exhaust air duct	1	50	Camshaft assembly	1
23	Cylinder head assembly	1	51	Regulating swing rod	1
24	M8/M6X110 Bolt	2	52	Sealing washer	1
25	Intake gasket	1	53	M5X16 Bolt	1
26	Heat insulation plate	1	54	Tappet	2
27	Carburetor washer	1	55	Handspike	2
28	Carburetor assembly	1	56	Intake valve	1
57	Exhaust valve	1	82	Bearing 6202	1
58	Oil baffle	1	83	Check valve assembly	1
59	Spring	2	84	Washer	1
60	Spring base	1	85	Starting Motor	1
61	Rotor	1	86	M8X32 Bolt	2
62	Spring base	1	87	Rubber plug	1
63	Handspike guider	1	88	Charge winding	1
64	Bolt	2	89	Latch	1
65	Rocker	2	90	Washer	1
66	Rocker shaft	2	91	Rubber bushing	1
67	Adjusting nut	2	92	M6X30 Bolt	2
68	Regulating bracket assembly	1	93	B-spring	1
69	Restoring spring	1	94	O-ring	1
70	Spring	1	95	Wire lock	1
71	Regulating pull rod	1	96	Plastic lock	1
72	Regulating arm	1	97	Wire lock	1
73	T-Bolt	1	98	Fuel pipe	1
74	Piston pin	1	99	Duct lock	1
75	Locking washer	2	100	Lock bushing	1
76	Connecting rod assembly	1	101	Exhaust pipe	1

NO.	Description	Qty	NO.	Description	Qty
77	Piston	1	102	Muffle washer	1
78	Piston ring assembly	1	103	Exhaust washer	1
79	M6X60 Bolt assembly	1	104	M8 Nut	2
80	Lower air baffle	1	105	Spring washer	2
81	Air filter gasket	1	106	Regulating electromagnetic valve	1

WIRING DIAGRAM

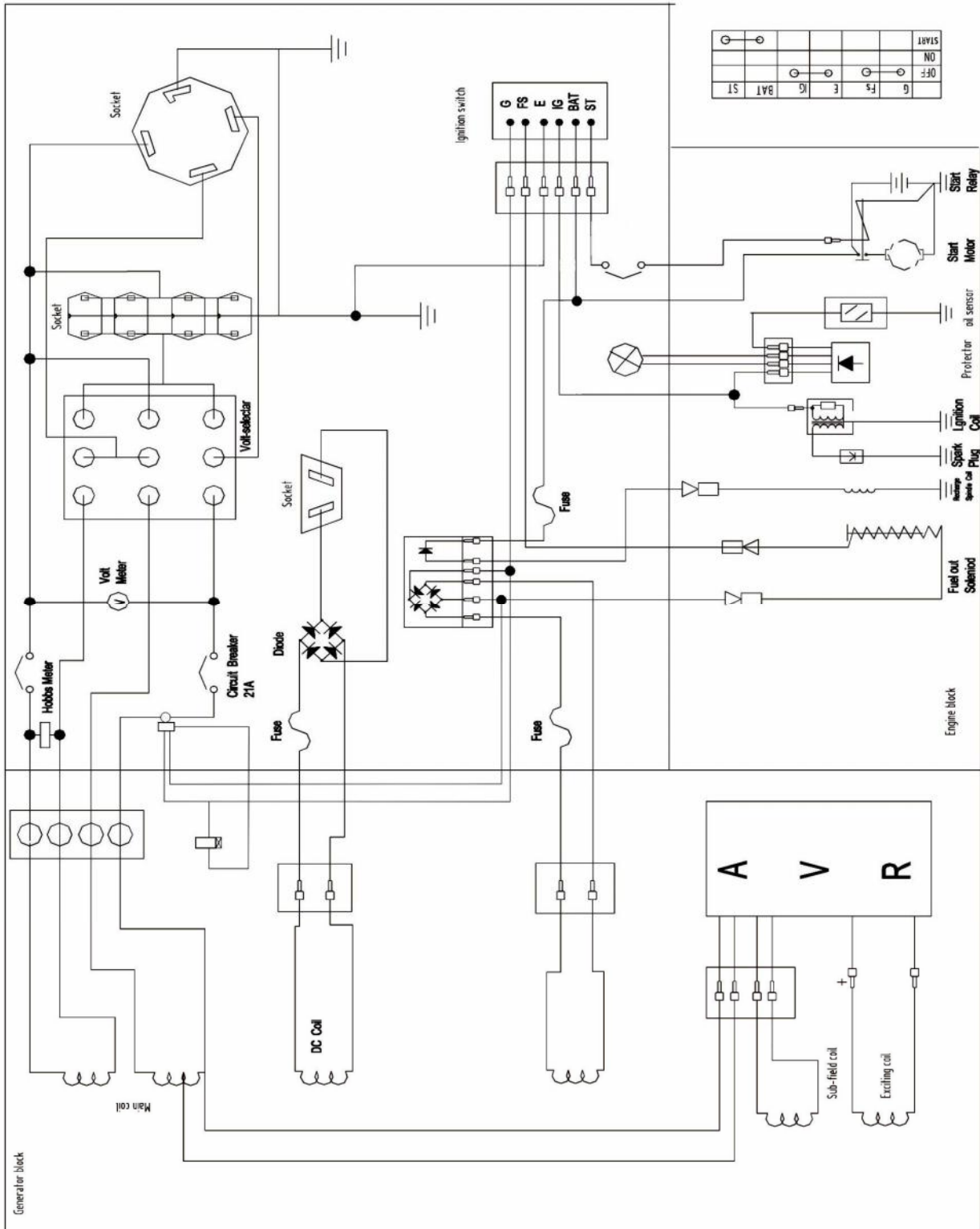

LIMITED WARRANTY FOR MULTI-POWER GENERATORS

Remember to save your receipt and to accurately fill out and mail your product registration card. You must provide proof of purchase for all warranty work.

Multi-Power generators are warranted to be free from defects in materials and workmanship for a period of one (1) year from date of original purchase. Generators used for Commercial or Rental use have a warranty period of 90 days from date of original purchase. Keep purchase receipt and mail in the product registration card for proof of purchase.

Multi-Power will repair or replace, at its discretion, any part that is proven to be defective in materials or workmanship under normal use during the one (1) year warranty period. Warranty repairs or replacements will be made without charge for parts or labor. Parts replaced during warranty repairs will be considered as part of the original product and will have the same warranty period as the original product.

To exercise the warranty, **DO NOT RETURN TO RETAILER**. Instead, call the toll free Customer Service number: **(877) 968-3733** and you will be instructed on where to take the generator for warranty service. Take the generator and proof of purchase (your receipt) to the repair facility recommended by the Customer Service Representative.

All transportation costs under warranty, including return to the factory if necessary, are to be borne by the purchaser and prepaid by the purchaser. The term "purchaser" means the person for whom the generator is originally purchased. This warranty is non-transferable.

The warranty does not extend to generators damaged or affected by fuel contamination, accidents, neglect, misuse, unauthorized alterations, use in an application for which the product was not designed and any other modifications or abuse.

Multi-Power is not liable for any indirect, incidental or consequential damages from the sale or use of this product. Any implied warranties are limited to one (1) year as stated in this written limited warranty. Some states do not allow the exclusion or limitation of incidental or consequential damages. Some states do not allow limitation on the length of an implied warranty. This warranty gives you specific legal rights, and you may have other rights that vary from state to state.