



IGNITION COMPONENTS

IGNITION • DISTRIBUTORS • COILS • POINTS CONVERSION

FUEL. AIR.

SPARK. TECHNOLOGY.



As you can see with the new FAST® Ignition Catalog, we are working hard to put a lot more **SPARK** into Fuel Air Spark Technology! We've always had the ability to control the spark and resulting RPM of your engine, but we're excited to announce that we're expanding the Spark component of FAST® with a full line of high performance ignition components.

For starters, FAST® now offers a full line of capacitive discharge, multi-striking ignition controls. These ignitions will deliver full power, high output sparks to ignite the fuel mixture delivered by carburetors or FAST® EFI systems. No matter how you use your car, street, strip or track, we have an E-series CD Ignition Control that will fire up your engine!

To complement the E-series of Ignition Controls, FAST® also offers a full line of performance coils, Race Billet Distributors, FireWire® Spark Plug Wires and a number of accessories. All of the FAST® ignition components are designed for use with our EFI systems (where a distributor is used) from the EZ-EFI® line to the XFI® Sportsman series.

When you're looking to finish off your engine's ignition system, you can now have the **SPARK** come from the company that does it all – Fuel Air Spark Technology – FAST®!

Ignition

E6 CD IGNITION

MADE
IN USA



306425
CARB EO# D-225-66

E6 CD Ignition

The FAST® E6 Capacitive Discharge Ignition will fire up your engine with high voltage, full power sparks from cranking to redline RPM. FAST® understands the goals and needs of a reliable, high energy spark and now offers an ignition designed for nearly any 4, 6, and 8-cylinder distributor triggered engine – carbureted or fuel injected.

The E6 is our base CD ignition, making it ideal for street rods, muscle cars and daily drivers. The ignition produces a series of sparks at lower RPM resulting in quick starts, smooths out the idle and helps with throttle transitions. This series of multi strikes burns in the cylinder for 20° of crankshaft rotation through 3,000 RPM. Higher RPM receives a full voltage spark that will improve the mid-range and higher RPM pull.

The E6 will easily connect to breaker points, amplifiers and the line of FAST® Billet Race and Pro Race Distributors (pages 21 and 23). It will also connect to the output of any FAST® EFI System. Each unit is built with modern surface-mount technology and then is secured and sealed in a sturdy, easy-to-mount housing.

- Full power, multi-strike CD ignition control designed for carbs and EFI
- Modern digital controller, transformer and capacitor for improved efficiency
- High energy sparks from idle to redline ensure complete combustion for increased power
- Completely encased in soft urethane for protection against moisture and vibration

E6 CD Ignition	306425
E6 CD Ignition & E92 Coil Kit (See Page 15 for Coil Specs)	306401

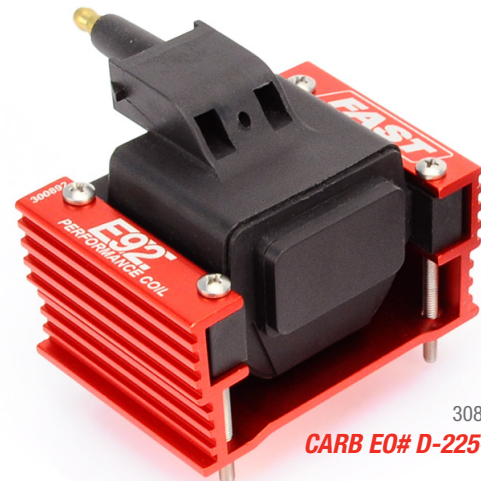

308250
CARB EO# D-225-60

SPECS

Operating Voltage:	6V-18V, Reverse Polarity Protected, Negative Ground Only
Current Draw:	7.0 Amps Max. at 10,000 RPM
Operating Range:	12,000+ RPM
Multi-Strike Duration:	20° Crankshaft Rotation Through 3,000 RPM
Primary Voltage Output:	450V
Primary Energy Output:	1200 mJ/Sequence
Peak Spark Gap Current:	510mA w/ E92 Coil
Dimensions:	8" L x 4.5" W x 2" H, 4.5 lbs.

*Specifications were measured with a FAST® E92 Coil #308250 - see page 15.

Ignition

E6 CD IGNITION W/ REV LIMITER



MADE IN USA

The two RPM limits are adjustable in 100 RPM increments through positive stop rotary dials built into the side panel of the E6.

E6 CD Ignition w/ Rev Limiter

If you're concerned about redline RPM and the possibility of overrevving the engine, the FAST® E6 Ignition is also available with an adjustable rev limiter. Not only is our rev limiting technology extremely accurate, it is the smoothest limit available thanks to our advanced sequential limiting technology.

The RPM limit is easily set with two rotary dials on the side of the ignition and can be adjusted within 100 RPM increments all the way through 9,900 RPM.

This E6 is supplied with a Weatherpak connector and harness to help route the wiring, as well as sturdy vibration mounts. It can be used on distributor triggered, 4, 6 and 8-cylinder engines and is compatible with FAST® EFI systems or carbureted applications.

E6 CD Ignition Control w/ Rev Limiter	6000-6400
E6 CD Ignition Control w/ Rev Limiter & E92 Coil Kit	6000-6405

- Built-in engine protecting rev limiter is adjustable in 100 RPM increments up to 9,900 RPM
- Sequential rev limiting technology produces smooth, accurate rev limiting action
- Multi-strike CD ignition produces high output through redline RPM

E6 CD Ignition w/ Dual Stage Rev Limiter

If you plan to split your time between the street and strip, the E6 with a Dual Stage Rev Limiter is the right choice. The high voltage, multi-strike CD ignition improves overall performance and shares the same high output, capacitive discharge technology as the other E6 ignitions, plus it features two rev limiters.

The idea behind two rev limits is to have one set for overrev protection, while the second limit can be activated on the starting line. This will provide a consistent launch RPM while allowing you to concentrate on the starting light.

E6 CD Ignition w/ Dual Stage Rev Limiter	6000-6424
E6 CD Ignition w/ Dual Stage Rev Limiter & E92 Coil Kit	6000-6424-KIT

- Two adjustable rev limiters; one for overrev protection, the second for a launch RPM
- Adjustable in 100 RPM increments with positive detent rotary dials
- Timing is held to within a half degree and the rev limiter is accurate within 30 RPM

SPECS

Operating Voltage: 6V-18V, Reverse Polarity Protected, Negative Ground Only	Primary Voltage Output: 450V
Current Draw: 7.0 Amps Max. at 10,000 RPM	Primary Energy Output: 1200 mJ/Sequence
Operating Range: 12,000+ RPM	Peak Spark Gap Current: 380mA w/ I91 Coil; 510mA w/ E92 Coil
Limiter Range: 900-9,900 RPM, 100 RPM Increments	Dimensions: 8"L x 4.5"W x 2"H, 4.5 lbs.
Multi-Strike Duration: 20° Crankshaft Rotation under 3,000 RPM	

*Specifications were measured with a FAST® E92 Coil (Part #308250) - see page 15.

REV LIMITERS At FAST® we're not fans of rev limiters that bang and pop! Our rev limiter is controlled digitally and will sequentially drop the spark to one cylinder at a time, making sure to never cancel the same cylinder in a row. This keeps the engine balanced and prevents fuel from loading up during the limiting action. This also produces a much more accurate and stable rev limit.

Ignition

E6 CD CIRCLE TRACK IGNITION



E6 CD Circle Track Ignition w/ Rev Limiter

Circle track racing, on the dirt or pavement, puts a lot of pressure on the ignition. Not only does the ignition need to continuously fire off sparks at high RPM, it needs to be able to handle the abuse that race cars endure, which is why FAST® offers an E6 Ignition designed specifically for circle track racing.

All of the wiring of the E6 ignition is terminated into Weatherpak connectors for a secure, locked connection. To combat harsh racing conditions, the surface mount electronics are fully encased in a soft urethane material complemented with sturdy vibration mounts.

Since most racers run locked-out ignition timing, the E6 Circle Track Racing Ignition features a built-in start retard circuit. During cranking, the timing retards 20° to ease the pressure on the starter and flywheel. Once the engine reaches 600 RPM, the timing returns to the mechanical value. There is also a rev limiter that is adjustable through sealed rotary dials in 100 RPM increments through 9,900 RPM.

- **CD (Capacitive Discharge) technology produces full voltage sparks through high RPM**
- **Built-in 20° start retard eases cranking and start-up**
- **All wiring is routed into approved Weatherpak connectors**
- **Accurate and smooth sequential rev limiter is adjustable in 100 RPM steps**
- **Completely encased in soft urethane for protection against moisture and vibration**

E6 CD Circle Track Ignition w/ Rev Limiter

6000-6700

SPECS

Operating Voltage:	6V-18V, Reverse Polarity Protected, Negative Ground Only	Primary Voltage Output:	450V
Current Draw:	7.0 Amps Max. at 10,000 RPM	Primary Energy Output:	1200 mJ/Sequence
Operating Range:	12,000+ RPM	Peak Spark Gap Current:	510mA w/ E93 Coil
Limiter Range:	900-9,900 RPM, 100 RPM Increments	Dimensions:	8"L x 4.5"W x 2"H, 4.5 lbs.
Multi-Strike Duration:	20° Crankshaft Rot. Through 3,000 RPM. Max		

*Specifications were measured with a FAST® E92 Coil (Part #308250) - see page 15.

**APPROVED
SANCTIONING
BODIES**

American Modified Series, ARCA/CRA Super Series, ARCA Midwest Tour, Blizzard Series, JEGS/CRA All Star Tour, IMCA, PASS, Snowball Derby, Southern Super Series, USMTS, USRA, WISSOTA Racing Series

Ignition

E6 CD CIRCLE TRACK IGNITION KITS

E6 CD Circle Track Ignition, E93 Coil & Mount Kit

FAST® makes installation of the E6 Circle Track Ignition system easy with this ignition/coil kit that is also supplied with a sturdy mounting panel. This kit is supplied with the E6 CD Circle Track Ignition Control and the matched E93 Coil Kit mounted to an aluminum panel that simply mounts in your race car. All of the wiring is routed into Weatherpak connectors for an easy and reliable installation. This setup also makes it simple to remove the ignition during cleaning and maintenance on the car.



E6 CD Circle Track Ignition, E93 Coil & Mount Kit	6000-6701
Replacement Mounting Tray	6000-6363P

6000-6701

E6 CD Circle Track Ignition Kits

Racers demand performance and reliability, and we're making it simple to get a complete ignition kit that will deliver! Each ignition kit is designed to deliver the power, timing accuracy and performance that you expect from FAST®.

Each kit starts with the E6 CD circle track ignition control that is designed for all out circle track racing performance. For the most spark possible, an E93 coil is supplied, which produces high energy sparks at racing RPM. These kits also include CNC-machined, billet aluminum distributors that hold the ignition timing to the exact degree (see page 21-25 for more information). Plus, you can rely on the low resistance of FAST® FireWire® Spark Plug Wires to get the spark to the plugs throughout the race.

Each kit is supplied with the installation hardware and a harness terminated with Weatherpak connectors for easy installation.

- One part number for a complete circle track racing ignition system
- The E6 ignition is paired with the E93 coil for the best spark output
- Accurate optically triggered billet distributor has zero mag pickup retard
- Double silicon protected 25-ohm FireWire® Spark Plug Wire Kit ensures the most spark reaches the plugs



E6 CD Circle Track Ignition Kit for Chevrolet		6000-6700C
COMPONENTS	E6 CD Circle Track Ignition w/ Adjustable Rev Limiter, Start Retard	6000-6700
	Race Billet Optical Trigger Distributor	1000-1511
	E93 E-Core Coil	730-0192
	FireWire® Universal Plug Wire Kit	255-0082
E6 CD Circle Track Ignition Kit for Small Block Ford		6000-6700SBF
COMPONENTS	E6 CD Circle Track Ignition w/ Adjustable Rev Limiter, Start Retard	6000-6700
	Race Billet Optical Trigger Distributor	1000-1611
	E93 E-Core Coil	730-0192
	FireWire® Universal Plug Wire Kit	255-0083
E6 CD Circle Track Ignition Kit for Ford 351W		6000-6700FW
COMPONENTS	E6 CD Circle Track Ignition w/ Adjustable Rev Limiter, Start Retard	6000-6700
	Race Billet Optical Trigger Distributor	1000-1613
	E93 E-Core Coil	730-0192
	FireWire® Universal Plug Wire Kit	255-0083

Ignition

E7 CD IGNITION

**MADE
IN USA**



307222

- High energy sparks to handle extreme compression, boost or nitrous
- Built-in 20° start retard eases cranking and start up
- Accurate and smooth sequential rev limiters for overrev and starting line RPM
- Multi-strike spark series below 3,000 RPM for clean low RPM operation
- Completely encased in soft urethane for protection against moisture and vibration
- Advanced digital technology produces timing accuracy within $\pm .5^\circ$

E7 CD Ignition¹

When it comes to high compression, screaming RPM and power adders, the E7 Ignition is up to the task. The CD technology of the E7 delivers high output fire power, up to 160mJ of energy, to ignite racing fuel under the toughest combustion chambers!

The high voltage sparks of the E7 are managed by an efficient digital controller coupled with an efficient transformer and capacitor. When the ignition is at idle speeds, there is a series of multi-strikes that help keep your race engine running clear and crisp.

For overrev protection, the E7 features an adjustable rev limiter along with a second limiter that can be set while staged and waiting for the green light. Both limits are accurately set with positive feeling detent rotary switches. You'll also notice that the advanced sequential limiter produces a smooth, bang-and-pop free rev limiting action – easy on your engine and ears.

Another useful feature of the E7 is a built-in start retard of 20°. This extra retard rate is active only when the engine cranks over which eases pressure on the starter and flywheel. Once the engine reaches 600 RPM, the timing returns to the mechanical, set amount or programmed timing in an EFI application.

E7 CD Ignition	307222
E7 CD Ignition, E93 Coil & Mounting Kit	307222-KIT
Replacement Mounting Tray	307223

¹Not for use on pollution controlled vehicles

SPECS

Operating Voltage:	10V-20V, Reverse Polarity Protected, Negative Ground Only	Multi-Strike Duration:	20° Crankshaft Rot. Through 3,000 RPM
Current Draw:	1.0 Amp Per 1,000 RPM	Primary Voltage Output:	450V
Operating Range:	12,000+ RPM	Primary Energy Output:	160 mJ
Limiter Range:	To 12,000 RPM, 100 RPM Increments	Peak Spark Gap Current:	510mA w/ E93 Coil
Limiter Accuracy:	± 30 RPM	Dimensions:	8.3"L x 6.3"W x 2.2"H, 3.75 lbs.
Timing Accuracy:	$\pm .5^\circ$ From 500-9,900 RPM		

*Must use FAST® E93 Coil (Part #730-0192) for maximum ignition output – see page 15.

E7 ACCESSORIES

Crank Trigger Kits:	Precise ignition triggering – see page 12.
TRC Module:	Easily install a step or boost retard – see page 9.
Billet Racing Distributors:	The most accurate distributors available– see pages 21-23.





XIM™ Ignition Controller

The XIM™ Ignition Controller allows you to easily control all aspects of the ignition system when used with a FAST® EZ-EFI 2.0®, XFI 2.0™ or XFI Sportsman™. A number of different wiring kits are available for late model GM LS platforms, 5.7 and 6.1 Chrysler Hemis and Ford's mod motor or the Coyote series.

This versatile ignition controller is also capable of giving you coil-per-cylinder operation on any engine using a standard crank trigger and a simple pulse per revolution cam sensor.

- Control the ignition timing of distributor-less ignition systems when used with FAST® EFI systems
- Plug-and-play installation w/ factory style connectors
- Can be used as a stand-alone ignition control in carbureted applications

	Kits*	Standalone**
XIM™ Ignition Module (No Harness)	305008	–
GM LS1/LS6 XIM™ Kit w/ Harness	301311	3013112
GM LS2/LS3/LS7 XIM™ Kit w/ Harness	301312 ¹	3013122
GM LS1/LS2/LS3/LS6/LS7 XIM™ Connector Kit	301311K ¹	–
Ford 5.0 Coyote Coil-On-Plug XIM™ Kit w/ Harness	301317	3013172
Ford Modular Coil-On-Plug XIM™ Kit w/ Harness	301313	3013132
Ford Modular Coil-On-Plug (Includes XIM™) Alternate Coil Option	301313A ²	–
Chrysler 5.7L EFI Hemi XIM™ Kit w/ Harness	301316	3013162
Chrysler 5.7L EFI Hemi XIM™ Connector Kit	301316K	–
Chrysler 6.1L EFI Hemi XIM™ Kit w/ Harness	301314	3013142
Chrysler 6.1L EFI Hemi XIM™ Connector Kit	301314K	–
Universal XIM™ Connector Kit	301315K	–
LS2, LS7 Cam Pickup Adapter Harness	301415	–
LS2, LS7 Crank Pickup Adapter Harness	301416	–
GM Gen III/IV L92 Truck-Style Coil	30256-8 ¹	–

* For use w/ EZ-EFI 2.0®, XFI 2.0™, XFI Sportsman™
 ** For use w/ original EZ-EFI® or carb applications

¹ Includes #301145 & #301416.
² Must use part #30256-8.

XR-1A Smart Coil

The FAST® High Output Smart Coils are designed for extreme compression, high RPM race engines making in excess of 1,000 horsepower. The compact coil can deliver up to 44,000 volts with 103mJ of spark energy – similar to many capacitive discharge ignition systems. The smart coil design doesn't require a coil driver making it ideal for coil-on-plug systems.

Set of (8) Coils w/ Connectors	30260-T8
Set of (8) Coils ONLY (No Connectors)	30260-8
Single Coil w/ Connector	30260-T1
Single Coil ONLY (No Connector)	30260-1



#30260-1

Ignition Control

EZ-LS™



#301312E

EZ-LS™

There is no denying the endurance and power capabilities of the LS series of engines and their use in everything from street rods to off-road race trucks. When it comes to fuel and ignition control, FAST® has the technology and components to provide the fire to ignite the fuel of your LS engine.

The EZ-LS™ Ignition Controller is for use with an EZ-EFI 2.0®, XFI 2.0™ or the XFI Sportsman™ system and simply connects to the factory sensors of the LS engine. The system was designed as a plug-in and go system with easy configuration and control of functions such as rev limits, step retards or even a boost/timing based map. Ideal for LS swaps.

EZ-LS Ignition Controller Kit w/ Wiring Harness

301312E

* Works with all 1997-Current GM coil-near-plug ignition systems and both 24x/58x tooth reluctor wheels. Not compatible with LS truck-finned coils. Wiring harness included. Requires use of EZ 2.0™, XFI 2.0™, or XFI Sportsman™. (Does NOT work with original EZ-EFI™ or carburetors)

- Complete control over the ignition timing on Gen 3 and 4 LS series engines using a FAST® EFI system
- Easy installation with plug-and-play wiring harness
- Recognizes 24x or 58x crankshaft sensors
- Tune through the EZ-EFI 2.0® hand-held or with the XFI® C-Com software of an XFI 2.0™ or XFI Sportsman™ EFI system
- Built-in LEDs indicate operation and input/output signals
- Clean, simplified installation with a compact, waterproof ignition controller

Ignition Accessories

TIMING & TACHS

TRC-2 Timing Retard Control

The compact TRC-2 Retard Control allows you to easily adjust or select a timing retard – from the driver's seat! The TRC-2 easily wires to all of the FAST® I6, E6 and E7 Ignitions¹ and simply mounts under the dash.

There are three different ways to adjust the timing. The first is by simply turning the rotary dial to retard the timing to match your driving specifications – no more crawling under the hood with a timing light and distributor wrench. You can also set it to act as a nitrous retard that will only activate when the nitrous is live.

If you're a boost fan, the TRC-2 can be connected to a MAP sensor (available separately) allowing you to adjust a boost/retard setting. It can be set to retard 0-4° per pound of boost with a maximum of 20°. The unit is sealed and features an LED to show when the retard is active.

- Retard the timing up to 20° for racing, on the street or towing
- Easily connects to any of the FAST® E6, E7 or I6 Ignitions¹
- Use as a step retard to activate when using nitrous
- Will retard the timing in a ratio as boost pressure increases
- Simply dial-back the timing in times of detonation or load



6000-6425
CARB EO# D-225-57

TRC-2 Timing Retard Control	6000-6425
-----------------------------	-----------

¹ Not compatible with E6 Circle Track Ignition, Part #6000-6700

MAP Sensors

These sensors monitor the vacuum inside the manifold and relay the information back to the ECU or the TRC-2 Controller of the ignition. This information in turn is used to determine the proper amount of fueling and ignition adjustments.

MAP 1 Bar Sensor	307007	MAP 3 Bar Sensor	307009 ¹
MAP 1 Bar Sensor, LS1 Style	307029	MAP 5 Bar Sensor	307047 ^{1,2}
MAP 2 Bar Sensor	307008 ¹		

¹ Includes replacement matching connector body (to retro-fit existing FAST® Part #301100 or #301101 main harness)

² Includes 5 bar adapter.

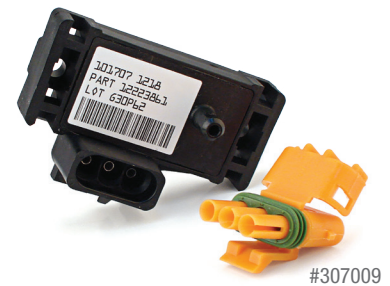

E6 CD Ignition Tach Adapter

If you find that your older factory fuel injected vehicle, primarily from '81-'95, doesn't start or runs rough after the installation of an E6 Ignition, this Tach Adapter will get you fired up quickly. This unit connects to the trigger input on the E6 and strengthens the signal required for the tach and the EFI, allowing both systems to function together. It may also correct issues with a factory tachometer.

E6 CD Ignition Control Tach Adapter	6000-8910
-------------------------------------	-----------



Tel Tac Tach Adapter

If you're using a digital Tel Tac tachometer, this compact and lightweight module will correct any irregular readings caused by the addition of a FAST® E6 Ignition. The billet unit is sealed in soft urethane for protection in racing environments and has color coded wiring for quick installation.

Tel Tac Tach Adapter	1000-1010
----------------------	-----------

Surge Protection Kit

A 16V filter capacitor/surge protector for use with most all CD ignitions.

Surge Protector Kit	9000-0014
---------------------	-----------

Ignition Accessories

HARNESSES & AIR/FUEL

Harnesses

Things happen on performance and race cars which is why we offer a number of different wiring harnesses as replacements or when you're connecting different components together. All of the FAST® harnesses are hand-built with the correct, factory required crimping tools combined with the proper seals and connectors. All wiring is matched to the ignition or distributor's factory gauge and color combination for an easy connection or swap.

6-Pin Weatherpak Connector E6 Race Ignition, Car Side Harness	6000-6715
3-Pin Weatherpak Connector, Car Side Harness	6000-6716
Race Billet Distributor, Car Side Harness	6000-6717
Race Billet Distributor to MSD Ignition Harness	6000-6719
E6 Ignition to MSD Distributor	6000-6727

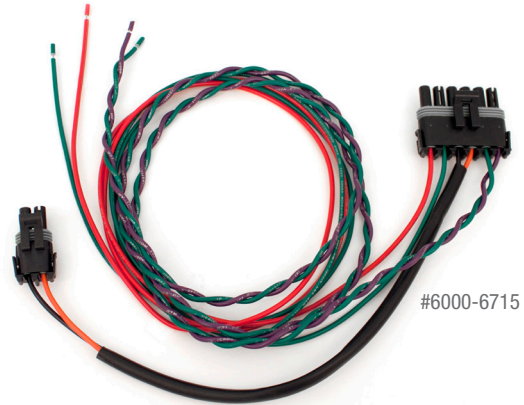

#6000-6715

Shock/Vibration Mounts

These sturdy rubber mounts will help isolate the vibrations and frequencies experienced on a race track from the ignition or coil. Supplied in a set of four, one side has stud with a lock washer and nut, the other accepts the included #10-32 Allen bolt.

Vibration Mounts, Set of 4	1000-1032
----------------------------	-----------



#307010



#1000-1032

Relays

For switching any high current or high load device.

20-AMP Relay (EZ-EFI®)	307010	75-AMP Relay	307019
30-AMP Relay	307011	Digital 20-AMP Relay	307043

- Ideal for carbureted & EFI engines
- Available in single or dual sensor units
- Built-in data logging; no laptop required
- Meters for gasoline, diesel & E85 fuels
- PC-based software analysis tool
- RPM-based option



Air/Fuel Meters

With no laptop required, FAST™ has developed three simple, easy-to-use air/fuel meters for gasoline, diesel and Ethanol/Methanol (E85) fuels. Available in single or dual sensor units, these meters give tuners the power to read two wide-band O₂ sensors individually or to average them together for maximum accuracy of the engine's air/fuel ratio reading. FAST™ Air/ Fuel Meters include several enhanced capabilities, including the built-in data logging function that plays back recorded information on a lighted, full graphical display screen rather than using a laptop computer. Additional features include outputs for external data loggers, digital gauges, and a narrow-band simulator function that allows you to feed your engine's computer a factory signal while using the wide-band sensor for air/fuel measurement.

Gasoline Air/Fuel Meter (Single Sensor)	170401	Diesel Air/Fuel Meter (Single Sensor)	170701
Gasoline Air/Fuel Meter (Dual Sensor)	170402	Diesel Air/Fuel Meter (Dual Sensor)	170702
Motorcycle Gasoline Air/Fuel Meter (Single Sensor)	170501	Ethanol/Methanol Air/Fuel Meter (Single Sensor)	170590
Motorcycle Gasoline Air/Fuel Meter (Dual Sensor)	170502	Ethanol/Methanol Air/Fuel Meter (Dual Sensor)	170608
Dyno Gasoline Air/Fuel Meter (Single Sensor)	170601	Master Tuner Dual Sensor Air/Fuel Meter Kit	170614
Dyno Gasoline Air/Fuel Meter (Dual Sensor)	170602		

Ignition Accessories

CONNECTORS & WIRING TOOLS

Weatherpak Connector Kits

It may take a little longer, but you'll have the confidence of a locked and sealed connection when you use FAST® Weatherpak Connectors on your wiring. These connectors are mandated in many racing sanctioning bodies as they're impervious to water, oils and fuel, thanks to their heavy-duty sealed design. Plus, the connectors lock together for a secure connection every time.

Weatherpak 1-Pin Connector Kit	6000-6721	Weatherpak 3-Pin Connector Kit	6000-6723
Weatherpak 2-Pin Connector Kit	6000-6722	Weatherpak 6-Pin Connector Kit	6000-6726

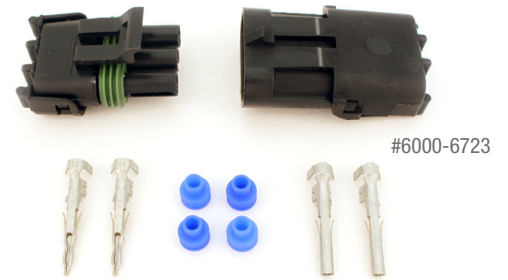

Each kit is sold with the seals & terminals for each side of the connector.

Pin Removal Tools

These special little tools are required when disassembling connectors.

Weatherpak Pin Removal Tool - Yellow	307065
Metripak Pin Removal Tool - Green	307066



Weatherpak Crimp Tools

A unique Crimp Tool is required when assembling the Weatherpak connectors and FAST® offers two; an economical, value crimper as well as a professional grade model for serious wiring projects.

Weatherpak Crimp Tool	307067
Professional Weatherpak Crimp Tool	1000-1100

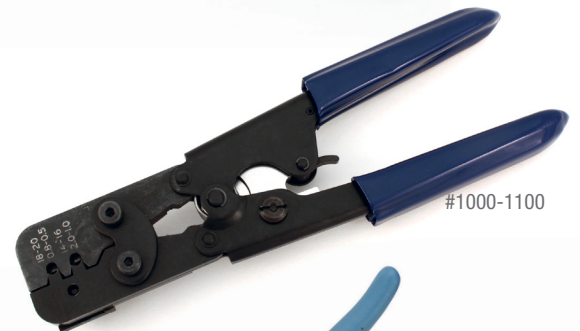

Wire Stripping Tool

If you work with a lot of wiring, do yourself a favor and step up to a professional grade stripping tool. Our heavy-duty strip tool will consistently and easily strip 22-10 AWG wire to save you time during wiring projects.

Professional Wire Stripping Tool	307068
----------------------------------	--------



Spark Plug Crimper

If you plan on building several sets of FireWire® spark plug wires, a FAST® Spark Plug Wire Crimp Tool is a must! The heavy-duty steel construction features a ratcheting action so each crimp is consistent and strong every time. There is plenty of leverage and supportive grips to keep you crimping all afternoon.

Pro Spark Plug Crimp Tool	1000-1120
---------------------------	-----------



Ground Cable

One of the most important things you need to do on your vehicle is provide an effective ground path back to the battery. This ground cable is 24" long with 3/8" eyelets on each side. The flexible tin plated copper braid provides maximum grounding capabilities.

Ground Cable	170720
--------------	--------



Crank Triggers

KITS & PICKUPS

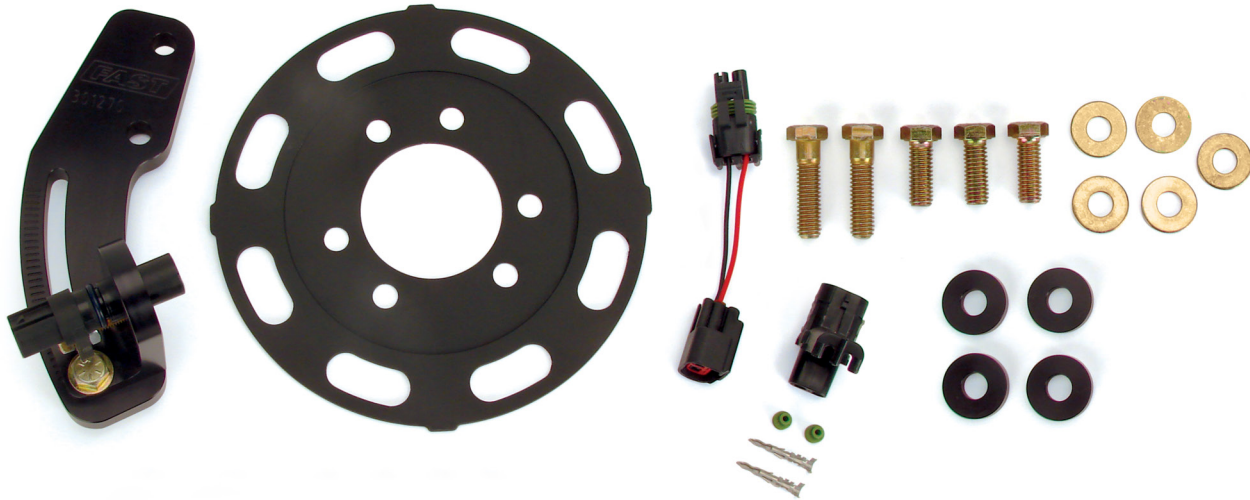

Crank Triggers

The FAST™ Crank Trigger is a magnet free device with a durable wheel constructed from high strength steel. With a .125" wheel, it requires less space than competitors' aluminum versions. With the wheel being this thin, it not only weighs less but requires less space than competitors' aluminum versions. The FAST™ inductive sensor is also much smaller than others on the market and is hermetically sealed with the connector molded into the body. This long lasting sensor is used by OEMs both on and inside the motor and provides accurate timing. Compatible with XFI 2.0™, XFI Sportsman™, EZ-EFI 2.0® or for use with other aftermarket EFI/ignitions.

- Ultra durable CNC-machined aluminum bracket w/ clearly labeled precision timing marks
- Magnet-free, ultra-thin .125" steel wheel
- Small OEM-quality inductive sensor provides unrivaled accuracy while saving space
- Includes all required mounting hardware; plug & play with any aftermarket EFI system

Small Block Chevy Crank Trigger For 7.00" Balancer	301270
Small Block Chevy Crank Trigger For 8.00" Balancer	301280
Big Block Chevy Crank Trigger For 8.00" Balancer	301180
Small Block Ford Crank Trigger For 6.562" Balancer	303565

Non-Magnetic Crank Trigger Pickup Replacement (Flying Magnet)

If you're running a crank trigger system with the magnets installed in the trigger wheel, the FAST® Non-Magnetic Crank Trigger Pickup is a more accurate, highly reliable replacement sensor. It is designed to replace a common non-magnetic pickup with a 3/4"-16 UNF threaded housing.

The FAST® sensor produces the most precise signal from cranking through redline RPM and is accurate to within $\pm 0.1^\circ$! There is also a useful LED built-in that is extremely helpful when setting up the static timing before firing up the engine.

The wiring is sealed inside the housing and routed into a shielded, 3-pin Deutsch connector.

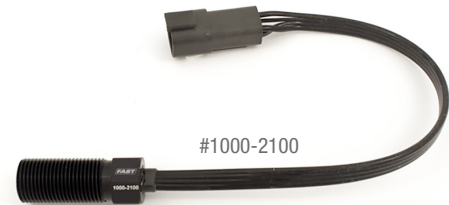

Non-Magnetic Crank Trigger Pickup Replacement (Flying Magnet)	1000-2100
---	-----------

Crank Trigger Sensor Guard

This billet housing serves two purposes; it replaces the locknut of the crank trigger sensor while surrounding the sensor and wiring for protection. Installs over all 3/4"-16 UNF threaded crank trigger sensors.

Crank Trigger Sensor Guard	1000-2110
----------------------------	-----------



Ignition Coils

INTRO

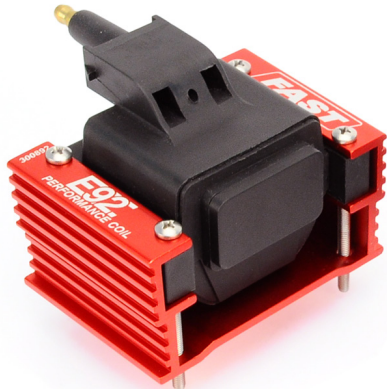
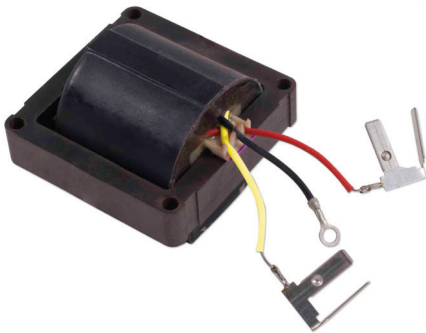

Ignition Coils

Choosing the correct coil for your ignition system is an important consideration. A coil is responsible for taking in low voltage with higher current and converting it to a high voltage with lower current to fire the spark plug.

Coils may look similar on the outside, but internally they can have a number of variations that affect their overall output and application. Engineers can manipulate aspects such as the turns ratio of the primary and secondary windings, the resistance of the materials used, and even the layout of the coil, all of which change the function and output of the coil.

FAST® offers several coils, all of which are designed to produce the best output when coupled with our ignition controls. There are coils designed to improve the output of factory systems, higher output models to run with our ignition controls, models designed for high RPM racing for the track and even coils to handle high compression and boost.

Coil Selection

IGNITION SYSTEM	COIL						
	PS20	PS40	PS50	PS60	I91	E92	E93
Factory Points or Electronic Amplifiers	✓	✓			✓		
I6 Ignition Control			✓	✓	✓		
XR-i	✓	✓					
XR-700	✓	✓					
XR-3000			✓	✓	✓		
E6 for Street						✓	
E6 for Strip or Track						✓	✓
E7 Ignition Control							✓

Ignition Coils

CANISTER

The FAST® canister style coils may look traditional on the outside but their internals are designed to pack a high voltage punch. We have you covered with two different style coils.

PS20/PS40 Coils

The PS20 and PS40 Coils are designed to enhance the output of factory ignition systems. They fit in place of most OEM canister coils, and thanks to their lower resistance and optimized turns ratio, will produce a higher output spark when used with breaker points, amplified ignitions or with the FAST® XR-i Points Replacement system.

These coils will reliably deliver a high output spark through 6,500 RPM on mild street performance applications and are oil filled to keep the windings cool. Both coils are supplied with a ballast resistor which is required if you plan to fire up your original breaker point style ignition system.

PS20 Premium Street Coil, Black	730-0020
PS40 Premium Street Coil, Nickel Plated	730-0040



PS50/PS60 Coils

The PS50 and PS60 Coils are ideal for street cars packing a little more power and are running a FAST® I6 Ignition or XR-3000 Breakerless Conversion System.

These coils feature lower resistance windings to ensure the most voltage possible is brought into the coil with an optimized turns ratio for the best output. This combination is ideal for engines that endure higher RPM and performance such as circle track, road racing and off-road racing. The coils are filled with oil for optimum cooling and are housed in a sturdy steel canister that can handle the abuse of racing. They're topped off with an alkyl molded top and brass, screw-type terminals.

PS50 Performance Coil, Black	730-0050
PS60 Performance Coil, Nickel Plated	730-0060



Ballast Resistor

Ballast Resistor, 1.4 ohm	9000-0015
---------------------------	-----------



COIL SPECS

	PS20/40	PS50/60
Primary Resistance:	1.4 ohms	.40 ohms
Secondary Resistance:	5.2 Kohms	3.8 Kohms
Primary Inductance:	7.5 mH	5.3 mH
Secondary Inductance:	26 H	15 H
Leakage Inductance:	1.3 mH	.5 mH
Turns Ratio:	60:1	54:1
Typical Dimensions:	2 1/8" D x 5 3/4" L, 1 3/4 lbs.	

Ignition Coils

E-CORE

When your performance ignition plan includes a FAST® Ignition Control, it's time to consider one of our E-core series coils. E-Core coils are a more efficient design than the old canister style coils thanks to a closed magnetic path. This means less inductance loss with improved energy transfer to create an improved spark.

I91 Inductive Coil

The I91 Coil is designed for use with FAST® high output inductive ignition systems such as the I6 Ignition Control or the XR-3000 Electronic Conversion Systems. The internal design is optimized to produce a long duration spark coupled with higher voltage output making it ideal for street and performance applications.

I91 Inductive Coil	730-0891
--------------------	----------

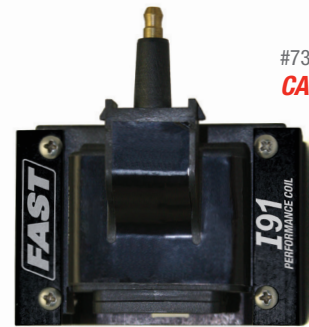

#730-0891
CARB EO# D-255-60

E92 Coil Performance/Street

The E92 Coil was designed for high performance street engines running an E6-series Ignition Control. The efficient E-core construction provides a secure housing that can handle the rigors of street and performance use while producing a high output spark. The extruded aluminum housing provides a durable mount and acts as an effective heat sync as well.

E92 E-Core Ignition Coil	308250
--------------------------	--------



#308250
CARB EO# D-255-60

E93 E-Coil Racing Coil

When it comes to high compression and cylinder pressures with redline revving RPM, the E93 Coil is the best choice. This coil was engineered from the inside out to handle the needs of race engines.

Inside the low profile coil housing is heavy gauge wiring for use on both sets of windings resulting in a highly effective turns ratio of 60:1. The internals are encapsulated in urethane for protection against extreme vibration and abuse from racing environments. The secondary tower is also lengthened to aid in spark isolation and terminal connection.

E93 E-Core Ignition Coil	730-0192
--------------------------	----------



#730-0192
CARB EO# D-255-60

Locking Coil Wire Kit

This coil wire kit is supplied with a locking clip that secures the FireWire® to the coil. Boots, terminals and a 40" FireWire® Spark Plug Wire are supplied.

Locking Coil Wire Kit for I91 & E92 Coils	235-0001
---	----------

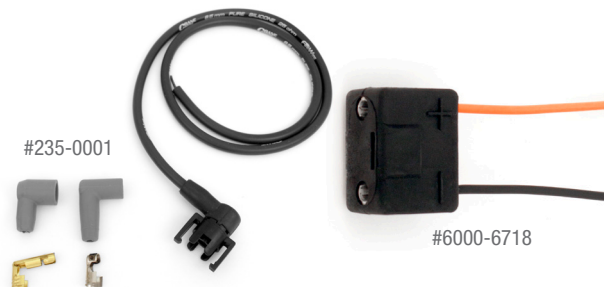

#235-0001

#6000-6718

Coil Adapter Plug For I91 & E92/E93

Coil Adapter Plug For I91 & E92/E93	6000-6718
-------------------------------------	-----------

COIL SPECS	I91	E92	E93
Primary Resistance:	.40 ohms	.23 ohms	.20 ohms
Secondary Resistance:	4.6 Kohms	920 ohms	.82 Kohms
Primary Inductance:	4.7 mH	1.7mH	1.9 mH
Secondary Inductance:	14.4 H	4.5-6.5 H	6.8 H
Leakage Inductance:	.23 mH	.14 mH	.14 mH
Turns Ratio:	57:1	60:1	60:1
Typical Dimensions:	3 3/4" L x 2 1/2" W x 3" H, 1 1/4 lbs.	3 3/4" L x 2 1/2" W x 3" H, 1 1/4 lbs.	4 1/4" L x 3 1/2" W x 3 1/4" H, 2 1/8 lbs.

Points Conversion

XR-i

XR-i

Tired of setting your points, or hitting that magical point at higher RPM where they seem to float, costing you power and performance? It's time to pull out those ancient contacts and benefit from modern day, digital technology with the FAST® XR-i Replacement Module.

The XR-i is a compact module that bolts directly in place of the breaker point assembly. It simply triggers from the factory cam lobe, making installation a breeze with only two wires to connect. The microcontroller of the module manages the signal and dwell time in the coil to produce a much higher output spark that will improve the performance and driveability of your classic as well. Another great feature is a built-in rev limiter to protect your engine in the event of driveline failure or a missed shift.

A number of applications are available and more are coming soon.

For more information on the PS20 Coil, see page 14.

	XR-i Only	XR-i w/ PS20 Coil Kit
Chevrolet V8, 1957-1974	750-1710	750-1715
Ford V8, 1959-74	750-1700	750-1705
Oldsmobile V8, 1967-1974	750-1720	750-1725
Pontiac V8, 1957-74	750-1720	750-1725



**CARB E.O. D-225-67
50-STATE LEGAL**

- The easiest points upgrade available
- Triggers from the factory cam lobe with precision timing
- Increases spark output for improved driveability
- Simple two wire connection to retain factory appearances
- Set an engine saving rev limit

SPECS

Operating Voltage:	6V-18V, Reverse Polarity Protected, Negative Ground Only	Primary Voltage Output:	400V (Inductive Discharge)
Current Draw:	3.0 Amps Max. at 5,500 RPM	Primary Energy Output:	45mJ w/ PS20 Coil & 1.65L Ballast Resistor
Operating Range:	8,000 RPM	Peak Spark Gap Current:	50 Milliamps w/ PS20 Coil & 1.65L Ballast Resistor
Limiter Range:	4,000-8,000 RPM	Spark Duration:	2100 Microseconds @ 2,000 RPM

Optical Trigger Points Replacement

Replace your breaker points with the accuracy and reliability of an optical trigger. These kits are supplied with everything you need to bolt the optical trigger into your factory distributor to send a reliable trigger signal to an E6 or I6 ignition control.

The Optical Trigger and an Installation Kit are required. Installation kits include the shutter wheel, brackets and installation hardware.

Optical Trigger Conversion Unit (Installation Kit Required)	715-0020
Trigger Installation Kits	
Domestic 4, 6, & 8 Cyl. Engines, CARB E.O D-47-2	700-2226
VW/Bosch 009 Distributors, CARB E.O D-47-2	700-2226
Universal Imports, 4, 6 & 8 Cyl. Engines, CARB E.O D-47-2	700-2231
1974-1983 Imports, 4 & 6 Cyl. Engines w/ Bosch, Hitachi or Nippondenso OE Ignition Modules, CARB E.O D-47-3	700-2292
1979-1983 British 4, 6, & 8 Cyl. Engines w/ Lucas OPUS Distributor	700-2300

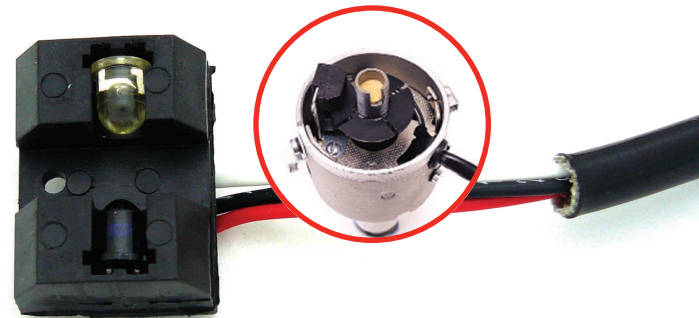

- Convert breaker points to a reliable optical pickup
- Provides a trigger signal for a FAST® I6 or E6 series ignition control
- Maintenance-free with no adjustment or replacement
- Stable timing from idle to high RPM

SPECS

Operating Voltage:	6-18V, Reverse Polarity Protected, Negative Ground Only. Not Compatible w/ 6V Electrical Systems.
Trigger Output:	Points/Module Type (12V Square Wave). Triggers Spark on Rising Edge. 1/4 Amp Max. Note: Output Cannot Directly Drive Any Coil or Part #6000-8910 Tach Adapter.

Points Conversion

XR-700

MADE
IN USA

XR-700

The XR-700 Points Replacement System is designed as an affordable and better performing alternative to many factory points/electronic module systems such as those from Hitachi, Nippondenso, Bosch, Lucas and others.

The system starts with the reliable FAST® optical trigger that bolts in place of the breaker points in the distributor. From there, it triggers the XR-700 Ignition Module. This compact inductive ignition module is compatible with 12-volt systems and even accepts positive ground systems. It improves the spark output and delivers up to 400 primary volts with about 60mJ of spark energy so your engine will rev quicker and pull through the straights like never before.

The XR-700 Ignition Module, Optical Pickup and Installation Kit may be purchased separately.

Recommended Coil: The best coil for use with the XR-700 is the FAST® PS20 or PS40 Coil, see page 14.



50-STATE LEGAL

XR-700 Ignition Module ONLY	700-0001
XR-700 Optical Trigger ONLY	700-0020
Complete Kits	
Domestic 4, 6, & 8 Cyl. Engines, CARB E.O D-47-2	700-0226
VW/Bosch 009 Distributors, CARB E.O D-47-2	700-0226
Universal Imports, 4, 6 & 8 Cyl. Engines, CARB E.O D-47-2	700-0231
1974-1983 Imports, 4 & 6 Cyl. Engines w/ Bosch, Hitachi or Nippondenso OE Ignition Modules, CARB E.O D-47-3	700-0292
1979-1983 British 4, 6, & 8 Cyl. Engines w/ Lucas OPUS Distributor, CARB E.O D-47-2	700-0300

- Replaces the points and ignition module of many Bosch, Lucas, Hitachi and Nippondenso systems
- Compatible with positive ground electrical systems
- Improved timing accuracy and ignition output
- Optical trigger provides precise and reliable trigger signals
- Higher energy and voltage in a more reliable package

Note: The OE OPUS pickup must have three wires. If it has two, the optical trigger cannot be used.

SPECS

Operating Voltage:	6-18 volts, Reverse Polarity Protected, Negative or Positive Ground. Not Compatible w/ 6 volt systems	Primary Voltage Output:	60mJ w/ PS20/PS40 Coils
Coil Current Limit:	4.5 Amps	Peak Spark Gap Current:	60 Milliamps w/ PS20/PS40 Coils
Operating Range:	6,000 RPM on V8 (Higher on 4 & 6 Cyl. Engines)	Spark Duration:	300 Microseconds @ 6,000 RPM
Primary Voltage Output:	400V (Inductive Discharge)	Dimensions:	3 1/2" L x 3" W x 1 1/2" H, 1 lb.

Ballast Resistor

Ballast Resistor, 1.4 ohm	9000-0015
---------------------------	-----------



#9000-0015

TECH TIPS: BALLAST RESISTANCE

HOW CAN I TELL IF MY VEHICLE HAS A BALLAST RESISTOR ?

Here's a quick test for ballast resistance. Run the engine at fast idle and measure battery voltage using a volt meter. It should be about 14 volts. Then measure the voltage at the Coil+ terminal. If there is a difference of more than 3 volts, a ballast resistor is present.

WHEN IS A BALLAST RESISTOR REQUIRED?

A ballast resistor is required with XR-700 systems. Without proper ballast resistance, the XR-700 and coil will overheat. All vehicles with original equipment points ignition are factory equipped with ballast resistance. This can be in the form of a ceramic ballast resistor or a resistance wire between the ignition key and COIL- terminal. It can also be in the form of internal resistance within the coil, such as Bosch blue coils (typical on VW) and Lucas coils found on older British vehicles.

Points Conversion

XR-3000

**MADE
IN USA**



3000-0001
CARB EO# D-225-5



700-0020
CARB EO# D-225-52

XR-3000

The FAST® XR-3000 is the most powerful system to replace breaker points or OEM points/module combinations. It all starts with our proven optical trigger kit that replaces the breaker points in the distributor. From there, it triggers a high output ignition module, the XR-3000.

This ignition module is a high output inductive ignition that produces higher voltage and current that will fire up your engine. You'll notice faster revving, improved pulling and whip-like throttle response from the increased spark energy reaching the gap – up to 150% more spark energy!

The XR-3000 is CARB approved for use in all states. An installation kit may be purchased separately.

Recommended Coil: The best coil for use with the XR-3000 is the FAST® I91 Coil, see more on page 15.

XR-3000 Ignition Module ONLY	3000-0001
XR-3000 Optical Trigger ONLY	700-0020

Complete Kits	
Domestic 4, 6, & 8 Cyl. Engines, CARB E.O D-47-2	3000-0226
VW/Bosch 009 Distributors, CARB E.O D-47-2	3000-0226
Universal Imports, 4, 6 & 8 Cyl. Engines, CARB E.O D-47-2	3000-0231
1974-1983 Imports, 4 & 6 Cyl. Engines w/ Bosch, Hitachi or Nippondenso OE Ignition Modules, CARB E.O D-47-3	3000-0292

- Upgrade from points to a maintenance-free optical trigger combined with a high energy ignition
- Ideal for vintage racing classes
- Up to 150% more spark energy over the OE points ignition
- Fully sealed for protection from vibration and moisture
- Improved timing accuracy and ignition output

SPECS

Operating Voltage:	6-18 volts, Reverse Polarity Protected, Negative or Positive Ground. Not Compatible w/ 6 volt systems
Coil Current Limit:	4.5 Amps
Operating Range:	6,500 RPM
Primary Voltage Output:	400V (Inductive Discharge)

Primary Energy Output:	90mJ w/ I91 Coil
Peak Spark Gap Current:	100 Milliamps w/ I91 Coil
Spark Duration:	2800 Microseconds @ 2,000 RPM
Dimensions:	5" L x 3" W x 1 1/2" H, 1 1/2 lbs.

Ignition Control

I6 INDUCTIVE IGNITION



**MADE
IN USA**



- Compact inductive ignition produces up to 70% more spark energy than stock
- Multi-strike spark series below 2,000 RPM for crisp low RPM operation
- Long duration spark with max output through 8,000 RPM
- Built-in rev limiter is adjustable in 100 RPM increments
- Circuitry is encased in soft urethane for protection against moisture and vibration

CARB E.O. D-225-59

I6 Inductive Ignition Control

Looking for an economical way to enhance the spark output of your street rod or muscle car? The compact I6 Ignition Control is easy to install with breaker points or electronic triggers and delivers multi-strike, high-output sparks to improve your engine's idle, throttle response and driveability.

The I6 is an inductive ignition control that improves the spark output and enhances the current and dwell control of the coil resulting in higher spark energy – up to 70% over OEM systems. From cranking speed through 2,000 RPM, there is a series of multi-strike sparks to enhance starting, idle and low speed cruising.

The I6 also has a smooth rev limiter that is adjustable within 100 RPM increments. For the most output, it is recommended to run the FAST® I91 Coil.

I6 Inductive Ignition Control – Universal	6000-6300
I6 Inductive Ignition Control & I91 Coil Kit – Universal	6000-6305

Compatible with 4, 6 & 8 cyl. engines with a distributor

SPECS

Operating Voltage:	6V-18V, Reverse Polarity Protected, Negative Ground	Primary Voltage Output:	450V (Inductive Discharge)
Current Draw:	5.0 Amps Max. at 7,000 RPM	Spark Duration:	2,800 Microseconds at 2,000 RPM
Operating Range:	8,000 RPM w/ V8; 10,000 RPM w/ 4 Cyl.	Trigger Input:	Module Trigger (12V Square Wave)
Limiter Range:	3,100-9,900 RPM	Dimensions:	5.5"L x 3"W x 1.5"H, 2 3/8 lbs.
Multi-Strike Duration:	20° Crankshaft Rotation Below 2,000 RPM		

NEED TIMING CONTROL?

If you do a lot of cruising, you've probably run into a little detonation due to elevation or fuel changes. The FAST® TRC-2 Module allows you to retard the ignition timing from the driver's seat to adjust for changing driving conditions. It is also useful for boosted or power adders. See page 9 for more information.

POINTS REPLACEMENTS

We're in the 21st century – why are you still running points? Check out our Optical Trigger Kits to update your factory breaker point distributor starting on page 16.



Distributors

HEI

Street HEI Distributors

The FAST® Street HEI is designed for Small and Big Block Chevy engines running a carburetor or aftermarket EFI. The cast distributor is all new, including the high output ignition module and coil. This module was designed with an isolated RPM output signal making it ideal to trigger EFI systems or for aftermarket tachs that require a clean 12 volt square wave signal. This digitally controlled ignition module utilizes a rugged coil driver and is paired with a high output coil that will produce full power sparks through higher RPM.

The FAST® Street HEI Distributor is equipped with a new steel gear that is compatible with many cam grinds and features a mechanical advance and adjustable vacuum canister.

HEI Street Distributor – Chevrolet V8 Engines	303051
HEI Street Module ONLY – Fits Most 4-Pin HEI Distributors	303050
HEI Street Ignition Kit – Includes Module, Coil, Rotor and Black Cap	1000-2514

HEI Upgrade Kit

If you already have an HEI distributor that is mechanically sound but needs a serious spark upgrade, this kit is supplied with our street HEI module and coil, plus a new cap and rotor.

HEI Upgrade Kit - Includes Street HEI Module, Coil, Cap & Rotor	1000-2513
---	-----------

Performance HEI Coils

Designed to produce optimum spark energy and voltage when using a FAST Street Performance HEI Module.

Internal HEI Coil, Clockwise Rotation Distributor, Red/Yellow Wiring	730-0291
Internal HEI Coil, Counter Clockwise Rotation Distributor, Red/White Wiring	730-0191

Race HEI Distributors

Racers asked for a high output, precision HEI for circle track racing and FAST® delivered. New from the steel gear up to the top of the plug wire retainer, this HEI distributor means business. The heart of the unit is a digital ignition module that drives the paired coil with up to 8.5 amps to create a powerful spark that remains at full power from warm-up laps to high RPM. The module also manages the trigger signals to keep the locked-out timing solid at all RPM. Since there is no centrifugal advance, there is a built-in 20° start retard to ease cranking. There is also a separate tach signal that provides a clean 12V square wave signal to trigger a tachometer or EFI system.

HEI Race Distributor	1000-2500
HEI Race Module ONLY - Fits Most 4-Pin HEI Distributors	1000-2511

*Fits most 4-Pin HEI Distributors. For more HEI distributor accessories, see page 25.

HEI Low Resistance Bushing

When running a higher output HEI Module, such as the FAST® unit, this Lower Resistance Rotor Button is required.

HEI Low Resistance Bushing	730-8412
----------------------------	----------



#1000-2500



#303051

#1000-2513



#730-8412

#730-0291

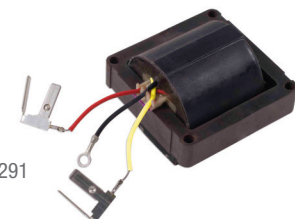

Billet Race Distributors

The FAST® Race Billet Distributors were designed to deliver the most accurate trigger signal possible throughout the entire RPM range of your race engine. This is accomplished through the use of an advanced Hall-effect style pickup which is then converted to a signal that most CD ignition controls accept. The benefit of a Hall-effect pickup is there is no retard, commonly called magnetic pickup compensation, so you can ensure your timing remains stable from idle to race RPM.

Inside the CNC-machined billet housing is a polished stainless steel shaft that is supported with sealed ball bearing on the top and a long bushing on the bottom. FAST® also has gone through great strides to reduce end play in the distributor to take out any timing variations and damage to the gear.

Each distributor is supplied with a high-quality rotor and distributor cap. A FAST® Ignition Control (E6 or E7 series) must be used. Note that there is no mechanical advance, the timing is locked out.

Race Billet Distributors are available with a large diameter Ford style cap or smaller diameter GM points size cap with HEI terminals. Also, each application is available with either a steel, bronze or composite gear or even without a gear.



LARGE CAP

	Steel Gear	Bronze Gear	Composite Gear	No Gear
Small Block & Big Block Chevrolet	1000-1510	1000-1510B	1000-1510C	1000-1510NG
Chevrolet Hex Drive	1000-1512	1000-1512B	1000-1512C	1000-1512NG
Chrysler LA 273-360	1000-1810	1000-1810B	1000-1810C	1000-1810NG
Small Block Ford	1000-1610	1000-1610B	1000-1610C	1000-1610NG
Ford Windsor	1000-1612	1000-1612B	1000-1612C	1000-1612NG
Ford 351C, 429-460	1000-1614	1000-1614B	1000-1614C	1000-1614NG
Ford FE	1000-1616	1000-1616B	1000-1616C	1000-1616NG
Holden	1000-1710	1000-1710B	1000-1710C	1000-1710NG

SMALL CAP

	Steel Gear	Bronze Gear	Composite Gear	No Gear
Small Block & Big Block Chevrolet	1000-1511	1000-1511B	1000-1511C	1000-1511NG
Chrysler LA 273-360	1000-1811	1000-1811B	1000-1811C	1000-1811NG
Chrysler B Engine 383-400	1000-1812	1000-1812B	1000-1812C	1000-1812NG
Chrysler RB Engine 426-440	1000-1813	1000-1813B	1000-1813C	1000-1813NG
Small Block Ford	1000-1611	1000-1611B	1000-1611C	1000-1611NG
Ford Windsor	1000-1613	1000-1613B	1000-1613C	1000-1613NG
Ford 351C, 429-460	1000-1615	1000-1615B	1000-1615C	1000-1615NG
Ford FE	1000-1617	1000-1617B	1000-1617C	1000-1617NG
Holden	1000-1711	1000-1711B	1000-1711C	1000-1711NG

For replacement distributor caps, rotors, gears and accessories see page 25.

Race Billet Distributor Replacement Parts

Race Billet Distributor Deutsch 3-Pin Connector/Terminal Kit	6000-6724
Slip Collar for Chevrolet Race Billet Distributors	1000-1209

Distributors

DUAL-SYNC

MADE
IN USA

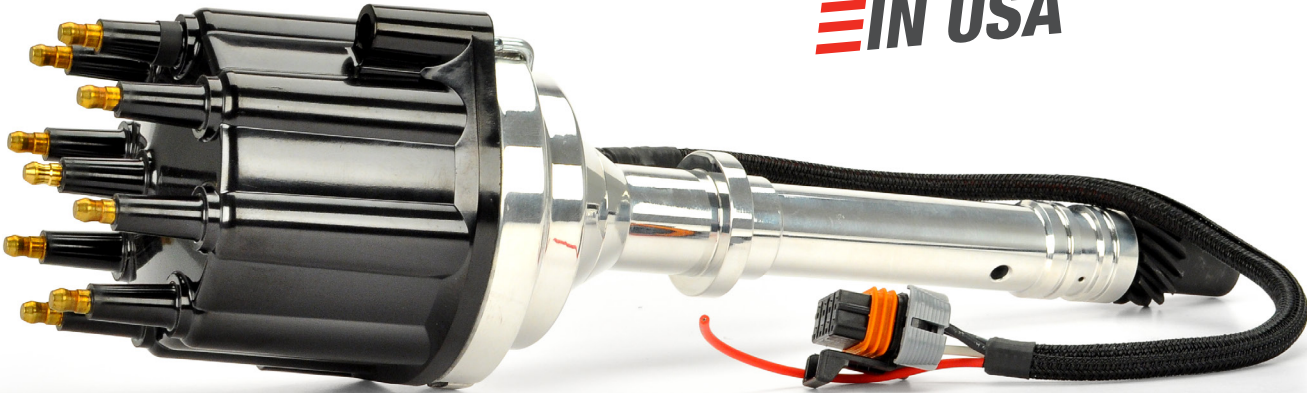

#305007

Dual-Sync Distributors

FAST® Dual-Sync Distributors are designed for a simple drop-in, plug-and-play solution for V8 engines running a fully sequential EFI system. Each distributor feature reluctors and pickups that are properly aligned saving you a lot of time during setup with no need to worry about rotor phasing.

Each Dual-Sync Distributor is based on an accurate CNC-machined 6061-T6 aluminum housing that fits with a ball bearing guide to ensure long life and stability at higher RPM. Hall-effect pickups are used to trigger both the ignition circuit as well as the cam sync signal and all of the wiring is routed into a single connector for a sealed and locked connection to a FAST® XFI™ or EZ-EFI 2.0® fuel injection system.

- Dual pickups deliver the required signals for the ignition and fuel injection
- Reluctors and pickups are properly aligned out of the box for easy installation
- Strong signal magnetic pickups are impervious to electronic noise and are maintenance-free
- CNC-Machined billet aluminum housings for absolute strength and accuracy
- Direct plug-in installation to FAST® XFI™ and EZ-EFI 2.0®

Small/Big Block Chevrolet	305005
Tall Deck Big Block Chevrolet	305017
Small Block Ford	305007
Ford Windsor	305009
FE Ford	305010
Ford 351C-460	305015
Chrysler LA 273-360	305011
Chrysler B Engine 383-400	305012
Chrysler RB Engine 426-440	305013
Pontiac	305016
Oldsmobile	305018

Distributors

CIRCLE TRACK PRO RACE

MADE
IN USA

Circle Track Pro Race Distributors

When it comes to high end circle track racing where engines demand the most accurate timing and reliable trigger signals, FAST® Pro Race Distributors are the only choice. These distributors are engineered from the inside-out to deliver the precise control and super-speedway endurance race teams require.

For the most reliable and accurate trigger signal, we incorporated dual optical trigger pickups. The signal from these optical pickups is then synthesized into a common magnetic trigger signal that can be used with most racing ignitions such as the E6 series. A stainless steel trigger wheel is incorporated which also allows for modifications so a custom cylinder-to-cylinder timing order could be created.

The wiring is routed into Weatherpak connectors that will plug into common wiring harnesses for sealed and locked connections. For high RPM endurance, the stainless steel distributor shaft rides in a ball bearing guide with two seals for optimum oil and vacuum control.

Each distributor is supplied with a bolt-down distributor cap, wire retainer and rotor. A FAST® E6 or E7 race series ignition is required (see page 5). Distributor gear is NOT supplied.

- **The most accurate and advanced distributor for racing**
- **Approved for use in NASCAR competition**
- **Dual optical triggers are synchronized to within $\pm 0.2^\circ$**
- **Electronically synthesized magnetic pickup signals trigger most CD ignitions**
- **Double lip seals for oil and vacuum control**
- **LED displays operation status of each optical pickup**
- **Stainless steel reluctor can be modified for individual timing capability**

Small Block & Big Block Chevrolet	1000-1400*
Small Block & Big Block Chevrolet Single Trigger	1000-1430
Small Block Ford	1000-1441
Ford Windsor	1000-1401*
Ford Windsor 90° Trigger	1000-1421
Ford FR9 Forward/R45	1000-1451*
Toyota (Deutsch)	1000-1412*

*Approved for use in NASCAR competition



CUTAWAY VIEW

Distributors

CRANK TRIGGER & GEARS

Crank Trigger Distributors

You can't beat the accuracy of a crank trigger when it comes to timing signals, however you still need a distributor to transfer the high voltage from the coil to the spark plugs. FAST® Crank Trigger Distributors are designed for strength and reliability.

Small & Big Block Chevy	1000-1520
Small Block Ford	1000-1620
Ford Windsor	1000-1622
Ford 351C, 429-460	1000-1624
Holden	1000-1720

For replacement distributor caps, rotors, gears and accessories see page 25.

- Strong and precise housing is CNC-machined from 6061-T6 aluminum
- High-quality injection molded cap and rotor resist spark scatter
- Large diameter cap allows for rotor phasing changes during timing retard
- Supplied with copper alloy gear



#1000-1620

DISTRIBUTOR GEARS

STEEL GEARS

These gears are made to work with induction hardened and carburized steel billet roller cams and flat tappet camshafts.

BRONZE GEARS

On race engines running an 8620 steel billet cam or high volume oil pumps, these high silicon copper alloy (aluminum bronze) are required.

RACE BILLET DISTRIBUTOR GEARS

Application	Steel	Gear I.D.	Bronze	Gear I.D.	Shaft O.D.
Chevrolet	11951-1	.492	11990-1	.491	.491
Small Block Ford	36971-1	.500	36989-1	.499	.499
Ford 351W	44970-1	.531	44990-1	.530	.530
Ford 351C	52971-1	.531	44990-1	.530	.530

CIRCLE TRACK PRO RACE DISTRIBUTOR GEARS

Application	Steel	Gear I.D.	Bronze	Gear I.D.	Shaft O.D.
Chevrolet	11950-1	.500	11979-1	.499	.499
Ford Small Block	44970-1	.531	44990-1	.530	.530
Ford 351W	44970-1	.531	44990-1	.530	.530

Miscellaneous Accessories

Distributor Gear Pin – 3/16" x 7/8" for GM	1000-1560
Distributor Gear Pin – 3/16" x 3/4" for Ford	1000-1561



Distributors ACCESSORIES

HEI Distributor Accessories and Replacement/Maintenance Components

Advance Lock-Out Kit	1000-2503
Adjustable Vacuum Canister	1000-2512
Distributor Cap, Coil Cover & Rotor Kit – Black	1000-2506



External Coil Kit For An HEI

This kit allows you to install an external coil with on an HEI distributor and includes an adapter and FireWire® coil wire (coil not included).

External Coil Kit For HEI	730-0590
---------------------------	----------



HEI/CD Ignition Conversion Kit

This kit allows you to run a remote-mount coil and E6 Ignition Control.

HEI/CD Ignition Conversion Kit - Includes E6 Circle Track Ignition & E92 Coil	6000-2500
---	-----------

Race Billet Distributor Replacement/Maintenance Components

Distributor Cap – Large	1000-1550
Distributor Cap Adapter	1000-1551
Distributor Cap – Small	1000-1552
Rotor – Small	1000-1556
Rotor – Large	1000-1557
Car Side Harness – Race Billet Distributor	6000-6717
Car Side Harness – Race Billet Distributor to MSD Ignition	6000-6719



Dual-Sync Distributor Replacement/Maintenance Components

Distributor Cap & Rotor	305014
Distributor Cap	305014C
Module	305014M
Rotor	305014R

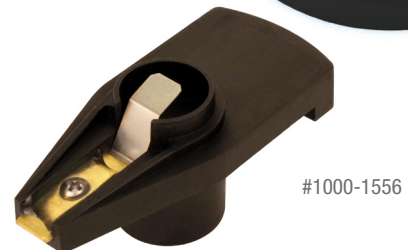

Circle Track Pro Race Distributor Replacement/Maintenance Components

Distributor Cap	1000-1403
Distributor Cap Adapter	1000-1411
Wire Retainer Distributor Cap	1000-1408
Rotor	1000-1558
Fiber Optic Trigger	1000-5500
Dashboard Mount Fiber Optic Trigger Interface Converter	1000-5600
Optical Trigger Sensor Unit – Weatherpak	1000-1424
Replacement Hardware Kit	1000-1406

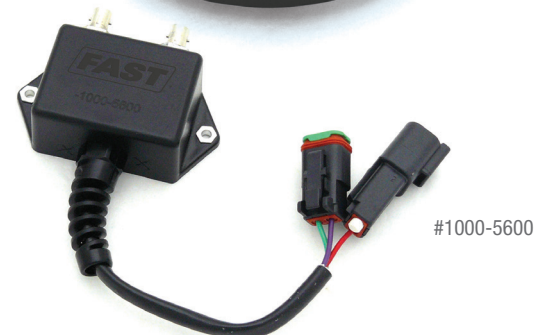
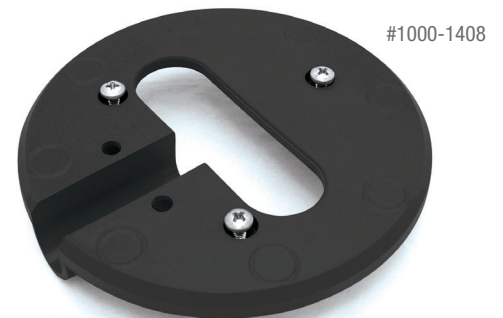

FireWire® Spark Plug Wires

INTRO

MADE
IN USA

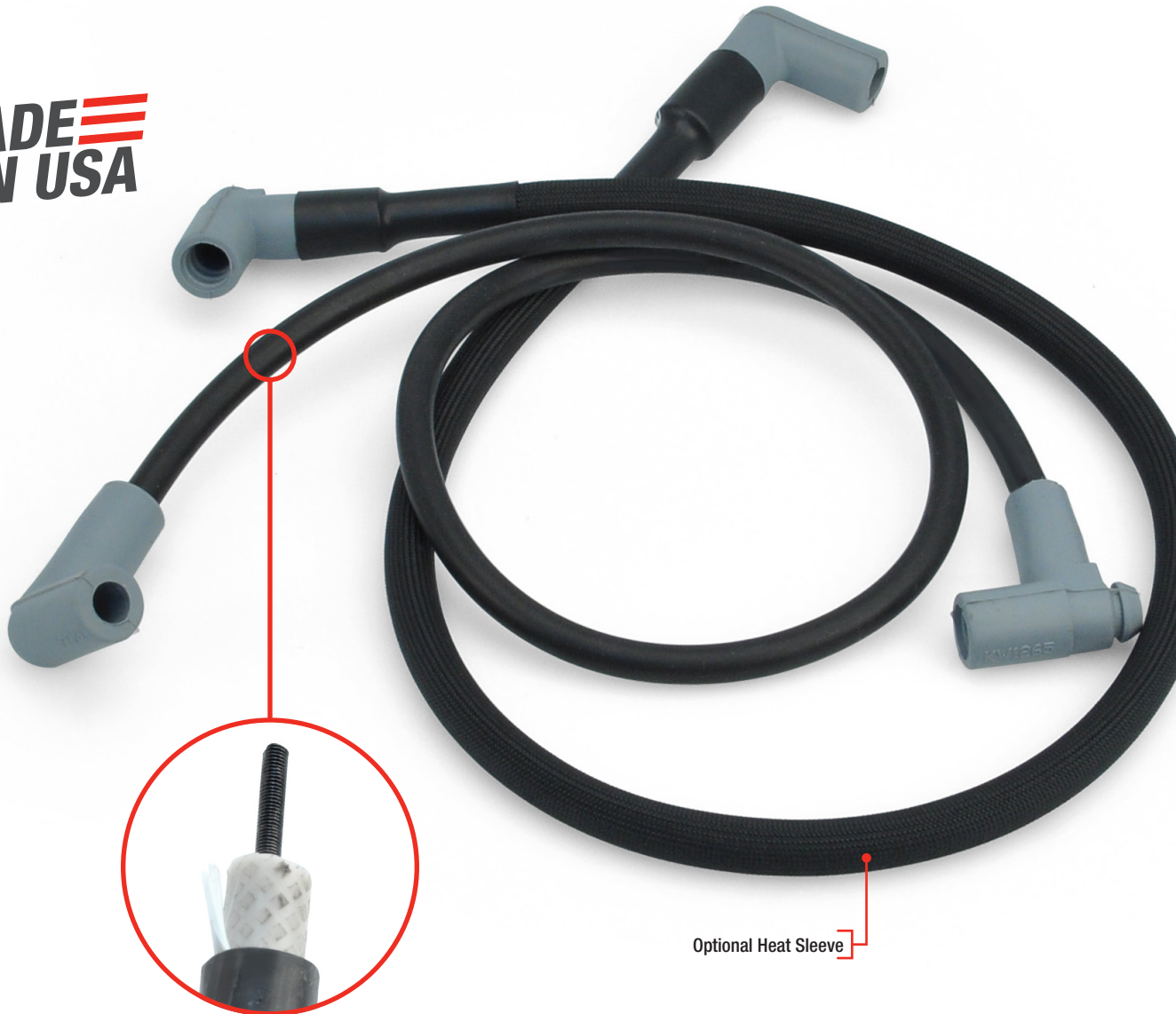

FireWire® Spark Plug Wires

Having a high powered ignition control is only half the equation when it comes to your engine's performance – you also need to ensure that the voltage makes it to the spark plug! The FAST® FireWire® Spark Plug Wire was designed for performance and racing from the inside-out!

For FAST®, one of the most important aspects of engineering the low resistance FireWire® was to ensure it could effectively filter the electro-magnetic interference and “noise” that occurs within all spark plug wires. The answer lies within a unique reactive core design that effectively suppresses EMI ensuring trouble-free operation of the ignition control, EFI system and other on-board electronics.

From a performance standpoint, the conductor of the FireWire® features the lowest resistance, less than 25 ohms per foot. Less resistance means the most spark energy reaches the plug gap for every firing. To combat the extreme conditions that wires face under the hood, the core and conductor are protected with a sleeve of double-layered silicone. This design is effective against header heat, oils and abrasion, and to complete the package, our silicone boots can withstand 550°F!

- **The lowest resistance wire available with only 25 ohms per foot**
- **Extreme suppression capabilities prevent electronic interference**
- **Low resistance means more spark energy reaches the spark plugs**
- **Silicone plug boots handle 550°F for long life**
- **Silicone-on-silicone sleeve construction resists high temperatures and abrasion**
- **Available in custom, universal and sets with heat sleeve installed**

FireWire® Spark Plug Wires KITS

FireWire® with Heat Sleeve

We understand the needs and desires of racers, which is why we also offer our low-resistance FireWire® Plug Wires in kits with a special heat sleeve. The FAST® Heat Sleeve is a braided fiberglass sleeve that provides an extra level of protection against heat. In fact, the heavy-duty sleeving will withstand up to 1,200°F!

These FireWire® sets are also supplied with cylinder number heat shrink ends to secure the sleeve and help you identify each wire. Sets are available in custom and cut-to-fit applications.



Universal FireWire® Kits

The FAST® FireWire® Universal Kits are designed to allow you to route and cut your wires to fit exactly how you prefer. Each wire is supplied with the spark plug terminal and boot installed and the distributor side loose. HEI style and socket terminals and boots, along with a coil wire side, are included with each kit.

Custom FireWire® Kits

These kits are cut to specific lengths and terminated on both ends for a direct plug-in and fire it up installation!

8.5mm FireWire® Custom Fit

	Spark Plug Boot	Distributor Terminal	FireWire® Set	FireWire® w/ Heat Sleeve
CHRYSLER				
2001-Present 2.4L DOHC, SRT-4, PT Turbo	–	–	255-4040	–
SMALL BLOCK CHEVY				
All Over Valve Covers	90°	HEI	255-2402	–
All Under Headers	90°	Socket	255-2405	–
All Under Headers	90°	HEI	255-2407	–
BIG BLOCK CHEVY				
All Under Headers	90°	HEI	255-2416	295-2416
LS1/LS6				
2002-Present Truck LS1 Vortec	–	–	255-2420*	–
2002-Present Camaro, Corvette, Firebird	–	–	255-2419*	–
GM				
GM Sprint Car	90°	–	255-2404	–
USAR Pro Cup Motor	90°	–	–	255-2401
FORD				
351W	45°	HEI-Style	255-2426	295-2426

*Firewire for LS applications are based on an 8mm sleeve for the best fit to factory style coils

8.5mm FireWire® Universal Cut-To-Fit Sets

	Spark Plug Boot	Distributor Terminal	FireWire® Set	FireWire® w/ Heat Sleeve
4 CYLINDER				
Universal	Straight	HEI/Socket	255-0041	–
6 CYLINDER				
Universal	Straight	HEI/Socket	255-0061	–
8 CYLINDER				
Universal	Straight	HEI/Socket	255-0081	295-0081
Universal	90°	HEI/Socket	255-0082	295-0082
Universal	45°	HEI/Socket	255-0083	295-0083

FireWire® Spark Plug Wires

ACCESSORIES

Bulk FireWire® Terminals & Boots

Whether you're looking for bulk supplies to build a number of FireWire® Plug Wire sets or just like to have a few boots and terminals on-hand for maintenance, FAST® offers a number of terminals, boots and wire separately.

100" Roll Firewire	255-0001	
	2-Pack	25-Pack
Straight Spark Plug Boots & Terminals	255-0011-2	255-0011-25
90° Spark Plug Boots & Terminals	255-0010-2	255-0010-25
45° Spark Plug Boots & Terminals	255-0013-2	255-0013-25
90° Cannister Coil Boots & Terminals	255-0025-2	255-0025-25
90° HEI Spark Plug Boots & Terminals	255-0032-2	255-0032-25



#255-0001

Cylinder Number Shrink Sleeve

Save time in the shop and the pits with these Heat Shrink Cylinder Numbers. They simply slide over the boot and wire or will help secure the Heat Sleeve once heat is applied to shrink them in place.

Cylinder Number Heat Shrink Kit – 8.5mm Universal	230-0007
---	----------



#230-0007

Locking Coil Wire For I91/E92

This 40-inch long cut-to-fit wire is supplied with a boot and terminal installed that locks in place on the FAST® coils. A socket and spark plug-style terminal are supplied to install on the distributor cap.

Locking Coil Wire For I91/E92 Coils (Custom Retainer Fitted to Coil Boot)	235-0001
---	----------



#235-0001

Replacement Coil Wire

This 10-inch long FireWire® features 90° spark plug style terminals and boots on each side.

Replacement Coil Wire – 10.5" Long w/ 90° HEI Boots	235-0004
---	----------



#235-0004

Locking Coil Wire Retainer Boot

This unique retainer locks the coil wire to a FAST® I91 or E92 Coil.

Locking Coil Wire Retainer Boot	235-0003
---------------------------------	----------



#235-0003

Miscellaneous

TESTERS & TOOLS

Digital Tester

This useful tool will not only check and confirm the operation of your FAST® E6 CD Ignition Control and Coil, it will also verify the accuracy of your tachometer, rev limiter and any other RPM controlled device.

The tester simply plugs inline on the 6-pin Weatherpak connector of most E6 ignitions and is supplied with a load/test plug that you install on the coil wire at the distributor cap. With the ignition on, you can simulate a trigger signal that fires the ignition and coil. From there you can compare the tester's accurate digital readout with the tachometer and also test the function of any RPM activated switch such as for a nitrous solenoid or shifter. A very useful tool to have on hand.

CD Ignition & Rev Limit Digital Tester	1000-1050
--	-----------



Pro Digital Timing Light

When it comes to checking and setting your ignition timing, the accuracy is going to be in the light and the FAST® Pro Digital Timing Light is built for heavy-duty use in the garage or pits. The light has a removable harness that is great for storage (as well as the rare case of pulling off when it contacts a spinning engine component), along with a melt-free metal inductive pickup. There is a backlit LCD screen that displays the RPM and timing of the engine and allows you to digitally dial back the timing to confirm the total timing without revving the engine to the moon in the garage. Supplied with a heavy-duty storage case.

Pro Digital Timing Light	1000-1130
--------------------------	-----------



Pro Internal Engine Inspection Camera

This handy tool allows you to take a peek inside the cylinder or intake ports to inspect for damage or other issues. The fiber optic camera is easy to move around inside the engine and the scene is viewed on the 2.4-inch color monitor of the module.

Pro Internal Engine Inspection Camera	1000-1140
---------------------------------------	-----------



The background of the advertisement is a detailed, high-contrast black and white photograph of an engine's internal components, including the intake manifold and various valves. The lighting creates strong highlights and deep shadows, emphasizing the mechanical complexity. A "FAST" logo is visible on one of the engine parts.

The Leading Name In Fuel Air Spark Technology

EFI SYSTEMS • FUEL SYSTEMS • INTAKE MANIFOLDS • IGNITION SYSTEMS

Hot Products



Table Of Contents

Resources

EZ-EFI® Advisor.....	2	How To Order An XFI 2.0™ System.....	32
EZ-EFI 2.0® Comparison	16	Intake Manifold Selection Chart.....	48
XFI™ & EZ-EFI - Which Is Right For Me?	23	Frequently Asked Questions	64
XFI™ Advisor	24	Limited Warranty Policy	65

EZ-EFI® Fuel Self Tuning Fuel Injection System

System Information	3
Components.....	4

KITS

Base Kit.....	6
Master Kit w/ In-Tank Fuel Pump Kit	6
Master Kit w/ Inline Fuel Pump Kit.....	6
Multi-Port Retro-Fit Kit.....	7
Dual Quad Upgrade Kit.....	7
Jeep Kit.....	7
EZ-EFI® Marine Kits.....	7
Multi-Port Kits	8
Sidedraft Induction System.....	8

ENGINE KITS

GM LS Engine Kit.....	9
GM LS Engine Kit w/ EZ-TCU.....	9
GM LS Engine & Manifold Kit.....	10
GM LS Engine & Manifold Kit w/ EZ-TCU.....	10

Accessories.....	11
HEI Distributor For Chevy	11
Cable Mount Kit	11
Hand-Held Touchscreen Upgrade Kit	11

EZ-EFI 2.0® Fuel + Ignition Self Tuning Fuel Injection System

System Information	13
Components.....	14

KITS

Base Kit.....	18
Master Kit w/ In-Tank Fuel Pump Kit	18
Master Kit w/ Inline Fuel Pump Kit.....	18
Master High Horsepower Kit w/ Inline Fuel Pump Kit.....	19
Multi-Port Retro-Fit Kit.....	19
LS Self Tuning Engine Control Kit	19
Multi-Port Kits	20
Cable Mount Kit	20
8-Stack Induction Systems.....	21
Sidedraft Induction Systems.....	21

XFI™ Sportsman Engine Management System

System Information	26
Base Kits	26
Blow-Through Supercharger Kit.....	27
Roots Blower Dual Quad Kit	27

XFI 2.0™ Fuel Injection System

System Information	28
Complete XFI™ Kits.....	31
EFI Crate/Transplant Kits	31

BASE COMPONENTS

Harnesses	32
EZ-LS™ Ignition Controller.....	33
XIM™ Ignition Controllers.....	33
XR-1A High-Output Ignition Coil Set	33
Ignition Adapter Harnesses & Connector Kits	33
Dual-Sync Distributors.....	34
Crank Triggers.....	34
E6/E92 Digital CD Ignition & Coil Kits	35
E7 Ignition Controller.....	35

EFI Components & Accessories

eDash	36
Touchscreen Dash/Data Logger	36
Exhaust Gas Temperature (EGT) Module	37
3-Axis Accelerometer Module.....	37
Bump Stager	37
Upgrade Options.....	38
Optional Harnesses & Connector Kits.....	38
Connector Cables	38
Plug & Play Dry Nitrous Kits	38
Sensors & Sensor Kits.....	39
Relays.....	39
Throttle Position Sensor (TPS)	39
Coolant Temperature Sensor (CTS).....	39
Air Temperature Sensor (ATS).....	39
Oxygen Sensors	40
Pressure Sensors	40
Manifold Absolute Pressure Sensors (MAP).....	40
Idle Air Control Motor (IAC)	41
Driveshaft Speed Sensor Kit	41
Boost Control Solenoid	41
Fuel Injectors.....	42

Intake Manifolds & Throttle Bodies

LSX™ 92mm Intake Manifold	44
LSX _R ™ 102mm Intake Manifolds	45
LSX _R ™/LSX _{RT} ™ Intake Runners.....	46
LSX _{RT} ™ 102mm Intake Manifold	47
Fuel Rails.....	50
Single Plane Intake Manifolds	51
Fuel Injector Bunges	51
Big Mouth Throttle Bodies™.....	52
4 Barrel Throttle Bodies.....	53
Seals & Hardware	54
Porting Tools.....	54

Fuel Systems

Race Fuel Systems.....	55
Street/Strip Fuel Systems.....	56
Fuel System Components.....	57

Air/Fuel Meters

Wide-Band Digital Air/Fuel Meters.....	58
Digital Air/Fuel Meter RPM Module.....	59
Air/Fuel Ratio Module Kits.....	59
Digital Air/Fuel Meter Interior Mount Kit	59
Wide-Band Air/Fuel Gauge Kit	59
EZ-Clamp-On Tailpipe Wide-Band Sensor Mount Kit.....	59

Electronic Programmers & Controllers

EZ-TCU™ Transmission Controller	60
FAST-Flash™ Power Programmers.....	60

Miscellaneous

Valve Covers.....	61
Air Cleaner.....	61
Terminal Tools.....	61
Carburetor Jets	62
Merchandise.....	63

EZ-EFI® ADVISOR

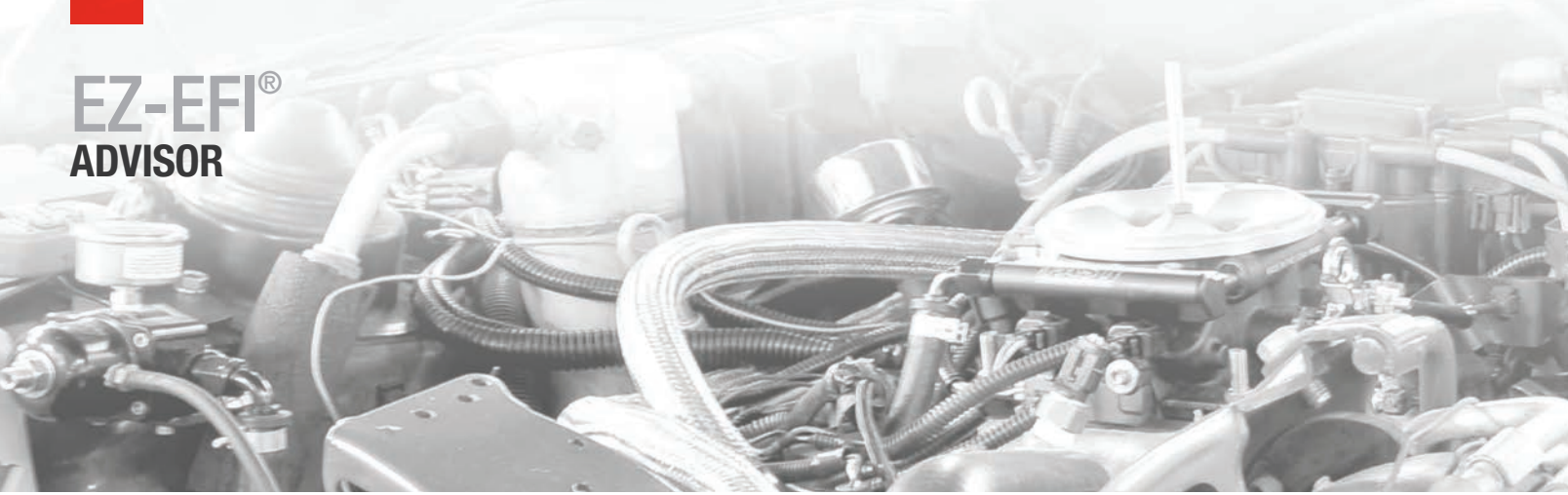

Incredibly Advanced. Seriously EZ.

In the past, carburetor-to-EFI conversion was no picnic. At the very least, you needed a laptop and significant tuning experience. But thanks to FAST™ engineers utilizing thirty years of experience in fuel injection strategy, those days are over. With the EZ-EFI® Self Tuning Fuel Injection Systems, you get EFI technology that does all the work for you. Simply hook it up, answer the basic Setup Wizard questions on the included hand-held display, and the system tunes itself as you drive. As the most popular self tuning EFI systems on the market today, FAST™ EZ-EFI® systems have thousands of successful installs.

FAST™ offers two EZ self tuning systems. First is the original EZ-EFI®, now known as EZ-EFI® Fuel, with more advanced features than the first generation EZ-EFI®, as well as providing better fuel distribution and airflow for systems up to 650 horsepower. Second is EZ-EFI® 2.0 Fuel + Ignition that builds from the proven EZ-EFI® foundation, adding the ability to control ignition, eight progressively staged fuel injectors with 1200 horsepower capability and the most advanced and intuitive Setup Wizard on the market.

With both systems available, along with numerous master systems comprised of the base EZ-EFI® Fuel/EZ-EFI® 2.0 Fuel + Ignition kits and other FAST™ components, you're sure to find exactly what suits your specific application's needs to convert from a carbureted setup to electronic fuel injection. Don't worry, it's never been EZ-ier.

EZ-EFI® Advisor

Answer each question below for help deciding which system serves your needs.

QUESTIONS

APPROVED SYSTEMS

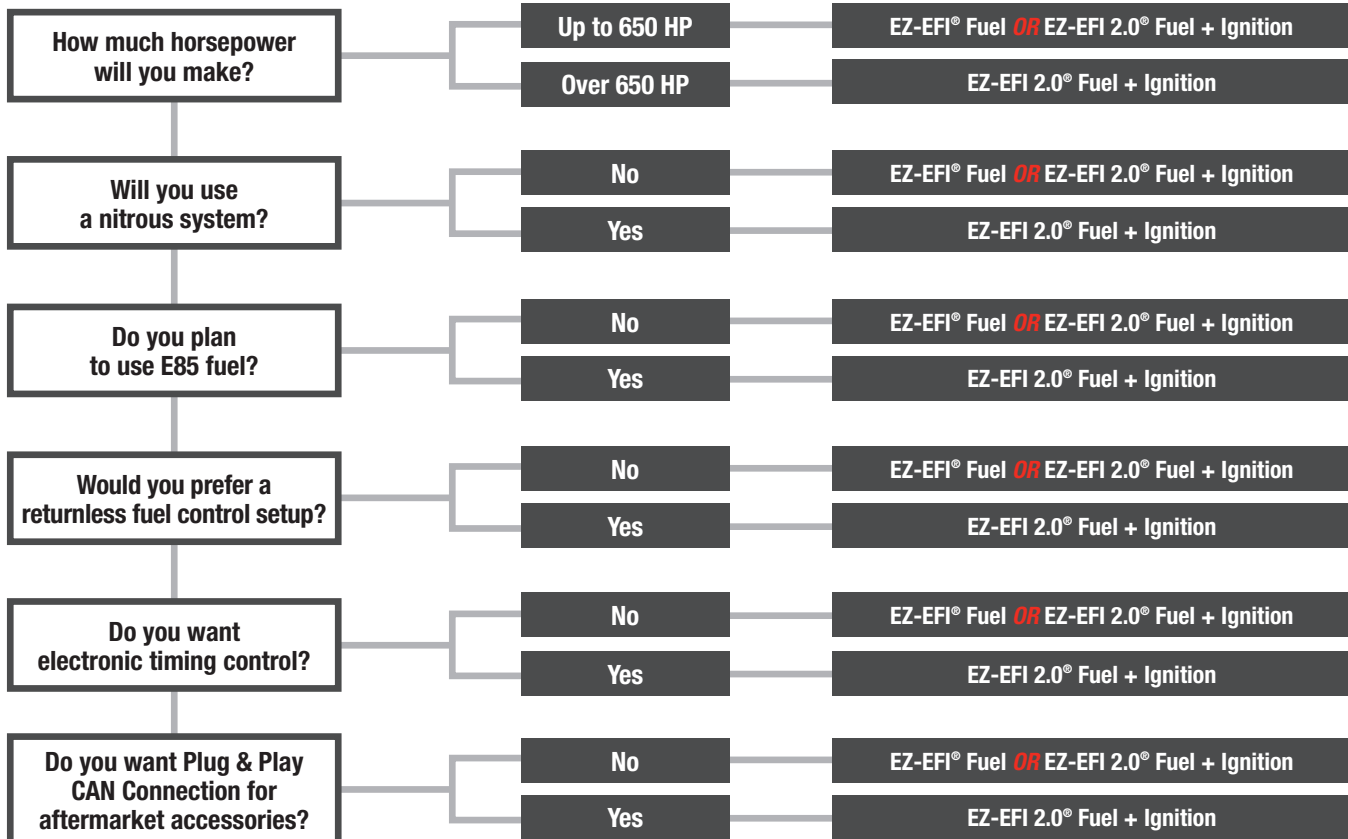

EZ-EFI® FUEL SELF TUNING FUEL INJECTION SYSTEM



NEW DESIGN



The next generation of the world's simplest self tuning fuel injection system is here. Designed for all applications making up to 650 horsepower, the EZ-EFI® Fuel system easily bolts onto any carbureted or multi-port application in a single afternoon, making it the easiest EFI system you will ever install. Simply hook up the system, answer the questions from the improved Setup Wizard on the color touchscreen hand-held unit, and the system will tune itself as you drive.

The hand-held includes a variety of display dashes, a clean and easy to use interface and an LED indicator that can alert users to errors (including overheating) or be used as a shift light. An updated wiring harness features a premium loom, added protective fuses and a streamlined design, while the ECU hardware has been updated to provide added protection against electrical/ignition noise and hardware damage.

FAST™ EZ-EFI® Fuel now features a die cast and black powder-coated four injector throttle body with integrated fuel rails. It provides even better fuel distribution and more airflow than the original, and *NO manifold replacement is needed*. In addition to matching any 4150-style carbureted manifold, the EZ-EFI® Fuel Self Tuning Fuel Injection System also works with your original carb-style throttle linkage and features OEM sensors, including standard GM versions available at any auto parts store. What's more, it works with all ignition setups – including HEI. EZ-EFI® Fuel can be installed easily in an afternoon and is a “must have” for your street rod or muscle car.

For more aggressive applications, the EZ-EFI® Dual Quad Upgrade Kit is capable of supporting 1200+ horsepower engines with dual quad carburetor-type manifolds. In addition, the Multi-Port Retro-Fit EZ-EFI® allows owners of multi-port fuel injected applications to experience the benefits of EFI with no limit on horsepower because the system is based on each customer's supplied injectors. Meanwhile, the EZ-EFI® Jeep Kit with Inline or In-Tank Fuel Pump Kit is engineered specifically to work with the unique requirements of 1972-1991 Jeep CJ/YJ 4.2L, 6-cylinder applications.

- Standard single throttle body system handles up to 650 HP
- 4150 throttle body works with original carb-style linkage & uses all OEM sensors
- NO tuning experience or laptop needed; intuitive Setup Wizard guides you through the start-up process & the system tunes itself
- Works with any ignition setup – including HEI
- Carb replacement, dual quad, multi-port, & Jeep specific systems available
- Built-in diagnostics & “limp mode” provide maximum engine protection in the event of trouble
- Made in the USA

Base Kit Includes:

- Engine Control Unit (ECU)
- Color Touchscreen Hand-Held Unit w/ Mount
- 650 HP-Capable Throttle Body w/ Integrated Fuel Injectors, Sensors & Rails
- Fully Mesh Wrapped Wiring Harness w/ Added Protective Fuses
- Wide-Band O₂ Sensor
- Installation Hardware
- Chrome EZ-EFI® Badge

EZ-EFI® FUEL COMPONENTS

ECU

- No software necessary; intuitive self-learning system will work with only a few simple questions answered in the hand-held's Setup Wizard & one throttle screw adjustment
- Capable of driving up to eight high-impedance fuel injectors in a bank-to-bank configuration
- Utilizes the Bosch LSU 4.2 wide-band O₂ sensor for closed loop control of the engine's air/fuel ratios
- Built-in diagnostics for easy troubleshooting
- Can control electric fuel pump, electric cooling fan & A/C line to raise idle RPM when A/C is turned on
- Weatherproof enclosure
- Nominal dimensions: 6"W x 3.5"H x 1.5"D

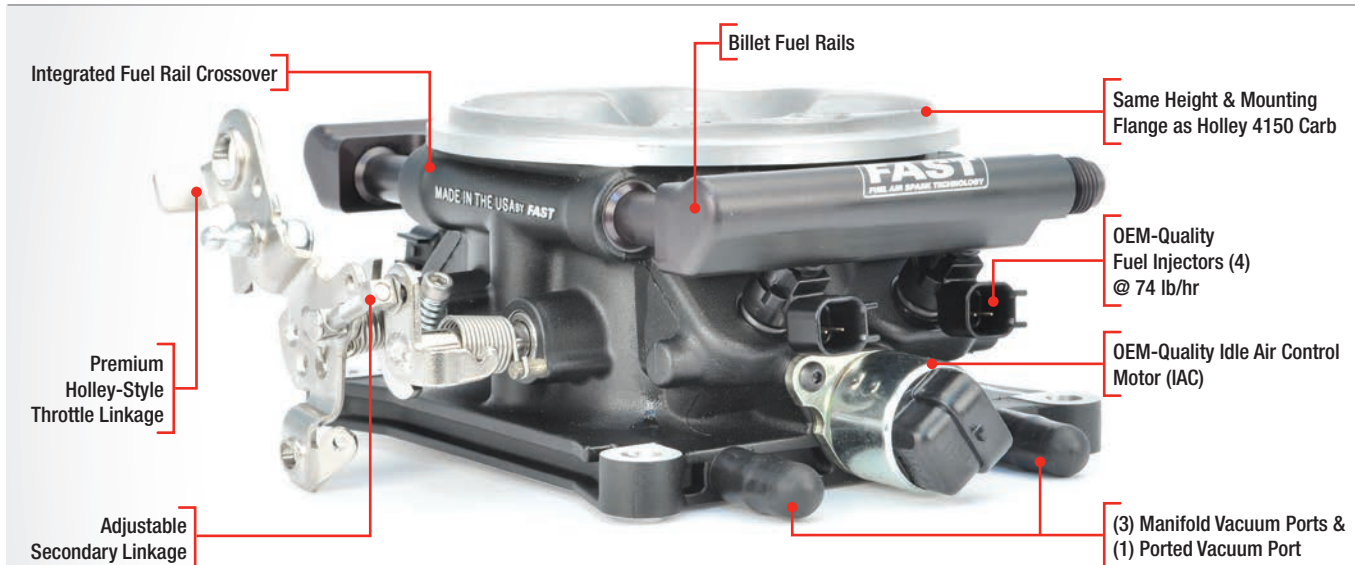
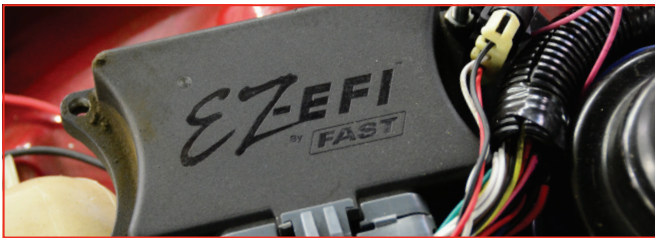

Throttle Body

- Direct bolt-on carb replacement with throttle body dimensions similar to Holley & other popular carburetors, including a Holley-style throttle linkage & 4150 square flange intake bolt pattern
- Includes injectors & fuel rails supporting up to 650 HP
- Advanced dyno-based design for proper fuel distribution in single & dual plane manifolds
- Lightweight aluminum construction
- Throttle body ships assembled with OEM-quality sensors & injectors

EZ-EFI® FUEL COMPONENTS



Color Touchscreen Hand-Held Unit

- Provides the only necessary interface to the ECU
- Setup Wizard guides you through start-up process
- Screens for viewing live running data
- Includes advanced tuner area where fuel can be adjusted or fine tuned for economy & best power
- Can be disconnected & stowed after initial setup

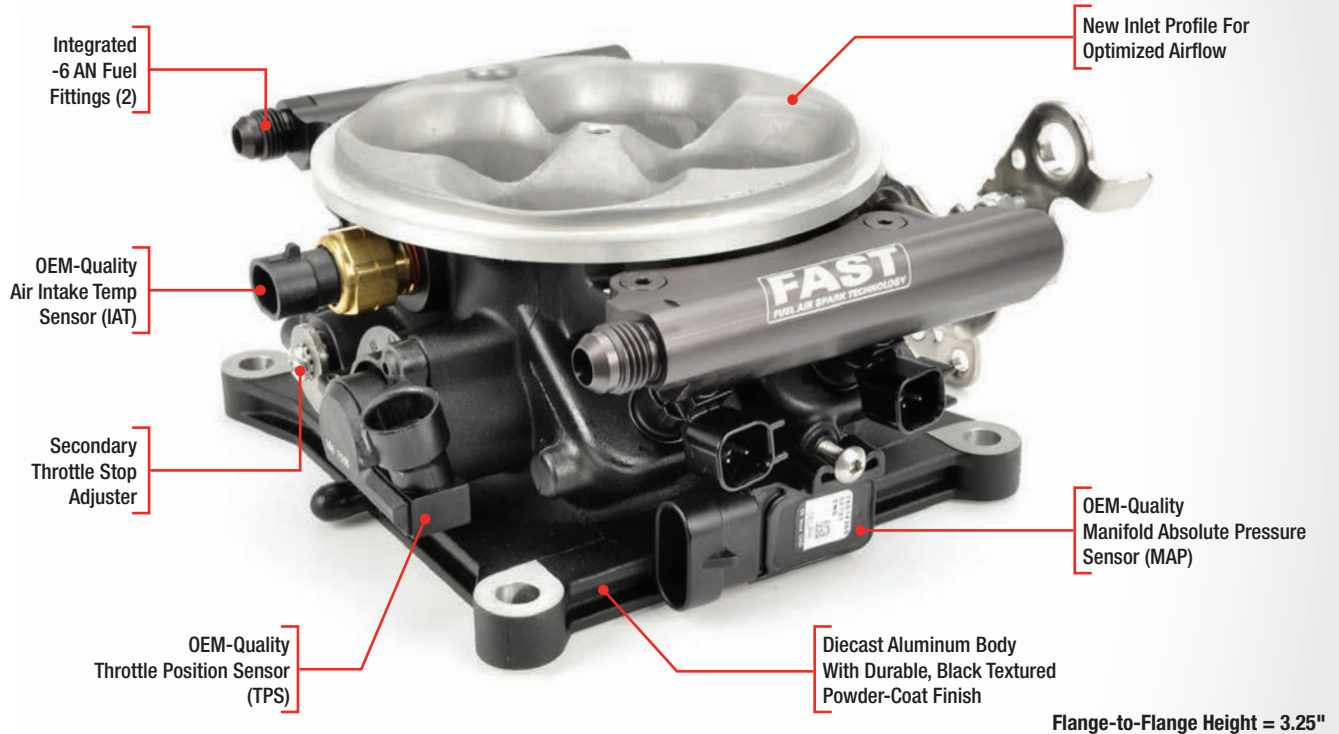
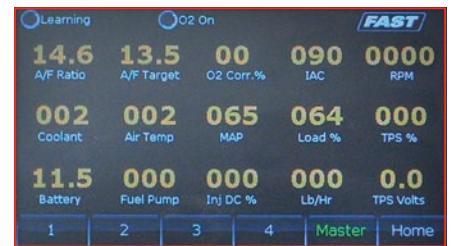
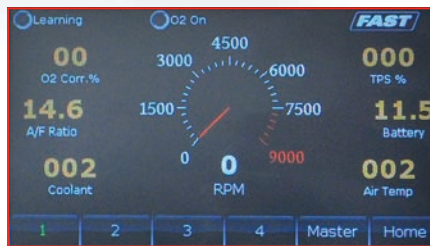

EZ-EFI® FUEL KITS

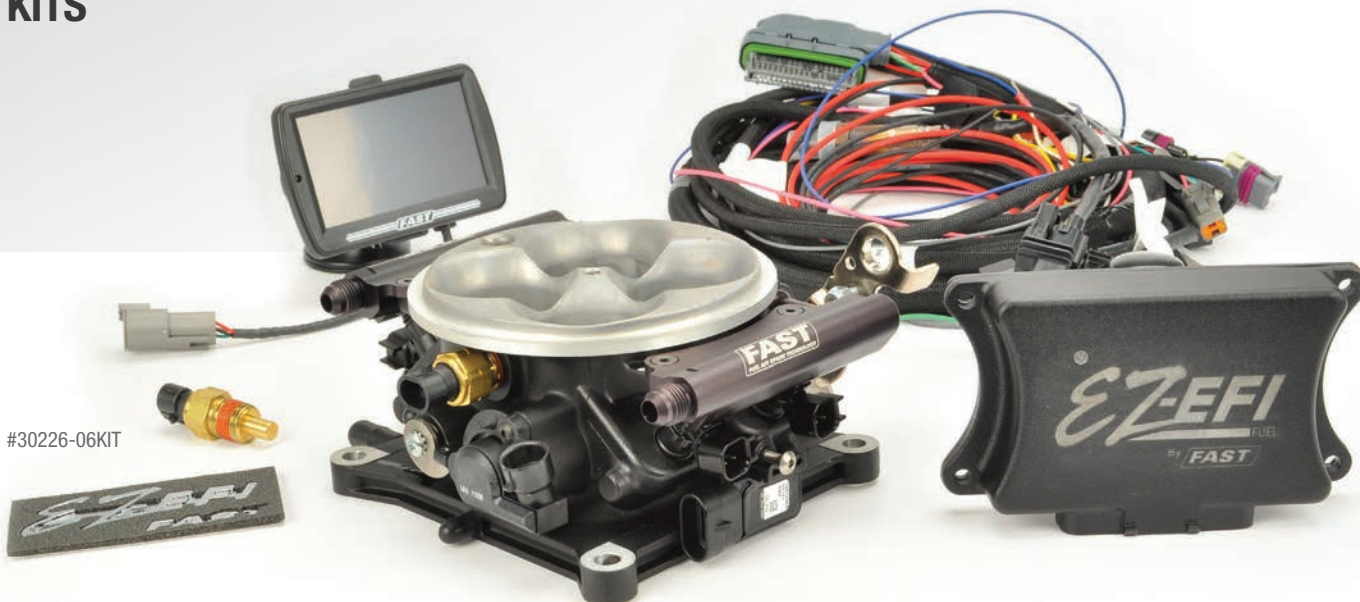

#30226-06KIT

EZ-EFI® Fuel Base Kit

Regardless of brand or engine size, the EZ-EFI® Fuel Base Kit bolts onto any 4150-style carbureted manifold, works with the original carb-style throttle linkage and includes all OEM sensors. **The EZ-EFI® Fuel Base Kit includes fuel injectors, fuel rails, a clearly labeled wiring harness, hand-held device, sensors, ECU and 4150 throttle body, which mounts onto any 4150 flange intake manifold.**

EZ-EFI® Fuel Self Tuning Fuel Injection System Base Kit 30226-06KIT

EZ-EFI® Fuel Master Kit With In-Tank Fuel Pump Kit

The EZ-EFI® Fuel Master Kit is now also available with an In-Tank Fuel Pump Kit. This kit includes a high pressure pump that is perfect for performance applications. Always primed and automatically cooled by the fuel in the tank, the pump is easily capable of supporting fuel flow for applications with up to 650 horsepower. The fuel system parts are designed to offer as much flexibility as possible for the broadest range of applications.

EZ-EFI® Fuel Self Tuning Fuel Injection System Master Kit w/ In-Tank Fuel Pump Kit 30447-06KIT



#30447-06KIT

EZ-EFI® Fuel Master Kit With Inline Fuel Pump Kit

The EZ-EFI® Fuel Master Kit With Inline Fuel Pump Kit includes all of the same components as the EZ-EFI® Fuel Base Kit but also includes an inline fuel pump kit that is able to support applications making up to 650 horsepower.

EZ-EFI® Fuel Self Tuning Fuel Injection System Master Kit w/ Inline Fuel Pump Kit 30227-06KIT



#30227-06KIT

In-Tank vs. Inline

Inline fuel pumps are easier to install than in-tank fuel pumps because the fuel tank does not have to be removed. However, there are several advantages to running an in-tank fuel pump versus an inline fuel pump. FAST™ engineers recommend an in-tank fuel pump when possible.

IN-TANK FUEL PUMP ADVANTAGES INCLUDE:

- Always Primed
- Runs Quieter
- Runs Cooler
- Method Used By All OEMs
- Required For Returnless Fuel Systems (EZ-EFI 2.0® Fuel + Ignition Only)

For individual fuel pump kits, see page 55.

EZ-EFI® FUEL KITS

EZ-EFI® Fuel Multi-Port Retro-Fit Kit

The EZ-EFI® Fuel Multi-Port Retro-Fit Kit allows owners of existing factory or aftermarket multi-port fuel injected applications to experience the benefits of an EZ-EFI® Fuel system with no limit on horsepower because the system is based on each customer's supplied injectors. The kit comes with everything needed to convert factory or aftermarket EFI systems into a complete FAST™ EZ-EFI® Fuel system.

EZ-EFI® Fuel Multi-Port Retro-Fit Kit

302000-06



EZ-EFI® Dual Quad Upgrade Kit

For more aggressive street rods and muscle cars, the EZ-EFI® Fuel Dual Quad Kit is capable of supporting 1200 horsepower engines. This system is an upgrade kit to the existing EZ-EFI® Fuel kits* and adds several additional parts, including a second unique throttle body, harness and linkage for use with existing dual quad carburetor-type manifolds.

* Must be used in conjunction with an EZ-EFI® Kit: #30226-06KIT, #30227-06KIT or #30447-06KIT.

EZ-EFI® Fuel Dual Quad Upgrade Kit

304155-06



EZ-EFI® Jeep Kit

The EZ-EFI® Fuel Jeep Kit is engineered specifically to work with the unique requirements of 1972-1991 6 cylinder Jeep applications. An exclusive FAST™ adapter plate for the throttle body eliminates the need to change manifolds, making this the only truly easy, bolt-on EFI kit for Jeeps on the market today. Jeep specific 4BBL, 2-injector EZ-EFI® Fuel throttle body.

EZ-EFI® Fuel Self Tuning Fuel Injection System Jeep Kit w/o Fuel Pump Kit

30294-06KIT

EZ-EFI® Fuel Self Tuning Fuel Injection System Master Jeep Kit w/ In-Tank Fuel Pump Kit

30296-06KIT

EZ-EFI® Fuel Self Tuning Fuel Injection System Master Jeep Kit w/ Inline Fuel Pump Kit

30295-06KIT



EZ-EFI® Marine

FAST™ EFI systems are ready to take to the sea with the self-tuning EZ-EFI® Marine kit that features the proven performance and reliability that comes standard in all FAST™ EZ-EFI® systems. The marine system upgrades the poor cold starting and rough idle often associated with boat engines running a carburetor, while improving overall performance and drivability.

The marine option is available as a complete kit that includes a blue ECU specific to the marine application, color touchscreen hand-held, specialized O₂ sensor bung and a die cast 4150-style, four-injector throttle body that supports up to 650 horsepower. It easily bolts on to engines using a 4150-style carburetor while allowing users to keep running their current ignition system. Also available are kits that include an inline fuel pump kit and a special adapter plate that allows for a simple bolt-on installation in a Mercury Marine wet exhaust system without any welding (fits most applications from the early 1980s to 2002).

EZ-EFI® Marine Base Kit w/ Universal O₂ Installation Kit

30362-06KIT

EZ-EFI® Marine Master Kit w/ Universal O₂ Installation Kit & Inline Fuel Pump Kit

30363-06KIT

EZ-EFI® Marine Base Kit w/ Mercury Marine O₂ Installation Kit

30364-06KIT

EZ-EFI® Marine Master Kit w/ Mercury Marine O₂ Installation Kit & Inline Fuel Pump Kit

30365-06KIT



EZ-EFI®

MULTI-PORT / SIDEDRAFT FUEL INJECTION KITS

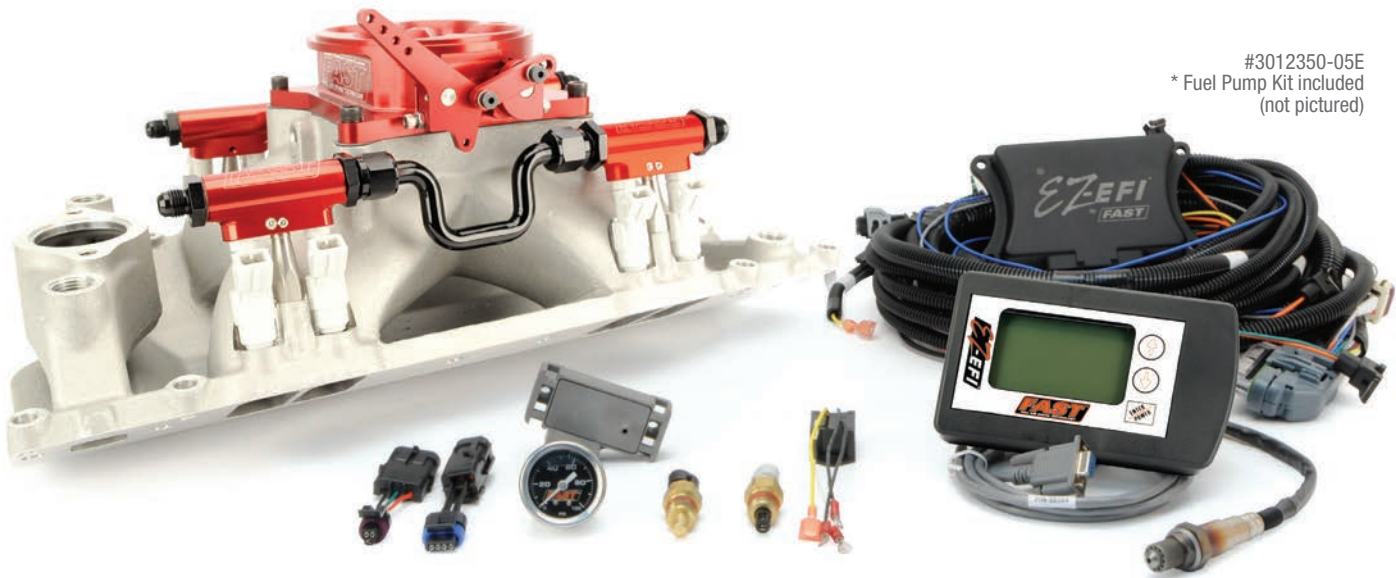

#3012350-05E
* Fuel Pump Kit included
(not pictured)

Multi-Port Fuel Injection Kits

Engineers at FAST™ have developed complete bolt-on EZ-EFI® Multi-Port Electronic Fuel Injection Kits that allow anyone to install a multi-port injection setup on Small and Big Block Chevy and Small Block Ford engines that were originally carbureted. These kits can be used on anything from mild street rods and muscle cars to 1,000 horsepower all-out race cars. EZ-EFI® Multi-Port Electronic Fuel Injection Kits include carefully matched components, including the EZ-EFI®, hand-held device, single plane EFI intake manifold, throttle body, Precision-Flow™ Fuel Injectors, fuel rails, fuel pump kit, all necessary sensors and clearly labeled wiring harnesses. These kits add style and function to any engine.

	Red Throttle Body	Polished Throttle Body
EZ-EFI® Fuel Injection Kit – SBC Up To 550 HP	3012350-05E	3012350-05EP
EZ-EFI® Fuel Injection Kit – SBC Up To 1,000 HP	3012350-10E	3012350-10EP
EZ-EFI® Fuel Injection Kit – BBC Up To 550 HP	3011454-05E	3011454-05EP
EZ-EFI® Fuel Injection Kit – BBC Up To 1,000 HP	3011454-10E	3011454-10EP
EZ-EFI® Fuel Injection Kit – BBC Tall Deck Up To 1,000 HP	3011572-10E	3011572-10EP
EZ-EFI® Fuel Injection Kit – SBF Up To 550 HP	3031302-05E	3031302-05EP
EZ-EFI® Fuel Injection Kit – SBF Up To 1,000 HP	3031302-10E	3031302-10EP
EZ-EFI® Fuel Injection Kit – 351W up to 550 HP	3035351-05E	3035351-05EP
EZ-EFI® Fuel Injection Kit – 351W up to 1,000 HP	3035351-10E	3035351-10EP

EZ-EFI® Sidedraft Induction System

EZ-EFI® Sidedraft EFI Systems combine proven FAST™ electronic fuel injection technology with Inglese™ sidedraft styling. Designed to work with the FAST™ EZ-EFI® System that supports up to 650 hp, they give customers a value-priced alternative to buying a full eight-stack system by adapting to an existing conventional four-barrel intake manifold. These adapter manifolds feature all necessary components, including integrated sensors, fuel rails and linkage, and easily bolt on to any engine using a single or dual plane 4150 flange 4-barrel intake. EZ-EFI® Sidedraft Systems make the same power as the standard four-barrel FAST™ EZ-EFI® throttle body with no loss in drivability. They are the ideal solution for adding both EFI performance and stunning looks to any hot rod or street machine.



EZ-EFI® Sidedraft Induction System NG4087E

#NG4087E

EZ-EFI® GM LS ENGINE TRANSPLANT KITS

The EZ-EFI® GM LS Engine Transplant Kits allow anyone to easily run a GM LS Gen III/IV engine and transmission outside of the original vehicle and factory controller. These FAST™ kits are the perfect no-headache solution for transplanting late model engines into street rods, muscle cars or other projects. Everything is covered, from fuel and spark to engine and electronic transmission. Optional package stages allow you to select the right level of kit based on your individual needs.



#302002L

EZ-EFI® Engine Kit

The Engine Kit combines the revolutionary self tuning EZ-EFI® with the bolt-on XIM™ Coil-Per-Cylinder Ignition System to provide LS applications with the easiest, most advanced self-tuning electronic fuel injection system available.

EZ-EFI® Engine Kit	302002
EZ-EFI® Engine Kit w/ In-Tank Fuel Pump	302002T
EZ-EFI® Engine Kit w/ Inline Fuel Pump	302002L



#302002-TCU

EZ-EFI® Engine Kit with EZ-TCU™

This kit combines the EZ-EFI® and XIM™ with the EZ-TCU™ for easy control of electronic GM 4-speed and TCI® 6-speed transmission shift points, shift firmness & shift speed, all without a laptop or tuning experience.

EZ-EFI® Engine Kit w/ TCU	302002-TCU
EZ-EFI® Engine Kit w/ TCU & In-Tank Fuel Pump	302002T-TCU
EZ-EFI® Engine Kit w/ TCU & Inline Fuel Pump	302002L-TCU

*See pg 60 for complete information on the EZ-TCU™

EZ-EFI®

GM LS ENGINE TRANSPLANT KITS



EZ-EFI® Engine & Manifold Kit

The Engine & Manifold Kit adds the FAST™ LSX_{RT}™ Intake Manifold, Big Mouth Throttle Body™ and fuel rails to the Engine Kit. This kit uses advanced fuel injection technology to easily provide additional 30+ horsepower gain with show quality looks.

EZ-EFI® Engine & Manifold Kit	302003
EZ-EFI® Engine & Manifold Kit w/ In-Tank Fuel Pump	302003T
EZ-EFI® Engine & Manifold Kit w/ Inline Fuel Pump	302003L



EZ-EFI® Engine & Manifold Kit with EZ-TCU™

For a complete powertrain control package, the Engine & Manifold Kit with EZ-TCU™ offers the most advanced self tuning engine management system on the market today. This kit combines the EZ-EFI®, XIM™, EZ-TCU™, LSX_{RT}™ Manifold, Big Mouth Throttle Body™ and fuel rails for full control of GM LS Gen III/IV engines and GM electronic 4-speed transmissions.

EZ-EFI® Engine & Manifold Kit w/ TCU	302003-TCU
EZ-EFI® Engine & Manifold Kit w/ TCU & In-Tank Fuel Pump	302003T-TCU
EZ-EFI® Engine & Manifold Kit w/ TCU & Inline Fuel Pump	302003L-TCU

EFI HEI Distributor For Chevy

Designed for Small and Big Block Chevrolets, this EFI HEI Distributor works plug-and-play with the EZ-EFI® Fuel and EZ-EFI® 2.0 Fuel+Ignition, as well as the XFI™ Sportsman system when EFI timing control is not required. The distributor supplies a discrete, square wave and noiseless RPM signal that provides a stable RPM output. It's unique in its use of this EFI-friendly RPM tach output signal, which allows the unit to work easily with many after-market EFI systems. It also utilizes a rugged coil driver – combined with microprocessor-controlled multi-spark technology – to permit increased spark energy and RPM operation over an OEM HEI distributor. This allows for more horsepower by creating a more complete burn of the air/fuel mixture, especially in higher performance applications. The distributor extends the RPM limit beyond that of an OEM HEI distributor and is more accurate due to less timing shift at higher RPM. Designed with a standard steel gear for many racing, street and off-road applications. Will work with carburetors. Also available as an HEI Distributor Module used to upgrade an OEM HEI distributor to be compatible with modern EFI.

EFI HEI Distributor for Chevy	303051
EFI HEI Distributor Module ONLY (Distributor NOT Included)	303050



EZ-EFI® Cable Mount Kit

The EZ-EFI® Cable Mount Kit is designed to work with and allow adjustability for automatic transmission TV cables, it is also specifically marked for the unique TV cable setup of GM 700R4 transmissions. The kit, built to be more accurate and stable than generic versions found in auto supply stores, features a proper tension double spring design to ensure accurate throttle closing and maximize the performance of any FAST™ EZ-EFI® system. The adjustable geometry of the linkage kit is also specifically engineered to ensure proper wide open throttle actuation.

* Includes all necessary hardware to install and adjust, and includes a comprehensive selection of cable mounting brackets to cover all major cables, applications and brands.

EZ-EFI® Cable Mount Kit	304147
-------------------------	--------



EZ-EFI® Fuel Hand-Held Upgrade Kit

This kit is for the upgrade of the original EZ-EFI® hand-held unit to a color touchscreen unit and includes the hand-held, harness, harness adapter and a suction cup mount.

EZ-EFI® Fuel Hand-Held Upgrade Kit	170633-06KIT
------------------------------------	--------------



*When Every Detail Matters,
FAST™ Is Always The*
TRUSTED CHOICE

**& WE WORK
WEEKENDS**

*Saturday Tech Office
9AM - 4PM CST.*



FUEL



AIR



SPARK



TECHNOLOGY

EZ-EFI 2.0[®] Fuel + Ignition SELF TUNING FUEL INJECTION SYSTEM



#30400-KIT

The next generation of the revolutionary self tuning EZ-EFI[®] has been upgraded with more features than ever before. Yet it maintains its ease-of-use that doesn't require a laptop or tuning experience.

As with the EZ-EFI[®] Fuel, simply hook up the system, answer the Setup Wizard questions on the hand-held, and EZ-EFI 2.0[®] Fuel + Ignition tunes itself as you drive. Its eight-injector, die cast throttle body features late model OEM sensors for accuracy and durability, supports up to 1200 horsepower (the highest on the market), includes optional ignition timing control and is able to run E85 fuels while competing versions cannot. It flows more air than the first generation EZ-EFI[®] throttle body due to an improved inlet, while a new secondary shaft throttle stop adjustment provides even more precise idle airflow adjustment and balance.

Meanwhile, an industry exclusive and unique-to-FAST[™] integrated fuel pulse damper creates precise fuel control. The EZ-EFI 2.0[®] Fuel + Ignition also incorporates needle-bearing supported shafts instead of bushings and an integrated fuel rail design with crossover for tighter packaging. Setup includes the market's fewest connection wires, including a high quality wiring harness that is encased in a sleek mesh-type loom.

The EZ-EFI 2.0[®] has an updated hand-held as well, featuring the industry's first color touchscreen. Self-powered through the ECU rather than requiring an outside power source, it shares the same mounting points as the Garmin Nuvi GPS, meaning there are nearly limitless mounting options (suction cup mount is included with all kits). Serving as the Setup Wizard initially, it then becomes an electronic gauge screen. The hand-held has various advanced features including screen hide/sleep function, expanded diagnostics and data screens, plus intuitive navigation.

The FAST[™] EZ-EFI 2.0[®] Fuel + Ignition works with either generation of EZ-EFI[®] throttle body, multi-port systems and Inglese[™] throttle bodies and is compatible with multiple fuel pump options including in-tank, inline, high horsepower inline, return style and returnless style*. Electronic fuel pressure measurement is standard on all kits, and each one works with a wet nitrous system, providing built-in nitrous timing retard and special nitrous AFR targeting. The EZ-Ignition[™] features an EZ-Solution[™] option, meaning that it can work with most common ignition systems, while precision control requires a FAST[™] distributor or crank trigger.

* FAST[™] engineers only recommend returnless operation when using FAST[™] In-Tank Fuel Pump Systems.

- Higher flowing and higher HP-capable throttle body for engines making up to 1200 HP
- Maintains ease-of-use that doesn't require a laptop or previous tuning experience
- Able to run E85 fuels as opposed to competitor versions
- Fuel pulse damper creates precise fuel control
- Features market's fewest connection wires, including sleek wiring harness and mesh-type loom
- Hand-held features a color touchscreen and shares the same mounting points as Garmin Nuvi GPS for almost limitless mounting options
- ECU includes LED diagnostic feature with on-board diagnostics and EZ-Test[™] Indicator Lights
- Works with both EZ-EFI[®] or Inglese[™] throttle bodies and multi-port systems
- Compatible w/ multiple fuel pump options
- EZ-Solution[™] option to allow integration with most common ignition systems

Base Kit Includes:

- Engine Control Unit (ECU)
- Color Touchscreen Hand-Held Unit w/ Mount
- 1200 HP-Capable Throttle Body w/ Integrated Fuel Injectors, Sensors & Rails
- Fully Mesh-Wrapped Main Harness
- Fuel Pressure Adapter Block & Sensor
- Wide-Band O₂ Sensor
- Installation Hardware
- Chrome EZ-EFI[®] Badge



EZ-EFI 2.0[®] Fuel + Ignition COMPONENTS

ECU

- No software necessary; self-learning system works with a few simple questions answered in the hand-held's Setup Wizard & one throttle screw adjustment
- Features include on-board diagnostics for troubleshooting
- EZ-Solution™ option to work with most common ignition systems
- EZ-Ignition™ is plug & play or user tunable
- Ignition strategy uses electronic vacuum advance, idle trim and full resolution ignition curve
- Nominal dimensions: 7.5"W x 4"H x 2"D



USB-Equipped For Update & Upgrade Capability

Throttle Body

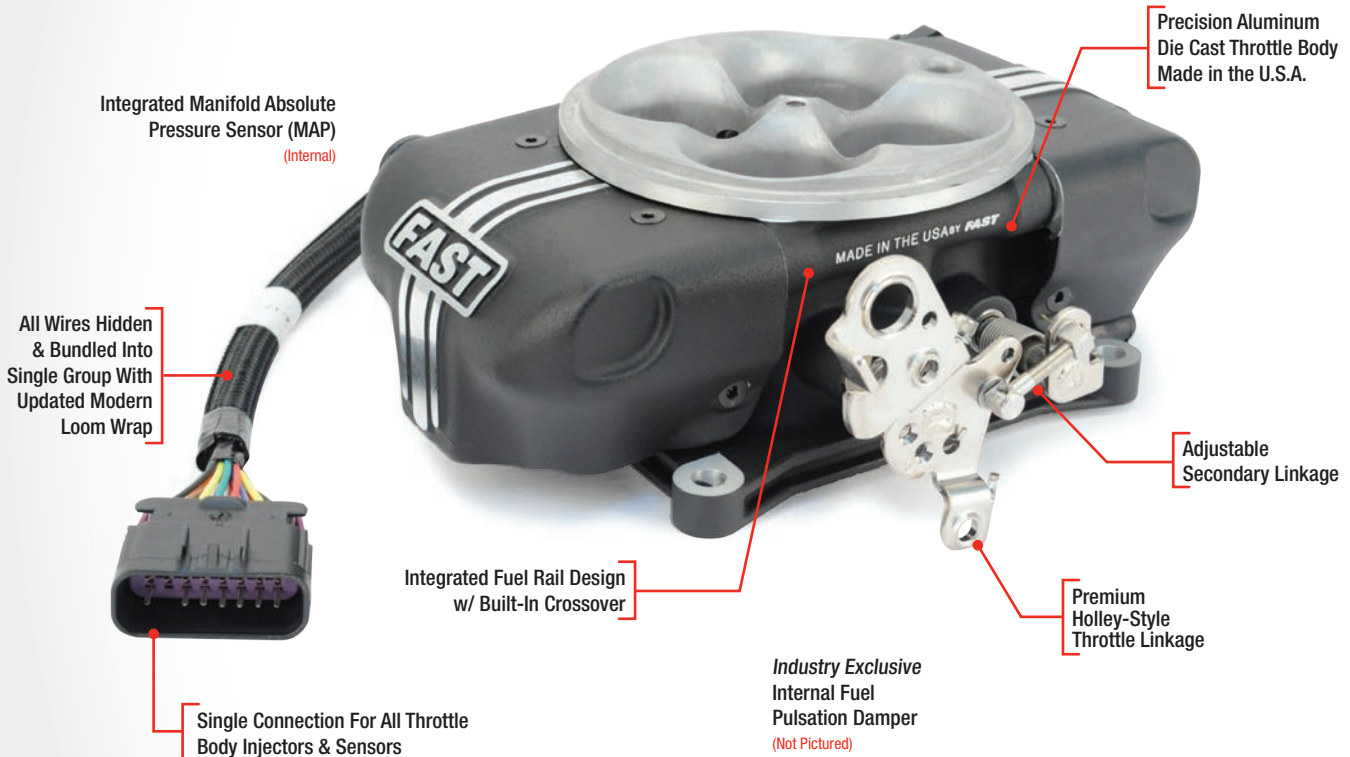

EZ-EFI 2.0[®] Fuel + Ignition COMPONENTS



Hand-Held Unit

- Provides the only necessary interface to the system's ECU
- Can be disconnected after initial setup
- Self-powered through ECU – no other connection necessary
- Includes screen hide/sleep function, expanded diagnostics, expanded data screens and intuitive navigation
- USB-Equipped for update and upgrade capability (not pictured)

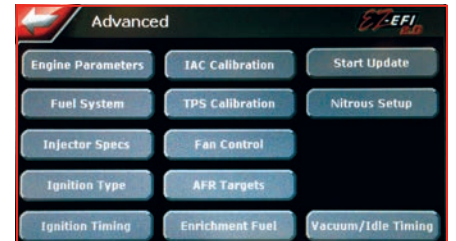

Throttle Body CUTAWAY VIEW

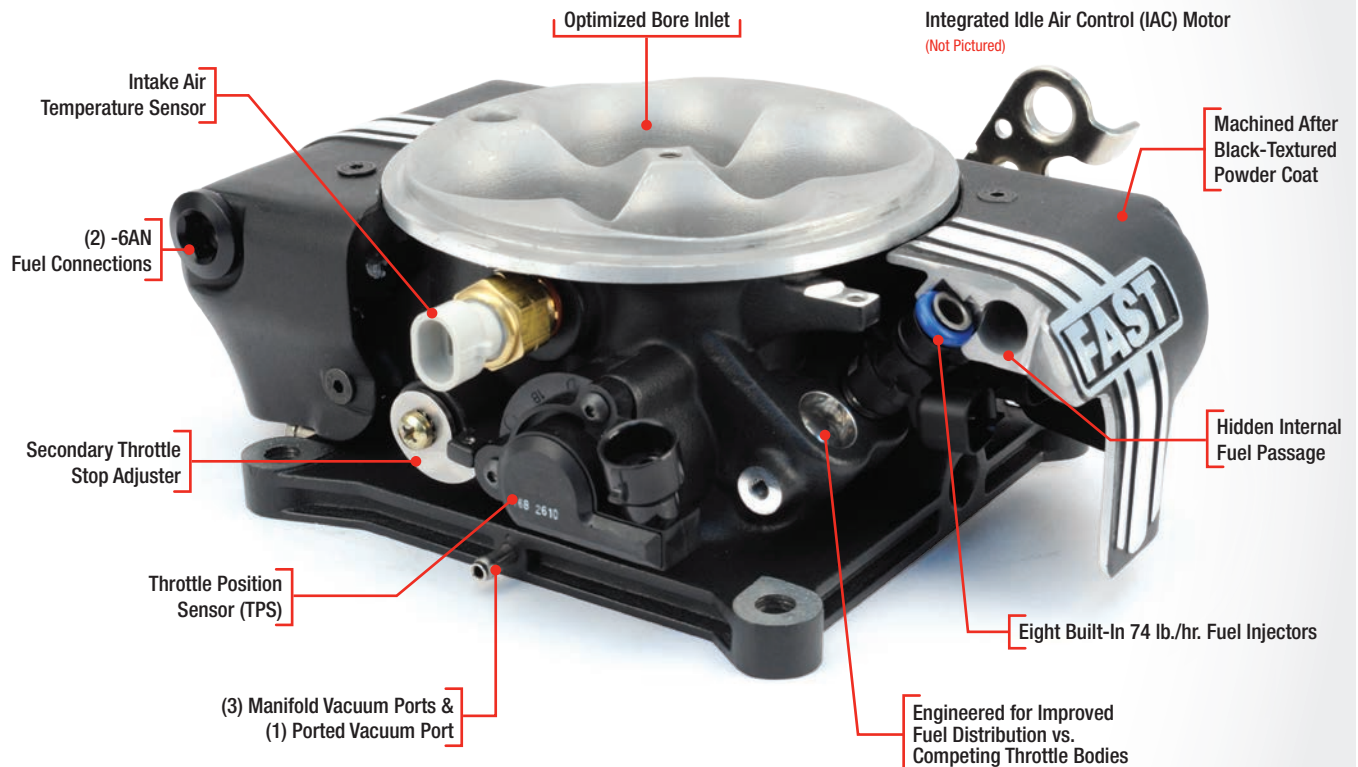

Flange-to-Flange Height = 3.25"

EZ-EFI 2.0[®] Fuel + Ignition COMPARISON

EZ-EFI 2.0[®] vs. The Other Guys

See the chart below for a direct comparison between the FAST[™] EZ-EFI 2.0[®] Fuel+Ignition, MSD Atomic, Holley Terminator and Edelbrock E-Street EFI systems. A “✔” signifies that the company listed at the top of the column DOES include the particular feature listed while an “✘” signifies that it does NOT include it.

*Information current as of October 14, 2015.

Features	FAST [™]	MSD	Holley	Edelbrock
Horsepower Capacity Of Throttle Body Determined primarily by fuel flow capacity using gasoline (E85 will be less)	1200 HP	620 HP	600 HP	600 HP
Throttle Body Airflow FAST [™] EZ-EFI 2.0 [®] Fuel+Ignition has unobstructed bores and a properly designed inlet bellmouth to allow for more airflow, which results in more power and efficient operation	1150 CFM	950 CFM	950 CFM	1000 CFM
Progressively Staged Control Of Eight Fuel Injectors FAST [™] EZ-EFI 2.0 [®] Fuel+Ignition turns on four injectors at idle and phases in all eight as fuel requirement demands, allowing one system to idle properly and still support high horsepower applications	✔	✘	✘	✘
Color Touchscreen Hand-Held Included Standard No laptop is required and an optimally sized hand-held makes for easy and intuitive installation. After initial setup, the hand-held makes for a color touchscreen dash (gauge cluster).	✔	✘	✘	✔
Hand-Held Mounting Bracket Kit Included Standard Includes suction cup and articulating mount, allowing hand-held unit to be clipped in place	✔	✘	✘	✔
Diagnostic LED Lights Built Into ECU FAST [™] EZ-EFI 2.0 [®] Fuel+Ignition has a full array of LEDs built in for at-a-glance diagnostics	✔	✘	✘	✘
Optional Returnless Fuel Control Enables a single fuel line connection with no return line or regulator necessary	✔	✔	✘	✔
Hassle-Free Returnless (No Temperature Limitations Or Rubber Line Requirements) Works in hot weather/temperatures and with steel fuel lines	✔	✘	✘	✘
Compatible W/ Nitrous Enables use of nitrous and allows user to retard timing and/or enrich fuel	✔	✔	✘	✘
Capable Of Controlling Ignition Timing Enables electronic and tunable control while improving idle control – the original EZ-EFI [®] did not include this feature	✔	✔	✔	✘
Offers Plug-And-Play Distributor No distributor lockout or rotor phasing required; no adapter harness required	✔	✘	✘	✘
Ignition Control Works W/ Most Stock Or Aftermarket Distributors Enables customer to use readily common distributors if desired	✔	✔	✘	✘
Adjustable Idle Trim Ignition Control Option Able to adjust idle timing control to help fine tune idle speed control	✔	✘	✘	✘
Vacuum Advance Ignition Control Option Able to utilize vacuum advance if desired to fine tune spark control for measured vehicle load based on MAP	✔	✔	✘	✘
Standard Replacement OEM Sensors Commonly available factory OEM sensors are best option	✔	✘	✔	✔

EZ-EFI 2.0[®] Fuel + Ignition COMPARISON

Features	FAST™	MSD	Holley	Edelbrock
Number Of Wire Connections Fewer connections result in an easier install. These are the number of connections required to start the system. <i>* Timing control is not included in this number, although FAST™ EZ-EFI 2.0[®] Fuel+Ignition still requires fewer connections even if timing control is utilized</i>	10	11	11	17
Integrated Fuel Pulse Damper Smooths fuel pressure and enables better and more consistent fuel delivery for improved idle and optimum returnless fuel delivery performance	✓	✗	✗	✗
Electronic Fuel Pressure Sensor Reads fuel pressure full time – this is much easier than looking under the hood at a mechanical gauge	✓	✓	✗	✓
CAN System For Plug-And-Play Aftermarket Gauges/Accessories Compatibility with other FAST™ components, as well as aftermarket gauges	✓	✗	✓	✗
Universal Multi-Port Compatibility (W/ LS, TPI, Ford 5.0 & Aftermarket Port Injection Manifolds) Enables use on various engines and setups	✓	LS Only	Limited	✗
Able To Update Via USB Ports W/ Included Cables If updates are available, consumers are able to update easily with provided cables. No additional cards, readers or cables are required.	✓	✗	✗	✓
Hand-Held Can Be Locked To Selected Gauge Screen(s) On Start-up After initial setup, the hand-held unit can be set to always start on the screen selected by the user. Users can select the desired start-up screen and change it at any time.	✓	✗	✗	✗
Controls One Or Two Electric Cooling Fans Options are available to control fans based on coolant temperatures. If a vehicle has two fans, they can be staged for different temperatures. The original EZ-EFI [®] did not include this feature.	✓	✓	✓	✓
Officially Tuned & Compatible W/ E85 No guessing or tuning required – simply select E85 and fill up	✓	✗	✗	✗
Single Button Switch Between Gasoline & E85 Switch modes with one button, no tuning necessary	✓	✗	✗	✗
Built-In Fuel Pump Manual Control & Test Screen Controls the fuel pump with the hand-held for diagnostics. Users will not have to deal with wires, relays or jumpers. Simply use the hand-held. It can be used to test the fuel system at any time.	✓	✗	✗	✗
Plug-And-Play EZ-TCU™ Electronic Transmission Control Unit Plug-and-play with the FAST™/TCI [®] EZ TCU™ and able to use the same sensors from EZ-EFI [®] without splicing or adding redundant wires	✓	✗	✗	✗
Number Of Sensor Readouts On Single Screen FAST™ EZ-EFI 2.0 [®] Fuel+Ignition has all sensors readable on a single master screen, which eliminates the need to scroll through various screens to read all data	21	7	6	19
Adjustable Secondary Shaft On Throttle Body Enables precise and individual adjustment of both throttle shafts for improved idle characteristics	✓	✓	✓	✗
Matching Die Cast Valve Covers & Air Cleaner Available Featuring the FAST™ logo, these matching die cast and powder coated accessories complete the look	✓	✗	✗	✗

EZ-EFI 2.0[®] Fuel + Ignition KITS

EZ-EFI 2.0[®] Fuel+Ignition Base Kit

The EZ-EFI 2.0[®] Fuel+Ignition Base Kit includes the ECU, hand-held unit, throttle body, main harness, electronic fuel pressure kit and appropriate sensors. A hand-held mounting bracket kit also ships with each system.

EZ-EFI 2.0[®] Fuel+Ignition Self Tuning Fuel Injection System, Base Kit
w/ 4 BBL Throttle Body (For Distributor Ignition)

30400-KIT



#30400-KIT

Best Choice For Most Setups



#30401-KIT

EZ-EFI 2.0[®] Fuel+Ignition Master Kit w/ In-Tank Fuel Pump Kit

The EZ-EFI 2.0[®] Master Kit is now also available with an In-Tank Fuel Pump Kit. This kit is an EZ-EFI 2.0[®] Fuel+Ignition Base Kit that includes a Walbro 450 LPH high pressure pump that is perfect for performance applications. Automatically cooled by the fuel in the tank, the pump easily flows enough fuel at 60 psi to support 1200 horsepower applications and is the highest flowing volume in-tank pump currently on the market. Recommended by FAST[™] engineers for all returnless applications.

EZ-EFI 2.0[®] Fuel+Ignition Self Tuning Fuel Injection System, Master In-Tank Pump Kit
– Return/Returnless, w/ 4 BBL Throttle Body (For Distributor Ignition)

30401-KIT

EZ-EFI 2.0[®] Fuel+Ignition Master Kit w/ Inline Fuel Pump Kit

Includes everything in the EZ-EFI[®] Base Kit, plus a Walbro 255 LPH high pressure pump and all necessary fuel lines, fittings and regulator.

EZ-EFI 2.0[®] Fuel+Ignition Self Tuning Fuel Injection System, Master Inline Pump Kit
– Return Only, w/ 4 BBL Throttle Body (For Distributor Ignition)

30402-KIT



#30402-KIT

In-Tank vs. Inline

Inline fuel pumps are easier to install than in-tank fuel pumps because the fuel tank does not have to be removed. However, there are several advantages to running an in-tank fuel pump versus an inline fuel pump. FAST[™] engineers recommend an in-tank fuel pump when possible.

IN-TANK FUEL PUMP ADVANTAGES INCLUDE:

- Always Primed
- Runs Quieter
- Runs Cooler
- Method Used By All OEMs
- Required For Returnless Fuel Systems (EZ-EFI 2.0[®] Fuel + Ignition Only)

For individual fuel pump kits, see page 55

EZ-EFI 2.0[®] Fuel + Ignition KITS

EZ-EFI 2.0[®] Fuel+Ignition Master High Horsepower Kit w/ Inline Fuel Pump Kit

Similar to our Master Kit with Inline Fuel Pump Kit, but this includes the FAST[™] Race Fuel System, Part #307500, allowing it to handle performance applications making **up to 1200 HP**. The race fuel system includes fuel pump, pre-filter, post-filter, Y-block and fuel regulator, as well as the system fittings and wiring harness. Constructed of aluminum and stainless steel to ensure years of reliable service.

EZ-EFI 2.0[®] Fuel+Ignition Self
Tuning Fuel Injection System,
Master High Horsepower Inline
Pump Kit – Return Only, w/ 4
BBL Throttle Body
(For Distributor Ignition) 30403-KIT

EZ-EFI 2.0[®] Fuel+Ignition Multi-Port Retro-Fit Kit

The EZ-EFI 2.0[®] Fuel+Ignition Multi-Port Retro-Fit Kit allows owners of existing factory or aftermarket multi-port fuel injected applications and intake manifolds to experience the benefits of an EZ-EFI 2.0[®] system with no limit on horsepower because the system is based on each customer's supplied injectors. Kit comes with everything needed to convert factory or aftermarket EFI systems into a complete FAST[™] EZ-EFI 2.0[®] Fuel+Ignition system.

EZ-EFI 2.0[®] Fuel+Ignition Multi-Port
Retro-Fit Kit (For Distributor Ignition) 30404-KIT

EZ-EFI 2.0[®] Fuel+Ignition LS Self Tuning Engine Control Kit

FAST[™] engineers have developed the simplest plug-and-play, self tuning engine control system on the market for LS engines. The FAST[™] EZ-EFI 2.0[®] Fuel+Ignition LS Self Tuning Engine Control Kit is the easiest way to get your LS transplant up and running without all the complex PCM flashing and harness reworking required with the stock unit. This kit features all of the advantages of the award-winning EZ-EFI 2.0[®] system, plus it includes the EZ-LS[™] Ignition Controller and utilizes stock or aftermarket LS injectors, sensors and coils. With the included ignition controller, the user can easily get running or optionally adjust timing.

EZ-EFI 2.0[®] Fuel+Ignition GM
LS Engine Transplant Kit (For LS
Coil-Per-Cylinder Ignition) 30405-KIT
GM EZ-LS[™] Ignition Controller Kit 301312E



**SEE PAGE 33
FOR MORE INFORMATION.**

EZ-EFI 2.0[®] Fuel + Ignition MULTI-PORT FUEL INJECTION KITS



#30412-05T

EZ-EFI 2.0[®] Fuel+Ignition Multi-Port Fuel Injection Kits

FAST[™] also offers complete bolt-on EZ-EFI 2.0[®] Fuel+Ignition Multi-Port Electronic Fuel Injection Kits that allow anyone to install a multi-port injection setup on Small and Big Block Chevy and Small Block Ford engines that were originally carbureted. These kits can be used on anything from mild street rods and muscle cars to 1,000 horsepower all-out race cars. EZ-EFI 2.0[®] Fuel+Ignition Multi-Port Electronic Fuel Injection Kits include carefully matched components, including the EZ-EFI 2.0[®] Fuel+Ignition, hand-held device, single plane EFI intake manifold, throttle body, Precision-Flow[™] Fuel Injectors, fuel rails, in-tank or inline fuel pump kit, electronic fuel pressure kit, all necessary sensors, clearly labeled wiring harnesses and the distributor.

* 1,000 HP Kits do NOT include fuel lines and fittings.

EZ-EFI 2.0 [®] Fuel Injection Kit – SBC Up To 550 HP, In-Tank	30412-05T	EZ-EFI 2.0 [®] Fuel Injection Kit – BBC Tall Deck Up To 1,000 HP, Inline	30411T-10L
EZ-EFI 2.0 [®] Fuel Injection Kit – SBC Up To 1,000 HP, In-Tank	30412-10T	EZ-EFI 2.0 [®] Fuel Injection Kit – SBF Up To 550 HP, In-Tank	30431-05T
EZ-EFI 2.0 [®] Fuel Injection Kit – SBC Up To 550 HP, Inline	30412-05L	EZ-EFI 2.0 [®] Fuel Injection Kit – SBF Up To 1,000 HP, In-Tank	30431-10T
EZ-EFI 2.0 [®] Fuel Injection Kit – SBC Up To 1,000 HP, Inline	30412-10L	EZ-EFI 2.0 [®] Fuel Injection Kit – SBF Up To 550 HP, Inline	30431-05L
EZ-EFI 2.0 [®] Fuel Injection Kit – BBC Up To 550 HP, In-Tank	30411-05T	EZ-EFI 2.0 [®] Fuel Injection Kit – SBF Up To 1,000 HP, Inline	30431-10L
EZ-EFI 2.0 [®] Fuel Injection Kit – BBC Up To 1,000 HP, In-Tank	30411-10T	EZ-EFI 2.0 [®] Fuel Injection Kit – 351W up to 550 HP, In-Tank	30435-05T
EZ-EFI 2.0 [®] Fuel Injection Kit – BBC Tall Deck Up To 1,000 HP, In-Tank	30411T-10T	EZ-EFI 2.0 [®] Fuel Injection Kit – 351W up to 1,000 HP, In-Tank	30435-10T
EZ-EFI 2.0 [®] Fuel Injection Kit – BBC Up To 550 HP, Inline	30411-05L	EZ-EFI 2.0 [®] Fuel Injection Kit – 351W up to 550 HP, Inline	30435-05L
EZ-EFI 2.0 [®] Fuel Injection Kit – BBC Up To 1,000 HP, Inline	30411-10L	EZ-EFI 2.0 [®] Fuel Injection Kit – 351W up to 1,000 HP, Inline	30435-10L

EZ-EFI[®] Cable Mount Kit

The EZ-EFI[®] Cable Mount Kit is designed to work with and allow adjustability for automatic transmission TV cables, it is also specifically marked for the unique TV cable setup of GM 700R4 transmissions. The kit, built to be more accurate and stable than generic versions found in auto supply stores, features a proper tension double spring design to ensure accurate throttle closing and maximize the performance of any FAST[™] EZ-EFI[®] system. The adjustable geometry of the linkage kit is also specifically engineered to ensure proper wide open throttle actuation.

* Includes all necessary hardware to install and adjust, and includes a comprehensive selection of cable mounting brackets to cover all major cables, applications and brands.



#304147

EZ-EFI [®] Cable Mount Kit	304147
-------------------------------------	--------

EZ-EFI 2.0[®] Fuel + Ignition INDUCTION KITS



#NG4089E

EZ-EFI 2.0[®] Fuel + Ignition 8-Stack Induction Systems

FAST™ and Inglese™ have partnered to create EZ-EFI 2.0[®] Fuel + Ignition Induction Systems that blend the classic stylings of Weber carburetors with the high-tech performance of electronic fuel injection. These technically advanced systems employ advanced FAST™ EZ-EFI[®] Fuel + Ignition electronics and our exclusive cast aluminum 50/58mm IDA-style throttle bodies. Delivering increased performance, cold starts and drivability for street rods and muscle cars with engines up to 1,000 HP, Inglese™ EZ-EFI 2.0[®] Fuel + Ignition 8-Stack Systems use custom-engineered, low profile fuel rails that sit below the stacks and between the throttle bodies for a much cleaner look.

	As Cast
Small Block Chevy 50mm IDA EZ-EFI [®] Induction System	NG4006E
GM LS w/ Cathedral Port Heads (LS1/LS2/LS6/4.8/5.3/6.0), IDA	NG4089E
GM LS w/ Rectangle Port Heads (LS3/L92/L99/L76), IDA	NG4090E
Small Block Ford 50mm IDA EZ-EFI [®] Induction System	NG4008E
Windsor Ford 50mm IDA EZ-EFI [®] Induction System	NG4010E
FE Ford 58mm IDA EZ-EFI [®] Induction System	NG4068E

Complete System Includes:

- Fully Assembled 8-Stack Induction System
- Throttle Bodies
- 1.5" Tall Billet Stacks
- Chrome-Top Air Filters (Press-On Style)
- Billet Fuel Rails
- 33 lb./hr. Fuel Injectors
- Throttle Linkage
- FAST™ Self Tuning EZ-EFI 2.0[®] Fuel + Ignition ECU w/ Wide-Band O₂
- All Necessary Wiring

EZ-EFI 2.0[®] Fuel + Ignition Sidedraft Induction Systems

Inglese™ Sidedraft EFI Systems combine proven FAST™ electronic fuel injection technology with radical Inglese™ sidedraft styling. Designed to work with FAST™ EZ-EFI 2.0[®] Fuel + Ignition Systems, they give customers a value-priced alternative to buying a full eight-stack system by adapting to an existing single or dual plane 4150 flange four barrel intake manifold. The Inglese™ Sidedraft system offers radical styling and excellent drivability for engines making up to 650 HP. The Inglese™ Dual Sidedraft system offers even more radical styling and power. They are the ideal solution for adding both EFI performance and stunning looks to any hot rod or street machine.

EZ-EFI 2.0 [®] Fuel + Ignition Sidedraft Induction System	NG4088E
EZ-EFI 2.0 [®] Fuel + Ignition Dual Sidedraft Induction System	NG4088DSE



#NG4088E

Inglese

A NEW ERA IN IGNITION

*With A Full Line Of Components
From The Trusted Leader In EFI Technology*

Ask About Our
New Ignition Catalog



IGNITION



DISTRIBUTORS



COILS



PLUG WIRES

XFI™ & EZ-EFI®

WHICH IS RIGHT FOR ME?

Which EFI system is right for you? If you're unsure whether or not you need to choose one of the FAST™ EZ-EFI® Self Tuning Systems or one of the more advanced XFI™ Systems, answer the questions below to help determine which type of FAST™ EFI system is the best choice for you.

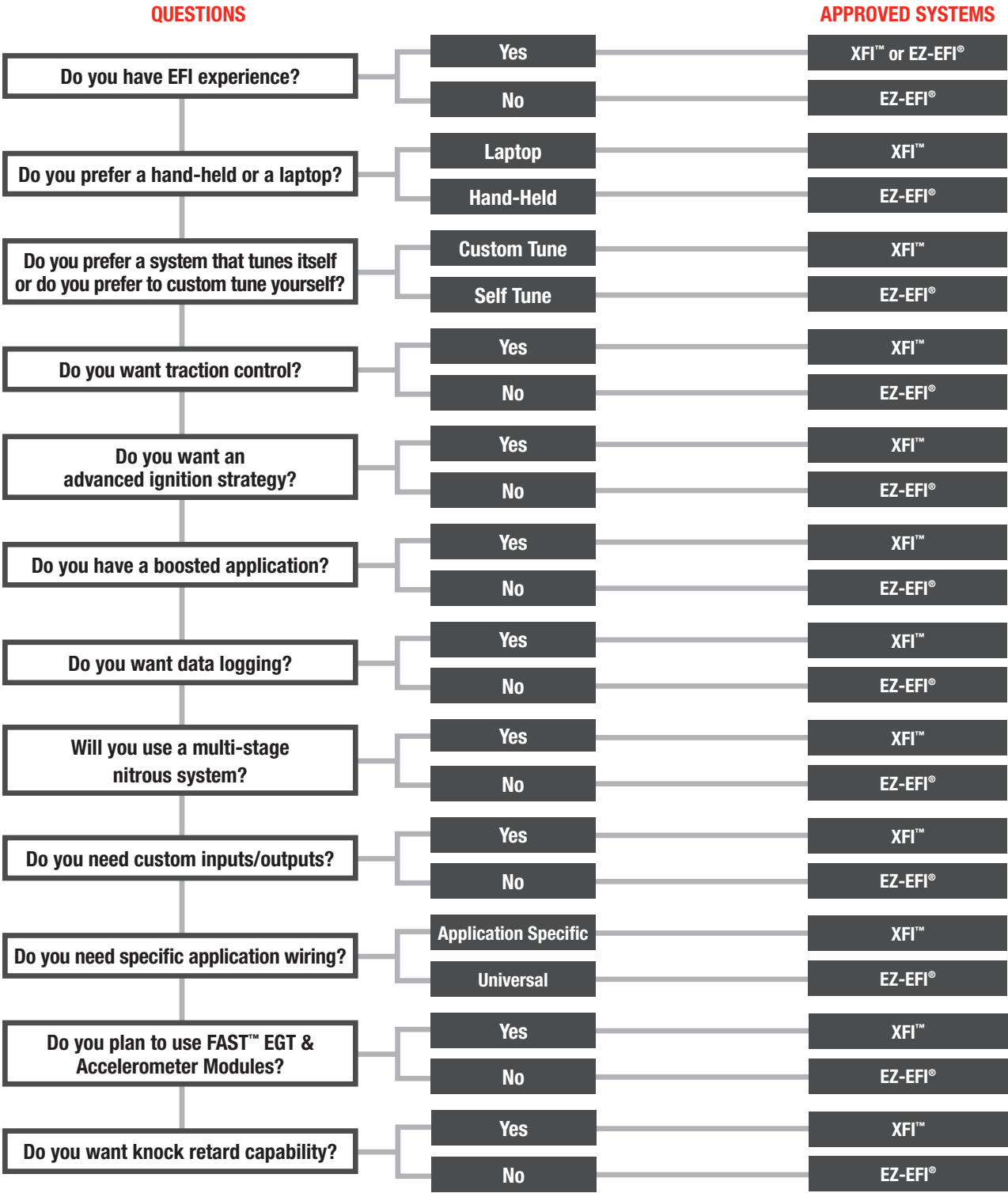

If you choose to use an EZ-EFI® system, see page 2 for further help selecting the proper system. If you choose to run an XFI™ system, see pages 24-25 to select the correct setup.

For more advanced tuners, FAST™ offers both the XFI 2.0™ and XFI Sportsman™ Fuel Injection Systems. Use the chart below to determine the features you need for your application, and then select the system that is best suited for you based on the corresponding “✓” or “✗”.

Features	XFI 2.0™	XFI Sportsman™
Internal Datalogging	✓	✓
Laptop Datalogging	✓	✓
Supports Boosted Applications	✓	✓
Boost Control	✓	✗
Wet Nitrous Application	✓	✓
Dry Nitrous Application	✓	✗
Multi-Stage Nitrous Control	✓	✗
Progressive Nitrous Control	✓	✗
Gasoline Or E85 Fuel	✓	✓
Methanol	✓	✓
Plug-And-Play CAN Communication for Optional Accessories – EZ-TCU™, XIM™, EZ-LS™ and XFI™ eDash	✓	✓
Plug-And-Play CAN Communication for Optional Accessories – EGT Module, Accelerometer Module, 3rd Party Gauges, Racepak, Dash/Data Logger	✓	✗
Compatible w/ FAST™ Dual-Sync & MSD Inductive Pickup Distributors, As Well As FAST™ Or MSD Crank Triggers	✓	✓
Compatible w/ Coil-Per-Cylinder Applications When Used With FAST™ XIM™ Or EZ-LS Ignition Modules	✓	✓
Advanced Ignition Capability – Buick DIS, GM HEI, Ford Thick Film, GM Optispark	✓	✗
Standard Ignition Compatibility – 2x, 3x, 4x IPU & Discrete	✓	✓
Patented Transbrake Creep Control	✓	✗
Intelligent Traction Control	✓	✗
Sequential Fueling Capability	✓	✗
Individual Cylinder Corrections	✓	✗

Features	XFI 2.0™	XFI Sportsman™
Multi-Stage Rev Limiters	✓	✗
Store Multiple Tunes Onboard	✓	✗
Low Impedance Injectors	✓	✗
High Impedance Injectors	✓	✓
RS-232 Serial Communication Compatible	✓	✗
USB Compatible	✓ (Adapter Included)	✓
Knock Retard Capability	✓	✗
AC & TCC Clutch Control	✓	✗
NTK Wide-Band O ₂	✓	✗
Bosch Wide-Band O ₂	✗	✓
Application Specific Harnesses	✓	✗
Universal Harness	✓	✓
Adaptive Learning	✓	✓
Proven C-COM Software	✓	✓
Scaleable 3D Fuel & Spark Tables	✓	✓
Load Indexed Speed Density Fueling Strategy for Accurate Fueling At All Elevations	✓	✓
Compatible with FAST™ XFI™ eDash	✓	✓
Remote Internet Tuning	✓	✓
Custom Programmable Digital Output	✓ (4 Available)	✗
Digital Inputs	✓ (8 Available)	✓ (1 Available)

XFI Sportsman™ ENGINE MANAGEMENT SYSTEM

NOW FEATURES
INTERNAL DATA LOGGING



Base Kit Includes:

- Waterproof ECU
- Wide-Band O₂ Sensor
- Multi-Port Wiring Harness
- Fuel Pressure Sensor Kit
- C-Com® Software

XFI™ Sportsman Engine Management System

Designed for muscle car, late model street and sportsman drag racing engines, along with boosted and individual runner throttle body applications, the FAST™ XFI™ Sportsman Engine Management System is a bank-to-bank, fully software-tunable EFI setup. It requires a laptop for tuning and uses FAST™ C-Com® software, which comes packaged along with the necessary USB connectivity cable. A user-configurable auxiliary input channel is included as well. The system offers both load-indexed Speed Density or Alpha-N fuel strategies; most users will use Speed Density but the Alpha-N option is specifically added to serve sportsman drag racers looking for absolute consistency.

The FAST™ XFI™ Sportsman System features full tables to monitor fueling, acceleration fuel, timing and air/fuel targets, while full function data logging is also included. It supports both naturally aspirated and boosted applications up to 5 BAR, is compatible with wet nitrous and has nitrous timing retard control. Built-in CAN network support for the EZ-TCU™, EZ-LS™ and XIM™ means users can easily plug and play those components with the included CAN wire. The FAST™ XFI™ Sportsman Engine Management System also features a Bosch wide-band O₂ sensor, utilizes built-in diagnostic LEDs, a waterproof ECU enclosure and includes a premium, mesh-type, wire loom multi-port harness.

Compatible with return and returnless fuel systems, XFI™ Sportsman is designed for use with high-impedance injectors, and works with a variety of multi-port systems or either generation of the FAST™ EZ-EFI® throttle body. XFI™ Sportsman is configurable to work with FAST™ distributors, FAST™ crank triggers, EZ-LS™, XIM™ or the RPM/tach signal from an aftermarket CD ignition box, XFI™ eDash, HEI big cap distributor or included tach adapter.

XFI Sportsman™ EFI System	303000
XFI Sportsman™ EFI System w/ 4150 Throttle Body	303001

*Kit now available w/ 4150
8-injector throttle body.*

- Easy-to-use programmable & custom-tunable unit fits perfectly between EZ-EFI 2.0® & XFI™ segments
- Utilizes FAST™ C-COM® software – comes packaged along w/ necessary USB connectively cable
- Utilizes Speed Density & Alpha-N fuel strategies; Alpha-N included just for sportsman drag racers
- Features Internal Data Logging, as well as full tables to monitor fuel
- Supports N/A & boosted applications up to 5 bar, works w/ nitrous & features nitrous timing retard control
- CAN network support for EZ-TCU™, EZ-LS™ & XIM™ for plug & play w/included CAN wire
- Compatible w/ multi-port systems & either generation EZ-EFI® throttle body
- Designed for muscle car, late model, boosted, individual runner throttle body & sportsman racing engines
- Nominal dimensions: 7.5"W x 4"H x 2"D

XFI Sportsman™ ENGINE MANAGEMENT SYSTEM



NOTE: Photos shown are representative of usage only. Air hat & blower not included.

XFI Sportsman™ Blow-Through Supercharger EFI System

Blow-through applications that are traditionally carbureted now have the option to utilize an EFI setup. This XFI Sportsman™-based system replaces the carburetor with an easy-to-install EZ-EFI 2.0™ throttle body. It supports up to 15psi of boost and 1000 horsepower on gasoline, making it twice as powerful as any other single throttle body blow-through product on the market today.

The eight-injector, die cast throttle body features late model OEM sensors for accuracy and durability and includes ignition timing control. A secondary shaft throttle stop adjustment provides extremely precise idle airflow adjustment and balance.

XFI Sportsman™ Blow-Through Supercharger EFI System

303001BT

Kit Includes:

- XFI Sportsman™ ECU
- EZ-EFI 2.0® Fuel + Ignition Throttle Body w/ TPS, 74# Injectors, 2 BAR MAP Sensor, Intake Air Temp Sensor and IAC
- Wide-Band O₂ Sensor
- Throttle Body Wiring Harness
- Fuel Pressure Sensor Kit
- C-Com® Software

XFI Sportsman™ Roots Blower Dual Quad EFI System

A complete EFI system for a 2x4 blower setup is now available in one part number. This kit is designed to replace outdated carburetor technology on top of a Roots-style blower in either street or strip vehicles. It includes two EZ-EFI® Fuel four-barrel throttle bodies, with the rear version including TPS and IAC sensors. Each throttle body has four 74lb./hr. injectors. The system includes all necessary sensors, Internal Data Logging and C-Com software. It supports up to 15psi of boost and 1000 horsepower at the crank on gasoline..

XFI Sportsman™ Roots Blower Dual Quad EFI System

303002RB

Kit Includes:

- XFI Sportsman™ ECU
- (2) EZ-EFI® Fuel Throttle Bodies w/ TPS, 74# Injectors, and IAC
- External 2 BAR MAP Sensor
- External Intake Air Temp. Sensor
- Wide-Band O₂ Sensor
- Multi-Port Wiring Harness
- Fuel Pressure Sensor Kit
- C-Com® Software

XFI 2.0™ FUEL INJECTION SYSTEMS



Compatible with all common ignition types, including GM HEI, LT1, LS1, -2, -6, -7 DIS, Ford EDIS (4.6L & 5.4L), and Chrysler 5.7L, 6.1L Hemi applications.

FAST™ engineers designed the revolutionary XFI 2.0™ with improved and expanded functions, capabilities and adjustability. In addition, they upgraded the user interface for power adders, including advanced forced induction, progressive controllability and other advanced racing specific strategies and features. Faster processing means no more flat spots in the power curve or settling for “close enough.” With a cutting edge self tuning option, this is the one EFI system with easy-to-use features and completely configurable capabilities that accurately balances fuel and spark, allowing you to fine tune and precisely control like never before.

Advanced Forced Induction, Power Adder & Race Controls

The Advanced Forced Induction, Power Adder and Race Controls include two separate, fully programmable sequential rev limiters for staging or boost building with six options for activation, four priority assignments and a user selectable mode for rev limiting. The Advanced Forced Induction Controls include a time based boost controller, user selectable fixed VE and/or fixed timing for boost building and staging repeatability. Expanded Progressive Power Adder Controls include configurations for both wet or dry applications; separate tables for power adder solenoid control and fuel control for perfect dry power adder tuning; user adjustable solenoid pulse frequency for optimum solenoid controllability; choice of fixed target air/fuel or standard air/fuel table for correction; and a dry power adder fuel delay in milliseconds for correcting rich spikes on activation. No other system matches the power and adjustability of XFI 2.0™.

Self Learning Auto Tuning VE Table*

The Self Learning Auto Tuning VE Table is an automated process option that makes for quick and easy fuel mapping with the XFI 2.0™. However, this option can be turned off should the user prefer to do the tuning manually. The self learning mode can also be used to speedily and accurately populate a base tune and then turned off for more fine tuning or custom control by the user – it's all up to you when and how you want to use it. The C-Com® software features enable conditions to turn it on/off automatically and also has an overall enable/disable feature.

* XFI 2.0™ C-Com® software requires suitable PC computer for use.

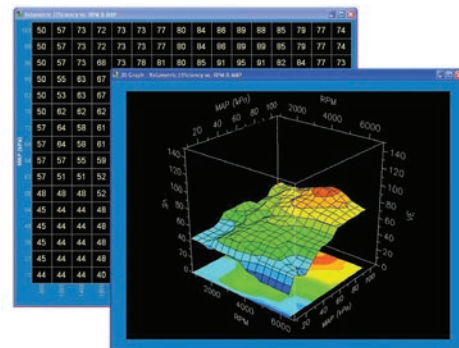

The VE table is shaped & refined by self learning capabilities.

XFI 2.0™ FUEL INJECTION SYSTEMS

Hardware

The XFI 2.0™ uses the latest in flash microprocessor technology to deliver a significantly faster processing speed. It processes, analyzes and adjusts four times faster than previous EFI systems. In addition, a surface mount component circuit board and billet ECU enclosure give the XFI 2.0™ superior durability. To simplify installation, FAST™ offers engine-specific wiring harnesses with clearly labeled connections.

Software Advances

The C-Com® XFI™ Windows-based software is easy to navigate and incorporates field-flashable capabilities that enable you to download the latest software updates via email or directly from the FAST™ website. Your system will stay current without ever needing to remove the XFI 2.0™ from your vehicle.

XFI 2.0™ provides a host of upgrades including individual cylinder correction referenced to RPM. This feature allows for very fine cylinder-by-cylinder tuning of an engine throughout its entire RPM band. Dynamic Fuel Pressure Correction also allows for user-enabled correction for fuel pressure changes in real time. XFI 2.0™ includes the added ability to interface with the cost-effective FAST™ EZ-LS™ Ignition Controller, while comprehensive, user-programmable dwell settings for EZ-LS™ and XIM™ applications allow the user to finely tune the dwell time to match the ignition coils that are being used. Other spark features include increased resolution for power adder ramp retard, a timing offset table supporting alternative fuels by their Fuel Energy Constant and a high-RPM, spark-cut rev limiter.

XFI 2.0™ provides a second communication port to allow for simultaneous use of the FAST™ XFI™ eDash and C-COM® software, while new calibration parameters are designed to initiate a minimum oil pressure shutdown. In addition, a dedicated real-time baro sensor supports live corrections of barometric pressure for altitude changes. Finally, the progressive power adder fuel and nitrous solenoid duty cycles have been merged into one table to allow for more convenient tuning.

Technology

The XFI 2.0™ features Qwik Tune™ Technology that allows ECU programming without a laptop. Preprogram up to four different EFI MAPs. You can optimize one setting for everyday driving, others for racing conditions and still another for improved fuel economy. Simply select the tune-up you need with the flip of an in-car switch. Other features include on-board diagnostics, EZ Test™ Indicator Lights, 5 bar MAP sensing and controls for your power adder and torque converter.

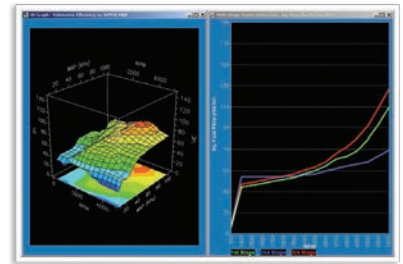

Easy-to-navigate C-Com XFI™ software contains the advanced features demanded by professionals, yet allows first-time EFI users to tune with confidence.

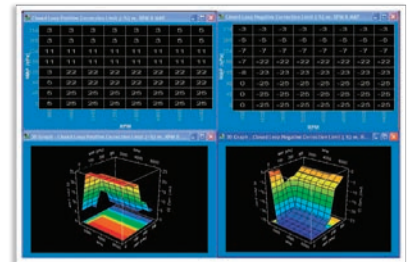

Standard Features

- Built-in wide-band O₂ sensor
- Fully sequential and/or bank-to-bank capability
- Individual cylinder correction
- Fan and fuel pump control
- Dynamic scaling of vectors in 2D & 3D tables
- Scalable TPS, air temp, water temp & calibrations
- 1, 2, 3 and 5 bar capability
- Spare definable inputs/outputs for auxiliary fan control, EGT monitoring, etc.
- Torque converter lock-up control
- Air conditioning wide-open throttle cutout
- Boost control
- Enhanced 4 stage power adder controls
- Multiple calibration stored in ECU w/ switching capability
- L-key function for easy steady-state table correction using wide-band
- On-board diagnostics
- Fuel and oil pressure logging
- Adjustable injector timing
- Adjustable battery voltage injector opening correction table
- Fixed timing test mode for easy verification of ignition timing accuracy
- Spark vs. coolant temp offset table
- Configurable target air/fuel offset table vs. coolant temp table: more accurate warm-up enrichment
- Selectable safety feature deactivates power adders in event of fault code
- Automatic and manual TPS calibration modes
- Additional transbrake control features
- Improved on-board diagnostics
- Nominal dimensions: 8.25"W x 5.25"H x 1.5"D

XFI 2.0™ FUEL INJECTION SYSTEMS

Option Features

Internal Data Logging (IDL)

The internal memory-based data logging option provides comprehensive data from all vehicle sensors and powertrain controllers. IDL allows recording of up to 24 input channels and sensors to instantly assemble a comprehensive, real-time picture of exactly what is going on under the hood of your vehicle. Newly expanded controls feature a separate arming input option. It doesn't require additional hardware and is an affordable option compared to purchasing an external data logger.

Intelligent Traction Control™ (ITC)

Intelligent Traction Control™ solves the problem of lost traction that results from trying to put too much engine power to the ground with too little tire by using state-of-the-art predictive software in conjunction with the most sophisticated electronics in the industry. The feature includes user adjustable delay to ignore erroneous starting line activation data and separate output wire activation upon ITC triggering. Intelligent Traction Control™ is not legal in all sanctioning bodies/classes; check your rulebook before ordering this upgrade.

16 Injector Option

The 16 injector option is available for already existing XFI™/XFI 2.0™ units by sending in your engine control unit and also for brand new XFI™ purchases. This allows the XFI 2.0™ injector drivers to operate up to 16 injectors and includes the injector Y adapter.



16 Injector Harness

XFI 2.0™ Marine

Specifically designed for marine applications, the XFI 2.0™ Marine features a waterproof housing and several system upgrades engineered specifically to maximize the power potential of a boat engine.

- ECU is o-ring and conformally sealed for marine use
- User defined pressure and temperature alarm sets off sirens, lights or any other preferred alert when problems arise
- Upgraded user interface for power adders including advanced forced induction and progressive controllability
- Revolutionary self tuning option combines easy-to-use features and completely configurable capabilities
- Nominal dimensions: 8.75"W x 5.5"H x 1.5"D



COMPLETE OR CUSTOM?

Choose a complete XFI 2.0™ kit for your application OR buy individual components specifically designed to work together to customize your own system.

COMPLETE XFI 2.0™ SYSTEMS
ON PG 31

-OR-

INDIVIDUAL COMPONENTS
BEGIN ON PG 32

XFI 2.0™ ELECTRONIC FUEL INJECTION KITS



#3012350-10

XFI 2.0™ Electronic Fuel Injection Kits

FAST™ offers bolt-on XFI 2.0™ Kits to install fully sequential EFI on Small and Big Block Chevy and Small Block Ford engines from mild street rods to 1000 HP all-out race cars. XFI 2.0™ Fuel Injection Kits include carefully matched components, including the XFI 2.0™, Dual-Sync Distributor, a single plane aluminum intake manifold, 4 barrel throttle body, proper size Precision-Flow™ Fuel Injectors, aluminum fuel rails, fuel pump kit, all necessary sensors, professional quality wiring harnesses with labeled connectors and the FAST™ EFI Installation & Tuning DVD.

* Kits may vary by application. Call for specific kit contents.

Notes: Minor machine work or clearancing to the intake manifold may be required, depending on the cylinder heads used. Naturally aspirated horsepower figures.

	Red Throttle Body	Polished Throttle Body
XFI 2.0™ Kit – SBC Up To 550 HP	3012350-05	3012350-05P
XFI 2.0™ Kit – SBC Up To 1,000 HP	3012350-10	3012350-10P
XFI 2.0™ Kit – BBC Up To 550 HP	3011454-05	3011454-05P
XFI 2.0™ Kit – BBC Up To 1,000 HP	3011454-10	3011454-10P
XFI 2.0™ Kit – BBC Tall Deck Up To 1,000 HP	3011572-10	3011572-10P
XFI 2.0™ Kit – SBF Up To 550 HP	3031302-05	3031302-05P
XFI 2.0™ Kit – SBF Up To 1,000 HP	3031302-10	3031302-10P
XFI 2.0™ Kit – Ford Windsor Up To 550 HP	3035351-05	3035351-05P
XFI 2.0™ Kit – Ford Windsor Up To 1,000 HP	3035351-10	3035351-10P

EFI Crate/Transplant Engine Management Kits

For owners of fuel injected crate/transplant engines, FAST™ presents a solution to allow easy conversion to aftermarket EFI for late model GM and Chrysler engines. Kits are tailored to perfectly match the specific brand and model of crate engine being converted and include a FAST™ XFI 2.0™ system, an XIM™ Ignition Module, cable-driven 92mm high-flow throttle body, and all necessary plug and play wiring.

- Kit allows easy conversion to more powerful aftermarket EFI for late model GM and Chrysler applications
- Includes XFI 2.0™, XIM™ Ignition Module, cable-driven throttle body and all necessary wiring
- Provides flexibility to precisely tune your engine for performance upgrades using aftermarket components



#301010

EFI Crate/Transplant Kit For GM LS1/LS6	301009 ¹
EFI Crate/Transplant Kit For GM LS2 – 2005 Only	301010
EFI Crate/Transplant Kit For GM LS2/LS3/LS7 – 2006 & Up	301011

¹ Part #301009 does not include throttle body.

EFI Crate/Transplant Kit For Chrysler 5.7L Hemi	301012
EFI Crate/Transplant Kit For Chrysler 6.1L/6.4L Hemi	301013
EFI Crate/Transplant Kit For Ford 5.0 4V Modular	301014

* Kit contents may vary by application. Call for specific kit contents.

XFI 2.0™ BASE COMPONENTS

HOW TO ORDER AN XFI™ 2.0 SYSTEM: Answer each question below for help deciding the best setup for your needs.

SELECT EACH OF THE FOLLOWING pg. 32

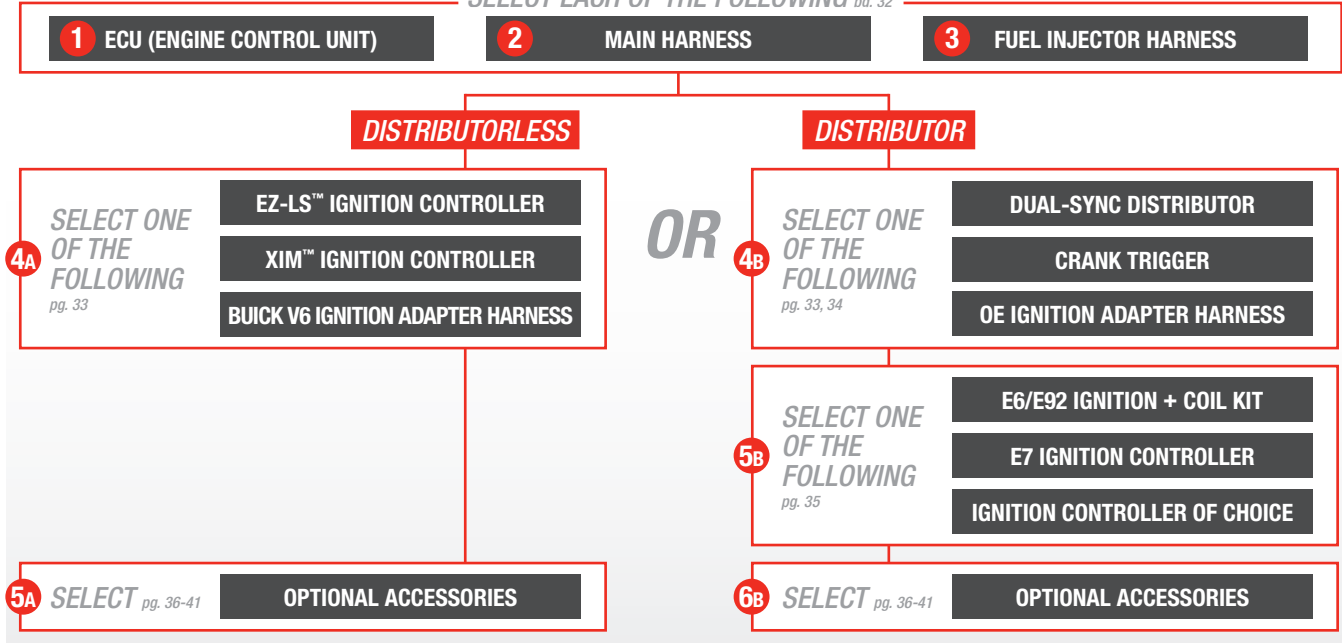

1 XFI 2.0™ ECU (Engine Control Unit)*

XFI 2.0™ ECU	301000	XFI 2.0™ ECU w/ Intelligent Traction Control™ – Black ECU (For 16 Injectors Including Fuel Injector Y Adapter)	301006
XFI 2.0™ ECU (For 16 Injectors Including Fuel Injector Y Adapter)	301001	XFI 2.0™ ECU w/ Internal Data Logging & Intelligent Traction Control™ – Black ECU	301007
XFI 2.0™ ECU w/ Internal Data Logging	301003	XFI 2.0™ ECU w/ Internal Data Logging & Intelligent Traction Control™ – Black ECU	301008
XFI 2.0™ ECU w/ Internal Data Logging (For 16 Injectors Including Fuel Injector Y Adapter)	301004	XFI 2.0™ Marine ECU – Blue ECU	301015
XFI 2.0™ ECU w/ Intelligent Traction Control™	301005		

* All XFI 2.0™ ECUs include (1) NTK O₂ sensor.

2 XFI 2.0™ Main Harnesses

GM TPI	301100	Universal (Flying Lead Harness w/ Weatherpack Connectors)	301105
GM LT1/Carb Conversion	301101	Rear Engine Dragster/Boat (Short Main Lead)	301106
GM LS1, -2, -3, -6, -7, -9, Trucks	301108	ECU Main Connector Kit (Connectors Only, No Wires)	301000K
Chrysler 5.7L, 6.1L, 6.4L Hemi	301104		

3 XFI 2.0™ Fuel Injector Harnesses

	Firing Order	Injector Type Connector*	
SBC, BBC, LT1	18436572	Minitimer	301200
Small/Big Block Chevy (4/7 Swap Cam)	18736542	Minitimer	301201
GM Gen III LS1, LS6 (See Injector Type for Proper Selection)	18726543	Minitimer	301202
GM Gen III LS2, LS3, LS7 (See Injector Type for Proper Selection)	18726543	USCAR	301209
Ford 5.0L Coyote	15486372	USCAR	301210
Ford 4.6L, 5.0L, 5.4L, 5.8L	13726548	Minitimer	301203
Ford 289, 302, FE, 429, 460	15426378	Minitimer	301204
Chrysler (Except 5.7L, 6.1L)	18436572	Minitimer	301200
Chrysler 5.7L, 6.1L, 6.4L Hemi	18436572	USCAR	301208
Y Adapter For Multiple Injector Applications	NA	NA	301205
Buick V6	165432	Minitimer	301206
4 Cylinder (Partially Completed Harness)	User Determined	Minitimer	301207

* See pg. 43 for details.

XFI 2.0™ BASE COMPONENTS

#305008



#301312E



#30260-1

4A EZ-LS™ Ignition Controller

With simplified wiring and tuning flexibility, the EZ-LS™ delivers proven ignition control for LS engine swaps. It works perfectly with EZ-EFI 2.0® Fuel+Ignition XFI 2.0™ and XFI Sportsman™, and utilizes a simplified plug-and-play wiring harness and compact, waterproof ECU. This kit is engineered to use stock LS crank and cam sensors and doesn't require tuning. For those that desire greater tuning control, the EZ-LS™ can be custom-tuned via the EZ-EFI 2.0® hand-held or XFI™ C-Com® software connected to an XFI 2.0™ system.

*Works with all 1997-Current GM coil-near-plug ignition systems and both 24x/58x tooth reluctor wheels. Not compatible with LS truck-finned coils. Wiring harness included. Requires use of EZ 2.0™, XFI 2.0™, or XFI Sportsman™. (Does NOT work with original EZ-EFI™ or carburetors)

EZ-LS™ Ignition Controller Kit w/ Harness	301312E
---	---------

XR-1A High-Output Ignition Coil Set

The XR-1A High-Output Ignition Coil Set is designed specifically for high-compression naturally aspirated, boosted or nitrous-equipped applications making more than 1,000 horsepower. The spark energy of these coils is comparable to CDI (capacitive discharge ignition) systems without the need to convert. The Smart Coil design requires no ignitor module. It delivers up to 44,000 volts, 103mJ of energy, and supports a maximum of 19 amps of current and 17 volts. Works with all OEM equipment, as well as FAST™ products that support coil-near-plug applications. Able to be used in coil per cylinder applications.

Set of (8) Coils w/ Connectors	30260-T8
Set of (8) Coils ONLY (No Connectors)	30260-8
Single Coil w/ Connector	30260-T1
Single Coil ONLY (No Connector)	30260-1

4A XIM™ Ignition Controller

(Connector Kits Consist Of Connectors, Terminals & Seals Only – No Wires)

The XIM™ Ignition Module lets you easily install the EZ-EFI 2.0® Fuel+Ignition, XFI 2.0™ or XFI Sportsman™ on many distributor-less ignition-type EFI engines. It's a simple plug-and-play installation with factory type connectors that plug into your factory sensors. Also available are standalone ignition modules for coil-per-cylinder carb applications or original EZ EFI™ that enable programmable control of the late model coil-per-cylinder ignition systems, independent of the fuel delivery method or any factory computer. Nominal dimensions: 7.25"W x 6"H x 2"D.

	Kits*	Standalone**
XIM™ Ignition Module (No Harness)	305008	–
GM LS1/LS6 XIM™ Kit w/ Harness	301311	3013112
GM LS2/LS3/LS7 XIM™ Kit w/ Harness	301312 ¹	3013122
GM LS1/LS2/LS3/LS6/LS7 XIM™ Connector Kit	301311K ¹	–
Ford 5.0 Coyote Coil-On-Plug XIM™ Kit w/ Harness	301317	3013172
Ford Modular Coil-On-Plug XIM™ Kit w/ Harness	301313	3013132
Ford Modular Coil-On-Plug (Includes XIM™) Alternate Coil Option	301313A ²	–
Chrysler 5.7L EFI Hemi XIM™ Kit w/ Harness	301316	3013162
Chrysler 5.7L EFI Hemi XIM™ Connector Kit	301316K	–
Chrysler 6.1L EFI Hemi XIM™ Kit w/ Harness	301314	3013142
Chrysler 6.1L EFI Hemi XIM™ Connector Kit	301314K	–
Universal XIM™ Connector Kit	301315K	–
LS2, LS7 Cam Pickup Adapter Harness	301415	–
LS2, LS7 Crank Pickup Adapter Harness	301416	–
GM Gen III/IV L92 Truck-Style Coil	30256-8 ¹	–

* For use w/ EZ-EFI 2.0®, XFI 2.0™, XFI Sportsman™
** For use w/ original EZ-EFI™ or carb applications

¹ Includes #301145 & #301416.
² Must use part #30256-8.

4B XFI 2.0™ Ignition Adapter Harnesses & Connector Kits

(Connector Kits Consist Of Connectors, Terminals & Seals Only – No Wires)

These adapters allow a common ECU and main harness to adapt to a wide variety of ignition strategies.

	Complete Harness	Kits
Inductive Pick-Up (IPU – 2-wire MSD-Type Distributor or Crank Trigger)	301300	301300K
Hall Effect	301301	301301K
4A Buick V6 (Early)	301307	NA
GM HEI	301302	301302K
GM LT1 (Long Connector)	301304	NA
Ford TFI	301308	301308K

XFI 2.0™

BASE COMPONENTS

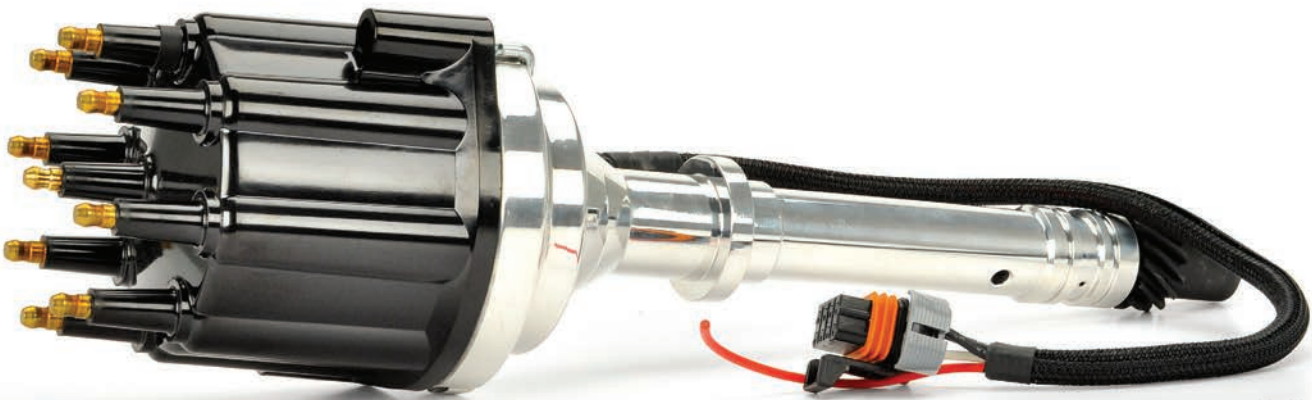

#305007

4B Dual-Sync Distributors

FAST™ Dual-Sync Distributors are an easy, drop-in, plug-and-play solution for fully sequential high performance V8 EFI engine applications. Featuring reluctors and pick-ups that have been properly aligned right out of the box, they eliminate the need to set crankshaft reference angles or manual rotor phasing before installation. FAST™ Dual-Sync Distributors also feature housings that are CNC-machined from high-quality 6061-T6 billet aluminum. Using high output magnetic pick-ups to generate high capacity, noise resistant, discrete switching signals to and FAST™ XFI™ and EZ-EFI 2.0® Fuel+Ignition ECU, these distributors deliver extremely precise ignition timing and extra long life.

Small/Big Block Chevrolet Distributor	305005
Big Block Chevrolet (Tall Deck) Distributor	305017
Small Block Ford Distributor	305007
Ford Windsor Distributor	305009
FE Ford Distributor	305010
Ford 351C-460 Distributor	305015
Small Block Chrysler Distributor	305011
B Engine (383-400) Chrysler Distributor	305012

RB Engine (426-440) Chrysler Distributor	305013
Pontiac Distributor	305016
Oldsmobile Distributor	305018
Replacement Distributor Cap & Rotor	305014
Replacement Distributor Cap	305014C
Replacement Distributor Module	305014M
Replacement Distributor Rotor	305014R

4B Crank Triggers

The FAST™ Crank Trigger is a magnet free device with a durable wheel constructed from high strength steel. With a .125" wheel, it requires less space than competitors' aluminum versions. The FAST™ inductive sensor is also much smaller than others on the market and is hermetically sealed with the connector molded into the body. This long lasting sensor is used by OEMs both on and inside the motor and provides accurate timing. Compatible with XFI 2.0™, XFI Sportsman™, EZ-EFI 2.0® Fuel+Ignition or for use with other aftermarket EFI/ignitions.

- **Ultra durable CNC-machined aluminum bracket with clearly labeled precision timing marks**
- **Magnet-free, ultra-thin .125" steel wheel**
- **Small OEM-quality inductive sensor provides unrivaled accuracy while saving space**
- **Includes all required mounting hardware; plug-and-play with any aftermarket EFI system**

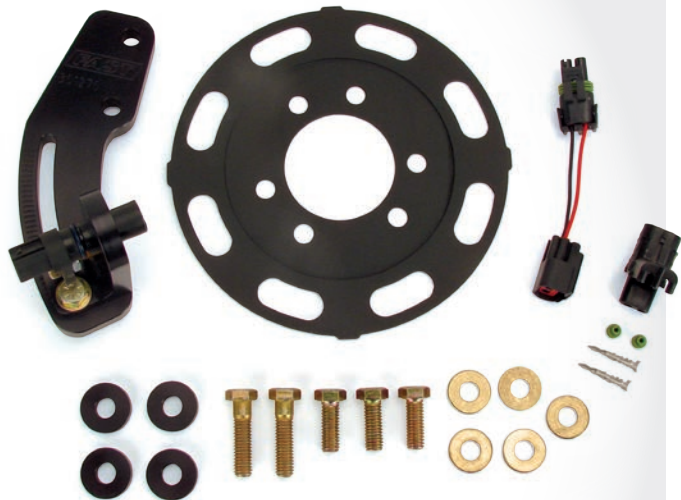

Small Block Chevy Crank Trigger For 7.00" Balancer	301270
Small Block Chevy Crank Trigger For 8.00" Balancer	301280

Big Block Chevy Crank Trigger For 8.00" Balancer	301180
Small Block Ford Crank Trigger For 6.562" Balancer	303565



5B E6/E92 Digital CD Ignition & Coil Kit

This E6 Digital CD Ignition Box was engineered to provide a solution for a digital electronic CD ignition that would work flawlessly with FAST™ EFI components. It features multiple spark functionality, meaning the engine will fire multiple sparks per cylinder while the engine is below 3000 RPM. The multiple-spark feature provides a more complete burning of the fuel in the combustion chamber, resulting in a smoother running engine and better fuel economy. The FAST™ E6 Digital CD Ignition Box is electronic fuel injection friendly and specifically designed to work with all FAST™ EFI Systems. The engineers at FAST™ also designed the E6 Digital Ignition box to be fully compatible with all carbureted applications.

Available to work directly with the FAST E6 ignition box or any other modern ignition system is the E92 E-Core Ignition Coil. It is able to provide up to 70% more output than standard OEM coils due to the computer-designed, robust gauge windings. This results in less resistance and better heat dissipation for improved higher RPM performance. The FAST™ E92 E-Core Ignition Coil is completely over-molded to ensure maximum protection from rust and corrosion. The over-molded design also allows the unit to be significantly lighter than the standard OEM component. A full kit that includes both the E6 Digital CD Ignition Box and the E92 E-Core Ignition Coil is available or parts may be purchased separately.

- Features multiple-spark technology for more complete burning of fuel in combustion chamber
- Multiple-spark function results in smoother running engine and increased fuel economy
- Engineered to support all FAST™ EFI systems and all carbureted applications

E6/E92 Digital CD Ignition & Coil Kit	306401
E6 Digital CD Ignition Box	306425
E92 E-Core Ignition Coil	308250

5B E7 Ignition Controller

This high-output, race-specific digital unit is a high-energy, high-RPM, fully environmentally protected capacitive ignition. It is designed to allow the full performance of a race engine where high-compression, nitrous oxide and boosted applications are common. The ignition includes two built-in rev limiters, a tach output and 20 degrees of start/retard for less wear and easier starting. The fully digital design allows for much higher speed and accuracy of spark timing and rev limits than analog systems. The controller's composite enclosure saves weight, while an aluminum-finned, extruded heat sink improves heat dissipation. Provides 160 MJ of energy output. This unit is perfect for drag, circle track and boat race applications.

E7 CD Ignition Controller	307222
---------------------------	--------



EFI Components & Accessories

DASHES

XFI 2.0™ eDash

Developed to make harnessing the power of FAST™ XFI™ systems even easier, the XFI™ eDash lets users view multiple sensors in real-time and make popular adjustments without any software, laptops or switches. This direct plug-and-play unit is compatible with all FAST™ XFI 2.0™ and XFI Sportsman™ units and offers an attractive, modern electronic digital dash that is small and compact, yet very readable. The full-color, touchscreen hand-held doesn't require a laptop or software as the unit automatically senses the EFI system to which it is attached. The unit features multiple live data sensor screens, which include various electronic digital dashes highlighting combinations of commonly used sensors. Includes a suction cup and articulating quick-release mount, making dash or window mounting easy.

FAST™ XFI 2.0™ and XFI Sportsman™ Systems REQUIRE a laptop for initial tuning; XFI™ eDash is for use after initial tuning is complete.



- Displays up to 20 different live sensor values at one time
- User can select start-up screen that will display each time unit restarts
- Unit logs both minimum and maximum sensor readings to allow easy recording of information
- Includes suction cup and articulating quick-release mount for easy window mounting
- Works with XFI 2.0™ and XFI Sportsman™

XFI 2.0™ eDash

301517

On-The-Fly Adjustment Options (w/ XFI 2.0®)

Pick From Up To 4 Street Or Race Tunes
Power Adder (eg. Nitrous) On/Off
Torque Converter Clutch Lock-up MPH (w/ EZ-TCU™)
Adaptive Learn Trim Adjustments

XFI™ Touchscreen Dash/Data Logger

With its state-of-the-art monitoring and data logging capabilities, the XFI 2.0™ Touchscreen Dash/Data Logger can assemble a comprehensive, real-time picture of up to 25 separate input channels and allows for fine tuning of the TCU through the dashboard without a laptop. It features a 6-inch, fully programmable LCD touchscreen display and has the ability to display its data in a multitude of scales, units and gauge configurations. Its backlit display can be user-customized at the touch of a finger or stylus. Engineered to work with any level of vehicle modification from stock to all-out race, the XFI™ Touchscreen Dash/Data Logger is able to monitor and display output, including frequency (RPM, wheel speed, etc.), analog input and sources that require programmable input parameters such as MAP and MAF. As a data logger, the unit has a 2 MB memory module* that will store up to one hour of data.

* Example based on 8 analog inputs, 2 speed inputs, and transmission controller and XFI™ ECU outputs recorded at a rate of 5 samples/second.



- 8 analog inputs, 2 speed inputs, & programmable input parameters
- Logged data is viewable through display screen or downloadable via USB into C-COM® XFI™ or other popular Windows based programs for convenient data manipulation and analysis
- 2 PWM outputs configurable for a variety of accessories, including relays, shift lights, nitrous or boost control solenoids, etc.
- CAN (Control Area Network) communication allows all engine data from XFI 2.0™ to be transferred to the dash via 2 wires
- Works with XFI 2.0™ but NOT XFI Sportsman™

XFI 2.0™ Touchscreen Dash/Data Logger	301417
Classic FAST™ To Dash Adapter Cable	301442
FAST™ GPS Module For Use With Touchscreen Dash	301445

EFI Components & Accessories

MODULES

XFI™ Exhaust Gas Temperature (EGT) Module

The XFI™ EGT (Exhaust Gas Temperature) Module from FAST™ allows XFI™/XFI 2.0™ owners to monitor up to 8 EGT sensors without requiring the use of the 8 spare auxiliary XFI™ inputs. The XFI™ EGT Module utilizes a small, thin cable to communicate through a high speed CAN connection.

XFI™ EGT Module	301418
XFI™ EGT Module Kit w/ Harness, Fittings & Thermocouples	301405
Single 12" Probe – 1/4" Diameter	30137
Single 18" Probe – 1/4" Diameter	30138
Single 24" Probe – 1/4" Diameter	30139
Single 36" Probe – 1/4" Diameter	30140
Single 48" Probe – 1/4" Diameter	301425
Weld-In EGT Fittings – 1/8" NPT	301443
EGT Fitting Caps	301444



XFI™ 3-Axis Accelerometer Module

The XFI™ 3-Axis Accelerometer Module gives you the ability to read g-forces for acceleration/deceleration, vertical motion and turns. This module, designed to communicate with the C-Com® XFI™ software, allows an individual to test and improve launches, braking and cornering. Great for off-road, road racing, drag racing and street performance vehicles.

XFI™ 3-Axis Accelerometer Module	301419
----------------------------------	--------

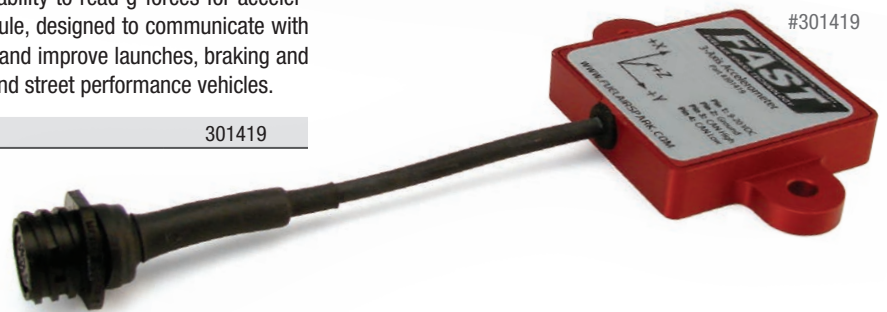

Bump Stager

Available as a complete kit, the Bump Stager lets drag racers carefully pulse the transbrake. This enables the vehicle to move forward slowly during staging, creating a higher degree of repeatability than racers are able to achieve manually. The complete kit comes with everything needed for use in the box, and a built-in 20-amp driver removes the hassle of wiring an external relay for most applications.

- Includes variety of adjustment options including ramp in/out times, output frequency & shift-light control
- Kit comes with everything needed in box
- Designed for all automatic transmission vehicles with installed transbrake solenoid, creating universal functionality

Bump Stager	30322
-------------	-------

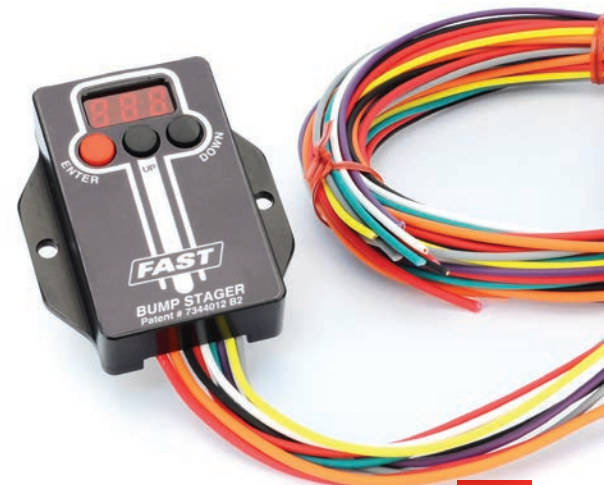

EFI Components & Accessories

OPTIONAL

Upgrade Options

(Available As A Conversion Service To Existing Or Older XFI 2.0™ Units)

XFI 2.0™ Update	301020	Internal Data Logging Option	301423
XFI 2.0™ Update w/ Enclosure	301021	Intelligent Traction Control™ Option	308027
		16 Injector Option	308028

Optional Harnesses & Connector Kits

(Connector Kits Consist Of Connectors, Terminals & Seals Only – No Wires)

	Complete Harness	Kits		Complete Harness	Kits
Power Adder	301400	301400K	CAN Retro-Fit	301412	301412K
Flash	301401	301401K	CAN Interconnect Cable	301413	NA
Analog Input	301402	301402K	CAN Terminating Resistor Set	301414	NA
VSS & Auxiliary Shaft	301403	301403K	Single Pressure Sensor Kit 0-100 psi (w/ Precision Sensors)	301408 ¹	NA
Switching Outputs (Terminated To Push Into Connector Directly)	301404	NA	Single Pressure Sensor Kit 0-200 psi (w/ Precision Sensors)	301420 ¹	NA
Fan & Fuel Pump	301406	301406K	Single Pressure Sensor Kit 0-1500 psi (w/ Precision Sensors)	301421 ¹	NA
Dual Pressure Sensor Kit 0-100 psi (w/ Precision Sensors)	301407 ¹	301407K ¹	MSD Crank Trigger to XFI™ Harness	307045	NA
Single Pressure Sensor Kit (w/ OE Style & Mount)	301410	NA	MSD Cam Trigger to XFI™ Harness	307046	NA
Qwik Tune™ Calibration Selector Switch	301409	NA			

¹ Includes 307602 sensor(s).

Connector Cables

5 ft. PC To ECU Cable	308019
25 ft. PC To ECU Cable	308014
USB To Serial Converter Cable	307044



XFI 2.0™ Plug & Play Dry Nitrous Systems For GM LS

A major component of XFI 2.0™ is its compatibility with nitrous. FAST™ has developed the only nitrous line that allows the user to utilize this feature without any complicated wires or relays. Each system's wiring plugs directly into the XFI™ power-adder harness for ease of installation, and utilizes XFI™ solid-state relay for progressive control. Plate and multi-port kits are available for LS applications. Each contains everything needed to be installed on an LSX-style manifold. No precision tube bending or fitment is required. FAST™ XFI 2.0™ Plug & Play Dry Nitrous Systems support up to a 300-horsepower nitrous shot and are designed for drag race, street performance and marine race applications.

- Complete, easy-to-install kit
- Allows the use of advanced power adder features without the complicated wiring
- Supports up to 300 HP of nitrous
- Drag race, street performance & marine applications

XFI 2.0™ Plug & Play Dry Nitrous Multi-Port Kit for GM LS	301400DP
XFI 2.0™ Plug & Play Dry Nitrous Plate Kit for GM LS	301400PP



EFI Components & Accessories

SENSORS

Sensor Kits

FAST™ has once again taken the lead in simplifying your conversion to EFI with our sensor kits. In each kit you receive every sensor you'll need. Our kit comes complete with excellent, high-quality sensors in a wide variety of styles to cover GM or Ford-style throttle position and 1, 2, 3 and 5 bar MAP sensors.

Ford 1 Bar/14.5 psi	307049	GM 1 Bar/14.5 psi	307053
Ford 2 Bar/29.0 psi	307050	GM 2 Bar/29.0 psi	307054
Ford 3 Bar/43.5 psi	307051	GM 3 Bar/43.5 psi	307055
Ford 5 Bar/72.5 psi	307052	GM 5 Bar/72.5 psi	307056

Sensor Kits Include the Following:

Ford		GM	
TPS	307005	TPS	307006
CTS	307003	CTS	307003
ATS	307004	ATS	307004

And (1) MAP of Choice:

1 Bar	307007	3 Bar	307009 ¹
2 Bar	307008 ¹	5 Bar	307047 ²

¹ Includes replacement matching connector body to retro-fit existing 301100 or 301101 main harness.

² Includes 5 bar adapter.

Relays

For switching any high current or high load device.

20-AMP Relay (EZ-EFI®)	307010	75-AMP Relay	307019
30-AMP Relay	307011	Digital 20-AMP Relay	307043

Throttle Position Sensor (TPS)

The throttle position sensor bolts to the throttle blade shaft and relays throttle opening/closing information to the system ECU. The TPS is constructed of high resistance material with a sensitive rotator for accurate throttle position measurement.

Throttle Position Sensor – Ford	307005
Throttle Position Sensor – GM	307006
Throttle Position Sensor – GM LT1 (EZ-EFI® & EZ-EFI 2.0®)	307028
Throttle Position Sensor – GM LS	54020
TPS Adapter Harness – Early To Late GM	308022
TPS Adapter Harness – Early To Late GM	308030

Coolant Temperature Sensor (CTS)

Coolant Temperature Sensor – 3/8" NPT	307003
---------------------------------------	--------

Air Temperature Sensor (ATS)

These sensors monitor incoming air temperature for the ECU system. This information helps the ECU inject the proper amount of fuel into the system.

Air Temperature Sensor – 3/8" NPT	307004
-----------------------------------	--------



EFI Components & Accessories

SENSORS

5 Wire Oxygen Sensor

For wide-band, closed-loop applications. Sensor can read air/fuel ratios from 9:1 to 16:1.

Replacement Wide-Band O ₂ Sensor (EZ-EFI®, EZ-EFI 2.0®, XFI™ Sportsman or Air/Fuel Meter)	170408
5 Wire Wide-Band Oxygen Sensor LHA-Type (XFI™, XFI 2.0® or XFI 2.0™ Marine)	301422
5 Wire Wide-Band Oxygen Sensor Mating Connector Kit (XFI™, XFI 2.0® or XFI 2.0™ Marine)	301422K
300 Series Stainless Steel Oxygen Sensor Fitting (Weld-In Bung)	30168
300 Series Stainless Steel Oxygen Sensor Fitting Plug	30169
300 Series Stainless Steel Oxygen Sensor Fitting & Plug Kit	307018



Precision Pressure Sensors

Compatible with XFI™ and the FAST™ Touchscreen Dash/Data Logger and designed for harsh automotive environments, these pressure sensors allow you to monitor vital pressures throughout your powertrain. Fuel, oil and nitrous pressure are just a few examples. Constructed from a stainless steel body with 1/8" NPT thread, each sensor is supplied with a sealed mating connector and terminals.

Single Pressure Sensor Kit 0-100 PSI	307062	Single Pressure Sensor Kit 0-1500 PSI	307064
Single Pressure Sensor Kit 0-200 PSI	307063		

For complete kit with XFI™ specific harness, see page 35.



OE-Style Fuel/Oil Pressure Sensors

0-100 PSI Sensor – Replacement Sensor, M16x1.5 Thread, 0-5V	30428
---	-------

For complete kit with XFI™ specific harness, see page 35.

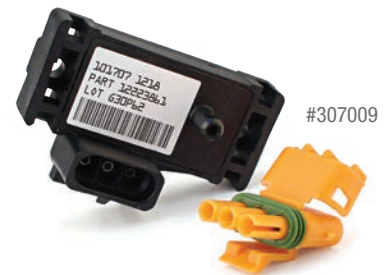
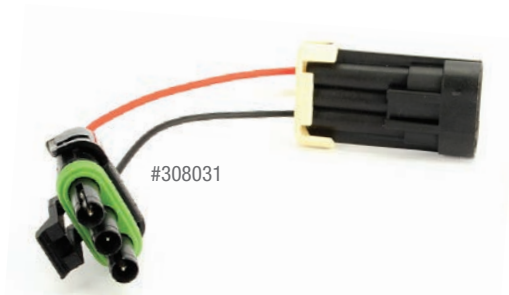

Manifold Absolute Pressure Sensors (MAP)

These sensors monitor intake manifold vacuum to measure the amount of load being placed on the engine. MAP sensors relay engine load output to the ECU, which in turn adjusts fueling for optimum performance and economy.

MAP 1 Bar Sensor, LS1 Style	307029	MAP 5 Bar Sensor	307047 ^{1,2}
MAP 1 Bar Sensor	307007	Adapter Harness – LS Sensor to Early GM Harness	308029
MAP 2 Bar Sensor	307008 ¹	Adapter Harness – Early GM to LS Sensor Harness	308031
MAP 3 Bar Sensor	307009 ¹		

¹ Includes replacement matching connector body (to retro-fit existing 301100 or 301101 main harness).

² Includes 5 bar adapter.

EFI Components & Accessories

SENSORS

Idle Air Control Motor (IAC)

The idle air control allows the ECU system to control engine idle speed by controlling air-flow around the throttle body blades.

IAC GM TPI Style	307014
IAC GM LT1/LT4 Style	307015
IAC GM LS1 Style	307059
Remote IAC Valve Adapter w/ Filter	307016 ¹
IAC Housing (Adapts Ford to GM)	307022 ²
IAC Adapter Harness – Early Harness To Late GM IAC	308023
IAC Adapter Harness – Late GM to Early Harness	308032

¹ Includes #307014 TPI-style IAC.

² Use with #307014 TPI-style IAC.

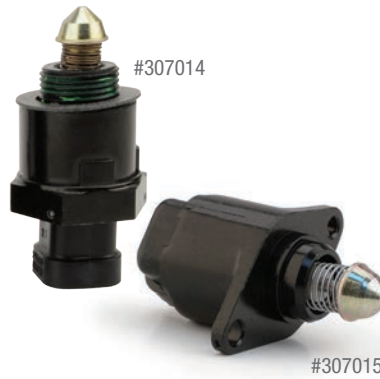

XFI™ Driveshaft Speed Sensor Kit

The XFI™ Driveshaft Speed Sensor Kit from FAST™ accurately measures driveshaft speed to provide better data for the traction control unit. Two magnets are fitted to the collar around the pinion yoke, which attaches to the driveshaft. When the magnet passes the pickup, it sends a signal to the XFI™ unit. The XFI™ uses that signal to calculate driveshaft RPM and also driveshaft acceleration. As a result, the XFI™ Driveshaft Speed Sensor Kit provides a much more accurate data reading than attempting to determine driveshaft speed solely through engine RPM. Perfect for drag race applications, this unit also provides an MPH reading, which allows the XFI™ to calculate miles per gallon.

XFI™ Driveshaft Speed Sensor Kit – 2.1875	301436	Replacement Speed Sensor Pickup	301438
XFI™ Driveshaft Speed Sensor Kit – 1.875	301437	Replacement Speed Sensor Trigger Magnet	301439



Boost Control Solenoid

Allows XFI 2.0™ to control boost.

XFI™ 3-Port Boost Control Solenoid	301440
------------------------------------	--------

EFI Components & Accessories

FUEL INJECTORS



Precision-Flow™ Fuel Injectors

FAST™ Precision-Flow™ Fuel Injectors deliver the outstanding idle quality, unparalleled flow consistency and durability essential for high performance EFI engine applications. Engineered to yield faster throttle response, reduced clogging and superior fuel atomization, Precision-Flow™ Fuel Injectors are manufactured to the tightest tolerances in the industry.

FAST™ also offers Precision-Flow™ Fuel Injectors specifically for GM Gen IV engines. They are the highest flowing injectors available for these applications and are uniquely designed for direct installation into LS2 and LS3/LS7/L76/L92/L99-style engines. Available in two different height configurations and a wide range of flow rates, the injectors are correctly sized (shorter than common LS1/LS6 injectors) and feature the correct EV6/USCAR connector, enabling a hassle-free plug-in operation.

* Low-impedance injectors can not be used with OEM computers.

Choosing your Precision-Flow™ Fuel Injectors

1. Take your target peak horsepower and multiply by

- 0.5 for naturally aspirated
- 0.6 for supercharged
- 0.625 for turbocharged

2. Take that figure and divide by the number of cylinders.

3. Divide by .9 (for 90% duty cycle).

This will give you the lb./hr. you will need from each injector.

Example: 520 horsepower, naturally aspirated V8
($520 \times 0.5 = 260$), ($260/8 = 32.5$), ($32.5/.9 = 36$)

This application would require 36 pound per hour Precision-Flow™ Fuel Injectors (Part #303600).

If the formula gives you a number that is not one of the injector sizes, the general rule is to move up to the next largest size.



The FAST™ R&D Fuel Flow Bench is a custom built fuel injector dyno that is unequaled. Designed by FAST™ engineers, the one-of-a-kind system allows for advanced testing and development of an injector's flow capabilities.

EFI Components & Accessories

FUEL INJECTORS



Fuel Injectors, Minitimer Connector¹ Style

36 lb./hr. (378cc/min) High-Impedance Single Injector	303600
60 lb./hr. (630cc/min) High-Impedance Single Injector	306000
220 lb./hr (2310 cc/min) Low-Impedance Single Injector	30355-1

¹ All injectors flow rated at 43.5 psi/3 Bar.

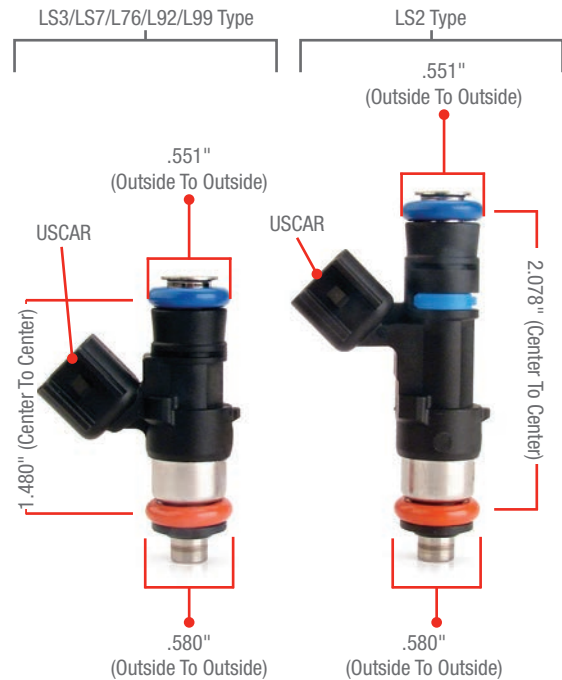

Fuel Injectors, USCAR Connector² Style

LS2-Type 33 lb./hr. (346.5cc/min) High-Impedance Single Injector	30332-1
LS2-Type 46 lb./hr. (483cc/min) High-Impedance Single Injector	30462-1
LS2-Type 57 lb./hr. (598.5cc/min) High-Impedance Single Injector	30572-1
LS2-Type 85 lb./hr. (892.5cc/min) High-Impedance Single Injector	30859-1
LS3/LS7/L76/L92/L99-Type 39 lb./hr. (409.5cc/min) High-Impedance Single Injector	30397-1
LS3/LS7/L76/L92/L99-Type 50 lb./hr. (525cc/min) High-Impedance Single Injector	30507-1
LS3/LS7/L76/L92/L99-Type 65 lb./hr. (682.5cc/min) High-Impedance Single Injector	30657-1
LS3/LS7/L76/L92/L99-Type 85 lb./hr. (892.5cc/min) High-Impedance Single Injector	30857-1

² All Injectors flow rated at 58 psi (Stock OE LS operating pressure).

Fuel Injector Adapter Harnesses & Connector Kits

FAST™ Fuel Injector Adapter Harnesses and Connector Kits enable easy retro-fitting of both new and old style electronic fuel injectors. New style fuel injectors can be used on vehicles equipped with older-style Minitimer connectors. Retro-fitting a Minitimer injector into a USCAR harness is also possible with a different adapter harness. Connector kits, complete with terminals, seals and plugs, are available as well, allowing direct re-termination of existing harnesses with the correct connectors, either Minitimer or USCAR.

Minitimer Type Connector Kit	170599-1
USCAR Type Connector Kit	170600-1
Minitimer To USCAR Type Connector	170603-1
USCAR To Minitimer Type Connector	170604-1

* Each connector & kit are also available in packs of 8. Simply change the -1 to -8.



Intake Manifolds & Throttle Bodies

LSX™ 92mm INTAKE MANIFOLD

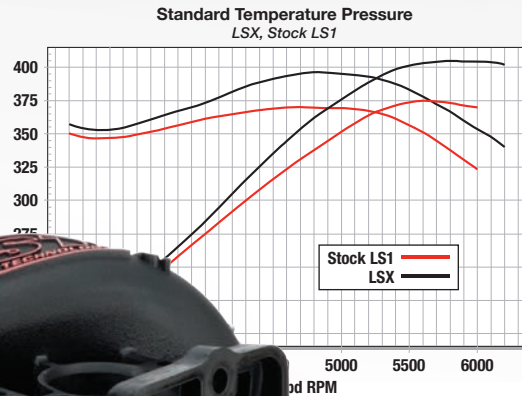

**50-STATE LEGAL
CARB EO# D-279-9**

LSX™ 92mm Black Intake Manifold *Patent No. 7,021,263 B1*

The patented LSX™ 92mm Black Intake Manifold from FAST™ is the only three-piece Gen III (cathedral port) composite manifold proven to deliver increased performance without compromising bottom-end drivability or high-RPM power. Available for both street and racing applications, the new black intake manifold is an easy bolt-on installation for GM Gen III (LS1, -2 & -6) engines and is designed to work with the FAST™ Big Mouth 92mm Throttle Body™. This intake manifold maintains the performance gains achieved over stock intakes with no loss in drivability or low RPM torque. While the manifold delivers terrific performance right out of the box, it can be ported by the customer for even more flow. As requested by previous LSX™ customers, the intake features the added benefits of corrosion-free stainless steel assembly bolts, an improved throttle body sealing flange with o-ring gasket and threaded insert throttle body mounts that provide increased durability.

- Improved throttle body sealing flange and o-ring gasket
- High-quality polymer materials resist the “heat sink” effect of aluminum
- Maximizes potential of other engine performance upgrades such as cylinder heads
- Designed to work with FAST™ Big Mouth and Big Mouth LT Throttle Bodies™ (92mm)
- Includes stainless steel bolts, threaded insert throttle body mounts and necessary mounting hardware



LSX™ 92mm Black Intake Manifold	Manifold	Upper Shell	Lower Shell
	54039B	54039BUS	54039BLS

The LSX™ 92mm Intake Manifold uses FAST™ Billet Fuel Rails (Part #54023) and either a Big Mouth Throttle Body™ (Part #54092) or Big Mouth LT Throttle Body™ (Part #54090).

Intake Manifolds & Throttle Bodies

LSX_R™ 102mm INTAKE MANIFOLDS

**50-STATE LEGAL
CARB EO# D-279-9**

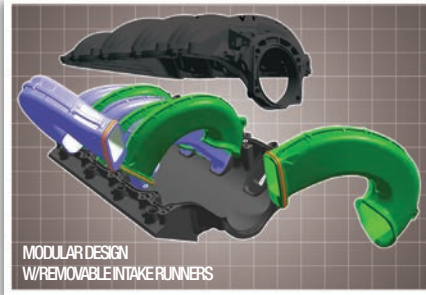

#146102B Shown with #54103

LSX_R™ 102mm Intake Manifold *Patent No. 8,567,366*

FAST™ engineers teamed up with airflow specialists at **RHS®** to develop polymer intake manifolds for rectangular port GM LS3 and LS7 engines and cathedral port LS1/LS2/LS6 engines. Testing on a near stock 500c.i. LS7 engine with a Big Mouth 102mm Throttle Body™ produced gains of 16+ horsepower and 26+ rear wheel horsepower. The LSX_R™ 102mm Intake Manifold features a revolutionary modular design that allows for fast and easy disassembly and features the ability to remove individual runners for porting.

Constructed from the same advanced polymer material as the original FAST™ LSX™ 92mm Intake Manifold, but now in the popular black color, the LSX_R™ offers a host of benefits over aluminum aftermarket intakes, including lighter weight, increased strength and improved heat dissipating characteristics. While the LSX_R™ features a 102mm air inlet that is perfectly suited to the FAST™ Big Mouth 102mm Throttle Body™, for maximum convenience it can also be used with OEM or aftermarket 90mm or 92mm throttle bodies. Other features include integrated nitrous bungs and perfect bolt-on fitment that allows the use of factory accessories without modification or clearance concerns. Fits most C5 and C6 Corvettes without modification.

Now available for LS3, L76, L92 and L99 rectangle port applications are High Horsepower and Race versions of the LSX_R™ Intake Manifold. With shorter and straighter runners than the original LSX™, the High HP intake can make up to 20+ more horsepower than the original while the Race intakes have proven to make up to 35+ more horsepower. Runner sets can also be purchased separately - see page 46.

	Manifold	Upper Shell	Lower Shell
LSX _R ™ 102mm STANDARD Intake Manifold – Rectangle Port, See Chart Below	146102B	146000B	146001
LSX _R ™ 102mm HIGH HP Intake Manifold – Rectangle Port, See Chart Below	146103B	146000B	146001
LSX _R ™ 102mm RACE Intake Manifold – Rectangle Port, See Chart Below	146104B	146000B	146001
LSX _R ™ 102mm Intake Intake Manifold – Raised Rectangle Port, See Chart Below	146202B	146000B	146201
LSX _R ™ 102mm Intake Intake Manifold – Cathedral Port, See Chart Below	146302B	146000B	146301

¹ See chart on page 48 for fuel rail options.

LS Port Identification

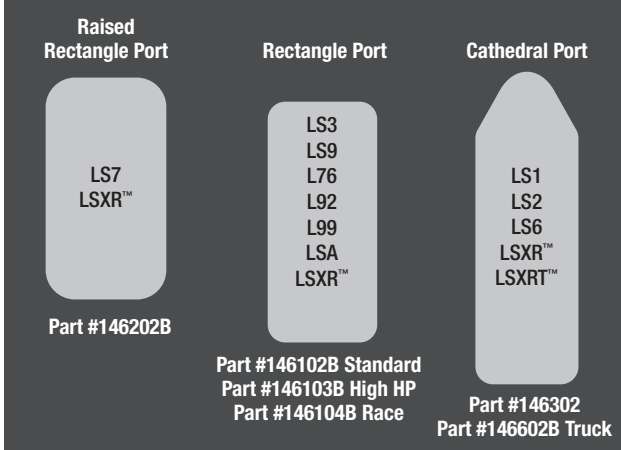

SEE PG 46 FOR NEW RUNNER SET OPTIONS

3rd Party Dyno Test

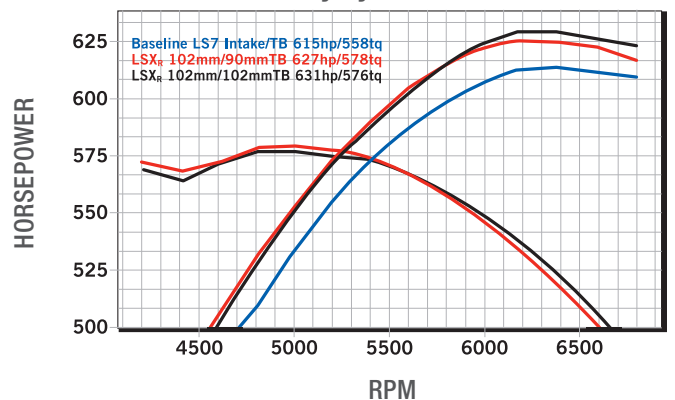

Intake Manifolds & Throttle Bodies

LSX_R[™] / LSX_{RT}[™] INTAKE RUNNERS

**MAXIMIZE
HORSEPOWER**

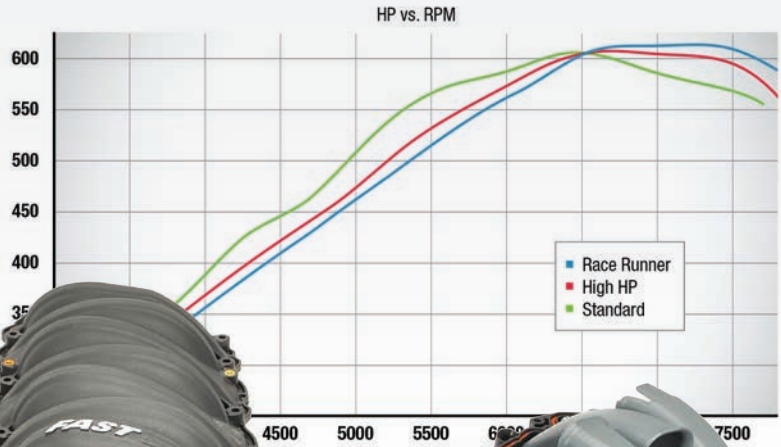

LSX_R[™] / LSX_{RT}[™] Interchangeable Intake Runners

High Horsepower and Race versions of the LSX_R[™] Intake Runners are designed specifically for LS3, L99, L76 and L92 engines that are built for high performance applications. The High HP Runner Set is based on Daytona prototype intakes that are shorter and straighter than previous market offerings, specifically to improve high-RPM horsepower and torque in vehicles with added performance modifications. The High HP version has been proven to make 20+ additional horsepower over the original LSX_R[™] manifold with a 500-1000 RPM shift up in peak horsepower on LS3 performance engines.

The Race Runner Set features the shortest and straightest runners that rival aluminum four-barrel intakes for horsepower potential. This setup utilizes a race runner engineered for all-out high-RPM performance and is ideal for vehicles with serious performance modifications and race converters. The Race Version can provide up to a 35+ horsepower gain over the original LSX_R[™] with a 500-1000 RPM upward shift in peak hp for all out race vehicles.

The runners are interchangeable and available in kits so LS3 manifolds ONLY may be configured with Standard, High HP or Race runners.



**MAXIMIZE HORSEPOWER WITH
INTERCHANGEABLE INTAKE RUNNER SETS**

	Runners Only	Manifold & Runner Set
LSX _R [™] 102mm STANDARD Intake Manifold & Runners – LS3 Car	146053	146102B
LSX _R [™] 102mm HIGH HP Intake Manifold & Runners – LS3 Car	146070	146103B
LSX _R [™] 102mm RACE Intake Manifold & Runners – LS3 Car	146071	146104B
LSX _R [™] 102mm Intake Manifold & Runners – LS7 Car	146253	146202B
LSX _R [™] 102mm Intake Manifold & Runners – LS1 Car	146353	146302B
LSX _{RT} [™] 102mm Intake Manifold & Runners - LS1 Truck	146653	146602B

- Standard runners work with stock or mild vehicles
- High HP & Race runners are shorter & straighter than conventional runners to improve high-RPM hp
- High HP option makes 20+ HP over original LSX_R[™] manifold, Race setup makes 35+ HP
- Interchangeable runners allow manifold to be configured as original, High HP or Race

Intake Manifolds & Throttle Bodies

LSX_{RT}[™] 102mm INTAKE MANIFOLD



#146602

25 HP BOLT-ON
GAINS FOR 1999 & UP
4.8L/5.3L/6.0L GM
TRUCKS

**50-STATE LEGAL
CARB EO# D-279-9**

LSX_{RT}[™] 102mm Intake Manifold *Patent No. 8,567,366*

Designed specifically for GM 4.8/5.3/6.0L cathedral port truck engines and cathedral port LS1, -2, -6 race applications where hood clearance is not a concern, the FAST[™] LSX_{RT}[™] 102mm Intake Manifold follows the path chartered by the original FAST[™] LSX[™] Gen III Intake. It features a modular design that allows for easy porting and disassembly and a runner design that yields an incredible 25 peak horsepower gain over the stock intake, on a stock 6.0L engine with a Big Mouth 102mm Throttle Body[™]. Extensive testing led to a runner design that is longer and less restrictive and gives the user the ability to remove individual runners from the manifold for modification.

The LSX_{RT}[™] is constructed from a proprietary precision injection molded black polymer which offers many benefits, including lighter weight, greater strength and lower heat soak propensity. While it features a 102mm air inlet that was designed for the FAST[™] Big Mouth 102mm Throttle Body[™], it can also be used with OEM electronic 78/90mm or aftermarket 90/92mm throttle bodies (three-bolt electronic throttle bodies require an adapter). Other features include integrated nitrous bungs and a precise bolt-on fit that permits the use of factory accessories and OEM fuel/emission connections without adjustments or clearance issues. Some GM truck models may require the FAST[™] 92mm or 102mm throttle body.

- Designed for use with FAST[™] 102mm Big Mouth Throttle Body[™]
- 102mm inlet also works w/ OEM electronic 78/90mm or aftermarket 90/92mm throttle bodies for high flow and minimal restriction (three-bolt electronic throttle bodies require an adapter)
- Advanced polymer material is strong, lightweight and cools intake charge for enhanced power
- Big gains in rear-wheel HP yet retains factory fitments and under-hood clearance requirements

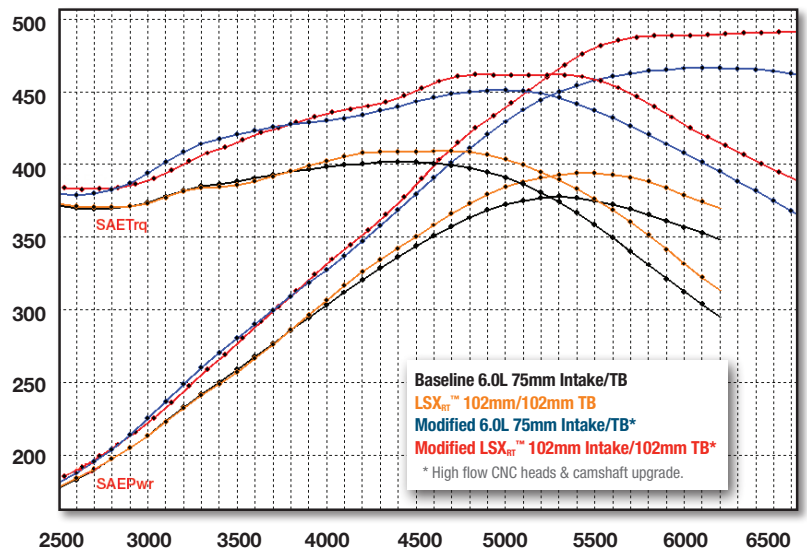

	Manifold	Upper Shell	Lower Shell
LSX _{RT} [™] 102mm Intake Manifold	146602B ¹	146100B	146601
LSX _{RT} [™] /LSX _{RT} [™] Throttle Body Adapter Plate			146029-KIT ²

¹ See diagram on page 48 for fuel rail options.

² Allows use of OEM electronic throttle body.

Replacement runners can be purchased separately - see page 46.

Intake Manifolds & Throttle Bodies

102MM INTAKE MANIFOLD OPTIONS

Having trouble determining which FAST™ Intake Manifold is the right one for your application? The diagram below can help. Find your LS application in one of the application boxes below and follow the lines to determine the proper intake manifold part number, along with fuel rail options and other required and optional accessory pieces. Please refer to these diagrams as some parts are REQUIRED with the installation of a FAST™ Intake Manifold.

LSX_R™ 102mm Intake Manifold (Rectangle, Raised Rectangle & Cathedral Port)

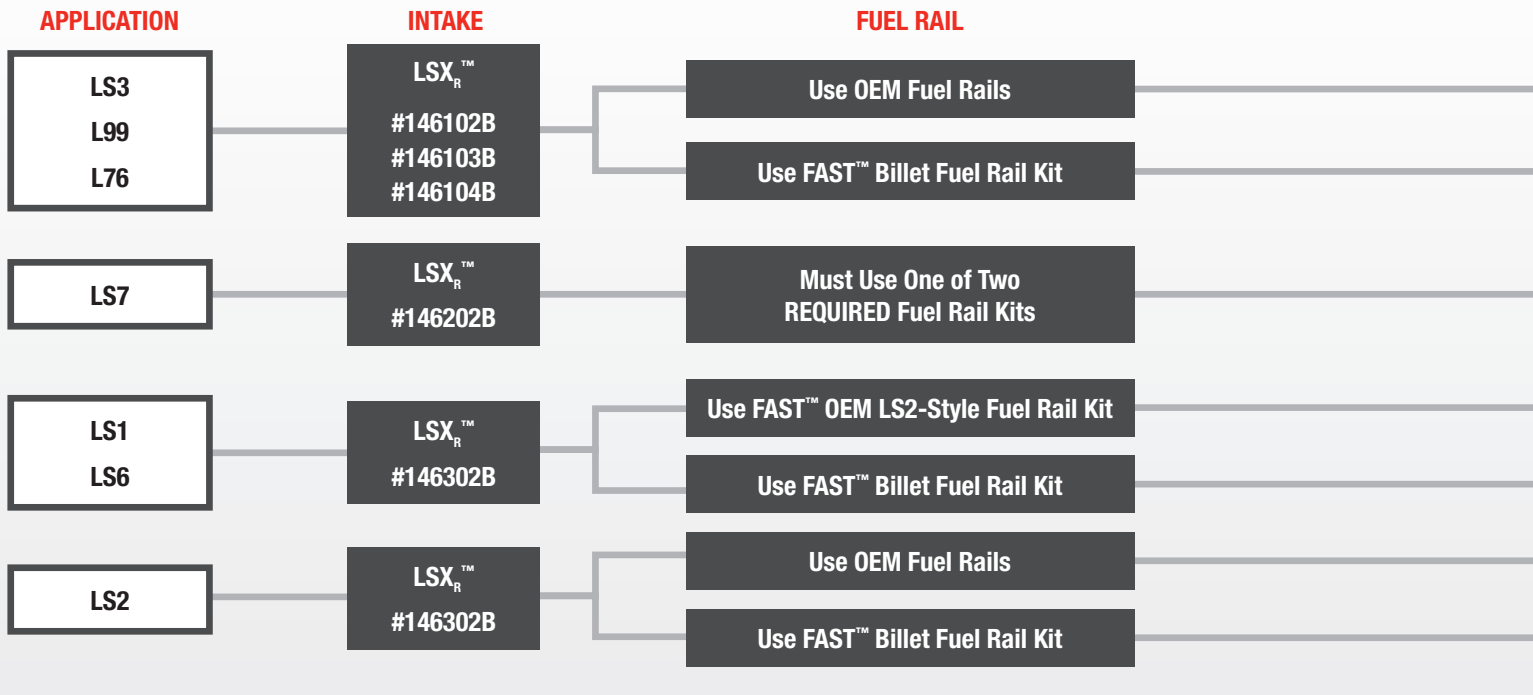

LSX_{RT}™ 102mm Intake Manifold (Cathedral Port)

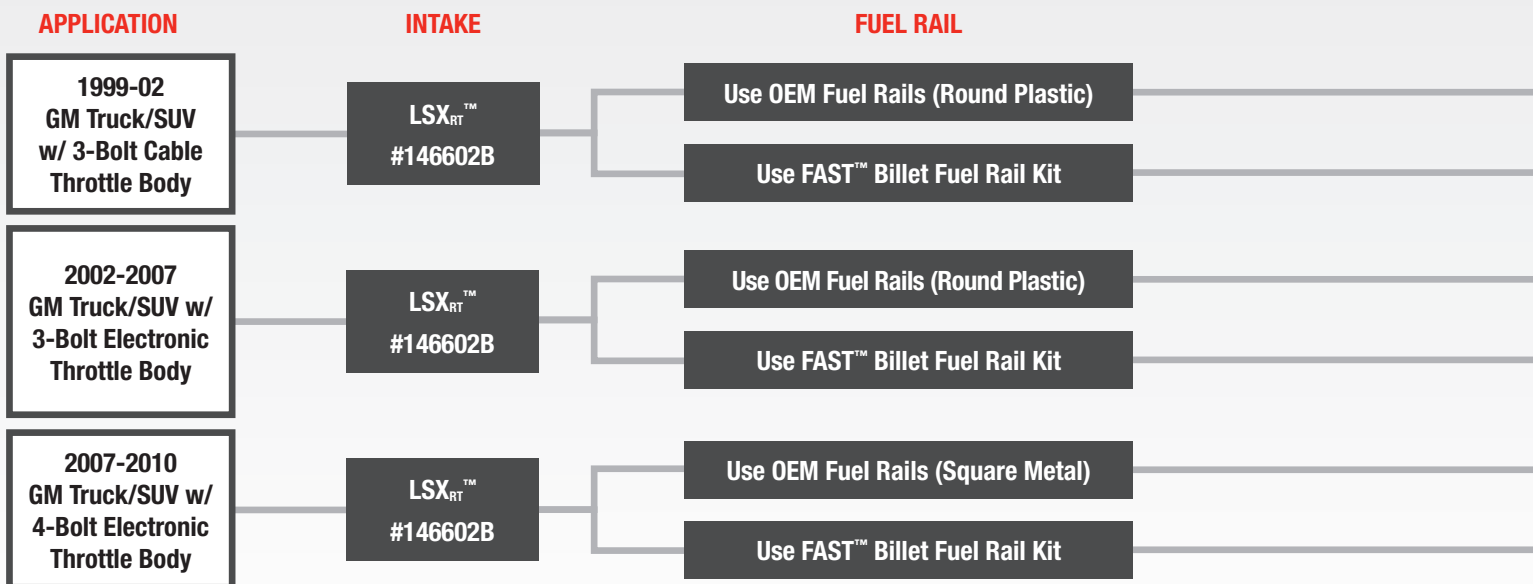

¹ Requires injector lower o-ring swap (included w/ manifold).

² Except Corvette, call FAST™ for recommendations.

³ Except 1997-1998 Corvettes.

⁴ Permanent modification to OEM fuel rail required.

⁵ For use w/ OEM GM Truck/SUV injectors & FAST™ LS2 Injectors.

⁶ Requires injector lower o-ring swap when using OEM injectors (included with manifold).

⁷ Excludes '06 Trailblazer SS, some cowl modifications required.

⁸ Includes '06 Trailblazer SS, some cowl modifications required.

⁹ Requires GM Purge Solenoid #12581282 (not sold by FAST™).

* LSX_R™ applications must use OEM injector length

Intake Manifolds & Throttle Bodies

102MM INTAKE MANIFOLD OPTIONS

LSX_R™ 102mm Intake Manifold (Rectangle, Raised Rectangle & Cathedral Port)

FUEL RAIL KIT

THROTTLE BODY

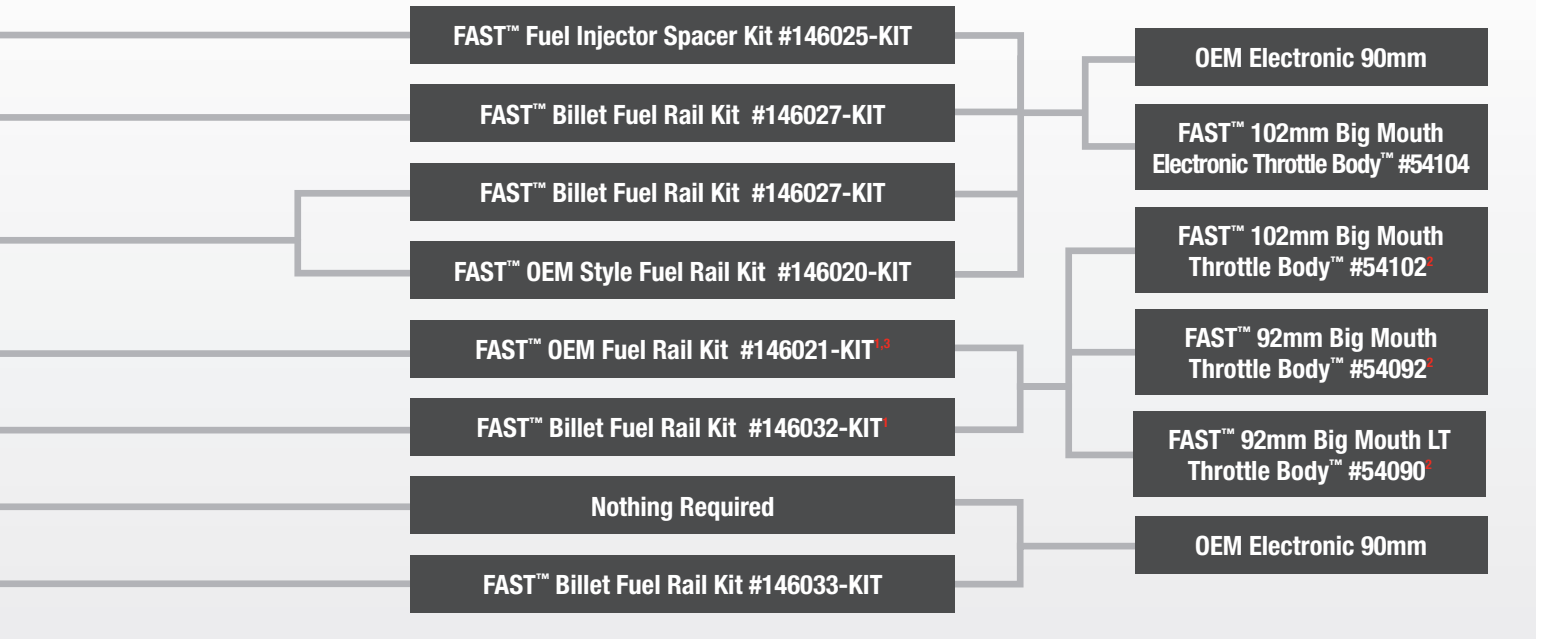

LSX_{RT}™ 102mm Intake Manifold (Cathedral Port)

FUEL RAIL KIT

THROTTLE ADAPTER PLATE

THROTTLE BODY



Intake Manifolds & Throttle Bodies

FUEL RAILS



LSX™/LSX_R™/LSX_{RT}™ Fuel Rails

FAST™ LSX™/LSX_R™/LSX_{RT}™ Fuel Rails feature a larger internal diameter that dampens the pulses and provides increased fuel volume, ensuring that your injectors never run dry. In addition, they yield better fuel distribution and ultimately greater horsepower. Featuring high strength billet, lightweight, red or black* (specific applications) anodized aluminum construction (does not include Part #146020-KIT or Part #146021-KIT), FAST™ fuel rails deliver performance in addition to a show car quality appearance.

	Red	Black
LSX™ LS1/LS6 Billet Fuel Rail Kit	146035-KIT	146035B-KIT
LSX™ LS1/LS6 Fuel Rails w/o Fittings	54023HDW	—
LSX™ LS1 Fittings, O-Rings & Hardware (No Fuel Rails)	54023FRH	—
LSX™ LS2 OEM Fuel Rail/Injector Adapter Kit	54026	—
LSX _R ™ LS1/LS6 Billet Fuel Rail Kit	146032-KIT	146032B-KIT
LSX _R ™ LS2-Style OEM Fuel Rail Kit For LS1/LS6 (Non-Billet)	146021-KIT	—
LSX _R ™ LS2 Billet Fuel Rail Kit	146033-KIT	146033B-KIT

	Red	Black
LSX _R ™ LS3/LS7 OEM Car Fuel Rail Kit (Non-Billet)	146020-KIT	—
LSX _R ™ LS3/LS7 OEM Fuel Injector Adapter Kit (No Fuel Rails)	146025-KIT	—
LSX _R ™ LS3/LS7 Billet Fuel Rail Kit	146027-KIT	146027B-KIT
LSX _{RT} ™ Gen III Billet Fuel Rail Kit	146028-KIT ¹	146028B-KIT ¹
LSX _{RT} ™ Round OEM Fuel Rail Bracket Kit (No Fuel Rails)	146030-KIT	—
LSX _{RT} ™ Square OEM Fuel Rail Bracket Kit (No Fuel Rails)	146031-KIT	—

¹ For use w/ OEM GM Truck/SUV injectors & FAST™ LS2 Injectors.

* LSX™/LSX_R™/LSX_{RT}™ parts are NOT interchangeable.



LSX™/LSX_R™/LSX_{RT}™ Fuel Rail Systems & Accessories

LSX™/LSX _R ™/LSX _{RT} ™ 0-100 EFI Fuel Pressure Gauge Kit	54027
LSX™/LSX _R ™/LSX _{RT} ™ 0-100 EFI Fuel Pressure Gauge (Only)	54027G
LS1 OEM Fuel 3/8" to -6AN Fuel System Conversion Fitting	54028
LSX™/LSX _R ™/LSX _{RT} ™ OEM Fuel Line Conversion Kit (1998-02 LS1 F-Bodies w/ FAST™ Billet Fuel Rails)	54028-KIT
LSX™/LSX _R ™/LSX _{RT} ™ OEM Fuel Line Conversion Kit w/ Fuel Pressure Gauge (Part 54028-KIT w/ Part 54027G)	54028G-KIT
-6AN, 90°/45° End Fuel Supply Line	54028FSL
-8AN, 90° End Crossover For FAST™ Fuel Rails	54028FRC

LSX™ LS1 Only Replacement O-Ring (Single)	54023OR-1
LSX™ 8 SAE O-Ring To -8AN Fitting	54023A-1
LSX™ 8 SAE O-Ring To -6AN Fitting	54023B-1
LSX™ 8 SAE O-Ring To 1/8 NPT Fitting	54027A
LSX™ 8 SAE O-Ring Plug & O-Ring	54028P
LSX _R ™ LS3/LS7/L76/L99 Injector O-Ring	146020COR
LSX _{RT} ™ LS3/LS7 OE Fuel Injector Adapter Kit	146025-KIT

¹ Includes 8 SAE o-ring to 1/8 NPT fitting and o-ring for use with FAST™ billet fuel rails.

² Includes Part #54028, #54028FSL, #54028FRC and #54028P.

* LSX™/LSX_R™/LSX_{RT}™ are NOT interchangeable unless listed together.

Black Anodized Fuel Rails

FAST™ Fuel Rails are machined from high strength aluminum and feature a large 11/16" inside diameter for consistent pressure at each fuel injector. Offered in 18", 24", 36", 48" and 72" lengths, FAST™ has you covered no matter the application.

Universal Fuel Rail – 18"	30700218B
Universal Fuel Rail – 24"	30700224B
Universal Fuel Rail – 36"	30700236B
Universal Fuel Rail – 48"	30700248B
Universal Fuel Rail – 72"	30700272B



Intake Manifolds & Throttle Bodies

SINGLE PLANE INTAKE MANIFOLDS

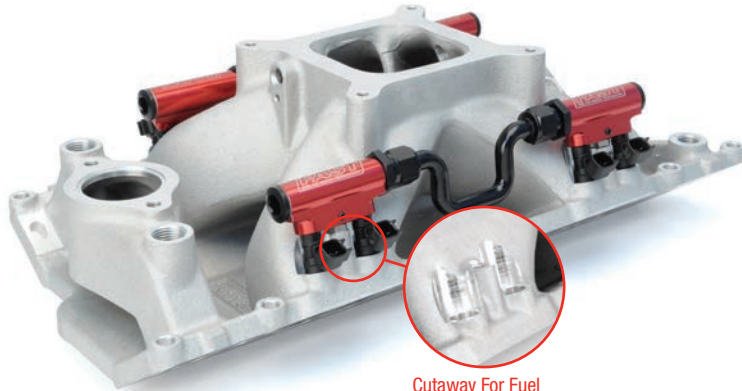

#12903-KIT

Cutaway For Fuel
Injector Clearance



#3035351

Single Plane Aluminum Intake Manifolds

FAST™ Single Plane Intake Manifolds are designed to produce tremendous horsepower and high RPM torque from 3500-7500 RPM (Big Block Chevy), 4500-8500 RPM (Small Block Chevy, 351W Ford) and 4500-9000 RPM (289/302 Ford). All manifolds accept square bore, four-barrel 4150-style throttle bodies, such as the FAST™ part #307603, and feature a fuel injector boss in each runner that will accept FAST™ high performance injectors.

Small Block Chevy versions of these intake manifolds are engineered specifically to port match fit RHS® Small Block Chevy cylinder heads. Additionally, these manifolds are the only ones designed with a 4150 flange and bolt machining to fit all versions of Small Block Chevy cylinder heads, including classic originals, GM Vortec heads and late model perimeter corner vertical bolt style crate engine heads. They provide the power and strong torque curve throughout the mid-RPM range that is required for performance street, circle track and drag race applications up to 434c.i. The manifolds also feature auxiliary water ports, integral water crossover and dual sided distributor mounting points. Female pipe fittings at all four corners allow external water lines for reverse cooling applications. FAST™ also offers a port fuel injection version of these manifolds. Unlike the competition, the EFI manifold features port angle optimized injector bung mounting and machining features. FAST™ engineers laid the injectors down on an angle that points injectors directly at the valve stem. Additionally, the EFI manifold features integral sensors improving function, fitment and packaging. This is the only 4BBL-type EFI manifold on the market with an air control circuit.

Fuel Injector Bungs

Designed for do-it-yourself fabricators who make their own multi-port fuel injection manifolds; these aluminum bushings can be welded or epoxied to a single plane, dual plane, tunnel ram or sheet metal manifold.

Fuel Injector Bungs (8-Pack)

307017

	As Cast
Small Block Chevy Manifold for Carbureted EZ-EFI® Applications	12902
Small Block Chevy Manifold for EFI Applications	12903-KIT ¹
Big Block Chevy Manifold	3011454 ²
Big Block Chevy 10.2" (Tall) Deck Manifold (Uses 4500/7602 TB)	3011366 ²
Ford 289/302 Manifold 8.2" Deck	3031302 ²
Ford 351W Manifold 9.5" Deck	3035351 ²
FE Ford Manifold	3033390 ²

¹ Includes fuel rails & hardware.

² Minor machine work or clearancing to the intake manifold may be required depending on the cylinder heads used.

Fuel Rail Kits

Big Block Chevy Fuel Rail Kit	30454
Small Block Ford Windsor Fuel Rail Kit	30351

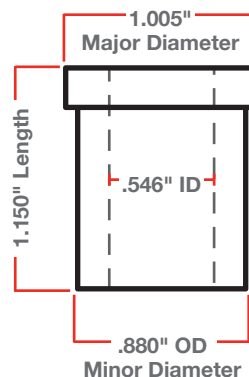

Intake Manifolds & Throttle Bodies

BIG MOUTH THROTTLE BODIES™



#54087



#54104



#54091



#54102



#54095

Big Mouth Throttle Bodies™

FAST™ Big Mouth Throttle Bodies™ for the LSX™ 92mm and LSX_R™/LSX_{RT}™ 102mm Intake Manifolds increase airflow through a series of innovative design changes and an enlarged throttle opening. These throttle bodies offer increased throttle blade thickness to eliminate deflection commonly found with other throttle bodies, especially those in boosted applications. A smoother operating offset blade pivot improves throttle response, and a beefed up linkage and dual throttle spring mechanism ensure total throttle control. Constructed from billet aluminum, the FAST™ Big Mouth 92mm Throttle Body™ will deliver bolt-on GM Gen III (LS1, -2 & -6) horsepower, while the 102mm version is designed to maximize performance upgrades on all Gen III and Gen IV engines with cable driven throttle bodies.

Also available for LS, Ford Coyote and Chrysler Hemi applications are the Big Mouth LT Throttle Bodies, new & improved versions of the original Big Mouth Throttle Body. With a 92mm throttle bore for LS and 87mm for the Ford Coyote and Chrysler Hemi, each one features black-wrinkle powder coating and all of the same features as the original.

All of the benefits of the 102mm Big Mouth Throttle Body are now available for drive-by-wire applications with the Big Mouth Electronic Throttle Body for GM LS engines. It provides a huge increase in airflow over stock – especially when applications are running a FAST™ manifold. It maintains stock characteristics at idle and is designed to be plug-and-play with the stock L99, LS3 or LS7 ECU, as well as with any LS engine utilizing a FAST™ XFI 2.0™ or XFI Sportsman™ system in conjunction with the FAST™ ETC module.

Big Mouth Billet

	W/ TPS & IAC	W/O TPS & IAC
92mm Big Mouth Throttle Body™	54095	54092
102mm Big Mouth Throttle Body™	54103	54102

Big Mouth LT

	W/ TPS & IAC	W/O TPS & IAC
87mm Big Mouth LT Throttle Body™ for Ford Coyote	54087	54086
87mm Big Mouth LT Throttle Body™ for Chrysler Hemi	54089	54088
92mm Big Mouth LT Throttle Body™ for GM LS	54091 ¹	54090 ¹

Big Mouth Electronic

102mm Big Mouth Throttle Body™ for GM LS	54104
--	-------

Sensors

Throttle Position Sensor (TPS)	54020
Idle Air Control Solenoid (IAC)	307059

¹ For LS 4-bolt applications or those equipped with LSX™/LSX_R™ Intake Manifolds.

Intake Manifolds & Throttle Bodies

4-BARREL THROTTLE BODIES



#304151

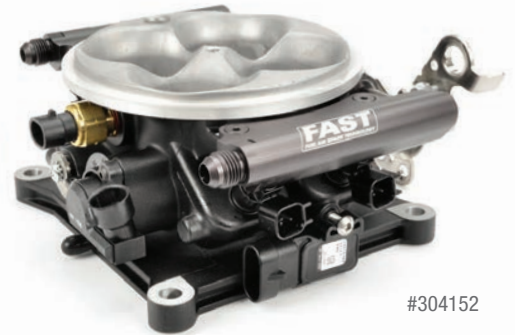

#304152



#304154

4 Barrel Throttle Bodies

FAST™ 4 Barrel Throttle Bodies incorporate tapered and radiused throttle bores and precisely machined progressive linkage for smooth throttle operation and unparalleled air-flow. More airflow equals more horsepower.

- Inward opening throttle blades improve performance by eliminating part throttle directional influence that causes poor air distribution
- Shorter height for better airflow, easier packaging for tight hood clearance and reduced weight

Port Injection Throttle Bodies (No Fuel Injectors/Air Only)	Natural	Polished
Billet High Flow 4150 Style 4 Barrel, Flows 1375 CFM	307603 ¹	307603P ¹
Billet High Flow 4500 Style 4 Barrel, Flows 2000 CFM	307604 ¹	307604P ¹
Precision Cast Air Only Throttle Body Assembly	304154 ²	—

Throttle Body Injection Units (Integrated Fuel Injectors Included)

Cast High Flow 4150 Throttle Body Assembly (4 Injector Version - 650 HP)	304152 ³
Cast High Flow 4150 Throttle Body Assembly (8 Injector Version w/ Harness - 1200)	304151 ^{3,4}

Accessories

EZ-EFI® Cable Mount Kit	304147 ⁵
Dual Quad Throttle Linkage Kit (EZ-EFI® Specific)	304110
Billet 4150 Open Style 1" Spacer	30244
Billet 4150 Open Style 1" Spacer (Includes Gasket & Studs)	30246

¹ Includes IAC, TPS and connector adapters.

² Includes MAP, IAT, IAC & TPS sensors. Does not include or use injectors or fuel rails.

³ Includes MAP, IAT, IAC & TPS sensors and 30857-1 injectors.

⁴ Harness and mating connector kit included.

⁵ Works with 304148, 304149, 304150, 304151.



#307603
(Includes IAC, TPS & Adapters)



#307604P¹
(Includes IAC, TPS & Adapters)

Intake Manifolds & Throttle Bodies

SEALS & HARDWARE

LSX™/LSX_R™/LSX_{RT}™ Seals & Hardware

Big Mouth 92mm/102mm Throttle Body™ Bolt Kit	146019
Complete LSX™ 92mm Manifold Hardware Kit (Includes TB Mounting Hardware)	54018C-KIT
LSX™ Manifold Only Hardware Kit	54018M-KIT
TPS Throttle Position Sensor (Cable Drive Only)	54020
Valley Plate Bolt Kit	54038VB-KIT
LS3 Pulley Spacer Washer	54043PS
LSX _R ™ O-Ring	54043-302
LSX _{RT} ™ O-Ring	54043-602
LSX™ LS1 Replacement Intake Port Seal	54009-8

LSX™ 90mm & 92mm Intake Rope Seal	54022
LSX _R ™/LSX _{RT} ™ Seal Kit	146017
LSX _R ™ LS7 Manifold Hardware Kit	146019-KIT
LSX _{RT} ™ 102mm Manifold Hardware Kit	146018-KIT
LSX _R ™ 102mm LS3 Intake Port Seal	146003-8
LSX _R ™/LSX _{RT} ™ 102mm LS1/LS6/LS7 Intake Port Seal	146203-8
LSX _R ™/LSX _{RT} ™ 102mm Throttle Body O-Ring Seal	146004
LSX _R ™/LSX _{RT} ™ 102mm Upper To Lower Shell Intake Seal	146005
LSX _R ™/LSX _{RT} ™ 102mm Intake Runner Seal	146006-8

* LSX™/LSX_R™/LSX_{RT}™ are NOT interchangeable unless listed together.

#146203-8



#146003-8



#54018C-KIT



Porting Tools & Accessories

When using one of the FAST™ LSX™, LSX_R™ or LSX_{RT}™ 102mm Intake Manifolds, you have the ability to easily port or disassemble the runners due to the intakes' modular design. Porting becomes even easier with our selection of porting tools and accessories.

Cartridge Rolls & Mandrels

Cartridge Roll Assortment	POW351705
3 Piece Mandrel Kit – 1", 4" and 8"	POW351510

* All individual cartridge rolls available in sets of 50 pieces.

** Mandrels also sold individually.

Carbide Burrs

1/2" Dia. 2" Cylinder w/ Radius Carbide Burr	POW355302
1/2" Dia. 2" Round Tree Carbide Burr	POW355402
1/2" Dia. 2" Oval Carbide Burr	POW355602
1/2" Dia. 2" Flame Carbide Burr	POW355802
3/8" Dia. 2" Pointed Tree Carbide Burr	POW353502
3/8" Dia. 2" Oval Carbide Burr	POW353602
3/8" Dia. 2" Ball Carbide Burr	POW353702

* Carbide burrs available in aluminum cut and 6" lengths.



FAST™ has taken the next step in making EFI (electronic fuel injection) easier with these FAST™ Complete Fuel System Kits. These kits cover all street performance applications and most bracket and super class drag racing categories. The fuel system kit is the perfect product for those switching from carburetion to EFI, building new EFI engines or simply upgrading their current fuel system.

FAST™ Complete Fuel System Kits are component-matched systems. With one part number, the FAST™ kits include everything you need for your state-of-the-art, EFI-equipped high performance engine.



Inline Race Fuel Systems

FAST™ Race Fuel Systems include fuel pump, pre-filter, post-filter, Y-block and fuel regulator, as well as the system fittings and wiring harness. Best of all, the components used to create the FAST™ Complete Fuel System Race Kits are made of aluminum and stainless steel to ensure years of long, trouble-free service.

1200 HP Forced Induction/1300 HP Naturally Aspirated Race Fuel System Includes: 307500

- | | | | |
|---|---|---|--|
| <ul style="list-style-type: none"> • 30 Amp Relay • Circuit Breaker, 10 Gauge Wire • Terminal Connectors | <ul style="list-style-type: none"> • 750 lb./hr. Pump @ 45 psi/13 volts • 3 Port EFI Regulator • 100 Micron Pre-Filter | <ul style="list-style-type: none"> • 10 Micron Post-Filter • Y-Block, -10AN Ins, -8AN Outs • (1) -6AN Fitting & O-Ring | <ul style="list-style-type: none"> • (2) -8AN Fittings & O-Rings • (5) -10AN Fittings & O-Rings • (2) -8 & -10AN Fittings & O-Rings |
|---|---|---|--|

1400 HP Forced Induction/1900 HP Naturally Aspirated Race Fuel System Includes: 307501

- | | | | |
|---|---|---|--|
| <ul style="list-style-type: none"> • 30 Amp Relay • Circuit Breaker, 10 Gauge Wire • Terminal Connectors | <ul style="list-style-type: none"> • 1000 lb./hr. Pump @ 45 psi/13 volts • 3 Port EFI Pro Series Regulator, (3) -8AN & (1) -10AN Ins & (1) -10AN Out • 100 Micron Pre-Filter | <ul style="list-style-type: none"> • 10 Micron Post-Filter • Y-Block, -10AN Ins, -8AN Outs • (4) -8AN Fittings & O-Rings | <ul style="list-style-type: none"> • (4) -10AN Fittings & O-Rings • (2) -12AN Fittings & O-Rings |
|---|---|---|--|

In-Tank vs. Inline

Inline fuel pumps are easier to install than in-tank fuel pumps because the fuel tank does not have to be removed. However, there are several advantages to running an in-tank fuel pump versus an inline fuel pump. FAST™ engineers recommend an in-tank fuel pump when possible.

IN-TANK FUEL PUMP ADVANTAGES INCLUDE:

- Always Primed
- Runs Quieter
- Runs Cooler
- Method Used By All OEMs
- Required For Returnless Fuel Systems
(EZ-EFI 2.0® Fuel + Ignition Only)

Fuel Systems

STREET/STRIP FUEL SYSTEMS



#30401-FK



#30402-FK

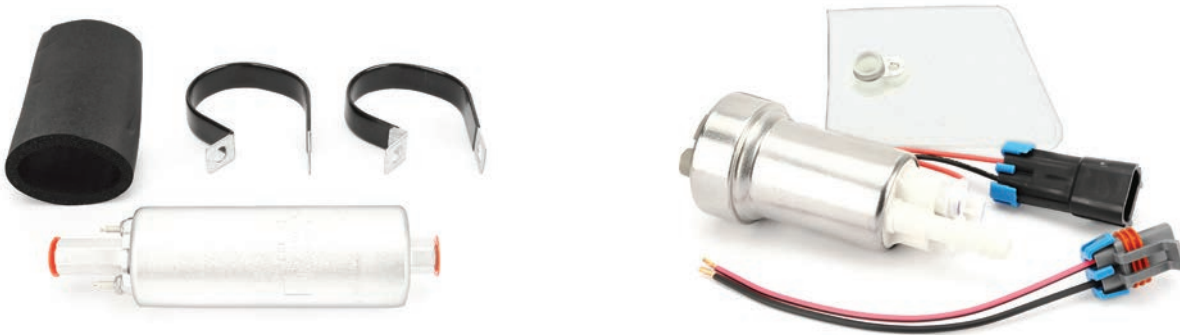

#30402-P

#30401-P

Street/Strip Fuel Systems

Whether you want to install a new inline fuel pump, or retro-fit an in-tank pump into a fuel tank that was originally manufactured without a pump, FAST™ has an easy solution for you. All FAST™ fuel pump kits are designed to work with FAST™ EFI systems flowing the right amount of fuel for the application. Master Kits include the fuel pump system, hose and fittings, while regular kits include the fuel pump system ONLY.

Master In-Tank Fuel Pump Kit (Includes Hose & Fittings)	30401-FK	Master Inline Fuel Pump Kit (Includes Hose & Fittings)	30402-FK
In-Tank Fuel Pump Kit (Hose & Fittings NOT Included)	30401-PK	Inline Fuel Pump Kit (Hose & Fittings NOT Included)	30402-PK
In-Tank Fuel Pump Only (1200 HP) w/ Pick-Up Filter & Connector Kit	30401-P	Inline Fuel Pump Only (650 HP) w/ Mounting Brackets	30402-P



#30272



#54028



#302530R-10

Fuel Fittings & Accessories

-8 SAE O-Ring To -8AN Fitting & O-Ring	54023A-1	-6AN High Pressure Fuel Hose	30277
-8 SAE O-Ring To -6AN Fitting & O-Ring	54023B-1	-3 SAE O-Ring To -6AN, Fitting & O-Ring	30253-1
-8 SAE O-Ring To 1/8 NPT Fitting	54027A-1	Replacement -3 SAE O-Ring, Pack Of 10	302530R-10
-8 SAE O-Ring Plug & O-Ring	54028P	-6AN To GM 16mm x 1.5 Or O-Ring, Steel Fuel Filter Fitting Adapter	30196
Replacement -8 SAE O-Ring, Pack Of 10	540230R-10	Factory GM LS1 Fuel Rail Push-On Inlet Adapter Fitting, Converts To -6AN	54028
-6 SAE O-Ring To -6AN, Fitting & O-Ring	30251-1	FAST™ 0-100 psi EFI Fuel Pressure Gauge, 1/8 NPT Rear Inlet (Works w/ All FAST™ Fuel Pressure Regulators)	54027G
-6 SAE Socket Hex Port Plug w/ O-Ring	30273-1	Billet -6AN Inlet/Outlet Mini Filter	30272
-6 SAE O-Ring To -8AN Straight Fitting w/ O-Ring	30281-1	GM OEM EFI Fuel Filter (Steel)	30195
Replacement -6 SAE O-Ring, Pack Of 10	302510R-10	Fuel Injector Bungs, Pack Of 8 (See Page 51 for Specs)	307017
-6AN To -6AN Female Coupler	30274-1	Universal Fuel Rail (See Page 50 for Listings and Specs)	-
-6AN To Push-Lock Nipple, Straight	30275-1		
-6AN 90° Push Lock Fitting	30276-1		



#307030

Fuel Pressure Regulators

The FAST™ Adjustable Fuel Pressure Regulator is a premium CNC billet regulator designed to exact specifications by FAST™ engineers. The unit features twin -6 SAE feed side ports and one -6 SAE return port on the bottom. The fully adjustable unit is vacuum referenced and utilizes a hex adjustment stud with jam nut. The unit has a 1/8 NPT gauge port as well. The regulator is part of a kit that includes the unit, mounting bracket, 1/8 NPT plug and 1/8 NPT to 3/16" barb. The regulator can be used with a single feed (plug second feed) or with dual feeds. Requires the purchase of port fittings separately (all three ports are -6 SAE o-ring type) and can be selected from the FAST™ fuel fitting section.

30-70 PSI Adjustable Fuel Pressure Regulator, -6 SAE O-Ring Ports (1 Return, 2 Feeds)	307030
---	--------

OEM-Type Fuel Pressure Regulators

Fuel Regulator – 5.0L Mustang	307024
Fuel Regulator – GM 25-60 PSI	307025
Fuel Regulator – LT1 Corvette	307026
Fuel Regulator – LT1 Firebird	307027



Electronic Fuel Pressure Kit

The Electronic Fuel Pressure Kit provides electronic fuel pressure measurement capability in an easy and affordable kit. It obtains an accurate and instantaneous fuel pressure measurement that can be used to improve fuel delivery accuracy and provide an accurate signal for data acquisition. The kit offers OEM reliability by including a GM OEM sensor designed to function and remain durable in the engine environment. It can measure oil pressure or other fluids in the 0-100 psi range for any application. For use with XFI 2.0™ or other suitable EFI systems.

Kit includes: billet aluminum mounting block with two -8 SAE o-ring type female connections ports, spacer and mounting hardware for easy connection and two -8 to -6 AN fitting

Electronic Fuel Pressure Kit	301410
------------------------------	--------

Air/Fuel Meters



- Ideal for carbureted & EFI engines
- Available in single or dual sensor units
- Built-in data logging; no laptop required
- Meters for gasoline, diesel & E85 fuels
- PC-based software analysis tool
- RPM-based option

Air/Fuel Meters

With no laptop required, FAST™ has developed three simple, easy-to-use air/fuel meters for gasoline, diesel and Ethanol/Methanol (E85) fuels. Available in single or dual sensor units, these meters give tuners the power to read two wide-band O₂ sensors individually or to average them together for maximum accuracy of the engine's air/fuel ratio reading. FAST™ Air/ Fuel Meters include several enhanced capabilities, including the built-in data logging function that plays back recorded information on a lighted, full graphical display screen rather than using a laptop computer. Additional features include outputs for external data loggers, digital gauges, and a narrow-band simulator function that allows you to feed your engine's computer a factory signal while using the wide-band sensor for air/fuel measurement.

Gasoline Air/Fuel Meter (Single Sensor)	170401	Diesel Air/Fuel Meter (Single Sensor)	170701
Gasoline Air/Fuel Meter (Dual Sensor)	170402	Diesel Air/Fuel Meter (Dual Sensor)	170702
Motorcycle Gasoline Air/Fuel Meter (Single Sensor)	170501	Ethanol/Methanol Air/Fuel Meter (Single Sensor)	170590
Motorcycle Gasoline Air/Fuel Meter (Dual Sensor)	170502	Ethanol/Methanol Air/Fuel Meter (Dual Sensor)	170608
Dyno Gasoline Air/Fuel Meter (Single Sensor)	170601	Master Tuner Dual Sensor Air/Fuel Meter Kit	170614
Dyno Gasoline Air/Fuel Meter (Dual Sensor)	170602		



#170614

Replacement Accessories

Threaded O ₂ Sensor Bushing (Weld-In)	30168
Replacement Wide-Band O ₂ Sensor	170408
Single To Dual O ₂ Meter Conversion Kit	170445
Replacement Cable (6 ft. w/ Power Lead)	170462
Replacement Cable (6 ft.)	170463
Replacement Cable (12 ft. w/ Power Lead)	170480
Replacement Cable (12 ft.)	170481
Replacement Cable (22 ft. w/ Power Lead)	170460
Replacement Cable (22 ft.)	170461

Air/Fuel Meters

ACCESSORIES

Digital Air/Fuel Meter RPM Module

Compatible with all FAST™ Digital Air/Fuel Meters, the FAST™ Air/Fuel Meter RPM Module monitors and records engine RPM data that can be overlaid with air/fuel ratio readings. It can be calibrated with the touch of a button, and the module plugs in-line with your existing O₂ sensor harness. The FAST™ Air/Fuel Meter RPM Module comes with everything you need, including the installation CD, communications cable, USB cable adapter, power source, RPM module, clip-on inductive pick-up and full instructions to get you up and running in no time.

Digital Air/Fuel Meter RPM Module	170536
-----------------------------------	--------



#170536

Air/Fuel Ratio Module Kits

FAST™ engineers have developed a kit that makes it easy for anyone to measure an engine's air/fuel ratio. This plug-and-play universal O₂ sensor processing kit allows your data acquisition system or dyno software to record and display air/fuel ratios. Since it uses fully automatic sensor calibration, there's no need for manual "free-air" calibration that competitive units require. Additionally, each sensor kit is a standalone unit, so using multiple kits for measuring all your engine's cylinders is easy. Compatible with FAST™ Digital Air/Fuel Meters.

Air/Fuel Ratio Module Kit	170579
XFI™ Wide-Band Auxiliary Air/Fuel Ratio Module Kit	170577
Air/Fuel Ratio Module Kit (4 Pin AMP Connector)	170636
High Resolution Wide Band O ₂ Module	1706472



#170577

Digital Air/Fuel Meter Interior Mount Kit

When hot-rod-ding down the street, it's hard to safely read air/fuel data if the meter is sliding around. For easy viewing and safety, the FAST™ Air/Fuel Meter Interior Mount Kit allows you to attach your FAST™ Digital Air/Fuel Meter to the windshield with a removable suction cup system. The suction cup mounts to the meter through adhesive tape; no drilling or gluing required.

Digital Air/Fuel Meter Interior Mount Kit	170493
---	--------



#170493

Wide-Band Air/Fuel Gauge Kit

The FAST™ Wide-Band Air/Fuel Gauge Kit combines an economical and extremely accurate 2 1/16" gauge, Bosch wide-band oxygen sensor and standalone sensor control unit that mounts quickly and easily in the interior of any vehicle. Backlit for easy night viewing and wired so it is powered up whenever the engine is running, this kit is not only for serious power tuning but also ideal for monitoring the overall fuel tune of the engine when daily driving or making passes at the track. Kit includes gauge, module, harness, sensor and bung.

Wide-Band Air/Fuel Gauge Kit	170634
------------------------------	--------



#170634

EZ Clamp-On Tailpipe Wide-Band Sensor Mount Kit

Made of stainless steel and convenient for quick oxygen sensor tests, this easy-to-use FAST™ kit slides into the tail pipe to prevent welding. The actual O₂ sensor screws into the kit, which includes a rubber cover to prevent damage to polished exhaust tips.

EZ Clamp-On Tailpipe Wide-Band Sensor Mount Kit	170620
---	--------



Electronics



EZ-TCU™ Transmission Controller

For computer controlled transmissions, nothing beats the TCI® EZ-TCU™ Transmission Controller. The EZ-TCU™ allows for maximum electronic control over shift points, shift firmness and shift speed. No software, laptop or tuning experience is required, and power data logging and self diagnostics allow users of every skill level to fully utilize the unit. Simply install it according to the enclosed instructions, and then start the system by answering the simple Setup Wizard questions on the included hand-held unit. It's that easy; the EZ-TCU™ does all the work for you!

The EZ-TCU™ is fully configured and ready to run right out of the box – no tuning necessary. But for those who demand customization, the unit is also optionally fully programmable based on load, speed and RPM. The EZ-TCU™ programming interface is completely intuitive. There is no real expertise needed if you want to custom program your calibration. The EZ-TCU™ is capable of real-time switchable calibrations, which allows for multiple setups. Run one calibration on the way to the track, and then, with the push of a button, have a more aggressive setup ready for the race. The multiple shift modes include full manual mode for using bump switch or paddle shifters.

- Maximum control over shift points, shift firmness and shift speed
- No software, laptop or experience needed
- Completely intuitive programming interface or optional fully programmable based on load, speed and RPM
- Multiple shift modes include full manual mode
- Compatible with popular GM transmissions, including 4L60E, 4L65E, 4L70E, 4L80E, and 4L85E, as well as the TCI® 6x Six-Speed™
- Included hand-held can operate as electronic dash
- Includes transmission control unit, hand-held and wiring harness

EZ-TCU™ Transmission Controller	30282-KIT
EZ-TCU™ Transmission Controller 2009 & 4L65E/70E	30299-KIT
EZ-TCU™ Hand-Held Vehicle Mount Kit	170493

FAST-FLASH™ Power Programmers

FAST-FLASH™ Power Programmers unlock hidden performance potential for maximum horsepower and torque. Just plug the programmer into your vehicle's ODBII port and answer a few questions. The FAST-FLASH™ automatically reprograms your vehicle's computer for idle quality, air/fuel ratios, ignition timing, shift points and more.

Vehicle	Engine	Year	Part
Chevrolet/GMC Full Size Truck/Van	4.8L, 5.3L, 6.0L	1999-2005	170382
Chevrolet/GMC Full Size Truck/Van, Suburban, Tahoe	5.0L, 5.7L	1996-1997	170383
Chevrolet Full Size Truck	5.0L, 5.7L	1998	170382
Chevrolet Camaro	5.7L	1999-2002	170382
Chevrolet Corvette	5.7L	1999-2002	170382
Chevrolet/GMC Full Size Truck/Van	7.4L	1996-1997	170383
Chevrolet/GMC Full Size Truck/Van	7.4L	1998-2000	170382
Chevrolet Full Size Truck/Van	8.1L	1999-2005	170382
Pontiac Firebird, Trans Am	5.7L	1999-2002	170382
Pontiac GTO	5.7L	2004	170382



#170382

Miscellaneous ACCESSORIES

Die Cast Aluminum Valve Covers

FAST™ Die Cast Aluminum Valve Covers are designed both to perform and to create a matching package with the FAST™ EZ-EFI 2.0® and FAST™ Aluminum Air Cleaners. Branded with the FAST™ logo, these black-wrinkle powder coated valve covers are manufactured in the USA and offered for Small Block Chevy, Big Block Chevy and Small Block Ford applications. A tall height is designed to clear aftermarket valve trains, while rails on the sealing flange help locate the gasket (SBC only). The valve covers are perimeter-bolt style, and each kit includes breathers.

Die Cast Aluminum Valve Covers for Small Block Chevy	3012001
Die Cast Aluminum Valve Covers for Big Block Chevy	3011011
Die Cast Aluminum Valve Covers for Small Block Ford	3035001



#3012001

Die Cast Aluminum Air Cleaner

This washable element air cleaner provide a functional, high-end design that perfectly complements the FAST™ EZ-EFI 2.0® Fuel + Ignition and Die Cast Aluminum Valve Covers. With exclusive FAST™ black-wrinkle powder coating and a machined finish, this cleaner is of lighter weight than others on the market due to the use of die casting versus the common sand casting manufacturing procedure. The “hidden” fastener design features a single “hidden” bolt that is creatively covered with a magnetic FAST™ logo insert (COMP Cams® and blank inserts are also included) on top of the cleaner, as opposed to the popular two-bolt designs that bolt from underneath the unit. This means no exposed or visible bolts or cumbersome wingnuts.

FAST™ Aluminum Air Cleaner measures 14"W x 12"H x 2.5"D and is designed for street rods or exposed engines. This unit will only add 3" to the top of the FAST™ EZ-EFI®/EZ-EFI 2.0® throttle bodies.

Compatible with FAST™ and TCI® linkage kits and are sold with a reusable K&N filter. Work with both FAST™ EZ-EFI® Fuel/EZ-EFI 2.0® Fuel+Ignition and Holley-style carburetors.

Aluminum Air Cleaner (14"W x 12"H x 2.5"D)	30420
--	-------

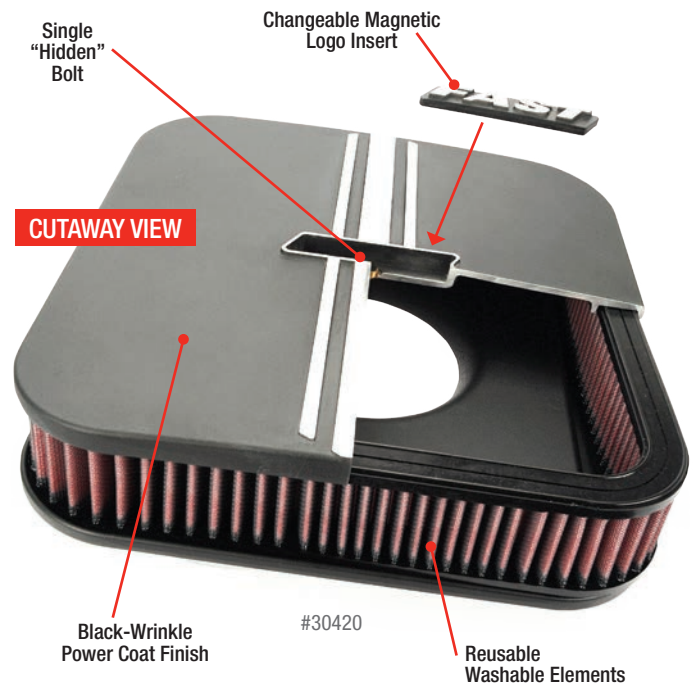

#30420

Terminal Tools

Weatherpack style terminals offer many significant benefits over conventional terminals, including superior resistance to the elements and a mechanically secure connection. But without the correct tools, they can prove very difficult to assemble and service. This series of terminal service tools from FAST™ is the ideal solution for the removal and installation of many types of Weatherpack connectors and will provide years of dependable service.

Yellow Extractor Tool	307065
Green Extractor Tool	307066
Crimp Tool	307067
Wire Stripper	307068



Miscellaneous

MAXJET™ PRECISION CARB JETS

Often you will hear a racer say, "I made two jet changes, but the engine still didn't run properly." The reason for this relates directly to the jets being used. Other jets are mass-produced with a wide tolerance, then plated. Many of these jets use the same orifice size with the only difference being different angle tapers that supposedly change the flow-rate characteristics. Other jets also use a slot that requires a special, expensive tool to install. Ultimately, these slots become damaged, and that damage creates a turbulence that severely affects the fuel flow by as much as 50 percent.

MaxJet™ Precision Carb Jets are available from 0.050" to 0.120" in gasoline jets and from 0.121" to 0.140" in alcohol jets. Sizes are in 0.001" increments and are compatible with all known racing fuels. MaxJet™ Precision Carb Jets are easily matched to Holley jets; simply find the Holley size that you are currently using on the left and cross over to the MaxJet™ column to find the corresponding part number.



#MJ140-2

Gasoline Jets (1/4-32 thread)

0.050-inch – Holley 52	MJ50-2	0.087-inch – Holley 80	MJ87-2
0.051-inch – Holley 53	MJ51-2	0.088-inch – N/A 80.50	MJ88-2
0.052-inch – Holley 54	MJ52-2	0.089-inch – Holley 81	MJ89-2
0.053-inch – Holley 55	MJ53-2	0.090-inch – Holley 82	MJ90-2
0.054-inch – Holley 56	MJ54-2	0.091-inch – N/A 82.25	MJ91-2
0.055-inch – Holley 57	MJ55-2	0.092-inch – N/A 82.50	MJ92-2
0.056-inch – Holley 58	MJ56-2	0.093-inch – Holley 83	MJ93-2
0.057-inch – Holley 59	MJ57-2	0.094-inch – Holley 84	MJ94-2
0.058-inch – Holley 60	MJ58-2	0.095-inch – Holley 85	MJ95-2
0.059-inch – Holley 61	MJ59-2	0.096-inch – Holley 86	MJ96-2
0.060-inch – Holley 62	MJ60-2	0.097-inch – N/A 86.50	MJ97-2
0.061-inch – Holley 63	MJ61-2	0.098-inch – Holley 87	MJ98-2
0.062-inch – Holley 64	MJ62-2	0.099-inch – N/A 87.50	MJ99-2
0.063-inch – Holley 65	MJ63-2	0.100-inch – Holley 88	MJ100-2
0.064-inch – Holley 66	MJ64-2	0.101-inch – Holley 89	MJ101-2
0.065-inch – Holley 67	MJ65-2	0.102-inch – Holley 90	MJ102-2
0.066-inch – Holley 68	MJ66-2	0.103-inch – N/A 90.50	MJ103-2
0.067-inch – Holley 69	MJ67-2	0.104-inch – Holley 91	MJ104-2
0.068-inch – N/A 69.25	MJ68-2	0.105-inch – N/A 91.50	MJ105-2
0.069-inch – N/A 69.50	MJ69-2	0.106-inch – Holley 92	MJ106-2
0.070-inch – N/A 69.75	MJ70-2	0.107-inch – N/A 92.50	MJ107-2
0.071-inch – Holley 70	MJ71-2	0.108-inch – Holley 93	MJ108-2
0.072-inch – N/A 70.25	MJ72-2	0.109-inch – N/A 93.25	MJ109-2
0.073-inch – N/A 70.50	MJ73-2	0.110-inch – N/A 93.50	MJ110-2
0.074-inch – N/A 70.75	MJ74-2	0.111-inch – Holley 94	MJ111-2
0.075-inch – Holley 71	MJ75-2	0.112-inch – Holley 95	MJ112-2
0.076-inch – Holley 72	MJ76-2	0.113-inch – Holley 96	MJ113-2
0.077-inch – Holley 73	MJ77-2	0.114-inch – N/A 96.25	MJ114-2
0.078-inch – Holley 74	MJ78-2	0.115-inch – N/A 96.50	MJ115-2
0.079-inch – Holley 75	MJ79-2	0.116-inch – Holley 97	MJ116-2
0.080-inch – Holley 76	MJ80-2	0.117-inch – Holley 98	MJ117-2
0.081-inch – N/A 76.25	MJ81-2	0.118-inch – Holley 99	MJ118-2
0.082-inch – N/A 76.50	MJ82-2	0.119-inch – N/A 99.50	MJ119-2
0.083-inch – Holley 77	MJ83-2	0.120-inch – Holley 100	MJ120-2
0.084-inch – Holley 78	MJ84-2		
0.085-inch – N/A 78.50	MJ85-2		
0.086-inch – Holley 79	MJ86-2		

Alcohol Jets

0.121-inch Alcohol	MJ121-2
0.122-inch Alcohol	MJ122-2

0.123-inch Alcohol	MJ123-2
0.124-inch Alcohol	MJ124-2
0.125-inch Alcohol	MJ125-2
0.126-inch Alcohol	MJ126-2
0.127-inch Alcohol	MJ127-2
0.128-inch Alcohol	MJ128-2
0.129-inch Alcohol	MJ129-2
0.130-inch Alcohol	MJ130-2
0.131-inch Alcohol	MJ131-2
0.132-inch Alcohol	MJ132-2
0.133-inch Alcohol	MJ133-2
0.134-inch Alcohol	MJ134-2
0.135-inch Alcohol	MJ135-2
0.136-inch Alcohol	MJ136-2
0.137-inch Alcohol	MJ137-2
0.138-inch Alcohol	MJ138-2
0.139-inch Alcohol	MJ139-2
0.140-inch Alcohol	MJ140-2

* All jets available in single units. Simply change -2 to -1.

Jet Kits

MJ50-2 to MJ60-2	MJ5060
MJ61-2 to MJ71-2	MJ6171
MJ72-2 to MJ82-2	MJ7282
MJ83-2 to MJ93-2	MJ8393
MJ94-2 to MJ 104-2	MJ94104
MJ105-2 to MJ115-2	MJ105115
MJ116-2 to MJ126-2	MJ116126
.070 – .088 Even Jets Only	MJ1000-KIT
.090 – .108 Even Jets Only	MJ2000-KIT

Accessories

Large Storage Box	MJ1-5
Nut Driver	MJ1-1
Holder Plates	MJ2-1
Brass Jet Extension	MJEXT-2