

# AT-GS900MX Series

## GIGABIT ETHERNET SWITCHES

- ❑ AT-GS924MX
- ❑ AT-GS924MPX
- ❑ AT-GS948MX
- ❑ AT-GS948MPX

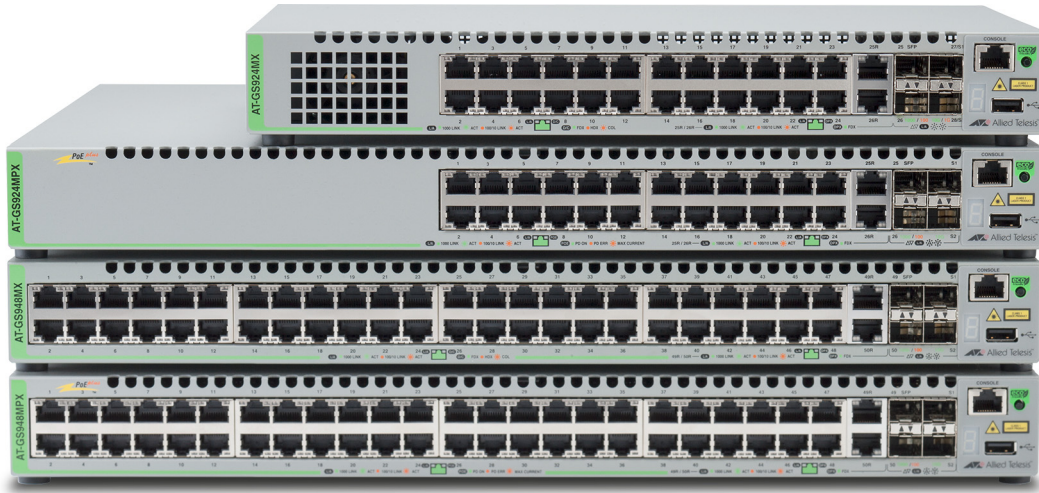

# Installation Guide for VCStack™

Copyright © 2015 Allied Telesis, Inc.

All rights reserved. No part of this publication may be reproduced without prior written permission from Allied Telesis, Inc.

Allied Telesis and the Allied Telesis logo are trademarks of Allied Telesis, Incorporated. All other product names, company names, logos or other designations mentioned herein are trademarks or registered trademarks of their respective owners.

Allied Telesis, Inc. reserves the right to make changes in specifications and other information contained in this document without prior written notice. The information provided herein is subject to change without notice. In no event shall Allied Telesis, Inc. be liable for any incidental, special, indirect, or consequential damages whatsoever, including but not limited to lost profits, arising out of or related to this manual or the information contained herein, even if Allied Telesis, Inc. has been advised of, known, or should have known, the possibility of such damages.

# Electrical Safety and Emissions Standards

---

This product meets the following standards.

## U.S. Federal Communications Commission

### Radiated Energy

Note: This equipment has been tested and found to comply with the limits for a Class A digital device pursuant to Part 15 of FCC Rules. These limits are designed to provide reasonable protection against harmful interference when the equipment is operated in a commercial environment. This equipment generates, uses, and can radiate radio frequency energy and, if not installed and used in accordance with this instruction manual, may cause harmful interference to radio communications. Operation of this equipment in a residential area is likely to cause harmful interference in which case the user will be required to correct the interference at his own expense.

Note: Modifications or changes not expressly approved of by the manufacturer or the FCC, can void your right to operate this equipment.

## Industry Canada

This Class A digital apparatus complies with Canadian ICES-003.

Cet appareil numérique de la classe A est conforme à la norme NMB-003 du Canada.

RFI Emissions: FCC Class A, EN55022 Class A, EN61000-3-2, EN61000-3-3, VCCI Class A, RCM, CE

**Warning:** In a domestic environment this product may cause radio interference in which case the user may be required to take adequate measures.

EMC (Immunity): EN55024

Electrical Safety: EN60950-1 (TUV), UL 60950-1 (CUL<sub>US</sub>)



Laser Safety

EN60825-1

# Translated Safety Statements

---

**Important:** Safety statements that have the  symbol are translated into multiple languages in the *Translated Safety Statements* document at [www.alliedtelesis.com/support](http://www.alliedtelesis.com/support).

# Contents

---

Document Conventions .....	12
Contacting Allied Telesis .....	13
<b>Chapter 1: Overview</b> .....	<b>15</b>
Features .....	16
AT-GS900MX Models .....	16
10/100/1000 Mbps Twisted Pair Ports .....	16
Power over Ethernet.....	17
SFP Slots .....	17
S1 and S2 Stacking Slots .....	17
LEDs.....	18
Installation Options.....	18
MAC Address Table .....	18
Management Software and Interfaces .....	18
Management Methods.....	18
Front and Back Panels .....	19
Management Panel .....	22
10/100/1000Base-T Twisted Pair Ports.....	23
Speed .....	23
Duplex Mode .....	23
Wiring Configuration.....	24
Maximum Distance.....	24
Power over Ethernet.....	24
Cable Requirements.....	24
Port Pinouts .....	25
Power over Ethernet.....	26
PoE Standards .....	26
Powered Device Classes .....	27
Cable Requirements.....	27
Power Budget.....	29
Port Prioritization .....	29
Wiring Implementation.....	30
SFP Slots.....	31
Combo Twisted Pair Ports and SFP Slots.....	32
Stacking Slots.....	33
eco-friendly Button.....	34
LEDs.....	35
LEDs for the Twisted Pair Ports .....	35
LEDs for the PoE Twisted Pair Ports.....	36
LEDs for the Combo Twisted Pair Ports.....	38
LEDs for the SFP Slots .....	40
LEDs for the Stacking Slots.....	40
Switch ID LED .....	41
USB Port.....	43
Console Port .....	44
Power Supply .....	45
<b>Chapter 2: Virtual Chassis Stacking</b> .....	<b>47</b>
Overview.....	48
Stacking Slots and Transceivers .....	49

Stacking Port Topologies .....	50
Master and Member Switches .....	54
Selection of the Master Switch .....	54
ID Numbers .....	55
Specifying Ports in the Command Line Interface .....	56
<b>Chapter 3: Beginning the Installation .....</b>	<b>57</b>
Reviewing Safety Precautions .....	58
Selecting a Site for the Stack .....	62
Planning a Stack .....	64
Unpacking the Switch .....	65
<b>Chapter 4: Installing the Switch on a Table or in an Equipment Rack .....</b>	<b>69</b>
Installing the Switch on a Table .....	70
Installing the Switch in an Equipment Rack .....	71
<b>Chapter 5: Verifying the Status of VCStack .....</b>	<b>77</b>
Verifying the Status of VCStack .....	78
Activating the VCStack Feature .....	79
Starting a Local Management Session .....	79
Activating VCStack .....	80
<b>Chapter 6: Cabling the Stacking Ports .....</b>	<b>83</b>
<b>Chapter 7: Powering On the Stack .....</b>	<b>87</b>
Installing the Power Cord Retaining Clip .....	88
Powering On the Switches Individually .....	89
Powering On the Switches Simultaneously .....	92
Verifying the Stack .....	94
Setting the Priority Numbers .....	95
Monitoring the Initialization Processes .....	97
<b>Chapter 8: Cabling the Networking Ports .....</b>	<b>101</b>
Cabling the Twisted Pair Ports .....	102
Installing SFP Transceivers .....	104
<b>Chapter 9: Troubleshooting .....</b>	<b>109</b>
<b>Appendix A: Technical Specifications .....</b>	<b>113</b>
Physical Specifications .....	113
Environmental Specifications .....	114
Power Specifications .....	114
Certifications .....	115
RJ-45 Twisted Pair Port Pinouts .....	116
RJ-45 Style Serial Console Port Pinouts .....	117

# Figures

---

Figure 1: Front Panels of the AT-GS924MX and AT-GS924MPX Switches.....	19
Figure 2: Front Panels of the AT-GS948MX and AT-GS948MPX Switches.....	20
Figure 3: Back Panel of the AT-GS924MX Switch .....	21
Figure 4: Back Panel of the AT-GS924MPX and AT-GS948MPX Switches .....	21
Figure 5: Back Panel of the AT-GS948MX Switch .....	21
Figure 6: AT-GS900MX Series Management Panel.....	22
Figure 7: Stacking Transceiver.....	33
Figure 8: LEDs for the Twisted Pair Ports on the AT-GS924MX and AT-GS948MX Switches .....	35
Figure 9: LEDs for the PoE Twisted Pair Ports on the AT-GS924MPX and AT-GS948MPX Switches.....	37
Figure 10: LEDs for the Combo Twisted Pair Ports.....	39
Figure 11: SFP Slot LEDs .....	40
Figure 12: Switch ID LED .....	41
Figure 13: Switch ID LED Not in Low Power Mode .....	42
Figure 14: Switch ID LEDs in Low Power Mode .....	42
Figure 15: Stacking Transceiver .....	49
Figure 16: Stack of Two Switches in the Linear Topology.....	50
Figure 17: Stack of Four Switches in the Linear Topology .....	51
Figure 18: Stack of Two Switches in the Ring Topology .....	52
Figure 19: Stack of Four Switches in the Ring Topology.....	53
Figure 20: PORT Parameter in the Command Line Interface.....	56
Figure 21: Components of the Switches.....	65
Figure 22: Components of the AT-GS924MX Switch .....	66
Figure 23: Turning the Switch Upside Down .....	71
Figure 24: Removing the Rubber Feet .....	71
Figure 25: Installing Brackets on the AT-GS924MX Switch .....	72
Figure 26: Attaching Brackets to the AT-GS924MPX, AT-GS948MX, or AT-GS948MPX Switch.....	73
Figure 27: Attaching Brackets to the AT-GS924MPX, AT-GS948MX, or AT-GS948MPX Switch (Continued).....	74
Figure 28: Mounting the Switch in an Equipment Rack.....	75
Figure 29: Connecting the Management Cable to the Console Port .....	79
Figure 30: User Exec Mode Prompt .....	80
Figure 31: Moving to the Privileged Exec Mode with the ENABLE Command.....	80
Figure 32: Moving to the Global Configuration Mode with the CONFIGURE TERMINAL Command .....	80
Figure 33: Activating VCStack with the STACK ENABLE Command.....	81
Figure 34: Returning to the Privileged Exec Mode with the EXIT Command .....	81
Figure 35: Saving the Change with the WRITE Command .....	81
Figure 36: Rebooting the Switch with the REBOOT Command .....	81
Figure 37: Removing the Dust Plug from the S1 Slot.....	83
Figure 38: Removing the Dust Cover from the Transceiver .....	84
Figure 39: Installing the Transceiver in Slot S1 .....	84
Figure 40: Removing the Dust Plug from the S2 Slot.....	85
Figure 41: Installing the Transceiver in Slot S2 .....	86
Figure 42: Installing the Retaining Clip.....	88
Figure 43: Plugging in the AC Power Cord.....	90
Figure 44: Lowering the Retaining Clip.....	91
Figure 45: SHOW STACK Command.....	94
Figure 46: Moving to the Global Configuration Mode with the CONFIGURE TERMINAL Command .....	95
Figure 47: Returning to the Privileged Exec Mode .....	96
Figure 48: Saving the Priority Values with the WRITE Command.....	96
Figure 49: Switch Initialization Messages.....	97

Figures

Figure 50: Switch Initialization Messages (Continued) .....	98
Figure 51: Switch Initialization Messages (Continued) .....	99
Figure 52: Removing the Dust Plug from an SFP Slot.....	105
Figure 53: Installing an SFP Transceiver .....	105
Figure 54: Removing the Dust Cover from an SFP Transceiver.....	106
Figure 55: Positioning the SFP Handle in the Upright Position.....	106
Figure 56: Connecting a Fiber Optic Cable to an SFP Transceiver.....	107
Figure 57: RJ-45 Socket Pin Layout (Front View).....	116



# Tables

---

Table 1: Twisted Pair Cable for the 10/100/1000Base-T Ports .....	24
Table 2: IEEE Powered Device Classes .....	27
Table 3: Twisted Pair Cable Requirements for the 10/100Base-TX Ports at 10 or 100Mbps .....	27
Table 4: Twisted Pair Cable Requirements for the 10/100/1000Base-T Ports at 1000Mbps .....	28
Table 5: Combo Port Pairs .....	32
Table 6: LEDs on the Twisted Pair Ports on the AT-GS924MX and AT-GS948MX Switches .....	36
Table 7: LEDs for the PoE Twisted Pair Ports on the AT-GS924MPX and AT-GS948MPX Switches .....	37
Table 8: LEDs on the Combo Twisted Pair Ports .....	39
Table 9: SFP Slot LEDs .....	40
Table 10: S1 and S2 Slot LEDs .....	41
Table 11: Product Dimensions .....	113
Table 12: Product Weights .....	113
Table 13: Ventilation Requirements .....	114
Table 14: Environmental Specifications .....	114
Table 15: Input Voltages .....	114
Table 16: Maximum Power Consumption .....	115
Table 17: Heat Dissipation .....	115
Table 18: Product Certifications .....	115
Table 19: Pin Signals for 10 and 100 Mbps .....	116
Table 20: Pin Signals for 1000 Mbps .....	117
Table 21: RJ-45 Style Serial Console Port Pin Signals .....	117



# Preface

---

This guide contains the installation instructions for the AT-GS900MX Series of Layer 2+ Gigabit Ethernet switches. This preface contains the following sections:

- “Document Conventions” on page 12
- “Contacting Allied Telesis” on page 13

---

**Note**

This guide explains how to install the switches in a stack with the Virtual Chassis Stack (VCStack™) feature. For instructions on how to install the switches as stand-alone units, refer to the *AT-GS900MX Series Installation Guide for Stand-alone Switches*.

---

## Document Conventions

---

This document uses the following conventions:

---

**Note**

Notes provide additional information.

---



---

**Caution**

Cautions inform you that performing or omitting a specific action may result in equipment damage or loss of data.

---



---

**Warning**

Warnings inform you that performing or omitting a specific action may result in bodily injury.

---

## Contacting Allied Telesis

---

If you need assistance with this product, you may contact Allied Telesis technical support by going to the Support & Services section of the Allied Telesis web site at [www.alliedtelesis.com/support](http://www.alliedtelesis.com/support). You can find links for the following services on this page:

- ❑ 24/7 Online Support — Enter our interactive support center to search for answers to your product questions in our knowledge database, to check support tickets, to learn about RMAs, and to contact Allied Telesis technical experts.
- ❑ USA and EMEA phone support — Select the phone number that best fits your location and customer type.
- ❑ Hardware warranty information — Learn about Allied Telesis warranties and register your product online.
- ❑ Replacement Services — Submit a Return Merchandise Authorization (RMA) request via our interactive support center.
- ❑ Documentation — View the most recent installation and user guides, software release notes, white papers, and data sheets for your products.
- ❑ Software Downloads — Download the latest software releases for your managed products.

For sales or corporate information, go to [www.alliedtelesis.com/purchase](http://www.alliedtelesis.com/purchase) and select your region.



# Chapter 1

# Overview

---

This chapter contains the following sections:

- “Features” on page 16
- “Front and Back Panels” on page 19
- “Management Panel” on page 22
- “10/100/1000Base-T Twisted Pair Ports” on page 23
- “Power over Ethernet” on page 26
- “SFP Slots” on page 31
- “Combo Twisted Pair Ports and SFP Slots” on page 32
- “Stacking Slots” on page 33
- “eco-friendly Button” on page 34
- “LEDs” on page 35
- “USB Port” on page 43
- “Console Port” on page 44
- “Power Supply” on page 45

---

**Note**

This guide explains how to install the switches in a stack with the Virtual Chassis Stack (VCStack™) feature. For instructions on how to install the switches as stand-alone units, refer to the *AT-GS900MX Series Installation Guide for Stand-alone Switches*.

---

## Features

---

The AT-GS900MX Series Switches and their features are listed in this section:

### **AT-GS900MX Models**

Here are model names of the AT-GS900MX Series switches:

- ❑ AT-GS924MX
- ❑ AT-GS924MPX
- ❑ AT-GS948MX
- ❑ AT-GS948MPX

### **10/100/1000 Mbps Twisted Pair Ports**

Here are the basic features of the 10/100/1000 Mbps twisted pair ports:

- ❑ 24 or 48 ports per switch
- ❑ 10Base-T, 100Base-TX, and 1000Base-T compliant
- ❑ IEEE 802.3u Auto-Negotiation compliant
- ❑ Auto-MDI/MDIX
- ❑ 100 meters (328 feet) maximum operating distance
- ❑ IEEE 802.3x flow control in 10/100Base-TX full-duplex mode
- ❑ IEEE 802.3x backpressure in 10/100Base-TX half-duplex mode
- ❑ IEEE 802.3ab 1000Base-T
- ❑ Jumbo frames up to 9KB
- ❑ RJ-45 connectors

---

#### **Note**

Two twisted pair ports are paired with the SFP slots to form combo ports. For information, refer to “Combo Twisted Pair Ports and SFP Slots” on page 32.

---



## Power over Ethernet

Here are the basic features of Power over Ethernet (PoE) on the twisted pair ports on the AT-GS924MPX and AT-GS948MPX Switches:

- Supported on ports 1 to 24 on the AT-GS924MPX Switch and ports 1 to 48 on the AT-GS948MPX Switch
- Supports PoE (15.4 watts maximum) and PoE+ (30 watts maximum) powered devices
- Supports powered device classes 0 to 4
- Maximum power budget of 370 watts
- Port prioritization
- Mode A wiring

## SFP Slots

Here are the basic features of the two SFP slots on the switches:

- Supports 1000Base-SX/LX SFP transceivers
- Supports single-port BiDi 1000Base-LX SFP transceivers
- Supports 1000Base-ZX SFP transceivers

---

### Note

SFP transceivers must be purchased separately. For a list of supported transceivers, contact your Allied Telesis distributor or reseller.

---



---

### Note

The SFP slots are paired with two twisted pair 10/100/1000Base-T ports to form combo port pairs. For information, refer to “Combo Twisted Pair Ports and SFP Slots” on page 32.

---

## S1 and S2 Stacking Slots

The S1 and S2 slots are stacking ports for the VCStack feature. You may use the slots to build a stack of up to four switches. The slots support AT-SP10TW Twisted Pair Transceivers. For further information, refer to Chapter 2, “Virtual Chassis Stacking” on page 47.

## LEDs

Here are the port LEDs:

- Link/activity and duplex mode LEDs for the twisted pair ports on non-PoE switches
- Link/activity and PoE status LEDs for the twisted pair ports on PoE switches
- Link/activity LEDs for SFP and SFP+ slots
- Switch ID number LED
- eco-friendly button turns off the LEDs to conserve electricity

## Installation Options

Here are the installation options for the switches of a stack:

- 19-inch equipment rack
- Desk or tabletop

---

### Note

The switches come with wall anchors and screws. Allied Telesis does not recommend installing the switches of a stack on a wall. Instead, they should be installed in an equipment rack or on a table.

---

## MAC Address Table

Here are the basic features of the MAC address tables of the switches:

- Storage capacity of 16,000 dynamic MAC address entries
- Storage capacity of 256 static MAC address entries
- Automatic learning and aging

## Management Software and Interfaces

Here are the management software and interfaces:

- AlliedWare Plus Management Software
- Command line interface

## Management Methods

Here are the methods for managing the switches:

- Local management through the Console port
- Remote Telnet and Secure Shell management
- SNMPv1, v2c, and v3

# Front and Back Panels

The front panels of the AT-GS900MX Series switches are shown in Figure 1 here and Figure 2 on page 20.

AT-GS924MX

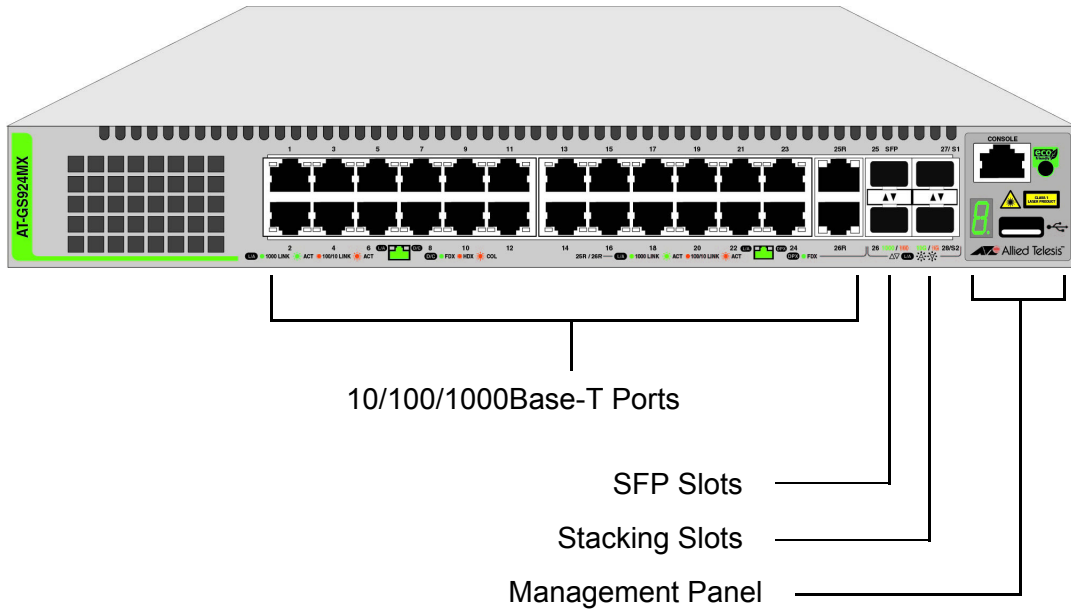

AT-GS924MPX

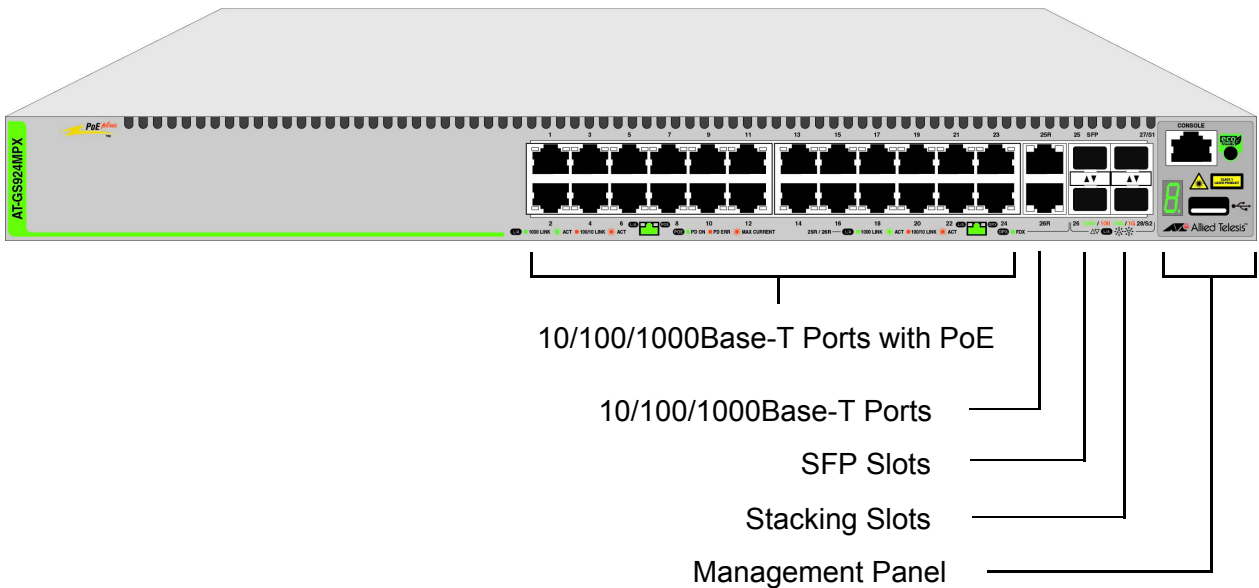
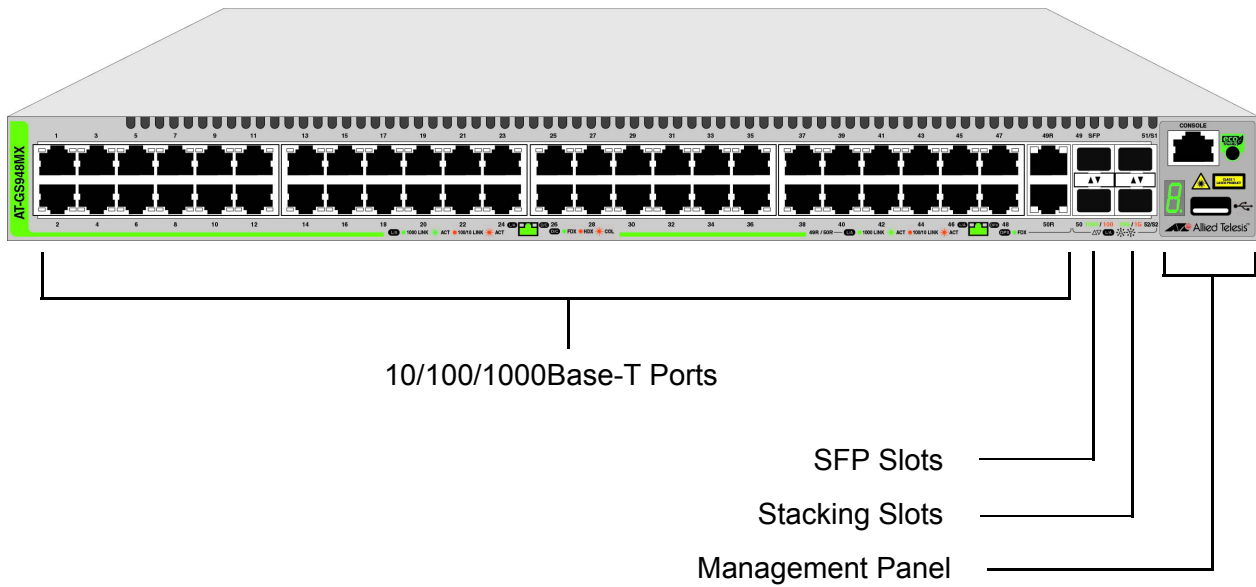

Figure 1. Front Panels of the AT-GS924MX and AT-GS924MPX Switches

### AT-GS948MX



### AT-GS948MPX

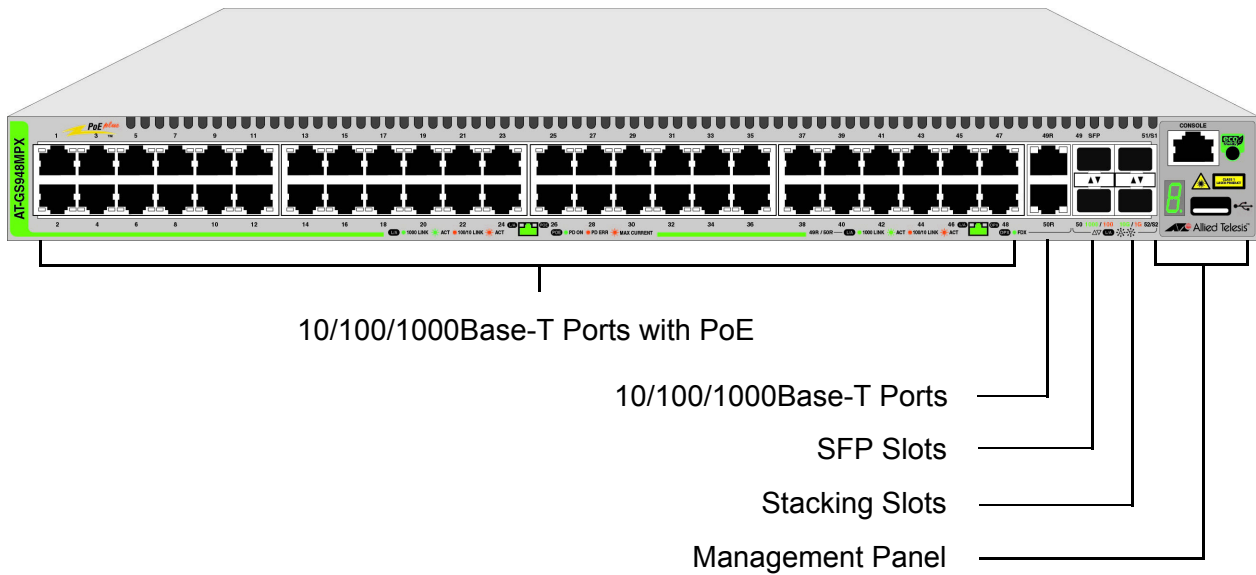

Figure 2. Front Panels of the AT-GS948MX and AT-GS948MPX Switches

The back panel of the AT-GS924MX Switch is shown in Figure 3.



Figure 3. Back Panel of the AT-GS924MX Switch

The back panel of the AT-GS924MPX and AT-GS948MPX Switches is shown in Figure 4.



Figure 4. Back Panel of the AT-GS924MPX and AT-GS948MPX Switches

The back panel of the AT-GS948MX Switch is shown in Figure 5.

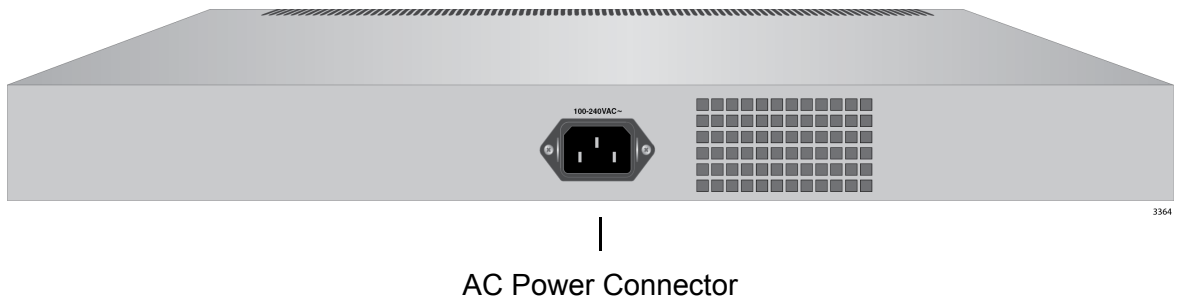

Figure 5. Back Panel of the AT-GS948MX Switch

# Management Panel

---

Figure 6 identifies the components in the management panels on the AT-GS900MX Series switches.

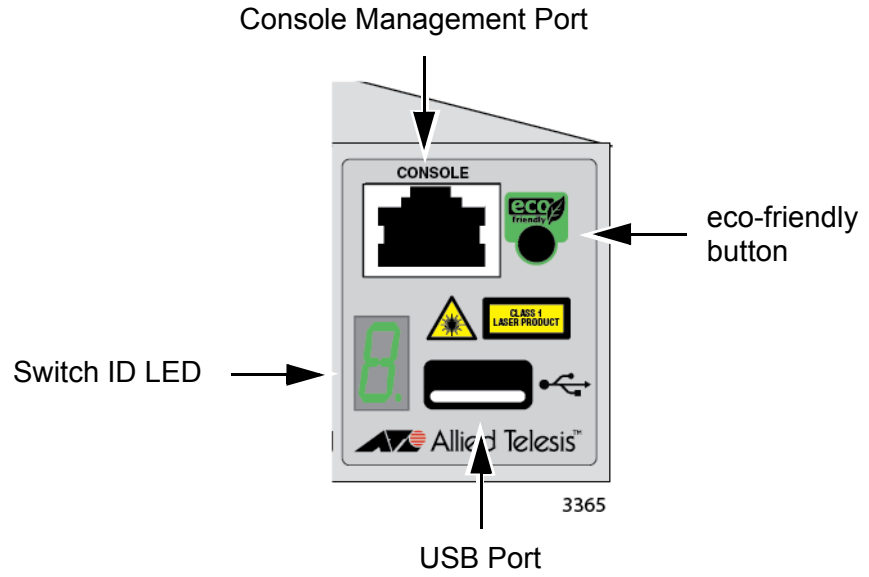

Figure 6. AT-GS900MX Series Management Panel

## 10/100/1000Base-T Twisted Pair Ports

---

The AT-GS900MX Series switches have 24 or 48 10/100/1000Base-T ports, depending on the model.

---

**Note**

Two twisted pair ports are paired with the SFP slots to form combo ports. For information, refer to “Combo Twisted Pair Ports and SFP Slots” on page 32.

---

**Speed** The ports can operate at 10, 100, or 1000 Mbps. The speeds may be set manually using the management software or automatically with Auto-Negotiation (IEEE 802.3u), the default setting.

---

**Note**

The ports must be set to Auto-Negotiation to function at 1000 Mbps and are not compatible with devices that are not IEEE 802.3u compliant.

---

**Duplex Mode** The twisted pair ports can operate in either half- or full-duplex mode. The duplex mode of a port, like port speed, may be set manually using the management software or automatically with Auto-Negotiation (IEEE 802.3u), the default setting.

The speed and duplex mode settings of a port may be set independently of each other. For example, a port may be configured such that its speed is set manually while its duplex mode is established through Auto-Negotiation.

---

**Note**

A switch port should not use Auto-Negotiation to set its duplex mode if it is connected to a network device that does not support Auto-Negotiation for 10 or 100 Mbps operation and has a fixed duplex mode of full-duplex. Otherwise, a duplex-mode mismatch may occur in which a switch port and a network device operate at different duplex modes. The duplex modes of switch ports that are connected to network devices that do not support Auto-Negotiation should be set manually through the management software.

---

## Wiring Configuration

The wiring configuration of a port operating at 10 or 100 Mbps can be MDI or MDI-X. The wiring configurations of a switch port and a network device connected with straight-through twisted pair cabling have to be opposite, such that one device is using MDI and the other MDI-X. For instance, a switch port has to be set to MDI-X if it is connected to a network device set to MDI.

You may set the wiring configurations of the ports manually or let the switch configure them automatically with auto-MDI/MDI-X (IEEE 802.3ab-compliant). This feature enables the switch to automatically negotiate with network devices to establish their proper settings.

The MDI and MDI-X settings do not apply when ports are operating at 1000 Mbps.

## Maximum Distance

The ports have a maximum operating distance of 100 meters (328 feet).

## Power over Ethernet

The 10/100/1000Base-T ports on the AT-GS924MPX and AT-GS948MPX Switches support Power over Ethernet (PoE). The ports supply DC power to network devices over the network twisted pair cables. The switches support PoE (IEEE 802.3af) and PoE+ (IEEE 802.3at). For background information, refer to “Power over Ethernet” on page 26.

## Cable Requirements

The cable requirements of the ports are given in Table 1.

Table 1. Twisted Pair Cable for the 10/100/1000Base-T Ports

Cable Type	10Mbps	100Mbps	1000Mbps
Standard TIA/EIA 568-B-compliant Category 3 shielded or unshielded cabling with 100 ohm impedance and a frequency of 16 MHz.	Yes	Yes	No
Standard TIA/EIA 568-A-compliant Category 5 or TIA/EIA 568-B-compliant Enhanced Category 5 (Cat 5e) shielded or unshielded cabling with 100 ohm impedance and a frequency of 100 MHz.	Yes	Yes	Yes
Standard TIA/EIA 568-B-compliant Category 6 or 6a shielded cabling.	Yes	Yes	Yes



**Port Pinouts** Refer to Table 19 on page 116 and Table 20 on page 117 for the port pinouts of the 10/100/1000Base-T twisted pair ports.

## Power over Ethernet

---

The AT-GS924MPX and AT-GS948MPX Switches feature Power over Ethernet (PoE) on the 10/100/1000Base-T ports. PoE is used to supply power to network devices over the same twisted pair cables that carry the network traffic.

The main advantage of PoE is that it can make it easier to install a network. The selection of a location for a network device is often limited by whether there is a power source nearby. This often limits equipment placement or requires the added time and cost of having additional electrical sources installed. But with PoE, you can install PoE-compatible devices wherever they are needed without having to worry about whether there are power sources nearby.

A device that provides PoE to other network devices is referred to as *power sourcing equipment* (PSE). The AT-GS924MPX and AT-GS948MPX Switches act as PSE units by adding DC power to the network cable, thus functioning as a central power source for other network devices.

Devices that receive their power from a PSE are called *powered devices* (PD). Examples include wireless access points, IP telephones, webcams, and even other Ethernet switches.

The switch automatically determines whether or not a device connected to a port is a powered device. Ports that are connected to network nodes that are not powered devices (that is, devices that receive their power from another power source) function as regular Ethernet ports, without PoE. The PoE feature remains activated on the ports, but no power is delivered to the devices.

### PoE Standards

The AT-GS924MPX and AT-GS948MPX Switches support these PoE standards:

- ❑ PoE (IEEE 802.3af): This standard provides up to 15.4 watts at the switch port to support powered devices that require up to 12.95 watts.
- ❑ PoE+ (IEEE 802.3at): This standard provides up to 30.0 watts at the switch port to support powered devices that require up to 25.5 watts.

**Powered Device Classes**

Powered devices are grouped into the five classes listed in Table 2. The classes are based on the amount of power the devices require. The switches support all five classes.

Table 2. IEEE Powered Device Classes

Class	Maximum Power Output from a Switch Port	PD Power Range
0	15.4W	0.44W to 12.95W
1	4.0W	0.44W to 3.84W
2	7.0W	3.84W to 6.49W
3	15.4W	6.49W to 12.95W
4	30.0W	12.95W to 25.5W

**Cable Requirements**

The cable requirements for ports operating at 10 or 100Mbps are given in Table 3.

Table 3. Twisted Pair Cable Requirements for the 10/100Base-TX Ports at 10 or 100Mbps

Cable Type	10Mbps			100Mbps		
	Non-PoE	PoE	PoE+	Non-PoE	PoE	PoE+
Standard TIA/EIA 568-B-compliant Category 3 shielded or unshielded cabling with 100 ohm impedance and a frequency of 16 MHz.	Yes	No	No	Yes	No	No
Standard TIA/EIA 568-A-compliant Category 5 shielded or unshielded cabling with 100 ohm impedance and a frequency of 100 MHz.	Yes	Yes	No	Yes	Yes	No
Standard TIA/EIA 568-B-compliant Enhanced Category 5 (Cat 5e) shielded or unshielded cabling with 100 ohm impedance and a frequency of 100 MHz.	Yes	Yes	Yes	Yes	Yes	Yes

Table 3. Twisted Pair Cable Requirements for the 10/100Base-TX Ports at 10 or 100Mbps

Cable Type	10Mbps			100Mbps		
	Non-PoE	PoE	PoE+	Non-PoE	PoE	PoE+
Standard TIA/EIA 568-B-compliant Category 6 or 6a shielded cabling.	Yes	Yes	Yes	Yes	Yes	Yes

The cable requirements for ports operating at 1000Mbps are given in Table 4.

Table 4. Twisted Pair Cable Requirements for the 10/100/1000Base-T Ports at 1000Mbps

Cable Type	1000Mbps		
	Non-PoE	PoE	PoE+
Standard TIA/EIA 568-B-compliant Category 3 shielded or unshielded cabling with 100 ohm impedance and a frequency of 16 MHz.	No	No	No
Standard TIA/EIA 568-A-compliant Category 5 shielded or unshielded cabling with 100 ohm impedance and a frequency of 100 MHz.	Yes	Yes	No
Standard TIA/EIA 568-B-compliant Enhanced Category 5 (Cat 5e) shielded or unshielded cabling with 100 ohm impedance and a frequency of 100 MHz.	Yes	Yes	Yes
Standard TIA/EIA 568-B-compliant Category 6 or 6a shielded cabling.	Yes	Yes	Yes

## Power Budget

The AT-GS924MPX and AT-GS948MPX Switches have a power budget of 370 watts. This is the maximum amount of power the switches can provide at one time to the powered devices.

The power requirements of the PoE devices determine the maximum number of devices the switch can support at one time. So long as the total power requirements of the powered devices is less than the power budget of the switch, the switch can supply power to all the devices. But if the total power requirements exceed the power budget, the switch denies power to one or more ports using a mechanism referred to as port prioritization.

To determine whether the power requirements of the PoE devices you plan to connect to the switch exceed its power budget, refer to their documentation for their power requirements and add the requirements together. The switch should be able to power all the devices simultaneously as long as the total is below its power budget. If the total exceeds the available power budget, you should consider reducing the number of PoE devices so that all of the devices receive power. Otherwise, the switch powers a subset of the devices, based on port prioritization.

The switch can handle different power requirements on different ports. This enables you to connect different classes of PoE equipment to the ports on the switch.

## Port Prioritization

If the power requirements of the powered devices exceed the switch's power budget, the switch denies power to some ports based on a system called port prioritization. You may use this mechanism to ensure that powered devices critical to the operations of your network are given preferential treatment by the switch in the distribution of power should the demands of the devices exceed the available capacity.

There are three priority levels:

- Critical
- High
- Low

Ports set to the Critical level, the highest priority level, are guaranteed power before any of the ports assigned to the other two priority levels. Ports assigned to the other priority levels receive power only if all the Critical ports are receiving power. Ports that are connected to your most critical powered devices should be assigned to this level. If there is not enough power to support all the ports set to the Critical priority level, power is provided to the ports based on port number, in ascending order.

The High level is the second highest level. Ports set to this level receive power only if all the ports set to the Critical level are already receiving power. If there is not enough power to support all of the ports set to the

High priority level, power is provided to the ports based on port number, in ascending order.

The lowest priority level is Low. This is the default setting. Ports set to this level only receive power if all of the ports assigned to the other two levels are already receiving power. As with the other levels, if there is not enough power to support all of the ports set to the Low priority level, power is provided to the ports based on port number, in ascending order.

Power allocation is dynamic. Ports supplying power to powered devices may cease power transmission if the switch's power budget is at maximum usage, and new powered devices, connected to ports with higher priorities, become active.

## **Wiring Implementation**

The IEEE 802.3af standard defines two methods for delivering DC power over twisted pair cable by a PSE, such as a switch, to PDs. These methods, known as Alternatives A and B, identify which of the wires within the cables are to carry the DC power from the switches to the PDs.

Twisted pair cabling typically consists of eight wires. With 10Base-T and 100Base-TX devices, the wires connected to pins 1, 2, 3, and 6 on the RJ-45 connectors carry the network traffic while the wires connected to pins 4, 5, 7, and 8 are unused. With 1000Base-T devices, all eight wires are used to carry network data.

It takes four wires to deliver DC power to a PD. With Alternative A, the power is delivered on pins 1, 2, 3, and 6. These are the same pins in 10Base-T and 100Base-TX devices that carry the network data. With Alternative B, the power is provided over 4, 5, 7, and 8, which are spare wires.

The ports on the AT-GS924MPX and AT-GS948MPX Switches deliver the power using pins 4, 5, 7, and 8, which corresponds to Alternative B in the IEEE 802.3af standard. Therefore, the switches can support PDs that use Alternative B to receive power.

PDs that comply with the IEEE 802.3af and 802.3at standards are required to support both Alternative A and B. However, non-standard PDs and PDs that were manufactured before the completion of the IEEE 802.3af and 802.3at standards and that support only Alternative A will not work with the switches.

## SFP Slots

---

The switches have two SFP slots that support the following types of SFP 1000Mbps transceivers:

- ❑ 1000Base-SX/LX SFP transceivers
- ❑ Single-port BiDi 1000Base-LX SFP transceivers
- ❑ 1000Base-ZX SFP transceivers

You may use the transceivers to connect switches to other network devices over large distances, build high-speed backbone networks between network devices, or connect high-speed devices, such as servers, to your network.

The switches support a variety of short and long distance SFP modules. For a list of supported SFP modules, contact your Allied Telesis representative or visit our web site.

---

**Note**

The SFP slots and two twisted pair ports are paired together to form combo port pairs. For information, refer to “Combo Twisted Pair Ports and SFP Slots” on page 32.

---

## Combo Twisted Pair Ports and SFP Slots

---

Two twisted pair ports and SFP slots are paired together to form combo port pairs. Each pair contains one 10/100/1000Base-T port and one SFP slot. The combo port pairs for the switches are listed in Table 5.

Table 5. Combo Port Pairs

Model	10/100/1000 Base-T Port	SFP Slot
AT-GS924MX and AT-GS924MPX	25R	25
	26R	26
AT-GS948MX and AT-GS948MPX	49R	49
	50R	50

The rule to follow when using the combo port pairs is to use only one device in a pair at a time. For example, if you decide to use twisted pair port 25R on the AT-GS924MX or AT-GS924MPX Switch, then you cannot use SFP slot 25. Or, if you choose to use SFP slot 49 on the AT-GS948MX or AT-GS948MPX Switch, then you cannot use the twisted pair port 49R.

The rules for using the combo port pairs are listed here:

- ❑ You may use either the twisted pair port or SFP slot of a combo port pair, but not both at the same time.
- ❑ If you connect both the twisted pair port and SFP slot of a combo port pair to network devices, the SFP slot takes priority, and the twisted pair port is blocked.
- ❑ The SFP slot becomes active when the SFP transceiver establishes a link to a network device.
- ❑ The twisted pair port and SFP slot of a combo port pair share the same settings, such as VLAN assignments, access control lists, and spanning tree.



## Stacking Slots

---

The S1 and S2 slots on the front panel of the switch are used with the VCStack feature and the stacking transceiver to create a stack of up to four switches. The switches of a stack act as a single virtual unit. They synchronize their actions so that switching operations, like spanning tree protocols, virtual LANs, and static port trunks, span across all the units and ports. The two main advantages of stacks are:

- ❑ You can manage multiple units simultaneously, which can simplify network management.
- ❑ You have more flexibility with some of the features. For instance, a static port trunk on a stand-alone switch has to consist of ports from the same switch. In contrast, a static trunk on a stack may consist of ports from different switches in the same stack.

The stacking transceiver is shown in Figure 7. It is called the AT-SP10TW, and has two SFP transceiver-style connectors and one meter of twinax cable.



Figure 7. Stacking Transceiver

---

**Note**

For stacking, the stacking slots only support the AT-SP10TW stacking transceiver. However, the stacking slots may also be used as regular networking ports.

---

## eco-friendly Button

---

The eco-friendly button on the front panel of the switch is used to toggle the port LEDs on or off. You might turn off the LEDs to conserve electricity when you are not monitoring the device. You can also toggle the LEDs with the ECOFRIENDLY LED and NO ECOFRIENDLY LED commands in the Global Configuration mode of the command line interface. The switch is said to be operating in a low power mode when the LEDs are turned off.

Operating the switch in the low power mode with the LEDs turned off does not interfere with the network operations of the device.

The management software on the switch has a command that blinks the LEDs so that you can quickly and easily identify a specific unit among the devices in an equipment rack. It is the FINDME command. The command works on the switch even if you turned off the LEDs with the eco-friendly button or NO ECOFRIENDLY LED command.

The Switch ID LED is always on, but it displays different information depending on whether the LEDs are on or off. When the LEDs are on, the ID LED displays the ID number of the switch. When the switch is operating in the low power mode with the LEDs off, the ID LED indicates whether the switch is a stand-alone unit or the master or member switch of a VCStack, as detailed in Figure 14 on page 42.

---

### **Note**

Before checking or troubleshooting the network connections to the ports on the switch, you should always check to be sure that the LEDs are on by either pressing the eco-friendly button or issuing the ECOFRIENDLY LED and NO ECOFRIENDLY LED commands in the Global Configuration mode of the command line interface.

---

# LEDs

This section describes the functions of the LEDs.

## LEDs for the Twisted Pair Ports

The twisted pair ports on the AT-GS924MX and AT-GS948MX Switches have two LEDs that display link, activity and duplex mode information. The LEDs are shown in Figure 8.

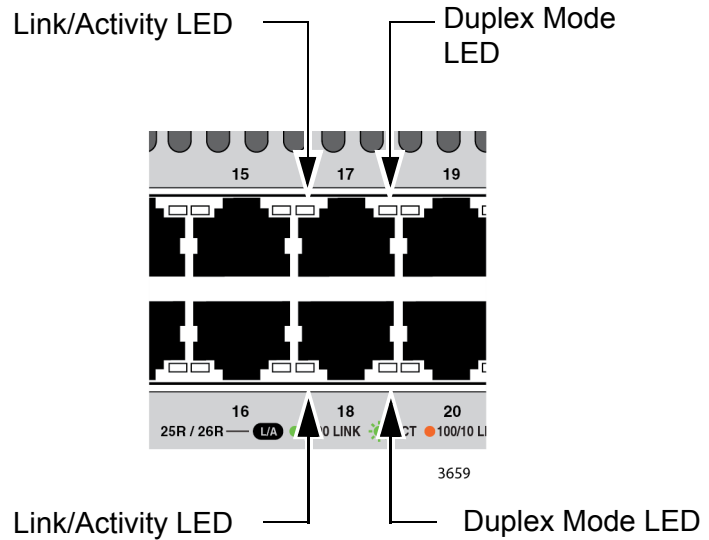

Figure 8. LEDs for the Twisted Pair Ports on the AT-GS924MX and AT-GS948MX Switches

The LEDs are described in Table 6 on page 36.

Table 6. LEDs on the Twisted Pair Ports on the AT-GS924MX and AT-GS948MX Switches

LED	State	Description
Link/ Activity LED	Solid Green	A port has established a 1000 Mbps link to a network device.
	Flashing Green	A port is transmitting or receiving data at 1000 Mbps.
	Solid Amber	A port has established a 10 or 100 Mbps link to a network device.
	Flashing Amber	A port is transmitting or receiving data at 10 or 100 Mbps.
	Off	A port has not established a link with another network device or the LEDs are turned off. To turn on the LEDs, use the eco-friendly button.
Duplex Mode LED	Solid Green	A port is operating in full-duplex mode.
	Solid Amber	A port is operating in half-duplex mode.
	Flashing Amber	Collisions are occurring on a port.

### LEDs for the PoE Twisted Pair Ports

The PoE twisted pair ports on the AT-GS924MPX and AT-GS948MPX Switches have two LEDs that display link, activity and PoE information. The LEDs are shown in Figure 9 on page 37.

---

#### Note

The duplex mode information for the ports on the AT-GS924MPX and AT-GS948MPX Switches is available from the management software.

---

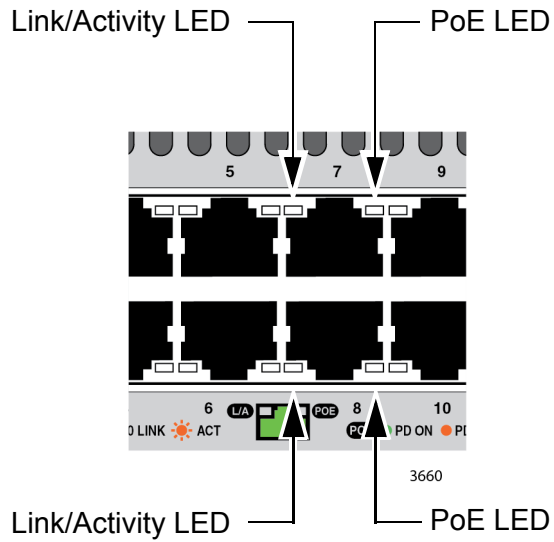

Figure 9. LEDs for the PoE Twisted Pair Ports on the AT-GS924MPX and AT-GS948MPX Switches

The LEDs are described in Table 7.

Table 7. LEDs for the PoE Twisted Pair Ports on the AT-GS924MPX and AT-GS948MPX Switches

LED	State	Description
Link/ Activity LED	Solid Green	A port has established a 1000 Mbps link to a network device.
	Flashing Green	A port is transmitting or receiving data at 1000 Mbps.
	Solid Amber	A port has established a 10 or 100 Mbps link to a network device.
	Flashing Amber	A port is transmitting or receiving data at 10 or 100 Mbps.
	Off	A port has not established a link with another network device or the LEDs are turned off. To turn on the LEDs, use the eco-friendly button.

Table 7. LEDs for the PoE Twisted Pair Ports on the AT-GS924MPX and AT-GS948MPX Switches (Continued)

LED	State	Description
PoE	Green	The switch is detecting a powered device (PD) on the port and is delivering power to it.
	Solid Amber	The switch has shut down PoE+ on the port because of a fault condition.
	Flashing Amber	The switch is detecting a PD on the port but is not delivering power to it because the maximum power budget has been reached.
	Off	This LED state can result from the following conditions: <ul style="list-style-type: none"> <li>❑ The port is not connected to a PD.</li> <li>❑ The PD is powered off.</li> <li>❑ The port is disabled in the management software.</li> <li>❑ PoE is disabled on the port.</li> <li>❑ The LEDs on the Ethernet line cards are turned off. To turn on the LEDs, use the eco-friendly button.</li> </ul>

**LEDs for the Combo Twisted Pair Ports**

Ports 25R and 26R on the AT-GS924MX and AT-GS924MPX Switches and ports 49R and 50R on the AT-GS948MX and AT-GS948MPX Switches have two LEDs that display link, activity and duplex mode information. The LEDs are shown in Figure 10 on page 39.

**Note**

The combo twisted pair ports are paired with the SFP slots to form combo port pairs. For information, refer to “Combo Twisted Pair Ports and SFP Slots” on page 32.

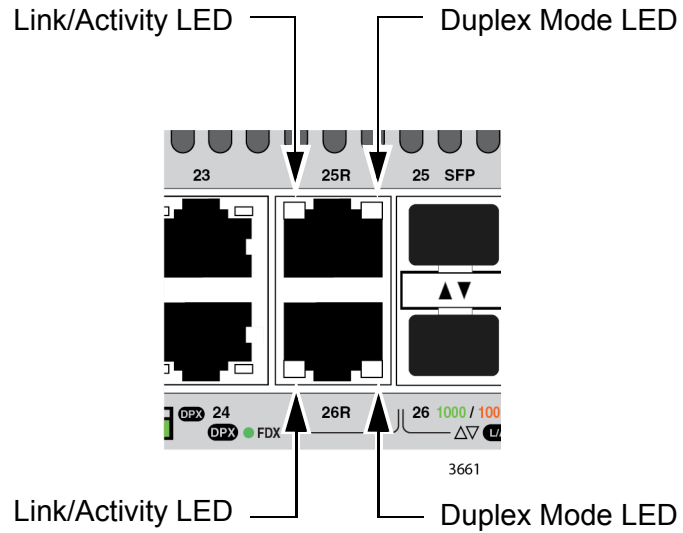

Figure 10. LEDs for the Combo Twisted Pair Ports

The LEDs are described in Table 8.

Table 8. LEDs on the Combo Twisted Pair Ports

LED	State	Description
Link/ Activity LED	Solid Green	A port has established a 1000 Mbps link to a network device.
	Flashing Green	A port is transmitting or receiving data at 1000 Mbps.
	Solid Amber	A port has established a 10 or 100 Mbps link to a network device.
	Flashing Amber	A port is transmitting or receiving data at 10 or 100 Mbps.
	Off	A port has not established a link with another network device or the LEDs are turned off. To turn on the LEDs, use the eco-friendly button.
Duplex Mode LED	Solid Green	A port is operating in full-duplex mode. (The ports do not support half-duplex mode.)
	Off	A port has not established a link with another network device or the LEDs are turned off. To turn on the LEDs, use the eco-friendly button.

## LEDs for the SFP Slots

The LEDs for the SFP slots are located between the slots, as shown in Figure 11. Each SFP slot has one LED. The left-hand LED is for the top slot and the right-hand LED is for the bottom slot.

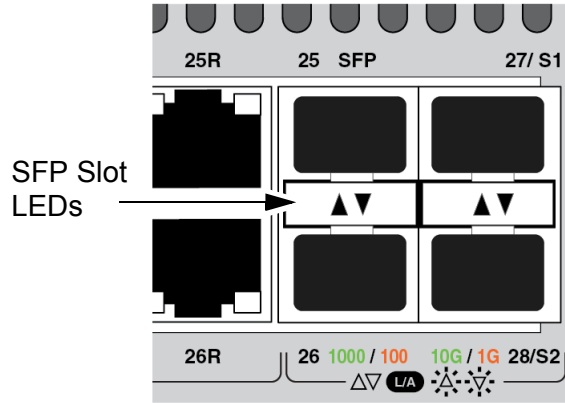

Figure 11. SFP Slot LEDs

The LEDs are described in Table 9.

Table 9. SFP Slot LEDs

LED	State	Description
Link/Activity	Off	The slot is empty, the SFP transceiver has not established a link to a network device, or the LEDs are turned off. To turn on the LEDs, use the eco-friendly button.
	Solid green	The SFP transceiver has established a 100 or 1000 Mbps link to a network device.
	Flashing green	The SFP transceiver is receiving or transmitting packets to a network device.

## LEDs for the Stacking Slots

Slots S1 and S2 are stacking slots for the VCStack feature. You can use the slots to build a virtual switch of up to four switches. For background information, refer to Chapter 2, “Virtual Chassis Stacking” on page 47. Table 10 on page 41 defines the LED states when the slots contain stacking transceivers.

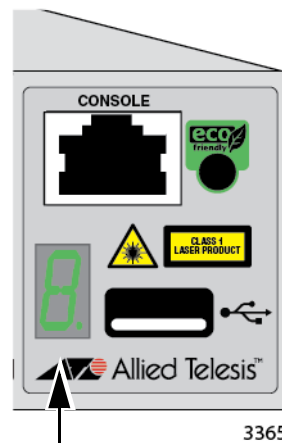

Table 10. S1 and S2 Slot LEDs

LED	State	Description
Link/Activity	Off	The slot is empty, the stacking transceiver has not established a link to a network device, or the LEDs are turned off. To turn on the LEDs, use the eco-friendly button.
	Solid green	The stacking transceiver has established a link to another switch in the stack.
	Flashing green	The stacking transceiver is receiving or transmitting packets.

**Switch ID LED**

The Switch ID LED, shown in Figure 12, displays the ID number of the switch. A stand-alone switch has the ID number 0. Switches in a VCStack have the numbers 1 to 4.



Switch ID LED

Figure 12. Switch ID LED

The states of the LED when the switch is not operating in the low power mode are shown in Figure 13 on page 42.

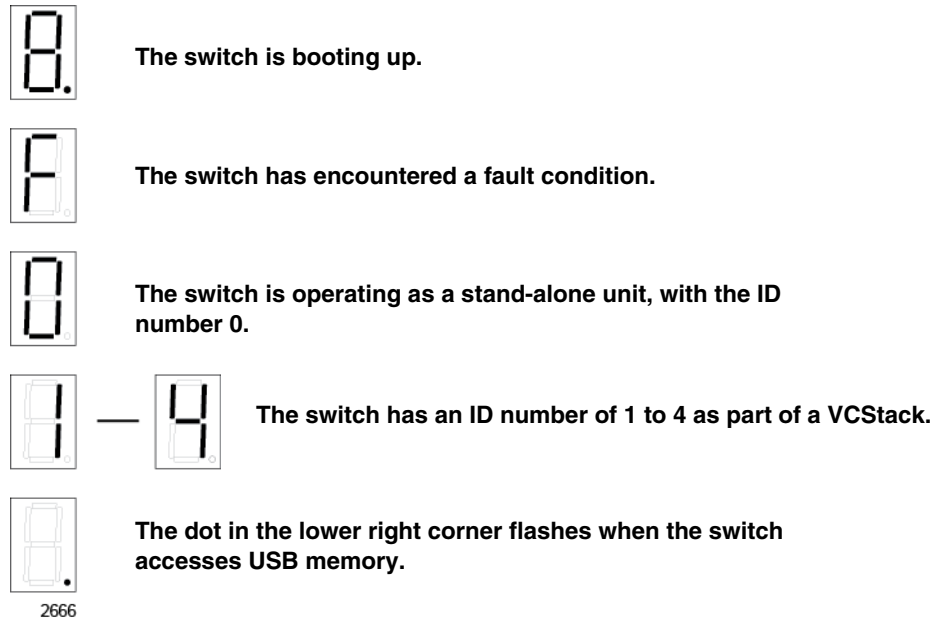

Figure 13. Switch ID LED Not in Low Power Mode

The switch displays the letter “F” for fault on the ID LED if it encounters one of the following problems:

- A cooling fan has failed.
- The internal temperature of the switch has exceeded the normal operating range and the switch may shut down.

---

**Note**

You can use the `SHOW SYSTEM ENVIRONMENT` command in the command line interface to identify the source of the problem.

---

The states of the LED when the switch is operating in the low power mode are shown in Figure 14.

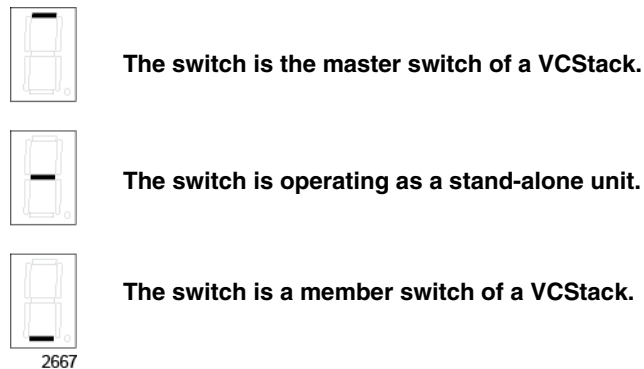

Figure 14. Switch ID LEDs in Low Power Mode

## USB Port

---

The management panel has a USB port. You may use the port to store configuration files on flash drives and to restore configuration files to switches whose settings have been lost or corrupted, or to quickly configure replacement units. You may also use the port and flash drives to update the management firmware on the switches.

The port is USB2.0 compatible.

## Console Port

---

The Console port is used to conduct management sessions with the switch to configure its features and parameter settings. This type of management uses serial RS-232 and is commonly referred to as local or out-of-band management because it is not conducted over your network. To perform local management, you must be at the location of the switch and must use the management cable included with the switch.

To establish a local management session with the switch, connect a terminal or a personal computer with a terminal emulation program to the Console port, which has an RJ-45 style (8P8C) connector, using the provided management cable. The cable has RJ-45 style (8P8C) and DB-9 (D-sub 9-pin) connectors.

The Console port is set to the following specifications:

- Default baud rate: 9600 bps (Range is 9600 to 115200 bps)
- Data bits: 8
- Parity: None
- Stop bits: 1
- Flow control: None

---

**Note**

These settings are for a DEC VT100 or ANSI terminal, or an equivalent terminal emulation program.

---

## Power Supply

---

The AT-GS900MX Series switches come with one AC power supply. The back panels have one AC connector. The power supply is not field-replaceable, refer to “Technical Specifications” on page 113 for the input voltage range.

**Warning**

Power cord is used as a disconnection device. To de-energize equipment, disconnect the power cord. ⚡ E3

---

---

**Note**

The switches are powered on or off by connecting or disconnecting the power cords.

---



## Chapter 2

# Virtual Chassis Stacking

---

The sections in this chapter are:

- “Overview” on page 48
- “Stacking Slots and Transceivers” on page 49
- “Stacking Port Topologies” on page 50
- “Master and Member Switches” on page 54
- “Specifying Ports in the Command Line Interface” on page 56

---

### **Note**

For more information on the VCStack feature, refer to the *Stacking Introduction and Stacking Commands* chapters in the *Software Reference for AT-GS900MX Series Switches, AlliedWare Plus Operating System* from [www.alliedtelesis.com/support](http://www.alliedtelesis.com/support).

---

## Overview

---

The Virtual Chassis Stack (VCStack) feature allows you to connect up to four AT-GS900MX Series switches to form a virtual switch so that the devices function as a single networking unit. The benefits of the VCStack feature are:

- ❑ Simplifies management - You can manage the devices of the stack as a single unit, rather than individually. Your local and remote management sessions automatically give you management access to all the devices.
- ❑ Reduces IP addresses - A stack requires only one IP address for remote management access, thereby reducing the number of IP addresses you have to assign to network devices. The one address gives you management access to all the units.
- ❑ Adds feature flexibility and resiliency - A stack gives you more flexibility in the available configurations of features. For instance, you can create port aggregators of ports from different switches in the stack, rather than from only one switch. If you distribute the ports of an aggregator across two or more switches in a stack, you increase its resiliency because the aggregator will continue to function, though at a reduced bandwidth, if one of the switches stops functioning.
- ❑ Reduces protocol requirements - Creating a stack might eliminate your need to configure some protocols, such as the Virtual Router Redundancy Protocol and Spanning Tree Protocol.



## Stacking Slots and Transceivers

---

The AT-GS900MX Series Switches come with two stacking slots. The slots are labeled “S1” and “S2”. For stacking, the slots may only be used with the VCStack feature and with the AT-SP10TW transceiver.

The stacking transceiver is shown in Figure 15. It has two SFP+ transceiver-style connectors and one meter of twinax cable.



Figure 15. Stacking Transceiver

---

**Note**

Stacking transceivers must be purchased separately.

---

## Stacking Port Topologies

The switches of a stack are connected with the S1 and S2 ports and AT-SP10TW transceiver, shown in Figure 15 on page 49.

There are two wiring configurations. The first topology is called the linear topology. In this topology, the switches are connected with a single pathway. The connections must cross over to different stacking slots on the switches. Slot S1 on one switch must be connected to slot S2 on the next switch.

Figure 16 is an example of a stack of two switches in the linear topology. The stacking transceiver connects the S1 slot on the top switch to the S2 slot on the bottom switch.

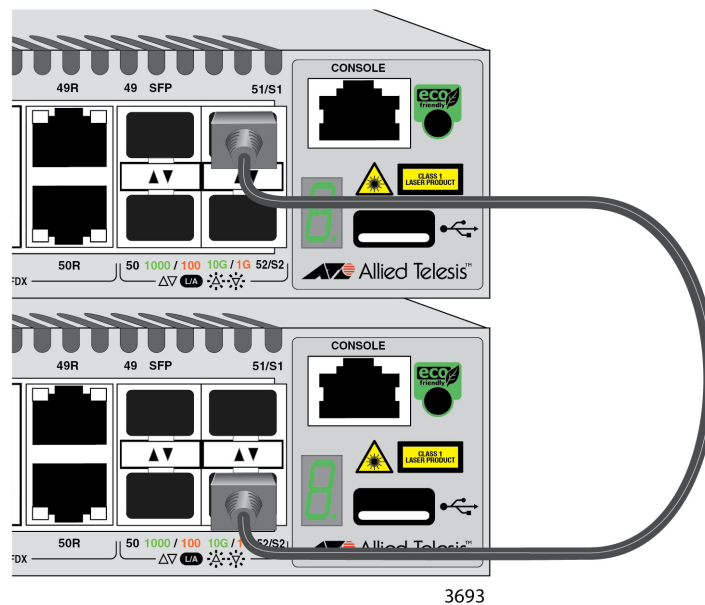

Figure 16. Stack of Two Switches in the Linear Topology



### Caution

The stack will not function if the connections to the S1 and S2 slots do not cross over on the switches. The switches will not form a stack and instead will operate as stand-alone devices. E78

The stack in Figure 17 on page 51 has four switches in the linear topology.

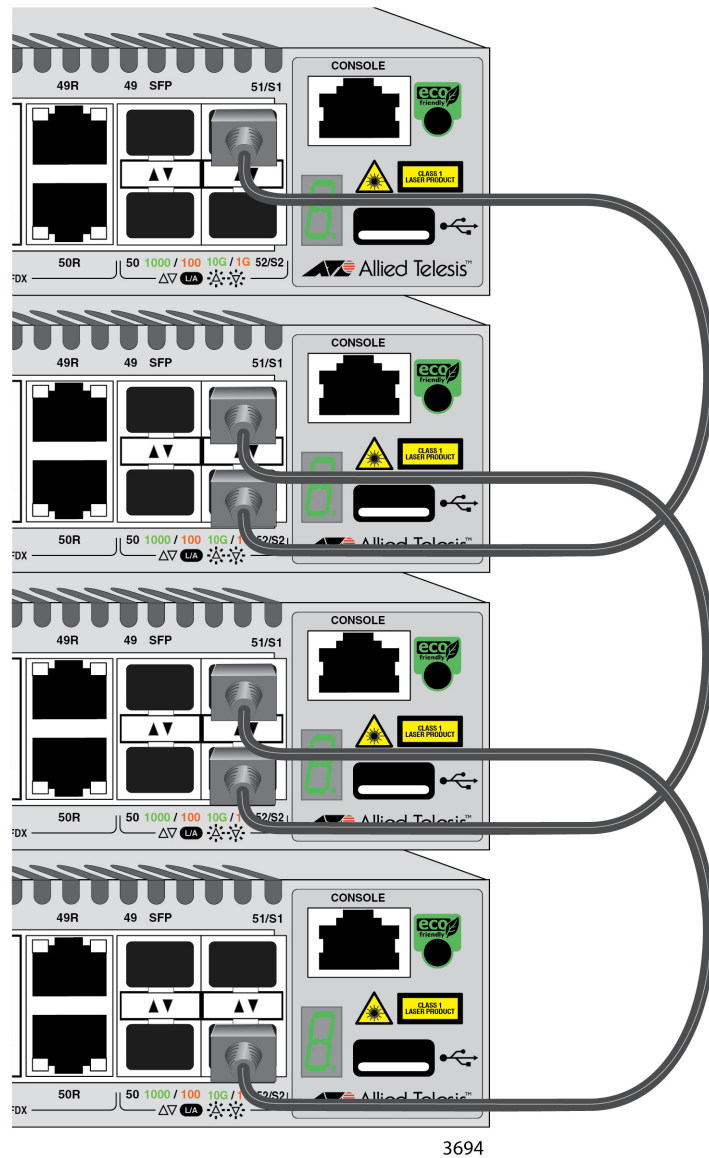

3694

Figure 17. Stack of Four Switches in the Linear Topology

The second topology is called the ring topology. It is similar to the linear topology, except that the unused stacking slots on the end switches of the stack are connected to form a physical loop. This topology is more resilient than the linear topology because there are two pathways through the stack. If one pathway fails, the switches can maintain communications through the alternate pathway. The example in Figure 18 on page 52 shows a ring topology of two switches.

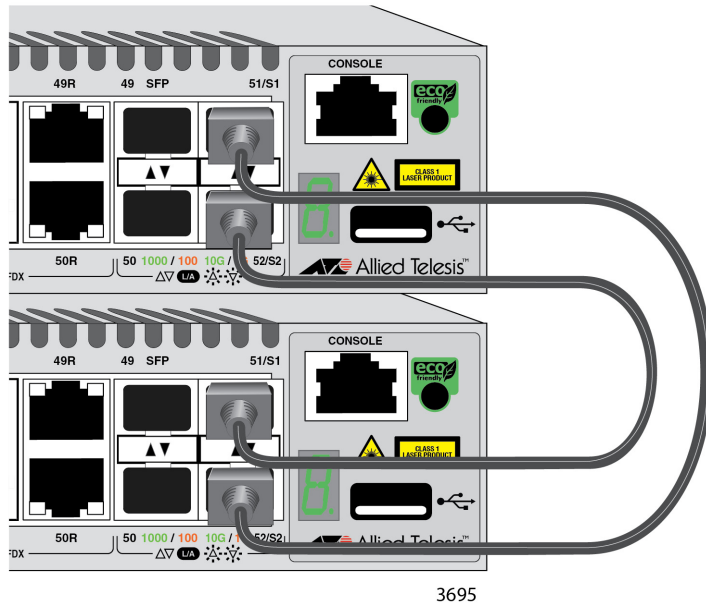

Figure 18. Stack of Two Switches in the Ring Topology

Figure 19 on page 53 is an example of a stack of four switches in the ring topology.

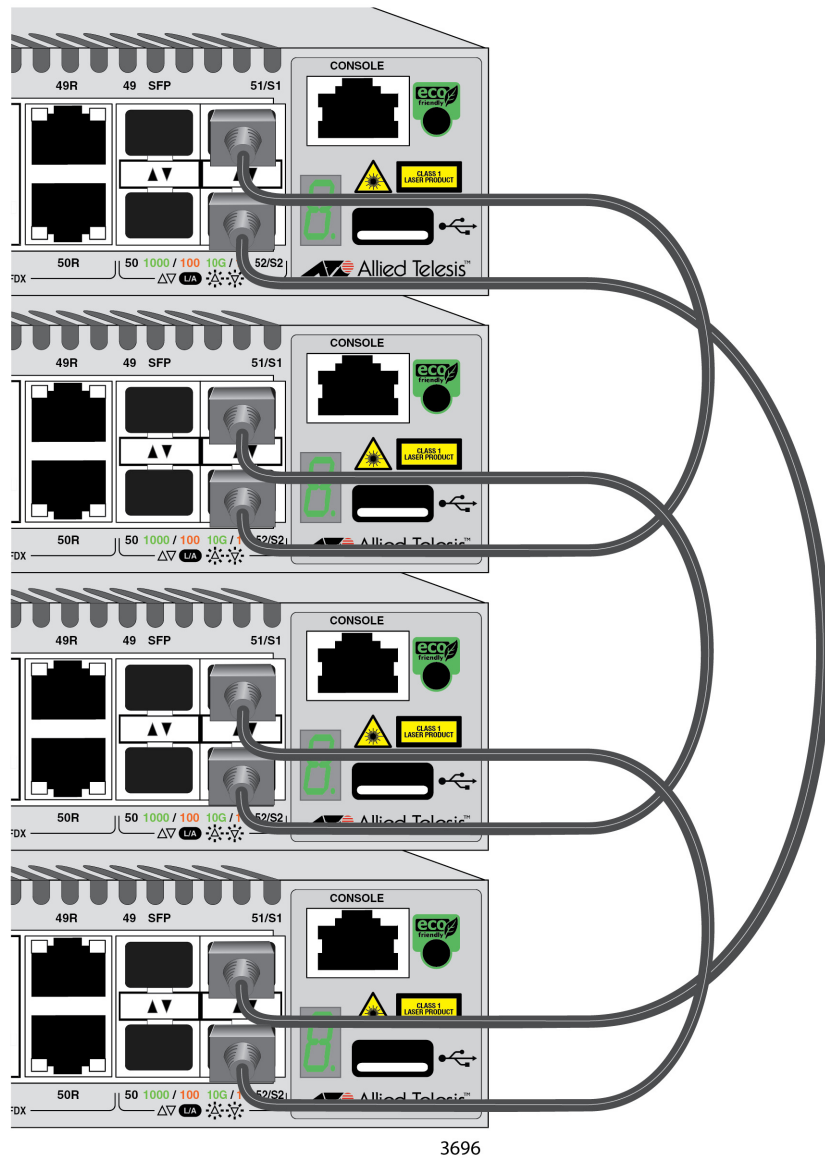

Figure 19. Stack of Four Switches in the Ring Topology

The topologies are the same in terms of network speed and performance. However, the ring topology is the recommended wiring configuration because of the secondary path through the stacking ports. The two pathways protect the switches of the stack against the loss of communications due to a failure of a stacking port, cable, or switch.

## Master and Member Switches

---

The stack has one master switch. The functions of the master switch include:

- ❑ Coordinating and monitoring stack operations.
- ❑ Verifying that the switches are using the same version of management software. It automatically downloads its management software over the stacking cables to switches with different software versions.
- ❑ Verifying that the switches have different ID numbers. It automatically assigns new ID numbers to resolve situations where two or more switches have the same ID number.
- ❑ Verifying that the stacking transceivers that connect the switches together are cabled correctly.

The other switches are called member switches. There can be up to three member switches in addition to the master switch. A member switch can automatically transition to the master role if the current master switch is removed from the stack or powered off. This ensures continued operations of the stack even if the master switch stops operating.

### Selection of the Master Switch

The devices compare the following numbers to choose the master switch when the stack is reset or powered on:

- ❑ Stack priority numbers
- ❑ MAC addresses

The stack priority number is an adjustable value of 0 to 255, where the lower the number, the higher the priority. The switch with the lowest priority number (highest priority) becomes the master switch of a stack. The default priority value is 128.

If the switches have the same priority values, the selection of the master switch is based on their MAC addresses. As with the priority value, the lower the MAC address, the higher the priority. The switch with the lowest MAC address becomes the master switch.

If you power on the stack for the first time without adjusting the priority values, the master switch is selected based on the MAC addresses if the units are powered on simultaneously. If you power on the switches one at a time, the master switch is the first switch to be powered on. This is explained in Chapter 7, “Powering On the Stack” on page 87.

After the stack is established and operating, you may, if you choose, change the priority settings on the individual units to let you control which switch will be the master switch after subsequent power cycles and resets.

## ID Numbers

Each switch must be assigned an ID number. The range is 1 to 4, and the default is 1. The ID numbers are displayed on the ID LEDs on the front panels of the units. You may assign the numbers yourself or you can let the master switch assign the numbers automatically, as explained in Chapter 7, “Powering On the Stack” on page 87.

You use the ID numbers to identify the individual ports and switches when you configure the devices with the commands in the management software. For further information, refer to “Specifying Ports in the Command Line Interface” on page 56.

The ID numbers are also used to identify the parameter settings that are stored in the configuration file. When the stack is reset or power cycled, the ID numbers identify the devices to which the parameter settings belong.



### Caution

You should not change the ID numbers of the switches after you have started to configure the parameter settings. Otherwise, the parameter settings might be applied to the wrong devices when you reset or power cycle the stack. *see* E79

---

The switches do not use the ID numbers to select the master switch. The selection of the master switch is typically based on the priority numbers and MAC addresses, as previously explained.

## Specifying Ports in the Command Line Interface

---

The command line interface in the management software on the switch has a parameter that you use to specify the individual ports. The parameter is the PORT parameter, and Figure 20 shows its format.

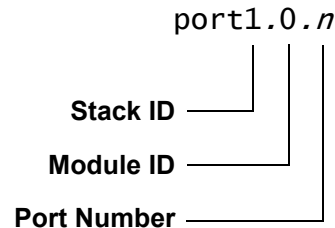

Figure 20. PORT Parameter in the Command Line Interface

The first number is the switch's ID number. The ID numbers of switches in a stack are displayed on their ID LEDs. You can also view the ID numbers with the `SHOW STACK` command in the command line interface.

The module ID value is used with multi-module products. This value does not apply to the AT-GS900MX Series switches and should always be 0.

The third value is a port number on the switch. You may specify only one port number in a PORT parameter, but you may specify more than one PORT parameter in many of the commands where the parameter is supported.

Here is an example of the PORT parameter. It uses the `INTERFACE` command to enter the Port Interface mode for ports 15 and 17 on the switch with ID 2:

```
awplus> enable
awplus# configure terminal
awplus(config)# interface port2.0.15,port2.0.17
```

For instructions on the command line interface and the PORT parameter, refer to the *Software Reference for AT-GS900MX Series Switches, AlliedWare Plus Operating System*.



## Chapter 3

# Beginning the Installation

---

The chapter contains the following sections:

- “Reviewing Safety Precautions” on page 58
- “Selecting a Site for the Stack” on page 62
- “Planning a Stack” on page 64
- “Unpacking the Switch” on page 65

## Reviewing Safety Precautions

---

Please review the following safety precautions before beginning the installation procedure.

---

### Note

Safety statements that have the  symbol are translated into multiple languages in the *Translated Safety Statements* document at [www.alliedtelesis.com/support](http://www.alliedtelesis.com/support).

---



---

### Warning

Class 1 Laser product.  L1

---



---

### Warning

Do not stare into the laser beam.  L2

---



---

### Warning

Do not look directly at the fiber optic cable ends or inspect the cable ends with an optical lens.  L6

---



---

### Warning

To prevent electric shock, do not remove the cover. No user-serviceable parts inside. This unit contains hazardous voltages and should only be opened by a trained and qualified technician. To avoid the possibility of electric shock, disconnect electric power to the product before connecting or disconnecting the LAN cables.  E1

---



---

### Warning

Do not work on equipment or cables during periods of lightning activity.  E2

---

**Warning**

Power cord is used as a disconnection device. To de-energize equipment, disconnect the power cord. ⚡ E3

---

**Warning**

Class I Equipment. This equipment must be earthed. The power plug must be connected to a properly wired earth ground socket outlet. An improperly wired socket outlet could place hazardous voltages on accessible metal parts. ⚡ E4

---

---

**Note**

Pluggable Equipment. The socket outlet shall be installed near the equipment and shall be easily accessible. ⚡ E5

---

**Caution**

Air vents must not be blocked and must have free access to the room ambient air for cooling. ⚡ E6

---

**Warning**

Operating Temperatures. This product is designed for a maximum ambient temperature of 50 degrees C. ⚡ E57

---

---

**Note**

All Countries: Install product in accordance with local and National Electrical Codes. ⚡ E8

---

**Warning**

Only trained and qualified personnel are allowed to install or replace this equipment. ⚡ E14

---



**Caution**

Circuit Overloading: Consideration should be given to the connection of the equipment to the supply circuit and the effect that overloading of circuits might have on overcurrent protection and supply wiring. Appropriate consideration of equipment nameplate ratings should be used when addressing this concern. ⚡ E21

---



**Caution**

Risk of explosion if battery is replaced by an incorrect type. Replace only with the same or equivalent type recommended by the manufacturer. Dispose of used batteries according to the manufacturer's instructions.

**Attention:** Le remplacement de la batterie par une batterie de type incorrect peut provoquer un danger d'explosion. La remplacer uniquement par une batterie du même type ou de type équivalent recommandée par le constructeur. Les batteries doivent être éliminées conformément aux instructions du constructeur. ⚡ E22

---



**Warning**

Mounting of the equipment in the rack should be such that a hazardous condition is not created due to uneven mechanical loading. ⚡ E25

---

---

**Note**

Use dedicated power circuits or power conditioners to supply reliable electrical power to the device. ⚡ E27

---



**Warning**

This unit might have more than one power cord. To reduce the risk of electric shock, disconnect all power cords before servicing the unit. ⚡ E30

---

---

**Note**

If installed in a closed or multi-unit rack assembly, the operating ambient temperature of the rack environment may be greater than the room ambient temperature. Therefore, consideration should be given to installing the equipment in an environment compatible with the manufacturer's maximum rated ambient temperature (T<sub>mra</sub>). ⌘ E35

---



---

**Caution**

Installation of the equipment in a rack should be such that the amount of air flow required for safe operation of the equipment is not compromised. ⌘ E36

---



---

**Warning**

Reliable earthing of rack-mounted equipment should be maintained. Particular attention should be given to supply connections other than direct connections to the branch circuits (e.g., use of power strips). ⌘ E37

---



---

**Warning**

To reduce the risk of electric shock, the PoE ports on this product must not connect to cabling that is routed outside the building where this device is located. ⌘ E40

---



---

**Caution**

The unit does not contain serviceable components. Please return damaged units for servicing. ⌘ E42

---



---

**Warning**

When you remove an SFP module from this product, the case temperature of the SFP may exceed 40° C (158° F). Exercise caution when handling with unprotected hands. ⌘ E43

---

## Selecting a Site for the Stack

---

Here are the site guidelines for the stack:

---

### Note

The switches of the stack should be installed on a table or in an equipment rack. They should not be installed on a wall.

---

- The power outlets should be located near the switches and be easily accessible.
- The site should allow for easy access to the ports on the front of the switches, so that you can easily connect and disconnect cables, and view the port LEDs.
- The site should allow for adequate air flow around the units and through the cooling vents on the front and rear panels. (The ventilation direction in a unit with a cooling fan is from front to back, with the fan on the back panel drawing the air out of the unit.)
- If you are installing the switches of the stack in an equipment rack, you should verify that the rack is safely secured so that it will not tip over. You should install devices starting at the bottom of the rack, with the heavier devices near the bottom.
- If you are installing the stack on a table or desk, you should verify that the table or desk is level and secure.
- If you are installing the stack on a table or desk, you should place the units side by side. Do not stack them on top of each other because that could pose a safety hazard.
- The site should not expose the switches to moisture or water.
- The site should be a dust-free environment.
- The site should include dedicated power circuits or power conditioners to supply reliable electrical power to the network devices.
- The site should not expose the twisted pair cabling to sources of electrical noise, such as radio transmitters, broadband amplifiers, power lines, electric motors, and fluorescent fixtures.
- Switch ports are suitable for intra-building connections, or where non-exposed cabling is required.
- Do not place objects on top of the switches.
- Do not install the switches in a wiring or utility box because they will overheat and fail from inadequate airflow.



**Warning**

Switches should not be stacked on top of one another on a table or desktop because that could present a personal safety hazard if you need to move or replace switches. *or* E76

---

## Planning a Stack

---

Here are the guidelines to planning a stack:

- ❑ A stack can have up to four AT-GS900MX Series switches.
- ❑ A stack can have different models of AT-GS900MX Series switches.
- ❑ Any AT-GS900MX Series switch model can be the master switch of a stack.
- ❑ Switches connected with stacking cables should be installed in a standard 19-inch equipment rack and not more than one meter apart, the length of the stacking cable. The end switches cannot be more than one meter apart if you want to create the ring topology, shown in Figure 18 on page 52 and Figure 19 on page 53.
- ❑ The wiring topology of the stack may be either linear or ring. Both topologies offer the same in terms of speed, but the ring topology adds wiring redundancy.
- ❑ The AT-GS900MX Series stack may not contain other stacking switches, such as x600 and x610 Series switches.
- ❑ The AT-GS900MX Series switches do not need any additional software for stacking. However, they do need stacking transceivers.
- ❑ All the switches must have the same licenses of optional features. If you install an optional feature on one switch, you must install it on all switches before assembling the stack.



## Unpacking the Switch

All switches, except the AT-GS924MX Switch, come with the components listed in Figure 21. If any item is missing or damaged, contact your Allied Telesis sales representative for assistance.

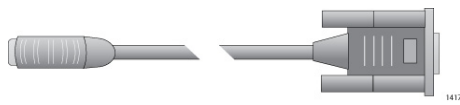

One 2 m (6.6 ft) local management cable with RJ-45 (8P8C) and DB-9 (D-sub 9-pin) connectors.

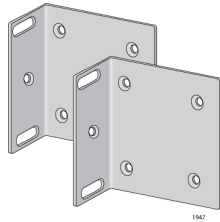

Two wall or equipment rack mounting brackets



One regional AC power cord

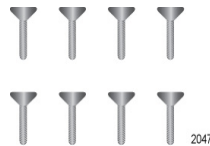

Eight bracket screws



Two anchors for concrete walls:  
Length: 29.6 mm (1 1/8 in.)  
Diameter: 6.0 mm (0.25 in)



Two screws for wood or concrete walls:  
Length: 31 mm (1 1/4 in.)  
Width: 4.3 mm (1/8 in.)



Power cord retaining clip

Figure 21. Components of the Switches

The AT-GS924MX Switch comes with the components shown in Figure 22 on page 66.



One 2 m (6.6 ft) local management cable with RJ-45 (8P8C) and DB-9 (D-sub 9-pin) connectors.

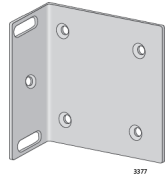

One wall or equipment rack mounting bracket

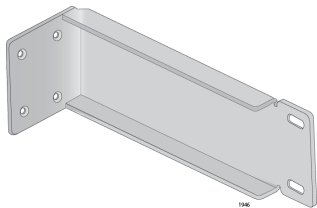

One long wall or equipment rack mounting bracket



One regional AC power cord



Eight bracket screws



Two anchors for concrete walls:  
Length: 29.6 mm (1 1/8 in.)  
Diameter: 6.0 mm (0.25 in)



Two screws for wood or concrete walls:  
Length: 31 mm (1 1/4 in.)  
Width: 4.3 mm (1/8 in.)



Power cord retaining clip

Figure 22. Components of the AT-GS924MX Switch

---

**Note**

You should retain the original packaging material in the event you need to return the unit to Allied Telesis.

---



## Chapter 4

# Installing the Switch on a Table or in an Equipment Rack

---

The procedures in this chapter are:

- “Installing the Switch on a Table” on page 70
- “Installing the Switch in an Equipment Rack” on page 71

## Installing the Switch on a Table

---

This section contains the procedure for installing the switch on a table or desk.

---

**Note**

The rubber feet on the bottom of the chassis should be left on for table installation.

---



---

**Warning**

Switches should not be stacked on top of one another on a table or desktop because that could present a personal safety hazard if you need to move or replace switches. *or* E76

---

To install the chassis on a table, perform the following procedure:

1. Review “Selecting a Site for the Stack” on page 62 to verify the suitability of the site for the switch.
2. Check to be sure that the table is strong enough to support the weight of the switch.
3. Lift the switch onto the table.
4. Go to Chapter 5, “Verifying the Status of VCStack” on page 77.

## Installing the Switch in an Equipment Rack

This procedure requires the following items:

- Eight bracket screws (included with the switch)
- Two equipment rack brackets (included with the switch)
- Flat-head screwdriver (not provided)
- Cross-head screwdriver (not provided)
- Four standard equipment rack screws (not provided)

Installation guidelines may be found in “Selecting a Site for the Stack” on page 62. Here is the procedure for installing the switch in a 19-inch equipment rack.



### Caution

The chassis may be heavy and awkward to lift. Allied Telesis recommends that you get assistance when mounting the chassis in an equipment rack. *⚡* E28

1. Place the unit upside down on a level, secure surface. See Figure 23.

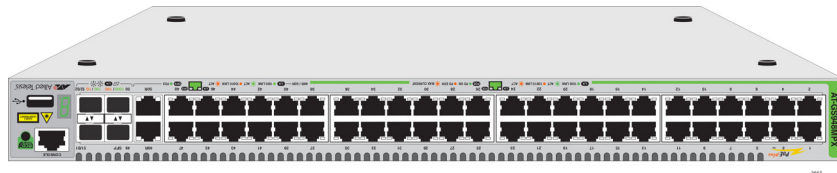

Figure 23. Turning the Switch Upside Down

2. Using a flat-head screwdriver, pry the rubber feet from the bottom of the switch. See Figure 24.

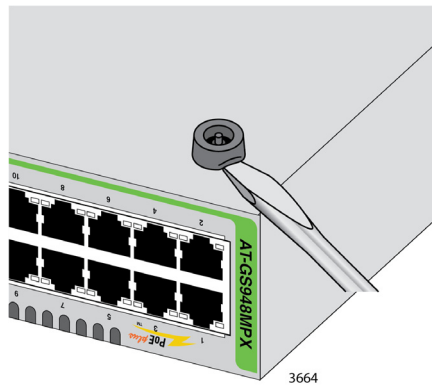

Figure 24. Removing the Rubber Feet

3. Turn the switch over.
4. Attach the two rack mount brackets to the sides of the switch with the eight bracket screws that come with the unit.

The AT-GS924MX Switch comes with one short bracket and one long bracket. Allied Telesis recommends installing the short bracket on the right side and the long bracket on the left side, as you face the front of the unit, so that the stacking ports on the unit align with the same ports on other AT-GS900MX Series switches in the equipment rack. The possible positions of the brackets are shown in Figure 25.



Figure 25. Installing Brackets on the AT-GS924MX Switch

The bracket positions for the AT-GS924MPX, AT-GS948MX, and AT-GS948MPX Switches are shown in Figure 26 on page 73 and Figure 27 on page 74.



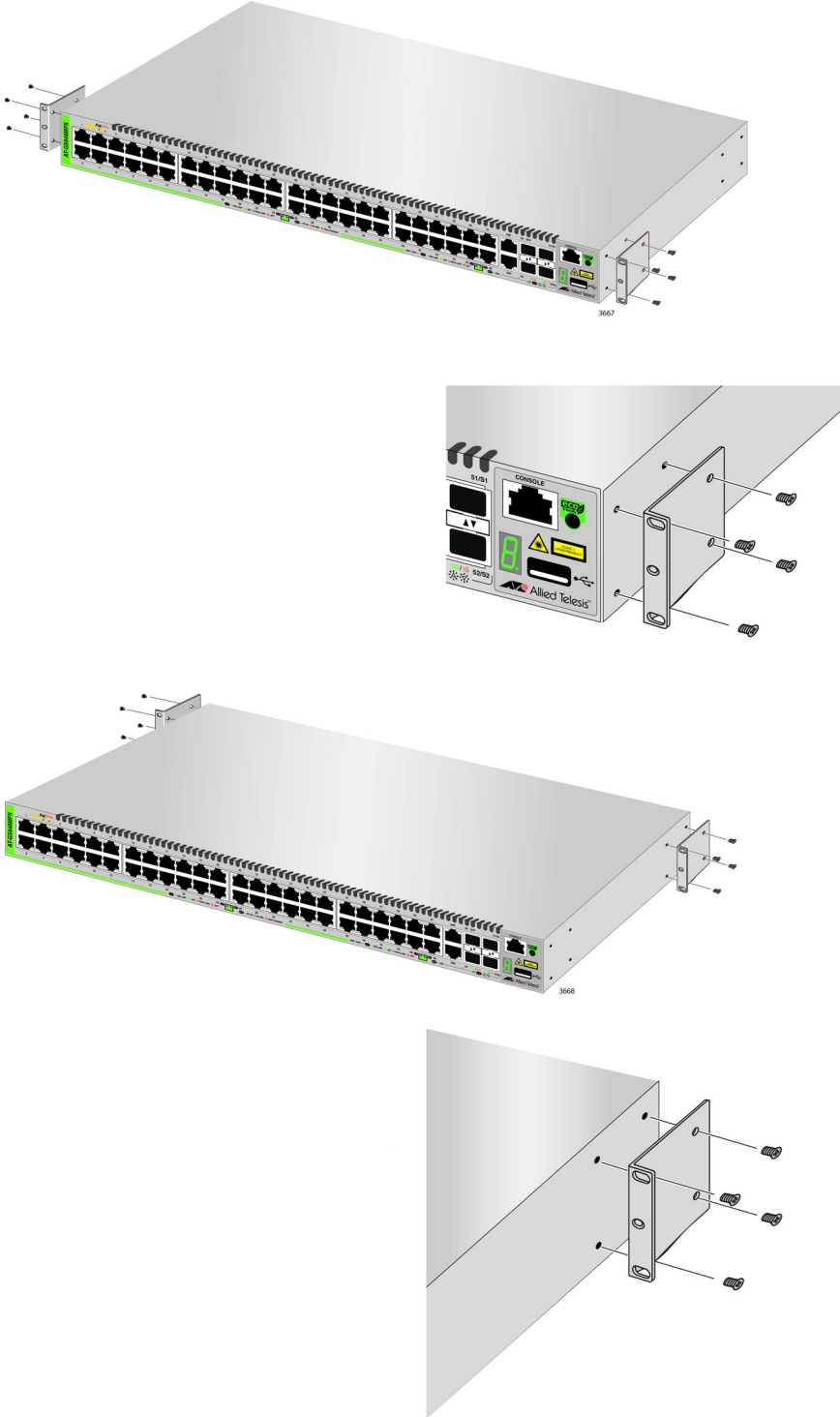

Figure 26. Attaching Brackets to the AT-GS924MPX, AT-GS948MX, or AT-GS948MPX Switch

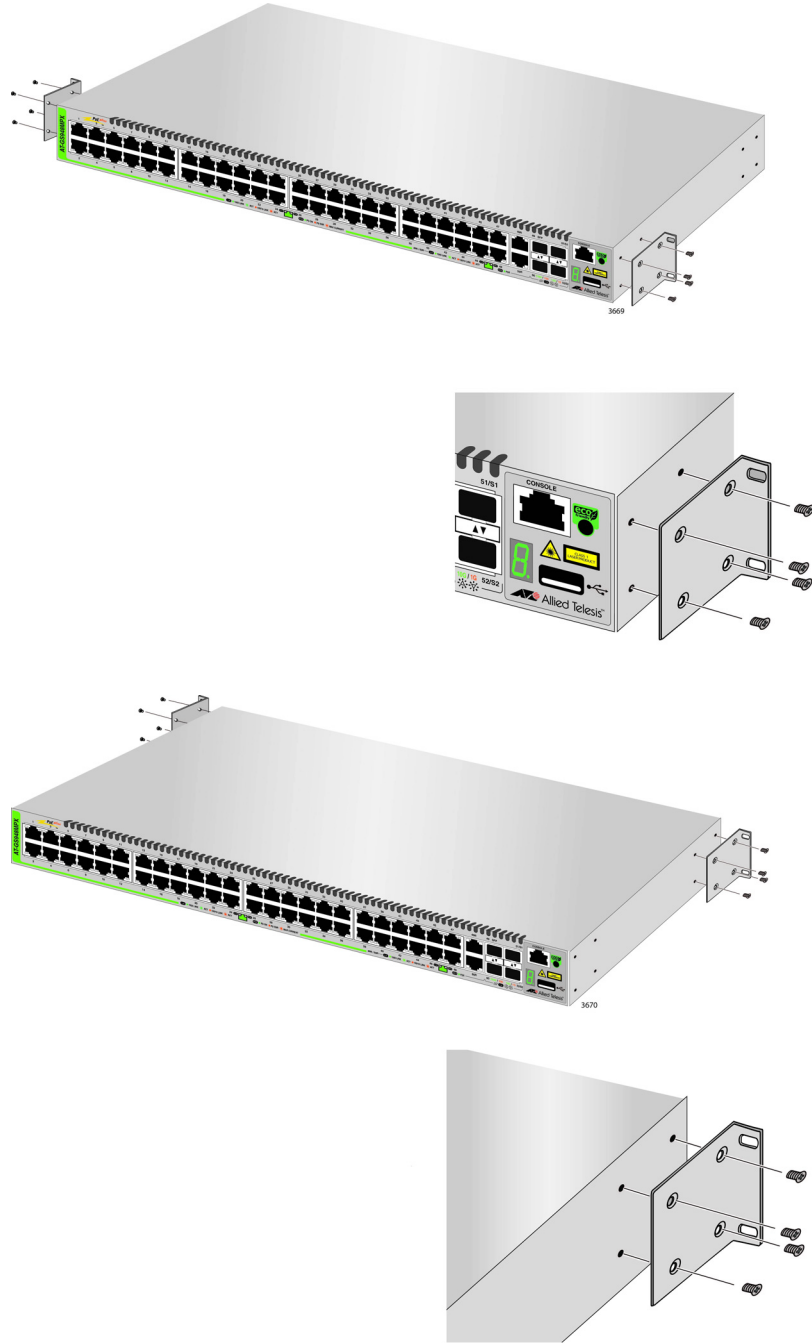

Figure 27. Attaching Brackets to the AT-GS924MPX, AT-GS948MX, or AT-GS948MPX Switch (Continued)

5. While another person holds the switch in the equipment rack, secure it with standard equipment rack screws (not provided), as shown in Figure 28.

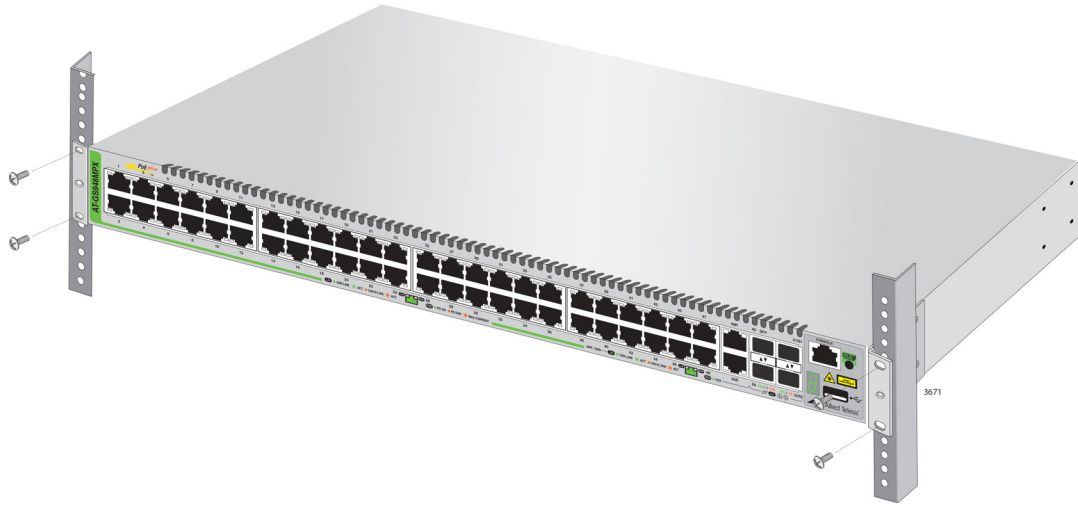

Figure 28. Mounting the Switch in an Equipment Rack

6. Go to Chapter 5, “Verifying the Status of VCStack” on page 77.



## Chapter 5

# Verifying the Status of VCStack

---

The procedures in this chapter are:

- “Verifying the Status of VCStack” on page 78
- “Activating the VCStack Feature” on page 79

## Verifying the Status of VCStack

---

Before you install the stacking transceivers to build the stack, you should first test the switches to determine whether the VCStack feature is enabled or disabled and enable it on any units where it is disabled. On new switches, the feature should be activated because that is the default setting. But on switches that were previously used as stand-alone units, the feature is probably disabled and needs to be enabled.

Testing the status of VCStack is simple. You power on a switch and watch the ID LED. If it displays a number from 1 to 4, VCStack is already enabled. If the LED displays the number 0, the feature is disabled and needs to be enabled.

To test the status of VCStack, perform the following procedure:

1. Power on one of the switches:

Connect a power cord to the power connector on the back panel and to an AC power source.

2. Wait one minute for the switch to initialize its management software.
3. View the ID LED and do one of the following:
  - ❑ If the ID LED is displaying a number from 1 to 4 (the default is 1), VCStack is already enabled on the switch. Power off the unit by disconnecting the power cord and test the remaining switches in the same manner. After testing all the switches, be sure the switches are powered off and go to Chapter 6, “Cabling the Stacking Ports” on page 83.
  - ❑ If the ID LED is displaying “0,” the VCStack feature is disabled on the switch. You must enable it by performing the procedure in “Activating the VCStack Feature” on page 79.

## Activating the VCStack Feature

---

Perform the following two procedures to activate the VCStack feature on switches that displayed the number “0” on their ID LEDs in the previous procedure. The tasks assume that you are continuing directly from the previous procedure and that the switch is powered on. The first procedure explains how to establish a local management session on the switch, and the second procedure explains how to active the VCStack feature.

### Starting a Local Management Session

To start a local management session on the switch, perform the following procedure:

1. Connect the RJ-45 connector on the management cable to the Console port on the front panel of the switch, as shown in Figure 29.

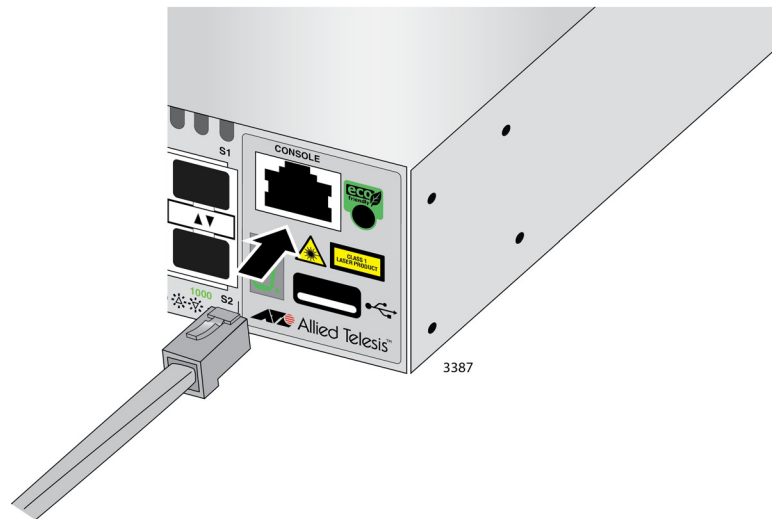

Figure 29. Connecting the Management Cable to the Console Port

2. Connect the other end of the cable to an RS-232 port on a terminal or PC with a terminal emulator program.
3. Configure the terminal or terminal emulator program as follows:
  - Baud rate: 9600 bps (The baud rate of the Console Port is adjustable from 1200 to 115200 bps. The default is 9600 bps.)
  - Data bits: 8
  - Parity: None
  - Stop bits: 1
  - Flow control: None

---

**Note**

The port settings are for a DEC VT100 or ANSI terminal, or an equivalent terminal emulator program.

---

4. Press Enter.

You are prompted for a user name and password.

5. If this is the initial management session of the switch, enter “manager” as the user name and “friend” as the password. The user name and password are case sensitive.

The local management session starts when the User Exec mode prompt, shown in Figure 30, is displayed.

```
awplus>
```

Figure 30. User Exec Mode Prompt

The User Exec mode is the first level in the command mode interface. For complete information on the modes and commands, refer to the *Software Reference for AT-GS900MX Series Switches, AlliedWare Plus Operating System* from [www.alliedtelesis.com/support](http://www.alliedtelesis.com/support).

## Activating VCStack

To activate the VCStack feature from the local management session, perform the following procedure:

1. Enter the ENABLE command to move from the User Exec mode to the Privileged Exec mode, as shown in Figure 31.

```
awplus> enable  
awplus#
```

Figure 31. Moving to the Privileged Exec Mode with the ENABLE Command

2. Enter the CONFIGURE TERMINAL command to move to the Global Configuration mode, as shown in Figure 32.

```
awplus# configure terminal  
Enter configuration commands, one per line. End with CNTL/Z.  
awplus(config)#
```

Figure 32. Moving to the Global Configuration Mode with the CONFIGURE TERMINAL Command



3. Enter the STACK ENABLE command to activate VCStack on the switch, as shown in Figure 33:

```
awplus(config)# stack enable
% The device needs to be restarted for this change to take effect.
awplus(config)#
```

Figure 33. Activating VCStack with the STACK ENABLE Command

4. Enter the EXIT command to return to the Privileged Exec mode, as shown in Figure 34.

```
awplus(config)# exit
awplus#
```

Figure 34. Returning to the Privileged Exec Mode with the EXIT Command

5. Enter the WRITE command to save your change, as shown in Figure 35.

```
awplus# write
Building configuration ...
[OK]
awplus#
```

Figure 35. Saving the Change with the WRITE Command

---

**Note**

If this is the initial management session of the switch, the WRITE command automatically creates, in flash memory, a new configuration file called DEFAULT.CFG in which it stores your configuration change. You may change the name of the file or designate a different file after you create the stack.

---

6. Restart the switch with the REBOOT command, as shown in Figure 36.

```
awplus# reboot
reboot system? (y/n):
awplus#
```

Figure 36. Rebooting the Switch with the REBOOT Command

7. Type “Y” for yes.
8. Wait one minute for the switch to initialize its management software.

9. Check the ID LED and do one of the following:
  - ❑ If the ID LED is displaying the number 1, 2, 3, or 4, VCStack is now enabled on the switch. Power off the switch by disconnecting the power cord and repeat the procedures in this chapter on the next switch. If there are no further switches to test, go to Chapter 6, “Cabling the Stacking Ports” on page 83.
  - ❑ If the ID LED is still displaying “0,” repeat this procedure. If the procedure was not successful, it might be because you did not issue the WRITE command in Step 5 to save your change.

## Chapter 6

# Cabling the Stacking Ports

This chapter contains the procedure for cabling the S1 and S2 stacking slots on the switches with AT-SP10TW stacking transceivers.

To cable the switches of the stack, perform the following procedure:



### Warning

A transceiver can be damaged by static electricity. Be sure to observe all standard electrostatic discharge (ESD) precautions, such as wearing an antistatic wrist strap, to avoid damaging the device. *~*  
E77

1. Remove the dust plug from the S1 slot on the top switch of the stack, as shown in Figure 37.

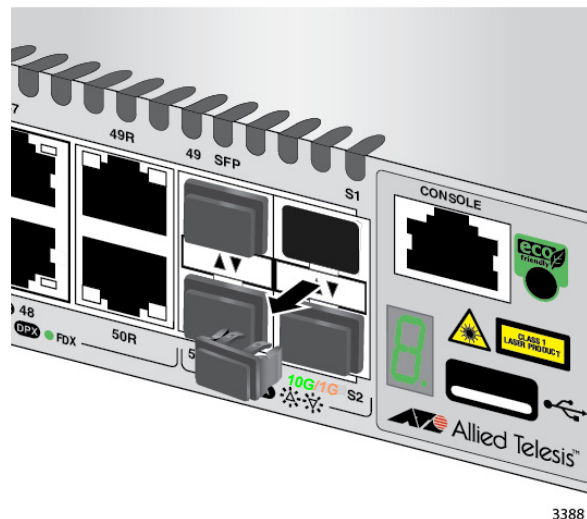

Figure 37. Removing the Dust Plug from the S1 Slot

2. Remove the transceiver from its shipping container and store the packaging material in a safe location.
3. Remove the dust cap from one end of the transceiver, as shown in Figure 38 on page 84.

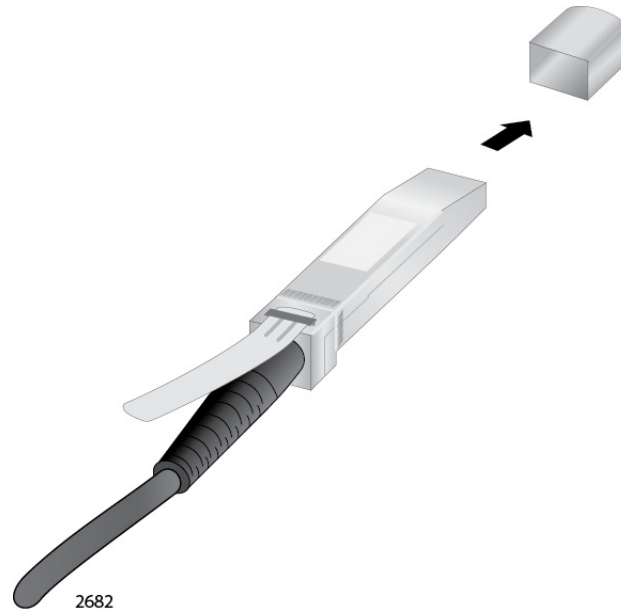

Figure 38. Removing the Dust Cover from the Transceiver

4. Position the transceiver with the release tab on top and slide the transceiver into the slot, as shown in Figure 39.

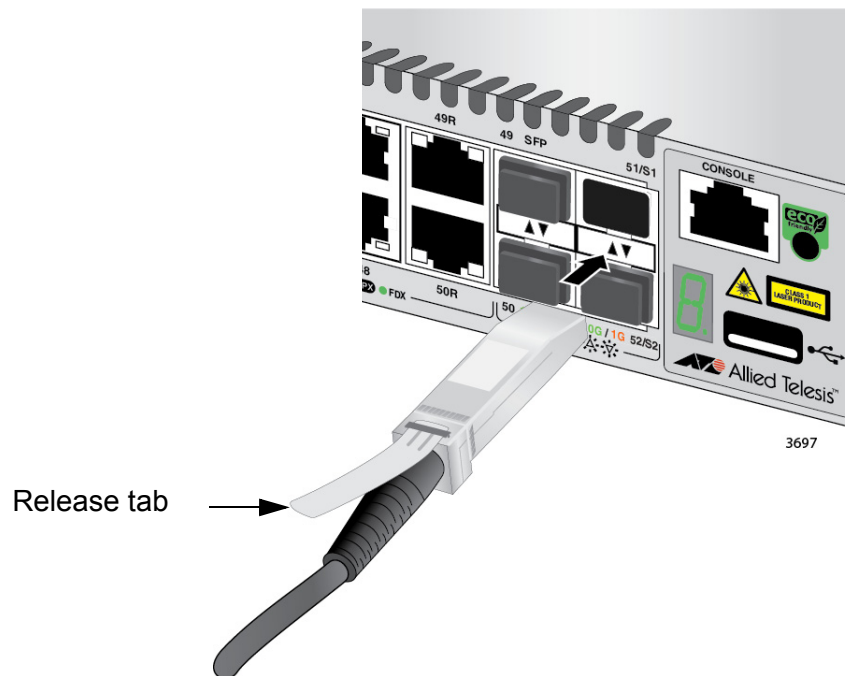

Figure 39. Installing the Transceiver in Slot S1

- Remove the dust cover from the S2 slot in the next switch in the stack as shown in Figure 40.

---

**Note**

The cable must cross over to different slots on the switches. The stack will not work if you connect two S1 or S2 slots together.

---

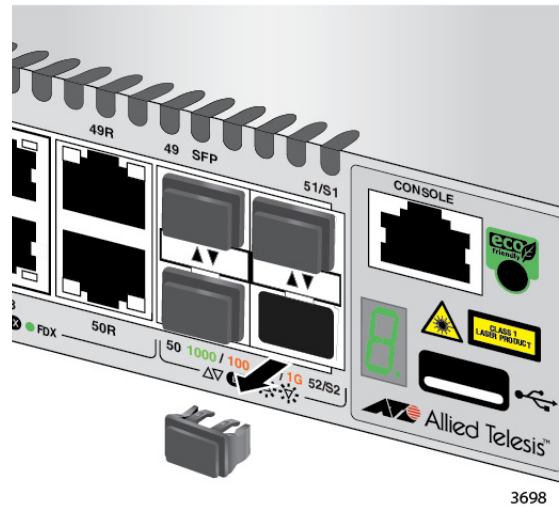

Figure 40. Removing the Dust Plug from the S2 Slot

- Remove the dust cover from the connector on the other end of the transceiver.
- Position the transceiver with the release tab on the bottom and slide it into the slot until it clicks into place, as shown in Figure 41 on page 86.

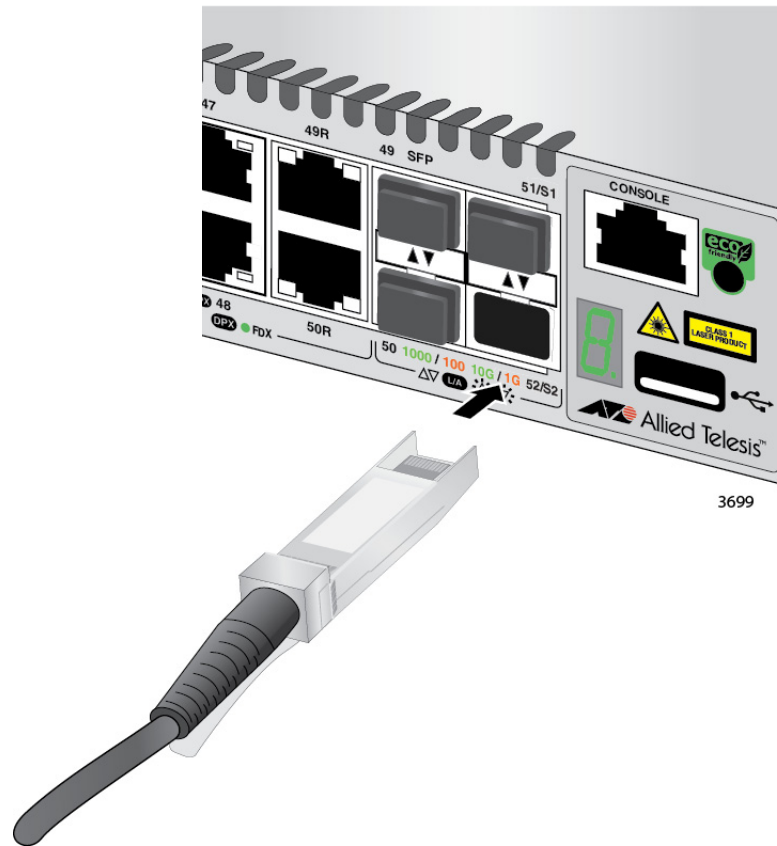

Figure 41. Installing the Transceiver in Slot S2

8. Repeat this procedure to connect additional switches to the stack with transceivers.
9. To create the redundant path with the ring topology shown in Figure 18 on page 52 and Figure 19 on page 53, connect a stacking cable to the empty stacking slots on the top and bottom switches.
10. After connecting the stacking cables to all the switches, go to Chapter 7, “Powering On the Stack” on page 87.

## Chapter 7

# Powering On the Stack

---

This chapter contains the following procedures:

- ❑ “Installing the Power Cord Retaining Clip” on page 88
- ❑ “Powering On the Switches Individually” on page 89
- ❑ “Powering On the Switches Simultaneously” on page 92
- ❑ “Verifying the Stack” on page 94
- ❑ “Monitoring the Initialization Processes” on page 97

Perform “Powering On the Switches Individually” on page 89 if you want to control the assignment of the ID numbers to the switches of the stack. The numbers are assigned in the order in which you power on the units. Otherwise, perform “Powering On the Switches Simultaneously” on page 92 to have the switches assign the numbers automatically. After the ID numbers are assigned, you may change them with the STACK RENUMBER command, described in the *Software Reference for AT-GS900MX Series Switches, AlliedWare Plus Operating System*.



### Caution

You should not change the ID numbers of the switches after you begin to configure the parameter settings. Otherwise, the stack might assign configuration settings to the wrong units. *⌘* E79

---

## Installing the Power Cord Retaining Clip

---

The power cord retaining clip that comes with the switch protects the power cord from being accidentally unplugged from the unit.

To install the power cord retaining clip, position the “u” part facing down, press in the sides, and insert the ends of the clip into the holes in the retaining bracket on the AC connector on the switch. See Figure 42.

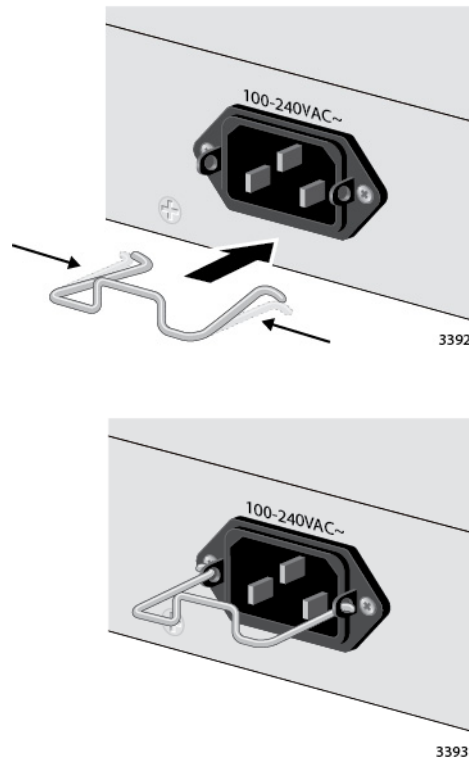

Figure 42. Installing the Retaining Clip

Go to either “Powering On the Switches Individually” on page 89 or “Powering On the Switches Simultaneously” on page 92.



## Powering On the Switches Individually

---

This procedure explains how you can control the assignment of the ID numbers of the switches by powering on the units one at a time during the initial power-on sequence. The first switch is assigned ID number 1, the next unit is assigned ID number 2, and so on. This procedure is useful when the switches are installed in the same equipment rack, and you want to number them in sequence, such as from top to bottom, to make them easy to identify. After the ID numbers are assigned, the switches retain their assignments even when you power off or reset the stack.

During the initial power-on sequence, the first switch to be powered on becomes the master switch of the stack. However, if you do not change the priority values of the units, the next time you reset or power cycle the stack, the units use their MAC addresses to select the master switch. This might result in a different switch being assigned that role. However, this does not affect their ID number assignments, the configuration of the switches, or the manner in which you manage the stack.

This procedure assumes the following:

- This is the initial power-on sequence of the stack.
- You verified that VCStack is enabled on the switches, as explained in Chapter 5, “Verifying the Status of VCStack” on page 77.
- You connected the switches with stacking transceivers, as explained in Chapter 6, “Cabling the Stacking Ports” on page 83.
- The ID numbers are set to the default 1.
- All the switches are powered off.

If you want to monitor the power-on sequence, you may connect a terminal or PC with a terminal emulator program to the Console port on the switch you intend to power on first. The messages are found in “Monitoring the Initialization Processes” on page 97.

Before powering on the switch, refer to “Power Specifications” on page 114 for the power specifications. To install the power cord retaining clip and power on the switch, perform the following procedure:

To power on the switches, perform the following procedure:

1. Power on the switch you want to be assigned ID number 1 by connecting its power cord to the AC connector on the back panel and to an appropriate power source. See Figure 43 on page 90. Refer to “Power Specifications” on page 114 for the power specifications of the switches.

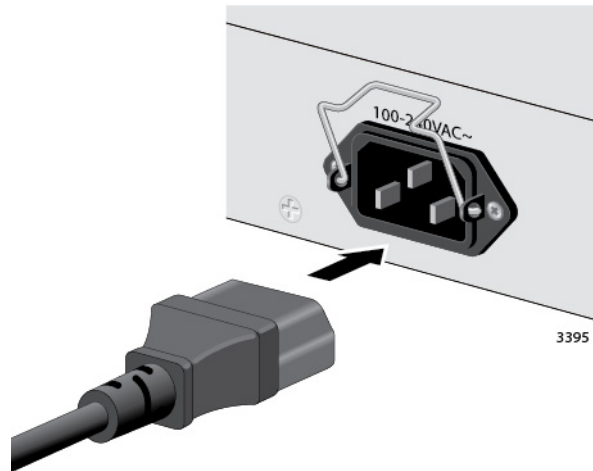

Figure 43. Plugging in the AC Power Cord



---

**Warning**

Power cord is used as a disconnection device. To de-energize equipment, disconnect the power cord. ⚡ E3

---

---

**Note**

Pluggable Equipment. The socket outlet shall be installed near the equipment and shall be easily accessible. ⚡ E5

---

2. Wait one minute for the switch to initialize its management software.

The switch should be displaying the number 1 on its ID LED.

3. Power on the switch to be assigned ID number 2.

4. Wait two minutes for the new switch to join the stack as a member.

As the new switch boots up, the first switch, which has the ID number 1 and at this point is the master switch of the stack, notifies the new switch that its current ID number is already being used and that it should change its number to the next available number, which is 2. The new switch responds by automatically changing its ID number to 2 and reboots. So the new switch is actually booting up twice, once with the ID number 1 and again with its new ID number 2, which is why it takes two minutes before the device becomes a full member of the stack.

5. If there is a third switch, power it on and wait another two minutes for it to join the stack as a member with the ID number 3.

6. If there is a fourth switch, power it on and wait two minutes for it to join the stack as a member with the ID number 4.

At this point, the stack is operational.

The ID numbers are automatically stored in special files in the flash memories of the switches and are retained by the devices even if you reset or power cycle the stack.

7. Secure the power cords to the switches by lowering the retaining clips. See Figure 44.

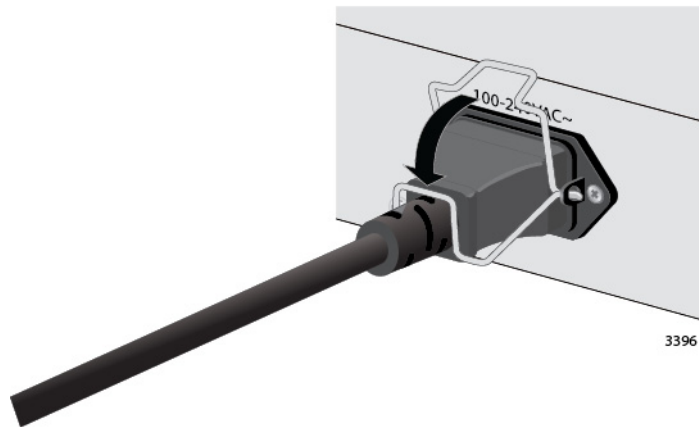

Figure 44. Lowering the Retaining Clip

8. To continue with the installation, go to “Verifying the Stack” on page 94.

## Powering On the Switches Simultaneously

---

If you want the switches of the stack to use their MAC addresses to automatically assign the ID numbers during the initial power-on sequence, all you have to do is power them on simultaneously, rather than one at a time as in the previous procedure. Here are the steps the switches perform:

- ❑ They initialize their management software and compare their MAC addresses.
- ❑ The switch with the lowest address is designated as the master switch of the stack.
- ❑ The master switch assigns itself the ID number 1.
- ❑ The master switch assigns ID numbers to the other switches.
- ❑ The other switches reset and initialize their management software again, with their new ID numbers.

This procedure assumes the following:

- ❑ This is the initial power-on sequence of the stack.
- ❑ You verified that VCStack is enabled on the switches, as explained in Chapter 5, “Verifying the Status of VCStack” on page 77.
- ❑ You connected the switches with stacking transceivers, as explained in Chapter 6, “Cabling the Stacking Ports” on page 83.
- ❑ All the switches are powered off.

If you want to monitor the power-on sequence, you may connect a terminal or PC with a terminal emulator program to the Console port on any of the switches. The messages are found in “Monitoring the Initialization Processes” on page 97.

To have the switches automatically assign the ID numbers, perform the following procedure:

1. Power on all the switches in the stack at the same time.

Connect the power cords to the connectors on the back panels and to the appropriate power sources, as shown in Figure 43 on page 90. Refer to “Power Specifications” on page 114 for the power specifications of the switches.



### Warning

Power cord is used as a disconnection device. To de-energize equipment, disconnect the power cord. *aw* E3

---

---

**Note**

Pluggable Equipment. The socket outlet shall be installed near the equipment and shall be easily accessible. ⚡ E5

---

2. Wait two or three minutes for the switches to select a master switch and to assign the ID numbers.

At this point, the stack is operational. The ID numbers are automatically stored in special files in the flash memories of the switches and are retained by the devices even if you reset or power cycle the stack.

3. To continue with the installation, go to “Verifying the Stack” on page 94.

## Verifying the Stack

To verify stack operations, perform the following procedure:

1. Establish a local management session on any switch in the stack. For instructions, refer to “Starting a Local Management Session” on page 79.
2. From the User Exec mode, enter the SHOW STACK command:

```
awplus> show stack
```

The command lists the switches in the stack. An example is shown in Figure 45.

```
awplus> show stack
Virtual Chassis Stacking summary information
ID      Pending ID      MAC address      Priority  Status  Role
1       -                 eccd:6dc1:ed30  128     Ready  Active Master
2       -                 eccd:6dc1:65ab  128     Ready  Backup Member
3       -                 eccd:6dc1:d4a7  128     Ready  Backup Member
4       -                 eccd:6dc1:c431  128     Ready  Backup Member
Operational Status      Normal operations
Stack MAC address      eccd:6dc1:ed30
awplus(config)#
```

Figure 45. SHOW STACK Command

Here are some things to consider:

- ❑ The command should list all the switches in the stack. If the list is incomplete, refer to Chapter 9, “Troubleshooting” on page 109.
  - ❑ The Operational Status field displays “Normal operations” when the switches are connected in the ring topology and “Not all stack ports are up” when the switches are connected in the linear topology.
  - ❑ The priority values will be 128, the default value, if you did not change them.
  - ❑ Given that there is no relationship between the ID numbers and the selection of the master switch, the active master in the SHOW STACK command might not have the ID number 1.
3. Do one of the following:
    - ❑ If you want to change the priority values of the switches, go to “Setting the Priority Numbers” on page 95. The procedure is optional.

- ❑ Otherwise, go to Chapter 8, “Cabling the Networking Ports” on page 101, to continue with the installation.

## Setting the Priority Numbers

This procedure is optional. It explains how to configure the priority settings of the switches. Changing the priority settings protects the stack configuration should you ever power on the stack with a new member switch that has a lower MAC address than an existing master or member switch.

This procedure assumes you are continuing directly on from the previous procedure.

To set the priority values of the switches, perform the following procedure:

1. Use the CONFIGURE TERMINAL command to move from the Privileged Exec mode to the Global Configuration mode, as shown in Figure 46.

```
awplus# configure terminal
Enter configuration commands, one per line. End with CNTL/Z.
awplus(config)#
```

Figure 46. Moving to the Global Configuration Mode with the CONFIGURE TERMINAL Command

2. Use the STACK PRIORITY command to set the priority numbers. The command has this format:

```
stack ID_number priority priority
```

The ID\_NUMBER parameter is the ID number of the switch whose priority value you are setting. The range is 1 to 4. The PRIORITY parameter is the new priority value for the switch. The range is 0 to 255. The default is 128.

Here are some examples. To assign the priority value 1 to the switch with the ID number 1, you enter this command:

```
awplus(config)# stack 1 priority 1
```

To set the priority value to 2 on the switch with the ID number 2, you enter:

```
awplus(config)# stack 2 priority 2
```

3. After setting the priority values, enter the EXIT command to return to the Privileged Exec mode, as shown in Figure 47 on page 96.

```
awplus(config)# exit  
awplus#
```

Figure 47. Returning to the Privileged Exec Mode

4. Enter the WRITE command to save your change in the configuration file. The switch displays the confirmation prompt in Figure 48.

```
awplus# write  
Building configuration ...  
[OK]  
awplus#
```

Figure 48. Saving the Priority Values with the WRITE Command

5. To end the management session, enter the EXIT command.
6. Go to Chapter 8, “Cabling the Networking Ports” on page 101, to continue with the installation.



## Monitoring the Initialization Processes

You may monitor the initialization sequence of the stack by connecting a terminal or computer that has a terminal emulator program to the Console port on any switch in the stack. You will see the messages in Figure 49 here to Figure 51 on page 99.

```

Bootloader 3.0.10 loaded
Press <Ctrl+B> for the Boot Menu

Reading filesystem...
Loading flash:gs900-5.4.4E-0.1.rel...
Verifying release... OK
Booting...
Starting base/first...           [ OK ]
Mounting virtual filesystems...  [ OK ]

      _____
     / \      / \      / \
    /   \    /   \    /   \
   /     \  /     \  /     \
  /       \ /       \ /       \
 /         \ /         \ /         \
/           \ /           \ /           \
/_____ \ /_____ \ /_____ \

Allied Telesis Inc.
AlliedWare Plus (TM) v5.4.4E
Current release filename: gs900-5.4.4E-0.1.rel
Original release filename: x310-5.4.4E-0.1.rel
Built: wed Jan 14 13:42:17 NZDT 2015
Mounting static filesystems...   [ OK ]
Checking flash filesystem...     [ OK ]
Mounting flash filesystem...     [ OK ]
Checking for last gasp debug output... [ OK ]
Checking NVS filesystem...       [ OK ]
Mounting NVS filesystem...       [ OK ]
Starting base/dbus...            [ OK ]
Starting base/syslog...          [ OK ]
Starting base/loopback...        [ OK ]

```

Figure 49. Switch Initialization Messages

```

Starting base/poe_done... [ OK ]
Starting base/sysctl... [ OK ]
Starting base/portmapper... [ OK ]
Received event syslog.done
Starting base/reboot-stability... [ OK ]
Checking system reboot stability... [ OK ]
Starting base/cron... [ OK ]
Starting base/appmond... [ OK ]
Starting hardware/openhpi... [ OK ]
Starting hardware/timeout... [ OK ]
Starting base/inet... [ OK ]
Starting base/modules... [ OK ]
Received event modules.done
Received event board.inserted
Starting network/poefw... [ OK ]
Received event poefw.done
Received event hardware.done
Starting network/startup... [ OK ]
Starting base/external-media... [ OK ]
Starting network/stackd... [ OK ]
Starting network/election.timeout... [ OK ]
Received event network.enabled

Initializing HA processes:
hostd, cntrd, nsm, sflowd, atmfd, auth, epsr
hsl, imiproxyd, irdpd, lacp, lldpd, loopprot, mstp
rmon, udldd, imi

Received event network.initialized
10:43:34 awplus-1 HPI: HOTSWAP Pluggable 1.0.27 hotswapped in: 2127931-2
10:43:34 awplus-1 HPI: HOTSWAP Pluggable 1.0.28 hotswapped in: 2127931-2
10:43:42 awplus-1 VCS[1151]: Member 2 (eccd.6ddf.4423) has joined the stack
10:43:43 awplus-1 VCS[1151]: Member 1 (eccd.6ddf.441c) has become the Active
Master
Received event vcs.elected-master
10:43:43 awplus VCS[1151]: Stack virtual MAC is 0000.cd37.097f

```

Figure 50. Switch Initialization Messages (Continued)

```
Assigning Active workload to HA processes:
hsl, nsm, lacpd, looprotd, rmond, sflowd, irdpd
lldpd, mstpd, authd, epsrd, imi, imiproxyd

00:01:04 awplus VCS[904]: Duplicate stack member 1 detected for
eccd:6dc1.1a60 and eccd:6dc1.19ff
00:01:04 awplus VCS[904]: Automatically renumbering stack member 1
(eccd:6dc1.1a60), selecting unused member-ID...

Received event network.activated

Loading default configuration
warning: flash:/default.cfg does not exist, loading factory defaults.
..
done!
Received event network.configured
00:01:22 awplus VCS[904]: Renumbering stack member 1 (eccd:6dc1.1a60) to ID2
00:01:22 awplus VCS[904]: Automatically rebooting stack member 2
(eccd:6dc1.1a60) due to duplicate member-ID
00:01:33 awplus VCS[904]: Member 2 (eccd:6dc1.1a60) has joined the stack
00:01:33 awplus VCS[904]: Please configure 'stack virtual-mac' to minimize
network disruption from failovers
00:01:34 awplus VCS[827]: All users returned to config mode while switch
synchronization is in progress.
00:01:42 awplus VCS[819]: Insertion event on unit 2.0 has been completed.
00:01:54 awplus VCS[827]: Configuration update completed for port2.0.1-
2.0.50

awplus login:
```

Figure 51. Switch Initialization Messages (Continued)



## Chapter 8

# Cabling the Networking Ports

---

This chapter contains the following procedures:

- “Cabling the Twisted Pair Ports” on page 102
- “Installing SFP Transceivers” on page 104

## Cabling the Twisted Pair Ports

---

Here are the guidelines to cabling the 10/100/1000Base-T twisted pair ports:

- ❑ The cable specifications for the twisted pair ports are listed in Table 1 on page 24.
- ❑ The connectors on the cables should fit snugly into the ports, and the tabs should lock the connectors into place.
- ❑ The default setting for the wiring configurations of the ports is auto-MDI/MDI-X. The default setting is appropriate for switch ports that are connected to 10/100Base-TX network devices that also support auto-MDI/MDI-X.
- ❑ The default auto-MDI/MDI-X setting is not appropriate for switch ports that are connected to 10/100Base-TX network devices that do not support auto-MDI/MDI-X and have a fixed wiring configuration. For switch ports connected to those types of network devices, you should disable auto-MDI/MDI-X and set the wiring configurations manually.
- ❑ The appropriate MDI/MDI-X setting for a switch port connected to a 10/100Base-TX network device with a fixed wiring configuration depends on the setting of the network device and whether the switch and network device are connected with straight-through or crossover cable. If you are using straight-through twisted pair cable, the wiring configurations of a port on the switch and a port on a network device must be opposite each other, such that one port uses MDI and the other MDI-X. For example, if a network device has a fixed wiring configuration of MDI, you must disable auto-MDI/MDI-X on the corresponding switch port and manually set it to MDI-X. If you are using crossover twisted pair cable, the wiring configurations of a port on the switch and a port on a network device must be the same.
- ❑ The default speed setting for the ports is Auto-Negotiation. This setting is appropriate for ports connected to network devices that also support Auto-Negotiation.
- ❑ The default speed setting of Auto-Negotiation is not appropriate for ports connected to 10/100Base-TX network devices that do not support Auto-Negotiation and have fixed speeds. For those switch ports, you should disable Auto-Negotiation and set the port's speed manually to match the speeds of the network devices.
- ❑ The 10/100/1000Base-T ports must be set to Auto-Negotiation, the default setting, to operate at 1000Mbps.
- ❑ The default duplex mode setting for the ports is Auto-Negotiation. This setting is appropriate for ports connected to network devices that also support Auto-Negotiation for duplex modes.

- ❑ The default duplex mode setting of Auto-Negotiation is not appropriate for ports connected to network devices that do not support Auto-Negotiation and have a fixed duplex mode. You should disable Auto-Negotiation on those ports and set their duplex modes manually to avoid the possibility of duplex mode mismatches. A switch port using Auto-Negotiation defaults to half-duplex if it detects that the end node is not using Auto-Negotiation. This can result in a mismatch if the end node is operating at a fixed duplex mode of full-duplex.
- ❑ Do not attach cables to ports of static or LACP port trunks until after you have configured the trunks on the switch. Otherwise, the ports will form network loops that can adversely affect network performance.

## Installing SFP Transceivers

---

This section contains the guidelines and procedure for installing SFP transceivers. The installation procedures are listed here:

Here are general installation guidelines for SFP transceivers:

- ❑ SFP transceivers are hot-swappable. You may install them while the chassis is powered on.
- ❑ The SFP slots are paired with two 10/100/1000Base-T twisted pair ports to form combo pair ports. You may use either the SFP slot or twisted pair port of a combo pair, but not both at the same time. For more information, refer to “Combo Twisted Pair Ports and SFP Slots” on page 32.
- ❑ Your Allied Telesis sales representative can provide you with a list of supported transceivers for the units.
- ❑ The operational specifications and fiber optic cable requirements of the transceivers are provided in the documents included with the devices.
- ❑ You should install a transceiver before connecting the fiber optic cable.
- ❑ Fiber optic transceivers are dust-sensitive. Always keep the plug in the optical bores when a fiber optic cable is not installed, or when you store the transceiver. When you do remove the plug, keep it for future use.
- ❑ Unnecessary removal and insertion of a transceiver can lead to premature failure.
- ❑ Do not install SFP transceivers in the S1 and S2 slots. These slots are for stacking transceivers and are not used when the switch is used as a stand-alone unit.



### Warning

A transceiver can be damaged by static electricity. Be sure to observe all standard electrostatic discharge (ESD) precautions, such as wearing an antistatic wrist strap, to avoid damaging the device. ⚡ E77

---

To install SFP transceivers in slots 25 and 26 of the 26-port switches or slots 49 and 50 of the 50-port switches, perform the following procedure:

1. Remove the dust plug from a transceiver slot on the switch. See Figure 52 on page 105.



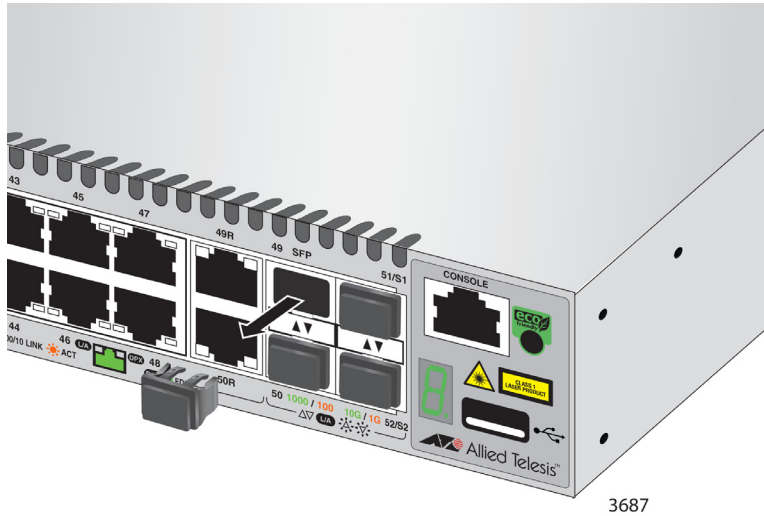

Figure 52. Removing the Dust Plug from an SFP Slot

2. Remove the transceiver from its shipping container and store the packaging material in a safe location.
3. If you are installing the transceiver in a top slot, position the transceiver with the handle on top. If you are installing the transceiver in a bottom slot, position the transceiver with the handle beneath the module.
4. Slide the transceiver into the slot until it clicks into place, as shown in Figure 53.

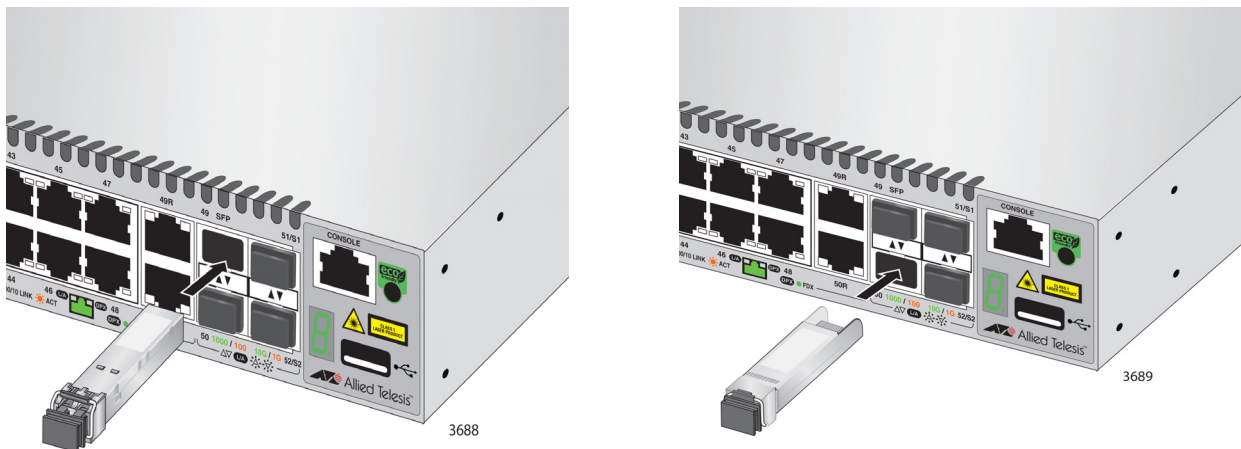

Figure 53. Installing an SFP Transceiver

**Note**

If you are ready to attach the fiber optic cable to the transceiver, continue with the next step. Otherwise, repeat Step 1 to Step 4 to install another SFP transceiver in the switch.

5. Remove the dust cover from the transceiver, as shown in Figure 54.

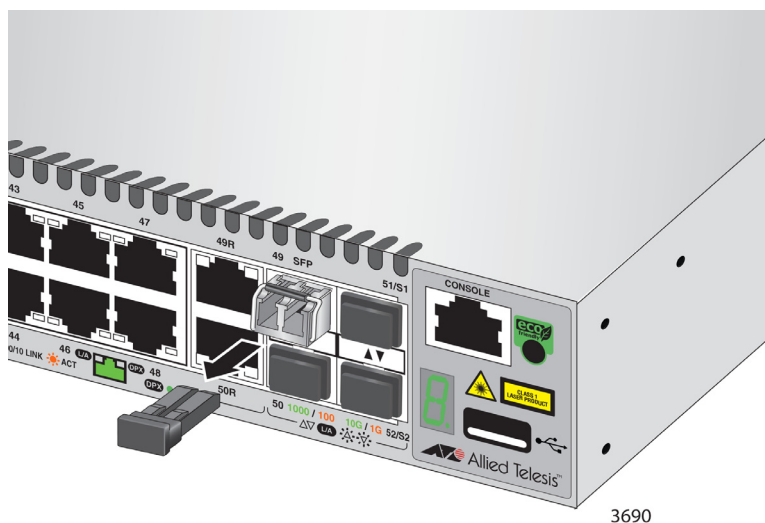

Figure 54. Removing the Dust Cover from an SFP Transceiver

6. Verify the position of the handle on the SFP transceiver. If the transceiver is in a top slot, the handle should be in the upright position, as shown in Figure 55. If the transceiver is in a bottom slot, the handle should be in the down position.

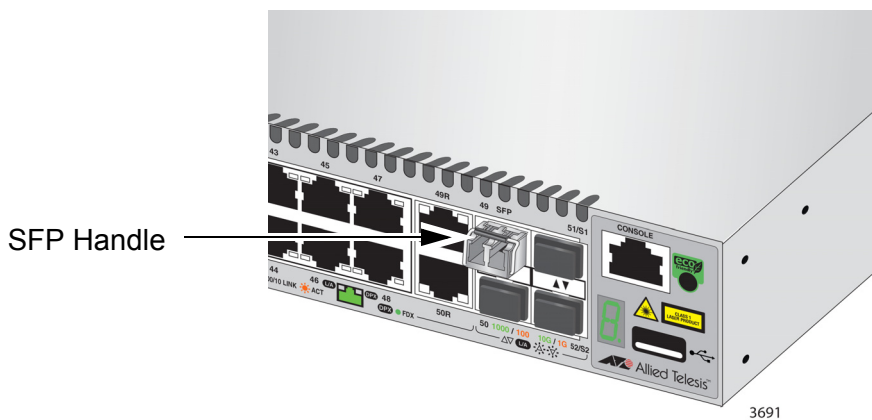

Figure 55. Positioning the SFP Handle in the Upright Position

7. Connect the fiber optic cable to the transceiver, as shown in Figure 56 on page 107. The connector on the cable should fit snugly into the port, and the tab should lock the connector into place.

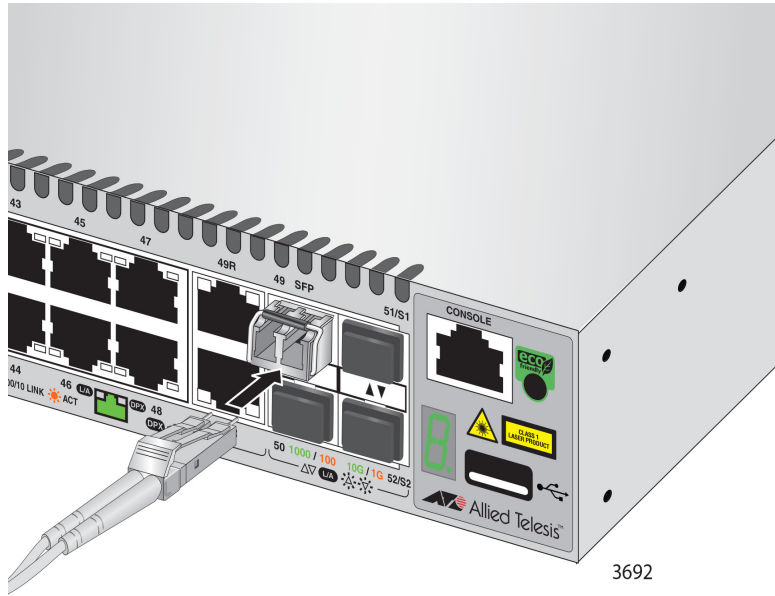

Figure 56. Connecting a Fiber Optic Cable to an SFP Transceiver

8. Repeat this procedure to install a second transceiver.

This completes the installation procedure for the switch. If you encounter a problem, refer to Chapter 9, “Troubleshooting” on page 109.



## Chapter 9

# Troubleshooting

---

This chapter contains suggestions on how to troubleshoot the switch if a problem occurs.

---

**Note**

For further assistance, please contact Allied Telesis Technical Support at [www.alliedtelesis.com/support](http://www.alliedtelesis.com/support).

---

**Problem 1:** The Switch ID LED on the front of the switch is off.

**Solutions:** The unit is not receiving power. Try the following:

- Verify that the power cord is securely connected to the power source and to the AC connector on the back panel of the switch.
- Verify that the power outlet has power by connecting another device to it.
- Try connecting the unit to another power source.
- Try a different power cord.
- Verify that the voltage from the power source is within the required levels for your region.

**Problem 2:** All of the port LEDs are off even though the ports are connected to active network devices.

**Solution:** The switch may be operating in the low power mode. To toggle on the LEDs, press the eco-friendly button on the front panel of the switch. You may also toggle the LEDs off and on with the ECOFRIENDLY LED and NO ECOFRIENDLY LED commands in the command line interface.

**Problem 3:** The SHOW STACK command is not displaying all the switches in the stack.

**Solutions:** One or more switches cannot join the stack. Try the following:

- Verify that the stacking transceivers in the S1 and S2 slots of the switches are properly cabled. The stacking cables must cross over to different slots on the switches. For instructions, refer to Chapter 6, “Cabling the Stacking Ports” on page 83.
- Verify that the transceivers are fully inserted into the S1 and S2 slots.

- ❑ Verify that VCStack is activated on the switches. For instructions, refer to Chapter 5, “Verifying the Status of VCStack” on page 77.
- ❑ It could be that the switches have incompatible versions of the management software. When a stack forms or a new switch is added to an existing stack, the master switch downloads its management software to member switches that do not have the same version. If the master switch encounters a problem downloading the management software to a member switch, it does not allow the device to join the stack.

**Problem 4:** A twisted pair port on the switch is connected to a network device, but the port’s LINK/ACT LED is off.

**Solutions:** The port is unable to establish a link to a network device. Try the following:

- ❑ Verify that the port is connected to the correct twisted pair cable. This is to eliminate the possibility that the port is connected to the wrong network device.
- ❑ Verify that the network device connected to the twisted pair port is powered on and is operating properly.
- ❑ Try connecting another network device to the twisted pair port with a different cable. If the twisted pair port is able to establish a link, then the problem is with the cable or the other network device.
- ❑ Verify that the twisted pair cable does not exceed 100 meters (328 feet).
- ❑ Verify that you are using the appropriate category of twisted pair cable. The cable types are listed in Table 1 on page 24 for the 10/100/1000Base-T ports.

---

**Note**

A 1000Base connection may require five to ten seconds to establish a link.

---

**Problem 5:** The LINK/ACT LED for an SFP transceiver is off.

**Solutions:** The fiber optic port on the transceiver is unable to establish a link to a network device. Try the following:

- ❑ Verify that the remote network device connected to the fiber optic port is operating properly.
- ❑ Verify that the fiber optic cable is securely connected to the port on the SFP module and to the port on the remote network device.
- ❑ Check that the transceiver is fully inserted in the slot.
- ❑ Check to be sure that the transceiver is not installed in slot S1 or S2 in the switch.

- ❑ Verify that the operating specifications of the fiber optic ports on the transceiver and remote network device are compatible.
- ❑ Verify that the correct type of fiber optic cabling is being used.
- ❑ Verify that the port is connected to the correct fiber optic cable. This is to eliminate the possibility that the port is connected to the wrong remote network device.
- ❑ Try connecting another network device to the fiber optic port using a different cable. If the port is able to establish a link, then the problem is with the cable or with the other network device.
- ❑ Use the switch's management software to verify that the port is enabled.
- ❑ If the remote network device is a managed device, use its management firmware to determine whether its port is enabled.
- ❑ Test the attenuation of both directions on the fiber optic cable with a fiber optic tester to determine whether the optical signal is too weak (sensitivity) or too strong (maximum input power).

**Problem 6:** Network performance between a twisted pair port on the switch and a network device is slow.

**Solution:** There might be a duplex mode mismatch between the port and the network device. This can occur when a twisted pair port using Auto-Negotiation is connected to a remote device that has a fixed speed of 10 or 100 Mbps and a fixed duplex mode of full-duplex. If this is the cause of the problem, adjust the duplex mode of the port on the network device or switch so that both ports are using the same duplex mode. You can use either the LEDs or management software on the switch to determine the duplex mode settings of the ports. The LEDs are described in Table 6 on page 36.

**Problem 7:** The switch functions intermittently.

**Solutions:** Check the system hardware status through the management software:

- ❑ Use the SHOW SYSTEM ENVIRONMENT command in the Privileged Exec mode to verify that the input voltage from the power source to the switch is stable and within the approved operating range. The unit will shut down if the input voltage fluctuates above or below the approved operating range.
- ❑ Use the SHOW SYSTEM ENVIRONMENT command in the Privileged Exec mode to verify that the fan is operating correctly.
- ❑ Verify that the location of the switch allows for adequate airflow. The unit will shut down if it is in danger of overheating.

**Problem 8:** The Switch ID LED on the front of the switch is flashing the letter “F.”

**Solutions:** One or more of the following problems has occurred:

- ❑ A cooling fan has failed.
- ❑ The input voltage on the power supply is outside the normal operating range.
- ❑ The internal temperature of the switch has exceeded the normal operating range, and the switch may shut down.

Contact your Allied Telesis sales representative for assistance.

**Problem 9:** The AT-GS924MPX or AT-GS948MPX Switch is not providing power to a PoE device.

**Solutions:** Try the following:

- ❑ Review the PD’s documentation to confirm that the device supports Alternative B of the IEEE 802.3at standard. Alternative B is one of two modes that define the connector pins that deliver the power from the port on the line card to the PD. In Alternative B, the power is carried on pins 4, 5, 7, and 8 on the RJ-45 port, the same pins that carry the network traffic. The other mode, Alternative A, defines pins 1, 2, 3, and 6 as the power carriers. The AT-GS924MPX and AT-GS948MPX Switches do not support Alternative A. Most powered devices are designed to accept power by either mode, but some legacy devices may only support one mode. This can be verified by reviewing the device’s documentation or data sheet. Legacy devices that only support Alternative A will not work with the switches.
- ❑ Check that the device’s power requirements do not exceed 30 W. This can be verified by reviewing the device’s documentation or data sheet.
- ❑ Verify that you are using the appropriate category of twisted-pair cable by referring to Table 1 on page 24.
- ❑ Use the management software on the switch to determine whether PoE is enabled on the port. The default setting for PoE is enabled.
- ❑ Use the management software on the switch to determine whether the PoE power setting for the port has been reduced to a value below the power requirements of the device.
- ❑ Try connecting the device to a different port on the switch.



## Appendix A

# Technical Specifications

---

This appendix contains the following sections:

- “Physical Specifications”
- “Environmental Specifications” on page 114
- “Power Specifications” on page 114
- “Certifications” on page 115
- “RJ-45 Twisted Pair Port Pinouts” on page 116
- “RJ-45 Style Serial Console Port Pinouts” on page 117

## Physical Specifications

---

### Dimensions (H x W x D)

Table 11. Product Dimensions

AT-GS924MX	4.4 cm x 33.9 cm x 21.1 cm (1.7 in. x 13.4 in. x 8.3 in.)
AT-GS924MPX	4.4 cm x 44.0 cm x 35.6 cm (1.7 in. x 17.3 in. x 14.0 in.)
AT-GS948MX	4.4 cm x 44.0 cm x 30.7 cm (1.7 in. x 17.3 in. x 12.1 in.)
AT-GS948MPX	4.4 cm x 44.0 cm x 35.6 cm (1.7 in. x 17.3 in. x 14.0 in.)

### Weights

Table 12. Product Weights

AT-GS924MX	2.5 kg (5.5 lb.)
AT-GS924MPX	5.3 kg (11.7 lb.)
AT-GS948MX	4.5 kg (9.9 lb.)
AT-GS948MPX	5.8 kg (12.8 lb.)

### Ventilation

Table 13. Ventilation Requirements

Recommended Minimum Ventilation on All Sides	10 cm (4.0 in)
--	----------------

## Environmental Specifications

---

Table 14. Environmental Specifications

Operating Ambient Temperature	0° C to 50° C (32° F to 113° F)
Storage Temperature	-25° C to 70° C (-13° F to 158° F)
Operating Humidity	5% to 90% noncondensing
Storage Humidity	5% to 95% noncondensing
Maximum Operating Altitude	AT-GS924MX: 2,000 m (6,562 ft)
	AT-GS924MPX: 3,000 m (9,842 ft)
	AT-GS948MX: 2,000 m (6,562 ft)
	AT-GS948MPX: 3,000 m (9,842 ft)
Maximum Nonoperating Altitude	4,000 m (13,100 ft)

## Power Specifications

---

### Input Voltages

Table 15. Input Voltages

AT-GS924MX	AC model: 100-240 VAC, 1.0A maximum, 50/60 Hz
AT-GS924MPX	AC model: 100-240 VAC, 5.0A maximum, 50/60 Hz
AT-GS948MX	AC model: 100-240 VAC, 1.0A maximum, 50/60 Hz
AT-GS948MPX	AC model: 100-240 VAC, 5.0A maximum, 50/60 Hz

## Maximum Power Consumption

Table 16. Maximum Power Consumption

AT-GS924MX	30.7 watts
AT-GS924MPX	464.3 watts
AT-GS948MX	50.8 watts
AT-GS948MPX	480.6 watts

## Heat Dissipation (British Thermal Units/hour)

Table 17. Heat Dissipation

AT-GS924MX	104.6 BTU/h
AT-GS924MPX	321.7 BTU/h
AT-GS948MX	173.1 BTU/h
AT-GS948MPX	377.4 BTU/h

## Certifications

---

Table 18. Product Certifications

EMI (Emissions)	FCC Class A, EN55022 Class A, EN61000-3-2, EN61000-3-3, VCCI Class A, CISPR Class A, RCM, CE
EMC (Immunity)	EN55024
Electrical and Laser Safety	EN60950-1 (TUV), UL 60950-1 (cUL <sub>US</sub> ), EN60825-1
Compliance Marks	CE, cUL <sub>US</sub> , TUV, RCM

## RJ-45 Twisted Pair Port Pinouts

---

The pin layout of the RJ-45 connectors and ports is shown in Figure 57.

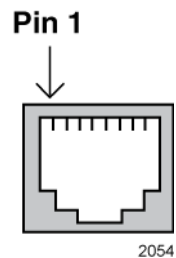

Figure 57. RJ-45 Socket Pin Layout (Front View)

Table 19 lists the pin signals for 10 and 100 Mbps.

Table 19. Pin Signals for 10 and 100 Mbps

Pin	MDI Signal	MDI-X Signal
1	TX+	RX+
2	TX-	RX-
3	RX+	TX+
4	Not used	Not used
5	Not used	Not used
6	RX-	TX-
7	Not used	Not used
8	Not used	Not used

The pin signals of a port operating at 1000 Mbps are shown in Table 20.

Table 20. Pin Signals for 1000 Mbps

Pinout	Pair
1	Pair 1 +
2	Pair 1 -
3	Pair 2 +
4	Pair 3 +
5	Pair 3 -
6	Pair 2 -
7	Pair 4 +
8	Pair 4 -

## RJ-45 Style Serial Console Port Pinouts

---

The pin signals of the RJ-45 style serial Console port are listed in Table 21.

Table 21. RJ-45 Style Serial Console Port Pin Signals

Pin	Signal
1	Looped to pin 8
2	Looped to pin 7
3	Transmit Data
4	Ground
5	Ground
6	Receive Data
7	Looped to pin 2
8	Looped to pin 1

