

G3 ELECTRONICS

PNEUMATIC VALVES



NUMATICS G3 ELECTRONICS

PRODUCT LEAFLET

G3 Fieldbus - Electronics Made Easy!

Innovative Graphic Display is used for easy commissioning, visual status & diagnostics.

Commissioning Capabilities

- Set network address (including IP & Subnet mask for Ethernet)
- Set baud rate
- Set auto or manual I/O sizes
- Set fault/idle output states
- Set brightness
- Set factory defaults

Visual Diagnostics

- Shorted and open load detection
- Shorted sensor/cable detection
- Low & missing power detection
- Missing module detection
- Self-test activation
- Log of network errors
- Distribution errors



Graphic Display for configuration & diagnostics



Auto Recovery Module



Highly Distributable



Easy, Robust Connections

G3 Fieldbus Communications Electronics

Why use Numatics Fieldbus communication electronics?

Modular Reality...

- No internal wiring simplifies assembly
- SPEEDCON M12 connector technology allows for fast and efficient 1/2 turn I/O connector attachment.
- Power connector allows output power to be removed while inputs and communication are left active.
- IP65 & IP67 protection
- Up to 1200 Input / 1200 Output capability with one communication node! (Present physical I/O combinations allows 1200 I / 544 O)
- 32 valve solenoids per manifold up to 17 manifolds per communication node!
- One node supports 16 I/O modules – Analog I/O, Digital I/O (NPN & PNP) and Specialty
- Innovative clip design allows easy module removal/replacement without dismantling manifold
- Auto Recovery Module (ARM) protects configuration information during a critical failure. Allows configuration information to be saved and reloaded to replacement module automatically.

Supported Protocols

- DeviceNet™
- DeviceNet™ w/Quick Connect
- DeviceNet™ w/DeviceLogix™
- Ethernet
- PROFIBUS®-DP
- CANopen®
- PROFINET®
- POWERLINK



* Numatics I/O with SPEEDCON technology

- 1/2 turn for faster I/O connections
- Backwards compatible with standard M12 cables/connectors
- Meets the same IP/NEMA standards as M12/Micro cables/connectors
- Same cost as standard M12/Micro cables/connectors
- See pages 50 & 51 for cables with SPEEDCON connector technology



DeviceNet™ is a trademark of ODVA.
 ControlNet is a trademark of ControlNet International, Ltd.
 DeviceLogix is a trademark of Rockwell Automation.
 AS-interface is a registered trademark of AS-International.
 PROFIBUS and PROFINET are registered trademarks of Profibus International.
 POWERLINK is an Ethernet protocol under the control of EPSG (Ethernet Powerlink Standardization Group)
 EtherCAT is a registered trademark of Beckhoff Automation GmbH

G3 Electronics Modularity

Discrete I/O

The G3 Series product line is a completely modular system. All of the G3 electronic modules plug together, via mechanical clips, allowing easy assembly and field changes. This makes the system highly distributable. Additional flexibility is incorporated because the same modules can be used in either centralized or distributed applications. The G3 electronics interfaces with the highly modular Numatics 503 Series, generation 2000 Series, ISO 5599/2 and ISO 15407-2 Series valve lines to further enhance the modularity and flexibility of the entire system.

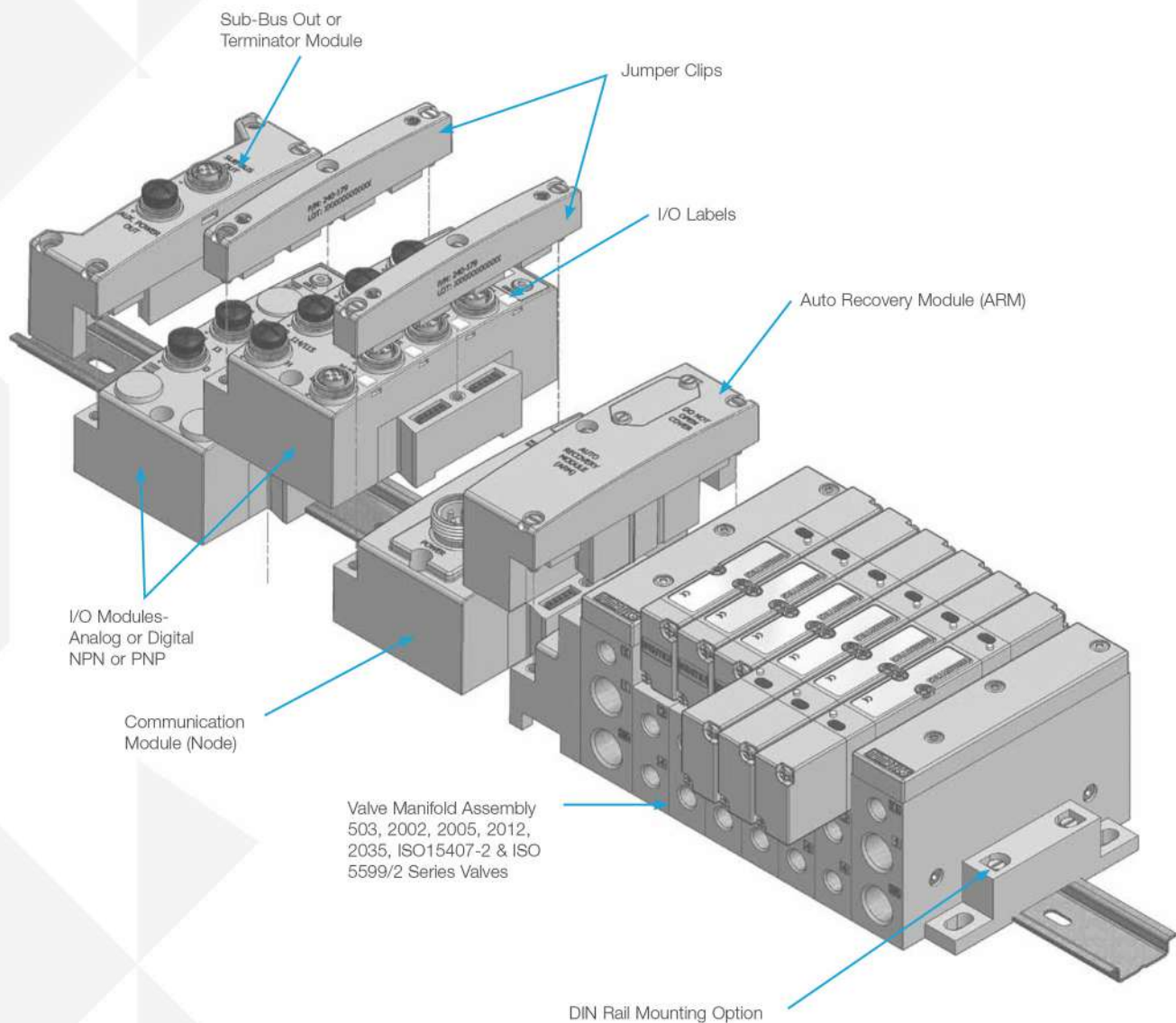

G3 Platform Distribution Options

Easy, Cost Effective Solutions for Digital I/O and Valve Automation using G3 Electronics

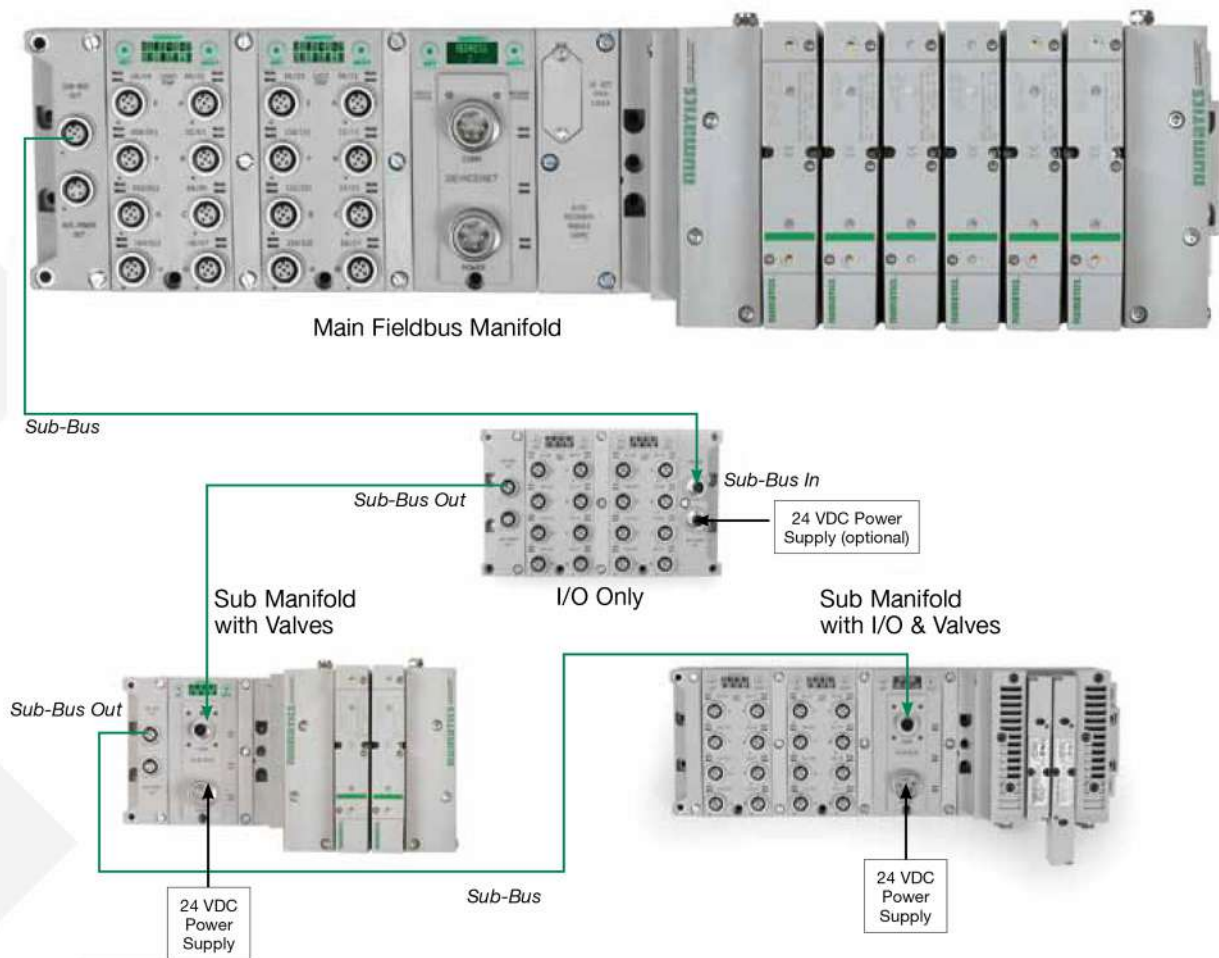

- Unique distribution system allows system efficiency by allowing the same modules to be used in either centralized or distributed applications
- Distribution options include:
 - Inputs OR Outputs
 - Inputs AND Outputs
 - Valves with Inputs AND Outputs
 - Valves with Inputs OR Outputs
 - Valves Only
- Maximum Sub-Bus length not to exceed 30 meters. Maximum Sub-Bus cable current not to exceed 4 amps or excessive cable voltage drops per segment. Auxiliary power connections available for currents above 4 amps. Consult factory for possible deviations.

G3 Platform Distribution Options

The G3 platform is flexible to the point that there are a virtually infinite number of I/O distribution options using the few basic G3 modules. The following basic rules should be followed in the configuration of your control architecture.

Valve Side

- Up to a total of 32 valve solenoids can be driven in a manifold assembly integrated into the Main Fieldbus Manifold. This can be any number of single or double solenoid valves with a total number of solenoids not to exceed 32.
- A Valve side output module is available. If a valve side output module is used, 16 outputs are allocated to the solenoids in the integral manifold and 16 are allocated to the output module in the manifold.

Typical Main Fieldbus Manifold

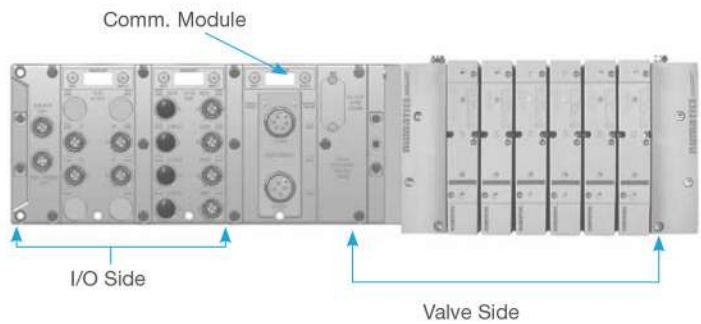

I/O Side Distribution

- A total of 16 modules can be integrated into the network and controlled by the main fieldbus communication module (Node)
- Modules include analog and digital I/O modules providing addressing capacity for up to 1200 Inputs / 1200 Outputs per node.
- Unique distribution system allows system efficiency by allowing the same modules to be used in either centralized or distributed applications
- Distribution options include Inputs only, Outputs only, I/O only, valves with Inputs, valves with Outputs and valves with I/O
- Configuration can include up to 16 of the following modules:
 - Digital I/O modules
 - Sub-Bus valve modules
 - Analog I/O modules

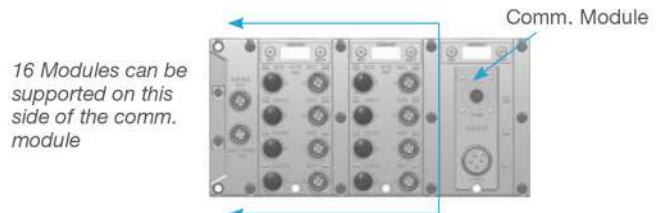
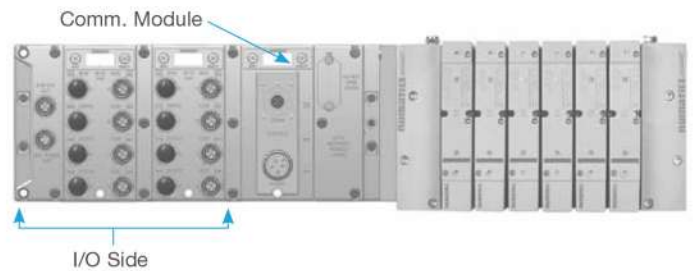



NUMATICS

G3 ELECTRONICS

PRODUCT LEAFLET

DeviceNet™

DeviceNet™ is an open bus fieldbus communication system developed by Allen-Bradley based on Controller Area Network (CAN) technology. The governing body for DeviceNet™ is the Open DeviceNet™ Vendors Association (ODVA). The ODVA controls the DeviceNet™ specification and oversees product conformance testing.

Numatics' G3 nodes for DeviceNet™ have an integrated graphic display and are capable of addressing combinations of up to 1200 Outputs and 1200 Inputs.

They have been tested and approved for conformance by the ODVA.

More information about DeviceNet™ and the ODVA can be obtained from the following WEB site: www.odva.org



Description	Replacement Part Number
DeviceNet™ communications module (node)	240-180

Technical Data

Electrical Data	Voltage	Current
Node Power at Max. Brightness	24 VDC +/- 10%	0.070 Amps
BUS Power	11-25 VDC	0.025 Amps
Valves & Discrete I/O	24 VDC +/- 10%	8 Amps Maximum
Power Connector	Single key 4 pin 7/8" MINI type (male)	
Communication Connector	Single key 5 pin 7/8" MINI type (male)	
LED's	Module Status and Network Status	

Operating Data	
Temperature Range (ambient)	-10° to 115° F (-23° to +50°C)
Humidity	95% relative humidity, non-condensing
Vibration / Shock	IEC 60068-2-27, IEC60068-2-6
Moisture Protection	IP65, IP67 (with appropriate assembly and termination)

Configuration Data	
Graphic Display	Display used for setting Node Address, Baud Rate, Fault / Idle Actions, DeviceNet™ QuickConnect and all other system settings.
ARM	(Auto Recovery Module) Optional module that contains automatic recovery of system setting in the event of total or partial system failure.
Maximum Valve-Solenoid Outputs	32
Maximum Addressable I/O Points	Various combinations of 1200 outputs and 1200 inputs

Network Data	
Supported Baud Rates	125K Baud, 250K Baud, 500K Baud, with Auto-Baud detection
Supported Connection Type	Polled, Cyclic, Change of State (COS) and combination Message Capability
Bus Connector	Single key 5 pin 7/8" MINI type (male)
Diagnostics	Power, short, open load conditions and module health are monitored
Special Features	Supports Auto-Device Replacement (ADR) and fail-safe device settings

Weight	
DeviceNet™ Communication Module	252g / 8.9 oz.



NUMATICS

G3 ELECTRONICS

PRODUCT LEAFLET

Ethernet (Ethernet/IP & Modbus TCP/IP)

Ethernet used throughout the world to network millions of PC's has now evolved into a viable industrial network. Ethernet is an open architecture high-level communication network that meets the demands of today's industrial applications requiring high-speed (10/100 Mbit/s), high-throughput and flexibility. Various application layers for this protocol including EtherNet/IP and Modbus TCP. Additionally, Ethernet technology can integrate an on-board Web server, which can make the node readily accessible to any standard Web browser for configuration, testing and even retrieval of technical documentation.

Numatics' G3 nodes for Ethernet have an integrated graphic display and are capable of addressing combinations of up to 1200 Outputs and 1200 Inputs.

The G3 Ethernet/IP nodes have been tested and approved for conformance by the ODVA.

More information about Ethernet/IP and the ODVA can be obtained from the following WEB site: www.odva.org



Description	Replacement Part Number
Ethernet/IP communications module (node)	240-181
Modbus TCP/IP communications module (node)	240-292

Technical Data

Electrical Data	Voltage	Current
Node Power at Max. Brightness	24 VDC +/- 10%	.091 Amps
Valves & Discrete I/O	24 VDC +/- 10%	8 Amps maximum
Power Connector	Single key 4 pin 7/8" MINI type (male)	
Communication Connector	D-coded 4 pin M12 type (female)	
LED's	Module Status, Network Status and Activity/Link	

Operating Data	
Temperature Range (ambient)	-10° to 115° F (-23° to +50°C)
Humidity	95% relative humidity, non-condensing
Vibration / Shock	IEC 60068-2-27, IEC60068-2-6
Moisture Protection	IP65, IP67 (with appropriate assembly and termination)

Configuration Data	
Graphic Display	Display used for setting IP Address, Subnet mask, Fault / Idle Actions, DHCP / BootP and all other system settings.
ARM	(Auto Recovery Module) Optional module that contains automatic recovery of system setting in the event of total or partial system failure
Maximum Valve-Solenoid Outputs	32
Maximum Addressable I/O Points	Various combinations of 1200 outputs and 1200 inputs

Network Data	
Supported Baud Rates	10 Mbit / 100 Mbit
Bus Connector	D-coded 5 pin M12 type (female)
Diagnostics	Power, short, open load conditions and module health are monitored
Special Features	Integrated web server, fail-safe device settings, HTTP, FTP, and UNICAST (for EtherNet/IP)

Weight	
Ethernet Communication Module	255g / 9 oz.



NUMATICS

G3 ELECTRONICS

PRODUCT LEAFET

PROFIBUS-DP®

PROFIBUS-DP® is a vendor-independent, open fieldbus protocol designed for communication between automation control systems and distributed I/O at the device level.

Numatics' G3 nodes for PROFIBUS-DP® have an integrated graphic display and are capable of addressing combinations of up to 1200 Outputs and 1200 Inputs.

The G3 nodes for PROFIBUS-DP® have been designed and tested to conform to the PROFIBUS® standard EN50170. Certification has been done by the PROFIBUS® Interface Center (PIC) according to the guidelines determined by the PROFIBUS® Trade Organization (PTO). The certification process ensures interoperability for all PROFIBUS® devices.

More information regarding PROFIBUS® can be obtained from the following WEB site:

www.profibus.com



Description	Replacement Part Number
PROFIBUS-DP® communications module (node)	240-239

Technical Data

Electrical Data	Voltage	Current
Node Power at Max. Brightness	24 VDC +/- 10%	.094 Amps
Valves & Discrete I/O	24 VDC +/- 10%	8 Amps Maximum
Power Connector	Single key 5 pin 7/8" MINI type (male)	
Communication Connector	Single reverse key (B-Coded) 5 pin M12 type (1 male and 1 female)	
LED's	Module Status and Network Status	

Operating Data	
Temperature Range (ambient)	-10° to 115° F (-23° to +50°C)
Humidity	95% relative humidity, non-condensing
Vibration / Shock	IEC 60068-2-27, IEC60068-2-6
Moisture Protection	IP65, IP67 (with appropriate assembly and termination)

Configuration Data	
Graphic Display	Display used for setting Node Address, Baud Rate, Fault / Idle Actions, and all other system settings.
ARM	(Auto Recovery Module) Optional module that contains automatic recovery of system setting in the event of total or partial system failure
Maximum Valve-Solenoid Outputs	32
Maximum Addressable I/O Points	Various combinations of 1200 outputs and 1200 inputs

Network Data	
Supported Baud Rates	125K Baud, 250K Baud, 500K Baud, with Auto-Baud detection
Bus Connector	Single key 5 pin 7/8" MINI type (male)
Diagnostics	Power, short, open load conditions and module health are monitored
Special Features	Supports Auto-Device Replacement (ADR) and fail-safe device settings

Weight	
PROFIBUS-DP® Communication Module	227g / 8 oz.



NUMATICS

G3 ELECTRONICS

PRODUCT LEAFLET

PROFINET®

PROFINET® is the innovative open standard for Industrial Ethernet, development by Siemens and the Profibus® User Organization (PNO). PROFINET® complies to IEC 61158 and IEC 61784 standards. PROFINET® products are certified by the PNO user organization, guaranteeing worldwide compatibility.

Numatics' G3 nodes for PROFINET IO (PROFINET RT) have an integrated graphic display and are capable of addressing combinations of up to 1200 Outputs and 1200 Inputs.

PROFINET® is based on Ethernet and uses TCP/IP and IT standards and complements them with specific protocols and mechanisms to achieve Real Time performance.

More information regarding PROFINET® can be obtained from the following WEB site:
www.profibus.com



Description	Replacement Part Number
PROFINET® communications module (node)	240-240

Technical Data

Electrical Data	Voltage	Current
Node Power at Max. Brightness	24 VDC +/- 10%	
Valves & Discrete I/O	24 VDC +/- 10%	8 Amps Maximum
Power Connector	Single key 5 pin 7/8" MINI type (male)	
Communication Connector	Two D-coded 4 pin M12 type (female)	
LED's	Module Status, Network Status and Activity/Link	

Operating Data	
Temperature Range (ambient)	-10° to 115° F (-23° to +50° C)
Humidity	95% relative humidity, non-condensing
Vibration / Shock	IEC 60068-2-27, IEC60068-2-6
Moisture Protection	IP65, IP67 (with appropriate assembly and termination)

Configuration Data	
Graphic Display	Display used for setting IP Address, Subnet Mask, Fault / Idle Actions, and all other system settings.
ARM	(Auto Recovery Module) Optional module that contains automatic recovery of system setting in the event of total or partial system failure.
Maximum Valve-Solenoid Outputs	32
Maximum Addressable I/O Points	Various combinations of 1200 outputs and 1200 inputs

Network Data	
Supported Baud Rates	10 Mbit / 100 Mbit
Bus Connector	Two D-coded 4 pin M12 type (2-Female)
Diagnostics	Power, short, open load conditions and module health and configuration are monitored
Special Features	Integrated web server, Integrated 2 port switch, fail-safe device settings, and FSU

Weight	
PROFINET® Communication Module	227g / 8 oz.



NUMATICS G3 ELECTRONICS

PRODUCT LEAFLET

CANopen®

CANopen® is an open protocol based on Controller Area Network (CAN). It was designed for motion oriented machine control networks but has migrated to various industrial applications. CAN in Automation (CIA) is the international users' and manufacturers' organization that develops and supports CAN-based protocols. Numatics' G3 nodes for CANopen® have an integrated graphic display and are capable of addressing combinations of up to 1200 Outputs and 1200 Inputs.

More information regarding this organization can be found at: www.can-cia.org



Description	Replacement Part Number
CANopen® communications module (node)	240-291

Technical Data

Electrical Data	Voltage	Current
Node Power at Max. Brightness	24 VDC +/- 10%	0.070 Amps
BUS Power	11-25 VDC	0.025 Amps
Valves & Discrete I/O	24 VDC +/- 10%	8 Amps maximum
Power Connector	Single key 4 pin 7/8" MINI type (male)	
Communication Connector	Single key 5 pin 7/8" MINI type (male)	
LED's	Module Status and Network Status	

Operating Data	
Temperature Range (ambient)	-10° to 115° F (-23° to +50° C)
Humidity	95% relative humidity, non-condensing
Vibration / Shock	IEC 60068-2-27, IEC60068-2-6
Moisture Protection	IP65, IP67 (with appropriate assembly and termination)

Configuration Data	
Graphic Display	Display used for setting Node Address, Baud Rate, Fault / Idle Actions, and all other system settings.
ARM	(Auto Recovery Module) Optional module that contains automatic recovery of system setting in the event of total or partial system failure.
Maximum Valve-Solenoid Outputs	32
Maximum Addressable I/O Points	Various combinations of 1200 outputs and 1200 inputs

Network Data	
Supported Baud Rates	125K Baud, 250K Baud, 500K Baud, 1M Baud
Bus Connector	Single key 5 pin 7/8" MINI type (male)
Diagnostics	Power, short, open load conditions and module health are monitored and fail-safe device settings

Weight	
CANopen® Communication Module	252g / 8.9 oz.



NUMATICS G3 ELECTRONICS

PRODUCT LEAFLET

DeviceLogix™

DeviceLogix™ is a Rockwell Automation technology that allows a DeviceNet™ node to be programmed to execute a sequence independently from the control for the main PLC/IPC. A DeviceLogix™ enabled DeviceNet™ node can be used in conjunction with a standard DeviceNet™ network, providing simple distributed control functionality. Additionally it can also be used in a standalone application, without a network connection or PLC/IPC, to sequence pneumatic valves and control I/O. Numatics has integrated this licensed technology into its DeviceNet™ compatible valve manifold series, which combine the functionality of a modular pneumatic valve system with integrated I/O.

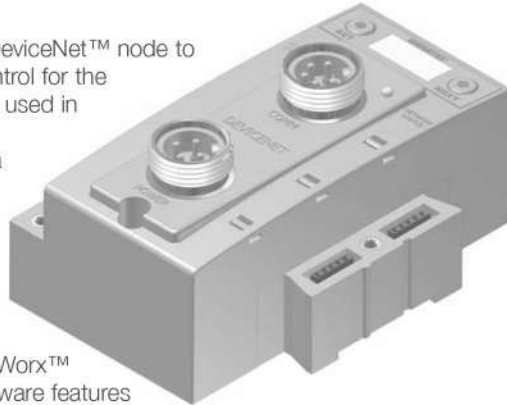

Programming of the DeviceLogix™ enabled node is done using the industry standard DeviceNet™ commissioning software tool RSNetWorx™ for DeviceNet™ from Rockwell Automation. The programming software features an easily understandable graphics environment where the users can simply "drag and drop" logic function blocks (i.e. AND, NAND, OR, NOR, XOR, XNOR, RS LATCHES, COUNTERS and TIMERS) onto a page and interconnect them to develop the required sequence, or ladder logic programming can be used to develop a sequence. The programmed sequence is downloaded to the node via standard DeviceNet™ communication connection, thus multiple nodes can be programmed on the same network.

Description	Replacement Part Number
DeviceLogix™ communications module (node)	240-293

Technical Data

Electrical Data	Voltage	Current
Node Power at Max. Brightness	24 VDC +/- 10%	0.070 Amps
BUS Power	11-25 VDC	0.025 Amps
Valves & Discrete I/O	24 VDC +/- 10%	8 Amps Maximum
Power Connector	Single key 4 pin 7/8" MINI type (male)	
Communication Connector	Single key 5 pin 7/8" MINI type (male)	
LED's	Module Status and Network Status	

Operating Data	
Temperature Range (ambient)	-10° to 115° F (-23° to +50° C)
Humidity	95% relative humidity, non-condensing
Vibration / Shock	IEC 60068-2-27, IEC60068-2-6
Moisture Protection	IP65, IP67 (with appropriate assembly and termination)

Configuration Data	
Communication Module	Display used for setting Node Address, Baud Rate, Fault / Idle Actions, and all other system settings.
ARM	(Auto Recovery Module) Optional module that contains automatic recovery of system setting in the event of total or partial system failure including embedded DeviceLogix™ logic instructions.
Maximum Valve-Solenoid Outputs	32

Network Data	
Supported Baud Rates	125K Baud, 250K Baud, 500K Baud, with Auto-Baud detection
Supported Connection Type	Polled, Cyclic, Change of State (COS) and combination Message Capability
Bus Connector	Single key 5 pin 7/8" MINI type (male)
Diagnostics	Power, short, open load conditions and module health are monitored and fail-safe device settings
Special Features	Supports function block diagram and ladder logic programming

Weight	
DeviceLogix™ Communication Module	252g / 8.9 oz.



NUMATICS G3 ELECTRONICS

PRODUCT LEAFLET

Ethernet POWERLINK®

Ethernet POWERLINK® is an open fieldbus protocol designed by B&R for communication between automation control systems and distributed I/O at the device level.

Numatics' G3 Ethernet POWERLINK® nodes have an integrated graphic display and are capable of addressing combinations of up to 512 Inputs / Outputs.

The G3 Ethernet POWERLINK® nodes have been designed and tested to conform to the Ethernet POWERLINK® specifications available at EPSG group (Ethernet Powerlink® Standardization Group).

The certification process ensures interoperability for all Ethernet POWERLINK® devices and compatible with B&R systems.

More information regarding Ethernet POWERLINK® can be obtained from the following WEB site.
www.ethernet-powerlink.org

ETHERNET POWERLINK®



Description	Replacement Part Number
POWERLINK® communications module (node)	240-309

Technical Data

Electrical Data	Voltage	Current
Node Power at Max. Brightness	24 VDC +/- 10%	
Valves & Discrete I/O	24 VDC +/- 10%	8 Amps maximum
Power Connector	Single key 5 pin 7/8" MINI type (male)	
Communication Connector	Two D-coded 4 pin M12 type (female)	
LED's	Module Status, Network Status and Activity/Link	

Operating Data	
Temperature Range (ambient)	-10° to 115° F (-23° to +50° C)
Humidity	95% relative humidity, non-condensing
Vibration / Shock	IEC 60068-2-27, IEC60068-2-6
Moisture Protection	IP65, IP67 (with appropriate assembly and termination)

Configuration Data	
Graphic Display	Display used for setting IP Address, Subnet Mask, Fault / Idle Actions, and all other system settings.
ARM	(Auto Recovery Module) Optional module that contains automatic recovery of system setting in the event of total or partial system failure.
Maximum Valve-Solenoid Outputs	32
Maximum Addressable I/O Points	Various combinations of 1200 outputs and 1200 inputs

Network Data	
Supported Baud Rates	10 Mbit / 100 Mbit
Bus Connector	Two D-coded 4 pin M12 type (2-Female)
Diagnostics	Power, short, open load conditions and module health and configuration are monitored
Special Features	Integrated web server, Integrated 2 port switch and fail-safe device settings

Weight	
POWERLINK® Communication Module	227g / 8 oz.



NUMATICS G3 ELECTRONICS

PRODUCT LEAFLET

EtherCAT®

EtherCAT® is an open ethernet based fieldbus protocol developed by Beckhoff. EtherCAT® sets new standards for real-time performance and topology flexibility with short data update/cycle times and low communication jitter.

Numatics' G3 EtherCAT® node has an integrated graphic display for simplified commissioning and diagnostics. It is capable of addressing combinations of up to 1200 outputs and 1200 inputs.

The G3 nodes for EtherCAT® have been designed and tested to conform with EtherCAT® specifications set forth by the ETG.

More information regarding EtherCAT® can be obtained from the following web site:
www.ethercat.org



Description	Replacement Part Number
EtherCAT® communications module	240-310

Technical Data

Electrical Data	Voltage	Current
Node Power at Max. Brightness Valves and Discrete I/O	24 VDC +/- 10% 24 VDC +/- 10%	8 Amps Maximum
Power Connector	Single key 5 pin 7/8" MINI type (male)	
Communication Connector	Two D-coded 4 pin M12 type (female)	
LED's	Module Status, Network Status and Activity /Link	

Operating Data	
Temperature Range	-10° to 115° F (-23° to +50° C)
Humidity	95% relative humidity, non-condensing
Vibration / Shock	IEC 60068-2-27, IEC 60068-2-6
Moisture	IP65, IP67 (with appropriate assembly and termination)

Configuration Data	
Graphic Display	Display used for setting IP address, Subnet Mask, Fault / Idle Actions, and all other system settings.
ARM	(Auto Recovery Module) Optional module that contains automatic recovery of system settings in the event of total or partial system failure.
Maximum Valve Solenoid Outputs	32
Maximum Sub-Bus I/O Points	Various combinations of 1200 outputs and 1200 inputs

Network Data	
Supported Baud Rates	10 Mbit / 100 Mbit
Bus Connector	Two D-coded 4 pin M12 type (female)
Diagnostics	Power, short, open load conditions and module health and configuration are monitored
Special Features	Integrated web server, fail-safe device settings.

Weight	
EtherCAT® communications module	227g / 8 oz



NUMATICS G3 ELECTRONICS

PRODUCT LEAFLET

EtherNet/IP DLR

EtherNet/IP used throughout the world to network millions of PC's has now evolved into a viable industry network. EtherNet/IP is an open architecture high-level communication network that meets the demands of today's industrial applications requiring high-speed (10/100 Mbit/s), high-throughput and flexibility. Additionally, EtherNet/IP technology can integrate an on-board Web server, which can make the node readily accessible to any standard Web browser for configuration, testing and even retrieval of technical documentation.

Numatics' G3 EtherNet/IP DLR (Device Level Ring) node with integrated display, has an embedded switch which allows the unit to be used in simplified networks with linear topology configurations (daisy chain). This technology alleviates the need for an external Ethernet switch device in a single subnet configuration. Additionally, the DLR compatibility allows the node to be used in a fault tolerant "ring" network, when using appropriate EtherNet/IP DLR scanners. DLR configuration allows communication recovery from a single point failure on the network ring (e.g. failed network connection or cable).

Numatics G3 EtherNet/IP nodes are capable of addressing combinations of up to 1200 Outputs and 1200 Inputs.

The G3 EtherNet/IP nodes have been tested and approved for conformance by the ODVA

More information about EtherNet and the ODVA can be obtained from the following WEB site:
Open Device Vendors Association (ODVA) www.odva.org



Description	Replacement Part Number
EtherNet/IP DLR communications module (node)	240-325

Technical Data

Electrical Data	Voltage	Current
Node Power at Max. Brightness Valves and Discrete I/O	24 VDC +/- 10% 24 VDC +/- 10%	8 Amps Maximum
Power Connector	Single key 4 pin 7/8" MINI type (male)	
Communication Connector	Two D-coded 4 pin M12 type (female)	
LED's	Module Status, Network Status and Activity / Link	

Operating Data	
Temperature Range	-10° to 115° F (-23° to +50° C)
Humidity	95% relative humidity, non-condensing
Vibration / Shock	IEC 60068-2-27, IEC 60068-2-6
Moisture	IP65, IP67 (with appropriate assembly and termination)

Configuration Data	
Graphic Display	Display used for setting IP address, Subnet Mask, Fault / Idle Actions, and all other system settings.
ARM	(Auto Recovery Module) Optional module that contains automatic recovery of system settings in the event of total or partial system failure.
Maximum Valve Solenoid Outputs	32
Maximum Sub-Bus I/O Points	Various combinations of 1200 outputs and 1200 inputs

Network Data	
Supported Baud Rates	10 Mbit / 100 Mbit
Bus Connector	Two D-coded 4 pin M12 type (female)
Diagnostics	Power, short, open load conditions and module health and configuration are monitored
Special Features	Embedded two port switch, Device Level Ring (DLR) compatibility, Linear network topology, Quick Connect capability, fail-safe device settings, integrated web server, HTTP, TFTP, UNICAST

Weight	
EtherCAT® communications module	227g / 8 oz



NUMATICS

G3 ELECTRONICS

PRODUCT LEAFLET

I/O Modules

Digital Inputs -Terminal Strip Modules

Description	Part Number
16 PNP Inputs	240-203
16 NPN Inputs	240-204

Technical Data

Operating Data	
Temperature Range (ambient)	-10° to 115° F (-23° to +50° C)
Humidity	95% relative humidity, non-condensing
Vibration / Shock	IEC 60068-2-27, IEC60068-2-6
Wire Range	12 to 24 AWG
Strip Length	7 mm
Tightening Torque	0.5 Nm
Moisture Protection	IP20

Spare Parts	
Replacement Terminal Strip (I/O 0-7)	140-1073
Replacement Terminal Strip (I/O 8-15)	140-1074
Keying Element for terminal strip	140-1076
Keying Element for Module	140-1077

Weight	
Input Module	292g / 10.3 oz.

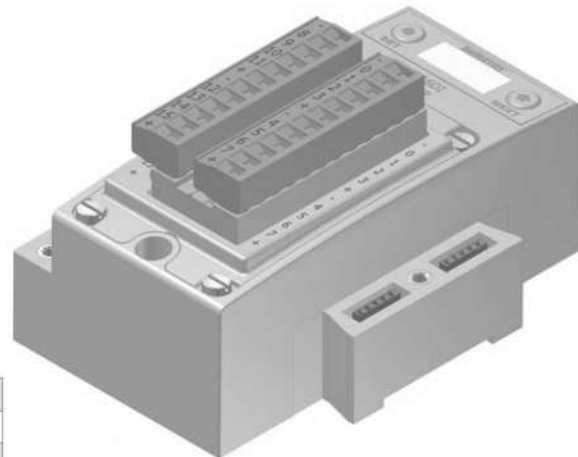

Output Module -Valve Side-Single 25 Pin Sub D

Description	Part Number
16 PNP Inputs	239-1713

Technical Data

Operating Data	
Temperature Range (ambient)	-10° to 115° F (-23° to +50° C)
Humidity	95% relative humidity, non-condensing
Vibration / Shock	IEC 60068-2-27, IEC60068-2-6
Moisture Protection	IP20

Spare Parts	
Cover Gasket	140-1073
Interface Gasket	140-1074

Weight	
Valve side output module	590g / 21 oz.

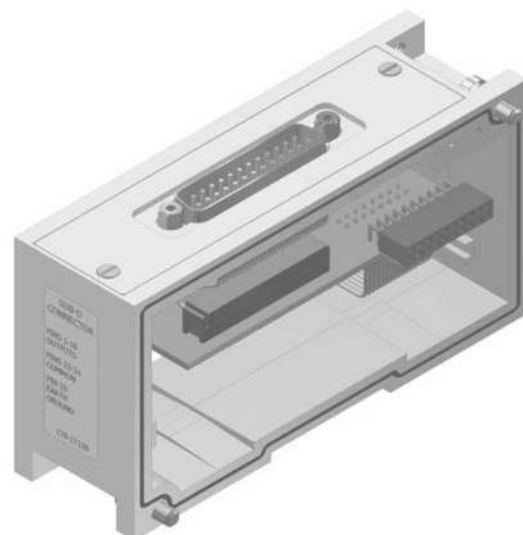



NUMATICS

G3 ELECTRONICS

PRODUCT LEAFLET

I/O Modules

Digital I/O 5-pin M12 Modules

Description	Part Number
Inputs	
8 PNP Inputs	240-206
8 NPN Inputs	240-210
16 PNP Inputs	240-205
16 NPN Inputs	240-209
Outputs	
8 PNP Outputs	240-208
8 PNP High Current Outputs (Fig. A Only)	240-300
16 PNP Outputs	240-207
Inputs and Outputs	
8 PNP Inputs and 8 PNP Outputs	240-211

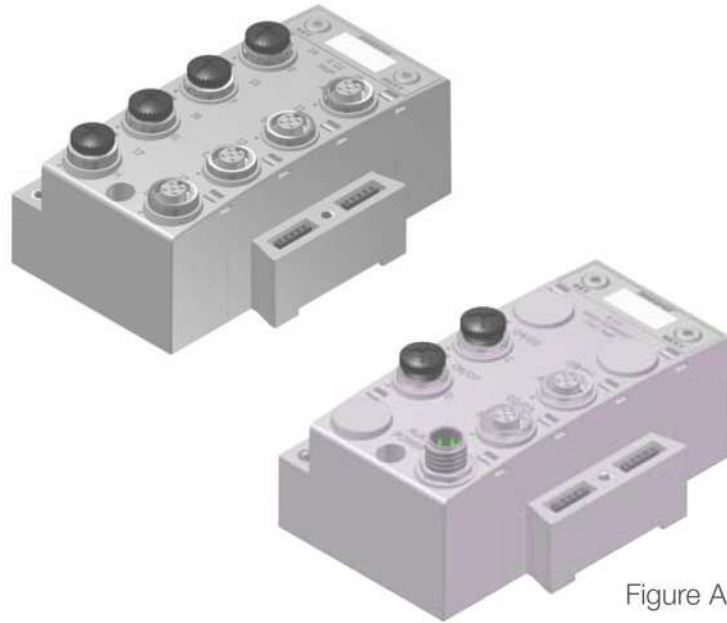

Figure A

Analog I/O with settable high and low alarms 5-pin M12 Modules

Description	Signal Type	Part Number
Inputs		
4 Analog Inputs	0-10 VDC	240-212
4 Analog Inputs	4-20 mA	240-214
Inputs and Outputs		
2 Analog Inputs & 2 Analog Outputs	0-10 VDC	240-213
2 Analog Inputs & 2 Analog Outputs	4-20 mA	240-215
2 Analog Inputs & 2 Analog Outputs High Current for Sentronic Devices	0-10 VDC	240-307



Technical Data

Operating Data	
Temperature Range (ambient)	-10° to 115° F (-23° to +50° C)
Humidity	95% relative humidity, non-condensing
Vibration / Shock	IEC 60068-2-27, IEC60068-2-6
Moisture Protection	IP65, IP67 (with appropriate assembly and termination)
Connector	Female 5-pin M12 SPEEDCON
Resolution	16 bit

Weight	
I/O Module-Analog	244g / 8.6 oz
I/O Module-Digital	274g / 9.7 oz

Dust Cover - M12 Male
230-647



G3 RTD Temperature Module

The RTD module is for use with RTD (Resistive Temperature Detectors), supporting up to four RTD devices simultaneously. The module supports various RTD types including: Pt100, Pt200, Pt500, Pt1000, Ni100 and Ni1000.

Technical Data

Electrical Data	
Voltage	24 VDC Module Supply (Via G3 System Aux. Power Connection)
Input Type	RTD (Resistive Temperature Detector), 4 per Module
Supported Sensor Type	Pt100, Pt200, Pt500, Pt1000, Ni100, Ni1000
Supported Temperature Coefficients	.00385; .00392; ...Ω/Ω/°C
Resolution	15 bits plus sign.
Data Format	Signed Integer
Calibration	Factory Calibrated Field Calibration w/ high tolerance (± .005%) 100 ohm and 350 ohm resistors.
Input Update (filter) Rate	Adjustable (5-20mS), factory default: 5ms
Accuracy	0.1% of full scale @ 25° C



Mechanical Data	
I/O Connector	M12 4 Pin Female (Accepts 5 Pin)
Mass	247g / 8.7 oz.

Operating Data	
Temperature Range	-10° to 115° F (-23° to 46° C)
Humidity	95% relative humidity: non-condensing
Ingress Protection	IP65 (with appropriate assembly and terminations)

240- 317 G3 [Ex ia] NAMUR Input Module

The [Ex ia] module is for use with NAMUR certified intrinsically safe (IS) sensors.

Technical Data

Electrical Data	
Voltage	24 VDC Module Supply Sensor Supply = 8.2 VDC Nominal
Input Type	NAMUR Signal Current (I) ≈ 2.1 mA Signal Current (I) ≤ 1.2 mA Short Circuit Monitoring < 100 Ω Open/Broken Wire Detection < 0.05 mA
Safety Parameter Output Maximums	Uo ≤ 9.6 V Io ≤ 13 mA Po ≤ 31 mW
Diagnostics	Open (broken wire) and Short Circuit



Certification	
Module Marking (ATEX)	II(1)GD [Ex ia Ga] IIC [Ex ia Da] IIIC

Mechanical Data	
I/O Connector	M12 4 Pin Female (Compatible with 5 Pin)
Mass	284g / 10.0 oz.

Operating Data	
Temperature Range	-10° to 115° F (-23° to 46° C)
Humidity	95% relative humidity: non-condensing
Ingress Protection	IP65 (with appropriate assembly and terminations)



NUMATICS G3 ELECTRONICS

PRODUCT LEAFLET

Sub-Bus Modules

Sub-Bus Valve Module

Provides Sub-Bus In and Aux. Power In connections to a distributed valve manifold

Description	Part Number	Weight
Sub-Bus Valve Module	240-241	235g / 8.3 oz



Sub-Bus Out Module

Provides Sub-Bus Out and Aux. Power Out connections for I/O distribution

Description	Part Number	Weight
Sub-Bus Out Module with DIN Rail Clips	240-244	141g / 5.0 oz
Sub-Bus Out Module	240-183	130g / 4.6 oz



Dust Cover - M12 Male
230-647



Sub-Bus In Module

Provides Sub-Bus In and Aux. Power In connections for I/O distribution

Description	Part Number	Weight
Sub-Bus In Module with DIN Rail Clips	240-246	141g / 5.0 oz
Sub-Bus In Module	240-185	130g / 4.6 oz



Dust Cover - M12 Female
230-1200





NUMATICS

G3 ELECTRONICS

PRODUCT LEAFLET

Miscellaneous Modules

Auto Recovery Module (ARM)

Protects configuration information during a critical failure. Allows configuration information to be saved and reloaded to replacement module automatically.



Description	Part Number	Weight
ARM Module	240-182	127g / 4.5 oz

Terminator Module

Provides termination for the sub-bus. Must be installed after the last I/O module or after the communication module if there are no I/O modules installed.



Description	Part Number	Weight
Terminator Module w/ DIN Rail Clips	240-245	102g / 3.6 oz
Terminator Module	240-184	91g / 3.2 oz

Jumper Clip

Provides electrical connections between modules

Description	Part Number	Weight
Jumper Clip	240-179	45g / 1.6 oz





NUMATICS G3 ELECTRONICS

PRODUCT LEAFET

Miscellaneous Modules

Valve Driver Module

Provides connections between the communication module or Sub-Bus valve module and the valve manifold

Generation 2000, ISO 5599/2 and ISO 15407-2 Series

Description	Part Number	Weight
Valve Driver Module w/ DIN Rail Clips	219-858	147g / 5.2 oz
Valve Driver Module	219-828	136g / 4.8 oz



503 Series

Description	Part Number
Valve Driver Module	P599AE425188001
Valve Driver Module w/ DIN Rail Clips	P599AE425188002

Right Hand Mounting Cover

Used when a communication module is used without local valves installed

Description	Part Number	Weight
Right Hand Mounting Cover w/ DIN Rail Clips	240-290	82g / 2.9 oz.
Right Hand Mounting Cover	240-255	71g / 2.5 oz.

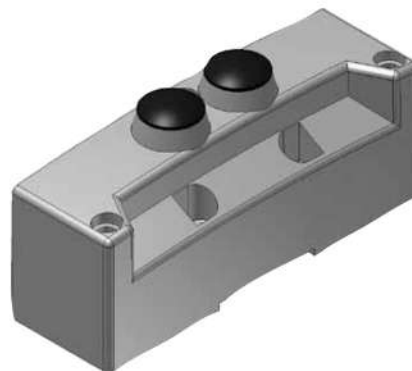

* Not for use in combination with ARM Module

Accessories

For use with Murrplastik[®] Type 20 Software

Labels - 122-1251

Technical Data	
Material	Polycarbonate (PC)
Color	White
Temperature Range	40° - 140° C
Label Dimensions	0.19" x 0.39"
Label - Printable Area	0.19" x 0.39"

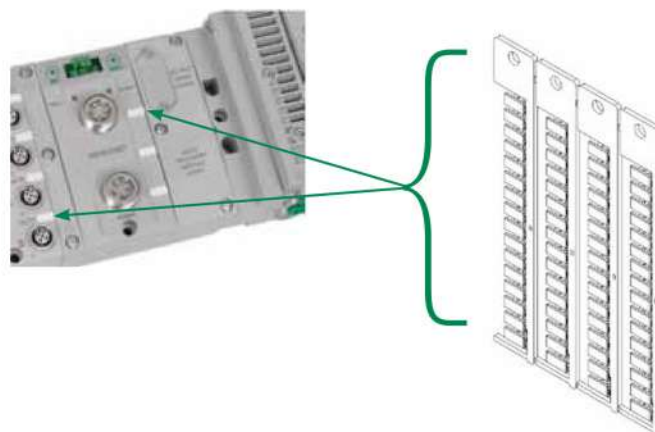

G3 RTD Temperature Module

The RTD module is for use with RTD (Resistive Temperature Detectors), supporting up to four RTD devices simultaneously. The module supports various RTD types including: Pt100, Pt200, Pt500, Pt1000, Ni100 and Ni1000.

Technical Data

Electrical Data	
Voltage	24 VDC Module Supply (Via G3 System Aux. Power Connection)
Input Type	RTD (Resistive Temperature Detector), 4 per Module
Supported Sensor Type	Pt100, Pt200, Pt500, Pt1000, Ni100, Ni1000
Supported Temperature Coefficients	.00385; .00392; ...Ω/Ω/°C
Resolution	15 bits plus sign.
Data Format	Signed Integer
Calibration	Factory Calibrated Field Calibration w/ high tolerance (± .005%) 100 ohm and 350 ohm resistors.
Input Update (filter) Rate	Adjustable (5-20ms), factory default: 5ms
Accuracy	0.1% of full scale @ 25° C



Mechanical Data	
I/O Connector	M12 4 Pin Female (Accepts 5 Pin)
Mass	247g / 8.7 oz

Operating Data	
Temperature Range	-10° to 115° F (-23° to 46° C)
Humidity	95% relative humidity: non-condensing
Ingress Protection	IP65 (with appropriate assembly and terminations)

240- 317 G3 [Ex ia] NAMUR Input Module

The [Ex ia] module is for use with NAMUR certified intrinsically safe (IS) sensors.

Technical Data

Electrical Data	
Voltage	24 VDC Module Supply Sensor Supply = 8.2 VDC Nominal
Input Type	NAMUR
NC (Normally Closed)	Signal Current (0) ≥ 2.1 mA Signal Current (1) ≤ 1.2 mA Short Circuit Monitoring < 100 Ω Open/Broken Wire Detection < 0.05 mA
Safety Parameter Output Maximums	Uo ≤ 9.6 V Io ≤ 13 mA Po ≤ 31 mW
Diagnostics	Open (broken wire) and Short Circuit



Certification	
Module Marking (ATEX)	II(1)GD [Ex ia Ga] IIC [Ex ia Da] IIC

Mechanical Data	
I/O Connector	M12 4 Pin Female (Compatible with 5 Pin)
Mass	284g / 10.0 oz

Operating Data	
Temperature Range	-10° to 115° F (-23° to 46° C)
Humidity	95% relative humidity: non-condensing
Ingress Protection	IP65 (with appropriate assembly and terminations)



NUMATICS G3 ELECTRONICS

PRODUCT LEAFLET

Sub-Bus Modules

Sub-Bus Valve Module

Provides Sub-Bus In and Aux. Power In connections to a distributed valve manifold

Description	Part Number	Weight
Sub-Bus Valve Module	240-241	235g / 8.3 oz



Sub-Bus Out Module

Provides Sub-Bus Out and Aux. Power Out connections for I/O distribution

Description	Part Number	Weight
Sub-Bus Out Module with DIN Rail Clips	240-244	141g / 5.0 oz
Sub-Bus Out Module	240-183	130g / 4.6 oz



Dust Cover - M12 Male
230-647



Sub-Bus In Module

Provides Sub-Bus In and Aux. Power In connections for I/O distribution

Description	Part Number	Weight
Sub-Bus In Module with DIN Rail Clips	240-246	141g / 5.0 oz
Sub-Bus In Module	240-185	130g / 4.6 oz



Dust Cover - M12 Female
230-1200





NUMATICS

G3 ELECTRONICS

PRODUCT LEAFLET

Miscellaneous Modules

Auto Recovery Module (ARM)

Protects configuration information during a critical failure. Allows configuration information to be saved and reloaded to replacement module automatically.



Description	Part Number	Weight
ARM Module	240-182	127g / 4.5 oz

Terminator Module

Provides termination for the sub-bus. Must be installed after the last I/O module or after the communication module if there are no I/O modules installed.

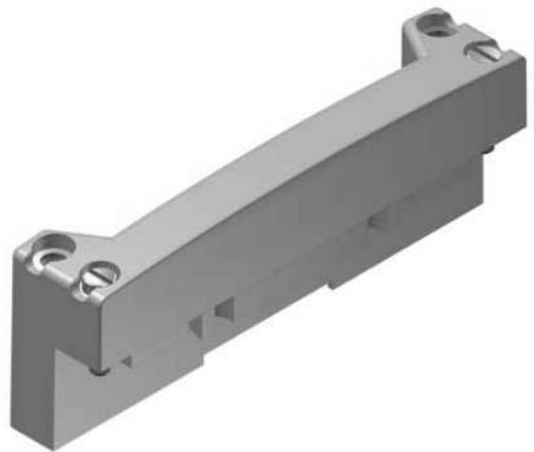

Description	Part Number	Weight
Terminator Module w/ DIN Rail Clips	240-245	102g / 3.6 oz
Terminator Module	240-184	91g / 3.2 oz

Jumper Clip

Provides electrical connections between modules



Description	Part Number	Weight
Jumper Clip	240-179	45g / 1.6 oz



NUMATICS G3 ELECTRONICS

PRODUCT LEAFLET

Miscellaneous Modules

Valve Driver Module

Provides connections between the communication module or Sub-Bus valve module and the valve manifold

Generation 2000, ISO 5599/2 and ISO 15407-2 Series

Description	Part Number	Weight
Valve Driver Module w/ DIN Rail Clips	219-858	147g / 5.2 oz
Valve Driver Module	219-828	136g / 4.8 oz



503 Series

Description	Part Number
Valve Driver Module	P599AE425188001
Valve Driver Module w/ DIN Rail Clips	P599AE425188002

Right Hand Mounting Cover

Used when a communication module is used without local valves installed

Description	Part Number	Weight
Right Hand Mounting Cover w/ DIN Rail Clips	240-290	82g / 2.9 oz.
Right Hand Mounting Cover	240-255	71g / 2.5 oz.

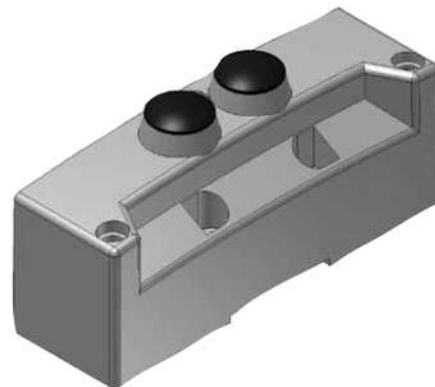

* Not for use in combination with ARM Module

Accessories

For use with Murrplastik[®] Type 20 Software

Labels - 122-1251

Technical Data	
Material	Polycarbonate (PC)
Color	White
Temperature Range	40° - 140° C
Label Dimensions	0.19" x 0.39"
Label - Printable Area	0.19" x 0.39"

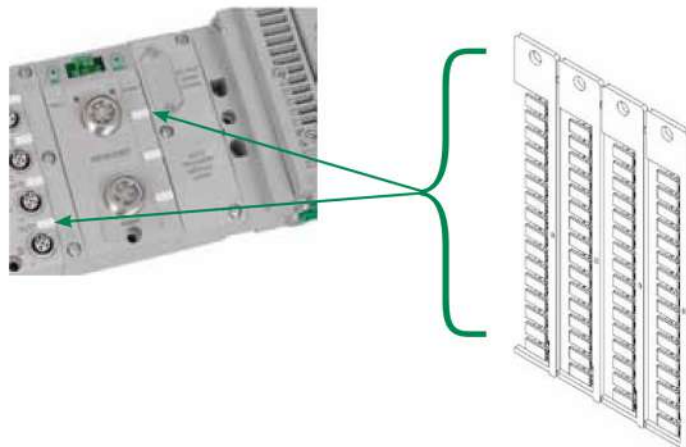

Dimensions: mm (Inches)

Dimensional Drawing - G3 Fieldbus Manifold Assembly

503 Series Valve Manifold Assembly with G3 Electronics and Sub-Bus Output

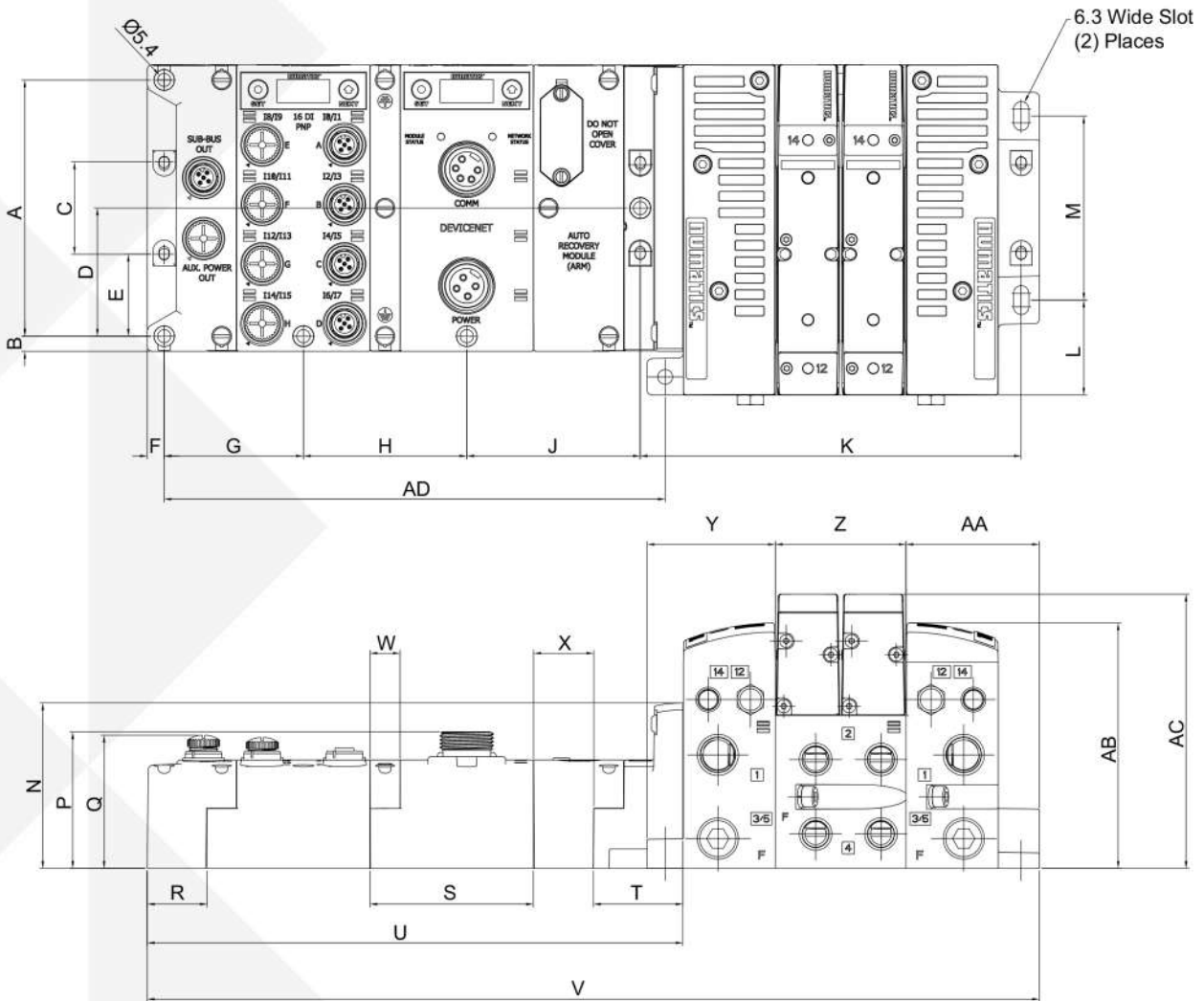

A	B	C	D	E	F	G	H	J	K	L	M	N	P
105.5 (4.154)	6.3 (0.248)	38 (1.5)	52.8 (2.08)	33.8 (1.33)	7 (0.28)	57.5 (2.264)	67.5 (2.66)	71.7 (2.82)	-	39.1 (1.54)	75.8 (2.984)	68.1 (2.68)	56.3 (2.217)

Q	R	S	T	U	V	W	X	Y	Z	AA	AB	AC	AD
54 (2.13)	24.8 (0.98)	67.5 (2.66)	36.9 (1.45)	221.3 (8.713)	368.6 (14.51)	12.5 (0.49)	24.8 (0.976)	53 (2.087)	-	55.1 (2.17)	101.1 (3.98)	112.9 (4.445)	207 (8.2)

* - For valve manifold dimensions refer to Valve Series product catalogs



NUMATICS

G3 ELECTRONICS

PRODUCT LEAFLET

Dimensions: Inches (mm)

Dimensional Drawing - G3 Fieldbus I/O Assembly

I/O Assembly with G3 Electronics and Sub-Bus Input

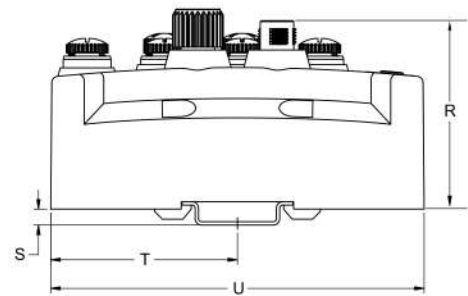
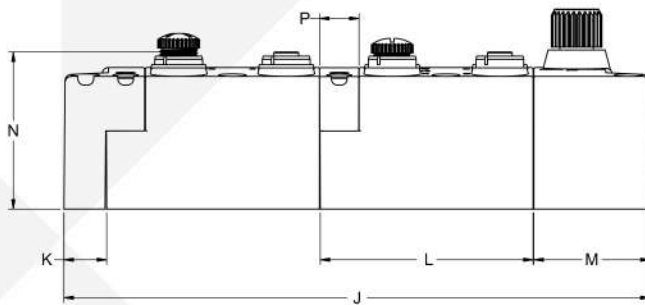
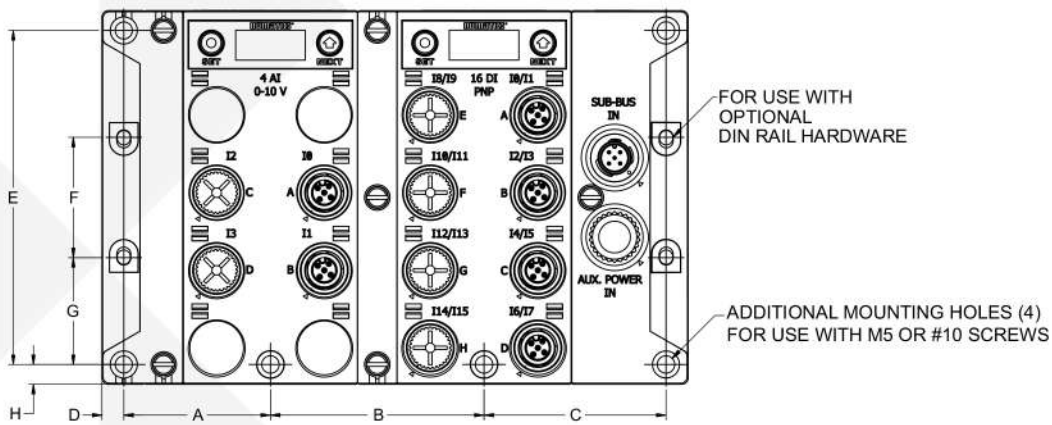

VIEW SHOWN WITH OPTIONAL DIN RAIL HARDWARE AND 35mm DIN RAIL

A	B	C	D	E	F	G	H	J	K	L	M	N	P	R	S	T	U
1.82 (46.35)	2.66 (67.50)	2.26 (57.50)	0.27 (6.90)	4.15 (105.50)	1.50 (38.00)	1.33 (33.75)	0.25 (6.25)	7.29 (185.25)	0.53 (13.50)	2.65 (67.25)	1.45 (36.75)	2.13 (54.00)	0.49 (12.50)	2.46 (62.50)	0.20 (5.05)	2.32 (59.00)	4.65 (118.00)



NUMATICS G3 ELECTRONICS

PRODUCT LEAFLET

Manifold Assembly How to Order

8 503 A V 3 B 2 0 0 V A00

Port Type

- 8 = NPTF¹
- G = ISO228/1-G¹
- K = Push-in Fittings

Product Series

- 503 = 26 mm Valve

Revision

- A = Initial Release

Product Type

- V = Valve Manifold Assembly

Electronics

- 3 = G3 Fieldbus Electronics

Number of Valve Stations

- | | | |
|--------|--------|--------|
| B = 2 | N = 14 | Z = 26 |
| D = 4 | P = 16 | 3 = 28 |
| F = 6 | R = 18 | 5 = 30 |
| H = 8 | T = 20 | 7 = 32 |
| J = 10 | V = 22 | |
| L = 12 | X = 24 | |

Options

- A00 = Standard (No Options)
- MUF = Muffler in End Plates
- DRM = DIN Rail Mount
- DWM = DIN Rail with MUF
- 14X = External Pilot Supply from Port # 14
- D12 = (14X) External Pilot Supply from Port # 14 and (MUF) Muffler in End Plates
- D14 = (14X) External Pilot Supply from Port # 14 and (DRM) DIN Rail Mount
- F06 = (14X) External Pilot Supply from Port # 14, (MUF) Muffler in End Plates, and (DRM) DIN Rail Mount

End Plate Style

- V = Vertical

End Plate Port Size

- 3 = 3/8
- 4 = 1/2
- K = 10 mm
- M = 12 mm

¹ Port Type '8' + 'G' only available in Port Size 3/8



NUMATICS

G3 ELECTRONICS

PRODUCT LEAFLET

How To Order

G3 Assembly Kit

A K 3 E D 0 0 0 0 3 L STD

Electrical / Electronic Type & Location

3 = G3 Electronics

Valve Series*

0 = N/A
 6 = 2002 - 02/R2
 E = 2005
 G = 2012
 B = 2035
 W = ISO 15407-2 18 mm
 X = ISO 15407-2 26 mm
 Q = ISO 5599/2 Size 1
 R = ISO 5599/2 Size 2
 S = ISO 5599/2 Size 3

Number of Valve Stations

A = 1 I = 9 Q = 17 Y = 25
 B = 2 J = 10 R = 18 Z = 26
 C = 3 K = 11 S = 19 2 = 27
 D = 4 L = 12 T = 20 3 = 28
 E = 5 M = 13 U = 21 4 = 29
 F = 6 N = 14 V = 22 5 = 30
 G = 7 O = 15 W = 23 6 = 31
 H = 8 P = 16 X = 24 7 = 32

Special Options

STD = Standard
 DRM = DIN Rail Mounting - Not available w/2035 and ISO 5599/2
 MUF = Muffler - Not available with ISO 5599/2
 DW M= DIN Rail w/ Muffler - Not available w/2035 and ISO 5599/2

End Plate Port Type

L = Push-In Fitting
 N = NPTF Pressure Ports (NPTF Conduit Ports if Applicable)
 G = ISO 228/1-G Tap Pressure Ports (ISO 228/1-G Conduit Ports if Applicable)

End Plate Port Size

2 = 1/4
 3 = 3/8
 4 = 1/2
 6 = 1
 H = 8 mm (5/16)
 K = 10 mm
 X = Two or more valve groups resulting in different standard end plate port sizes.

*For manifold assembly with multiple valve series - Consult Factory

How To Order

G3 Electronics

G3 EP1 00 R 0 STD

Electronics Protocols

CO1 = CANopen
 DL1 = Device Logix
 DN1 = DeviceNet
 EC1 = EtherCAT
 ED1 = EtherNet/IP DLR
 EM1 = Ethernet Modbus - TCP
 EP1 = EtherNet/IP
 PL1 = Ethernet POWERLINK
 PT1 = PROFIBUS-DP
 PN1 = PROFINET
 DS2 = Sub-Bus Valve Manifold
 DS3 = Sub-Bus I/O Assembly

Number of I/O Modules

00 = 0
 01 = 1
 02 = 2
 03 = 3
 04 = 4
 05 = 5
 06 = 6
 07 = 7
 08 = 8
 09 = 9
 10 = 10
 11 = 11
 12 = 12
 13 = 13
 14 = 14
 15 = 15
 16 = 16

Special Options

STD = Standard
 DRM = DIN Rail Mounting
 E23 = Fieldbus assembly without valves
 E28 = Valve Side 25 pin Sub D NPN output module
 E40 = Auto Recovery Module
 G32 = DRM-DIN Rail Mounting
 E40-Auto Recovery Module
 G33 = DRM-DIN Rail Mounting
 E28-Valve Side 25 pin Sub D NPN output module
 G34 = E28-Valve Side 25 pin Sub D NPN output module
 E40-Auto Recovery Module
 G36 = E23-Fieldbus assembly without valves
 DRM-DIN Rail Mounting
 J32 = DRM-DIN Rail Mounting
 E28-Valve Side 25 pin Sub D NPN output module
 E40-Auto Recovery Module

Modification

0 = Initial Release

Left Mounting

D = w/ Sub-Bus Out
 R = w/ Terminating Resistor



NUMATICS

G3 ELECTRONICS

PRODUCT LEAFLET

Ordering Valve Manifold Assemblies with G3 Electronics & Discrete I/O

For valve series 2002, 2005, 2012, 2035, ISO 15407-2 & ISO 5599/2 (2005 shown)

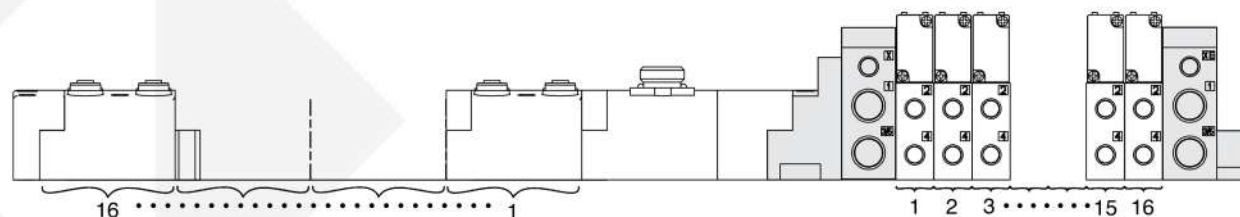

Shaded components are described by the assembly kit (AK) model number (see page 44). The communication module and number of I/O modules are described by the Electronic Interface (G3) model number designation (see page 44).

Each valve station is listed in sequential order from left to right when facing the port side of the manifold as shown.

Each discrete I/O module is listed in sequential order from RIGHT to LEFT starting from the communication module as shown.

NOTE:

1. A total of 32 solenoid outputs are available. Either 32 single solenoid valves or 16 double solenoid valves or any combination of singles and doubles not to exceed 32 outputs can be specified.
2. For manifold assemblies that exceed 16 solenoids, the assembly MUST be configured so that an even number of solenoids are utilized prior to the station using the ribbon cable feature. The 16th and the 17th solenoids cannot be on the same valve.

Example Order - 2005 Shown

Assy Kit	AK3EP00003LMUF
Station 1	052BB4Z2ML00061
Station 2	052BB4Z2ML00061
Station 3	052BB4Z2ML00061
Station 4	052BB4Z2ML00061
Station 5	052BB4Z2ML00061
Station 6	052BB4Z2ML00061
Station 7	052BB4Z2ML00061
Station 8	052BB4Z2ML00061
Station 9	052BB4R2ML00061
Station 10	052BB4Z2ML00061
Station 11	052BB4Z2ML00061
Station 12	052BB4Z2ML00061
Station 13	052BB4Z2ML00061
Station 14	052BB4Z2ML00061
Station 15	052BB4Z2ML00061
Station 16	052BB4Z2ML00061
Electronics	G3DN116R0E40
Station 1	240-205
Station 2	240-205
⋮	
Station 15	240-205
Station 16	240-205

How To Order

G3 Electronics

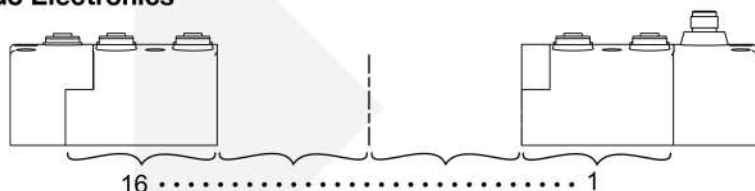

1. Refer to the selection table on page 44 to specify the control electronics and I/O configuration.
2. Each discrete I/O module is listed in sequential order from RIGHT to LEFT as shown.
3. A maximum of 16 I/O modules are supported by a single communication node. Analog I/O & digital I/O (NPN & PNP)

Example Order - I/O assembly

with Sub-Bus in and Sub-Bus out modules

Electronics	G3DS316D0STD
Station 1	240-205
Station 2	240-205
⋮	
Station 15	240-205
Station 16	240-205

7/8" MINI Cables

4 Pin Cables for DeviceNet™, DeviceLogix, Ethernet, Modbus TCP, CANopen, and Sub-Bus

7/8" MINI Straight 4 Pin Female Single Ended Cable, Euro Color Code
MC0405MAC0000000 – 5 Meter
MC0410MAC0000000 – 10 Meter

7/8" MINI 90° 4 Pin Female Single Ended Cable, Euro Color Code
MD0405MAC0000000 – 5 Meter
MD0410MAC0000000 – 10 Meter

5 Pin Cables for PROFIBUS DP, PROFINET and POWERLINK

7/8" MINI Straight 5 Pin Female Single Ended Cable, Euro Color Code
MC0505MAG0000000 – 5 Meter
MC0510MAG0000000 – 10 Meter

7/8" MINI 90° 5 Pin Female Single Ended Cable, Euro Color Code
MD0505MAG0000000 – 5 Meter
MD0510MAG0000000 – 10 Meter

7/8" MINI Field Wireable Connectors

4 Pin Connectors for DeviceNet™, DeviceLogix, Ethernet, Modbus TCP, CANopen, and Sub-Bus

7/8" MINI Straight 4 Pin Female Field Wireable Connector
MC04F90000000000 – Cable Gland – One size fits all

7/8" MINI 90° 4 Pin Female Field Wireable Connector
MD04F20000000000 – PG 9 Cable Gland

5 Pin Connectors for PROFIBUS DP, PROFINET and POWERLINK

7/8" MINI Straight 5 Pin Female Field Wireable Connector
MC05F90000000000 – Cable Gland – One size fits all

7/8" MINI 90° 5 Pin Female Field Wireable Connector
MD05F20000000000 – PG 9 Cable Gland



M12 to 7/8" MINI Cable



4 Pin Cable for Sub-Bus Power

M12 Straight 4 Pin Male to 7/8" MINI 4 Pin Female Extension
TA0401MA0MC0471T – 1 Meter
TA0405MA0MC0471T – 5 Meter
TA0410MA0MC0471T – 10 Meter

M12 Cables

4 Pin Cables for Sub-Bus Power



M12 Straight 4 Pin Female Single Ended Cable, Euro Color Code
TC0405MAE0000000 – 5 Meter
TC0410MAE0000000 – 10 Meter



M12 90° 4 Pin Female Single Ended Cable, Euro Color Code
TD0405MAE0000000 – 5 Meter
TD0410MAE0000000 – 10 Meter



M12 Straight 4 Pin Male to Female Cable Extension
TC0401MAETA04000 – 1 Meter
TC0405MAETA04000 – 5 Meter
TC0410MAETA04000 – 10 Meter

M12 Field Wireable Connectors

4 Pin Connectors for Sub-Bus Power



M12 Straight 4 Pin Female Field Wireable Connector
TC04F10000000000 – PG 7 Cable Gland
TC04F20000000000 – PG 9 Cable Gland



M12 90° 4 Pin Female Field Wireable Connector
TD04F10000000000 – PG 7 Cable Gland
TD04F20000000000 – PG 9 Cable Gland

Pin Out and Technical Data

M12 Cable - Pin Out / Euro Color Code (Male View)

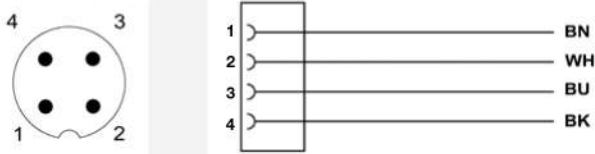

7/8" MINI Cable - Pin Out / Euro Color Code (Male View)

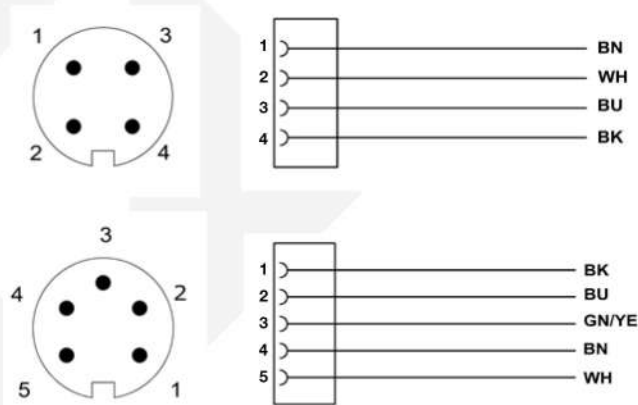

Technical Data	M12	7/8" MINI
Molded Body / Insert	Cable = PVC Field Wireable = Polyamide	Cable = PVC Field Wireable = Polyamide or PBT
Coupling Nut	Nickel Copper Alloy	Black Anodized Aluminum
Cable Jacket Material	PVC	PVC
Cable O.D.	7.4mm	7.4mm (4 Pin & 5 Pin)
Voltage Rating (Nominal)	250 V Max. @ 105° C	250 V Max. @ 105° C
Current Rating	Cables = 4.0 Amps Field Wireable = 4.0 Amps	Cables = 5.5 Amps Field Wireable = 8.0 Amps
Degree of Protection	IP67 (mated)	IP67 (mated)
Operating Temperature	-25° C - 85° C	-40° C - 85° C
Conductor Gauge	Cable = 18 AWG	Cable = 18 AWG
Bend Radius	Cable = 74mm	Cable = 74mm (4 Pin & 5 Pin)
Maximum Wire AWG	Field Wireable = 18 AWG	Field Wireable = 16 AWG
Wire Connection	Field Wireable = Screw Terminal	Field Wireable = Screw Terminal
PG 7 Range	4-6 mm	N/A
PG 9 Range	6-8 mm	5-13 mm – One size fits all
PG 13.5 Range	N/A	5-13 mm – One size fits all



7/8" MINI Drop Cables

7/8" MINI Straight 5 Pin Female Single Ended Cable - Shielded
MC0505MGD0000000 - 5 Meter
MC0510MGD0000000 - 10 Meter

M12 Drop Cables

M12 Straight 5 Pin Female Single Ended Cable - Shielded
TC0505MGD0000000 - 5 Meter
TC0510MGD0000000 - 10 Meter

7/8" MINI 3 Way "T"

3 Way 7/8" MINI "T"
MC0500000MT05000

Terminating Resistors "TR"

7/8" MINI & M12 Straight 5 Pin Male Terminators
TA05TR0000000000 - M12 Male
MA05TR0000000000 - MINI Male

7/8" MINI Field Wireable Connectors

7/8" MINI Straight 5 Pin Field Wireable Connectors
MC05F90000000000 - Female - Cable Gland - One size fits all
MA05F90000000000 - Male - Cable Gland - One size fits all

MINI Cable - Pin Out / Color Code (Male View)

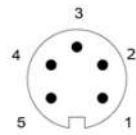

M12 Cable - Pin Out / Color Code (Male View)

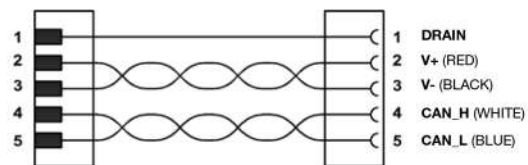
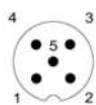

Technical Data	Cable	T & TR	Field Wireable
Molded Body / Insert	PVC	PVC	Body = Glass Filled Polyamide
Coupling Nut	Nickel Plated Brass or Anodized Aluminum	Clear Anodized Aluminum	Black Anodized Aluminum
Cable Jacket Material	PVC	N/A	N/A
Cable O.D.	MINI = 8mm M12 = 8mm	N/A	5-13mm - One size fits all
Voltage Rating (Nominal)	150 Volts	T = 300 Volts	600 Volts
Current Rating	MINI = 4.0 Amps MR = 3.0 Amps	T = 8.0 Amps TR = NA	8.0 Amps
Degree of Protection	IP65 (mated)	IP65 (mated)	IP65 (mated)
Operating Temperature	-40° C - 80° C	-40° C - 105° C	-40° C - 90° C
Conductor Gauge	22 AWG Power 24 AWG Signal	N/A	16-22 AWG
Bend Radius	Cable = 72mm	N/A	N/A
Wire Connection	NA	N/A	Screw Terminal



M12 D-Coded Cable - Pin Out / Color Code (Male View)

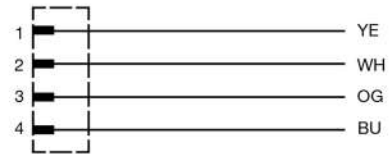
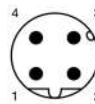

M12 D-Coded Cables

M12 Straight 4 Pin Male D-Coded Single Ended Cable

QA0405MR00000000 – 5 Meter

QA0410MR00000000 – 10 Meter

M12 Straight 4 Pin Male D-Coded Double Ended Cable

QA0405MR0QA04000 – 5 Meter

QA0410MR0QA04000 – 10 Meter

M12 Straight 4 Pin Male D-Coded to Male RJ45 Cable

QA0405MR0VA04000 – 5 Meter

QA0410MR0VA04000 – 10 Meter

M12 Straight 4 Pin Male D-Coded to RJ45 Female Socket Converter

QA04D2MK0VC04000 – 0.2 Meter

M12 D-Coded Field Attachable CONNECTORS

M12 Straight 4 Pin Male D-Coded Field Wireable Connector

QA04F20000000000 – PG 9 Cable Gland – Screw Terminal

M12 Straight 4 Pin Male D-Coded Field Wireable Connector W/IDC

QA04F200R000071N – PG 9 Cable Gland - IDC

RJ45 Field Attachable CONNECTOR

RJ45 Field Wireable Connector with IDC

VA08F200R000071N – PG 9 Cable Gland

Technical Data	Cable	RJ45 Field Attachable	M12 Field Attachable
Molded Body / Insert	TPU	Housing = PA Carrier = PC	Body = Nickel Plated Zinc Insert = PA 66
Coupling Nut	Nickel Plated Zinc	N/A	Nickel Plated Brass
Cable Jacket Material	PVC	N/A	N/A
Cable O.D.	6.5 to 7.4 mm	Accepts 4.5 to 8.0 mm	Accepts 6.0 to 8 mm
Voltage Rating (Nominal)	250 Volts	N/A	60 Volts
Current Rating	4.0 Amps	1.75 Amps	Screw 4.0 Amps IDC 1.75 Amps
Degree of Protection	IP65 (mated), RJ45 – IP20	IP20	IP 65 (mated)
Operating Temperature	-25° C - 60° C	-10° C - 60° C	-40° C - 85° C
Conductor Gauge	22 & 24 AWG	22 AWG Solid/Stranded	Screw 24-18 AWG IDC 26-22 AWG
Bend Radius Minimum	19.5mm (fixed) 45.5mm (Flexible)	N/A	N/A
Wire Connection	NA	IDC	Screw Terminal, IDC



M12 D-Coded Cable & RJ45
Pin Out / Color Code (Male View)

M12 D-Coded Cables

M12 Straight 4 Pin Male D-Coded Double Ended Cable
QA0405MSOQA04000 – 5 Meter
QA0410MSOQA04000 – 10 Meter
M12 Straight 4 Pin Male D-Coded to Male RJ45 Cable
QA0405MSOVA04000 – 5 Meter
QA0410MSOVA04000 – 10 Meter
M12 Straight 4 Pin Male D-Coded to RJ45 Female Socket Converter
QA04D2MKOVCO4000 – 0.2 Meter

M12 D-Coded Field Attachable CONNECTORS

M12 Straight 4 Pin Male D-Coded Field Wireable Connector
QA04F2000000000 – PG 9 Cable Gland – Screw Terminal
M12 Straight 4 Pin Male D-Coded Field Wireable Connector W/IDC
QA04F200R000071N – PG 9 Cable Gland - IDC

RJ45 Field Attachable CONNECTOR

RJ45 Field Wireable Connector with IDC
VA08F200R000071N – PG 9 Cable Gland

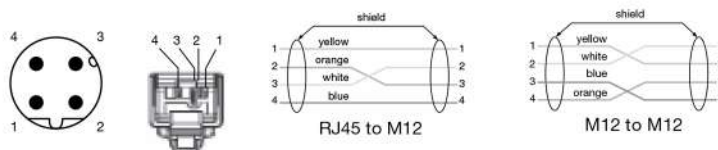

Technical Data	Cable	RJ45 Field Attachable	M12 Field Attachable
Molded Body / Insert	N/A	Housing = PA Carrier = PC	Body = Nickel Plated Zinc Insert = PA 66
Coupling Nut	Nickel Plated Zinc or Brass	N/A	Nickel Plated Brass
Cable Jacket Material	PUR	N/A	N/A
Cable O.D.	6.5 mm	Accepts 4.5 to 8.0 mm	Accepts 6.0 to 8 mm
Voltage Rating (Nominal)	N/A	N/A	60 Volts
Current Rating	N/A	1.75 Amps	Screw 4.0 Amps IDC 1.75 Amps
Degree of Protection	IP65 (mated), RJ45 – IP20	IP20	IP 65 (mated)
Operating Temperature	-25° C - 60° C	-10° C - 60° C	-40° C - 85° C
Conductor Gauge	22 AWG	22 AWG Solid/Stranded	Screw 24-18 AWG IDC 26-22 AWG
Bend Radius Minimum	45.5mm	N/A	N/A
Wire Connection	N/A	IDC	Screw Terminal, IDC



M12 D-Coded Cables

M12 Straight 4 Pin Male D-Coded Single Ended Cable - Shielded

QA0405MK00000000 – 5 Meter

QA0410MK00000000 – 10 Meter



M12 Straight 4 Pin Male D-Coded to Male RJ45 Cable - Shielded

QA0405MK0VA04000 – 5 Meter

QA0410MK0VA04000 – 10 Meter



M12 Straight 4 Pin Male D-Coded to RJ45 Female Socket Converter - Shielded

QA04D2MK0VC04000 – 0.2 Meter



M12 D-Coded Field Wireable Connectors

M12 Straight 4 Pin Male D-Coded Field Wireable Connector

QA04F20000000000 – PG 9 Cable Gland – Screw Terminal



M12 Straight 4 Pin Male D-Coded Field Wireable Connector w/IDC

QA04F2000000071N – PG 9 Cable Gland - IDC



RJ45 Field Wireable Connector

RJ45 Field Wireable Connector with IDC

VA08F2000000071N – PG 9 Cable Gland

M12 D-Coded Cable - Pin Out / Color Code (Male View)

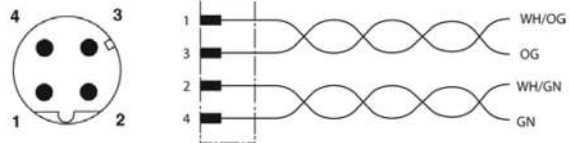

Technical Data	Cable	RJ45 Field Wireable	Field Wireable
Molded Body / Insert	TPU, PA, PA66	Housing = PA Carrier = PC	Body = Nickel Plated Zinc Insert = PA 66
Coupling Nut	Nickel Plated Zinc or Brass	N/A	Nickel Plated Brass
Cable Jacket Material	PUR or PVC	N/A	N/A
Cable O.D.	6.7 or 8.0 mm	4.5 to 8.0 mm	6.0 to 8.0 mm
Voltage Rating (Nominal)	42 Volts	N/A	60 Volts
Current Rating	1.5 Amps	1.75 Amps	Screw 4.0 Amps IDC 1.75 Amps
Degree of Protection	IP65 (mated)	IP20 (mated)	IP65 (mated)
Operating Temperature	-20° C - 60° C	-20° C - 70° C	-40° C - 85° C
Conductor Gauge	26 or 24 AWG	26-22 AWG Solid/Stranded	Screw 24-18 AWG IDC 26-22 AWG
Bend Radius	40mm	N/A	N/A
Wire Connection	NA	IDC	IDC, Screw Terminal



M12 Reverse Key B-Coded Cables

M12 Straight 5 Pin Male Reverse Key Single Ended Cable - Shielded
RA0505MHP0000000 – 5 Meter
RA0510MHP0000000 – 10 Meter

M12 Straight 5 Pin Female Reverse Key Single Ended Cable - Shielded
RC0505MHP0000000 – 5 Meter
RC0510MHP0000000 – 10 Meter

M12 Straight 5 Pin MALE TO FEMALE Reverse Key EXTENSION CABLE
RC0505MHPRC05000 – 5 Meter
RC0510MHPRC05000 – 10 Meter

M12 Reverse Key B-Coded Field Wireable Connectors

M12 Straight 5 Pin Male Reverse Key Field Wireable Connector
RA05F200P0000000 – PG 9 Cable Gland

M12 Straight 5 Pin Female Reverse Key Field Wireable Connector
RC05F200P0000000 – PG 9 Cable Gland

M12 Reverse Key B-Coded Terminating Resistor

M12 Straight 5 Pin Male Reverse Key Terminating Resistor
RA05TR0000000000 - Male

**M12 Reverse Key B-Coded Cable
Pin Out / Color Code
(Male View)**

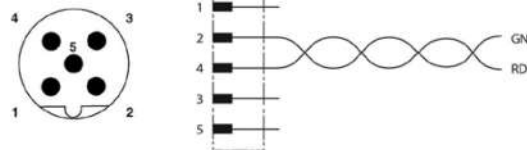

Technical Data	Cable	TR	Field Wireable
Molded Body / Insert	TPU	TR = TPU	Body = Nickel Plated Zinc Insert = PA 66
Coupling Nut	Nickel Plated Zinc	Nickel Plated Zinc or Brass	Nickel Plated Brass
Cable Jacket Material	PUR	N/A	N/A
Cable O.D.	7.4 mm	N/A	8.5 mm Max.
Voltage Rating (Nominal)	250 volts	60 Volts	60 Volts
Current Rating	4.0 Amps	4.0 Amps	4.0 Amps
Degree of Protection	IP65 (mated)	IP65 (mated)	IP 65 (mated)
Operating Temperature	-20° C - 80° C	-20° C - 80° C	-40° C - 85° C
Conductor Gauge	24 AWG	N/A	18 AWG Maximum
Bend Radius	Cable = 78mm	N/A	N/A
Wire Connection	N/A	N/A	Screw Terminal



I/O Cables with SPEEDCON Connector Technology

M12 Straight 4 Pin Male Single Ended Cable, Euro Color Code
TA04E5MIE000071P – 1.5 Meter
TA0403MIE000071P – 3 Meter
TA0405MIE000071P – 5 Meter



M12 90° 4 Pin Male Single Ended Cable, Euro Color Code
TB04E5MIE000071P – 1.5 Meter
TB0403MIE000071P – 3 Meter
TB0405MIE000071P – 5 Meter



M12 Straight 4 Pin Male to Female Cable Extension
TC04E5MIETA0471P – 1.5 Meter
TC0403MIETA0471P – 3 Meter



M12 Straight 3 Pin Male to M8 3 Pin Straight Female Extension
TC03E5MIEPA0371P – 1.5 Meter
TC0303MIEPA0371P – 3 Meter

I/O Connectors



M12 Straight 4 Pin Male Field Wireable Connector, IDC Connection
TA04F2000000081E – PG 9 Cable Gland w/ SPEEDCON connector technology



M12 Straight 4 Pin Male Field Wireable Connector, Screw Terminal
TA04F10000000000 – PG 7 Cable Gland
TA04F20000000000 – PG 9 Cable Gland



M12 90° 4 Pin Male Field Wireable Connector, Screw Terminal
TB04F10000000000 – PG 7 Cable Gland
TB04F20000000000 – PG 9 Cable Gland

I/O Splitters



M12 to M12 "Y" Splitter, 21mm Spacing
TA0500000JC05000



M12 to M8 "Y" Splitter
TA0400000KC03000



M12 Cable Splitter, 2 Straight M12 Female Connectors
TA04D3MIEJC04000 – 0.3 Meter
TA04E5MIEJC04000 – 1.5 Meter
TA0403MIEJC04000 – 3.0 Meter



M12 Cable Splitter, 2 Straight M8 Female Connectors
TA04D3MIEKC03000 – 0.3 Meter
TA04E5MIEKC03000 – 1.5 Meter
TA0403MIEKC03000 – 3.0 Meter



Wire Stripper Tool
140-1097

I/O Cable Connector Pin Out Diagrams

M12 Cable - Pin Out / Color Code
TA04XXMIE0000000, TB04XXMIE0000000
(Male View)



M12 Cable - Pin Out / Color Code
TC03XXMIEPA0371P
(Male to Female View)

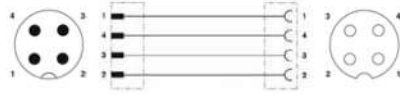

M12 Cable - Pin Out / Color Code
TC03XXMIEPA0371P
(Male to Female View)



M12 to M12 "Y" Splitter - Pin Out
TA0500000JC05000
(Male to Female View)

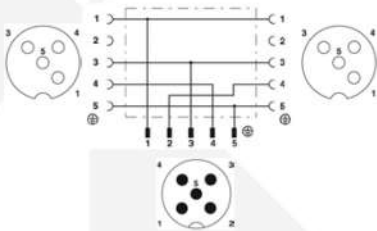

M12 to M8 "Y" Splitter - Pin Out
TA0400000KC03000
(Male to Female View)

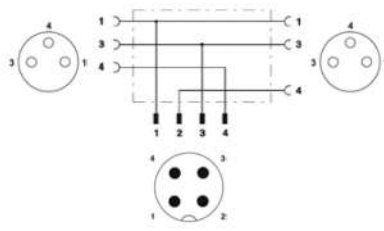

M12 Field Wireable (IDC) - Pin Out
TA04F2000000081E (SPEEDCON)
(Male View)

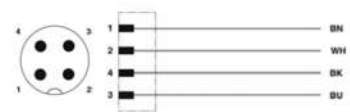

M12 to M12 Cable Splitter - Pin Out
TA04XXMIEJC04000
(Male to Female View)

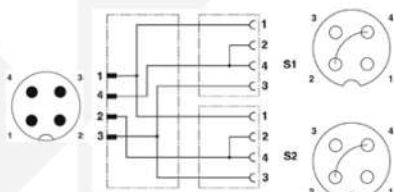

M12 to M8 Cable Splitter - Pin Out
TA04XXMIEKC03000
(Male to Female View)

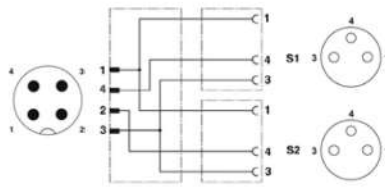

Note:
XX denotes allowable length
See pages 46 and 47.



NUMATICS

G3 ELECTRONICS

PRODUCT LEAFET

Cable and Connector Technical Data

Technical Data	M12 Cables	M12/M8 Cables	M12 Connectors
Molded Body / Insert	TPU	TPU	Polyamide (or) PA 66
Coupling Nut	Nickel Plated Zinc	Nickel Plated Zinc	Nickel Plated Zinc
Cable Jacket Material	PUR	PUR	NA
Cable O.D.	4.70 mm	4.70 mm	PG7 4.0 to 6.0 mm PG9 4.0 to 8.0 mm
Voltage Rating	250 Volts	60 Volts	50 Volts
Current Rating (Cond.)	4.0 Amps	3.0 Amps	4.0 Amps
Degree of Protection	IP65 (mated)	IP65 (mated)	IP67 (mated)
Operating Temperature	-25° C to 80° C (fixed instl.)	-25° C to 80° C (fixed instl.)	-25° C to 80° C
Conductor Gauge	22 AWG	22 AWG	22 AWG Min. 18 AWG Max.
Bend Radius	47 mm	47 mm	NA

Technical Data	I/O "Y" Splitter	I/O Cable Splitter
Molded Body / Insert	TPU	TPU
Coupling Nut	Nickel Plated Zinc	Nickel Plated Zinc
Cable Jacket Material	NA	PUR
Cable O.D.	NA	4.40 mm
Voltage Rating	60 Volts	60 Volts
Current Rating (Cond.)	3.0 Amps	3.0 Amps
Degree of Protection	IP67 (mated)	IP67 (mated)
Operating Temperature	-25° C to 90° C	-25° C to 80° C
Conductor Gauge	NA	22 AWG or 24 AWG
Bend Radius	NA	44 mm

Technical Data	Wire Stripper
Use with	PVC Insulation
Stripping Range	28 AWG to 10 AWG
Cutting Range (Flexible)	10 AWG
Cutting Range (Rigid)	12 AWG

Sub-Bus Cables



M12 Straight 5 Pin Male to Female Sub-Bus Cable - Shielded
TA0501MGDTC0571P – 1 Meter
TA0505MGDTC0571P – 5 Meter
TA0510MGDTC0571P – 10 Meter



M12 Straight 5 Pin Female FIELD WIREABLE CONNECTOR, SPRING CAGE
TC05F200000071V – PG9 Cable Gland



M12 Straight 5 Pin Male FIELD WIREABLE CONNECTOR, SPRING CAGE
TA05F200000071V – PG9 Cable Gland



M12 90° 5 Pin Female FIELD WIREABLE CONNECTOR, SPRING CAGE
TD05F200000071V – PG9 Cable Gland



M12 90° 5 Pin male FIELD WIREABLE CONNECTOR, SPRING CAGE
TB05F200000071V – PG9 Cable Gland



Bulk Sub-Bus Cable	*NOTE
000550MGD0005000 – 50 Meter Length	
0005A0MGD0005000 – 100 Meter Length	

*** Note:**

Length of field wired cables should not exceed the maximum length of 30 meters for total sub-bus communications link. See appropriate technical manual for sub-bus length requirements. The cable assemblies and Bulk cable are the only approved cables for the G3 Sub-Bus link. See technical document TDG3SBWD1-0EN for proper installation and wiring of field wireable connectors.

Technical Data

Technical Data	Cable	Connectors	Bulk Cable
Molded Body / Insert	TPU	Zinc - Nickel Plated	N/A
Coupling Nut	Zinc - Nickel Plated	Brass - Nickel Plated	N/A
Cable Jacket Material	PUR	N/A	Gray RAL 7001
Cable O.D.	6.70 mm	N/A	6.70 mm
Voltage Rating (Nominal)	60 Volts	60 Volts	60 Volts
Current Rating	4.0 Amps	4.0 Amps	4.0 Amps
Degree of Protection	IP65 (mated)	IP65 (mated)	IP65 (terminated)
Operating Temperature	-40° C - 80° C	-40° C - 80° C	-20° C - 75° C
Conductor Gauge	24 AWG Signal 22 AWG Power	26-20 AWG	24 AWG Signal 22 AWG Power
Bend Radius	67 mm	N/A	67 mm
No. of Bending Cycles	5 Million	N/A	5 Million

Example Sub-Bus Layout and Cabling (DeviceNet™ / CANopen® Network)

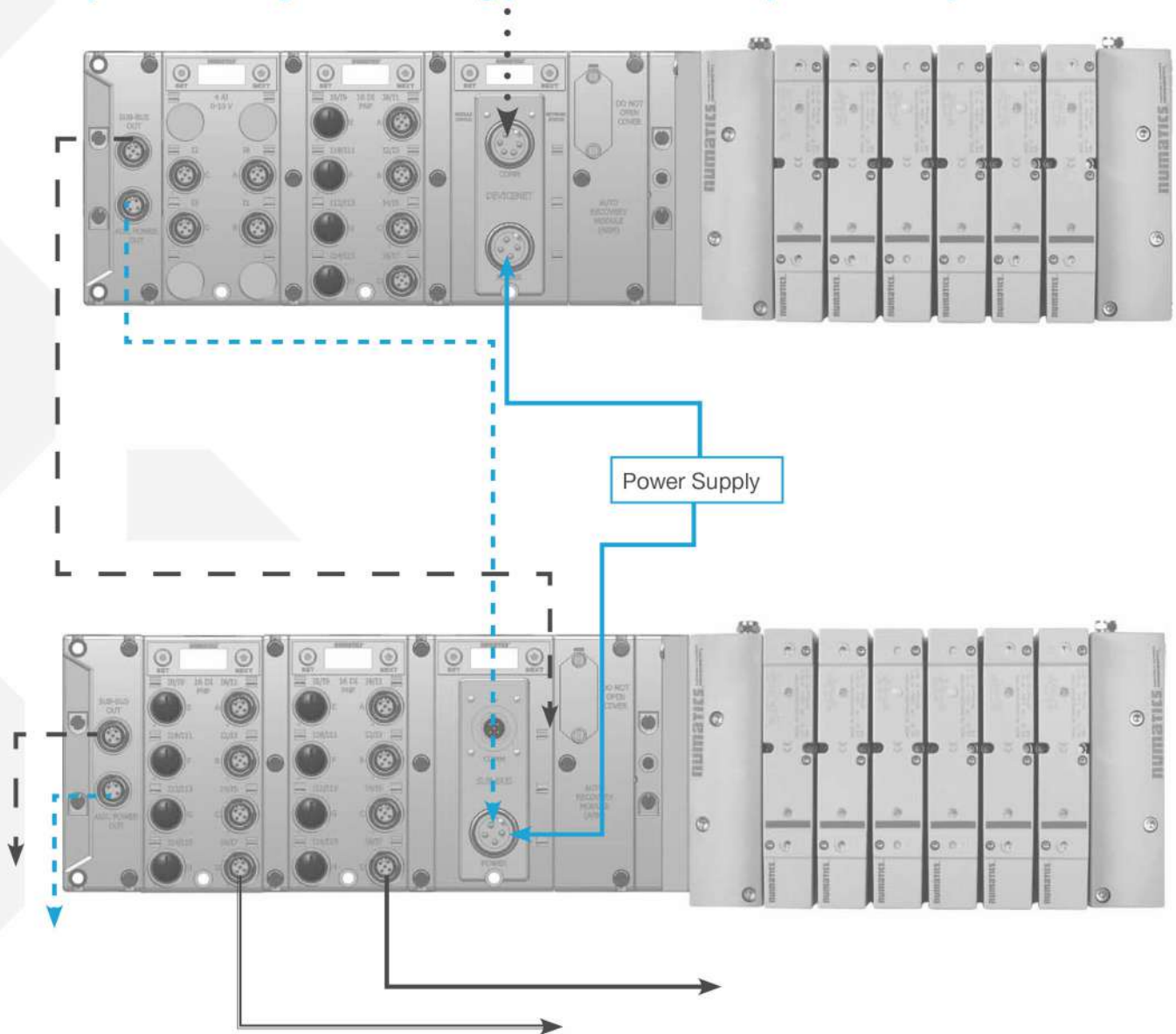

Cable	Description	Example Cable Part #	Page
	Power Cable	MC0405MAC0000000	354
	DeviceNet™/CANopen Communication Cable	MC0505MGD0000000	357
	Sub-Bus Cable	TA0501MGDTC057 1P	365
	Alternate Sub-Bus Power Option	TA0401MA0MC04000	355
	I/O Field Wireable Connector	TA04F2000000081E	362
	I/O Connector with Molded Cable	TA0405MIE000071P	362



NUMATICS

G3 ELECTRONICS

PRODUCT LEAFLET

Manifold Assembly How to Order

8 503 A V J B 2 0 0 V A00

Port Type

- S = NPTF¹
- G = ISO228/1-G¹
- K = Push-In Fittings

Product Series

- 503 = 26 mm Valve

Revision

- A = Initial Release

Product Type

- V = Valve Manifold Assembly

Electronics

- J = 26 Pin Sub-D
- M = 37 Pin Sub-D
- O = 19 Pin Round Connector
- T = Terminal Strip 1-32
- S = G3

Number of Valve Stations

- | | | | |
|-------|--------|--------|--------|
| B = 2 | J = 10 | R = 18 | Z = 26 |
| D = 4 | L = 12 | T = 20 | 3 = 28 |
| F = 6 | N = 14 | V = 22 | 5 = 30 |
| H = 8 | P = 16 | X = 24 | 7 = 32 |

Options

- A00 = Standard (No Options)
- MUF = Muffler in End Plates
- DRM = DIN Rail Mount
- DWM = DIN Rail with MUF
- 14X = External Pilot Supply from Port # 14
- D12 = (14X) External Pilot Supply from Port # 14 and (MUF) Muffler in End Plates
- D14 = (14X) External Pilot Supply from Port # 14 and (DRM) DIN Rail Mount
- F06 = (14X) External Pilot Supply from Port # 14, (MUF) Muffler in End Plates, and (DRM) DIN Rail Mount

End Plate Style

- V = Vertical
- H = Horizontal²

End Plate Port Size

- 3 = 3/8
- 4 = 1/2
- K = 10 mm
- M = 12 mm

¹ Port Type 'S' + 'G' only available in Port Size 3/8

² Horizontal end plates only available with Electronics option 'D' - No Electronics

Maximum Solenoid Outputs

Terminal Strip	25 Pin Sub-D	37 Pin Sub-D	19 Pin Round	G3 Fieldbus
32	22	32	16	32

*NOTE: Maximum number of valve stations is determined by:

- The electrical connection type.
- The valve type - single solenoid valves up to the maximum solenoid outputs allowed by the electrical connection type (see chart above) or a combination of single and/or double solenoid valves not to exceed the maximum number of solenoid outputs allowed.
- Combination of all stations cannot exceed 32 solenoids

25 or 37 Pin Sub-D, Terminal Strip and 19 Pin Round Connector

- Shaded components described by Assembly Kit model number designation (see #1, page 59).
- Each valve manifold station is listed in sequential order from left to right when facing the port side of the manifold as indicated.

Example order:

25 PIN SUB-D	8503AVJF300VA00
Valve Station #1	R503A2B40MA0061
Valve Station #2	R503A2B40MA0061
Mounting #1	8503AMM22MA0010
Valve Station #3	R503A2B60MA0061
Valve Station #4	R503A2B60MA0061
Mounting #2	8503AMM22MA0010
Valve Station #5	R503A2B40MA0061
Valve Station #6	R503A2B40MA0061
Mounting #3	8503AMM22MA0010
	ASSEMBLED

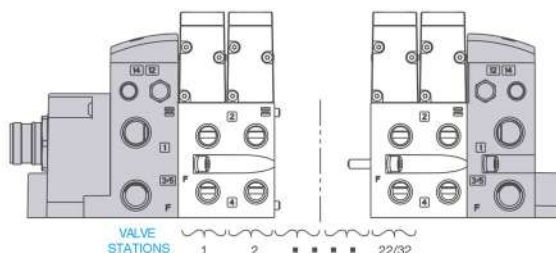
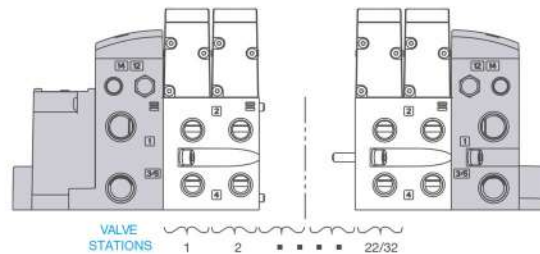

25 Pin Sub-D Connector Kit

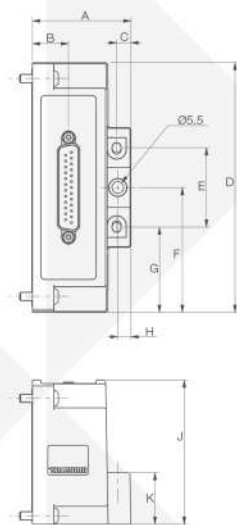

Dimensions: mm (Inches)									
A	B	C	D	E	F	G	H	J	K
46.4 (1.827)	17 (0.669)	6.7 (0.26)	118 (4.65)	37.5 (1.48)	59 (2.32)	40.2 (1.58)	40.2 (1.58)	68.1 (2.68)	24.4 (0.96)

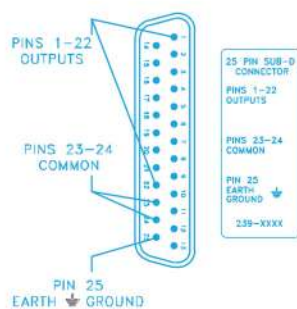

25 Pin Sub-D Connector Housing Kits	
P599AE428441001	25 PIN SUB-D ASSEMBLY WITHOUT DIN RAIL
P599AE428441002	25 PIN SUB-D ASSEMBLY WITH DIN RAIL

NOTE: External fusing or output protection recommended.

37 Pin Sub-D Connector Kit

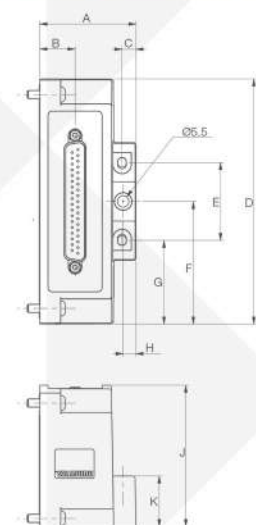

Dimensions: mm (Inches)									
A	B	C	D	E	F	G	H	J	K
46.4 (1.827)	17 (0.669)	6.7 (0.26)	118 (4.65)	37.5 (1.48)	59 (2.32)	40.2 (1.58)	40.2 (1.58)	68.1 (2.68)	24.4 (0.96)

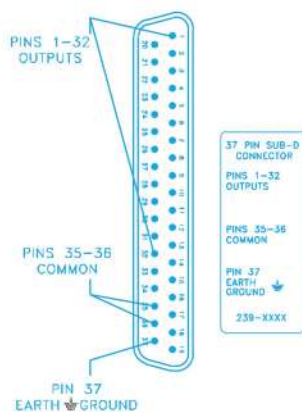

37 Pin Sub-D Connector Housing Kits	
P599AE428442001	37 PIN SUB-D ASSEMBLY WITHOUT DIN RAIL
P599AE428442002	37 PIN SUB-D ASSEMBLY WITH DIN RAIL

NOTE: External fusing or output protection recommended.

1-32 Terminal Strip Kit

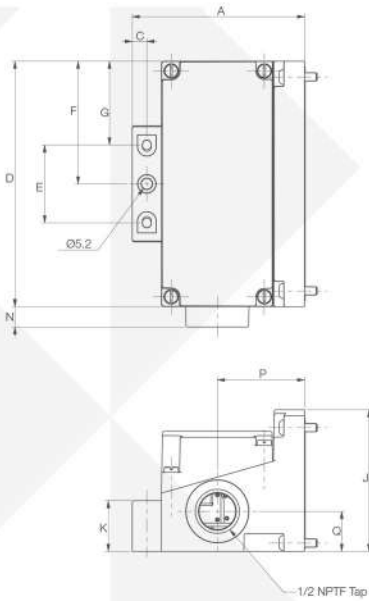

Dimensions: mm (Inches)

A	C	D	E	F	G	J	K	N	P	Q
82.7 (3.256)	7 (0.28)	118 (4.65)	37.5 (1.48)	59 (2.32)	40.2 (1.583)	68.1 (2.68)	24.4 (0.96)	9.8 (0.39)	41.9 (1.65)	19.3 (0.76)

TERMINAL STRIP
TERMINALS 1-32 OUTPUTS
TERMINAL COM COMMON
TERMINAL GND EARTH GROUND
18 AWG WIRE MAXIMUM

1 - 32 Terminal Strip Housing Kits

P599AE428444001	TERMINAL STRIP ASSEMBLY WITHOUT DIN RAIL
P599AE428444002	TERMINAL STRIP ASSEMBLY WITH DIN RAIL

NOTE: External fusing or output protection recommended.
NOTE: Min. Wire AWG 26
Max. Wire AWG 18

19 Pin Round Connector Kit

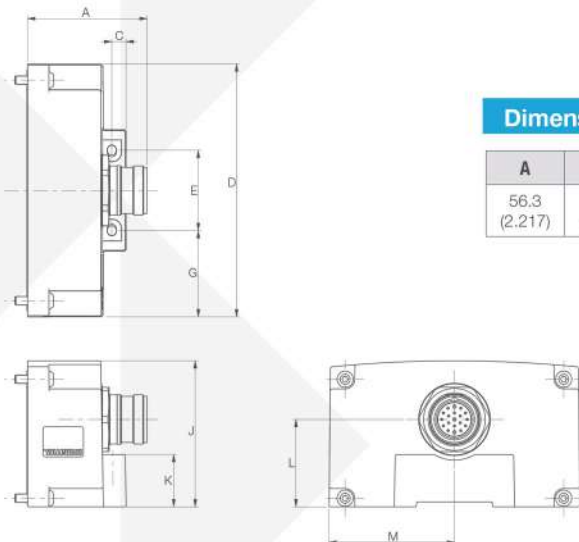

Dimensions: mm (Inches)

A	C	D	E	G	J	K	L	M
56.3 (2.217)	6.7 (0.26)	118 (4.65)	37.5 (1.48)	40.2 (1.583)	68.1 (2.68)	24.4 (0.96)	40.8 (1.61)	59 (2.323)

19 PIN CONNECTOR

PIN 1= COIL 15
PIN 2= COIL 11
PIN 3= COIL 7
PIN 4= COIL 4
PIN 5= COIL 3
PIN 6= COMMON
PIN 7= COIL 2
PIN 8= COIL 6
PIN 9= COIL 10
PIN 10= COIL 14
PIN 11= COIL 13
PIN 12= P.E.
PIN 13= COIL 12
PIN 14= COIL 8
PIN 15= COIL 1
PIN 16= COIL 5
PIN 17= COIL 9
PIN 18= COIL 16
PIN 19= N.C.

19 Pin Round Connector Housing Kits

P599AE428436001	19 PIN ASSEMBLY WITHOUT DIN RAIL
P599AE428436002	19 PIN ASSEMBLY WITH DIN RAIL

NOTE: External fusing or output protection recommended.



A.P.S. CONTROL CO., LTD., THAILAND

7 SOI ON-NUCH 62 SUKHUMVIT 77 RD. ON-NUCH SUANLUANG BANGKOK 10250 WWW.APSCONTROL.CO.TH
Tel: 0 2721 1800 (Auto) Fax: 0 2721 1791 E-mail: sales@apscontrol.co.th Line ID: aps.sales Tax.ID: 010-55430-20618

Note: We are engineering partner as a total system solution provider, Numatics global operations were unified brand, setting the stage for the company's next period of growth. As a comprehensive solution provider, We have great quality control procedures. The calculate various system designs and can work together perfectly. Finally we are fully committed to maintaining environment quality together.

NUMATICS INC., THE UNITED STATES

Note: NUMATICS leads in quality management via initiatives such as ISO 9001:2008, 6 Sigma continuous improvement, and lean manufacturing. Our products are tested up to 500 million cycles, far beyond the operating requirements of their intended applications. In fact, NUMATICS is certified as a test data facility for UL and CSA-these agencies accept our test data for many parameters to grant their approval of our products.

THE NUMATICS PNEUMATIC VALVE © 2019 Numatics. All Rights Reserved.