

Proceedings of the



This Project has received funding from the European Union's European Atomic Energy Community's (Euratom) FP7 under grant agreement n°269905, the LUCOEX project.

LUCOEX

Conference and Workshop



Full-scale demonstration tests in technology development of repositories for disposal of radioactive waste

Oskarshamn, Sweden
June 2–4, 2015



Welcome to the LUCOEX conference and workshop

On behalf of the Conference Group, we would like to warmly welcome you to Oskarshamn – the Energy municipal of Sweden, and to the LUCOEX End Conference and Workshop.



This year's conference theme, "Full-scale demonstration tests in technology development of repositories for disposal of radioactive waste", reflects a desire to refocus the attention of the nuclear waste research community towards the practical issues that remain unresolved, despite the significant work that has been performed in Europe during the last 15 years.

During the following days you will have the opportunity to listen to and interact with some of the industry leaders within the nuclear waste industry who will be presenting key aspects of planning and performing the full scale tests required for showing both decision makers and the general public that we are able to handle the construction, operation and closure of a nuclear repository.

In addition to the presentations, the conference will provide scholars, experts, and decision makers a unique opportunity to engage in deeper, more focused discussions on the latest development and enduring challenges during the poster session, luncheon, evening reception, and coffee breaks. We hope attendees will gain both theoretical and practical understanding of the issues at hand, and capitalize on the opportunity to network with other scholars, experts and decision makers.

Thank you once again for your participation, and welcome to Oskarshamn and the LUCOEX Conference and Workshop 2015.

Sincerely yours,

Erik Thurner, Conference chair and LUCOEX Scientific contact

Jan Gugala, LUCOEX Project Coordinator

Mary Westermark, Conference organizer

Monica Hammarström, Conference Group

Christer Svemar, Conference Group

Jean-Michel Bosgiraud, Conference Group

Marie Garcia, Conference Group

All presentations made at the conference will, if no other agreement is made, be published on the LUCOEX project webpage. If your presentation may not be published, make sure to inform Mary Westermark, mary.westermark@skb.se, before June 4th, 2015.



The conference has received funding from the European Union's European Atomic Energy Community's (Euratom) Seventh Framework Programme FP7/2007-2013 under grant agreement no 269905 (LUCOEX project).

Welcome to the

 This Project has received funding from the European Union's European Atomic Energy Community's (Euratom) FP7 under grant agreement n°269905, the LUCOEX project.

LUCOEX

Conference & Workshop

Full-scale demonstration tests in technology development of repositories for disposal of radioactive waste

2-4 June 2015, Oskarshamn, Sweden
Venue: Forum, Södra Långgatan 15, Oskarshamn

www.lucoex.eu/conference

Day 1

- 09.00-10.00 **Registration and coffee**
10.00 **Welcome and opening of conference**
(Magnus Westerlind, SKB Erik Thurner, SKB)
10.05-10.15 **News from EC** (Christophe Davies)

10.15 – 12.00 Session 1

National programmes of Geological disposal

National SF/HLW disposal programmes for geological disposal in crystalline hard rock and clay formations

Chair: Monica Hammarström, SKB

Geological disposal programmes in crystalline hard rock

- 10.20 SKB (Magnus Westerlind)
10.45 Posiva (Tiina Jalonen)

Geological disposal programmes in clay formation

- 11.10 Andra (Jean-Michel Bosgiraud)
11.35 Nagra (Tim Vietor)

12.00–12.45 Lunch

(at the conference premises, hosted by the project)

12.45 – 17.00 Session 2

Full-scale tests – planning and installation

Lessons learned from planning and installation activities of full-scale demonstration tests.

Chair: Jean-Michel Bosgiraud, Andra

Presentations from LUCOEX and other projects

- 12.50 **FE/LUCOEX: Backfilling a horizontal tunnel with granulated bentonite - machine development, pre- & mock-up tests and application at the Mont Terri URL**
Sven Köhler, Nagra
13.10 **Instrumenting, monitoring and heating the Full-Scale Emplacement (FE) Experiment at the Mont Terri URL**
Herwig Müller, Nagra

- 13.30 **HLW cell full scale demonstration test in Bure URL: method of realization and behaviour characterization**
Frédéric Bumbieler, Andra
13.55 **Technical feasibility of the Cigéo Project seals**
Régis Foin, Andra
14.15 **The preparation of the large-scale PRACLAY Heater test**
Philippe Van Marcke, ONDRAF
14.40 – 15.10 **Coffee break**
15.10 **Multi Purpose Test, LUCOEX WP4, a full scale demonstration of KBS-3H technology**
Magnus Kronberg, SKB
15.30 **Multi Purpose Test, LUCOEX WP4, Instrumentation – Experiences from planning, installation and monitoring**
Xavier Pintado, B+Tech
15.55 **Full-scale tests – planning and installation, KBS-3V**
Keijo Haapala, Posiva
16.20 **Review of monitoring technology for repositories: outcome of instrumentation performance obtained from dismantled long duration experiments and recently installed ones**
J.L. Garcia-Siñeriz, AITEMIN

17.00-19.00 Poster session

A light snack will be served during the session. Posters are listed last in the proceedings

- 19.00 **Dinner** at the Conference premises
(hosted by the project)

Day 2

08.30 – 09.40 Session 2 (Cont.)

Full-scale tests - planning and installation

Chair: Jean-Michel Bosgiraud, Andra

Presentations:

- 08.35 **Requirements-based Design In Support of Full-scale Tests of Plugs and Seals in the DOPAS Project**
Matt White, Galson
- 08.55 **Full-scale test of a Dome plug tunnel seal at Äspö HRL - Design, installation and results**
Pär Graham, SKB/DOPAS
- 09.15 **Dismantling of the Febex experiment**
Florian Kober, FEBEX

09.40 - 10.00 Coffee break

10.00 – 11.45 Session 3

Excavation of tunnels/drifts

Lessons learned from different excavation techniques in crystalline hard rock and clay formations

Chair: Jukka-Pekka Salo, Posiva

Presentations:

- 10.05 **Lessons learnt from constructing the FE tunnel incl. monitoring results**
Herwig Müller, Nagra
- 10.25 **KBS-3H, LUCOEX WP4 - Experiences from directional core drilling at the Äspö HRL**
Göran Nilsson, GNC AB
- 10.45 **Lessons learnt from excavating the clayish Callovo-Oxfordian host formation at the Bure URL and excavation technologies considered for the future Cigéo DGR**
François Chauvet, Andra
- 11.10 **Wire sawing of deposition tunnels**
Stig Pettersson, SKB

11.45–12.30 **Lunch** (at the conference premises, hosted by the project)

12.30 – 14.40 Session 4

Production of bentonite blocks and granulates

Lessons learned from different production techniques for bentonite blocks and granulates

Chair: Herwig Müller, Nagra

Presentations:

- 12.35 **FE/LUCOEX: Design criteria for bentonite block manufacturing and emplacement in an underground facility**
Tim Vietor, Nagra
- 12.55 **Production of buffer and backfill for the Multi-Purpose Test (MPT), LUCOEX WP4**
Peter Eriksson, SKB

13.15 **Manufacturing of Buffer Blocks, Backfill Blocks and Pellets for Posiva's KBS-3V concept**
Jutta Peura, VTT

13.35 **From ESDRED to NSC, SET and FSS: Fabrication and use of compacted Wyoming sodic bentonite in Andra's sealing experiments**
Sébastien Paysan, MPC

14.00 **Experimental works with bentonite pellets at the CEG**
Jan Smutek, Czech Technical University

14.20 **FE/LUCOEX: QA/QC during granulated bentonite material production and emplacement**
Hanspeter Weber, Nagra

14.40 - 15.00 Coffee break

15.00 – 17.00 Session 5

Panel discussion

Presentations from four organisations on their programmes and plans related to large/full scale tests, followed by discussions and advice from an expert panel.

Chair: Monica Hammarström, SKB

Co-Chair: Christer Svemar, SKB

Introduction: Ann Caroline Wiberg

Evaluation of how the LUCOEX results can be utilized by the less-advanced programs

Panel members: Jean-Michel Bosgiraud, Alan Hooper, Johanna Hansen, Stig Pettersson and Tim Vietor

- Surao (Czech Republic) Jiří Slovák
- PURAM (Hungary) Kálmán Benedek
- INR (Romania) Marius Iordache
- RWM (UK) Robert Whittleston

17.00 – 17.15 **Summary and Conclusions**

By the scientific rapporteurs: Lumir Nachmilner and Wilhelm Bollingerfehr

End of conference

Day 3, June 4th (Optional)

Visit ÄSPÖ HRL

08.00-12.00

A visit to the Äspö Hard Rock Laboratory (Transportation will be provided from Forum Oskarshamn at 07.30)

12.00-13.00 **Lunch** (hosted by SKB)

Transport to Oskarshamn/Kalmar in the afternoon will be provided. Kalmar Central station 14.30. Kalmar Öland Airport 14.45.

LUCOEX — Large Underground Concept Experiments

A consortium including four leading waste management organisations decided that the time was right to take practical steps towards showing how to excavate, construct, install and seal safe and efficient facilities for the disposal of high-level nuclear waste. The work has been performed during 2010–2015 in the EU-project LUCOEX.

GEOLOGICAL DISPOSAL

One of the safest ways to dispose of high-level nuclear waste would be to bury it deep underground, and in Europe plans for facilities with this capability have been a long time coming. In some countries, geological disposal has been under consideration and research for more than 30 years. However, the current operational best practice is to simply transfer high-level waste to an intermediate facility where it can express the majority of its radiation and heat. This situation may be about to change, thanks to an ambitious project designed to take the next step in the development of geological disposal facilities across Europe.

The European Atomic Energy Community (EURATOM)'s 'Large Underground Concept Experiments' (LUCOEX) initiative, aims to demonstrate the overall feasibility of constructing, manufacturing and sealing safe underground repositories for high-level nuclear waste. With participation from scientists and engineers at sites in France, Switzerland, Finland and Sweden, LUCOEX is an international effort to ensure safe disposal procedures for nuclear waste products in the years and decades to come. Initiated in 2010 funded by the EU Seventh Framework Programme (FP7) and running for a duration of five years, LUCOEX will come to an end in 2015.

TIME FOR ACTION

The vision of European waste management organisations is that the first geological disposal facility for high-level waste will be safely operating on the

continent by 2025, but reaching this goal will require a number of intermediate steps to be taken. Some of these are the remit of the LUCOEX project, which has created four different proof-of-concept purpose-built installations under repository-like conditions at different underground research labs.

The proof-of-concept installations are located in partner countries, situated on a different geological arrangement and associated with a consortium partner. In Switzerland, the National Cooperative for the Disposal of Radioactive Waste maintains a test facility in opalinus clay (in Mont Terri) where scientists are developing a horizontal disposal concept for high-level nuclear waste using large disposal tunnels. The National Agency for Radioactive Waste Management in France is operating a similar facility, but in callovo-oxfordian clay, where scientists are testing a horizontal disposal concept using smaller drifts optimised for supporting possible future retrieval.

In the Äspö Hard Rock Laboratory (HRL) and Onkalo site in Sweden and Finland, which are managed by consortium partners the Swedish Nuclear Fuel and Waste Management Company (SKB) and Posiva Oy, respectively, the setting is rather different. Both facilities are on crystalline hard rock and based around a concept called KBS-3, which has been developed by both SKB and Posiva together. In the LUCOEX project, SKB is focusing on developing a horizontal concept using 300 m drifts, while Posiva in Finland is exploring the vertical KBS-3

concept with one waste canister per deposition hole in a tunnel up to 300 m long.

SURGING FORWARD

To facilitate progress, the LUCOEX project has divided its objectives into six work packages. The first is concerned with the administration of the others, project management tasks and the integration of different working teams. Packages two through five represent the experiments carried out at the individual test facilities, and the final work package focuses on external communication and the dissemination of the project's findings.

The progress of the project has been excellent with only minor delays linked to procurement, machine development and the manufacture of buffer components, but the participants are confident that the main goals will be achieved before the end of the project.

SUBSTANTIAL ACHIEVEMENTS

The first work package to complete its technical work was undertaken at the French site, where the excavation, component manufacture, installation and sealing procedures were all completed without a hitch – a small seizure of the drill in the last 50 cm notwithstanding. In April 2013, the heating phase of that experiment began, which is elevating temperatures in the test cells to 90 °C over two years, to represent the thermal output of the waste. Monitoring of this facility is now ongoing.

Similarly, the proof-of-concept for horizontal disposal in crystalline rock at Äspö HRL in Sweden has reached an advan-



ced stage, where machine development, component manufacture, installation and sealing procedures were all completed in 2013. The final activity of proving the feasibility of efficiently drilling the necessary drifts with very small margins was finalized during 2015 fulfilling all the key goals for the work package. Although the Swiss and Finnish installations have met more challenges in their experiments they have also made substantial achievements and have both just finalized their installations. At the Mont Terri test facility in Switzerland excavation work, construction of galleries and manufacture of buffer components were finalized in 2014 and the final instrumentation and the installation were performed in 2015.

An updated technique using environmental protection containers for buffer protection and installation has been developed for the Finnish proof-of-concept installation. Two such containers have been successfully manufactured and, along with a gripping and lifting system for the installation machinery, stress tested with a 20 per cent overload. The factory acceptance tests were completed in Autumn 2014 and the final emplacement test was performed in the start of 2015.

All told, LUCOEX has been an ambitious and well-managed project that is now close to successful completion were out findings are presented both at the LUCOEX End Conference and other scientific conferences.

Further information regarding the results of the workpackages can be found in the following extended abstracts in this publication:

Bumbieler et al. HLW cell full scale demonstration test in Bure URL: method of realization and behavior characterization

Eriksson et al. Production of buffer and backfill for the Multi-Purpose Test (MPT)

Garitte et al FE/LUCOEX: Design criteria for bentonite block manufacturing and emplacement in an underground facility

Haapala et al. Full-scale tests – planning and installation, KBS-3V

Kronberg et al. Multi Purpose Test, LUCOEX WP4, a full scale demonstration of KBS-3H technology

Köhler et al. FE/LUCOEX: Backfilling a horizontal tunnel with granulated bentonite - machine development, pre- & mock-up tests and application at the Mont Terri URL

Müller et al. Instrumenting, monitoring and heating the Full-Scale Emplacement (FE) Experiment at the Mont Terri URL

Müller et al. Lessons learnt from constructing the FE tunnel incl. monitoring results

Nilsson et al. KBS-3H, LUCOEX WP4 - Experiences from directional core drilling at the Äspö HRL

Pintado et al. Multi Purpose Test, LUCOEX WP4, Instrumentation – Experiences from planning, installation and monitoring

Weber et al. FE/LUCOEX: QA/QC during granulated bentonite material production and emplacement

And a number of posters presented at the conference.

LUCOEX

OBJECTIVES

- To demonstrate the technical feasibility for safe and reliable construction, manufacturing, disposal and sealing of repositories for long-lived high-level nuclear waste
- To install four different emplacement concepts and demonstrate proof-of-concept with the goal of understanding and comparing important parameters regarding implementation and long-term safety

PROJECT PARTNERS

Swedish Nuclear Fuel and Waste Management Company (SKB), Sweden

National Agency for Radioactive Waste Management (ANDRA), France

National Cooperative for the Disposal of Radioactive Waste (Nagra), Switzerland

Posiva Oy, Finland

CONTACT

Jan Gugala
Project Coordinator

Svensk Kärnbränslehantering AB
Blekhölmstorget 30
PO Box 250
101 24 Stockholm
Sweden
+46 700 991 119
jan.gugala@skb.se
www.lucoex.eu

Acknowledgements

The research leading to these results has received funding from the European Union's European Atomic Energy Community's (Euratom) Seventh Framework Programme FP7/2007-2013 under grant agreement no 269905 (LUCOEX project).

The text in this article is an adaption of a LUCOEX-article previously published in International Innovation Issue 156 published by Research Media in 2014.



About Äspö Hard Rock Laboratory

The Äspö Hard Rock Laboratory (HRL), located in the Simpevarp area in the municipality of Oskarshamn in Sweden, Figure 1, constitutes an important part of the Swedish Nuclear Fuel and Waste Management (SKB) work with design and construction of a deep geological repository for final disposal of spent nuclear fuel. One of the fundamental reasons behind SKB's decision to construct an underground laboratory was to create an opportunity for research, development and demonstration in a realistic and undisturbed rock environment down to repository depth.

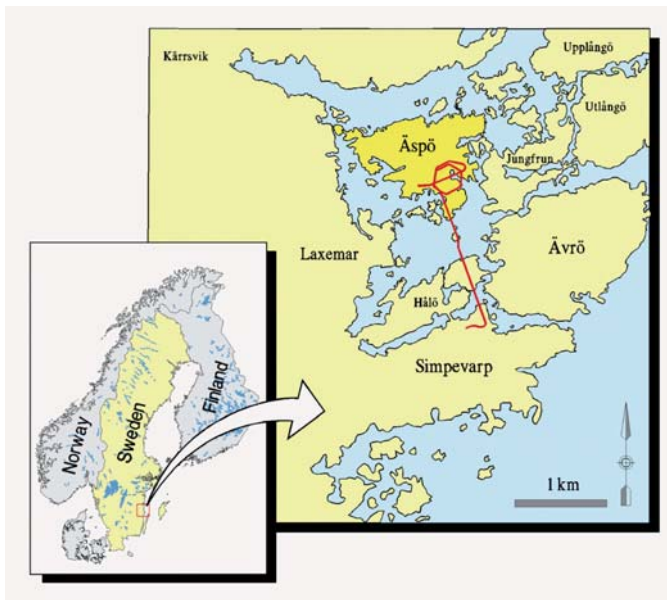

Figure 1. Location of the Äspö HRL.

Most of the research has concerned processes of importance for the long-term safety of a future final repository and the capability to model the processes taking place at repository depth. Demonstration addresses the performance of the engineered barriers and practical means of constructing a repository and emplacing the canisters containing spent fuel. SKB will in the coming years more focus on using the Äspö HRL for demonstrating technology for and function of important parts of the repository system before constructing and operate the spent nuclear fuel repository in Forsmark.

Äspö HRL includes both a research village with office space for 100 persons and different laboratories, and an underground research laboratory to a depth of 460m.

The Chemistry Laboratory was built in the late 1990's, and performed sampling and analysis on water samples collected at Äspö and in the underground facility. A Bentonite laboratory was inaugurated in 2007. Studies on buffer and backfill materials are performed at the laboratory to complement the studies performed in the underground research laboratory. A Material science laboratory was constructed at Äspö during 2013. In this laboratory, focus is on material chemistry of bentonite issues and competence development.

The underground part of the laboratory, Figure 2, consists of a main access tunnel from the Simpevarp peninsula to the southern part of the Äspö island where the tunnel continues in a spiral down to a depth of 460 m. The total length of the tunnel is 3 600 m. The main part of the tunnel has been excavated by conventional drill and blast technique and the last 400 m have been excavated by a tunnel boring machine (TBM) with a diameter of 5 m. The underground tunnel is connected to the ground surface through a hoist shaft and two ventilation shafts.

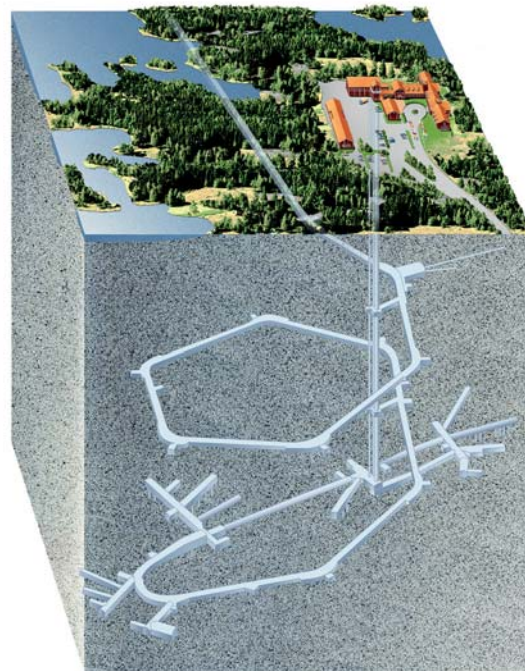

Figure 2. The Äspö HRL research tunnel.

In addition, Äspö HRL and its resources are available for national and international environmental research.

Oskarshamn – a municipality with a high quality of life and an international energy centre

There is a great deal of energy in Oskarshamn among our successful companies, in associations and among residents. Many people regard the municipality as the motor that currently drives Kalmar County due to its robust business sector. Oskarshamn is situated on the Småland Coast in the south-eastern part of Sweden and we have a beautiful archipelago with more than 5 400 small islands and islets. We are located in one of Europe's most interesting growth areas, close to the interesting markets of the Baltic region. The proximity to the open sea has always led to amazing possibilities for exchange, business and recreation.

Oskarshamn has jobs to offer – above all in the engineering/automotive industry and the energy sector, which are our two strongest business fields. The largest companies are Scania, OKG, Saft and Elajo. The Scania cab factory is the largest private workplace in the region with about 2 000 employees. Such a large factory also creates many jobs for subcontractors in the engineering and service sectors. Scania has now invested a lot of money so they can double the production capacity in Oskarshamn. They are also investing in a new logistic centre in Oskarshamn.

The job opportunities that OKG nuclear power plant generate are also many. OKG will need to recruit additional skilled and committed employees within the next few years. Ten per cent of Sweden's electricity supply comes from the nuclear power plant.

It has been agreed upon that the final storage facility for spent nuclear fuel in Sweden will not be located in Oskarshamn. On the other hand, the Swedish Nuclear Waste Management Company, SKB, has a lot of its nuclear waste facilities as well as research and development functions located in Oskarshamn. Since the final storage facility is not going to be built here a special agreement has been made on "Added values" within the years 2009 through 2025 with the Swedish nuclear industry. The agreement means that during these years the municipality will be able to receive funds of up to 2 billion Swedish crowns that shall be used for development in different areas: new jobs, education, support establishment of companies and infrastructure.

Oskarshamn is a place with high quality of life for all. The children gets to go to schools and pre schools that safe and we take good care of our residents. There are more than 180 associations in the municipality ranging from football to theatre and everything that is needed for an active life. A few times a year there are events of bigger proportions taking place in Oskarshamn such as the music festival Latitud 57.



And things are happening in Oskarshamn! The project "Inner Harbor" is about to transform the area in the inner harbor to housing and social areas for residents, a new commercial area is to be built and a new cinema theatre will be finished in December 2015.

What great opportunities there are indeed in Oskarshamn!



Index

Ann Caroline Wiberg

Evaluation of how the LUCOEX results can be utilized by less advanced programmes 11

Abstracts

Sven Köhler

FE/LUCOEX: Backfilling a Horizontal Tunnel with Granular Bentonite – Machine Development, Pre- & Mock-up Tests and Application at the Mont Terri URL 35

Herwig Müller

Instrumenting, monitoring and heating the Full-Scale Emplacement (FE) Experiment at the Mont Terri URL 49

Frédéric Bumbieler

HLW cell full scale demonstration test in Bure URL: method of realization and behaviour characterization 55

Régis Foin

Technical feasibility of the Cigéo Project seals 63

Philippe Van Marcke

The preparation of the large-scale PRACLAY Heater Test 71

Magnus Kronberg

Multi Purpose Test, LucoeX WP4, a full scale demonstration of KBS-3H technology 77

Xavier Pintado

Multi Purpose Test, LUCOEX WP4, Instrumentation – Experiences from planning, installation and monitoring 85

Keijo Haapala

Full-scale tests – planning and installation, KBS-3V 95

José-Luis Garcia-Siñeriz Martínez

Review of monitoring technology for repositories: outcome of instrumentation performance obtained from dismantled long duration experiments and recently installed ones 101

Matt White

Requirements-based Design In Support of Full-scale Tests of Plugs and Seals in the DOPAS Project 107

Pär Graham

Full-scale test of a Dome plug tunnel seal at Äspö HRL - Design, installation and results 115

Florian Kober

Dismantling of the FEBEX experiment after 18 Years of heating 123

Herwig Müller

Excavation of the FE tunnel at the Mont Terri URL 129

Göran Nilsson

KBS-3H, LucoeX WP4 - Experiences from directional core drilling at the Äspö HRL 135

Francois Chauvet

Lessons learnt from excavation the clayish Callovo-Oxfordian host formation at the Bure URL and excavation technologies considered for the future Cigéo DGR 143

Stig Pettersson

Wire sawing of deposition tunnels 149

Benoit Garitte et al

FE/LUCOEX: Design criteria for bentonite block manufacturing and emplacement in an underground facility 155

Peter Eriksson, SKB

Production of buffer and backfill for the Multi-Purpose Test (MPT) 161

Jutta Peura

Manufacturing of Buffer Blocks, Backfill Blocks and Pellets for Posiva's KBS-3V concept 167

Sébastien Paysan

From ESDRED to NSC, SET and FSS: Fabrication and use of compacted Wyoming sodic bentonite in Andra's sealing experiments 173

Jan Smutek	
Experimental works with bentonite pellets at the CEG	179
Hanspeter Weber	
FE/LUCOEX: QA/QC during granulated bentonite material production and emplacement	185
LUCOEX END CONFERENCE - Observations of Scientific Rapporteurs	195
Posters	
LUCOEX and its application on Europe - A. Wiberg	205
LUCOEX WP2 - Full-Scale Emplacement (FE) Experiment at Mont Terri URL - H. Muller et al	207
LUCOEX WP3 – Disposal in Callovo-Oxfordian Clay - J. Morel et al	209
LUCOEX WP4 – Horizontal disposal in crystalline rock - M. Kronberg	211
LUCOEX WP5 – KBS-3V Emplacement tests in Onkalo - K. Haapala	213
Assessment of 15 years of R&D in the Bure URL for the Design, Performance and Safety Analysis of the Cigéo Project - S. Dewonck et al	215
Experimental study of the mechanical behavior of a steel casing in a 500 m deep clay formation - F. Bumbieler et al	217
FE experiment/LUCOEX: Production of bentonite based backfill materials - B. Garitte et al	219
Quality control, traceability and verification of the process for construction of deposition tunnels – H. Ittner et al	221
A general overview of the DOPAS project - J. Hansen	223
DOPAS design basis workflow - M. White	225
Large scale sealing experiment in the Meuse/Haute-Marne Underground Research Laboratory - R. de La Vaissière et al	227
FE/LUCOEX: Density measurement of granulated bentonite mixture in a 2D pre-test using a dielectric moisture profile probe - Toshihiro Sakaki et al	229
FE/LUCOEX: Density measurement of granulated bentonite mixture in a full scale mockup test using dielectric tools - Toshihiro Sakaki et al	231
FE/ LUCOEX: Development of a prototype machine for backfilling horizontal emplacement tunnels with granulated bentonite - H. Jenni et al.	233
FE Experiment: The instrumentation and monitoring concept of a 1:1-scale heater experiment - T. Vogt et al.	235
Requirements and Approaches for Optimization of the Bentonite Barrier around SF HLW Disposal Canisters – S. Köhler et al	237
Stability of compacted bentonite blocks and block pedestals under changing climatic conditions in tunnels and long-term loads – B. Garitte et al	239
Synoptic structural geological analysis of the MB & FE tunnel excavation in the Mont Terri URL – J.K. Becker et al	241
Results from hydro-mechanical and geochemical analyses of the retrieved buffer material from the Prototype Repository at Äspö HRL – LE Johannesson et al	243
Prototype retrieval – Grahm et al	245
Ukrainian strategy for disposal in deep geological repository - B. Zlobenko	247
Management of spent nuclear fuel in Lithuania – Grigaliūnienė et al	249
Long-term performance of engineered barrier systems: Modelling the interactions of corrosion products with compacted bentonite in a HLW repository in granite – Naves et al	251



Evaluation of how the LUCOEX results can be utilized by less-advanced programs

Ann Caroline Wiberg

Abstract

The objective with this report is to investigate how results from the LUCOEX (Large Underground Concept Experiments) project can be utilized by less-advanced radioactive waste management programs, with respect to high-level waste and spent fuel, in member states of the European Union. This includes an evaluation of how far the European Union member states have come in their radioactive waste programs.

High-level long-lived waste and spent fuel requires the most comprehensive disposal of all types of radioactive waste. One of the most safe and feasible way to take care of this waste with today's technologies is by a geological disposal system. Geological disposal is the preferred solution for most countries with high-level waste and spent fuel.

The purpose of the LUCOEX project is to demonstrate the technical feasibility in situ for geological repositories for long-lived high-level nuclear waste. This includes a safe and reliable construction, manufacturing, disposal and sealing of the repositories. Two proof-of-concepts are made in clay and two in crystalline rock.

The countries that consider clay as an option for suitable host rock for deep geological disposal are Belgium, Bulgaria, France, Germany, Hungary, Lithuania, Netherlands, Poland, Romania, Slovakia, Slovenia, Spain, Switzerland and United Kingdom.

The countries that consider crystalline rock as an option for suitable host rock for deep geological disposal are Bulgaria, Czech Republic, Finland, Germany, Lithuania, Poland, Romania, Slovakia, Slovenia, Spain, Switzerland and United Kingdom.

Spain, Slovakia, Hungary, United Kingdom, Germany, Czech Republic and Belgium are countries that have made significant progress in their radioactive waste management programs, and therefore are in a position where results from the LUCOEX project can be utilized in a perspicuous future. This also concerns the participant countries of LUCOEX; Switzerland, France, Sweden and Finland.

In addition Bulgaria, Lithuania, Poland, Romania, the Netherlands, Slovenia and Croatia can utilize the results from the LUCOEX project to get information of one concept to aim for in the future.

Contents

1	Introduction	13
1.1	Method and Objective	13
1.2	Background	13
1.2.1	Radioactive waste and spent fuel	13
1.2.2	Different types of radioactive wastes	13
1.2.3	Geological Disposal.....	14
1.2.4	Reprocessing	14
1.2.5	LUCOEX project.....	15
1.2.6	Radioactive waste and spent fuel management directive	17
2	Situation for countries with advanced radioactive waste management programs	18
2.1	Finland.....	18
2.2	France	19
2.3	Sweden	19
3	Radioactive waste management programs in Europe.....	20
3.1	Belgium	20
3.2	Bulgaria	20
3.3	Czech Republic.....	21
3.4	Denmark	21
3.5	Germany	21
3.6	Hungary	22
3.7	Italy.....	22
3.8	Lithuania.....	23
3.9	The Netherlands	23
3.10	Poland.....	23
3.11	Romania.....	24
3.12	Slovakia.....	24
3.13	Slovenia.....	25
3.13.1	Croatia	25
3.14	Spain.....	25
3.15	Switzerland.....	26
3.16	United Kingdom	26
4	Results and conclusions.....	27
4.1	Conclusion.....	29
5	Discussion	29
6	Acknowledgement.....	30
7	References	31

1 Introduction

1.1 Method and Objective

The objective with this report is to investigate if and in which way results from the LUCOEX project can be utilized by countries in EU with less-advanced radioactive waste management programs, with respect to high-level waste and spent fuel. This includes an evaluation of how far the EU member states have come in their radioactive waste programs.

The method used in this study has been information processing and interviews. International contacts have been made through e-mail to gather information about radioactive waste management in European countries. Also participation in the LUCOEX workshop at Äspö, Sweden, and the IGDTP-Geodisposal conference in Manchester, United Kingdom, has also been utilized for connecting with relevant representatives for WMO's.

1.2 Background

1.2.1 Radioactive waste and spent fuel

Radioactive waste is material which contains radionuclides with a certain level of activity. The waste is a result from operation of nuclear power plants, all activities related to the nuclear fuel cycle and also other tasks where radioactive material is used. It is important that all radioactive waste is handled in a safe manner and that humans and their environment is well protected from the waste [1].

1.2.2 Different types of radioactive wastes

Very low-level waste

This is radioactive waste with concentrations of activity levels around or just above a limit which require radiation safety and protection. Most of it consists of materials involved in operation and decommissioning from nuclear industrial sites. Also other industries, for example food processing and chemical, can produce very low-level waste since the natural radioactivity occurs in some of the used minerals in the processes. It have very limited hazard though. For protection the waste can be disposed in engineered landfill surface facility types [2, 3].

Low-level waste

Low-level waste is mainly produced in hospitals and industries. Also steps in the nuclear fuel cycle can generate this waste. This waste is suitable for near surface disposal. The low-level waste with little activity doesn't need shielding during transport and handling but the waste with a bit higher does and can require isolation for several hundred years [2, 3].

Intermediate-level waste

This waste comes primarily from chemical sludge and used reactor core components. Intermediate waste contains long-lived radionuclides and need more isolation than is provided by near surface disposal. The disposal needs to be between tens and hundreds meters underground. This makes it possible to use both natural and engineered barriers in the isolation [2, 3].

High-level waste

This is waste with high levels of activity. It is produced when uranium fuel is burned in a nuclear reactor. High-level waste can also be generated when spent fuel is reprocessed. Because of the process of radionuclides decay, significant amount of heat can be generated. It can also contain large quantities of long-lived radionuclides. This waste requires even more isolation than intermediate waste and this is possible with disposal in a deep geological repository [2, 3].

Spent fuel is viewed as its entirety. Figure 1 shows how much spent fuel the member states have generated and how much they are expected to produce in the near future [4].

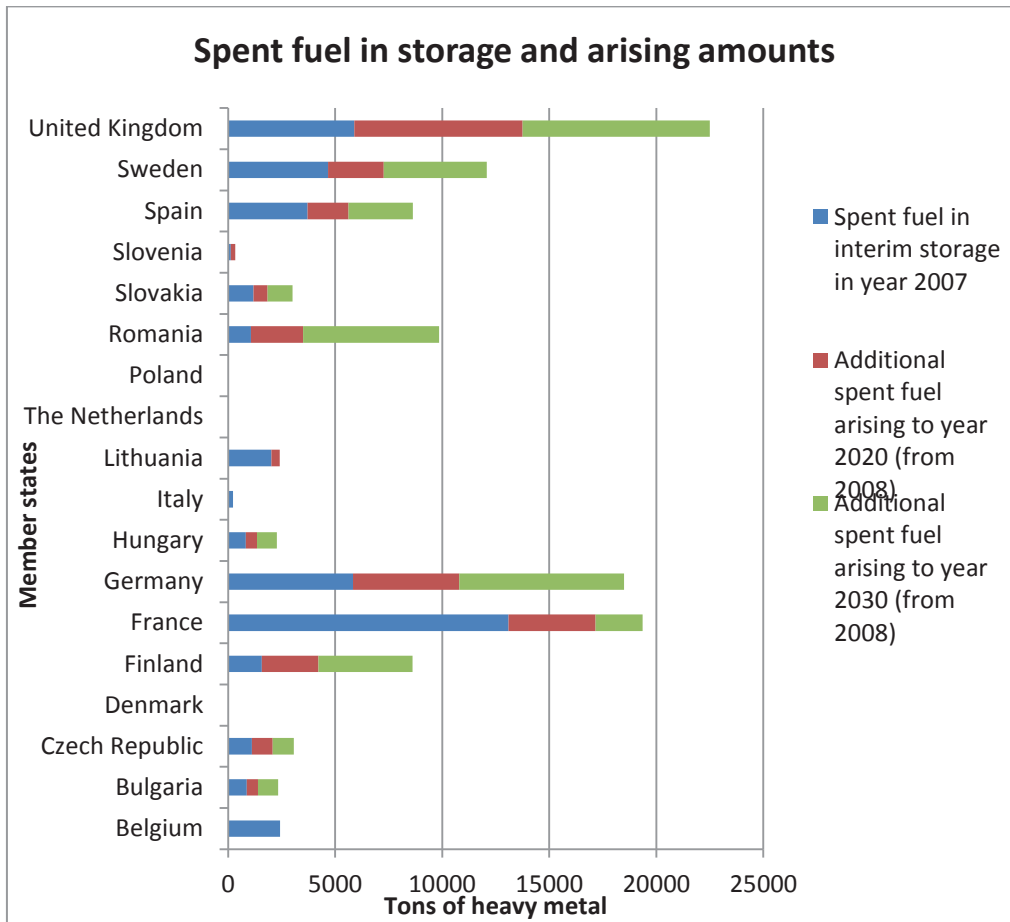

Figure 1 [4]

1.2.3 Geological Disposal

It is the high-level long-lived waste and spent fuel that requires the most comprehensive disposal of all the types of waste [4]. It has to be isolated from humans and the environment for several thousand years. With today's knowledge, the most safe and feasible way to take care of this waste is by a geological disposal system. This is a system that involves both the geology's ability and the engineered materials to establish several barriers with different functions to keep the safety functions at a high level. The disposal takes place hundreds of meters underground so the distance also contributes to the isolation [5].

Many countries have adopted deep geological disposal as the solution for their high-level waste and spent fuel in a long-term perspective. Several countries are making advancement towards implementation of geological disposal. Some countries face challenges that can make them take a step back, but still the geological disposal keeps being the reference option [5].

1.2.4 Reprocessing

In the current situation, there are three major options to manage the spent fuel. One is direct disposal, which includes geological disposal. Another one is the storage and postponed decision which is a "wait and see" option. Finally there are also the reprocessing and recycling options [6].

Reprocessing means that the spent fuel is recycled and also that the amount of high-level waste can be reduced [7]. It can also improve the use of fissile materials [6]. With today's policy's, four member states will continue with reprocessing for their spent fuel and these are Bulgaria, France, Italy and the Netherlands [4].

Historically, reprocessing was made to produce plutonium for nuclear weapons. Later on, in the 1960's countries with nuclear programs which had plans for reprocessing had it with the aim to supply start up fuel for breeder reactors. These reactors turned out to be less economic than expected. Today, reprocessing is not an option in most countries with nuclear power [8].

1.2.5 LUCOEX project

The purpose of the LUCOEX project is to demonstrate the technical feasibility in situ for geological repositories for long-lived high-level nuclear waste. This includes a safe and reliable construction, manufacturing, disposal and sealing of the repositories. The project involves four nations in Europe; Sweden, Finland, France and Switzerland. For each of the proof-of-concept installations, there are various focus areas and geological conditions [9, 10].

Horizontal disposal in Callovo-Oxfordian clay

The objective with the proof-of-concept installation in Bure is to optimize the design of the French repository concept for high-level waste disposal. The concept consists of a high-level waste cell which in this case is an approximately 80 m long micro tunnel with a diameter of around 0.7 m. In the cell a body part, where the packages can be stored and also a cell head, are positioned. These two components are separated by a steel radiological protection plug. A swelling plug presses against a concrete plug to manage to close the cell [10, 11].

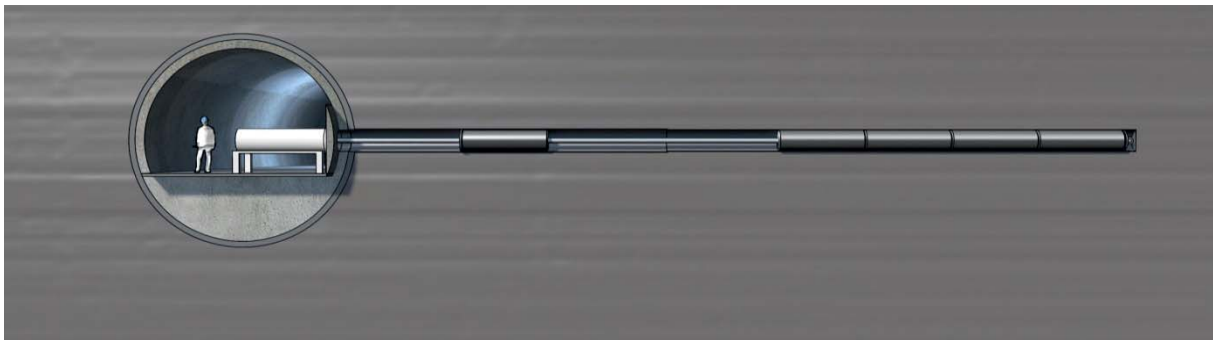

Figure 2: An illustration of the proof-of-concept installation in Bure (www.lucoex.eu)

This concept includes excavating of a cell demonstrator which can be representative of the high-level waste storage cell reference concept. Also electrical heaters are used which aim to simulate the thermal load that is induced by the waste packages. The thermal load behavior is further studied of the body part and insert and also the operation of the extension of the cell body and when it slides into the insert. Also the thermal load behavior of the rock interface and what impact it has on the linear mechanical load are being analyzed [10, 11].

Horizontal disposal in Opalinus Clay

The objective with this proof-of-concept is to confirm the sustainability of the Swiss repository concept in Opalinus Clay for high-level waste disposal. This is made in full-scale [10, 12].

This takes place in Mont Terri, Switzerland. The concept is testing how induced thermo-hydro-mechanical processes in the Opalinus Clay carry out. It also aims to verify how the emplacements techniques function under repository conditions [10, 12].

The demonstration contains construction of an emplacement tunnel, manufacturing bentonite buffer components and test equipment for buffer and waste emplacement, and also performance of the installation process [10, 12].

The Full-scale Emplacement (FE) gallery measures 2.7 m in diameter and with the length of 50 m. In NAGRA's repository concept, the waste emplacement tunnels will be up to 800 m long [10, 12].

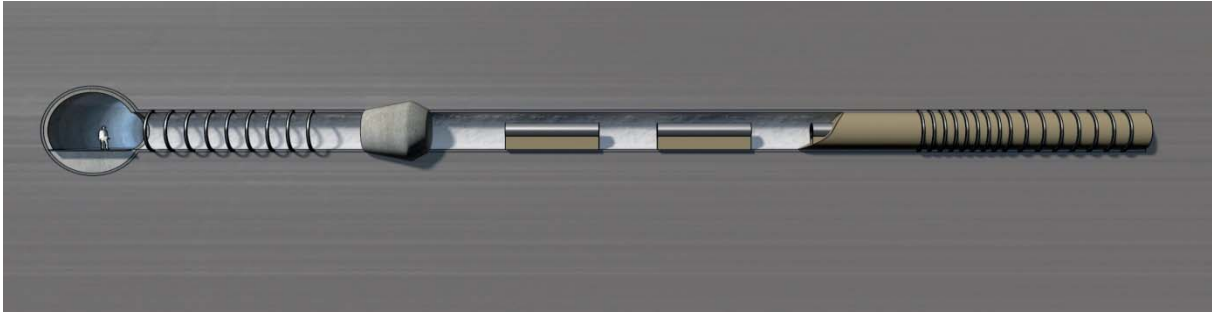

Figure 3: The illustration shows the horizontal disposal in Mont Terri. (www.lucoex.eu)

Both the demonstrators in Callovo-Oxfordian clay and Opalinus Clay aim to investigate the functionality of the repository concepts' core pieces. These are the cell excavation, emplacement techniques and backfilling. Also to explore the thermal heat monitoring effects are mutual in these two concepts [10, 11, 12].

Vertical disposal in crystalline hard rock

The objective with this proof-of-concept is to develop necessary machinery and a quality control programme. The programme includes problem management for the installation of the buffer in vertical deposition in crystalline rock. The reference concept is KBS-3V [10, 13].

The primary activities are to develop the installation technique for vertical bentonite buffer, the tools and methods for this buffer and also the required tools for problem handling if unexpected problems occur during the buffer installation [10, 13].

The demonstration takes place in Onkalo, Finland, which also will host the planned deep geological repository [10, 13].



Figure 4. Vertical disposal in crystalline rock (www.lucoex.eu)

The KBS-3 repository concept means that spent fuel is encapsulated in dense canisters which are resistant to corrosion and loadbearing. These canisters are deposited in crystalline rock and several hundred meters underground. The canisters are also surrounded by a buffer. This is to protect the canisters and prohibit the flow of water. The tunnels and openings in the rock that are involved in the disposal will be backfilled and closed [14].

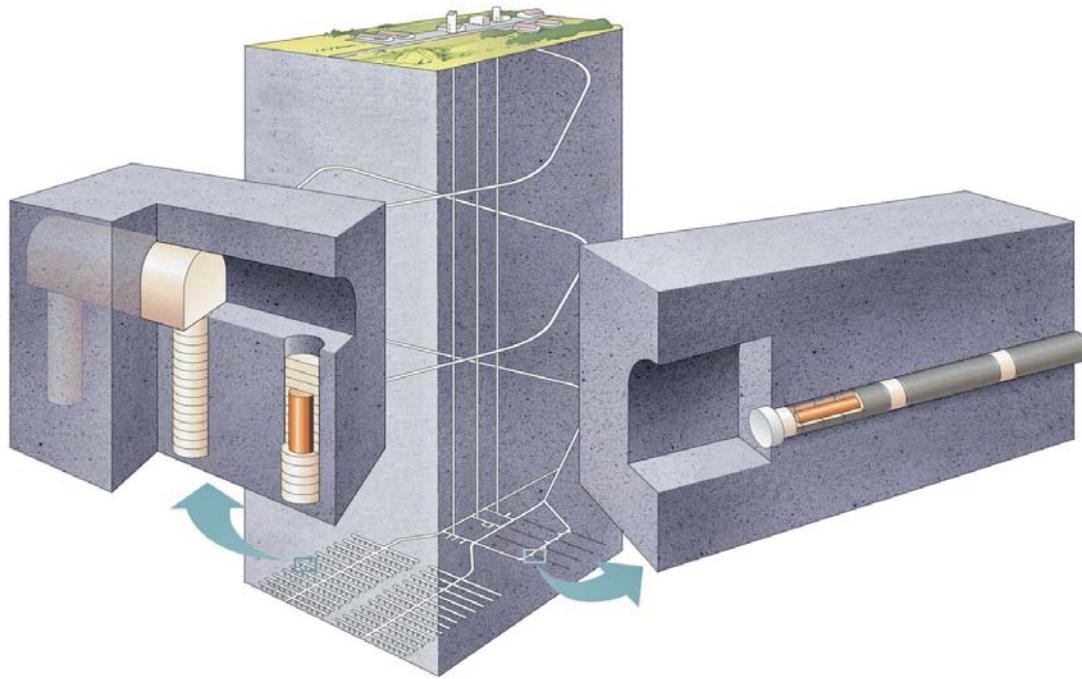

Figure 5. An illustration of the KBS-3 method. The reference design with vertical disposal, KBS-3V, is shown to the left and to the right is the alternative with horizontal disposal, KBS-3H. (www.lucoex.eu)

Horizontal disposal in crystalline hard rock

The objective with this proof-of-concept is to verify horizontal design for the high-level waste repository which is being researched. The test is based on KBS-3V as the reference concept [10, 15].

The name of the test is the Multi-Purpose test and the focus is to do full-scale tests with the system components in combination with each other. This is to verify the design implementation and component function. The main components are the super-container, distance blocks and a plug. It also contains a transition zone with a transition block and pellets. The test takes place in a 95 m long drift with a diameter of 1.85 m at Äspö, Sweden [10, 15].

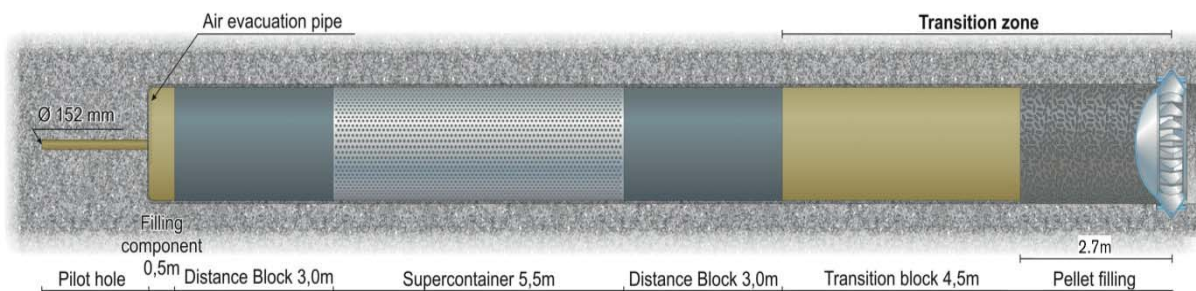

Figure 6. Horizontal disposal in the Multi-Purpose test (www.lucoex.eu)

1.2.6 Radioactive waste and spent fuel management directive

In 2011, the council of the European Union adopted the “Radioactive waste and spent fuel management directive” which requests member states to present national programmes that should include where, when and how they plan to construct and manage final repositories that should guarantee the highest safety standards. This directive was suggested by the European Commission. In 2015, the member states have to submit the first report about the implementation of their national programmes [16].

In the document, there are two statements focusing on the member states national programme:

“National programmes

1. Each Member State shall ensure the implementation of its national programme for the management of spent fuel and radioactive waste (‘national programme’), covering all types of spent fuel and radioactive waste under its jurisdiction and all stages of spent fuel and radioactive waste management from generation to disposal.

2. Each Member State shall regularly review and update its national programme, taking into account technical and scientific progress as appropriate as well as recommendations, lessons learned and good practices from peer reviews.” [16]

This is a step forward in EU to make all member states urged to invest and work on the implementation and progress on their national programme for the management of spent fuel and radioactive waste.

2 Situation for countries with advanced radioactive waste management programs

In a global perspective, there are several countries that have to manage hazard radioactive waste and spent fuel that they have generated. This concerns 43 countries of which 25 have made decisions that declare that deep geological disposal is the most secure and safest solution for this management. Some of the countries have made great advancement in their radioactive waste and spent fuel management programs. The European Union have several countries with severe progression in their programs. Also countries like Canada have made extensive work in the area of geological disposal and are therefore well ahead in their waste management programs [17].

In this report, focus is on the member states in the European Union plus Switzerland.

2.1 Finland

The company Posiva is responsible for the preparations and the following implementation of disposal of spent fuel in Finland [18].

At the end of 2013, about 1984 tons HM (heavy metal) spent fuel was stored in Finland. The spent fuel is stored in pools at the sites where it have been generated [18].

The construction application for construction of a disposal facility was submitted in 2012. A comprehensive research, development and design programme is ongoing to remain some open issues related to the licensing [18]. The operation license application are planned to be submitted in 2020 and the final disposal are expected to start in 2022 [19].

The reference concept for the deep geological disposal is based on the Swedish KBS-3 system. Finland is currently applying KBS-3V, which means that the canisters are placed vertical in the ground of crystalline rock [18].

Posiva has a substantial collaboration with SKB in Sweden and also with ANDRA in France, DBE in Germany and the Swiss NAGRA [18].

The producers of nuclear waste, TVO and Fortum, are according to the Nuclear Energy Act responsible for implementing the management of nuclear waste which is produced in the Olkiluoto and Loviisa nuclear power plants. They are also responsible for the costs that incurred [20].

In the 1980s, the Finnish Nuclear electricity company TVO started to focus on final disposal of spent nuclear fuel and adapted the concept of KBS-3 [21]. In 2004, an underground rock characterisation facility was started to be constructed and was finished a few years later [22].

Waste management and decommissioning costs are included in the price of the nuclear electricity. Every three years the license-holders pay contributions to a fund so the required security is provided to the state [18].

2.2 France

In 1991, the public agency ANDRA was established. ANDRA is responsible for the long-term management for radioactive waste that is produced in France [23].

In the end of 2010, there was 2700 m³ high-level waste in France. In 2020, the amount are expected to be 4000 m³ and in 2030, 5300 m³ [23]. The high-level waste is today stored at its production site [24].

One of the topics for the research and studies sustainable management of radioactive materials and waste is to investigate reversible disposal in deep geological formations. This includes choosing a site and designing a disposal facility so it will be possible to file in an application in 2015 for an authorization. After this the facility can be in operation by 2025 [23].

Several studies have led to the reversibility concept. This is wider than the retrievability concept since it permits an operational stepwise disposal process which will be determined by a political decision-making process [23].

ANDRA has a research facility in form of an underground research laboratory (URL) in Bure. The aim with this facility is to study the feasibility of reversible geological disposal with respect to high-level and long-lived intermediate-level radioactive waste in Callovo-Oxfordian clay. This was licensed in 1999 and its construction was achieved in 2006. Nearby, a technical exhibition facility was built in 2007. The objective with this is to design and operate prototypes and demonstrators [23].

In 2005, ANDRA states in a report that “in principle, the feasibility of storage in clay formations is now acquired”. However, there can be obstacles since only one site being researched. This because of less flexibility compared to if there were more sites [24].

The responsibility for the financing of the radioactive waste management is held by the operators of the nuclear installations. Additional financing to basic nuclear installations have been added by a Planning Act in 2006. This is to fund the economic development scheme that involves local municipalities in the geological repository for high-level and long-lived intermediate-level radioactive waste project [23, 25].

2.3 Sweden

The Swedish nuclear fuel and waste management Co, SKB, is responsible for management of spent fuel and radioactive waste. This includes the disposal and transport [26].

The estimated amount of spent fuel that will have been produced during the existing nuclear power plants lifetime is about 12000 tons. Today, spent fuel from all Swedish nuclear power plants is stored in a central interim storage in water in storage pools [26].

In 1976, the research project KBS, nuclear fuel safety, was initiated. Seven years later, a report was published which concluded that direct disposal for spent fuel was technical feasible and that geological preconditions existed in Sweden. 1985 the interim storage facility was opened. Between 1992 and 2001, studies were made in a number of areas to investigate the feasibility for hosting a deep geological disposal. In the 1995, the research facility of geological disposal Äspö hard rock laboratory was initiated and three years later a canister laboratory was opened. Year 2002, site investigations were started in two localizations for a geological repository. One of the sites was chosen in 2009 which was Forsmark in Östhammar municipality. The bedrock is crystalline rock. Two years later, SKB submitted a license application in order to construct a disposal facility for spent nuclear fuel [27, 28]. The construction of the geological repository is planned to start 2019 and ready ten years later, year 2029 [29].

The license of a nuclear facility must contribute with a nuclear waste fee. This covers the management and disposal of nuclear waste and spent fuel. A special fee per kilowatt-hour is collected together with the other fees to a nuclear waste fond [30].

3 Radioactive waste management programs in Europe

3.1 Belgium

Belgium's National radioactive waste management organisation is named ONDRAF/NIRAS [31].

Today the spent fuel is stored near the nuclear power plants where it has been generated. The fuel is placed in special facilities where they are stored either in pools, in Tihange, or in dry storage in Doel. A total of 4691 spent fuel elements are being stored [31].

According to the inventory in 2008 and an estimated exploitation time of 40 years, the expected amount of long-lived high-level waste of the scenario of full reprocessing is taken in consideration will end up in 600 m³. If the scenario will be with non-reprocessing, the amount will rise to 4500 m³. If the lifetime of the three oldest reactors extends with ten years, the amounts will be 650 m² respective 4900 m² [32].

In 2003, the Belgium federal parliament decided that a law would declare that the nuclear fission for electricity production will phase-out. The operational period for the existing plants was set to be 40 years [31, 32].

A comprehensive research and development program was started in 1974 to examine the possibility to use Boom clay formations as host rock for geological disposal. This led to the construction of an underground research laboratory in Boom clay layer at the Mol-Dessel area at a depth of 220 m, in 1980 [32]. Several in situ experiments have been taken place at this site. The main areas of research has contained the geology and hydrogeology of the clay, the concept of the deep underground repository's definition, the material of the backfilling, the interaction between the host rock, the engineered barriers and the waste. Also evaluation of disposal techniques for the spent fuel and the safety and performance of the potential repository have been made. During one important experiment, close collaboration has been made with the French ANDRA. The experiment is about lining in the gallery of the future repository [31].

Year 2002, the second Safety Assessment and Feasibility Interim Report (SAFIR 2) was published. It concluded that there is no primal problem that considers the safety and feasibility of high-level waste disposal in Boom clay. In 2007, the underground laboratory was extended to contain a disposal gallery in a representative scale. The main objective with this is to study heat response of the clay. The heating test is expected to start in 2014 [31].

A first safety and feasibility case is under preparation. The aim is to gain confidence of all stakeholders in all phases of implement a geological disposal. This will support the government to begin the siting phase [31].

ONDRAF/NIRAS have created a law that command waste producers to pay the costs that the management of the produced waste requires. A fund exists where the producers pay a fee depending on how much waste they generate [31].

3.2 Bulgaria

The responsibility for the radioactive waste management is held by the State Enterprise Radioactive Wastes (SE-RAW) [33].

In the end of 2010, the spent fuel stored in Bulgaria was 910 tons of HM which was in 6024 fuel assemblies. Spent fuel used to be transported back to Russia. This was made according to contracts that were signed between 1998 and 2002 [34]. The used fuel has been stored in a pool-type storage facility. A dry storage facility was opened in 2011 and will accommodate spent fuel from the units. This allows Bulgaria to store the spent fuel in a long-term if shipping abroad wouldn't be possible [35].

Bulgaria is a member of the European Repository Development Organisation Working Group (ERDO-WG) [36]. One goal with this group is to investigate the feasibility of implementing one or more shared geological repository in Europe [37].

Bulgaria is investigating the possibilities to construct a deep geological disposal. Three interesting regions have been identified and in those, five potential areas have been localized. This has led to six potential geological blocks that can be further explored. The potential host rocks are thick clay mergels or granite [34].

The financing for the radioactive waste management is made by the operators of the nuclear installations which on a regular basis pay fees to funds [4].

3.3 Czech Republic

The Czech government adopted a radioactive waste management policy in 2002. The state organisation Radioactive Waste Repository Authority (SURA) is responsible for the development of the deep geological repository for disposal of high-level waste and spent fuel. Before it will be disposed, it will be stored nearby the place where it was generated or in facilities of SURA [38].

The current storage facilities are estimated to have enough capacity to store all expected spent fuel which will be produced in Czech Republic's two existing power plants. They will produce around four thousand tons of spent fuel during their lifetime. But plans are also to construct up to three new reactors and then the spent fuel will arise to nine thousand tons and also more storage capacity will be required [39].

The main option for Czech Republic's management is national disposal in a deep geological repository [38]. The start of operation for a deep geological disposal is expected around year 2065 [39].

The reference concept for deep geological disposal is similar to the Swedish and Finnish concept. It is based on disposal using engineered barriers with metal container and bentonite surrounded by a granite host rock. But the concept is not complete yet [39].

In the beginning of 1990, research was made on available geological data and different areas were carried out to be further investigated for the alternative to host a geological repository. A few years later, eight different locations were identified to be possibly suitable. This program also resulted in a reference project. In 1997, SURA took over the responsibility of the program. A new site selection study was made with six localisations in granite to be focused on as a result [39].

Czech Republic's management program is now at its first step in the site selection process [38].

The costs for the high-level waste and spent fuel management are provided by regulator instalments which come from the producers of spent fuel depending on how much they produce. This is made through a nuclear fund [38, 39].

3.4 Denmark

Dansk Decommissioning (DD) is responsible for the radioactive waste management [40].

Denmark don't have any nuclear power plant but there are a number of research reactors of which two have been fully decommissioned and one is under decommissioning [41]. The country possesses 233 kg spent uranium fuel which is stored at the facilities for storage of radioactive waste at Danish Decommissioning [42].

Denmark has searched for an international solution for its minimal amount of spent fuel. If this won't be found, the spent fuel will be disposed in a Danish low- and intermediate-level waste repository [42].

The management is financed with government bonds [4].

3.5 Germany

In Germany, the Federal Office for Radiation Protection (BfS) is responsible for radioactive waste disposal [43].

The current waste management policy for heat generating radioactive waste is formed by the modification of the atomic law, which is also known as the nuclear phase-out law, the end of

reprocessing spent fuel in other countries and finally the development of disposal concepts and siting process of geological repositories [44].

The spent fuel, which is generated and will be generated in the future, is intermediately stored at the sites where it was generated before a deep geological disposal will be in operation [45]. Around 28000 m³ conditioned heat-generating radioactive waste are expected to be produced until year 2080 [44].

A conceptual design has been considered for the repository. After several decades of interim storage, the spent fuel will be packed into containers. These will be sealed leak tight and there after disposed in deep geological formations. Prototypes for the facility that can pack the spent fuel in containers that are suitable for this disposal have been built. The goal is that the repository will be in operation around 2035. The disposal of spent fuel reference concept contains taking out the fuel rods from the fuel assemblies, pack the fuel rods casks which is self-shielded and sealed thick walled and finally emplaced in deep geological repository [45].

One site that has been investigated to host a deep geological repository for high-level waste is the Gorleben site, which is a salt dome. In 2013, a law on site selection was adopted. A commission was recently implemented with the aim to structure how the site selection procedure should progress. The proposals will be submitted in the end of 2015 [46]. Gorleben will be included as potential site. In the new site selection, adding to salt also clay and crystalline rock will be considered as options for a geological disposal [47]. The decisions of what site that will be selected for the deep geological repository are expected to be made in 2031 [45].

The financing of the waste managing in Germany is included in the price of electricity. All waste producer finance the preparation and planning of the intended waste disposal [45].

3.6 Hungary

Public Limited Company for Radioactive Waste Management (PURAM) is a company that take response for activities that relates to management and disposal of radioactive nuclear waste in Hungary [48].

The spent nuclear fuel is placed in an interim storage, near to where it has been generated, for at least 50 years. In 2013, 97.7 m³ high-level waste was stored in the available storage. The amount of spent fuel was 9113 fuel assemblies. Adding the expected amount that will be generated in the future, including decommission, the total high-level waste will be 718.9 m³ from the nuclear power plants and 17560 fuel assemblies of spent fuel [48].

In 1993, an exploration program started to investigate if Boda Claystone was able to be suitable host rock for geological disposal. In 2000, a countrywide geological screening program was started to find a suitable host rock for a deep geological repository. The result of the program was that the Boda Claystone was the most suitable host rock [48].

Year 2015, the high-level waste conceptual design will start to be reviewed. Three years later, an underground research laboratory license application will be made and the URL is planned to be constructed in 2030. In 2055, an underground repository will be constructed and be ready for disposal nine years later [48].

Hungary has a central nuclear financial fund which is a state fund that finances the construction of the facilities for disposal of radioactive waste and spent fuel. The fund is financed by the nuclear power plants and also other institutes that generate radioactive waste in associated facilities. The government contributes also to the fund [49].

3.7 Italy

Sogin is a State company in Italy which is in charge of the safe management of radioactive waste [50].

In Italy there is a total of 1.700 m³ intermediate and high-level waste. 20 m³ reprocessed spent fuel will be returned from UK and about the same amount from France [51]. The spent fuel is currently

stored at pool storage at one of the nuclear power plants, at a special pool storage facility and at one of the reprocessing facilities [52].

Italy has since the beginning of its nuclear programme had the option of reprocess the spent fuel abroad. However, when the political decision was made to stop all nuclear power activities, also the shipments abroad for reprocessing was adjourned. But in 2006, an agreement was signed between Italy and France which declared that the present spent fuel would be transferred to France [51].

Italy is a member of the ERDO-WG. One goal with this group is to investigate the feasibility of implementing one or more shared geological repository in Europe [36, 37].

The radioactive waste management is financed from the funds which are allocated for the decommissioning of nuclear installations [51].

3.8 Lithuania

The Radioactive Waste Management Agency (RATA) is responsible for the management and radioactive waste disposal from the country's nuclear power plant [53].

Some used fuel is being stored on the nuclear power plant site in storage pools or in a dry storage facility. The amount of spent fuel that is expected to be disposed in a geological disposal is 2510 tons of uranium and 8612 m³ of other radioactive waste [54].

Initial studies on the possibility to establish a geological repository have been made. What option that will be used is mostly a political decision. The studies have showed that crystalline rock or clay is possible media to host the repository [54]. Some studies have been performed in corporation with Swedish experts between the year 2002 and 2005. If the host rock will be crystalline rock Lithuania has adapted the repository concept developed in Sweden, KBS-3 [55].

The site selection process will start in 2030 if no new technologies have occurred and the international practise is unmodified [35]. Lithuania is a member of ERDO-WG [36].

Financing the radioactive waste management is made from different sources. These are state budget and decommissioning funds [54].

3.9 The Netherlands

The Central Organisation for Radioactive Waste (COVRA) is responsible for the management of radioactive waste [56].

At the moment, spent fuel from the Netherlands nuclear power plants is being reprocessed. The existing radioactive waste will be stored above ground for at least a hundred years. One reason is to gain enough waste before a deep geological disposal could be sufficient economical. Another option is to share a repository with another country [56]. The Netherlands are a member of ERDO-WG [4].

Interim storage of reprocess spent fuel is made in a bunker at a COVRA-facility [35]. In 2010, 52 m³ high-level waste was stored in the Netherlands [56].

Currently, a research program on the final disposal of radioactive waste is undergoing. In the past, the option of salt as a host rock has been well investigated. Now most focus will be on examining Boom clay, which can favor cooperation with Belgium [57].

The users of the interim storage for high-level waste and spent fuel have financed its construction according to how much waste storage they have reserved. Also the operational cost is paid by the users [4].

3.10 Poland

The responsibility for the radioactive waste management in Poland is assigned to the Radioactive Waste Management Plant (RWMP) [58].

For the spent fuel from the research reactors, Poland implemented Russian Research Reactor Fuel Return program (RRRFR). All of the high enrichment spent fuel from the former Ewa reactor and a majority of the spent fuel from the active Maria reactor has been shipped back to the country of origin. Also the additional spent fuel that will be produced is expected to be transported back to the Russian Federation. There is no commercial use of nuclear power in Poland today, but the first nuclear power plant is expected to be operational in year 2020 [58].

The Rozan site is the only repository for all radioactive waste in Poland. It is located in a former military fort and will be completely filled by 2020 [58]. In 2007, there was 200 kg of spent fuel in storage [4].

Poland is a member of the ERDO-WG. One goal with this group is to investigate the feasibility of implementing one or more shared geological repository in Europe [36, 37].

In the end of the eighties, a strategic governmental program was established to cover the aspects of radioactive waste management in the country. The localization for a new underground repository for high-level waste and spent fuel was studied. Several places were considered as suitable for the deposition. This included different types of rocks, salt deposits and clay formations. Today, there are no ongoing projects concerning the localization [58].

The financing for the radioactive management is available with state budgets through the budgets of Ministry of Economy and the National Atomic Energy Agency (NAEA). Also service activities from RWMP generate incomes [58].

3.11 Romania

National Agency for Radioactive Waste (ANDRAD) is an authority which coordinates safe management of spent nuclear fuel and radioactive waste [59].

The spent fuel is stored at a dry storage facility after being stored at the nuclear power plant a few years [60]. In the end of 2007, 131 tons of spent fuel was stored in Romania [4].

The possibilities for a deep geological repository have been investigated since 1992. Six potential geological formations have been identified [60]. The most appropriate formations are likely to be granites, green schist, salt, basalt, clay and volcanic tuff so these will be further studied. Cooperation to study the green schist has been made with the Swiss NAGRA [61]. The research is though in a very preliminary stage. Romania estimates that a geological repository can be available in the year 2055 [35, 59].

Romania has a very small nuclear energy program so if the country will construct a geological repository the cost will be proportionally very high. That's why Romania considers that disposal in an international repository would be a better solution [35]. Romania is a member of ERDO-WG [36].

The financing for the disposal of radioactive waste and spent fuel is made through a fee on the produced electricity per kWh. This is collected to a fund [4].

3.12 Slovakia

In Slovakia, JAVYS - Nuclear and Decommissioning Company are responsible for the safety of spent fuel and radioactive waste management [62].

Spent fuel is interim stored at a facility in pools. In 2010, there were 9959 fuel assemblies stored in Slovakia [63].

In 1996, Slovakia started a program for deep geological disposal. A number of localities were identified for further investigation, two in sedimentary rocks and three in granite rocks. This program was stopped in 2001. In 2008 a new strategy was outlined where the two preferred options would be either an international solution, like export or participate in an international repository, or keep the spent fuel interim stored for a non-specified time [63]. Slovakia is participating in ERDO-WG [4]. The option for a national geological repository still remains though. The next step in this process is

focusing on review the past work about site investigations in order to reduce the number of proposed localities and after that undergo further studies [64].

For the financing of the radioactive waste management, there is a fund to where the producers of electricity pay a levy for the amount of sold electricity, and other contributions [63].

3.13 Slovenia

In accordance with the bilateral Slovenian-Croatian agreement on the Krško Nuclear Power Plant (NPP), the decommissioning and management of radioactive waste and spent fuel from Krško NPP is a shared responsibility between Slovenia and Croatia. This was made in 2003 [65].

The Agency for Radwaste Management (ARAO) is an organisation of the Slovenia government which handle the spent fuel and radioactive waste management [66].

The spent fuel from Krško NPP is stored in the site's spent fuel pool. In the end of 2012, 1041 fuel assemblies were stored there [66].

The planned scenario for disposal of spent fuel is following the Swedish KBS-3V concept. This consist disposal in hard rock environment at 500 m depth [67]. Also hard clays have been identified as a potentially suitable geological formation for the disposal [68].

Year 1996, the Slovenian government implemented a strategy for long-time spent fuel management. In 2004, Slovenia and Croatia approved the Programme for decommissioning of the Krško NPP and disposal of LILW and high-level waste. Here they used the Swedish concept of geological disposal as a guideline. Spent fuel will be moved to dry storage between year 2024 and 2030 and will thereafter be stored to 2065 when the deep geological repository are expected to be to be ready. The repository will operate to year 2070 and closed five years later. Also the option of export the spent fuel to another country for disposal has been considered [69]. Slovenia is a member of the ERDO-WG [36].

The financing for the spent fuel and radioactive waste management is assured trough a fund. A fee is paid for every kWh delivered by Krško NPP. Also Croatia contributes with an adequate fund [67].

3.13.1 Croatia

At the moment, there are no nuclear facilities in Croatia. A national utility in Croatia is a co-owner with a half share of a nuclear power plant that is placed in Slovenia. Croatia and Slovenia have the shared responsibility for the waste management for this nuclear power plant [70].

3.14 Spain

The radioactive waste management in Spain are a competence of the government. The body which is responsible for the radioactive waste management activities is Empresa Nacional de Residuos Radiactivos (ENRESA) [71].

Most of the spent fuel which is generated in Spain is stored on the site of the nuclear power plant, from which it's produced. It's there stored in storage pools and sometimes in dry storage systems. The total amount of high-level waste, including spent fuel, to be managed during the present nuclear power plants lifetime will rise to 6,700 tons [71].

Spain has been working with deep geological disposal as an option since 1985. The work has been divided in four basic areas. One is about the site selection plan. This has provided enough information to ensure that the required abundance of granite and clay to host a disposal installation exist. Another area is the performance of the conceptual designs in order to create a definitive disposal facility in these lithologies. Also performance of safety assessment with respect to these conceptual designs is one area. The last area is the research and development plans. This area have been evolved and adapted to the waste management program with respect to spent fuel and high-level waste [71].

Some of the ongoing work is focused on consolidation on generic design for the host rocks and the safety assessments are being revised and updated [71].

The financing for the radioactive waste management is done through a fee on the electricity bills which is paid to a fund for this purpose [71].

3.15 Switzerland

The federal government and the operators of nuclear power plant have implemented the National Co-operative for the Disposal of Radioactive Waste (NAGRA). NAGRA is responsible for carrying out permanent and safe disposal of radioactive waste [72].

Each nuclear power plant has an interim storage facility where its produced radioactive waste is stored. The radioactive waste that has been returned for being reprocessed from abroad are stored at a central storage facility [72]. With an operation time of 50 years for the existing nuclear power plants, the expected amount of high-level waste and spent fuel that will require deep geological disposal will be around 7300 m³ [73].

Until 2006, Switzerland sent spent fuel for reprocessing to France and United Kingdom. The shipment is now prohibited because of a moratorium to the year 2016 [72].

For geological disposal of high-level waste, crystalline basement early became a prior option for host rock. 1979 an application for construction of a rock laboratory in this formation was submitted and 1984 the operation started [72].

In 2008, a new site selection process was started. It has three stages [74]. The first step identified three potential areas for high-level waste disposal and all of them were with Opalinus Clay as host rock [72]. The second stage is now undergoing and consists of concretising the different project and comparing the identified areas to find the most suitable. The key focus is on safety. The last stage involves the licensing of the high-level repository and is expected in about ten years [75].

A repository for high-level waste is expected to be ready around year 2050 [76].

The producers of radioactive waste are responsible to finance the costs of the management of their waste. There is also a fund, disposal fund for nuclear power plants, to which the nuclear power plants pay through contributions [72].

3.16 United Kingdom

The authority responsible for the nuclear sector is Nuclear Decommissioning Authority (NDA). They are responsible for implementing geological disposal for high-level waste and radioactive waste management solutions [77].

Spent fuel and high-level waste are stored at the site where it has been produced [78]. In 2013, there was 1770 m³ of high-level waste in UK. After it has been conditioned, the volume is expected to be around 700 m³ less [79].

The United Kingdom government have initiated a waste managing radioactive safely programme to find a solution for the high-level waste in the country. In 2008, the white paper “Managing radioactive waste safely – a framework for implementing geological disposal” was published. This was a start for a site selection process but this ended after five years. Instead, a renewed white paper was published in July 2014 by the government. This sets out a process for the siting of a geological disposal facility for high-level waste. In the process, clay, granite and salt are included as options as host rock for a geological disposal. The siting of a geological disposal is based on how willing the local communities are to participate in the process [78].

The reference conceptual design is based on the Swedish KBS-3V design. This means that the fuel assemblies will be inserted into a robust disposal canister and thereafter emplaced in deposition holes and backfilled with bentonite [80].

The producer and owners of radioactive waste are responsible for the costs of management and disposal of their own waste [81].

4 Results and conclusions

All the countries have some kind of authority or organisation that is responsible for the radioactive waste management. They have also developed a program for this waste management.

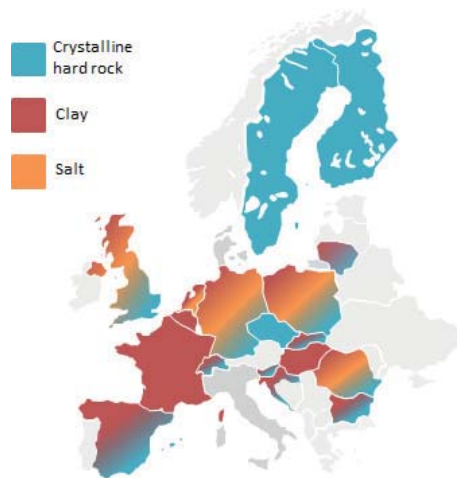

Everyone has made a waste inventory. Some of the countries have also made estimates of how much waste that will be produced from the currently existing nuclear facilities.

Most of the countries have made some form of inventory of the geology to find a suitable host rock for deep geological repository. In Denmark, Italy and Croatia, there haven't been any concluded suitable host rock yet. The different options are presented in figure 7 and table 1.

Figure 7(Can also be seen in poster nr1)

Table 1

Country	Geological inventory for deep geological repository	Country	Geological inventory for deep geological repository
Belgium	Clay	Lithuania	Clay, Crystalline rock
Bulgaria	Clay, Crystalline rock	The Netherlands	Clay, Salt
Croatia		Poland	Clay, Crystalline rock, Salt
Denmark		Romania	Clay, Crystalline rock, Salt
Czech Republic	Crystalline rock	Slovakia	Clay, Crystalline rock
Finland	Crystalline rock	Slovenia	Clay, Crystalline rock
France	Clay	Spain	Clay, Crystalline rock
Germany	Clay, Crystalline rock, Salt	Sweden	Crystalline rock
Hungary	Clay	Switzerland	Clay, Crystalline rock
Italy		United Kingdom	Clay, Crystalline rock, Salt

Some of the countries have started to develop a reference design for the deep geological repository. Of these, United Kingdom, Lithuania, Slovenia and Czech Republic have in some way considered the KBS3-3H or/and KBS-3V, which is one of the reference designs used in LUCOEX project, as an option.

Some of the countries have been in collaboration with the participated organisations of the LUCOEX project. The French ANDRA has been involved in one of Belgium's experiment of its future repository. Romania has collaborated with the Swiss NAGRA in investigation of the country's host rock.

A number of countries have set a planned year for when the repository will be constructed and in operation. They are presented in table 2.

Some of the countries declare that they prefer an international solution for the geological disposal. The main reason is that the countries possess too little waste so a national repository won't be economical enough. These countries are: Bulgaria, Denmark, Italy, Lithuania, The Netherlands, Slovakia, Romania, Slovenia and Croatia.

In terms of financing the radioactive waste management, a number of countries make the producers contribute to the financing through a fee depending on how much electricity they deliver or in other criteria's. This includes all of the countries except from Denmark, Lithuania and Poland.

Table 2

Country	Year for start of operation of deep geological repository	Country	Year for start of operation of deep geological repository
Belgium		Lithuania	
Bulgaria		The Netherlands	
Croatia		Poland	
Denmark		Romania	2055
Czech Republic	2065	Slovakia	
Finland	2022	Slovenia	2065
France	2025	Spain	
Germany	2035	Sweden	2029
Hungary	2064	Switzerland	2050
Italy		United Kingdom	

The countries with the most advanced radioactive waste management programs, with respect to high-level waste and spent fuel, are Finland, Sweden and France which also are three of the participated countries in the LUCOEX project. They all plan to have a deep geological repository constructed before year 2030.

Denmark's and Italy's radioactive waste management programs, with respect to high-level waste and spent fuel, are not very advanced since they haven't concluded any suitable host rock for deep geological disposal. Neither have Croatia but Croatia have shared responsibility of the waste management with Slovenia and Slovenia has declared some options for appropriate host rock. Slovenia is in a very early step in its waste program though and so are the situation for Poland and Romania. Likewise are Bulgaria, Lithuania and the Netherlands in a primary stage in their program but a little more extensive studies have been made in these countries. Spain is also in a primary stage but has made some more work with the disposal questions. A bit more advanced is Slovakia which has made more extensive site investigations. Hungary is a little further since the country is about to review the high-level waste conceptual design and send in an application for construction of an URL in a few years. Next is United Kingdom, which have made a lot of work in the past, but are now about to do over the site selection process. Similar is Germany which also is going to redo some processes for the site selection. A bit further is Czech Republic, which has started its siting process. Also a good way ahead is Belgium which is about to begin the siting phase. The most advanced program of the less-advanced programmes in this report is Switzerland. In a few years one site for deep geological disposal will be selected and then a repository will be ready around 2050.

In figure 8, an overview of how for the member states have come in their radioactive waste program, is shown.

According to how advanced the radioactive waste management programs are for the countries, with respect to high-level waste and spent fuel, statements can be made of how well the country can utilize results from the LUCOEX project in their repository work. Since the LUCOEX project is focusing on studies on a relatively advanced level for the repository work, countries with too less advanced programs aren't current in the stage where those topics are relevant at the moment. Therefore, Denmark, Italy, Slovenia and Croatia, Poland, Romania, Bulgaria, Lithuania and The Netherlands are not now at a phase where LUCOEX findings are primarily relevant. On the other hand, the findings from LUCOEX can help to direct the less-advanced countries to get information of which concept to aim for. This is convenient if they have made a waste inventory and have concluded clay or crystalline as a potential host rock. This can be very useful for the countries to get guidelines to how they should structure their preparatory work in terms of design and long-term safety analysis so they can apply one of the concepts in the future.

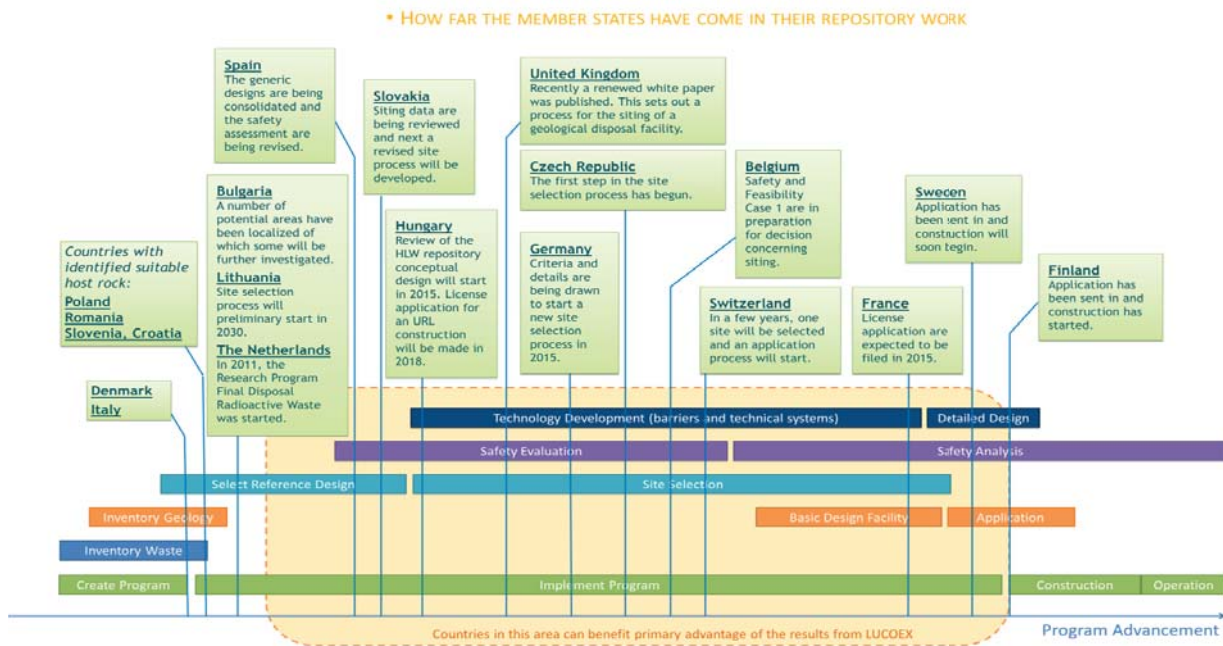

Figure 8 (For better visibility the figure can be seen in poster nr1)

The other countries though, which have a bit more advanced programs, it's more possible that LUCOEX results can be useful and all of them have either clay or crystalline rock as a possible host rock for the geological disposal.

4.1 Conclusion

All of the countries have made a nuclear waste and spent fuel inventory.

Belgium, Bulgaria, France, Germany, Hungary, Lithuania, the Netherlands, Poland, Romania, Slovakia, Slovenia, Spain, Switzerland and United Kingdom consider clay as an option for suitable host rock for deep geological disposal.

Bulgaria, Czech Republic, Finland, Germany, Lithuania, Poland, Romania, Slovakia, Slovenia, Spain, Switzerland and United Kingdom consider crystalline rock as an option for suitable host rock for deep geological disposal.

The countries that have made significant progress in their radioactive waste management programs, and therefore are in a position where results from the LUCOEX project can be utilized in a perspicuous future are Spain, Slovakia, Hungary, United Kingdom, Germany, Czech Republic and Belgium. This also concerns the participant countries of LUCOEX; Switzerland, France, Sweden and Finland.

Bulgaria, Lithuania, Poland, Romania, the Netherlands, Slovenia and Croatia can utilize the results from the LUCOEX project to get information of one concept to aim for in the future.

5 Discussion

All of the countries have made a waste inventory to gain information of how much high-level waste and spent fuel that will require future geological disposal. The amounts differ a lot between the member states. Some of the member states don't possess any of this waste or spent fuel at all or have very little like the Netherlands with 52 m³. Compared to France with 2700 m³ of high-level waste it's understandable that not all member state find it economical supportably to construct a national deep geological repository as against countries with a larger amount of waste. A number of the countries therefore seek the solution for a shared internationally repository. This is not an option with today's

practice and plans but if the concept would change this would lead to a situation with both pros and cons. The question of which country or countries that would host the repository will probably be a difficult task. Also how the economic situation would be solved, and how the country that hosts the repository should be funded, are controversial questions.

In the LUCOEX project two concepts are tested in clay and two concepts in crystalline rock. Almost all of the member states have one of these as options in their current or upcoming site selection process. This means that potentially all of these countries can have use of the outcome of the results from the LUCOEX experiments in the aspect of parts relating to the host rock interaction. Some of the countries consider salt as an option so if they decide to use this then they won't have the same advantage.

Some of the countries have considered KBS-3 in their past or current conceptual design of the disposal of spent fuel and high-level waste. Since KBS-3V is one of the reference concepts in the LUCOEX project, findings from LUCOEX might be useful for the countries if they select to use the KBS-3 as their design. Also a horizontal disposal of the KBS-3, the KBS-3H, is investigated in LUCOEX. If this turn out to be successful also these results can be utilized by the current countries.

All of the countries have a well incorporated financing of the radioactive waste management. Many of the countries have a system where the operator of a nuclear facility pays a fee to fund the waste management organisation. In this way, the producers of the waste make the capital grow in rate with how much waste that has to be managed. This can also play a role in how much finance that is available for investments in the geological disposal work. This can be a reason to that most countries with significant amounts of high-level waste and spent fuel are ahead in the implementation work.

The countries have made different progress in how far they have come in their radioactive waste management program towards deep geological disposal. Their advancements are in some cases difficult to estimate. For example United Kingdom has made extensive studies of the site selection but has recently decided to start over with the process. Also if the country has set a planned year for when the repository should be operational can be misleading. One example is Slovenia which have planned the repository to be ready in 2065, but is in a very early stage in their program, compared to countries where more work on their program have been made, but they haven't declared a planned year yet. Therefore, an overall picture is needed to get an understanding of the situation.

To answer the main objective of this report, if any country with less-advanced radioactive waste management program can utilize the results from the LUCOEX project, it's most likely that in principle all of the countries could in some way. Even though the results cannot be used at the current phase, the situation in the future may be different. Some of the countries prefer to send their radioactive waste and spent fuel abroad and if the possibility occurs; the host repository might be able to utilize findings from LUCOEX project.

6 Acknowledgement

I would like to thank my supervisors Erik Thurner, Jan Gugala and Magnus Kronberg for all the help, ideas, contacts and administrative work that have made it possible for me to produce this report. I wish also to thank SKB for giving me the opportunity to make this task assignment.

The work leading to these results has received funding from the European Union's European Atomic Energy Community's (Euratom) Seventh Framework Programme FP7/2007-2013 under grant agreement no 269905 (LUCOEX project).

7 References

- [1] IAEA (International Atomic Energy Agency) (2011), *Geological Disposal Facilities for Radioactive Waste, IAEA Safety Standards Series No. SSG-14*.
- [2] IAEA (International Atomic Energy Agency) (2009), *Classification of Radioactive Waste, General Safety Guide No. GSG-1*.
- [3] WNA (World Nuclear Association), *Processing of Used Nuclear Fuel*. (Online) Available at: <http://www.world-nuclear.org/info/Nuclear-Fuel-Cycle/Nuclear-Wastes/Radioactive-Waste-Management/> (2014-09-04)
- [4] European Commission (2011), *Seventh Situation Report Radioactive Waste and Spent Fuel Management in the European Union*.
- [5] NEA, OECD (Nuclear Energy Agency, Organisation for Economic Co-operation and Development) (2008), *Moving Forward with Geological Disposal of Radioactive Waste, A Collective Statement by the NEA Radioactive Waste Management Committee (RWMC)*. (Online) Available at: <http://www.oecd-nea.org/rwm/reports/2008/nea6433-statement.pdf> (2014-08-04)
- [6] IAEA (International Atomic Energy Agency) (2008), *Spent Fuel Reprocessing Options, IAEA-TECDOC-1587*.
- [7] WNA (World Nuclear Association), *Processing of Used Nuclear Fuel*. (Online) Available at: <http://www.world-nuclear.org/info/Nuclear-Fuel-Cycle/Fuel-Recycling/Processing-of-Used-Nuclear-Fuel/> (2014-07-30)
- [8] Feiveson H, Mian Z, Ramana M.V, Hippel F. *Spent fuel from nuclear power reactors, An overview of a new study by the international panel on fissile materials*. IPFM, 2011.
- [9] LUCOEX (Large Underground Concept Experiments), *About the Lucoex Project*. (Online) Available at: http://lucoex.eu/the_project.html (2014-08-14)
- [10] LUCOEX (Large Underground Concept Experiments), *Communication*, (Online) Available at: <http://lucoex.eu/communication.html> (2014-08-14)
- [11] LUCOEX (Large Underground Concept Experiments), *Full Scale Emplacement Experiment (FE) Mont Terri*. (Online) Available at: <http://lucoex.eu/wp2.html> (2014-08-14)
- [12] LUCOEX (Large Underground Concept Experiments), *ALC Full scale emplacement experiment at Bure*. (Online) Available at: <http://lucoex.eu/wp3.html> (2014-08-14)
- [13] LUCOEX (Large Underground Concept Experiments), *KBS-3V Emplacement tests in ONKALO*. (Online) Available at: <http://lucoex.eu/wp5.html> (2014-08-14)
- [14] SKB (Swedish Nuclear Fuel and Waste Management Company) (2010). *Design and production of the KBS - 3 repository TR-10-13*. (Online) Available at: www.skb.se/upload/publications/pdf/tr-10-13.pdf (2014-07-30)
- [15] LUCOEX (Large Underground Concept Experiments), *KBS-3H*. (Online) Available at: <http://lucoex.eu/wp4.html> (2014-08-14)
- [16] Council Directive 2011/70/EURATOM establishing a Community framework for the responsible and safe management of spent fuel and radioactive waste, OJ L 199, 2.8.2011, p. 48–56. (Online) Available at: <http://eur-lex.europa.eu/legal-content/EN/TXT/?uri=CELEX:32011L0070> (2014-07-31)
- [17] NDA (Nuclear decommissioning authority) (2013), *Geological Disposal - How the world is dealing with its radioactive wastes*.
- [18] NEA, OECD (Nuclear Energy Agency, Organisation for Economic Co-operation and Development) (2014), *Radioactive Waste Management Programmes in OECD/NEA Member Countries, Country Report: Finland*.
- [19] Posiva Oy, *General Time Schedule for Final Disposal*. (Online) Available at: http://www.posiva.fi/en/final_disposal/general_time_schedule_for_final_disposal#.U_ZzHMTvntR (2014-08-13)
- [20] Posiva Oy (2013), *YJH-2012 Nuclear Waste Management at Olkiluoto and Loviisa Power Plants: Review of Current Status and Future Plans for 2013-2015*. (Online) Available at: www.posiva.fi/files/3056/YJH-2012eng.pdf (2014-07-10)

- [21] NEA, OECD (Nuclear Energy Agency, Organisation for Economic Co-operation and Development) (2014), *Radioactive Waste Management Programmes in OECD/NEA Member Countries, Country Profile: Finland*.
- [22] A. Nurmi, M. Kojon and T. Litmanen. *Identifying remaining socio-technical challenges at the national level: Finland*, University of Tampere. InSOTEC, 2012.
- [23] NEA, OECD (Nuclear Energy Agency, Organisation for Economic Co-operation and Development) (2014), *Radioactive Waste Management Programmes in OECD/NEA Member Countries, Country Report: France*.
- [24] Y. Barthe and M. Meyer. *Identifying remaining socio-technical challenges at the national level: France*. InSOTEC, 2012.
- [25] ANDRA (The National Radioactive Waste Management Agency), *Financing of Radioactive Waste Management*. (Online) Available at: <http://www.andra.fr/international/pages/en/menu21/waste-management/financing-of-radioactive-waste-management-1623.html> (2014-07-10)
- [26] NEA, OECD (Nuclear Energy Agency, Organisation for Economic Co-operation and Development) (2013), *Radioactive Waste Management Programmes in OECD/NEA Member Countries, Country Report: Sweden*.
- [27] A. Adoud and M. Elam. *Identifying remaining socio-technical challenges at the national level: Sweden*. InSOTEC, 2012.
- [28] SKB (Swedish Nuclear Fuel and Waste Management Company), *Milestones*. (Online) Available at: http://skb.se/Templates/Standard_25342.aspx (2014-08-18)
- [29] SKB (Swedish Nuclear Fuel and Waste Management Company), *Planned repository for spent nuclear fuel*. (Online) Available at: http://skb.se/Templates/Standard_28506.aspx (2014-08-18)
- [30] Ministry of the environment Sweden (2011), *Sweden's fourth national report under the Joint Convention on the safety of spent fuel management and the safety of radioactive waste management*. (Online) Available at: <http://data.riksdagen.se/fil/EB4F6FD6-7D1D-4430-8462-27A20BE81642> (2014-07-03)
- [31] NEA, OECD (Nuclear Energy Agency, Organisation for Economic Co-operation and Development) (2013), *Radioactive Waste Management Programmes in OECD/NEA Member Countries, Country Profile: Belgium*.
- [32] J. Schröder and A. Bergmans. *Identifying remaining socio-technical challenges at the national level: Belgium*. University of Antwerpen, InSOTEC, 2012.
- [33] WNA (World Nuclear Association), *Nuclear Power in Bulgaria*. (Online) Available at: <http://www.world-nuclear.org/info/Country-Profiles/Countries-A-F/Bulgaria/> (2014-07-10)
- [34] The republic of Bulgaria (2011), *Fourth national report on fulfilment of the obligations on the joint convention on the safety of spent fuel management and on the safety of radioactive waste management*.
- [35] H. Damveld and D. Bannink. *Management of spent fuel and radioactive waste, State of affairs a worldwide overview*. Nuclear Monitor 746/7/8, 2012.
- [36] ERDO-WG (European Repository Development Organisation Working Group), *Members*. (Online) Available at: <http://www.erdo-wg.eu/Members.html> (2014-07-30)
- [37] ERDO-WG (European Repository Development Organisation Working Group) (2011), *SHARED SOLUTIONS FOR SPENT FUEL AND RADIOACTIVE WASTES responding to EC Directive 2011/70/EURATOM*. (Online) Available at: <http://www.erdo-wg.eu/Documents.html> (2014-07-30)
- [38] NEA, OECD (Nuclear Energy Agency, Organisation for Economic Co-operation and Development) (2013), *Radioactive Waste Management Programmes in OECD/NEA Member Countries, Country Report: Czech Republic*.
- [39] K. Swacina and Z. Konopásek. *Identifying remaining socio-technical challenges at the national level: Czech Republic*. Charles University, Prague, InSOTEC, 2012.
- [40] Danish Decommissioning, *Our mission*. (Online) Available at: <http://www.ddcom.dk/vores-opgave.aspx> (2014-05-28)
- [41] ENSREG (European Nuclear Safety Regulation Group) *Nuclear in the EU: Denmark*. (Online) Available at: <http://www.ensreg.eu/country-profile/Denmark> (2014-05-28)

- [42] National Board of Health (2011), *Joint Convention on the Safety of Spent Fuel Management and on the Safety of Radioactive Waste Management, Fourth National Report from Denmark*.
- [43] BfS (The Federal Office for Radiation Protection). *Disposal – waste*. (Online) Available at: <http://www.bfs.de/en/endlager/abfaelle> (2014-08-15)
- [44] NEA, OECD (Nuclear Energy Agency, Organisation for Economic Co-operation and Development) (2013), *Radioactive Waste Management Programmes in OECD/NEA Member Countries, Country Report: Germany*.
- [45] A. Minhans and B Kallenbach-Herbert. *Identifying remaining socio-technical challenges at the national level: Germany*. Oeko-Institut e.V, InSOTEC, 2012.
- [46] BfS (The Federal Office for Radiation Protection), *Repository search in Germany*. (Online) Available at: http://www.bfs.de/en/endlager/standortfindung/endlagersuche_deutschland.html (2014-08-15)
- [47] BfS (The Federal Office for Radiation Protection), *Repository search in different host rocks*. (Online) Available at: <http://www.bfs.de/en/endlager/standortfindung/standag/wirtsgesteine> (2014-08-15)
- [48] PURAM (Public Limited Company for Radioactive Waste Management) (2013), *The 13th intermediate and long-term plan, for the activities to be financed from the central nuclear financial fund*.
- [49] Republic of Hungary (2011), *NATIONAL REPORT Fourth Report prepared within the framework of the Joint Convention on the Safety of Spent Fuel Management and on the Safety of Radioactive Waste Management*.
- [50] SOGIN, *About us*. (Online) Available at: <http://www.sogin.it/en/about-us/about-us.html> (2014-05-28)
- [51] NEA, OECD (Nuclear Energy Agency, Organisation for Economic Co-operation and Development) (2013), *Radioactive Waste Management Programmes in OECD/NEA Member Countries, Country Report: Italy*.
- [52] IAEA (International Atomic Energy Agency), *Country profile: Italy*. (Online) Available at: <http://newmdb.iaea.org/PROFILES.ASPX?ByCountry=IT> (2014-05-28)
- [53] RATA (State Enterprise Radioactive Waste Management Agency), *About RATA*. (Online) Available at: http://www.rata.lt/en.php/about_rata/general_information/ (2014-05-28)
- [54] Joint Convention on the Safety of Spent Fuel and on the Safety of Radioactive Waste Management, *Third National Report of Lithuania in accordance with Article 32 of the Convention*, 2011.
- [55] P. Poskas, A. Brazauskaite, E. Narkunas, A. Smaizys and A. Sirvydas. *Generic repository concept for RBMK-1500 spent nuclear fuel disposal in crystalline rocks in Lithuania*. Nuclear Engineering Laboratory, Lithuanian Energy Institute 3 Breslaujos st. LT-4403 Kaunas, Lithuania, 2006.
- [56] IAEA (International Atomic Energy Agency), *Country profile: The Netherlands*. (Online) Available at: <http://newmdb.iaea.org/profiles.aspx?ByCountry=NL> (2014-07-15)
- [57] Jantine Schröder. *Identifying remaining socio-technical challenges at the national level: The Netherlands*. University of Antwerpen, InSOTEC, 2012.
- [58] NEA, OECD (Nuclear Energy Agency, Organisation for Economic Co-operation and Development) (2014), *Radioactive Waste Management Programmes in OECD/NEA Member Countries, Country Report: Poland*.
- [59] IAEA (International Atomic Energy Agency) *Country Nuclear Power profile: Romania*. (Online) Available at: http://www-pub.iaea.org/MTCD/publications/PDF/CNPP2011_CD/countryprofiles/Romania/Romania2011.htm (2014-07-16)
- [60] WNA (World Nuclear Association), *Nuclear Power in Romania*. (Online) Available at: <http://www.world-nuclear.org/info/Country-Profiles/Countries-O-S/Romania/> (2014-05-26)
- [61] ANDRAD (Nuclear Agency & Radioactive Waste), *Geological Repository*. (Online) Available at: http://www.agentianucleara.ro/en/?page_id=159 (2014-05-26)
- [62] JAVYS (Nuclear and Decommissioning Company), *Vision and Mission*. (Online) Available at: <http://www.javys.sk/en/about-the-company/company-profile/vision-and-mission> (2014-07-14)

- [63] NATIONAL REPORT OF THE SLOVAK REPUBLIC Compiled in Terms of the Joint Convention on the Safety of Spent Fuel Management and on The Safety of Radwaste Management, 2011.
- [64] JAVYS (Nuclear and Decommissioning Company) *Deep Underground Storage*. (Online) Available at: <http://www.javys.sk/en/about-the-company/activities-of-the-company/snf-management/deep-underground-storage> (2014-07-14)
- [65] NEA, OECD (Nuclear Energy Agency, Organisation for Economic Co-operation and Development) (2013), *Nuclear Legislation in OECD and NEA Countries: Slovenia*. (Online) Available at: <https://www.oecd-nea.org/law/legislation/slovenia.html> (2014-07-15)
- [66] N. Zeleznik and L. Kegel. *Spent Fuel Management in Slovenia: Current Status and Future Plans*, ARAO-Agency for Radwaste Management, Ljubljana, 2011.
- [67] NEA, OECD (Nuclear Energy Agency, Organisation for Economic Co-operation and Development) (2014), *Radioactive Waste Management Programmes in OECD/NEA Member Countries, Country Report: Slovenia*.
- [68] Peter Tomše. *Report on Network Participant: Slovenia*. IAEA TC 193/7 Technical Meeting, Vienna 6 -10 December 2004.
- [69] Republic of Slovenia ministry of the environment and spatial planning Slovenian nuclear safety administration (2011). *Fourth Slovenian Report under the Joint Convention on the Safety of Spent Fuel Management and on the Safety of Radioactive Waste Management*.
- [70] Republic of Croatia (2010). *Croatian Report on Nuclear Safety, 5th Croatian National Report on the Implementation of the Obligations under the Convention on Nuclear Safety*.
- [71] NEA, OECD (Nuclear Energy Agency, Organisation for Economic Co-operation and Development) (2013), *Radioactive Waste Management Programmes in OECD/NEA Member Countries, Country Report: Spain*.
- [72] NEA, OECD (Nuclear Energy Agency, Organisation for Economic Co-operation and Development) (2013), *Radioactive Waste Management Programmes in OECD/NEA Member Countries, Country Report: Switzerland*.
- [73] NAGRA (National Cooperative for the Disposal of Radioactive Waste), Waste volumes. (Online) Available at: <http://www.nagra.ch/en/volumes1.htm> (2014-08-04)
- [74] Swiss Federal Office of Energy (2008). *Sectoral Plan for Deep Geological Repositories Conceptual Part*.
- [75] NAGRA (National Cooperative for the Disposal of Radioactive Waste), *Disposal-where?* (Online) Available at: <http://www.nagra.ch/en/locationareas.htm> (2014-08-14)
- [76] NAGRA (National Cooperative for the Disposal of Radioactive Waste), *Geological repository for high-level waste*. (Online) Available at: <http://www.nagra.ch/en/tlhaae.htm> (2014-08-14)
- [77] NDA (Nuclear decommissioning authority), *Our work*. (Online) Available at: <http://www.nda.gov.uk/what-we-do/> (2014-07-28)
- [78] Department of Energy and Climate Change (2014). *Implementing Geological Disposal, A Framework for the long-term management of higher activity radioactive waste*. (Online) Available at: <https://www.gov.uk/government/publications/implementing-geological-disposal> (2014-07-28)
- [79] NDA (Nuclear decommissioning authority) (2014), *The 2013 UK Radioactive Waste Inventory; Waste Quantities from all Sources*. (Online) Available at: <http://www.nda.gov.uk/ukinventory/> (2014-07-28)
- [80] NDA (Nuclear decommissioning authority) (2014), *Geological Disposal Feasibility studies exploring options for storage, transport and disposal of spent fuel from potential new nuclear power stations*. Report no. NDA/RWMD/060/Rev.
- [81] NEA, OECD (Nuclear Energy Agency, Organisation for Economic Co-operation and Development) (2013), *Radioactive Waste Management Programmes in OECD/NEA Member Countries, Country Report: United Kingdom*.

Backfilling a Horizontal Tunnel with Granular Bentonite – Machine Development, Pre- & Mock-up Tests and Application at the Mont Terri URL

Sven Köhler¹, Toshihiro Sakaki¹, Hanspeter Weber¹, Benoit Garitte¹, Herwig R. Müller¹

¹NAGRA, National Cooperative for the Disposal of Radioactive Waste,
Hardstrasse 73, CH-5430 Wettingen, Switzerland

sven.koehler@nagra.ch

Abstract

The Full-Scale Emplacement (FE) Experiment at the Mont Terri underground rock laboratory (URL) is a full-scale multiple heater test in a clay-rich formation ('Opalinus Clay'). It simulates the construction, waste emplacement, backfilling and early post-closure evolution of a spent fuel (SF) / vitrified high-level waste (HLW) repository tunnel as realistically as possible. One of the main aims of the FE experiment is the investigation and demonstration of horizontal backfilling procedures for emplacement tunnels according to the Swiss repository concept.

Introduction and experimental aims

The FE Experiment is based on the Swiss disposal concept for SF / HLW. In the FE tunnel three heaters with dimensions similar to those of waste canisters were emplaced on top of pedestals built of bentonite blocks (Figure 1). The remaining space was backfilled with granular bentonite using a prototype backfilling machine with 5 screw conveyors.

The main aim of the FE Experiment is to investigate SF / HLW repository-induced thermo-hydro-mechanical (THM) coupled effects onto the host rock at this scale and to validate existing coupled THM models. Further aims are the verification of the technical feasibility of constructing a repository tunnel using standard industrial equipment (Daneluzzi et al. 2014; Müller et al. 2015a), the optimisation of the bentonite buffer material production (Weber et al. 2015) and the investigation of (horizontal) canister and buffer emplacement procedures at underground conditions.

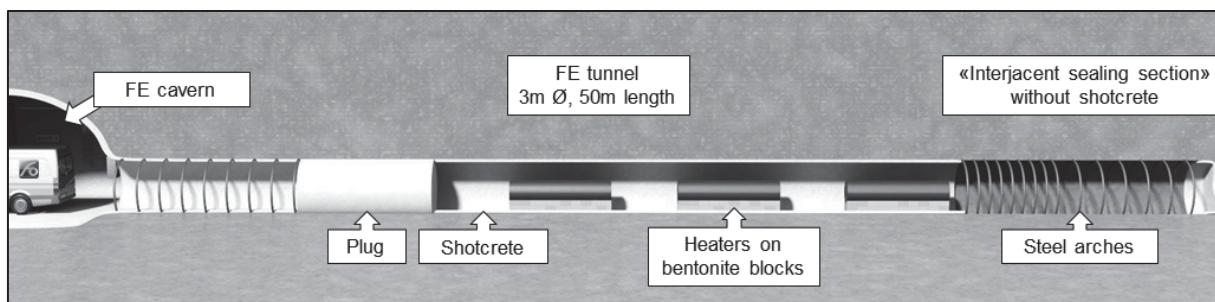

Figure 1. Visualization of the general experimental layout of the Full-Scale Emplacement (FE) experiment at the Mont Terri URL; sensors and bentonite backfill are not displayed.

Backfilling concept

Based on the experiences from the EB experiment (Kennedy & Plötze, 2003) and the ESDRED project (Plötze & Weber, 2007), the decision was made to design and fabricate a five-arm screw conveyor backfilling machine that was able to backfill a horizontal tunnel as tightly and homogeneous as possible (Figure 2). This prototype was meant to demonstrate the backfilling process in the FE-tunnel (diameter 2.5 to 3 m) with a dry granulated bentonite mixture according to the Swiss reference concept for HLW.

The main requirement for the backfill was an overall bulk dry density of at least 1.45 t/m^3 . The aim of using five screw conveyors was to improve the backfilling quality in terms of homogeneity, since segregation effects had been observed during the ESDRED project. A staggered alignment of the screw conveyors was chosen with respect to the expected repose angle of the backfill material. Moreover, an increased compaction was expected as each screw conveyor remained within the material bulk building up a conveyance pressure. Oblique screw conveyor tips were designed in order to fill-up irregular overbreaks in the upper part of the tunnel profile.



Figure 2. CAD-illustration of the backfilling machine built for the FE Experiment, driving over a dummy canister resting on a pedestal made of bentonite blocks. Total length of the backfilling machine including the feeding device was 17 m. (illustration by McKie, Nagra).

The backfilling principle is shown in Figure 3. The backfilling machine drives over the last canister emplaced and starts backfilling from the bentonite material slope covering the preceding canister.

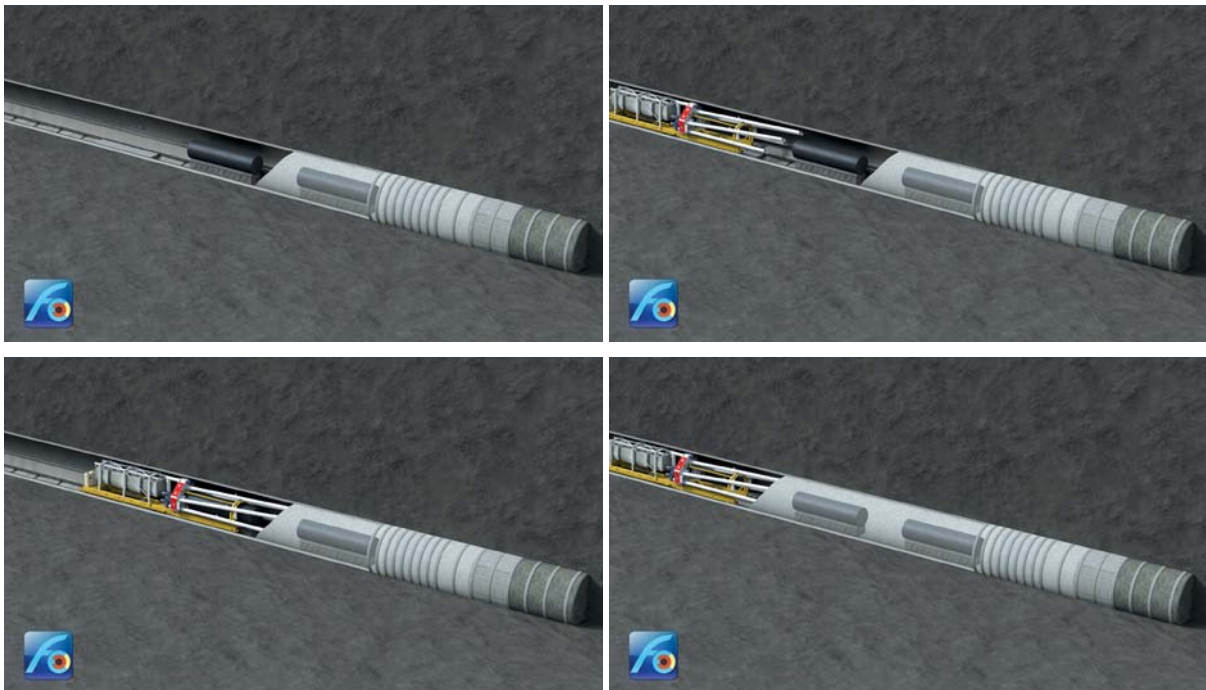

Figure 3. Backfilling sequence for one heater element in the FE tunnel at Mont Terri Rock Laboratory (illustration by McKie, Nagra).

Investigations before backfilling machine construction

Before the backfilling machine was built, two pre-tests were carried out. One of them (pre-test A, Figure 4 and Figure 5) focused on the coupled effects of material conveyance, the potential to push the bulk material upwards, the resulting backfilling pressure and the corresponding actuation parameters of the screw conveyors.

The second (pre-test B, Figure 6) aimed at a better understanding of the bulk material behaviour depending on accessory measures such as slope coverage, insertion of a vibration needle etc., as well as at collecting data for optimization of the backfill material's grain size distribution with regard to the required dry density.

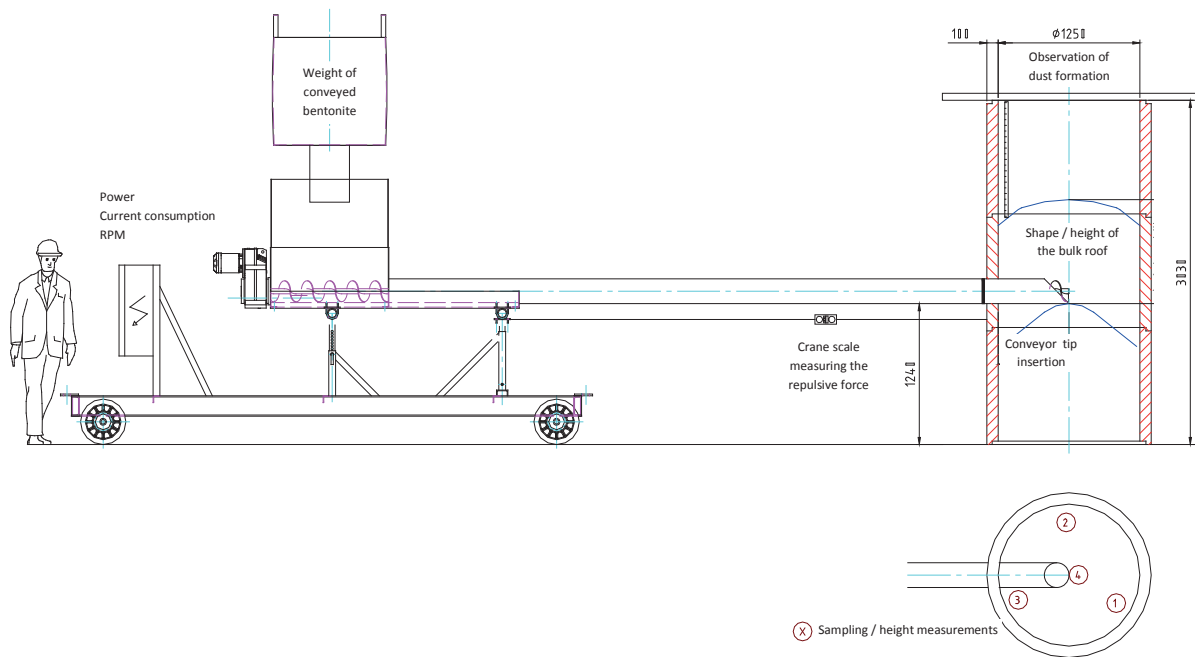

Figure 4. Setup of pre-test A indicating the observed parameters.



Figure 5. Pre-test A aimed at investigating the potential of pushing the bulk material upwards in a tube of 1.25 m diameter including corresponding parameters.



Figure 6. Pre-test B visualised the intensity of segregation effects depending on various measures during backfilling (here: no measures in the top pictures, dry density $\rho_d \approx 1.43 \text{ t/m}^3$ vs. flexible slope coverage and broader grain size distribution in the lower ones, $\rho_d \approx 1.46 \text{ t/m}^3$).

Backfilling machine construction

According to the Swiss backfilling concept, the backfilling system is rail bound. It consists of the backfilling machine with the screw conveyance system and the feeding wagon carrying specially designed bigbags. Both devices have their own drive units. The control unit for the backfilling system is placed at the rear end of the feeding wagon. Figure 8 shows a photo of the whole backfilling system during test operations.

The feeding wagon is a vehicle carrying four bigbags hanging on rollers to be pushed forward manually as soon as the big bag in the front gets empty and is removed. The feeding wagon does not exhibit any demonstration character with regard to the Swiss backfilling concept. It is an economical solution for the non-industrial sized FE experiment in terms of the relatively small volume to be backfilled.

The feeding hopper attached to the backfilling machine is the interface between feeding wagon and the backfilling machine.

The core component of the backfilling machine (Figure 7) is the conveyance unit. It consists of a horizontal discharging screw conveyor placed below the feeding hopper, a vertical and a horizontal feeding conveyor towards the distribution box (painted white and red). The latter is equipped with level transmitters to adjust the speed of the discharging screw and thus provide optimal conditions for the bulk material to steadily flow through the distribution box and enter the five horizontal "stuffing" screw conveyors. These are aligned in a staggered manner with respect to the expected bulk material slope in the emplacement tunnel (repose angle of ca. 35°). The tips of the screw conveyor tubes are cut obliquely in order to push the conveyed material upwards. By this, not only the complete crown area but also gaps and overbreaks resulting from the uneven tunnel wall surface were meant to be filled.



Figure 7. The prototype backfilling machine (CAD model) with five screw conveyors developed for backfilling the horizontal FE tunnel with granulated bentonite as tightly as possible. The longest screw conveyor is 8.5 m long, total length of the device is 11.5 m. (Illustration by McKie, Nagra).

Testing and commissioning of the machine

Before acceptance of the new backfilling machine it had to be extensively tested. For this purpose, a test site was set up in a factory building where all relevant processes related to heater emplacement and backfilling could be tested. Temporary rails and a steel tube with a diameter of 2.50 m and a length of 8 m were installed. This "1:1 mock-up test" aimed at

- 1 Technology demonstration of the backfilling process with the backfilling machine
 - a) Check and optimise the functionality of the entire system "backfilling technology" under realistic conditions
 - b) Check and optimise the control parameters of the backfilling technology incl. calibration of the braking forces
 - c) Check and optimise process related interfaces such as bentonite pedestal as well as sensors' and cables' positions for instrumentation, heater elements etc.
- 2 Check the process sequences incl. their duration for the assessment of a work programme for the implementation at Mont Terri
- 3 Quality control (QC) of the backfill: global and local assessment of the bulk dry density backfilled into the *dummy-tunnel*



Figure 8. The prototype machine with feeding- and control unit carrying four bigbags. The photo was taken during a 1:1 scale mock-up test in an off-site workshop. To the left, a dummy-tunnel and a dummy-canister resting on a steel pedestal can be seen (photo: Comet).

Figure 9 gives an impression of the test set-up (without rails and backfilling machine). The mock-up test comprised two fillings of the steel tube. During mock-up test No. 1, the focus was put on technical functionality (e.g. adjustment of the hydraulic brakes to 32 kN horizontal repulsive forces, calibration of force transmitters etc.) and procedural optimisations (handling, QC methodology etc.). Before mock-up test No. 2 started, minor technical issues were fixed and the focus was put on the backfilling procedure and QC in terms of density verification and sampling (aims No. 2 and 3).



Figure 9. CAD-visualisation of the mock-up test-tunnel showing pipes for density measurements (illustration by McKie, Nagra).

During backfilling all screw conveyors are filled and remain in the GBM bulk slope in order to prevent dust formation and to build up a conveyance pressure (Figure 10). This pressure pushes the material bulk upwards, filling overbreaks in the tunnel crown. The backfilling machine is held in place against the repulsive forces by hydraulic breaks which have to ease off at approximately 32 kN in

order to keep high conveyance pressure but not to overload the screw actuators. With sophisticated controls, many parameters such as each actuator's power consumption, rotation speed and the hydraulically controlled braking force were controlled and displayed (Figure 11).

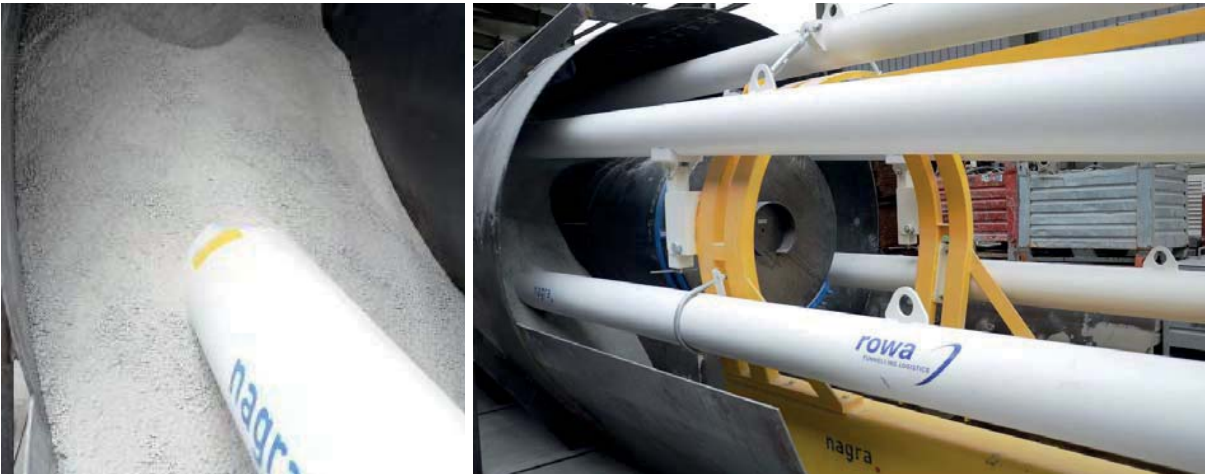

Figure 10. The new backfilling machine being tested in a 1:1-scale tunnel model in an off-site metalworking factory. The 1 m diameter dummy heater can be seen in between the screw conveyors (photos: Nagra).

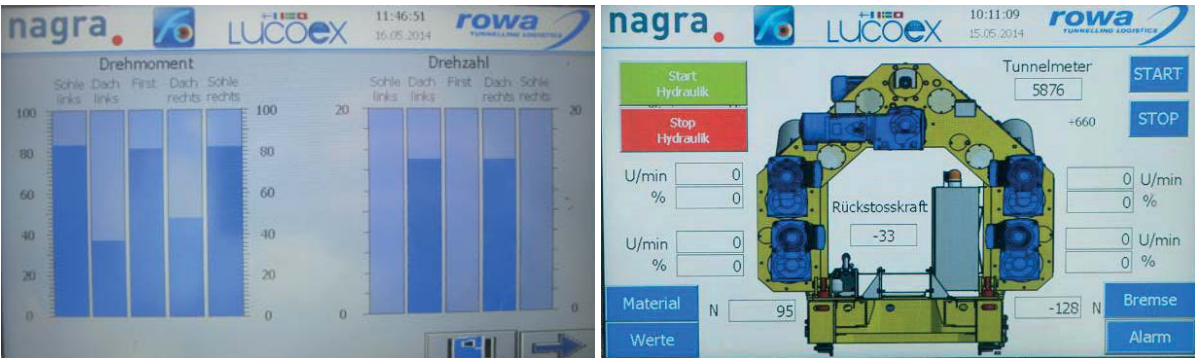

Figure 11. Touch screen panel for controlling the backfilling machine, showing two different displays (photos: Nagra and Comet).

Regarding QC measures, classical mass-volume-balance was calculated from the backfilled weight and the backfilled volume. In mock-up test 1 the volume was estimated by combining the known geometry of the steel tube and the application of a novel 3D camera based on time-of-flight (TOF) technology to capture the slope geometry. For mock-up test 2 the slope was laser scanned with a classical geodetic total station. In order to distinctly determine the density around the dummy canister and behind it, laser scanning was done at two different slope positions (Figure 12).

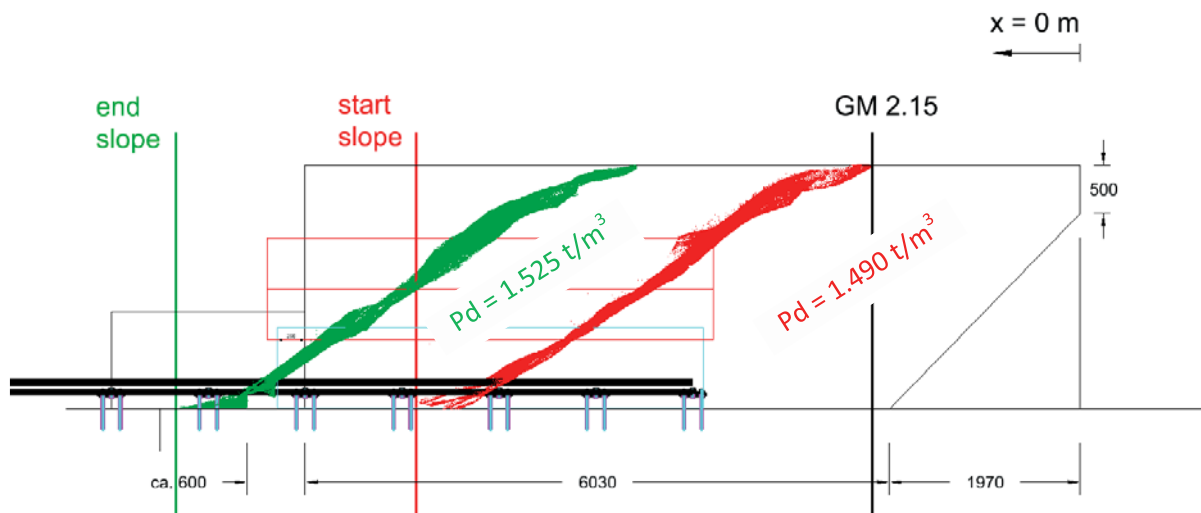

Figure 12. Array of curves from scanning the "start slope" (red) and the "end slope" (green) for distinct volume and density determination behind and around the canister.

Moreover, the test set-up yielded the special advantage of the backfilled bulk material not only to be accessed through the slope, but also radially through the steel tube. Local density was measured using dielectric tools, radioactive logging and horizontal cone penetration testing. In Figure 9 small pipes are displayed that allow specific probes to be inserted for this purpose.

The dry density results are listed in Table 1. The average dry density was 1.50 t/m^3 , meeting the target dry density. At the same time the demonstration demand of the FE experiment was reached.

Table 1: Dry density results in $[\text{t/m}^3]$ calculated from mass-volume measurements.

Values for deviation result from conservative assumption of

- 0.35% due to weighing inaccuracy and 2.5 kg material loss per big bag
- standard deviation in water content measurements ($5.54 \pm 0.16\%$ for Mock-up 1 and $5.60 \pm 0.09\%$ for Mock-up 2)
- inaccuracy in volume estimation (1% for Mock-up 1 and 0.2% for Mock-up 2)
- inaccuracy in positioning of the survey ($\pm 0.01 \text{ m}^3$)

Values in $[\text{t/m}^3]$	Mock-up 1	Mock-up 2 gap	Mock-up 2 around canister	Mock-up 2 total
Average dry density	1.498	1.490	1.525	1.502
Deviation	0.023	0.013	0.022	0.009

Operation at Mont Terri Rock Laboratory

Figure 13 shows the backfilling machine with attached feeding wagon passing through the FE-A niche into the FE-tunnel at Mont Terri Rock Laboratory. Further photo impressions of the machine driving through the FE-tunnel and over a heater resting on a bentonite block pedestal, followed by the backfilling process are given in Figure 14 and Figure 15. For reloading bigbags, the feeding wagon was detached from the backfilling machine and driven to Mont Terri's intersection of MB and GA 08 (Figure 16) while the backfilling machine kept waiting in the FE-gallery with the screw conveyors inserted in the bulk material.

Figure 17 shows the control unit on the rear end of the feeding wagon attached to the backfilling machine.



Figure 13. Backfilling machine passing under the gantry crane in the FE-A niche at Mont Terri (photo: Comet).



Figure 14. Five screw conveyors on the backfilling machine in the FE emplacement tunnel (photo: Comet).

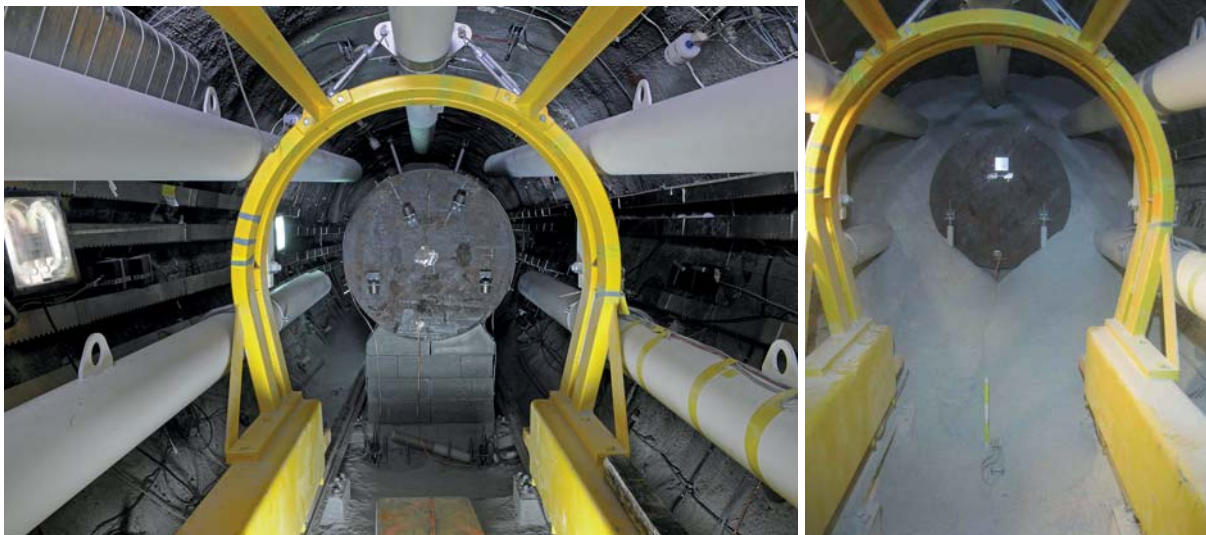

Figure 15. Backfilling machine with screw conveyors driving over the heater and its pedestal (left, photo: Comet) and during backfilling operation (right, photo: Nagra).



Figure 16. Loading Big Bags (photo: Comet).

Figure 17. Rear end of the feeding wagon with control unit visible and breaks attached to the rails (photo: Nagra).



Figure 18. Geodetic survey of slopes (left) and sample-shapes (right) for differential volume and subsequent density calculations (photos: Nagra).

The backfilling at Mont Terri URL was carried out in four different periods of three days, alternating with periods of several weeks for manual assembly of the three bentonite pedestals and the

emplacement of the heaters including sensor installations. Each backfilling period was suspended by two further interventions for sensor installation (Müller et al. 2015b). In total, the backfilling machine was driven out of the FE-tunnel eleven times, leaving the slope accessible for QC. Eleven 3D laser scans resulted from these slopes (Figure 18) yielding 12 volume determinations in conjunction with a laser scan of the complete tunnel section before backfilling. By mass-volume calculations, this resulted in twelve distinct dry densities along the backfilled tunnel section of 29.6 m length (Table 2 and Figure 19).

Table 2: Dry density results in [t/m³] per section calculated from mass-volume measurements. Deviation is estimated 0.007 t/m³ resulting from the assumption of 0.35% material loss and weighing inaccuracy plus 0.1% volume estimation inaccuracy.

Section	Wall TM 15	Slope 11	Slope 10	Slope 9	Slope 8	Slope 7	Slope 6	Slope 5	Slope 4	Slope 3	Slope 2	Slope 1
Local dry density [t/m ³]	1.403	1.477	1.444	1.555	1.530	1.496	1.519	1.494	1.487	1.474	1.495	1.496

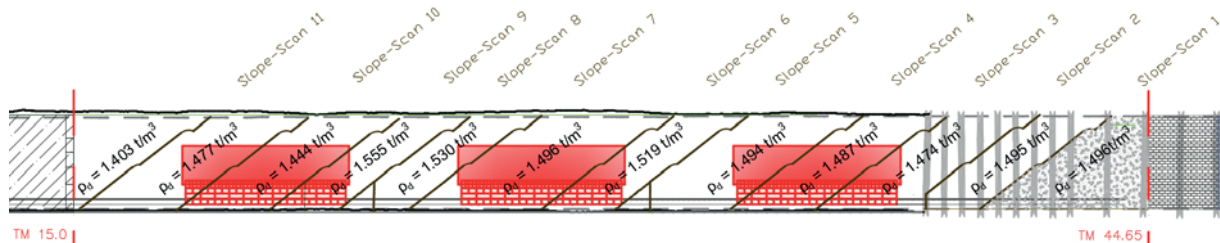

Figure 19. Longitudinal section of the backfilling sequences indicating the measured local dry densities.

The overall average dry density was 1.489 ± 0.003 t/m³. The smaller deviation compared to the sectional values according to Table 2 results from the fact that material losses generally occurred along the way to be backfilled within the FE-tunnel. This contributes to local inaccuracy but not to the overall mass balance. Hence, the mass balance is limited to weighing inaccuracy of 0.1%. Volume inaccuracy is 0.1%, too.

Regarding the notably low value of 1.444 t/m³ covered by slope 10, lower quality material in a few bigbags happened to be used for backfilling in this section of the FE-tunnel. The respective backfill material exhibits a high portion of powder instead of the expected fuller type grain size distribution. The reason for lower backfill material quality is most likely related to the reuse of granular bentonite material from the mock-up test. Local accumulation of dust had probably not been detected during recycling with a vacuum truck and repacking in bigbags.

Samples for QC measures were taken from every bigbag while pouring into the feeding hopper just before backfilling. Water content, specific pellet density and grain size distribution were analysed systematically (Weber et al. 2015).

An unexpected finding was the obvious signs of wear on the conveyor screws and the respective tubes (Figure 20). This effect was more pronounced the bigger the work performance of the distinct screw conveyor had been. This applies in particular to the middle augers. The reason for this is a significant deflection of the conveyor tube during backfilling due to the vertical component of the repulsive force. This is attributed to the oblique tips of the tubes. For future screw conveyor designs, this problem should be addressed.



Figure 20. Signs of wear from friction between screw conveyor-screw and top part of the screw conveyor tube due to the oblique cut of the tube tip resulting in a vertical reaction force component and corresponding deflection. Note that the very front part of the screw is not affected.

Conclusion

The backfilling at Mont Terri URL and at other pre-testing sites was achieved without any breakdowns or accidents. All project aims concerning demonstration aspects and backfill quality were reached. New problematic findings such as the signs of wear of the screw conveyors will be analysed and resolved in future developments.

Acknowledgments

The FE experiment is implemented in the Mont Terri URL, which is operated by swisstopo. The initiator and lead organisation for the FE experiment is NAGRA; ANDRA (France), BGR (Germany), DOE/LBNL (U.S.A), GRS (Germany) and NWMO (Canada) are participating in the Experiment.

The engineering and demonstration components of the FE experiment are also part of NAGRA's participation in the EC co-funded 'Large Underground CONcept EXperiments' (LUCOEX) project; parts of the research leading to these results have therefore received funding from the European Union's European Atomic Energy Community's (Euratom) Seventh Framework Programme FP7/2007-2013 under grant agreement no 269905 (LUCOEX project).

References

- Kennedy K, Plötze M, 2003.** Engineered Barrier Emplacement Experiment in Opalinus Clay (EB). Granular Material Backfill Emplacement Methods Evaluation. EC contract FIKW-CT-2000-00017. Project deliverable D4.
- Plötze M, Weber H, 2007.:** ESDRED Emplacement tests with granular bentonite MX-80 – Laboratory results from ETH Zürich. Nagra Arbeitsbericht NAB 07-24.
- Daneluzzi R, Burrus F, Küttel T, Müller H R, Köhler S. 2014.** LUCOEX Deliverable D2.2: Report on the construction of the emplacement tunnel. WP2 – Full-Scale Emplacement Experiment (FE) at Mont Terri. EU report downloadable from www.lucoex.eu
- Köhler S, Fries T, Müller H, Gaus I, 2015.** Swiss backfilling concept. Requirements and Approaches for Optimization of the Bentonite Barrier around SF/HLW Disposal Canisters. Poster presentation and abstract at the Clay Conference in March 2015, Brussels.
- Müller H R, Köhler S, Vogt T. 2015a.** Excavation of the FE tunnel at the Mont Terri URL. LUCOEX Conference & Workshop, Oskarshamn, Sweden, 2-4 June 2015.
- Müller H R, Vogt T, Garitte B, Sakaki T, Spillmann T, Hertrich M, Giroud N, 2015b.** Instrumenting, monitoring and heating the Full-Scale Emplacement (FE) Experiment at the Mont Terri URL. LUCOEX Conference & Workshop, Oskarshamn, Sweden, 2-4 June 2015.
- Sakaki T, Köhler S, Hertrich M, Müller H R, 2015.** FE Experiment: Density Measurement of Granulated Bentonite Mixture in a 3D 1:1 Scale Mockup Test Using Dielectric Tools. Poster presentation and abstract at the Clay Conference in March 2015, Brussels.
- Weber H, Garitte B, Köhler S, Müller H, 2015.** LUCOEX: QA/QC during bentonite material production & emplacement in the framework of the FE Experiment. LUCOEX Conference & Workshop, Oskarshamn, Sweden, 2-4 June 2015.

Instrumenting, monitoring and heating the Full-Scale Emplacement (FE) Experiment at the Mont Terri URL

*Herwig R. Müller¹, Tobias Vogt¹, Benoit Garitte¹, Toshihiro Sakaki¹,
Thomas Spillmann¹, Marian Hertrich¹, Niels Giroud¹*

¹NAGRA, National Cooperative for the Disposal of Radioactive Waste,
Hardstrasse 73, CH-5430 Wettingen, Switzerland

Corresponding author e-mail: herwig.mueller@nagra.ch

Abstract

The Full-Scale Emplacement (FE) Experiment at the Mont Terri underground rock laboratory (URL) is a full-scale multiple heater test in a clay-rich formation ('Opalinus Clay'). It simulates the construction, waste emplacement, backfilling and early post-closure evolution of a spent fuel (SF) / vitrified high-level waste (HLW) repository tunnel as realistically as possible.

Introduction and experimental aims

The main aim of this experiment is to investigate SF / HLW repository-induced thermo-hydro-mechanical (THM) coupled effects onto the host rock at this scale and to validate existing coupled THM models. Further aims are a) the verification of the technical feasibility of constructing a repository tunnel using standard industrial equipment, b) the optimisation of the bentonite buffer material production and c) the investigation of (horizontal) canister and buffer emplacement procedures at underground conditions.

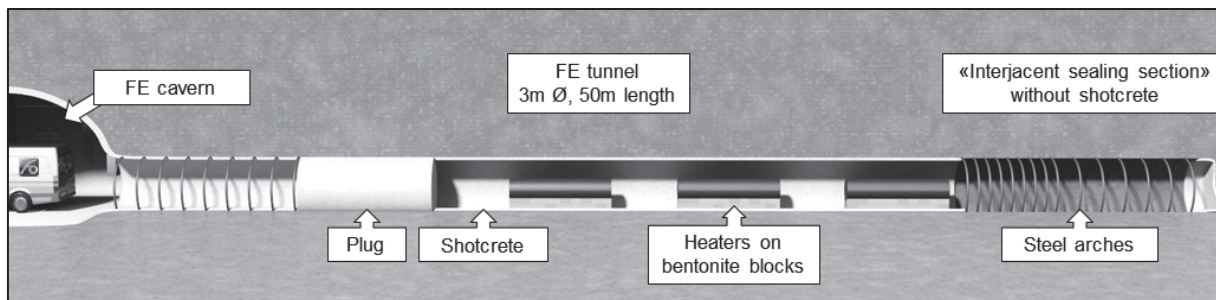

Figure 1: Visualization of the general experimental layout of the Full-Scale Emplacement (FE) Experiment at the Mont Terri URL; sensors and bentonite backfill are not displayed.

Experimental layout

The FE Experiment is based on the Swiss disposal concept for SF / HLW. The construction of the 50 meter long experimental tunnel with a diameter of approx. 3 meters was completed in September 2012. At the deep end of the tunnel the so-called 'interjacent sealing section' (ISS) was built using only steel arches for rock support, whereas the rest of the tunnel is supported by shotcrete.

In the FE tunnel three heaters with dimensions similar to those of waste canisters were emplaced on top of pedestals built of bentonite blocks (see Figure 1). The remaining space was backfilled with granular bentonite; for details see Köhler et al. (2015).

In February and March 2015 (after backfilling was completed) the FE tunnel was sealed off towards the FE cavern with a retaining wall and a 5 meter long concrete plug, holding the buffer in place and reducing air and water flow.

THM instrumentation

The entire experiment implementation as well as the post-closure THM(C) evolution is monitored using a network of several hundreds of sensors. The sensors are distributed in the rock in the near- and far-field, the tunnel lining, the engineered barrier system (EBS) and on the heaters.

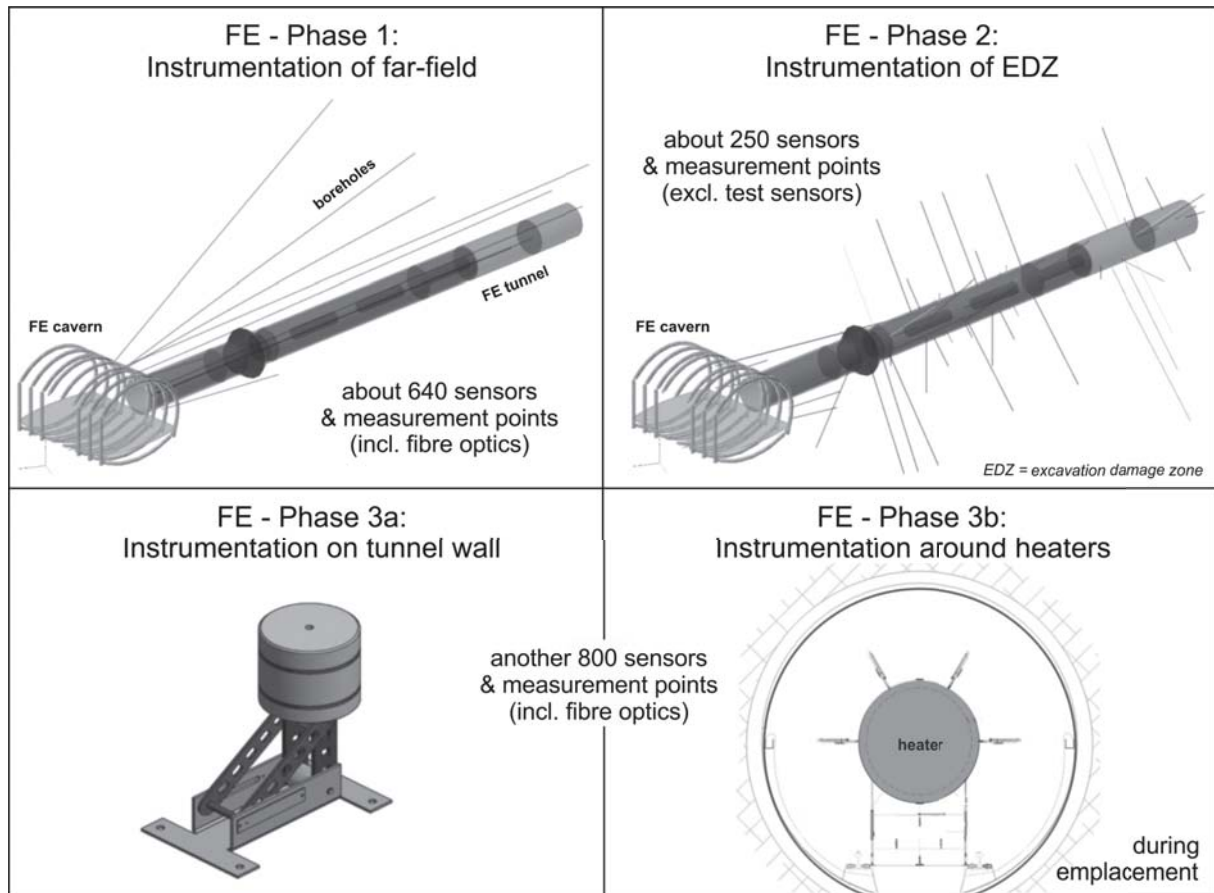

Figure 2: Overview showing the main instrumentation phases of the FE Experiment at the Mont Terri URL as well as the approximate 3D arrangement of the longitudinal and radial boreholes.

The rock in the far-field was instrumented with up to 50 meter long boreholes drilled from the FE cavern; this instrumentation was completed in April 2012 before the FE tunnel was built and therefore allowed a ‘mine-by’ observation of the later tunnel construction. Until February 2014 the ‘excavation damage zone’ (EDZ) was instrumented with radial boreholes drilled from within the FE tunnel (see upper right square in *Figure 2*).

In June 2014 the instrumentation of the tunnel wall was completed for monitoring the bentonite buffer. Here also many fibre optic cables for distributed temperature and deformation monitoring were installed. The sensors for monitoring the heaters and the EBS in close proximity to the heaters were implemented together with the three heaters in October 2014, November 2014 and January 2015.

The sensors on the tunnel wall, in the EBS and on the heaters had to be installed on erectable sensor holders due to the space conflict with the prototype machine developed for backfilling the FE tunnel with granular bentonite; for details see Köhler et al. (2015).

The main monitored parameters are temperature, pressure, deformation, and humidity / water content, but geophysical and gas related monitoring is also performed.

- Water pressure in rock: 6 boreholes with multi-packer-systems and 6 intervals each, 8 boreholes with multi-packer-systems and 2 intervals each, 13 boreholes with single-packer-systems and 1 interval each.
- Rock deformation: 5 boreholes with standard rod extensometer and 6 boreholes with specially designed long-lasting rod extensometer. 2 boreholes with horizontal inclinometer chains with 40 segments each. 7 boreholes with fibre optic strain sensors (SOFO).
- Water content in rock: 29 boreholes with water content (TDR / FDR) and relative humidity sensors.
- Rock temperature: All boreholes were equipped with in total 320 temperature sensors (PT1000 and thermocouples). In addition, 360 meters of fibre optic cable on the inclinometer casing and 250 meters at the tunnel wall for distributed temperature sensing were installed. Also a heatable fibre optic cable was installed on the tunnel wall.
- Tunnel climate: 12 sensors (RH, temperature, wind speed and air pressure) were monitoring the tunnel climate during the (ventilated) phase between tunnel construction and backfilling.
- Heater monitoring (sensors per heater): 6 internal temperature sensors, 44 temperature sensors on heater surface (thermocouples and fibre optic FBG sensors), 7 displacement sensors (LVDT and fibre optic FBG sensors) to track heater movement, 2 total pressure cells on heater surface, polished areas at heaters to investigate corrosion after a potential future dismantling.
- Bentonite (EBS) monitoring: 105 conventional temperature sensors (thermocouples and PT1000), approx. 430 meters of fibre optic cables for distributed temperature and strain sensing, 99 RH sensors, 15 water content (TDR/FDR) sensors, 27 total pressure cells at shotcrete - bentonite interface to monitor swelling pressures, 12 thermal conductivity sensors.
- Gas monitoring in the EBS: 14 in-situ hydrogen sensors and 5 in-situ oxygen sensors as well as 9 sampling lines.
- Geophysical monitoring of the EBS: 7 permanently installed seismic transmitters and receivers as well as monitoring pipes that penetrate into the EBS to run temporary seismic, radar and other geophysical logging tools (such as e.g. gamma-gamma-density).

Heating

For the FE Experiment three customized heaters each with a length of approx. 4.6 meters and a diameter of approx. 1 meter were manufactured and consequently emplaced in the FE tunnel. The heaters were designed as hollow carbon steel cylinders in order to allow the installation of high resistive electrical wires on the inside as heating devices. This experimental set-up resulted in a total heater weight of 5 tons each.

After the heater emplacement and the consequent backfilling, the heating phase was started in December 2015 with the deepest heater H1 first. Finally in February 2015 the middle heater H2 and heater H3 close to the plug (see *Figure 3*) were turned on. The heaters are run power controlled meaning that the temperature is not fixed and therefore an experimental outcome. The resulting temperature distribution is influenced mainly by the thermal properties of the (at the beginning relatively dry and therefore poorly heat conducting) bentonite backfill, but also by the thermal properties of the rock and the boundary conditions at Mont Terri URL.

According to current plans the power level of 1'350 W per heater will be kept for a period of up to approx. 3 years. At the end of this continuous heating period temperatures of approx. 130-150°C at the surface of the middle heater and 60-80°C at the rock surface are expected for the FE experiment. Afterwards it is planned to decrease the power according to a decay function typical for high-level waste. The heating and monitoring phase of the FE experiment at Mont Terri is envisaged to last at least 10 to 15 years.

First temperature measurements from the surface of heater H1 are shown in *Figure 4*.

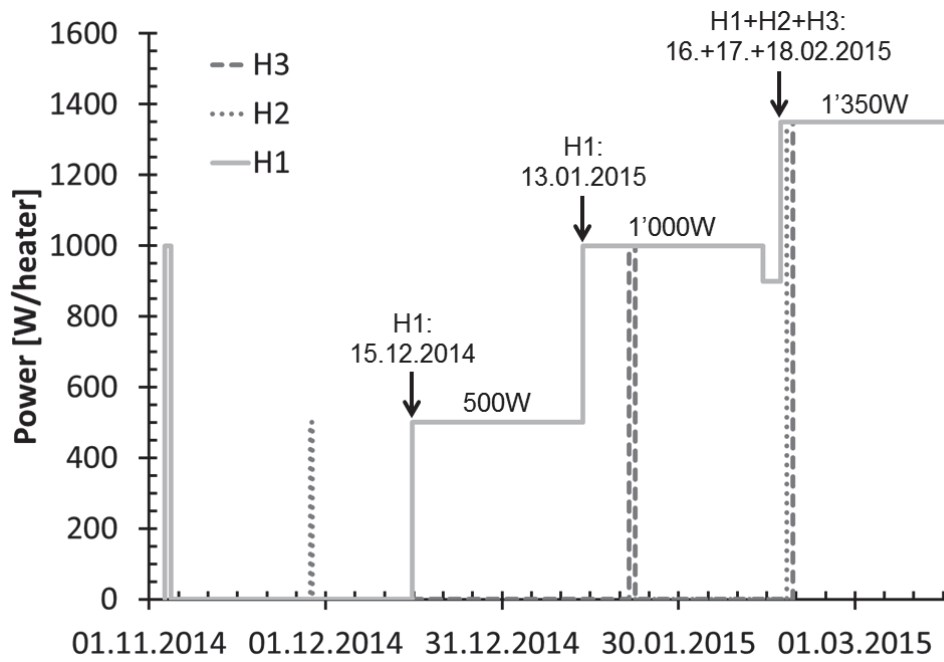

Figure 3: Time series plot showing how the (power-controlled) heating of the FE Experiment at Mont Terri URL was started. The deepest heater H1 was backfilled and turned on first. The first power step at 500 Watts (W) was started on 15th of December 2015. After approx. one month the power was increased to 1'000 W. Finally on 16th, 17th and 18th of February 2015 all three heaters were turned on successively to a power level of 1'350 W for each heater.

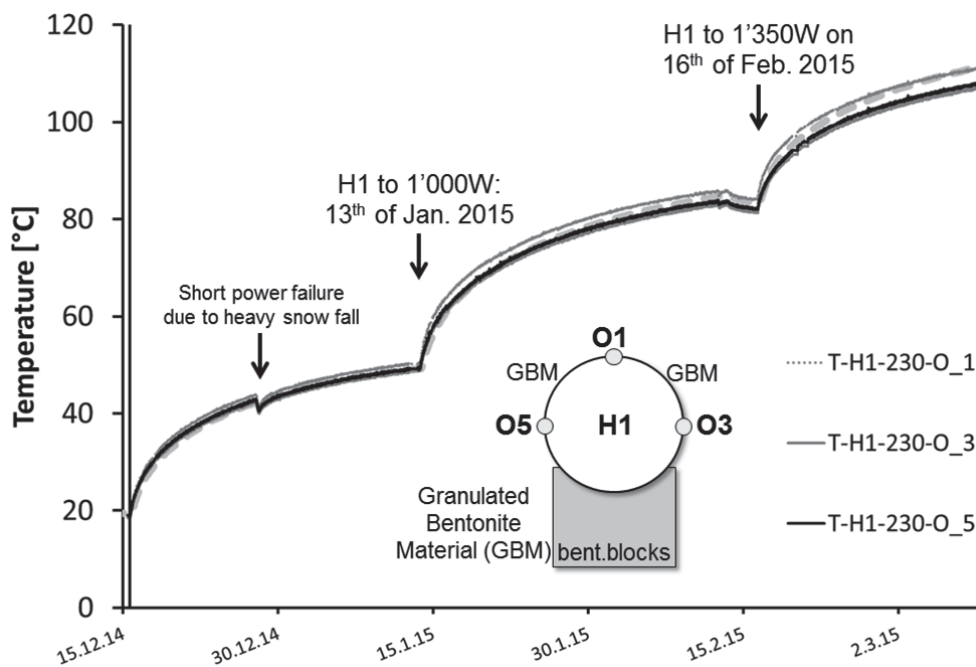

Figure 4: Time series plot showing how the surface temperature of the deepest heater H1 reacted to the chosen turn on sequence (shown in Figure 3). The calculated temperature prediction for an initially (with a water content of approx. 5 %) relatively dry granulated bentonite material (GBM) with a thermal conductivity of 0.3 W/mK is represented as a dashed grey line in the background.

Monitoring

Most of the installed sensors take one measurement every 10 minutes. Also the heaters control parameters such as Ohm, Volt & Ampere respectively Watt (W) are continuously logged and automatically checked. All available measurements are continuously sent to a central data acquisition system (DAS) which not only stores and archives the readings, but also makes them available via the internet. An interface allows a quick check of the data with the help of pre-defined diagrams such as time series graphs, cross plots, etc.

Conclusions

The monitoring environment of the FE experiment is challenging, especially considering the targeted observation period of at least 10 to 15 years. Temperatures of up to 130-150°C in the bentonite buffer and of up to 60-80°C at the rock surface are expected. In addition, saline pore water could cause corrosion of metallic sensor components in the rock and in the humid (partially water saturated) areas close to the tunnel wall.

Although some state-of-the-art sensors and measurement systems were installed, prototype measurement systems had to be developed. This was especially necessary concerning the choice of material. Not only was the corrosion potential taken into account, but also a minimal thermal disturbance was envisaged by choosing materials with a low thermal conductivity (and by avoiding thermal bridges in the general instrumentation set-up).

Distributed fibre optic sensing is a suitable monitoring technique for the application in large scale heater tests, because the sensor (fibre optic cable) is heat and corrosion resistant due to the absence of electronics at the measurement location. In addition, the distributed sensing method provides a spatial resolution in the decimetre to meter range along the fibre optic cable.

Acknowledgments

The FE experiment is implemented in the Mont Terri URL, which is operated by swisstopo. The initiator and lead organisation for the FE experiment is NAGRA; ANDRA (France), BGR (Germany), DOE/LBNL (U.S.A), GRS (Germany) and NWMO (Canada) are participating in the Experiment.

The engineering and demonstration components of the FE experiment are also part of NAGRA's participation in the EC co-funded 'Large Underground COnccept EXperiments' (LUCEOEX) project; parts of the research leading to these results have therefore received funding from the European Union's European Atomic Energy Community's (Euratom) Seventh Framework Programme FP7/2007-2013 under grant agreement no 269905 (LUCEOEX project).

References

Köhler S, Sakaki T, Weber H P, Garitte B, Müller H R, 2015. FE/LUCEOEX: Backfilling a horizontal tunnel with granulated bentonite - machine development, pre- & mock-up tests and application at the Mont Terri URL. LUCEOEX Conference & Workshop, Oskarshamn, Sweden, 2-4 June 2015.

HLW cell full scale demonstration test in Bure URL: method of realization and behaviour characterization

Jacques Morel¹, Frédéric Bumbieler¹, Nathalie Conil¹, Laurence Richard-Panot¹, Gilles Armand¹

¹Andra, Meuse Haute Marne Center, RD960, BP9, 55290 Bure, France

Corresponding author e-mail: frederic.bumbieler@andra.fr

Abstract

At the Meuse/Haute Marne Underground Research Laboratory, a specific technical and scientific programme is being carried out by Andra for several years to test the feasibility of realization and the behaviour of disposal cells for high level – long life nuclear waste packages (HLW) in a 500 m deep clay layer. Lessons learned from the first phases of this programme were used to achieve, as part of the European project LUCOEX, a full scale disposal cell demonstrator representative of the 2009 benchmark concept. Electrical heaters installed inside the cell are used to simulate heat generated by waste packages. All along the demonstration programme, different kinds of measurements, on the excavation machine, in the cell and in the host rock, were done in order to improve the realization method and understand the THM behaviour of the cell and of the surrounding rock.

Introduction

Andra, the French national radioactive waste management agency, is in charge of the study on the possibility of disposal for intermediate to high level activity – long life (IL/HLW) nuclear waste in deep geological repositories. In this aim, the Meuse/Haute Marne Underground Research Laboratory (URL) has been excavated since 2000 in a 500 m deep claystone layer (Callovo-Oxfordian, COX) to characterize the confining properties of the clay-stone and demonstrate the feasibility of construction and operation of a geological disposal (Delay et al. 2007).

The main level of the URL is excavated at a depth of 490 m in the middle of a 135 m thick argillaceous rock layer, overlain and underlain by poorly permeable carbonate formations. Argillaceous rock contains a mixture of clay minerals (40 to 45% on average) and clay-size fraction of other compositions. The clay minerals offer groundwater tightness and radionuclides retention. Silica and carbonate-rich sedimentary components contribute to high strength of the rock and stability of the underground construction. Sedimentation has led to a slightly anisotropic behaviour of claystones. In-situ measurements indicate a strong coupling between mechanical and hydraulic processes (Armand et al. 2011). In-situ stress field in COX claystones is anisotropic (Wileveau et al. 2007), with $\sigma_v \approx \sigma_h$ and the ratio σ_H/σ_h close to 1.3 at the main level of the URL.

The 2009 benchmark concept of disposal cells for HLW waste consists in horizontal micro-tunnels at least 80 m long and about 70 cm in diameter (Figure 1).

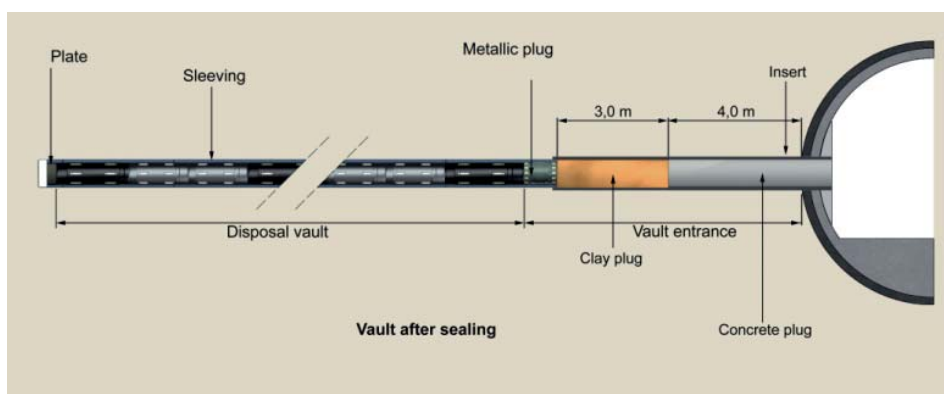

Figure 1. 2009 concept of disposal cell for HLW waste.

It comprises a body part, for package disposal, and a head part for cell closure. They are favourably aligned with respect to the stress field. To prevent against rock deformation and allow the potential retrieval of waste containers during the reversibility period, both body and head parts have a non-alloy steel sleeve. A metal radiation-protection plug separates the cell head from the body part. For cell closure, the head is partly backfilled with a swelling-clay plug and then sealed with a concrete plug to provide additional safety.

Demonstration programme

In order to check the feasibility of such disposal cells construction, and study the behaviour of the cell and its impact on the surrounding rock, an experimental programme has been defined and carried out through different phases since 2009.

Drilling method

The excavation method uses a guided auger drilling machine. The drilling head can be adapted to excavate in diameter 70 to 80 cm. It also allows the retraction of the drilling machine at the end of the excavation, by rotating the machine to the opposite direction of the excavation. The drilling machine is laser-guided, which allows the control of the micro-tunnel trajectory with a precision better than +/- 2 cm.

The excavation can be achieved with or without casing. The casing is made of 2 m long, 70 cm in diameter and 2 cm thick steel tubes. The 2 m long elements are welded or socketed to each other as the excavation advances. The drilling is carried out with air.

Experience feedback from former phases

The first phase, carried out in 2009-2010, aimed to check that it was possible to dig cells in several directions with respect to the stress field in the host formation, to test the excavation method (with or without advance casing) and to specify operating procedures for cell excavation in the next phases (Morel et al. 2010). It also provided initial data on the hydro-mechanical behaviour of the cells and their environment: the influence distance of the cells, their mechanical behaviour and rock damage around them.

Phase 2, carried out in 2011, aimed to test the production of a cell head with an insert installed with a small annular space, and to produce a 40 m long cell with an instrumented sleeve, to study how sleeve/rock clearance reduces over time and its influence on the mechanical behaviour of the sleeve. The test of cell head production was included in the LUCOEX project. Lessons learned from this phase 2 (cell head length and annular space, sleeve instrumentation procedure) were used to prepare and optimize phase 3 corresponding to the full scale heating demonstrator.

Full scale disposal cell demonstrator

The purpose of the full scale heating demonstrator (phase 3 of the programme) is to study the behaviour of a HLW cell, representative of the 2009 benchmark concept, under thermal loading by simulating the heat produced by waste packages. The aims are to demonstrate production and operation of such a disposal cell, and to understand the THM behaviour of the cell, of its interface with the rock and of the surrounding rock.

Full scale experiment set-up

Cell demonstrator characteristics

The full scale demonstration cell is 25 m long, and consists in a 6 m long, 791 mm diameter head part and a 19 m long, 750 mm diameter body part. Design calculations have demonstrated that this total length of 25 m was enough to be representative of the THM behaviour of longer cell. The cell is excavated in the major horizontal stress direction. Heat is produced in the deepest 15 m. The sleeve consists in 2 m long sections (2 cm thick, 700 mm external diameter) socketed to each other. The

insert consists also in 2 m long sections (2.1 cm thick, 767 mm external diameter) welded to each other. Both sleeve and insert are instrumented to monitor their thermo-mechanical behaviour. Base plate, body part's head plate and insert cover plate are bolted on crowns themselves bolted on the sleeve or insert.

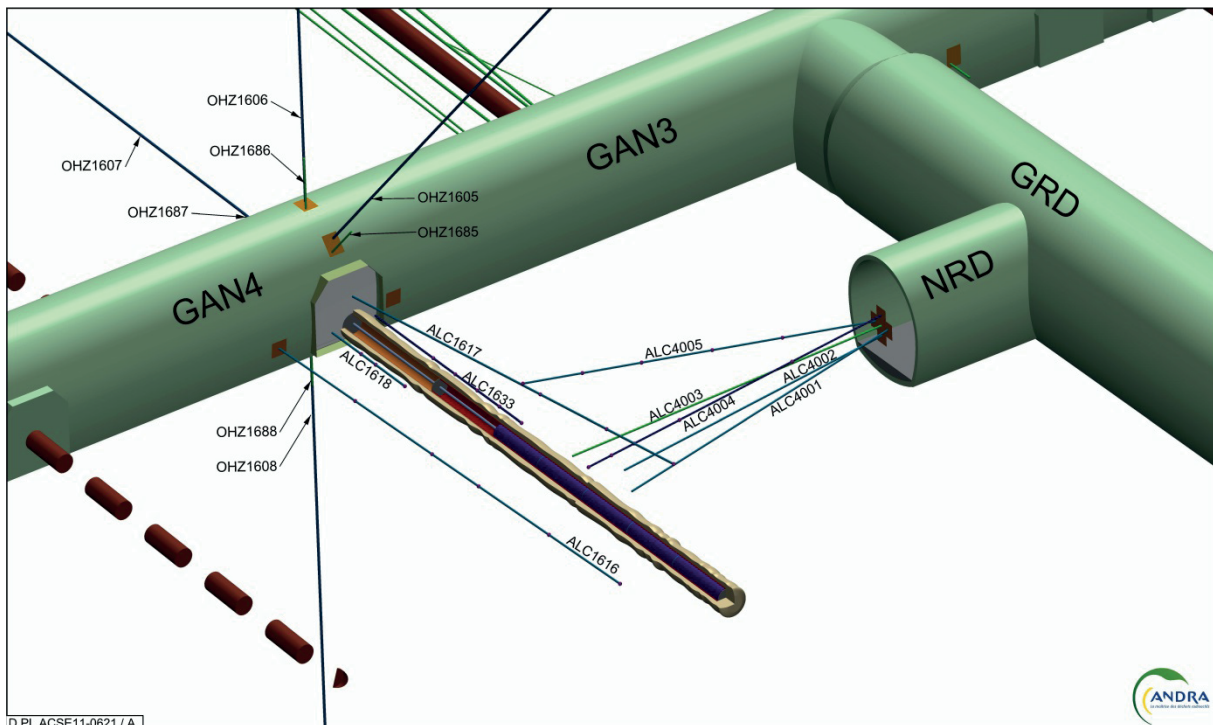

Figure 2. General view of the full scale experiment.

Cell equipment and instrumentation

The heater device consists of five identical elements, each 3 m long, 508 mm in diameter and a weight of about 500 kg. Made of stainless steel, each element contains 2 electrical resistors controlled by a power regulation system.

Four sleeve sections (among which 3 are in the heated zone) are fitted, on their internal surface, with strain gages placed evenly around the pipe in 6 measurement areas, to measure circumferential and axial local strain. On each of these sections, the total pressure at the rock/sleeve interface is also measured at 2 locations, as well as rock/sleeve clearance reduction at the sides and vault of the sleeve through specific drillings. Relative humidity and temperature are measured in the annular space. Two insert sections are, as for the sleeve ones, instrumented with 6 strain gages measurements area. Relative humidity is measured inside the insert.

Two temperature profiles are measured along the cell (sleeve and insert), at the vault and at the side, with one measuring point per sleeve or insert section.

Sleeve and insert diameter variations are measured along horizontal and vertical directions for each instrumented sections outside the heated zone (inside the heated zone space is occupied by heaters).

The sliding of the sleeve in the insert is measured with 3 displacement sensors fixed to the insert inner surface and in contact with the body part's head plate.

Peripheral instrumentation

Peripheral instrumentation is installed in 9 surrounding boreholes drilled from the access drift, from one perpendicular borehole (Figure 2), and in the access drift.

Six boreholes are equipped with pore pressure single or multipacker devices with measuring points at different distances from the cell wall in the horizontal and vertical planes. Each pore pressure measuring point is coupled with a temperature measuring point. The devices allow the realization at

each measuring point of hydrogeological tests to estimate rock permeability. Two boreholes, parallel and perpendicular to the cell, are equipped with temperature sensors. The last borehole, oriented perpendicularly to the cell, allows very fine deformation measurements at different distances from the cell wall.

The access drift instrumentation, in the immediate vicinity of the cell head, consists of supporting instrumentation (strain gages and displacement sensors on sliding steel arches), and displacement and tilt sensors to measure drift wall deformation induced by thermal gradient along the cell.

Realization

Most of the surrounding boreholes, as well as drift support instrumentation, were realized before cell excavation in order to monitor the hydro-mechanical impact of excavation on surrounding rock mass and drift behaviour.

The cell was excavated from 23rd to 31st October 2012 (Figure 3), the insert first and then the body part after changing the cutter head diameter. The first 24 m were excavated in about 3 days; a technical problem that occurred on the drilling machine had then to be solved before the last meter could be excavated. A 3D scan performed before instrumentation showed that the cell trajectory was close to the theoretical one, with a maximum deviation of 3 cm in the horizontal plane and 8 cm in the vertical plane.



Figure 3. Excavation of the cell (left) using the auger drilling machine (right).

Instrumentation of the sleeve and insert was then installed, and all sensors connected to the URL data acquisition system in about 1 month. Heaters were finally inserted in the cell in January 2013 (Figure 4).



Figure 4. Heater installation (left), instrumented sleeve (right).

After a quick test at very low power (33 Watt/m) in February, in order to validate the operation of the heaters regulation system and the measurements acquisition, the main heating phase was launched on 18th April 2013 at a constant power of 220 Watt/m, in order to reach 90°C on the sleeve in about 2 years.

Maximum temperature on the sleeve is reached at 18 m depth (Figure 5), i.e. in the centre of the heated zone. Temperature at the vault of the sleeve is about 4°C higher than on the side. This difference may result from both, heat convection inside the sleeve, and difference in thermal boundary conditions around the sleeve due to the presence of rock cuttings in the annular space.

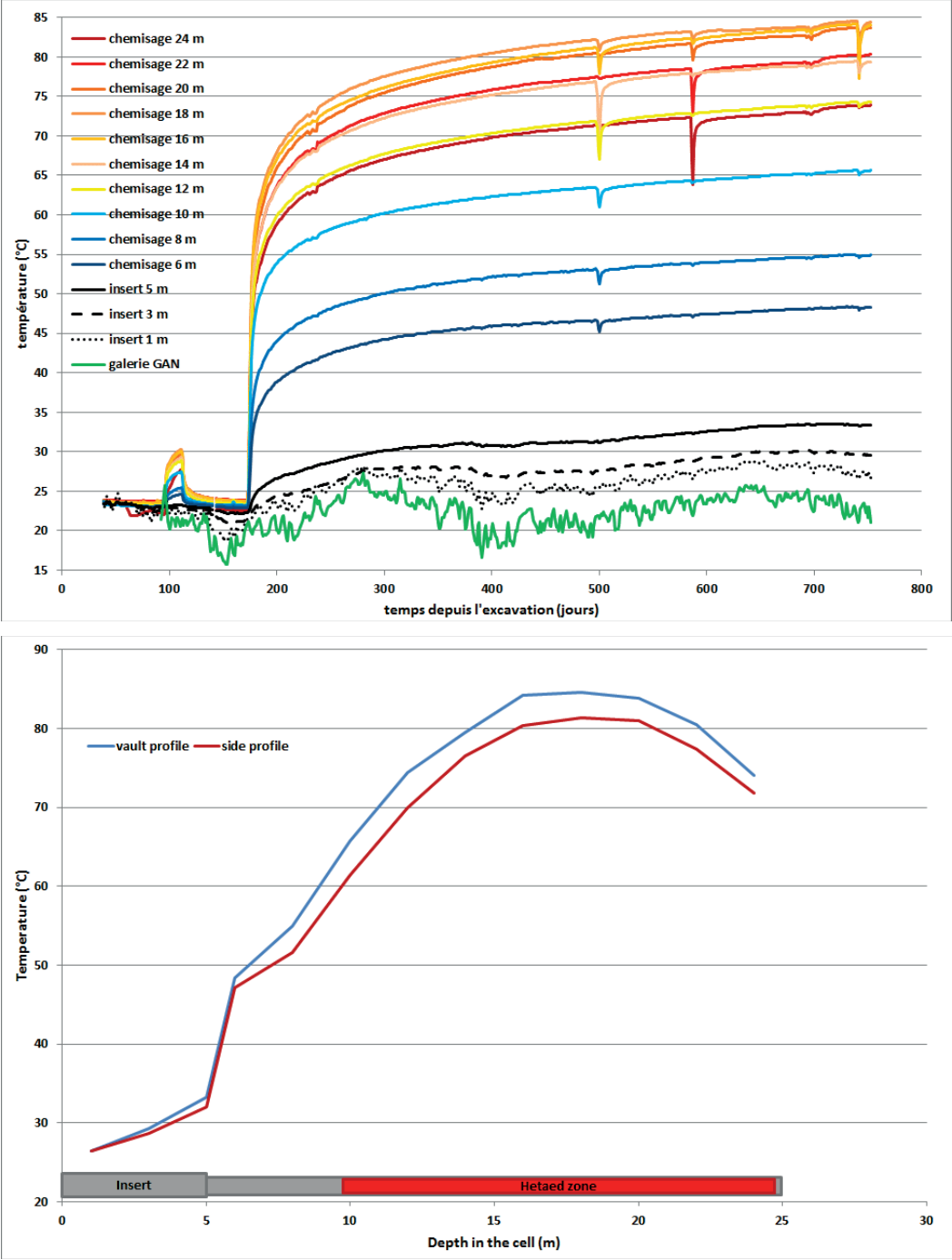

Figure 5. Temperature evolution at the sleeve vault (top), Temperature axial profile on the sleeve after 700 days (bottom).

Results and discussion

THM impact on the surrounding rock

Hydro-mechanical impact of the cell excavation on the surrounding rock mass was found to be very consistent with what was measured during the former phases of the demonstration programme. Induced overpressures in the horizontal plane ranged between 9 and 35 bars at distances between 2.4 and 1 m respectively from the cell wall. The time to reach the pressure peak increases with distance to cell wall.

The heating phase also induces strong overpressures during diffusion of the thermal field in the surrounding rock, due to the difference in thermal dilation coefficients between pore water and rock mass. These overpressures can reach more than 3MPa at 2 m distance from the cell wall. The time needed to reach the overpressure peak is longer in the vertical plane, according to claystone thermal anisotropic properties. This observed THM behaviour is in agreement with measurements made on former small scale THM experiments in the Bure URL.

The impact of heat on the access drift behaviour is not significant.

Cell behaviour under thermal load

Before starting the heating phase and as soon as the sensors were connected, sleeve convergence measurements show compression in the horizontal direction and extension in the vertical direction (Figure 6). This indicates a contact with the cell wall and subsequent mechanical load of the sleeve first in the horizontal direction while no contact occurs with the cell vault. This behaviour has been observed in the former phases of the demonstration programme as well as on smaller scale experiments of similar orientation with respect to the stress field. This phenomenon is directly related to the shape of the excavated damaged zone around the cell which is much more pronounced in the horizontal direction, thus inducing a greater horizontal convergence of the cell wall. The presence of excavation rubbles in the annular space contributes also to this early contact in the horizontal direction.

The heating phase strongly increases the cell wall convergence rate and thus the sleeve deformation, until a contact between the sleeve and the cell vault occurs that stops sleeve ovalization. The loading anisotropy of the sleeve tends then to decrease slightly with the evolution of the contact surface between the sleeve and the cell wall. This anisotropic loading of the sleeve can also be revealed using the strain gages measurements. Analysing the circumferential deformation measured by each gage as a function of its angular position on the sleeve gives the mechanical signature of the loading, which appears globally horizontal (Figure 6).

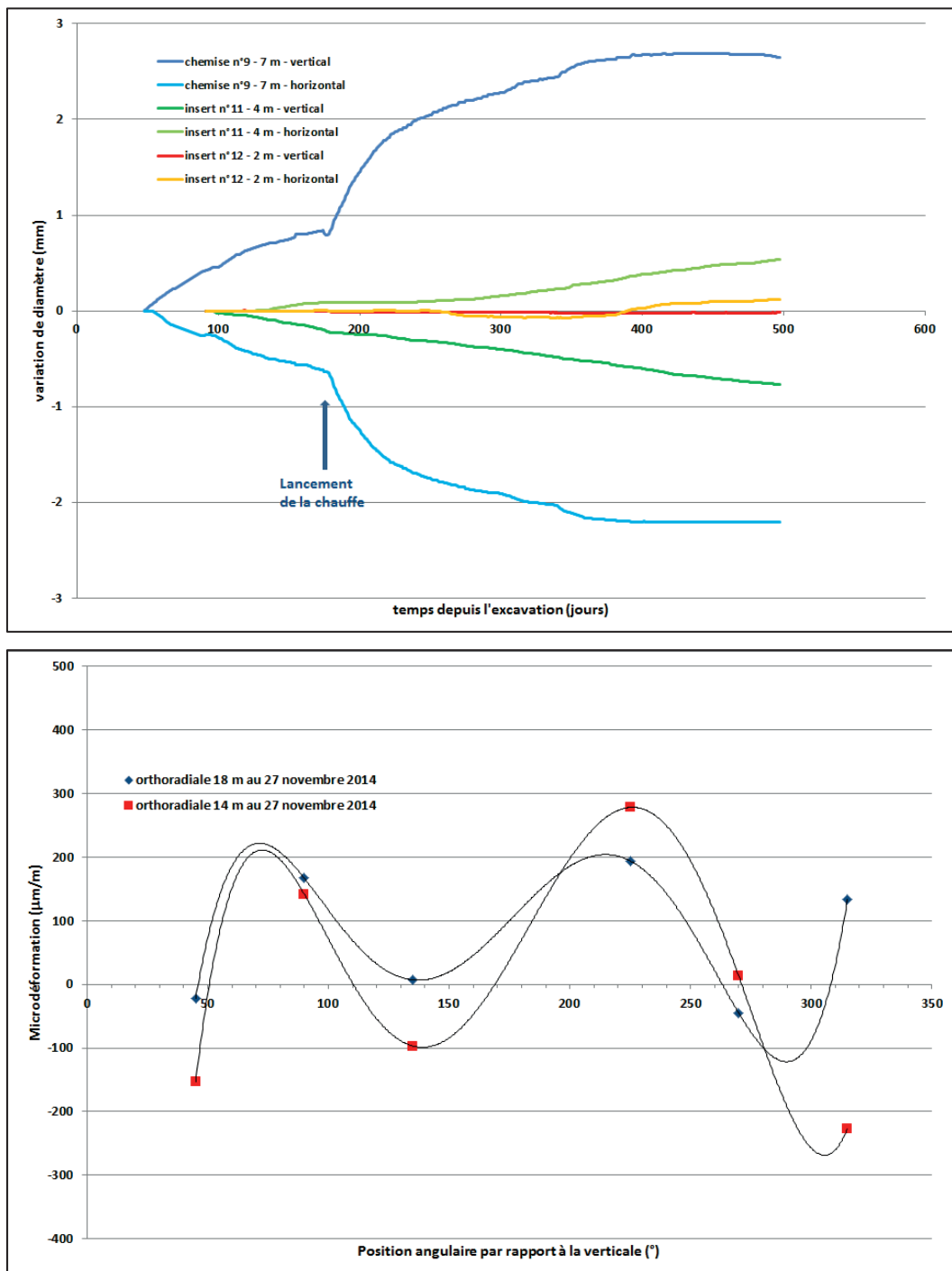

Figure 6. Sleeve diameter variation (top) and mechanical signature of the loading (bottom).

Clearance reduction rate between cell wall and sleeve also increases significantly once the heating phase has started, with a stronger reduction on the left side of the sleeve, indicating that the sleeve was initially slightly deformed on the right. This result is consistent with the increase of the convergence rate with the thermal load.

Conclusions

Using the experience feedback from the former phases of the dedicated experimental programme carried out since 2009, a full scale HLW waste demonstration cell (2009 concept) has been designed and successfully realized and instrumented at the Meuse/Haute Marne URL.

First results are consistent with measurements made during former phases of the demonstration programme as well as lower scale THM experiments. The measurements bring precision at scale 1 on the THM response of the host rock, especially in terms of overpressures generated by heat. They allow also understanding of the main characteristics of the mechanical behaviour of the sleeve under thermal loading. These results are important in the framework of the final design of the storage cells and of the storage itself.

Numerical simulations are ongoing in order to be compared to in situ data and help understanding the global behaviour of the demonstrator.

Acknowledgement

The research leading to these results has received funding from the European Union's European Atomic Energy Community's (Euratom) Seventh Framework Programme FP7/2007-2013 under grant agreement no 269905 (LUCOEX project).

References

Armand G, Noiret A, Cruchaudet M, Conil N, 2011. Mine by experiment performed in the Callovo-Oxfordian claystone at the Meuse Haute Marne Underground Research Laboratory (France). *ISRM 12th International Congress on Rock Mechanics, 9-13 October 2011, Beijing*

Delay J, Vinsot A, Krieger J M, Rebours H, Armand G. 2007. Making of underground scientific experimental program at the Meuse/Haute-Marne Underground Research Laboratory, North Eastern France. *Phys Chem Earth* 32: 2–18.

Morel J, Renaud V, Armand G, 2010. Feasibility of excavation of disposal cells in 500 m deep clay formation. *Rock Engineering in difficult ground conditions – Soft rocks and karst – EUROCK 2009:* 561-566

Wileveau Y, Cornet .H, Desroches J, Blümling P, 2007. Complete in situ stress determination in an argillite sedimentary formation, *Phys. & Chem. of the Earth*, 32, 866-878.

Technical feasibility of the Cigéo Project seals

*Régis Foin**, *Jean-Michel Bosgiraud**, *Gilles Armand**, *Aurélien Noiret**,

*ANDRA

Corresponding authors e-mails: regis.foin@andra.fr; jean-michel.bosgiraud@andra.fr;
gilles.armand@andra.fr; aurelien.noiret@andra.fr

Abstract

In the context of the law n° 91-1381 of December 30th 1991, the National Agency for the management of radioactive waste (Andra) built in Bure (Meuse) an underground research laboratory (URL), in which experiments of scientific and technological character are implemented.

Since June 28th 2006, the law n° 2006-739 relating to sustainable management of materials and radioactive waste extends the approach of the first law of 1991, specifying that for the reversible storage in deep geological formation, it is planned to produce by 2015 all the elements necessary for granting a license.

IRSN (the French public body in charge of supervising design and construction of the nuclear installations), as part of its statements of June 2011, mentioned that Andra must demonstrate the technical feasibility of the seals considered in the repository.

To answer this demand, Andra programmed different experiments and especially:

- The NSC experiment (seal core investigation) carried out at scale ½ in the underground drifts of the URL;
- The hydraulic cut-off experiments (TSS and SET) carried out for the first, in the underground drifts of the URL, and for the second, built inside a concrete made drift model located in Andra surface technological space;
- The FSS experiment (complete seal), constructed scale 1 inside a concrete made drift model built in a hangar.

The purpose of this paper is to provide an overall view of the main results of FSS experiment.

Introduction

• Long term safety in the French Deep Geological Repository (aka Cigéo)

Andra's successful implementation of Cigéo relies on a sound demonstration of long term safety and on a relevant scientific and engineering basis as well as on social aspects such as stakeholders' acceptance and confidence.

The Repository progressive closure (by backfilling and sealing) policy is considered as instrumental in serving the above safety, technical and social objectives. The FSS (Full Scale Seal) experiment aims to raise the implementer's industrial know-how and the acceptance of the sealing strategy by the evaluators and the stakeholders, to whom FSS was presented during its implementation. The FSS experiment story and its outcomes are presented below.

The industrial stakes related to sealing activities are high, since, in the present Repository concept, there are some 130 seals to be built in Cigéo during its progressive closure (Figure 1 shows the seal positioning principles as set up at this stage of design): it is particularly important to master the construction processes and the associated commissioning protocols and to evaluate the coactivity factor (i.e. the practical organizational relations between seal construction activities and nuclear operations).

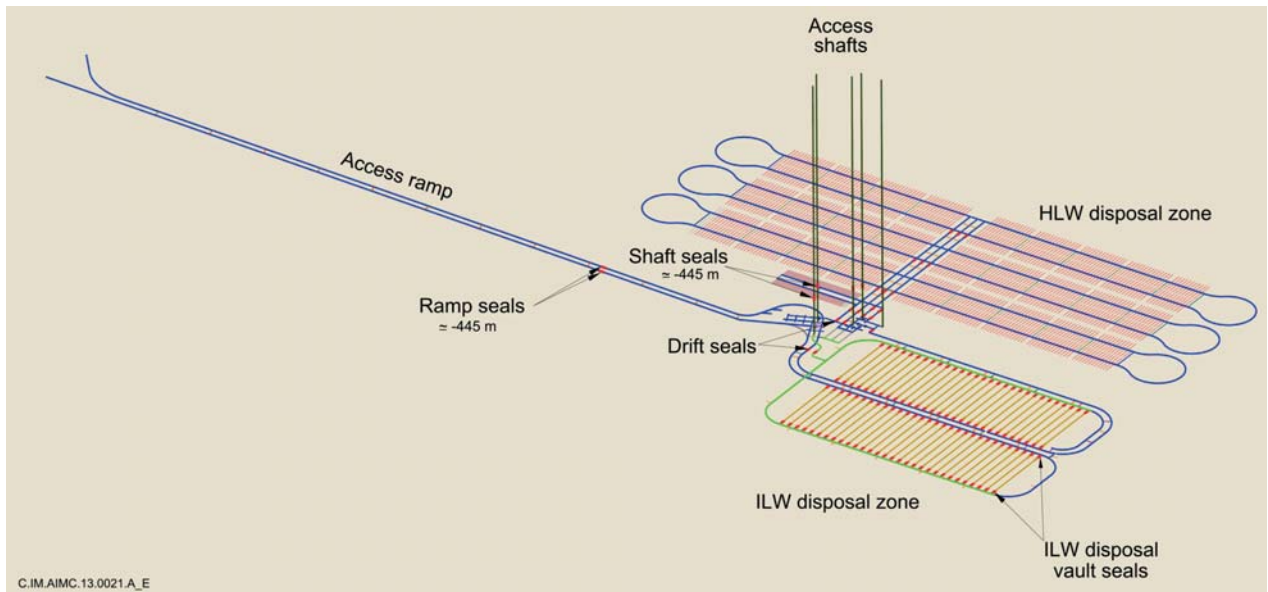

Figure 1 Positioning of seals (red dots) in Cigéo shafts, ramps, drifts and vaults

The Full Scale Seal FSS experiment is built to demonstrate the technical feasibility and check the performance of the seals which will be constructed in the shafts, ramps, drifts and disposal vaults, at time of Cigéo underground facilities progressive closure.

- **Drift Sealing Concepts in the French Deep Geological Repository**

At time of Repository progressive closure, the sealing of shafts, ramps, horizontal drifts and disposal caverns must be assured by the construction of a specific barrier. The seal is composed of a swelling clay core (bentonite) with 2 low pH concrete containment plugs, one at each end. The remaining part of the underground openings is backfilled with the original excavated material (i.e. the argillites from the Callovo-Oxfordian formation constituting the host rock).

In the reference design, a horizontal seal is installed in a section of a horizontal drift/vault head, where the concrete liner will have been partly dismantled, thus allowing a direct contact between the argillite formation and the bentonite core, the swelling pressure of which should be close to 4MPa (5 max). This conceptual design is illustrated in Figure 2.

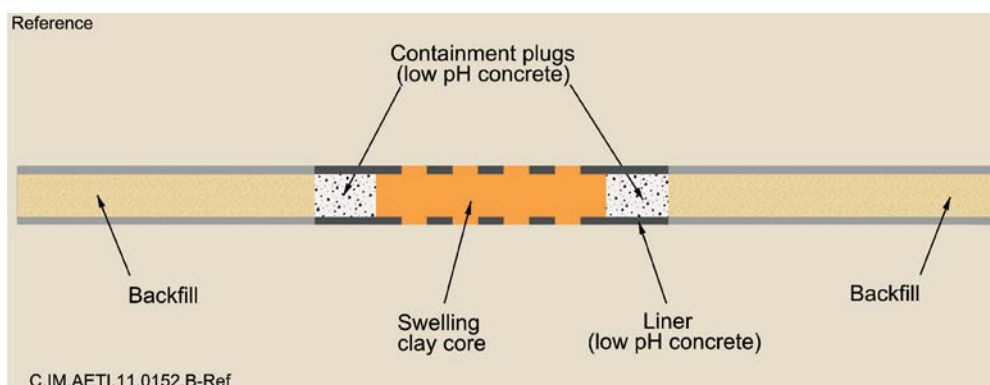

Figure 2 Reference horizontal drift sealing and backfilling concept.

The feasibility, in real conditions, of such seals has to be demonstrated in the FSS experiment.

Description

- **FSS technical characteristics**

FSS was built inside a concrete made drift model fabricated in a hangar for the purpose. The drift model was some 7.6m ID and 36m long. The drift concrete lining (70cm thick) and the formation break outs (recesses) likely to be generated by the drift lining deposition (up to 1m deep at the lining extrados) were simulated. Representative underground ambient conditions (temperature around 18-30°C, hygrometry between 50% and 75%) were maintained inside the hangar.

One low pH self-compacting concrete (SCC) containment wall and one low pH shotcrete containment wall, each 5m long and with a 250m³ volume, closed the volume of the swelling core, on both sides. The bentonite swelling core (some 750m³ of pellets/powder admixture) was some 14m long.

Figure 3 shows the concept of the FSS seal as constructed (at the end of the experiment).

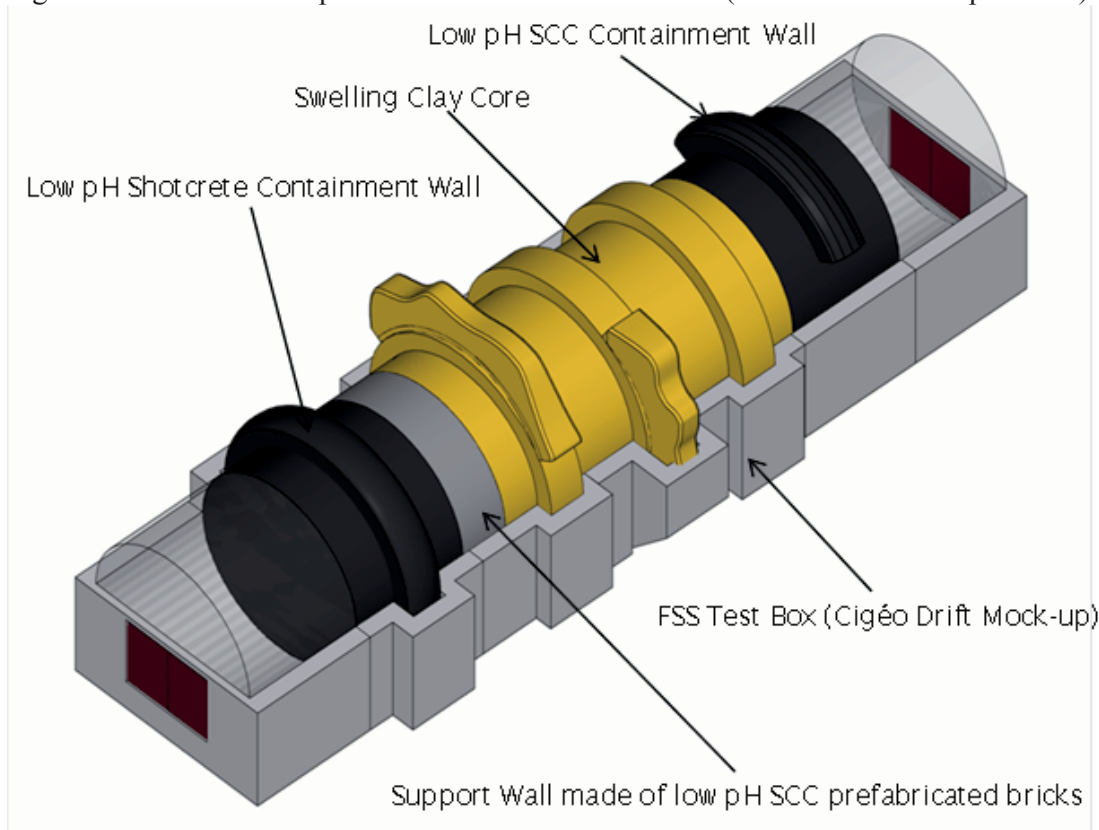

Figure 3 Longitudinal view of the FSS experiment as built in its test box.

- **Construction of the test box (drift model)**

The test box construction started on October 29th, 2012 and was completed in early June 2013. It was equipped (prior to its backfilling) with openings (observation windows) at its periphery and internally with temperature probes and shrinkage sensors for the low pH concrete containment walls and with TDR (Time Domain Reflectometry) sensors along the bentonite core emplacement zone.

Figure 4 shows the FSS test box following its commissioning before the FSS backfilling start-up.



Figure 4 The FSS test box ready for seal construction

An information of interest was to measure as accurately as possible (by 3D scanning) the actual internal box volumes for each type of seal components concerned to be filled in later. The information on the volumes measured was later cross-checked with the information on the volume of concrete and the mass of bentonite emplaced, as measured by operators at time of backfilling.

- **Construction of the low pH SCC containment wall**

The formulation of the low pH SCC was validated at various volumetric scales (decimetric and metric in research labs, metric at the mixing plant and later metric at the test site), before proceeding with the pouring of the containment wall.

The casting operations were preceded by preparation activities implemented in June 2013. The main issue was to design and erect a proper form similarly to what could be mounted underground in Cigéo, a one face form was used (by contrast with a traditional double form with cross bars).

It was also necessary to install 4 washout vents: 2 pipes were set to release the air trapped when the concrete rises up into the test box recesses and the 2 others were pre-positioned for the future “containment wall to box liner” bonding operations.

The low pH SCC casting operations were carried out with 3 main objectives in mind:

- to realize a monolith type containment wall (~ 250 m³),
- to abide by a maximum concrete curing temperature criterion of 50°C,
- to try to limit as much as possible concrete shrinkage and cracking.

For that purpose, it was decided to pour (mixing truck) batches of 7m³ each, with a stand-by time of 2 hours between two passes of pouring imposed, at the exception of the summital part (when one batch per hour was poured). See pouring operations in Figure 5

Some 28 days of hardening later, the injection of a low pH slurry (grout) was started to bond the containment wall extrados with the test box concrete liner intrados. The quantity of injected slurry turned out to be very small (a few tens of liters). It was inferred that in this experimentation, there was little vacuum remaining or/and that the bonding had already taken place.

At the end of the casting and bonding operations, it was possible to watch a very homogeneous monolith without traces of cracks or fractures. The contact between the concrete monolith extrados and the box liner inner surface also looked excellent.



Figure 5 Easy pouring and even emplacement of low pH SCC inside the test box

- **Construction of the swelling clay core**

The swelling clay core backfilling sequence was also preceded by a metric scale emplacement test inside a sewage type concrete pipe (see Figure 6). This metric test helped to optimize the operating parameters: the rotating speed of the screw conveyors used to transport the bentonite powder/pellets admixture from the hoppers into the bentonite heap (progressively forming the core), the target value of the expected pulverulent material dry density (around 1.50 g/cm^3), the natural slope of the heap (around 30%) and of course the bentonite admixture proportion: 30% of powder and 70% of pellets.

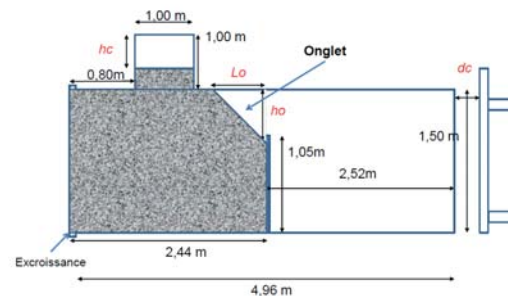

Figure 6- The metric test emplacement for bentonite admixture

The full scale swelling clay core backfilling sequence took place in 2 times June/July and then August 2014 (it was stopped at about mid-work because of a premature wear of the screw conveyors which led to a replacement of this piece of equipment). At the end, the effective average density of the emplaced bentonite material was 1.485 g/cm^3 (1.5 was obtained during the preliminary metric test phase). The main issue was the density discontinuity / space variability of the emplaced material, due to the mechanical interference of the backfilling machine boom with the upper parts of the supporting wall: The last recess could not be filled in as well as expected. Figure 7 shows some of the backfilling activities and size of the equipment mobilized for the purpose.





Figure 7 The swelling clay core emplacement operations

- **Construction of the low pH shotcrete containment wall**

As for the SCC formulation, the development of the low pH shotcrete was also validated at various volumetric scales (decimetric and metric scales in research labs, then on test panels both at the mixing plant and later at the test site), before proceeding with the construction of the second containment wall.

The shotcrete was easily sprayed in 10 to 15cm layers with a minimum of 4 hours between 2 applications. Rebound rate was minimized (some 10 to 12 % of total volume).

This second plug was completed on September 5th, 2014 and closed the construction of the seal.

Figure 8 shows the operator during shotcreting and the end result (a dome shape containment wall).



Figure 8 The low pH shotcrete containment wall construction (spraying/ left; end product/right)

- **Compliance assessment activities**

Some monitoring devices were preliminarily installed in the test box to evaluate:

- The concrete shrinkage and temperature evolution with time,
- The bentonitic material backfilling quality (mainly in the recesses).

At this stage of evaluation the main outcomes are:

- **For containment walls:**

- For the SCC monolith: an excellent shrinkage value (less than 300 $\mu\text{m}/\text{m}$) and a curing temperature which never exceeded 45°C (targets were less than 350 $\mu\text{m}/\text{m}$ and 50°C respectively);

- For the shotcrete monolith, some deviation is noticed: temperature rose up to 67°C (above target, but less than 70°C which is deemed critical). Shrinkage value is not available yet (not stabilized);
 - For the low pH monoliths, various cores have been taken and the samples are undergoing analysis: pH values (should be equal or less than 10.5 after 1 year of curing and hardening), porosity, compressive strength.
 - The next step is the wire sawing (scheduled in mid-2015) of the 2 containment walls, which will provide a unique opportunity to check the homogeneity and cohesiveness of the construction at large, as well as the quality of the low pH concrete bonding with that of the OPC concrete forming the test box lining.
- **For the swelling clay core:**
 - The TDR sensors show a relatively poor presence of bentonite in the upper parts of the recesses.
 - Some gamma-gamma logging was carried out, evidencing a good radial and longitudinal homogeneity of the bentonitic material (at the exception of the upper parts of the recesses). This will be completed and confirmed by penetrometer tests planned in the early 2015.

Conclusion

The FSS construction test has proven the industrial constructability of the horizontal seal components, as designed in Cigéo. Of course, there is room for various improvements in the processes and significantly better results can be obtained. The main improvements identified to date are listed:

- **For containment walls:**
 - To use a SCC is easier than that of a shotcrete which requires a permanent supervision (to take care of the rebound) during spraying operations.
 - The use of low pH SCC should be preferred to a low pH shotcrete, even if the preparatory work (positioning of forms) takes some time. However, the low pH shotcrete can be considered to create a formwork placed at contact with the ordinary argillite backfill. The quality of the SCC obtained is far better than with shotcrete, even if in the case of FSS, the use of 2 different formulations made with 2 different cement types does not allow a thorough comparison.
 - For the SCC, once the form is installed, the productivity (by pumping) is very good and well adapted to the volumes expected in the seals of the Repository. However it would be interesting to watch whether it would not be possible to increase the concreting productivity, without modification of the imposed specifications to optimize the global time of realization.
 - For shotcrete, it should be useful to make new formulations, new metric test and new decametric test to finalize the best formulation able to satisfy all the technical specifications including the limitation of temperature rise.
 - The necessity of bonding with slurry a SCC monolith has to be confirmed during dismantling by wire sawing which must show the quality of the contact between the concrete of the drift model and this of the containment wall.
- **For the swelling clay core:**
 - One of the major challenges to solve is to obtain a better filling of the summital recesses, and especially the last recess, to reach the best global dry density. This may be achieved through a redefinition of the position of the last recess, a few meters away from the

supporting wall so that, at the end of filling operations, the slope of bentonite material ($\approx 30\%$) doesn't destabilize the material inside the recess. Another way could be to have an additional backfilling device to fill the end of the core, and/or a preliminary spraying of shotclay in order to reach a more homogeneous and higher density of the emplaced bentonite at the top of the core.

- During swelling clay core backfilling operations the dust is quite always present. It appears during the transfer of the bentonite materials and during the filling. This is a problem for the worker's health and safety conditions; and that's also a problem for the construction which is realized in the nuclear zone where it's useful to prevent HEPA filters clogging. The use of mine type ventilation doesn't show it was sufficient to prevent the dispersion of dust. Some additional devices should be developed to mitigate the dust impact.
- Others dispositions should be imagined to assess in real time the dry density of each part of the core to anticipate the final result.

These improvements (and other not identified at this stage) should be incorporated in the "full scale demonstrators" which are required by the Nuclear Safety Authority in the early stage of Cigéo (during the Pilot Phase), around 2030: one seal in a horizontal seal (in a real drift) and another one in a ramp. Their successful achievement will be a requisite to proceed with further operations in the underground nuclear facility.

Acknowledgements

Andra acknowledges the financial support of the EC (Grant agreement 323273) for the implementation of the FSS experiment, within the frame of the European cooperative Project DOPAS and the scientific expert contribution of NAGRA (Switzerland) to the FSS construction.

References

1. <http://www.andra.fr/>
2. <http://www.posiva.fi/dopas/>
3. <http://www.igntp.eu/>

The preparation of the large-scale PRACLAY Heater Test

Philippe Van Marcke¹, Guangjing Chen², Arnaud Dizier², , Xiangling Li², Ioannis Troullinos², Jan Verstricht², Xavier Sillen¹

¹ONDRAF/NIRAS, Avenue des Arts 14, 1210 Brussels, Belgium, ²ESV EURIDICE, Boeretang 200, 2400, Mol, Belgium

Corresponding author e-mail: p.vanmarcke@nirond.be

Abstract

The PRACLAY Heater Test is a key experiment in the Belgian RD&D programme on the geological disposal of high-level waste (ONDRAF/NIRAS, 2013). It aims at examining the impact of a large-scale thermal load on Boom Clay which is a potential host rock formation for the geological disposal in Belgium.

Designing and installing the large-scale test comprised the construction of a gallery to host the test, the installation of a bentonite-based hydraulic seal and water-saturated backfill sand to achieve the required hydraulic conditions and the installation of a heating system. In addition, instrumentation was placed in every test component and in the clay to monitor their behaviour and performance. The installation of the test took several years and was finally completed in 2012.

This however did not mean that the heating system could be switched on immediately after having completed the test installation. Switching on required sufficiently high bentonite pressures in the seal and the heating and instrumentation systems needed to be sufficiently tested prior to starting the test.

The team following up the test needed to be sufficiently well prepared for it as well. The test follow-up comprises the management of the vast amount of data that will be generated by the test, the maintenance of the test set-up and, more generally, the further steering of the test. This requires adequate data management tools, a good knowledge on the expected evolution of the experiment and clear organisational procedures.

These issues were addressed very rigorously in the run-up to the switch-on of the test. By November 2014, both the test set-up and the team following up on the test were ready to start and the heating system was switched on.

Introduction

The experiment is installed in the underground laboratory HADES (Mol, Belgium) which is managed by EURIDICE. The Heater Test will impose a constant temperature of 80°C at the gallery extrados over a 35 m long gallery section during at least 10 years. The aim is to examine the impact of such a large-scale thermal load on Boom Clay.

Figure 1 shows the layout of the PRACLAY Heater Test which is installed in the so-called PRACLAY gallery and closed off from the rest of the laboratory by a hydraulic seal.

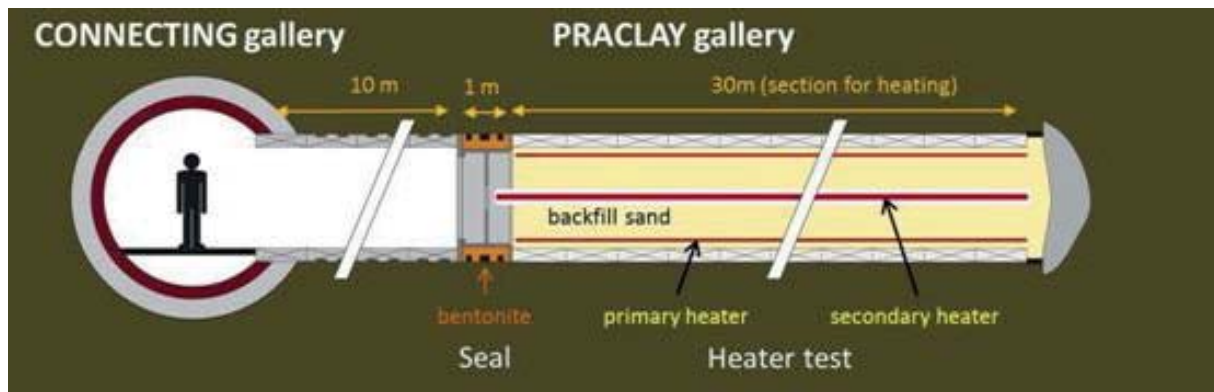

Figure 1. The PRACLAY Heater test is installed in a section of the PRACLAY gallery which is closed off from the non-heated section by a bentonite-based hydraulic seal

The design and installation of the test took several years. The installation started in 2007 with the construction of the PRACLAY gallery to host the test (Van Marcke and Bastiaens, 2012). This was followed in 2010 by the installation of a bentonite-based hydraulic seal to physically and hydraulically separate the heated from the non-heated part of the PRACLAY gallery (Van Marcke et al, 2014). This seal had a central opening so that the heated part of the gallery remained accessible for the installation of the heating system and water-saturated backfill sand in 2011. The water-saturated sand will make sure that, together with the hydraulic seal, the hydraulic conditions required for the test are achieved.

Finally, at the end of 2011, after having installed the heating system and the backfill sand, the central opening in the seal was closed and the test installation was completed (Van Marcke et al., 2013). Before the heating system could be switched on, however, both the state of the test set-up and the EURIDICE team itself had to be ready for it.

The readiness of the test set-up state depended on:

- the hydration degree of the bentonite in the hydraulic seal;
- the saturation degree of the backfill sand;
- the assurance of the proper functioning of the heating system;
- the installation and testing of all instrumentation.

Hydrating the bentonite in the seal and saturating the backfill sand were partially done artificially, by injecting water, and partly naturally, by pore water coming from the Boom Clay around the gallery. The heating system, and in particular its control system, were tested thoroughly to solve all bugs and to guarantee they function as intended. The already installed instrumentation was connected to a data acquisition (DAQ) system with data backup and uninterruptible power supply (UPS) systems to avoid any data loss in case of power failure or a failure of another kind.

The preparatory phase of the EURIDICE team concerned:

- setting up the data management tools to archive, analyse, display and report the measurements obtained during the test quickly and in an orderly way;
- numerically simulating the expected evolution of the test in order to know what to expect;
- establishing a set of procedures necessary for an adequate management and steering of the test.

By November 2014 EURIDICE considered both the test set-up and its organisation ready for switch-on because

- the bentonite hydration and backfill saturation were sufficient;
- the heating and instrumentation systems were completely installed and tested;

- all numerical simulations describing the expected evolution of the test were performed, including a sensitivity analysis on the input parameters and altered evolution scenarios;
- a “PRACLAY Heater Test Management Guide” was completed describing the complete management of the test by the use of a set of procedures.

On the 3rd of November 2014 the heater was switched on. The preparation phase that preceded the switch-on was very rigorous and is further described in the following section.

Discussion

The final preparation phase of the Heater Test switch-on consisted of the following actions:

1. putting in place data management tools to enable handling the huge amount of data generated during the Heater Test;
2. acquiring a good knowledge and understanding of the expected evolution in the clay and gallery lining by numerical simulations; and
3. establishing a set of procedures for the follow-up and management of the test.

Data management

The proper management of the large amount of data that is and will be generated during the Heater Test requires quick and convenient access to the data. This implies, among others, that possible conversions of raw data into the desired parameter unit can be done automatically by the software (for example the conversion of piezometer measurements from electric current to pressure) and that graphs can be readily generated (without first needing to import the data into Excel for example).

This is assured by using a data management and visualisation software tool which enables the data to be archived, analysed and displayed in a user friendly way and format. The system also makes it possible to automatically generate reports in a predefined format. This functionality is used to generate a weekly report containing the most relevant measurements and a daily safety report which contains all safety indicators (like pore water pressures in the backfill sand) and alarms. The safety report is used to make an assessment if it is safe to enter the PRACLAY gallery.

The system also enables an overview of key experiment parameters (temperatures, pore water pressures and total stresses) to be generated in real time. This can be of great aid when urgent decisions need to be taken in case of an emergency.

A first report describing the initial state of the clay around the gallery and the test components was made before the start of the Heater Test. As such the T_0 -state of the clay and test components were defined and documented and the proper functioning of the instrumentation, the DAQ system and the software was tested.

Numerical simulations

The follow-up and steering of the experiment is supported by a profound knowledge of the expected evolution of the test. This knowledge is based on two important tools that EURIDICE has prepared:

- an expected evolution scenario analysis including a sensitivity analysis;
- an altered evolution scenario analysis.

The expected evolution scenario analysis consists of numerical simulations of the expected evolution of the clay around the PRACLAY gallery during the Heater Test. It consists of a “best estimate” of the evolution and a sensitivity analysis taking into account a spread on the input parameters which are considered acceptable or realistic.

As an example, Figure 2 shows the expected evolution of the pore water pressure evolution in the clay at the interface with the PRACLAY gallery lining taking account of a variation of 30% on the Boom Clay permeability.

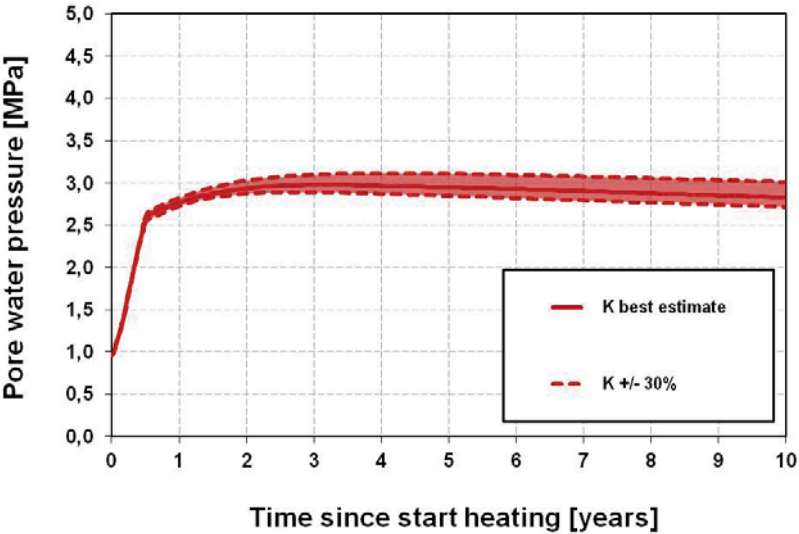

Figure2. Numerical simulation of the pore water pressure evolution in the clay at the interface with the PRACLAY gallery lining taking account of a variation of 30% of the Boom Clay permeability.

Having an idea of the impact of variations on the input parameters will facilitate interpreting the measurements from the Heater Test and identifying the cause where a trend deviates from the expected evolution. Knowing the cause of a deviation is essential to decide whether the test set-up needs to be altered and how.

The altered evolution scenario analysis consists of an extensive set of numerical simulations representing various scenarios. Figure 3 shows the impact of a leakage in the hydraulic seal occurring after 1 year of heating for different leakage fluxes and durations.

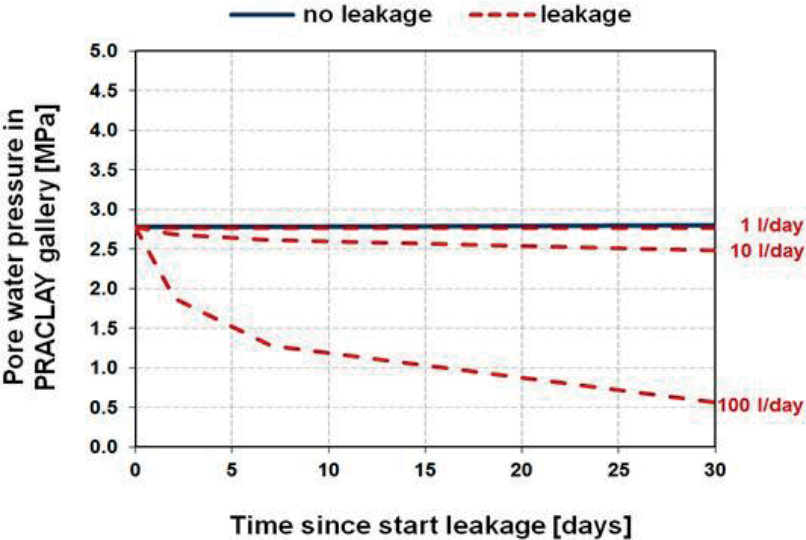

Figure3. Numerical simulation of the pore water pressure evolution in the clay at the interface with the PRACLAY gallery lining when a leakage in the hydraulic seal occurs after 1 year of heating.

A lot of scenarios have already been simulated to obtain a “feel” for their impact. Simulating all potential scenarios in advance is, of course, not possible. Therefore a matrix of scenarios has been

prepared to quickly identify the relevant ones for a given situation and perform additional simulations of that situation.

Both scenario analyses will also help to evaluate the impact of changes to the test set-up on the representativeness of the test (for example, a change in the target temperature). In this way they are crucial tools in the steering of the test.

Test follow-up procedures

In preparation of the switch-on, a “PRACLAY Heater Test Management Guide” was established. The guide describes the complete management of the test (i.e. its follow-up, both technically and scientifically, and the steering) by the use of a set of procedures. These procedures aim at:

- describing the follow-up of the test;
- defining the action plan in case of unexpected events as to be well prepared for such events;
- clearly outlining and assigning the different responsibilities

The procedures enable EURIDICE to manage the test in a systematic way and avoid or at least minimise improvisation during the test. It also enables the EURIDICE personnel to be well aware of each one’s task in the test management by defining the decision and information chains that need to be respected during the test.

Two sets of procedures were prepared: procedures addressing all aspects of the test follow-up where the experiment evolves as expected and procedures addressing the necessary actions where the experiment does not. An unexpected evolution can be observed via measurements that deviate or via alarms or incidents (e.g. water leakage in the hydraulic seal). The procedures for normal experiment evolution address all aspects of the test follow-up from the manner in which data are reported and reviewed, to how maintenance and ordinary repairs will be done. The procedures for abnormal evolution are largely based on the expected and altered evolution scenario analyses

Conclusions

The design and installation of the PRACLAY Heater Test took several years and was finally completed in 2011. Switching on the heating system, and starting the test, could however only be done when both the test set-up and the EURIDICE team following up the test were ready for it.

The readiness of the test set-up depended on the hydration degree of the bentonite in the hydraulic seal, the saturation degree of the backfill sand, the assurance of the proper functioning of the heating system and the installation and testing of all instrumentation.

The preparation of the EURIDICE team was done in a very rigorous way. First, all the data management tools were set-up to archive, analyse, display and report the measurements obtained during the test quickly and in an orderly way. Secondly the expected evolution of the test was well prepared by numerical simulations of the expected evolution, including a sensitivity analysis, and of various possible scenarios. These analyses facilitate the interpretation of the measurements during the Heater Test and help to identify the cause where a trend deviates from the expected evolution. They also inform decisions on whether and how the test set-up needs to be altered. Finally, procedures necessary for managing and steering of the experiment were established.

In November 2014 both the test set-up and the team managing and following up on the test were ready to start and the heating system was switched on.

References

ONDRAF/NIRAS, 2013. ONDRAF/NIRAS Research, Development and Demonstration (RD&D) Plan for the geological disposal of high-level and/or long-lived radioactive waste including irradiated fuel if considered as waste. State-of-the-art report as of December 2012. NIROND-TR 2013-12E.

Van Marcke P, Bastiaens W, 2012. Construction of the PRACLAY Experimental Gallery at the HADES URF, Clays in Natural and Engineered Barriers for Radioactive Waste Confinement, Nantes, France, 29 March - 1 April 2010, Andra, pp. 7-18.

Van Marcke P, Li XL, Bastiaens W, Verstricht J, Chen G, Leysen J, Rypens J, 2013. The design and installation of the PRACLAY In-Situ Experiment. EURIDICE report 13-129.

Van Marcke P, Li XL, Chen G, Verstricht J, Bastiaens W, Sillen, W, 2014. Installation of the PRACLAY Seal and Heater. Clays in Natural and Engineered Barriers for Radioactive Waste Confinement. Geological Society, London, Special Publications, pp. 107-115.

Multi Purpose Test, LUCOEX WP4, a demonstration of KBS-3H technology

Magnus Kronberg

¹ Swedish Nuclear Fuel and Waste Management Co (SKB)

Corresponding author e-mail: magnus.kronberg@skb.se

Abstract

Successful installation of the horizontal deposition concept (KBS-3H) was demonstrated in the Multi Purpose Test (MPT) at the Äspö HRL, Sweden. Comprehensive experiences were gained during the installation and a few implementation issues were identified. Key issues were the need to redesign the Supercontainer buffer blocks, changing their water content, and the need to redesign and optimise the KBS-3H plugs. These issues, together with possible solutions are discussed.

Introduction

SKB's disposal concept constitutes a three-barrier system including a Cu/Fe canister embedded in bentonite buffer at c. 500 m depth in crystalline granitic bedrock. This disposal concept is also shared and investigated by SKB's Finnish sister organization Posiva Oy.

Two concepts are being studied, the current reference design KBS-3V (vertical deposition) and KBS-3H (horizontal deposition). The topic covered here is the Multi Purpose Test (MPT) which is a full scale demonstration of the KBS-3H design. The installation is done according to Drainage, Artificial Watering and air Evacuation (DAWE), which is the KBS-3H reference design, (SKB 2012).

The demonstration is part of the LUCOEX-project, which overall objective is to demonstrate technical feasibility of safe and reliable construction, disposal and sealing of geological disposal facilities through a number of in situ proof-of-concept installations.

The DAWE design is based on 300 m long, slightly inclined, horizontal drifts (Ø 1.85 m) where Supercontainers (canisters surrounded by buffer and an outer metallic shell) are placed and separated hydraulically and thermally by use of distance blocks (bentonite blocks). Each drift is separated into two 150 m long compartments using two metallic plugs, each accompanied by a transition zone (pellets filling section and a transition block). The Supercontainers and distance blocks are placed on feet such that inflowing water is drained underneath them during deposition. Once the plug is installed, the void around the components is filled with water while the air is evacuated through a pipe. Artificial addition of water is done in order to initiate an early and simultaneous swelling of the bentonite in a compartment. Further details on the KBS-3H components and their design premises are given in (SKB 2012).

SKB and Posiva have previously excavated two KBS-3H deposition drifts at the -220 m level of the Äspö Hard Rock Laboratory (Äspö HRL), Sweden. One drift is 15 m long and the other is 95 m long (Bäckblom et al. 2005). The 95 m drift was used for the development and testing of a machine for horizontal disposal, here disposing concrete dummy distance blocks and dummy Supercontainers, while the 15 m drift was used to test the compartment plug (SKB 2012).

The next step in the suite of KBS-3H demonstration activities is the MPT which is a sub-system test that combines all the previously tested components, c.f. Figure 1, installed in the innermost part of the 95 m drift. One of the main differences compared to earlier KBS-3H demonstrations is the use of bentonite components. SKB and Posiva have extensive experience from working with bentonite in full scale within KBS-3V. However, the KBS-3H components have some differences in their

requirements/designs and the way they are handled. In order to keep the number of parameters down the MPT is carried out as a non-heated test.

The MPT involves several steps; characterisation of the pre-installation drift conditions, drift preparations, manufacturing and assembly of the components, installation, monitoring of the system's evolution over time and finally dismantling and evaluation of the experiment. In the following account of the MPT experiment the focus is on experiences in relation to the Supercontainer assembly and plug installation.

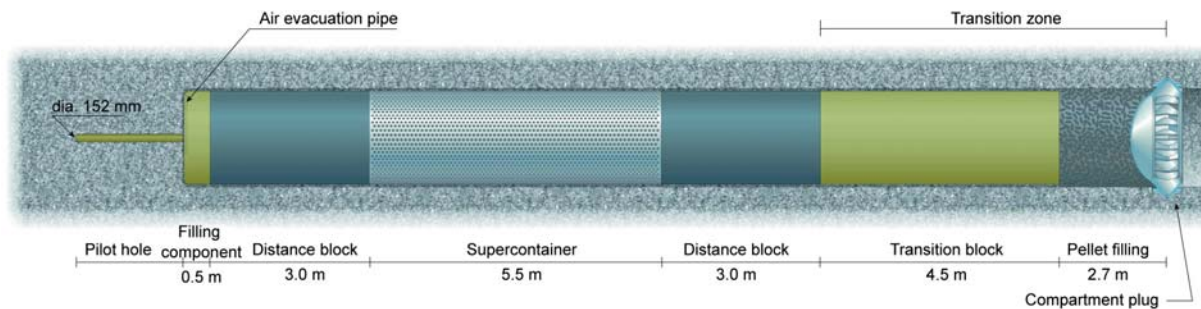

Figure 1. Schematic illustration of the MPT layout. It includes a Supercontainer flanked by bentonite distance blocks on both sides and a compartment plug with its accompanying transition zone made up of a section filled with bentonite pellets and a bentonite transition block.

Description

The MPT has two main objectives:

- Test the system components in full scale and in combination with each other to obtain an initial verification of design implementation and component function
- This includes the ability to manufacture full scale components, carry out installation (according to DAWE) and monitor the initial system state of the MPT and its subsequent evolution

A key part of the experiment is thus to enable the recognition of potential implementation issues of the DAWE design.

Supercontainer assembly

Prior to the Supercontainer assembly a test distance block had been assembled. The distance block segments have a water content of $21 \pm 1\%$ which equilibrates with a relative humidity in the air of close to 90 %. Plastic foil was intended to protect the blocks during handling. However, with winter conditions and a relative humidity of between 15-25 % the assembly quickly encountered problems with blocks showing evidence of cracking. Many blocks became impossible to lift by vacuum tools within a few hours because of small surface cracks. In order to address the problem the assembly hall was equipped with a humidifier which enabled a controlled environment. With the relative humidity under control the cracking issue was solved.

In a repository scenario, the Supercontainers will be assembled in an underground assembly facility where robots will carry out lifts and welding in a fully automated process. In the MPT case the assembly was done on ground surface using manually operated cranes and manual welding equipment.

Figure 2 illustrates the assembly procedure. A cable block, which is an MPT specific equipment used to handle the sensor cabling, was placed on the gamma gate (part of the transport system) after which the shell was positioned. In the KBS-3H reference design, titanium is used for long term safety reasons (SKB 2012). However, for the MPT a structural steel shell, previously used for concrete dummy testing, was re-used for reasons of cost saving. Titanium welding is also deemed to be reasonably

straightforward and a titanium shell can be part of future demonstrations. The shell was straightened using 10 stiffeners placed around its circumference. Once the shell was in place the solid bottom buffer block “end block” was placed followed by nine buffer rings. Four layers of sensors were placed in-between blocks with cabling pulled downwards and into the cable block. The distance between the top of the 9th buffer ring and the top of the shell was measured and the height of the 10th buffer ring machined accordingly. The 10th ring was then placed followed by the canister and the top buffer block, after which the Supercontainer assembly was finalised by welding the top plate of the shell in place.

In order to achieve the required saturated density for the deposited Supercontainer, its solid buffer end blocks and rings have different dry densities. The requirements on the Supercontainer’s solid bottom and top buffer blocks are $1,753 \pm 20 \text{ kg/m}^3$ with $17 \pm 1\%$ water content and for the buffer rings $1,885 \pm 20 \text{ kg/m}^3$ with $10\text{-}12 \pm 1\%$ water content. For the MPT, water contents of 17 % (solid blocks) and 11 % (rings) were selected. However, the relative humidity in the assembly hall cannot be optimised for two different water contents. See the discussion section on the need for updated requirements in this context.

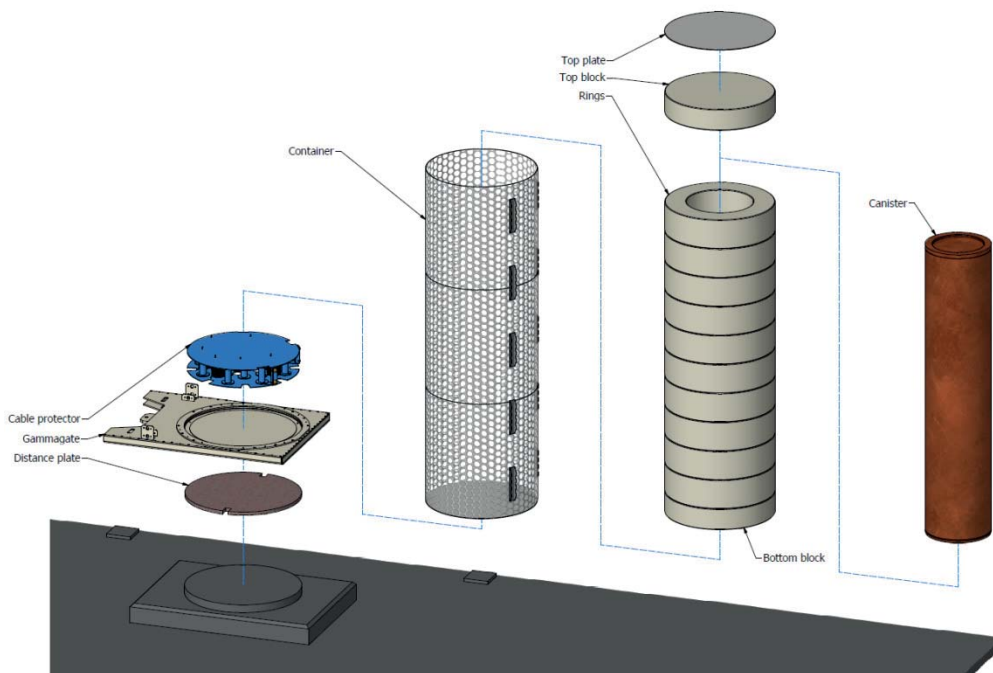

Figure 2. Assembly sequence for the Supercontainer used in the MPT.

Compartment plug installation

The KBS-3H Compartment plugs are used to hydraulically separate and seal off sections in the deposition drift (~150 m in length) and they also enable the water filling procedures of DAWE. The plugs are designed to withstand the hydrostatic water pressure.

In addition to the (intermediate) Compartment plug, KBS-3H also has a Drift plug at the entrance of the drift. The function of the Drift plug is similar to the Compartment plug but it is used to seal the end of the deposition drift to avoid significant water flow out from the drift, which could give rise to piping and erosion of the buffer. The Drift plug is sturdier and competent since it shall withstand the hydrostatic water pressure plus the full buffer swelling pressure.

With the MPT being a short duration test where high buffer swelling pressures are not expected the installed plug demonstrates the situation at a Compartment plug.

The Compartment plug, c.f. Figure 3, is made up of three main parts; the fastening ring which is casted into a rock notch, the collar which is welded to the fastening ring and the cap which is welded on to the collar to seal the section. A cylindrical rail system is used to saw out the rock notch. Contact

grouting tubes are placed at the rock-casting and casting-steel interfaces, these allow for Silica Sol contact grouting after welding. A key feature of the Compartment plug is that the fastening ring is casted in place during drift preparations; hence it has adequate time for setting well ahead of deposition. A steel or concrete 'bridge' allows the deposition machine to pass over the fastening ring. When the various components have been deposited the 'bridge' is removed and it only requires welding work to build the plug at this stage, which allows for a quick installation. The collar is fitted with lead-throughs for the water filling and air evacuation procedures of DAWE. In the MPT case the collar is also fitted with lead-throughs for cabling. For detailed requirements and design of the Compartment plug see (SKB 2012).

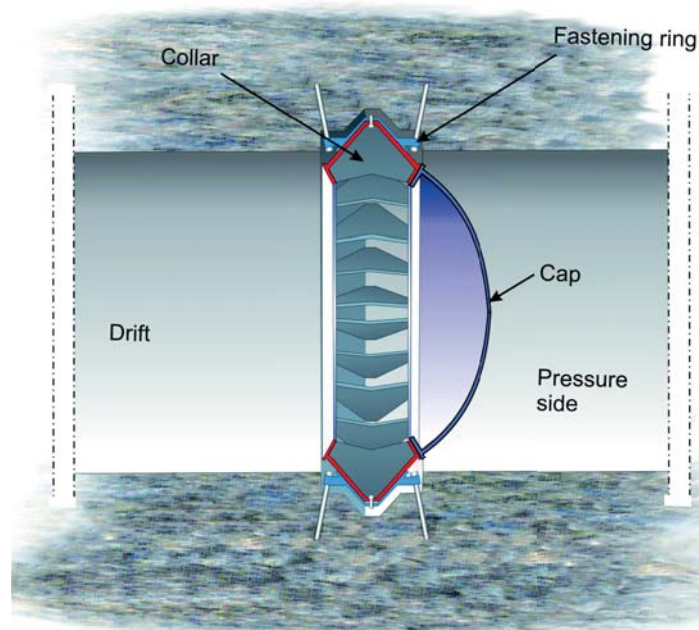

Figure 3. Schematic illustration of the compartment plug. The fastening ring and collar is made up of four pieces each and the cap is made in one piece.

Each welding step in the Compartment plug installation includes an inspection of the welds. An earlier Compartment plug installation (SKB 2012) had demonstrated the difficulties of both welding and inspection. However, tight welds were still achieved and an automated process (robotic welding) was expected to solve the problem. A redesign had not been carried out and the MPT employed the same Compartment plug design as previously used. In case of MPT the difficulties became more apparent as pores in the welds had to be re-welded in several steps before a tight plug was accomplished.

In addition to the welding issues it was noted that water would start accumulating inside the plug once the collar was installed but prior to the cap being mounted. This could be a problem both for the welding and for the outermost buffer blocks, which could be wetted and start to crack and erode. A third issue noted was the difficulty in placing the contact grouting tube at the casting-steel interface. See further discussion of the optimisation of the plug in the discussion section.

Discussion

Supercontainer buffer

The MPT highlighted that the current Supercontainer buffer design with blocks of two different water contents is unsuitable since the blocks are in equilibrium with two different relative humidities in the air. In the MPT case a compromise employing a relative humidity in-between the optimal values for the two block types was selected. It worked out well to some extent but the buffer rings started to flake. A more rapid automated assembly can be foreseen in the repository case. However, the Supercontainers would be stored for a few days before installation, during which the surrounding air could not be optimised and cracking and/or flaking would most likely be unavoidable. An optimisation is therefore needed. This optimisation has currently not been done but a possible solution is outlined below.

Lowering the water content of the solid buffer blocks to the same level as the ring blocks, 10-12 %, is probably not feasible since they would have to be compacted with low pressures and their abrasion resistance would most likely come out too low. A water content level in the order of, or above, 14 % would most likely be needed.

Increasing the water content of the ring blocks to the same level as the solid blocks, 17 %, is probably not feasible either. The compaction pressure needed would be very high; it would be above the capability of the press currently used. The requirement 10-12 % for the rings was actually set based on the fact that higher water contents would be difficult to compact with the equipment and the bentonite used at the time. There are, however, differences in the material batches and the ones used most recently are easier to compact and a sufficiently high density could be achieved with somewhat higher water content, being in the order of 14 %.

The reasons for the differences in the compaction parameters are currently not fully understood but both materials fulfil the requirements with respect to montmorillonite, carbon, sulphide and sulphur contents. Differences in the grain size distributions between batches could be one of the factors contributing to the observed phenomenon. Further studies on the compaction parameters will be needed and it has to be confirmed that materials with the needed properties can be purchased and conditioned in large enough quantities, if a change is to be done on the block requirements.

Further studies and calculations are required but it is deemed likely that a water content of approximately 14 % could eventually be employed in both types of blocks allowing for proper optimisation of the relative humidity in the assembly facility.

Compartment plug

The MPT required re-welding in order to achieve a tight plug. This highlights the need for an updated design which facilitates easier welding and inspection.

Figure 4 details the current Compartment and Drift plug designs. In general, the plug designs are complicated, including a large number of welds also requiring tight tolerances and demands on shape accuracy which makes the components complicated and costly to manufacture. A redesign should therefore also aim at simplifications and evaluation of alternative manufacturing methods.

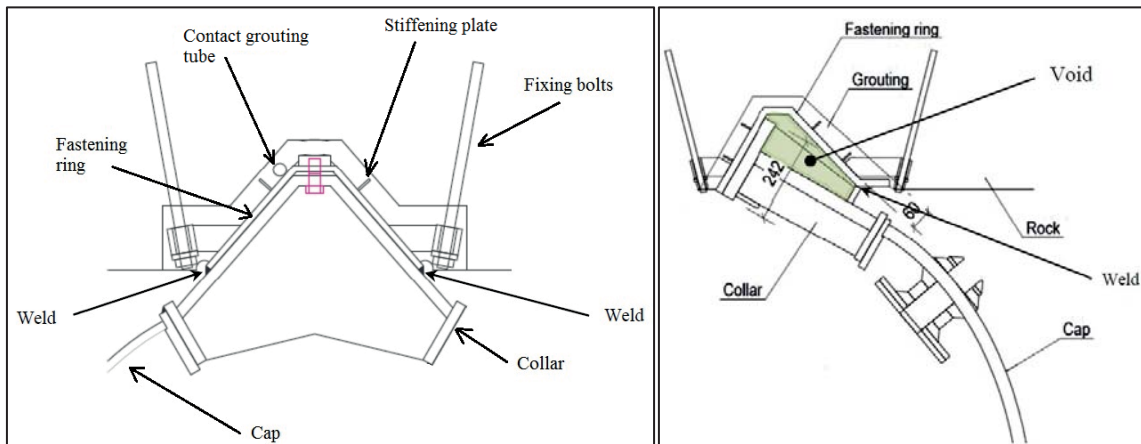

Figure 4. Section view showing details of the Compartment plug (left) and a similar view for the Drift plug (right).

Fastening ring

The casting of the fastening ring should be as watertight as possible to minimise groundwater leakage around the plug. The present fastening ring is provided with only one stiffening plate on each side of the ring near the bottom of its V-shaped form, c.f. Figure 4. The top of the “V” (inner edges of the ring) where the weld is placed is without stiffening plates or “potting studs”. There is consequently a potential risk that the plate will separate from the casting during welding near the weld area due to shape changes/material shrinkage.

The set screws, which are supposed to be anchored in the rock, are also very difficult to install. Since they are angled in two directions it is more or less impossible to use them as adjustment screws if they are fixed in the rock. They, however, do not have to be fixed in the rock; the screws can be exchanged for studs that are simply providing support to the fastening ring against the rock. The screws have no structural function after casting.

Collar

As seen in Figure 4, the shape of the collar limits the access to the area where the weld between the fastening ring and the collar is placed. The limited space is not only a problem for welding but also a problem when inspecting the weld visually or by liquid Penetrant Testing (PT). Redesign should also consider placing future welds easier adapted to automated welding systems.

The drift shall be kept drained from water leaking in from the rock to prevent disruption of the buffer until start for the artificial water filling. However, and as mentioned previously, when the collar is installed it should prevent water to flow out from the drift. A drain pipe through the collar should therefore be installed in the lowest part of the collar. This drain should be closed before start of the pellet filling behind the plug.

Redesign

A proposed new design is shown in Figure 5.

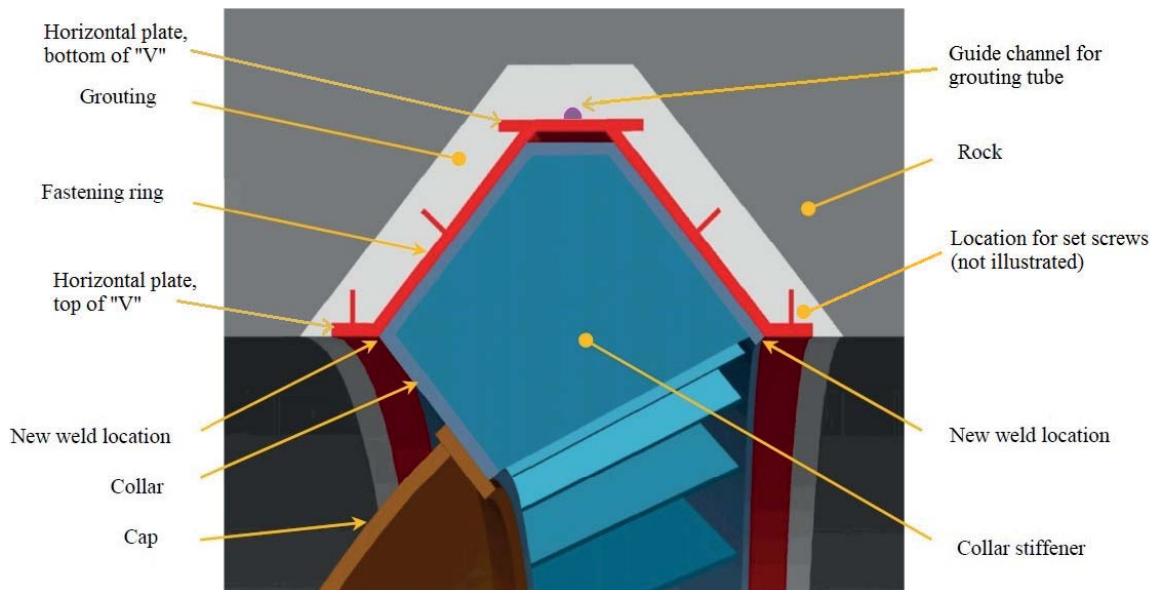

Figure 5. Section view of a proposed redesign of the Compartment plug.

The fastening ring is proposed to be fitted with horizontal plates provided with stiffeners at the top of the “V” to improve the bonding to the grout near the weld area. The plate at the bottom of the “V” has also been extended to improve the bonding capability and together with the other stiffeners extend the potential leak path between the fastening ring and the casting.

It is also proposed to install a guiding channel at the bottom of the “V” for a contact grouting tube. The guiding channel will allow for installation of the contact grouting tube during assembly of the fastening ring segments. The guiding channel will ensure the correct positioning of the contact grouting tube at the metal-grout interface. The guiding channel can be made of a “half pipe” or u-bar provided with holes/slots welded to the ring segments. The side oriented towards the grout should be covered with a fibre cloth to prevent the grout from entering into the guiding channel.

Set screws (studs) for fixation/positioning of the fastening ring can be placed and arranged in the new horizontal plate at the top of the “V”, Figure 6. After installation, the fixing screws shall be cut flush with the fastening ring plate to avoid any parts protruding inside the drift periphery.

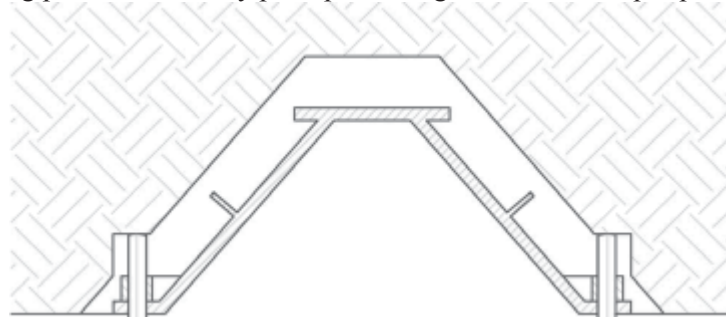

Figure 6. Section view at the set screw position.

The proposed collar design will make it much easier to access the weld locations. This will also improve the possibility to use automated welding equipment and improve accessibility for examination of the welds. The proposed design will also reduce the overall weight. In addition the shape will make the installation of the lead-trough for the water filling and air evacuation pipes easier.

The collar should be fitted with a drainage pipe at the low point. The drainage pipe can in principle be identical with the water and air evacuation pipes.

It is assumed that the main design can be used for both the Compartment plug and the Drift plug collar and that only plate thickness, especially in the cap, and number of stiffeners in the collar will vary.

The proposed plug design and its feasibility are presently based on experience and engineering judgment. However, this must be verified by new calculations during detailed engineering.

With respect to manufacturing; revisit of casting techniques can be one way of overcoming troublesome fabrication sequences. Some parts of the plugs, such as the fastening ring and the collar should be subject to evaluation whether there is a possibility for manufacturing these parts from titanium castings. The key reason for selecting titanium casting would be the potential cost savings. The cost advantages can be attained through increased design flexibility, better utilization of available material or reduction in the cost for machining.

Conclusions

The MPT has demonstrated the potential of the KBS-3H design. The key components have, as intended, been manufactured and tested mutually in combination with each other according to the DAWE reference design. Subsequent assessment of sensor and dismantling data will at a later stage allow for additional evaluation of the functionality of the KBS-3H design.

A key objective of the experiment was to identify potential implementation issues of the DAWE design. Two issues of main importance were recognized; the need for updated buffer and plug designs, respectively. Both issues are of high importance to address in order to ensure a robust KBS-3H design. The plugs should be possible to redesign as suggested above and the Supercontainer buffer is also expected to be possible to redesign, however, requiring further material and compaction studies.

In situ, full scale tests like the MPT are expensive, but deemed necessary, in order to recognize weaknesses in the design that are difficult to identify on the drawing board or in down-sized laboratory experiments on individual components. This is especially true when several sub-systems are integrated with each other for the first time.

Two larger design issues have been in focus in the current work; the need for a harmonised water content in the Supercontainer buffer and the practical challenges met during the plug installation. In addition, several technical solutions were developed under way and significant practical experiences were gained that can be directly implemented in possible future KBS-3H tests.

Acknowledgement

The research leading to these results has received funding from the European Union's European Atomic Energy Community's (Euratom) Seventh Framework Programme FP7/2007-2013 under grant agreement no 269905 (LUCOEX project).

References

Bäckblom G, Lindgren E, 2005. KBS-3H - Excavation of two horizontal drifts at the Äspö Hard Rock Laboratory during year 2004-2005. Work description, summary of results and experience. SKB R-05-44, Svensk Kärnbränslehantering AB.

Johannesson L-E, 2014, Working Report on manufacturing of distance blocks and blocks for the Supercontainer. Deliverable D4:02. LucoEX.

SKB, 2012. KBS-3H Complementary studies, 2008-2010. SKB TR-12-01, Svensk Kärnbränslehantering AB

Multi Purpose Test, LUCOEX WP4, Instrumentation – Experiences from planning, installation and monitoring

Xavier Pintado¹, Jorma Autio², José-Luis García-Siñeriz³, Magnus Kronberg⁴

¹B+Tech Oy, ²B+Tech Oy, ³Aitemin, ⁴SKB AB

Corresponding author e-mail: xavier.pintado@btech.fi

Abstract

The MPT (Multi Purpose Test) aimed at demonstrating KBS-3H repository system is instrumented with sensors for measuring the evolution of the total pressure, relative humidity, suction, volumetric water content, pore pressure, displacements, rotations and strains during the saturation process. The sensors were installed in key components of the system, namely rock, plug, Supercontainer and buffer blocks made of bentonite. A novelty wireless system is used to monitor part of sensors in order to reduce the number of cables. The results indicate that the total pressure in rock wall increased quite fast but the swelling pressure inside the blocks was almost negligible after the six first months of the test. The increase of the degree of saturation was clear in the outer part of the bentonite blocks but not in their inner part. Some movements were measured in the blocks too. The plug was observed to be tight. The wireless transmitters worked fine at the beginning of the test but some problems were observed in signal transmission after filling the gap with water

Introduction

The Multi Purpose Test (MPT), currently underway at -220 m level of the Äspö HRL, is a full-scale, demonstration of the KBS-3H reference design (SKB 2012). The test is isothermal (no heating) and includes the main KBS-3H components (Figure 1). Dismantling and post-mortem analysis will be carried out at a later stage and the timing for this is currently not decided. It will be dependent on the measured data and a desired state of evolution which will be defined in detail during 2015.

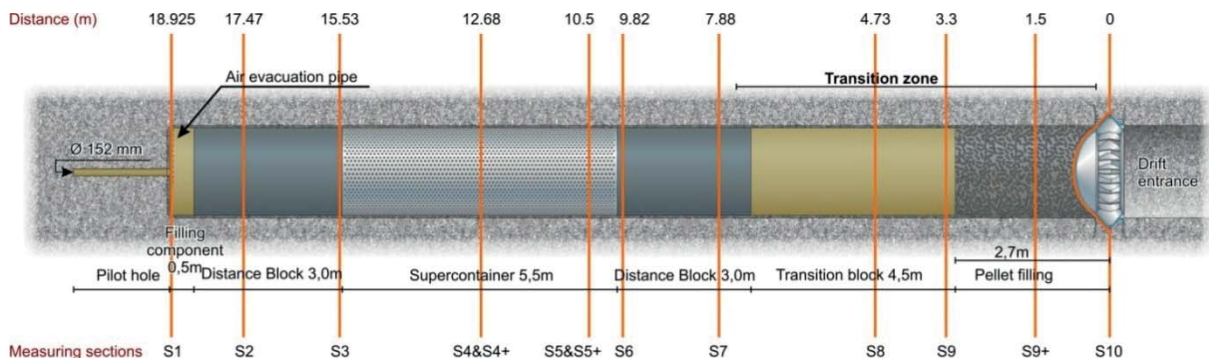

Figure 1. Main KBS-3H components (Supercontainer, distance blocks and a compartment plug with transition zone) as configured in the Multi Purpose Test and sections instrumented.

The test consists of a Supercontainer, detailed in Figure 2, with a dummy canister and distance blocks (DBs) around it, followed by a compartment plug made of carbon steel with 30 mm thickness, with the belonging transition zone made up of transition blocks (TBs) and filling of bentonite pellets. The TBs are the same as those used as DBs and are used for compensating loss of buffer density in the pellet-filled sections. The thickness of all bentonite blocks is approximately 500 mm. Supercontainer shell has 10 cm in diameter perforations and the end plates have no perforations. The canister is 1.05 m in diameter and 4.8 m in length. The only difference with the KBS-3H design is the pellet filling, which in KBS-3H is 1.3 m in length and in the MPT 2.7 m as more space was needed for assembling the test because of the instrumentation.

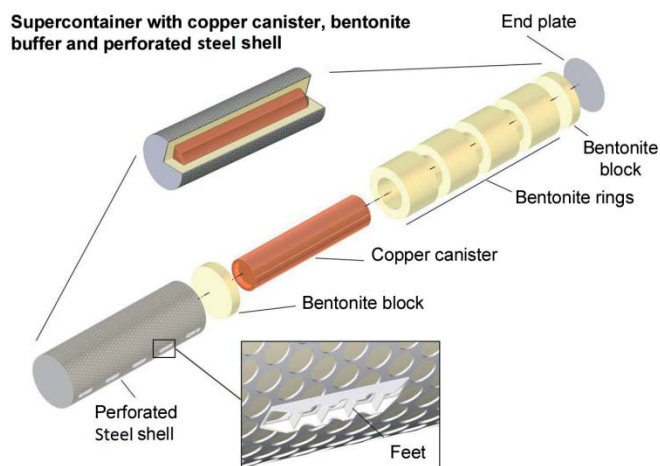

Figure 2. Supercontainer design, in the MPT the bentonite rings are approximately 500 mm high.

The objective of the instrumentation is to study the buffer and filling component behaviour during the early part of the buffer evolution; movements in the system components, water content, pore and total pressure and buffer swelling pressure at the rock interface are measured. In particular, the development of swelling pressure is going to be investigated to evaluate e.g. its effect on thermally induced spalling.

The development of swelling pressure exerted on the compartment plug during the operational phase (due to transition zone and distance blocks) is also assessed. Another objective is to increase the understanding of the relative effect of three different water transport paths, which are buffer, EDZ and near field rock.

Besides, the influence of the Äspö water to different materials at the early stages will be studied after dismantling the test by the evaluation of the corrosion of some coupons (made of stainless steel AISI 316, titanium grade 3, copper Cu-OFE, Cu-ETP and carbon steel S235 and S355).

Initially, the test was planned as a short-term one, with dismantling after approximately 400 days of operation, with the buffer expected to be only partially saturated. However, during planning, parallel research, within the KBS-3H project highlighted the need for a longer operational time.

Instrumentation

The MPT test was primarily planned to demonstrate the operation of the KBS-3H repository. Instrumentation was added in order to study the early stage of the saturation process and the swelling pressure development.

Simplified hydraulic modelling was carried out to aid with design of instrumentation. The geometry of the model was axisymmetric, so the gravity effect was not taken into account. The rock was considered homogeneous although different inflows were measured in different sections of the drift. No fractures were implemented. The limit of the rock mass considered in the analysis was 20 m from the tunnel axis and the boundary condition was constant liquid pressure. The hydraulic conductivity of the rock was calculated taking into account the inflows to the tunnel and the outer boundary condition. The results (Figure 3) indicated detectable changes during the first 400 days.

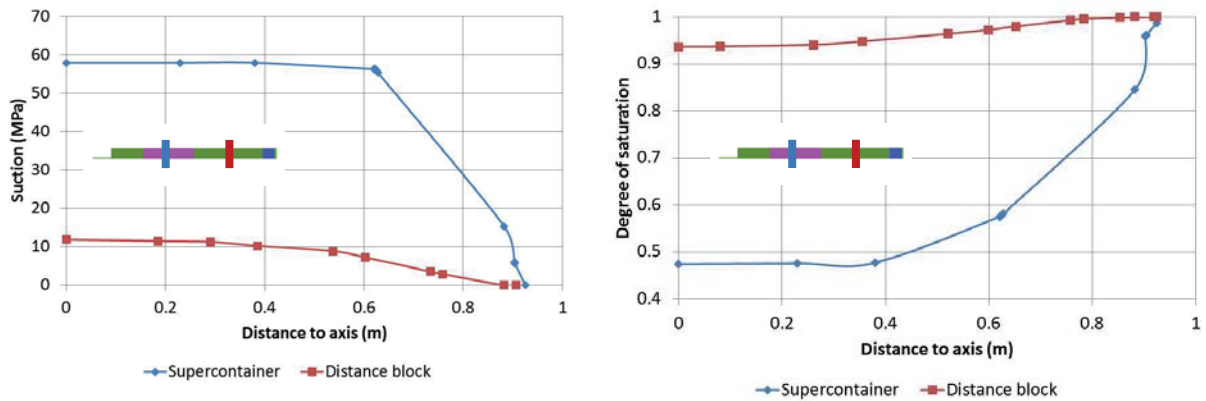

Figure 3. Suction (left) and degree of saturation (right) after 400 days in Supercontainer discs (the canister was not taken into account in the modelling) and distance blocks. The insert shows the sections.

A total of 227 sensors are installed in 10 sections along the test and outside (see Figure 1). There are 194 wired sensors, 33 wireless and 12 pipes connected with sensors outside for measuring the pore pressure in rock and gas pressure in the gap between the different components and the rock. The sensor's cables run inside stainless steel tubes for mechanical and hydraulic protection from the measurement section up to the plug through notches excavated in the rock walls (see Figure 4). Inserting the cables in long tubes was difficult and the tube diameter had to be chosen carefully. The wireless transmitters and the sensors connected to them were assembled on wooden templates of the bentonite blocks in the workshop and sent to Äspö HRL ready to be installed in blocks.

The installation process of KBS-3H was quite complex since the sensors are installed in an assembly hall and then the full components are deposited as packages in the drift. The tubes with the cables from the sensors were rolled in a metal holder between the blocks/Supercontainer and the installation machine. The tubes were extended and connected to the tubes in notches after the installation of the components. Four units were installed in total: 3 corresponding to distance and transition blocks and one corresponding to the Supercontainer. Figure 4 illustrates the first distance block and the Supercontainer.

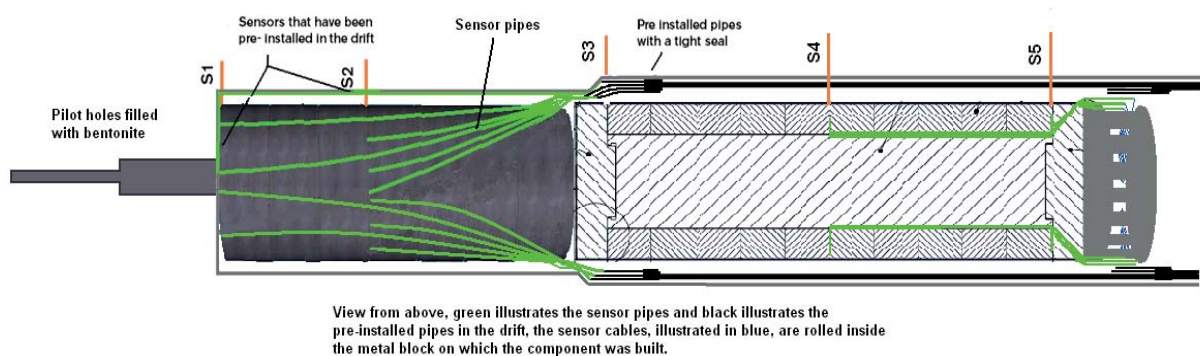

Figure 4. Cables from wired sensors running from the components, inside protection tubes, to lead through pipes in the drift wall.

The instrumentation in bentonite blocks was designed for measuring the wide range of suctions expected (with capacitive hygrometers and psychrometers) and once the bentonite was saturated, with pore pressure sensors. A fourth sensor type was used for covering the complete saturation range, the FDR (Frequency Domain Reflectometer), which measures the volumetric water content instead of suction. Total pressure sensors, extensometers (Figure 5, left) and inclinometers were also installed in blocks.

Sensors in rock were installed in cavities sealed with grout (total pressure sensors, Figure 5 middle) or mortar (pore pressure sensors, Figure 5 right).

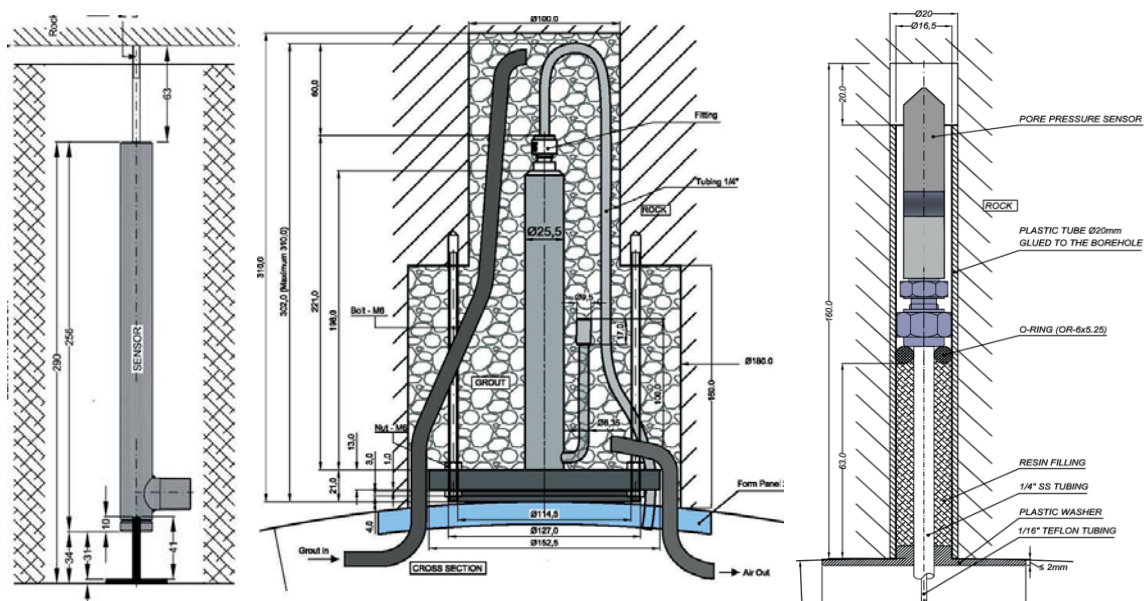

Figure 5. Installation of sensors: Extensometers installed in bentonite blocks for measuring displacements between the block and the rock (left), total pressure sensor in rock (middle) and pore pressure in rock close to drift wall (right).

Strain gauges were glued on to the Supercontainer and the metallic plug. The strain gauges in Supercontainer are protected against the water but without any mechanical protection.

Three holes were drilled in section 9 with 10 m length. Each hole was divided by packers into six sections and connected to pore pressure sensors outside the plug. The evolution of the pore pressure in rock is useful for calculating its hydraulic conductivity.

Discussions

Section 2 in the inner distance block has been chosen as an example for showing the present results briefly. Figure 6 presents the measures from the capacitive hygrometers and psychrometers. The capacitive hygrometers can measure in full range (0-100% RH) but above 95% RH the errors are too large and another sensor is needed for measuring the upper range of relative humidity (low suctions down to 50 kPa). For temperatures between 5°C and 15°C an equilibrium RH (relative humidity) of 95% corresponds with suctions between 6.6 and 6.8 MPa.

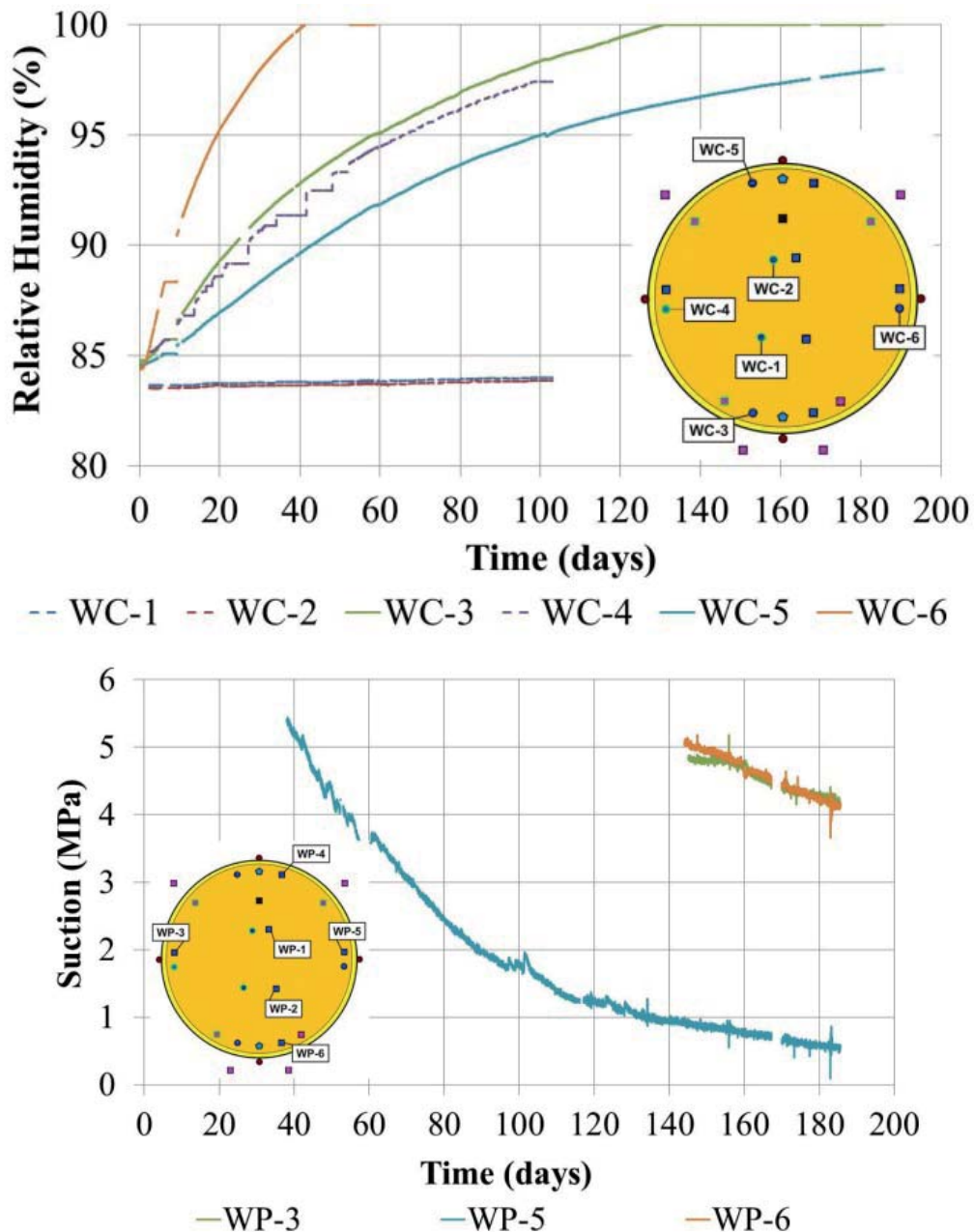

Figure 6. Saturation process in section 2: Relative humidity sensors (top) and psychrometers (bottom). The capacitive sensors can measure up to 100% RH but their accuracy decrease a lot above 95%. Complementarily, psychrometers start to read suction above 95% RH, which equals to around 5.5-6 MPa in this test. Dashed lines belong to wireless sensors and they stopped providing reliable data after a bit more than 100 days.

The psychrometers and pore pressure sensors give a direct measure of the liquid pressure and the relative humidity is related to the suction (negative liquid pressure) by the psychrometric law, so the measures can be used directly for the modelling. Despite the FDR sensors are able to measure saturation in the full range (Figure 7, bottom), as they provide volumetric water content, the interpretation of the measures is difficult. The volumetric water content is related with the degree of saturation, which can be affected by porosity changes if the blocks have variations in volume as well. The degree of saturation is related to the suction by the water retention curve, which is a parameter measured in the laboratory with large scatter.

Finally, as the pore pressure sensors are installed inside the bentonite blocks and they require that water fills the bentonite pores and then the measuring cavity in the sensor to start the pressurization, they have not showed positive measures yet (Figure 7, top).

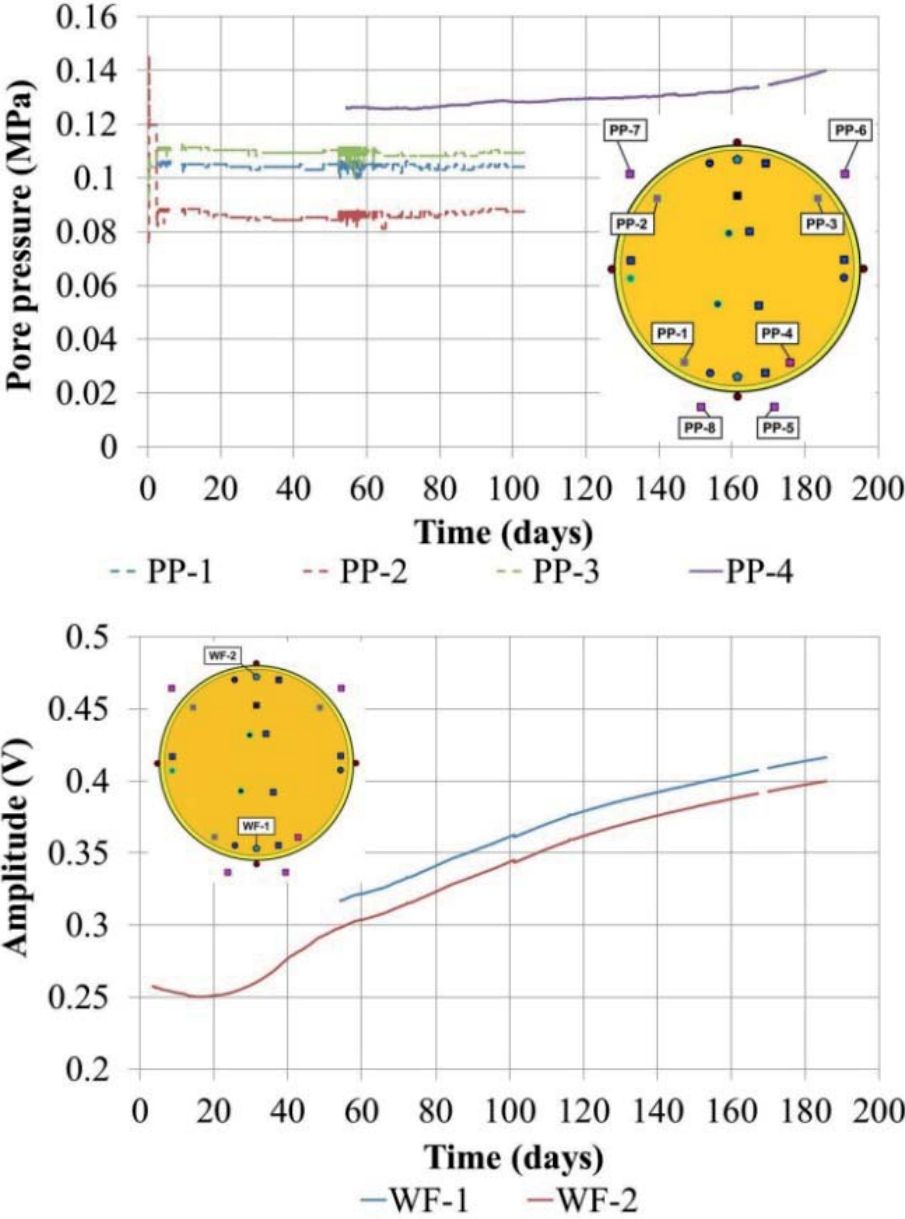

Figure 7. Saturation process in section 2: Pore pressure (top) and volumetric water content (bottom). The FDR were specifically calibrated for the test environment because the measure/signal depends of the medium (sand, bentonite). A small drop can be seen in the amplitude at the beginning. This could be due to change of volume in blocks and proofs the difficulties in the interpretation of this sensor measures. Dashed lines belong to wireless sensors.

The total pressure and pore pressure in rock are presented in Figure 8. It is possible to see that one of the pore pressure sensors followed the same tendency as the total pressure sensors. This proofs that the total pressure sensors were measuring the liquid pressure in the gap and that the swelling pressure had

not developed yet. The pressure dropped and recovered suddenly after 100 days approximately. Some pore pressure sensors were not reading positive pressures, probably due to presence of bubbles in the tubes.

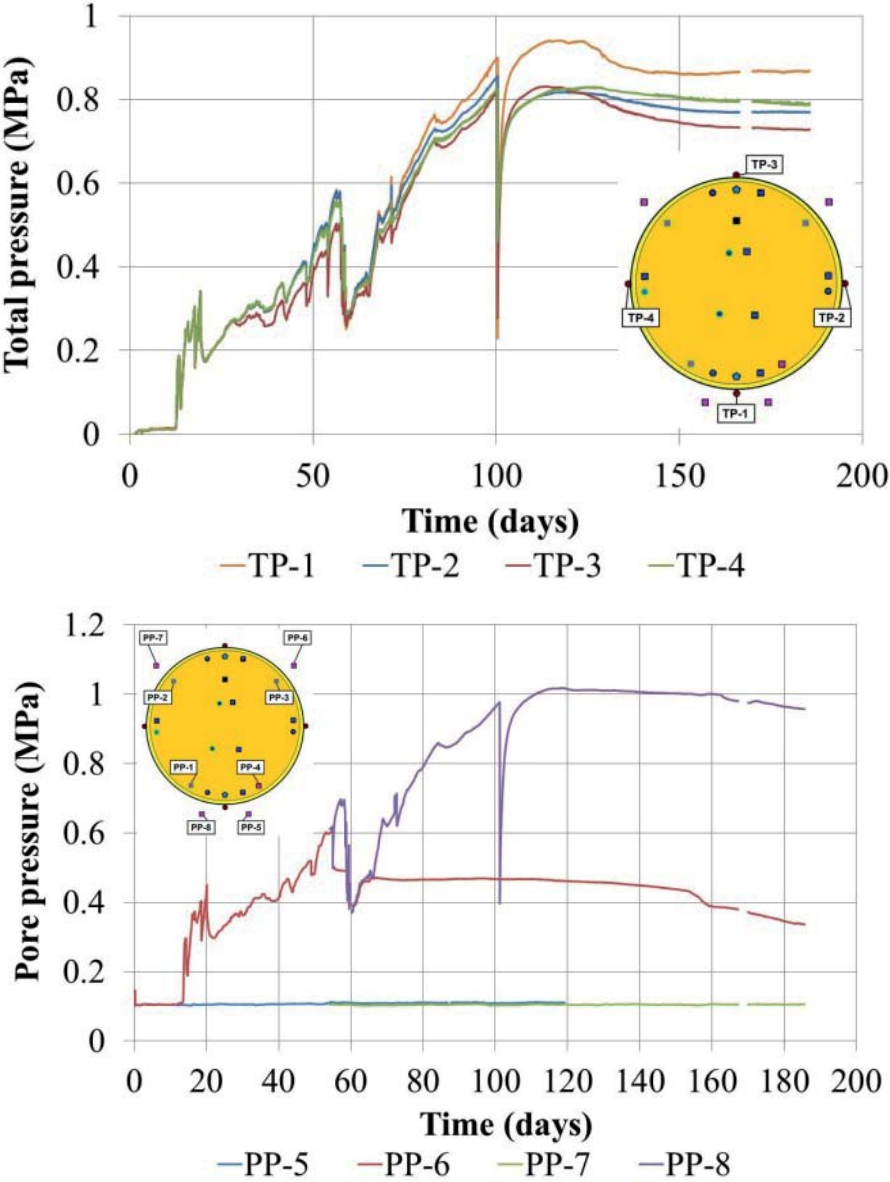

Figure 8. Section 2. Evolution of total pressure in rock wall (top) and pore pressure in rock close to the drift (bottom).

Comparison of the total pressure evolution in two different sections is also presented (Figure 9).

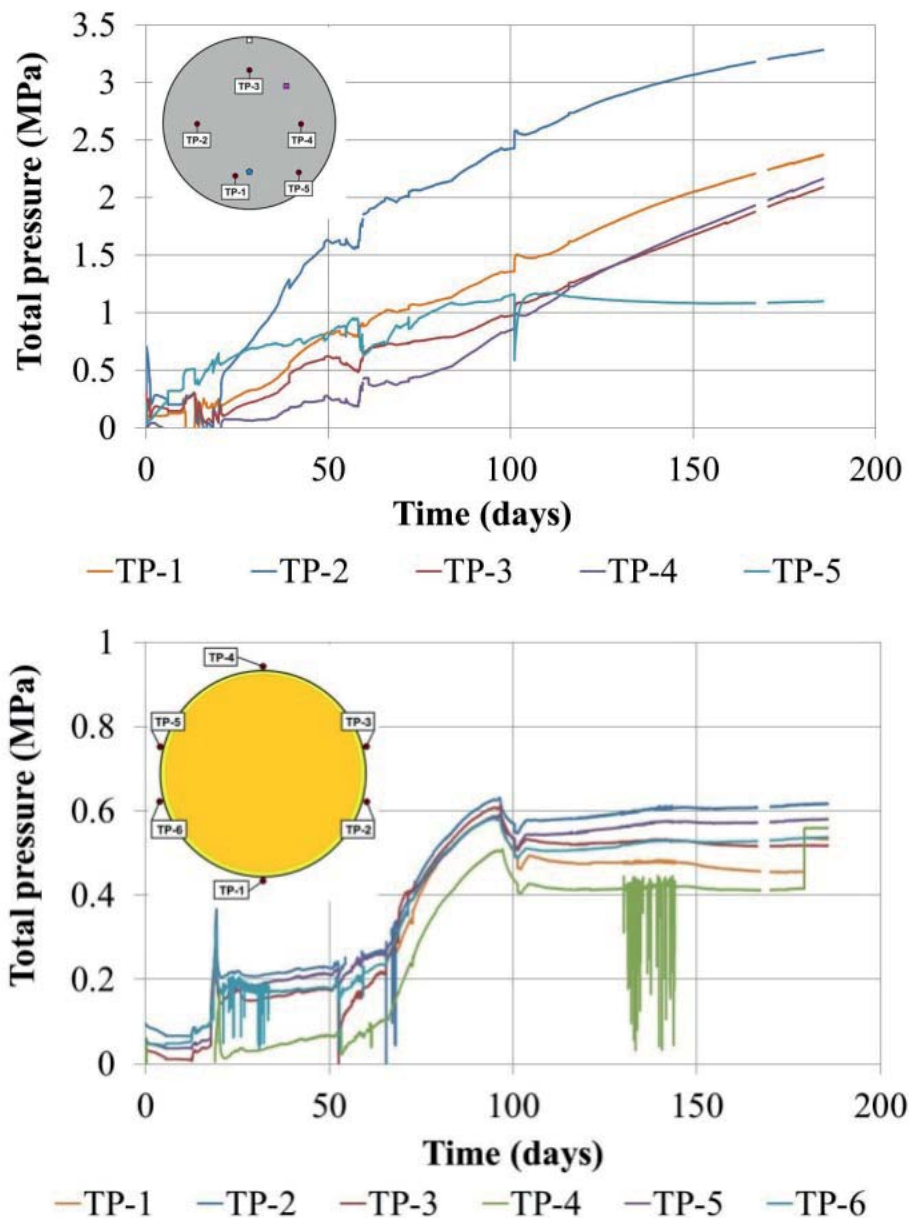

Figure 9. Evolution of total pressure in section 1, drift front (top). The buffer is quite close to the rock and for this reason, they were able to start reading swelling pressure (pore pressure cannot be more than 2.2 MPa). Evolution of total pressure in section 9+ (pellet filling, bottom).

Conclusions

The swelling pressure was not developed during the six first months in the gap between the buffer components and the rock. The only position where swelling pressure was measured was at the drift front (Figure 9, left). The gap around the components was artificially filled with water and after that the rock was able to supply the amount of water that the buffer components were able to absorb. It does not seem to be any difference between sections with blocks (distance blocks, transition blocks and Supercontainer) neither in saturation process nor in swelling pressure development while the pellet filling behaves different (see Figures 8 top and 9 bottom).

The novel wireless data acquisition and monitoring system was used to avoid the disturbances and complexity caused by having many cables inside the test system. Despite the transmitters were properly sealed and the system checked before and right after the installation, some units failed soon after the water pressurisation and others some time later. Therefore, it is evident that the system needs to be improved, for instance by the installation of redundant receivers and a better isolation to humidity in particular for the wired connections.

Acknowledgement

The research leading to these results has received funding from the European Union's European Atomic Energy Community's (Euratom) Seventh Framework Programme FP7/2007-2013 under grant agreement no 269905 (LUCOEX project).

References

SKB, 2012. KBS3-H Complementary studies, 2008–2010. SKB TR-12-01, Svensk Kärnbränslehantering AB.

Full-scale tests – planning and installation, KBS-3V

Keijo Haapala

Posiva

Corresponding author email: keijo.haapala@posiva.fi

Abstract

Posiva is one of the participants in the LUCOEX project and contributes with development of an improved method for emplacement of the bentonite buffer in the KBS-3V method. Two machines - Buffer Installation Machine (BIM) and Buffer Transportation Machine (BTD) – have been designed, manufactured and tested. Also tools and methods for handling unexpected problems during emplacement have been developed and tested. All tests have been carried out in the ONKALO, Underground Rock Characterization Facility (URCF) with good result.

Introduction

Posiva Oy is currently planning the ONKALO URCF in Olkiluoto, which is located adjacent to the final repository at the same depth. The final repository will consist of deposition holes deep in the bedrock where the copper canisters containing the spent fuel will be surrounded by a bentonite buffer. The KBS-3V design calls for the horizontal deposition tunnels containing the vertical deposition buffer and canister holes to be backfilled with highly compacted bentonite blocks. Compacted bentonite pellets are also used around the circumference of both the buffer and backfill, to ensure thermal and hydro stability with the surrounding bedrock. The function of the bentonite buffer and backfill materials is to restrict groundwater flow and to protect the canister. The bentonite components of the Engineering Barrier System (EBS) have to fulfil certain density and homogeneity requirements to ensure safe functional performance for thousands of years.

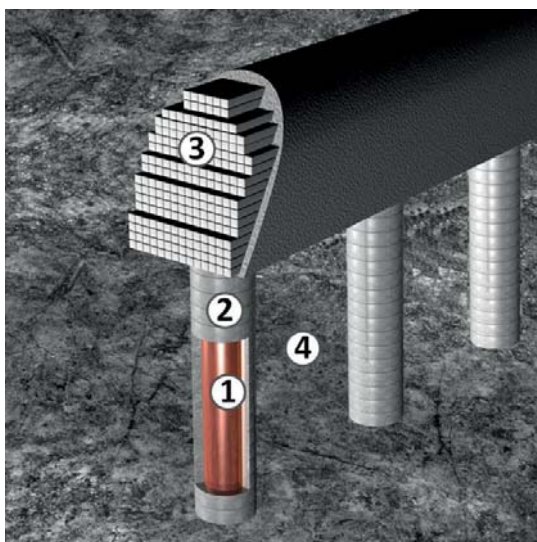

Figure 1. Illustration of the KBS-3V method: 1) Copper canister, 2) Bentonite buffer blocks, 3) Backfill blocks, 4) Host rock.

Description of WP5

In LUCOEX Work Package 5 Posiva is developing the installation of a bentonite buffer for spent nuclear fuel. The experiment aims at developing the necessary machinery and quality control programme, including problem handling for installation of the buffer in a vertical deposition in crystalline rock, in order to create stable proof of the KBS-3V concept.

The main activities in this work package are to develop:

- The installation technique for a vertical bentonite buffer. The work includes the design and manufacturing of the machine and, in the end, the testing of the concept.
- The tools and methods for quality control of the bentonite buffer installation.
- The tools needed in the event of unexpected problems during the buffer installation.

The final part of the work involves the demonstrations of the bentonite buffer and pellets installation in the ONKALO URCF demonstration tunnel.

Development of buffer installation

The work started in 2011 with a study of the buffer installation procedure. The target was to find new ideas for the buffer block installation and handling.

The result of the work was a separate BIM and a separate BTM for feeding the BIM with buffer blocks in the disposal tunnel. During the transportation the buffer blocks are protected against the moisture inside the transportation containers.

Manufacturing of machines and devices started in July 2012 and ended in September 2013.

An important goal of the demonstrations is the accurate positioning of the blocks. The requirement for positioning the centre of the block is ± 1 mm. In Posiva's buffer design the requirement of positioning is ± 2 mm. More demanding requirement of positioning was used in this work in order to ensure that the required installation tolerances in the final repository will be possible to meet, finally. The reason for more demanding positioning requirement is set according the earlier installation tests and a recent study about the sensitivity of buffer block to air humidity. If the time of bentonite buffer installation is long, the swelling of buffer blocks will jeopardize the whole disposal process.

Another requirement is the installation time for the buffer as a whole – not more than two (2) hours.

Developed machinery

The machinery for the installation of the bentonite buffer includes the BIM and the BTM. Both machines will be moved by a terminal tractor.

The set also includes containers where the bentonite buffer blocks are placed during transportation from storage to the BIM and tools for unexpected buffer installation problems

The Bentonite Installation Machine BIM

The bentonite buffer is installed on the deposition holes by a remotely controlled BIM. The BIM is transported to the deposition hole by a terminal tractor. Rough positioning is performed with 5 cm accuracy. The more accurate positioning is carried out by a laser tracker, utilising the focus points attached to the deposition tunnel. In accurate positioning, the BIM raises on legs and it is carefully moved in a transverse direction on top of the deposition hole. The accurate longitudinal positioning will be made by the crane of the BIM during the block installation.



Figure 2. Bentonite buffer installation machine BIM in the ONKALO area test hall.

The Bentonite Transportation Device BTD

The BTD is used for transportation of buffer block containers from the deposition tunnel entrance into the tunnel and up to the BIM. The blocks are transported to the BIM one-by-one. The BTD is remotely controlled and moved by a terminal tractor.



Figure 3. Bentonite transportation device BTB in ONKALO URCF.

Tools for unexpected buffer installation problems

During the installation of blocks with a vacuum lifter, risk exists of dropping the block into the deposition hole. A radiating copper canister separates the problem into two stages – before and after canister installation. Before installation of the canister, it is possible to use conventional methods to lift the pieces of block out from the hole. After installation of a radiating canister into the disposal hole only the methods which can be operated remotely can be used. In this work, drilling anchors and the water-jet cutting method are tested.



Figure 4. Testing of bentonite block water-jet cutting method.

Buffer Installation demonstration

The installation of the buffer blocks is tested in two places: in the test hall, which is located at the ONKALO site, and in the ONKALO URCF demonstration tunnel at a level of 420 m. The tests are performed with concrete and bentonite blocks. In this installation concept, the blocks are placed in air-tight containers when they are transported to ONKALO. The container top (lid) also includes compartments for bentonite pellets.

Buffer installation demonstrations started 2014 in ONKALO area test hall and continued 2015 in ONKALO demonstration tunnel at 420 meters.

Demonstration of buffer installation in test hall

The installation of buffer blocks is tested first in a test hall, which is located at the ONKALO site. In the floor of test hall is a full scale disposal hole made of transparent plexiglass.

The installation tests in the test hall is preceded by a testing of automation components in BIM and BTD. The whole buffer block and pellet installation cycle is tested first in the test hall before moving to ONKALO URCF. Some improvements for the BIM and BTD is made before the moving to ONKALO URCF.



Figure 5. Installation of concrete block to full scale disposal hole in test hall, which is located in ONKALO area.

Demonstration of buffer installation

The start of new type of demonstration in ONKALO URCF is required work to get started. A limited access of subcontractors resulted in delays in preparation work which always is needed with prototypes. Also the handling of heavy concrete blocks to the use of installation machine requires special tools.

At the beginning of the demonstration, the BIM is positioned over the deposition hole, and buffer blocks are ready in containers at the mouth of the demonstration tunnel. The BTD transports the blocks to the BIM and the BIM's crane fetches a buffer block from the BTD located in the front part of the BIM. The crane lifts the block out from the container and moves it above the hole. After that, the crane lowers the block to the hole. The final part of lowering is performed by using a laser tracker. After that, the vacuum is released and the container top is removed from the block. Then the crane lifts the container top from the hole to the shelf of the BTD.



Figure 6. Adjusting of measuring tools of buffer installation machine in the ONKALO URCF demonstration tunnel.



Figure 7. Buffer installation machine operating in ONKALO demonstration tunnel.

Conclusions

Requirements of precision in buffer installation are very demanding. Performed demonstrations showed that the chosen technology can fulfill requirements. Ability to install the blocks with laser tracker in millimeter accuracy is confirmed.

The installation phases required more time than expected. Achieving the targeted installation speed, installation time for the buffer as a whole – not more than two (2) hours, requires improvements of the machine and more installation test cycles.

Results from the buffer installation demonstrations is encouraging and suggested to continue the development of chosen installation concept.

Acknowledgement

The research leading to these results has received funding from the European Union's European Atomic Energy Community's (Euratom) Seventh Framework Programme FP7/2007-2013 under grant agreement no 269905 (LUCOEX project).

Review of monitoring technology for repositories: outcome of instrumentation performance obtained from dismantled long duration experiments and recently installed ones

J-L. García-Siñeriz¹, I. Bárcena¹ and M. Rey¹

¹AITEMIN

Corresponding authors e-mails: jlg.sineriz@aitemin.es, ignacio.barcena@aitemin.es and maria.rey@aitemin.es

Abstract

The results of the monitoring instrumentation used in representative long lived experiments developed in European URLs (Underground Research Laboratories), as for instance the FEBEX at Grimsel or the EB in Mont Terri that were partially or completely dismantled, are of the greatest interest when evaluating if there are sound technologies and sensors available to develop the future repository monitoring programmes. Also the difficulties found to provide the right instrumentation in more recent experiments, as for instance the MPT (Multi Purpose Test) at Äspö or the FE in Mont Terri when trying to minimise the number of cables or when looking for sensors capable of working under high temperatures, provide relevant information about what is still needed for future repositories operation.

Introduction

The successful implementation of a repository programme relies on both the technical aspects of a sound safety strategy, comprising scientific and engineering excellence, as well as on social aspects such as public acceptance. Monitoring has the potential to contribute to both aspects and thus has an important role to play as national radioactive waste disposal programmes move forward towards a successful conclusion, i.e. safe and accepted implementation of geological disposal [White M-J, 2014].

In this sense, the outcomes of well documented long term storage experiments made in URLs, which provide real experience in comparable monitoring environments, are relevant and give insight on the state of art in this matter and, what is more important, on the work that needs to be done to have the appropriate tools for future repository operation.

Description

The FEBEX in situ test is being performed under natural conditions and at full scale within a drift excavated in the underground laboratory managed by NAGRA at the Grimsel Test Site (Switzerland). The thickness of the bentonite barrier is 65 cm, and the surface heater temperature is 100°C. The experiment, installed between 1996 and 1997, was provided with a total of 632 sensors of different types along a number of measuring sections, both in the bentonite buffer and in the host rock, to monitor relevant parameters such as temperature, humidity, total pressure, pore pressure or displacements. From April to July 2002 a section of the test was dismantled after five years of heating, and the bentonite and the instrumentation inside (up to 150 sensors) were retrieved and analysed [ENRESA, 2003]. The other half section continued running and will be dismantled this year after more than 18 years of operation.

The EB experiment was an isothermal test carried out at the Mont Terri rock laboratory (Switzerland) under the lead of ENRESA. The experiment was installed between 2001 and 2002 in a gallery excavated in the Opalinus clay [Mayor J-C et al, 2005]. A dummy canister was installed on top of a base made of compacted bentonite blocks, and the gap canister-rock was backfilled with GBM (Granular Buffer Material). The bentonite buffer was provided with an artificial water injection-

distribution system to accelerate the hydration process. Relative humidity and temperature in the rock and in the bentonite buffer, rock displacement, pore pressure and total pressure were registered by means of different types of sensors. A concrete plug sealed the experimental area. After 11 years of operation and with the barrier expected to be fully saturated, the experiment was dismantled between October 2012 and February 2013. Samples of the bentonite buffer and all sensors within were taken for analysis.

The MPT is part of the KBS-3H System Design phase and also of the Euratom LUCOEX project. It is led by SKB and Posiva and it was installed at the Äspö HRL by late 2013. The goal of MPT is to demonstrate the manufacturing, transport and handling of the full scale KBS-3H components. In addition, another objective is to follow the initial behaviour of the system after installation. The test was instrumented with 226 sensors that have been in operation during 400 days long monitoring phase [García-Siñeriz J-L et al, 2013a]. The test is isothermal and therefore only the variables related to the water content, stresses and displacements are measured.

The FE experiment is currently being installed at the Mont Terri Rock Laboratory under the lead of NAGRA. It is composed of three electrical heaters, weighing around 5 t each, installed on top of bases made of compacted bentonite blocks in a horizontal drift. The remaining volume around the heaters has been filled up with a GBM made of compacted bentonite pellets. The GBM was introduced and compacted in place by using a deposition machine with five screw feeders specifically designed and constructed for this purpose. The installation will finish with the construction of a concrete frictional plug to seal the test. A total of 704 sensors have been installed in the bentonite buffer, in the rock wall and in the plug to measure the evolution of the THM parameters [García-Siñeriz J-L et al, 2013b].

Discussions

The results gathered from the FEBEX in-situ partial dismantling and from the EB full dismantling provide useful information on the behaviour of monitoring instrumentation under realistic conditions. The major problems found in the FEBEX instrumentation [García-Siñeriz J-L et al, 2004] were related in some cases to flooding or mechanical damages, when sensors were not properly constructed (some sensors were prototypes with not well designed protection against the environmental conditions) and in some other cases to corrosion, being these located in a somewhat “warm” zone corresponding to the mid part of the 65 cm thick barrier surrounding the heaters, (see Figure 1). The analysis carried out on the corrosion products [ENRESA, 2004] from the corroded sensors revealed a noticeable presence of sulphur and the microbiological analysis of the bentonite surrounding the sensors revealed a significant content of sulphate reducing bacteria (SRB). The high damage observed was explained by a local corrosion phenomenon induced by the sulphides generated during the metabolic activity of SRB, as these sulphides create a very corrosive media with the high water content of the bentonite close to the rock. The source of sulphates reduced by the SRB is the bentonite itself. Furthermore, the corrosion was developed only in high humidity zones with moderate temperatures, around 50°C, but not in colder or hotter areas.

The results from EB confirmed that, when properly designed, sensors can withstand the mechanical and pore pressures developed without difficulties, and that corrosion is not an issue when temperatures are below 50°C (this was an isothermal test) [Palacios, B. et al, 2013]. They were found almost intact after 11 years of operation (see Figure 2).



Figure 1. Example of mechanical and corrosion damages on displacement sensors. Obtained from the partial dismantling of the FEBEX experiment at Grimsel.



Figure 2. Sensors appearance during the dismantling of the EB experiment at Mont Terri (extensometers on the left hand side and water content sensors on the right).

The results from FEBEX and EB were used when designing the instrumentation for new recent experiments as the MPT and FE. In particular, sensors that were found to be mechanically weak, as the capacitive type sensors or psychrometers that are used for measuring the water content, were improved in terms of robustness. Also the risk of having preferential corrosion in warm areas between the heaters and the rock walls was taken into account for FE, avoiding the use of metals in such areas or protecting them in a proper way.

Another relevant problem when dealing with the instrumentation of an experiment is how to handle all the cables coming from the sensors (see Figure 3). They are not only an obstacle that makes the installation more difficult, but a potential preferential flow path for water and gas, which could jeopardize the interpretation of the processes going on in the experiment. Therefore, some wireless

units were implemented in MPT to minimise this problem (see Figure 4) and several solutions based on fibre optic arrays (FOS) were installed in FE.

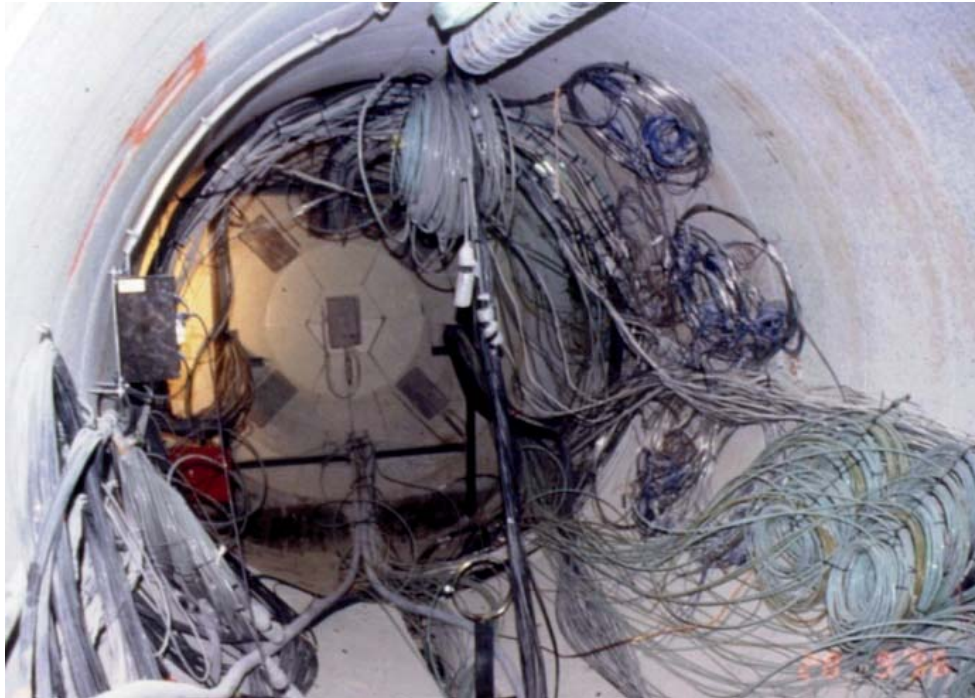

Figure 3. Bundles of cables from the FEBEX instrumentation before building the concrete plug.

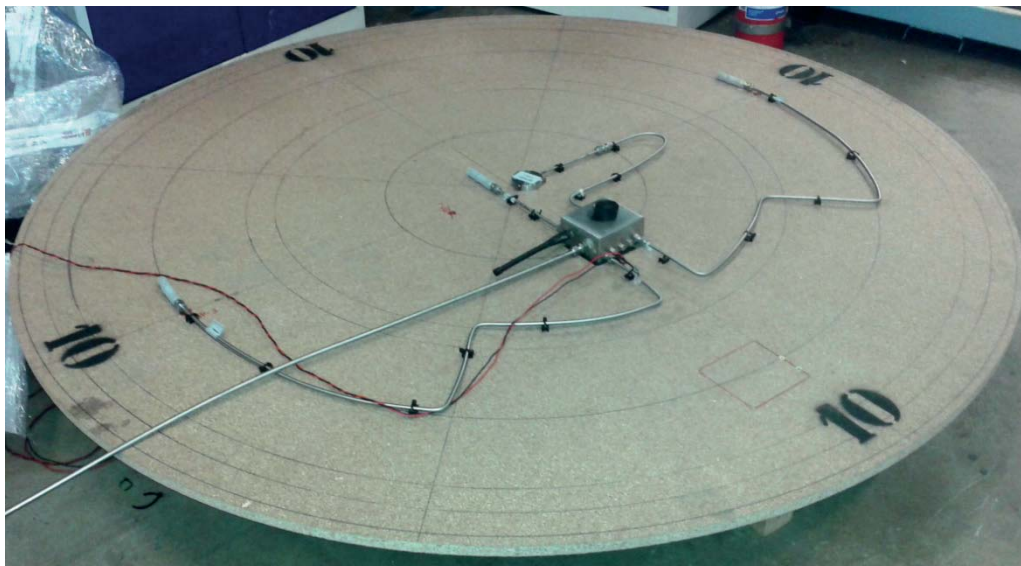

Figure 4. Example of wireless data transmission unit installed in MPT experiment.

Besides, additional difficulties were found during the selection of the instrumentation to be installed in the vicinity of the electrical heaters when target temperatures are quite high, up to 150°C in the case of FE. Under such conditions it is almost impossible to find electronics suitable to operate with guarantees and therefore the options to install total pressure cells or water content sensors are severely constrained.

Another problem that remains unsolved is related to the reliable tracking of the heaters or containers within the buffer due to the complexity of the possible movements (longitudinal displacements combined with rotations) and the required "attachments" of the sensors to the bodies to be monitored. Finally, the monitoring of the buffer saturation requires better or new type of sensors to cover the evolution from high saturation to full saturation.

Conclusions

Results gained during the highlighted experiments indicate that there are already techniques and sensors available to develop the future repository monitoring programmes. Nevertheless, it is also clear that a potential margin of improvement exists for instance in terms of robustness, reliability checking or high temperature operation.

In addition, a sound solution to avoid/minimise the number of cables is necessary and further efforts should be made to obtain a reliable and qualified means for the data transmission using wireless techniques. The same applies to FOS, which will reduce the number of cables due to the multiplexing capability.

In this sense, the upcoming project Modern2020 (Bertrand J et al, 2014) should serve to progress significantly in the path of having the appropriate tools for future repository operation monitoring.

References

- Bertrand J, Garcia M, 2014.** Project "Development and Demonstration of monitoring strategies and technologies for geological disposal", Modern2020. Call NFRP-2014-2015. Topic NFRP-06-2014. Proposal ID 662177. Non public document issued by the Participant Portal Submission Service of European Commission.
- ENRESA, 2003.** FEBEX Project: Dismantling of the heater 1 at the FEBEX "in situ" test, Publicación Técnica ENRESA 9/2003, Madrid. 134 pp.
- ENRESA, 2004.** FEBEX Project: Post Mortem Analysis. Corrosion Study. Publicación Técnica ENRESA 08/2004, San Sebastián. 75 pp.
- García-Siñeriz J-L, Bárcena I, Fernández P, Sanz F-J, 2004.** Instruments Analysis Report. FEBEX report 70-AIT-L-6-8. AITEMIN, Madrid. 79 pp. Unpublished report.
- García-Siñeriz J-L, Tuñón S, de la Rosa C, 2013a.** Multi purpose test (MPT): INSTRUMENTATION PLAN. Report for B+Tech Oy. AITEMIN, Madrid. 96 pp. Unpublished report.
- García-Siñeriz J-L, Bárcena I, Rey M, Abós H, Martínez V, 2013b.** Design of Instrumentation for FE Experiment at Mont Terri rock laboratory. Report for NAGRA. AITEMIN, Madrid. 41 pp. Unpublished report.
- Mayor J-C, García-Siñeriz J-L, Alonso E E, Alheid H-J, Blümbling P, 2005.** Engineered barrier emplacement experiment in Opalinus Clay for the disposal of radioactive waste in underground repositories. Final Report. Publicación Técnica ENRESA 02/05. Madrid, 101 pp.
- White M-J, 2014.** Monitoring During the Staged Implementation of Geological Disposal: The MoDeRn Project Synthesis. Deliverable D6.1. Available at <http://www.modern-fp7.eu/>. 90 pp.

Palacios B, Rey M, García-Siñeriz J-L, 2013. Engineered Barrier Emplacement Experiment in Opalinus Clay: “EB” Experiment. As-built of dismantling operation. PEBS Deliverable-nº: D2.1-4. Contract Grant Agreement Number FP7 249681. AITEMIN, 95 pp.

Palacios B, García-Siñeriz J-L, Mayor J-C, 2014. Outcome of the Dismantling of “EB” Experiment. In: Schäfers, A., Fahland, S. (Eds.), Proceedings International Conference on the Performance of Engineered Barriers, 6-7 February 2014, BGR, Hannover, pp. 45-52.

Requirements-based Design In Support of Full-scale Tests of Plugs and Seals in the DOPAS Project

Matt White

Galson Sciences Limited
Corresponding author e-mail: mjw@galson-sciences.co.uk

Abstract

Full-scale demonstrator tests of plugs and seals are being undertaken within the Full-Scale Demonstration Of Plugs And Seals (DOPAS) Project. Five different plugs and seals are being investigated. The design basis for each plug or seal has been collated. This has allowed comparison of the requirements on the different plugs and seals, and consideration of the generic methods used to develop and describe the design basis. Development of the design basis is an iterative and hierarchical activity that is undertaken in parallel with development and testing of the design.

Introduction

The DOPAS Project is a European Commission (EC) programme of work jointly funded by the Euratom Seventh Framework Programme and European nuclear waste management organisations (WMOs). The DOPAS Project is running in the period September 2012 – August 2016. Fourteen European WMOs and research and consultancy institutions from eight European countries are participating in DOPAS. The project is coordinated by Posiva, Finland. A set of full-scale experiments, laboratory tests, and performance assessment studies of plugs and seals for geological repositories will be carried out in the course of the project.

DOPAS aims to improve the industrial feasibility of plugs and seals, the measurement of their characteristics, the control of their behaviour over time in repository conditions, and their performance with respect to safety objectives.

The DOPAS Project focuses on tunnel, drift, vault and shaft plugs and seals for crystalline, clay and salt rocks:

- Crystalline rocks: experiments related to plugs in horizontal tunnels, including the Dome Plug (DOMPLU) experiment being undertaken by SKB at the Äspö Hard Rock Laboratory (ÄHRL) in Sweden, the Posiva Plug (POPLU) experiment being undertaken by Posiva at the ONKALO underground rock characterisation facility (URCF) in Finland, and the Experimental Pressure and Sealing Plug (EPSP) experiment being undertaken by SÚRAO and the Czech Technical University (CTU) at the Josef underground research laboratory (Josef URL) in the Czech Republic.
- Clay rocks: the Full-scale Seal (FSS) experiment, being undertaken by Andra in a warehouse at St Dizier, is an experiment of the construction of a drift and intermediate-level waste (ILW) disposal vault seal.
- Salt rocks: tests related to seals in vertical shafts under the banner of the Entwicklung von Schachtverschlusskonzepten (development of shaft closure concepts – ELSA) experiments, being undertaken by DBETEC together with the Technical University of Freiberg and associated

partners complemented by laboratory testing performed by GRS during the LAVA and LASA Projects.

Each experiment represents a different state of development. The Swedish experiment was started prior to the start of the DOPAS Project. The Finnish, Czech and French experiments are being designed and constructed during DOPAS. The German tests focus on the early stages of design basis development and on demonstration of the suitability of designs through performance assessment studies, and will feed into a full-scale experiment of some shaft seal components to be carried out after DOPAS. Work Package 2 (WP2) of the DOPAS Project is focusing on the design basis, reference designs and strategies used to demonstrate the compliance of the installed plugs and seals to the design basis.

Description

Design Basis Development Process

Definition of the Design Basis

All WMO partners in DOPAS, including those not directly implementing a full-scale experiment (Nagra and RWM), manage the development of designs through a process that includes identification of the requirements on structures and the conditions under which these requirements must be met. Requirements most commonly relate to the performance needed from the structure (e.g. the ability to withstand loads). Conditions relate to the environment in which the structure is constructed (e.g. the dimensions, the environmental conditions such as temperature and humidity, and the working conditions such as man access and rate of emplacement). For all of these programmes, the design basis is represented by a list of requirements on the structure (i.e. the plug or seal) and the conditions under which these requirements must be met. Therefore, the understanding of what constitutes a design basis is consistent across all WMOs in DOPAS.

In DOPAS, a distinction is made between the design basis for the reference repository conceptual design and the design basis for the experiment. The reference design is the one that is used across the national programme (e.g. for licensing). The design basis for the experiment may differ from the design basis for the reference design because the experiments may be testing only specific aspects of a plug or seal, because the testing may involve acceleration of processes, or because the experiment may be testing a different design to the reference. An example of an experiment considering only specific aspects of a seal is FSS, which will not be saturated or otherwise pressurised. However, the design basis for FSS does include requirements to ensure that the experiment is appropriately defined (e.g. the density of the emplaced bentonite must be sufficient that it would provide the necessary swelling pressure and hydraulic conductivity should the system be saturated). An example of the acceleration of processes is the rate at which DOMPLU and EPSP will be pressurised, a feature of the experiments that could have significant impacts on the performance of the structures being tested. POPLU and EPSP are examples of experiments that are not addressing the reference design.

In addition, the design basis for specific experiments is developed to a more detailed degree than the design basis for the plugs and seals in the reference repository conceptual designs. This is because the design bases for repository plugs and seals contain high-level requirements and conditions that are fixed (see Section 8.1.2) and because outstanding uncertainty does not allow more detailed specification of the reference designs at the present time. In contrast, the design basis for the experiments must be specified in greater detail to allow the experiment to be designed and implemented.

Iterative Development of the Design Basis

All of the design bases considered in DOPAS include national regulations and other stakeholder requirements as a starting point. Examples include the further development of particular technologies and materials in the case of EPSP (e.g. use of Czech bentonite and use of fibre reinforced sprayed concrete) and the consideration of national repository safety requirements and mining law in the case of ELSA.

High-level conceptual designs of plugs and seals typically build on existing designs for plugs and seals applied in other industries. Examples include experience from the sealing of hydroelectric plants in Sweden, development of plugs from gas storage facilities in the Czech Republic, and experience of the sealing of salt and potash mine shafts in Germany. Therefore, technology transfer and existing knowledge is a significant part of the process used to develop the design basis for plugs and seals in repository concepts.

High-level conceptual designs will allow the principal functions of plugs and seals to be specified (e.g. for the KBS-3V deposition tunnel plug, the functions are to confine the backfill in the tunnel, to support saturation of the backfill, and to provide a barrier to water flow that may cause harmful erosion of the bentonite in buffer and backfill). These functions will, at an appropriate stage in the programme, become fixed, although this should not occur until significant confidence in the function (and the wording that is used to define it) has been achieved.

Existing knowledge on plugs and seals can be used to propose more detailed functional requirements that a plug or seal must achieve (e.g. a water leakage rate). These initial requirements may be tested through full-scale demonstration and through performance assessment studies, the learning from which is fed back into the design basis. Examples of full-scale experiments that have been important in the development of the design bases for the DOPAS experiments include the Stripa Tunnel Plugging Experiment, the Äspö Backfill and Plug Test, the Äspö Prototype Repository, the Tunnel Sealing Experiment (at the URL near Whiteshell, Canada), the concrete plugs developed for the Hájek underground gas storage facility, and the Salzdetfurth Experimental Shaft.

Experimental tests and feasibility studies are carried out, the outcomes of which may result in new updates to the detailed design requirements. For example, it may be found that using a certain recipe of concrete for constructing a plug proved difficult or inadequate, and a change may be required. Such testing can help to develop the design basis for plugs and seals, for example the structures that they contain (concrete plugs, bentonite seals, filters etc.), the acceptable materials (e.g. type of concrete) and the performance requirements (e.g. leakage rates, swelling pressures and hydraulic conductivities). As performance assessments are undertaken, more light can be shed on the expected long-term performance of the engineered barriers. Any unacceptable results from a safety point of view can be analysed and the relevant inputs, as dictated by the design basis requirements, may need to be re-evaluated. This in turn can result in a need to modify a requirement or revise the already-established safety functions.

In developing a design basis, it is therefore essential to use experience from any full-scale experiments and ensure that collaboration and coordination of effort between designers, safety evaluators and other experts are established. Therefore, the development of a design basis can be considered as a continuous process where learning from new and previous experiments, performance assessments, and changes in the safety concept can result in the need to change some aspects of the design (Figure 1).

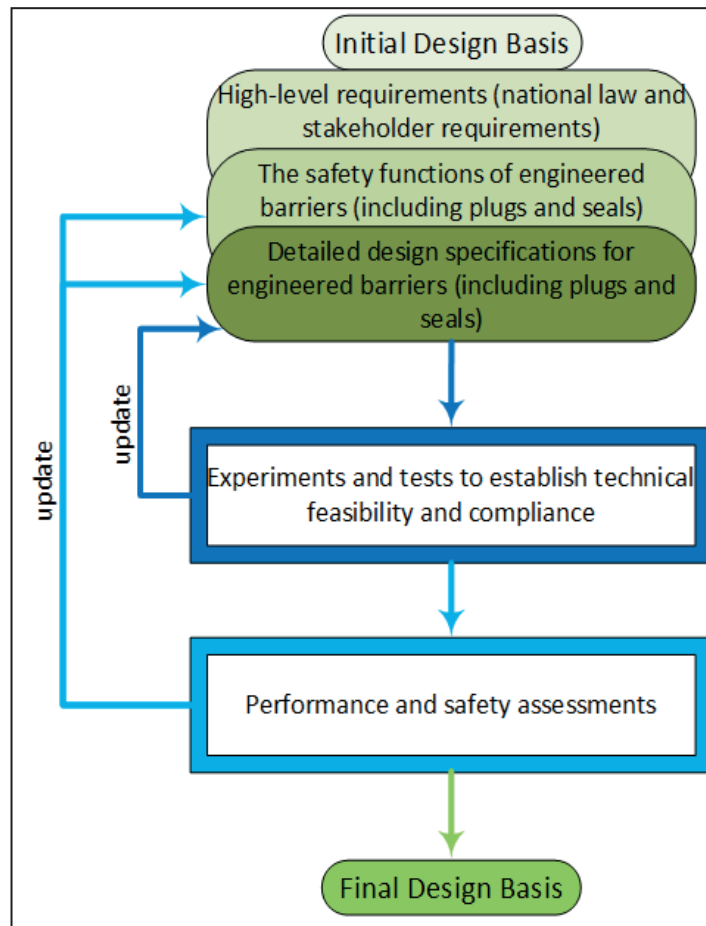

Figure 1. Iterative process for developing a design basis.

Management of Design Basis Requirements

Of the five WMOs developing an experiment in DOPAS, only two, SKB and Posiva, are implementing a systems engineering approach to identification and management of the design basis. SKB and Posiva have worked collaboratively on the implementation of requirement management systems (RMSs) in their programmes and have introduced a hierarchical structure, consisting of five levels of requirements (these five levels consist of stakeholder requirements, system requirements, sub-system requirements, design requirements and design specifications). An RMS enables information on the links between requirements, historical development of a requirement, and reasons for adding or removing any entries to be recorded.

However, the systems developed by both SKB and Posiva have only partially been introduced: the SKB system does not yet incorporate all of the requirements identified in its Production Reports and the Posiva system concentrates on requirements related to post-closure safety.

An issue for requirements management is the significant time and effort required to develop and manage requirements. Andra, for example, where requirements are linked to the phenomenological analysis of safety functions, required several years to develop an agreed and stable set of safety functions for the repository concept and its constituent components. These safety functions are fixed and have not changed since the publication of Dossier 2005, although sub-functions (e.g. those related to gas migration) might be changed in the future.

In addition, two of the WMOs (SÚRAO and RWM) with less mature programmes recognise the benefit of introducing RMSs during the early development of their repository concepts. To date, SÚRAO has identified high-level requirements only, as the Czech programme is focusing on conceptual studies. RWM has decided to implement an RMS, and is currently developing the approach to its implementation. Requirements are currently listed in the Disposal System Specification (DSS) documents, and the RMS is intended to help to ensure that the DSS provides a unified and comprehensive specification of requirements. Work is currently ongoing to develop the DSS requirements into a hierarchical structure. The hierarchical structure will present systematically the DSS requirements from the highest level requirements distilled from national policy, legislation, regulatory requirements, and boundary conditions set out by RWM, down to disposal system generic safety functional requirements in terms of design, construction, operation and closure of the disposal system.

All of the WMOs in DOPAS are currently managing the design basis for plugs and seals (and the design basis for the repository) through documentation. These documents contain lists of requirements and conditions on the structures, and different methods for describing the background, interpretation and justification of the requirements.

Content of the Design Basis for Plugs and Seals

Influence of Host Rock on Plugs and Seals Design Basis

The repository host rock can have a significant influence on the design basis for plugs and seals.

Typically, crystalline rocks are relatively strong but potentially contain water-conducting features (e.g. fractures) either naturally or as part of an excavation damaged zone (EDZ) resulting from construction. Therefore, the design basis for crystalline rocks may include specific requirements associated with both the presence of these features and the impact on the EDZ of construction methods. For example, the DOMPLU design basis includes a requirement that the excavation method shall minimise the development of an EDZ, and a requirement that rock surfaces connecting to the concrete dome abutment shall be free from an EDZ with harmful impact.

However, the main impact of crystalline host rocks on plugs and seals is associated with the disposal concept developed for such rocks. The KBS-3 method, in particular, places a high reliance on containment by the canister and key functions of the buffer and the deposition tunnel backfill are to protect the canister. Therefore, the deposition tunnel plug does not have a post-closure safety role and its main function is to protect the bentonite in the deposition hole buffer and in the deposition tunnel backfill from erosion, and the buffer and backfill from piping.

In contrast with typical crystalline rocks, clay and salt host rocks are relatively weak and are expected to have very low hydraulic conductivity. The repository access ways represent a possible short circuit to the geosphere containment function. Therefore, the key function for seals in these systems is to seal the repository such that groundwater flow into and out of the repository is restricted. This function is expected to last until the host rock and backfill have re-established *in situ* hydraulic performance, which may be a period of hundreds of years in a salt and thousands of years in clay.

Current Practice in Defining the Design Basis for Plugs and Seals

The design bases for the DOPAS experiments have illustrated different approaches to specification of the design basis for similar features and processes of plugs and seals. These are discussed below in

relation to hydraulic, mechanical, chemical and gas issues. In addition, the current approaches to defining other aspects of the design basis, including the incorporation of operational issues, are discussed.

Requirements on Hydraulic Performance

The hydraulic function of plugs and seals responds to different safety functions in different disposal concepts. For the Cigéo repository concept, the hydraulic conductivity of the seal must be equal to or less than 1×10^{-9} m/s, to meet the performance assessment requirement that groundwater flow is predominantly through the geosphere. For the crystalline rock cases, especially DOMPLU and POPLU, the requirement is that the water flow does not lead to piping and erosion of the deposition tunnel backfill.

Definition of the hydraulic function is undertaken following an analysis of the main pathways through the plug or seal. For DOMPLU, the main pathways are likely to be the contact between the concrete dome and the rock and through the EDZ. In terms of the contact zone, the design basis is based on a regular discontinuity being developed between the concrete and the rock, which relies on a smooth rock surface (which is produced by wire sawing) and homogeneous cooling of the concrete (which leads to the introduction of cooling pipes). The shrinkage gap that is formed during cooling is grouted, and, owing to the small volume of grout required, it is considered acceptable to use high-pH grout. In terms of the EDZ, this requires appropriate construction techniques to be employed and appropriate siting of the plug. Existing requirements on the EDZ call for the region to be free from through-going discontinuities, but this requirement is not verifiable by existing methods (e.g. imaging using ground penetrating radar). However, further work is required to understand how a verifiable requirement on the hydraulic conductivity of the EDZ can be set – such a requirement would need to be site-specific and could make use of 3D techniques for stochastic modelling of fracture systems.

A further issue is the measurement of any leakage across the plug. DOMPLU is currently investigating the water leakage value that can be achieved for a plug. In ventilated tunnels, water leaking through a plug at the expected low rate would evaporate rather than condense, and is therefore difficult to measure. SKB is using a plastic sheet over the DOMPLU experiment to reduce the effects of ventilation on any water that leaks through the seal.

For FSS and EPSP, the bentonite in the system provides a significant hydraulic function. However, the design basis for both experiments recognises that definition of the hydraulic conductivity of the bentonite depends on the density that can be achieved during emplacement. For EPSP the decision has been made to define the density of the bentonite; this is regarded as a practical approach to definition of the design basis. For FSS, the design basis has been defined in terms of the required hydraulic conductivity, as this has been defined in response to performance assessment studies, although the bentonite dry density will be monitored to establish whether the required hydraulic conductivity is achieved.

Requirements on Mechanical Performance

In terms of mechanical performance, a key issue to be considered in the development of a design basis is whether or not a filter or transition zone is required to reduce pressures acting on the principal component of the plug. This must be decided during the development of the design basis in order to place the appropriate requirements on the filter if it is included. The inclusion of a filter would reduce the required performance of the principal component of a plug (e.g. a concrete dome) during construction, but would make installation of the plug more complicated. It is anticipated that the

work on POPLU, which is currently on-going, will contribute to consideration of the need for transition zones in plugs.

Requirements on Chemical Performance

In terms of chemical performance, the issues include the potential for interaction of any cementitious materials with clay materials, in particular the potential for high-pH waters emanating from cement reducing the performance of bentonite seals and/or clay host rocks, and the possible impact of any harmful substances. This has been addressed in all designs by requiring low-pH cement to be used for all cementitious materials, with the exception of the contact grout to be used in DOMPLU.

However, the approach to specifying the chemical performance of cementitious materials for each of the full-scale experiments in DOPAS is different:

- For DOMPLU, a pH value of ≤ 11 is specified as a requirement.
- For POPLU, a calcium to silica mass ratio less than 1:6 is specified (the value of this ratio is currently under review).
- For EPSP, which concentrates on fundamental understanding of materials, a less stringent requirement is set which requires that cement with a relatively low pH shall be used for all the concrete and shotcrete components to develop further understanding of these materials.
- For FSS, an original specification that required the concrete plugs to have a pH of 10.5 to 11 by 28 days after mixing was found to be quite optimistic during initial testing. This requirement has been modified so that the pH value has to be fulfilled by 90 days after mixing.

Requirements on the introduction of harmful substances are recognised in the POPLU design basis; plug materials shall be selected so as to limit the contents of harmful substances (organics, oxidising compounds, sulphur, and nitrogen compounds) and microbial activity. This does not feature in other experiment design bases, as the experiments are not at potential repository sites.

Requirements on Gas Migration

Of the DOPAS experiments, the only requirements related to gas, are for the gas permeability of the FSS concrete to be measured. There are no particular requirements that set for gas migration for DOMPLU, POPLU, ELSA and EPSP.

Requirements on the Host Rock

The current assumption for all programmes is that plugs and seals will be of a single design and rock requirements will be defined in concert with plug and seal requirements. An alternative approach would be for WMOs to adopt flexible design bases for plugs and seals, for example developing more than one plug design, which could provide greater flexibility in responding to rock conditions encountered during operations. This would mitigate against the loss of deposition tunnels on grounds of unsuitability should rock conditions not meet the most stringent requirements.

Requirements on Operational Issues

DOMPLU and FSS also recognise requirements related to operational issues. As implementation of geological disposal moves closer, operational considerations may become a more significant aspect of the design basis, especially for KBS-3V, where construction of deposition tunnel plugs may need to

take account of other underground activities. Operational requirements for other experiments in DOPAS have not been documented yet.

Discussion and Conclusions

The development of detailed design bases for the reference and experiment designs of plugs and seals in DOPAS is providing a structured method for supporting the experiments. In particular, use of the experiment design basis to conduct a structured audit of experiment performance of the experiments presents a traceable and auditable method for analysing experiment results and to prepare for the industrial implementation of plugs and seals during repository operation. The work on analysing experiment results is on-going and the status in this work will be presented at the workshop.

Acknowledgements

The research leading to these results has received funding from the European Atomic Energy Community's (Euratom) Seventh Framework Programme FP7/2007-2013 under grant agreement no 323273, the DOPAS project.

Full-scale test of a Dome plug tunnel seal at Äspö HRL - Design, installation and results

Pär Grahm¹, Petri Koho²

¹ Swedish Nuclear Fuel and Waste Management Co, Oskarshamn, Sweden, ² Posiva Oy, Finland

Corresponding author e-mail: par.grahm@skb.se

Abstract

System design development for deposition tunnel end plugs has been carried out in cooperation between SKB and Posiva Oy according to the KBS-3V reference disposal concept. The system design development has included verification of the dome plug design by analytical and numerical calculations, laboratory examinations and small scale tests. The main activity though, was to test a plug system in full scale (The DOMPLU experiment) with representative hydrogeological conditions at the Äspö Hard Rock Laboratory (HRL). This abstract gives a brief summary of the design, installation and results of DOMPLU during the monitoring period from casting of the concrete dome on March 13, 2013 until the data freeze for technical reporting on September 30, 2014.

Monitoring, evaluation and technical reporting of DOMPLU have been part of the Project “Full-Scale Demonstration of Plugs and Seals” (DOPAS). The DOPAS project is a European Commission (EC) programme of work jointly funded by the Euratom Seventh Framework Programme and European nuclear waste management organizations, in which full-scale experiments, laboratory tests and performance assessments studies of plugs and seals for geological repositories are being carried out. DOMPLU have thus received funding from the Euratom Seventh Framework Programme FP7/2007-2013.

Introduction

In Sweden, a site has been selected at Forsmark for final disposal of spent nuclear fuel from the Swedish nuclear power plants. The Spent Fuel Repository will be located approximately 470 m below the ground surface in crystalline rock. A license application for disposal of spent fuel, based on the KBS-3V method, was submitted in March 2011.

The long-term safety principles of the KBS-3 method are based on isolation and containment of radioactive waste through the choice of a stable geological environment at depth and the use of a multi-barrier system consisting of engineered barriers (canister, buffer, backfill, and closure) and the host rock. In KBS-3V, the canisters are emplaced in vertical holes, containing pre-compacted blocks of bentonite buffer, below horizontal deposition tunnels. The deposition tunnels are backfilled with bentonite blocks and pellets, and sealed with a deposition tunnel plug, see Figure 1 (SKB 2010a).

The principal role of the deposition tunnel plug is to hold the backfill in place during ongoing repository operations in other areas; this is achieved through use of a strong, dome-shaped concrete plug. As the function of deposition tunnel plugs is related to operational activities, the designed service life of this structure is 100 years.

After all canisters have been emplaced and all deposition tunnels backfilled and plugged, the rest of the repository will be backfilled and sealed (Closure) from the underground level to the surface.

The KBS-3 repository facility with completed parts of the KBS-3 repository

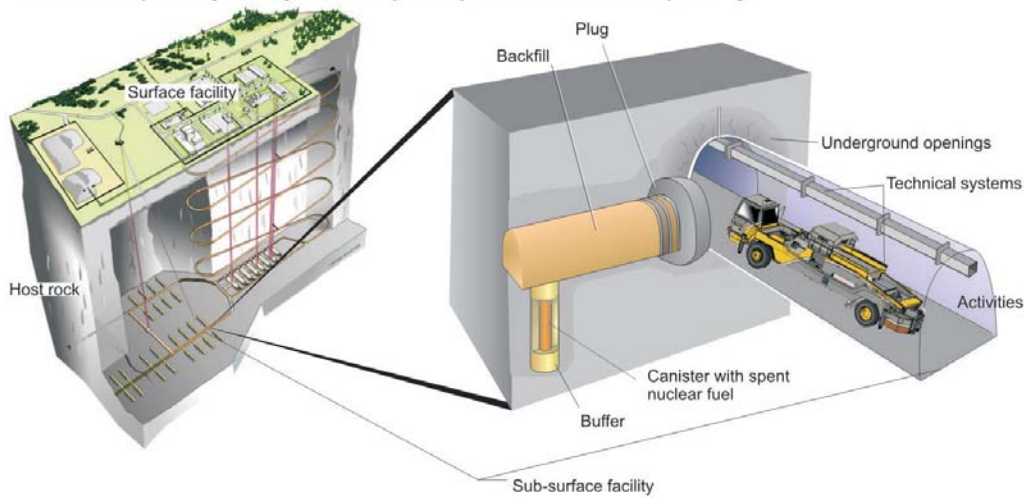

The KBS-3 repository

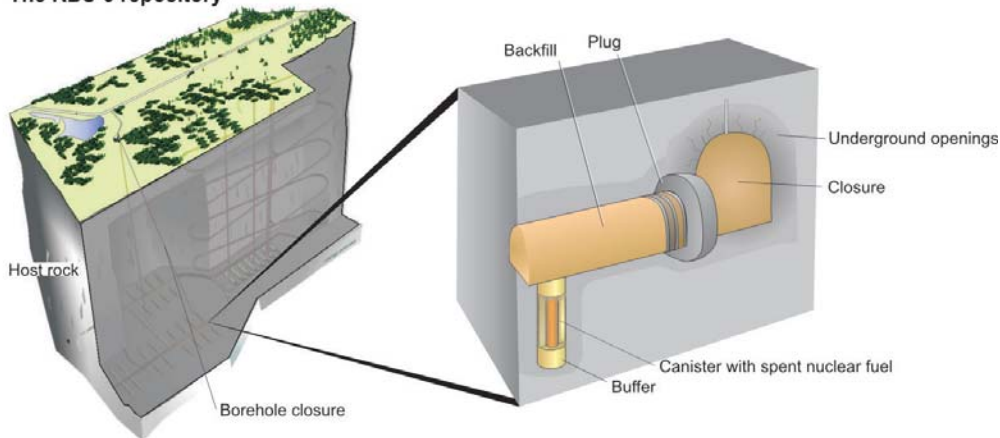

Figure 1. The KBS-3 repository facility and the KBS-3 repository. The KBS-3 repository is constructed within the KBS-3 repository facility. (SKB 2010a)

The groundwater leakage past the plug has to be small enough in order to result in a build-up of groundwater pressure inside the plugged volume and to keep water escape from the tunnel at an acceptable level. This will prevent unacceptable erosion of buffer clay from the deposition holes during the operational phase of the repository (about 100 years).

Construction of a plug takes between four and five months, including 100 days for hardening and a final contact grouting of the concrete dome. During that time the plug construction site must be kept free from water. Wet tunnels therefore require a drainage system (i.e. a filter section) which can take care of the water coming from the inner parts of the deposition tunnel.

By testing the plug system design in a full-scale demonstration (DOMPLU) it is to be proven that the method for plugging of a deposition tunnel is feasible and controllable. The requirements on tightness of the plug are to be evaluated. A preliminary design basis is that the plug system should allow a maximum groundwater flow of <math><0.1\text{ l/min}</math> past the structure during its operational century.

Description

The current SKB reference conceptual design for a deposition tunnel plug is described in SKB's *Design, production and initial state of the backfill and plug in deposition tunnels* report (SKB 2010b). The DOMPLU design and the current SKB reference design are broadly similar, with the exception of a few modifications intended to test the performance of new materials planned to be introduced as part of a slightly revised reference design.

The full-scale test consists of a number of components, each with its own purpose, see Figure 2. The innermost component is a 1 m backfill zone which consists of a stack of bentonite blocks with a surrounding pellet filling. The next section is the filter which is composed of 0.3 m thick lightweight expanded clay/concrete aggregate (LECA) beams and a 0.3 m layer of gravel (2-4 mm). The filter section serves for drainage of groundwater during construction and curing of the concrete. In addition, the filter accelerates wetting of the bentonite seal when the drainage is finally closed subsequent to contact grouting of the concrete dome (about 100 days after casting). The gravel and the bentonite seal are separated by a geo-textile delimiter which also facilitates an even distribution of water into the sealing. The bentonite seal consists of a 0.5 m thick stack of highly compacted MX-80 bentonite blocks with a surrounding MX-80 pellet filling closest to the rock. Finally, the restraining concrete structure is designed as an unreinforced octagonal dome plug, cast in-situ by low-pH concrete recipe B200 (SKB 2009). The diameter of the concrete dome is about 8.8 m while the concrete thickness is 1.79 m in the hub.

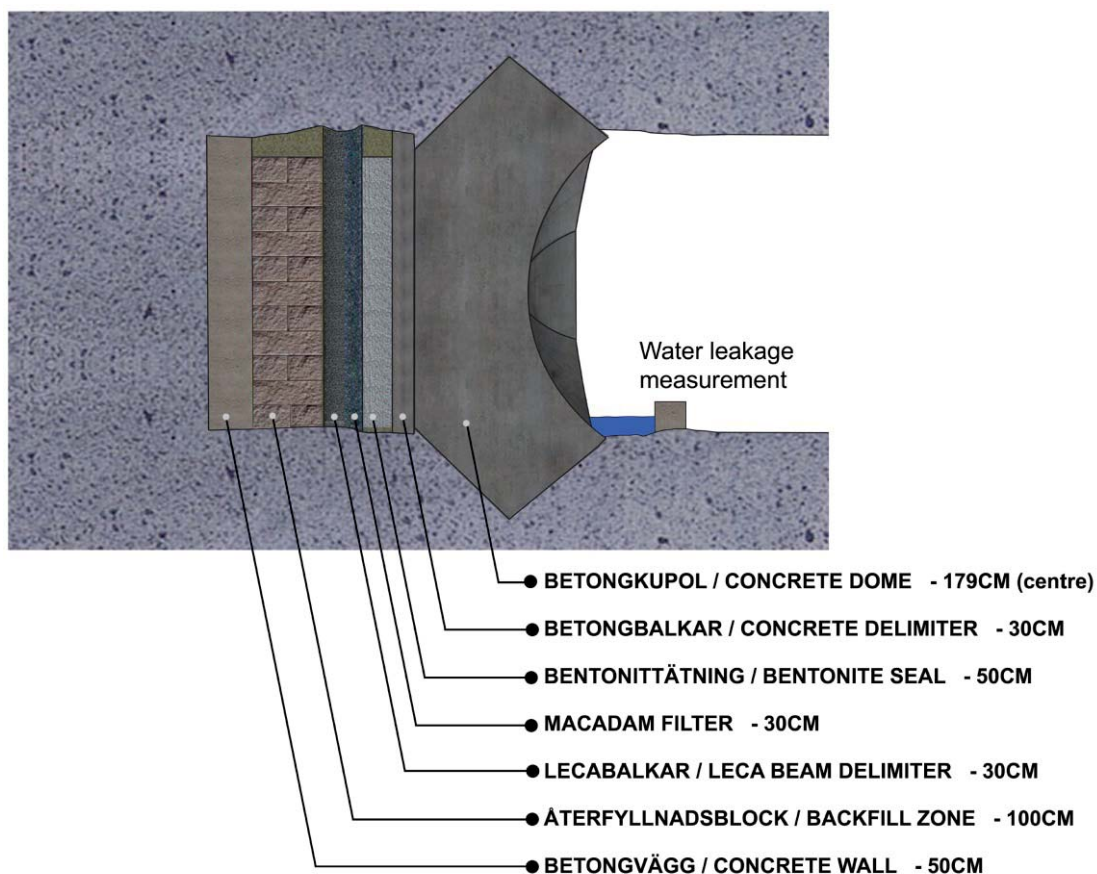

Figure 2. Schematic section of the DOMPLU full-scale test.

By testing the design through a full-scale demonstration, it is intended to show that the method is feasible and performances are predictable. A main goal of the DOMPLU test is also to evaluate leakage past the plug at a stable water pressure of 4 MPa (400 m head).

The backfill, filter and bentonite seal components are instrumented by 51 sensors at several positions. The properties being measured by the array of sensors includes temperature, relative humidity, displacements, pore pressures and total pressures. These were placed on-site at the same time as the components. The cables from sensors in the backfill and seal layers are lead sideward through pipes in the rock to a monitoring niche in the neighboring tunnel, a distance of about 21 meters. The main purpose with this route was to avoid penetrating the bentonite seal by sensor cables.

Monitoring of the concrete dome structure is done by 56 sensors measuring strains, temperatures, axial and radial displacements. Sensors within the concrete are lead out the front face of the concrete plug.

Installation of DOMPLU

A new 14 m long experiment tunnel in Äspö HRL was dedicated exclusively for the DOMPLU full-scale test. In the summer of 2012 a concrete wall was cast at the tunnel face to provide a defined start position for installation of the plug components. In the autumn of 2012, an octagonal slot excavation for the concrete dome abutment was carried out by wire-sawing, see Figure 3. Technical challenges were taken into account related to minimization of Excavation Damaged Zone (EDZ) in the tunnel and smoothness of surfaces required for controlled concrete fitting. New workers safety arrangements were also developed.

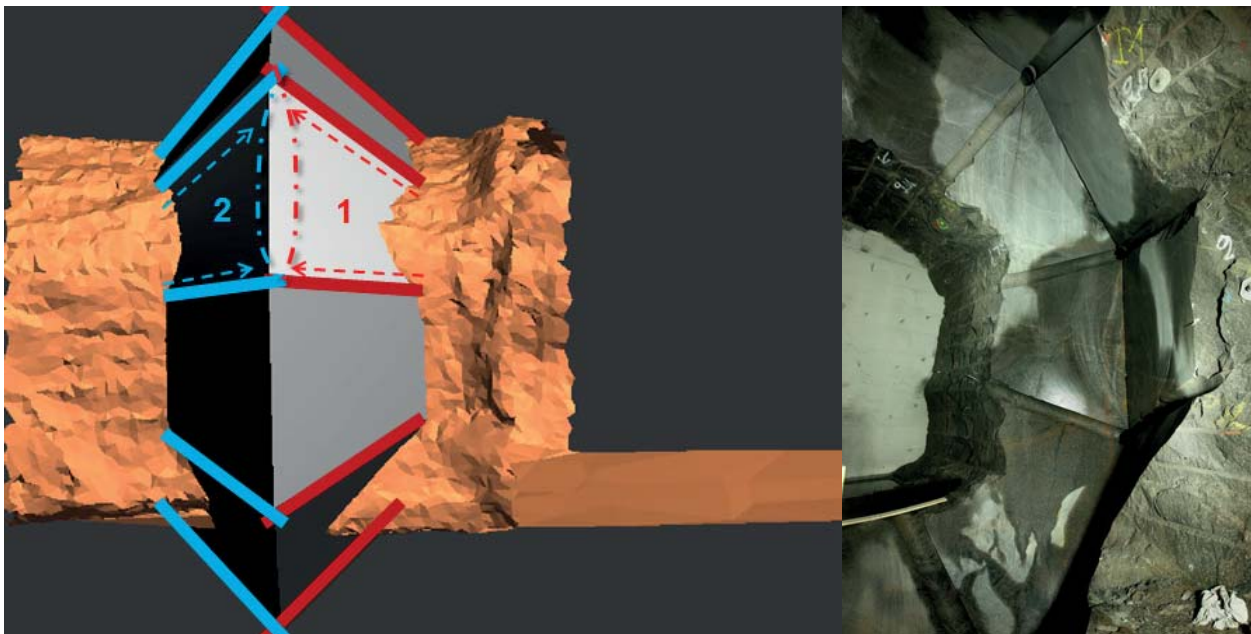

Figure 3. Left: Principle for drilling and wire-sawing of the octagonal slot by blind cuts. Right: Part of the excavated slot after completion.

The backfill, the bentonite seal and the filter components were installed in January 2013, see Figure 4. (January 30, 2013 is defined as day 1 of measurements in Figure 6). Pipes for contact grouting and the concrete cooling system were installed during mid February directly followed by formwork assembly. The concrete dome was cast on March 13, 2013, see Figure 5. The cooling system was used to cool the structure down to +4°C at the time of casting to prevent thermal gradients. Finally, about three months after casting, contact grouting with ultrafine cement was performed in June 2013. At this time, the cooling system was once again activated stepwise to +1°C during two weeks to force contraction and opening of the concrete-tunnel gap to facilitate grouting of the gap between the concrete dome and the rock contact.

Figure 4. Photo of the plug system installation in January 2013. From left to right: Filter section (LECA beams, drainage/air pipe and gravel), geotextile delimiter, bentonite seal (MX-80 blocks and pellets) and concrete beam delimiter. Two sensors (Geokon, total pressure) are visible on the rock wall. All cables inside the plugged volume are led in steel tubes to protect them from being damaged due to high water pressure.



Figure 5. Left: Formwork by Doka used for casting of the concrete dome in March 2013. Right: The concrete dome after removal of formwork in late April 2013.

During summer of 2013, the two drainage pipes were connected to a water inlet system and thus the filter section was flooded. The water pressure inside the filter was controlled at low level (7 m head) to provide possibility for the bentonite seal to gently initiate saturation (from day 117 and forward). It had been shown in laboratory tests that the bentonite seal gives reliable sealing function when a swelling pressure of about 500 kPa is reached in all its parts. Predictive calculations acknowledge this process to take between 1-2 years in full scale.

After four months flooding of the filter, the drainage valves from the filter section were closed (day 243). Subsequently pressurization of DOMPLU began by natural groundwater inflow from October 2013. The pump system was then started on December 2, 2013 (day 306). The artificial pressurization was stepwise increased to 4 MPa during the period from December 2013 to February 2014, and has been maintained at this level until the date for data freeze for the DOPAS project on September 30, 2014 (day 608).

Discussions

The measurement of leakage past the plug has been made using several different methods. The primary method automatically transfers seepage water from the weir located on downstream side of the dome (seen to the right in Figure 2) to a scale that weighs the leakage mass for on-line recording. In addition to this, two manual measurement locations were introduced since experiment-related leakages started to occur at high pressure; one water escape route was via the cable bundle from sensors within the concrete dome and the other involved water escape via a rock fracture. The experimental related water escapes should not occur in a future repository since the rock quality is superior in Forsmark and all sensor cables will be excluded.

The sequence for pressurization of DOMPLU and follow-up of the leakage flow past the plug system is provided by Figure 6. At the time for data freeze (day 608), the measured leakage past the plug (collected in the weir) was 44 ml/min while the inflow needed for maintaining a water pressure of 4 MPa inside the plugged volume was approximately 400 ml/min. Experiment related water escapes in the rock fracture and via cables together accounts for about 185 ml/min. Consequently more than 40% of the inflow is either absorbed by the bentonite or escapes in other rock fractures. The DOMPLU plug system is obviously tighter than the rock at the experimental site.

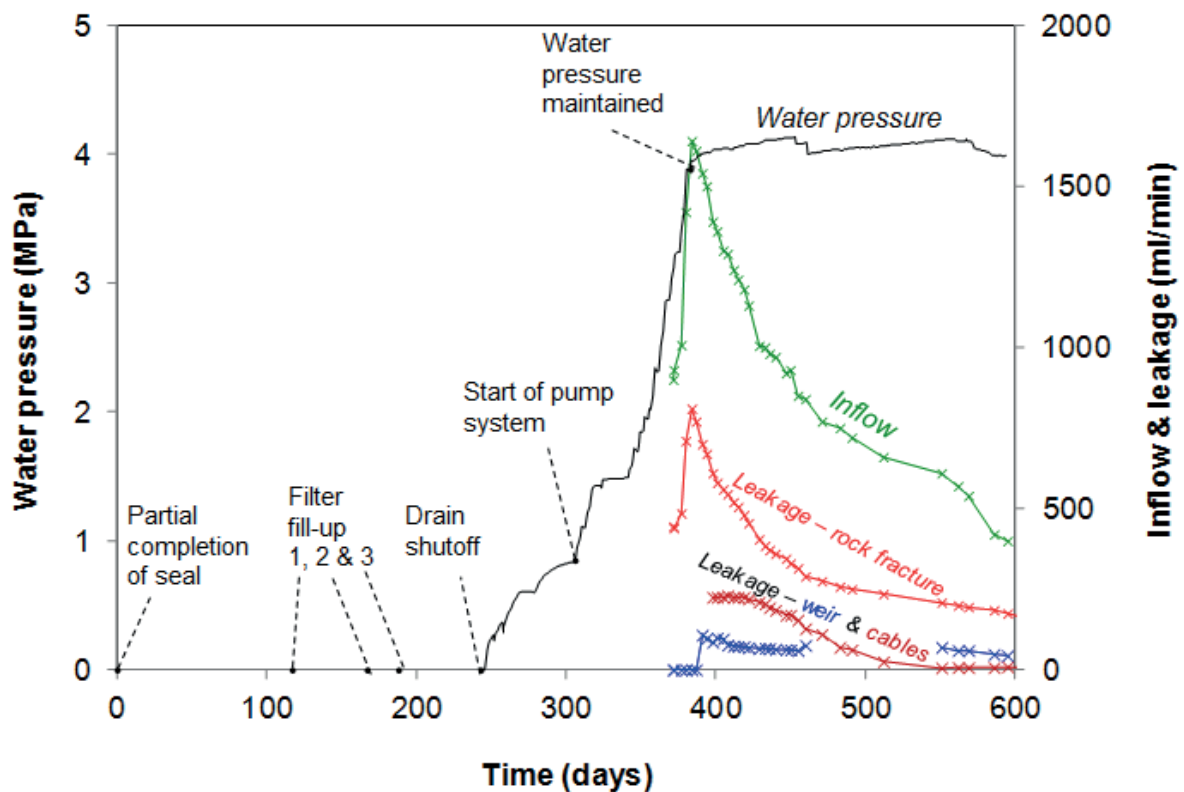

Figure 6. Diagram showing the applied water pressure (MPa) together with recorded inflow and leakage rates past the plug (ml/min).

In addition to the recordings of leakage, results are available from monitoring performances of the backfill, bentonite seal, filter section and the concrete dome. A full summary of DOMPLU design, installation and results is presented in the technical report (SKB 2014). This report is a deliverable (D4.3) within the DOPAS project and can be found at the website <http://www.posiva.fi/en/dopas/deliverables>.

Conclusions

One of the main outcomes from the full-scale test is showing that it is possible to build the dome plug system. This includes practical aspects of logistics and arranging of parallel construction activities in a tunnel system etc. The civil work for DOMPLU was in general successful with a few important experiences gained from construction. These experiences are highlighted and provided in (SKB 2014).

About the concrete dome, it was shown that it is possible to use an unreinforced concrete dome plug consisting of low-pH concrete mix B200. Due to the lack of reinforcement, the tensile stresses in the concrete dome have to be limited in order to prevent it from cracking. High tensile stresses may occur during hydration and due to shrinkage if the concrete dome is subjected to restraint, i.e. bonded to the rock in the slot. The previous design calculations (SKB 2012) were all based on the fact that the induced stresses were limited prior to contact grouting, i.e. it was assumed the concrete dome would release from the rock. In order to reduce the induced stresses in the concrete dome, an advanced cooling scheme was used for DOMPLU to i) reduce the temperature rise due to heat from hydration, ii) force the concrete dome to release from the rock and iii) create a gap between concrete and rock before contact grouting. The full-scale test showed that tensile stresses were induced in the concrete dome as the heat from the hydration reduced. These stresses are high enough to have forced the concrete dome to at least partially release from the rock, but may also have caused some cracks in the concrete dome. Based on the evaluation of the measurements, it can be concluded that the dome did not release fully and remained at least locally bonded to the rock.

After 8 months (to September 30, 2014) of subjecting the plug system to a water pressure of 4 MPa (400 m head) the total rate of leakage out of the pressurized region was about 0.044 l/min (2.6 l/h). This is well below the desired level of a leakage past the plug lower than 0.1 l/min (to avoid risk for an unacceptable loss of bentonite from the repository). Based on the appearance of the measured leakage versus time plots, this rate is expected to decrease further. The results show that the water pressure next to the concrete dome is decreasing while the water pressure on the upstream side of the bentonite seal is being maintained. Thereby, it can be concluded that the bentonite seal is becoming more and more water-tight with the slot between concrete and rock gradually becoming less water conductive.

The project outcomes can be used by the international waste management community to enhance the safety and especially location selection, design, construction and quality management practices for future tunnel plugs and seals used in various types of repository configurations and geological conditions. The results obtained related to materials, instrumentation, monitoring, modelling and quality control are also applicable for improved practices in any types of waste management and geological disposal concepts.

According to SKB's RD&D programme (SKB 2013) monitoring of DOMPLU will continue at least until late 2016.

Acknowledgement

The research leading to these results has received funding from the European Union's European Atomic Energy Community's (Euratom) Seventh Framework Programme FP7/2007-2013 under grant agreement no 323273, the DOPAS project.

References

- SKB, 2009.** Low pH self compacting concrete for deposition tunnel plugs. SKB R-09-07, Svensk Kärnbränslehantering AB
- SKB, 2010a.** Design and Production of the KBS-3 Repository. SKB TR-10-12. Svensk Kärnbränslehantering AB.

SKB, 2010b. Design, Production and Initial State of the Backfill and Plug in Deposition Tunnels. SKB TR-10-16. Svensk Kärnbränslehantering AB.

SKB, 2012. Low-pH concrete plug for sealing the KBS-3V deposition tunnels. SKB R-11-04. Svensk Kärnbränslehantering AB.

SKB, 2013. RD&D Programme 2013. Programme for research, development and demonstration of methods for the management and disposal of nuclear waste. SKB TR-13-18. Svensk Kärnbränslehantering AB.

SKB, 2014. System design and full-scale testing of the Dome Plug for KBS-3V deposition tunnels. Main report. SKB TR-14-23. Svensk Kärnbränslehantering AB.

Dismantling of the FEBEX experiment after 18 years of heating

Kober, F.¹, Thurner, E.²

¹ Nagra, Hardtsrasse 73, 5430 Wettingen, Switzerland, ²Svensk Kärnbränslehantering AB, SKB

Corresponding author e-mail: erik.thurner@skb.se

Abstract

The FEBEX experiment was initiated by Enresa in 1995 and has been in operation in the Grimsel Test Site for 18 years. In 2002 the outer part was dismantled and sampled. This year (2015) the inner part is dismantled and sampled. Several European, Asian and North American partners participate in the work. A detailed planning has been done and the dismantling activities have just begun.

Introduction

This extended abstract gives an overview of the contribution of the Full-Scale Engineered Barrier Experiment (FEBEX) to the understanding of the near-field of a repository for high-level radioactive waste. The aim is to provide an overview of the experiment with focus on the planning and start of dismantling of the remaining inner part of the experiment in 2015.

The FEBEX experiment has since 2008 been operated by a consortium consisting of Ciemat, KAERI, Nagra, Posiva and SKB. The dismantling of the remaining inner part of the experiment is set-up as a larger international project with the former FEBEX-partners and newly participating partners from Europe, Asia and North America.

Description

The FEBEX experiment at the Grimsel Test Site (GTS) in Switzerland consists of an in-situ full-scale engineered barrier system (EBS) test for the disposal of high level waste (HLW). The experiment is based on the Spanish reference concept for the disposal of radioactive waste in crystalline rock and was initiated by Enresa in 1995.

It is performed under natural conditions in crystalline rock in which two canisters with heaters are placed horizontally in a drift and surrounded by a clay barrier constructed of highly compacted bentonite blocks, see Figure 1.

Heating of the FEBEX started in 1997 and since then a constant temperature of 100°C has been maintained, while the bentonite buffer has been slowly hydrating by natural supply of groundwater from the rock.

The outer part – one canister and the outer part of the bentonite buffer – was dismantled and sampled during 2002. A new plug was cast in front of the inner part. The remaining part is shown in Figure 2.

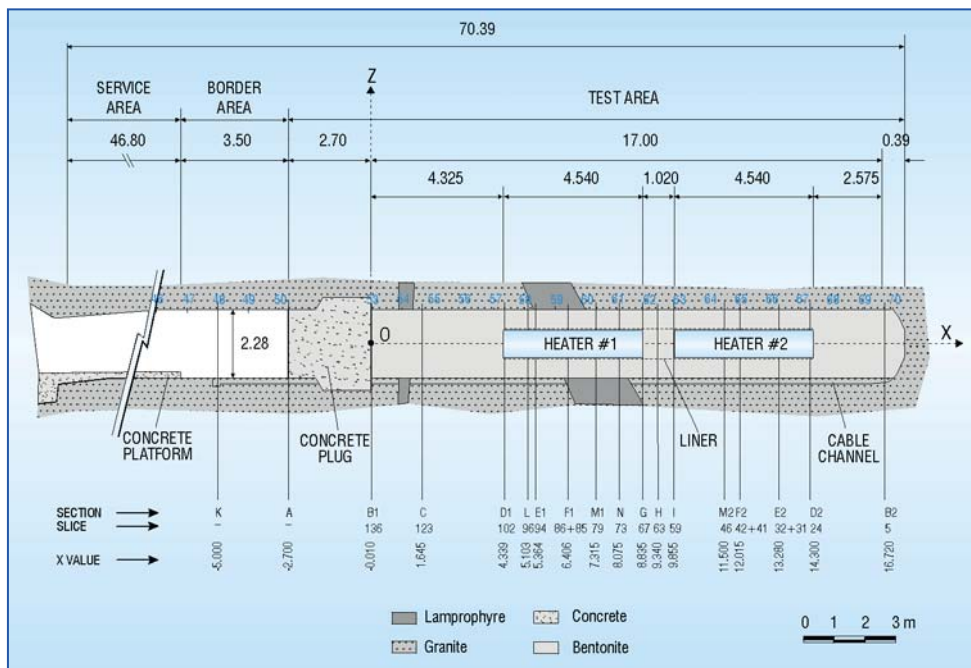

Figure 1. Initial layout of the FEBEX experiment

A total of 632 sensors in the bentonite barrier, the rock mass, the heaters and the service zone record temperature, water saturation, humidity, total pressure, displacement, and water pressure.

The hydration pattern is relatively symmetric, with no major differences along the axis. Although the host rock is characterized by heterogeneities with zones of higher permeability, the re-saturation process is driven by the suction of the bentonite rather than by the availability of water in the rock, especially in the early phase. After 17 years, the water content in the buffer close to the heater still continues to increase slowly. The hydraulic pore pressures in the buffer and the geosphere have practically stabilized. The total pressure in general continues to increase in most points in the buffer, where in some parts pressures of over 6 MPa are registered.

The long monitoring phase and the partial dismantling in 2002 indicate that the EBS has largely performed as expected and the major processes and couplings affecting the buffer saturation during the initial thermal period identified prior to the start of the experiment have been confirmed. A comprehensive report documents and reviews the state of the FEBEX (Lanyon & Gaus, 2013).

After 18 years of operation the remaining part of the experiment will be excavated and dismantled in 2015. The main objectives of the FEBEX dismantling project (FEBEX-DP) are:

- Characterisation of the key physical properties (e.g., density, water content) of the barrier and their distribution.
- Characterisation of corrosion and microbiological processes on instruments and coupons resulting from evolving redox conditions and saturation states, including gas analysis.
- Characterisation of macro- and micro level studies of mineralogical interactions at material interfaces (e.g., cement-bentonite or iron-bentonite, rock-bentonite).
- Assessment of sensor performance.
- Increased understanding of the thermo-hydro-mechanical (THM) and thermo-hydro-chemical (THC) processes through integration of monitoring and dismantling results.

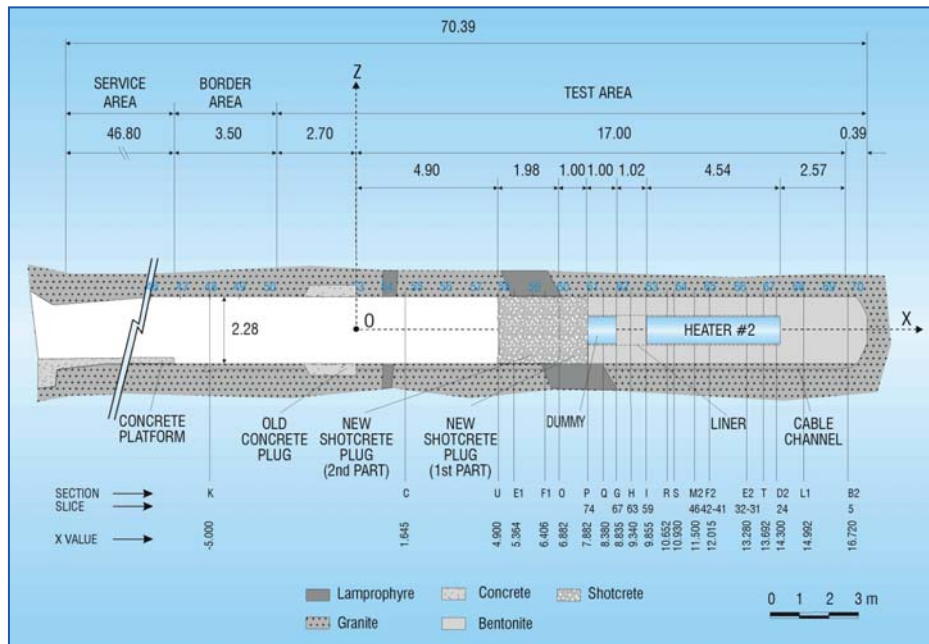

Figure 2. Current layout of the FEBEX experiment after the dismantling of the outer part in 2002.

Discussions

The planning of the dismantling of the remaining part of the FEBEX experiment started with a prediction on how the condition in different parts of the experiment would be. This is based on measuring and modelling activities completed in the course of the experiment and experience from the partial dismantling carried out during 2002. The purpose is to identify the areas or major components of the experiment that are of interest for detailed examinations in order to meet the objectives of the FEBEX-DP. This is an important input to the planning work.

During 2013-2014 detailed planning of the dismantling was conducted. The principle is to dismantle the experiment in the same way as in 2002. Experiences from the previous dismantling have been considered, also to prepare other techniques for dismantling, e.g. the liner and the canister due to more saturated conditions of the buffer or focus has been given to interfaces by obtaining intact interfaces via an overcoring technique. Additionally, focus was given to corrosion and microbiological aspects.

A detailed dismantling plan and sampling plan together with a time schedule were compiled during 2014. These documents are the bases for the dismantling work. In Figure 3 an illustration of the sectioning of the dismantling is presented and where sampling will be conducted.

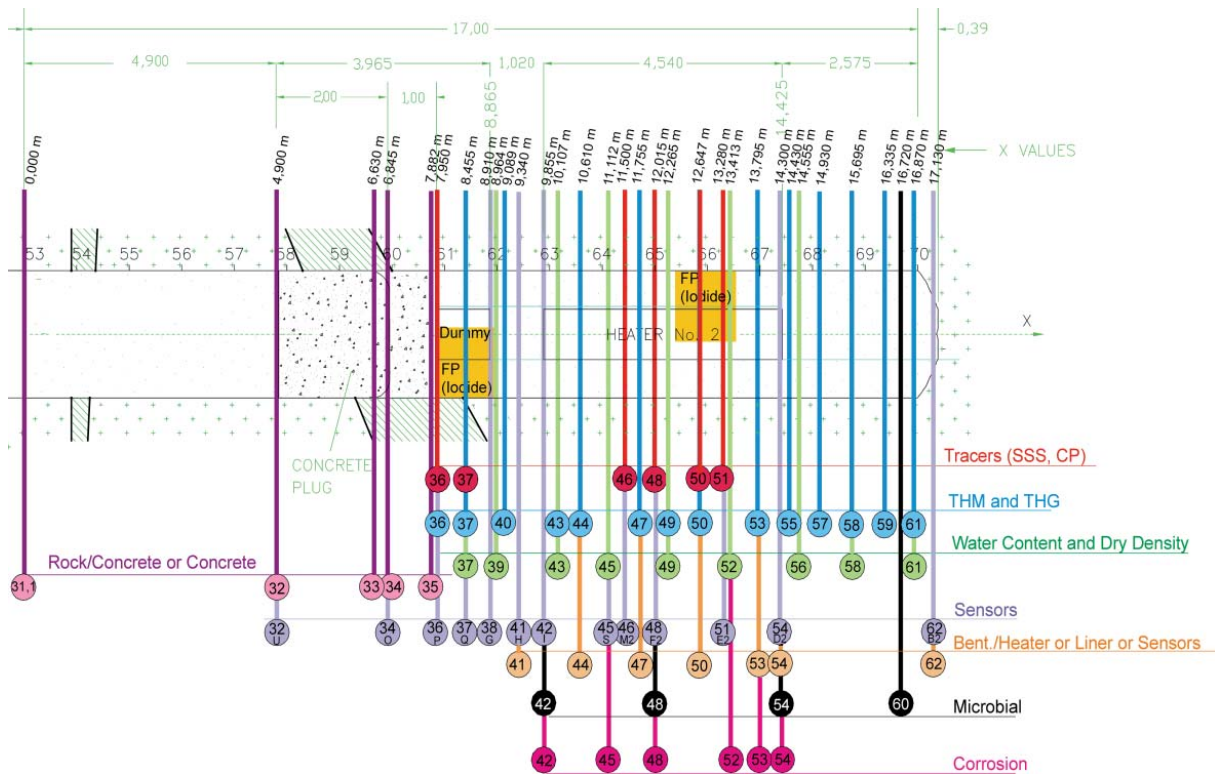

Figure 3. Layout for sampling during final dismantling.

The dismantling work of the remaining FEBEX experiment started in the beginning of March 2015. The first part is to take samples from the plug and the interface between concrete and buffer. This has been accomplished with core drilling through the concrete plug, see Figure 4.

The dismantling operation will be carried out according to the following sequence:

- Removal of instrumentation and auxiliary systems, protection of acquisition cabinets.
- Completion of steel tracks up to plug.
- Shotcrete plug demolition (and sampling if required) thereby trying to avoid damage to cables and instruments. Fulfilment of the associated quality control documentation during the sampling (samples/instrumentation removal included).
- Removal of “dummy canister”.
- Removal and sampling of bentonite and liner up to the front of the heater 2, and shipping of samples. Fulfilment of the associated quality control documentation during the sampling.
- Analysis and extraction of heater 2.
- Removal and sampling of the remaining bentonite and liner, and shipping of samples. Fulfilment of the associated quality control documentation during the sampling.
- Removal of monitoring and control system.

The dismantling activities are planned to be finalised in September 2015.

An intensive laboratory program will be conducted in 2015/2016 in order to achieve the outlined main objectives. It includes extensive mineralogical, chemical and biological investigations of the buffer and the related interfaces. It will be accompanied by pre- and post-dismantling modelling efforts. Unique data are expected after completing one of the longest running 1:1 in-situ EBS experiment under continued heating and natural saturation conditions. It will further consolidate the EBS knowledge and will act as a benchmark for major coupled modelling codes.



Figure 4. Dismantling of the FEBEX experiment

Conclusions

Clear goals and detailed planning of dismantling of an experiment is very important. For the planning of the dismantling and sampling of the remaining inner part of the FEBEX experiment the five consortium member organization conducted intensive planning work. In a later stage new organizations were given the possibility to join the project and also comment on the planning work. These comments gave valuable input to the finalization of the planning work and provide individual and unique sampling and analysis opportunities for these new partners.

It is expected that results from the final excavation in 2015, after 18 years of chemical impacts taking place, will provide more evidence regarding the corrosion and the chemical processes affecting the EBS.

References

Lanyon GW, Gaus I (Ed.), 2013: Main outcomes and review of the FEBEX In Situ Test (GTS) and Mock-Up after 15 years of operation. Nagra Arbeitsbericht. NAB 13-096. Nagra, Wettingen.

Further information about the Febex experiment can be found under <http://www.grimsel.com/gts-phase-vi/febex-dp/febex-dp-introduction>.

Excavation of the FE tunnel at the Mont Terri URL

Herwig R. Müller¹, Sven Köhler¹, Tobias Vogt¹

¹NAGRA, National Cooperative for the Disposal of Radioactive Waste,
Hardstrasse 73, CH-5430 Wettingen, Switzerland

Corresponding author e-mail: herwig.mueller@nagra.ch

Abstract

The Full-Scale Emplacement (FE) Experiment at the Mont Terri underground rock laboratory (URL) is a full-scale multiple heater test in a clay-rich formation ('Opalinus Clay'). It simulates the construction, waste emplacement, backfilling and early post-closure evolution of a spent fuel (SF) / vitrified high-level waste (HLW) repository tunnel as realistically as possible.

The FE tunnel was excavated with a pneumatic hammer and a road-header. For most of the tunnel the support consisted of mesh reinforced shotcrete with rock bolts. The last quarter of the tunnel was built using only steel arches and no shotcrete for rock support. Both types of tunnel support worked well. The technical feasibility of constructing a repository tunnel in an over-consolidated clay-stone using standard industrial equipment was successfully verified.

Introduction and experimental aims

The FE Experiment is based on the Swiss disposal concept for SF / HLW. In the FE tunnel three heaters with dimensions similar to those of waste canisters were emplaced on top of pedestals built of bentonite blocks (see *Figure 1*). The remaining space was backfilled with granular bentonite using a prototype backfilling machine with 5 screw conveyors; for details see Köhler et al. (2015).

The main aim of the FE Experiment is to investigate SF / HLW repository-induced thermo-hydro-mechanical (THM) coupled effects onto the host rock at this scale and to validate existing coupled THM models. Further aims are the verification of the technical feasibility of constructing a repository tunnel using standard industrial equipment, the optimisation of the bentonite buffer material production and the investigation of (horizontal) canister and buffer emplacement procedures at underground conditions.

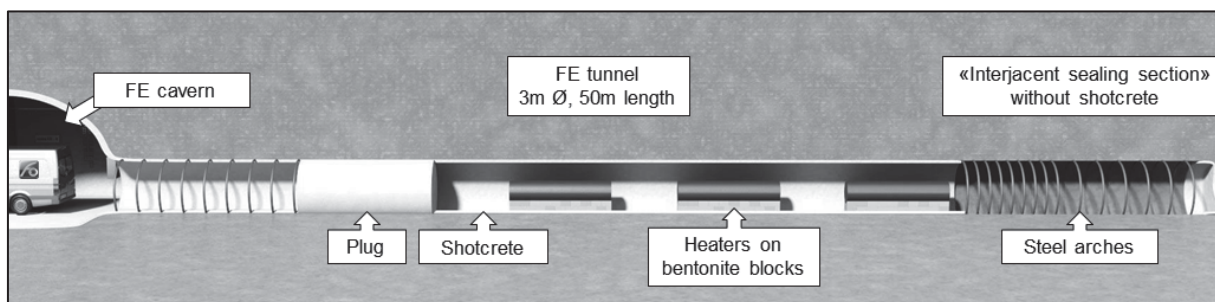

Figure 1: Visualization of the general experimental layout of the Full-Scale Emplacement (FE) experiment at the Mont Terri URL; sensors and bentonite backfill are not displayed.

Geological setting

The URL of Mont Terri is located in the Jurassic fold belt in the north-western corner of Switzerland close to the small town of St. Ursanne. The URL lies in the south-eastern flank of the Mont Terri anticline at a depth of approx. 250 to 300 meters.

The FE tunnel is located in the clay-rich facies of the Opalinus Clay. The tunnel was constructed parallel to the strike of the bedding, which at this location dips on average with ca. 33° towards SE.

Opalinus Clay is an over-consolidated clay-stone with an uniaxial compressive strength (UCS) of approx. 15 MPa (perpendicular to bedding). At Mont Terri the rock is partially strongly tectonized and locally even faulted. The FE tunnel encountered such a fault zone around tunnel meter (TM) 15. The core zone of this fault zone had a normal thickness of up to approx. 1 meter. The fault was orientated roughly bedding-parallel and therefore remained within the tunnel's cross-section until TM 50.

Instrumentation

The rock mass in the 'far-field' was instrumented with 45 meter long boreholes drilled from the FE cavern. This instrumentation was completed in April 2012 before the FE tunnel was built and therefore allowed a 'mine-by' observation of the later tunnel excavation. In two boreholes, drilled sub-parallel to the axis of the FE tunnel, horizontal inclinometer chains were installed. In 3 boreholes drilled parallel to the bedding and in 3 boreholes drilled perpendicular to the bedding multi-packer-systems with a total of 36 pore pressure monitoring intervals were implemented (see *Figure 2*).

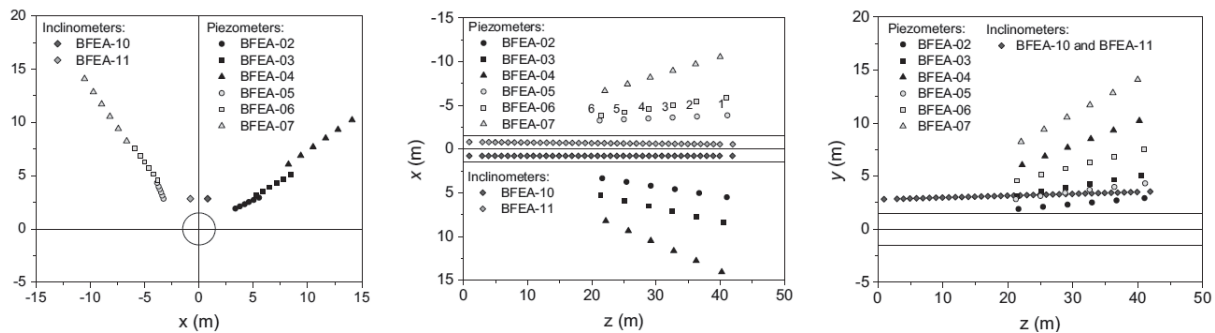

Figure 2 (from Lisjak et al. 2015): Location of horizontal inclinometers for measuring settlement above the FE tunnel and multi-packer-systems for monitoring pore pressures around the FE tunnel.

During construction and until February 2014 the 'excavation damage zone' (EDZ) was instrumented with radial boreholes drilled from within the tunnel. This instrumentation phase started with five radial extensometers installed already during the excavation of the tunnel (sections E1 and E2 in *Figure 3*).

Additionally the tunnel construction was surveyed with a total of ten convergence measurement sections which were installed during the excavation within the FE tunnel with an average spacing of approx. 6 meters. At measurement sections C1 to C4 (see *Figure 3*) the radial configuration consisted of five observation targets; at measurement sections C5 to C9 the radial configuration consisted of seven observation targets. In total 55 observation targets were installed. These targets were continuously monitored not only during the tunnel construction but also long afterwards. In fact the targets were only removed shortly before backfilling the FE tunnel at the end of 2014.

For details about the instrumentation and the heating see Müller et al. (2015).

Tunnel construction

The 50 meter long FE tunnel was excavated full-face between April and July 2012. The excavated tunnel diameter was approx. 3 meters. The excavation method consisted of a combination of pneumatic hammer and a small road-header which was mainly used for profiling (see *Figure 7*). The excavation speed was varying between 1.0 and 1.5 meters per day.

From TM 0 to TM 38 the support in the tunnel consisted of mesh reinforced shotcrete (see *Figure 3*). Between TM 9 and TM 38 the shotcrete was applied in 2 layers with a total thickness of at least 16 centimetres. The dry application method was used (adding water at the spraying nozzle). 40% of the Portland cement was substituted by silica fume in order to obtain a shotcrete with a reduced pH value.

The deep end of the FE tunnel (from TM 38 to TM 50) was built using only steel arches and no shotcrete for rock support (see *Figure 4*). With this, the so-called 'interjacent sealing section' (ISS) of a repository tunnel according to the Swiss concept was simulated. In the FE tunnel the spacing of the

steel arches was normally 1 meter (but 0.5 meters close to the end of the shotcrete section). Each steel arch was composed of several pieces with sliding connections which were tightened by bolts with a 300 Nm torque spanner allowing some movement even after installation; see Daneluzzi et al. (2014).

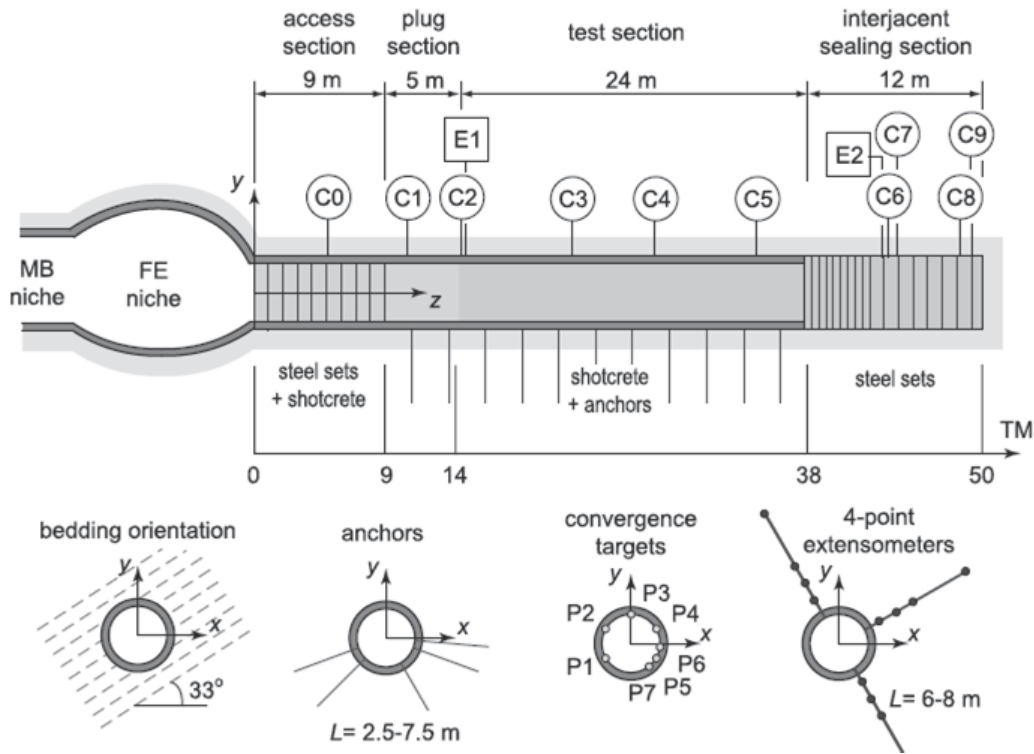

Figure 3 (from Lisjak et al. 2015): Simplified longitudinal cross section of the FE tunnel showing the installed support measures, the convergence measuring sections (C0 to C9) and the location of the radial extensometers (E1 and E2) installed during tunnel construction.

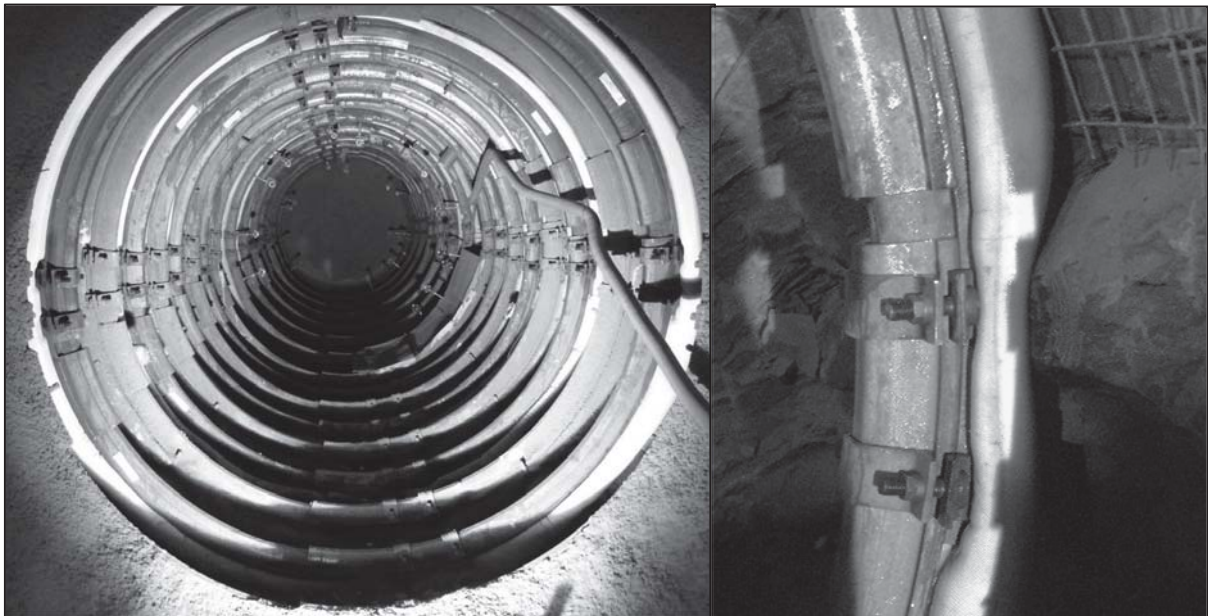

Figure 4: The photo on the left shows the 12m long shotcrete-free ‘interjacent sealing section’ (ISS) at the end of the FE tunnel. The photo on the right shows a detail of a steel arch in the ISS. The steel arches were bedded on flexible grout-injected (Bullflex®) hoses in order to allow load transfer from the rock onto the support after hardening of the grout. Each steel arch was composed of several pieces with sliding connections which were tightened by bolts.

Whereas the steel arch section showed normal deformation rates and a more or less symmetric tunnel wall convergence, the shotcrete section initially was characterized by very asymmetric deformations with a convergence of several centimetres at the lower right side wall of the tunnel (see *Figure 5*).

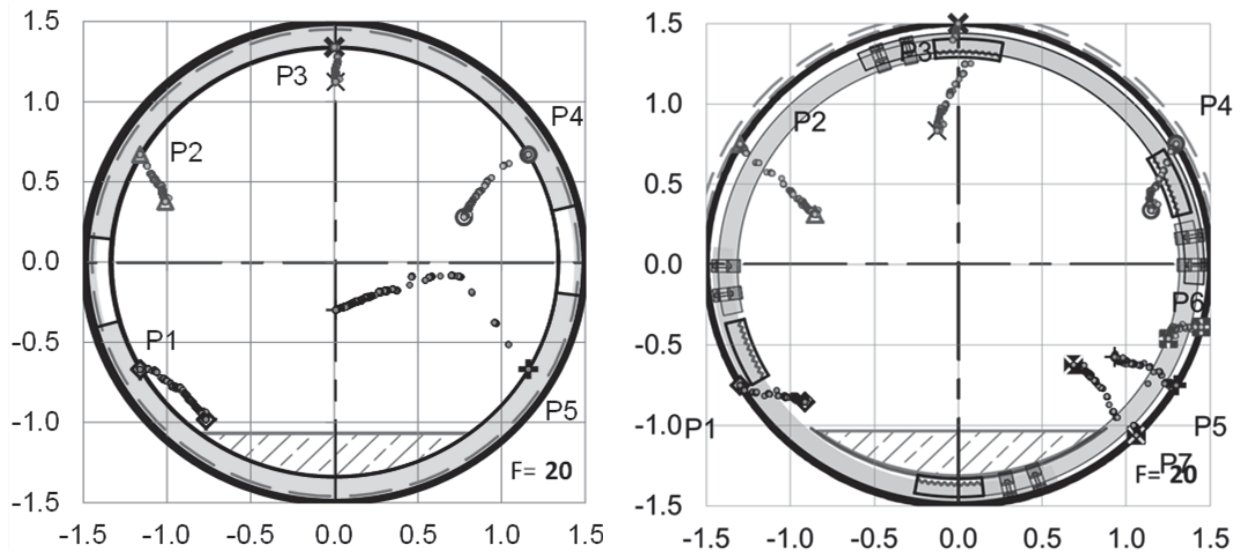

Figure 5: 90-days tunnel wall convergences at two exemplary measurement sections C04 (left graph) and C07 (right graph). C04 was located in the shotcrete section of the tunnel and C07 in the shotcrete-free section supported only by steel arches. The scale of the displacement vectors is amplified by a factor of 20 with respect to the excavated tunnel represented by a black circle.

Because of the observed deformation rates, 7.5 meter long (steel) rock bolts were installed in the lower right side wall of the shotcrete section. Nevertheless the shotcrete in the invert failed and had to be renewed. The renovation of the tunnel section TM 9 to TM 38 was completed in September 2012. Segment by segment the old shotcrete was removed and new (mesh reinforced) shotcrete was applied.

During the renovation extra 7.5 meter long (steel) rock bolts were installed in the right side wall of the FE tunnel. This was done in a pattern which reduced the risk of the interface between the old and the new shotcrete becoming a potential weakness of the tunnel lining. In the left side wall of the FE tunnel 2.5 meter long (fibre reinforced plastic) rock bolts were installed in the same pattern.

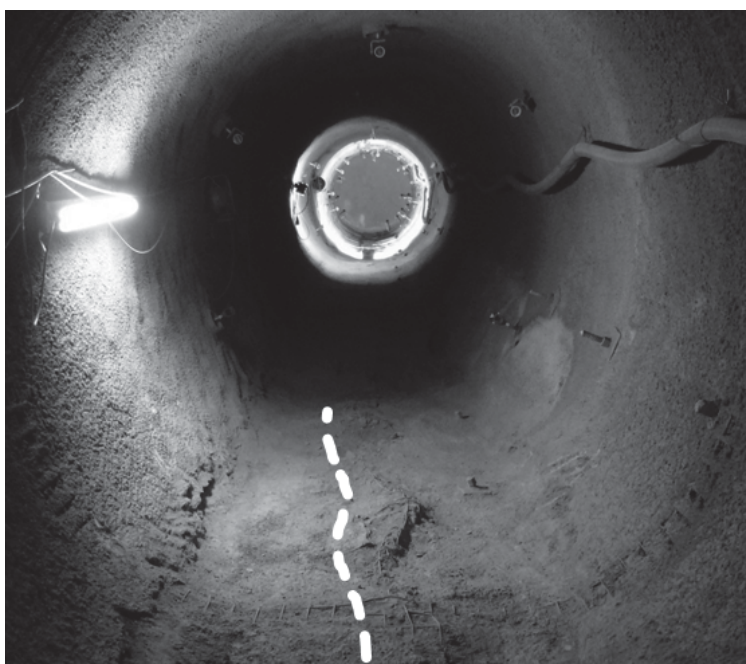

Figure 6: Photo from the failed shotcrete invert (right of the dashed white line) before the renovation in September 2012. Also visible are rock bolts and several targets for measuring the convergences.

The failure of the shotcrete invert was mainly caused by an irregular, not perfectly circular excavation profile and by the resulting shear and bending forces in the lining. An intensive coring and lab testing program additionally proved that the shotcrete in the invert did not have the required quality (although the strength^{*)} targets were clearly met in the upper part of tunnel). Loose muck and rebound below the invert as well as layering within the shotcrete were detected. The shotcrete in the invert was partially also too unevenly and thinly applied, locally even of crumbling appearance and therefore too weak.

Seemingly these circumstances contributed to the failure of the invert more than the properties of the faulted and tectonically weakened rock mass. This thesis is supported by the observation that, although the ISS was built in the same geological setting as the shotcrete section, the steel arch section generally showed a homogeneous tunnel wall convergence and lower deformation rates (see *Figure 5*).

With the renovation works the deformation rates in the shotcrete section were, if not stopped, extremely reduced. Until the concreting of the experimental plug (between TM 10 and TM 15) in March 2015 no further problems with the tunnel stability were encountered.

Conclusions

In the framework of the FE Experiment a tunnel with a length of 50 meters and a diameter of 3 meters was built in the shaly facies of the Opalinus Clay at the Mont Terri URL. The excavation was carried out with a pneumatic hammer as well as a small road-header (see *Figure 7*). The tunnel not only was constructed parallel to the strike of the bedding, but also followed a fault zone for most of its length.

With shotcrete until TM 38 and with only steel arches until TM 50 two different tunnel support systems were tested. Whereas the steel arch section behaved favourable, the shotcrete section initially showed an asymmetric tunnel wall convergence with high deformation rates. An investigation programme conducted after the failure of the invert proofed that the shotcrete in the invert did not meet the quality requirements. Segment by segment the faulty shotcrete had to be removed and replaced with new shotcrete. After the renovation of the tunnel invert in September 2012 (until the plug was constructed in March 2015) no further problems with the tunnel stability were observed.

The technical feasibility of constructing a repository tunnel in an over-consolidated clay-stone using standard industrial equipment was successfully verified at the Mont Terri URL.



Figure 7: Photo (© COMET) of the small road-header used in the FE tunnel mainly for profiling.

^{*)} The UCS of “good” shotcrete was on average approx. 42MPa after 28 days and approx. 50MPa after 91 days.

Acknowledgments

The FE experiment is implemented in the Mont Terri URL, which is operated by swisstopo. The initiator and lead organisation for the FE experiment is NAGRA; ANDRA (France), BGR (Germany), DOE/LBNL (U.S.A), GRS (Germany) and NWMO (Canada) are participating in the Experiment.

The engineering and demonstration components of the FE experiment are also part of NAGRA's participation in the EC co-funded 'Large Underground COnccept EXperiments' (LUCEOEX) project; parts of the research leading to these results have therefore received funding from the European Union's European Atomic Energy Community's (Euratom) Seventh Framework Programme FP7/2007-2013 under grant agreement no 269905 (LUCEOEX project).

References

Daneluzzi R, Burrus F, Küttel T, Müller H R, Köhler S, 2014. LUCOEX Deliverable D2.2: Report on the construction of the emplacement tunnel. WP2 – Full-Scale Emplacement Experiment (FE) at Mont Terri. EU report downloadable from www.lucoex.eu

Köhler S, Sakaki T, Weber H P, Garitte B, Müller H R, 2015. FE/LUCOEX: Backfilling a horizontal tunnel with granulated bentonite - machine development, pre- & mock-up tests and application at the Mont Terri URL. LUCOEX Conference & Workshop, Oskarshamn, Sweden, 2-4 June 2015.

Lisjak A, Garitte B, Grasselli G, Müller H R, Vietor T, 2015. The excavation of a circular tunnel in a bedded argillaceous rock (Opalinus Clay): Short-term rock mass response and FDEM numerical analysis. Tunnelling and Underground Space Technology, Volume 45, January 2015, Pages 227-248, <http://dx.doi.org/10.1016/j.tust.2014.09.014>

Müller H R, Vogt T, Garitte B, Sakaki T, Spillmann T, Hertrich M, Giroud N, 2015. Instrumenting, monitoring and heating the Full-Scale Emplacement (FE) Experiment at the Mont Terri URL. LUCOEX Conference & Workshop, Oskarshamn, Sweden, 2-4 June 2015.

KBS-3H, LUCOEX WP4 - Experiences from directional core drilling at the Äspö HRL

¹Göran Nilsson, ²Magnus Kronberg

¹GNC AB, ² Swedish Nuclear Fuel and Waste Management Co (SKB)

Corresponding author e-mail: magnus.kronberg@skb.se

Abstract

Successful application of directional drilling was demonstrated in the core drilling of borehole K08028F01 at the -400 m level in the Äspö Hard Rock Laboratory, answering up to the strict geometrical demands set forth by the KBS-3H project. The drilling was preceded by assessment of various deviation measurement tools in a novel surface facility specially devised for this purpose and a trial run of directional drilling in a neighbouring borehole sampling the same rock types. The experiences gained will be utilised in the continued KBS-3H development which will involve reproduction and demonstration of directional drilling over a length scale of 300 m.

Introduction

SKB's disposal concept constitutes a three-barrier system including a copper canister embedded in bentonite buffer at c. 500 m depth in crystalline granitic bedrock. This disposal concept is also shared and investigated by SKB's Finnish sister organization Posiva Oy. Two alternatives of the KBS-3 method are currently being researched by SKB and Posiva, the current reference design being KBS-3V (vertical emplacement) and KBS-3H (horizontal emplacement). KBS-3H utilises 300 m long drifts (Ø 1.85 m) for sequential deposition of multiple Supercontainers which are comprised of an outer metallic shell with bentonite buffer surrounding a copper canister (SKB 2012). In order to achieve the required buffer density the annular void space between the rock wall and the Supercontainer is small (42.5 mm). This introduces strict demands on drift geometry in order to allow for successful deposition of the Supercontainers, cf. Table 1.

Table 1. Geometrical requirements on KBS-3H disposal drifts.

Issue	Requirement	Justification
Length	< 300m	The repository layout shall be similar to KBS-3V. The length is considered to be feasible from a construction and operational point of view. However, optimisation of this length will be necessary after the KBS-3H technology has been demonstrated.
Diameter	1,850 + 5 mm	The drift diameter and the given tolerances are based upon operational as well as thermal heat flow, buffer density and swelling pressure considerations. In particular, the tolerances constrain the void space outside the Supercontainer such that acceptable buffer density and swelling pressure are after saturation.
Inclination	2° ± 1°	A positive inclination is a prerequisite for water drainage.
Deviation of pilot hole	< 2m from the nominal position at a distance of 300 m	A minimum distance between the drifts of 36 m has been adopted in thermal dimensioning of the repository layout for the 40 m layout alternative.
Steps	≤ 5 mm	Full-scale laboratory tests have verified that the emplacement equipment can move properly in the drift for steps of up to 5mm.
Roughness	≤ 5 mm	Full-scale laboratory tests have verified that the emplacement equipment functions properly for a roughness up to 5mm.
Straightness, vertical	± 10 mm over a length of 6000 mm	The centre line deviation must be kept within small tolerances to prevent the Supercontainer from contacting the rock surface during transport in the drift. Stricter than horizontal due to the lifting action of the deposition machine.
Straightness, horizontal	± 50 mm over a length of 6000 mm	The centre line deviation must be kept within small tolerances to prevent the Supercontainer from contacting the rock surface during transport in the drift.

The method for excavation of the disposal drifts is currently full face push reaming, (Bäckblom et.al. 2005), a technique that requires a pilot borehole to serve as a guide for the reamer head. Thereby, the quality of the drift is to a large extent governed by the geometrical accuracy of the pilot borehole.

Directional core drilling is currently the primary technique researched for achieving pilot holes which answers up to KBS-3H requirements.

One of the main objectives during the current KBS-3H project phase is to verify that 300 m long pilot boreholes can be drilled according to the KBS-3H requirements. A stepwise approach is employed and the first three steps have been carried out (2014):

1. Assessment of deviation tools in the Äspö HRL surface-based deviation facility,
2. Test of directional drilling (100 m cored borehole in Äspö HRL),
3. Directional core drilling (95 m cored borehole in Äspö HRL),
4. Directional core drilling (300 m in Posiva's Onkalo facility, Finland)
5. Reaming borehole (3) to full drift size

Devico's DeviDrill system has been used for the directional drilling. It utilizes a drive shaft running through a bushing offset from the centre line of the tool. Expanding pads fixates the orientation while drilling in a curve. The system allows for recovery of a core of smaller diameter ($\text{\O} 31.5 \text{ mm}$).

The decision process as to when to take various directional drilling actions relies heavily on down-hole deviation measurements' delivering high precision coordinates in 3D space.

There exist a number of commercially available deviation instruments based on different physical measurement principles. Some instruments are based on magnetometer-accelerometer technology, whereas others follow principles of angular momentum (gyro instruments). Optical systems have also been frequently used. A well-known weakness of all deviation measurement systems, irrespective of measurement principle, is that performance and accuracy are difficult to control, since it is difficult to calibrate the instruments properly. This is due to the fact that boreholes seldom are accessible for successive direct independent direct geodetic control measurements in the absolute sense, e.g. during tunneling.

Previously, the strategy to overcome this inherent quality problem and in order to develop methods to quantify uncertainties in borehole deviation data has been to use multiple repeated measurements with at least two independent measurement methods. However, there is still a potential to improve the techniques for borehole deviation measurements in order to increase the reliability of deviation data. For this purpose, and to ensure that accurate instruments and modern measurement techniques will be used in the future, SKB has recently completed the construction of a surface-based deviation calibration facility for instruments aimed for deviation measurements at the Äspö HRL.

The deviation facility essentially constitutes a 300 m long plastic tube ($\text{\O} 75 \text{ mm}$) secured firmly to the ground with 151 fastening devices, following the topography but also including an introduced engineered undulation that is mapping the specific KBS-3H demands. All materials used in the construction are non-magnetic, such as plastics and aluminum. Each fastening position can be geodetically surveyed such that highly accurate coordinates of the facility can be established.



Figure 1. The Äspö deviation facility allows for high precision evaluation of different borehole deviation measurement tools.

Description

Assessment and selection of deviation tools

Measurements in the deviation facility were carried out in two steps, first between 0–62 m where the facility is shaped like a sinusoidal wave-form geometry that is even stricter than the KBS-3H requirements. In this part measurements were made every metre. In a second step the full 0-300 m was measured, with measurements taken every 2nd metre. In both cases measurements were taken when moving the tool into and out of the facility, respectively, thereby producing two sets of geometrical data from each point along the simulated borehole.

Several deviation tools have been tested in the deviation facility, most of them with good results, displaying high accuracy. Two of them were eventually selected for the directional core drilling. The magnetic Devi shot instrument (Pee Wee) by Devico, which is also adapted for use together with the wire-line technology employed during drilling, being pumped and propelled through the drill pipe and through the drill bit. This means that the deviation measurements (including data management and input to decision making) can be carried out rapidly. The instrument is also used to orient the directional core barrel (tool face) and to make expedient measurements especially of the inclination. Due to magnetic disturbances introduced by the Äspö bedrock, the tool is not fully reliable for azimuth measurements and therefore the second supporting instrument selected was the Reflex gyro by Reflex. Due to the diameter of the tool, the gyro measurements must be carried out in an open borehole (with drill rods retrieved), which means that it is time-consuming, especially at great drilling depth. The gyro must also be handled with great care in order to acquire data of high accuracy, if the instrument loses its reference of location due to rough handling, such deviations would tend to accelerate.

Test of directional drilling in borehole K03009F01

The main purpose of the tests of directional drilling in borehole K03009F01 was to gain experience of carefully conducted drilling and to test different kinds of low settings on the directional steering equipment to establish which ones gave rise to measurable changes in the Pee-Wee instrument. Normally, the directional equipment is used for producing much larger corrections than what SKB and Posiva need. In total, nine directional actions were carried out and it was concluded that the Pee Wee provided reliable results for inclination measurements, whereas the magnetic bedrock disturbed the accuracy in the establishment of azimuth and it was clear that a complementing tool such as the gyro would be required when continuing with the next drilling operation. It was also concluded that the very delicate directional drilling required in order to avoid sudden directional changes in the borehole is feasible with Devico's directional drilling technology.

Directional cored drilling of borehole K08028F01

This drilling was carried out at the -400 m level in Äspö HRL in the new KBS-3H niche. The cored borehole is subsequently planned to be reamed to a full scale drift diameter at a later stage, if the geometrical requirements on the borehole are fulfilled.

Preparations

The following measures were taken in order to maximise the probability of fulfilling the requirements:

- A stable work platform to prevent the drill rig from dislodging during drilling. This was considered essential since the borehole is collared c. 3.5 m above the tunnel floor.
- Careful alignment of the casing using equipment specially developed for this purpose, with the casing hole drilled under a separate contract using a small drill rig. See further details in the discussion section.
- A powerful drilling rig to enable carefully controlled drilling (thrust and torque) in conjunction with the steering actions.
- The directional core barrel must be complete and in good condition complemented by a variety of soft and hard drill bits and including the different dimensions of the reamer and stabilizer parts of the core barrel.

- Experienced staff that understands the purpose of the borehole and is familiar with the drilling and steering equipment, including the implications and use of deviation measurement instruments and the data they produce.
- A clear strategy facilitating all aspects of decision-making during the drilling
- Finally, and perhaps most decisive in order to achieve a straight borehole, is that the staff must have a good understanding for how the rock, drilling and measurement equipment co-function and interact.

Directional drilling strategy

A composite directional drilling strategy making use of two deviation measurement tools was set up prior to the drilling, as presented below:

If deviation measurements as obtained by two instruments based on independent measurement principles indicate a significant trend towards a discrepancy in vertical direction amounting to 0.1° (10 mm/6 m) or 0.5° (50 mm/6 m) in horizontal direction, a directional drilling action should generally be implemented, but if the noted trend is ambiguous or if it constitutes a borderline case, an additional 6 m should be drilled before a new assessment is made. A decision to activate directional drilling is made in consensus by the activity leader and drilling contractor and should always be based on the overall assessment of the data available at the time.

The KBS-3H requirements are visualized in a simplified manner in Figure 2, where successively larger rectangles represent the area within which the borehole must be kept. At the beginning the rectangles are small, but they grow successively with increasing borehole length. The height of the rectangles are derived from the stipulated requirement $2^\circ \pm 1^\circ$ and the width is derived from the requirement < 2 m from the nominal position at a distance of 300 m. The width is theoretically allowed to be ± 2 m at shallow depth, however, the borehole's inherent trajectory and the benefits of staying close to the theoretical line motivate this definition. In summary, this means that the tolerances increase with increasing borehole length; as an example a 0.5 m horizontal deviation is not allowed at a 50 m borehole depth, but is acceptable at 98 meters depth. The directional drilling strategy also includes the additional challenge to always target the borehole as centrally positioned as possible within a given rectangle (Figure 2). A guideline is that action should be taken if the deviation measurements fall outside 50% of the current rectangle (distance wise, omnidirectional), but with the added reservation that the first rectangles (within about 0-30 m) are relatively small, and more data may be needed before action is taken. It is however fundamental that the borehole trajectory is never allowed to end up outside the rectangles at any given length in accordance with Figure 2.

Ideally, the borehole will basically follow the theoretical trajectory during the drilling. If not, the following criteria set the outer boundaries:

- The local inclination (I) should never fall below 1° (i.e. upward inclined), and a margin for this should always be maintained. Actions must be taken if $I \leq 1.3^\circ$. Correspondingly, the local inclination should never exceed 3° , action must be taken at $I \geq 2.8^\circ$.

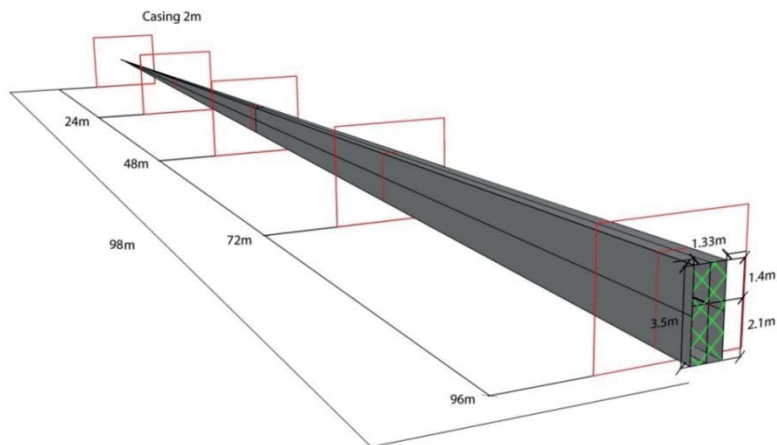

Figure 2. Schematic figure showing the maximum acceptable tolerances of the borehole geometry as a function of borehole length. The start inclination which is an ‘as built’ inclination is 2.18° instead of 2.00° which gives an upward discrepancy.

Deviation measurements and drilling

Drilling was carried out with deviation measurements made every 6th meter using the two selected instruments (Devico Pee-Wee and the Reflex gyro) which generate data on inclination and azimuth and the corresponding (x, y, z) coordinates. Initially, at the start of the drilling, only one set of measurements exists (first measurement at 6 m), but during the course of the drilling process successively more data are generated as each new measurement gives data for the full borehole length. The accumulated data set serves as the basis for decisions by the contractor and activity leader regarding the number and nature of steering activity to be applied in a given situation. .

In addition to the data from the deviation measurements, a close look was kept on the drill core in order to identify possible foliation or preferential fracture sets that could affect the orientation.

Results and discussion

Alignment of casing in borehole K08028F01

Much effort was devoted to secure an accurate starting orientation, i.e. the orientation of the casing. Geodetic survey data showed that the casing was installed with an inclination of 2.18° , originally aimed at 2° . The orientation of the casing hole was originally measured very close to 2.0° , however, the orientation changed during casting. For future installations, if a similar borehole orientation is achieved, the casing can simply be centered with shims before casting. So far, only one casing has been installed with the new methodology but it seems very promising. As a comparison the casing in K03009F01, which was conventionally installed, an inclination of -0.37° was obtained, originally aiming at -1° .

The casing angle ‘as built’ was set as the theoretical line rather than the target 2.0° inclination. This was done in order to lower the risk of having to do an early directional drilling which was deemed to be a higher risk since there are very tight margins/“small rectangles” during the beginning of the drilling, cf. Figure 2. Selecting the “as built” angle as the theoretical line is a compelling possibility, but it requires an accurate casing orientation to start with. For KBS-3H it is actually the requirement on a maximum sideways deviation of 2 m that is the strictest overall constraint. The latter corresponds to less than 0.4° deviation sideways in the starting angle. When extrapolated as a straight line to 300 m, i.e. if the casing was set with a 0.4° sideways error a perfectly straight hole would still violate the

requirement at 300 m. The KBS-3H project will assess if an additional requirement need to be assigned on the casing orientation and if this can be combined with the aim of selecting the ‘as built’ angle as the basis for the theoretical straight line extension of the pilot hole.

Directional core drilling of borehole K08028F01

During the drilling the frequent surveys showed that the borehole initially aligned relatively well with the theoretical line. Its orientation could even be subtly controlled by simply adjusting the position and sequence of the reamers of the core barrel. Using this inherent capability introduced by the great care taken in establishing the initial geometry it was eventually possible to drill 2/3 of the borehole length according to the stipulated requirements before the first directional drilling action had to be carried out at roughly 63 m borehole length.

At 63 m borehole length the deviation was 12 cm to the right and 4 cm downwards, corresponding to approximately 30% of the allowed rectangle at this borehole depth, Figure 2. The employed directional drilling strategy stipulates that if the borehole deviates 50% in absolute distance, a directional drilling shall be carried out. However, if the borehole continues to deviate to the right, the risk of performing a too late directional drilling increases. The result of the directional drilling would also be difficult to evaluate, if it was carried out to close to the end of the borehole.

The first directional action was prompted based on the criteria described. In this case the DeviDrill directional core barrel was prepared with a low offset angle and directed to the left (tool face = 270°) and over a drilling length of 1.2 m. Thereafter the borehole was extended to 72.74 m and the deviation measurement carried out to 72 m showed that the effect of the directional drilling was as expected, with the borehole turning left (0.014°/m between 64-72 m), however, along with a larger upward inclination (0.017°/m between 64-72 m), but still within the stipulated requirements. Figure 3 shows the borehole deviation data. The red and the blue line, respectively, represents the average of all deviation measurements combined and the black and orange the final gyro measurements, respectively.

Based on the data obtained at 72 m a decision was made to conduct a second directional drilling as it was necessary to reduce the inclination, at the same time maintaining the azimuth trend to the left. The correction at 73 m was directed 235° and drilled 1.2 m. The outcome of the directional drilling can be seen in Figure 3. It worked out as the rise in inclination was reduced and a smooth turn to the left was achieved.

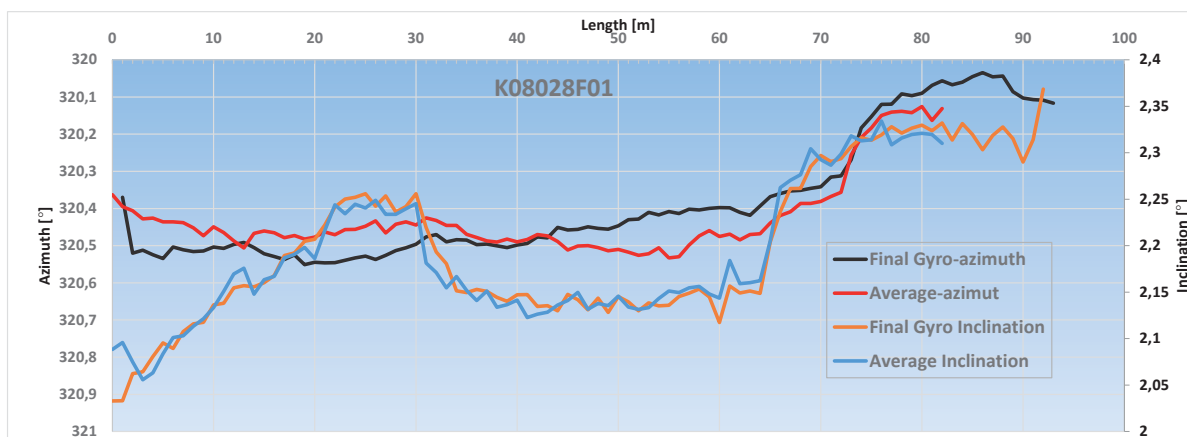

Figure 3. Final deviation measurements (azimuth and inclination) with Reflex Gyro and average calculated results from all deviation measurements taken during drilling of K08028F01.

When the (x,y,z)- coordinates were calculated, the deviation of the hole at its end point at 94,39 m was 1.8 cm to the right and 1.2 cm upwards from target coordinate, cf. Figure 4. The borehole was even heading exactly towards the bulls-eye, had it been drilled to 100 m length. However, due to heavy foliation and red staining at the last core recovery, indicating near proximity of a major deformation

zone with an increased risk for massive groundwater inflows, the drilling was terminated at 94.39 m length.

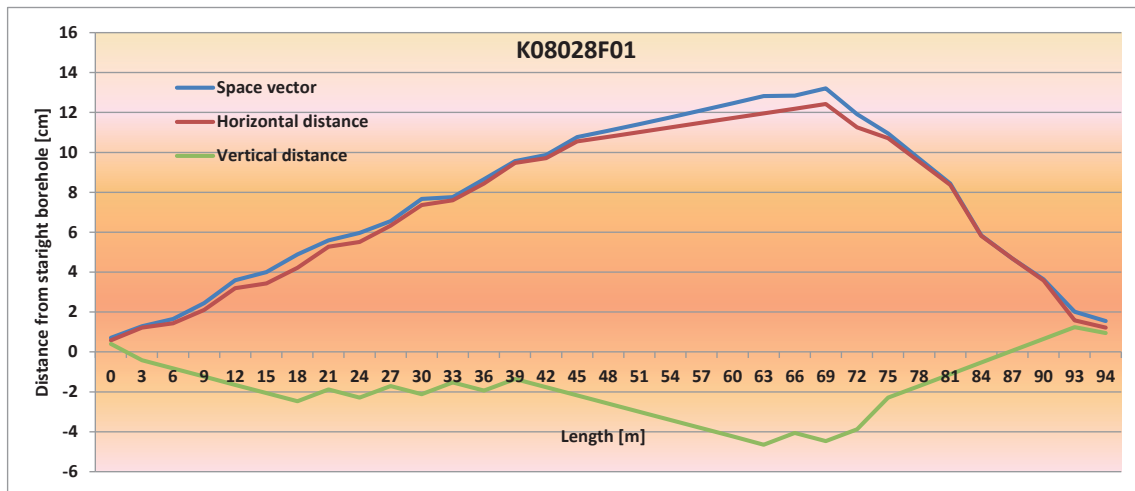

Figure 4. Final distance from the theoretical straight line borehole is presented in terms of vertical distance (green), horizontal distance (red) and the 3D space vector (blue).

Conclusions

Measurements in the deviation facility at Äspö HRL have demonstrated that there exist commercially available deviation tools, which can provide the accuracy required by SKB and Posiva. The performed demonstrations also highlight the importance of experienced operators in order to provide deviation measurement data of high accuracy.

An important success factor is that the drilling equipment is adapted for drilling straight holes, implying that a well-maintained and sufficiently powerful drill rig is used. Furthermore, that the directional core barrel is well maintained, and that drill bits of different hardness and reamers and stabilizers of various sizes are available at onset. The equipment must also be operated by a skilled working team and good internal communication is imperative. It is important that the crew is made fully aware that the high quality aspects have a higher priority than production capacity in terms of drilled borehole length.

The importance of an accurately installed casing is emphasized, and the KBS-3H project will consider to assign separate requirements on the casing orientation in order to ensure an even better starting orientation of the pilot borehole. An accurate starting orientation is expected to allow the initial part of the drilling to be carried out without requiring directional actions and should maximize the chances that the drilling can proceed very close to the projected theoretical straight line.

Establishing directional drilling strategy applicable for all possible conditions is probably not possible and the operators' experience and knowledge of the rock will always be of high importance. However, SKB's and Posiva's repositories are planned to be constructed in homogeneous rock, featuring a large number of parallel deposition tunnels, which through successive building of site-specific experience should allow for definition of rather clear guidelines as to how and when to resort directional actions in order to ensure fulfilment of the requirements.

Prior to start of the drilling of K08028F01 in the Äspö HRL there remained, despite the extensive and careful preparations undertaken, some uncertainty whether it was actually feasible to fully comply with the strict KBS-3H geometrical requirements over a 100 m length scale. With the experiences from the completed drilling in hand it can be concluded that the requirements can be met over this length scale. It is also concluded that it should be possible to meet the requirements also over 300 m, which constitutes the next experimental step, planned to be carried out in Posiva's Onkalo facility where a strategy similar to that employed at Äspö will be applied.

Acknowledgement

The research leading to these results has received funding from the European Union's European Atomic Energy Community's (Euratom) Seventh Framework Programme FP7/2007-2013 under grant agreement no 269905 (LUCOEX project).

Comments and suggestions made by Anders Winberg (Conterra AB) on an early draft of this paper are gratefully acknowledged.

References

Bäckblom G, Lindgren E, 2005. KBS-3H - Excavation of two horizontal drifts at the Äspö Hard Rock Laboratory during year 2004-2005. Work description, summary of results and experience. SKB R-05-44, Svensk Kärnbränslehantering AB.

SKB, 2012. KBS-3H Complementary studies, 2008-2010. SKB TR-12-01, Svensk Kärnbränslehantering AB

Lessons learnt from excavating the clayish Callovo-Oxfordian host formation at the Bure URL and excavation technologies considered for the future Cigéo DGR

François Chauvet, Jean-Michel Bosgiraud

* ANDRA

Corresponding authors e-mails: francois.chauvet@andra.fr; jean-michel.bosgiraud@andra.fr

Abstract

Since November 1999, ANDRA (the French public body in charge of radioactive waste management) has been working [1] at the Bure Underground Research Laboratory (URL) in order to investigate and qualify the Callovian-Oxfordian clayish formation (aka the “argillites”) likely to receive in 2028 the first of many intermediate and high level long lived waste packages [2].

The French industrial geological disposal project (aka “Cigéo”) must take into account all the data, knowledge and experience gathered over more than 15 years of activities in the Bure URL.

The spectrum of activities concerned encompasses a wide array of subjects: preliminary surface and subsurface scientific investigations, construction of surface facilities and excavation works (shaft sinking, digging of drifts, drilling vertical, slanted and horizontal boreholes), scientific experimentations (from geophysics to geomechanics, including geology, hydrogeology, geochemistry, corrosion, biology, diffusion, monitoring...), maintenance and operation, environmental monitoring, communication and dialogue with the stakeholders to ease the social acceptance.

The license application for the Cigéo facility construction will be submitted to the safety authority in 2017 (with a construction start-up in 2021 and a first disposal package emplacement scheduled in 2028), while the Bure URL was granted the right to operate in parallel until 2030.

The purpose of this paper is to provide an overall view of the URL construction experience and its input for the preparation of the future Cigéo licensing act and the associated engineering studies and excavation activities, based on information gained during the 15 first years of work at Bure.

Introduction

The Bure URL is site specific, since it is used i) to confirm the suitability of the selected host rock (the argillites), ii) to guide the specific design and architecture of the future disposal facility, iii) and to validate some of the various technological construction methods in conditions that are particular to the site. As such, it has been constructed in the vicinity (5 km) of the potential future disposal underground facility footprint.

Indeed, there are practical limits to the engineering and construction work that can be carried out in the URL and transposed to the potential disposal site since the activities implemented in the site-specific underground laboratory were initially rather more focused on the qualification of the host formation to safely receive and contain (on a long term basis) radioactive waste, than on construction technology development.

Furthermore, technical tests are somehow limited by the infrastructures of the Bure URL (size of shafts and drifts are at scale ½ of the work considered in Cigéo, excavation and transport means are also commensurate with the initially science-oriented needs). Those infrastructures were deliberately down-sized to comfort the stakeholders in the belief that the URL could never be transformed at a later stage in a repository (technically speaking, this transformation is effectively not possible).

However, in the most recent years of URL operations, technical tests focusing on excavation technologies have been implemented and are still planned for the years to come. They are paving the way to the final choices of construction techniques considered for Cigéo.

Description of the Bure URL

Geological Setting

The North of the Haute-Marne district and South of the Meuse district form a simple geological domain of the Paris Basin, comprising a sequence of near horizontal limestone layers, marls and argillaceous rocks, deposited at the bottom of former oceans (Figure 1), some 150 million years ago.

The detailed study of seismic geophysical profiles of the sector shows that the tectonic deformations affecting the region over the past 150 million years have been mild and essentially limited by the Gondrecourt and the River Marne fault systems at the boundaries of the study sector. Between the 2 main faults, the Callovian-Oxfordian layer is even and planar.

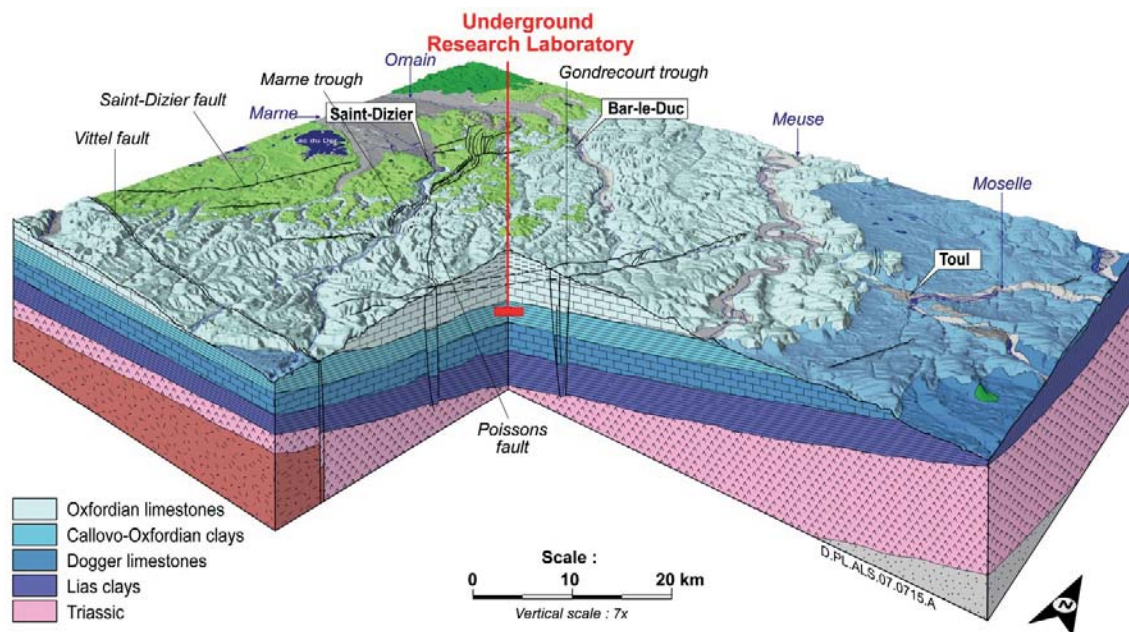

Figure 1 - Geological 3D block diagram of the Meuse-Haute-Marne site (ANDRA, 2005)

The Bure URL Architecture

The URL infrastructures are composed of 2 vertical shafts (access and auxiliary), technical drifts (dedicated to access, escape routes, power supply, safety shelters, mechanical maintenance, ventilation or water exhaust) and experimental drifts per se.

All those underground components are shown on Figure 2 (also indicating the dates of construction). The shaft sinking operations started in 2000 and finished in 2005 (completion of shaft equipment). The drift excavation activities (mainly at a 490m depth) started in 2005 and are planned to be still ongoing at least until 2030.

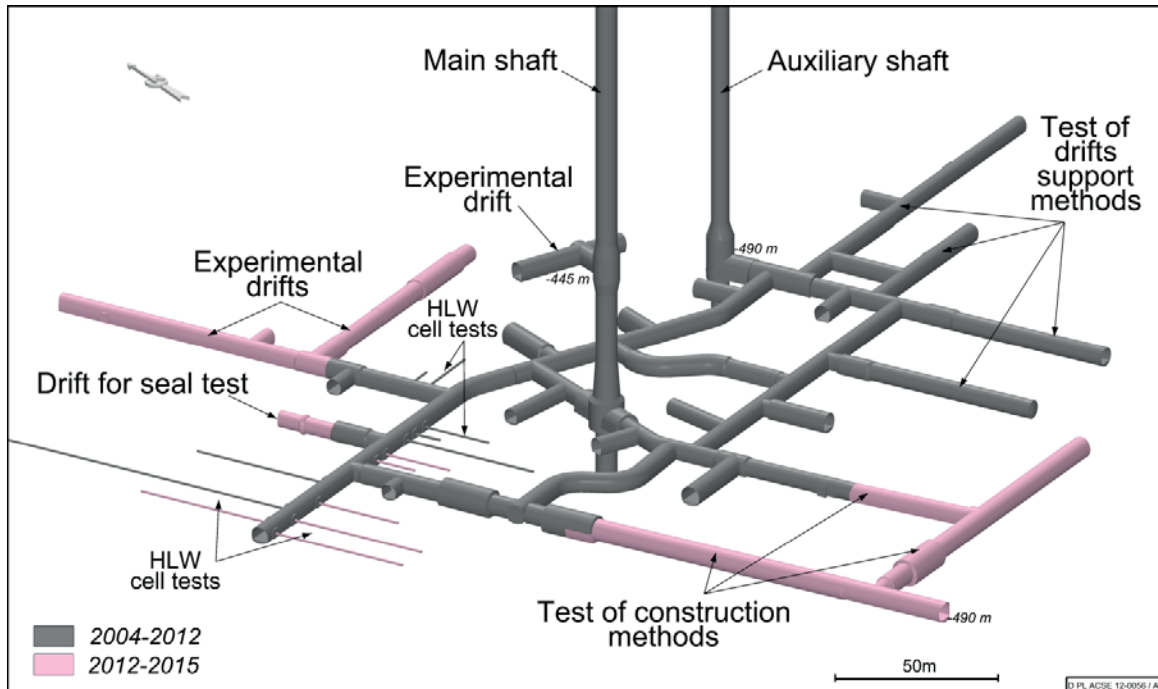

Figure 2 - 3D views of the Bure URL infrastructures (ANDRA, 2013)

Description of the Cigéo infrastructures

The Cigéo repository will enable as of 2028 to dispose of the intermediate and high level long lived waste packages produced by the nuclear waste generators. It should be operated over more than 100 years before closure. In terms of magnitude (footprint, volume of waste packages, social impact) and budget (investment cost and life cycle cost), this project has (at the time) no equivalent in the world (the US-Yucca Mountain project excepted).

Located some 5km north of the Bure URL, the Cigéo repository should be granted a license by the end of 2020 and the construction operations should start in the early 2021, enabling the emplacement of a first waste package in 2028. As of this date, coactivity between construction operations and nuclear operations will be a concern.

Even though Cigéo infrastructures' design phase has just started (basic studies should be completed in mid-2015), a significant mileage of horizontal works (excavated at an average depth of 500-520m) is anticipated: some 90km of 9-10m wide drifts and intermediate waste disposal vaults, some 150km of vitrified waste disposal cells (metric size diameter).

The diameter of the shafts, ramps and drifts in Cigéo will be somehow twice that of the existing Bure URL infrastructures. The Figure 3 shows the extension of the repository at time of closure (as well as the location of the seals in the infrastructures).

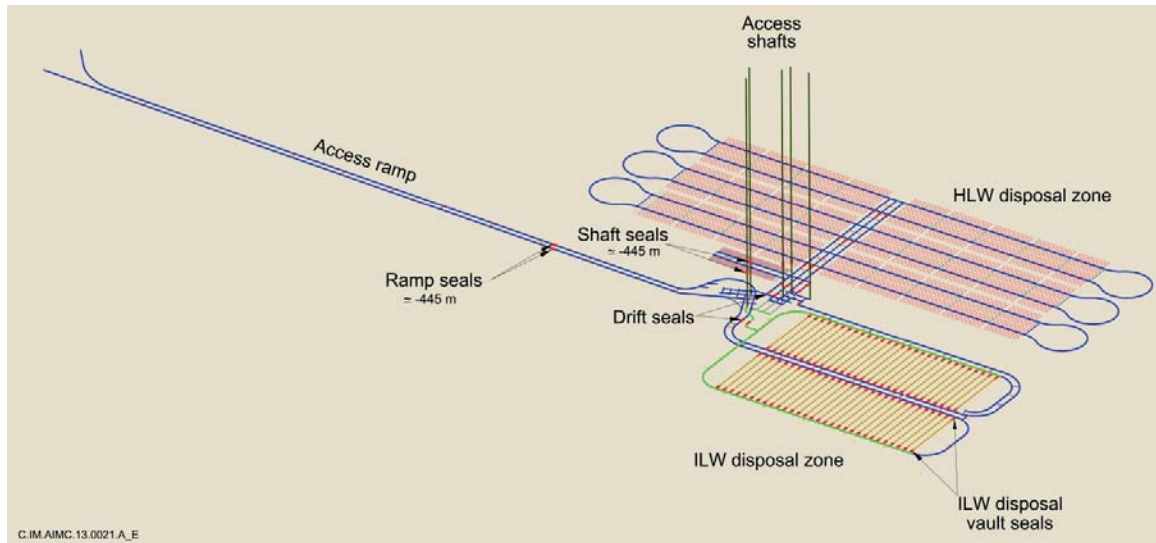

Figure 3 - 3D view of the Cigéo infrastructures at time of closure (ANDRA, 2013)

Discussion on experience gained in the URL and transposition to the Cigéo Project

Geomechanics

This domain of knowledge is certainly one of the most sensitive issues concerning Cigéo, be it regarding the evolution (self-healing with time) of the excavation damaged zone (EDZ) or the dimensioning of the repository underground works (there is a need for a 150 year structural integrity of drift and vault concrete linings, in order to abide by retrievability requirements). Very little pre-existing knowledge is available on the Callovian-Oxfordian formation mechanical properties at similar depths.

In spite of 10 years (as of 2005) of experimental, monitoring and excavating activities in the Bure URL horizontal drifts (with various excavation techniques and various structural support solutions), at different scales (from decimetric to plurimetric components), the rock “squeeze law” (also called the “convergence-confinement analysis”) is not well determined yet. Thus, the prediction of the stress evolution (over a period between 15 and 150 years) in the concrete lining is difficult. However, the orientation of the formation horizontal stress field has been confirmed, as well as the shape, vertical and horizontal extent of the EDZ.

This information was used in the Cigéo design for the orientation of the disposal vaults, disposal cells and hydraulic seals. All these underground works are parallel to the major horizontal stress orientation. A practical approach has been selected to solve the lining dimensioning issue. It is discussed here after under the “URL construction activities” heading.

URL Construction activities

There are many construction activities concerning Cigéo infrastructures which can learn from the Bure URL construction story. However, this is not true for all the nuclear operations which will be “Cigéo specific”. A few examples have been selected.

- Shaft sinking: as long as the shaft sinking technique chosen for the Cigéo shafts is the “drill and blast” method, the Bure URL experience is totally transposable. Nevertheless, the Cigéo shafts will have a bigger diameter which is a favoring factor for ease of construction.
- Drift excavation: “mining techniques” (hydraulic hammer, road header, bolts, mesh, steel arches and shotcrete) and “civil engineering” techniques (mainly for the concrete support lining and the

drift slabs) have been used. This URL experience is summarized in a 200 pages document made available to the Cigéo designers and building contractors.

- Tunnel boring machine (TBM): The Cigéo access ramps and some of the mains will be excavated thanks to a TBM. A TBM (c/w a segment erector) is being tested in the Bure URL. A drift parallel to the major horizontal stress orientation was successfully excavated and completed in October 2013; a second drift, parallel to the minor horizontal stress orientation will be progressively deployed in 2015-2016. As the TBM is a critical device, in terms of construction cost and performance, the experience collected in the URL will help in limiting the “degree of unknown”, when ordering the Cigéo TBM’s and starting their operation. Geomechanical data are collected as the TBM excavating impact is different from that of traditional excavating techniques. This TBM activity is also a unique opportunity to check the relevance of “compressible materials” placed at the extrados of the concrete lining (in the annular gap between the clay rock wall and the lining extrados) and intended to reduce-differ-mitigate the rock creeping effect, hence minimizing the size (dimensioning) of the concrete lining thickness.
- Disposal cell prototype (for vitrified waste packages): it was demonstrated that drilling and steel casing a 100m long, 75cm diameter horizontal tunnel was possible, in spite of an intensive rock spalling phenomenon (jamming the translation of the steel liner inside the drilled hole). Additional technical tests are needed in the years to come, to improve the performance and reliability of operations and to see how efficient can the cementing operations of the annular gap (formed between the casing extrados and the host rock wall) be to minimize the creeping effect and the corrosion phenomena due to the host formation progressive resaturation.
- Disposal vault prototype (for intermediate long live waste packages): as previously mentioned, a significant degree of uncertainty remains regarding the dimensioning of the drifts and disposal vaults linings. Several “small” (i.e. 5.2 to 7.8m) lining prototypes have been constructed and instrumented in the URL: compliant lining, thick shotcrete, rigid lining and finally the first set of reinforced concrete rings (made of an assembly of 9 segments placed with the TBM. The monitoring of the rock convergence and stress measurement should help in the refining of the “squeeze law”. Nevertheless, it was decided to build in the Bure URL, in 2018-2020 (at a scale 1:1 representative of Cigéo, and with a lining thickness commensurate with that of Cigéo design) a “disposal vault prototype”. It will be instrumented and monitored for at least 5 years, before the construction start-up of the first “active” (i.e. containing waste packages) vault in Cigéo, likely to receive its first package in 2028. The evolution of the stress values and of the EDZ, as measured in the “prototype” vault liner at the Bure URL, should help in a very practical way to forecast the future stress evolution in the first Cigéo vault liner.

15 more years of activities at Bure (2015-2030)

Even if the “main substance of proof” is now available to proceed with the elaboration of the Cigéo licensing file, it is mandatory to continue the acquisition of data and experience at the Bure URL: many experiments are “long shots” (e.g. seal experiments, geomechanical experiments), for which chronicles must be established and followed over the next decade. The “vault prototype” needs to be closely monitored over the period.

Besides, there is room for continuing the development of different construction technologies, for which the availability of the host formation is an asset.

As an example, one of the main items at stake is the drilling and casing of the vitrified waste disposal cells, as far as cost and delay are concerned: thousands of cells are planned. Thanks to the “learning curve”, it is expected to drastically improve the existing drilling and casing technology and the associated cementation operation know-how.

Another example is the testing of the TBM and the selection of the most efficient buffer material reducing

the anisotropic effects of the progressive rock convergence around the concrete segments rings forming the drift lining.

Conclusion

The Bure URL is now in a mature stage and the scientific and technical issues addressed are ever more sophisticated. As a result of a large component of international cooperation, the URL has made it possible to mobilize the human skills required for this type of research. The URL will enable to accompany the future detailed design stage of Cigéo, allowing various contractors to test construction solutions and industrial prototypes.

The “large scale” works related to the intermediate waste disposal vault prototype, scheduled in 2018-2020 and monitored until at least 2030, will be instrumental in obtaining (from the Safety Authority) the “green light” to operate waste emplacement activities in Cigéo in 2028.

Beyond the scientific and nuclear communities which may take advantage of the research center created, the Bure URL offers unique possibilities to demonstrate to the interested general public and stakeholders, the scientific and technical achievements, to help them assess the operational safety and long term safety of a repository.

Besides the URL activities and outcomes significantly contribute to building the public confidence in radioactive waste disposal and to the social acceptance of the Cigéo repository project.

References

1. French law 91-1381 of 30 December 1991 relating to research on the management of radioactive waste,
2. National Inventory of Radioactive Materials and Waste, 2012, Synthesis Report, <http://www.ANDRA.fr/download/ANDRA-international-en/document/editions/467va.pdf>

Wire sawing of deposition tunnels

Stig Pettersson

Swedish Nuclear Fuel and Waste Management Co, Stockholm, Sweden

Corresponding author e-mail: stig.pettersson@skb.se

Abstract

Wire sawing is a proven method used in various applications in hard rock, e.g. quarries for production of granite blocks and lately also for underground construction of tunnels and shafts for ventilation, power cables, escalators, etc in densely populated areas. The possibility to use the method for excavation of the deposition tunnels in a KBS-3V repository is investigated by SKB and SKB participated in the field test of wire sawing of all sides for a 16 m long tunnel during the construction of the City Line railway tunnels under the centre of Stockholm. The result confirmed the technical feasibility and indicated a potentially favourable compared to the reference drill-and-blast method in a KBS-3V repository

Introduction

Design and dimensions of deposition tunnels for KBS-3V

The SKB:s deposition tunnels for KBS-3V has preliminarily a length of up to 300 m and a cross section $W \times H = 4.2 \times 4.8$ m which gives a theoretical area of about 20 m^2 . The length and cross section through a deposition tunnel is shown in Figure 1.

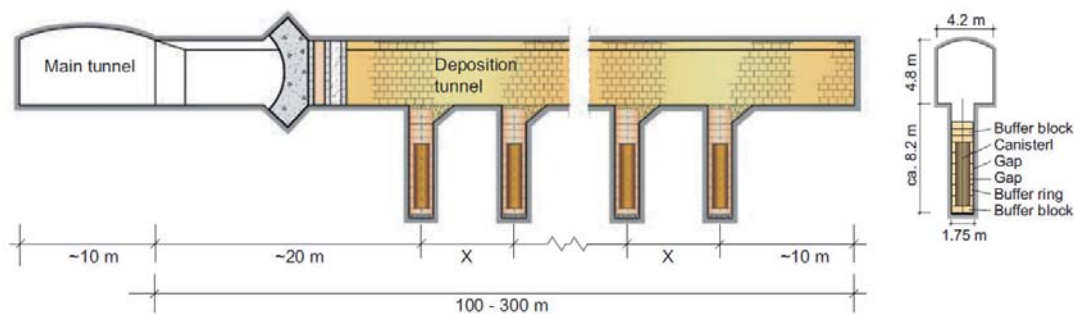

Figure 1. Illustration of the KBS-3V deposition tunnel with dimensions valid for SKB.

Figure 2 shows the cross section of the tunnel with the deposition machine. The longitudinal section of the tunnel shows the size of the lock-out in the tunnel contour using the drill-and-blast method.

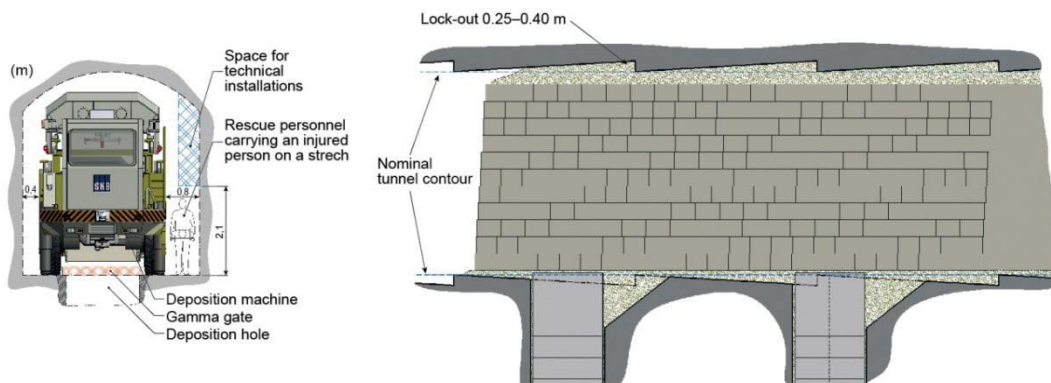

Figure 2. Illustration of the deposition machine in the deposition tunnel and backfilling of the tunnel.

Different methods for rock excavation of deposition tunnels

At present four main alternatives for tunnel excavation are under discussion within SKB as shown in Figure 3.

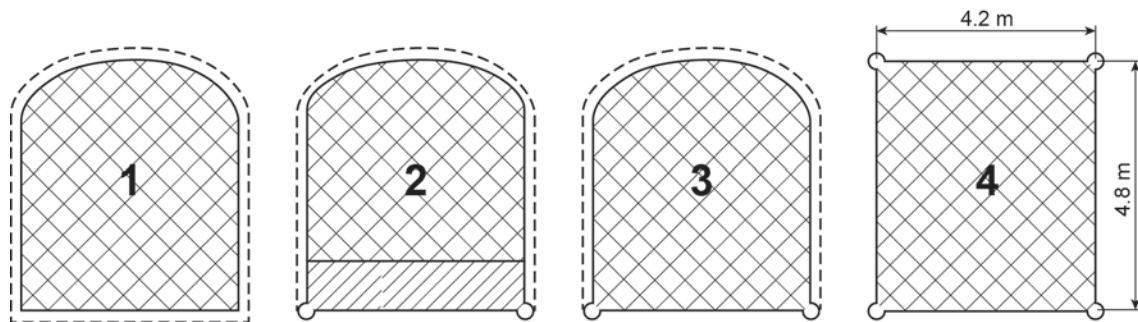

Figure 3. Illustration of the KBS-3V deposition tunnel with dimensions valid for SKB.

Alternative 1 represents the SKB reference tunnel design with drill-and-blast of the full tunnel area in one blast. Alternative 2 starts with drill-and-blast of the upper part of the tunnel followed by wire sawing of the floor and removal of the bench by e.g. drill-and-blast. Alternative 3 starts with wire sawing of the floor followed by drill-and-blast of the full tunnel area. In alternative 4 the whole tunnel is wire sawn followed by removal of the freed rock volume by e.g. drill-and-blast. The solid line shown in Figure 3 is the required inner tunnel contour and the dotted line shows the real rock contour as a result of the lock-out for drilling of the contour holes.

The wire sawing alternatives – alternatives 2, 3 and 4 – provides the benefit of a minimum of excavation disturbance of the rock and a smooth tunnel floor without unevenness caused by look-outs, which eliminate the need for a road bed for the heavy machines working in the tunnel during buffer emplacement, canister disposal and tunnel backfilling. The drilling of the deposition holes can also be made with a minimum of preparation of the floor.

Description

Sawing of all surfaces for a short deposition tunnel

In 2011/2012 SKB participated in a field test with wire sawing of floor, roof and side walls in a simulated deposition tunnel in a KBS-3V repository during construction of the City Line railway tunnels under the centre of Stockholm. The wire sawing was made in one of the railway tunnels and resulted in a short, about 16 m long tunnel with the same dimensions as a wire sawn deposition tunnel in the final repository. The rock was removed by a smooth drill-and-blast method /1/.

Drilling of the holes in the corners of the deposition tunnel was done in three steps: 1) core drilling, $\text{Ø } 76 \text{ mm}$, 2) reaming from $\text{Ø } 76 \text{ mm}$ to $\text{Ø } 165 \text{ mm}$ and 3) final reaming from $\text{Ø } 165 \text{ mm}$ to $\text{Ø } 255 \text{ mm}$.



Figure 4. 3D illustration of the tunnel and photos of the drilling equipment used in the field test.

The same boom and auxiliary equipment was used for core drilling and also the reaming/percussion drilling, which reduced the set-up time for reaming. However, scaffoldings were needed for drilling the upper corner holes. In spite of the short tunnel the sawing was done in two phases and the blasting was done in five rounds, with three rounds in the first phase and two blast rounds in the second phase as shown in Figure 5.

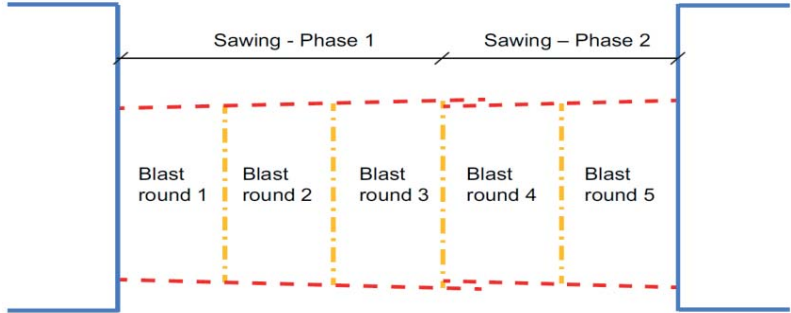

Figure 5. Execution of the rock removal: Sawing in two phases and drill-and-blast in five steps.

Figure 6 are photos taken during execution of the field work. The left part of Figure 6 is a photo of the face of the truck tunnel showing the corner holes for the sawing equipment the deposition tunnel and the right hand side of the figure shows the start of drilling for sawing-phase 2.



Figure 6. Photo of the truck tunnel with four corner holes needed for wire sawing and scaffoldings needed for drilling and sawing of phase 2 of the tunnel.

The sawing equipment was designed to make it possible to wire saw from the front and inwards into the rock which is not the normal application. Wire sawing from the front and inwards was possible by drilling one hole in each corner of the deposition and using fixed push rods with pulleys for the diamond wire for sawing of the floor, walls and ceiling. The driving unit for the wire was mounted on rails and was keeping correct speed and tension of the wire during the sawing. This arrangement is shown in Figure 7. When sawing the sides and ceiling additional pulleys was needed for the wire as the drive unit was still placed on the tunnel floor.

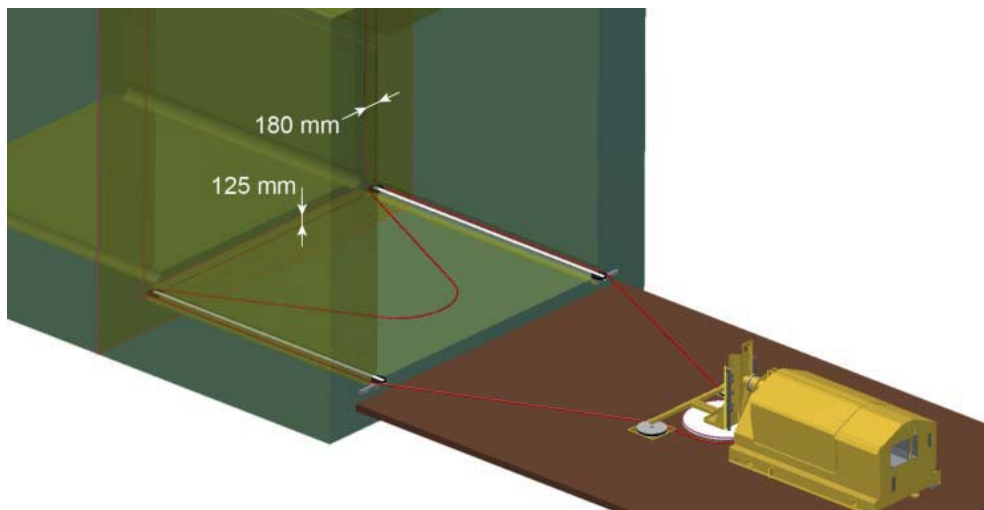

Figure 7. 3D-illustration of the sawing equipment with fixed push rods with pulleys for the diamond wire and a rail bound driving unit for tension and rotation of the wire.

Figure 7 also shows that it will be a step of 125 mm in the floor and 180 mm in the walls between phase 1 and 2 due to the need for a lock-out between the drilling phases. If the step in the floor would cause problem for driving in the tunnel or for the backfilling process, the step in the floor can easily be smoothed or levelled out by additional sawing over a distance of one to two meters.

Production rate and cost comparison of alternative excavation methods

In the calculation of the production rate it has been assumed that, on average, drilling and blasting can be made with 2.5 blasts on three fronts per working day with two shifts. The round length is assumed to be 4.5 m, but effective advance per round is 4.3 m, or approximately 96% of theoretical length.

This gives an average production rate or advance of excavation of 10.75 m/working day. With an advance of 10.75 m per working day about 140 days with two shifts per working day or 28 weeks are needed to complete 1,500 m deposition tunnel.

The option of just sawing the floor and then drill-and-blast the full tunnel area will need 36 weeks with two shifts per working day for drilling for sawing and sawing and also two shifts per working day for the drill-and-blast. As the drilling for sawing and sawing must precede the drill-and-blast work, this method requires working at five tunnel fronts in parallel.

The option to saw all surfaces, i.e. floor, walls and ceiling, is a rather labour-intensive method. It requires virtually continuous work with drilling and sawing three shifts, five days per week, over a period of about 38 weeks. The drill-and-blast of the freed rock can be done in two shifts five days per week. Also this alternative requires working at five tunnel fronts in parallel as the drilling and sawing must be made before the drill-and-blast. It also requires additional drilling and sawing equipment in order to keep the production rate, but the drilling jumbo can be less advanced as no contours need to be drilled.

The blasting will be done at the end of each working day, and it also means that the drilling for sawing and the wire sawing then must be interrupted. In this analysis it has been assumed that one hour falls off during each shift, even if only one shift per working day will be affected by blasting and ventilation of explosive gases. The adaptation of the shift time is therefore important to minimize disturbance in connection with blasting.

The alternative that includes drill-and-blast of the tunnel gallery, wire sawing the floor and removal of the bench by drill-and-blast is at present considered as a back-up alternative only.

The different production methods will give different production costs for rock removal and backfill and the major cost differences in MSEK and price level 2012 are shown in Table 1. It should be noted that these costs are the cost differences for factors that are different between the methods and not the total production cost.

Table 1. Major cost differences between the main alternatives for excavation of 1,500 m of deposition tunnels year.

Annual costs in MSEK	Drilling blasting	Sawing all surfaces	Sawing only floor
Capital costs	2.5	2.4	3.5
Consumables	4.8	10.3	6.8
Labour	2.5	9.6	6.6
Additional cost for additional rock	1.4	0	1.1
Cost for tunnel floor levelling/cleaning	3.8	0	0
Additional cost of backfilling	9.6	0	7.2
Total:	24.6	22.3	25.2

Conclusion and future plans

The field test of wire sawing a deposition tunnel in the City Line railway tunnels showed that it is possible to excavate the deposition tunnels in the final repository for spent fuel by wire sawing and smooth drill-and-blast techniques but the equipment for drilling for sawing and the sawing have to be more advanced in order to improve the production rate and reduce the labour cost.

The production rate could be improved by e.g. reducing the start-up time for the drilling for sawing and sawing by using a dedicated carrier for the drilling and sawing equipment. The drilling equipment should be designed for drilling hole in the right and left hand side with minimum size of the lock-out between two drilling steps. By using a carrier for the drilling equipment fixed scaffoldings are not needed.

The wire saw should be remotely operated and self-propelled using two crawler units in the corner holes. The start of the sawing is done with help of start tubes handled by a dedicated carrier and fixes scaffoldings will therefore not be needed. Further, the diamond wire can be optimised for the area to be cut and the surface will be within small tolerances. The sawing start with the floor, the two sides are sawn at the same time with two saws and the top is done last.

The drill-and-blast design with drill pattern and loading must also be studied in detail. It may be possible to even further reduce the number of holes for the charging and a simplified drilling machine for the charge holes could be used as no contour holes are needed.

A small field test with the next generation of the drilling and sawing equipment was performed in a quarry in Lysekil, north of Gothenburg, during April-May 2015. The results of the field tests at Lysekil will later on be used for updating of the production time and cost presented in Table 1 /1/.

The field test in Lysekil included drilling of three 50 m deep holes to extend one of the floors in the quarry. The distance between the bore holes was 4.2 m i.e. the same distance as the floor for a deposition tunnel.

The results from the field test in Lysekil will be used for future decision regarding the final production method for the deposition tunnels but more studies and field test would be required before the final decision is made about production methods for the deposition tunnels.

The results from the tests in Lysekil may be used as the base for a more extensive field test of e.g. a 50 m deposition tunnel using the new drilling and sawing equipment with a load carrier.

Such a field test should also include the step between two phases in order to make it possible to evaluate if the step between the phases would be a problem for the backfilling process. A new field test should also include testing of improved drill-and-blast design for removal of the freed rock with a reduced number of holes for explosives that would cut costs without creating any new problem.

Reference

Christiansson R, Lehtimäki T, Pettersson S, Olsson M, 2014. Study of wire sawing for deposition tunnels, SKB R-14-08, Svensk Kärnbränslehantering AB.

FE/LUCOEX: Design criteria for bentonite block manufacturing and emplacement in an underground facility

Benoit Garitte, Herwig R. Müller, Hanspeter Weber

¹Nagra (Nationale Genossenschaft für die Lagerung radioaktiver Abfälle)

Corresponding author e-mail: benoit.garitte@nagra.ch

Abstract

The Full-Scale Emplacement (FE) Experiment at the Mont Terri underground research laboratory is a full-scale heater test with three heaters in a clay-rich formation ('Opalinus Clay'). Approx. 3,000 bentonite blocks (70 tons) produced in a high pressure press using a natural (non-activated) sodium bentonite from Wyoming were necessary for the experiment. Optimisation of the bentonite blocks production parameters required for this experiment and the production itself are discussed in terms of design parameters and production quality control. The design parameters were derived from different tests prior to the FE experiment. The bentonite blocks were successfully used in the FE experiment to backfill a 2m long tunnel section in direct contact with the rock and to build pedestals that support the heaters.

Introduction

In the last decade, compacted bentonite blocks used in different in-situ experiments were damaged during operations (e.g. Teodori et al., 2011). This damage related to their sensitivity to ambient relative humidity. As shown in figure 1, compacted bentonite has a tendency to disintegrate and this disintegration seemed to be controlled by the original water content of the blocks (i.e. the lower the water content of the raw material used to manufacture the blocks, the faster they start to disintegrate under RH=100%).

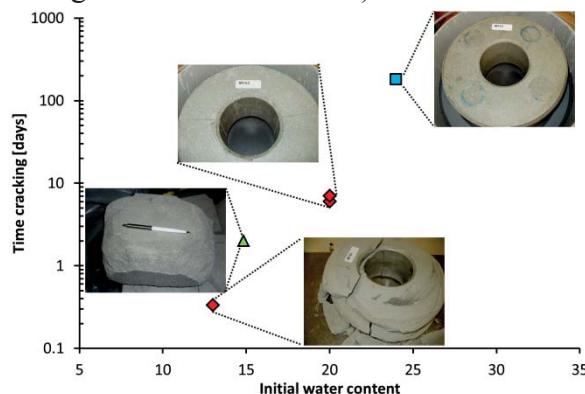

Figure 1: Time before first cracking measured for blocks at different initial water contents exposed at relative humidity close to 100% (modified from Sanden et al., 2008 and Teodori et al., 2011).

One of the objectives of the FE experiment was to produce bentonite blocks that are capable to resist to the ambient conditions in Mont Terri during storage and operation phases.

Pre-production of bentonite blocks and laboratory tests

A total of 90 bentonite blocks at three different water contents and three different compaction pressures were produced with a natural sodium bentonite (Gelclay WH2) to investigate the behaviour of the blocks as a function of those production parameters. The resulting dry

density for each of the 9 different block groups is depicted in figure 2 (left). In the considered water content range, the compaction is on the “wet side” of Proctor (increasing dry density with increasing water content for the same compaction pressure) and the blocks with the highest water content are close to saturation (constant dry density with increasing compaction pressure). The blocks were then isolated in airtight chambers together with a relative humidity (RH) sensor. The equilibrium RH shows a clear correlation to the initial water content with secondary trend as a function of the compaction pressure (figure 2, right).

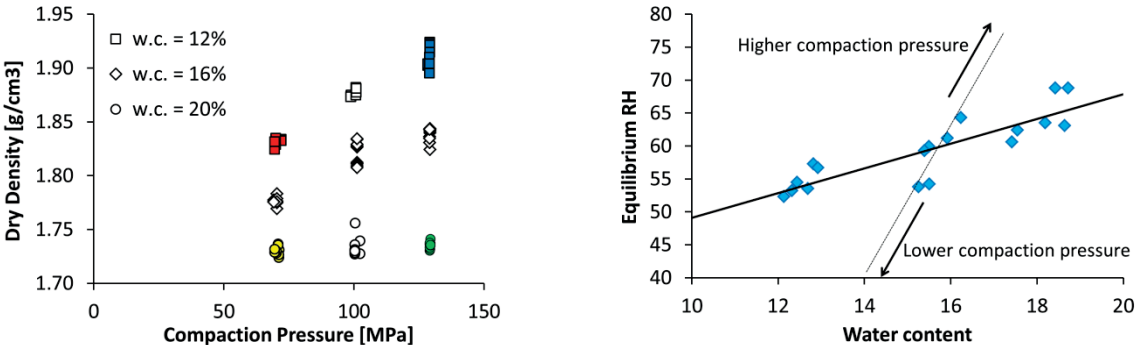

Figure 2: Dry density of the bentonite blocks of the pre-production manufactured at 3 different water contents and 3 different compaction pressures (left) and equilibrium RH of the blocks as a function of their water content.

45 blocks (5 blocks of each of the 9 groups described in figure 2, left) were then submitted to uniaxial compression strength tests in 5 tests series. In the first series, the blocks were tested directly after production and in the next series the blocks were first disposed in a climate chamber imposing a RH of 50%, 70%, 90% and 35% until the blocks reached equilibrium. The compression test results (figure 3) clearly show that (1) imposing a RH to a bentonite block higher than its natural equilibrium RH drastically reduces its strength. On the contrary, (2) imposing a RH to a block lower than its equilibrium RH leaves the block strength unaffected. Blocks with a high equilibrium RH are thus likely to be more resistant to RH variations and retain their strength.

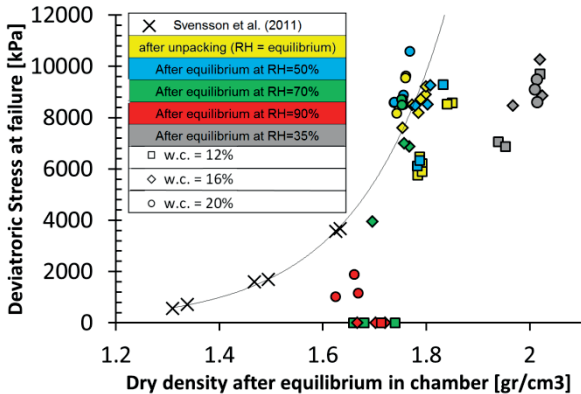

Figure 3: Uniaxial compression strength (UCS) of the pre-production blocks after equilibrium at different RH values as a function of the dry density after equilibrium. Values from saturated blocks (Svansson et al, 2011) were added as a reference.

Disintegration mechanism

In the Bentonite Long-term Load (BLL) test, 4 groups of 2 blocks with different initial conditions (indicated by coloured dots in figure 2, left) were emplaced in an environment characterized by a varying RH between 50% and 90% and were loaded with a similar pressure

to that induced by a heater on the bentonite blocks in the FE experiment. It was set up (1) to verify the previous laboratory test results and (2) to investigate phenomenologically the mechanisms behind those results. The experiment was installed on 19.09.13 at 11:00 (RH at that time =70%). Blocks compacted at a low water content disintegrated very fast: support capability was lost only within one month and the first significant fractures appeared in the first days after emplacement (figure 4). Cameras set up in front of the blocks and recording a picture every minute allowed following up the block disintegration behaviour. In the low water content blocks the first fractures appeared in the first hours and the videos (see QR codes in figure 4) clearly showed the link between fracture development and swelling behaviour. The swelling, caused by water absorption by the relatively dry bentonite from relatively wet air, generated cracks that propagated very fast because the relatively wet air penetrates into the fractures and extend the fracture inside the block. Drying cracks were also observed in the blocks equilibrated at 35% in the laboratory test, but these were shrinkage cracks and they did not penetrate into the blocks. Blocks produced at a high water content and thus characterized by a higher equilibrium RH did nearly not take up water and proved to be very stable over a large time period of approx. 1.5 years.

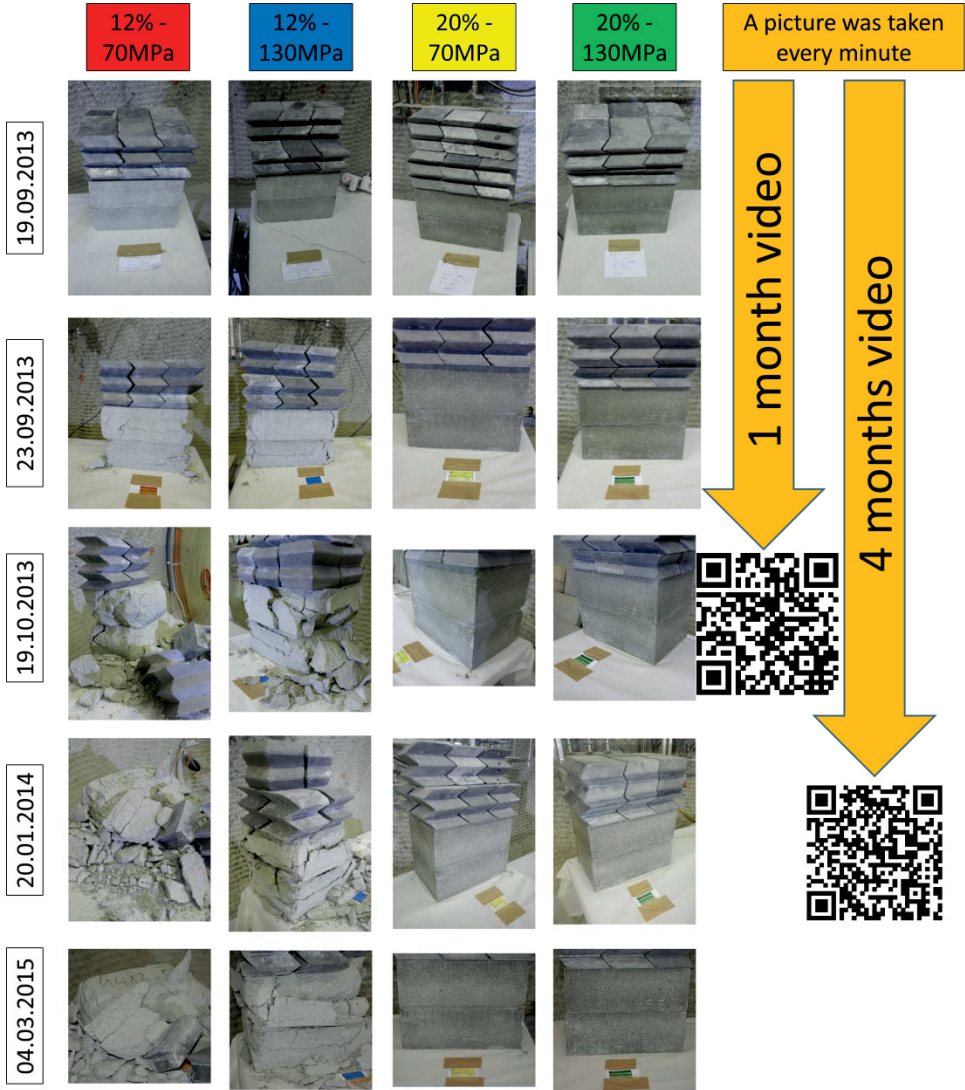

Figure 4: Resistance of compacted bentonite blocks to exposition time to ambient RH as a function to the production parameters (water content and compaction pressure are indicated on top of the figure). The QR codes are linked to time-lapse videos of the block evolution.

Production of bentonite blocks

About 2500 rectangular and 500 curved “top layer” blocks were produced in March 2014 (figure 5) using a natural sodium bentonite (trade name Gelclay WH2). The production parameters were set according to the tests described above to obtain stable blocks that are capable to support heaters under the expected climatic conditions in Mont Terri:

- water content of the raw material (18% +/-1%)
- compaction pressure (130MPa)

QC variables (acting as rejection criteria) during production were:

- The block dimensions (required precision: 0.85mm)
- Geometric density (required precision of 0.02 g/cm³)
- No visible cracks
- Minimum UCS of 6MPa (checked every 100th block in beginning of production and every 500th block afterwards)

The bentonite blocks were produced at a rate of one block per minute. The average characteristics of the rectangular blocks are given in table 1. The selected compaction pressure and water content resulted in an average dry density of 1.78 g/cm³. The QC variables measured during production were found to be very stable (figure 6) and mostly within the required limits, resulting in a very small quantity of rejected blocks.



Figure 5: Rectangular and curved blocks after pressing (left) and curved blocks before storage (right)

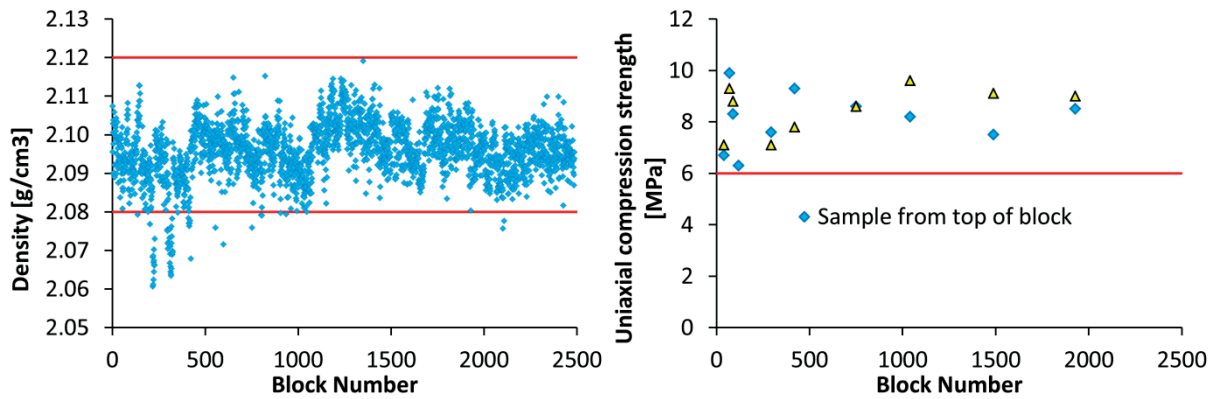

Figure 6: Quality control during the block production: geometric density (left) and uniaxial compression strength (right).

Table 1: Average production parameters and characteristics of the 2500 rectangular bentonite blocks

	Compaction pressure [Mpa]	Weight [g]	Length [mm]	Width [mm]	Height [mm]	Bulk Density [g/cm ³]	Measured water content [%]
Average	129.6	24,517	401.3	200.6	145.3	2.096	18.00
Std dev.	0.4	93	0.2	0.2	0.3	0.007	0.67
Min	128.7	23,920	400.5	199.9	143.9	2.061	17.27
Max	131.5	25,000	402.1	201.7	146.5	2.119	19.74

Block storage/conservation

After production, the blocks were packed in airtight pallets to prevent water absorption from the environment which could have caused damage. 5% of the pallets were equipped with a wireless RH sensor to detect potential leakages of the packaging. On-board sensors were found unaffected by the RH evolution outside the packaging, proving the tightness of the packaging throughout the storage period (figure 7, left). The QC variables were combined to compute the degree of saturation in the mould (during compaction) and after unmoulding (figure 7, right). The results suggest that while in the mould, the bentonite was very close to saturation and the elastic rebound occurring when unmoulding decrease the saturation to about 90%. This suggests that manufacturing blocks with an equilibrium RH higher than 70% might be impossible.

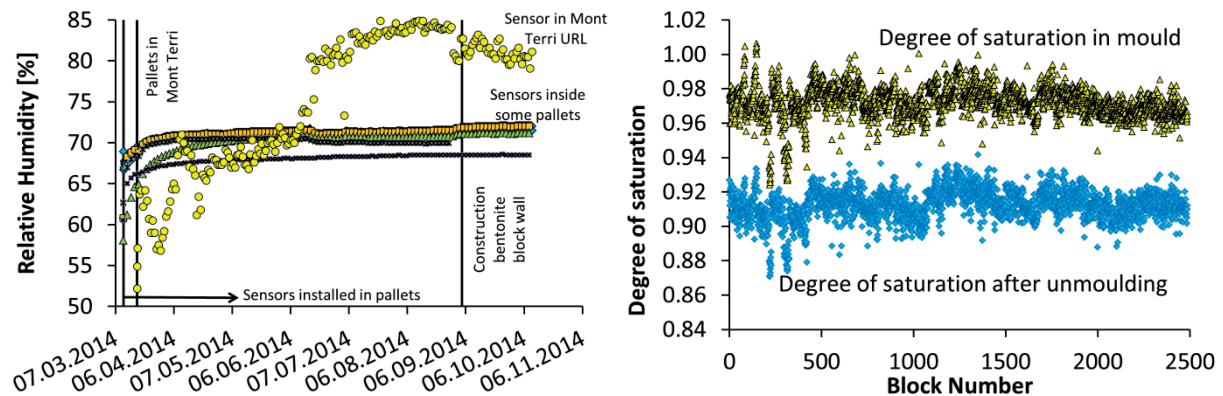

Figure 7: RH inside bentonite blocks package and ambient RH outside the packages (left) and degree of saturation of the bentonite blocks during and after production (right).

Emplacement of the blocks in the FE tunnel

The construction of the bentonite block wall (figure 7 left) took place in early September 2014, when the RH in Mont Terri was still relatively high (see figure 7, left). Even under these harsh RH conditions, the blocks survived the 2 weeks of emplacement without any degradation (figure 8, left). Each of the three bentonite block pedestals for the heaters survived not only the ambient load but also the 5 tons of the heater (figure 8, right).



Figure 8: Emplaced bentonite blocks in the FE tunnel: bentonite block wall in the interjacent sealing section and bentonite block pedestal sustaining a heater.

Conclusions

The sensitivity of compacted bentonite blocks to ambient relative humidity was thoroughly and systematically investigated in the framework of the FE experiment to optimize the manufacturing parameters and to avoid damages to the blocks as experienced in other previous in-situ experiments. Observing that the damage was mainly due to water absorption of relatively dry compacted bentonite from relatively wet ambient air, the concept of equilibrium relative humidity characteristic for each compacted bentonite was introduced. The equilibrium relative humidity is easy to measure and once known, it allows determining whether or not the compacted bentonite will disintegrate in ambient conditions according to the following simple rule: a bentonite block is stable as long as ambient relative humidity does not exceed its equilibrium relative humidity by more than 5% to 10%.

References

- Sandén Torbjörn, Börgesson Lennart, Dueck Ann, Goudarzi Reza, Lönnqvist Margareta, Nilsson Ulf, Åkesson Mattias (2008): Description of buffer tests in 2005–2007: Results of laboratory tests. SKB R-08-40.
- Svensson Daniel, Dueck Ann, Nilsson Ulf, Olsson Siv, Sandén Torbjörn, Lydmark Sara, Jägerwall Sara, Pedersen Karsten, Hansen Staffan (2011): Alternative buffer material: Status of the ongoing laboratory investigation of reference materials and test package 1. SKB TR-11-06.
- Teodori Sven-Peter, ed., Gaus Irina, ed., Köhler Sven, Weber Hanspeter, Nagra, Rösli Ursula, Steiner P., Trick T., Garcia Sineriz J.-L, Nussbaum Christophe, Wiczorek K., Schuster K., Mayor J .C. (2011): Long term performance of engineered barrier systems (PEBS). Mont Terri HG-E experiment: as-built report. Nagra Arbeitsbericht. NAB 11-025. Nagra, Wettingen.

Acknowledgements

The research leading to these results has received funding from the European Union's European Atomic Energy Community's (Euratom) Seventh Framework Programme FP7/2007-2013 under grant agreement no 269905 (LUCOEX project)

Production of Buffer and filling components for the Multi-Purpose Test (MPT)

Peter Eriksson, Lars-Erik Johannesson, Magnus Kronberg

SKB

Corresponding author e-mail: peter.eriksson@skb.se

Abstract

The topic covered is recent experiences within Swedish Nuclear Fuel and Waste Management Co (SKB) concerning manufacturing of buffer and backfill components including delivery control of the bentonite (MX-80), adjusting of the water content of the bentonite, compaction of blocks and pellets, machining of the blocks and quality assurance of the manufactured components.

Introduction

SKB's and Posiva's disposal system for spent nuclear fuel is the KBS-3 method. Two concepts are considered, the current reference design KBS-3V (vertical) and KBS-3H (horizontal), Figure 1.

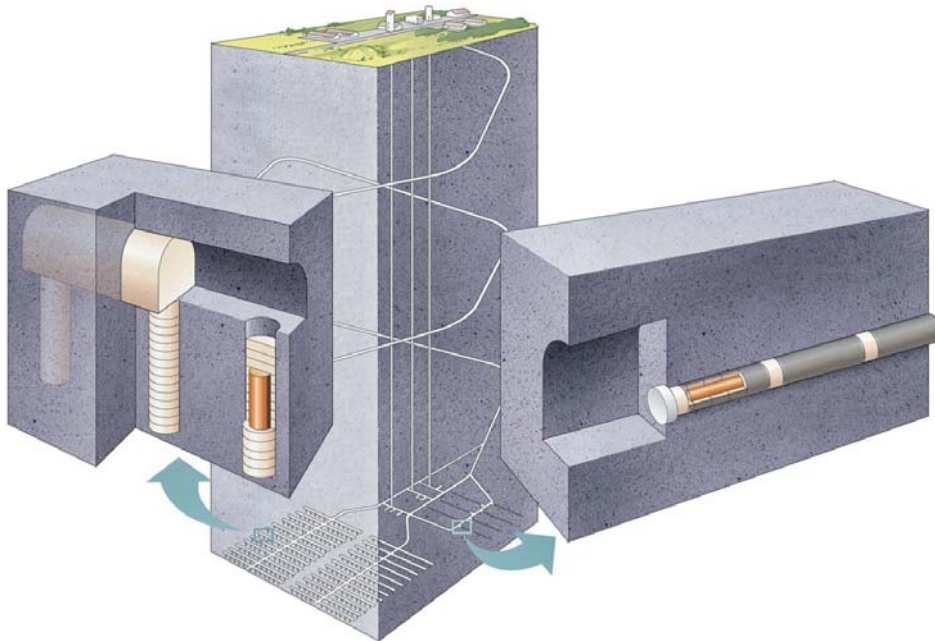

Figure 1. A schematic drawing of the vertical reference design (left) and the horizontal alternative (right) according to the KBS-3 method.

The principle behind KBS-3 is a multiple barrier system to ensure that radionuclide release is within the stipulated requirements. One of the main barriers is the buffer placed around the copper canisters. The buffer shall prevent flow of water and protect the canister. In case the containment provided by the canister should be damaged the buffer shall prevent and retard transport of radioactive substances from the canister to the bedrock. The properties of most importance for the buffers barrier function are

its hydraulic conductivity, swelling pressure and stiffness/strength. These properties are related to its montmorillonite content and density.

The buffer in both KBS-3V and KBS-3H consists of compacted solid blocks below and above the canister and ring shaped blocks around the canister. For KBS-3V a gap between the blocks and the deposition hole walls is required to accommodate auxiliary equipment used to prevent saturation and swelling of the buffer before the backfill in the deposition tunnel is installed i.e. during the installation phase. In the vertical reference design the gap is filled with compacted buffer pellets.

For KBS-3H the canisters are hydraulically and thermally separated by distance blocks which are also part of the KBS-3H buffer.

The backfill which is used to fill the deposition tunnel in KBS-3V shall sustain the multi-barrier principle by keeping the buffer in place and limit groundwater flow through the deposition tunnels. The properties of the backfill of most importance for its barrier functions are its hydraulic conductivity, swelling pressure and compressibility. These properties are also related to its montmorillonite content and density.

Acceptable hydraulic conductivity, swelling pressure, stiffness/strength and compressibility are provided from the assessment of the long-term safety for both the buffer and backfill.

Table 1 summarises the requirements on the KBS-3 buffer material.

Table 1. Material requirements for the buffer in KBS-3 method.

Design parameter	Nominal design [wt-%]	Accepted variation [wt-%]
Montmorillonite content	80-85	75-90
Sulphide content	limited	< 0.5
Total sulphur content (including the sulphide)	limited	< 1
Organic carbon	limited	< 1

Description

The description and discussion largely relates to the MPT buffer manufacturing and further details can be viewed in (Johannesson 2014).

Material control

In order to ensure the fulfilment of the requirements on the material according to Table 1 and to establish the compaction parameters needed for the block manufacturing a material control program is carried out. Measurement of the hydraulic conductivity, swelling pressure and montmorillonite content are time consuming, so they are complemented by indirect measurements, which are good indicators of the material quality.

The control programme for the MPT includes:

Direct measurements:

- XRD (X-ray diffraction) to quantify the montmorillonite content
- Chemical composition
- Swelling pressure and hydraulic conductivity
- Compaction properties

Indirect measurements:

- Normalized free swelling
- Liquid limit
- CEC (Cation Exchange Capacity)

- EC (Exchangeable Cations)

Regarding the compaction properties recent material controls indicate that there can be quite a large difference in the compaction properties for bentonite which in the other measured properties are relatively similar. This is further discussed in the discussion section.

Mixing and storage

The bentonite used for the blocks have three different water contents, 11%, 17% and 21%. Purchased bentonite has typically a water content around 11% so in order to reach the required water contents; water is added to the bentonite in a mixer. The mixer currently used by SKB is an intensive mixer and the maximum batch that can be handled in this mixer is about 500 kg.

The bentonite is filled into a silo placed beside the mixer and then transported to the mixer with a conveyor screw. About 350 kg of bentonite is generally mixed in each batch. A small sample of the bentonite is taken from each Big-Bag for determining its initial water content. This water content and the total amount of bentonite are used for calculating the amount of water to be added in order to get the required water content. Each batch is mixed for about 3 minutes after the water is added. The final water content of the batches is determined by drying small samples in an oven.

The bentonite is stored indoors after mixing. Currently Big-Bags are used but in order to get a more homogenized material, bulk-storage is preferable because differences in water content between the smaller batches will be evened out with time as they are put together in the same storage.

Block compaction, machining and storage

Currently a press with a maximum capacity of 30,000 tons is used for the compaction of full scale blocks, which is well within the, up to 11,000 tons, needed load for the blocks used in the MPT as well as other full scale demonstrations. The press is normally used to manufacture heat exchangers and has a limitation in opening, implying that the maximum block height is approximately 0.5 m. It is also not possible to control the relative humidity in the compression plant which would be beneficial to minimize the risk of occurrence of cracks on the blocks.

At the compaction the required amount of bentonite is filled slowly into a mould from the Big-Bags. Material from 2-3 Big-Bags is used for each block. The mould is lubricated with a molybdensulfide based grease prior to filling in order to ensure low friction between the bentonite and the mould at the compaction,

The mould is placed in the press with a subsequent compaction of the bentonite in accordance with the compaction parameters established during the material controls. After the removing of the block from the mould, it is placed on a pallet and an air tight cap is placed over the block to prevent the block from drying.

In order to get a buffer with a homogenous density after saturation, the cylindrical blocks have to be compacted to a lower density than the ring shaped blocks and hence the cylindrical blocks must be compacted with a lower pressure.

The compacted blocks are over-sized and have to be machined in order to fulfil the requirements regarding their dimensions. The machining also removes the lubricant left from the compaction on the blocks outer surfaces. For the blocks used for the MPT all surfaces except for the bottom were machined.

After the machining the final weight of the blocks are determined. Data from a recent compaction of KBS-3H ring shaped blocks gave an average dry density of 1,900 kg/m³ with a standard deviation of 10.9 kg/m³. Corresponding values for the distance blocks were 1,728 and 9.2 kg/m³ respectively. This data should be compared with the reference design of the blocks which are 1,885±20 kg/m³ and 1,712±20 kg/m³. A few blocks have densities above the requirements.

Discussions

The manufacturing of both buffer and backfill has been demonstrated within several projects at SKB. Prior to the designing of larger production facilities will be made there are some issues to be addressed.

- The mixing of the bentonite is a relatively straight forward process. However, the method for moving the bentonite by means of conveyor screws has proven problematic. The screws are clogging up when bentonite of higher water contents are transported. In order to avoid this, which also tends to produce bentonite lumps in the material, other means of transport should be used, such as conveyor belts or simply using gravity, i.e. putting the silo with unmixed bentonite above the mixer and empty the mixed bentonite from the bottom of the mixer and thereby avoiding inclined or horizontal transportation of the bentonite. For the storage of the mixed material, bulk storage would improve the homogeneity of the material, which is favourable for the block production.
- The buffer block compaction is currently done in a facility that is not designed for this kind of work. The equipment like the mould, the mould filling equipment and handling tools are not optimal for this kind of work. Adapted equipment will have to be developed when moving to larger production facilities.
- The manufacturing of the blocks are made in relatively small series. At the start of the production, the first 5-10 blocks are used to fine-tune the process and can therefore deviate from the nominal quality of the blocks i.e. its shape and density. When the process is fine-tuned, blocks with repeatable density are produced as long as the water content of the bentonite has a small variation. Because the blocks currently are produced in small series, typically for a demonstration like the MPT, it is not possible to discard the first blocks since the production volume would be too small. The assessment is that the quality of the blocks would be much better when it is made in productions facility dedicated for producing buffer blocks and when the production is made in larger series.
- More experience on how the machining influence the density of the blocks is needed. At the compaction, the blocks have a lower density close to its outer circumference due to the friction between the mould and the bentonite. At the machining this part with lower density is machined off and thereby the density of the machined block is higher compared to the density before the machining. There was very little or no experience on how large this density change would be when designing the mould used for the MPT.
- Recent demonstrations highlighted the need for a controlled environment in all steps of the bentonite handling. In the MPT this was initially not the case which leads to cracking blocks that were impossible to handle with lifting vacuum tools. Generally, better control of the environment around the blocks and a minimizing of the time when blocks are exposed to undesirable relative humidity are important to maintain crack free blocks. One part of the production were this was not done in a proper way was at the machining of the blocks. At this stage the blocks can start to dry, which in turn can lead to cracking. Storage can be done in air-tight containers or plastic bags. However, in order to handle large quantities of blocks the storage facilities should ideally also have the correct RH.

The variation in water content and density of the blocks are mainly caused by a non-optimised production process and equipment. By integrating the process of mixing, compaction and machining in one facility with optimised equipment and a better control of logistics and the environment the blocks are subjected to, it should be possible to fulfil the current requirements with margins. However, this is not possible until a production facility is built for the purpose of producing buffer block. Therefore relative large variations in block for future full scale tests can be expected.

Conclusions

Bentonite blocks have been produced for the MPT, most of the blocks fulfil the requirements but some of them exceed the maximum density specified. However, on average the eventually installed density of the MPT is within the specifications and therefore the blocks were judged to be good enough to be used in the MPT.

There were some problems of getting the correct density and water content for the blocks. However, this is mainly related to the lack of optimised equipment. There have also been problems with the handling of the blocks. The KBS-3H distance blocks require a relative humidity in the facility of close to 90% in order not to dry and this was initially not maintained which led to drying of the blocks which in turn led to cracks on the surfaces of the blocks. The cracks caused problems when the blocks were lifted with a vacuum tool. This problem was eventually solved by complementing the plastic protection used with a humidifier that maintained the relative humidity at the required level.

Lots of the challenges currently faced can be solved by moving the block production to an industrialised scale, where bentonite will be stored in bulk volumes and compaction will be ongoing during longer periods so that the compaction parameters can be optimised. The facilities should also be operated with proper relative humidity in the air.

Acknowledgement

The research leading to these results has received funding from the European Union's European Atomic Energy Community's (Euratom) Seventh Framework Programme FP7/2007-2013 under grant agreement no 269905 (LUCOEX project).

References

Johannesson L-E, 2014. KBS-3H, Manufacturing of buffer and filling components for the Multi Purpose Test, P-14-07, Svensk Kärnbränslehantering AB

Manufacturing of Buffer Blocks, Backfill Blocks and Pellets for Posiva's KBS-3V concept

*Peura, Jutta*¹, *Sjöblom, Ville*¹, *Ritola, Jouko*¹, *Holt, Erika*¹, *Haapala, Keijo*²

1) VTT Technical Research Centre of Finland, Espoo, Finland

2) Posiva, Eurajoki, Finland

Corresponding author email: jutta.peura@vtt.fi

Abstract

There are two main methods of producing bentonite buffer or backfill components: by uniaxial or isostatic compression. The development of the manufacturing technique and testing methods has advanced from small-scale laboratory scale blocks to large scale factory blocks in both methods. The results have shown that during block compaction there is a clear relation between density and bentonite water content, at all pressure levels. The density is often independent of the size or shape of the compressed blocks. During isostatic pressing, the filling with vibration results in about 20% higher initial bentonite density, which can be helpful for achieving certain dimensions. For both uniaxial and isostatic large scale blocks, there has been very little difference in properties across the block when the optimal water content has been used. During manufacturing of pellets, it was possible to achieve uniform pellets with sufficient crush strength and abrasion resistance, which are important parameters needed to avoid breaking during placement.

Introduction

Posiva Oy has the Underground Rock Characterization Facility (URCF) or ONKALO in Olkiluoto. The future repository will consist of deposition holes deep in the bedrock where the copper canisters containing the spent fuel will be surrounded by a bentonite buffer. The KBS-3V design calls for the horizontal deposition tunnels containing the vertical deposition buffer and canister holes to be backfilled with highly compacted bentonite blocks. Compacted bentonite pellets are also used around the circumference of both the buffer and backfill, to ensure thermal and hydraulic stability with the surrounding bedrock. The function of the bentonite buffer and backfill materials is to restrict groundwater flow and to protect the canister. The bentonite components of the Engineering Barrier System (EBS) have to fulfil certain density and homogeneity requirements to ensure safe functional performance for thousands of years.

Bentonite components used in the EBS of a nuclear waste repository can be manufactured using various methods. The size of the buffer blocks in the final repository will be 1,650 mm in diameter and at least 400 mm in height. In some cases ring-shaped blocks are produced to surround the canister. The dimensions of the backfill blocks are specified to be 550 mm in length, 470 mm in width and 330 mm in height. Manufacturing tolerances are typically around 1 mm. The manufacturing of the EBS clay components has been developed in Finland during the past five years, from small-scale laboratory pressing through full-scale factory production.

Description

Methods and material properties

There are two main methods of producing bentonite buffer or backfill components: by uniaxial or isostatic compression. In the *uniaxial method*, bentonite powder is poured into a rigid form and a piston is pushed by a pressing device so the bentonite is compacted at a certain pressure along the vertical axis. In the *isostatic method*, bentonite is enclosed in a flexible membrane surrounded by a pressurized liquid medium, generating

simultaneous compression from all directions. Bentonite pellets are typically roller-compacted or extrusion pressed to achieve a target density. Posiva has developed their own moulds to be used in the manufacturing processes, based on experience and modelling. An example of the half-scale uniaxial block mould, developed in research and then used, is shown in Figure 1, where the mould's vertical walls had a heat-treatment nitriding permanent coating, inclination of 0.5% and rounded mould corners of 5 mm radius to minimize defects during manufacturing and sample removal.



Figure 1. Medium-scale uniaxial backfill block manufacturing mould, for pressing.

Posiva's reference material for buffer blocks is MX-80 type bentonite, having a water content of $17\% \pm 1\%$. The target density of the saturated buffer is $2,000 \text{ kg/m}^3 \pm 50 \text{ kg/m}^3$ in a deposition hole. For the backfill blocks the reference material is Friedland clay having a target dry density of $2,030 \pm 40 \text{ kg/m}^3$ at 10% water content. The alternative material for backfill blocks is Ibeco RWC-BF. Pellets can be either MX-80 or lower-quality bentonite, and the water content is usually similar to the levels used in the corresponding buffer or backfill. In all manufacturing cases, the loading level and rate are adjusted to obtain the best products. For instance, in uniaxial compaction the pressure is often in the range of 25-100 MPa. Removal of the blocks from moulds can prove challenging, especially for uniaxial compaction when trying to avoid the use of lubricants or coatings. The components must be homogenous, with minimal cracks or defects. The tensile strength capacity needs to be sufficient to handle vacuum lifting during handling and emplacement. Large components made by isostatic compaction are typically manufactured with 5-10% greater dimensions and then machined down by dry-cutting and polishing to obtain the actual specific dimensions.

Upscaling and manufacturing

Manufacturing of the buffer and backfill block components by the isostatic and uniaxial compression methods have been studied and developed by Posiva for over 5 years. The development of the manufacturing technique and testing methods has advanced from small-scale laboratory scale blocks to full scale factory blocks in both methods (Figure 2). Finite Element (FE)-modelling has been done to evaluate the compaction process and optimal mould designs, taking into account materials parameters and mould friction.

The results have shown that during block compaction there is a clear relation between density and bentonite water content, at all pressure levels. The density is often independent of the size or shape of the compressed blocks. Table 1 presents examples of results from 2014 year work with full-scale compaction of Posiva's reference backfill blocks.



Figure 2. Up-scaling of isostatic compaction of buffer blocks, from small, medium and full-scale.

Table 1. Example of consistency in results from full-scale uniaxially compacted backfill blocks, Friedland clay.

Block no.	Number of Specimens	Bulk density (kg/m ³)	Std. dev. (kg/m ³)	Dry density (kg/m ³)	Std. dev. (kg/m ³)	Water content (%)	Std. dev. (%)	Splitting tensile strength (Mpa)	Std. dev. (MPa)
1	6	2,254	6,4	2,051	7,2	9,90	0,08	0,63	0,03
3	6	2,248	17,1	2,047	17,0	9,83	0,13	0,55	0,06
8	6	2,257	9,9	2,055	9,2	9,80	0,11	0,58	0,07
10	6	2,253	15,1	2,057	14,5	9,51	0,10	0,58	0,05

During isostatic pressing of buffer blocks, it has been found that mould filling aided by vibration results in about 20% higher initial bentonite density, which can be helpful for achieving certain dimensions. During uniaxial factory pressing, it is critical to understand how the material properties and water content can impact the compaction factors, which relates to the achieved density at varying mould fill heights (Figure 3). The compaction factors and optimal water contents can be evaluated in small-scale test prior to factory trials for optimization of the manufacturing cycles. For both uniaxial and isostatic compaction of large scale blocks, there has been very little difference in properties (such as strength, bulk density and water content) across the block when the optimal water content has been used. It has been noted that variations in bentonite particle shape and angularity may have an impact on compacted component properties, such as tensile strength. Non-destructive testing, such as X-ray and ultrasound, has not proven sufficient to detect minor variations in properties of the high compacted blocks. Figure 4 shows an example of 3D scans for quality control of isostatic produced blocks.

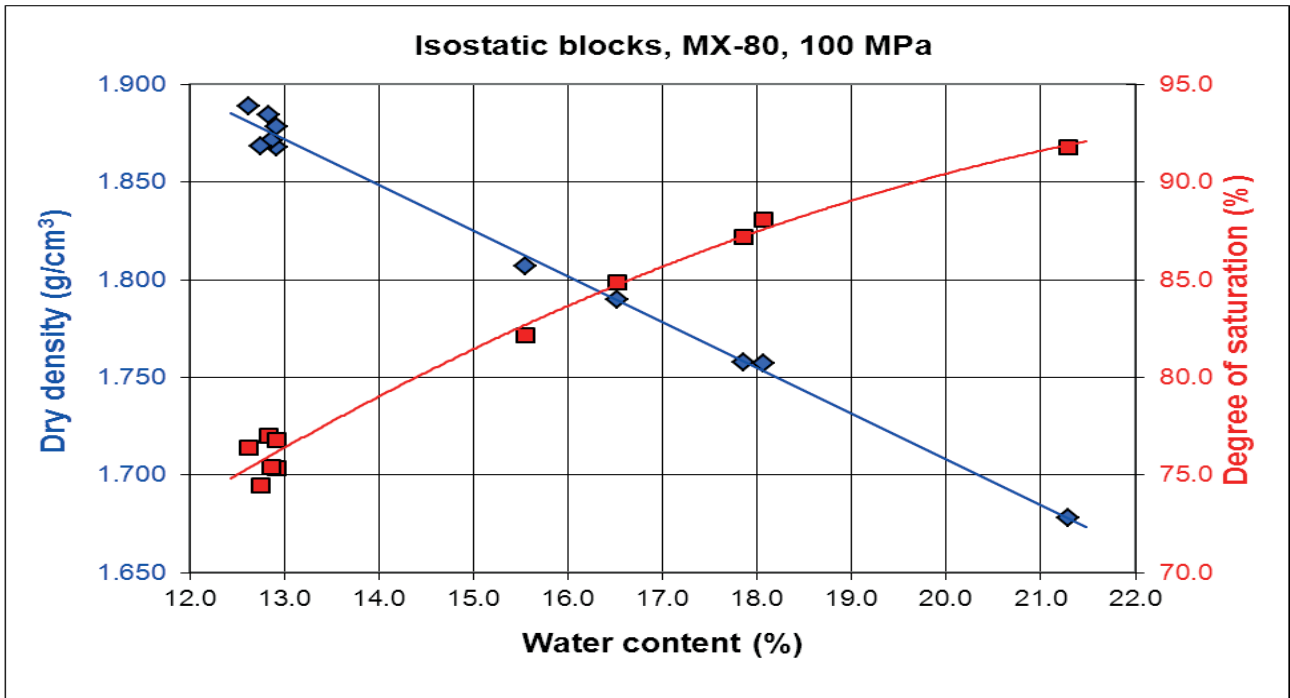

Figure 3. The Isostatic MX-80 block properties, showing the relationship between water content, dry density and degree of saturation.

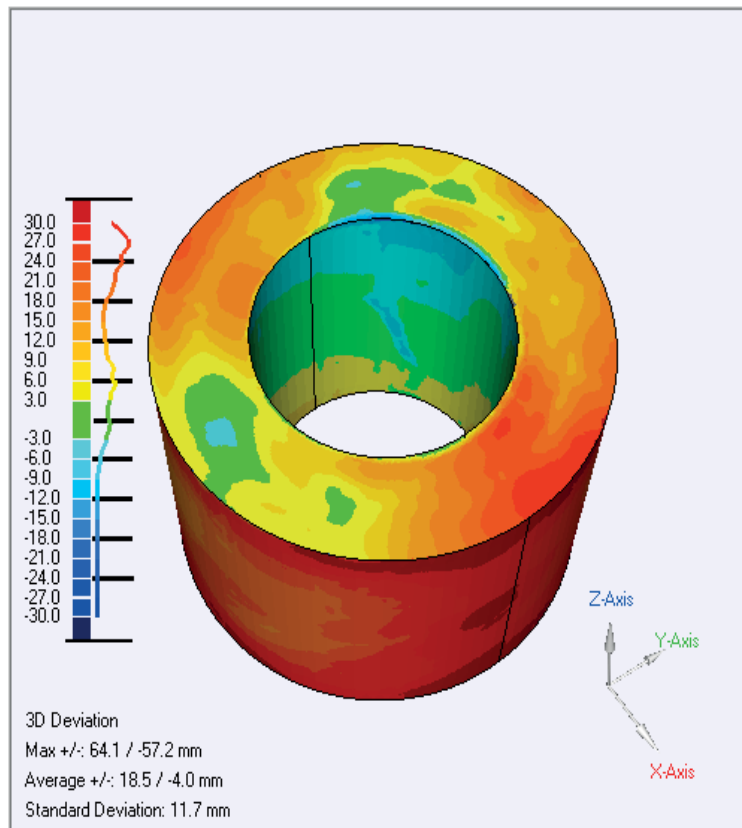

Figure 4. 3D scan for quality control of dimensions of buffer ring produced by isostatic compaction.

Conclusions

During manufacturing of pellets, it was possible to achieve uniform pellets with sufficient crush strength and abrasion resistance, which are important parameters needed in order to avoid breakage during emplacement. It was possible to produce pellets with higher water contents, for instance to 21% with MX-80, when making extrusion pellets compared to roller-compacted pellets. The amount of void space between pellets, when placed as gap filling, was sufficient to allow for rapid water infiltration during artificial wetting.

During manufacturing and storage of EBS components, the relative humidity of the production environment has proven to be important. Raw materials and compacted samples must be protected against moisture at all stages. The suitable relative humidity has been found to be 60-75 % to prevent defects in the blocks.

The results of these studies are used in Posiva's buffer and backfill design work and in preparation for full-scale in-situ demonstrations at ONKALO.

Acknowledgement

The research leading to these results has received funding from Posiva Oy.

References

Holt E, Peura J, 2011. Buffer component manufacturing by uniaxial compression method – Small scale. Posiva Working report 2011-42. 91 p.

Holt E, Sjöblom V, Fortino S, Koskinen V, 2015. Uniaxial Compression of Bentonite Backfill Blocks, from Lab to Factory Scale. Posiva Working Report 2015-xx, 105 p. (draft)

Laaksonen R, 2010. MANU – Isostatic compression of buffer blocks – Small scale. Posiva Working Report 2009-134. 40 p.

Marjavaara P, Holt E, Sjöblom V, 2013. Customized Bentonite Pellets: Manufacturing, Performance and Gap Filling Properties. Posiva Working Report 2012-62, 76 p.

Ritola J, Pyy E, 2012. Isostatic compression of buffer blocks – Middle scale. Posiva Working Report 2011-62. 61 p.

Ritola J, Sjöblom V, Peura J, Sorsimo A, 2015. Quality Control and Testing of Factory-scale Uniaxially Produced Backfill Blocks and Purchasing of Bentonite Pellets. Posiva Working Report 2015-xx (draft).

From ESDRED to NSC, SET and FSS: Fabrication and use of compacted Wyoming sodium bentonite in Andra's sealing experiments

Sébastien Paysan¹, Claude Gatabin²

¹Laviosa MPC, ²CEA/LECBA

Corresponding author e-mail: sebastien.paysan@laviosa.com

Abstract

During the last decades, Andra has studied the ways to upscale knowledge and need from laboratory scale to industrial scale for fabrication of blocks and pellets with Wyoming natural sodium bentonite. The goal has been to develop techniques and equipment for constructing an industrial repository for nuclear wastes disposal in France.

Several 1:1 scale mock-ups have been operated in order to study all the appropriate parameters to be set when fabricating different shapes of blocks by compaction in industrial series with the same material specifications and performances as in the laboratory scale.

Introduction

Four large 1:1 scale mock-ups involving compressed Wyoming bentonite have been carried out by Andra during the last decade.

ESDRED Module 1 fabricated in 2005/2008 18 blocks (pineapple slice shaped), 4tons each, in order to study the possibility of using an engineered barrier of bentonite.

In 2011/2012, the NSC project (Noyau de SCellement - Sealing Core) fabricated more than 200tons of rectangular blocks (300mm x 200 mm x 100 mm), 13kg each, in order to construct and study a gallery sealing core in Andra's URL, 5m in diameter, 5m in length.

In 2012/2013, the SET project (Scellement à l'Espace Technologique - Sealing at Andra's Technologic Centre) fabricated more than 2,000 self-blocking blocks, 6.5kg each, in order to study the emplacement of a hydraulic stop.

In 2012/2014, the DOPAS FSS project (Full Scale Sealing) fabricated more than 1,200tons of pellets, 32 mm in diameter, 45g each, and more than 400tons of crushed pellets powder, in order to construct and test a full scale sealing plug with a volume of 725m³, a diameter of 7.6m and a length of 13.5m.

These four projects showed the way for the industrial fabrication of blocks with Wyoming sodium bentonite, and particularly the most important questions to consider during preparation of the bentonite material and its compressing.

ESDRED Module 1 project



Figure 1. Bentonite ring

Basic parameters:

Material:	Na bentonite + silica sand
Dried mass ratio:	70/30
Unit mass:	4tons
Outer diameter:	2.30m
Inner diameter:	0.70m
Thickness:	0.50m

In order to fabricate such large and heavy blocks by compaction, special and specifically designed tools have been manufactured (compaction, handling, packaging, storing). A central tool was the mould.

The mass of 4 tons per ring block contained a lot of air that had to be removed during the compaction cycle. The mould was designed to take care of this problem and was manufactured with a degassing area at the bottom and connected to a vacuum pump that was turned on during the compaction cycle.

The compaction cycle was carried through in steps with air evacuation sequences between the compaction sequences in order to achieve a uniform density in all parts of the blocks. It was important to find a balanced compromise between good air evacuation and an efficient industrial block production process.

NSC project



Figure 2. NSC blocks

Basic parameters:

Material:	Na bentonite + silica sand
Dried mass ratio:	40/60
Unit mass:	13kg
Length:	300mm
Width:	200mm
Height:	100mm

The main difficulty in this project was to ensure reliable dimensions during the fabrication of the 15,000 blocks e.g. compaction of 200tons of blocks during 15 days. The large quantity of sand, which was part of the used bentonite-sand mixture, wore on the mould and by time the dimensions of the blocks (length and width) increased more and more.

One of the key point to achieve reliable dimensions of the blocks with a low standard deviation (< 0.5%), is a regular control of the dimensions of the blocks during the production and to detect the

moment where the trend of the dimensions is going up. Then a new mould is needed in order to get back to the targeted dimensions.

SET project



Figure 3. SET pair of self-blocking block

Basic parameters:

Material:	Na bentonite + silica sand
Dried mass ratio:	80/20
Unit mass:	2 x 6.5kg
Length:	300mm assembled
Width:	200mm
Height:	100mm

The main difficulties in this project was to achieve a uniform density, even in the tight corner of the blocks, without breaking it during removal from the mould, and to achieve reliable dimensions with low standard deviation in order to provide an optimal self-blocking system in the mock-up, by pushing the second half block with the first one.

In order to ensure a uniform density, the filling of the mould has been arranged with more powder in the tight corner.

DOPAS FSS project



Figure 4. EXPANGEL SP32 pellets

Basic parameters:

Material:	Na bentonite
Dried mass ratio:	100%
Unit mass:	40 to 45g
Height:	32 to 33 mm
Diameter:	32 mm

The main difficulties in this project was to achieve a high and uniform density at a high production rate (1ton/h e.g. 25,000 pellets/h) during the fabrication of 1,200tons of pellets on the allocated time.

The dry density target was to reach more than 2.0 g/cm³ in each pellet.

To achieve such a high density, a low water content (4.5 to 5.5%) was chosen and used in a new roller pressing machine that was able to apply a high pressure at high speed (30 to 32tons of pressure at 10 to 12 RPM).

Pellets have been produced with a dry density between 2.04 and 2.09 g/cm³, always at the rate of 1ton/h (10 to 12 RPM and 36 pellets/RPM).

DOPAS FSS project



Figure 5. EXPANGEL SP32 pellets crushed

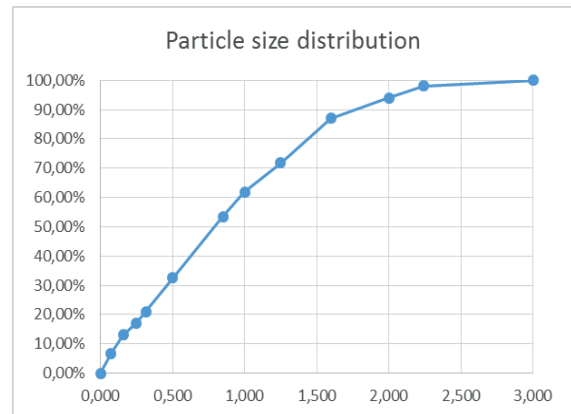

Figure 6. Particle size distribution

Basic parameters:

Material: Na bentonite
Dried mass ratio: 100%
PSD: 0 to 2.5 mm

The main difficulties in this project were to produce a powder with a high bulk density and small enough particle size to fill the voids between the 32mm pellets at an industrial production speed.

The dry density target was to reach at least 1.20 g/cm^3 in each ton produced.

The fabricated powder has been recorded to have a bulk density between 1.25 and 1.30 g/cm^3 , when using pre-compacted EXPANGEL SP32 pellets with high density and crush them to a powder with higher bulk density than the original raw powder.

Laviosa MPC plants localizations and equipment

2 plants are used for compressing the bentonite or the bentonite-sand mixture.

Limay plant (Paris Area) is usually producing bentonite and clays for various types of application such as tunneling, drilling and civil engineering.

This plant is hosting powder mixers, roller compacting presses and crushers.

The powder mixer used in these applications is a horizontal ploughshare mixer, 3,000 liters in capacity, able to mix up to 1,200kg of material. Water can be added to the mixture through 7 nozzles connected to a pump, on the upper part of the mixer.

The roller press used for compressing the 32mm pellets is a 36 stations roller press, 2m in height, 2x2m on the floor, fed by a belt conveyor to fabricate 1ton of pellets per hour.

Saint Etienne plant (Lyon area) is usually compressing refractory materials. It is hosting an uniaxial press with a pressing capacity of 1,600tons, 10m in height, 4x4m on the floor.

When bentonite-sand mixture was used, the sand used was a dry silica sand reference TH1000, with a particle size distribution close to the one of the bentonite (0 – 2 mm).

Conclusions

Each size or shape of bentonite blocks and pellets has its own production process, its own production tips and needs to be the result of a previous development with a preliminary industrial trial set-up.

In the industrial scale, the main difficulty is always to have a reliable process that gives low standard deviations to have the same characteristics on all the series.

So far, all the fabrication processes for block and pellet types that Andra wants to be able to produce at an industrial scale have been established through dedicated development work with due consideration to respect specifications and by adapting CEA/LECBA's and Laviosa MPC's knowledge and experience from production processes already in industrial operation with other materials than bentonite.

Acknowledgements

The research leading to these results has received funding from the European Union's European Atomic Energy Community's (Euratom) Seventh Framework Programme FP7/2007-2013 under grant agreement no 269905 (LUCOEX project) and grant agreement no 323273 (DOPAS project).

Experimental works with bentonite pellets at the CEG

Jiri Stastka, Jan Smutek

Centre of Experimental Geotechnics, Faculty of Civil Engineering, Czech Technical University in Prague

Corresponding author e-mail: jan.smutek@fsv.cvut.cz

Abstract

One of the potential ways in which to achieve the required dry density of bentonite consists of compaction into the form of pellets or granules and it is proposed that such compacted forms will provide a sustainable solution for a variety of applications in the future Czech deep geological repository (DGR) and the multi-barrier system thereof. Recent experimental research at the Centre of Experimental Geotechnics (CEG) has concentrated on the design and testing of bentonite pellets made from Czech Bentonite 75 (B75). Two different technologies are being employed in order to produce the compacted material; the first involves the use of a roller compaction machine and the second a roller mill. Both technologies are capable of producing material with an acceptable level of compaction.

Bentonite pellets will be used for the construction of the sealing layer in the Experimental Pressure and Sealing Plug (EPSP) in-situ experiment currently under way at the Josef Underground Laboratory, in connection with which the material to be used in, and the procedure concerning, construction have already been successfully designed. A further part of the research is aimed at the filling of the gap between the buffer and the host rock in DGR disposal wells. The gap-filling process was simulated employing a small-scale laboratory model. The laboratory experiments resulted in a sufficiently high level of dry density of the emplaced material as required by the design of the buffer currently under consideration for DGR use.

Introduction

The CEG has, for several years, been closely involved in the research and development of engineered barriers containing clay materials intended for use in the future Czech DGR. Bentonite clay, which contains excellent sealing properties, has proven to be particularly suitable in this respect. It is proposed that bentonite will be used as a buffer material surrounding the stored spent nuclear fuel containers as well as for the eventual backfilling of the access tunnels leading to the disposal chambers. Each of these uses imposes different demands in terms of the characteristics of the clay material employed, especially with respect to sealing ability. The compaction of bentonite into pellets or granules is one of a number of potential ways in which to fulfil future DGR requirements in this respect.

Experimental research has been conducted with bentonite pellets, granular bentonite and mixtures of the two for use in different applications, one of which involves the use of bentonite pellets in the EPSP experiment which makes up part of the pan-European DOPAS project (Dvorakova et al., 2014). The second element of the experimental research concerns the filling of the gap between the buffer and the host rock in DGR disposal wells.

Compacted bentonite production process

Czech raw B75 in powder form was selected as the material to be employed for compaction into pellet form. B75 is a Czech calcium magnesium bentonite with a montmorillonite content of around 60% (Hanusova, 2014) extracted from the Cerny vrch deposit (north-western region of the Czech Republic). Previous geotechnical research has successfully demonstrated that B75 might be used as the buffer material in a future DGR (Stastka and Vasicek, 2012). Its sealing properties (hydraulic

conductivity, swelling pressure) have been proven to be highly dependent on compaction level (dry density) and mineralogical composition. Table 1 provides a summary of the basic geotechnical properties of B75.

Table 1 - Basic geotechnical properties of B75 bentonite (average values from the CEG database).

Water content on liquid limit	229%
Water content on plastic limit	65%
Specific density	2.82Mg/m ³
Hydraulic conductivity at 1.5Mg/m ³	5.10 ⁻¹² m/s
Swelling pressure at 1.5Mg/m ³	3MPa
Thermal conductivity at 1.45Mg/m ³ and water content 7.5%	0.4W/mK
Swell index (volume of 2g of B75 following swelling in water)	22ml/2g

Several different technologies concerning the compaction of powdered bentonite were tested during the course of the research and two were finally selected for further experimentation purposes. The first method involves the production of compacted pellets by means of a roller compaction machine. A number of tests were conducted with respect to the manufacture of the bentonite pellets, the main aim of which was to determine the conditions to be employed in order to achieve bentonite compaction resulting in the best possible dry density parameters. Figure 1 reveals the results of the pilot testing process which commenced with a material water content of around 28% with a resulting dry density value of around 1.40Mg/m³. The water content of the material was gradually reduced to a value of 16% which proved to represent the limit of the technological ability of the roller machine employed in the research. The final product (B75 PEL12) with a maximum dry density value of around 1.80Mg/m³ was selected for further experimental testing purposes. The pellets have a diameter of 12mm, a length of up to 40mm and a dry density of 1.82Mg/m³ (Figure 2).

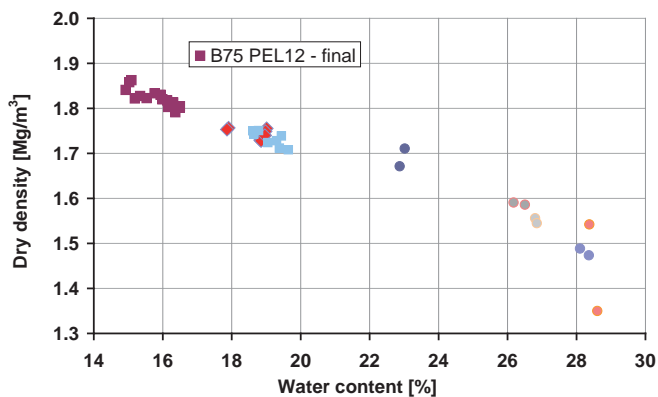

Figure 1. Results of compaction technology testing.



Figure 2. B75 PEL12 material.

The second method considered in the research is based on the compaction of powdered bentonite using a roller mill. The material produced by the roller mill is subsequently crushed and sieved into different grain size fractions. The final product, which featured a good level of compaction and low water content, was named B75 REC (Figure 4); this material is not produced commercially. The results of both of the methods tested are compared in Figure 3.

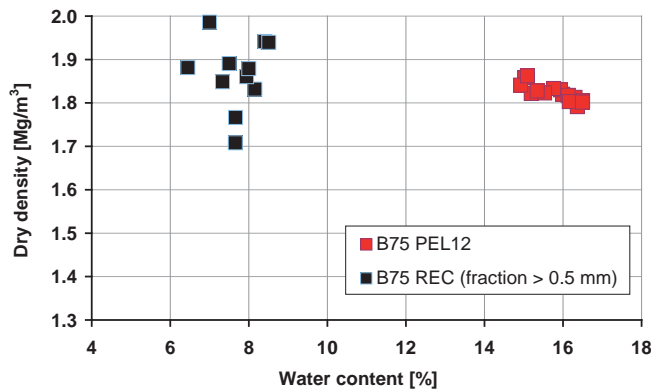

Figure 3. Comparison of the two final products.



Figure 4. B75 REC material.

Experimental Pressure and Sealing Plug (EPSP)

EPSP is an in-situ experiment dedicated to the construction and testing of a sealing tunnel plug for use in deep radioactive waste repositories. The experiment is principally concerned with the fundamental understanding of the materials and technologies to be employed in the future construction of plugs used for sealing purposes in deep repositories. The EPSP experiment is currently under construction at the Josef Underground Laboratory. Figure 5 illustrates the conceptual design of the experiment. The principal structural elements of the experiment consist of two layers of fibre shotcrete enclosing a layer of bentonite; the experiment also features a gravel filtration layer, walls constructed from concrete blocks and an injection chamber. The two-meter long sealing layer will be made up of compacted bentonite pellets, the function of which will be to both absorb and prevent the undesired leakage of water which will flow from the injection chamber through or around the first concrete plug.

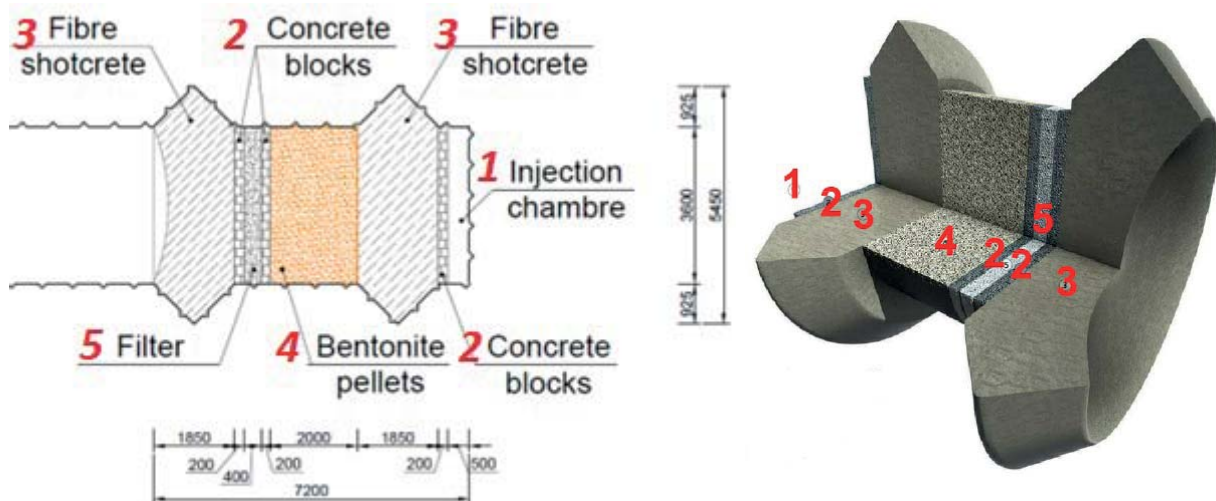

Figure 5. Scheme of the conceptual design of EPSP (Dvorakova et al., 2014).

Based on project requirements, which consist of the bentonite layer, a minimum swelling pressure of 2MPa and maximum hydraulic conductivity of 10^{-12}ms^{-1} , a minimum dry density limit of 1.4Mgm^{-3} was prescribed. Following the intensive laboratory testing of the bentonite material (Vasicek et al., 2014) the testing of techniques to be used in the emplacement of the bentonite commenced. Both of the materials, B75 PEL 12 and B75 REC, were first placed and then compacted in a testing box with a volume of 0.25m^3 using different machines (Figure 6). Because of its higher water content B75 PEL

12 proved to be more suitable for the compaction process. Figure 7 illustrates the state of the material following compaction. Table 2 summarises the dry density results; a limit of 1.4Mg/m^3 was exceeded in all the tests conducted.

The second method employed for the emplacement of the material consisted of spraying technology which has been extensively tested at the CEG in the past (Svoboda et al., 2014); the material used for this method consisted of B75 REC. In this case it also proved possible to achieve the required dry density limit, but it soon became apparent that this method has a number of drawbacks including a high rebound ratio and high dust levels, both of which are limiting factors in terms of use in underground environments.

The planned bentonite emplacement procedure involves the use of vibration machines in most of the gallery profile; the upper parts of the sealing layer will be installed using the spraying method. A total of 36 tonnes of B75 PEL 12 was produced for the construction of the sealing layer. Figure 8 summarises the results of the controlled measurement of water content and dry density taken on samples extracted during the production process which lasted one week.



Figure 6. Compaction testing with a vibrating tamper.



Figure 7. Sample taken from the testing box for dry density determination.

Table 2. Results of compaction tests using the B75 PEL material.

Compaction machine [weight; compaction force]	Average bulk density [Mg/m^3]	Average dry density [Mg/m^3]
NTC compaction plate: 105kg, 20kN	1.67	1.44
Ammann compaction plate: 500kg, 65kN	1.75	1.49
Masalta vibrating tamper: 75kg, 14kN	1.71	1.46

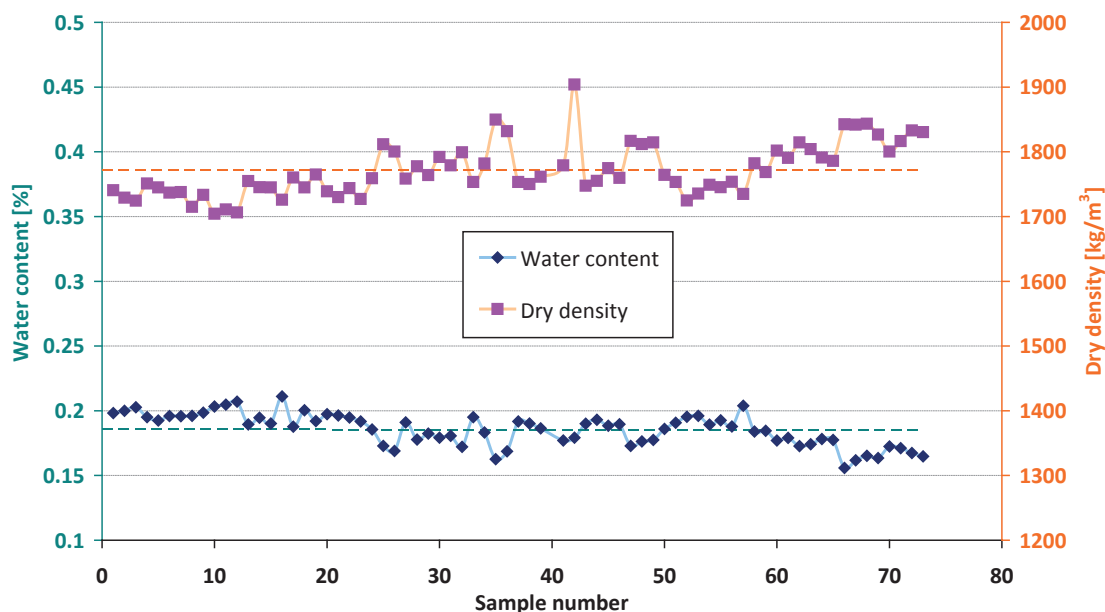

Figure 8. Results of sampling during the production process.

Gap filling

The objective of the research is to investigate both the methods and materials to be used for the filling of the gap between the rock wall of DGR disposal wells and the bentonite blocks which will make up the buffer. The properties of the filling material employed in the gap could have a significant influence on the functioning of the buffer, i.e. unfilled air gaps could significantly affect the temperature within the buffer. The main argument in support of gap filling is that it provides a physical “heat bridge” through which heat produced by the waste container can flow into the host rock.

A small-scale block model has been constructed in order to test and perfect potential gap-filling materials. The model is 35mm wide, 350mm long and has a height of 250mm. Two techniques were employed for the emplacement of bentonite in the model: free fall pouring and free fall pouring with manual vibration. The results of all the tests performed using different materials are summarised in Table 3. The table contains information on the dry density and effective montmorillonite dry density (EMDD) values of the materials used.

First, the model was filled with pellets (B75 PEL 12) and subsequently with two grain-size fractions of B75 REC (0.8-2.0mm and 0.8-5.0mm). The next step consisted of the preparation of a bentonite mixture (named B75 REC 70/30) which is composed of 0.8-2.0mm (70%) and 0.8-5.0mm (30%) fractions. The final phase consisted of the preparation of a mixture (B75 F LAB MIX) according to the Fuller equation in order to achieve the best grain size distribution (Stastka, 2014). The testing box was subsequently filled, using spraying technology, with B75 REC 0.8-5, i.e. the material which will be used in the EPSP experiment.

Table 3. Results of laboratory tests on gap-filling materials.

	Average Dry Density [Mg/m^3] / EMDD [Mg/m^3] / Water content [w]		
Material / technology	Free fall pouring	Free fall pouring and vibration	Spraying
B75 PEL 12	0.98/0.68/16	1.17/0.84/16	---

	Average Dry Density [Mg/m ³] / EMDD [Mg/m ³] / Water content [w]		
B75 REC 0.8-2	1.03/0.73/8	1.21/0.88/8	---
B75 REC 0.8-5	1.07/0.76/8	1.25/0.91/8	1.40/1.05/25
B75 REC 70/30	1.11/0.79/8	1.29/0.95/8	---
B75 REC F LAB MIX	1.21/0.87/8	1.50/1.14/8	---

Conclusions

The CEG, along with its various partners, has developed technologies for the compaction of Czech Bentonite 75 into pellet form. Both of the selected materials (B75 PEL 12 and B75 REC) exhibit good compaction levels and neither of the technologies are limited by quantity production considerations.

The EPSP experiment is currently under construction at the Josef Underground Laboratory and the technology and materials to be used in the construction of the bentonite sealing layer are currently in the preparation stage.

The experimental testing of gap filling using small scale models has provided good material compaction results, which imply that all the filling materials and methods tested under laboratory conditions would result in the sufficiently high dry density levels required by future DGR buffers. However, it will be necessary to verify the use of the tested materials by means of a full-scale physical model.

Acknowledgements

The research is being funded from the European Union European Atomic Energy Community (Euratom) Seventh Framework Programme FP7 (2007-2013) according to grant agreement no. 323273, the DOPAS project.

References

Dvorakova M, Hanusova I, Vencel M, Svoboda J, 2014. EPSP Experiment – Construction of a Plug for a Deep-Seated Radioactive Waste Repository within the Framework of the European Project DOPAS. *Tunel. ITA-AITES*. vol. 23, no. 2, p. 4-10. Available from: www.ita-aites.cz/files/tunel/2014/tunel_2_14-140630.pdf. ISSN 1211-0728.

Hanusova I, 2014. Internal data from the Czech Radioactive Waste Repository Authority.

Stastka J, Vasicek R, 2012. The Development of Clay Barriers for Radioactive Waste Disposal at the Centre of Experimental Geotechnics. In: 21st International Conference on Nuclear Energy for a New Europe: Proceedings. 2012. Ljubljana: Nuclear Society of Slovenia. ISBN 978-961-6207-35-5.

Svoboda J, Stastka J, Smutek J, 2014. Verification of Sprayed Clay Technology with Respect to the Geological Disposal of Radioactive Waste. *Acta Geodynamica et Geomaterialia*, vol. 2014, no. 174, p. 145-152. ISSN 1211-1910.

Stastka J, 2014. Bentonite Gap Filling For High-Level Waste. In SGEM2014 GeoConference Proceedings. Sofia: International Multidisciplinary Scientific GeoConference SGEM. p. 139-146. ISSN 1314-2704. ISBN 978-619-7105-08-7.

Vasicek R et al., 2014. Deliverable D3.17 - Interim results of EPSP laboratory testing, DOPAS project FP7 EURATOM, no. 323273, Prague. 32 p.

FE/LUCOEX: QA/QC during granulated bentonite material production and emplacement

Hanspeter Weber, Benoit Garitte, Sven Köhler and Herwig Müller

NAGRA, Wettingen, Switzerland

Corresponding author e-mail: hanspeter.weber@nagra.ch

Abstract

The Full-Scale Emplacement (FE) Experiment at the Mont Terri underground rock laboratory is a full-scale multiple heater test in a clay-rich geological formation. A natural (non-activated) sodium bentonite from Wyoming was used for the production of the pellets and of the blocks. The production and emplacement of approximately 350 tons of a highly compacted granulated bentonite mixture is described in terms of design parameters and production quality control.

Introduction

The overall objective of the LUCOEX project is the in situ demonstration of the technical feasibility of safe and reliable construction and sealing of repositories for high-level nuclear waste (HLW) and Spent Fuel (SF). Among the four different demonstrators tested individually in this project by each national programme, both the Andra and Nagra demonstrators concern geological disposal concepts in clay formations.

Nagra's repository concept for HLW and SF in Opalinus Clay envisions an array of long (up to 800m) parallel waste emplacement tunnels at a depth of 600-900m containing canisters with a bentonite backfill on bentonite block pedestals.

This demonstration aims to test the functionality of core pieces of the Nagra repository concept (tunnel excavation, emplacement techniques, backfilling) and to understand the THM effects onto the host rock.

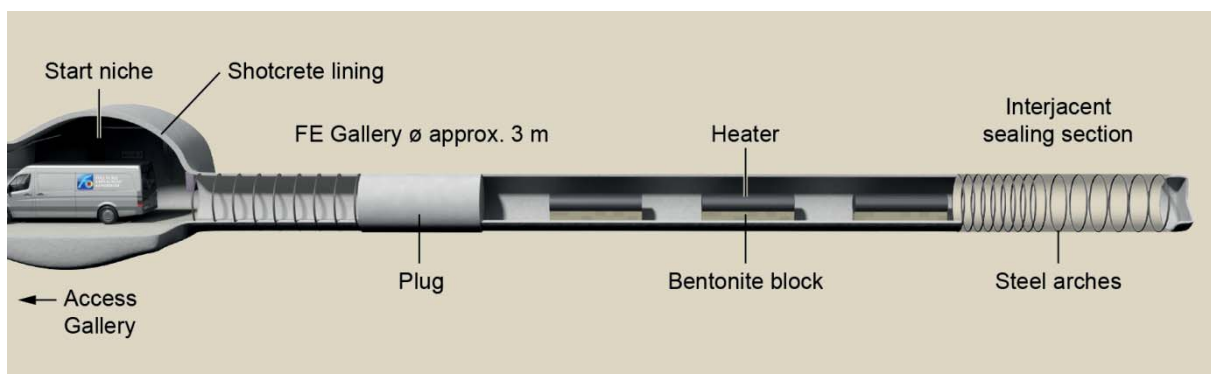

Figure 1. Visualisation of the FE/LUCOEX experiment at the Mont Terri URL. Electric heaters are used to simulate the heat producing waste packages.

Description

Requirements WP 1: Raw bentonite (Brand-name: Cebo National Standard)

The delivery of 350 tonnes raw bentonite has to fulfil the following minimal technical requirements:

Table 1. *Technical requirements of the raw bentonite.*

Criterion	Description
Material	Natural (non-activated) sodium bentonite
Smectite content by dried weight Measured by X-ray diffraction using a dried sample	>75%
Additives (such as Magnetite, Baryte, etc.)	No additives allowed
CEC (Cation Exchange Capacity) (by Cu(II)- triethylenetetramine method)	>70meq/100g
Water content, measured according to the norm ASTM D2216 - 10	<14%
Pyrite content by dried weight Measured by X-ray diffraction using a dried sample	< 1%
Sulphur content by dried weight Measured by emission or mass spectroscopy	< 0.5% (corresponds to approx. 1% of pyrite)
Organic carbon by dried weight Measured by emission or mass spectroscopy	< 1%
Grain size distribution of the delivered raw material according to the norm ISO 3310-1, BS 410-1	Well distributed between very fine and maximum 2mm

Laboratory measurements WP 1: Raw bentonite (Brand-name: Cebo National Standard)

Table 2. *Laboratory measurements.*

Criterion	Description
Material	Natural (non-activated) sodium bentonite was confirmed by x-ray diffraction at different laboratories
Smectite content	Cebo 90%; BGR 88-89%,, see Table 3 below; ETH 78%
CEC	94.3meq/100g ETH
Water Content	11.4% ETH
Grain size distribution	Measurements ETH, see Figure 2 below.

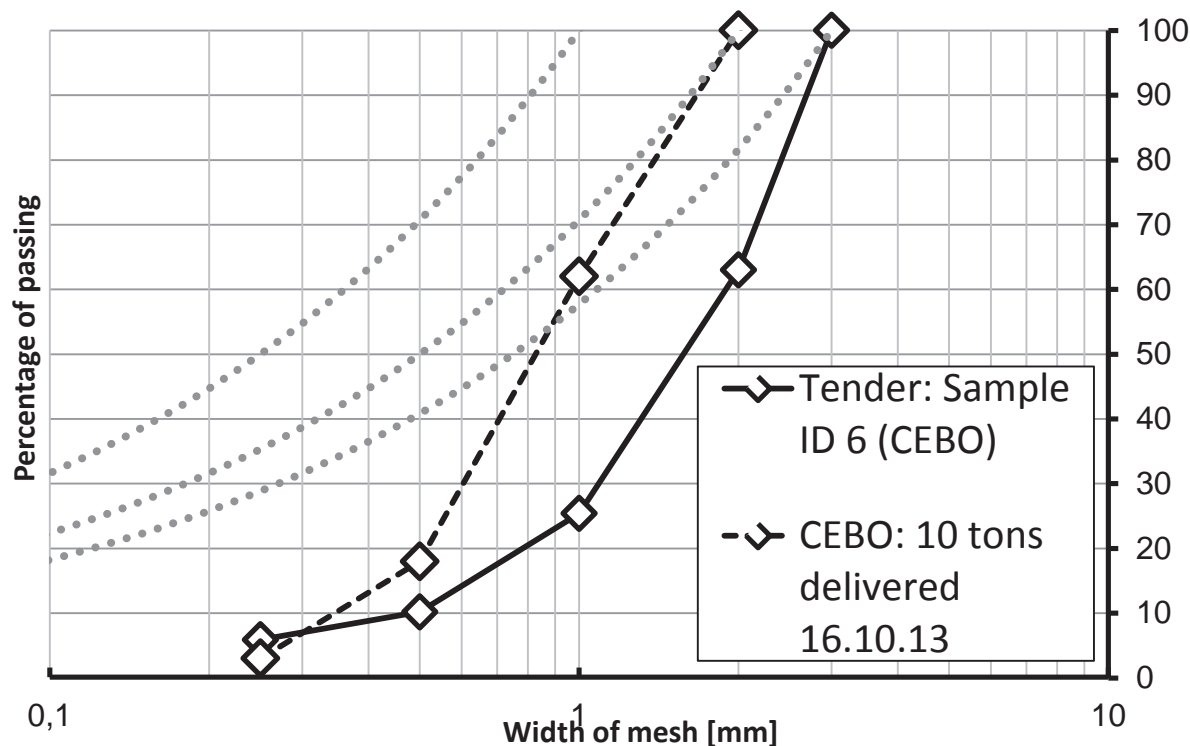

Figure 2. Laboratory measurements at ETH of the produced Cebo raw bentonite. (The dotted lines are Fuller curves (Exponent 0.5) with maximum grain sizes of 1, 2 and 3mm).

Table 3. Laboratory measurements of mineralogical composition of the used bentonite (Analyses by BGR Germany).

Minerals	Crude national standard (%)	pellet fraction A (%)	pellet fraction C (%)
Smectite	89.0	88.9	88.5
Muscovite	0.4	0.4	0.4
Quartz	4.0	4.2	4.1
Feldspar	3.7	3.1	3.4
Gypsum	0.8	0.8	0.8
Pyrite	0.3	0.3	0.3
Calcite	0.1	0.5	0.5
Siderite	1.3	1.3	1.3
Cristobalite	0.3	0.4	0.6

Requirements WP 2: Drying of the raw material (Cebo, Netherlands)

To reach finally a high pellet dry density and a high overall emplacement density the delivered raw bentonite from WP 1 has to be dried down from a water content of about 12% to a lower water content between 4 and 6%.

The maximum temperature the raw bentonite may be exposed to during the drying process is 80°C. Exceeding this temperature may lead to mineralogy changes resulting in a non-appropriate material for our use.

Laboratory measurements WP 2: Drying of the raw material (Cebo, Netherlands)**Table 4.** *Laboratory measurement water content ETH Zürich.*

Criterion	Description
Water Content	6.0% (on the high side of the requirement) ETH
Max. Temperature	The maximum temperature during the drying process did not exceed 80°C

Requirement WP 3: Producing granulated bentonite material (Rettenmaier, Germany)

The dried raw bentonite from WP 2 has to be transformed into bentonite pellets. The pellets have to satisfy the following minimal requirements:

Table 5. *Technical requirements of the granulated bentonite material (pellets).*

Criterion	Description
Dry density of single pellet measured as: - single pellet weight - volume of single pellet (determined with a pycnometer by displacement of a medium which does not intrude the sample pores) - dry pellet 72 hours at 105° - dried pellet weight - dry density = dried weight/original volume	$> 2 \text{ g/cm}^3$
Water content	Between 4% and 6% (as close as possible to that of the material from WP 2). Large changes in direction to higher water contents not allowed during the pelletization process.
Size of individual pellet (characteristic size)	At least one pellet size with 10 - 15mm
Mechanical resistance of pellet	90% out of 30 pellets resist 5 drops of 2m high on concrete floor Other (equivalent and simple) method can be proposed.
Temperature	Max. temperature the bentonite may be exposed to during the pelletizing process: 80°C

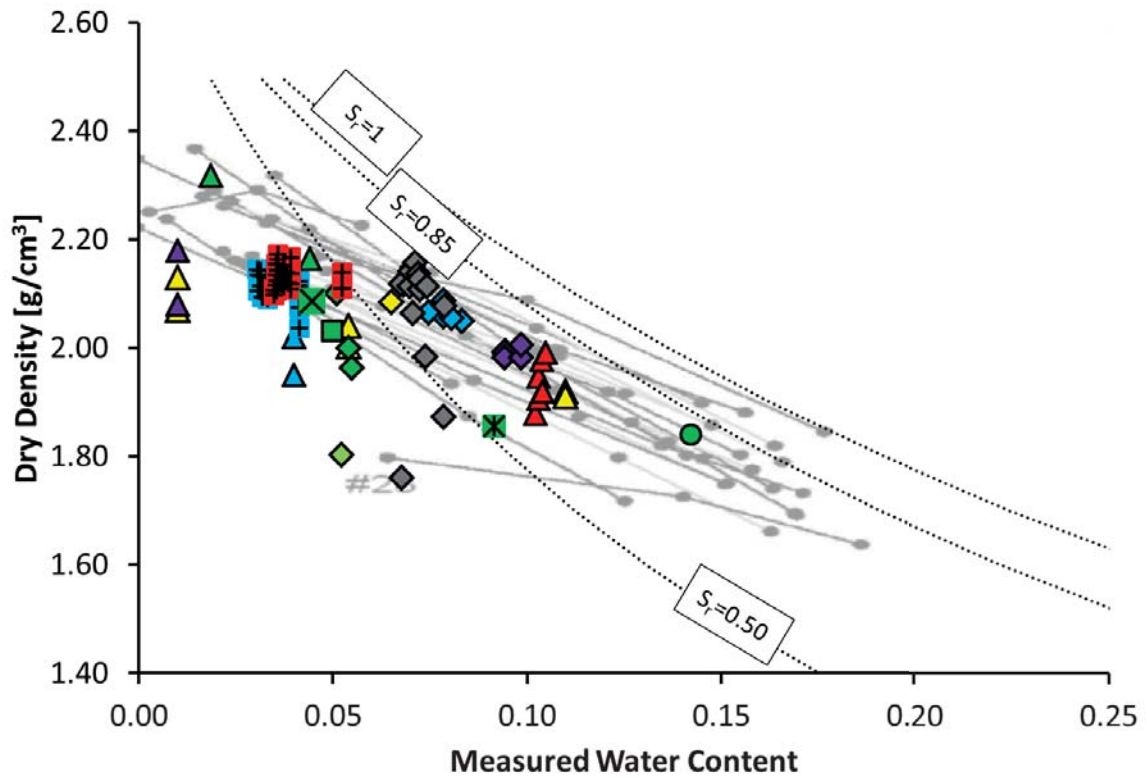

Figure 3. *Laboratory measurements on Wyoming bentonite samples. Relation between initial water content and dry density reached after compaction. Data from pellets produced at Rettenmaier the last 10 years for different Nagra projects with different types of bentonite (dotted lines are water saturation curves).*

Generally with lower initial water contents, higher pellet densities can be reached during compaction. With this type of natural sodium Wyoming bentonite material the optimal proctor density can be reached with a water content of about 4 to 5%.

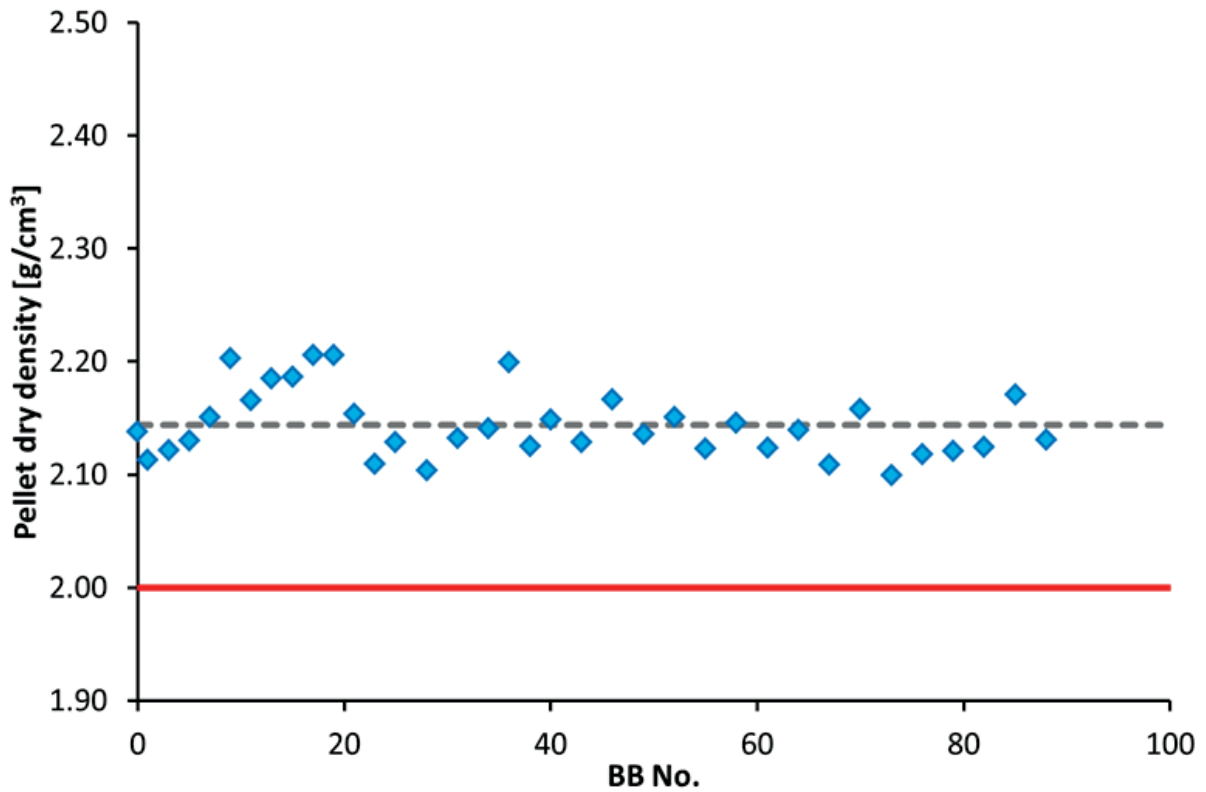

Figure 4. Quality control of the dry density of the produced pellets during compaction with a roller press at Rettenmaier.

Laboratory measurements WP 3: Producing granulated bentonite material (Rettenmaier)

Table 6. Technical requirements of the granulated bentonite material (pellets).

Criterion	Description
Dry Density	2.15 ± 0.04% measurements ETH. A high pellet dry density could be reached, see Figure 4.
Water Content	5.74 ± 0.5% measurements ETH. During the pelletization process the water content could be slightly reduced
Size of pellets	It was difficult to produce pellets larger than about 10mm diameter with an ideal shape close to spherical
Mechanical resistance	The produced pellets were mechanically quite stable

Requirement WP 4: Bentonite pellet mixing to a Fuller type distribution, including rounding of the constituents (Rettenmaier)

The pellets from WP3 have to be transformed in a mixture with the following requirements:

Table 7. Technical requirements of bentonite pellet mixture.

Criterion	Description
Pellets size distribution (mixture) Grain size distribution of the mixture will be verified according to the norm ISO 3310-1, BS 410-1	Fuller type, with $D_{max} = [10-15\text{mm}]$, $n = 0.4$
Shape of the constituents	Rounded and spherical
Water content	Between 4% and 6% (as close as possible to that of the material from WP 3). Large changes not allowed during the mixing process.
Mixture	Homogeneous

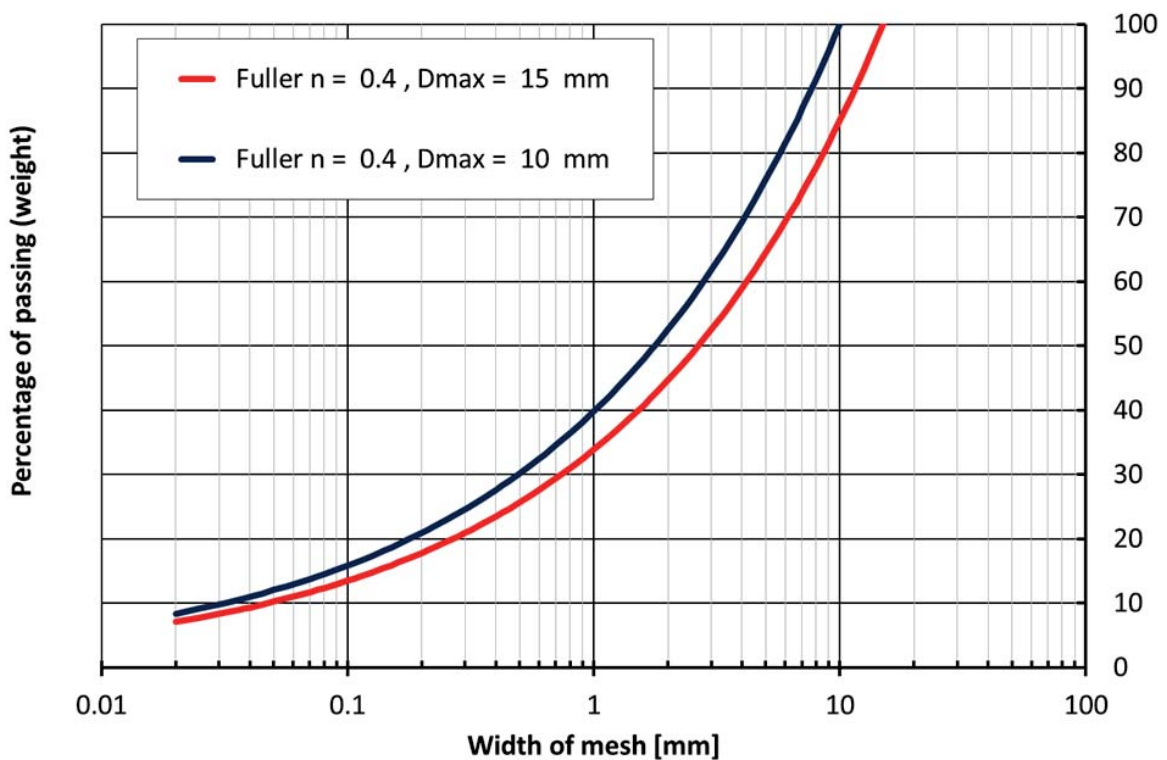

Figure 5. Envisaged Fuller type grain size distribution (Exponent 0.4) with a maximum grain size of 10, resp. 15mm.

Laboratory measurements WP 4: Bentonite pellet mixing to a Fuller type distribution

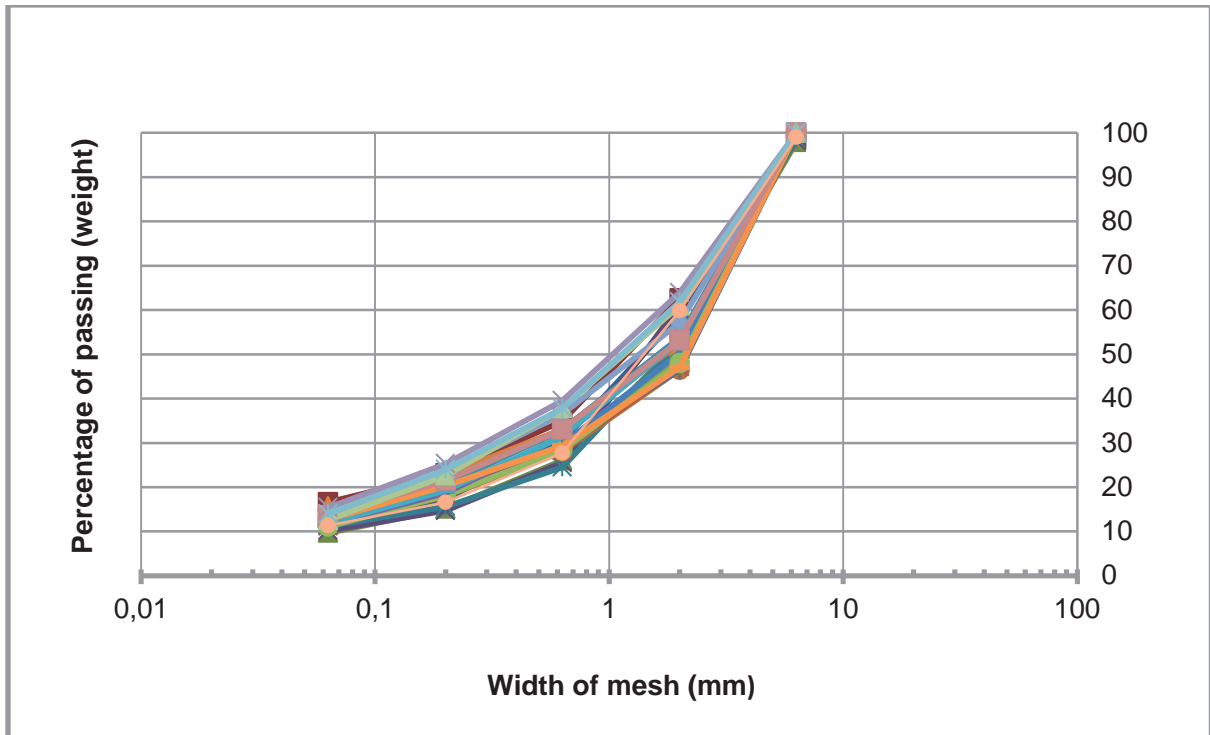

Figure 6. Grain size distribution of the emplaced granulated bentonite at Mont Terri.



Figure 7. Photo of the granulated bentonite mixture produced.



Figure 8. *Photo of granular bentonite emplacement at Mont Terri rock laboratory. Steel canister (Heater), emplacement machine (5 augers), granular bentonite, Tobias Vogt (Nagra).*

Conclusions

Approximately 350 tons of a highly compacted granulated bentonite material was produced under real conditions. The quality was checked during production and emplacement. Parameters like mineralogy, smectite content, water content, pellet density, grain size distribution and cation exchange capacity were determined on a regular QC basis during the production and the emplacement. The results indicated that the production and backfilling of the granulated backfilling material was achieved under full-scale conditions according to the preset requirements.

Acknowledgements

The research leading to these results has received funding from the European Union's European Atomic Energy Community's (Euratom) Seventh Framework Programme FP7/2007-2013 under grant agreement no 269905 (LUCOEX project).

Reference

Garitte B, Müller HR, Weber HP, 2015. Requirements, manufacturing and QC of the buffer components (blocks and pellets). LUCOEX EC Delivery D2.03 in preparation. Nationale Genossenschaft für die Lagerung radioaktiver Abfälle (Nagra).



EUROPEAN
COMMISSION

Community research



This Project has received funding from the European Union's European Atomic Energy Community's (Euratom) FP7 under grant agreement n°269905, the LUCOEX project.



(GRANT AGREEMENT: 269905)

DELIVERABLE (D-N°:D1:13)

LUCOEX END CONFERENCE - Observations of Scientific Rapporteurs

Author(s):

Lumir Nachmilner, Consultant

Wilhelm Bollingerfehr, DBE

Date of issue of this report: **01/09/2015**

Start date of project: 01/01/11

Duration: 56 Months

Project co-funded by the European Commission under the Seventh Euratom Framework Programme for Nuclear Research & Training Activities (2007-2011)		
Dissemination Level		
PU	Public	PU
RE	Restricted to a group specified by the partners of the LUCOEX	
CO	Confidential, only for partners of the LUCOEX project	

LUCOEX



Contents

1	Introduction.....	2
1.1	Session 1: National Programmes of DGD	2
2	Session 2: Full scale tests.....	3
2.1	Backfilling & sealing.....	3
2.2	Instrumentation and monitoring issues	3
2.3	Heating	4
2.4	THM-Modelling.....	4
2.5	Planning and installations.....	4
2.6	Highlights.....	5
3	Session 3: Excavation of Tunnels and Drifts	5
3.1	Important messages:.....	6
4	Session 4: Production of Bentonite Blocks/ Granulates.....	7
4.1	Manufacturing issues	7
4.2	Lessons learnt.....	7
5	Poster Session.....	7
6	Panel Discussion	8

1 Introduction

The conference and workshop was opened by Magnus Westerlind, SKB, and then followed by a keynote speech of Christophe Davies, EC, who presented news from the European Commission with regard to ECs Energy Policy as a reaction on Climate Change. On basis of this policy the R&D-Programme HORIZON 2020 was set up two years ago, which he explained in detail and eventually promoted participation in the next call for proposals at the end of the year. He emphasises that EC continuously did and will support national programmes on geological disposal by providing budgets for RD&D; and he underlined that IGD-TP has a key role to play in the evolution of EC RD&D policy.

1.1 Session 1: National Programmes of DGD

Session 1 consisted of 4 presentations all of them dealing with the status of the National Programmes of Deep Geological Disposal (DGD). Two presentations were dealing with Deep Geological Disposal in crystalline rock whereas the other two were describing the programmes for a DGD in clay formations.

SKB described the Swedish spent nuclear fuel repository project development from the beginning in the late 1970ies until the status as of today. Eventually, in 2010, Forsmark (host rock: crystalline rock) was selected by SKB as a suitable site. The following year, the license application was submitted and is currently being processed. Start of repository operation is expected in 2029. Two main challenges were mentioned. On the one hand side the flexibility of the licensing process with regard to conceptual modifications is an important issue which requires appropriate timing. Despite of the strong public support (85%) today the challenge will be to keep a continuity of the support in particular during the phase of industrialisation of the facilities and the programme.

Posiva gave a presentation of the Finnish waste management programme for spent nuclear fuel from the beginning until today. The programme started in the late 1970ies with preliminary studies followed by a site selection process and the decision on the site Olkiluoto in 2001. In 2012, the application for the construction of the repository was submitted; a decision is expected in autumn 2015. In the course of the discussion with the authorities STUK requested an RD&D-plan on demonstration tests. These tests are being or will be performed in ONKALO. The challenge will be to successfully demonstrate safe and reliable waste package transport and emplacement as well as suitable plugging and sealing systems. Important news is the decision to use a shaft instead of a ramp for the waste package transport.

ANDRA described the evolution of the French waste management programme which considers the disposal of reprocessing waste only. The potential site in a Callovo-Oxfordian (COX) clay formation will be in the vicinity of the URL at Bure. An appropriate repository project- called Cigéo – was launched. This includes siting in the context of public participation as well as industrial preliminary repository design. In 2017, this design will be accomplished and the application for license will be submitted. The URL Bure is and will be used to qualify the processes and technologies and to perform investigations at an industrial scale. The major challenges are the setup of a detailed RD&D-programme which includes the waste transport and handling demonstration tests under real repository conditions. The industrial pilot phase of Cigéo is of uppermost importance and will start in 2015 followed by the first emplacement in 2028.

NAGRA presented in detail the approach to how to find a site for a Swiss HLW repository and explained the status as of today. In 2008 a new site selection process (sectoral plan) was launched which first started with the definition of rules and the agreement with stakeholders on their participation. The stepwise approach led to 6 potential regions in phase 1 and in dialogue with stakeholders in two of the regions in the following phase 2. A decision of the government for the next phase is expected in 2017. The most important lessons learnt were that a strong driver of the repository site selection and implementation process is required to keep the programme on track. And the involvement of stakeholders is very important. The stakeholder engagement may have impact on the decision of single repositories for ILW and HLW or a combined repository for both waste categories.

2 Session 2: Full scale tests

Session 2 consisted of 12 presentations describing LUCOEX, DOPAS, PRACLAY and FEBEX experiments; links to MODERN programmes were also discussed. The fact that results of different programmes are presented at a special event devoted to a single EC project is seen as positive; DOPAS & LUCOEX experiments are complementary, their results are to be shared. Interesting is also confrontation of nearly completed long term FEBEX with newly starting experiments.

Presentations delivered treated the following topics:

2.1 Backfilling & sealing

Performed experiments have served to demonstrate the technologies to manufacture, handle and place the sealing components of the disposal system. This has included the development of the necessary equipment and relevant procedures.

The experience gained has resulted in optimisation of material composition to achieve better performance during manufacturing, storage, handling and placement of the sealing components. Bentonite sensitiveness to humidity is a well-known issue; however, some ways how to manage this problem were reported, including adoption and control of the manufacturing/handling procedures, optimising bentonite water content and the relative humidity of the air, the density and the grain size (see also presentations delivered within the Session 4). It has also been identified that rings and end blocks around canisters should preferably have harmonised water contents in order to improve handling and storage. Indications are that this should be possible with the bentonites currently used.

To achieve the required final homogeneous density of bentonite backfill, grain size and dry density of the used pellets need to be optimised and homogeneous material be used. Certain local variations (e.g. between bottom and roof section, and between different batches) have not had impact on the target average density of the whole seal. It was recognized during testing campaigns that the swelling effect of bentonite was slower than anticipated. The role of systematic pre-testing is vital for the successful emplacement procedures during the full size experiment.

Technologies for the emplacement of sealing materials, both in powder/pellet and block forms has been developed and proved. However, some findings (e.g. wear of screw conveyors) have indicated the need for further optimisation of these technologies and the equipment involved. They may result in changing equipment designs and optimising the procedures applied.

The use of very big blocks, over 2.3 meters in diameter, has not been seen as an optimal method for backfilling of horizontal emplacement tunnels in clay due to handling difficulties and the need to fill in gaps between the blocks and the rock surface which is not normally smooth and regular. In such case, the use of continuous mixture of pellets and powder seems to be more feasible. Another direction to be further investigated consists in the selection and perfecting of excavation tools and methods to achieve better contact between the seal and rock.

The major achievements could be formulated as follows:

- Design basis for plugs/seals have been developed – the proven approach and methodology are applicable to other repository elements
- Feasibility of full scale sealing has been demonstrated, and
- Manufacturing and handling large sealing components has been found feasible.

2.2 Instrumentation and monitoring issues

The major problem regarding monitoring the system performance in these experiments is the limited longevity of the sensors and especially the wireless technology that have been utilized. Therefore, it has

been deemed necessary to install spare wires and sensors to ensure that experiments can be evaluated and interpreted during their whole duration (1-2 decades).

Specific materials and designs are needed for better performance of sensors, specifically to improve the temperature and corrosion resistance. In particular, the energy supply to sensors and transmitters for decades is still a challenge. Wireless transmission and the use of fibre optic cables are potential promising solutions but they need more development, specifically for maintaining their function over period of a couple decades.

Radiation effects are not considered for the current systems, however, in future monitoring of real disposal system it will also be a challenge.

There is still contradiction regarding timing: while monitoring of a closed disposal system can work for some decades, the real disposal system will reach equilibrium after centuries. Hence, there is a need to arrive at a common opinion on whether to monitor and, if affirmative, what, why, and how to do it.

Monitoring approaches have been and are being more elaborated within the EC MODERN projects: the tight cooperation would be beneficial for participants of both projects.

2.3 Heating

The heating sequence of experimental systems has not followed real anticipated conditions: the thermal load increase was controlled in steps to better understand the system performance and response under elevated temperature; it has been found satisfactory and the THM response to heating was under full control. Nevertheless, the thermal shock of host engineered and natural systems when disposing real container would need also to be investigated.

It shall be noted that the 'historical' temperature limit of some 90 °C for bentonite sealing has been challenged: instead, the overheating to some 130-150 °C with the evaluation of functional consequences for the disposal system is a new – and positive - strategy in some concepts.

2.4 THM-Modelling

THM modelling is generally considered as a tool supporting repository design. In particular, modelling is part of the pre-testing experiments: the values predicted were mostly consistent with real measurements in small scale. However, some discrepancies were found in modelling of the near-field of the full scale experiments where the swelling in real systems is slower than anticipated, thus, full scale experiments may require artificial watering of the bentonite layer. Comparison of mathematical predictions with real system performance will certainly help in validation and optimisation of the used modelling approaches.

Another issue requiring attention is that a real system will be affected by overlapping thermal fields from individual disposal cells where the bigger thermal gradient could create more severe consequences.

2.5 Planning and installations

A good example of systematic planning of large scale experiments has been demonstrated at starting DOPAS, terminating FEBEX, and delayed PRACLAY projects: all these approaches can be effectively shared with less advanced programmes.

Within DOPAS, design bases for plug/seal demonstrators were defined and iteratively developed prior the start of experiments and collated for each DOPAS experiment. They include information on safety functions for particular host rocks, requirements on hydraulic, chemical and mechanical performance and on gas migration, operational constraints, working practices, environmental conditions/impacts.

One of the first full scale experiments, FEBEX, was initiated in 1995 by ENRESA. Heating started in 1997, a part of the experiment was dismantled in 2002 and the remaining part is to be dismantled in 2015. Planning for dismantling started together with modelling predictions of the system performance based on partial dismantling experience. Detailed planning was initiated some 2 years prior anticipated start. It was broadly

discussed among involved organisations and, later, also with new invited partners. As a result, the detailed plan for dismantling operations and sampling was proposed considering principles and experience from 2002 dismantling.

The PRACLAY test had originally to start in 1995, but it was delayed due to the necessity of the sinking of the 2nd shaft, waiting for bentonite hydrating, etc.; as a result, heating was initiated in 2014. As a consequence, experiment conditions and ideas were changing over time (design, staff rotation, material demands, availability of contractors, regulation evolvement). The key issues to be maintained included the need for keeping knowledge (knowledge management), assuring continuity of the staff capabilities, and the management of requirements. The most challenging was to keep track of all documents and information collected in preparatory stages of the document. Bentonite hydration was slower than anticipated. Any planner should be aware of this uncertainty, perform numerical simulations of the test and verify it based on collected data; these uncertainties should be included in planning. There have been financial consequences as well: any delay increases the costs (staff must be paid without interruption), on the other hand, delays allow for re-launching of tenders if a contractor is too expensive. The preparation phase consisted of the mobilisation of data management tools, numerical analysing of the system evolution, and establishing procedures for managing the test and follow-up actions.

2.6 Highlights

In situ large scale tests in URLs are expensive but needed to confirm THM-model-predictions and to identify weaknesses of the disposal system.

The results obtained during the preparation and initiation of full scale tests indicate that the selected approaches provide feasible solutions and sufficient answers for determined tasks; identified challenges provide a shopping list for future activities. A question arose to what extent experiments should and could represent real repository conditions.

The gained experience provides bases for optimisation of technologies and equipment.

Thorough planning is a key to the successful implementation of experiments (it shall include responsibility, allocation, procedure definition, control mechanisms and risk assessment)

There is a clear need for keeping know-how and continuity of the staff involved: the experiments may last up to 2 decades from the first idea to the final evaluation of the measured data.

One important issue seems to be keeping track of all documents and information (knowledge management) – appropriate measures shall be installed from the very beginning of the project to ensure its successful implementation and evaluation.

All large scale experiments have faced some delays – the thorough analysis of reasons and responses would help in planning future experiments and DGR construction.

Future activities will focus on optimising excavation and emplacement methodologies and relevant equipment, engineered barrier material performance, and increasing the monitoring capabilities in disposal systems.

3 Session 3: Excavation of Tunnels and Drifts

Session 3 consisted of 4 presentations on experiences gained during excavation work and on wire sawing in the URLs Mt Terri (Switzerland), Bure (France) and Äspö (Sweden).

The FE experiment tunnel excavation at the URL Mont Terri was successfully performed with standard mining equipment (e.g. pneumatic hammer and road headers). Daily geological mapping was a part of this activity as well as the installation of an adequate monitoring system. The real challenge in the process of

preparing the FE experiment tunnel for utilization over a couple of years was the installation of the liner in particular the shotcrete liner. Several attempts were necessary to be successful.

The host rock at the URL Bure (as well as that of the expected site for the French repository Cigéo) is COX-clay. In total 5 shafts, 2 ramps several kilometres of connecting tunnels and approx. 1400 HLW emplacement cells (horizontal boreholes with 100cm diameter and 100m length) have to be excavated. Excavation exercises at dedicated test areas in the URL Bure were performed to learn and to investigate to what extent the selected technology can be transferred to the real repository. State of the art technology was applied like drill and blast technique, TBM, road headers and micro-TBM to excavate the openings and to construct liners (bolts, shotcrete and steel liners). Main challenges were the proper functioning of the TBM in COX clay (no experience available) and the speed to insert steel liners into the horizontal boreholes because of the fast creep behaviour of the COX clay.

As an alternative to the reference disposal concept KBS-3V SKB and Posiva do analyse the possibility of disposing Supercontainers into long horizontal boreholes, KBS-3H. For this purpose drilling of horizontal 300m boreholes with large diameters (1,85m) is necessary. The first experiments in this regard were performed in 2005 at the Äspö HRL. This drilling technique is not standardised and requires a step wise approach (test drillings/core drillings followed by extension drillings) and a series of deviation measurement and steering equipment to keep the drilling on track without deviations in vertical and lateral directions. This drilling technique cannot be applied in clay or salt formations.

In the context of optimizing the excavation technique in crystalline rock in particular in the vicinity of positions for plugs and seals SKB did investigate the wire sawing technology at the Äspö URL. Advantages were expected regarding more precise drift and tunnel surfaces, less impact on the EDZ of the tunnel contour, and saving money. At the end of test campaigns it was concluded that further development and testing is necessary to optimise the wire sawing technology.

3.1 Important messages:

- It was emphasised that a careful analysis of the geological environment at the URL test site is needed to be able to transfer the achieved results to other potential sites of a repository. By this procedure surprises can be avoided (e.g. excavation in faulted areas, anisotropic behaviour, etc.).
- The excavation of different types of openings in hard rock by appropriate technical means is state of the art: e.g. tunnel boring machine (TBM) or road headers for large drifts/tunnels; micro-TBM for emplacement cells. However, there are only few experiences in excavating tunnels and drifts in clay formations (e.g.: COX clay). Known and unsolved challenges still are the opening/excavation of tunnel-liners after long periods of time because of the time dependent increase of rock-pressure behind the liners and the concurrent activities of drilling horizontal emplacement cells and insertion of steel liners into the cells.
- Horizontal drilling of 300m boreholes in crystalline rock requires detailed preparation and a stepwise approach. Lessons learnt from test drillings at Äspö showed that pilot drilling with a small diameter (76 mm) can fulfil the requirements with regard to minimum longitudinal deviation (over a 100 m length scale so far). The (76 mm) pilot boreholes are planned to be stepwise reamed up to full drift diameter (1,85m). Further tests are necessary to demonstrate the accuracy for 300m long boreholes as well.
- For excavating tunnels in crystalline rock wire sawing appeared as a possible alternative. In contrast to the standard technology of drill and blast; this technique enables creation of tunnels with even and smooth rock surfaces (e.g. floor to drive on) and tunnels without lock-outs in roof and walls (facilitates more efficient backfilling). However, further development work and testing is necessary to optimise this technology.

4 Session 4: Production of Bentonite Blocks/ Granulates

Session 4 consisted of 6 presentations describing the production of bentonite blocks and granulates as backfill and sealing material for HLW-repositories in crystalline rock and clay formations.

4.1 Manufacturing issues

The water content in the bentonite is the main factor influencing the quality of blocks and pellets. Achieving the required dry density of bentonite requires optimisation of water content in compacted mixture respecting also requirements for storage conditions because of the hygroscopic material behaviour. A concept based on equilibrium of water content in blocks to the air humidity has brought positive and promising results.

Water content of the bentonite mixture was selected different for different purposes: this requires optimising manufacturing conditions for each particular purpose and bentonite block type. Also, equipment for bentonite transport needs to be selected with respect to its water content (e.g. clogging up screw conveyor while higher humidity material is transported).

All experiments used bentonite prepared in pilot plant or improvised industrial (= non-standard) conditions: the quality of products might differ according to the quality of input material (water content, homogeneity, or recycling of used bentonite) and reproducibility of the manufacturing process. It is anticipated that bentonite produced in an industrial scale will have more standard quality.

4.2 Lessons learnt

Due to the high sensitivity of bentonite to conditions under which blocks or pellets are produced and stored effective QA/QC measures have to be established and maintained. These measures are vital for the product quality and they must be set as a part of the manufacturing and handling technology development.

The technology (process and equipment) of block production still needs further development to keep the standard quality of the product.

Production of pellets/granulate is less challenging, however, the quality of raw bentonite is critical for the material production: e.g. bulk storage of raw bentonite results in more homogeneous product comparing to bags storage (different humidity of each batch).

Decision on whether to use isostatic or uniaxial compaction does not have clear bases: in both cases the required quality of blocks can be achieved. Each method has its pros and cons regarding the production rate, the need to further process produced blocks, and the control of optimal water content for reaching the required density.

Each size/shape of bentonite product requires its own manufacturing technology (process & equipment). The main challenge is to ensure keeping prescribed quality of the product and minimise any deviations.

Determination of design criteria for the input material and the final product is the basis for the establishment of an effective QA/QC system. As bentonite materials are vital for repository backfill and sealing concepts the production process has to be developed to an industrial standard reproducing the required bentonite quality in appropriate quantities.

5 Poster Session

About 30 posters were shown in a dedicated poster session. They provided complementary information and technical details extending information presented by conference speakers, as well as overview summaries of some national programmes/concepts, and projects LUCOEX, DOPAS. They contributed to delivering the conference key messages indicating that full scale experiments are needed:

- to fully understand principles of material behaviour (in particular bentonite) in repository conditions,
- to identify and fully understand responses of the host rock to construction and operation of a DGR,
- to verify management of repository construction processes (construction and QA measures) under repository like conditions,
- to test the reliable and safe operation of transport and emplacement technique, and
- to develop and validate monitoring approaches for the assessment of the disposal system performance.

6 Panel Discussion

As an introduction a presentation of a master thesis was given by Ann Caroline Wiberg on the Utilization of LUCOEX-results for others. The message she gave was that all LUCOEX results are valuable back-bones for the evolution of country specific waste management programmes.

Prior to the panel discussion four presentations from WMOs representing programmes in less advanced programs (SURA0: Vitezslav Duda; PURAM: Kalman Benedek; INR: Marius Iordache; RWM: Robert MacLavery) were given on their national programme status and plans related to large scale /full scale experiments. They all stressed that international cooperation is a key facet in research strategy and that URL Research can help to achieve progress in national WM programme. To a certain extent they do operate national URLs like SURA0 does in the Joseph-Gallery. All of them expressed the strong wish to benefit from achievements in particular from EU funded RD&D projects. In addition it was mentioned that they are interested in information exchange / cooperation / participation in future RD&D-actions. In this context a few points of particular interest were mentioned e.g. waste package storage, waste treatment, repository concept development, plugging and sealing, and disposal programme planning.

The five panellists (Johanna Hansen, Jean-Michel Bosgiraud, Alan Hooper, Stig Pettersson and Tim Vietor) were discussing pros and cons of Full Scale Tests in URLs. All the panellists are experienced scientists and engineers and familiar with the complex and time consuming work of developing and testing of new materials, processes, techniques and equipment. They commonly listed the convincing arguments/reasons (**pros**) for performing/ participating in large/full scale tests:

- cost saving: access to documented data (open platforms), participation in existing URLs instead of constructing own facilities (large or small size), conformation laboratories vs generic laboratories,
- confidence building: people can get in contact with repository components prior to repository construction and operation, proper scientific work,
- staff training (security issues, mastering of procedure, knowledge transfer),
- development of quality management systems for repository construction and operation/closure, and
- operational safety: full-scale tests provide realistic data on reliability and safety of repository components and techniques, avoiding surprises and malfunction in real repository construction /operation (early involvement of safety authorities).

However, a few arguments against (**cons**) performing/ participating in large/full scale tests were mentioned. All these are more or less commercial aspects; like the need of early investments, the share of financial burden, the approach that with time technologies might be state of the art an could be bought on market.

LUCOEX - LARGE UNDERGROUND CONCEPT EXPERIMENTS

GEOLOGICAL DISPOSAL

In the last decades, a variety of radioactive wastes have been produced. This includes a significant amount of high-level long-lived waste. This is waste that must be isolated and stored in hundreds of thousands of years before it is safe for exposure to humans, animals and nature. One way to make this possible is by geological disposal. Studies have shown that it is the safest way to take care of the high level waste with today's technology. The method means that the waste is placed several hundred meters underground surrounded by multiple barriers.

Currently, there is no active geological repository in Europe for this high level waste but the IGD-TP's goal is that the first shall be operational before the year 2025. Several studies and experiment are ongoing at different sites in Europe where the goal is to find a custom-made concept that will suit for each country in need of a geological repository.

THE LUCOEX PROJECT

The purpose of the LUCOEX project is to demonstrate the technical feasibility in situ for safe and reliable construction, manufacturing, disposal and sealing of repositories for long-lived high-level nuclear waste. The project involves four nations in Europe; Sweden, Finland, France and Switzerland. For each of the proof-of-concept installations, there are various focus areas and geological conditions.

One of the objectives is also to investigate how other country in Europe could use the knowledge and conclusions reached in the experiments. (www.lucoex.eu)

HORIZONTAL DISPOSAL IN CALOVO-OXFORDIAN CLAY

The objective with the experiment in Bure is to optimize the design of the French repository concept for high-level waste disposal. This includes a complete installation.

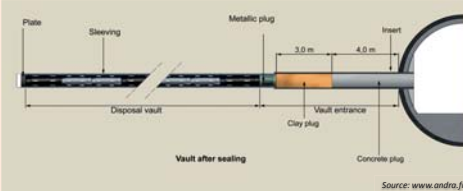

HORIZONTAL DISPOSAL IN OPALINUS CLAY

The objective with this Full Scale Emplacement Experiment is to confirm the sustainability of the Swiss repository concept in Opalinus Clay for high level waste disposal.

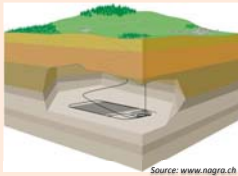

LUCOEX-SITES AND

SUITABLE BEDROCK FOR GEOLOGICAL DISPOSAL

- Crystalline hard rock
- Clay
- Salt

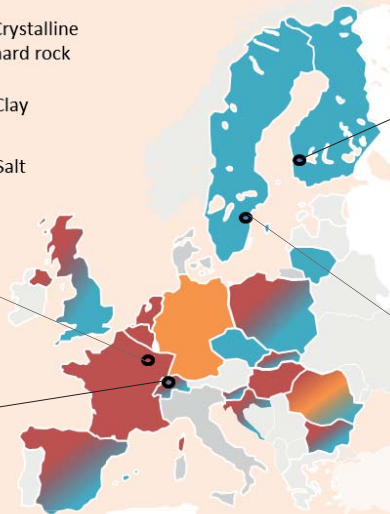

The map illustrates the EU member states which are considering a geological disposal, their main rock type and the different localizations for the LUCOEX project.

VERTICAL DISPOSAL IN CRYSTALLINE HARD ROCK

The objective with this experiment is to develop necessary machinery and a quality control programme. The programme includes problem management for the installation of the buffer in vertical deposition in crystalline rock.



HORIZONTAL DISPOSAL IN CRYSTALLINE HARD ROCK

The objective with this experiment is to verify horizontal design for the high-level waste repository concept KBS-3. KBS-3V is SKB's reference design and KBS-3H is an alternative design which is being researched.

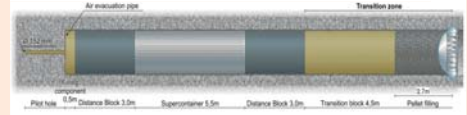

HOW FAR THE MEMBER STATES HAVE COME IN THEIR REPOSITORY WORK

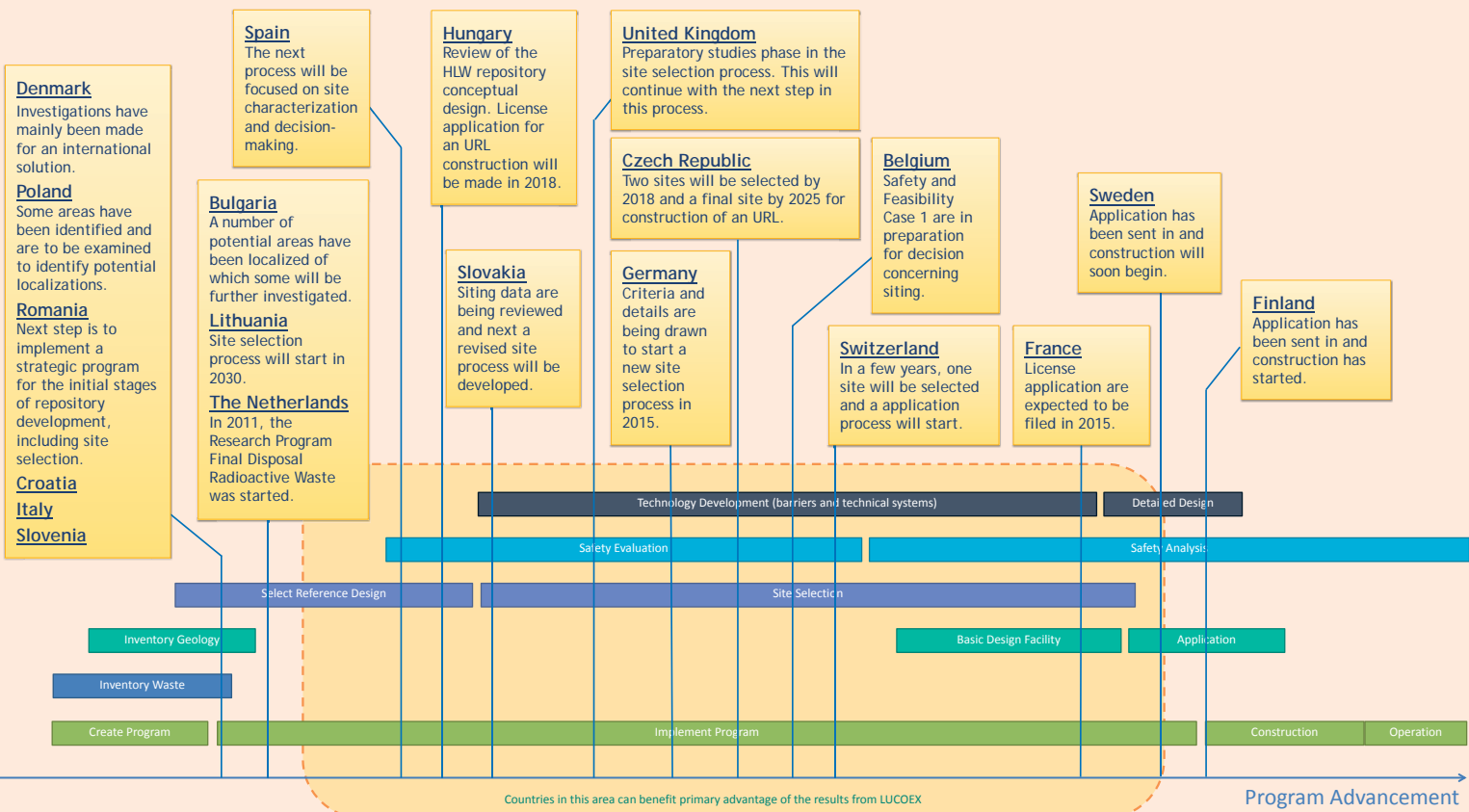

INTRODUCTION

According to Andra's concept, a high-level waste (HLW) cell is an about 80m long micro-tunnel with an about 0.7m diameter. It consists of a body part (where packages are stored) and a cell head.

The cell head is separated from the body part by a steel radiological protection plug. It has a steel liner ("insert") containing a swelling clay plug pressing against a concrete plug, which closes the cell.

The body part has a non-alloy steel liner and an "end plate". The diameter of the body-liner is smaller than the diameter of the insert in the cell head. This telescopic arrangement is required to be able to handle the thermal elongation (caused by the rise in temperature due to the exothermic waste packages). The thickness of the liner is designed to maintain its structural integrity over a 500 years period.

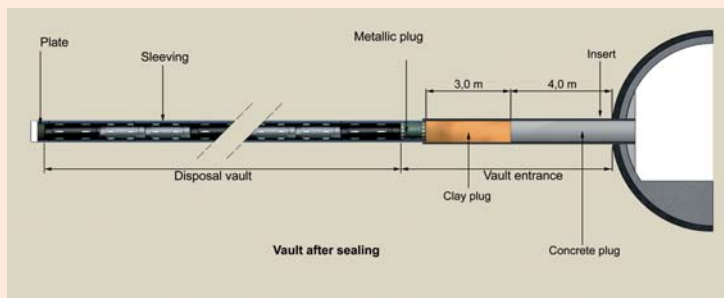

Objectives of the ALC full scale emplacement experiment are:

- to excavate a cell demonstrator representative of the HLW storage cell reference concept
- to simulate the thermal load induced by waste packages using electrical heaters
- to study the TM behavior of the steel liner (body part and insert), and the operation of the cell head (dilation of the cell body and sliding into the insert)
- to analyze the THM behavior of the rock/liner interface and its impact on the liner mechanical load

CELL DEMONSTRATOR CHARACTERISTICS

The cell demonstrator is 25 m long (6m cell head and 19m body part) with a 1-metre overlap area between the liner and the insert. The liners are complemented by a plate at the head of the liner and a plate at the head of the insert.

Heating is carried out in the deepest 15 m. Both the liner and the insert are instrumented to monitor their thermo-mechanical behavior.

Peripheral boreholes are equipped with pore pressure, temperature and deformation sensors to monitor the THM behavior of the surrounding rock mass.

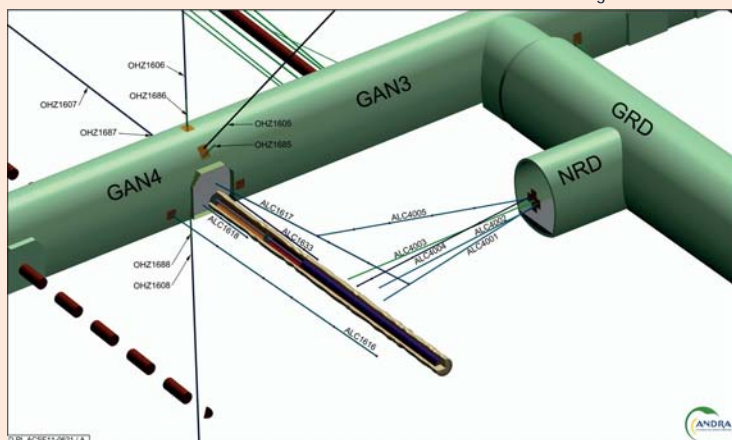

TUNNEL CONSTRUCTION

The cell was excavated in October 2012, using a laser-guided auger drilling machine. The excavated cell head measures 791 mm in diameter, with a fitted insert having an external diameter of 767 mm and a thickness of 21 mm.

The body section measures 750 mm in diameter, with a fitted liner having an external diameter of 700 mm and a thickness of 20 mm.

The deviation to theoretical trajectory is 3 cm in the horizontal plan and 8 cm in the vertical one.



INSTRUMENTATION

The instrumentation for the experiment comprises:

- Cell liner: strain gauges, total pressure sensors at the rock/liner interface, rock/liner clearance reduction sensors, relative humidity and temperature sensors, an axial extensometer, liner convergence sensors
- Cell head insert: strain gauges, relative humidity and temperature sensors, insert convergence sensors
- Insert/liner overlap area: monitor the liner sliding

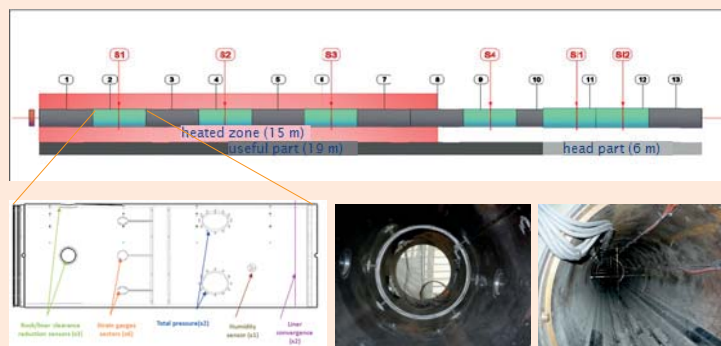

HEATERS

Five 3 m long electrical heaters put in place between 10 and 25 m depth in the cell.



A first heating test at low power has been done in February 2013 to test the sensors and the heating regulation system. The main heating phase has started in April 2013 (220 W/m) with the objective to reach 90°C at the rock interface within 2 years.

Temperature on the liner reaches about 83°C after 14 months.

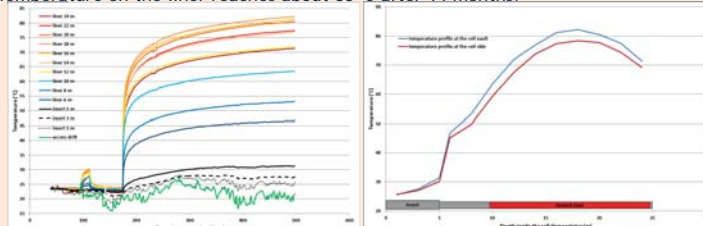

STATUS AND SUMMARY

A full scale HLW cell demonstrator has been designed and successfully realized at the Meuse/Haute Marne URL.

Results from HM impact of excavation are consistent with similar measurements performed on former cell demonstrators. TM behavior of the liner and THM behavior of the surrounding rock mass is currently being monitored and analyzed, and will be compared to numerical modelling.

INTRODUCTION

This experiment, named the Multi Purpose Test (MPT) and presented in Figure 1 concerns a horizontal design alternative for the high level waste repository, KBS-3, developed by SKB and POSIVA. The focus is to test the system components in full scale and in combination with each other to obtain an initial verification of the design implementation and component function.

This includes the ability to manufacture full scale components, carry out installation and monitor the initial system behavior of the experiment and its subsequent evolution. The test is a short term, non-heated installation of the reference design for KBS-3H, Drainage, Artificial Watering and air Evacuation (DAWE), with the main KBS-3H components.

The test is carried out in the already existing 95 m long drift with a diameter of 1.85 m diameter at the -220 m level in the Äspö HRL. The main components that are included are the Supercontainer, distance blocks and a plug with its transition zone made up of a transition block and pellets. In the KBS-3H reference design, multiple Supercontainers are placed with distance blocks in-between, but the MPT is in that respect simplified and includes only one Supercontainer.

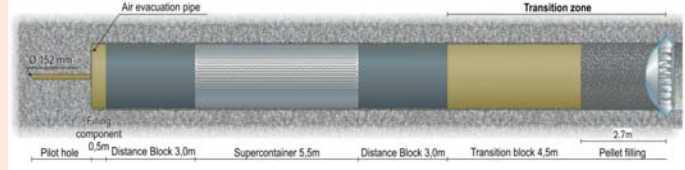

Figure 1. Illustration of the MPT, a full scale experiment including all key components in the KBS-3H design.

REPOSITORY FOR HIGH-LEVEL WASTE IN SWEDEN

SKB and Posiva are developing a geological disposal concept, KBS-3, based in crystalline rock where the spent nuclear fuel is placed in copper canisters surrounded by bentonite clay which are emplaced at a depth of 400-500 metres. The vertical alternative, KBS-3V, is the current reference design and horizontal emplacement is studied as a possible alternative. The two concepts studied are presented in Figure 2.

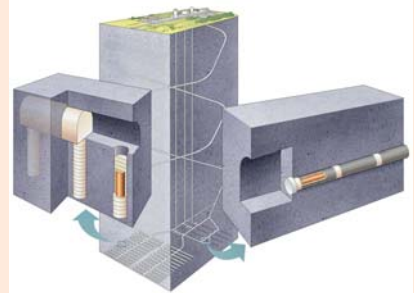

Figure 2. Illustration of the KBS-3 method. To the left the vertical reference design, KBS-3V, and to the right the horizontal alternative, KBS-3H.

TUNNEL CONSTRUCTION

The method currently used for excavating horizontal drifts for the KBS-3H design is push reaming. A pilot hole is drilled and characterized after which it is reamed in several steps up to the full 1.85 m diameter. For the LUCOEX-project a previously excavated drift is used, Figure 3.



Figure 3. The 95 m long drift at the Äspö HRL which is used for the MPT.

DEPOSITION MACHINE

A first prototype of the deposition machine was designed within the ESDRED project, it uses a water cushion technique to transport the components. The machines soft-and hardware have been further developed during the LUCOEX-project. Upgrades have been focused at enabling a balanced, autonomous deposition sequence for the components. The functionality of the machine was successfully demonstrated for bentonite components when the MPT was installed.

SUPERCONTAINER AND DRIFT PLUGS

The Supercontainer is a package made up of a copper canister with spent fuel surrounded by bentonite blocks in the form of rings and solid end blocks. An outer perforated metallic shell holds it together into one unit. In the LucOeX experiment the shell is made of carbon steel, but in the KBS-3H reference design it is made of titanium for long term safety reasons.

The Supercontainer has feet to enable deposition with the deposition machine. The weight of the package is approximately 45 tons and it has a diameter of 1.765 m (1.761 m for titanium) giving a very tight fit in the drifts (1.85 m).

One of the potentially largest advantages of the horizontal design when comparing it to the vertical reference design is that the Supercontainers can be manufactured in controlled and automated assembly facilities.

There are two sizes of plugs used in the KBS-3H design: a compartment plug to facilitate artificial wetting of the innermost compartment, Figure 4, (verified in LUCOEX), which is designed to take mainly hydraulic pressure and a drift plug which is designed to seal drifts taking both hydraulic and buffer swelling pressure. The plug material is steel in the MPT but in the KBS-3H reference design it is made of titanium for long term safety reasons.



Figure 4. Compartment plug under installation during the MPT.

BUFFER PRODUCTION, ASSEMBLY AND EMPLACEMENT

SKB and Posiva have experience in block and pellet manufacturing from the vertical design. For the LUCOEX experiment a new buffer mould has been manufactured to enable the compaction of the KBS-3H blocks which are slightly larger than the vertical blocks.

An extensive set of bentonite material control measurements were made to ensure that the buffer requirements were fulfilled before the bentonite was mixed to the right water content (11, 17 and 21 % in different blocks). Compactions were successfully made of all types and the blocks were later machined according to the KBS-3H requirements.

A Supercontainer, two distance blocks and one transition block was subsequently assembled. This work was done in an assembly hall with a controlled relative humidity suitable for the blocks. Sensors were installed in several sections between the blocks, Figure 5.

After assembly the components were transported one at a time down to the drift, Figure 6, where they were successfully emplaced and their sensors connected to the data acquisition system (DAS). The installation of components, plug and the DAS was done in 24 days with the handling of sensors taking the majority of the time.



Figure 5. Left, sensor installation in the blocks. Right, Supercontainer, distance and transition blocks assembled and ready for installation.



Figure 6. Left, transport of a component down to the drift. Right, MPT test section prepared for installation.

STATUS AND SUMMARY

The MPT was successfully installed end 2013. This meant that the objectives relating to the ability to manufacture full scale components, assemble them and to carry out an installation were fulfilled. Additionally, a few implementation issues were identified and will be addressed in upcoming design optimization work.

The relatively quick installation also illustrated the potential advantage of the pre-assembled Supercontainer.

Monitoring is currently ongoing and the objectives relating to the initial system behavior and its subsequent evolution will be evaluated in detail in coming years. Dismantling and analysis will later provide additional information on the function of the components.

INTRODUCTION

Posiva is developing the installation of a bentonite buffer for spent nuclear fuel. The experiment aims at developing the necessary machinery and quality control programme, including problem handling for installation of the buffer in a vertical deposition in crystalline rock, in order to create stable proof of the KBS-3V concept.

- The main activities in this work package are to develop:
- The installation technique for a vertical bentonite buffer. The work includes the design and manufacturing of the machine and, in the end, the testing of the concept.
 - The tools and methods for quality control of the bentonite buffer installation.
 - The tools needed in the event of unexpected problems during the buffer installation.

The final part of the work involves the demonstrations of the bentonite buffer installation in the Onkalo demonstration tunnel.

DEVELOPED MACHINERY

The machinery for the installation of the bentonite buffer includes the buffer installation machine BIM and buffer transportation machine BTM. Both machines will be moved by a terminal tractor.

The set also includes containers where the bentonite buffer blocks are placed during transportation from storage to the usage of the BIM.

BENTONITE INSTALLATION MACHINE (BIM)

The bentonite buffer is installed on the deposition holes by a remotely controlled BIM. The BIM is transported to the deposition hole by a terminal tractor. Rough positioning is performed with 5 cm accuracy. The more accurate positioning is carried out by a laser tracker, utilising the focus points attached to the deposition tunnel. In accurate positioning, the BIM raises on legs and it is carefully moved in a transverse direction on top of the deposition hole. The accurate longitudinal positioning will be made by the crane of the BIM during the block installation.



BENTONITE TRANSPORTATION DEVICE (BTM)

The BTM is used for transportation of buffer block containers from the deposition tunnel entrance into the tunnel, for the use of the BIM. The blocks are transported to the BIM one-by-one. The BTM is remotely controlled and moved by a terminal tractor.



INSTALLATION



At the beginning of the demonstration, the BIM is positioned over the deposition hole, and buffer blocks are ready in containers at the mouth of the demonstration tunnel. The BTM transports the blocks to the BIM and the BIM's crane fetches a buffer block from the BTM located in the front part of the BIM. The crane lifts the block out from the container and moves it above the hole.

After that, the crane lowers the block to the hole, and the final part of lowering is performed by a laser tracker. After that, the vacuum is released and the container top is removed from the block. Then the crane lifts the container top from the hole to the shelf of the BTM.



DEMONSTRATION OF BENTONITE BUFFER INSTALLATION

The installation of the buffer blocks is tested in two places: in the test hall, which is located at the Onkalo site, and in the Onkalo demonstration tunnel at a level of 420m.

An important goal of the demonstrations is the accurate positioning of the blocks. The requirement for positioning the centre of the block is +/-1 mm. Another requirement is the installation time for the buffer as a whole - not more than two (2) hours.

The tests are performed with concrete and bentonite blocks. In this installation concept, the blocks are placed in air-tight containers when they are transported to Onkalo. The container top (lid) also includes compartments for bentonite pellets.



TOOLS FOR UNEXPECTED PROBLEMS

During the installation of blocks with a vacuum lifter, risk exists of dropping the block into the deposition hole. A radiating copper canister separates the problem into two stages - before and after canister installation.



Before installation of the canister, it is possible to use conventional methods to lift the pieces of block out from the hole. After installation of a radiating canister into the disposal hole only the methods which can be operated remotely can be used.

In this work, drilling anchors and the water-jet cutting method are tested.



Assessment of 15 years of R&D in the Bure URL for the Design, Performance and Safety Analysis of the Cigéo Project – LUCOEX Conference

S. Dewonck, L. Richard-Panot, JM. Bosgiraud, J. Delay, G. Armand, A. Vinsot & F. Plas

¹ANDRA, 1-7 rue Jean Monnet, 92298 Chatenay-Malabry Cedex, France



Surface facility view : main shaft, ventilation shaft



Technological exhibition center : robots for waste packages emplacement, various type of waste packages (IL-LLW & HL-LLW)

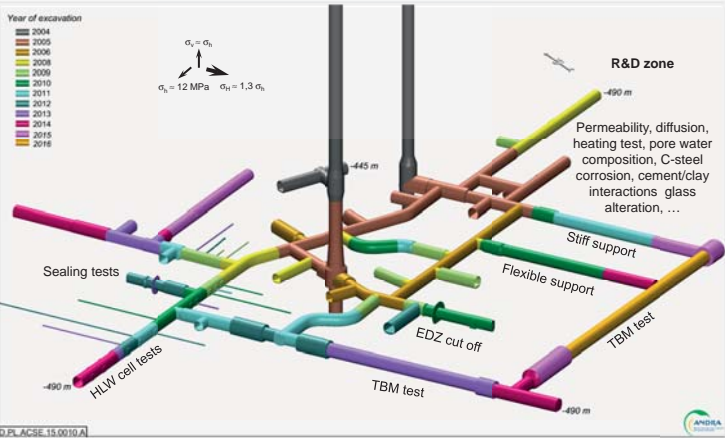

3D views of the Bure URL development with time: 1.5 km of drifts, 650 boreholes and 10 000 sensors. According to the next steps of the Cigéo project, the Meuse/Haute-Marne URL has been granted to operate until 2030.



Corrosion studies

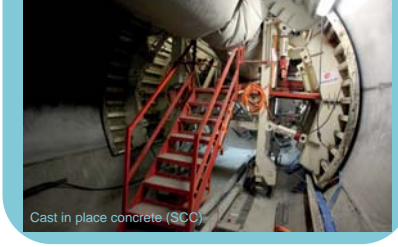

Cast in place concrete (SCC)

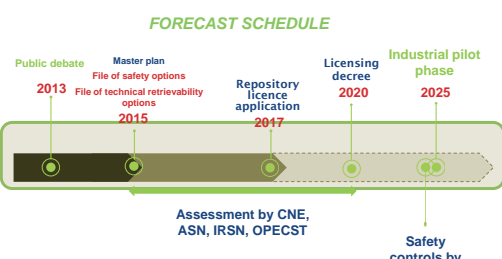

HLW cell studies

- The R&D works focused on three main axes:
- to consolidate the characterization of the argillites properties, in particular through long term experiments,
 - to optimize the underground facilities construction (drifts, disposal cells, seals),
 - to link between the technological aspects and the THMCR behavior of the engineered components and the Callovo-Oxfordian near field, in connection with the Cigéo requirements (the reversibility and the retrievability of waste packages, the safety objectives in operation and post closure).

After a local public inquiry and a citizen conference in 2013-2014, Andra proposed to modify the time schedule (licensing authorization request is now postponed in 2017) and to introduce a first prototype Industrial phase according to a step-wise industrial development of Cigéo

Experimental study of the mechanical behavior of a steel casing in a 500 m deep clay formation based on *in-situ* experiments: analysis of the scale effect

Frédéric Bumbieler¹, Jacques Morel¹, Nathalie Conil¹, Gilles Armand¹

¹ Andra, Laboratoire Souterrain de Meuse/Haute-Marne, RD960, 55290 Bure, France

Context

Andra's concept of High Level activity Wastes (HLW) cells consists of horizontal dead-end micro-tunnels equipped with a steel casing to allow the retrieval of the waste packages during at least 100 years. The understanding of mechanical interactions between the host rock and the casing with respect to the expected damage mechanisms (plasticity, buckling and corrosion) is therefore a key issue for ensuring the reliability of HLW cells and for optimizing their design.

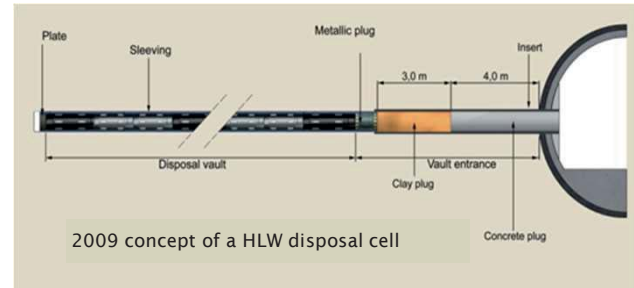

Objectives of *in-situ* experiments

- To analyze the short term (a few years) mechanical behavior of a steel casing parallel to major horizontal stress σ_H at different scales
- Determine the influence of main design parameters: casing thickness, backfilling the annular space with cement grout

Small scale (1:5) experimental set-up

- 10 m long steel tubings parallel to σ_H
- Initial annular spaces vary from 0.017 \varnothing to 0.028 \varnothing

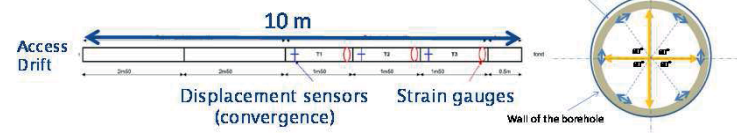

Full scale experimental set-up

- 40 m long steel casing parallel to σ_H
- Initial annular space = 0.028 \varnothing

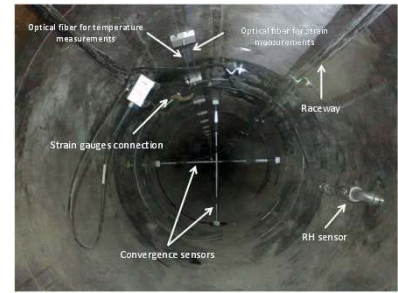
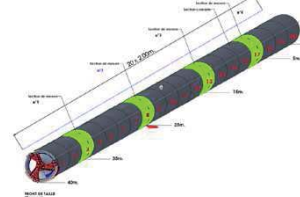

Short term mechanical load measured on small scale tubings

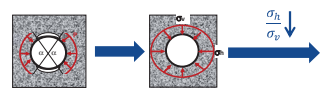
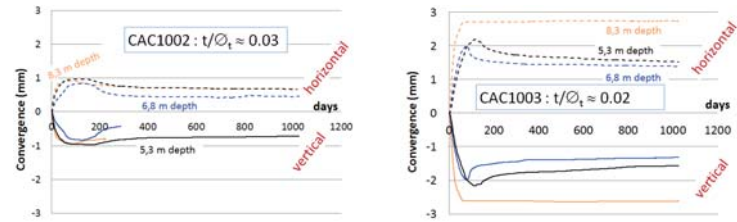

Strongly anisotropic mechanical load:

- 1st loading step ($t < 100$ days): localized radial load in the horizontal direction which corresponds to the maximum extension of the excavation induced fracture network
- 2nd loading step: anisotropic radial load
- 3rd loading step: decrease of the load anisotropy
- Radial bending of the tubing $\Rightarrow \sigma_{90max}$ can reach 350 MPa on the inner face of the tubing, whatever the thickness

Short term mechanical load measured on full scale casing

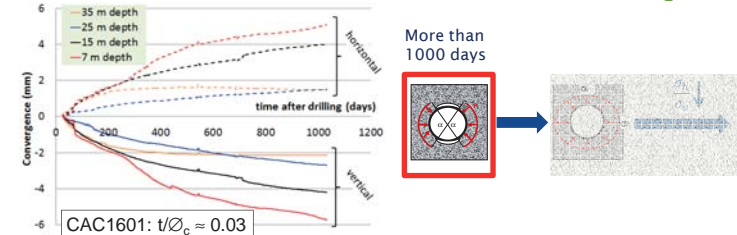

- Similar anisotropic short term mechanical load
- Convergence of the casing is not stabilized after 3 years: casing is still in the 1st loading step
- Much lower initial loading rate

Impact of backfilling the initial annular space

Backfilling material : cement / bentonite grout ($E \approx 1000$ MPa after 90 days)

Mechanical behavior at reduced scale (1:5)

Tubing CAC1102 ($t/\varnothing_t \approx 0.03$; initial annular space = 0.13 \varnothing)

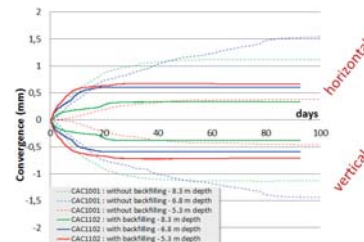

- Ovalization of the tubing is quickly blocked and diameter convergence remains less than 0.7 mm
- 2nd loading step is reached in less than 20 days

Mechanical behavior at full scale

Casing CAC1602 ($t/\varnothing_c \approx 0.03$; initial annular space = 0.04 \varnothing)

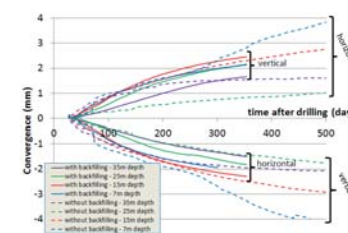

Vault backfilling quality



Extension of the fracture network around a full scale HLW cell demonstrator parallel to σ_H



- Ovalization of the casing is not yet blocked (after more than 1 year)
- Maximum loading axis has rotated 90° in comparison with experiments without backfilling
 - ✓ Impact of the thickness of backfilling
 - ✓ Impact of circumferential evolution of rock mechanical properties around the casing

Benoit Garitte, Herwig R. Müller and Hanspeter Weber
Nagra, Hardstr. 73, 5430 Wettingen, Switzerland (benoit.garitte@nagra.ch)

The Full-Scale Emplacement (FE) Experiment at the Mont Terri underground research laboratory is a full-scale heater test with three heaters in a clay-rich formation ('Opalinus Clay'). The general lay-out and experimental aims are described in a companion paper (Müller et al., 2015). For the production of bentonite blocks and for the production of the granulated bentonite mixture (GBM), a natural (non-activated) sodium bentonite from Wyoming was used. The production of approx. 3,000 bentonite blocks (70 tons) in a high pressure press and of approx. 350 tons of GBM, is described in terms of design parameters and production quality control.

Granulated Bentonite Mixture

The trade name of the bentonite used for the production of the FE GBM is **National Standard® WP2**.

Production target was the highest possible mixture dry density, as close as possible to the target emplacement dry density (red curve in figure hereunder).

The **production strategy** was designed on the dependency of the mixture dry density on the pellet dry density and the porosity between the pellets:

$$\rho_{mixture} = (1 - \varphi_{inter-pel}) \rho_{dry\ pel}$$

For the pellet dry density, a minimum value of 2 g/cm³ was required.

Inter-pellet porosities cannot be set as a requirement and it was chosen to optimize the grain size distribution instead.

The mixture was required to have a Fuller type distribution: the percentage of passing p (in weight) through a sieve of size d is

$$p = \left(\frac{d_i}{D}\right)^n \cdot 100$$

where n , the shape parameter was required to be 0.4 and where D , the max grain size of the mixture was required to be in the range [5mm, 10mm]

Raw material

The water content and grain size distribution were required in a certain range (red lines and green lines in the left and right figure, respectively). The required water content is believed to be close to the Proctor optimum for the compaction energy used.

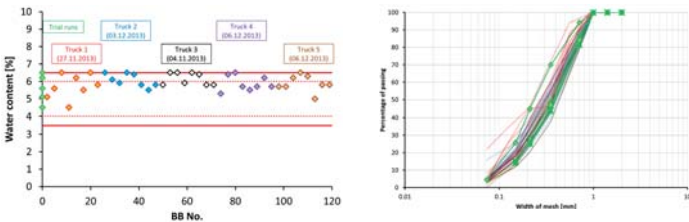

Production of pellets

The production was done in two steps (1 in 2013 and 1 in 2014) to minimize the risks during the production of the biggest batch. Pellet dry density requirement was overachieved in the 2 productions.

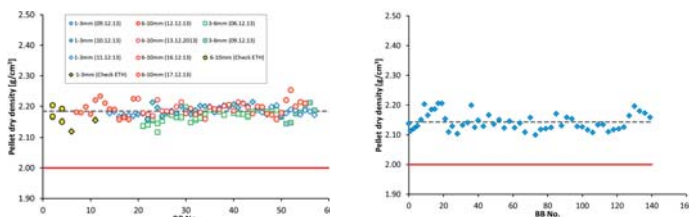

Production of the mixture

During the first production step (2013), several iterations had to be done to achieve the required result (left figure hereunder). The pouring dry density of the mixture was satisfactorily and allowed to achieve the target emplaced dry density in the FE.

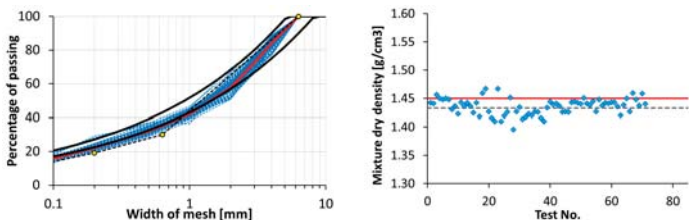

Conclusions/lessons learnt

- During the mixing process the broadly distributed grain size distribution is obtained by grinding big particles into smaller. The produced fines have a smaller particle density. Optimizing this (e.g. by producing directly different fractions in the right amount and softly mix them) was found economically not viable.
- Higher D value (max grain size of the mixture) could potentially increase the mixture dry density even more.
- A broad grain size distribution results in a mixture with a high compaction potential.

Bentonite blocks

The trade name of the bentonite used for the production of the FE bentonite blocks is **Gelclay WH2**.

Production target was to obtain stable blocks under the expected climatic conditions in Mont Terri and thus (see companion poster) the steering parameters were:

- The water content of the raw material (18% +/-1%)
- The compaction pressure (130MPa)

QC variables (acting as **rejection criteria**) during production were:

- The block dimensions (required precision: 0.85mm)
- Geometric density (required precision of 0.02 g/cm³)
- No visible cracks
- Minimum UCS of 6MPa (checked every 100th block in beginning of production and every 500th block afterwards)

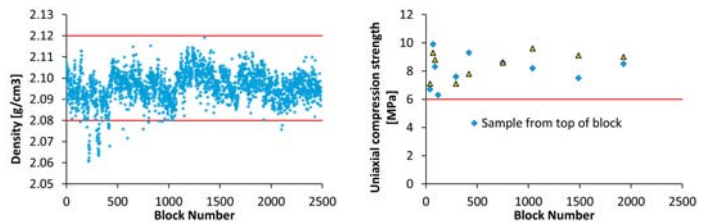

Block storage/conservation

After production, the blocks were packed in airtight pallets to prevent water absorption from the environment which would have caused damage. 5% of the pallets were equipped with a wireless RH sensor to detect potential leakages of the packaging. On-board sensors were found unaffected by the RH evolution outside the packaging, proving the tightness of the packaging.



The QC variables were combined to compute the degree of saturation in the mould and after unmoulding. The results suggest that while in the mould, the bentonite is very close to saturation and the elastic rebound occurring when unmoulding decrease the saturation to about 90%. This suggests that manufacturing blocks with an equilibrium RH higher than 70% might be impossible.

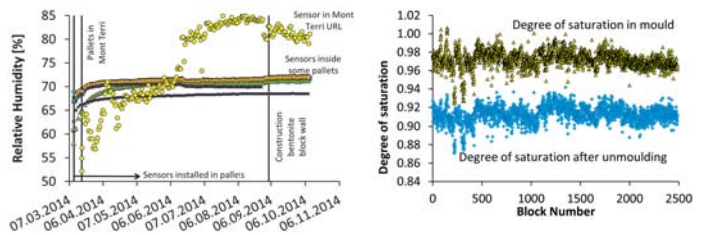

Emplacement of the blocks in the FE tunnel

The construction of the bentonite block wall (left picture) took place in early September, when the RH in Mont Terri was still quite high (see graph above). Nevertheless, the blocks proved their resistance to high RH and survived the 2 weeks of emplacement without degradation.

Each of the three bentonite block pedestals for the heaters survived the load as well.

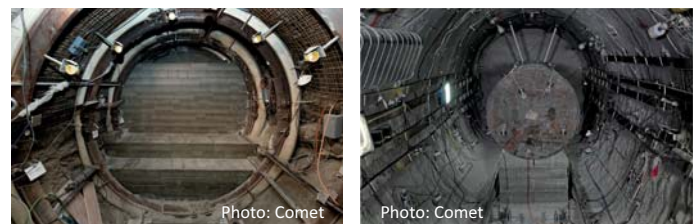

Acknowledgements

The FE experiment is implemented in the Mont Terri URL, which is operated by Swissstop. The initiator and lead organisation for the FE experiment is NAGRA; ANDRA (France), BGR (Germany), DOE/LBNL (U.S.A), GRS (Germany) and NIMMO (Canada) are participating in the Experiment. The engineering and demonstration components of the FE experiment are also part of NAGRA's participation in the EC co-funded 'Large Underground Concept Experiments' (LUCOEX) project and therefore receive funding from the European Atomic Energy Community's Seventh Framework Programme (FP7) under grant agreement no 269905.



Quality Control, Traceability and Verification of the Process for Construction of Deposition Tunnels

Henrik Ittner and Rolf Christiansson
 Swedish Nuclear Fuel and Waste Management Co, SKB, Sweden.

Reference case: Äspö HRL Expansion Project

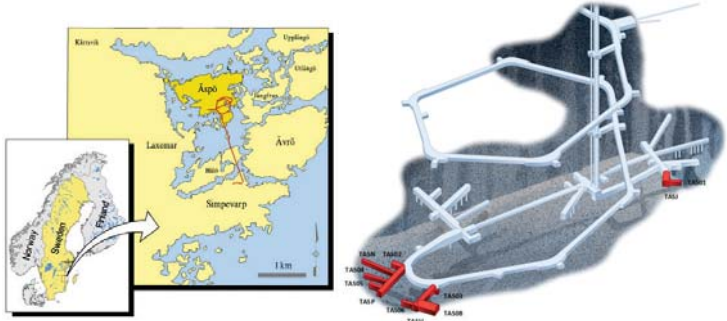

The Äspö Hard Rock Laboratory, Sweden, is used by SKB for research and development of technology required for the final repository for spent nuclear fuel. The Äspö HRL was expanded in 2012 in order to create new tunnels for future experiments. Three new main tunnels and 7 new experimental tunnels were excavated on the -410 m level. The tunnels were excavated using a factory new drilling jumbo and emulsion explosives, both with modern logger equipment, in order to receive a good control and documentation of the drilling and charging works.

Requirements for the drilling and charging were specified as below.

Drilling tolerances	Deviation	Hole type	Charging tolerances
Collaring of contour	± 7 cm	Contour	0.350 ± 0.05 kg/m
Theoretical endpoint of contour	± 20 cm	Helpers and bottom	0.500 ± 0.05 kg/m

Requirements for Documentation and Configuration Management in a Repository for Spent Nuclear Fuel

In 2011, SKB applied for a license to construct a final repository for spent nuclear fuel at Forsmark, Sweden. The repository will be constructed according to the KBS-3 method, where the spent fuel is deposited in a system of deposition tunnels at 500 m depth in the bedrock and isolated by copper canisters surrounded by a buffer material of bentonite clay.

Traceability in all work steps is necessary in order to verify that requirements for post-closure safety on the underground openings are met. The unique requirements on post-closure safety related to the construction of a disposal facility for spent nuclear fuel is related to limit the hydraulic connectivity in the EDZ. Based on blast design research SKB has implemented the requirements on post-closure safety to specifications on how the blasting works should be conducted.

Design requirements

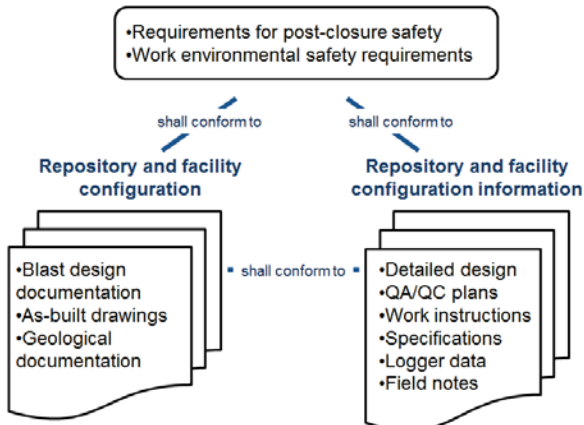

The deposition tunnels will be continuously excavated through the operation of the repository. There are strict requirements on the repository (as for any nuclear facility) for traceability in configuration management, design and construction with demands that documentation of as-built information agrees with the design information. This puts high demands on planning, design, organization for quality control and technology applied for construction of the final repository.

Examples of Control and Documentation Methods

The control plans for the work included measures to control, document and verify the process and results of the excavation. The start and end points of the contour holes were, for example, measured in order to determine the achieved drilling precision.

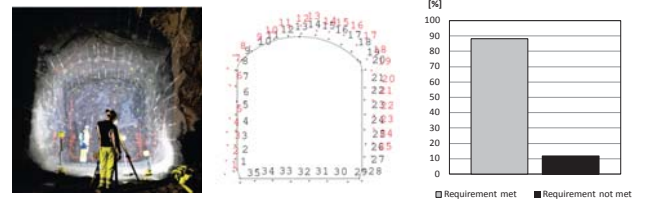

The figure below shows the theoretical extension of the longest crack, the order of charging and results for the experimental tunnel TAS04. The colors in the figure to the left represents the different hole types and the radius of the circles represents the theoretical extension of the longest blast induced crack. Order of charging of the contour holes and logged amount of explosives in each contour hole is presented in the middle and to the right in the figure below.

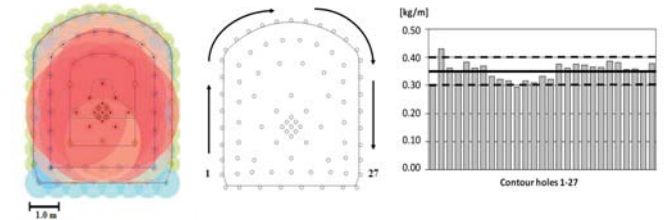

The different types of digital data available enabled visualization and integrated analysis of different geometry and logger data from the excavation works. This method was a powerful tool for understanding the results of the excavation and for suggesting improvements to the blast design. It also improved the on-site knowledge of the different logging systems.



The figure to the left above shows a visualization of a blast round. Photogrammetry data is shown together with logged drill data from the jumbo (red lines) and measured collaring and end points of contour holes (green lines) from round 4 in TASJ. The figure to the right above shows interpreted GPR reflectors together with investigation bore holes in the floor of TAS04.

Discussion and Conclusions

The experience from the Äspö HRL expansion project shows that it is possible to excavate deposition tunnels and to meet the special requirements on quality control and documentation for a nuclear disposal facility using the technology available today.

The amount and quality of the documentation required in order to verify traceability, clarity and justification for a repository for spent nuclear fuel is unique in underground construction and must therefore be carefully planned and the construction organization need to be aided with suitable tools for quality assurance. The experience is that the need for qualified personal for supervision, documentation and quality assurance is more extensive than in a conventional rock engineering project.



FULL-SCALE DEMONSTRATION OF PLUGS AND SEALS

DOPAS

DOPAS will run in the period
September 2012 – August 2016

The DOPAS project is being carried out by a consortium of 14 partners representing waste management organizations, research institutes, academia and consulting companies.

DOPAS aims to improve the knowledge regarding the industrial feasibility of plugs and seals, the measurement of their characteristics, the monitoring of their hydraulic and mechanical behavior under repository conditions, and their performance with respect to a range of safety objectives.

DOPAS will identify the design basis of plugs and seals in geological disposal facilities, reference designs, and strategies to demonstrate the compliance of the reference designs to the design basis and to implement them into the experiments.

DOPAS is focusing on tunnel plugs for clay host rock (French and Swiss disposal concepts), tunnel plugs for crystalline rock (Czech, Finnish and Swedish disposal concepts), and shaft seals for salt host rock (German disposal concept).

DOPAS Experiments play a key role in achieving the objectives set for the project.

Experiment 1, FSS, a full-scale seal, is conducted above surface, representing the clay host rock conditions, with recesses in a lined drift model. FSS is implemented by Andra (FR) and Nagra (CH) with the aim of demonstrating the technological feasibility of seal construction. The clay core has a length of 13.5 meters and a width of 7.5 meters. The clay core is surrounded by a self-compacting low-pH concrete plug at one end and a low-pH shotcrete plug at the other. The plug was constructed in the period 2013-2014, and the dismantling is expected to take place in late 2015. REM, a "metric-scale resaturation" test, was installed in September 2014. The aim of the REM test is to increase the phenomenological understanding of swelling clay core (same mixture as that emplaced in FSS) behavior in near natural resaturation conditions.

Experiment 2, EPSP, the experimental pressure and sealing plug experiment, is conducted in the Josef Gallery and the demonstration will evaluate the pneumatic emplacement methods for a repository plug for Czech bentonite-based mixtures and low-pH concrete developed for repository plug. The Czech Technical University (CTU, CZ) together with SURAO (CZ) and ÚJV Řež, a.s. (ÚJV, CZ) are responsible for the EPSP experiment. The instrumentation of the EPSP Experiment is designed so that the processes occurring during the plug's loading may be unambiguously identified, described and assessed. These measurements will also provide the data required for the numerical modelling of the THM processes arising in the plug and its vicinity. The construction and installing activities have been undertaken during 2014-2015.

Experiment 3, DOMPLU, the Dome Plug, demonstrates the monitoring and pressurising of a deposition tunnel end plug consisting of an arched low-pH concrete dome, a bentonite seal, filter materials and delimiters in crystalline host rock. The DOMPLU plug was constructed jointly by SKB (SE) and Posiva (FI) in crystalline bedrock. The design of the DOMPLU Experiment was completed during 2011 and the plug was emplaced in March 2013 in a tunnel at a depth of -460m in the Äspö Hard Rock Laboratory (Oskarshamn, Sweden), but the design phase and major parts of the installation were conducted prior to the onset of the DOPAS project. In the DOMPLU design, many technical challenges have been considered related to the practical implementation of plugs, including issues like the excavation damaged zone in the tunnel; plug-backfill interactions with pressure conditions at repository depth; and smoothness of surfaces required for controlled concrete fitting. A full-scale demonstration is vital to validate the underlying assumptions and the performed numerical simulations of the concrete dome. In addition, the functions of the filter and the bentonite seal will be thoroughly monitored and the water leakage past the plug will be determined under realistic conditions. The work of DOMPLU within DOPAS is focused on the monitoring and performance assessment of the full-scale plug.

Experiment 4, POPLU, the Posiva Plug, is the first underground full-scale engineered barrier system (EBS) component demonstration at Posiva's future repository site in ONKALO. The experiment is carried out jointly by Posiva (FI) and SKB (SE), together with VTT (FI) and BTECH (FI). The POPLU experiment includes aspects related to the oversight of the work by STUK – the Radiation and Nuclear Safety Authority, Finland, as ONKALO will be part of Posiva's future repository. The POPLU practices for information exchange procedures with the authorities and the procedures for various long-term safety and quality assurance approval (i.e. of stray materials and the requirements related to the classified nuclear safety related components) are important issues, as well as the construction and monitoring of the experiment. The suitability of the plug location in crystalline bedrock has been demonstrated by application of the rock suitability classification (RSC) procedure and thereafter the plug slot has been produced by drilling, wedging and grinding of the rock. The plug emplacement activities take place in 2015.

Experiment 5, ELSA, performed by DBETEC/TUBAF (DE) and related activities by GRS (DE) including (LASA, LAVA and THM-TON) mainly consist of the development of shaft sealing designs, laboratory and in-situ studies of material behaviour focussing on the preparation of large scale in-situ tests in salt and clay host rocks.



POPLU Experiment plug location is ready for installing and casting activities. © Posiva

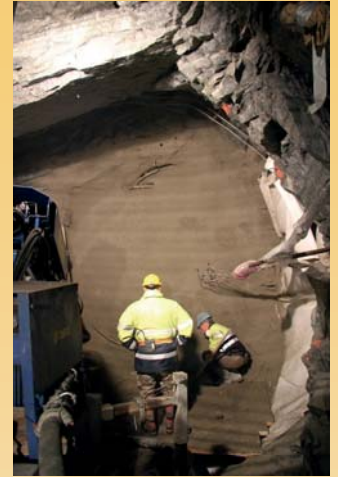

EPSP Experiment and installing activities. Emplacement and sampling of low-pH shotcrete as one component in the plug. © SURAO and CTU



FSS Emplacement of swelling clay core inside the drift model was undertaken in 2014. © Andra



ELSA In-situ compaction tests of specific salt and clay mixtures. © DBETEC and TUBAF

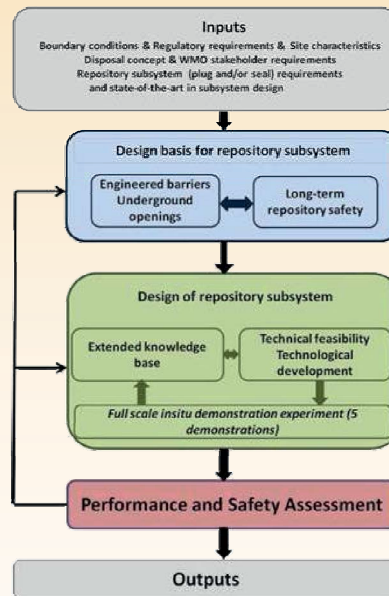

DOMPLU Experiment after installation. The instruments and probes behind the concrete wall provide information on the slow saturation of the bentonite seal. © SKB

DOPAS 2016 in Turku
25th-27th May 2016

SAVE THE DATE

An international topical seminar on plugging and sealing technology for geological disposal of radioactive waste will be organised towards the end of DOPAS project where the results of DOPAS project will be presented to the whole scientific community as well as within waste management organisations.

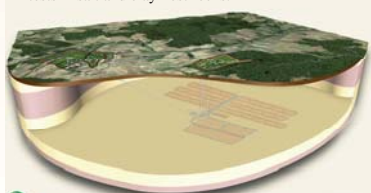

The research leading to these results has received funding from the European Union's European Atomic Energy Community's (Euratom) Seventh Framework Programme FP7/2007-2013, under Grant Agreement No. 323273 for the DOPAS project.



Project Coordinator
johanna.hansen@posiva.fi

www.posiva.fi/en/dopas



Design Basis Development Workflow for Plugs and Seals

Matt White and Slimane Doudou,
Galson Sciences Limited

The DOPAS Project

The DOPAS Project is a European Commission programme of work jointly funded by the Euratom Seventh Framework Programme and European nuclear waste management organisations (September 2012 - August 2016). DOPAS aims to improve the industrial feasibility of plugs and seals, the measurement of their characteristics, and the control of their behaviour in repository conditions. A set of full-scale experiments, laboratory tests, and performance assessment studies of plugs and seals for geological repositories are being carried out during the project.

WP2 and Design Basis Workflow

Work Package 2 (WP2) of DOPAS addresses the design basis for plugs and seals, their reference designs, and the strategies used to demonstrate the compliance of the plugs and seals to the design basis. The learning provided by WP2 during the course of the project has been used to develop and describe a generic process for development of the design basis for plugs and seals - termed the "Design Basis Development Workflow". The design basis is developed in an iterative fashion, it is hierarchical, and is developed in parallel with the design. In this poster, the key steps used to develop the design bases for the DOPAS plugs and seals are described and related to the generic Design Basis Development Workflow. The workflow is currently under development and will be finalised later in the project.

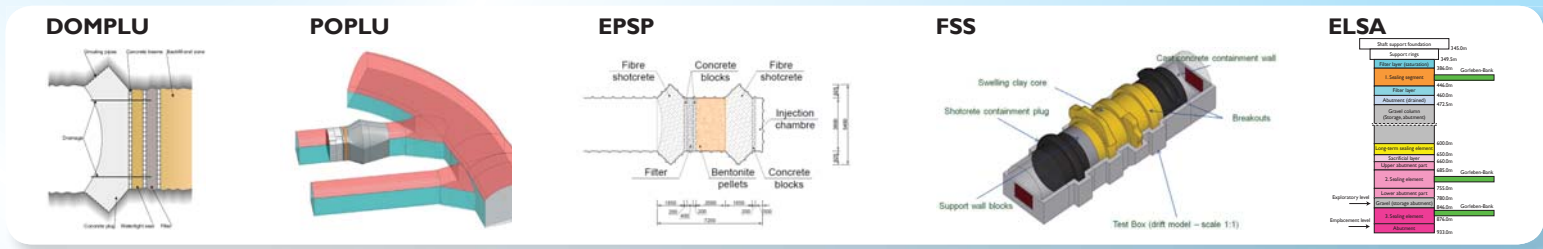

Conceptual Design

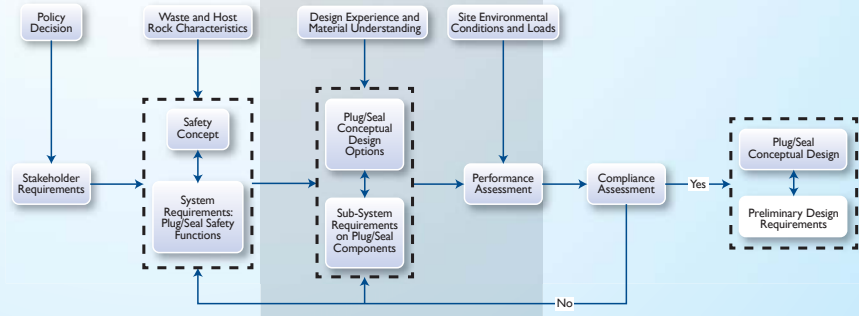

Conceptual Design

The design basis for a conceptual design includes: the stakeholder requirements that define the overall objectives of geological disposal (e.g. the safety criteria that must be met); safety functions for each of the components of the disposal system (e.g., for plugs and seals, this may include limiting groundwater flux through the repository); and the sub-system requirements on each of the components of a plug/seal (e.g. the role of a concrete dome or bentonite seal). The system requirements are dependent on decisions made on the safety concept, and sub-system requirements are dependent on conceptual design options. Consideration of the environmental conditions and loads acting on the structures allows conduct of a safety assessment, the results of which feed into a compliance assessment used to ascertain whether the system and sub-system requirements have been met by different design options. The outcome is selection of a conceptual design, and preliminary design requirements to be tested during development of the basic design.

Basic Design

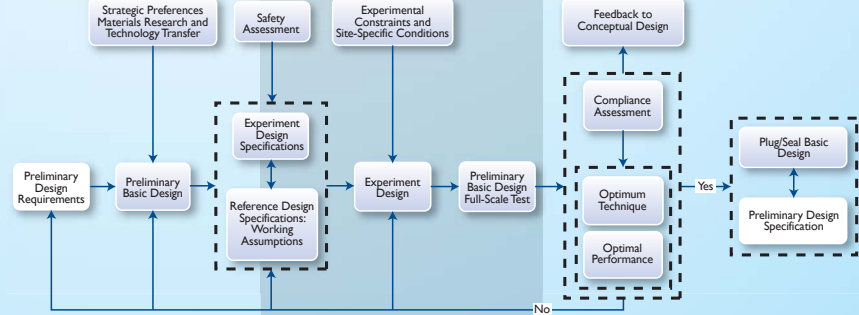

Basic Design

Preliminary design requirements are used as the basis for developing preliminary basic designs. During DOPAS, basic designs have been tested through full-scale tests. This has required the development of a set of working assumptions for the design specifications, which are used to design the experiment and to assess its performance. The full-scale demonstrations undertaken in DOPAS have addressed specific objectives, for example, technological feasibility (FSS), performance (DOMPLU), alternative design options (POPLU) and materials research in support of preliminary basic design (EPSP and ELSA). The results of full-scale tests provide further support to design decisions, especially optimisation issues such as the identification of design solutions with the best available technique and the best available performance. Compliance assessment ensures that the experiment results meet the experiment design specifications. These may be revised based on learning from the experiments. The outcome of a satisfactory compliance assessment is selection of a basic design, and preliminary design specifications to be tested during development of the detailed design.

Detailed Design

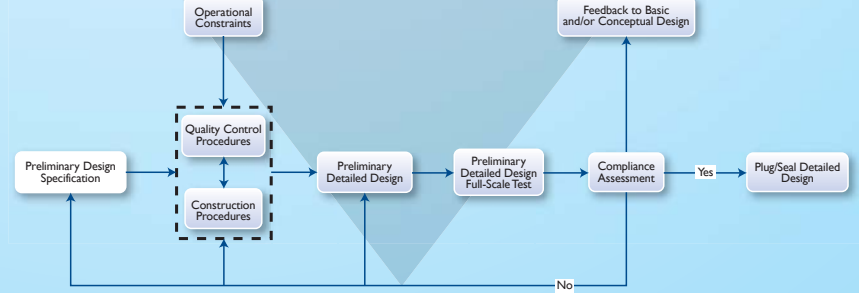

Detailed Design

During detailed design, the preliminary design specification and operational constraints are considered in order to establish quality control procedures and construction procedures. These allow development of a preliminary detailed design which is subject to a full-scale test. In contrast to demonstration testing, the full-scale test is a trial of the plug/seal as it is expected to be implemented in the repository. Consideration may be given to monitoring of these tests over long periods, as in the case of Andra's Industrial Pilot. Compliance assessment of the full-scale test could lead to a revision of the design specifications, for example to write them in a manner that is amenable to checking using quality control or construction procedures. Compliance testing may also identify the need for revisions to the preliminary detailed design, which may, therefore, also lead to a need for further testing. Once the compliance assessment is acceptable, the plug/seal detailed design can be finalised and the preliminary design specification accepted as the final design specification (subject to further revision based on learning during repository operation).

The research leading to these results has received funding from the European Atomic Energy Community's (Euratom) Seventh Framework Programme FP7/2007-2013 under grant agreement no 323273, the DOPAS project.
Corresponding Author: mjl@galson-sciences.co.uk



Large-scale sealing experiment in the Meuse/Haute Marne Underground Research Laboratory

Rémi de La Vaissière, Nathalie Conil, François Leveau & Gilles Armand

Andra, Laboratoire Souterrain de Meuse/Haute-Marne, RD960, 55290 Bure, France. Contact @: remi.delavaissiere@andra.fr

Objective

A large-scale sealing experiment (called **NSC**) has been installed in the Andra's underground research laboratory at Meuse/Haute-Marne (France). NCS experiment has to evaluate **the performance i.e. hydraulic conductivity of the seal itself but also the interface and damaged zone surrounding the seal**

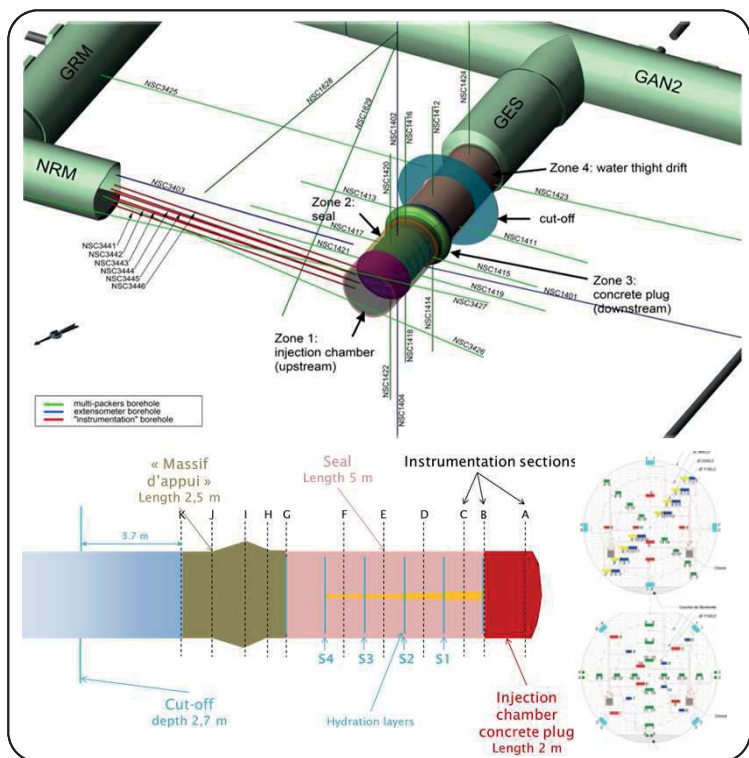

General layout

- **Seal size**
 - Seal diameter: 4.6 m
 - Seal length: 5 m
 - Seal volume ~ 91.5 m³
- **Two concrete plugs**
 - "Injection chamber" corresponds to the upstream reservoir during the performance test
 - "Massif d'appui" corresponds to the downstream reservoir during the performance test

Instrumentation

- 11 cross-sections of instrumentation (Section A to K)
- Pore pressure, total pressure, relative humidity, temperature, deformation, displacement
- 6 hydration membranes (Section B, Section 1 to 4, Section G)
- Tomography survey of the concrete plug "massif d'appui" by INERIS
- 1 cut-off
 - ✓ **A total of 420 sensors**
- 6 "instrumentation" boreholes for passing all the cables and hydraulic lines of the instrumentation (A to F and S1 to S4)
- 19 boreholes dedicated to pore pressure measurement and to performe hydraulic tests
- 4 extensometers
 - ✓ **A total of 866 measuring points**

Seal description

- **Block of bentonite:**
 - 176 tons of block = 94.4 % in mass = ~13800 blocks
 - Ratio: MX80 - sand : 40% - 60%
 - Dry density of clay material ~1.49 g/cm³
 - Compacting pressure: 80 MPa
- **Pellets & powder:**
 - ~ 7.6 tons of pellets
 - ~ 2.9 tons of powder
 - 5.6 % in mass
 - Pure MX80 with a dry density of ~1.7 g/cm³
- **Void ratio ~ 2.1 – 2.2 %**
- **Swelling pressure between 2.5 to 6.4 MPa**
- **Average hydraulic conductivity is expected to be closed to 10⁻¹¹ m/s**
- The water volume needed to saturate the seal is evaluated to 17-18 m³ ± 3 m³

Artificial hydration

- Water injection began first on section B then the others one were progressively introduced
 - ✓ First at constant flow rate
 - ✓ Then, if possible, at constant pressure
- Water injection in section B started the 28th January 2014
- Currently a total amount of 11 m³ has been injected

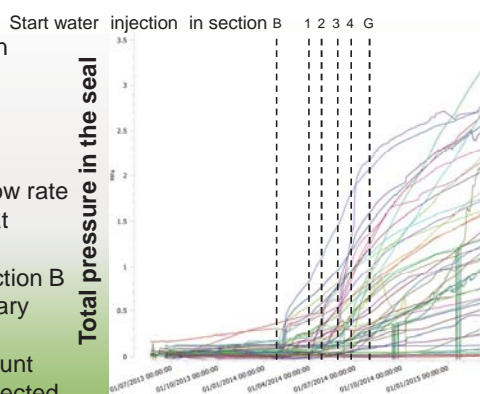

Installation

January 2013 to March 2014

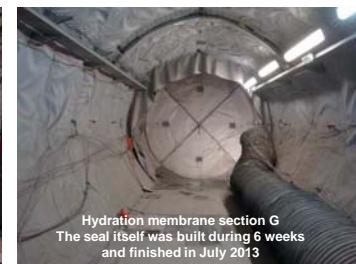
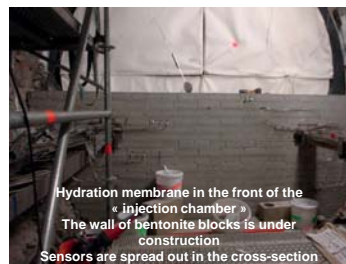
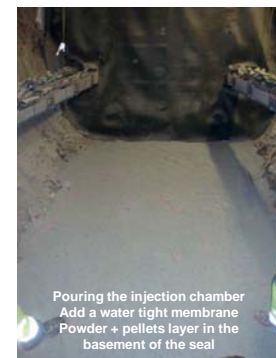

Acknowledgement

- CEA/LECBA defined the composition of the sand-bentonite mixture in the respect to the objectives (hydraulic conductivity, swelling pressure)
- Laviosa provided the blocks, pellets and powder in respect of the specification
- AITEMIN and Solexperts France provided and installed all the equipments in the NSC experiment excluding the tomography survey which was provided and installed by INERIS



Toshihiro Sakaki*, Sven Köhler and Herwig R. Müller

Nagra, Hardstrasse 73, 5430 Wettingen, Switzerland, *toshihiro.sakaki@nagra.ch

1. BACKGROUND

In the Full-Scale Emplacement (FE) Experiment at the Mont Terri Rock Laboratory, Nagra has constructed a 5-arm screw feeder system to emplace granulated bentonite mixture (GBM) around three heaters that are placed horizontally on bentonite block pedestals. The target dry density of the bulk GBM as emplaced is 1.45 Mg/m³ or higher.

A series of pre-tests has been performed in an intermediate-scale tank with a single screw feeder. Density of the emplaced GBM was monitored using a dielectric moisture profile probe and compared with that from the mass balance method.



4. INTERMEDIATE-SCALE 2D TANK SETUP

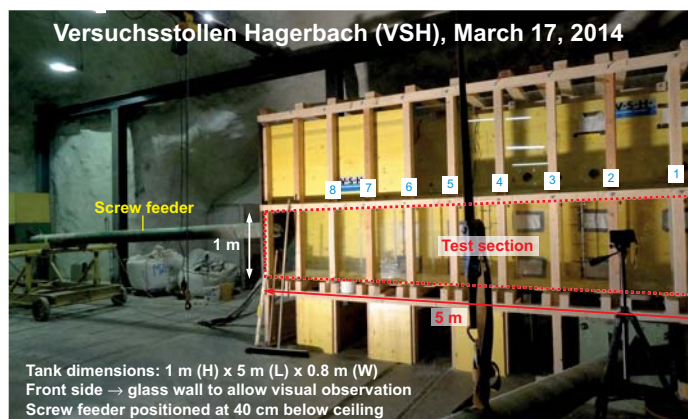

- GBM filled at rate of ~170 kg/min.
- Screw conveyor pulled back when emplacement force reached 5 to 6 kN

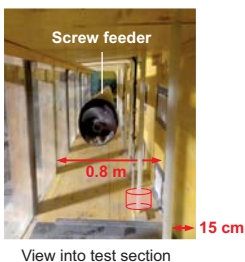

Dielectric tool used PR2-6 PROFILE PROBE

- Widely used to monitor soil water content profile in various environmental and agricultural applications
- Five pairs of electrodes
- Access tube (O.D. 28 mm) installed in soil/rock
- Operation frequency 100 MHz

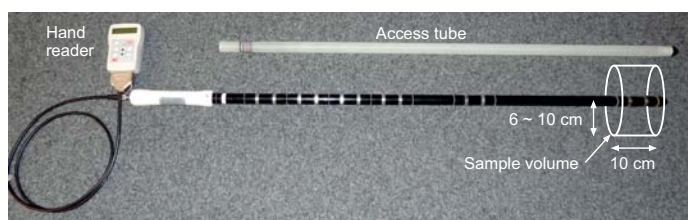

Why dielectric "moisture" sensor to measure "density"?

- Dielectric property reflects the amount of water in the material
- Water content of GBM -> controlled to be ~5 % by weight
 - High density -> more water (in sensor's sampling volume)
 - Low density -> less water
- "Density" can be inferred using dielectric moisture sensors
- How accurate? -> UNKNOWN -> examined in this test

Calibration

- mV outputs -> sufficient sensitivity to various densities
- Best-fit linear function (calibration) with 95 % confidence intervals uncertainty of ± 0.033 Mg/m³

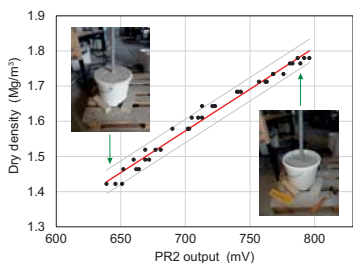

$$\rho_d = 0.00237 \text{ mV} - 0.0861$$

2. OBJECTIVES

- Emplace GBM in an intermediate-scale tank using single screw feeder
- Apply dielectric moisture profile probe to measure emplacement density and evaluate its applicability
- Assess degree of heterogeneity in the GBM when backfilled with screw feeder
- Examine if target dry density can be achieved for this GBM when backfilled with screw feeder

3. GRANULATED BENTONITE MIXTURE

GBM (Mixture 1)

- Originated in Wyoming, USA
- Processed in Germany to meet the following requirements
 - Pellet average density of 2.18 Mg/m³ -> milled and mixed
 - Particle size distribution -> Fuller's curve, up to ~10 mm
 - Water content -> 5.18 % by weight

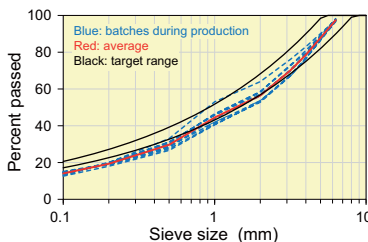

5. TEST RESULTS

Dry density distributions

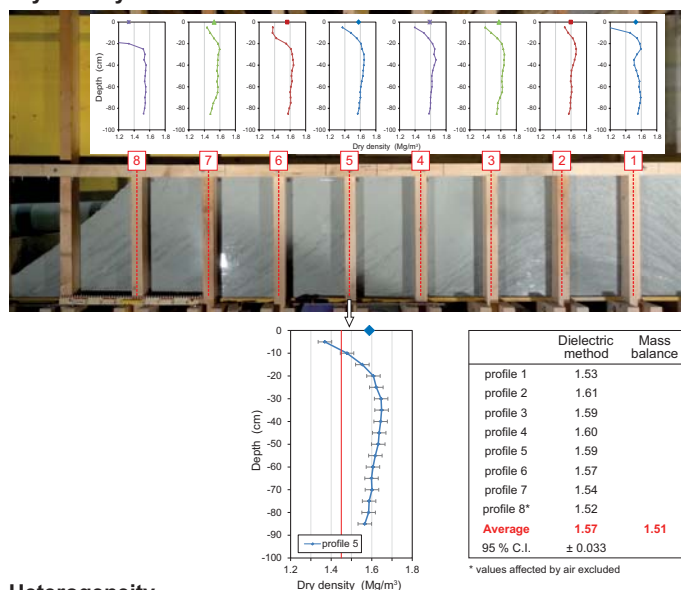

Heterogeneity

- Profiles 1 and 8 -> partially affected by the boundary/air
- Profiles 2 through 7 -> similar density distribution
- Highest density observed near screw feeder but lower near ceiling

Average dry density

- Mass balance -> 1.51 Mg/m³
- Dielectric method -> 1.57 ± 0.033 Mg/m³
- Mass balance estimate is lower probably because:
 - it includes the slope where the density may be lower
 - 2D assumption may not be perfectly correct
- Average dry density > target dry density of 1.45 Mg/m³

Applicability of dielectric profile probe to density monitoring

- Reasonable accuracy with proper calibration, sufficient spatial resolution with manual measurement, easy/quick to use -> powerful tool for monitoring GBM density

Acknowledgments

The FE experiment is implemented in the Mont Terri URL, which is operated by swisstopo. The initiator and lead organisation for the FE experiment is NAGRA; ANDRA (France), BGR (Germany), DOE/LBNL (U.S.A.), GRS (Germany) and NWMO (Canada) are participating in the Experiment. The engineering and demonstration components of the FE experiment are also part of NAGRA's participation in the EC co-funded "Large Underground COncent Experiments" (LUCOEX) project and therefore receive funding from the European Atomic Energy Community's Seventh Framework Programme (FP7) under grant agreement no 269905.

Toshihiro Sakaki¹, Sven Köhler, Marian Hertrich and Herwig R. Müller

Nagra, Hardstrasse 73, 5430 Wettingen, Switzerland, *toshihiro.sakaki@nagra.ch

1. BACKGROUND

In the Full-Scale Emplacement (FE) Experiment at the Mont Terri Rock Laboratory, Nagra has constructed a 5-arm screw feeder system to emplace granulated bentonite mixture (GBM) around three heaters that are placed horizontally on bentonite block pedestals. The target dry density of the bulk GBM as emplaced is 1.45 Mg/m³ or more.

In order to test the newly built prototype backfilling machine and to verify the achievable density of the emplaced GBM, an 1:1 scale mock-up tunnel with a dummy waste canister and pedestal was constructed and filled with GBM. This study presents results of bulk dry density of the GBM measured during the mock-up test using different dielectric tools.

4. 1:1 SCALE 3D MOCKUP SETUP

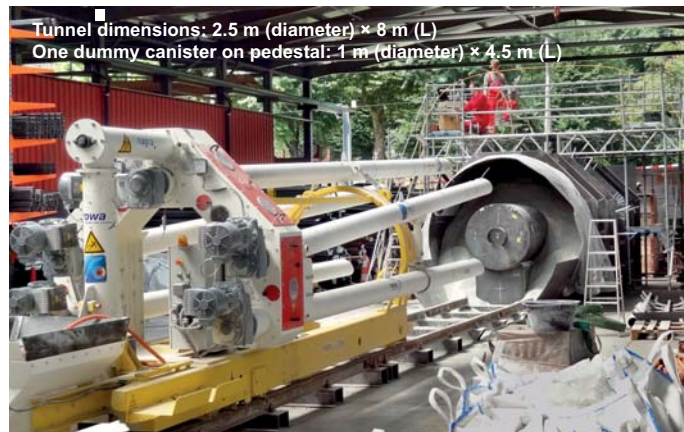

Dielectric tools used

- Radial directions → PR2 profile probe (1 m)
- Vertical & horizontal → PICO TDR (3 m)
- Wall & center → EC-5 sensor (point)

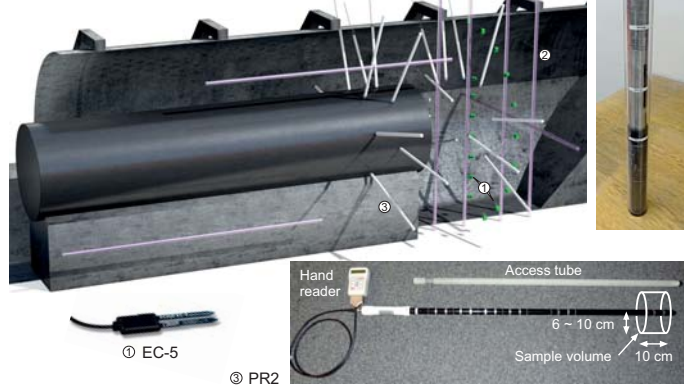

Why dielectric "moisture" sensor to measure "density"?

- Dielectric property reflects the amount of water in the material
- Water content of GBM → controlled to be ~5 % by weight
 - High density → more water (in sensor's sampling volume)
 - Low density → less water
- "Density" can be inferred using dielectric moisture sensors
- How accurate? → UNKNOWN → examined in this test

Calibrations

- sensor outputs under various densities (1.4-1.8 Mg/m³):
 - PR2 → 650-800 mV
 - PICO → 34-44 pseudo time (x1/10 ns)
 - EC-5 → 700-850 raw counts
- All tools showed sufficient sensitivity to density

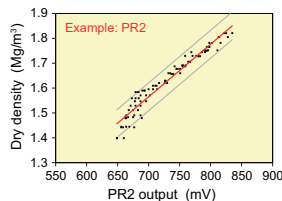

2. OBJECTIVES

- Emplace GBM in full-scale mockup tunnel using newly constructed 5-arm screw feeder system
- Apply dielectric moisture tools to measure emplacement density and evaluate their applicability
- Assess degree of heterogeneity in the GBM when backfilled with screw feeder
- Examine if target dry density can be achieved for this GBM when backfilled with screw feeder

3. GRANULATED BENTONITE MIXTURE

GBM (Mixture 3)

- Originated in Wyoming, USA
- Processed in Germany to meet the following requirements
 - Pellet average density of 2.18 Mg/m³ → milled and mixed
 - Particle size distribution → Fuller's curve, up to ~10 mm
 - Water content → ~5 % by weight

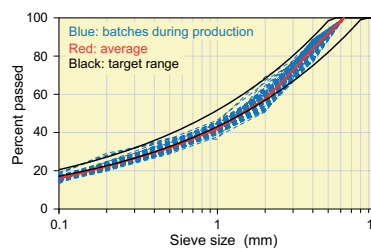

5. SELECTED RESULTS

Radial profiles (PR2)

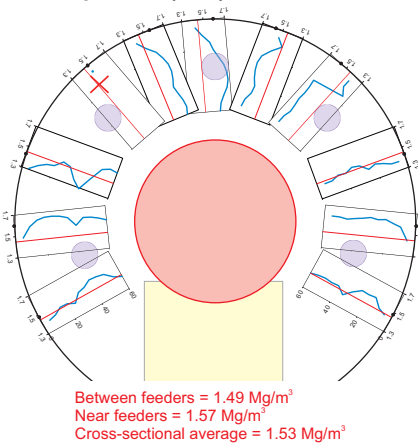

Along wall (EC-5)

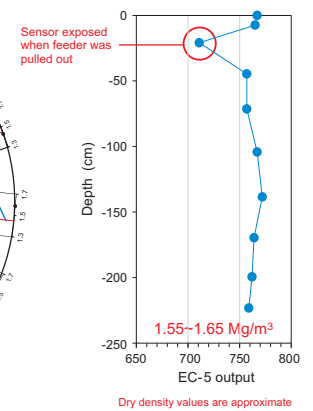

Vertical profiles (PICO)

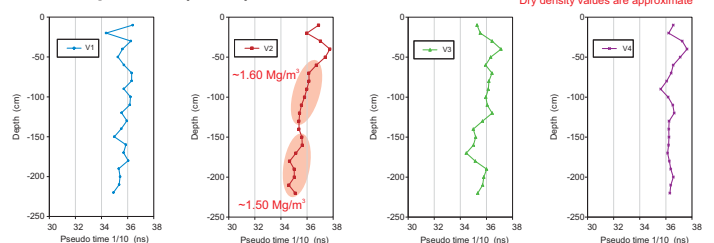

Heterogeneity

- Similar degree as observed in pretests (e.g., intermediate-scale tank)
- Higher dry density near screw feeders, also higher in the top half

Average dry density

- Mass balance → 1.51 Mg/m³
- Dielectric method → 1.53 ± 0.033 Mg/m³
- Average dry density > target dry density of 1.45 Mg/m³

Applicability of dielectric tools to density monitoring

- Reasonable accuracy with proper calibration
- Reliable and powerful tools for monitoring GBM density



Development of a Prototype Machine for Backfilling Horizontal Emplacement Tunnels with Granulated Bentonite



Heinz Jenni ¹, Sven Köhler ², Herwig Müller ² (¹ Rowa Tunnelling Logistics AG, Wangen, Switzerland; ² Nagra, Wettingen, Switzerland)

Introduction

The Full-Scale Emplacement (FE) Experiment at the Mont Terri underground rock laboratory (URL) is a full-scale heater test in a clay-rich formation. It simulates the construction, waste emplacement and backfilling of a spent fuel (SF) / vitrified high-level waste (HLW) repository tunnel as realistically as possible. One of the main aims of the FE experiment, which is also Nagra's participation in the EC co-funded 'Large Underground COnccept EXperiments' (LUCOEX) project, is the investigation of backfilling procedures for underground conditions. An overview about the FE experiment in general is given by Müller et al. (2015).

Based on the experiences from ESDRED (Plötze & Weber, 2007), a new prototype backfilling machine with five horizontal auger conveyors was developed for the FE experiment (see Figure 2). This prototype will be used to backfill a horizontal tunnel with a diameter of 2.5-3 m with dry granulated bentonite material as tightly as possible. According to the Swiss high-level waste disposal concept, this material had to be emplaced with an overall bulk dry density of at least 1'450 kg/m³.

For the FE experiment about 350 tons of a granulated bentonite mixture (GBM) with an average "pellet" dry density of 2.18 g/cm³ and with a very broad "pellet" size distribution (a so-called Fullertype distribution) were produced. This material has to be delivered to the prototype machine in big bags. After emptying the big bags into a hopper, the prototype machine transports, emplaces and compresses the GBM into the tunnel using five auger conveyors simultaneously.



Figure 1: The prototype backfilling machine (CAD modell) with five auger conveyors developed for backfilling the horizontal FE tunnel with granulated bentonite as tightly as possible. The longest auger is 8.5 m long, total length of the device is 11.5 m.



Figure 2: The prototype machine with feeding- and control unit carrying four bigbags. Total length of the backfilling machine including the feeding wagon is 17 m. The photo was taken during a 1:1 scale mock-up test in an off-site workshop. To the left, a dummy-tunnel and a dummy-canister resting on a pedestal can be seen.

Function

During the backfilling procedure all augers are filled (see Figure 3, left) and remain in the GBM bulk slope in order to build up a backfilling pressure. This pressure pushes the material up to 70 cm upwards after leaving the augers, filling gaps and overbreaks in the tunnel ceiling. During this process, the prototype is held in place by hydraulic breaks which have to hold a force of up to approx. 32 kN. With sophisticated controls, many parameters such as the auger force & rotation speed and the pushback resp. breaking force and therefore the backfilling speed resp. the bulk emplaced density can be controlled and steered (see Figure 3, right).



Figure 3: Left photo: Front end of one auger conveyor partially filled with a fuller-type granulated bentonite mixture (GBM). The screw diameter is approx. 25 cm. Right photo: The control panel steers various machine parameters such as the screw turning speed & torque

The advantage of this method is its flexibility regarding tunnel shape and obstacles (such as the canisters). Together with the Fuller-type GBM which does not need special care during handling (except of keeping it dry) this method is – once developed – robust and fairly easy to use. Further optimizations and developments are possible and will be implemented in future projects, contributing to optimise this backfilling method.

1:1 Scale Mock Up Test

With several, partially even 1:1-scale pre- and mock-up-tests (one shown in Figure 4) the prototype was tested and found to be functioning as planned and anticipated. An average bulk emplaced dry density was achieved that clearly exceeded the target dry density.



Figure 4: The newly developed backfilling machine being tested in a 1:1-scale tunnel model in an off-site workshop. The 1 m diameter dummy heater can be seen in between the augers.

Backfilling at the Mont Terri Rock Laboratory



Figure 5: Backfilling machine front in the FE emplacement tunnel



Figure 6: Backfilling machine passing under the gantry crane in the FE-A niche at Mont Terri



Figure 7: Loading Big Bags



Figure 8: Breaks attached to the rails

Acknowledgement

The engineering and demonstration components of the FE experiment are part of Nagra's participation in the EC co-funded 'Large Underground COnccept EXperiments' (LUCOEX) project and therefore receive funding from the European Atomic Energy Community's Seventh Framework Programme (FP7) under grant agreement n269905.

References

Müller H., Vogt T., Garitte B., Köhler S., Sakaki T., Weber H., Vietor T. (2015): The Full-Scale Emplacement Experiment – Implementation of a multiple heater experiment at the Mont Terri URL. Clay Conference 2015, Brussels.
Plötze, M., Weber, H. (2007): ESDRED Emplacement tests with granular bentonite MX-80 – Laboratory results from ETH Zürich. Nagra Arbeitsbericht NAB 07-24

Tobias Vogt, Herwig R. Müller, Toshihiro Sakaki, Marian Hertrich, Thomas Spillmann, Benoit Garitte, Niels Giroud, Tim Vietor
Nagra, Hardstr. 73, 5430 Wettingen, Switzerland (tobias.vogt@nagra.ch)

Introduction

The Full-Scale Emplacement (FE) Experiment at the Mont Terri underground research laboratory (URL) is a full-scale heater test in a clay-rich formation ('Opalinus Clay'). One of the main aims of this experiment is to investigate repository-induced THM coupled effects mainly on the host rock but also in the engineered barrier system (EBS). The entire experiment implementation (in a 50 m long tunnel with a diameter of approx. 3 m) as well as the post-closure THM(C) evolution is being monitored using a network of several hundreds of sensors. The sensors are distributed in the rock near- & far-field, the tunnel lining, the EBS, and on the heaters.

Timeline

The rock in the 'far-field' was instrumented with up to 50 m long boreholes drilled from the FE cavern; this instrumentation was completed in April 2012 before the FE tunnel was built. Until February 2014 the 'excavation damage zone' (EDZ) was instrumented with radial boreholes drilled from the FE tunnel. In June 2014 the instrumentation of the tunnel wall was completed for future monitoring of the bentonite buffer; here also many fibre optical cables for distributed temperature and deformation monitoring were installed. More sensors for monitoring the EBS close to the heaters were brought in together with the heaters.

Details

The main parameters to be monitored are temperature, pressure, deformation, and humidity/water content but also geophysical and gas related monitoring will be performed.

- 6 boreholes with multi-packer systems and 6 intervals each, 8 boreholes with multi-packer systems and 2 intervals each, 13 boreholes with single-packer systems and 1 interval each.
- 5 boreholes with standard rod extensometer and 6 boreholes with specially designed long-term rod extensometer. 2 boreholes with inclinometer-chains, 40 segments each, two measurement axes. 7 boreholes with fibre-optic strain sensors (SOFO).
- 29 boreholes with water content (TDR/FDR) and relative humidity sensors.
- All boreholes are equipped with in total 320 temperature sensors (PT1000 and thermocouples). In addition, 360 m of fibre-optical cable on the inclinometer casing and 250 m at tunnel wall for distributed temperature sensing are installed.
- 12 climate sensors (RH & temperature, wind speed, air pressure) during ventilation phase.
- Sensors per heater: 6 internal temperature sensors, 44 temperature sensors on heater surface (thermocouples and fibre-optic FBG sensors), 7 displacement sensors (LVDT and fibre-optic FBG sensors) to track heater movement, 2 total pressure cells on heater surface.
- Bentonite monitoring: 105 conventional temperature sensors (thermocouples and PT1000), approx. 430 m of fibre-optic cables for distributed temperature and strain sensing, 99 RH sensors, 15 water content (TDR/ FDR) sensors, 27 total pressure cells, 12 thermal conductivity sensors.
- Gas monitoring: 14 in-situ H₂ sensors and 5 in-situ O₂ sensors and 9 sampling lines.
- Geophysical monitoring: 7 permanently installed seismic transmitters and receivers as well as monitoring pipes to do temporary geophysical measurements.



Instrumentation on the tunnel wall



Long-term heater movement monitoring

Conclusion

The monitoring environment is challenging. Temperatures of up to 150°C in the bentonite buffer and of up to 60-80°C in the rock are expected. In addition, saline pore water will cause corrosion in the rock and in the humid / (partially) water saturated areas close to the tunnel wall. So although some state-of-the-art sensors and measurement systems could be installed, also prototype measurement systems were developed especially regarding the choice of material with respect to corrosion and thermal conductivity. Naturally novel fibre-optical sensor technology was also heavily used.

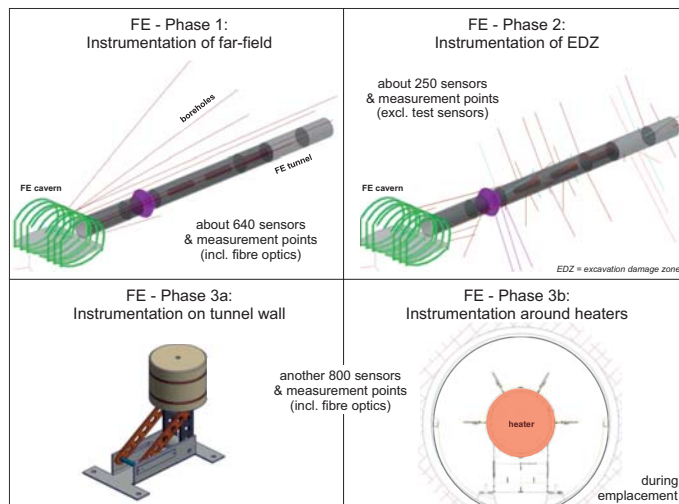

Overview showing the main instrumentation phases of the FE Experiment

Details



Heater instrumentation on erectable sensor holders

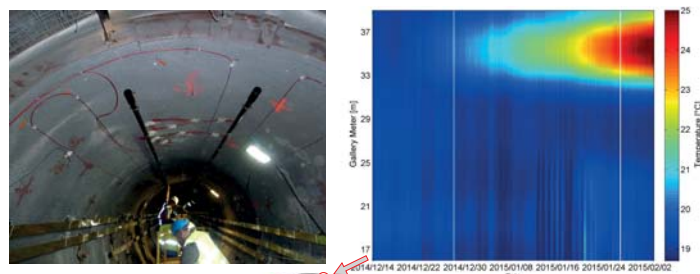

Fibre-optical cable for distributed temperature sensing (DTS) based on Raman backscattering



Results from DTS measurements with one fibre-optical cable (marked with red arrow) installed on the tunnel wall along the total length of the tunnel vs. time; the heat from the first heater reaching the tunnel wall can be observed.

Acknowledgments

The FE experiment is implemented in the Mont Terri URL, which is operated by swisstopo. The initiator and lead organisation for the FE experiment is NAGRA; ANDRA (France), BGR (Germany), DOE/LBNL (U.S.A.), GRS (Germany) and NWMO (Canada) are participating in the Experiment.

Sven Köhler, Thomas Fries, Herwig Müller, Irina Gaus (Nagra, Wettingen, Switzerland)

Introduction

The Swiss reference repository concept for spent fuel / high level radioactive waste (SF/HLW) (fig. 1) is based on a multi barrier system. Besides the natural geological barrier (Opalinus Clay), it comprises several engineered barriers, such as the disposal canister, backfill surrounding the canister and several tunnel seals.

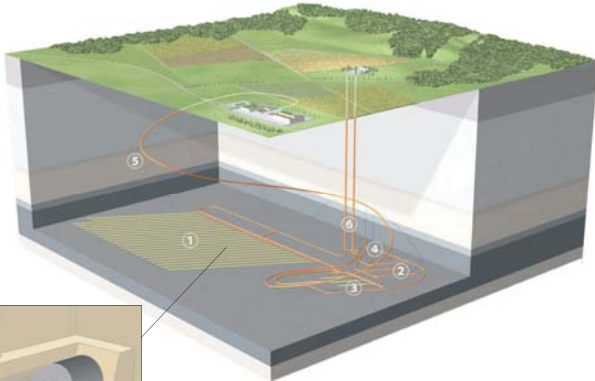
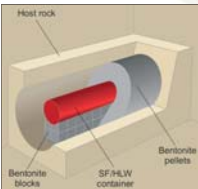

Fig. 1: Swiss reference repository concept for spent fuel / high level waste (SF/HLW)

- ① SF/HLW repository (Emplacement tunnels)
- ② ILW repository
- ③ Pilot facility
- ④ Test facility
- ⑤ Access tunnel
- ⑥ Construction shaft and ventilation shaft



Bentonite backfill

According to the current reference concept, SF/HLW will be emplaced in disposal tunnels (inner diameter of 2.8m). Each disposal canister will be embedded in a suitable buffer material that is made of bentonite blocks and of (highly compacted) granulated bentonite mixture (GBM). The tunnel will be backfilled with GBM after emplacement of each disposal canister. The bentonite material as well as the backfilling procedure have to fulfill several requirements regarding long term safety (Leupin & Johnson, 2013) and technical feasibility.

Long-term safety requirements

Final saturated density is considered the key property to ensure adequate long-term performance of the bentonite based backfill material in a repository since it directly influences the safety relevant attributes such as swelling pressure, gas- and water permeability, porosity and suppression of microbial activity. Suppression of microbial activity sets perhaps the most stringent density requirement. Stroes-Gascoyne (2011) reported that microbial activity is clearly suppressed in highly compacted bentonite. Leupin & Johnson (2013) concluded that a saturated density of 1.90 t/m³ (corresponding to a dry density of 1.45 t/m³) for bentonite MX-80 is a desirable target as it may decrease the likelihood of microbial induced corrosion.

Design Requirements

Hence, for the Swiss reference concept, a dry density of 1.45 t/m³ is regarded as a target design requirement in the emplacement tunnels for SF/HLW. This value has proven to be achievable in terms of technical feasibility (Plötze & Weber, 2007; Gaus et al., 2011).

Regarding the backfilling method, the major requirements are attributed to the complete backfilling of the SF/HLW emplacement tunnels around, before and behind each disposal canister allowing for

- a target dry density of 1.45 t/m³ or higher for the entire bentonite backfill. This includes the necessity of a high content of swelling minerals (i.e. basically montmorillonite).
- a homogeneous distribution of the backfilled GBM and the target dry density.

Moreover, in choosing an appropriate backfilling method, the following aspects have to be considered:

- Continuous backfilling process in a retreating mode for each disposal canister with high reliability and availability
- Iteration with the emplacement of disposal canister units incorporating pedestals made of highly compacted bentonite blocks
- Accurate backfilling quality for varying tunnel radius due to gallery excavation deviations and support elements (e.g. shotcrete lining, steel ribs etc.)

Prototype Backfilling Machine

A prototype backfilling machine (fig. 2) has been designed and fabricated in the framework of the Full-scale Emplacement (FE) Experiment that has been implemented at the Mont Terri Rock Laboratory (Müller et al. 2015; Jenni et al. 2015). This backfilling machine is based on screw conveyance methodology exhibiting five horizontal augers. The overall dry density target of the backfilled granulated bentonite mixture was clearly met. However, there is still some potential for further improvement of backfilling quality in terms material homogeneity, since some segregation effects were observed.



Fig. 2: Prototype backfilling machine fabricated for the Fullscale Emplacement (FE) Experiment. (Side note: The pictured feeding device containing bigbags does not exhibit any prototype character.)

Outlook

Current and future work focuses on the estimation and analysis of local dry density variations (Sakaki et al. 2015a and Sakaki et al. 2015b), as well as on its mitigation by innovative process engineering.

References

- Gaus, I., Köhler S., Teodori, S., Weber, H., Rösli, U., Steiner, P., Trick, T., Siñeriz, J.-L., Nussbaum, C., Czaikowski, O., Wiczeorek, K., Schuster, K., Kuhlmann, K., Garitte, B., Gens, A., Mayor J. C. (2011): Long Term performance of Engineered Barrier Systems (PEBS). Mont Terri HE-E experiment: detailed design. Nagra Arbeitsbericht NAB 11-01
- Jenni, H., Köhler, S., Oberberger, A., Battisti, L., Müller, H.R.: FE Experiment / LUCOEX (2015): Development of a prototype machine for backfilling horizontal tunnels with granulated bentonite. Conference companion paper
- Leupin, O.X., Johnson, L.H. (2013): Buffer Requirements for a SF/HLW Repository in Opalinus Clay. Nagra Arbeitsbericht NAB 13-46
- Müller H.R., Vogt T., Garitte B., Köhler, S., Sakaki, T., Weber H., Vietor, T. (2015): The Full-Scale Emplacement Experiment – Implementation of a multiple heater experiment at the Mont Terri URL. Conference companion paper.
- Nagra (2002a): Projekt Opalinuston: Konzept für die Anlage und den Betrieb eines geologischen Tiefenlagers: Entsorgungsnachweis für abgebrannte Brennelemente, verglaste hochaktive sowie langlebige mittelaktive Abfälle. Nagra Technical Report NTB 02-02.
- Plötze, M.; Weber, H. (2007): ESDRED Emplacement tests with granular bentonite MX-80 – Laboratory results from ETH Zürich. Nagra Arbeitsbericht NAB 07-24
- Sakaki, T., Köhler, S., Müller, H.R. (2015a): FE Experiment: Density measurement of granulated bentonite mixture in a 2D pre-test using a dielectric moisture profile probe. Conference companion paper
- Sakaki, T., Köhler, S., Hertrich, M., Müller, H.R. (2015b): FE Experiment: Density measurement of granulated bentonite mixture in a 3D 1:1 scale mockup test using dielectric tools. Conference companion paper
- Stroes-Gascoyne, S. (2011): Atomic Energy of Canada Limited AECL: Microbiological Characteristics of Compacted Bentonite at a dry density of 1450 kg/m³ – A Literature Review. Nagra Arbeitsbericht NAB 11-05

Benoit Garitte, Florian Kober, Herwig R. Müller, Sven Köhler, Hanspeter Weber and Ingo Blechschmidt
Nagra, Hardstr. 73, 5430 Wettingen, Switzerland (benoit.garitte@nagra.ch)

The BeLLT (Bentonite Large scale Load Test) and the BLL (Bentonite Long term Load) experiments aim at investigating the stability of compacted bentonite blocks under climatic and mechanical loads. They are satellite experiments of the FE experiment (Müller et al., 2015) and were designed to optimize the production parameters of the FE bentonite blocks (Garitte et al., 2015) and the design of the bentonite block pedestals of the FE experiment that must sustain the 5 ton heaters. Both experiments were performed at Grimsel Test Site (GTS) and were associated with a series of mechanical laboratory experiments run at CEA

Pre-production of bentonite blocks and laboratory tests

Bentonite blocks are sensitive to ambient relative humidity. This sensitivity is seemingly dependent on the original water content of the blocks (i.e. the water content of the raw material used to manufacture the blocks) and the compaction pressure.

It was thus decided to produce 90 bentonite blocks at **three different water contents and three different compaction pressures** with a natural sodium bentonite (Gelclay WH2).

The blocks were isolated in airtight chambers together with a Relative Humidity sensor. The **equilibrium RH** shows a clear trend as a function of the initial water content and secondary trends as a function of the compaction pressure.

The blocks were then submitted to **uniaxial compression strength** tests. Some of them directly after the production, some of them after several weeks in a climate chamber in which different RH were imposed.

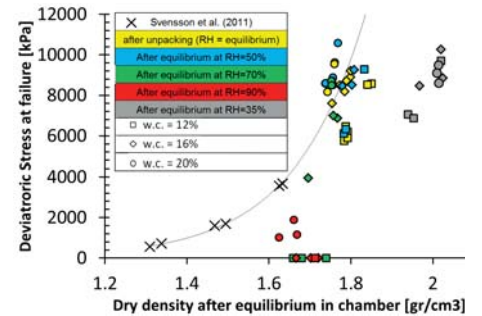
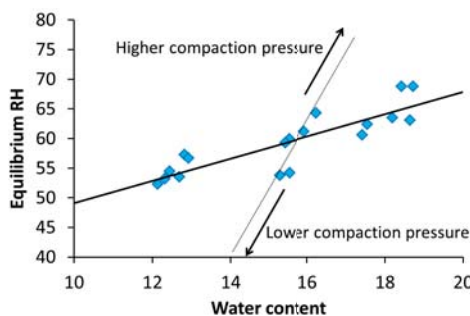
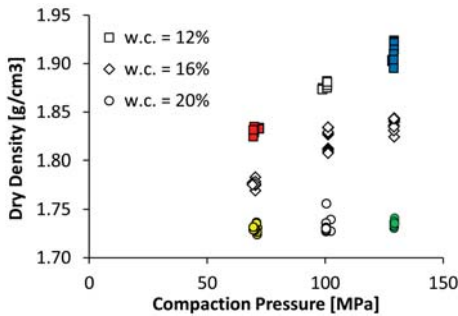

The laboratory test results clearly show that (1) imposing a RH to a bentonite block higher than its natural equilibrium RH drastically reduces its strength. On the contrary, (2) imposing a RH to a block lower than its equilibrium RH leaves the block strength unaffected. Blocks with a high equilibrium RH are thus likely to be more resistant to RH variations.

BLL (Bentonite Long term Load)

BLL was set up (1) to verify the previous laboratory results and (2) to investigate phenomenologically the mechanisms behind those results. To this purpose, 2 blocks of four different initial conditions (indicated by coloured dots in the compaction pressure – dry density graph above) were placed in an environment characterized by RH variations similar as those expected in the FE tunnel. Additionally those blocks were loaded with a similar pressure to that applied by a heater on the bentonite blocks in the FE experiment. The experiment was set up on 19.09.13 at 11:00 (RH at that time =70%).

12% - 70MPa

12% - 130MPa

20% - 70MPa

20% - 130MPa

A picture was taken every minute

1 month video

4 month video

Scan and watch the video on your mobile.

The videos clearly show 1) the fracture development and 2) the swelling behaviour of the cracking blocks. The fractures are believed to be induced by swelling, caused by water absorption by the relatively dried bentonite from relatively wet air. They propagate very fast because the relatively wet air penetrates into the fractures and extend the fracture inside the block. Drying cracks were also observed in the blocks equilibrated at 35% in the laboratory test, but these are shrinkage cracks and they do not penetrate into the blocks.

BeLLT (Bentonite Large scale Load Test)

Mechanical parameters derived from the laboratory tests were used in a FEM-DEM computation aiming at verifying the stability of a bentonite blocks arrangement under load. The expected failure load of an FE pedestal was determined to be about 1000 tons.

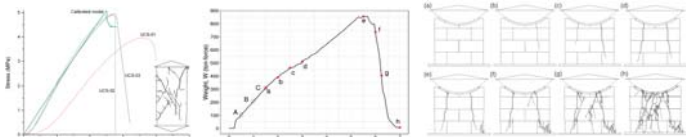

The BeLLT experiment was set-up to verify the upscaling results obtained by modelling. It consists of a 1:1 scale FE bentonite block in transversal section. The length of the BeLLT pedestal is 5.5 times smaller than an FE pedestal.

The BeLLT pedestal was loaded by a half cylinder and hydraulic jacks providing a vertical load.



The BeLLT pedestal supported a load of over 1000 FE equivalent tons.

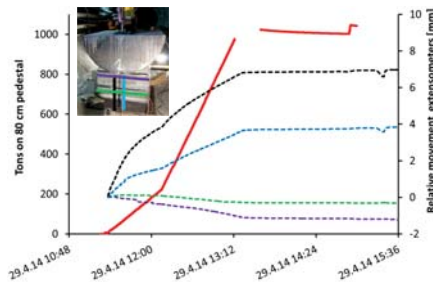

The first (minor) cracks appeared after several days under load (1000 FE equivalent tons)



The BeLLT pedestal supported this load during several months.

Acknowledgements

The FE experiment is implemented in the Mont Terri URL, which is operated by Swissstop. The initiator and lead organisation for the FE experiment is NAGRA; ANDRA (France), BGR (Germany), DOE/LBNL (U.S.A.), GRS (Germany) and NWMO (Canada) are participating in the Experiment. The engineering and demonstration components of the FE experiment are also part of NAGRA's participation in the EC co-funded 'Large Underground Concept Experiments' (LUCOEX) project and therefore receive funding from the European Atomic Energy Community's Seventh Framework Programme (FP7) under grant agreement no 269905.

J.K. Becker ⁽¹⁾, D. Jaeggi ⁽²⁾, A. Lisjak ⁽³⁾, H. Madritsch ⁽¹⁾, S. Schefer ⁽⁴⁾, H.R. Müller ⁽¹⁾, T. Vietor ⁽¹⁾

¹ Nagra, Switzerland (jens.becker@nagra.ch); ² Mont Terri Consortium, Swisstopo, Rue de la gare 63, CH-2882 St-Ursanne; ³ Geomechanica Inc., 90 Adelaide St. W., Suite 300, Toronto, Canada; ⁴ Geo Explorers Ltd., Wasserturmplatz 1, CH-4410 Liestal

Introduction

Between 2008 and 2012, several niches and tunnels were excavated within the Opalinus Clay of the Mont Terri underground research laboratory (URL). During the excavation phases, each newly-excavated section was geologically mapped in detail. The mapping focussed on the orientation of the bedding and on the inventory of structural features, including fractures of the excavation damaged zone (EDZ). Consideration of additional measurements such as breakout phenomena, pore pressure measurements, gas permeability measurements and in-situ stress conditions help to illustrate the influence of pre-existing fracture systems on the rock mass stability and EDZ characteristics.

Underground lab Mont Terri, Switzerland

The Mont Terri underground lab is located in northwestern Switzerland along the security gallery of a highway tunnel. The floorplan below also shows the chronostratigraphic boundaries and major faults (zones).

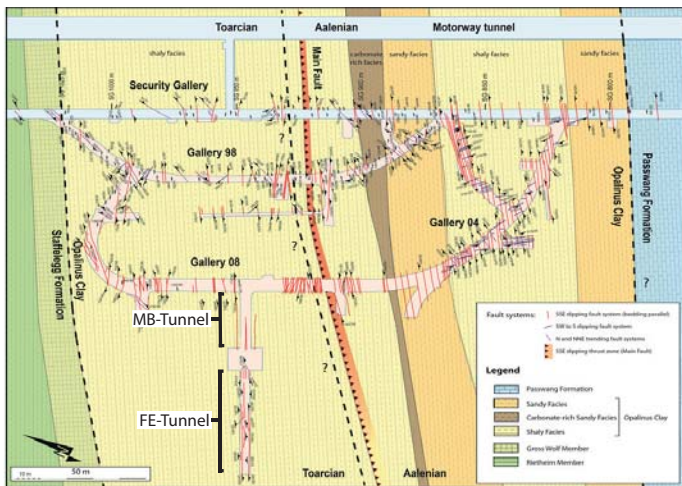

Setting of the URL Mont Terri and location of the MB- and FE-Tunnels described here.

MB-Tunnel

The results of detailed structural mapping during the initial excavation of the MB-Tunnel are shown in a synoptic sketch below. Observations on fracture kinematics such as slip indicators or cross cutting relationships turned out to be particularly valuable to unravel the genesis and evolution of the observed fracture system. A synthesis of these observations allows a distinction between pre-existing (tectonic) and EDZ related fractures, their structural relationships and influence on face stability.

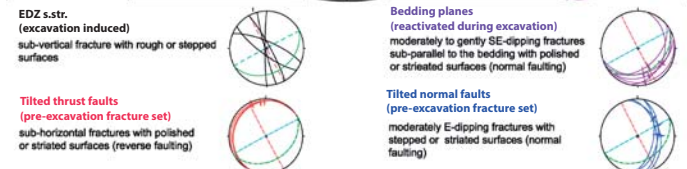
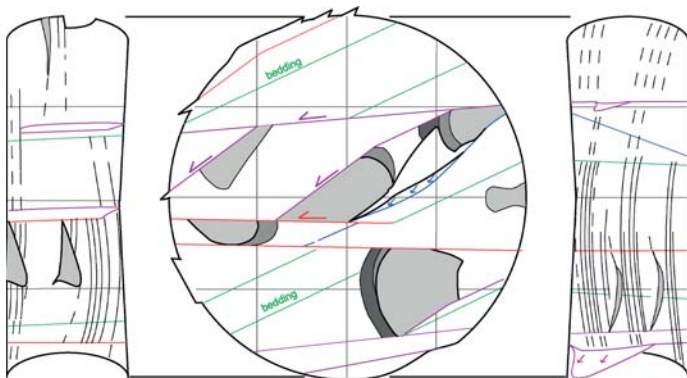

Tilting criteria: Fractures with slip indicators can be assumed to predate the formation of the Mont Terri anticline if they fulfill an Andersonian stress state after backtilting of the bedding (left image). This criteria turned out to be useful to identify fracture systems that pre-date the excavation (tectonic fractures; see above).

As indicated in the synoptic tunnel sketch the structural features pre-dating the excavation were partly reactivated during the excavation progress but also acted as breakout limiting discontinuities.



REFERENCES:

Lanyon, G.W., Martin, D., Giger, S., Marschall, P. (2014): Development and evolution of the Excavation Damaged Zone (EDZ) in the Opalinus Clay - A synopsis of the state of knowledge from Mont Terri. NAB 14-87

FE-Tunnel

The FE-Tunnel is a 50m long extension of the MB-Tunnel with a diameter of 3m. The tunnel was excavated between April and June 2012 using a pneumatic hammer and a roadheader. The accuracy of the initially circular profile was low, the invert was excavated as a flat section. The used support varied along the tunnel using combinations of shotcrete, steel arches and steel meshing.

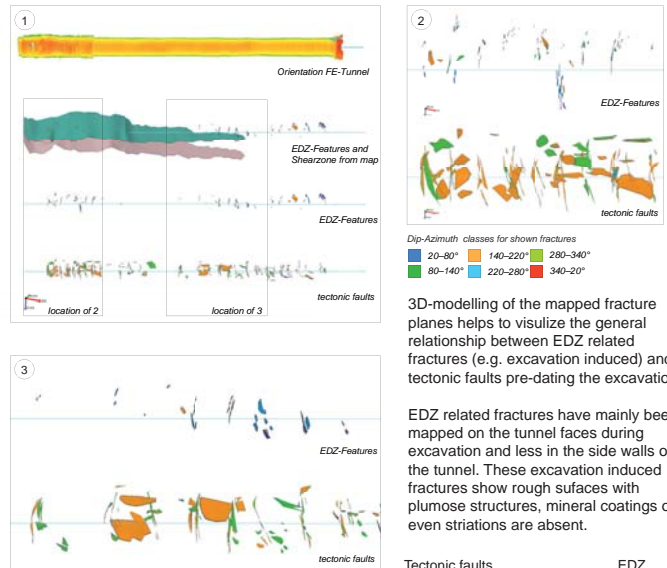

3D-modelling of the mapped fracture planes helps to visualize the general relationship between EDZ related fractures (e.g. excavation induced) and tectonic faults pre-dating the excavation.

EDZ related fractures have mainly been mapped on the tunnel faces during excavation and less in the side walls of the tunnel. These excavation induced fractures show rough surfaces with plumose structures, mineral coatings or even striations are absent.

Most of the mapped tectonic features are bedding parallel and bedding sub-parallel faults and associated splays. The orientations of the tectonic faults show no clear trend for a change of their orientation along the tunnel.

The most prominent tectonic feature of the tunnel is a shear zone which affects about 70% of the 50 m long tunnel (see 1). It appears that this shear zone is constituted by the dense occurrence of minor bedding parallel faults.

Scaled sketch of the FE-Tunnel from tunnel meter 0 to tunnel meter 50. The lower hemisphere projections show tectonic faults and EDZ-faults of 4 sections. The projections are rotated with respect to the tunnel axis.

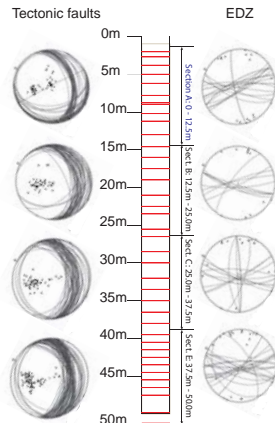

Summary

Pre-existing fractures have a great influence on the tunnel stability and the development of the EDZ. Compiling all available data in a 3D model certainly helps to understand the relationship between different faults sets but since it is often hard to distinguish between pure EDZ-features (excavation induced) and reactivated pre-existing faults, „secondary“ measurements such as pore pressure, gas permeability, electric resistivity or seismic tomography must also be taken into account.

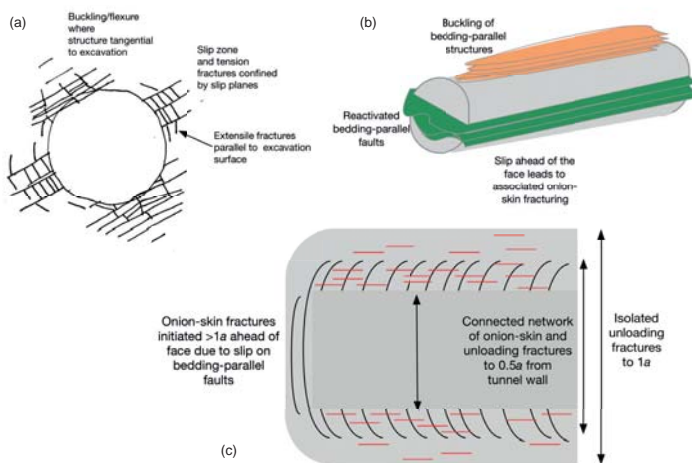

Shown above is a conceptual model of the EDZ fracture network for excavations parallel to bedding strike (MB- and FE-Tunnel) at Mont Terri (from Lanyon et al., 2014):

(a) cross-section illustrating fracturing mechanisms; (b) sketch illustrating slip on tectonic faults ahead-of the face and associated band of fracturing in side-wall; (c) cross-section parallel to bedding.

Results from hydro-mechanical and geochemical analyses of the retrieved buffer material from the Prototype Repository at Äspö HRL

Lars-Erik Johannesson, Pär Graham, Anders Sjöland, SKB, Äspö Hard Rock Laboratory, Oskarshamn, Sweden, www.skb.se



Introduction

The Prototype Repository is a full-scale trial of the KBS-3V system, installed at the Äspö Hard Rock Laboratory in 2001-2003. The trial consists of six full-scale deposition holes in a TBM-tunnel at a depth of 450 metres in crystalline rock. Each deposition hole was installed with bentonite buffer (MX-80) and full-scale canisters, equipped with heaters to simulate residual heat from spent fuel. The deposition tunnel was backfilled with a mixture of crushed rock and bentonite (30 % bentonite).

The dimensions of the tunnel and the deposition holes are shown in Figure 1 and Figure 2 respectively. The design of the trial includes two sections separated by a concrete dome plug. The inner section (I), which still is in operation, consists of four deposition holes. The outer section (II) with two deposition holes was opened and retrieved during 2011 in a project led by SKB and Posiva Oy supported by six international partners.

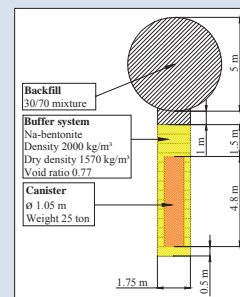

Figure 2. Schematic view over a deposition hole.

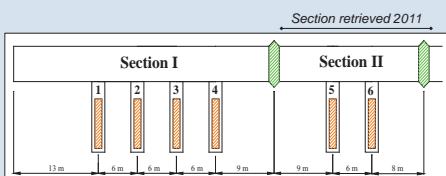

Figure 1. Schematic view of the layout of the Prototype Repository at Äspö HRL

Sampling of the buffer

About 4000 determinations of density and water content were made in each buffer. The results show that after almost 8 years of wetting, none of the two buffers was homogeneous and large variations in water saturation existed, both between the deposition holes, between blocks in the same hole, and also within one and the same block, see Figure 3 and Figure 4.

At the retrieval of the buffer, samples were also taken for laboratory examinations concerning hydro-mechanical, chemical and mineralogical characterisation. Examinations were performed on both field exposed material and on reference samples, saved from the manufacturing of the buffer blocks. The purpose of this procedure was to study possible changes in the buffer material after almost 8 years of exposure to elevated temperature and saturation of groundwater from the surrounding rock. The maximum temperature was below ~85°C during the test period. Due to malfunction of heaters in deposition hole 6 the temperature was somewhat lower in this buffer compared to deposition hole 5.

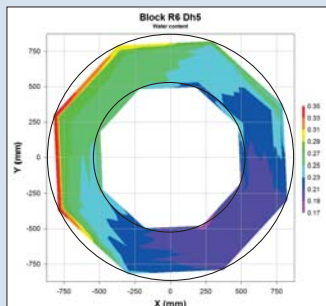

Figure 3. Measured water content in block R6 deposition hole 5

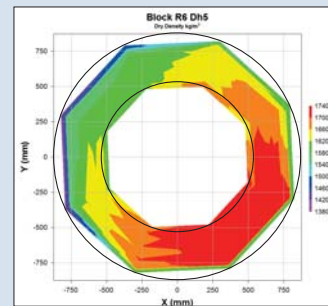

Figure 4. Measured dry density in block R6 deposition hole 5

Hydro-mechanical analyses of the buffer

Hydro-mechanical tests were performed on samples from one radial profile of the warmest part of each buffer and included determinations of hydraulic conductivity, swelling pressure and unconfined compression strength and shear strength.

The measurements of the swelling pressure and hydraulic conductivity were made on both reference material and on field exposed material, see Figure 5. The results show no large differences in swelling pressure between the reference specimens and the specimens with field-exposed material while there is a small tendency that the hydraulic conductivity is somewhat lower for the field exposed material compared to the reference material.

The unconfined compression tests were made with two different sample heights (20 mm and 40 mm), see Figure 6. The maximum deviator stress and the strain at failure were determined in these tests. The stress at failure increased with increasing dry density but no large differences in strength between the reference specimens and the specimens with field exposed material could be seen. The field exposed material was somewhat more brittle than the reference specimens i.e. the strain at failure was lower for the field exposed material.

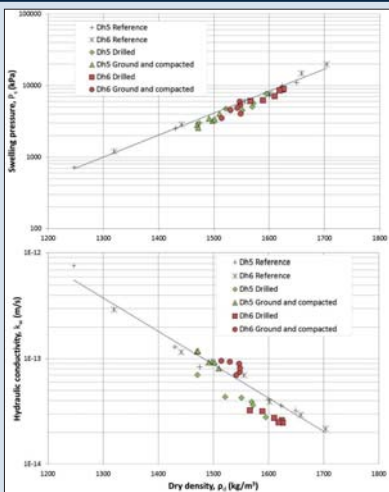

Figure 5. Swelling pressure and hydraulic conductivity for the buffer

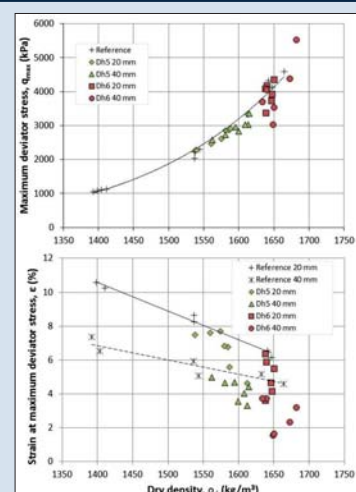

Figure 6. Maximum deviator stress and strain at failure for the buffer.

Chemical-mineralogical analyses of the buffer

Chemical-mineralogical analyses were carried on four radial profiles from three blocks with variable water content. The analyses included determinations of water-soluble salts, chemical composition, cation exchange capacity, exchangeable cations, and mineralogy. The results from the analyses show that:

- the chloride concentration in the three saturated profiles had increased 3 to 6-fold. Soluble accessory minerals in the bentonite, mainly gypsum but also calcite, had been redistributed and re-precipitated close to the canister,
- the major change in the exchangeable cation pool was a small but general loss in magnesium relative to the reference concentration, in the outer and middle parts of all profiles investigated, see Figure 7,
- the bentonite from the buffer tended to have somewhat lower cation exchange capacity than the reference samples, see Figure 8,
- non-exchangeable magnesium had increased relative the reference level close to the canister, suggesting a transfer of magnesium along the thermal gradient, and accumulation in the warmest part of the buffer, see Figure 9,
- the FTIR- and XRD-characteristics, the calculated structural smectite formulae, and the CEC of the <0.5 μm fraction provided no significant evidence of any structural changes in the montmorillonite, see Figure 10.

Results from laboratory test have been published in SKB TR-13-21. Experience and main conclusions from the retrieval of the Prototype Repository will be published in June 2015 (SKB TR-13-22).



Figure 7. Relative distribution of exchangeable Ca, K, Mg and Na in two buffer profiles

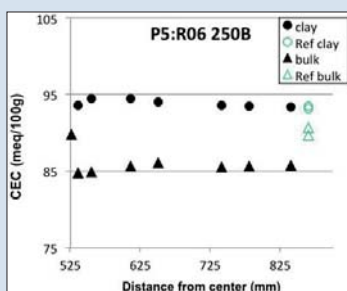

Figure 8. CEC values for the buffer. Reference samples are presented as green circles in the right end of the profile

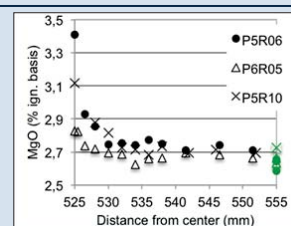

Figure 9. Distribution of magnesium in bulk samples taken close to the canister. Reference samples plotted in green on the right axis

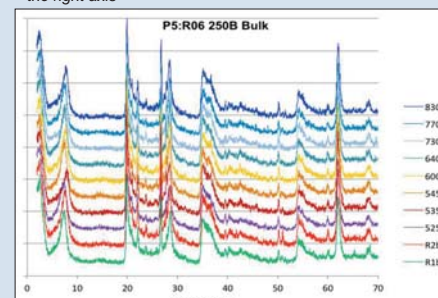

Figure 10. XRD patterns of bulk samples from one profile. The labels represent the distance from the hole center

International partners





Layout of the Äspö HRL Prototype Repository. Retrieved outer section in red circle above.

The ÄSPÖ HRL Prototype Repository:

- Crystalline rock at -450 meters level.
- The inner section (I) was installed 2001.
- The outer section (II) was installed 2003.
- The retrieval of the outer section began in November 2010 and was completed in December 2011
- In total, about 10,000 clay samples were collected.

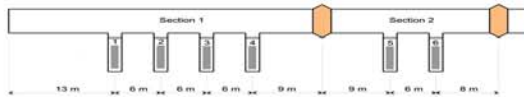

PLUG OPENING



- The outer plug consists of 120 tons reinforced concrete (4.4 tons steel)
- Two lead-through pipes for sensor cables

• The plug breaching started with core drilling of a cross and four contact samples to study grouting between concrete & rock.



• Hydraulic splitting was successfully combined with mechanical demolition.

• Reinforcement was sawn off by hand.



• The sensor cables passing the plug were kept in function as long as possible. Finally, the concrete beams were lifted off, and the backfill was exposed.

BACKFILL SAMPLING AND REMOVAL

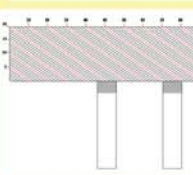

- The backfilling consists of 30% bentonite and 70% crushed rock.
- In 2003, backfill was installed and compacted in 20 cm layers with 35° inclination.

- It was decided that the backfill should be removed and sampled in layers of 2 meters with inclination as steep as possible.
- About 1000 samples (in 11 layers) were planned. 86 sensors should be possible to find (low priority to retrieve with respect to focus on sampling).

- Circular saw machine and plastic bags were used to collect the samples.
- Approx. 100 samples from each backfill layer.



- Platforms mounted on the backfill slope.
- Each sample was positioned by geodetic survey.



- The 30/70 backfill was fully saturated.
- A very slippery, heavy and hard material to work with.

BUFFER SAMPLING AND REMOVAL

- The buffer consists of Na-bentonite MX-80 with density 2,0 ton/m³ (dry density 1,57).
- 4 blocks and 10 rings (uniaxially compacted) for each deposition hole, installed in 2003.
- About 8000 samples were planned for determination of density and water content.
- 220 sensors should be possible to find (low priority to retrieve) and furthermore 27 water cups (sample collectors).

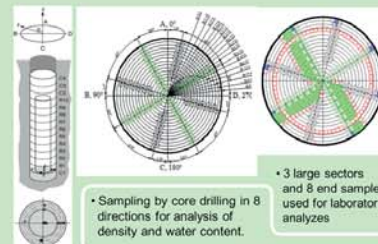
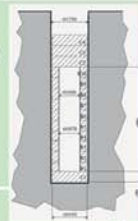

- 3 large sectors and 8 end samples used for laboratory analyzes
- Sampling by core drilling in 8 directions for analysis of density and water content.



- Wooden templates were helpful to position each core drill sample according to the governing activity plan.

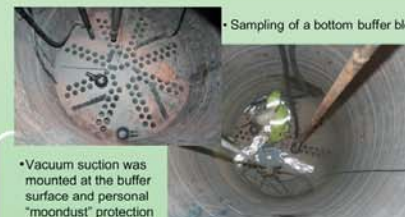

- Vacuum suction was mounted at the buffer surface and personal "moondust" protection was used.

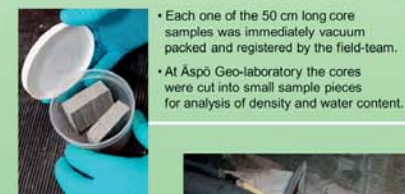

- Each one of the 50 cm long core samples was immediately vacuum packed and registered by the field-team.
- At Äspö Geo-laboratory the cores were cut into small sample pieces for analysis of density and water content.

- A special sample of copper/bentonite interface used for corrosion studies.



EXPERIENCES FROM THE PLUG BREACHING

- Start by core drilling of a cross through the entire concrete dome was necessary before demolition.
- Hydraulic splitting and mechanical demolition was successfully combined
- Don't waste time on untried methods like the use of sylvanite
- Time consuming activity, in total 12 weeks. Reasons for this were the extensive reinforcement and precautions for sensor cables.
- Costs for demolition were equal to casting a new plug.



EXPERIENCES FROM SAMPLING OF BACKFILL

- No actual problems during the excavation.
- Plastic bags sometimes broke.
- Positioning of each sample gives good reliability to data.
- Use of good quality machines was essential.
- Most of the retrieved sensors were destroyed by the excavator. During installation, the sensors should have been better protected, better surveyed, and the cables should have been led along the floor level and optimized in length.



EXPERIENCES FROM SAMPLING OF BUFFER

- Sampling methods worked fine! Effective drilling from above with two machines placed on a rail.
- Large sector samples are very heavy to handle, a crane was needed.
- Many of the retrieved sensors were destroyed by the drilling.
- Only 35 cm space when collecting samples from buffer rings.
- Dusty and noisy environment. Use of masks was necessary and head-set vital to allow conversation!



OVERALL EXPERIENCES

- A forecast of anticipated status, before the retrieval starts, creates great confidence in the project.
- Documentation from the installation is very helpful.
- Staff with experience from installation is great!
- Try to keep the same staff during the entire project!
- A realistic schedule is a basis for a good performance.
- Low priority for retrieval of sensors was crucial for progress in sampling.
- Workers safety must be priority no.1.
- Endeavor for a structured management of samples in near-field.
- Important to have a local geo-laboratory and good routines.

CANISTER RETRIEVAL

- The canisters were raised with the same special equipment used for depositing in 2001/2003.
- Explosive gas inside a canister due to hydrolysis of material in heaters and cabling?
- Canisters were punctured and assayed for hydrogen and oxygen content.
- Study of mechanical deformations at the Canister Laboratory.
- Corrosion sample programme added when canisters had been retrieved.



INTERNATIONAL PARTNERS



State of the art of geological disposal in Ukraine

Zlobenko Borys, Shabalin Borys



SI "Institute of Environmental Geochemistry NAS of Ukraine"
Corresponding author e-mail: borys.zl@gmail.com

Introduction

Currently there are 15 reactors in operation at four Ukrainian nuclear power plants, including 13 VVER-1000 reactors and 2 VVER-440 reactors. Ukraine takes seventh place in the world and fifth in Europe in terms of installed nuclear capacity.

The general concept for radioactive waste isolation in geological formations in Ukraine is based on the experience of countries having more developed waste management programmes, the IAEA basic principles, and technical criteria adapted to geological, socio-economic and ecological conditions in Ukraine.

Based on these considerations a law has been passed in Ukraine "On Radioactive Waste Management". It provides for the ultimate disposal of HLW and ILW in deep geological formations. According to Article 17 of this law, HLW (including waste originating from processing of used fuel from Ukrainian NPPs at foreign enterprises and then returned to the Ukraine) is subject to long term storage and/or disposal in deep geological formations. Today, this issue is not resolved properly, as Ukraine does not have a concept of the geological repository design. Development of this concept should be accelerated in accordance with the regulatory document "General Safety Provisions for Radioactive Waste Disposal in Geological Repositories". But as for today, activities within this area are on the pre-conceptual level and realistic deadlines for creation of the geological repository are not defined. Under these conditions, it is planned to store long-lived RW for a long period of time (50 years) in facilities for long-term storage at the "Vector" site in the Chernobyl exclusion zone till creation of a geological repository.

Waste inventory for GDR

Ukraine has made intensive use of nuclear technologies for several decades resulting in the generation of large amounts of radioactive waste. Only rough estimation of long-lived RW volumes may be performed (from 11,500 to 15,000 m³ of HLW and 130,000 m³ of ILW), and the total activity is estimated as 10¹⁸ - 10¹⁹ Bq. Inventory of Spent Fuel, 5059.87t - of heavy metal weight. The waste inventory of irradiated graphite waste of Chernobyl NPP (Units 1-3) - 5687t. (3732 m³) and emergency graphite - 700t in Shelter. Vitrified HLW after WWER SF reprocessing: app.110 to 1250 m³ (depend on future SF management strategy and 2400t U - SNF from RBMK-1000 reactors.

Absence of governmental decision about direct disposal or reprocessing of SF is the main source of uncertainties in selection a repository design for Ukrainian conditions.

Waste management organisation

Following the reform in the system of central executive authorities, The State Exclusion Zone Management Agency was established and entrusted with functions of state management of radwaste management at all stages of long-term storage and disposal and with implementation of the state policy for radwaste management.

On 9 December 2010 according to ME Ordinance #1086 established a unique national operating organization for radwaste management at the stage of long-term storage and disposal, SSE CRME, based on two enterprises that dealt with the lifetime stages of radwaste disposal facilities in the exclusion zone.

Legislation

Law on Radioactive Waste Management;
Law on Nuclear Energy Use and Radiation Safety;
Law on Procedure for Making Decisions on Siting, Design and Construction of Nuclear Installations and Radioactive Waste Management Facilities of National Importance;
Law on Revising Certain Laws of Ukraine on Radioactive Waste Management (establishing National Radioactive Waste Fund)
Norms of Ukraine for Radiation Safety (NRBU-97/D-2000), 2000
General Sanitary Rules of Ukraine, 2005
General Provisions on Safety of Radwaste Disposal in Geological Disposal Facility, 2007
Requirements for Siting for a Radioactive Waste Disposal Facility, 2008

Geological formations for GDR

Regarding siting of radwaste disposal facilities, the regulation "Requirements for Siting for a Radioactive Waste Disposal Facility" states that a site is considered acceptable for a disposal facility if its safety assessment has proved that the disposal system is capable of confining and/or isolating radwaste from the accessible environment over the period while waste remains potentially hazardous, in compliance with radiation safety requirements and criteria.

Consideration shall be given to site characteristics that:

- ensure radionuclide isolation from accessible environment;
- may influence the rate of transport and accumulation of radioactive substances in the environment;
- ensure protection of engineering barriers against external events and processes. External natural and technology-related events and processes that may affect the safety of the disposal system during operation, closure and in the post-closure period are also considered.

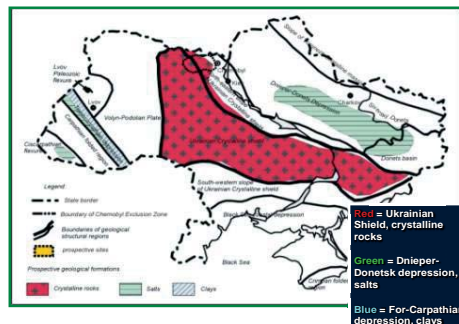

The preparatory stage of research on RAW isolation in geological formations has been completed. The territory of Ukraine has been assessed with respect to conditions for RAW isolation, and geological regions and formations favorable for this purpose have been selected.

A process of regional investigations involving evaluation of the territory of Ukraine and the selection of geological regions and formations potentially suitable for radioactive waste isolation has been completed. Two zones within the geological region known as the Ukrainian Shield have been identified as being potentially favourable sites for a repository for radioactive waste disposal. These are the Korosten Pluton and a group of Proterozoic gabbro-anorthositic structures in the Middle Dnieper area.

Siting of geological repositories

In the preparatory phase of the R&D programme, certain criteria were adopted, and an evaluation of the territory of Ukraine was carried out [Takis, U4.02/93]. The Veresnia site (Fig.1) is located in the northern part of the Ukraine in the watershed area of the Uzh (tributary of Prypiat) and the Teteriv (tributary of Dnieper) rivers. The site covers an area of 290 km², forming a square with a side length of 17 km. Veresnia site belongs to Polesie administrative district of Kyiv region. In the north-east Veresnia site borders the Chernobyl Exclusion Zone.



Fig.1 Regional geological map of crystalline basement of CEZ and its neighboring areas (IAEA TECDOC no. 1717)

Public involvement

According to the Law of Ukraine "On Decision Making Procedure for Siting, Design and Construction of Nuclear Facilities and Radioactive Waste Management Facilities of National Importance", a decision on siting and design of a radwaste disposal facility is made by the Verkhovna Rada of Ukraine through adoption of a relevant law. The Verkhovna Rada makes this decision only if the site for a disposal facility is agreed by the local executive authorities and local governments following a consultative referendum involving the public and public hearings.

International bearings

The realization of Ukrainian National Program is supported by project INT/9/173 of the IAEA and by the relevant project in the TACIS program where an EU was proposed to support the Ukrainian authorities in the selection of a disposal option candidate disposal site for LLW/HLW radioactive waste. Now ongoing EC funded project: U4.01/09-B - (Disposal concepts for radioactive waste in Ukraine) in the framework of the Instrument for Nuclear Safety Cooperation (INSC).

The IAEA Network of Underground Research Facilities for Geological Disposal and projects on Demonstrating the Safety of Geological Disposal (GEOSAF) are examples of the practical support Ukraine to getting of knowledge and experience.

Upon request from Ukraine in 2012 the European Commission has been working on a new INSC project focused on development of a national radioactive waste geological disposal plan and its implementation schedule. This plan is aimed at site selection, design, construction operation, closure and post-closure of a geological disposal facility in Ukraine.

The geological programme in Ukraine is at the siting stage and safety assessment reports for three potential sites are foreseen to be developed until 2017, as part of the EC-Ukraine Joint Project.



MANAGEMENT OF SPENT NUCLEAR FUEL IN LITHUANIA

Dalia Grigaliūnienė (Dalia.Grigaliuniene@lei.lt), Povilas Poškas (Povilas.Poskas@lei.lt)
Lithuanian Energy Institute, Nuclear Engineering Laboratory, Breslaujos str. 3, LT-44403 Kaunas, Lithuania

LITHUANIAN ENERGY INSTITUTE

3 Breslaujos str., LT-44403 Kaunas, LITHUANIA
http://www.lei.lt

In 1948, the Lithuanian Academy of Sciences established the Institute of Technical Sciences. This institute analysed the issues of rational water energy and fuel consumption, metals industry rationalization and its work processes automation as well as typical projects of industry and dwelling construction.

In the institute, the spreading research in various fields of technical sciences became more related to the physics. Therefore, in 1952 the Institute of Technical Sciences was reorganized into the Institute of Physics-Technology.

In 1956, on the basis of institute laboratories or their groups several new institutes were established. On the basis of remaining laboratories the Institute of Energy and Electrotechnics was established.

In 1967 it was renamed as the Institute of Physical-Technical Energy Problems.

Since 1992 institute is named as Lithuanian Energy Institute.

Nuclear Engineering Laboratory

Main nuclear research areas:

- Safety of spent nuclear fuel management: modelling of fuel characteristics, safety and environmental impact assessment of storage and disposal facilities, normative and legislative base;

- Safety of radioactive waste management: strategy, safety and environmental impact assessments of treatment, storage and disposal facilities, normative and legislative base;

- Evaluation of different factors related to decommissioning of nuclear power plants: planning and cost estimation of decommissioning and dismantling, radiological characterisation of buildings, systems and facilities, safety and environmental impact assessment, normative and legislative base;

- Fire hazard analysis in nuclear power plants and other facilities;

- Research related to the construction of new nuclear power plant in Lithuania.

INTRODUCTION

There is one nuclear power plant (NPP) in Lithuania – the Ignalina nuclear power plant (INPP). It is located in the north-eastern part of the country, on the bank of Lake Druksiai. INPP has two RBMK-1500 reactor units. INPP reactors started operation in December 1983 and August 1987, respectively and provided ~70-80 % of the electricity produced in Lithuania.

Final shutdown of the 1st unit - 31 December 2004, 2nd unit - 31 December 2009.

As a result of operation of the INPP about 22 thousands of spent nuclear fuel (SNF) assemblies (UO₂ fuel with 2.0, 2.4, 2.6 and 2.8 % initial U-235 enrichment) were accumulated.



Ignalina nuclear power plant

DRY STORAGE OF SNF



Existing SNF storage facility

According to EC Directive 2011/70/EURATOM, storage of radioactive waste, including long-term storage, is an interim solution, but not an alternative to disposal. Up to now, the decision on the final option of Lithuanian SNF management has not been made yet, but some investigations on possibilities to dispose of SNF in Lithuania were initiated.

New interim SNF storage facility

Part of SNF is stored for the moment in the dry storage facility since 1999. Storage facility has been extended for several times and currently is filled up to its final capacity with 118 cast iron and heavy concrete containers.

The remaining SNF is still stored in the Unit 2 reactor and storage pools. The new SNF storage facility will accommodate all the SNF from the water pools. It is foreseen to store about 200 containers in this new storage facility.



ACTIVITIES RELATED TO SNF DISPOSAL

- Activities related to SNF disposal started with development of the Strategy for Radioactive Waste Management, which was approved by the Lithuanian Government in 2002. Following the implementation of the Strategy, the National research program for 2003-2007 was developed and approved.
- Around that time a multiyear cooperation project with Swedish International Project for Nuclear Safety (SIP) on Competence development in the area of SNF disposal was initiated.
- In 2008, the Strategy for Radioactive Waste Management was revised and subsequently the National research program for 2008-2012 was developed and approved by the Lithuanian Government.
- With regard to EC Directive 2011/70/EURATOM, a new national program on management of spent nuclear fuel and radioactive waste (with content according to the Directive) is under preparation.

OUTCOMES OF THE NATIONAL RESEARCH PROGRAMS

Geological investigations

Based on the investigations of Lithuanian geological structure several formations were named as possible for deep geological repository. After more detailed analysis of the suitable formations, performed in 2002-2005 with support of Swedish experts, the priority was given to the three formations:

- The crystalline rocks in the southern Lithuania;
- The Lower Triassic clay formation;
- The Lower Cambrian Baltic Group clay formation.

Thus crystalline rocks as well as clayey formations need further more detailed studies.



Potentially suitable formations for deep geological repository

Dose rate

Sequences SAS2H and SAS4 from SCALE 4.3 computer code were used for dose rate assessment of the canister with RBMK-1500 SNF.

Neutron and gamma radiation forms the total equivalent dose rate and from the canister with 50 years stored RBMK-1500 SNF the total equivalent dose rate is approx. 500 mSv/h and does not exceed the target value of 1 Sv/h.

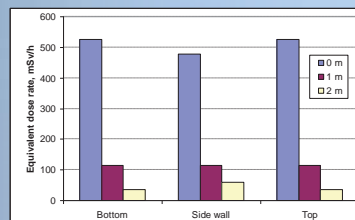

Total equivalent dose rate values from the copper canister surface

Radionuclide migration from canister with initial defect

Radionuclide transport analysis was focused on the engineered barrier system (EBS) with a horizontal canister emplacement.

Based on the mass transfer analysis complemented by the analysis of radiotoxicity flux it was identified that radionuclides with the largest radiological impact are I-129 and Ra-226.

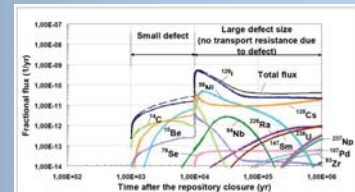

Fractional flux of radionuclides diffused from the engineered barriers to the geosphere

Repository concept in crystalline rocks

Implementing research on SNF disposal in Lithuania, the Lithuanian Energy Institute (LEI) with the assistance of the Swedish experts proposed the concept of a deep geological repository in crystalline rock formations. It is based on KBS-3 concept developed by SKB for disposal of the SNF in Sweden. Both, vertical (KBS-3V) and horizontal (KBS-3H) canister emplacement options were under considerations.

Following KBS-3 concept, the copper canister with a cast iron insert was proposed for RBMK-1500 SNF disposal. Based on preliminary assessment, the reference canister would be of 1050 mm diameter and 4070 mm length. For the Lithuanian SNF disposal purposes about 1400 of such canisters would be required.

The proposed canister for Lithuanian SNF disposal



Criticality

Criticality safety analysis for the copper disposal canister with 2.8 % U-235 RBMK-1500 SNF was performed using SCALE 4.3 computer codes system.

For a copper disposal canister when long-term processes (corrosion, degradation, etc.) were not taken into account, k_{eff} values were less than allowable value of 0.95.

Temperature evolution in SNF tunnels

Initially temperature evolution in the SNF tunnels was assessed using FLUENT code and later on updated taking into account the coupling with hydrodynamical (TH analysis) and hydrodynamical-mechanical processes (THM analysis) using modelling tool COMPASS.

The modelling results revealed the importance of coupled heat (T) and hydrodynamical (H) processes for peak temperature in the engineered barriers. Evaluated peak temperature at the outer surface of the disposal canister (~92 °C) did not exceed the permissible temperature of 100 °C.

CONCLUSIONS

- ✓ For the moment the Lithuanian SNF disposal program is at the initial site investigation and preliminary facility design stage.
- ✓ Starting from 2000 the outcome from research and other activities undertaken resulted in prioritisation of potential geological formations for SNF disposal; proposal of the preliminary repository concept; and preliminary calculations of temperature distribution, criticality, dose rate from disposal canisters, modelling of radionuclide migration.
- ✓ The main points in the near future activities include planning of the implementation of geological repository, investigations and characterisation of perspective regions, initiation of development of repository concept as well as increase of competence through international cooperation.



The LOCOEX project has received funding from the European Atomic Energy Community's 7th Framework Programme (FP7/2007-2011) under the grant agreement No. 26990.

LONG-TERM PERFORMANCE OF ENGINEERED BARRIER SYSTEMS: MODELLING THE INTERACTIONS OF CORROSION PRODUCTS WITH COMPACTED BENTONITE IN A HLW REPOSITORY IN GRANITE

A. Naves (LUCOEX End Conference scholarship), J. Samper, L. Montenegro & A. Mon. University of A Coruña (Spain).

INTRODUCTION & OBJETIVES

- > **Canister corrosion and the chemical interactions of corrosion products with bentonite** are key reactions for the long term performance of a repository in granite.
- > **Long-term simulations (1Ma)** of the geochemical conditions in the bentonite barrier for a reference scenario
- > **Sensitivity analysis** of the key geochemical variables to model parameters & **analyses of uncertainties** by simulating a set of variant scenarios

DISPOSAL CONCEPT

Spanish reference concept (ENRESA, 2005)

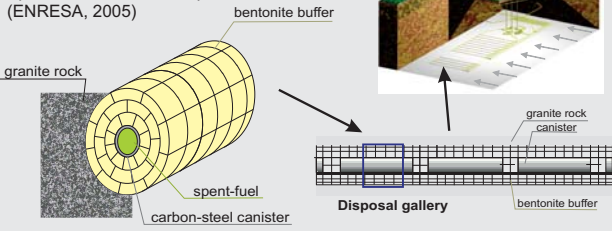

CONCEPTUAL & NUMERICAL MODEL

1D AXI-SYMMETRIC NUMERICAL MODEL
Materials: canister and bentonite.
1D radial finite element grid

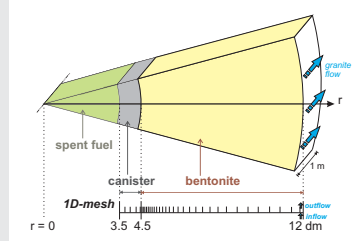

Simulations performed with **CORE^{2D} V4** our own code for water flow and reactive transport

FLOW AND TRANSPORT

Isothermal conditions (25° C)
Bentonite buffer is fully saturated (no flow)
Water flow in granite parallel to the gallery: a constant flow (0.01L/y/m) at the bentonite-granite interface

GEOCHEMISTRY

- > Chemical reactions: 1) acid-base; 2) aqueous complexation; 3) redox; 4) mineral dissolution/precipitation; 5) cation exchange & 6) surface complexation
- > 16 primary species - H_2O , H^+ , Cl^- , SO_4^{2-} , HCO_3^- , Ca^{2+} , Mg^{2+} , Na^+ , K^+ , Fe^{2+} , $SiO_2(aq)$, $Al(OH)_3$, $O_2(aq)$, $S_2O_8^{2-}$, S_wOH and S_wOH^-
- > 39 aqueous complexes
- > 7 minerals: Fe(s) (carbon steel), calcite, gypsum, quartz, magnetite, siderite & goethite. Smectite, analcime & Fe-phylosilicates are included in some analyses
- > 5 exchangeable cations: Ca^{2+} , Mg^{2+} , Na^+ , K^+ and Fe^{2+}
- > Three sites surface complexation model (strong, weak 1 and weak 2) according to Bradbury & Baeyens (1997).

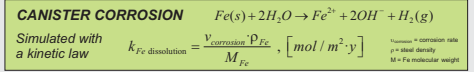

NUMERICAL RESULTS

- > The canister is fully corroded after $5 \cdot 10^4$ y
- > Canister corrosion causes an increase in dissolved Fe^{2+} and pH
- > Most of released Fe^{2+} diffuses into bentonite where it may precipitate, sorb or exchange
- > The competition of Fe^{2+} and H^+ for the weak 1 sorption sites leads to sorption fronts around the canister. pH, Eh and Fe^{2+} fronts are also observed at the same locations and times
- > The precipitation of corrosion products causes a relevant porosity reduction close to the canister.

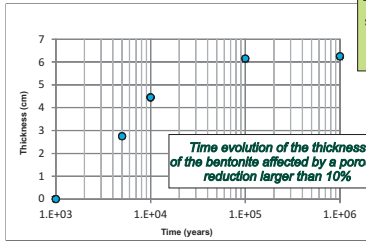

The bentonite thickness significantly affected by porosity reduction is of ~ 7 cm after 1 Ma

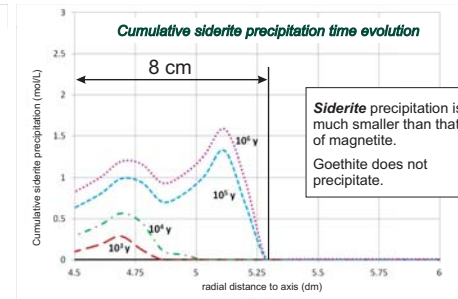
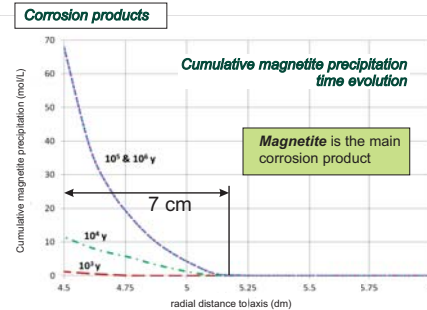
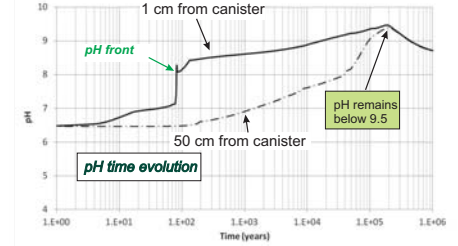
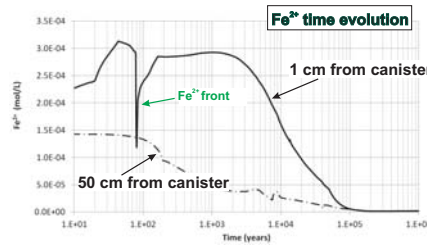

SENSITIVITY ANALYSIS

SENSITIVITY ANALYSIS of the key geochemical variables to the following parameters:

- 1) Canister corrosion rates
- 2) Water flow through the granite
- 3) Bentonite transport

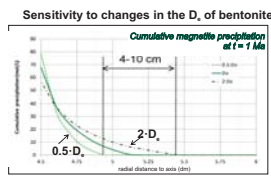
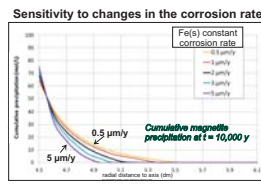
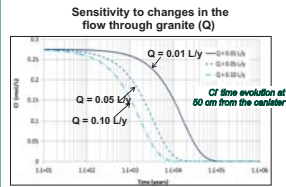

MODEL UNCERTAINTIES ANALYSIS

Analyses of uncertainties by simulating a set of variant scenarios accounting for:

- 1) The thermal transient
- 2) Dependence of corrosion rate on temperature or saturation
- 3) Kinetically controlled magnetite precipitation
- 4) Smectite dissolution at local equilibrium and kinetically controlled
- 5) Neof ormation of secondary mineral phases such as zeolites Fe-phylosilicates

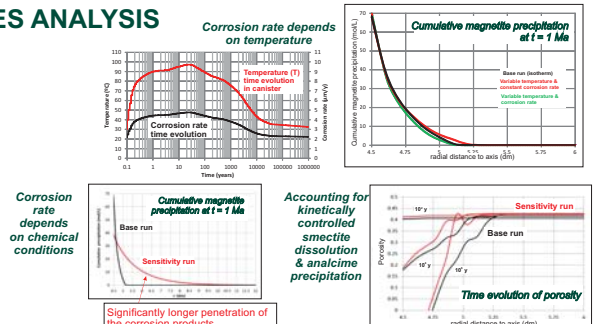

MAJOR FINDINGS

- > The **precipitation of corrosion products** close to the canister could significantly **decrease the porosity of the bentonite** and even **clog bentonite pores**
- > The **thickness** of the bentonite zone affected by the decrease of porosity increases with time and reaches **7 cm** at $t = 1$ Ma.
- > The **thermal transient** (accounting for the temperature effect on chemical reactions) **does not have a significant effect** on the overall geochemical evolution of the EBS and does not affect the thickness of the altered bentonite
- > The uncertainty in the **effect of temperature on the corrosion rate** does not have a large impact
- > Accounting for the **dependence of the corrosion rate on the chemical conditions** (ph, Eh, Fe concentration) leads to an **important change** in the patterns of the corrosion products. The thickness of the altered zone is doubled.
- > The **long-term effect** of the kinetic **dissolution of smectite** on bentonite porosity and the thickness of altered bentonite is **small**.

ACKNOWLEDGEMENTS

- The research leading to these results has received funding from the European Atomic Energy Community's Seventh Framework Programme (FP7/2007-2011) under grant agreement 232598
- This work was partly funded by ENRESA (Spain), the Spanish Ministry of Economy and Competitiveness and FEDER Funds (Project CGL2012-36560) and Galician Regional Government (Fund 2012/181 from "Consolidación e estruturação de unidades de investigación competitivas")
- We acknowledge the contributions of Juan Carlos Mayor from ENRESA





This Project has received funding from the European Union's European Atomic Energy Community's (Euratom) FP7 under grant agreement n°269905, the LUCOEX project.

LUCOEX

