

**C & U**

CREATIVE  
& UNIQUE



Handheld Spectrum Analyzer

# MSA300 series



GOOD DESIGN AWARD



**MSA338**  
**MSA358**  
**MSA338TG**  
**MSA338E**

# MICRONIX

# Handheld spectrum analyzer has been announced earlier than others all over the world.

The MSA300 series is a first authentic handheld spectrum analyzer providing good characteristics and abundant functions in spite of compact, lightweight and inexpensive model.

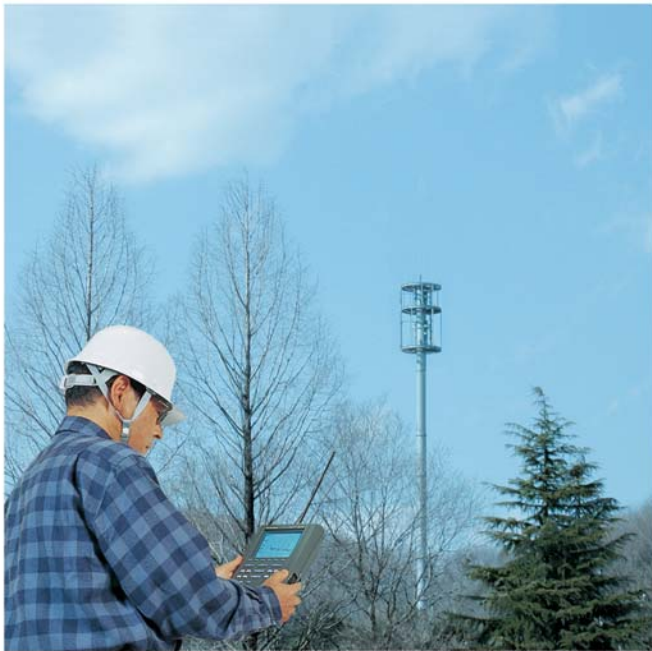

## Features of MSA300 series

### 1 Compact and lightweight 1.8kg

The dimensions are as small as 162(W)×70(H)×260(D)mm, and the weight is only 1.8kg including the battery. It is very convenient for outdoor use and on business trip.

### 2 150 minutes battery operation

Ni-MH battery MB300 (option) fully charged enables about 150 minutes battery operation at backlight-off.

### 3 Accurate frequency measurement by PLL synthesizer

The center frequency is accurately set by PLL (Phase Locked Loop) synthesizer. Moreover, the frequency counter (factory option) enables to measure the frequency of the signal more accurately.

### 4 Average noise level -117dBm

The low average noise level of -117dBm @ 1GHz provides a wide dynamic range.

### 5 Competitive functions

- Measuring functions : Channel power, Adjacent channel power, Occupied bandwidth, Electric field strength, Magnetic field strength and Frequency measurement
- Calculation functions : Max hold, Min hold, Averaging, Over write
- Marker measurement and peak search function
- Save/Load function
- Hard copy with printer

### 6 Easy operation by AUTO mode

- By auto range operation, RBW, VBW and sweep time are automatically selected based on the frequency span.
- By auto tuning operation, the center frequency is adjusted to the maximum level within full span, and the optimum RBW, VBW and sweep time are chosen.

### 7 Hard copy of screen image

Only pushing **PRINT** key after connecting the printer (option). The screen image is easily printed out.

### 8 Measuring electric field strength from 300MHz to 6.2GHz

The band from 300MHz to 6.2GHz is covered with the six kinds of dipole antennas. According to an application, one of them is chosen. This function is useful for the electric field strength measurement of wireless communication system and the noise measurement.

### 9 Abundant options

A lot of options such as PC software, Logging software, VSWR bridge, Dipole antenna, Magnetic field probe, Printer, Frequency counter, Ni-MH battery, RS-232C/GP-IB converter, Charger and Test accessories are available.

## Lineup of four models

Model	Contents
MSA338	50kHz to 3.3GHz The most popular model <b>Applications</b> Cellular phone, 2.4GHz wireless LAN, 2.5GHz WiMAX, RF-ID, Broadcasting
MSA358	50kHz to 8.5GHz Covering most of the wireless communication <b>Applications</b> 5GHz wireless LAN, 3.5/5.8GHz WiMAX, ETC/DSRC, Maintenance of wireless base station
MSA338TG	50kHz to 3.3GHz With 5MHz to 3.3GHz tracking generator <b>Applications</b> Frequency characteristics measurement of electronic component/circuit and return loss measurement
MSA338E	50kHz to 3.3GHz For EMI test <b>Applications</b> Radiated emission measurement and conducted emission measurement

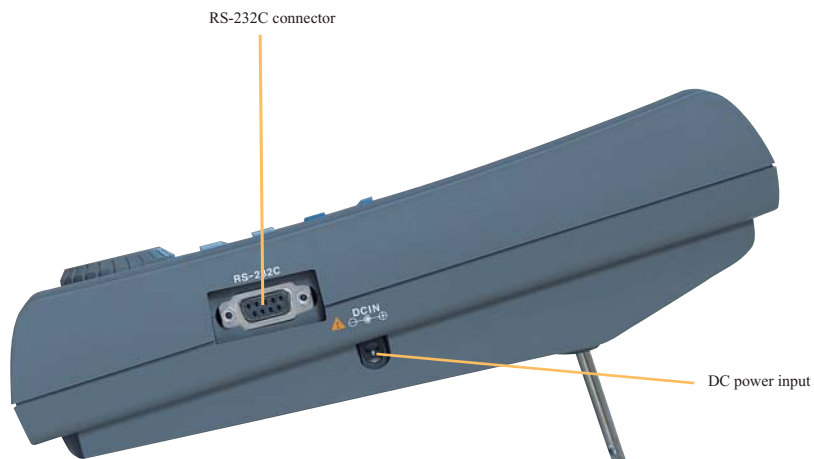
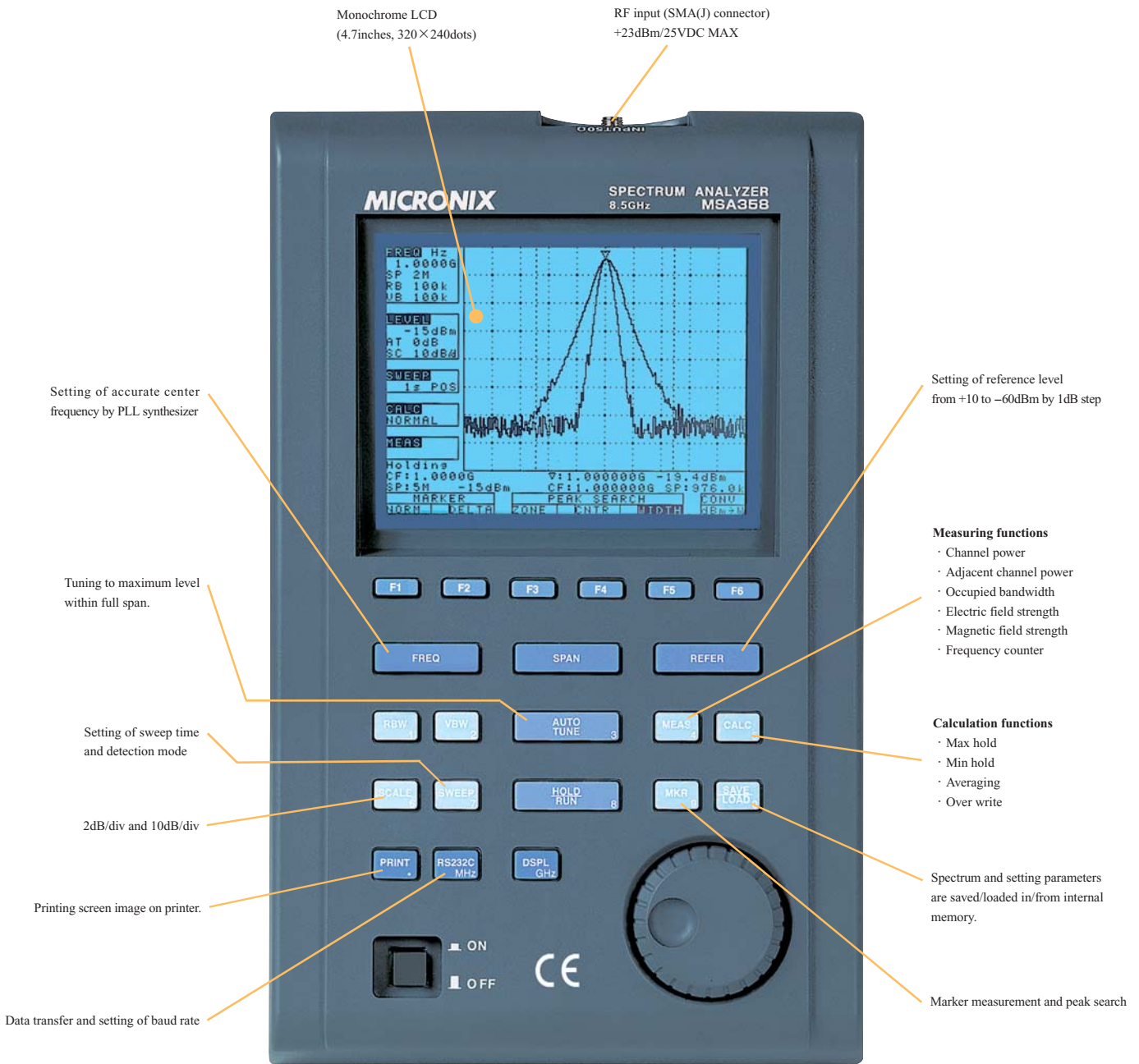



## Measuring functions

### Channel power measurement

The sum of power in the band specified by band center and band width (colored area) is measured. In short, it is possible to measure the total power in the specified frequency band. Of course, this function enables to measure a noise power.

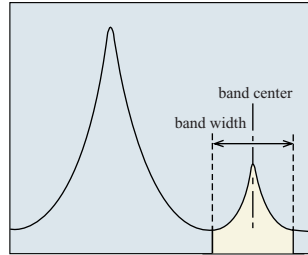

### Adjacent channel power measurement

The adjacent channel leakage power is measured as the ratio of power in the range specified by offset frequency and bandwidth (colored area) to carrier power. Both of leakage power at the upper and lower side are measured. Furthermore, the method for measurement is selected out of three methods based on the classification of definition of carrier power ; total power method, reference level method and in-band method.

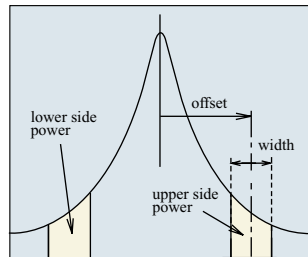

### Occupied bandwidth measurement

It is possible to measure the occupied frequency bandwidth defined as the width of points that are X (dB) lower than the peak level, or as the width of points at N(%) of the total power.

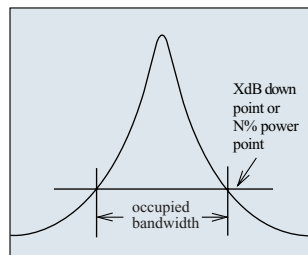

### Electric field strength measurement

A dipole antenna (option) connected to the RF input enables the measurement of the electric field strength. According to the measuring frequency band, one antenna can be chosen from six kinds of antennas. M301 is mainly for PDC 800MHz and GSM 900MHz band, M302 is mainly for PDC 1500MHz band, M303 is mainly for PHS, W-CDMA and GSM 1800/1900MHz band, M304 is mainly for 2.4GHz wireless LAN and Bluetooth, M305 is mainly for 400MHz wireless, and M306 is mainly for 5GHz wireless LAN and 5.8GHz DSRC (ETC). M304 is capable of measuring direct sequence spread spectrum, frequency hopping and Bluetooth system because of 10ms sweep time and MAX HOLD function.

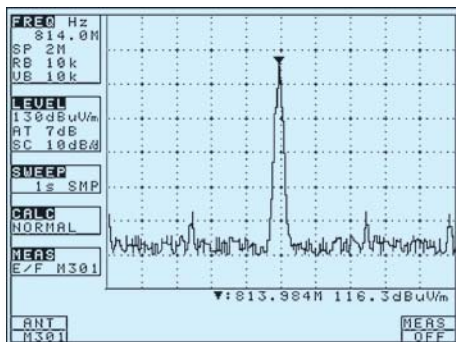

The conventional method covering the wide band with a single antenna results in low antenna gain because of using the range away from an antenna resonance point, and the dynamic range extremely worsens as a result. To use a resonance point where the antenna gain is high, six kinds of antennas are provided according to the frequency bands. Therefore, each antenna secures a wide dynamic range. Antennas of other bands will be also provided if requested.

Since the electric field strength is calibrated for each antenna in MSA300 series, it is possible to directly read the measured value.

Moreover, the electric field strength is also measured with an user's antenna besides antennas from M301 to M306 if "USER" antenna is selected.

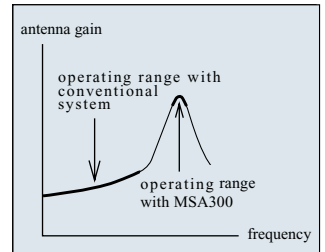

### Magnetic field strength measurement

MSA300 series measures precisely the magnetic field distribution on LSI or PCB using the magnetic field probe CP-2S (option). As the magnetic field detection portion of CP-2S is of a shielded loop structure using a glass ceramic multi-layer board technology with excellent high frequency characteristics, it enables the measurement with high reproducibility by detecting magnetic field components only. The measuring frequency range is as broad as 10MHz to 3GHz, and the measured value is calibrated in the instrument.

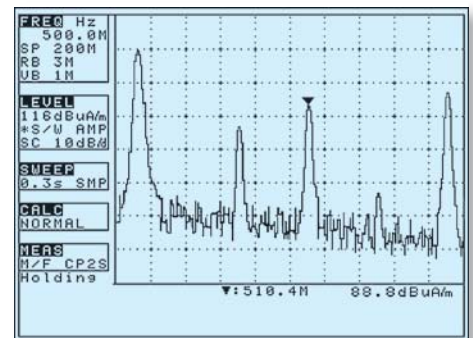

The typical applications of CP-2S are the evaluation of effectiveness of a bypass capacitor located at a power supply terminal of LSI and the evaluation of wiring rule of PCB. CP-2S is not affected by adjacent patterns because of high space resolution.

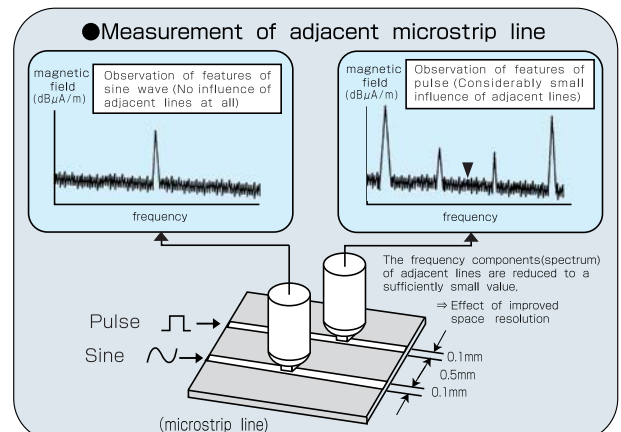

## Calculation functions

### Max hold

The update spectrum data is compared with the data left last time at each point on X axis, and the larger one is retained and displayed. The number of times of the sweep can be set in the range from 2 to 1024 times by a power of 2, or by infinite. It is possible to observe a burst signal generated intermittently like a cellular phone and a frequency drift. In addition, this function is effective when the maximum level such as EMI test should be measured.

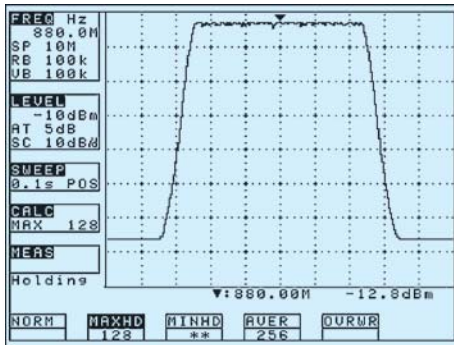

### Min hold

The update spectrum data is compared with the data left last time at each point on X axis, and the smaller one is retained and displayed. The number of times of the sweep can be set in the range from 2 to 1024 times by a power of 2, or by infinite.

### Averaging

The simple averaging processing is executed at each sweep. The number of times of the averaging can be set in the range from 2 to 256 times by a power of 2. Even the spectrum buried in noise is observed.

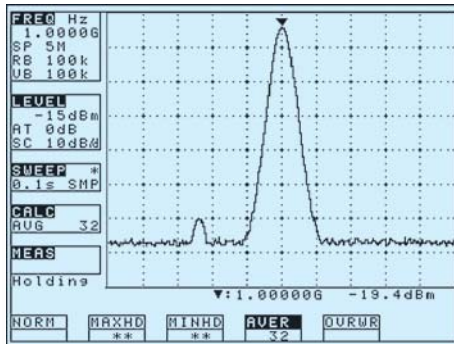

### Over write

The image on the screen is not deleted at each sweep and is overwritten infinitely. However, the overwriting execution stops in the moment HOLD key is pushed. This function is, therefore, convenient for observing a process of changes of the signal. Moreover, it is effective for observing a signal occasionally generated.

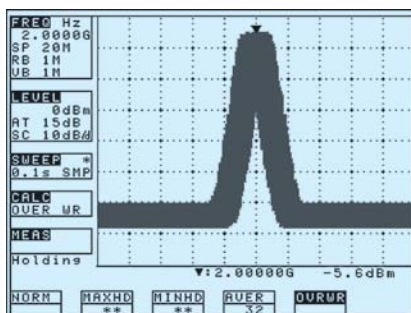

## Marker and peak search

### Marker measurement

Two different modes are available for the marker measurement. One is the normal marker mode to calculate and display the frequency (maximum effective digits: 7) and the level (maximum effective digits: 4) at marker point. And another is the delta marker mode to calculate and display the frequency difference and the level difference between two markers (one of which is the reference marker).

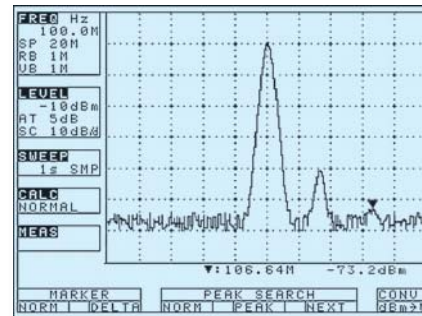

Normal marker measurement

Delta marker measurement

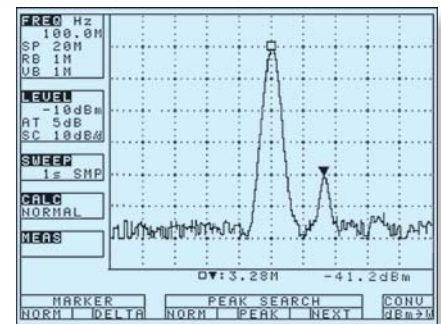

### Peak search

Two different modes are available for the peak search. One is the normal peak search mode to search for a peak level within all of 10div of the frequency axis as the search range. And another is the zone peak search mode to search for a peak level in the range specified by the center value and width. At the normal mode, the marker moves to a peak level only when the search key is pushed, but at the zone mode, it follows to a peak level at each sweep. In addition, the NEXT search to search for the next smaller level is permitted in the normal peak search mode.

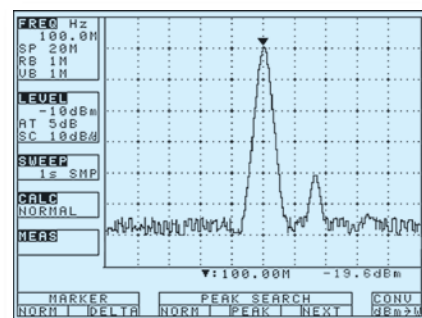

Normal peak search

Zone peak search

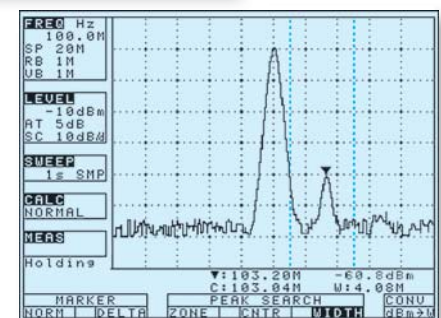

## Storage of measurement data

### Storage into internal memory

The storage into internal memory is executed with **(SAVE/LOAD)** key. It is possible to save 100 spectrums and 100 setting parameters. One spectrum and one setting parameter are loaded. This function may be used when various data are acquired and they are evaluated later, or when it is needed to make a comparison with formerly acquired data. The saved data is also transferred to a PC through RS-232C.

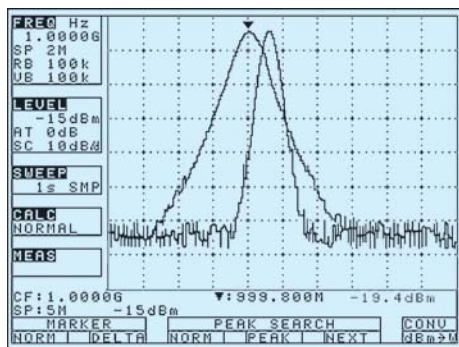

### Print on printer

The MSA300 series enables a hard copy of the screen by connecting a printer (option) to RS-232C connector with RS-232C cable MI180 (option). Printing is started when pushing **(PRINT)** key. Since the printer corresponds to two kinds of power supplies of dedicated AC adaptor and dry battery, the hard copy of the screen image is easily accomplished even in the open where there is no AC power supply. The dry battery allows the hard copy of almost 140 images.

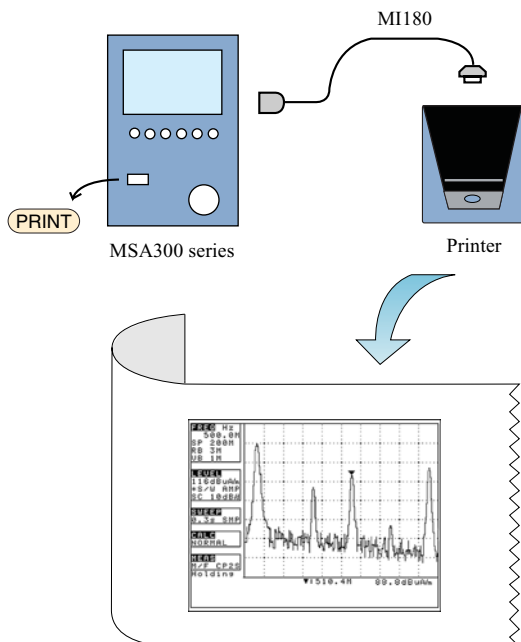

### Storage with PC software and Logging software

It is possible to store the data in the PC by using PC software MAS300 (option), which enables to set the setting parameters with the PC and display the spectrum on the PC screen.

In addition, Logging software MAS310 (option) makes it possible to collect the data by uninhabited for a long time and store them.

Refer to "Option" for details.

## Auto tuning

When pushing **(AUTO TUNE)** key, the spectrum with the maximum level is searched within full span (3.3GHz @ MSA338/338TG/338E and 8.5GHz @ MSA358), and then it is adjusted to the center of the screen. That spectrum is displayed on the screen at the specified frequency span, and at reference level, resolution bandwidth, video bandwidth and sweep time that are automatically set to the optimum parameters based on the span.

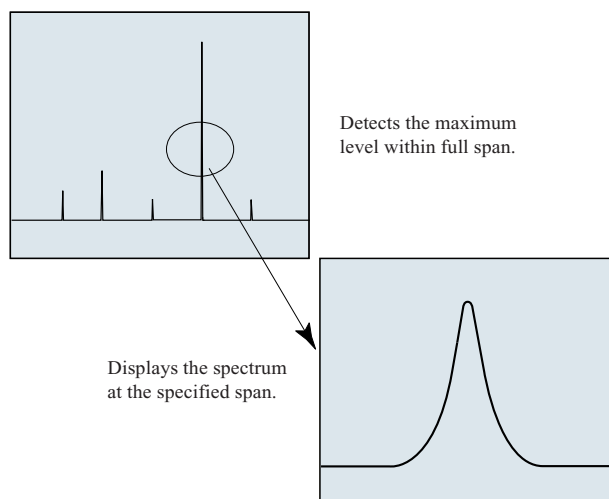

## Easy operation by AUTO mode

Resolution bandwidth, video bandwidth and sweep time are set automatically based on the specified frequency span. Furthermore, it is also possible to automatically set one or two parameters of either resolution bandwidth, video bandwidth or sweep time.

The operator is released from troublesome operation because these three parameters accompanying the frequency span are set automatically.

Moreover, the input attenuator and the IF amplifier are automatically set to the optimum values based on the reference level.

## Precise frequency measurement

- The center frequency is precisely set by PLL (Phase Locked Loop) synthesizer. The setting resolution is 100kHz.

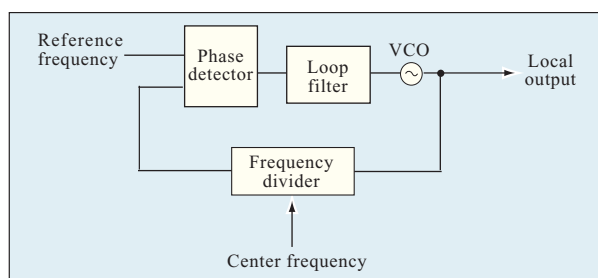

- The frequency counter (factory option) enables you to measure the frequency of input signal more accurately. The frequency is measured by 100Hz resolution and 8 digits or less. The frequency accuracy of the reference crystal oscillator is  $\pm 2\text{ppm}$  @ 23°C and the measuring frequency range is from 1MHz to the maximum measuring frequency of each model.



with Tracking Generator

# MSA338TG

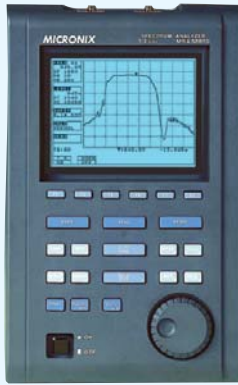

MVS300

The tracking generator is a signal source which generates the sine wave synchronized with the sweep of the spectrum analyzer.

For example, the tracking generator outputs 1MHz sine wave when the spectrum analyzer is at 1MHz sweep point. The 1GHz is output at 1GHz sweep point as well. Therefore, the amplitude frequency characteristics of various electronic components and circuits can be observed on the screen without any troublesome operation.

Moreover, the VSWR bridge MVS300 (option) enables to measure the return loss.

## Frequency response of filter

The input and the output of a filter are connected to TG OUT and RF IN respectively. The frequency response of a filter is observed in the range of 5MHz to 3.3GHz.

The frequency response of the coaxial cable and MSA338TG is made flat by using the NORMALIZING function.

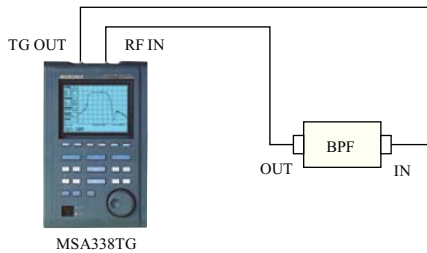

MSA338TG

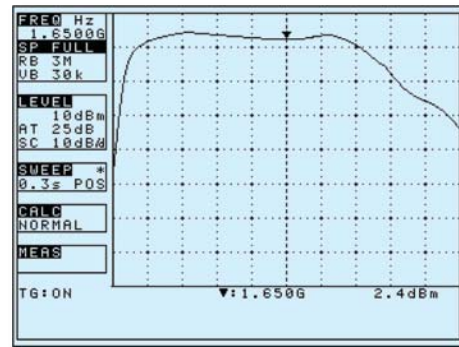
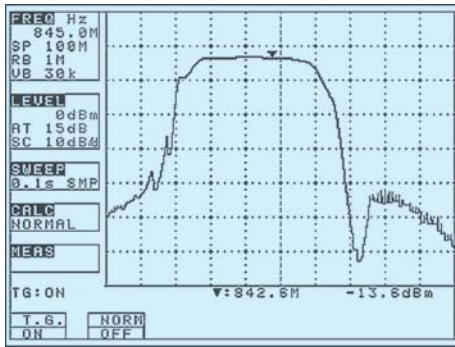

## Return loss measurement

VSWR bridge MVS300 (option) connected to TG OUT and RF IN of MSA338TG enables the return loss measurement. The measured frequency range is from 5MHz to 3GHz.

Additionally, the calibration of the return loss 0dB is done by using the NORMALIZING function.

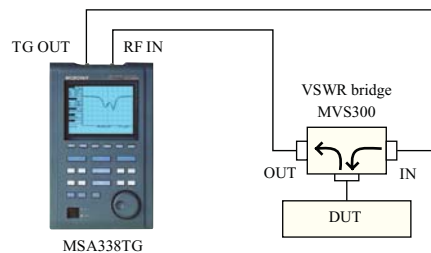

MSA338TG

## Gain characteristics of amplifier

The frequency response of an active circuit such as an amplifier besides a passive circuit such as LC filter is measured. A measurement example of the gain-frequency characteristics of an amplifier is shown in the figure below. The level of TG OUT is -10dBm.

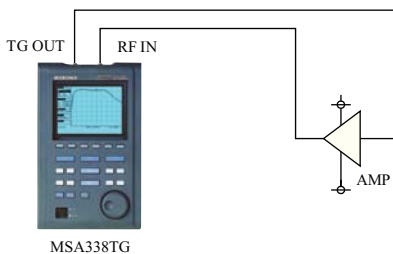

MSA338TG

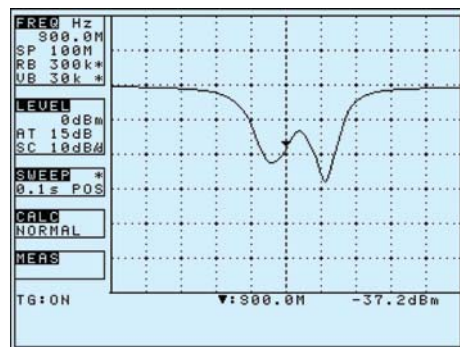

for EMI Test

# MSA338E

EMI total test system  
MR2300



MSA338E is a key instrument of EMI measurement. Since it has functions such as PK detection, QP detection, AV detection and RBW 9kHz/120kHz(6dB), it enables the radiated emission measurement and the conducted emission measurement for precompliance.

Furthermore, the magnetic field probe CP-2S (option) finds out the source of disturbance noise.

## Measurement mode and Preset

Three measurement modes shown below are available. The troublesome setting for EMI test is unnecessary because the parameters corresponding to the measurement mode are automatically preset.

Measurement mode	Function key	Preset
Normal measurement	NORM (F1)	Presets initial parameters of normal mode
Conducted emission measurement	EMI-C (F2)	Presets initial parameters of conducted emission mode
Radiated emission measurement	EMI-R (F3)	Presets initial parameters of radiated emission mode

## Detection mode

MSA338E has three detection modes of PK (peak), QP (quasi-peak) and AV (average). As for the detection level, the relational expression of  $PK \geq QP \geq AV$  is valid as shown in the figure below. Additionally,  $PK=QP=AV$  is correct in case of a narrowband signal like CW wave.

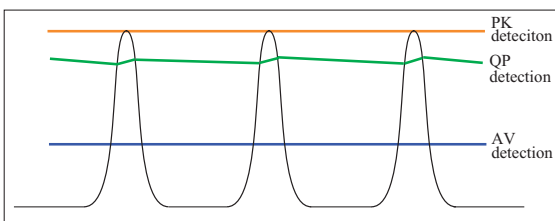

The PK detection is achieved by setting the measurement mode to normal measurement, the detection mode to positive peak and the calculation function to MaxHold. By the way, a signal of time width 200ns or more is detected by positive peak detector because the sampling speed of A/D converter is 5MS/s. When observing a disturbance noise, the PK detection enables the fast sweep because its time constant is much smaller than QP or AV.

Therefore, it is convenient to use the PK detection when narrowing the disturbance noise spectrums out of specification down to small number.

## Resolution bandwidth (RBW)

CISPR provides that the radiated and conducted emissions should be measured with RBW filters of 9kHz and 120kHz respectively. The bandwidth is defined as 6dB width. MSA338E also has five RBW filters besides these two filters, whose bandwidths at 3dB are 3kHz, 30kHz, 300kHz, 1MHz and 3MHz.

## Horizontal axis data of 1001 points

Although the spectrum is displayed by 251 points on the horizontal axis of the screen of MSA338E, it is captured by 1001 points per sweep in the instrument. All of these 1001 points are transferred to a personal computer and displayed on the PC screen after processed by PC software MAS230. The image, therefore, becomes clearer.

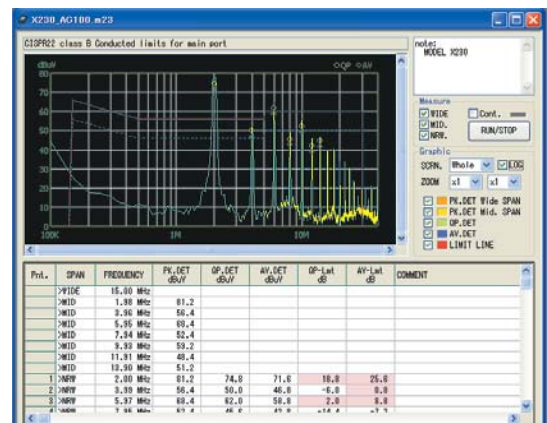



# Specifications

## Frequency section

Frequency range	50kHz to 3.3GHz (MSA338/338TG/338E) 50kHz to 8.5GHz (MSA358)
Center frequency	
Setting resolution	100kHz Allows rotary encoder, numeric key and function key.
Accuracy	$\pm(30+20T)\text{kHz} \pm 1 \text{ dot}$ @ Span $\leq 10\text{MHz}$ , RBW3kHz, ※1 $\pm(60+300T)\text{kHz} \pm 1 \text{ dot}$ @ Span $\geq 20\text{MHz}$ , RBW100kHz, ※1
RBW frequency error	$\pm 4\text{kHz}$ @ 3kHz, 10kHz, 30kHz RBW $\pm 20\%$ @ 100kHz, 300kHz RBW $\pm 10\%$ @ 1MHz, 3MHz
Frequency span	
Setting range	<MSA338/338TG/338E> 0Hz (zero span), 200kHz to 2GHz (1-2-5 step) and 3.3GHz (full span) <MSA358> 0Hz (zero span), 200kHz to 5GHz (1-2-5 step) and 8.5GHz (full span)
Accuracy	$\pm 3\% \pm 1 \text{ dot}$ @ one step slower sweep time than AUTO, ※1
Display dots	251 dots @ LCD screen, 1001dots @ RS-232C communication ※1001 dots are captured in the unit.
Resolution bandwidth	3dB bandwidth
Setting range	<MSA338/358/338TG> 3kHz to 3MHz (1-3 step) and AUTO <MSA338E> 3k, 9k (6dB), 30k, 120k (6dB), 300k, 1M, 3MHz and AUTO
Accuracy	$\pm 20\%$
Selectivity	1 : 12 (typical) @ 3dB:60dB
Video bandwidth	100Hz to 1MHz (1-3 step) and AUTO
SSB phase noise	-90dBc/Hz (typical) @ 100kHz offset, RBW 3kHz, VBW100Hz, sweep time 1s
Spurious response	less than -60dBc
Harmonics	less than -40dBc @ $\geq 100\text{MHz}$

## Amplitude section

Reference level	
Setting range	+10 to -60dBm, 1dB step
Accuracy	$\pm 0.8\text{dB} \pm 1 \text{ dot}$ @ CF100MHz, RBW3MHz, VBW 1MHz, REF -15dBm, ※1
Unit	dBm, dBV, dBmV, dB $\mu$ V, dB $\mu$ V/m, dB $\mu$ A/m
Average noise level	-117dBm (typical) @ 1GHz
Frequency characteristics	$\pm 2.0\text{dB} \pm 1 \text{ dot}$ @ < 100MHz $\pm 1.0\text{dB} \pm 1 \text{ dot}$ @ $\geq 100\text{MHz}$
Input impedance	50 $\Omega$
Input VSWR	less than 2.0
Input attenuator	
Operating range	0 to 25dB (1dB step), coupled with reference level
Switching error	$\pm 0.6\text{dB}$ @ 100MHz
RBW switching error	$\pm 0.6\text{dB}$
Display scale	
Display dots	201 dots/10div
Scale	2dB/div, 10dB/div
Accuracy	$\pm(0.2\text{dB}+1 \text{ dot})/2\text{dB}$ $\pm(0.8\text{dB}+1 \text{ dot})/10\text{dB}$ $\pm(1.6\text{dB}+1 \text{ dot})/70\text{dB}$
Input damage level	+23dBm(CW average power), 25VDC
Input connector	SMA(J) connector

## Sweep section

Sweep time	
Setting range	10ms to 30s (1-3 step, Span 0 to 2GHz) and AUTO 30ms to 30s (1-3 step, Span 5GHz @ MSA358 and full) and AUTO
Accuracy	$\pm 0.1\% \pm 1 \text{ dot}$ @ Span 0 to 5GHz $\pm 2.5\% \pm 1 \text{ dot}$ @ Full span
Trigger	Available only for zero span
Trigger mode	AUTO
Trigger source	Internal
Detection mode	Positive peak, Negative peak, Sample ※ As for MSA338E, QP and AV are added further.

T : sweep time (s), ※1 :  $23 \pm 5^\circ\text{C}$ , less than  $28^\circ\text{C}/70\%\text{RH}$

## Functions

Marker measurement	NORM : displays frequency (7digits max) and level (4digits max) at marker point. DELTA : displays frequency difference and level difference between two markers.
Peak search function	Searches for peak level with all of 10 div (NORM mode) or within ZONE specified (ZONE mode) and displays frequency and level at peak level, and moreover NEXT peak at NORM mode.
Calculation function	NORM, MAX HOLD, MIN HOLD, AVERAGE, OVER WRITE Number of sweeps is 2 to 1024 (power of 2) and infinite.
Measuring function	Channel power, Adjacent channel power, Occupied bandwidth, Electric field strength (needs optional dipole antenna), Magnetic field strength (needs optional magnetic field probe) and Frequency counter (factory option)
Auto tuning	When pressing AUTO TUNE key, the spectrum of maximum level within full span is adjusted to center, and reference level, RBW, VBW and sweep time are set to optimum parameters.
Save/ Load	
Save	Saves 100 spectrums and 100 setting parameters.
Load	Loads one spectrum and one setting parameter.

## Tracking generator (only MSA338TG)

Frequency range	5MHz to 3.3GHz
Output level	-10dBm $\pm$ 1dB @ 1GHz
Output level flatness	$\pm 1.5\text{dB}$
Normalizing function	Compensates input frequency response flat on screen.
Output impedance	50 $\Omega$
Output VSWR	less than 2.0
Output connector	SMA(J) connector

## EMI measurement function (only MSA338E)

Detection mode	PK (peak), QP (quasi peak) and AV (average) detections
Resolution bandwidth	3kHz, 9kHz (6dB), 30kHz, 120kHz (6dB), 300kHz, 1MHz, 3MHz ※3dB bandwidth excluding 9kHz and 120kHz.

Time constant of QP

Time constant	RBW	9kHz	120kHz
Charge		1ms	1ms
Discharge		160ms	550ms

## General

Communication	
Interface	RS-232C
Baud rate	2,400 to 38,400bps
Hard copy	Printer (option) enables hard copy of screen.
Display	
Display	4.7 inches and monochrome LCD
Backlight	CFL backlight
Number of dots	320(H) $\times$ 240(V) dots
Power supply	
Kind of power supply	External DC source (by dedicated AC adaptor MA300) and Ni-MH battery (by optional MB300)
Dedicated AC adaptor	Input : 100 to 240 VAC Output : 5VDC/4A
Ni-MH battery	4.8V/4200mAh

## Other

Operating temperature	0 to 50 $^\circ\text{C}$ (guaranteed at $23 \pm 10^\circ\text{C}$ but at $23 \pm 5^\circ\text{C}$ as to items with ※1, without carrying case)
Operating humidity	less than 40 $^\circ\text{C}/80\%\text{RH}$ (guaranteed at less than 33 $^\circ\text{C}/70\%\text{RH}$ but at less than 28 $^\circ\text{C}/70\%\text{RH}$ as to items with ※1, without carrying case)
Storage temperature	-20 to 60 $^\circ\text{C}$ , less than 60 $^\circ\text{C}/70\%\text{RH}$
Dimensions	162(W) $\times$ 70(H) $\times$ 260(D)mm (excluding projections and stand)
Weight	approx. 1.8kg (including battery)
Standard accessories	· AC adaptor MA300 · Carrying case · Accessory pouch · Operation manual

## Option

### PC software MAS300

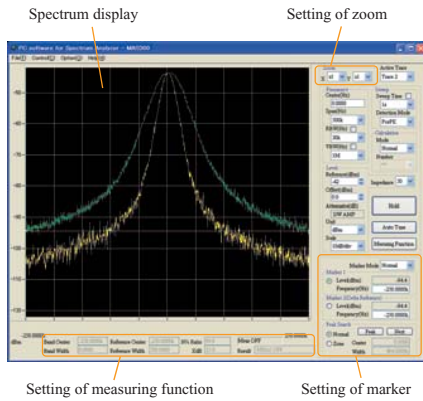

MAS300 is a software that controls the spectrum analyzers of four models by the PC. 1001 points are captured in the spectrum analyzer. Although 251 points are displayed on its screen, the number of points transferred to the PC is all of 1001 points.

The screen image is stored by BMP format and the spectrum is stored by CSV format each point (frequency and level).

### Logging software MAS310

MAS310 is a logging software that collects the measurement data by uninhabited. It is optimum for watching an abnormal signal at night and recording the data by uninhabited for a long time.

- Logging at specified frequency band, sampling interval and measurement time.
- Makes it possible to fast-forward and fast-rewind the images in the file like a video recorder, and moreover, to jump to the image with spectrum exceeding the limit line.
- ERROR is automatically displayed when the signal exceeding the limit line is input.

#### Recording

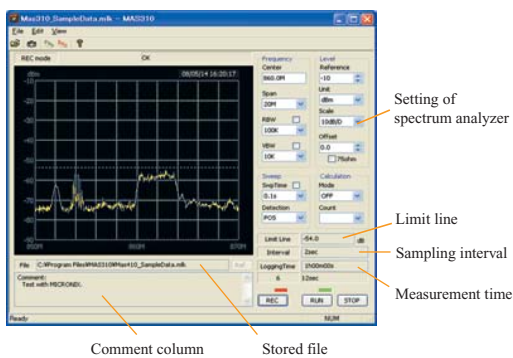

#### Playback



### VSWR bridge MVS300



Frequency range : 5 to 3000MHz  
 Directivity : more than 40dB @ 50 to 3000MHz  
 more than 25dB @ 5 to 50MHz  
 Insertion loss :  
 less than 7dB @ SOURCE to DUT  
 less than 8dB @ DUT to REFLECTED  
 Dimensions : 50(W)×31(H)×114(D)mm  
 Weight : approx.240g  
 Connectors : SMA(J) (for three ports)

### Dipole antenna M301 to M306



Model	Freq.range	Antenna gain	VSWR	Dimensions	Weight
M301	0.8 to 1GHz	>1dBi	<1.5	7.5φ×250mm	approx.20g
M302	1.25 to 1.65GHz	>1dBi	<1.5	7.5φ×250mm	approx.20g
M303	1.7 to 2.2GHz	>1dBi	<1.5	7.5φ×180mm	approx.15g
M304	2.25 to 2.65GHz	>1dBi	<1.5	7.5φ×180mm	approx.15g
M305	300 to 500MHz	>1dBi	<1.5	8.0φ×195mm	approx.30g
M306	4.7 to 6.2GHz	>1dBi	<1.5	7.5φ×120mm	approx.10g

- 1) Antenna gain and VSWR are specified at a center of frequency range.
- 2) Connector : SMA(P)

### Magnetic field probe CP-2S



Frequency range : 10MHz to 3GHz  
 Space resolution : approx.0.25mm  
 (depending on objects)  
 Dimensions : outside 12φ×135mm  
 probe tip 2mm(W)×1mm(T)  
 Connector : SMA(P)

### Printer



Printing method : Thermal line dot method  
 Paper : 80mm width thermal paper  
 Power source :  
 internal : AA-sized alkaline battery (4 pcs)  
 external : 7.5VDC/3A (dedicated AC adaptor)  
 Dimensions : 134(W)×60(H)×180(D)mm  
 Weight : approx.450g (mainframe only)  
 Interface : RS-232C

( With AC adaptor )  
 and one rollpaper )  
 ※ Option : Rollpaper (10 rolls)

### Frequency counter (factory option)

Items	Specifications
Freq.range	1MHz to 3.3GHz@MSA338/338TG/338E 1MHz to 8.5GHz@MSA358
Measured level	+10 to -70dBm@1MHz to 2GHz,RBW100kHz +10 to -60dBm@2GHz to 8.5GHz,RBW100kHz
Measurement resolution	100Hz
Display digits	8 digits max
Reference x'tal	Accuracy : $\pm 2$ ppm@23°C Temp.characteristics : $\pm 5$ ppm@0 to 40°C

### Ni-MH battery MB300



4.8V/4200mAh

### Charger MBC300



AC adaptor MA300 which is a standard accessory of spectrum analyzer MSA300 series is used for power source of this charger.

Input voltage : DC5V  $\pm$  0.25V

Input current : 4A max

Charging time : roughly two hours

### RS-232C/GP-IB converter ZS-6144TM



It is possible to use the spectrum analyzer as an instrument with GP-IB interface.  
The data transfer can be performed not related to GP-IB state because RS-232C side is equipped with full duplex mode and buffer memory.

(With AC adaptor and 25P/9P conversion connector)

Buffer memory capacity : 8K bytes  
(both of input/output)  
Dimensions : 130(W)  $\times$  40(H)  $\times$  200(D)mm  
Weight : approx.1.8kg

### Coaxial attenuator MG-XXdB

Model	Attenuation error		V S W R	Rated power
	DC to 12.4GHz	12.4GHz to 18GHz		
MG-1dB, 2dB, 3dB, 4dB	$< \pm 0.5$ dB	$< \pm 1$ dB	$< 1.15$ @DC to 4GHz $< 1.2$ @4 to 12.4GHz $< 1.3$ @12.4 to 18GHz	1W
MG-5dB, 6dB, 7dB, 8dB	$< \pm 0.7$ dB	$< \pm 1.2$ dB		
MG-9dB, 10dB, 12dB, 13dB	$< \pm 1.0$ dB	$< \pm 1.25$ dB		
MG-14dB, 15dB, 20dB	$< \pm 1.2$ dB	$< \pm 1.3$ dB		
MG-30dB	$< \pm 1.2$ dB@DC to 8GHz	$< 1.2$ @DC to 8GHz		

※Connector, impedance : SMA(P)/SMA(J), 50Ω

### Terminator

Model	Freq.range	V S W R				Rated power	Connector
		DC to 4GHz	4 to 8GHz	8 to 12.4GHz	12.4 to 18GHz		
MG-50S	DC to 18GHz	$< 1.08$	$< 1.10$	$< 1.15$	$< 1.20$	0.25W	SMA(P)
MG-50N	DC to 8GHz	$< 1.2$ @DC to 8GHz				2W	N(P)

※Impedance : 50Ω

### Coaxial cable

Model	Connector	Length	Freq.range
MC102	SMA(P)/BNC(P)	1.5m	DC to 2GHz
MC201	SMA(P)/SMA(P)	0.5m	DC to 18.5GHz
MC202	SMA(P)/SMA(P)	3m	DC to 18.5GHz
MC203	SMA(P)/SMA(P)	4m	DC to 18.5GHz
MC204	SMA(P)/SMA(P)	1.5m	DC to 12.4GHz
MC301	SMA(P)/SMA(P)	0.5m	DC to 10GHz
MC302	SMA(P)/SMA(P)	1m	DC to 10GHz
MC303	SMA(P)/SMA(P)	1.5m	DC to 10GHz
MC304	SMA(P)/N(J)	0.2m	DC to 4GHz
MC305	SMA(P)/N(P)	0.2m	DC to 4GHz
MC306	SMA(P)/BNC(J)	0.2m	DC to 2GHz
MC307	SMA(P)/BNC(P)	0.2m	DC to 2GHz
MC308	N(P)/N(P)	0.5m	DC to 10GHz
MC309	N(P)/N(P)	1m	DC to 10GHz
MC310	N(P)/N(P)	1.5m	DC to 10GHz
MC311	N(P)/SMA(J)	0.2m	DC to 10GHz
MC312	N(P)/BNC(J)	0.2m	DC to 2GHz
MC313	N(P)/BNC(P)	0.2m	DC to 2GHz
MC314	BNC(P)/BNC(P)	1.5m	DC to 2GHz

※Impedance : 50Ω

### Adaptor

Model	Connector	Impedance	Freq.range
MA301	BNC(P)/BNC(J)	50Ω/75Ω	DC to 2GHz
MA302	BNC(P)/N(J)	75Ω/75Ω	DC to 1.8GHz
MA303	BNC(P)/N(P)	75Ω/75Ω	DC to 1.8GHz
MA304	BNC(P)/F(J)	75Ω/75Ω	DC to 1.8GHz
MA305	BNC(P)/F(P)	75Ω/75Ω	DC to 1.8GHz
MA306	N(P)/SMA(J)	50Ω/50Ω	DC to 12.4GHz
MA307	N(P)/BNC(J)	50Ω/50Ω	DC to 2GHz
MA308	N(P)/BNC(J)	50Ω/75Ω	DC to 2GHz
MA309	N(J)/BNC(P)	50Ω/50Ω	DC to 2GHz

### RS-232C cable MI180



Connector : D-sub 9pins  
Length : 1.5m



MICRONIX Corporation reserves the right to make changes in design, specification and other information without prior notice.

---

**MICRONIX**

AGENCY

**MICRONIX CORPORATION**

2987- 2, KOBIKI-CHO, HACHIOJI-SHI, TOKYO 193-0934 JAPAN

TEL. +81-42-637-3667 FAX. +81-42-637-0227

URL: <http://www.micronix-jp.com> E-mail: [micronix\\_e@micronix-jp.com](mailto:micronix_e@micronix-jp.com)