

TTP™



Labels for Life.

THERMAL TRANSFER PRODUCTS



www.identco.com
IMEXICO PRODUCT PORTFOLIO

IDENTCO partners with industrial, transportation, and electronics customers across the globe to develop high performance labeling solutions that outlast the products they identify. We have a singular focus: labeling solutions. Adopting this singular focus has allowed us to develop and refine our processes over the past 30 years, and become leaders in collaborative, technology driven solutions.

IDENTCO TTP™ solutions offer optimal labels, ribbons, and equipment for your company's on-demand identification needs.

TTP™ – THERMAL TRANSFER PRODUCTS

- Stock Blank Labels
- Custom Blank and Pre-printed Labels
- Labels for Automatic Placement Equipment
- Thermal Transfer Ribbons
- Thermal Transfer Printers & Label Software
- Scanners, Rewinders, Dispensers, & SMT Label Feeders



CPP™ – CUSTOM PRINTED PRODUCTS

- Brand Recognition Labels
- Graphic Overlays
- UL / CSA Nameplates
- Information & Instructional Labels
- Security & Anti-Counterfeiting Labels



DCP™ – DIE CUT PRODUCTS

- Protective Masks & Lenses
- Adhesives & Bonding
- Insulators
- Custom Engineered Products



WMP™ – WIRE MARKING PRODUCTS

- Heat Shrink Sleeves (formatted and continuous)
- Self-laminating Cable Identification Labels
- Print-protected Labels
- Flag Wire Markers



TTP iMEXICO PRODUCT PORTFOLIO 1000-101-0117
(Certain products only available in Mexico)

TTP™

THERMAL TRANSFER PRODUCTS





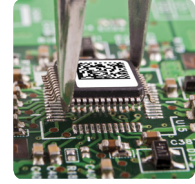





















Labels for Life.



Material Reference	TTP: Thermal Transfer Label Materials	2
Label Reference Guide	Standard Label Configuration & Terms	3
Circuit Board & Electronic Component Labels	TTL™ 100 Series	4
TTL™ 100 Series Product Specifications	Illustrations & Reference: TTL™ 100-149	5-17
Wire & Cable Identification Labels	TTL™ 200 Series	18
TTL™ 200 Series Product Specifications	Illustrations & Reference: TTL™ 200-210	19-22
Packaging & Shipping Labels	TTL™ 1-14 Series	23
UL/CSA Nameplate Labels	TTL™ 300 Series	24
TTL™ 300 Series Product Specifications	Illustrations & Reference: TTL™ 300-312	25-28
Print Protection	GraphicLock™ TT for Thermal Transfer Printing	29
Thermal Transfer Ribbons	TTRR™ Series: Resin & Wax/Resin Combination Ribbons	30
Thermal Transfer Ribbons	TTR™ Series: Wax Ribbons	31
Print Service Bureau	Variable Printing Alternative	32
Custom Blank Labels	Special Shapes, Sizes & Die Cuts	33
Thermal Transfer Printers	ELP™ Series	34
Thermal Transfer Printers	ELP™ Series Model Comparisons	35
ELP-A™ Print & Apply Applicator	IDENTCO ELP-A™ Series	36
Precision Labels for Automatic Applications	Auto-Apply Labels	37
Automation Equipment	Pre-printed Label Presenter	38
IMS Series Heat Shrink Wire Markers	Visual Data Management for Tough Environments	39
Assume Quality, Expect Perfection	Highest Quality Global Production	40

MATERIAL REFERENCE

TTP: THERMAL TRANSFER LABEL MATERIALS

	MATERIAL	COLOR	FINISH	TEMPERATURE RANGE	MATERIAL DESCRIPTION	RECOMMENDED RIBBON	AUTO APPLY	AGENCY RECOGNITION*
POLYIMIDE	TT403	White	Gloss	-40 ¹ °F to 572°F -40°C to 300°C	High temperature film designed for top-side, bottom-side identification labels that are exposed to high temperatures and lead-free solder used primarily in the PCBA industry.	TTRR-B TTRR-D	•	
	TT403GR	Green	Gloss	-40°F to 572°F -40°C to 300°C	Green was designed to indicate lead-free applications. Ideal for high temperatures, lead-free solder, bottom side of boards.	TTRR-B TTRR-D	•	
	TT411	Tan	Matte	-40°F to 572°F -40°C to 300°C	High temp film designed for top-side, bottom-side identification labels that are exposed to high temperatures and lead-free solder used primarily in the PCBA industry. (Must use TTRR TM AK ribbon.)	TTRR-AK	•	
	TT433	White	Gloss	-40°F to 572°F -40°C to 300°C	Ultra solvent resistant high temperature film. Withstands the new aggressive cleaning agents from KYZEN® and ZESTRON® for in-line and batch washing process. Use TTRR TM CR ribbon for top performance.	TTRR-CR	•	
	TT451	White	Semi-Gloss	-40°F to 572°F -40°C to 300°C	ESD / Static dissipative top coat. Ideal for high temperatures, lead-free solder, bottom side of boards.	TTRR-B TTRR-D	•	
	TT490	White	Gloss	-40°F to 572°F -40°C to 300°C	High temperatures, lead-free solder top and bottom side of boards.	TTRR-B TTRR-D	•	
	TT491	White	Matte	-40°F to 572°F -40°C to 300°C	High temperatures, lead-free solder top and bottom side of boards.	TTRR-B TTRR-D	•	
	TT492	White	Gloss	-40°F to 572°F -40°C to 300°C	Low profile film (1 mil) ideal for high temperatures, lead-free solder , top and bottom side of boards.	TTRR-B TTRR-D		
	TT493	White	Matte	-40°F to 572°F -40°C to 300°C	Low profile film (1 mil) ideal for high temperatures, lead-free solder, top and bottom side of boards.	TTRR-B TTRR-D		
POLYESTER	TT700	White	Gloss	-40°F to 302°F -40°C to 150°C	Product identification and top side labeling.	TTRR-B TTRR-D	•	 
	TT701	White	Matte	-40°F to 302°F -40°C to 150°C	Product identification and top side labeling.	TTRR-B TTRR-D	•	 
	TT724	Silver	Gloss	-40°F to 302°F -40°C to 150°C	Product and top side labeling. Extra heavy adhesive that adheres better to textured/rough surfaces.	TTRR-B TTRR-D	•	 
	TT730	Silver	Gloss	-40°F to 302°F -40°C to 150°C	Material provides a "metal nameplate" look when labeling a product with UL / CSA nameplate or rating plate.	TTRR-B TTRR-D	•	
	TT740	Silver	Matte	40°F to 302°F -40°C to 150°C	Material provides a "metal nameplate" look when labeling a product with UL / CSA nameplate or rating plate.	TTRR-B TTRR-D	•	 
	TT760	White	Gloss	-40°F to 302°F -40°C to 150°C	Extra heavy adhesive that is ideal for textured / rough surfaces and and LSE plastics. Product and top side labeling.	TTRR-B TTRR-D	•	 
	TT770	White	Gloss	-40°F to 275°F -40°C to 125°C	ESD / Static dissipative. Ideal for use in static free environments and top side labeling.	TTRR-D		
VINYL	TT727	Clear	Gloss	-20°F to 140°F -29°C to 60°C	Highly conformable film that is used on self-laminating wire and cable identification labels.	TTRR-A		
	TT733	White	Matte	40°F to 300°F -40°C to 150°C	Security material that has excellent conformability and is very fragile; tamper evident film.	TTRR-B TTRR-D		
POLYPROPYLENE	TT705A	White	Gloss	-40°F to 250°F -40°C to 121°C	Ideal material for use when the service temperature does not exceed 250°F. Lower cost alternative to polyester	TTRR-B TTRR-D		
	TT773	White	Matte	-40°F to 176°F -40°C to 80°C	Product identification and barcoding when the heat resistance of polyester is not required. Adhesive offers high initial tack and excellent long-term adhesion.	TTRR-B TTRR-D		
PAPER	TT726	White	Dull	-65°F to 180°F -54°C to 82°C	Removable paper label.	TTR	•	
	TT728	White	Dull	-65°F to 180°F -54°C to 82°C	Packaging label.	TTR	•	
	TT516	Clear	Semi-Gloss	-65°F to 180°F -54°C to 82°C	Packaging label – recommended for flexo printing.	TTR	•	

DID YOU KNOW...

* UL recognition / CSA approval is contingent upon printing your IDENTCO labels with the appropriate IDENTCO TTRRTM series thermal transfer ribbon, which has been approved by the testing conducted at Underwriters Laboratories and/or the Canadian Standards Association.

LABEL REFERENCE GUIDE

STANDARD LABEL CONFIGURATION & TERMS

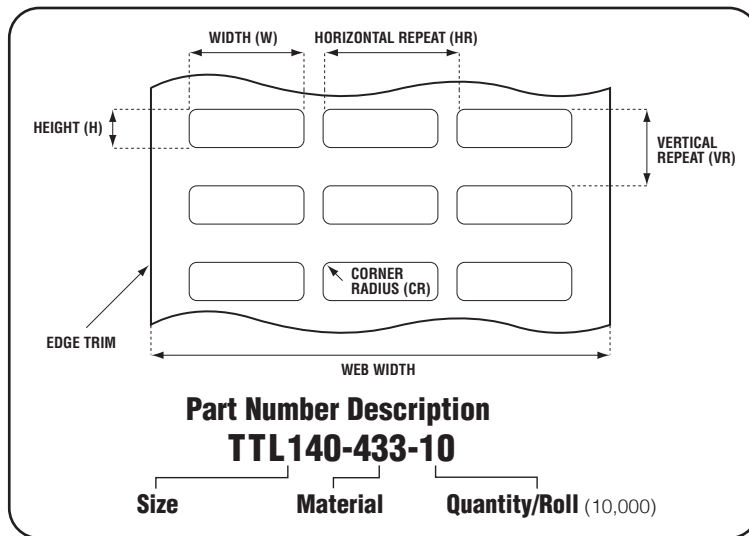

WIDTH (W)

- Horizontal measurement from left to right of label

HEIGHT (H)

- Vertical measurement from top to bottom of label

VERTICAL REPEAT (VR)

- Vertical measurement from the top of the label to the top of the next label

HORIZONTAL REPEAT (HR) (2 or more across)

- Horizontal measurement from the left edge of the label to the left edge of the next label
- Applies only to multiple across layouts

WEB

- Horizontal measurement of the liner

CORNER RADIUS (CR)

- Measurement of label corner — use corner measurement tool
- Standard = 0.0625" (1.59mm)
- 0.0156" (0.40mm) is the minimum to be used

EDGE TRIM

- Horizontal measurement from edge of liner to outer edge of closest label
- Measurement is taken from both ends of liner

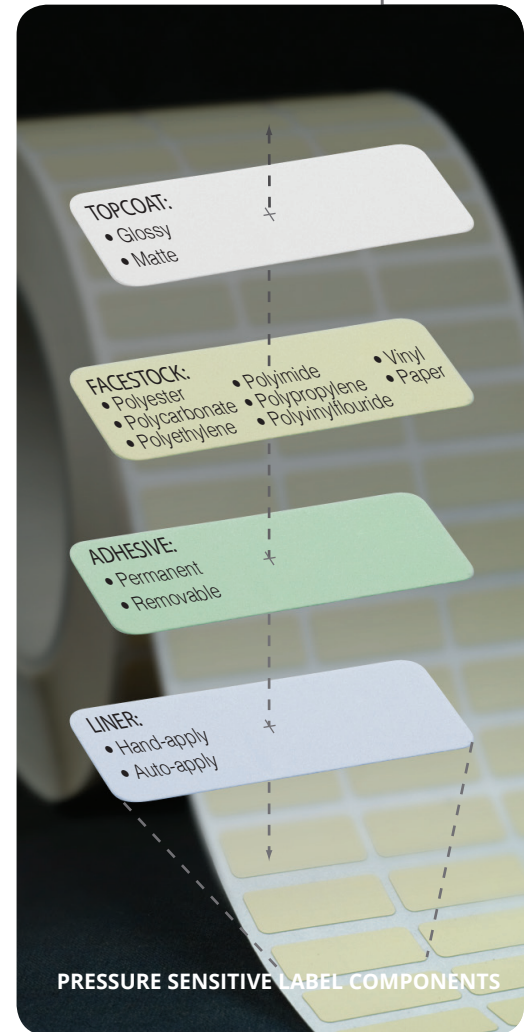

CIRCUIT BOARD & ELECTRONIC COMPONENT LABELS

TTL™ 100 SERIES

HIGHLIGHTS

- Endures harsh manufacturing environments
- Renders lifelong identification
- **UL/CSA approved***

FEATURES

- Thermal transfer printable
- Top-side, bottom-side, or after-process identification

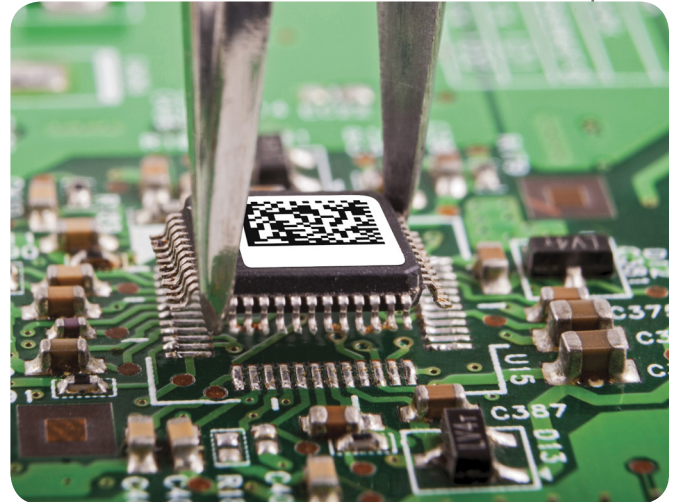

Engineered for use on printed circuit boards (PCBs) and electronic components, the TTL™ 100 series labels endure harsh environments such as high heat, aggressive fluxes, and caustic cleaners commonly used in the manufacturing process. Materials are intended for top-side, bottom-side, or after-process identification.

To achieve optimal print quality, durability, and **UL/CSA recognition**, IDENTCO TTL™ 100 series products have been thoroughly tested and qualified to match a TTRR™ series ribbon.

***UL/CSA recognitions are contingent upon printing with the appropriate IDENTCO material and TTRR™ ribbon combination specified by the Underwriters Laboratories and Canadian Standards Association.**

IN-STOCK MATERIALS INCLUDE:

- White polyester
- Silver polyester
- White polyimide
- Tan polyimide
- Low-profile polyimide
- Anti-static polyimide

Refer to pages 5-17 for charts and specifications



TTL™ 100 SERIES

Actual Size	Part #	Inches (w x h)	mm (w x h)	Labels per row	Actual Size	Part #	Inches (w x h)	mm (w x h)	Labels per row
	TTL140-XXX - 10	0.17 x 0.13	4.32 x 3.30	5		TTL105-XXX-10 TTL131-XXX-10	1.00 x .375 1.00 x .375	25.40 x 9.53 25.40 x 9.53	3 1
	TTL100-XXX - 10 TTL124-XXX - 10 TTL148-XXX - 10	0.25 x 0.25 0.25 x 0.25 0.25 x 0.25	6.35 x 6.35 6.35 x 6.35 6.35 x 6.35	12 8 7		TTL106-XXX-10 TTL147-XXX-10	1.00 x 0.50 1.00 x 0.50	25.40 x 12.70 25.40 x 12.70	3 1
	TTL113-XXX - 10	0.27 x 0.27	6.86 x 6.86	5		TTL144-XXX-10	1.00 x 1.00	25.40 x 25.40	3
	TTL139-XXX - 10	0.30 x 0.20	7.62 x 5.08	5		TTL138-XXX-10	1.1 x 0.38	27.94 x 9.65	2
	TTL111-XXX - 10	0.3125 x 0.3125	7.93 x 7.93	5		TTL118-XXX-10 TTL134-XXX-10	1.25 x 0.25 1.25 x 0.25	31.75 x 6.35 31.75 x 6.35	2 1
	TTL146-XXX - 10	0.315 x 0.315	8.00 x 8.00	8		TTL149-XXX-10	1.25 x 0.375	31.75 x 9.53	2
	TTL116-XXX - 10 TTL125-XXX - 10	0.375 x 0.375 0.375 x 0.375	9.52 x 9.52 9.53 x 9.53	7 4		TTL115-XXX-10 TTL133-XXX-10	1.50 x 0.125 1.50 x 0.125	38.10 x 3.18 38.10 x 3.18	2 1
	TTL145-XXX - 25	0.449 x 0.157	11.405 x 3.98	6		TTL114-XXX-10 TTL132-XXX-10	1.50 x 0.25 1.50 x 0.25	38.10 x 6.35 38.10 x 6.35	2 1
	TTL121-XXX-10 TTL126-XXX-10	0.50 x 0.20 0.50 x 0.20	12.70 x 5.08 12.70 x 5.08	5 4		TTL119-XXX-10	1.5 x 0.5	38.10 x 12.70	2
	TTL101-XXX-10	0.50 x 0.25	12.70 x 6.35	5		TTL107-XXX-10	1.75 x 0.25	44.45 x 6.35	1
	TTL112-XXX-10 TTL127-XXX-10	0.50 x 0.4375 0.50 x 0.4375	12.70 x 11.125 12.70 x 11.125	5 3		TTL117-XXX-10	2.0 x 0.25	50.80 x 6.35	1
	TTL137-XXX-10	0.60 x 0.25	15.24 x 6.35	1		TTL109-XXX-10	2.0 x 0.375	50.80 x 9.53	1
	TTL102-XXX-10 TTL128-XXX-10 TTL136-XXX-10	0.65 x 0.20 0.65 x 0.20 0.65 x 0.20	16.51 x 5.08 16.51 x 5.08 16.51 x 5.08	4 2 1		TTL120-XXX-10	2.0 x 0.5	50.80 x 12.70	1
	TTL122-XXX-10	0.70 x 0.375	17.78 x 9.53	4		TTL110-XXX-10	3.0 x 0.3125	76.20 x 7.93	1
	TTL103-XXX-10 TTL129-XXX-10 TTL141-XXX-10	0.75 X 0.25 0.75 X 0.25 0.75 X 0.25	19.05 x 6.35 19.05 x 6.35 19.05 x 6.35	4 1 4					
	TTL123-XXX-10	0.75 x 0.75	19.05 x 19.05	4					
	TTL104-XXX-10 TTL130-XXX-10	0.90 x 0.25 0.90 x 0.25	22.86 x 6.35 22.86 x 6.35	3 1					
	TTL135-XXX-10	1.00 x 0.25	25.40 x 6.35	1					

0.250" x 0.250"
6.35 mm x 6.35 mm

TTL™ 100

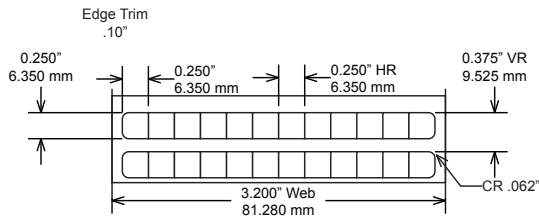

Part Number	Material Description	TTRR™
TTL-100-433-10	Hi-Performance Gloss White Polyimide	CR
TTL-100-403-10	Gloss White Polyimide	B,D
TTL-100-403GR-10	Gloss Green Polyimide	B,D
TTL-100-490-10	Economy Gloss White Polyimide	B,D
TTL-100-494-10	ESD Matte White Polyimide	B,D
TTL-100-492-10	Low Profile Gloss White Polyimide	B,CR
TTL-100-700-10	Gloss White Polyester	B,D

0.500" x 0.250"
12.70 mm x 12.70 mm

TTL™ 101

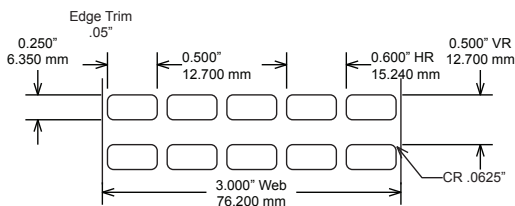

Part Number	Material Description	TTRR™
TTL-101-433-10	Hi-Performance Gloss White Polyimide	CR
TTL-101-403-10	Gloss White Polyimide	B,D
TTL-101-403GR-10	Gloss Green Polyimide	B,D
TTL-101-490-10	Economy Gloss White Polyimide	B,D
TTL-101-494-10	ESD Matte White Polyimide	B,D
TTL-101-492-10	Low Profile Gloss White Polyimide	B,CR
TTL-101-700-10	Gloss White Polyester	B,D

0.650" x 0.200"
16.51 mm x 5.08 mm

TTL™ 102

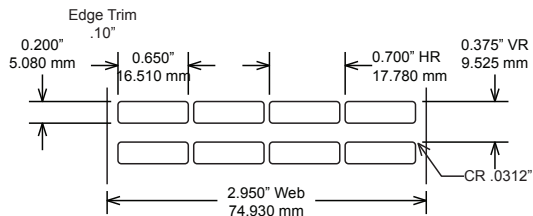

Part Number	Material Description	TTRR™
TTL-102-433-10	Hi-Performance Gloss White Polyimide	CR
TTL-102-403-10	Gloss White Polyimide	B,D
TTL-102-403GR-10	Gloss Green Polyimide	B,D
TTL-102-490-10	Economy Gloss White Polyimide	B,D
TTL-102-494-10	ESD Matte White Polyimide	B,D
TTL-102-492-10	Low Profile Gloss White Polyimide	B,CR
TTL-102-700-10	Gloss White Polyester	B,D

0.750" x 0.250"
19.05 mm x 6.35 mm

TTL™ 103

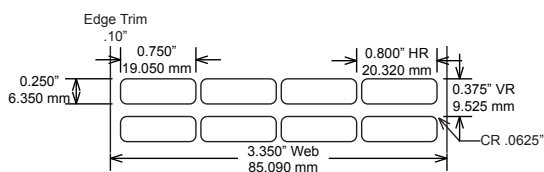

Part Number	Material Description	TTRR™
TTL-103-433-10	Hi-Performance Gloss White Polyimide	CR
TTL-103-403-10	Gloss White Polyimide	B,D
TTL-103-403GR-10	Gloss Green Polyimide	B,D
TTL-103-490-10	Economy Gloss White Polyimide	B,D
TTL-103-494-10	ESD Matte White Polyimide	B,D
TTL-103-492-10	Low Profile Gloss White Polyimide	B,CR
TTL-103-700-10	Gloss White Polyester	B,D

0.900" x 0.250"
22.86 mm x 6.35 mm

TTL™ 104

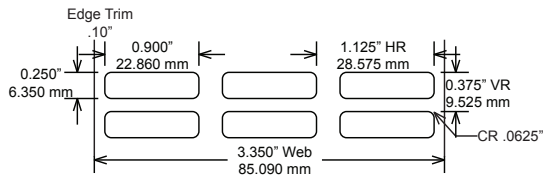

Part Number	Material Description	TTRR™
TTL-104-433-10	Hi-Performance Gloss White Polyimide	CR
TTL-104-403-10	Gloss White Polyimide	B,D
TTL-104-403GR-10	Gloss Green Polyimide	B,D
TTL-104-490-10	Economy Gloss White Polyimide	B,D
TTL-104-494-10	ESD Matte White Polyimide	B,D
TTL-104-492-10	Low Profile Gloss White Polyimide	B,CR
TTL-104-700-10	Gloss White Polyester	B,D

1.000" x 0.375"
25.40 mm x 9.53 mm

TTL™ 105

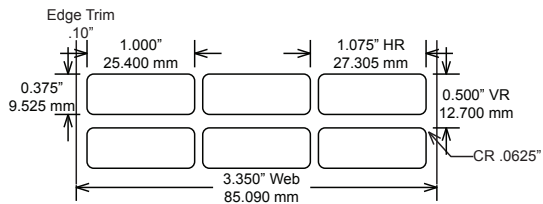

Part Number	Material Description	TTRR™
TTL-105-433-10	Hi-Performance Gloss White Polyimide	CR
TTL-105-403-10	Gloss White Polyimide	B,D
TTL-105-403GR-10	Gloss Green Polyimide	B,D
TTL-105-490-10	Economy Gloss White Polyimide	B,D
TTL-105-494-10	ESD Matte White Polyimide	B,D
TTL-105-492-10	Low Profile Gloss White Polyimide	B,CR
TTL-105-700-10	Gloss White Polyester	B,D

1.000" x 0.500"
25.40 mm x 12.70 mm

TTL™ 106

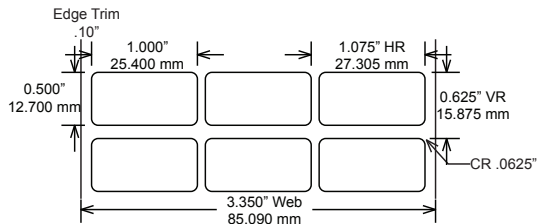

Part Number	Material Description	TTRR™
TTL-106-433-10	Hi-Performance Gloss White Polyimide	CR
TTL-106-403-10	Gloss White Polyimide	B,D
TTL-106-403GR-10	Gloss Green Polyimide	B,D
TTL-106-490-10	Economy Gloss White Polyimide	B,D
TTL-106-494-10	ESD Matte White Polyimide	B,D
TTL-106-492-10	Low Profile Gloss White Polyimide	B,CR
TTL-106-700-10	Gloss White Polyester	B,D

1.750" x 0.250"
44.45 mm x 6.35 mm

TTL™ 107

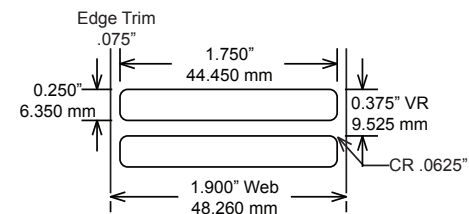

Part Number	Material Description	TTRR™
TTL-107-433-10	Hi-Performance Gloss White Polyimide	CR
TTL-107-403-10	Gloss White Polyimide	B,D
TTL-107-403GR-10	Gloss Green Polyimide	B,D
TTL-107-490-10	Economy Gloss White Polyimide	B,D
TTL-107-494-10	ESD Matte White Polyimide	B,D
TTL-107-492-10	Low Profile Gloss White Polyimide	B,CR
TTL-107-700-10	Gloss White Polyester	B,D

2.000" x 0.375"
50.80 mm x 9.35 mm

TTL™ 109

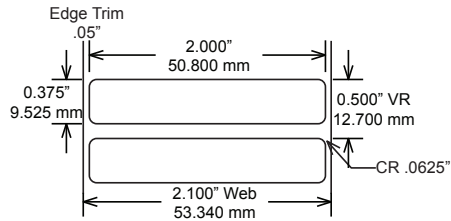

Part Number	Material Description	TTRR™
TTL-109-433-10	Hi-Performance Gloss White Polyimide	CR
TTL-109-403-10	Gloss White Polyimide	B,D
TTL-109-403GR-10	Gloss Green Polyimide	B,D
TTL-109-490-10	Economy Gloss White Polyimide	B,D
TTL-109-494-10	ESD Matte White Polyimide	B,D
TTL-109-492-10	Low Profile Gloss White Polyimide	B,CR
TTL-109-700-10	Gloss White Polyester	B,D

3.000" x 0.313"
76.20 mm x 7.95 mm

TTL™ 110

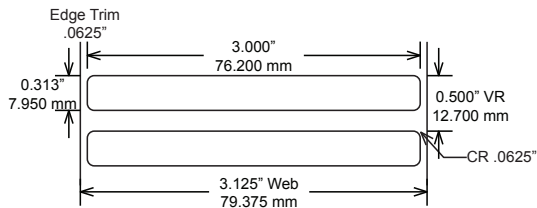

Part Number	Material Description	TTRR™
TTL-110-433-10	Hi-Performance Gloss White Polyimide	CR
TTL-110-403-10	Gloss White Polyimide	B,D
TTL-110-403GR-10	Gloss Green Polyimide	B,D
TTL-110-490-10	Economy Gloss White Polyimide	B,D
TTL-110-494-10	ESD Matte White Polyimide	B,D
TTL-110-492-10	Low Profile Gloss White Polyimide	B,CR
TTL-110-700-10	Gloss White Polyester	B,D

0.313" x 0.313"
7.95 mm x 7.95 mm

TTL™ 111

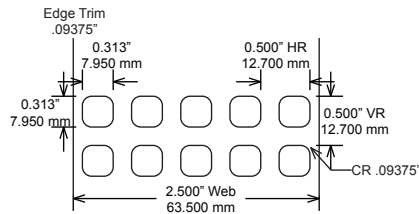

Part Number	Material Description	TTRR™
TTL-111-433-10	Hi-Performance Gloss White Polyimide	CR
TTL-111-403-10	Gloss White Polyimide	B,D
TTL-111-403GR-10	Gloss Green Polyimide	B,D
TTL-111-490-10	Economy Gloss White Polyimide	B,D
TTL-111-494-10	ESD Matte White Polyimide	B,D
TTL-111-492-10	Low Profile Gloss White Polyimide	B,CR
TTL-111-700-10	Gloss White Polyester	B,D

0.500" x 0.438"
12.70 mm x 11.13 mm

TTL™ 112

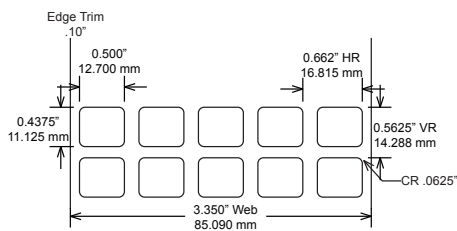

Part Number	Material Description	TTRR™
TTL-112-433-10	Hi-Performance Gloss White Polyimide	CR
TTL-112-403-10	Gloss White Polyimide	B,D
TTL-112-403GR-10	Gloss Green Polyimide	B,D
TTL-112-416-10	Economy Gloss White Polyimide	B,D
TTL-112-451-10	ESD Semi-Gloss White Polyimide	B,D
TTL-112-481-10	Low Profile Gloss White Polyimide	B,CR
TTL-112-700-10	Gloss White Polyester	B,D

0.270" x 0.270"
6.86 mm x 6.86 mm

TTL™ 113

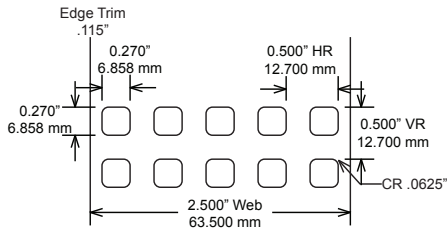

Part Number	Material Description	TTRR™
TTL-113-433-10	Hi-Performance Gloss White Polyimide	CR
TTL-113-403-10	Gloss White Polyimide	B,D
TTL-113-403GR-10	Gloss Green Polyimide	B,D
TTL-113-490-10	Economy Gloss White Polyimide	B,D
TTL-113-494-10	ESD Matte White Polyimide	B,D
TTL-113-492-10	Low Profile Gloss White Polyimide	B,CR
TTL-113-700-10	Gloss White Polyester	B,D

1.500" x 0.250"
38.10 mm x 6.35 mm

TTL™ 114

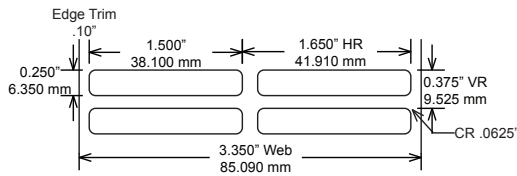

Part Number	Material Description	TTRR™
TTL-114-433-10	Hi-Performance Gloss White Polyimide	CR
TTL-114-403-10	Gloss White Polyimide	B,D
TTL-114-403GR-10	Gloss Green Polyimide	B,D
TTL-114-490-10	Economy Gloss White Polyimide	B,D
TTL-114-494-10	ESD Matte White Polyimide	B,D
TTL-114-492-10	Low Profile Gloss White Polyimide	B,CR
TTL-114-700-10	Gloss White Polyester	B,D

1.500" x 0.125"
38.10 mm x 3.18 mm

TTL™ 115

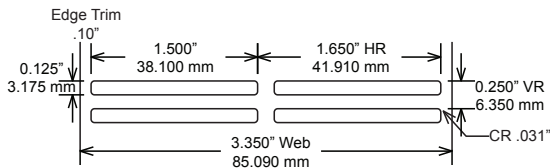

Part Number	Material Description	TTRR™
TTL-115-433-10	Hi-Performance Gloss White Polyimide	CR
TTL-115-403-10	Gloss White Polyimide	B,D
TTL-115-403GR-10	Gloss Green Polyimide	B,D
TTL-115-490-10	Economy Gloss White Polyimide	B,D
TTL-115-494-10	ESD Matte White Polyimide	B,D
TTL-115-492-10	Low Profile Gloss White Polyimide	B,CR
TTL-115-700-10	Gloss White Polyester	B,D

0.375" x 0.375"
9.52 mm x 9.52 mm

TTL™ 116

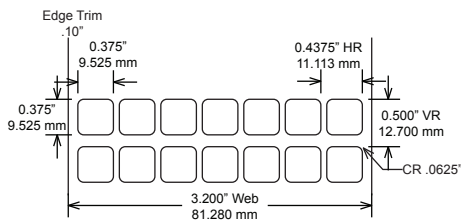

Part Number	Material Description	TTRR™
TTL-116-433-10	Hi-Performance Gloss White Polyimide	CR
TTL-116-403-10	Gloss White Polyimide	B,D
TTL-116-403GR-10	Gloss Green Polyimide	B,D
TTL-116-490-10	Economy Gloss White Polyimide	B,D
TTL-116-494-10	ESD Matte White Polyimide	B,D
TTL-116-492-10	Low Profile Gloss White Polyimide	B,CR
TTL-116-700-10	Gloss White Polyester	B,D

2.000" x 0.250"
50.80 mm x 6.35 mm

TTL™ 117

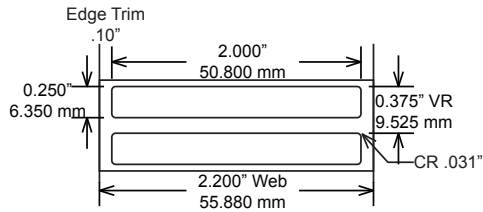

Part Number	Material Description	TTRR™
TTL-117-433-10	Hi-Performance Gloss White Polyimide	CR
TTL-117-403-10	Gloss White Polyimide	B,D
TTL-117-403GR-10	Gloss Green Polyimide	B,D
TTL-117-490-10	Economy Gloss White Polyimide	B,D
TTL-117-494-10	ESD Matte White Polyimide	B,D
TTL-117-492-10	Low Profile Gloss White Polyimide	B,CR
TTL-117-700-10	Gloss White Polyester	B,D

1.250" x 0.250"
31.75 mm x 6.35 mm

TTL™ 118

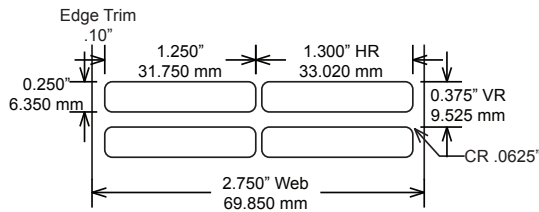

Part Number	Material Description	TTRR™
TTL-118-433-10	Hi-Performance Gloss White Polyimide	CR
TTL-118-403-10	Gloss White Polyimide	B,D
TTL-118-403GR-10	Gloss Green Polyimide	B,D
TTL-118-490-10	Economy Gloss White Polyimide	B,D
TTL-118-494-10	ESD Matte White Polyimide	B,D
TTL-118-492-10	Low Profile Gloss White Polyimide	B,CR
TTL-118-700-10	Gloss White Polyester	B,D

1.500" x 0.500"
38.10 mm x 12.70 mm

TTL™ 119

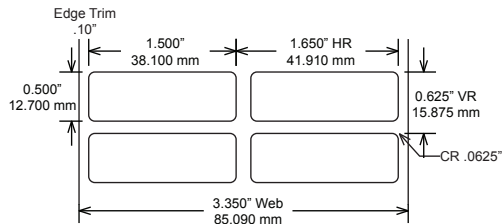

Part Number	Material Description	TTRR™
TTL-119-433-10	Hi-Performance Gloss White Polyimide	CR
TTL-119-403-10	Gloss White Polyimide	B,D
TTL-119-403GR-10	Gloss Green Polyimide	B,D
TTL-119-490-10	Economy Gloss White Polyimide	B,D
TTL-119-494-10	ESD Matte White Polyimide	B,D
TTL-119-492-10	Low Profile Gloss White Polyimide	B,CR
TTL-119-700-10	Gloss White Polyester	B,D

2.000" x 0.500"
50.80 mm x 12.70 mm

TTL™ 120

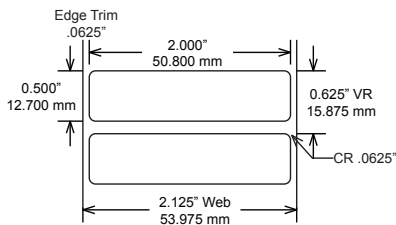

Part Number	Material Description	TTRR™
TTL-120-433-10	Hi-Performance Gloss White Polyimide	CR
TTL-120-403-10	Gloss White Polyimide	B,D
TTL-120-403GR-10	Gloss Green Polyimide	B,D
TTL-120-490-10	Economy Gloss White Polyimide	B,D
TTL-120-494-10	ESD Matte White Polyimide	B,D
TTL-120-492-10	Low Profile Gloss White Polyimide	B,CR
TTL-120-700-10	Gloss White Polyester	B,D

0.500" x 0.200"
12.70 mm x 5.08 mm

TTL™ 121

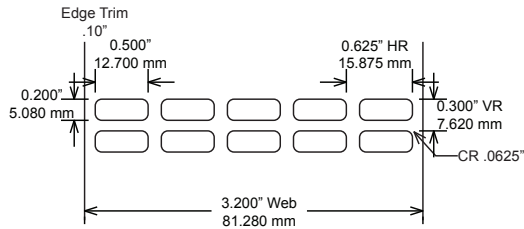

Part Number	Material Description	TTRR™
TTL-121-433-10	Hi-Performance Gloss White Polyimide	CR
TTL-121-403-10	Gloss White Polyimide	B,D
TTL-121-403GR-10	Gloss Green Polyimide	B,D
TTL-121-490-10	Economy Gloss White Polyimide	B,D
TTL-121-494-10	ESD Matte White Polyimide	B,D
TTL-121-492-10	Low Profile Gloss White Polyimide	B,CR
TTL-121-700-10	Gloss White Polyester	B,D

0.700" x 0.375"
17.78 mm x 9.53 mm

TTL™ 122

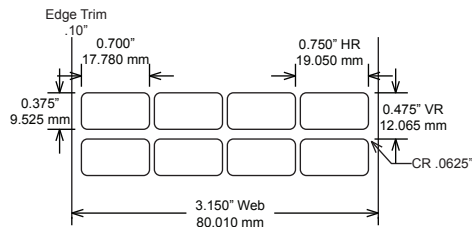

Part Number	Material Description	TTRR™
TTL-122-433-10	Hi-Performance Gloss White Polyimide	CR
TTL-122-403-10	Gloss White Polyimide	B,D
TTL-122-403GR-10	Gloss Green Polyimide	B,D
TTL-122-490-10	Economy Gloss White Polyimide	B,D
TTL-122-494-10	ESD Matte White Polyimide	B,D
TTL-122-492-10	Low Profile Gloss White Polyimide	B,CR
TTL-122-700-10	Gloss White Polyester	B,D

0.750" x 0.750"
19.05 mm x 19.05 mm

TTL™ 123

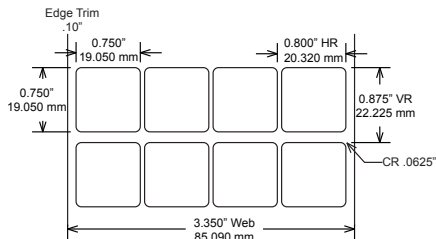

Part Number	Material Description	TTRR™
TTL-123-433-10	Hi-Performance Gloss White Polyimide	CR
TTL-123-403-10	Gloss White Polyimide	B,D
TTL-123-403GR-10	Gloss Green Polyimide	B,D
TTL-123-490-10	Economy Gloss White Polyimide	B,D
TTL-123-494-10	ESD Matte White Polyimide	B,D
TTL-123-492-10	Low Profile Gloss White Polyimide	B,CR
TTL-123-700-10	Gloss White Polyester	B,D

0.250" x 0.250"
6.35 mm x 6.35 mm

TTL™ 124

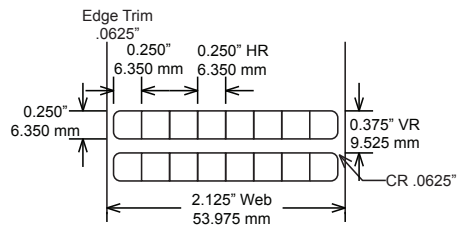

Part Number	Material Description	TTRR™
TTL-124-433-10	Hi-Performance Gloss White Polyimide	CR
TTL-124-403-10	Gloss White Polyimide	B,D
TTL-124-403GR-10	Gloss Green Polyimide	B,D
TTL-124-490-10	Economy Gloss White Polyimide	B,D
TTL-124-494-10	ESD Matte White Polyimide	B,D
TTL-124-492-10	Low Profile Gloss White Polyimide	B,CR
TTL-124-700-10	Gloss White Polyester	B,D

0.375" x 0.375"
9.53 mm x 9.53 mm

TTL™ 125

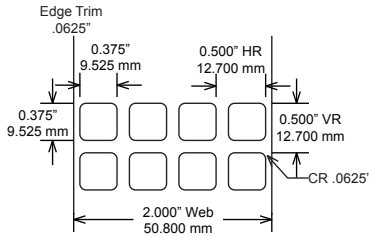

Part Number	Material Description	TTRR™
TTL-125-433-10	Hi-Performance Gloss White Polyimide	CR
TTL-125-403-10	Gloss White Polyimide	B,D
TTL-125-403GR-10	Gloss Green Polyimide	B,D
TTL-125-490-10	Economy Gloss White Polyimide	B,D
TTL-125-494-10	ESD Matte White Polyimide	B,D
TTL-125-492-10	Low Profile Gloss White Polyimide	B,CR
TTL-125-700-10	Gloss White Polyester	B,D

0.500" x 0.200"
12.70 mm x 5.08 mm

TTL™ 126

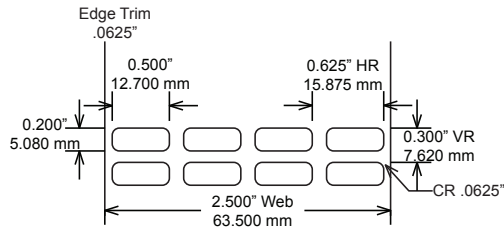

Part Number	Material Description	TTRR™
TTL-126-433-10	Hi-Performance Gloss White Polyimide	CR
TTL-126-403-10	Gloss White Polyimide	B,D
TTL-126-403GR-10	Gloss Green Polyimide	B,D
TTL-126-490-10	Economy Gloss White Polyimide	B,D
TTL-126-494-10	ESD Matte White Polyimide	B,D
TTL-126-492-10	Low Profile Gloss White Polyimide	B,CR
TTL-126-700-10	Gloss White Polyester	B,D

0.500" x 0.438"
12.70 mm x 11.13 mm

TTL™ 127

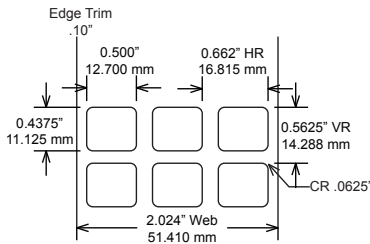

Part Number	Material Description	TTRR™
TTL-127-433-10	Hi-Performance Gloss White Polyimide	CR
TTL-127-403-10	Gloss White Polyimide	B,D
TTL-127-403GR-10	Gloss Green Polyimide	B,D
TTL-127-490-10	Economy Gloss White Polyimide	B,D
TTL-127-494-10	ESD Matte White Polyimide	B,D
TTL-127-492-10	Low Profile Gloss White Polyimide	B,CR
TTL-127-700-10	Gloss White Polyester	B,D

0.650" x 0.200"
16.51 mm x 5.08 mm

TTL™ 128

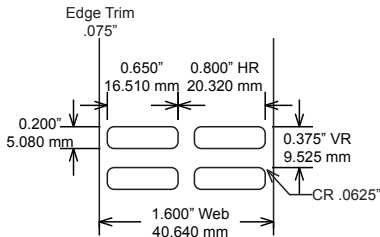

Part Number	Material Description	TTRR™
TTL-128-433-10	Hi-Performance Gloss White Polyimide	CR
TTL-128-403-10	Gloss White Polyimide	B,D
TTL-128-403GR-10	Gloss Green Polyimide	B,D
TTL-128-490-10	Economy Gloss White Polyimide	B,D
TTL-128-494-10	ESD Matte White Polyimide	B,D
TTL-128-492-10	Low Profile Gloss White Polyimide	B,CR
TTL-128-700-10	Gloss White Polyester	B,D

0.750" x 0.250"
19.05 mm x 6.35 mm

TTL™ 129

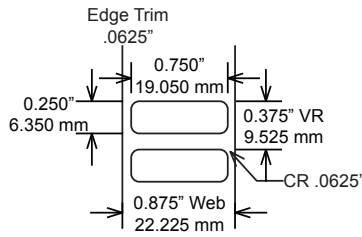

Part Number	Material Description	TTRR™
TTL-129-433-10	Hi-Performance Gloss White Polyimide	CR
TTL-129-403-10	Gloss White Polyimide	B,D
TTL-129-403GR-10	Gloss Green Polyimide	B,D
TTL-129-490-10	Economy Gloss White Polyimide	B,D
TTL-129-494-10	ESD Matte White Polyimide	B,D
TTL-129-492-10	Low Profile Gloss White Polyimide	B,CR
TTL-129-700-10	Gloss White Polyester	B,D

0.900" x 0.250"
22.86 mm x 6.35 mm

TTL™ 130

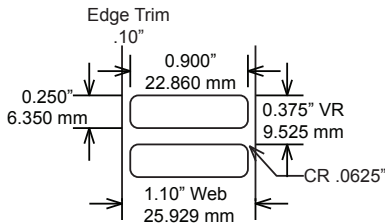

Part Number	Material Description	TTRR™
TTL-130-433-10	Hi-Performance Gloss White Polyimide	CR
TTL-130-403-10	Gloss White Polyimide	B,D
TTL-130-403GR-10	Gloss Green Polyimide	B,D
TTL-130-490-10	Economy Gloss White Polyimide	B,D
TTL-130-494-10	ESD Matte White Polyimide	B,D
TTL-130-492-10	Low Profile Gloss White Polyimide	B,CR
TTL-130-700-10	Gloss White Polyester	B,D

1.000" x 0.375"
25.40 mm x 9.53 mm

TTL™ 131

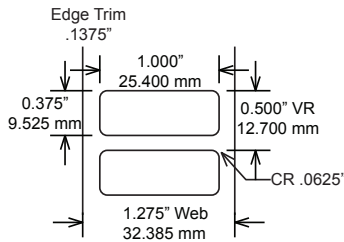

Part Number	Material Description	TTRR™
TTL-131-433-10	Hi-Performance Gloss White Polyimide	CR
TTL-131-403-10	Gloss White Polyimide	B,D
TTL-131-403GR-10	Gloss Green Polyimide	B,D
TTL-131-490-10	Economy Gloss White Polyimide	B,D
TTL-131-494-10	ESD Matte White Polyimide	B,D
TTL-131-492-10	Low Profile Gloss White Polyimide	B,CR
TTL-131-700-10	Gloss White Polyester	B,D

1.500" x 0.250"
38.10 mm x 6.35 mm

TTL™ 132

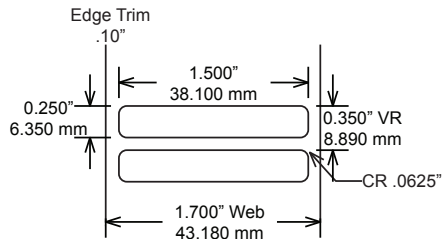

Part Number	Material Description	TTRR™
TTL-132-433-10	Hi-Performance Gloss White Polyimide	CR
TTL-132-403-10	Gloss White Polyimide	B,D
TTL-132-403GR-10	Gloss Green Polyimide	B,D
TTL-132-490-10	Economy Gloss White Polyimide	B,D
TTL-132-494-10	ESD Matte White Polyimide	B,D
TTL-132-492-10	Low Profile Gloss White Polyimide	B,CR
TTL-132-700-10	Gloss White Polyester	B,D

1.500" x 0.125"
38.10 mm x 3.18 mm

TTL™ 133

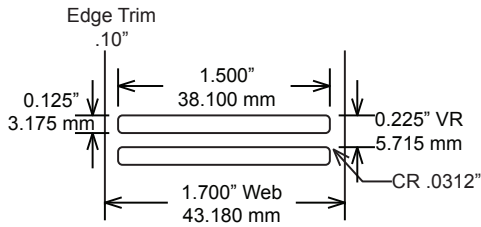

Part Number	Material Description	TTRR™
TTL-133-433-10	Hi-Performance Gloss White Polyimide	CR
TTL-133-403-10	Gloss White Polyimide	B,D
TTL-133-403GR-10	Gloss Green Polyimide	B,D
TTL-133-490-10	Economy Gloss White Polyimide	B,D
TTL-133-494-10	ESD Matte White Polyimide	B,D
TTL-133-492-10	Low Profile Gloss White Polyimide	B,CR
TTL-133-700-10	Gloss White Polyester	B,D

1.250" x 0.250"
31.75 mm x 6.35 mm

TTL™ 134

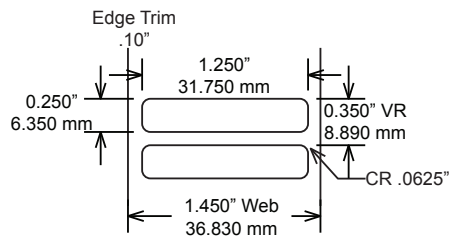

Part Number	Material Description	TTRR™
TTL-134-433-10	Hi-Performance Gloss White Polyimide	CR
TTL-134-403-10	Gloss White Polyimide	B,D
TTL-134-403GR-10	Gloss Green Polyimide	B,D
TTL-134-490-10	Economy Gloss White Polyimide	B,D
TTL-134-494-10	ESD Matte White Polyimide	B,D
TTL-134-492-10	Low Profile Gloss White Polyimide	B,CR
TTL-134-700-10	Gloss White Polyester	B,D

1.000" x 0.250"
25.40 mm x 6.35 mm

TTL™ 135

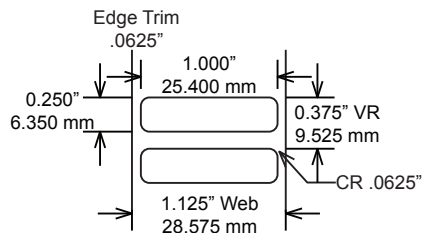

Part Number	Material Description	TTRR™
TTL-135-433-10	Hi-Performance Gloss White Polyimide	CR
TTL-135-403-10	Gloss White Polyimide	B,D
TTL-135-403GR-10	Gloss Green Polyimide	B,D
TTL-135-490-10	Economy Gloss White Polyimide	B,D
TTL-135-494-10	ESD Matte White Polyimide	B,D
TTL-135-492-10	Low Profile Gloss White Polyimide	B,CR
TTL-135-700-10	Gloss White Polyester	B,D

0.650" x 0.200"
16.51 mm x 5.08 mm

TTL™ 136

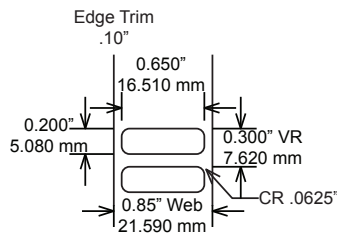

Part Number	Material Description	TTRR™
TTL-136-433-10	Hi-Performance Gloss White Polyimide	CR
TTL-136-403-10	Gloss White Polyimide	B,D
TTL-136-403GR-10	Gloss Green Polyimide	B,D
TTL-136-490-10	Economy Gloss White Polyimide	B,D
TTL-136-494-10	ESD Matte White Polyimide	B,D
TTL-136-492-10	Low Profile Gloss White Polyimide	B,CR
TTL-136-700-10	Gloss White Polyester	B,D

0.600" x 0.250"
15.24 mm x 6.35 mm

TTL™ 137

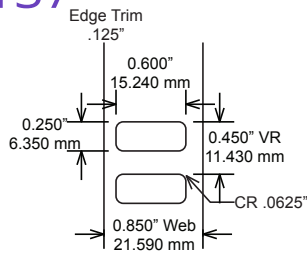

Part Number	Material Description	TTRR™
TTL-137-433-10	Hi-Performance Gloss White Polyimide	CR
TTL-137-403-10	Gloss White Polyimide	B,D
TTL-137-403GR-10	Gloss Green Polyimide	B,D
TTL-137-490-10	Economy Gloss White Polyimide	B,D
TTL-137-494-10	ESD Matte White Polyimide	B,D
TTL-137-492-10	Low Profile Gloss White Polyimide	B,CR
TTL-137-700-10	Gloss White Polyester	B,D

1.100" x 0.380"
27.94 mm x 9.65 mm

TTL™ 138

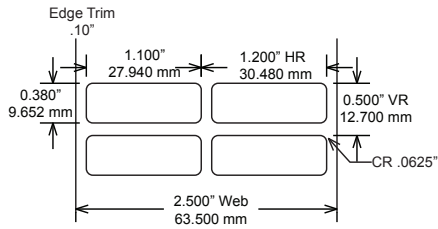

Part Number	Material Description	TTRR™
TTL-138-433-10	Hi-Performance Gloss White Polyimide	CR
TTL-138-403-10	Gloss White Polyimide	B,D
TTL-138-403GR-10	Gloss Green Polyimide	B,D
TTL-138-490-10	Economy Gloss White Polyimide	B,D
TTL-138-494-10	ESD Matte White Polyimide	B,D
TTL-138-492-10	Low Profile Gloss White Polyimide	B,CR
TTL-138-700-10	Gloss White Polyester	B,D

0.300" x 0.200"
7.62 mm x 5.08 mm

TTL™ 139

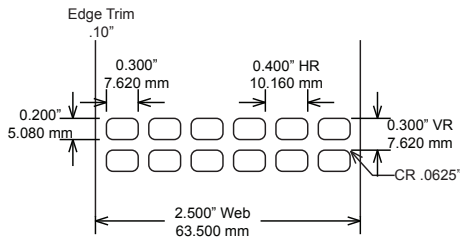

Part Number	Material Description	TTRR™
TTL-139-433-10	Hi-Performance Gloss White Polyimide	CR
TTL-139-403-10	Gloss White Polyimide	B,D
TTL-139-403GR-10	Gloss Green Polyimide	B,D
TTL-139-490-10	Economy Gloss White Polyimide	B,D
TTL-139-494-10	ESD Matte White Polyimide	B,D
TTL-139-492-10	Low Profile Gloss White Polyimide	B,CR
TTL-139-700-10	Gloss White Polyester	B,D

0.170" x 0.130"
4.32 mm x 3.30 mm

TTL™ 140

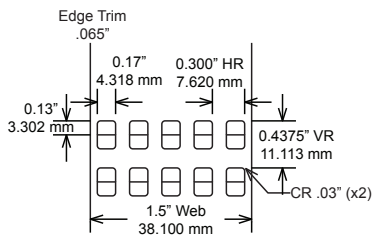

Part Number	Material Description	TTRR™
TTL-140-433-10	Hi-Performance Gloss White Polyimide	CR
TTL-140-403-10	Gloss White Polyimide	B,D
TTL-140-403GR-10	Gloss Green Polyimide	B,D
TTL-140-490-10	Economy Gloss White Polyimide	B,D
TTL-140-494-10	ESD Matte White Polyimide	B,D
TTL-140-492-10	Low Profile Gloss White Polyimide	B,CR
TTL-140-700-10	Gloss White Polyester	B,D

0.750" x 0.250"
19.05 mm x 6.35 mm

TTL™ 141

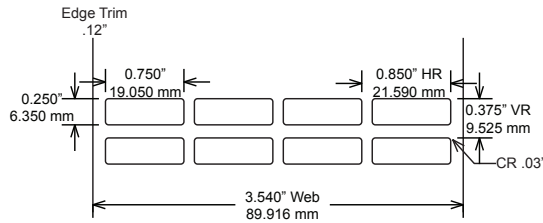

Part Number	Material Description	TTRR™
TTL-141-433-10	Hi-Performance Gloss White Polyimide	CR
TTL-141-403-10	Gloss White Polyimide	B,D
TTL-141-403GR-10	Gloss Green Polyimide	B,D
TTL-141-490-10	Economy Gloss White Polyimide	B,D
TTL-141-494-10	ESD Matte White Polyimide	B,D
TTL-141-492-10	Low Profile Gloss White Polyimide	B,CR
TTL-141-700-10	Gloss White Polyester	B,D

1.000" x 1.000"
25.40 mm x 25.40 mm

TTL™ 144

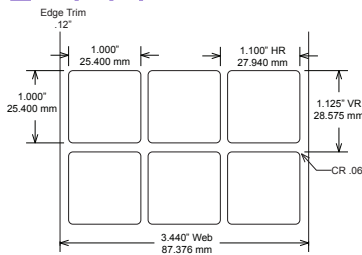

Part Number	Material Description	TTRR™
TTL-144-433-10	Hi-Performance Gloss White Polyimide	CR
TTL-144-403-10	Gloss White Polyimide	B,D
TTL-144-403GR-10	Gloss Green Polyimide	B,D
TTL-144-490-10	Economy Gloss White Polyimide	B,D
TTL-144-494-10	ESD Matte White Polyimide	B,D
TTL-144-492-10	Low Profile Gloss White Polyimide	B,CR
TTL-144-700-10	Gloss White Polyester	B,D

0.449" x 0.157"
11.41 mm x 3.98 mm

TTL™ 145

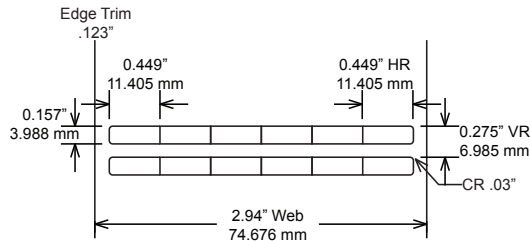

Part Number	Material Description	TTRR™
TTL-145-433-10	Hi-Performance Gloss White Polyimide	CR
TTL-145-403-10	Gloss White Polyimide	B,D
TTL-145-403GR-10	Gloss Green Polyimide	B,D
TTL-145-490-10	Economy Gloss White Polyimide	B,D
TTL-145-494-10	ESD Matte White Polyimide	B,D
TTL-145-492-10	Low Profile Gloss White Polyimide	B,CR
TTL-145-700-10	Gloss White Polyester	B,D

0.315" x 0.315"
8.00 mm x 8.00 mm

TTL™ 146

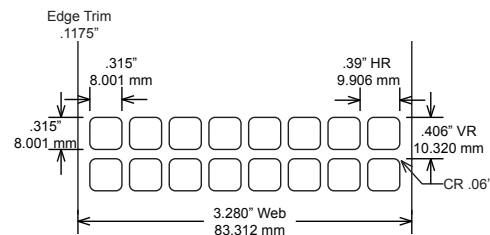

Part Number	Material Description	TTRR™
TTL-146-433-10	Hi-Performance Gloss White Polyimide	CR
TTL-146-403-10	Gloss White Polyimide	B,D
TTL-146-403GR-10	Gloss Green Polyimide	B,D
TTL-146-490-10	Economy Gloss White Polyimide	B,D
TTL-146-494-10	ESD Matte White Polyimide	B,D
TTL-146-492-10	Low Profile Gloss White Polyimide	B,CR
TTL-146-700-10	Gloss White Polyester	B,D

1.000" x 0.500"
25.40 mm x 12.70 mm

TTL™ 147

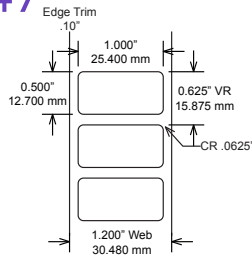

Part Number	Material Description	TTRR™
TTL-147-433-10	Hi-Performance Gloss White Polyimide	CR
TTL-147-403-10	Gloss White Polyimide	B,D
TTL-147-403GR-10	Gloss Green Polyimide	B,D
TTL-147-490-10	Economy Gloss White Polyimide	B,D
TTL-147-494-10	ESD Matte White Polyimide	B,D
TTL-147-492-10	Low Profile Gloss White Polyimide	B,CR
TTL-147-700-10	Gloss White Polyester	B,D

0.250" x 0.250"
6.35 mm x 6.35 mm

TTL™ 148

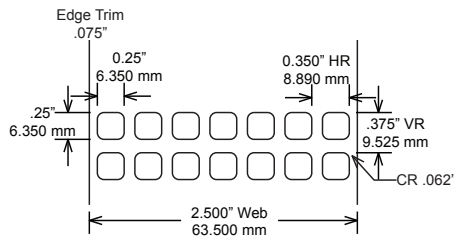

Part Number	Material Description	TTRR™
TTL-148-433-10	Hi-Performance Gloss White Polyimide	CR
TTL-148-403-10	Gloss White Polyimide	B,D
TTL-148-403GR-10	Gloss Green Polyimide	B,D
TTL-148-490-10	Economy Gloss White Polyimide	B,D
TTL-148-494-10	ESD Matte White Polyimide	B,D
TTL-148-492-10	Low Profile Gloss White Polyimide	B,CR
TTL-148-700-10	Gloss White Polyester	B,D

1.250" x 0.375"
31.75 mm x 9.53 mm

TTL™ 149

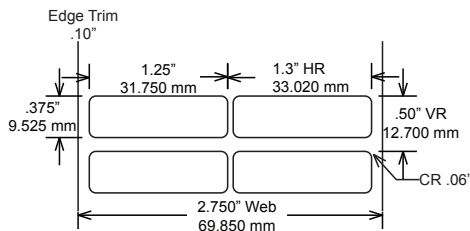

Part Number	Material Description	TTRR™
TTL-149-433-10	Hi-Performance Gloss White Polyimide	CR
TTL-149-403-10	Gloss White Polyimide	B,D
TTL-149-403GR-10	Gloss Green Polyimide	B,D
TTL-149-490-10	Economy Gloss White Polyimide	B,D
TTL-149-494-10	ESD Matte White Polyimide	B,D
TTL-149-492-10	Low Profile Gloss White Polyimide	B,CR
TTL-149-700-10	Gloss White Polyester	B,D

your #1 resource for...
Thermal Transfer
Ribbons



Pages 30-31

WIRE & CABLE IDENTIFICATION LABELS

TTL™ 200 SERIES

HIGHLIGHTS

- Excellent product conformity
- Unique “site-hole” technology
- **UL approved***

FEATURES

- Thermal transfer printable
- Self-laminating vinyl film
- Custom sizes, colors, and formats

Designed for cable and wire identification, the TTL™ 200 Series also works on other surfaces requiring conformability. IDENTCO unique “site-hole” technology allows virtually any thermal transfer printer to print clear self-laminating labels accurately with minimal waste.

IDENTCO wire and cable labels have been thoroughly tested and qualified to match the TTRR™-A ribbon.

Combining the wire and cable labels with the TTRR™-A ribbon promises optimal print quality, **UL recognition** and lifelong product labels.

***UL recognition is contingent upon printing with the appropriate IDENTCO material and TTRR™ ribbon combination as specified by Underwriters Laboratories testing.**

Refer to pages 19–22 for charts and specifications

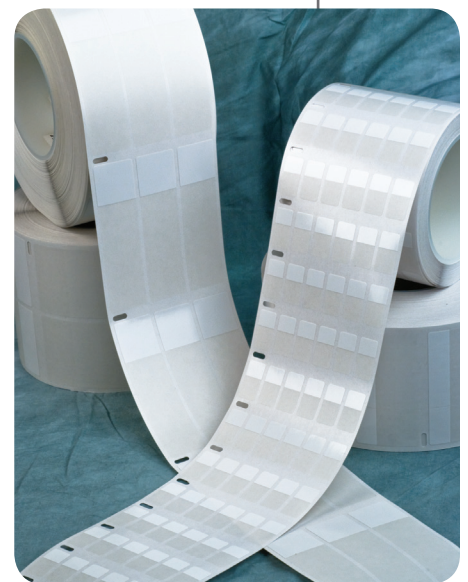

TTL™ 200 SERIES

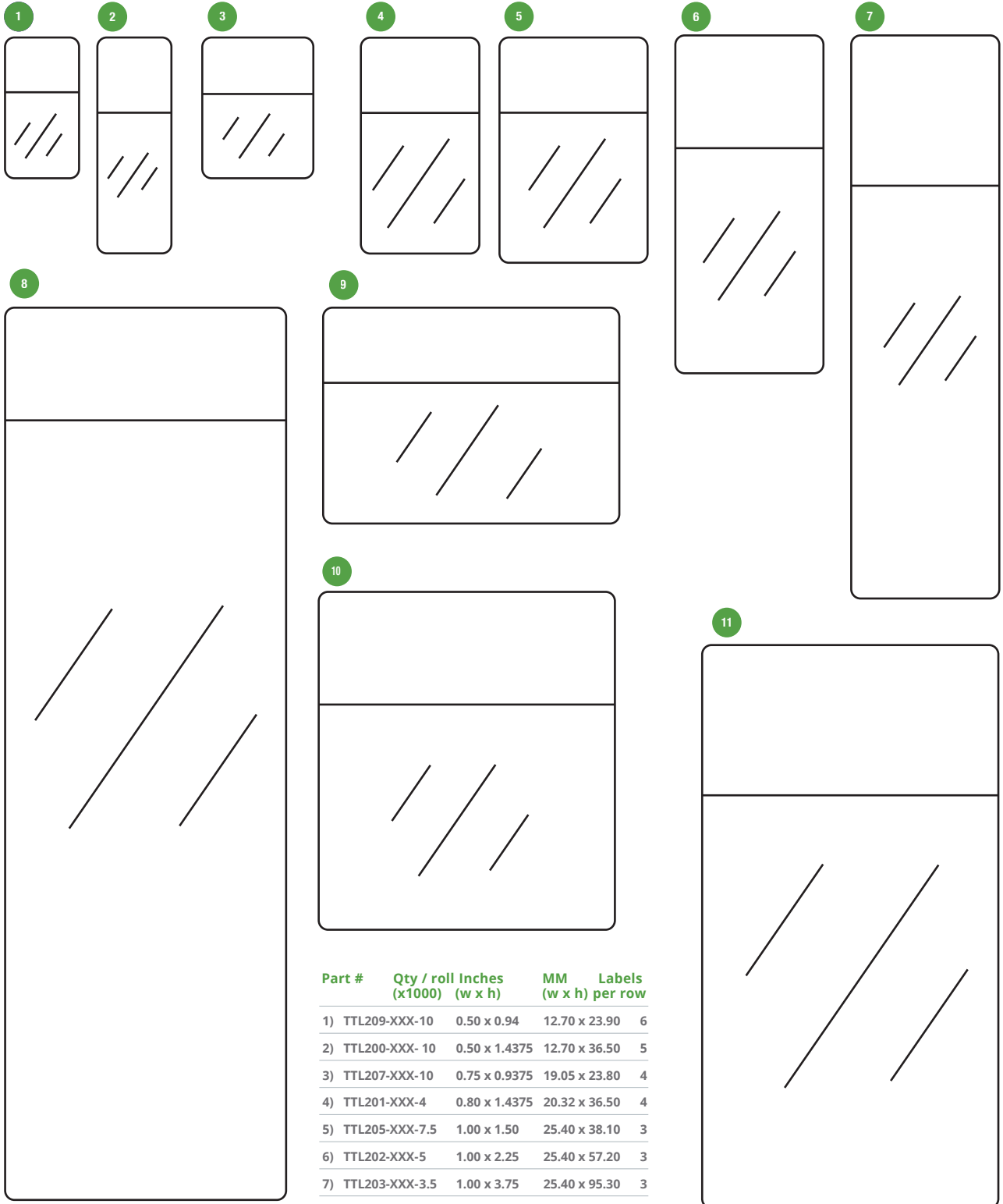

Part #	Qty / roll (x1000)	Inches (w x h)	MM (w x h)	Labels per row
1) TTL209-XXX-10		0.50 x 0.94	12.70 x 23.90	6
2) TTL200-XXX-10		0.50 x 1.4375	12.70 x 36.50	5
3) TTL207-XXX-10		0.75 x 0.9375	19.05 x 23.80	4
4) TTL201-XXX-4		0.80 x 1.4375	20.32 x 36.50	4
5) TTL205-XXX-7.5		1.00 x 1.50	25.40 x 38.10	3
6) TTL202-XXX-5		1.00 x 2.25	25.40 x 57.20	3
7) TTL203-XXX-3.5		1.00 x 3.75	25.40 x 95.30	3
8) TTL208-XXX-1		1.90 x 5.94	48.26 x 151.00	2
9) TTL210-XXX-2.5		2.00 x 1.4375	50.80 x 36.50	2
10) TTL204-XXX-1		2.00 x 2.25	50.80 x 57.20	1
11) TTL206-XXX-1		2.00 x 3.75	50.80 x 95.30	1

Labels shown actual size

0.500" x 1.438"
12.70 mm x 36.51 mm

Part Number **Material Description** **TTRR™**

TTL™ 200

TTL200-727-10 Self-Laminating Vinyl with White Thermal Transfer Printable Area A

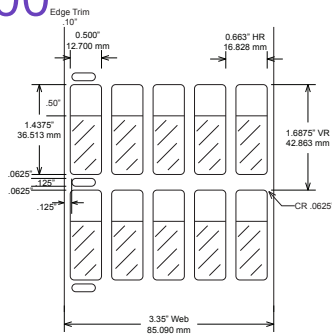

0.800" x 1.438"
20.32 mm x 36.51 mm

Part Number **Material Description** **TTRR™**

TTL™ 201

TTL201-727-10 Self-Laminating Vinyl with White Thermal Transfer Printable Area A

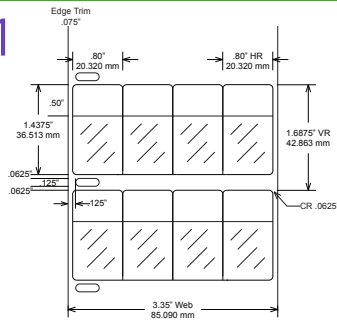

1.000" x 2.250"
25.40 mm x 57.15 mm

Part Number **Material Description** **TTRR™**

TTL™ 202

TTL202-727-5 Self-Laminating Vinyl with White Thermal Transfer Printable Area A

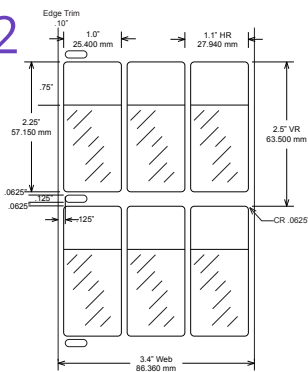

1.000" x 3.750"
25.40 mm x 95.25 mm

Part Number **Material Description** **TTRR™**

TTL™ 203

TTL203-727-3.5 Self-Laminating Vinyl with White Thermal Transfer Printable Area A

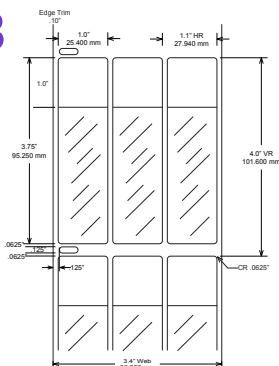

2.000" x 2.250"
50.80 mm x 57.15 mm

TTL™ 204

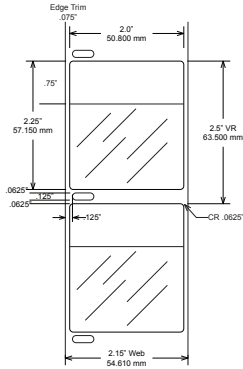

Part Number **Material Description** **TTRR™**

TTL204-727-1 Self-Laminating Vinyl with White Thermal Transfer Printable Area A

1.000" x 1.500"
25.40 mm x 38.10 mm

TTL™ 205

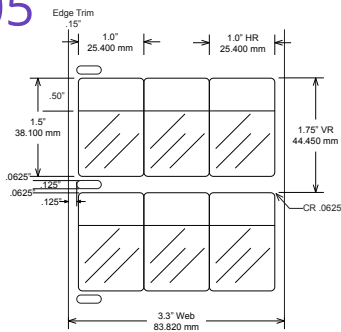

Part Number **Material Description** **TTRR™**

TTL205-727-7.5 Self-Laminating Vinyl with White Thermal Transfer Printable Area A

2.000" x 3.750"
50.80 mm x 95.25 mm

TTL™ 206

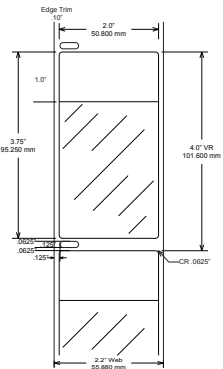

Part Number **Material Description** **TTRR™**

TTL206-727-1 Self-Laminating Vinyl with White Thermal Transfer Printable Area A

0.750" x 0.938"
19.05 mm x 23.81 mm

TTL™ 207

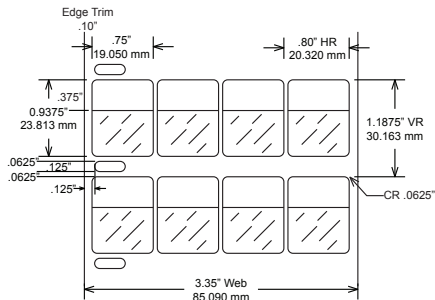

Part Number **Material Description** **TTRR™**

TTL207-727-10 Self-Laminating Vinyl with White Thermal Transfer Printable Area A

1.900" x 5.940"
48.26 mm x 150.88 mm

TTL™ 208

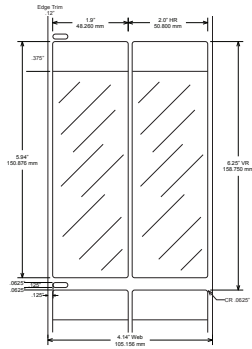

Part Number **Material Description** **TTRR™**

TTL208-727-1 Self-Laminating Vinyl with White Thermal Transfer Printable Area A

0.500" x 0.940"
12.70 mm x 23.88 mm

TTL™ 209

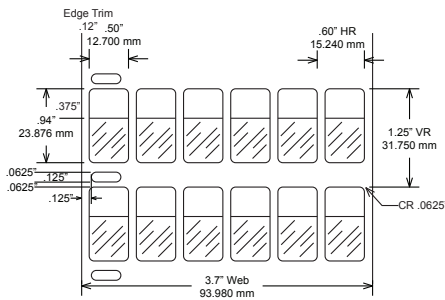

Part Number **Material Description** **TTRR™**

TTL209-727-10 Self-Laminating Vinyl with White Thermal Transfer Printable Area A

2.000" x 1.438"
50.80 mm x 36.51 mm

TTL™ 210

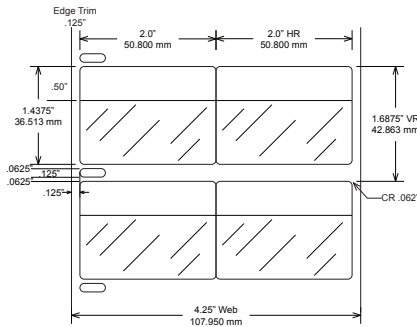

Part Number **Material Description** **TTRR™**

TTL210-727-2.5 Self-Laminating Vinyl with White Thermal Transfer Printable Area A

PACKAGING & SHIPPING LABELS

TTL™ 1-14 SERIES

IDENTCO TTL™ 1-14 series offers a wide variety of stock label options to fit your paper packaging needs. No need for a custom solution when you can choose a cost effective label from our selection.

TTL™ 1-14 series products work with the TTR™ series wax ribbons.



Part Number	Perf.	Inches Width x Height	Millimeters Width x Height	Labels/Row	Qty/Roll	Case Qty
TTL™ 2P-1	•	2.00" x 1.00"	50.80 x 25.40	1	5,500	12
TTL™ 3P	•	3.50" x 1.00"	88.90 x 25.40	1	5,500	4
TTL™ 4		3.00" x 2.00"	76.20 x 50.80	1	2,900	8
TTL™ 4P	•	3.00" x 2.00"	76.20 x 50.80	1	2,900	8
TTL™ 5		4.00" x 2.00"	101.60 x 50.80	1	2,900	4
TTL™ 5P	•	4.00" x 2.00"	101.60 x 50.80	1	2,900	4
TTL™ 7P	•	4.00" x 2.50"	101.60 x 63.50	1	2,500	4
TTL™ 8		4.00" x 3.00"	101.60 x 76.20	1	2,000	4
TTL™ 8P	•	4.00" x 3.00"	101.60 x 76.20	1	2,000	4
TTL™ 9P	•	4.00" x 4.00"	101.60 x 101.60	1	1,500	4
TTL™ 10		3.00" x 5.00"	76.20 x 127.00	1	1,200	8
TTL™ 10P	•	3.00" x 5.00"	76.20 x 127.00	1	1,200	8
TTL™ 11		4.00" x 6.00"	101.60 x 152.40	1	1,000	4
TTL™ 11P	•	4.00" x 6.00"	101.60 x 152.40	1	1,000	4
TTL™ 12P	•	4.00" x 6.50"	101.60 x 165.10	1	900	4
TTL™ 13		3.00" x 1.00"	76.20 x 25.40	1	5,500	8
TTL™ 13P	•	3.00" x 1.00"	76.20 x 25.40	1	5,500	8
TTL™ 14P	•	4.00" x 1.00"	101.60 x 25.40	1	5,500	4

UL/CSA NAMEPLATE LABELS

TTL™ 300 SERIES

HIGHLIGHTS

- Economical nameplates, rating plates, serialized barcode, and instructional labels
- Lifelong product identification
- **UL/CSA approved***

FEATURES

- Thermal transfer printable
- 10 stock sizes

TTL™ 300 series labels are cost-effective **UL/CSA recognized products** for nameplates, rating plates, serialized barcode, and instructional labels used on smooth surfaces. Contact an IDENTCO Application Engineer for recommendations on alternative materials for powder coated surfaces.

To achieve optimal print quality and **UL/CSA recognition**, IDENTCO TTL™ 300 series labels have been thoroughly tested and qualified to match a TTRR™ series ribbon.

***UL/CSA recognitions are contingent upon printing with the appropriate IDENTCO material and TTRR™ ribbon combination specified by the testing at Underwriters Laboratories and Canadian Standards Association.**

IN-STOCK MATERIALS INCLUDE:

- Gloss white polyester
- Matte white polyester
- Gloss silver polyester
- Matte silver polyester

Refer to pages 25–28 for charts and specifications

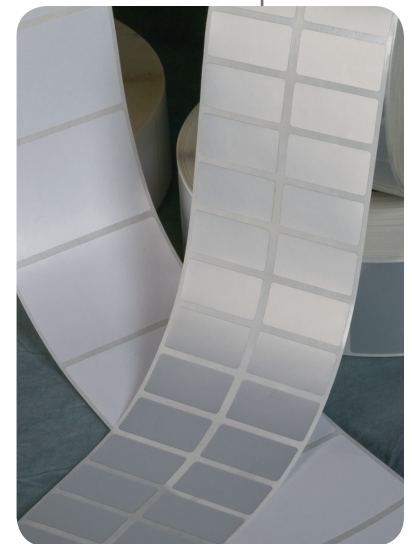

TTL™ 300 SERIES

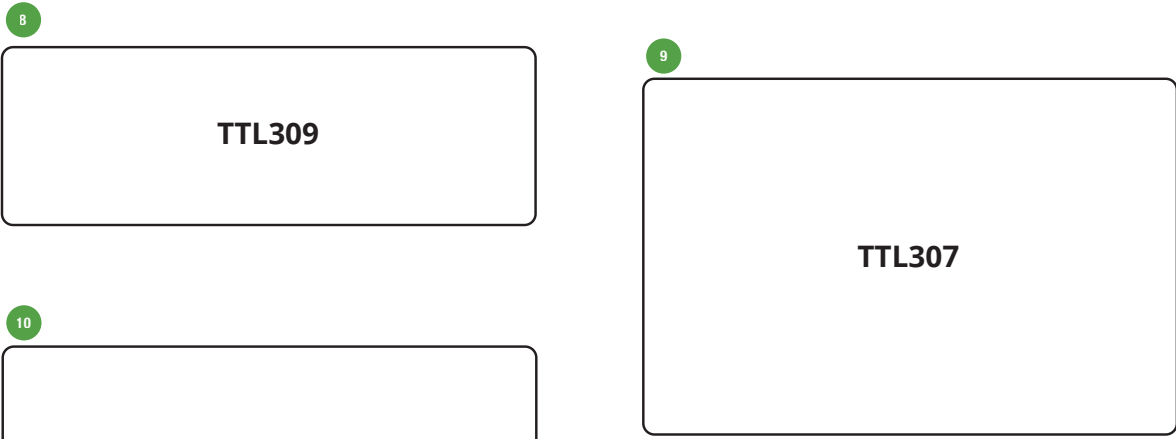
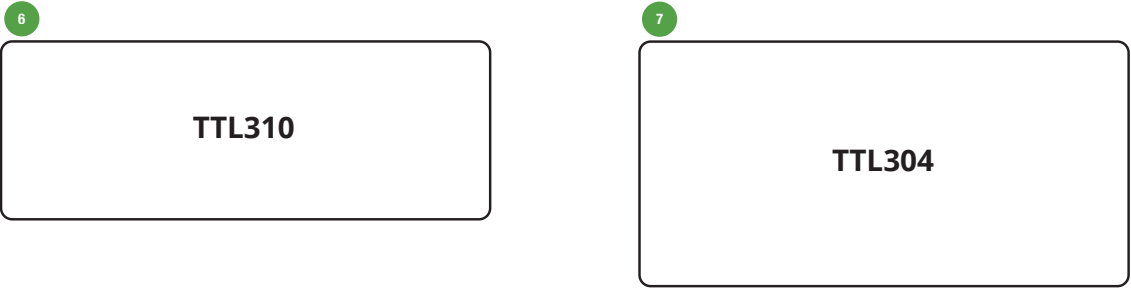
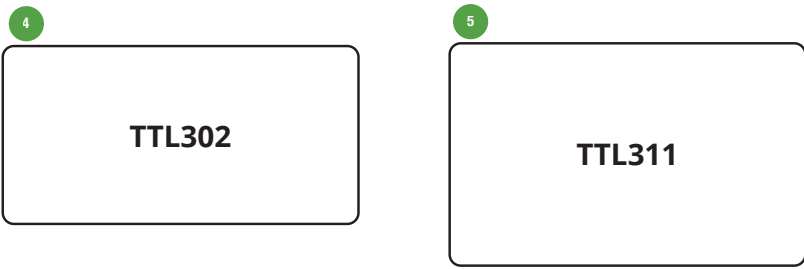

Part #	Qty/roll (x1000)	Inches (w x h)	MM (w x h)	Labels/ row
1) TTL300-XXX-	12	1.25 x 1.00	31.75 x 25.40	2
2) TTL308-XXX-	10	1.50 x 0.75	38.10 x 19.10	2
3) TTL301-XXX-	6	1.50 x 1.00	38.10 x 25.40	1
4) TTL302-XXX-	6	2.00 x 1.00	50.80 x 31.80	1
5) TTL311-XXX-	2.5	2.00 x 1.25	50.80 x 31.75	1
6) TTL310-XXX-	5	2.75 x 1.00	69.85 x 25.40	1
7) TTL304-XXX-	4	2.75 x 1.375	69.85 x 34.90	1
8) TTL309-XXX-	5	3.00 x 1.00	76.20 x 25.40	1
9) TTL307-XXX-	3	3.00 x 2.00	76.20 x 50.80	1
10) TTL312-XXX-	2.5	3.00 x 1.50	76.20 x 38.10	1

Labels shown actual size

1.250" x 1.000"
31.75 mm x 25.40 mm

TTL™ 300

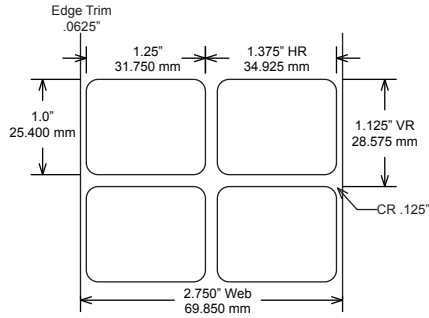

Part Number	Material Description	TTRR™
TTL300-700-12	Gloss White Polyester	B,D
TTL300-701-12	Matte White Polyester	B,D
TTL300-730-12	Gloss Silver Polyester	B,D
TTL300-740-12	Matte Silver Polyester	B,D

1.500" x 1.000"
38.10 mm x 25.40 mm

TTL™ 301

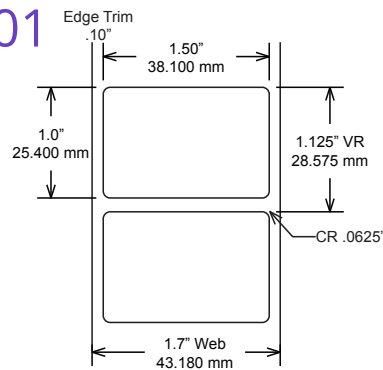

Part Number	Material Description	TTRR™
TTL301-700-6	Gloss White Polyester	B,D
TTL301-701-6	Matte White Polyester	B,D
TTL301-730-6	Gloss Silver Polyester	B,D
TTL301-740-6	Matte Silver Polyester	B,D

2.000" x 1.000"
50.80 mm x 25.40 mm

TTL™ 302

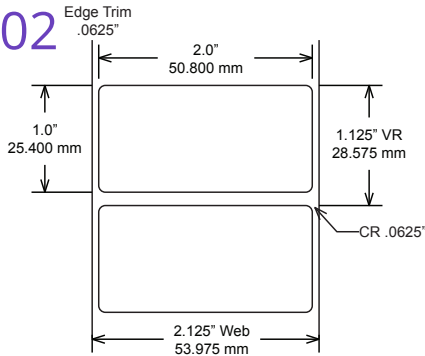

Part Number	Material Description	TTRR™
TTL302-700-6	Gloss White Polyester	B,D
TTL302-701-6	Matte White Polyester	B,D
TTL302-730-6	Gloss Silver Polyester	B,D
TTL302-740-6	Matte Silver Polyester	B,D

2.750" x 1.375"
69.85 mm x 34.93 mm

TTL™ 304

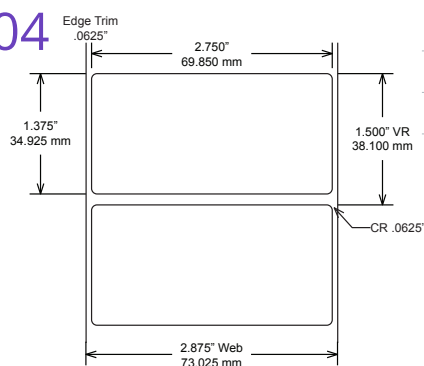

Part Number	Material Description	TTRR™
TTL304-700-4	Gloss White Polyester	B,D
TTL304-701-4	Matte White Polyester	B,D
TTL304-730-4	Gloss Silver Polyester	B,D
TTL304-740-4	Matte Silver Polyester	B,D

3.000" x 2.000"
76.20 mm x 50.80 mm

TTL™ 307

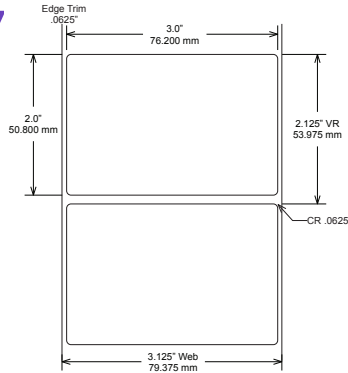

Part Number	Material Description	TTRR™
TTL307-700-3	Gloss White Polyester	B,D
TTL307-701-3	Matte White Polyester	B,D
TTL307-730-3	Gloss Silver Polyester	B,D
TTL307-740-3	Matte Silver Polyester	B,D

1.500" x 0.750"
38.10 mm x 19.05 mm

TTL™ 308

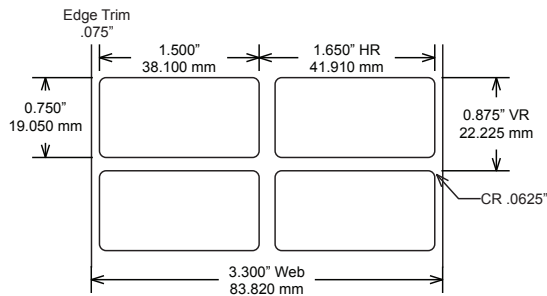

Part Number	Material Description	TTRR™
TTL308-700-10	Gloss White Polyester	B,D
TTL308-701-10	Matte White Polyester	B,D
TTL308-730-10	Gloss Silver Polyester	B,D
TTL308-740-10	Matte Silver Polyester	B,D

3.000" x 1.000"
76.20 mm x 25.40 mm

TTL™ 309

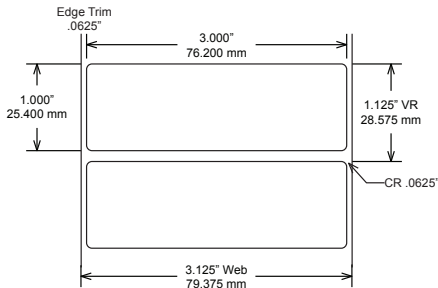

Part Number	Material Description	TTRR™
TTL309-700-5	Gloss White Polyester	B,D
TTL309-701-5	Matte White Polyester	B,D
TTL309-730-5	Gloss Silver Polyester	B,D
TTL309-740-5	Matte Silver Polyester	B,D

2.750" x 1.000"
69.85 mm x 25.40 mm

TTL™ 310

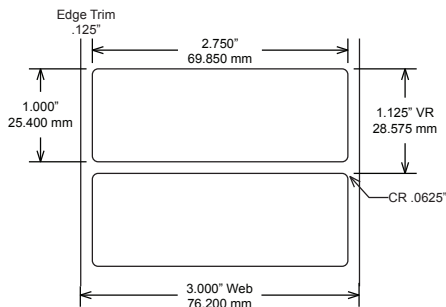

Part Number	Material Description	TTRR™
TTL310-700-5	Gloss White Polyester	B,D
TTL310-701-5	Matte White Polyester	B,D
TTL310-730-5	Gloss Silver Polyester	B,D
TTL310-740-5	Matte Silver Polyester	B,D

2.000" x 1.250"
50.80 mm x 31.75 mm

TTL™ 311

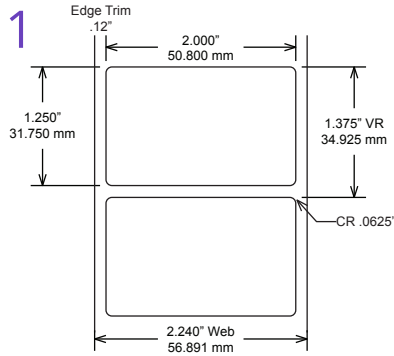

Part Number	Material Description	TTRR™
TTL311-700-2.5	Gloss White Polyester	B,D
TTL311-701-2.5	Matte White Polyester	B,D
TTL311-730-2.5	Gloss Silver Polyester	B,D
TTL311-740-2.5	Matte Silver Polyester	B,D

3.000" x 1.500"
76.20 mm x 38.10 mm

TTL™ 312

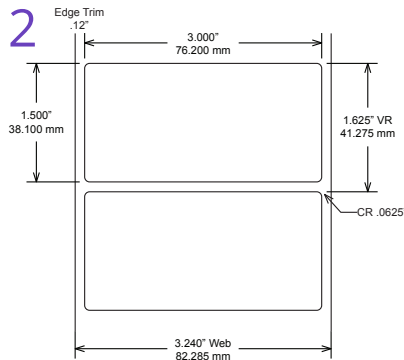

Part Number	Material Description	TTRR™
TTL312-700-2.5	Gloss White Polyester	B,D
TTL312-701-2.5	Matte White Polyester	B,D
TTL312-730-2.5	Gloss Silver Polyester	B,D
TTL312-740-2.5	Matte Silver Polyester	B,D

your **#1 resource** for...
Printers



Pages 34-35

PRINT PROTECTION

GraphicLock™ TT For Thermal Transfer Printing

METAL NAMEPLATE ALTERNATIVE

HIGHLIGHTS

- Easy — print and apply!
- Cost Savings — no costly overlaminates
- Thermal transfer printable
- Harsh environment durability

FEATURES

- Print on-demand with IDENTCO ELP-A™ Series printers:
 - Graphics/Lettering
 - Serial Numbers
- Add graphics and variable information subsurface

QUALITY ENDORSEMENTS

- **UL/CSA recognized*** label and ribbon combinations
- RoHS compliant

***UL recognition is contingent upon printing with the appropriate IDENTCO material and TTR™ ribbon combination specified by the Underwriters Laboratories testing.**



GraphicLock™

Fundamentally changes how IDENTCO prints and protects durable graphics



- Reduces the cost of subsurface printed labels without sacrificing performance
- Offers the ultimate in abrasion and chemical resistance
- Typical applications include: rating plates, branding labels, and warning and safety labels

IDENTCO GraphicLock™ using Avery Dennison TurnLock™ technology.

THERMAL TRANSFER RIBBONS

TTRR™ SERIES

HIGHLIGHTS

- Abrasion & solvent resistant
- Legend permanence
- Compatible with standard thermal transfer printers
- **UL/CSA approved***

FEATURES

- High performance resin and resin / wax
- Coated side in / side out



***The TTRR™ Series ribbon passes rigorous quality testing to meet the performance requirements of the TTL™ 100 and TTL™ 300 Series labels. These ribbons are ideal for products which require UL / CSA recognition. Recognition is contingent upon printing with the appropriate ribbon and material, and the critical bond between the two ensures lasting legend permanence.**

TTRR-D: ULTRA-DURABLE RESIN RIBBON - FILM CSO CSI

TTRR-D1.0Z	Black	1.00" x 985 ft.	25mm x 300m	•
TTRR-D1.57ZJ	Black	1.57" x 1,476 ft.	40mm x 450m	•
TTRR-D2.36ZJ	Black	2.36" x 1,476 ft.	60mm x 450m	•
TTRR-D3.27ZJ	Black	3.27" x 1,476 ft.	83mm x 450m	•
TTRR-D3.54ZJ	Black	3.54" x 1,476 ft.	90mm x 450m	•
TTRR-D4.33ZJ	Black	4.33" x 1,476 ft.	110mm x 450m	•
TTRR-D1.5F	Black	1.50" x 1,181 ft.	38mm x 360m	•
TTRR-D2.0F	Black	2.00" x 1,181 ft.	51mm x 360m	•
TTRR-D3.0F	Black	3.00" x 1,181 ft.	76mm x 360m	•
TTRR-D3.5F	Black	3.50" x 1,181 ft.	89mm x 360m	•
TTRR-D4.25F	Black	4.25" x 1,181 ft.	108mm x 360m	•

TTRR-D (COLORS): ULTRA-DURABLE RESIN RIBBON - FILM CSO CSI

TTRR-D3.54RDZ	Red	3.54" x 985 ft.	89mm x 300m	•
TTRR-D3.54BLZ	Blue	3.54" x 985 ft.	89mm x 300m	•
TTRR-D3.54GRZ	Green	3.54" x 985 ft.	89mm x 300m	•

TTRR-B: HIGH PERFORMANCE RESIN RIBBONS - FILM CSO CSI

TTRR-B1.0Z	Black	1.00" x 985 ft.	25mm x 300m	•
TTRR-B1.57ZJ	Black	1.57" x 1,476 ft.	40mm x 450m	•
TTRR-B2.52ZJ	Black	2.52" x 1,476 ft.	64mm x 450m	•
TTRR-B3.15ZJ	Black	3.15" x 1,476 ft.	80mm x 450m	•
TTRR-B3.50ZJ	Black	3.50" x 1,476 ft.	89mm x 450m	•
TTRR-B4.33Z	Black	4.33" x 985 ft.	110mm x 300m	•
TTRR-B4.33ZJ	Black	4.33" x 1,476 ft.	110mm x 450m	•
TTRR-B2.09F	Black	2.06" x 1,182 ft.	52mm x 360m	•
TTRR-B2.99F	Black	2.99" x 1,182 ft.	76mm x 360m	•
TTRR-B3.15F	Black	3.15" x 1,182 ft.	80mm x 360m	•
TTRR-B3.54F	Black	3.54" x 1,182 ft.	90mm x 360m	•
TTRR-B4.33F	Black	4.33" x 1,182 ft.	110mm x 360m	•



THERMAL TRANSFER RIBBONS



TTR™ SERIES

HIGHLIGHTS

- Legend permanence
- Compatible with standard thermal transfer printers

FEATURES

- General purpose wax
- Coated side in / side out

IDENTCO TTR™ Series thermal transfer ribbons are ideal for general purpose applications, including packaging and shipping labels. IDENTCO offers a complete line of thermal transfer ribbons. Please contact an IDENTCO Application Engineer for recommendations on the selection of the appropriate ribbons.

TTR™ SERIES: GENERAL PURPOSE WAX RIBBONS

Part Number	Color	Width	Length	Width	Length	CSO	CSI
TTR-1.57ZJ	Black	1.57" x	1,476 ft.	40mm x	450m	•	
TTR-2.36ZJ	Black	2.36" x	1,476 ft.	60mm x	450m	•	
TTR-3.15Z	Black	3.15" x	985 ft.	80mm x	300m	•	
TTR-3.26ZJ	Black	3.26" x	1,476 ft.	83mm x	450m	•	
TTR-3.5F	Black	3.50" x	985 ft.	89mm x	300m		•
TTR-3.54ZJ	Black	3.50" x	1,476 ft.	89mm x	450m	•	
TTR-3.75Z	Black	3.75" x	985 ft.	95mm x	300m	•	
TTR-4.0F	Black	4.00" x	1,182 ft.	102mm x	360m		•
TTR-4.25F	Black	4.25" x	1,182 ft.	108mm x	360m		•
TTR-4.33Z	Black	4.33" x	985 ft.	110mm x	300m	•	
TTR-4.33ZJ	Black	4.33" x	1,476 ft.	110mm x	450m	•	
TTR-4.5F	Black	4.50" x	1,182 ft.	114mm x	360m		•
TTR-5.12ZJ	Black	5.12" x	1,476 ft.	130mm x	450m	•	
TTR-6.0ZJ	Black	6.00" x	1,476 ft.	152mm x	450m	•	
TTR-6.5Z	Black	6.50" x	985 ft.	165mm x	300m	•	



PRINT SERVICE BUREAU

VARIABLE PRINTING ALTERNATIVE

HIGHLIGHTS

- Eliminate the hassle of in-house printing
- Meet specific label needs, quality & efficiently
- Reduce in-house labor costs
- Reduce inventory costs and potential waste
- Quality is ASSURED
- Select from a wide range of stock labels for fast turnaround
- On Time Delivery – Have labels when and where you need them
- Guaranteed integrity of database

IDENTCO Print Service Bureaus are a cost effective, no hassle alternative to variable printing and barcoding of labels in-house. This service is ideally designed for sequential barcoding, whether your need is for linear or 2D barcodes.

For quick and easy fulfillment we can print your information on any of the stock label offerings in this catalog. For specific needs we can provide custom labels in any size or shape with a full array of label material choices.



CUSTOM BLANK LABELS

SPECIAL SHAPES, SIZES & DIE-CUTS

HIGHLIGHTS

- A limitless array of sizes and shapes
- Engineered for your specific application
- **UL/CSA approved***

FEATURES

- Precision die-cutting
- Thermal transfer printable

If your application cannot be addressed with one of our stock products, IDENTCO will custom manufacture a solution for you. Our project engineers will work with you to choose the exact components and processes to ensure your product will perform consistently.

IDENTCO can choose from over **500 material adhesive combinations** and over **10,000 in-house dies** to meet your needs and specifications. If custom tooling is required, IDENTCO will deliver a **cost saving quote in 30 minutes and your custom labels ready in under 72 hours**.

***UL recognition is contingent upon printing with the appropriate IDENTCO material and TTRR™ ribbon combination as specified by Underwriters Laboratories testing.**

IDENTCO has earned a reputation for being **FAST, RESPONSIVE and EASY** to work with. No matter what difficulties or challenges your company is facing, IDENTCO is an agile partner you can rely on to provide innovative solutions on time and on budget.

MATERIALS INCLUDE:

- Papers
- Polyolefins
- Polypropylenes
- Vinyls
- Polyesters
- Polyimides
- Synthetics



THERMAL TRANSFER PRINTERS

ELP-D™ & ELP-I™ SERIES

- Desktop Printer: ELP-D™
- Industrial Printer: ELP-I™

HIGHLIGHTS

- Extremely cost-effective printers
- Quickly integrates with production lines
- Readily accepts a broad array of labels and ribbons

ELP-D™

Quality thermal printing for any budget. An affordable and easy-to-use desktop printer for a wide variety of basic, lower-volume labeling applications, including wire-marking products.

ELP-I™

Perfect for economical, high-performance printing. Rugged and reliable for printing a wide variety of durable label formats in high-volume, demanding applications. A universal printer capable of multiple connectivity and label printing and presenting options making it an easy fit in any industrial operation.

Check us out on YouTube:

www.youtube.com/user/IDENTCOCorp



THERMAL TRANSFER PRINTERS

ELP-D™ & ELP-I™ SERIES

FEATURES

- Dpi conversion capability
- Multiple label presentation modes
- Multi connectivity (USB, Ethernet & Wireless, Serial)
- Stand-alone mode printing
- Micro-miniature printing
- ZPL emulation
- On-site service plans*
- 2 year warranty (Printhead and Parts)
- 5 Year extended warranty*
- Tech Support programs
- Unlimited phone support*

* Please call (800) 533-2559 and ask to speak to one of our Printer Application Engineers



SPECIFICATIONS

	ELP-D™	ELP-I™
Print method	Thermal Transfer & Direct Thermal	
Print resolution dpi	300	600
Print speed up to mm/s	127	250
Print width mm	106	106
Media roll total up to mm	127	205
Label width mm	20 -112	4 -112

IDENTCO presents the ELP™ series of thermal transfer printers. Faster ELP™ printers allow users to load, print, and change materials more efficiently. The ability to operate with a computer or network or in stand alone mode offers flexible printer operation.



PRINT & APPLY APPLICATOR

ELP-A™ SERIES

Labels not only need to be printed, but also applied. Manually applying labels at high rates is very challenging and often results in inconsistent placement and poor adhesion performance. IDENTCO's ELP-A™ print and apply applicator is a cost effective solution that ensures consistent accuracy and adhesion performance at high rates. The applicator is designed to handle a broad range of sizes and shapes.

FEATURES

- Precise application tolerances of +/- .2mm (.007")
- Print and apply labels as small as 4mm x 4mm
- Large graphic display
- Application can be bottom to top, top to bottom or from either side
- Easily integrated into production lines or work cells
- Product can be presented to the applicator by hand or by automation
- Die-cast aluminum chassis provides a solid framework
- Ball-bearing transport rollers ensure highly accurate feeding of labels
- Easy to change printhead without adjustments or setups
- Host connection or stand alone operation

Speak to one of our Labeling Systems Engineers to discover more about the many ways IDENTCO can improve your quality and increase productivity.



SPECIFICATIONS

ELP-A™

Print method	Thermal Transfer & Direct Thermal
Print resolution dpi	600
Print speed up to mm/s	100
Print width mm	57.0
Media roll total diameter up to mm	205
Label width mm	4-58

PRECISION LABELS FOR AUTOMATIC APPLICATIONS

AUTO-APPLY LABELS

HIGHLIGHTS

- Available for a wide array of automation systems
- Perfect for static reduction
- **UL approved***

FEATURES

- Precision die-cutting
- Quick release film liners
 - Anti-static dissipative
 - Dust-free
- Reel-e™ spools
 - Robust design
 - Anti-static dissipative
 - RoHS compliant



As an industry leader, IDENTCO understands high speed automatic application equipment requires a precisely manufactured part for static free assembly. With over 30 years experience, IDENTCO can design and produce labels for all major automation equipment.

To eliminate damaging static build-up in the production area, IDENTCO engineered the REEL-e™.

The REEL-e™ is recyclable, 100% RoHS compliant and made of an electrostatic dissipative plastic material that aids in the elimination of static build-up. This ensures static-free delivery of labels and die-cut parts to feeders and auto-apply machines.

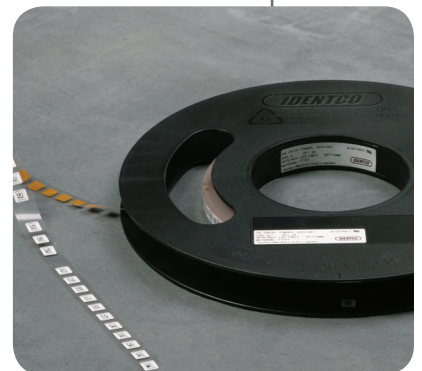

DID YOU KNOW...

* UL recognition approval is contingent upon printing your IDENTCO labels with the appropriate IDENTCO TTRR™ series thermal transfer ribbon? These combinations have been tested & approved by Underwriters Laboratories.

AUTOMATION EQUIPMENT

PRE-PRINTED LABEL PRESENTER

FEATURES

- Automatically places labels using existing pick-and-place equipment
- On machine placement similar to any other feeder
- Maximum label placement accuracy
- Flexible solutions for circuit board applications
- Saves time and money with low maintenance costs
- Optimal performance when used with IDENTCO Reel-e™ label spools and quick release liners

Earning a reputation as “the best auto-apply label supplier” in the marketplace, IDENTCO leads the industry by providing innovative automation solutions. We teamed up with Hover-Davis to offer the most flexible alternative for placing labels automatically with existing pick and place equipment.

IDENTCO helps customers optimize their investment in automation technologies by improving placement accuracy and speed of the label process. These skillfully engineered label feeders combined with the appropriate auto apply labels are designed to exceed your labeling requirements. The pre-printed label presenter places the label like any other SMT component to help streamline your labeling process.

The Hover-Davis label feeder has a modular design consisting of two basic assemblies. The first element is the Label Presenter (LP), which provides the mechanical and electrical interface to the host machine. The second element is the Label Specific Module (LMG) designed specifically to peel and present the label.

Combining IDENTCO industry expertise with a Hover-Davis custom component delivery system provides additional value to manufacturers seeking to perfect operations and data delivery control through labeling.

LPS SERIES PRESENTERS FOR:

- Assembleon
- Juki
- Universal
- Fuji
- Panasonic
- Samsung
- Siemens
- Yamaha
- MYDATA

IDENTCO is an authorized distributor for **HOVER-DAVIS**



IMS SERIES HEAT SHRINK WIRE MARKERS

VISUAL DATA MANAGEMENT FOR TOUGH ENVIRONMENTS

HIGHLIGHTS

- Military grade standards
- 3:1 shrink ratio standard (2:1 available)
- Thermal transfer printable
- Chemical and abrasion resistance
- Custom colors and sizes available

FEATURES

- Multiple shrink ratios
- Permanent identification sleeves
- Made from a flame retardant, radiation cross-linked heat shrinkable polyolefin
- Quick cool down time for heat sensitive areas
- Optimal performance when printed with the recommended IDENTCO TTR™-D ribbon and printer
- Resistant to harsh chemicals, abrasion, as well as many fuels & oils



IDENTCO MARKING SYSTEM 3:1 SHRINK RATIO

Part Number	Size in.	Size mm
IMS-2.0-.094SM-2.5W	3/32"	2.4
IMS-2.0-.125SM-2.0W	1/8"	3.2
IMS-2.0-.188SM-1.5W	3/16"	4.8
IMS-2.0-.250SM-1.5W	1/4"	6.4
IMS-2.0-.375SM-1.0W	3/8"	9.5
IMS-2.0-.500SM-0.5W	1/2"	12.7
IMS-2.0-.750SM-0.5W	3/4"	19.1
IMS-2.0-1.00SM-0.25W	1"	25.4
IMS-2.0-1.50SM-0.25W	1 1/2"	38.1



ASSUME QUALITY, EXPECT PERFECTION.

HIGHEST QUALITY GLOBAL PRODUCTION

With IDENTCO quality-control safeguards we are able to ensure consistent, accurate production globally. To achieve this, we use the same equipment, materials, inks, and procedures in all of our facilities. So no matter where we produce your labels, they look and perform the same every time.

All of our locations are able to meet the same branding, performance, and regulatory specifications. We provide excellent color-matching capabilities and accuracy, as well as a fully-equipped testing laboratory with superior quality control processes. It's just another way IDENTCO can ensure our customers consistent success.

QUALITY MANAGEMENT SYSTEMS



ISO-CERTIFIED Quality Management System

ISO 9001 - QUALITY MANAGEMENT STANDARD
TS 16949 - AUTOMOTIVE MANAGEMENT STANDARD
ISO 14001 - ENVIRONMENTAL MANAGEMENT STANDARD

AGENCY RECOGNITIONS



UL: UNDERWRITERS LABORATORIES
UL-Authorized Label Supplier Program
UL-Recognized Label and Ribbon Combinations

CSA: CANADIAN STANDARDS ASSOCIATION



IDENTCO MEXICO, MONTERREY
Carr. a Laredo Km. 16.5 Interior
14B, Col. Moisés Sáenz, 66613
Apodaca, Nuevo Leon
Phone: (81) 8008 - 0438

••• NOTES •••

A large rectangular area filled with a grid of dashed lines, intended for writing notes. The grid consists of 20 columns and 30 rows of small squares.



Labels for Life.

www.identco.com

**UNITED STATES
HEADQUARTERS**

28164 W. Concrete Drive
Ingleside, IL 60041
Phone: +1 (815) 385 - 0011
Fax +1 (815) 385 - 0359

**MEXICO
MONTERREY**

Carr. a Laredo Km. 16.5 Interior
14B, Col. Moisés Sáenz, 66613
Apodaca, Nuevo Leon
Phone: +52 (81) 8008 - 0438

**GERMANY
FRANKFURT**

Güterbahnhofstrasse 3-7
63450 Hanau
Phone: +49 (6181) 440 830 - 0
Fax: +49 (6181) 440 830 - 99

**PRC
HONG KONG**

Unit 1708, 17/F, 9 Wing Hong St.
Cheung Sha Wan, Kowloon
Phone: +852 2959 2156
Fax: +852 2959 2019

**MALAYSIA
PENANG**

Suite 163E, Level 16, Room 1602
Hunza Tower Gurney Paragon
Jalan Kelawei, Georgetown
10250 Penang
Phone: +6012 466 - 0866