

Liebert® IntelliSlot® Unity Card

User Manual—Web, SNMP, Modbus, BACnet, YDN23

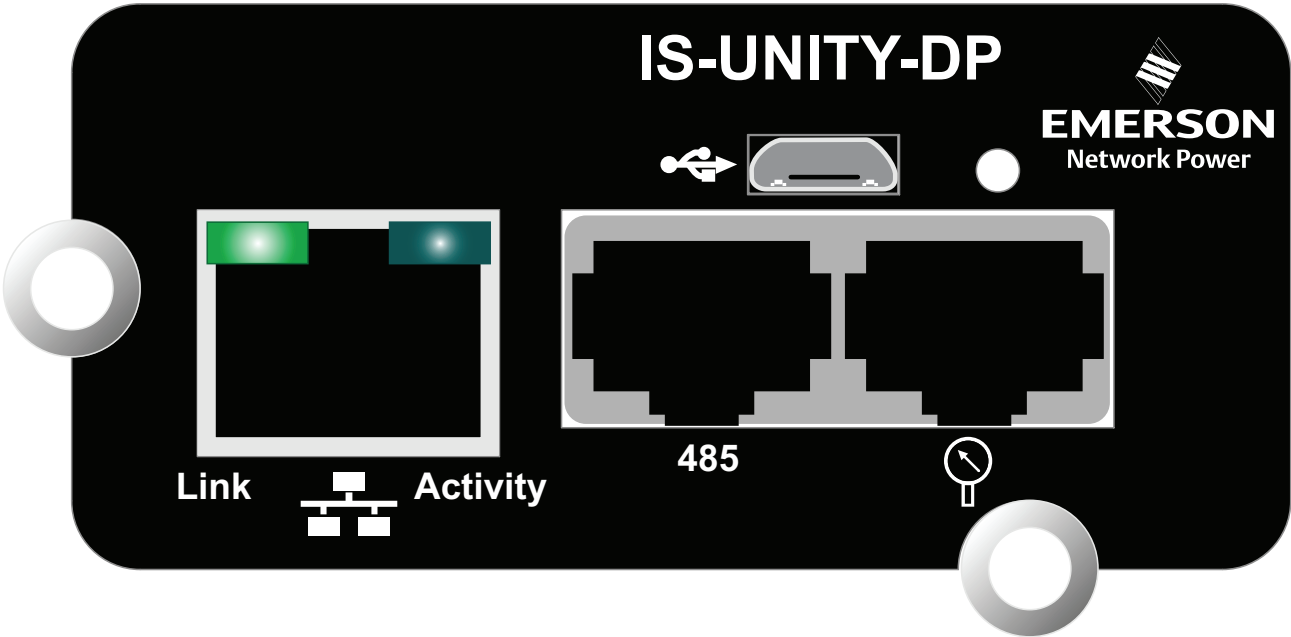

TABLE OF CONTENTS

IMPORTANT SAFETY INSTRUCTIONS	1
1.0 INTRODUCTION	2
1.1 Protocols	2
1.2 Compatibility With Other Emerson Products and Communication Protocols	3
2.0 INSTALLATION	5
2.1 Installing the Liebert IntelliSlot Unity Card	5
2.1.1 Assigning the Card's IP Address	5
2.1.2 Connect an Ethernet Cable	6
2.1.3 Connect an RS-485 Serial Cable	7
2.2 Change User Names and Passwords Immediately	7
2.3 Configure the Card	8
2.4 Installing Multiple Liebert IntelliSlot Unity Cards in a System	9
3.0 ENABLE COMMUNICATION PROTOCOLS	10
3.1 Enable Protocols	10
3.1.1 Enable Modbus Protocol	11
3.1.2 Enable BACnet Protocol	13
3.1.3 Enable SNMP	16
4.0 LIEBERT INTELLISLOT UNITY CARD WEB PAGE LAYOUT	21
4.1 Web Page Sections	21
4.2 Help Text	23
4.3 Managed Equipment Tab Menus	24
4.4 Unity Tab Menus	25
5.0 EDIT THE LIEBERT INTELLISLOT UNITY CARD CONFIGURATION	26
5.1 Web Page Unity Tab Folders	27
5.1.1 Unity Tab-Active Events Folder	27
5.2 Unity Tab-Downloads Folder	27
5.3 Unity Tab-Configuration Folder	27
5.3.1 Configuration Folder—System	28
5.3.2 Configuration Folder—User Settings	28
5.3.3 Configuration Folder—Network Settings	29
5.3.4 Configuration Folder—Web Server Settings	30
5.3.5 Configuration Folder—LIFE™	31
5.3.6 Configuration Folder—Emerson Protocol	31
5.4 Configuration Folder—Messaging Settings	31
5.4.1 Email Settings	31
5.4.2 SMS Settings	32
5.4.3 Messaging Test	33
5.5 Unity Tab—Protocols	34
5.6 Protocols Folder—BACnet Folder	34
5.6.1 Protocols Folder—BACnet IP Folder	35
5.6.2 Protocols Folder—BACnet MSTP Folder	35
5.7 Protocols Folder—Modbus	35
5.7.1 Modbus TCP	36
5.7.2 Modbus RTU	36

5.8	Protocols Folder—SNMP Subfolder	37
5.8.1	SNMPv3 User Settings	38
5.8.2	Edit the SNMPv3 Table	39
5.8.3	SNMPv1 Trap Settings	40
5.8.4	SNMPv1/v2c Access Settings	41
5.9	Protocols Folder—YDN23 Protocol	42
5.10	Configuration—Unity Tab-Status Folder	42
5.11	Configuration—Unity Tab-Support Folder	43
5.11.1	Unity Tab-Support Folder—Active Networking	44
5.11.2	Unity Tab-Support Folder—Firmware Update	45
6.0	FIRMWARE UPDATES	46
6.1	Updating the Liebert IntelliSlot Unity Card's Firmware	46
6.2	Revert to Alternate Firmware	48
APPENDIX A - CONFIGURATION FOLDER—LIFE™ SUBFOLDER		A49

FIGURES

Figure 1	Liebert IntelliSlot Unity-DP card features	2
Figure 2	Command prompt access	6
Figure 3	Change administrator and general user names and passwords	8
Figure 4	Enabling the communication protocol—IPv4 or IPv6	9
Figure 5	Enable protocols; enable commands	11
Figure 6	Modbus TCP-Trusted IP List	12
Figure 7	Modbus-RS-485	13
Figure 8	BACnet protocol settings	14
Figure 9	BACnet IP settings	15
Figure 10	BACnet MSTP settings	16
Figure 11	SNMP settings	17
Figure 12	SNMPv3 user settings	18
Figure 13	SNMPv1 trap settings	19
Figure 14	SNMPv1/v2c access settings	20
Figure 15	Web page sections, UPS example	22
Figure 16	Web page sections, Thermal Management unit example	22
Figure 17	Help text on mouse-over	23
Figure 18	Managed Equipment Tab examples, Liebert APS™ and Liebert CRV™	24
Figure 19	Editing configuration settings	26
Figure 20	Configuration folder, System subfolder	28
Figure 21	Configuration folder, System subfolder, Time Service Settings	28
Figure 22	IPv4/IPv6 settings	29
Figure 23	Edit the SNMPv3 table	39
Figure 24	Ethernet port	46
Figure 25	Firmware update screen	47

TABLES

Table 1	Compatibility with Liebert equipment	3
Table 2	Liebert IntelliSlot card communication protocols	3
Table 3	Help text and icons	23
Table 4	Unity Tab menus	25

IMPORTANT SAFETY INSTRUCTIONS

SAVE THESE INSTRUCTIONS



WARNING

Risk of improper installation. Can cause equipment damage, injury or death.

Only a qualified service professional should install these products. Emerson recommends having an Emerson Network Power® Liebert Services representative perform the installation in large UPS's. Contact Liebert Services at 1-800-LIEBERT (1-800-543-2378).



WARNING

Risk of electric shock. Can cause equipment damage, injury or death.

Service and maintenance work must be performed only by properly trained and qualified personnel and in accordance with applicable regulations and manufacturers' specifications.

Opening or removing the covers to any equipment may expose personnel to lethal voltages within the unit even when it is apparently not operating and the input wiring is disconnected from the electrical source.

Check the circuits with a voltmeter before beginning installation.

1.0 INTRODUCTION

This Liebert IntelliSlot Unity platform delivers enhanced communication and control of AC Power, Power Distribution and Thermal Management products. The platform communicates with Emerson Network Power® software tools and services, including Trellis®, LIFE™ Technology, Liebert SiteScan Web™ and Liebert Nform®.

The platform includes the Liebert IntelliSlot Unity DP™ and Liebert IntelliSlot Unity LIFE™ cards.

Each card employs the Emerson Protocol to monitor and manage a wide range of operating parameters, alarms and notifications about the power, distribution and Thermal Management equipment. The cards also communicate with Building Management Systems and Network Management Systems.

Figure 1 Liebert IntelliSlot Unity-DP card features

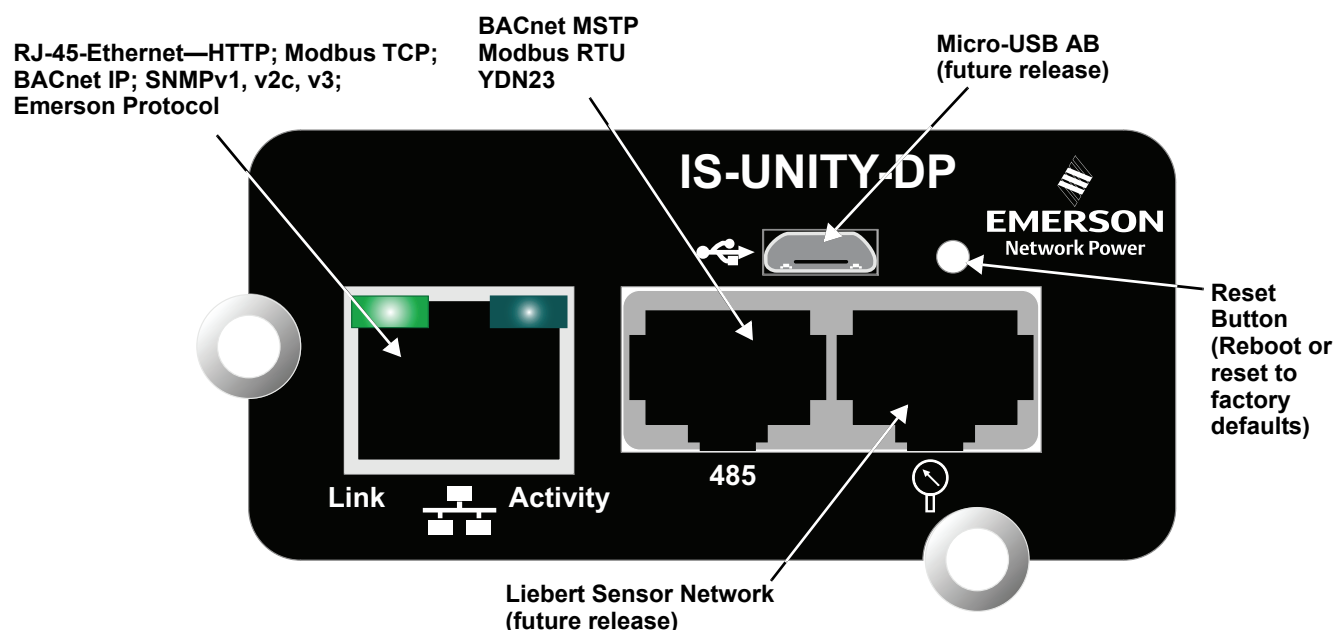

1.1 Protocols

Each card supports the Emerson Protocol, Remote Service Delivery Protocol and HTTP Web by default.

The Liebert IntelliSlot Unity DP supports selecting two third-party protocols; the Liebert IntelliSlot Unity LIFE card supports the default protocols only (Emerson Protocol, Remote Service Delivery Protocol and HTTP Web).

Available protocols are

- BACnet IP—BACnet over Internet Protocol
- BACnet MSTP—BACnet Master-Slave/Token-Passing (MSTP) communications protocol over a RS-485 serial network (also known as BACnet MSTP RS-485)
- Modbus RTU—Modbus Remote Terminal Unit (RTU) communication protocol over a RS-485 serial network (also known as Modbus RTU RS-485)
- Modbus TCP—Modbus Transmission Control Protocol over Internet Protocol (also known as Modbus TCP/IP)
- SNMP
- YDN23 - YD-T-1363 specification protocol (also known as YD/T 1363)

1.2 Compatibility With Other Emerson Products and Communication Protocols

The Liebert IntelliSlot Unity platform includes:

Table 1 Compatibility with Liebert equipment

Liebert IntelliSlot Card	Compatible with:
Liebert IS-UNITY-DP Liebert IS-UNITY-LIFE	Liebert APM TM , Liebert APS TM , Liebert CRV TM , Liebert CW TM , Liebert Challenger 3000 TM Liebert DCP TM , Liebert Deluxe System/3 TM , Liebert DS TM , Liebert DSE TM , Liebert HPC TM Liebert HPC-S/M/R/W/Generic TM , Liebert HPM TM , Liebert NXC TM , Liebert NXL TM *, Liebert NXR TM , Liebert PCW TM /PDX TM , Liebert PeX TM *, Liebert XDC TM , Liebert XDP TM , Liebert XDP-Cray TM

The Liebert IntelliSlot Unity-DP platform supports the following protocols:

Table 2 Liebert IntelliSlot card communication protocols

Liebert IntelliSlot Card (Part #)	Communication Protocols Available								
	HTTP HTTPS	Emerson Protocol	Remote Service Delivery Protocol	Email	SMS	SNMP v1, v2c, v3	BACnet IP BACnet MSTP	Modbus TCP Modbus RTU	YDN23 *
Liebert IS-UNITY-DP (IS-UNITY-DP)	✓	✓	✓	✓	✓	✓	✓	✓	✓
Liebert IS-UNITY-LIFE (IS-UNITY-LIFE)	✓	✓	✓	—	—	—	—	—	—

* YDN23 applicable only to Liebert PeX and Liebert NXL.

The Liebert IntelliSlot Unity platform supports both 10Mbit and 100Mbit communication speeds and either half or full duplex.

Password Protection

Control and configuration capabilities are protected by an administrator's username and password combination. Optionally, status information can be password-protected. The default user name for the administrator is *Liebert* and the default password is also *Liebert*.

The user name and password can be changed with the Web interface. See **2.2 - Change User Names and Passwords Immediately** for details.

SNMP Support

The Liebert IntelliSlot Unity card enables SNMP management of Liebert equipment. To integrate the card into a SNMP implementation, import or compile the Liebert Global Products MIB on the network management station (NMS).

The Liebert Global Products MIB is available at Liebert's Web site (www.liebert.com); it supports both Windows® (192436P1) and Unix (192435P1) file formats.

Web Support

The Liebert IntelliSlot Unity card delivers Web management and control to Liebert equipment over HTTP and HTTPS. All authorized users on your network will be able to view status information.

Modbus TCP and Modbus RTU Support

The Liebert IntelliSlot Unity card supports Modbus TCP and Modbus RTU for the full range of information available from the managed device. The Modbus protocol mapping document, SL-28170, is available at Liebert's Web site: www.liebert.com

BACnet IP and BACnet MSTP Support

The Liebert IntelliSlot Unity card supports BACnet IP and BACnet MSTP for the full range of information available from the managed device. The BACnet protocol mapping document, SL-28170, is available at Liebert's Web site: (www.liebert.com). This document includes the BACnet Protocol Implementation Conformance Statement (PICS) document as a guide to implementing the BACnet protocol.

YDN23 Support

The Liebert IntelliSlot Unity card supports YD/T-1363 specification for the full range of information available from managed Liebert NXL™ or Liebert PeX™ units.

Trellis™ Support

The Liebert IntelliSlot Unity-DP card communicates a rich set of Emerson Protocol information to the Trellis DCIM platform.

Trellis can manage and control Liebert equipment using SNMP, Modbus or the Emerson Protocol. This allows monitoring all Liebert equipment using Liebert IntelliSlot Web, Liebert IntelliSlot 485, Liebert IntelliSlot IPBML, Liebert IntelliSlot Web ADPT or Liebert IntelliSlot Unity platform communication interfaces.

Liebert Nform® Support

Utilizing the Emerson Protocol or SNMP and Web technologies built into each Liebert IntelliSlot Unity card, Liebert Nform will centrally manage alarm notifications to provide an easy interface to access critical equipment information.

A downloadable version is available online at: nform.liebert.com

Liebert MultiLink® Support

The Liebert IntelliSlot Unity card integrates with Liebert's MultiLink software to provide unattended, graceful operating system shutdown of PCs, servers and workstations. The card can be monitored by Liebert MultiLink over the network, eliminating the need for serial cables.

For more information on Liebert MultiLink and a downloadable version of Liebert MultiLink software, visit multilink.liebert.com

2.0 INSTALLATION



WARNING

Risk of improper installation. Can cause equipment damage, injury and death. Only a properly trained and qualified service professional should install these products. Emerson recommends having an Emerson Network Power® Liebert Services representative perform the installation in large UPS's. Contact Liebert Services at 1-800-LIEBERT (1-800-543-2378).

NOTICE

Risk of duplicate node ID's if two or more Liebert IntelliSlot cards are installed. Can cause network conflicts.

An internal networking conflict may occur within a device when multiple communication cards with duplicate Node IDs are installed in the device.

Each Liebert IntelliSlot card must have a unique node ID. This will not be a problem if only one card is installed on your system. Duplicate node ID's are easily averted with the procedure detailed in 2.4 - **Installing Multiple Liebert IntelliSlot Unity Cards in a System.**

2.1 Installing the Liebert IntelliSlot Unity Card

The Liebert IntelliSlot Unity card may be installed at the factory or field-installed. To perform a field-installation:

1. Find the Liebert IntelliSlot bay on your Liebert equipment—It may have a plastic cover.
2. Insert the card into the Liebert IntelliSlot bay.



NOTE

The card will only fit one way in the Liebert IntelliSlot bay because the circuit board is not centered on the faceplate. The slot in the Liebert IntelliSlot bay also is not centered.

3. Secure the card with the screws supplied with the cover plate.
4. Connect an Ethernet cable to the card's Ethernet RJ-45 port for IP communication interfaces.
5. Connect a serial cable to the card's 485 RJ-45 port for RS-485 communication interfaces (see 2.1.3 - **Connect an RS-485 Serial Cable.**)

2.1.1 Assigning the Card's IP Address

DHCP

The Liebert IntelliSlot Unity card is factory-configured for DHCP. If you require a Static or BootP network configuration, be sure to change the Boot Mode as described in **Static IP on page 6**. Connect an RJ-45 cable to the card and it will receive an IP address from the DHCP server. Contact the DHCP administrator to obtain the IP address using the Liebert IntelliSlot Unity card's MAC address. The MAC address is printed on the card's faceplate.

If the DHCP administrator is not available or there is no way of determining the IP address assigned by the DHCP server, use a computer with a direct Ethernet connection to the Liebert IntelliSlot Unity card, and the Autoconfiguration IPv4 Address convention described in 2.1.2 - **Connect an Ethernet Cable** to access the card's Web page and configure the card. To see the card's last DHCP-assigned IP address, click on the Unity Tab, then on the left side menu select **Support > Active Networking**. The table of information will show the last IP address assigned by the DHCP server. The card may retain that IP address when it reconnects to the DHCP network because most DHCP systems reuse the same IP address for the same device.

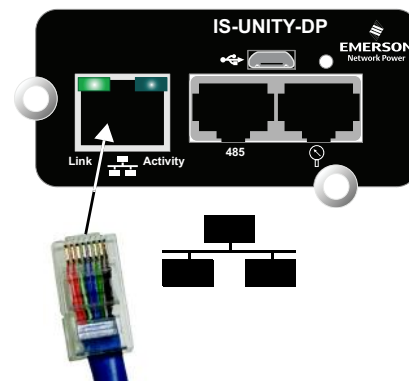

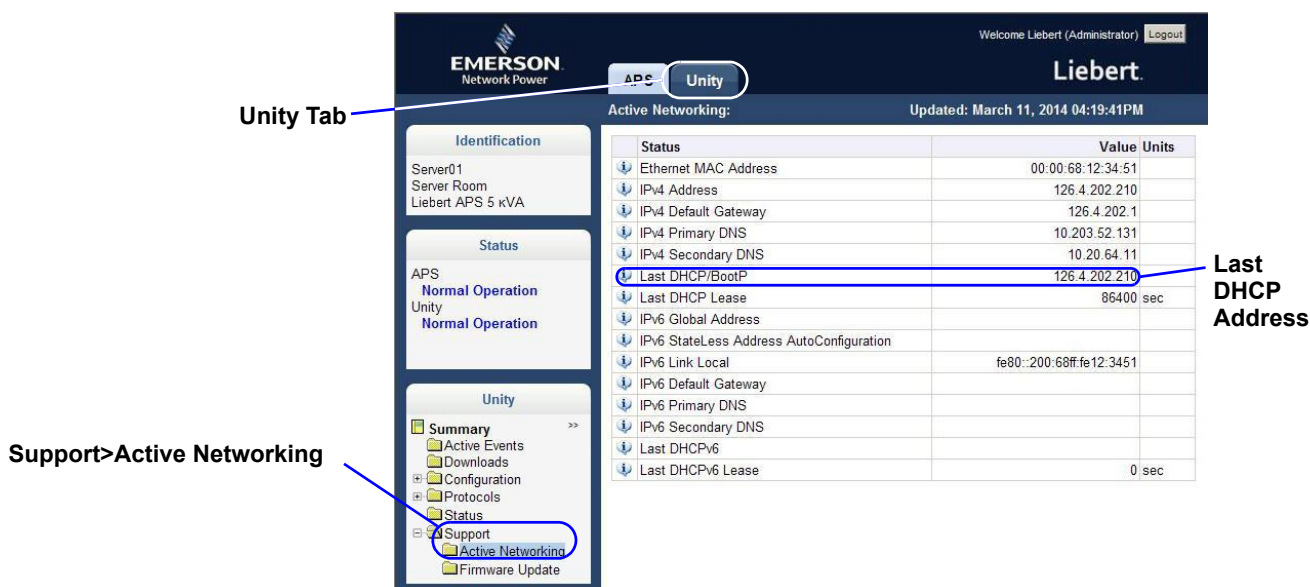

Static IP

To assign a static IP address, use the Ethernet connection to configure the card. Proceed to **2.1.2 - Connect an Ethernet Cable** and **2.2 - Change User Names and Passwords Immediately**.

2.1.2 Connect an Ethernet Cable

1. Connect a computer running a Microsoft Windows operating system (Microsoft Windows® XP with SP2 [64-bit] or SP3 [32-bit] or later) to the card by plugging a network cable into the RJ-45 port on the computer and the Liebert IntelliSlot Unity card.
2. Autoconfiguration, which is normally enabled on computers running Microsoft Windows operating systems, will automatically negotiate the communication settings. This takes about one minute.



NOTE

If the computer does not automatically connect, verify that autoconfiguration is enabled by: Open the Command Prompt window from the computer's Start menu.

Enter ipconfig/all to verify that Autoconfiguration is enabled on the computer and that an Autoconfiguration IPv4 Address has been assigned: Enabled = Yes (see Figure 2). An Autoconfiguration IPv4 Address begins with 169.254.)

3. If the Ethernet adapter being used to attach to the card does not show an Autoconfiguration IPv4 Address, open a new Command Prompt and type `ipconfig/renew` and press Enter. This forces the computer to acquire an Autoconfiguration IPv4 Address.
4. When the computer has an Autoconfiguration IPv4 Address, open a browser window on the computer and type `169.254.24.7` (the card's default Autoconfiguration IPv4 Address) in the URL address field. The card's Web page will appear.

Figure 2 Command prompt access

```
Ethernet adapter Local Area Connection:
Connection-specific DNS Suffix . : 
Description . . . . . : Intel(R) 82579LM Gigabit Network Connection
Physical Address. . . . . : E0-DB-55-E2-3F-54
DHCP Enabled. . . . . : Yes
Autoconfiguration Enabled . . . . : Yes
Link-local IPv6 Address . . . . . : fe80::1dc0:2a66:a01f:f92a%11(Preferred)
Autoconfiguration IPv4 Address. . . : 169.254.249.42(Preferred)
Subnet Mask . . . . . : 255.255.0.0
Default Gateway . . . . . : 
DHCPv6 Iaid . . . . . : 266394453
DHCPv6 Client DUID. . . . . : 00-01-00-01-18-9B-0A-82-E0-DB-55-E2-3F-54
```

2.1.3 Connect an RS-485 Serial Cable

For Building Management Systems using serial network connections, an RS-485 serial cable connection will be used.

Liebert IntelliSlot Unity cards come with an Adapter RJ-45-2POS Terminal Block. The adapter has two screw terminals to attach the ends of a RS-485 cable for communicating to a building management system.

1. Find the serial cable from the building management system. If it already has an RJ-45 connector on the end, determine whether it uses the same pinout as the Liebert IntelliSlot Unity card's connector. If the pinout is the same as the Liebert IntelliSlot Unity card connector's pinout, skip to **Step 6**.
2. Strip the ends of the positive (typically red) and negative (typically black) leads on the RS-485 cable so that enough bare wire is exposed for connection, about 1/4" (6mm).



NOTE

No bare wire should be exposed when the connection is completed.

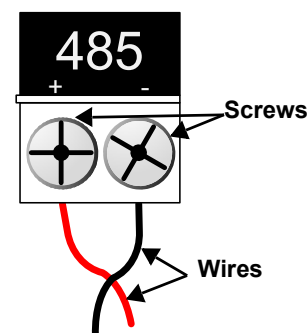

3. Position the adapter so the side with the positive and negative marks is face up. The small markings are on the same side as the screw heads, as shown at right.
4. Loosen the screw to the positive terminal and insert the red wire far enough to insert the bare wires into the terminal block under the screw, then tighten the screw. Be careful not to break the wires.
5. Repeat **Step 3** with the negative terminal and the black wire.
6. Plug the cable into the 485 RJ-45 port on the Liebert IntelliSlot Unity card.

2.2 Change User Names and Passwords Immediately

Emerson recommends changing the administrative user name and password **immediately** to safeguard protected configuration and control areas of the Liebert IntelliSlot Unity card.

The user name and password are set at the factory; each is *Liebert* (case-sensitive). All printable characters are valid except \ : ' < > ~ ? " #

A general user name and password are also set at the factory: *User* and *User* (case-sensitive). This may be left at the factory default or changed. The general user has access only to non-protected configuration and control areas of the Liebert IntelliSlot Unity card.

To change the default user names:

1. Select the Unity Tab > Configuration > User Settings.
2. Click the **Edit** button and enter the factory-set user name (*Liebert*) and password (*Liebert*).
3. Click **OK**.
4. Enter a new administrator user name and password.
5. Re-enter the administrator password to confirm it.

Optional General User Name Change

6. Enter a new general user name and password.
7. Re-enter the general user's password to confirm it.
8. Click the **Save** button to confirm the changes or click **Cancel** to discard them.



NOTE

Record the new user names and passwords and save them in a secure place where they can be found if forgotten.

Figure 3 Change administrator and general user names and passwords

The screenshot shows the 'User Settings' page in the Liebert web interface. The page is titled 'User Settings' and includes a sidebar with 'Identification' and 'Status' sections. The main content area contains a table of settings for Administrator and General User credentials. Arrows point from text labels to the corresponding input fields.

Settings	Edit	Save	Cancel	Units
Administrator Username				
Administrator Password				
Reenter Administrator Password				
General User Username				
General User Password				
Reenter General User Password				

Labels and arrows in the image:

- Administrator User Name and Password:** Points to the Administrator Username and Administrator Password fields.
- General User Name and Password:** Points to the General User Username and General User Password fields.

2.3 Configure the Card

The Liebert IntelliSlot Unity card requires minor configuration, such as choosing the IP/Web communication interface, serial RS-485 communication interface, or both. The default for IP/Web communication is IPv4, but this can be changed to IPv6 for greater security; contact your network administrator to determine whether it is compatible with your network. To choose the communication interface refer to **Figure 4**:

1. Select Unity Tab > Configuration > Network Settings.
2. Enable the protocol, either IPv4 or IPv6, that will be used to communicate with the Liebert IntelliSlot Unity card and with the Liebert equipment.
 - a. Click on either IPv4 Settings or IPv6 Settings.
 - b. Click the **Edit** button.
 - c. When prompted with a login display, enter the user name and password (the defaults are *Liebert* and *Liebert*).
 - d. Put a check mark (✓) in the **enabled** box.
 - e. Insert the desired or assigned IP address along with the rest of the required networking information; contact your system administrator if necessary.
3. Click on **Save** to confirm the changes or click on **Cancel** to discard them. The changes will take effect after the card is restarted.

Figure 4 Enabling the communication protocol—IPv4 or IPv6

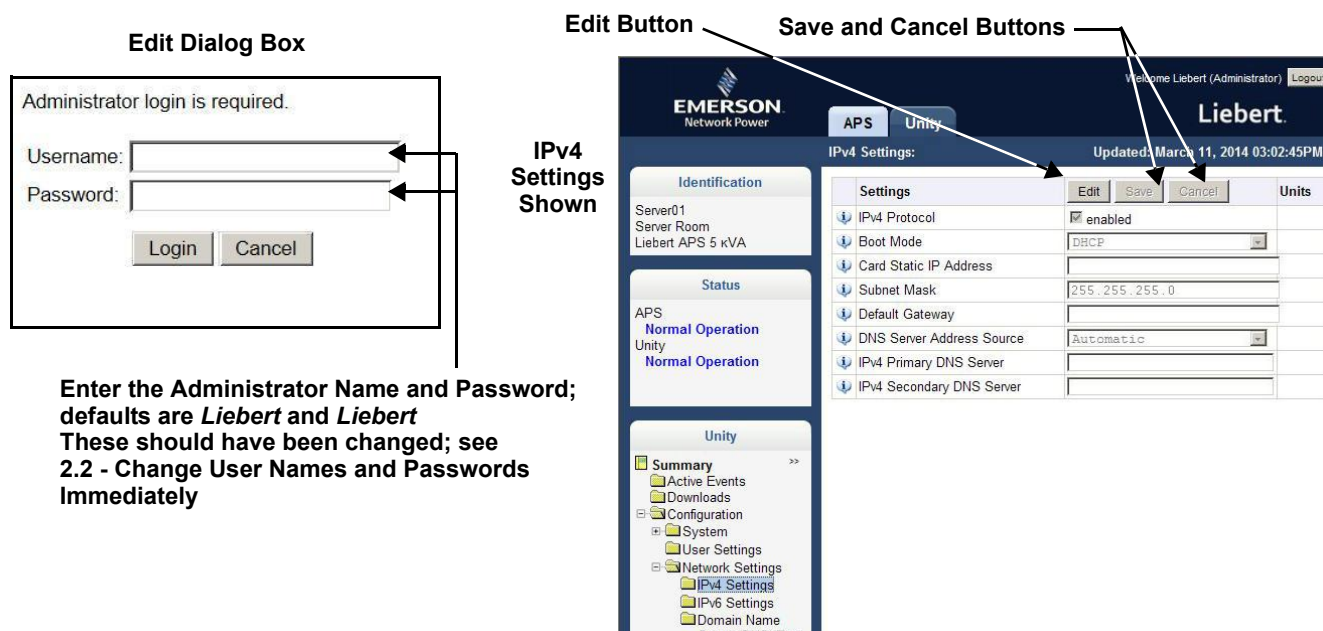

2.4 Installing Multiple Liebert IntelliSlot Unity Cards in a System

More than one Liebert IntelliSlot card may be installed in a system, but circular routes and duplicate node ID's must be avoided during installation. The instructions below apply if the second card to be installed is a Liebert IntelliSlot Unity card. If the second card is not a Liebert IntelliSlot Unity card, follow instructions in the user manual for that card.

Before beginning installation of a second Liebert IntelliSlot card, verify that the first card functions properly.

If the first card is a Liebert IntelliSlot card, but not a Liebert IntelliSlot Unity card, and if both cards connect to the same Ethernet network, then you should disable the router function on the first card. This will avoid circular routes. Follow instructions in the user manual for the first card.

If the first and second cards are both Liebert IntelliSlot Unity cards, steps must be taken to avoid duplicate Emerson Protocol MSTP node ID's. By default, the two cards would use the same node ID, and one or both cards would report a duplicate node error and fail to communicate with the system.

The default node ID for a Liebert IntelliSlot Unity card is 0, so the second card should use 1 or 2 preferably, or 127 if necessary. Contact your system administrator about the proper node ID for the second card, then perform the steps below.

1. Open a Web browser and navigate to the second Liebert IntelliSlot Unity card.
2. Click on Unity Tab > Configuration > Emerson Protocol > MSTP.
3. Click on Edit and enter a password and username, if required.
4. Enter the new node ID.
5. Click Save to confirm the changes or click Cancel to discard them.
6. Restart the card as follows.
 - a. Select the Unity Tab > Support.
 - b. Click on Enable.
 - c. Click on Restart.

3.0 ENABLE COMMUNICATION PROTOCOLS

The Liebert IntelliSlot Unity card will communicate with equipment and third-party systems over these protocols:

- BACnet IP
- BACnet MSTP
- Modbus TCP
- Modbus RTU
- SNMP
- YDN23



NOTE

Only two of the protocols may be enabled on one card.

- *Only one version of BACnet may be selected, either BACnet IP or BACnet MSTP*
- *Only one version of Modbus may be selected, either Modbus TCP or Modbus RTU*
- *Only one of the protocols can use the 485 port; choosing two 485 protocols will cause conflicts.*

3.1 Enable Protocols

Protocols may be enabled after a card has been installed and configured. After a protocol is enabled, it must be configured, which requires opening that protocol's folder (Unity>Protocols> (desired protocol)).

To enable two communication protocols:

1. Select Unity Tab > Protocols.
2. Click on **Edit** and enter the administrator user name and password.
3. Put a check mark (✓) in the desired protocols—Only two may be enabled; only one of the two can use the 485 port.
4. Click **Save** to confirm the changes or click on **Cancel** to discard them.
5. Configure the protocols selected. For details, refer to **5.0 - Edit the Liebert IntelliSlot Unity Card Configuration**.
6. Restart the card (refer to **5.11 - Configuration—Unity Tab-Support Folder**).
 - a. Select Unity Tab > Support.
 - b. Enable the commands.
 - c. Click on **Restart**.

Figure 5 Enable protocols; enable commands

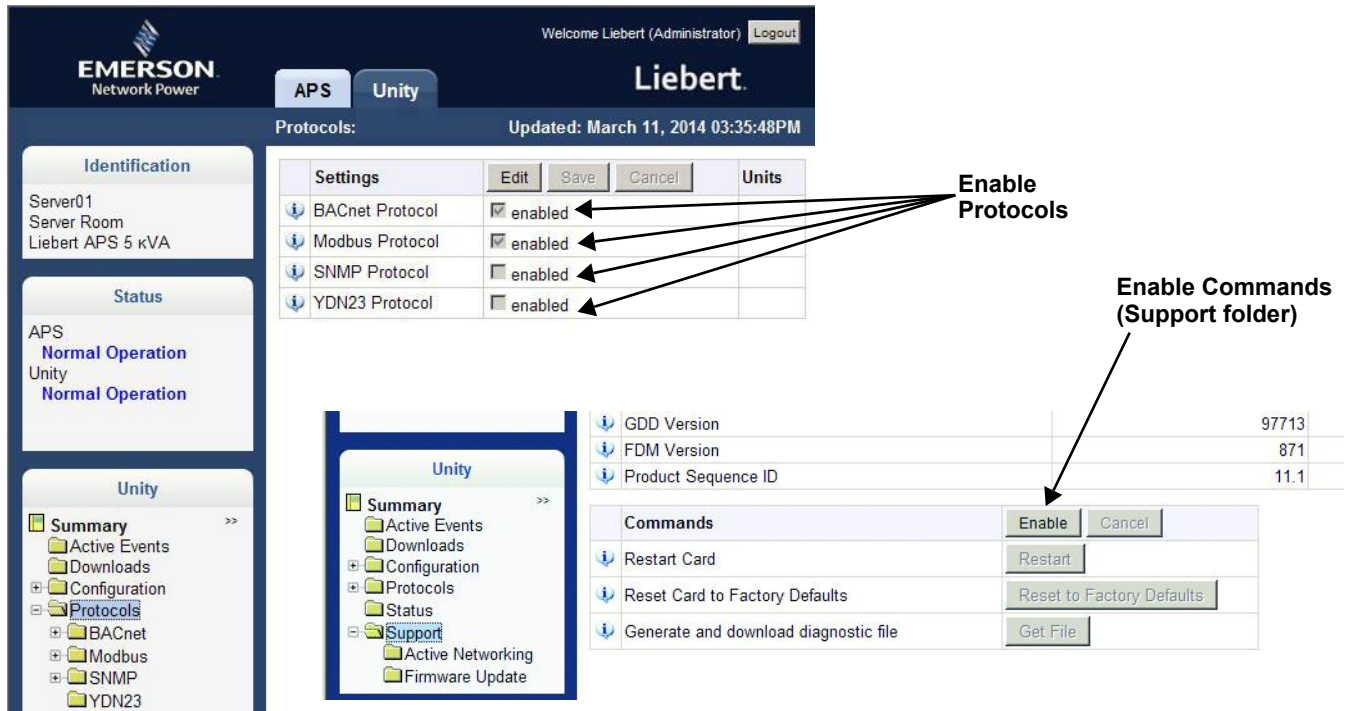

3.1.1 Enable Modbus Protocol

Protocols may be enabled after a card has been installed and configured. To enable Modbus protocol:

1. Select Unity Tab > Protocols > Modbus.
2. Click on **Edit** and enter a User name and password.
3. Select the access level (Read Only or Read/Write).
4. Select the Modbus interface, (Modbus TCP or Modbus RTU).
5. Click **Save** to confirm the changes or click on **Cancel** to discard the changes.
6. Configure the Modbus interface chosen; refer to **Configure Modbus TCP** or **Configure Modbus RTU**. For additional details, see **5.7 - Protocols Folder—Modbus**.

Configure Modbus TCP

1. Select the Unity Tab > Protocols > Modbus TCP.
2. Click on **Edit** and enter a User name and password if required.
3. Set the Limit Network Access Type by choosing from the drop-down list (Open/Same Subnet/Trusted IP List). Refer to **5.7 - Protocols Folder—Modbus** for additional details.
4. Enter the port to be used by the Modbus Server to listen for and respond to Modbus protocol requests based on limit Network Access Type setting.
5. Enter the Maximum Client Connection Count.
6. Click **Save** to confirm the changes or click on **Cancel** to discard them.
7. Restart the card to confirm the changes.
 - a. Select Unity Tab > Support.
 - b. Enable the commands.
 - c. Click on **Restart**.

Figure 6 Modbus TCP-Trusted IP List

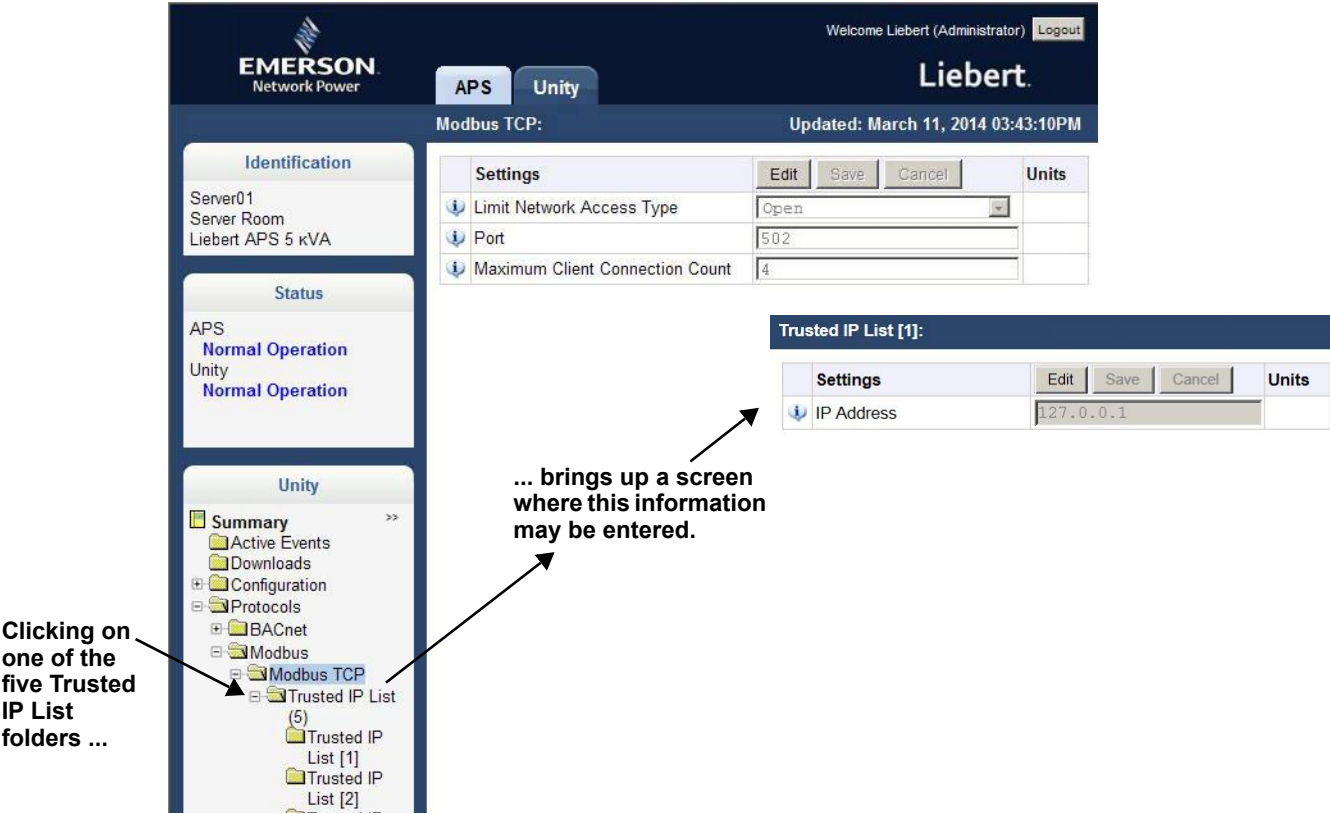

Configure Modbus RTU

1. Select the Unity Tab > Protocols > Modbus RTU.
2. Click on **Edit** and enter a user name and password if required.
3. Set the Node ID and the Baud Rate.
 The Node ID defaults to 1, but must have a value from 1 to 255 that is unique among devices connected through the RS-485 interface.
 The default baud rate is 9600; 19200 and 38400 also available.
 Contact your system administrator if you are uncertain about the settings.
4. Click **Save** to confirm the changes or click on **Cancel** to discard them.
5. Restart the card to confirm the changes.
 - a. Select Unity Tab > Support.
 - b. Enable the commands.
 - c. Click on **Restart**.

Figure 7 Modbus-RS-485

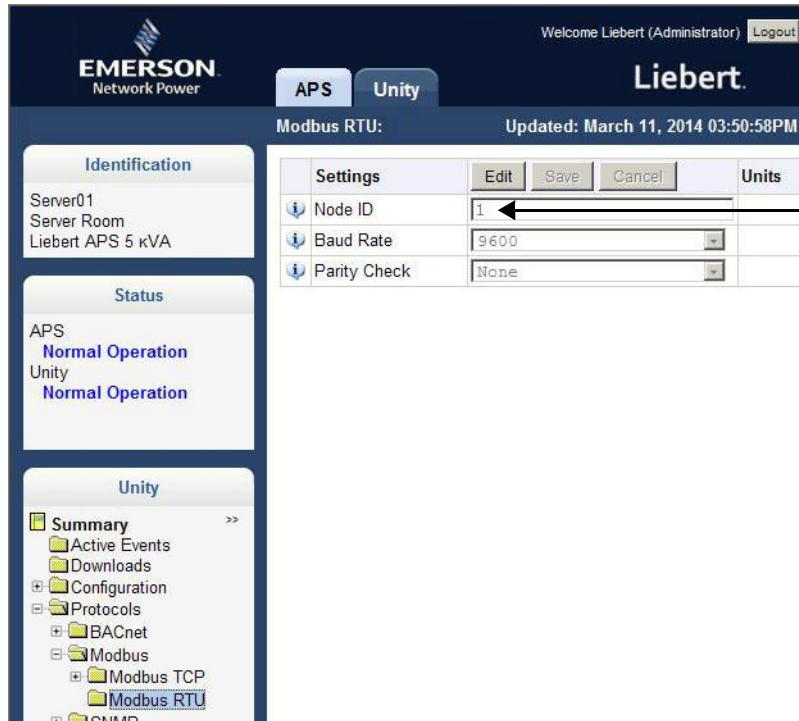

The screenshot shows the Emerson Liebert web interface. The top navigation bar includes 'EMERSON Network Power', 'Liebert', and 'Welcome Liebert (Administrator) Logout'. The main content area is titled 'Modbus RTU' and 'Updated: March 11, 2014 03:50:58PM'. On the left, there are three panels: 'Identification' (Server01, Server Room, Liebert APS 5 kVA), 'Status' (APS Normal Operation, Unity Normal Operation), and 'Unity' (Summary, Active Events, Downloads, Configuration, Protocols, BACnet, Modbus, Modbus TCP, Modbus RTU, CMMP). The main settings table is as follows:

Settings	Edit	Save	Cancel	Units
Node ID	1			
Baud Rate	9600			
Parity Check	None			

Node ID must be unique on the RS-485 bus this card is connected to.

3.1.2 Enable BACnet Protocol

Contact your system administrator or building management system administrator if you are uncertain about the settings.

1. Select Unity Tab > Protocols > BACnet.
2. Click on **Edit** and enter a user name and password if required.
3. Enter the Managed Device Write Access level (Read Only or Read/Write). This determines a user's ability to change settings in the Liebert IntelliSlot Unity card.
4. Choose the BACnet interface, either BACnet IP or BACnet MSTP
5. Set the Device Object Instance Number.
6. Set the Device Object Name.
7. Set the APDU Timeout.
8. Set the APDU Retries.
9. Click **Save** to confirm the changes or click on **Cancel** to discard them.
10. Configure the BACnet interface chosen; refer to **Configure BACnet IP Protocol** or **Configure BACnet MSTP Protocol**. For additional details, see **5.6 - Protocols Folder—BACnet Folder**.

Figure 8 BACnet protocol settings

The screenshot displays the Liebert web interface for configuring BACnet settings. The top navigation bar includes the Emerson Network Power logo, 'APS' and 'Unity' tabs, and a 'Welcome Liebert (Administrator)' message with a 'Logout' button. The main header shows 'BACnet:' and 'Updated: March 11, 2014 03:37:12PM'.

The left sidebar contains three sections:

- Identification:** Server01, Server Room, Liebert APS 5 kVA
- Status:** APS (Normal Operation), Unity (Normal Operation)
- Unity:** A tree view showing folders for Summary, Active Events, Downloads, Configuration, Protocols, and BACnet (with sub-items BACnet IP and BACnet MSTP).

The main content area features a 'Settings' table with the following data:

Settings	Edit	Save	Cancel	Units
Managed Device Write Access	<input type="button" value="Read Only"/>			
BACnet Interface	<input type="text" value="BACnet IP"/>			
Device Object Instance Number	<input type="text" value="1130000"/>			
Device Object Name	<input type="text" value="Device1130000"/>			
APDU Timeout	<input type="text" value="3000"/>			
APDU Retries	<input type="text" value="3"/>			

Configure BACnet IP Protocol

Contact your system administrator if you are uncertain about the settings.

1. Select Unity Tab > Protocols > BACnet IP.
2. Click on **Edit** and enter a User name and password if required.
3. Set the BACnetIP/Port Number
4. If the Liebert IntelliSlot Unity card is on a different subnet, a possibility when the monitored units are part of a Liebert SiteScan network or other third-party monitoring service:
 - a. Choose whether to enable Register as Foreign Device.
 - b. Enter the IP address of the BBMD (BACnet Broadcast Management Device).
 - c. Enter a time in seconds for Foreign Device Time-to-Live.
5. Click **Save** to confirm the changes or click on **Cancel** to discard them.
6. Restart the card to activate the changes.
 - a. Select the Unity Tab > Support.
 - b. Enable the commands.
 - c. Click on **Restart**.

Figure 9 BACnet IP settings

The screenshot displays the Liebert web interface for configuring BACnet IP settings. The interface is divided into several sections:

- Header:** Includes the Emerson Network Power logo, the user name 'Welcome Liebert (Administrator)', a 'Logout' button, and the 'Liebert' brand name.
- Navigation:** Tabs for 'APS' and 'Unity' are visible. Below them, the current page is identified as 'BACnet IP:' with an update timestamp of 'Updated: March 11, 2014 03:39:00PM'.
- Left Sidebar:**
 - Identification:** Lists 'Server01', 'Server Room', and 'Liebert APS 5 kVA'.
 - Status:** Shows 'APS' in 'Normal Operation' and 'Unity' in 'Normal Operation'.
 - Unity:** A tree view showing a 'Summary' section and a 'Protocols' section containing 'BACnet' (with sub-items 'BACnet IP' and 'BACnet MSTP'), 'Modbus', 'SNMP', and 'YDN23'.
- Main Content Area:** A table titled 'Settings' with columns for 'Edit', 'Save', 'Cancel', and 'Units'.

Settings	Edit	Save	Cancel	Units
BACnet IP Port Number	<input type="text" value="47808"/>			
Register as Foreign Device	<input checked="" type="checkbox"/>	enabled		
IP Address of BBMD	<input type="text"/>			
Foreign Device Time-to-Live	<input type="text" value="1800"/>			sec

Configure BACnet MSTP Protocol

Contact your system administrator if you are uncertain about the settings.

1. Select Unity Tab > Protocols > BACnet MSTP.
2. Click on **Edit** and enter a user name and password if required.
3. Set the BACnet MSTP Node ID. The ID default is 1.
4. Set the BACnet MSTP Data Rate.
5. Set the BACnet MSTP Max Master Address.
6. Set the BACnet MSTP Max Info Frames. The default is 8.
7. Click **Save** to confirm the changes or click on **Cancel** to discard them.
8. Restart the card to activate the changes.
 - a. Select Unity Tab > Support.
 - b. Enable the commands.
 - c. Click on **Restart**.

Figure 10 BACnet MSTP settings

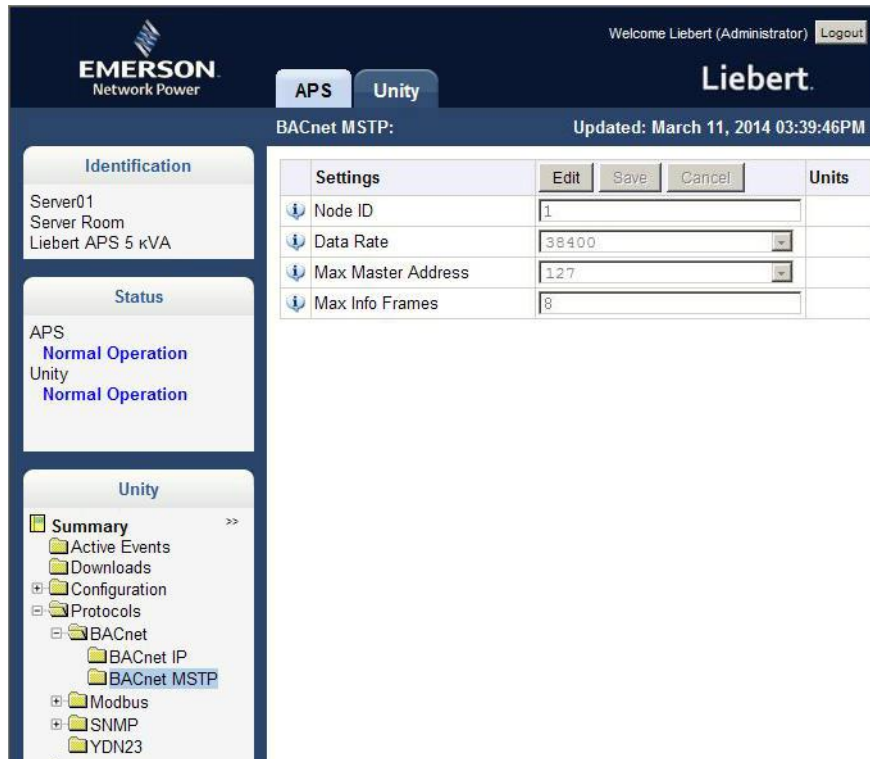

3.1.3 Enable SNMP

SNMPv1/v2c and SNMPv3 are enabled by default. The protocols may be configured or their default values may be accepted. Authentication Traps are not enabled by default. The default Heartbeat Trap interval is 24 hours; this can be disabled or the interval may be changed.

1. Select the Unity Tab > Protocols > SNMP.
2. Click on **Edit** and enter a User name and password if required.
3. To enable Authentication Traps, put a check mark (✓) in the box.
4. To change the Heartbeat Trap Interval, choose a time from the drop-down list or choose Disabled to prevent any heartbeat traps from being sent.
The interval times offered are 5 minutes, 30 minutes, or 1, 4, 8, 12 or 24 hours.
5. Choose whether to disable the traps or to set the interval to one of the periods on the menu.
6. Click **Save** to confirm the changes or click on **Cancel** to discard them.
7. Restart the card to activate the changes.
 - a. Select the Unity Tab > Support.
 - b. Enable the commands.
 - c. Click on **Restart**.

Figure 11 SNMP settings

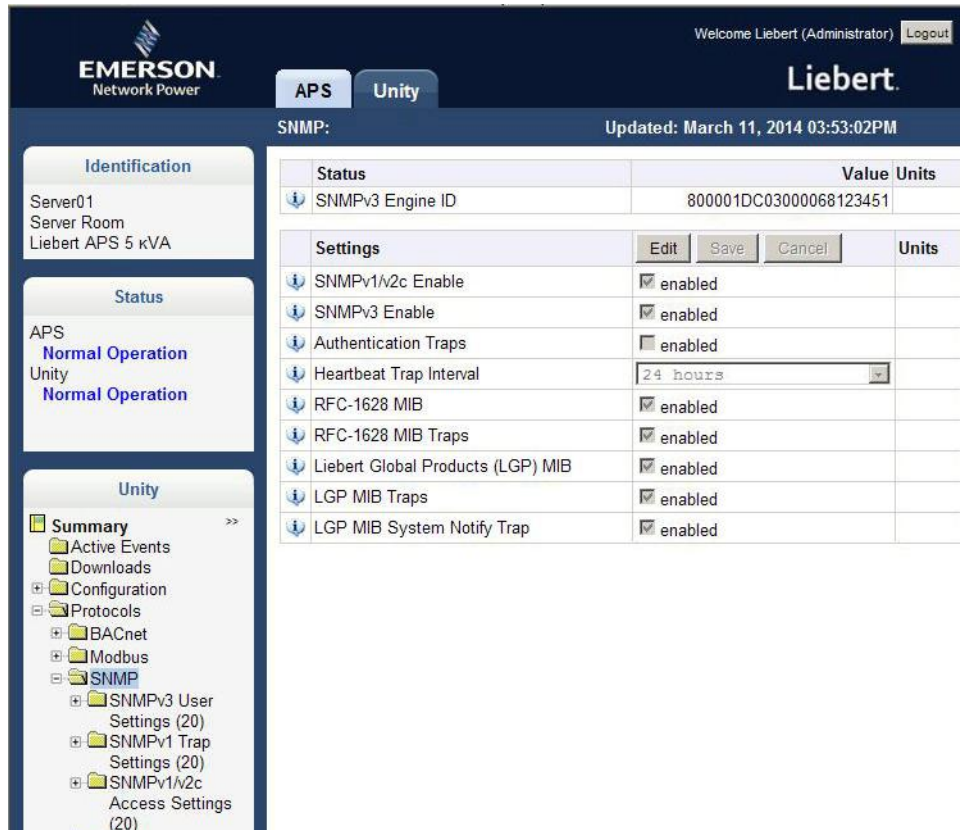

Configure SNMP Settings

SNMPv3 Users or SNMPv1/v2c Trap and Access settings must be made before SNMP access or notifications can occur. The Liebert IntelliSlot Unity card permits up to 20 SNMPv3 Users, up to 20 SNMPv1 Trap targets, and up to 20 SNMPv1/v2c Access addresses.

The required changes vary according to the type of SNMP protocol used. For SNMPv1, trap settings must be made. SNMPv2c must have Access Settings made. SMPv3 users must have settings configured. SNMPv1 trap settings are separate from the access settings for SNMPv1/v2c.

Configure SNMPv3 Settings

The settings must be made for each user who will receive notifications.

1. Select Unity Tab > Protocols > SNMP > SNMPv3 Users Setting (20) > SNMPv3 Users Setting (1).
2. Click on **Edit** and enter a User name and password if required.
3. Enter the information and set the permissions appropriate to the user. Refer to **Figure 12** for the information required.
4. Click **Save** to confirm the changes or click on **Cancel** to discard them.
5. Repeat **Steps 1** through **4** for any additional users.
6. Restart the card to activate the changes.
 - a. Select the Unity Tab > Support.
 - b. Enable the commands.
 - c. Click on **Restart**.

Figure 12 SNMPv3 user settings

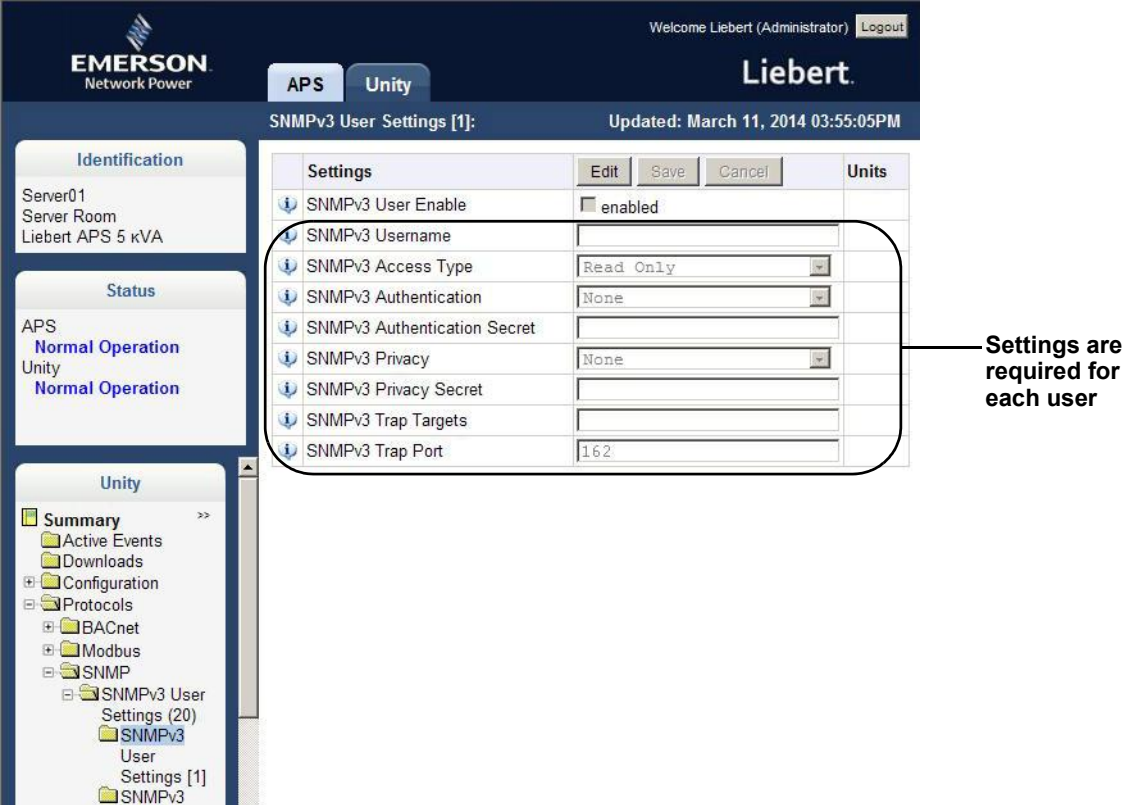

Configure SNMPv1 Trap Settings

1. Select Unity Tab > Protocols > SNMP > SNMPv1 Trap Settings (20).
2. Click on **Edit** and enter a User name and password if required.
3. Enter the information and set the permissions appropriate to the user. Refer to **Figure 13** for the information required.
4. Click **Save** to confirm the changes or click on **Cancel** to discard them.
5. Repeat **Steps 1** through **4** for any additional users.
6. Restart the card to confirm the changes.
 - a. Select the Unity Tab > Support.
 - b. Enable the commands.
 - c. Click on **Restart**.

Figure 13 SNMPv1 trap settings

The screenshot shows the Emerson Liebert web interface. At the top, the Emerson Network Power logo is on the left, and the Liebert logo is on the right. Below the logos, there are tabs for 'APS' and 'Unity'. The main title is 'SNMPv1 Trap Settings [1]:' with a timestamp 'Updated: March 11, 2014 04:05:59PM'. On the left side, there is a navigation tree with categories like 'Identification', 'Status', and 'Unity'. Under 'Unity', there is a sub-menu for 'SNMPv1 Trap Settings [1]'. The main content area displays a table with the following data:

Settings	Edit	Save	Cancel	Units
SNMP Trap Target	<input type="text" value="126.4.202.194"/>	<input type="button" value="Save"/>	<input type="button" value="Cancel"/>	
SNMP Trap Port	<input type="text" value="162"/>	<input type="button" value="Save"/>	<input type="button" value="Cancel"/>	
SNMP Trap Community String	<input type="text" value="*****"/>	<input type="button" value="Save"/>	<input type="button" value="Cancel"/>	

Settings required for each address that will receive SNMP notifications.

Configure SNMPv1/v2c Access Settings

1. Select Unity Tab > Protocols > SNMP > SNMPv1/v2c Access Settings (20) > SNMPv1/v2c Access Settings (1).
2. Click on **Edit** and enter a User name and password if required.
3. Enter the information and set the permissions appropriate to the user. Refer to **Figure 13** for the information required.
4. Click **Save** to confirm the changes or click on **Cancel** to discard them.
5. Restart the card to confirm the changes—The card must be restarted before another user’s settings may be changed.
 - a. Select the Unity Tab > Support.
 - b. Enable the commands.
 - c. Click on **Restart**.

Figure 14 SNMPv1/v2c access settings

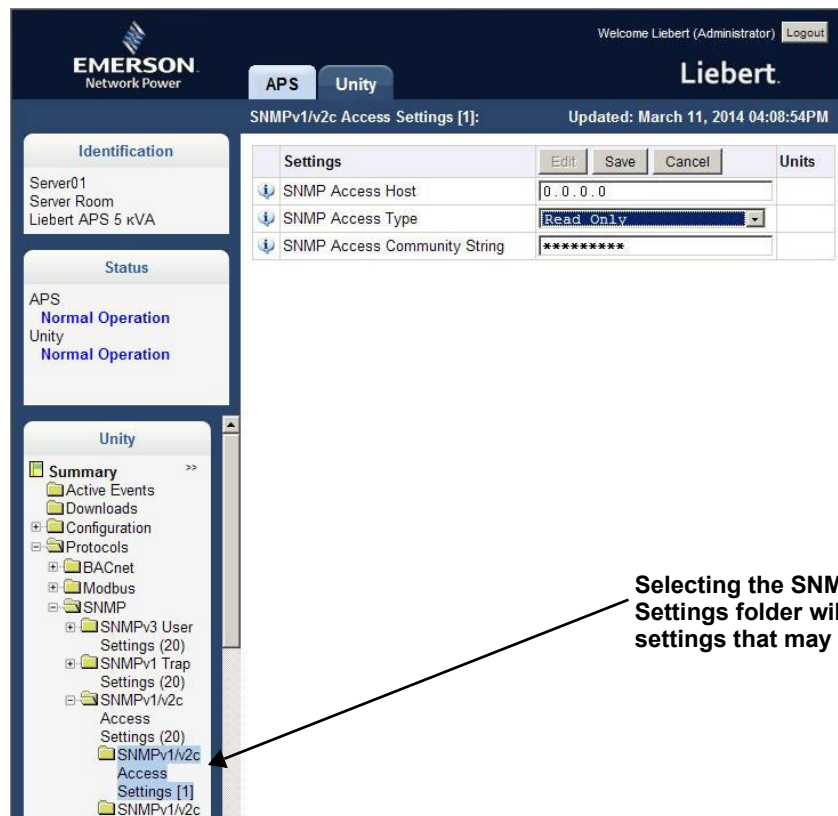

Selecting the SNMPv1v2cAccess Settings folder will bring up the settings that may be changed.

4.0 LIEBERT INTELLISLOT UNITY CARD WEB PAGE LAYOUT

Default settings in the Liebert IntelliSlot Unity card permit using it immediately after installation to monitor the equipment the card is installed in. The Web interface permits customizing the information to ease monitoring the equipment and troubleshooting problems. Users can name the equipment, enter a location, set up e-mail and text alerts and change equipment settings.



NOTE

The Edit button will be grayed-out if the settings on a menu cannot be changed.

4.1 Web Page Sections

Each Web page displayed by the Liebert IntelliSlot Unity card has these main areas (see **Figure 15**):

- Identification
- Status
- Tab Menus
- Detail

Identification

Displays the System Name, System Location and System Description

Status

Displays the status of the monitored equipment and of the Liebert IntelliSlot Unity card.

Tab Menus

The Liebert IntelliSlot Unity card has two tabs: the Managed Equipment tab, which will display the name of the monitored equipment, and the Unity Tab. The tab selected determines the Tab Menu shown.

- **Managed Equipment Tab**—Information pertaining to the equipment being monitored and controlled. Refer to **4.3 - Managed Equipment Tab Menus** for details. The tab label refers to the type of Liebert unit the card is installed in. **Figure 15** shows a Managed Equipment Tab labeled “APM,” meaning the card is installed in a Liebert APM UPS. **Figure 16** a Web page example for a Liebert IntelliSlot Unity card installed in a Liebert CRV.
- **Unity Tab**—Information about the Liebert IntelliSlot Unity card, such as the overall event status of the equipment and communication interface, logs of third-party information, communication settings, third-party protocol settings and system status. Refer to **4.4 - Unity Tab Menus** for details.

Detail

Displays detailed information about the device based on the menu selection made in the Tab Menu area. Edits to the device and its configuration are made in this section.

Figure 15 Web page sections, UPS example

Managed Equipment Tab Card in a Liebert APM

Unity Tab

Identification

Status

Tab Menu (changes according to monitored equipment)

Information on Opening Screen depends on type of unit being monitored

ØA	ØB	ØC	Units
L-N 119	120	120	VAC
Frequency 59.9 Hz			

ØA	ØB	ØC	Units
L-N 120	120	119	VAC
Frequency 59.9 Hz			

ØA	ØB	ØC	Units
L-N 119	120	120	VAC
System 51	30	42	A AC
System 41	25	34	%
System	14		kVA
System	13		kW
Frequency 59.9 Hz			

Voltage	323	VDC	Current	0	A DC
Temperature	20	°C	Time Remaining	109	min

Figure 16 Web page sections, Thermal Management unit example

Managed Equipment Tab Card in a Liebert CRV

Unity Tab

Identification

Status

Tab Menu (changes according to monitored equipment)

Information on Opening Screen depends on type of unit being monitored

4.2 Help Text

Each Web page shown by the Liebert IntelliSlot Unity-DP card has informational text that is revealed by hovering a mouse pointer over the icon to the left of the Status, Events or Settings row, as shown below. The Web page may display any of six icons beside the Status, Events or Setting entry:

Table 3 Help text and icons







Icon	Description
	a check mark (✓) on a green button (Event Normal)
	an <i>i</i> on a blue button (Event Information)
	an <i>x</i> on a red button (Event Alarm)
	an exclamation point (!) on a yellow shield (Event Warning)
	an exclamation point (!) on a red button (Event Critical)
	an <i>i</i> in a word balloon (Tool Tip).

Figure 17 Help text on mouse-over



The screenshot shows the web interface for the Liebert IntelliSlot Unity card. The left sidebar contains a navigation menu with sections for Identification, Status, and APS. The main content area displays the 'Input' section, which includes a table of system input parameters and an 'Events' table. A mouse-over tooltip is shown over the 'System Input RMS L1-N' entry in the 'Status' table, displaying the text: 'The System Input RMS Voltage between Line 1 and Neutral'. Annotations with arrows point to the tooltip and the 'System Input RMS L1-N' entry.

Hovering a mouse pointer over the icon reveals information about that entry.

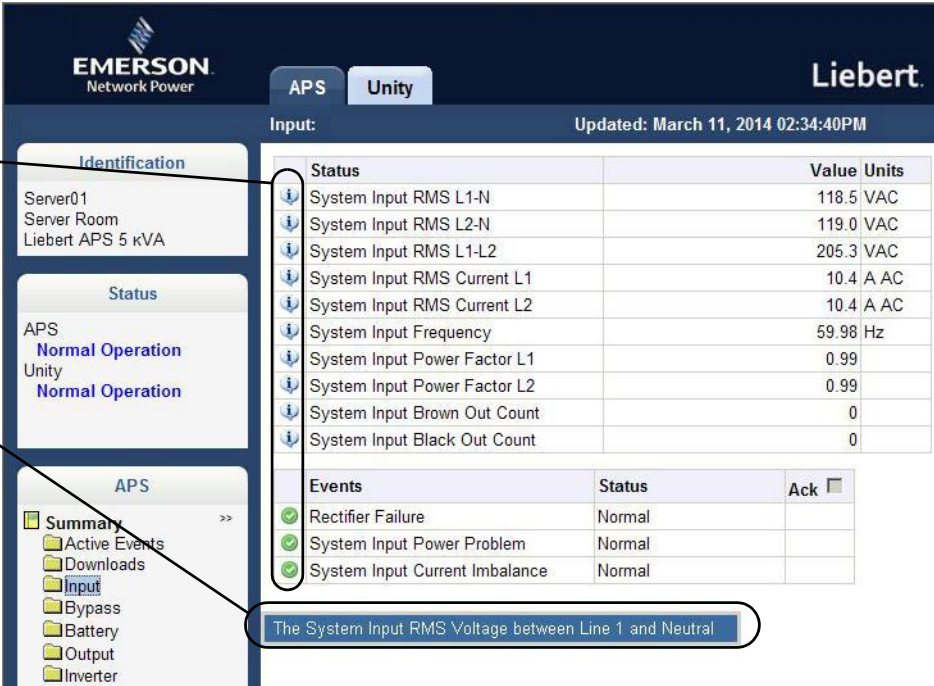
Help text about the System Input RMS L1-N entry on the Managed Equipment Tab, System Status Menu.

The System Input RMS Voltage between Line 1 and Neutral

4.3 Managed Equipment Tab Menus

Menus on the Managed Equipment tab list only data that is relevant to the equipment being monitored. For example, menus shown by a Liebert IntelliSlot Unity card installed in a UPS differ from menus shown by a card installed in Thermal Management equipment. Information on those menus will also differ depending on the equipment the card is installed in.

Figure 18 Managed Equipment Tab examples, Liebert APS™ and Liebert CRV™

Equipment tab will display Status or Events for the applicable equipment only.

Equipment tab will display Status, Events or Settings for the applicable equipment only.

EMERSON Network Power | **APS** | **Unity** | **Liebert.**

Updated: March 11, 2014 02:33:44PM

Identification
 APS UPS
 Monitoring Lab
 APS 01

Status
 APS
Normal Operation
 Unity
Normal Operation

APS

Summary >>
 Active Events
 Downloads
 Input
 Bypass
 Battery
 Output
 Inverter
 System Status
 PowerModule [1]
 BatteryModule (6)
 BypassControlModule
 System Configuration

Status	Value	Units
System Input RMS L1-N	118.9	VAC
System Input RMS L2-N	119.5	VAC
System Input RMS L1-L2	206.2	VAC
System Input RMS Current L1	10.0	A AC
System Input RMS Current L2	9.9	A AC
System Input Frequency	59.98	Hz
System Input Power Factor L1	0.99	
System Input Power Factor L2	0.99	
System Input Brown Out Count	0	
System Input Black Out Count	0	

Events	Status	Ack
Rectifier Failure	Normal	<input type="checkbox"/>
System Input Power Problem	Normal	<input type="checkbox"/>
System Input Current Imbalance	Normal	<input type="checkbox"/>

EMERSON Network Power | **Liebert CRV** | **Unity**

NOTE: It may take several seconds to update after submitting changes.

Identify | Edit | Save | Cancel

Identification
 Unity
 Unity Communications C...

Status
 Liebert CRV
Normal Operation
 Unity
Normal Operation

Liebert CRV

Summary >>
 Active Events
 Downloads
 Air Temperature
 Humidity
 Fans
 Remote Sensors (10)
 Compressor
 Reheater
 Condenser
 Chilled Water
 System Info
 System Operations
 Event Configuration
 System Events
 Asset Management
 Time

Supported Status	Value	Units
Supply Humidity	71.5	% RH
Return Humidity	41.0	% RH

Supported Events	Status	Ack
High Return Humidity	Normal	<input type="checkbox"/>
Low Return Humidity	Normal	<input type="checkbox"/>
Humidifier Hours Exceeded	Normal	<input type="checkbox"/>
Dehumidifier Hours Exceeded	Normal	<input type="checkbox"/>
Humidifier Under Current	Normal	<input type="checkbox"/>
Humidifier Over Current	Normal	<input type="checkbox"/>
Humidifier Low Water	Normal	<input type="checkbox"/>
Humidifier Cylinder Worn	Normal	<input type="checkbox"/>
Humidifier Issue	Normal	<input type="checkbox"/>
Ext Humidifier Lockout	Normal	<input type="checkbox"/>
Humidifier Control Board Not Detected	Normal	<input type="checkbox"/>
Return Humidity Out Of Proportional Band	Normal	<input type="checkbox"/>
Dehumidifier Disabled	Normal	<input type="checkbox"/>
Dehumidifier 12 Hour Lock Out	Normal	<input type="checkbox"/>
Dehumidifier Enabled	Normal	<input type="checkbox"/>
Humidifier Disabled	Normal	<input type="checkbox"/>
Humidifier Enabled	Normal	<input type="checkbox"/>

Supported Settings	Value	Units
Humidity Set Point	45	% RH
Humidification Proportional Band	5	% RH
Dehumidification Proportional Band	5	% RH
Humidity Dead Band	5.0	% RH
High Return Humidity Threshold	60.0	% RH
Low Return Humidity Threshold	15.0	% RH

4.4 Unity Tab Menus

The Unity Tab shows the overall event status of the equipment and communication interface. It contains logs of third party information, communications settings, third party protocol settings and system status information as detailed below.

Table 4 Unity Tab menus

Unity Tab Menus	Description	See Details:
Active Events	Displays the current event activity	page 27
Downloads Agent (or Unity Card) Logs Event Logs Data Logs Other files	Downloading files to text-accessible, comma-delimited or tab-delimited files ease troubleshooting.	page 27
Configuration System User Settings Network Settings Web Server Settings LIFE Emerson Protocol Messaging Settings	Displays information about the system setup, access, network connections, Emerson Protocol settings and whether e-mail and SMS messaging are enabled	page 27
Protocols Modbus BACnet SNMP YDN23	Lists information and settings related to available third-party protocols employed to monitor equipment.	page 34
Status System Status System Restart Required LIFE™ device identity changed-LIFE™ needs to be reconfigured RS-485 Port Conflict Duplicate Emerson Protocol MSTP Node ID Duplicate BACnet MSTP Node ID	Shows the overall condition of the system and whether a restart is needed to activate configuration changes; restart is performed only from the Support Folder	page 42
Support Agent time and Date Agent Model Agent App Firmware Version Agent App Firmware Label Agent Boot Firmware Version Agent Boot Firmware Label Agent Serial Number Agent Manufacture Date Agent Hardware Version GDD Version FDM Version Product Sequence ID Restart Card Reset Card to Factory Defaults (see Note below) Generate and download diagnostic file Firmware Update Active Networking	Shows information needed for maintenance or troubleshooting and shortcuts to reboot the card, reset the Liebert IntelliSlot Unity card to its factory defaults and to update the card's firmware.	page 43 (Firmware Update also on page 46)



NOTE

The card may be reset to factory defaults manually by briefly pressing the reset button five times within 10 seconds.

Do not hold the reset button too long: Pressing the reset button and holding it for 5 seconds will restart the card without resetting it to factory defaults.

*To perform either function, insert a straightened paper clip into the small hole on the front of the card (see **Figure 1** for the Reset Button's location).*

5.0 EDIT THE LIEBERT INTELLISLOT UNITY CARD CONFIGURATION

The Web-based interface can be used to change settings for the Liebert IntelliSlot Unity card and for the monitored equipment. The following steps apply to making changes in all sections of the Liebert IntelliSlot Unity card.

To edit the configuration:

1. Open a Web browser and enter the card's IP address.
2. Click on the Unity Tab.
3. Select the menu in the Tab Menu area that contains the configuration setting to be changed.
4. Click the **Edit** button near the top of the Web page (see **Figure 19**).
5. Enter the administrator name and password for the Liebert IntelliSlot Unity card in the dialog box that opens (the default settings are *Liebert* and *Liebert*).
6. Click **OK**.
7. Change the settings.
8. Click on **Save** to apply the changes or click **Cancel** to discard them.

Figure 19 Editing configuration settings

The screenshot shows the Liebert IntelliSlot Unity Card configuration interface. At the top, there are tabs for 'APS' and 'Unity', with an arrow pointing to the 'Unity' tab labeled 'Select Unity Tab'. The main content area is titled 'Email Settings' and includes a table of settings. An arrow points to the 'Edit' button in the top right of the settings table, labeled 'Edit Button'. On the left side, there is a 'Tab Menu' containing various configuration categories, with an arrow pointing to 'Email Settings' labeled 'Tab Menu containing the setting to be changed'. Below the settings table, a dialog box titled 'Administrator login is required.' is shown, with fields for 'Username:' and 'Password:', and 'Login' and 'Cancel' buttons. An arrow points to this dialog box with the label 'Enter Password Dialog Box (from clicking on Edit)'.

Settings	Value	Units
Email From Address		
Email To Address		
Email Subject Type	Default	
Custom Subject Text	DEFAULT_SUBJECT	
SMTP Server Address	0.0.0.0	
SMTP Server Port	25	
Include IP Address in Message	<input checked="" type="checkbox"/>	
Include Event Description in Message	<input checked="" type="checkbox"/>	
Include Name in Message	<input type="checkbox"/>	
Include Contact in Message	<input type="checkbox"/>	
Include Location in Message	<input type="checkbox"/>	
Include Description in Message	<input type="checkbox"/>	
Include Web Link in Message	<input type="checkbox"/>	
Enable Event Consolidation	<input checked="" type="checkbox"/>	
Consolidation Time Limit	60	
Consolidation Event Limit	20	

5.1 Web Page Unity Tab Folders

The Unity Tab contains information about the overall event status of the equipment and communication interface. It presents logs of third-party information, communication settings, third-party protocol settings and system status information.

The Unity Tab folders are shown at right.

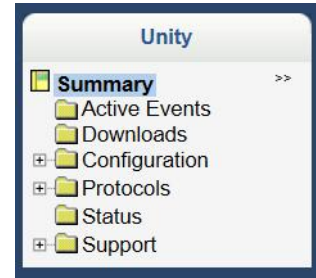

5.1.1 Unity Tab-Active Events Folder

The Unity Tab's Active Events folder contains no configurable settings. The folder displays events affecting the Liebert IntelliSlot Unity card.

5.2 Unity Tab-Downloads Folder

The Unity Tab's Downloads folder contains no configurable settings. The folder displays links to download logs of third-party protocols that are enabled on the Liebert IntelliSlot Unity card. The logs help in configuring and troubleshooting communication between the Network Management or Building Management Systems being used to monitor the managed equipment.

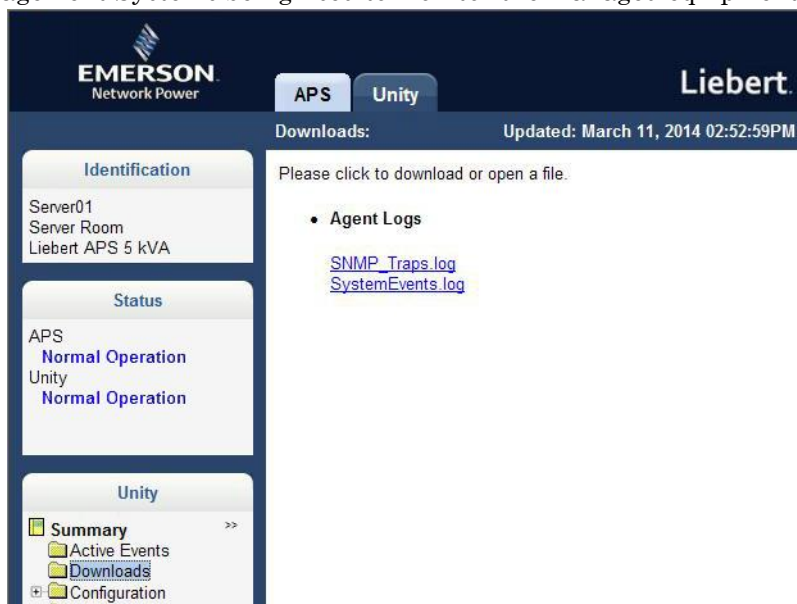

5.3 Unity Tab-Configuration Folder

The Configuration folder's top level displays the System Model Name of the Liebert IntelliSlot Unity card. This name is factory-set and cannot be changed (the **Edit** button is grayed out). The Configuration folder contains seven subfolders:

- System
- User Settings
- Network Settings
- Web Server Settings
- LIFE™
- Emerson Protocol
- Messaging Settings

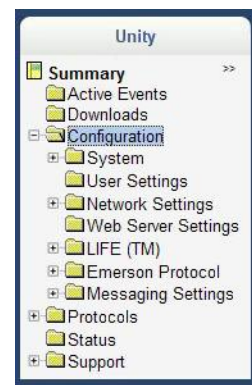

5.3.1 Configuration Folder—System

The System subfolder displays general information about the monitored and managed equipment and the display of some data. Refer to **Figure 20**. The data displayed is set by the user and can assist in troubleshooting. To alter the information displayed, click on the **Edit** button, enter the administrator name and password and make changes. Click **Save** to save the changes; click **Cancel** to discard the changes.

Figure 20 Configuration folder, System subfolder



Enter the information in the dialog boxes and choose temperature display, either Celsius or Fahrenheit

Time Service Settings

The System Subfolder contains one folder: Time Service Settings. Each setting offers either a menu of choices or an enable/disable check box. Users can set these parameters

Figure 21 Configuration folder, System subfolder, Time Service Settings

Settings	Edit	Save	Cancel	Units
External Time Source				NTP Server
NTP Time Server				pool.ntp.org
NTP Time Sync Rate				1 Hour
Time Zone				(GMT-05:00) Eastern Ti
Enable Auto-Sync To Managed Device				<input checked="" type="checkbox"/> enabled
Managed Device Auto-Sync Rate				1 Hour

- External Time Source—The external source to be used for time synchronization.
- NTP Time Server—Network Time Server (NTP) URL or IP address
- NTP Time Sync Rate—The rate at which time will be synchronized with the Network Time Protocol server, if NTP is the external time source.
- Time Zone—Time zone where the device is located.
- Enable Auto-Sync to Managed Device—Enable automatic writing time to the managed device.
- Managed Device Auto-Sync Rate—Rate at which time will be written to the managed device, if an external time source has been selected.

5.3.2 Configuration Folder—User Settings

The User Settings subfolder displays the administrator’s and general user’s name and password. Each can be changed. The default user name and password for the administrator are *Liebert* and *Liebert*. The defaults for the general user are *User* and *User*. To change either, click on **Edit**, enter the default username and password and enter the new information. Click on **Save** to accept the changes or click **Cancel** to discard the changes.



5.3.3 Configuration Folder—Network Settings

The top level of the Network Settings subfolder displays:

- Speed Duplex
- Domain Name Suffix List

The Speed Duplex item selects the speed and duplex configuration of the card’s Ethernet port. It is set to Auto by default. If it requires changing, contact the system administrator for the proper settings.

The Domain Name Suffix List is a listing of domain name suffixes for resolution of hostnames. If it requires changing, contact the system administrator for the proper setting.

The Network Settings subfolder contains three subfolders related to communication:

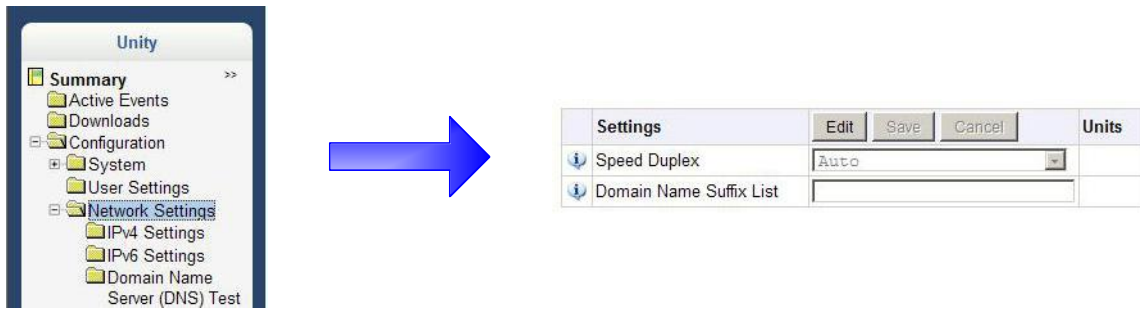

IPv4/IPv6 Settings

The IPv4 and IPv6 settings determine which Internet Protocol will be used for communication over the network connected to the Ethernet port. IPv4 and IPv6 networks will run in parallel (dual-stack network), but the protocols are different. See your network administrator to determine which protocol should be enabled and to determine the correct settings.

Figure 22 IPv4/IPv6 settings

Settings	Edit	Save	Cancel	Units
IPv4 Protocol	<input checked="" type="checkbox"/>			
Boot Mode				
Card Static IP Address				
Subnet Mask				
Default Gateway				
DNS Server Address Source				
IPv4 Primary DNS Server				
IPv4 Secondary DNS Server				

IPv4 Settings

Settings	Edit	Save	Cancel	Units
IPv6 Protocol	<input checked="" type="checkbox"/>			
Boot Mode				
Card Static IP Address				
Prefix Length				
Default Gateway				
DNS Server Address Source				
IPv6 Primary DNS Server				
IPv6 Secondary DNS Server				

IPv6 Settings

IPv4 Settings

- IPv4 Protocol—Enables IPv4 in the card
- Boot Mode—Mode the card boots into to be a network ready device (Static, DHCP, BootP)
- Card IP Address—Network address for the interface
- Subnet Mask—Network mask for the interface which divides a network into manageable segments
- Default Gateway—IP address of the gateway for network traffic destined for other networks or subnets
- DNS Server Address Source—Source of DNS server identification (None, Automatic, Configured)
- IPv4 Primary DNS Server
- IPv4 Secondary DNS Server

IPv6 Settings

- IPv6 Protocol—Enables IPv6 in the card.
- Boot Mode—Mode the card boots into to be a network ready device (Static, Auto)
- Card IP Address—Network address for the interface.
- Prefix Length—Prefix length for the address that divides a network into manageable segments.
- Default Gateway—IP address of the gateway for network traffic destined for other networks or subnets.
- DNS Server Address Source—Source of DNS server identification (None, Automatic, Configured)
- IPv6 Primary DNS Server
- IPv6 Secondary DNS Server

Domain Name Server (DNS) Test

The Domain Name Server Test checks key points of a Domain Name Server (DNS) setup for a given domain.

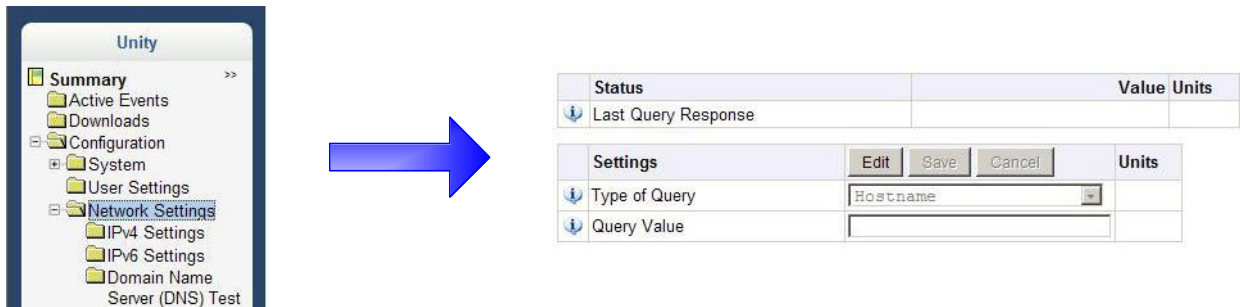

Domain Name Server (DNS) Test Settings

- Last Query Response—Response from a domain name server (DNS) to the last query
Example: *gxtwebdemo.liebert.com* resolved to *126.4.203.234*
- Type of Query—Type of DNS query. (Hostname, IP Address)
- Query Value—Value for the domain name server (DNS) to resolve. Example: *gxtwebdemo.liebert.com*

5.3.4 Configuration Folder—Web Server Settings

The Web Server Settings permits making some security settings, such as HTTP or HTTPS, and password enabling.

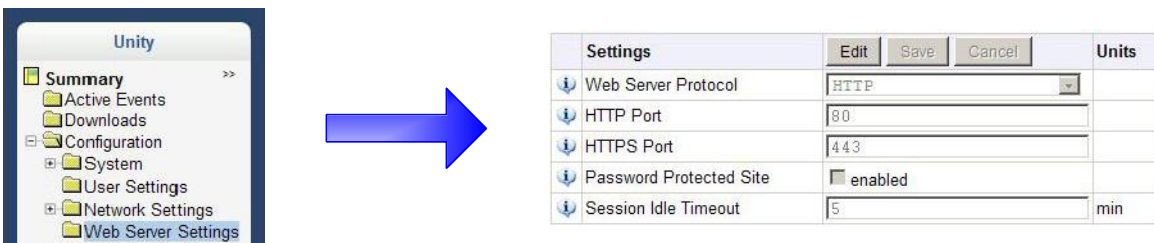

Web Server Settings

- Web Server Protocol—Select the operation mode of the Web Server (HTTP, HTTPS)
- HTTP Port—Standard web port not encrypted. Required if HTTP is enabled as Web Server Protocol.
- HTTPS Port—Standard secure Web port; all communication is encrypted. Required if HTTPS is enabled as Web Server Protocol.
- Password Protect Site—When enabled, a login session is required before any device information is displayed to the user. User level credentials will allow only viewing of device information. Administrator level credentials are required to make any changes.
- Session Idle Timeout—The interval the software will wait before logging off a user unless there is user activity (Default is 5 min.)

5.3.5 Configuration Folder—LIFE™

The LIFE subfolder contains settings that affect use of the Emerson® LIFE Technology, a remote monitoring and diagnostic service for Emerson Network Power units. The LIFE settings are for use by trained Emerson Network Power personnel only and require no user changes. For information about the LIFE settings, refer to **Appendix A - Configuration Folder—LIFE™ Subfolder**.

5.3.6 Configuration Folder—Emerson Protocol

Emerson Protocol contains four subfolders: Managed Device, MSTP, Ethernet and Internal.



NOTE

With the exception of changing the node ID when multiple cards are used, the settings in the Emerson Protocol subfolders should not be modified unless directed by an Emerson representative.

5.4 Configuration Folder—Messaging Settings

The Messaging Settings subfolder permits enabling e-mail and text messaging about events. The subfolder also contains a test to determine whether the notifications are sent. Settings for the two notification methods permit specifying who gets the notifications, the format and other details.

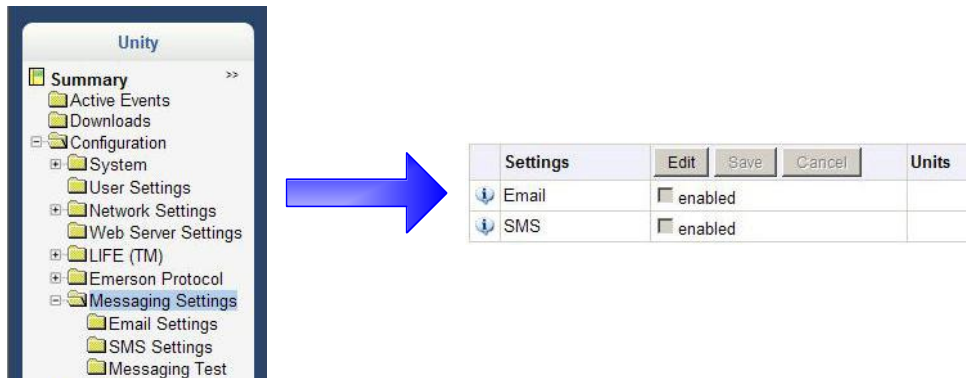

- Email—May be enabled to send e-mail messages about events
- SMS—May be enabled to send text messages about events

5.4.1 Email Settings

Selections in Email Settings determine how the card sends e-mails about events.

Settings	Edit	Save	Cancel	Units
Email From Address				
Email To Address				
Email Subject Type		Default		
Custom Subject Text		DEFAULT_SUBJECT		
SMTP Server Address		0.0.0.0		
SMTP Server Port		25		
Include IP Address in Message	<input checked="" type="checkbox"/>			
Include Event Description in Message	<input checked="" type="checkbox"/>			
Include Name in Message	<input type="checkbox"/>			
Include Contact in Message	<input type="checkbox"/>			
Include Location in Message	<input type="checkbox"/>			
Include Description in Message	<input type="checkbox"/>			
Include Web Link in Message	<input type="checkbox"/>			
Enable Event Consolidation	<input checked="" type="checkbox"/>			
Consolidation Time Limit		60		
Consolidation Event Limit		20		

Email Settings

- Email From Address—Sender’s email address. In most cases this will be the email address of the person to whom replies should be sent. Example *Support@company.com*
- Email To Address—Email address of the recipient. Multiple email addresses should be separated by a semicolon. The maximum length for an email address is 64 characters.
- Email Subject Type—Subject of the email. This value will default to the event description. The subject line can be customized.
- Custom Subject Text—The subject of the email can be changed
- SMTP Server Address—Fully qualified domain name or IP address of the server used for relaying email messages. The maximum length for this entry is 32 characters. If using a server name, a DNS server must be configured under Network Settings.
- SMTP Server Port—SMTP server port. Note: Typically the default of 25 should be used.
- Include IP Address in Message—If checked, the IP Address of the agent card will be included in outgoing messages.
- Include Event Description in Message—If checked, SNMP event description will be included in outgoing messages.
- Include Name in Message—If checked, the agent card Name will be included in outgoing messages.
- Include Contact in Message—If checked, the agent card Contact will be included in outgoing messages.
- Include Location in Message—If checked the agent card Location will be included in outgoing messages.
- Include Description in Message—If checked, the agent card Description will be included in outgoing messages.
- Include Web Link in Message—If checked, a Web link to the agent card and Web Server listening port number will be included in outgoing messages.
- Enable Event Consolidation—If checked, multiple events will be sent per outgoing message.
- Consolidation Time Limit—If Event Consolidation is enabled, a message will be sent when 'Consolidation Time Limit' seconds has passed since the first buffered event was received.
- Consolidation Event Limit—If Event Consolidation is enabled, a message will be sent when the number of buffered events reaches the 'Consolidation Event Limit.'

5.4.2 SMS Settings

Selections in SMS Settings determine how the card sends text messages about events.

Settings	Edit	Save	Cancel	Units
SMS From Address				
SMS To Address				
SMS Subject Type			Default	
Custom Subject Text			DEFAULT_SUBJECT	
SMTP Server Address			0.0.0.0	
SMTP Server Port			25	
Include IP Address in Message			<input checked="" type="checkbox"/>	
Include Event Description in Message			<input checked="" type="checkbox"/>	
Include Name in Message			<input type="checkbox"/>	
Include Contact in Message			<input type="checkbox"/>	
Include Location in Message			<input type="checkbox"/>	
Include Description in Message			<input type="checkbox"/>	
Include Web Link in Message			<input type="checkbox"/>	
Enable Event Consolidation			<input checked="" type="checkbox"/>	
Consolidation Time Limit			60	
Consolidation Event Limit			20	

SMS Settings

- SMS From Address—Sender’s SMS address. In most cases this will be the SMS address of the person to whom replies should be sent. For example: Support@company.com
- SMS To Address—SMS address of the recipient. Multiple SMS addresses should be separated by a semicolon Note: The maximum length for an SMS address entry is 64 characters.
- SMS Subject Type—Subject of the message, either Default or Custom.
- Custom Subject Text—The subject of the message; can be customized by the customer
- SMTP Server Address—Fully qualified domain name or IP address of the server used for relaying SMS messages. The maximum length for this entry is 32 characters. Note 2: If using a server name, a DNS server must be configured under IP Settings.
- SMTP Server Port—SMTP server port. Note: Typically the default of 25 should be used.
- Include IP Address in Message—If checked the IP Address of the agent card will be included in outgoing messages.
- Include Event Description in Message—If checked SNMP event description will be included in outgoing messages.
- Include Name in Message—If checked the agent card Name will be included in outgoing messages.
- Include Contact in Message—If checked the agent card Contact will be included in outgoing messages.
- Include Location in Message—If checked the agent card Location will be included in outgoing messages.
- Include Description in Message—If checked the agent card Description will be included in outgoing messages.
- Include Web Link in Message—If checked a Web link to the agent card and Web Server listening port number will be included in outgoing messages.
- Enable Event Consolidation—If checked multiple events will be sent per outgoing message.
- Consolidation Time Limit—If Event Consolidation is enabled, a message will be sent when 'Consolidation Time Limit' seconds has passed since the first buffered event was received.
- Consolidation Event Limit—If Event Consolidation is enabled, a message will be sent when the number of buffered events reaches the 'Consolidation Event Limit.'

5.4.3 Messaging Test

Selections here permit testing the setup for e-mail and SMS messages. If the test fails, incorrect settings should be changed to ensure that the Liebert IntelliSlot Unity card sends proper notifications if an event should occur.

Status	Value	Units
Messaging Test Results		

Settings	Value	Units
Send Test Message	<input type="button" value="Edit"/> <input type="button" value="Save"/> <input type="button" value="Cancel"/>	
	Idle	

Messaging Test Settings

- Messaging Test Results—The messaging test results field.
- Send Test Message—The messaging test control used to send test email or SMS messages.

5.5 Unity Tab—Protocols

The Protocols folder displays the types of protocols that may be enabled for a Liebert IntelliSlot Unity card. Not all protocols are available at the same time. Some protocols may not be available for some types of managed devices (see **1.2 - Compatibility With Other Emerson Products and Communication Protocols**). The Liebert IntelliSlot Unity card allows selecting two third-party protocols.

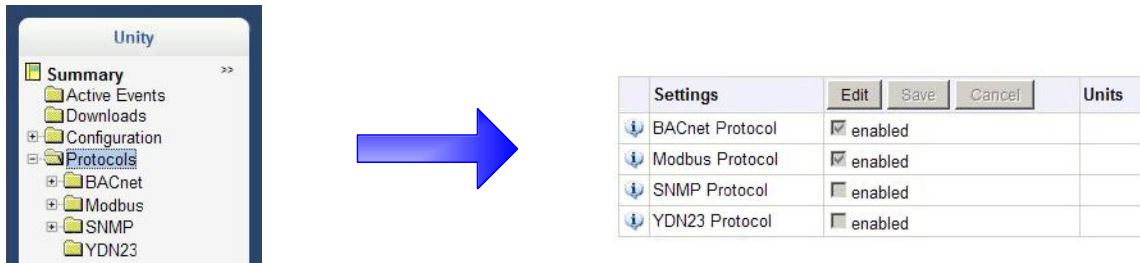

The folders contained by the Protocols folder are:

- **BACnet**
 - BACnet IP
 - BACnet MSTP
- **Modbus**
 - Modbus TCP
 - Modbus RTU
- **SNMP**
 - SNMPv3 User Settings (20)
 - SNMPv1 Trap Settings (20)
 - SNMPv1/v2c Access Settings (20)
- **YDN23**

Settings in each permit configuring the protocols available on the Liebert IntelliSlot Unity card.

5.6 Protocols Folder—BACnet Folder

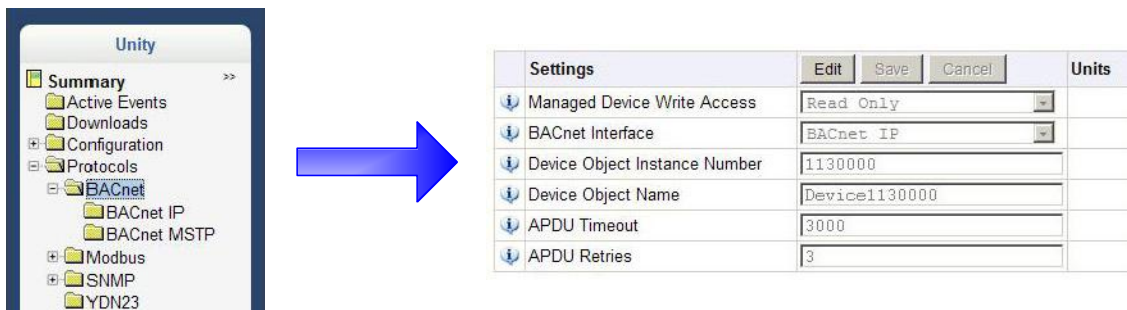

BACnet Settings

- **Managed Device Write Access**—Enable or Disable the BACnet server to write to the managed device.
- **BACnet Interface**—BACnet server interface: BACnet IP or BACnet MSTP.
- **Device Object Instance Number**—The instance number (0-4194302) of the BACnet server's device object.
- **Device Object Name**—The name of the BACnet server's device object.
- **APDU Timeout**—The timeout in milliseconds between APDU retries (1-65535).
- **APDU Retries**—The number of times to retransmit an APDU after the initial attempt (0-8).

5.6.1 Protocols Folder—BACnet IP Folder

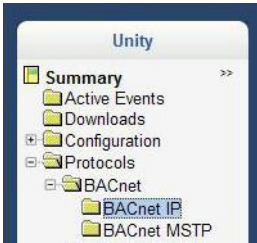

Settings	Edit	Save	Cancel	Units
BACnet IP Port Number	47808			
Register as Foreign Device	<input checked="" type="checkbox"/> enabled			
IP Address of BBMD				
Foreign Device Time-to-Live	1800			sec

BACnet IP Settings

- BACnet IP Port Number—The port for the BACnet server's UDP/IP connection.
- Register as Foreign Device—Enable or Disable registration as a foreign device.
- IP Address of BBMD—IP Address of the BACnet Broadcast Management Device (BBMD) to be accessed for Foreign Device Registration
- Foreign Device Time-to Live—Time to remain in the BBMD Foreign Device table after registration.

5.6.2 Protocols Folder—BACnet MSTP Folder

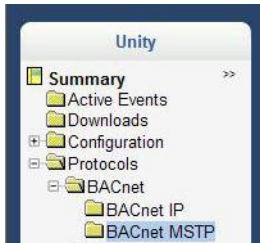

Settings	Edit	Save	Cancel	Units
Node ID	1			
Data Rate	38400			
Max Master Address	127			
Max Info Frames	8			

BACnet MSTP Settings

- Node ID—The BACnet server's MS/TP node ID (MAC).
- Data Rate—The BACnet MSTP communication rate (bits per second).
- Max Master Address—The maximum node ID (MAC) in use on the MS/TP network.
- Max Info Frames—Maximum number of information frames this node may send before it must pass the token.

5.7 Protocols Folder—Modbus

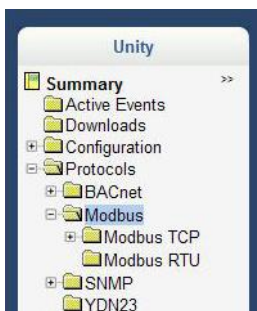

Settings	Edit	Save	Cancel	Units
Managed Device Write Access	Read Only			
Modbus Interface	Modbus TCP			

Modbus Settings

- Managed Device Write Access—Enable or Disable the Modbus server to write to the managed device
- Modbus Interface—Select the Modbus interface, either Modbus TCP or Modbus RTU

5.7.1 Modbus TCP

The Modbus TCP permits connection to the card by:

- any client (Open) permits communication by any IP address
- clients on the same subnet as the Liebert IntelliSlot Unity card
- clients with specific IP addresses (Trusted IP Lists); only five addresses are permitted

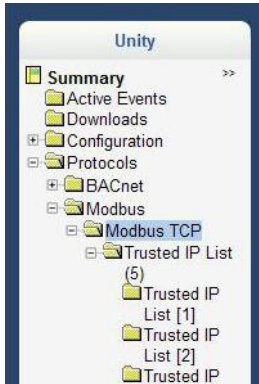

Settings	Edit	Save	Cancel	Units
Limit Network Access Type				
Port				
Maximum Client Connection Count				

Modbus TCP Settings

- Limit Network Access Type
- IP Access List (Open, Same Subnet, Trusted IP List)
- Port—The TCP port used by the Modbus Server to listen for and respond to Modbus protocol requests based on Limit Network Access Type setting.
- Maximum Client Connection Count

5.7.2 Modbus RTU

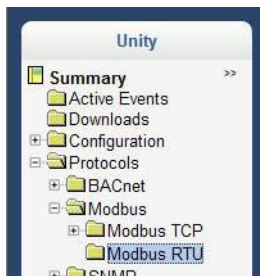

Settings	Edit	Save	Cancel	Units
Node ID				
Baud Rate				
Parity Check				

Modbus RTU Settings

- Node ID—Modbus Server ID for the interface; obtain from network administrator.
- Baud Rate—Communication rate (9600, 19200, 38400)
- Parity Check—The communication parity check (None, Even, Odd)

5.8 Protocols Folder—SNMP Subfolder

Folders and settings in this folder permit configuring the card for various types of SNMP communication, including access, traps and other user settings.



Status	Value	Units
SNMPv3 Engine ID	800001DC03000068123451	

Settings	Edit	Save	Cancel	Units
SNMPv1/v2c Enable	<input checked="" type="checkbox"/>	enabled		
SNMPv3 Enable	<input checked="" type="checkbox"/>	enabled		
Authentication Traps	<input type="checkbox"/>	enabled		
Heartbeat Trap Interval		24 hours		
RFC-1628 MIB	<input checked="" type="checkbox"/>	enabled		
RFC-1628 MIB Traps	<input checked="" type="checkbox"/>	enabled		
Liebert Global Products (LGP) MIB	<input checked="" type="checkbox"/>	enabled		
LGP MIB Traps	<input checked="" type="checkbox"/>	enabled		
LGP MIB System Notify Trap	<input checked="" type="checkbox"/>	enabled		

SNMP Settings

- **SNMPv3 Engine ID**—The SNMPv3 engine ID; assigned automatically
- **SNMP v1/v2c Enable**—Enable or Disable SNMP v1/v2c
- **SNMP v3 Enable**—Enable or Disable SNMPv3
- **Authentication Traps**—An Authentication Trap is sent if an SNMP host tries to access the card via SNMP, but either the host address is not in the SNMP Access Settings or it is using the wrong Community String.
- **Heartbeat Trap Interval**—Enable or Disable and set interval 5 minutes, 30 minutes, 1 hour, 4 hours, 8 hours, 12 hours and 24 hours
- **RFC-1628 MIB**—Enable or Disable support for retrieval of data from the RFC-1628 MIB objects. Required for proper operation of Liebert MultiLink® and applies only to managed UPS equipment
- **RFC-1628 MIB Traps**—Enable or Disable support for sending RFC-1628 traps. Required for proper operation of Liebert MultiLink and applies only to managed UPS equipment
- **Liebert Global Products (LGP) MIB**—Enable or Disable support for getting and setting data using the Liebert Global Products MIB.
- **LGP MIB Traps**—Enable or Disable support for Liebert Global Products MIB traps. LGP traps will not be sent unless LGP MIB is enabled.
- **LGP MIB System Notify Trap**—Enable or Disable support for the LGP System Notification trap. This is a single trap sent each time an alarm or warning is added or removed from the conditions table. It provides a text description of the event in a varbind of the trap message. LGP System Notify Traps will not be generated unless the LGP MIB is enabled.

5.8.1 SNMPv3 User Settings

The Liebert IntelliSlot-Unity card supports up to 20 SNMPv3 users. The top level page has a table with settings for all 20. The page displays a link to edit the table columns displayed for each SNMPv3 user. The same settings may be accessed by clicking on a folder for a user, such as SNMPv3 User Settings [1].

The Web page below shows the settings that can be changed for a SNMPv3 user. To display the settings, click on any of the SNMPv3 Users Setting links. After making any changes, click **Save** to make the changes effective; click **Cancel** to discard the changes.

The screenshot shows the Liebert IntelliSlot Unity web interface. At the top, it says 'Welcome Liebert (Administrator)' and 'Logout'. The main header is 'Liebert' with 'APS' and 'Unity' tabs. Below the header, it says 'SNMPv3 User Settings: Table' and 'Updated: March 11, 2014 03:57:33PM'. There is a link: 'Click here to edit columns displayed in the table'. A table with 20 rows is shown, each row representing a user setting (e.g., 'SNMPv3 User Settings [1]') and its status ('disabled'). A callout box points to one of these links. Below the table, there is a 'Settings' page for a selected user. This page has 'Edit', 'Save', and 'Cancel' buttons. The settings include: 'SNMPv3 User Enable' (checkbox checked, 'enabled'), 'SNMPv3 Username' (text field), 'SNMPv3 Access Type' (dropdown menu showing 'Read Only'), 'SNMPv3 Authentication' (dropdown menu showing 'None'), 'SNMPv3 Authentication Secret' (text field), 'SNMPv3 Privacy' (dropdown menu showing 'None'), 'SNMPv3 Privacy Secret' (text field), 'SNMPv3 Trap Targets' (text field), and 'SNMPv3 Trap Port' (text field with '162').

Click on a SNMPv3User Settings folder or a link to get this settings page.

SNMPv3 User Settings

- SNMPv3 User Enable—Select to enable read, write or sending notifications with the user's credentials.
- SNMPv3 Username—The User name the authentication and privacy settings apply to. This string can be composed of printable characters except colon, tab, double quote, and question mark.
- SNMPv3 Access Type—Read Only, Read/Write or Traps only
- SNMPv3 Authentication—Cryptographic algorithm used for authentication: None, MD5 or SHA-1
- SNMPv3 Authentication Secret—Pass phrase or password used for SNMPv3 Get request. This string can be composed of printable characters with the exception of colon, tab, double quote, and question mark. Note: The entry must be 8 or more characters but not more than 64.
- SNMPv3 Privacy—Cryptographic algorithm used for encryption: None or DES.
- SNMPv3 Privacy Secret—Pass phrase or password used for SNMPv3 Get request. This string can be composed of printable characters with the exception of colon, tab, double quote, and question mark. Note: The entry must be 8 or more characters but not more than 64.
- SNMPv3 Trap Target Addresses—Network hosts that will receive SNMPv3 traps, identified with either a network name or IP address. Multiple addresses must be separated by commas. The field has a maximum length of 125 characters
- SNMPv3 Trap Port—Port used by the target host for receiving SNMPv3 traps; default is 162.

5.8.2 Edit the SNMPv3 Table

The table on the SNMPv3 User Settings [20] page may be altered to provide more or less information. To do so, click on the command above the table (Click here to edit columns displayed in this table). Put a check mark (✓) in the boxes beside the desired information (see **Figure 23**). The choices permit showing the same information in this screen that is displayed by clicking on a SNMPv3 User Settings folder or a SNMPv3 User Settings link.

Figure 23 Edit the SNMPv3 table

Click on this link to change the information shown in the table

[Click here to edit columns displayed in the table](#)

Report	SNMPv3 User Enable
SNMPv3 User Settings [1]	disabled
SNMPv3 User Settings [2]	disabled
SNMPv3 User Settings [3]	disabled
SNMPv3 User Settings [4]	disabled
SNMPv3 User Settings [5]	disabled
SNMPv3 User Settings [6]	disabled
SNMPv3 User Settings [7]	disabled
SNMPv3 User Settings [8]	disabled
SNMPv3 User Settings [9]	disabled
SNMPv3 User Settings [10]	disabled
SNMPv3 User Settings [11]	disabled
SNMPv3 User Settings [12]	disabled
SNMPv3 User Settings [13]	disabled
SNMPv3 User Settings [14]	disabled
SNMPv3 User Settings [15]	disabled
SNMPv3 User Settings [16]	disabled
SNMPv3 User Settings [17]	disabled
SNMPv3 User Settings [18]	disabled
SNMPv3 User Settings [19]	disabled
SNMPv3 User Settings [20]	disabled

Choose data points to be displayed as columns in the table and hit 'Update' button. To exit without changes, hit 'Cancel' button.
(Note: Information is saved as browser cookies.)

- SNMPv3 User Enable
- SNMPv3 Username
- SNMPv3 Access Type
- SNMPv3 Authentication
- SNMPv3 Authentication Secret
- SNMPv3 Privacy
- SNMPv3 Privacy Secret
- SNMPv3 Trap Targets
- SNMPv3 Trap Port

Checking all choices will display the information below on the SNMPv3 User Settings [20] page

Advanced Settings:

Number of tables:

- Hide column text (Useful to reduce a width of table)

SNMPv3 User Enable	SNMPv3 Username	SNMPv3 Access Type	SNMPv3 Authentication	SNMPv3 Authentication Secret	SNMPv3 Privacy	SNMPv3 Privacy Secret	SNMPv3 Trap Targets	SNMPv3 Trap Port
disabled		Read Only	None		None			162

The information in the table for one user may be viewed by clicking on a SNMPv3 User Settings folder or a SNMPv3 User Settings link, as shown at right.

Settings	Edit	Save	Cancel	Units
SNMPv3 User Enable	<input type="checkbox"/>	enabled		
SNMPv3 Username				
SNMPv3 Access Type		Read Only		
SNMPv3 Authentication		None		
SNMPv3 Authentication Secret				
SNMPv3 Privacy		None		
SNMPv3 Privacy Secret				
SNMPv3 Trap Targets				
SNMPv3 Trap Port		162		

5.8.3 SNMPv1 Trap Settings

This page contains settings for network hosts that will receive SNMPv1 traps. Up to 20 trap recipients can be enabled and configured. Like the SNMPv3 pages, the setting for each target may be reached by clicking on the links in the Detail portion of the page or by clicking on the folders for the trap targets. Also, data shown in the table may be changed by clicking on the link above the table.

The screenshot shows the configuration page for the Liebert IntelliSlot Unity Card. The page title is "SNMPv1 Trap Settings: Table" and it was updated on March 11, 2014, at 04:04:52PM. The interface is divided into several sections:

- Identification:** Shows three uninitialized items.
- Status:** Shows APS and Unity both in "Normal Operation".
- Unity:** A navigation tree with folders for Summary, Active Events, Downloads, Configuration, Protocols, BACnet, Modbus, SNMP, SNMPv3 User Settings (20), and SNMPv1 Trap Settings (20). The "SNMPv1 Trap Settings [1]" folder is highlighted.
- Table:** A table with two columns: "Report" and "SNMP Trap Target". The first row shows "SNMPv1 Trap Settings [1]" with the target IP "126.4.202.194". Rows 2 through 20 are empty.
- Settings Form:** A detailed view for a selected trap target. It includes fields for "SNMP Trap Target" (126.4.202.194), "SNMP Trap Port" (162), and "SNMP Trap Community String" (*****). There are "Edit", "Save", and "Cancel" buttons.

Annotations in the image include:

- An arrow pointing to the link "Click here to edit columns displayed in the table" with the text: "Click on this link to change the information shown in the table on this page to the information shown below."
- An arrow pointing from the "SNMPv1 Trap Settings [1]" folder in the navigation tree to the "Settings" form with the text: "Click on a SNMPv1 Trap Settings folder or a link to get this settings page."

SNMPv1 Trap Settings

- **SNMP Trap Target Addresses**—Configure network hosts that will receive alert notifications (i.e., SNMP Traps). The host can be identified as either an IP address or the host’s network name.
- **SNMP Trap Port**—Port used by the target host for receiving notifications; default is 162.
- **SNMP Trap Community String**—String identifying a 'secret' known only by those hosts that want to be notified of device status changes.

5.8.4 SNMPv1/v2c Access Settings

This page contains settings for network hosts that can access data using SNMPv1/v2c. Up to 20 access hosts can be enabled and configured. Like the SNMPv3 pages, the setting for each host may be reached by clicking on the links in the data portion of the page or by clicking on the folders for the access hosts. Also, data shown in the table may be changed by clicking on the link above the table.

The screenshot shows the Liebert configuration interface. On the left is a navigation tree with categories like Identification, Status, and Unity. The main area displays a table titled "SNMPv1/v2c Access Settings: Table" with columns for "Report" and "SNMP Access Host". A link above the table says "Click here to edit columns displayed in the table". On the right, a detailed settings form is shown with fields for "SNMP Access Host", "SNMP Access Type", and "SNMP Access Community String".

Click on this link to change the information shown in the table on this page to the information shown below.

Click on a SNMPv1v2c Access Settings folder or a link to get this settings page.

Report	SNMP Access Host
SNMPv1/v2c Access Settings [1]	0.0.0.0
SNMPv1/v2c Access Settings [2]	
SNMPv1/v2c Access Settings [3]	
SNMPv1/v2c Access Settings [4]	
SNMPv1/v2c Access Settings [5]	
SNMPv1/v2c Access Settings [6]	
SNMPv1/v2c Access Settings [7]	
SNMPv1/v2c Access Settings [8]	
SNMPv1/v2c Access Settings [9]	
SNMPv1/v2c Access Settings [10]	
SNMPv1/v2c Access Settings [11]	
SNMPv1/v2c Access Settings [12]	
SNMPv1/v2c Access Settings [13]	
SNMPv1/v2c Access Settings [14]	
SNMPv1/v2c Access Settings [15]	
SNMPv1/v2c Access Settings [16]	
SNMPv1/v2c Access Settings [17]	
SNMPv1/v2c Access Settings [18]	
SNMPv1/v2c Access Settings [19]	
SNMPv1/v2c Access Settings [20]	

Settings	Edit	Save	Cancel	Units
SNMP Access Host				
SNMP Access Type				
SNMP Access Community String				

SNMPv1/v2c Access Settings

- SNMP Access IP Address—Configure network hosts interested in device information access. The host can be identified as either an IP address or the host’s network name
- SNMP Access Type—SNMPv1/v2C access type: Read Only or Read/Write
- SNMP Access Community String—SNMP Community String

5.9 Protocols Folder—YDN23 Protocol

The YDN23 protocol supported is based on the YD-T-1363 specification using an RS-485 network connection.

Settings	Edit	Save	Cancel	Units
Managed Device Write Access	Read Only			
Device Address	1			
Baud Rate	9600			

YDN23 Protocol

- Managed Device Write Access—Enable or Disable the YDN23 server to write to the managed device.
- Device Address—YDN23 device address
- Baud Rate—The communications rate in bps.

5.10 Configuration—Unity Tab-Status Folder

The Status folder contains no configurable items. It displays the System Status of the Liebert IntelliSlot Unity card and a list of events that affect the card's status. A green check mark (✓) indicates the status is Normal, as shown in the Status column

Status	Value	Units
System Status	Normal Operation	

Events	Status	Ack
System Restart Required	Normal	<input type="checkbox"/>
LIFE (TM) device identity changed - LIFE (TM) needs to be reconfigured.	Normal	<input type="checkbox"/>
RS-485 Port Conflict	Normal	<input type="checkbox"/>
Duplicate Emerson Protocol MSTP Node ID	Normal	<input type="checkbox"/>
Duplicate BACnet MSTP Node ID	Normal	<input type="checkbox"/>

5.11 Configuration—Unity Tab-Support Folder

The Support folder permits restarting the Liebert IntelliSlot Unity card, resetting the card to its factory defaults and updating the card's firmware. *Agent* refers to the Liebert IntelliSlot Unity card. The folder also displays information about the card for help in troubleshooting, such as the card's firmware version, label, MAC address and related information.

The screenshot shows the Liebert IntelliSlot Unity Card Configuration web interface. The top navigation bar includes the Emerson Network Power logo, 'APS' and 'Unity' tabs, and a 'Logout' button. The main content area is titled 'Support' and shows the following information:

Identification:
 Server01
 Server Room
 Liebert APS 5 kVA

Status:
 APS: Normal Operation
 Unity: Normal Operation

Unity:
 Summary >>
 Active Events
 Downloads
 Configuration
 Protocols
 Status
 Support
 Active Networking
 Firmware Update

Status Table:

Status	Value	Units
Agent Date and Time	2014-03-11 16:17:46	
Agent Model	Unity Platform	
Agent App Firmware Version	4.0.0.0	
Agent App Firmware Label	IS-UNITY_4.0.0.0_83532	
Agent Boot Firmware Version	1.0.0.0	
Agent Boot Firmware Label	UNITY_HID1_1.0.0.0_68768	
Agent Serial Number	UnityPwbAssyNo01D2012JAN300003	
Agent Manufacture Date	JAN 30 2012	
Agent Hardware Version	1	
GDD Version	97713	
FDM Version	871	
Product Sequence ID	11.1	

Commands:

Commands	Enable	Cancel
Restart Card	Restart	
Reset Card to Factory Defaults	Reset to Factory Defaults	
Generate and download diagnostic file	Get File	

Support Folder Settings

- Agent Date and Time—Date and time setting for the card.
- Agent Model—The card's model (Unity Platform)
- Agent App Firmware Version—The card's firmware version (2.0 or higher)
- Agent App Firmware Label—The card's firmware label
- Agent Boot Firmware Version—The card's Boot firmware version
- Agent Boot Firmware Label—The card's boot firmware label
- Agent Serial Number—The card's serial number
- Agent Manufacture Date—The card's manufacture date
- Agent Hardware Version—The card's hardware version
- GDD Version—The card's GDD version, current when the card's firmware was installed; the GDD is a proprietary reference document for device data.
- FDM Version—The card's FDM version; the FDM is a data model document that defines data supported by devices that use the Emerson Protocol.
- Product Sequence ID—The card's product sequence identifier

Commands - Enable/Cancel

- Restart Card—Restart card and implement configuration changes
- Reset Card to Factory Defaults—Reset the card's configuration to its factory defaults
- Generate and download diagnostic file—Generate a file containing diagnostic information and download it with a Web browser.

5.11.1 Unity Tab-Support Folder—Active Networking

Status of the currently active IP network settings for the Liebert IntelliSlot Unity card along with some previous values for troubleshooting IP communication issues.

The screenshot shows the Liebert IntelliSlot Unity Card configuration interface. The top navigation bar includes the Emerson Network Power logo, 'APS' and 'Unity' tabs, and the 'Liebert' brand name. The main content area is titled 'Active Networking' and is updated as of March 11, 2014, at 04:19:41 PM. On the left, there are three panels: 'Identification' (Server01, Server Room, Liebert APS 5 kVA), 'Status' (APS: Normal Operation, Unity: Normal Operation), and 'Unity' (a tree view with 'Active Networking' selected). The main panel displays a table of network settings:

Status	Value	Units
Ethernet MAC Address	00:00:68:12:34:51	
IPv4 Address	126.4.202.210	
IPv4 Default Gateway	126.4.202.1	
IPv4 Primary DNS	10.203.52.131	
IPv4 Secondary DNS	10.20.64.11	
Last DHCP/BootP	126.4.202.210	
Last DHCP Lease	86400	sec
IPv6 Global Address		
IPv6 Stateless Address AutoConfiguration		
IPv6 Link Local	fe80::200:68ff:fe12:3451	
IPv6 Default Gateway		
IPv6 Primary DNS		
IPv6 Secondary DNS		
Last DHCPv6		
Last DHCPv6 Lease		0 sec

Active Networking

- Ethernet MAC Address—Ethernet MAC Address for the Liebert IntelliSlot card
- IPv4 Address—Presently used IPv4 network address
- IPv4 Default Gateway—Presently used IPv4 network address of the gateway for network traffic destined for other networks or subnets
- IPv4 Primary DNS—Presently used IPv4 Primary DNS
- IPv4 Secondary DNS—Presently used IPv4 Secondary DNS
- Last DHCP/BootP—Last known IPv4 address assigned by DHCP
- Last DHCP Lease—Lease time of last known DHCP address
- IPv6 Global Address—Shows if DHCPv6 or Static address is presently being used
- IPv6 Stateless Address AutoConfiguration—IPv6 SLAAC is assigned automatically from Router Advertisement, if “A” flag is set, combining Prefix with EUI-64 MAC
- IPv6 Link Local—Presently used IPv6 Link Local Address
- IPv6 Default Gateway—Presently used IPv6 network address of the gateway for network traffic destined for other networks or subnets
- IPv6 Primary DNS—IPv6 Primary DNS
- IPv6 Secondary DNS
- IPv6 Secondary DNS
- Last DHCPv6—Last known IPv6 address assigned by DHCPv6
- Last DHCPv6 Lease—Lease time of last known DHCPv6 address

5.11.2 Unity Tab-Support Folder—Firmware Update

The Firmware Update folder supports updating the firmware of the Liebert IntelliSlot Unity card or reverting to an alternate firmware version and configuration (if the current firmware is not the initial load).

The screenshot shows the Liebert IntelliSlot Unity Card configuration interface. The top navigation bar includes the Emerson Network Power logo, 'APS' and 'Unity' tabs, and a 'Welcome Liebert (Administrator)' message with a 'Logout' button. The main content area is titled 'Firmware Update:' and shows 'Updated: March 11, 2014 04:20:28PM'. On the left, there are three sections: 'Identification' (Uninitialized), 'Status' (APS Normal Operation, Unity Normal Operation), and 'Unity' (Summary, Active Events, Downloads, Configuration, Protocols, Status, Support, Active Networking, Firmware Update). The main area contains a table with 'Status' and 'Value Units' columns, and a 'Commands' section with buttons for 'Enable', 'Cancel', 'Run Alternate', and 'Web'.

Status	Value	Units
Current Firmware Version	4.0.0.0	
Current Firmware Label	IS-UNITY_4.0.0.0_83532	
Current Firmware Date	Feb 28 2014 - 15:33:57	
Alternate Firmware Version	3.1.0.0	
Alternate Firmware Label	IS-UNITY_3.1.0.0_82316	
Alternate Firmware Date	Jan 9 2014 - 15:52:31	

Commands	Enable	Cancel
Run Alternate Firmware	Run Alternate	
Firmware Update	Web	

Firmware Update

- Current Firmware Version—The version of the firmware running on the card
- Current Firmware Label—The label of the firmware running on the card
- Current Firmware Date—The build date of the firmware running on the card
- Alternate Firmware Version—The version of the firmware in the alternate area
- Alternate Firmware Label—The label of the firmware in the alternate area
- Alternate Firmware Date—The build date of the firmware in the alternate area

Commands

- Run Alternate Firmware—Return the card's firmware to a version in the alternate area (the version in use before the most recent firmware update).
- Firmware Update—Update the card's firmware to a new version

6.0 FIRMWARE UPDATES

The Liebert IntelliSlot Unity card has two areas in flash memory for the firmware and the configuration. One area is currently operating on the card. The other area is the previous firmware on the card and is considered an alternate. For information on the alternate firmware, see **6.2 - Revert to Alternate Firmware**.

6.1 Updating the Liebert IntelliSlot Unity Card's Firmware

To update the Liebert IntelliSlot Unity card's firmware:

1. Download onto your computer the latest Liebert IntelliSlot Unity card firmware update from the Liebert software download Web site at www.liebert.com
2. If the card's DHCP or Static-IP address is known, type the IP address in the Web browser address window.
3. If the card does not have a known IP address and it is configured for DHCP, connect the card to a computer with an Ethernet cable and open a Web browser. The card has an Ethernet RJ-45 connector on the front (see **Figure 24**). The card and computer will automatically negotiate communications, which will take about one minute (for details on autoconfiguration, see **2.1.2 - Connect an Ethernet Cable**). When communication is established, open a Web browser and enter the address *169.254.24.7*, the card's default Autoconfiguration IPv4 Address. The card's Web page will appear.

Figure 24 Ethernet port

Liebert IntelliSlot
Card Ethernet Port

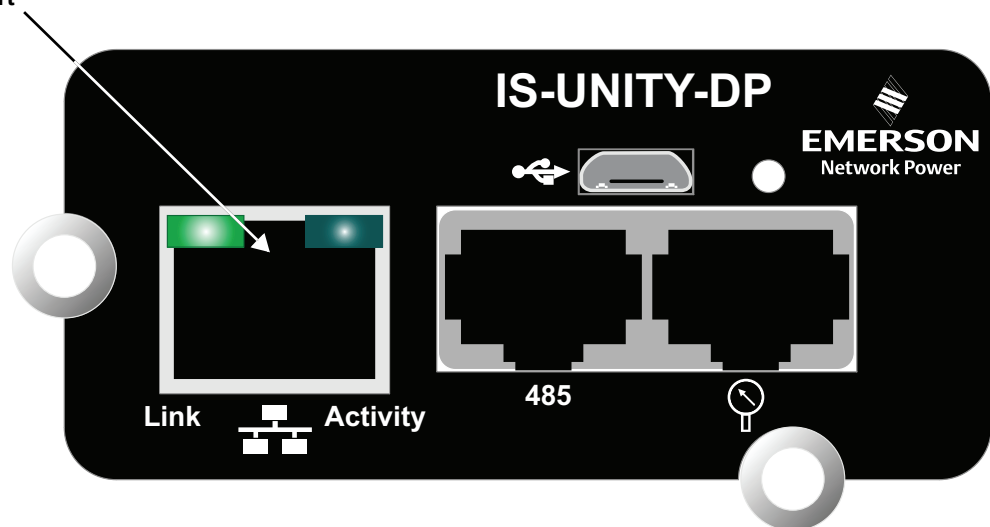

4. Select the Unity Tab at the top of the screen, then the Support folder from the Unity folders on the left of the screen and then the Firmware Update folder.
5. Select the **Enable** button.
6. Enter the administrator user name and password selected previously (see **2.2 - Change User Names and Passwords Immediately**) in the security dialog box that appears.
7. Click on the **Web** button and the firmware update screen will appear.
8. Browse to the firmware file to update, select it and click the **Update Firmware** button.



NOTE

Do not navigate away from the Firmware Update screen and do not close the browser once the update begins. Either action will interrupt the download.

Figure 25 Firmware update screen

The screenshot displays the Emerson Liebert web interface for firmware updates. The top navigation bar includes the Emerson logo, 'Network Power', and the Liebert brand name. The user is logged in as 'Liebert (Administrator)'. The main content area is titled 'Firmware Update:' and shows the current update status as 'Updated: March 11, 2014 04:20:28PM'.

On the left side, there are three panels: 'Identification' (showing 'Uninitialized'), 'Status' (showing 'APS Normal Operation' and 'Unity Normal Operation'), and 'Unity' (a tree view with folders like 'Summary', 'Active Events', 'Downloads', 'Configuration', 'Protocols', 'Status', 'Support', 'Active Networking', and 'Firmware Update').

The main area contains a 'Status' table and a 'Commands' section. The 'Status' table lists current and alternate firmware versions, labels, and dates. The 'Commands' section includes 'Run Alternate Firmware' and 'Firmware Update'. The 'Firmware Update' command has an 'Enable' button, a 'Cancel' button, and a 'Web' button.

Annotations include:

- Enable Button:** Points to the 'Enable' button in the 'Commands' section.
- Support Folder:** Points to the 'Support' folder in the 'Unity' tree view.
- Firmware Update:** Points to the 'Firmware Update' folder in the 'Unity' tree view.
- Web button becomes active when enabled and administrator's user name and password are entered:** Points to the 'Web' button.
- User name and password must be entered to update firmware:** Points to a login dialog box with fields for 'Username:' and 'Password:', and 'Login' and 'Cancel' buttons.

Status	Value	Units
Current Firmware Version	4.0.0.0	
Current Firmware Label	IS-UNITY_4.0.0.0_83532	
Current Firmware Date	Feb 28 2014 - 15:33:57	
Alternate Firmware Version	3.1.0.0	
Alternate Firmware Label	IS-UNITY_3.1.0.0_82316	
Alternate Firmware Date	Jan 9 2014 - 15:52:31	

6.2 Revert to Alternate Firmware

The Liebert IntelliSlot Unity card has two areas in flash memory for the firmware and the configuration. One area is currently operating on the card. The other area is considered an alternate.

When a card's firmware is updated, the previous firmware and configuration are moved to the alternate area. The Liebert IntelliSlot Unity card allows returning to the firmware version and configuration that are kept in the alternate area.



NOTE

Reverting to an alternate firmware version will not be possible if the currently operating firmware is the initial version loaded on the Liebert IntelliSlot Unity card. If the initially loaded firmware is still running on the card, the Alternate Version fields will be blank, and it will not be possible to revert to an alternate version.

1. Select the Unity Tab at the top of the screen.
2. Select the Support folder, then select the Update Firmware folder.
3. Select the **Enable** button.
4. Enter the user name and password in the security dialog box that appears; use the administrator user name and password from the user settings.
5. Click on the **Run Alternate** button and a confirmation dialog box will appear.
6. Click the **OK** button on the confirmation dialog box.



NOTE

The card will reboot. After the reboot, the card will be running the previous version of the firmware and configuration, which had been stored in flash memory. The previous firmware and configuration will have been moved to the alternate area.

APPENDIX A - CONFIGURATION FOLDER—LIFE™ SUBFOLDER

The LIFE subfolder contains settings that affect use of the Emerson® LIFE Technology, a remote monitoring and diagnostic service for Emerson units. The LIFE settings are for use by trained Emerson Network Power personnel only and require no user changes.

Status	Description
Connection Media	The LIFE Technology connection media
Enable Date and Time	The date and time that LIFE Technology support was enabled.
Settings	Description
LIFE Technology	Enable or disable the LIFE Technology
System Serial Number	System serial number, obtained from the unit automatically
Site Equipment Tag Number	Site equipment tag number
Site Identifier	Site identifier, entered by the Service Technician
Answer Incoming Call	Enable answering of LIFE Watch Station incoming calls
Next Call Date and Time	Date and Time of next call to make to the LIFE Watch Station server
Call Interval Days	Days between routine calls to LIFE Watch Station
Call Interval Hours	Number of hours between LIFE Watch Station routine calls
Call Interval Minutes	Number of minutes between routine LIFE Watch Station calls. This value is used in conjunction with val_life_callInterval_hours.
Call Trials Number	The number of attempts to retry a call after it fails before rescheduling the call.

UPS State SMS Messaging Configuration

Settings	Description
Primary Mains Restored SMS	Send SMS when Primary Mains are restored
Primary Mains Restored SMS Value	Value sent via SMS when Primary Mains are restored
Primary Mains Failure SMS	Send SMS when Primary Mains fail
Primary Mains Failure SMS Value	Value sent via SMS when Primary Mains fail
Bypass Mains Fail SMS	Send SMS when Bypass Mains fail
Bypass Mains Failure SMS Value	Value sent via SMS when Bypass Mains fail
Load On Bypass SMS	LIFE Load on Bypass SMS Enable
Load On Bypass SMS Delay	The amount of time to delay sending an SMS after a Load is on Bypass if the condition still exists.

Gate Settings

Status	Description
HTTP Transport Result	HTTP Transport Result contains the result of the last HTTP transaction.
HTTP Transport Error Value	HTTP Transport Error value from the last HTTP transaction
HTTP Transport Reply Time	HTTP transport reply time
Connection Result	IP connection result
Bridge State	IP Bridge state machine state
Error Count	Gate connection error count
Settings	Description
Proxy Enable	Enable Gate proxy
Proxy Authentication	Enable Gate proxy authentication
Proxy IP Address	Gate proxy IP address
Proxy IP Port Number	Gate proxy IP port number
Proxy User Name	Gate proxy user name
Proxy User Password	Gate proxy user password
LIFE Gate IP Address	LIFE Gate IP address
LIFE Gate IP Port Number	LIFE Gate Port Number

Advanced

Status	Description
Device State	Whether the device is connected or unconnected
Connection Status	The connection status of the Remote Service Delivery application system interface. This is the interface by which Remote Service Delivery services communicates with the Unity system software.
Call Type	The type of call currently in progress with the LIFE™ Watch Station server.
Scheduled Call Delay Time	The delay time before the next call to the LIFE Watch Station server.
Heartbeat Status	Device status as determined by heartbeat traps
Date and Time (UTC) of Last Call	The date and time (in UTC) of the LIFE Watch Station that was retrieved when the last successful call was made. YY-MM-DD HH:MM:SS
Commands	Description
Make Manual Call	Sends all currently collected events
Reset Scheduled Call Delay Time	Forces a rescheduled call to be done immediately
Reset Activity and Data	Resets all LIFE in-progress activity and deletes all LIFE data
Settings	Description
Service Mode	Enable or Disable LIFE service Mode

Technical Support / Service

Web Site

www.liebert.com

Monitoring

liebert.monitoring@emerson.com

800-222-5877

Outside North America: +00800 1155 4499

Single-Phase UPS & Server Cabinets

liebert.upstech@emerson.com

800-222-5877

Outside North America: +00800 1155 4499

Three-Phase UPS & Power Systems

800-543-2378

Outside North America: 614-841-6598

Environmental Systems

800-543-2778

Outside the United States: 614-888-0246

Locations

United States

1050 Dearborn Drive

P.O. Box 29186

Columbus, OH 43229

Europe

Via Leonardo Da Vinci 8

Zona Industriale Tognana

35028 Piove Di Sacco (PD) Italy

+39 049 9719 111

Fax: +39 049 5841 257

Asia

29/F, The Orient Square Building

F. Ortigas Jr. Road, Ortigas Center

Pasig City 1605

Philippines

+63 2 687 6615

Fax: +63 2 730 9572

While every precaution has been taken to ensure the accuracy and completeness of this literature, Liebert Corporation assumes no responsibility and disclaims all liability for damages resulting from use of this information or for any errors or omissions.

© 2013 Liebert Corporation

All rights reserved throughout the world. Specifications subject to change without notice.

© Liebert is a registered trademark of Liebert Corporation.

All names referred to are trademarks

or registered trademarks of their respective owners.

SL-52645_REV2_06-14

Emerson Network Power

Division: Liebert

Web: www.emerson.com