

# Nemschoff

## 2015 Price Book

Effective February 2, 2015



**OUR STORY** At Nemschoff, we believe that people make a difference, things should be built to last, and design can improve the way we live, work, and heal. We've built our company, our furniture, and our reputation in Healthcare on this belief, and we continue this tradition by providing innovative solutions for any high-use environment, including education and public spaces. Our products combine high-quality materials and expertise, thoughtful features, and unparalleled comfort, into a unique style of craft and design that you will only find at Nemschoff. We've stayed true to this path for over 60 years, and we're proud to offer you a broad portfolio of solutions that make a difference in people's lives.

# Welcoming & Waiting Contents



## Lounge Seating

- |                                     |                           |                           |
|-------------------------------------|---------------------------|---------------------------|
| <b>10</b> Brava Classic             | <b>49</b> Iris            | <b>74</b> Steps ◀         |
| <b>13</b> Brava Platform ◀          | <b>50</b> Lauderdale      | <b>81</b> Valor           |
| <b>18</b> Brooklyn                  | <b>52</b> Leonard II      | <b>83</b> Workhaven       |
| <b>20</b> Cities Small Crosstown ◀  | <b>54</b> Marco Grande II | ◀ Spanner table available |
| <b>24</b> Cities Medium Crosstown   | <b>56</b> Marsack         | + Plus model available    |
| <b>27</b> Cities Small Downtown ◀ + | <b>58</b> Maurice         |                           |
| <b>31</b> Cities Medium Downtown    | <b>59</b> Mod Pod ◀       |                           |
| <b>33</b> Cities Small Uptown ◀ +   | <b>62</b> Monarch         |                           |
| <b>37</b> Cities Medium Uptown      | <b>64</b> Oliver          |                           |
| <b>39</b> Evita ◀                   | <b>65</b> Olivia +        |                           |
| <b>42</b> Florabella                | <b>67</b> Ottoman         |                           |
| <b>43</b> Franklin                  | <b>68</b> Pamona          |                           |
| <b>45</b> Hadleigh                  | <b>70</b> Riva            |                           |
| <b>47</b> Harmon                    | <b>72</b> Sophia          |                           |

## Multiple & Tandem Seating

- |                           |                          |                           |
|---------------------------|--------------------------|---------------------------|
| <b>86</b> 2600 Series ◀   | <b>115</b> Capella       | <b>140</b> Reliant ◀ +    |
| <b>88</b> 2700 Series ◀ + | <b>117</b> Horizon ◀ +   | <b>146</b> Torii +        |
| <b>92</b> 2750 Series ◀   | <b>123</b> Marco +       | <b>148</b> Valor +        |
| <b>95</b> 2770 Series ◀   | <b>125</b> Mayfield ◀ +  | ◀ Spanner table available |
| <b>98</b> Anderson ◀ +    | <b>127</b> Meridian ◀ +  | + Plus model available    |
| <b>100</b> Auburn ◀ +     | <b>132</b> Monarch +     |                           |
| <b>109</b> Brava 862 +    | <b>134</b> Pause ◀       |                           |
| <b>112</b> Brava 863 +    | <b>138</b> Princeton ◀ + |                           |





## Welcoming & Waiting Contents



### Side, Stacking & Folding Chairs

- |                                |                                     |                              |
|--------------------------------|-------------------------------------|------------------------------|
| <b>150</b> Altair Side Chair + | <b>157</b> Dex Stack Chair          | <b>162</b> Torii Side Chair  |
| <b>151</b> Brava Side Chair    | <b>158</b> Diane Side Chair         | <b>163</b> Valor Stack Chair |
| <b>152</b> Capella Side Chair  | <b>159</b> Monarch Stack Chair      | <b>164</b> Whisk Stack Chair |
| <b>153</b> Cities Side Chair   | <b>160</b> Revive Side Chair        | + Plus model available       |
| <b>155</b> Dex Folding Chair   | <b>161</b> Romeo/Juliet Stack Chair |                              |



### Occasional Tables

- |                                |                         |                          |
|--------------------------------|-------------------------|--------------------------|
| <b>166</b> 2000 Series         | <b>179</b> Florabella   | <b>188</b> Olivia        |
| <b>168</b> Auburn              | <b>180</b> Hadleigh     | <b>189</b> Palisade      |
| <b>169</b> Brava               | <b>181</b> Horizon      | <b>190</b> Pamona        |
| <b>170</b> Brooklyn            | <b>182</b> Hudson       | <b>196</b> Reliant       |
| <b>171</b> Capella             | <b>183</b> Lauderdale   | <b>198</b> Riva          |
| <b>172</b> Carlson             | <b>184</b> Marco Grande | <b>199</b> Rockwood      |
| <b>173</b> Cities              | <b>185</b> Marsack      | <b>200</b> Torii         |
| <b>175</b> Cubes and Cylinders | <b>186</b> Meridian     | <b>201</b> Valor         |
| <b>178</b> Evita               | <b>187</b> Monarch      | <b>202</b> Custom Tables |

# Patient Areas Contents



## Patient Chairs

- |                             |                        |                        |
|-----------------------------|------------------------|------------------------|
| <b>209</b> 2750 Series      | <b>223</b> Easy Access | <b>235</b> Olivia      |
| <b>211</b> Brava +          | <b>225</b> Harmon      | <b>236</b> Revive      |
| <b>213</b> Brooklyn         | <b>226</b> Horizon     | <b>238</b> Torii       |
| <b>214</b> Capella          | <b>227</b> Marco       | <b>240</b> Valor       |
| <b>215</b> Centé            | <b>228</b> McKinley    | + Plus model available |
| <b>217</b> Cities Crosstown | <b>229</b> Meridian    |                        |
| <b>219</b> Cities Downtown  | <b>230</b> Monarch     |                        |
| <b>221</b> Cities Uptown    | <b>231</b> Nala        |                        |

## Recliners

- |  |   |                      |
|--|---|----------------------|
| <b>241</b> 2755 Adjustable Back Chair    | <b>251</b> Cities Uptown CompactComfort   | <b>260</b> Pamona    |
| <b>242</b> 2755 CompactComfort           | <b>253</b> Consoul                        | <b>261</b> Pristo II |
| <b>243</b> Auburn                        | <b>254</b> Culla                          | <b>263</b> Wallsaver |
| <b>245</b> Brava Adjustable Back Chair   | <b>255</b> Hadleigh Adjustable Back Chair |                      |
| <b>247</b> Brava CompactComfort          | <b>256</b> Horizon                        |                      |
| <b>249</b> Capella Adjustable Back Chair | <b>258</b> Leonard II                     |                      |
| <b>250</b> Capella CompactComfort        | <b>259</b> Oliver                         |                      |

## Treatment Chairs

- |                        |                         |                         |
|------------------------|-------------------------|-------------------------|
| <b>265</b> Pristo II + | <b>269</b> Serenity II  | <b>273</b> Serenity III |
| <b>267</b> Pristo IIT  | <b>271</b> Serenity IIS | + Plus model available  |

## Rockers & Gliders

- |   |                                    |                           |
|---|------------------------------------|---------------------------|
| <b>275</b> Auburn Glider                  | <b>281</b> Cities Crosstown Rocker | <b>291</b> Horizon Glider |
| <b>276</b> Avery Rocker                   | <b>283</b> Cities Downtown Rocker  | <b>292</b> Marco Glider   |
| <b>277</b> Brava Glider                   | <b>285</b> Cities Downtown Glider  | <b>293</b> Olivia Glider  |
| <b>279</b> Capella Glider                 | <b>287</b> Cities Uptown Rocker    | <b>294</b> Torii Rocker   |
| <b>280</b> Capella Adjustable Back Glider | <b>289</b> Cities Uptown Glider    | <b>295</b> Torii Glider   |



## Patient Areas Contents



### Overbed Tables

- 296** EZ-123
- 297** Oasis
- 299** Overbed Table



### Sleepover Seating

- |                                       |                                     |                                |
|---------------------------------------|-------------------------------------|--------------------------------|
| <b>300</b> Beaumont Chair and Settee  | <b>309</b> Monarch Chair and Settee | <b>319</b> SleepOver Bench     |
| <b>301</b> Brava Flop Sofa            | <b>311</b> Oliver Settee            | <b>321</b> SleepOver Flop Sofa |
| <b>302</b> Brava Settee               | <b>312</b> Palisade Flop Sofa       | <b>323</b> SleepOver Settee    |
| <b>303</b> Consoul Chair and Settee   | <b>314</b> Pamona Flop Sofa         | <b>321</b> SleepOver Sofa      |
| <b>305</b> Leonard II Sofa and Settee | <b>315</b> Revive Guest Center      |                                |
| <b>307</b> Merge Flop Sofa            | <b>318</b> SleepOver 1-2-3 Chair    |                                |



### Casegoods

- |                      |                      |
|----------------------|----------------------|
| <b>327</b> Bedford   | <b>349</b> Prague II |
| <b>335</b> Finley    | <b>353</b> Pristo    |
| <b>339</b> Hadleigh  | <b>354</b> Pristo II |
| <b>343</b> Montello  | <b>355</b> Revive    |
| <b>346</b> Palisade  | <b>361</b> Ten       |
| <b>348</b> Perinatal |                      |

### Casegoods Systems

- 365** Terra
- 371** Terra for Treatment Areas



### Display & Accessories

- 384** Palisade
- 385** Revive Display System

# Specialty Contents



## Children's Furniture

- 387** Erica Junior
- 388** Junior 200
- 389** Junior Recliner



## Behavioral Health

### Casegoods

- 390** Bedsides and Nightstands
- 391** Chests
- 392** Wardrobes
- 394** Desks
- 396** Beds

### Seating

- 400** High Use
- 401** Marsack III
- 403** Meridian



## Caregiver Stools

- 405** Lab Stools
- 406** Palisade
- 407** Physician Stools

# Reference Contents

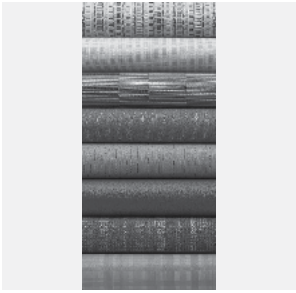

## **409 Illustrated Glossary**

## **415 Model Number Index**

## **421 Fabrics**

Nemschoff Performance Fabrics

Graded-In Fabrics

Customer's Own Material (COM)

## **425 Finishes**

About Nemschoff Finishes

Finish Colors

## **427 Hardware**

## **429 Warranties & Certifications**

Flammability

Five-Year Fabric Warranty

Limited Lifetime Warranty

GREENGUARD Certification

## **432 Ordering**

Online Ordering

Pacesetter Program

General Terms and Conditions

Collections by Brand

Trademarks

## Welcoming & Waiting



# Brava Classic Lounge Seating



## Standard Features

- Solid maple frame
- Mortise and tenon joinery
- Spring seat construction
- Clean-out design
- Replaceable components
- Upholstered arms
- Non-marring 7/8" rubber-cushioned glides
- Nemschoff healthcare wood finish
- GREENGUARD Gold Certified
- Limited Lifetime Warranty

## Available Options

- Moisture barrier + \$69 per seat or back
- Black urethane arm caps + \$116
- Desert or Pewter urethane arm caps + \$210
- Wood arm caps + \$116
- CTB-133 + \$83/yd
- Two fabrics + \$64
- Three (or more) fabrics + \$90
- Arm with literature storage (LSF, RSF, both sides) + \$495 per arm

## Specification Decisions

- Select fabric
  - Select standard wood finish
  - Add wood or urethane arm caps
  - Add moisture barrier
  - Add CTB-133
  - Apply multiple fabrics
  - Add arm with literature storage
- Model numbers with **S** indicate standard seat and back covers, and model numbers with **P** indicate removable covers.

## Flammability Type

- Type 6

## Coordinating Products

- [Brava Platform Lounge Seating](#)
- [Brava 862 Multiple Seating](#)
- [Brava 863 Multiple Seating](#)
- [Brava Side Chair](#)
- [Brava Tables](#)
- [Brava Adjustable Back Chair](#)
- [Brava CompactComfort Recliner](#)
- [Brava Patient Chair](#)
- [Brava Glider](#)
- [Brava Flop Sofa](#)
- [Brava Sleep Settee](#)

## Key Dimensions

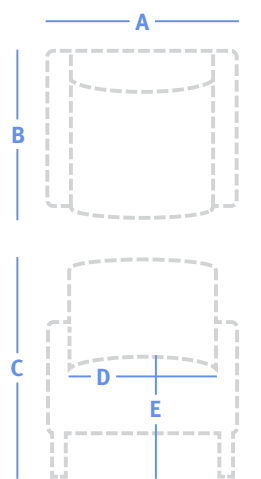

<b>A</b>	Overall Width	See price table
<b>B</b>	Overall Depth	28.5"
<b>C</b>	Overall Height	32"
<b>D</b>	Seat Width	
	Chair:	21.5", 23.5", 25.5"
	Settee / Two Seat:	40.5", 43.5", 47.5", 48.5", 51.5"
	Sofa / Three Seat:	65.25", 65.5", 67", 71.25", 71.5", 73.5"
<b>E</b>	Seat Height	18.75"
<b>F</b>	Arm Height	25"

### More Information

Illustrated Glossary ▶ 409





Fabrics ▶ 421

Flammability (CTB-133) ▶ 429

Finishes ▶ 426

Ordering and Warranties ▶ 432

## Brava Classic Lounge Seating

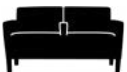
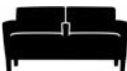
	<b>28.5" W, Chair</b>									48 lbs   4.5 yds
	Model	Series 2	Series 3	Series 4	Series 5	Series 6	Series 7	Series 8	COM	
	<b>861-10-1 S</b>	\$2,121	\$2,267	\$2,510	\$2,764	\$3,066	\$3,372	\$3,753	\$2,267	
	<b>861-10-1 P</b>	\$2,394	\$2,540	\$2,783	\$3,037	\$3,339	\$3,645	\$4,026	\$2,540	
	<b>30.5" W, Chair</b>									50 lbs   4.5 yds
	Model	Series 2	Series 3	Series 4	Series 5	Series 6	Series 7	Series 8	COM	
	<b>861-10-2 S</b>	\$2,121	\$2,267	\$2,510	\$2,764	\$3,066	\$3,372	\$3,753	\$2,267	
	<b>861-10-2 P</b>	\$2,394	\$2,540	\$2,783	\$3,037	\$3,339	\$3,645	\$4,026	\$2,540	
	<b>32.5" W, Chair</b>									52 lbs   6 yds
	Model	Series 2	Series 3	Series 4	Series 5	Series 6	Series 7	Series 8	COM	
	<b>861-10-3 S</b>	\$2,102	\$2,297	\$2,621	\$2,960	\$3,363	\$3,770	\$4,279	\$2,297	
	<b>861-10-3 P</b>	\$2,378	\$2,573	\$2,897	\$3,236	\$3,639	\$4,046	\$4,555	\$2,573	
	<b>50.5" W, Two seat</b>									74 lbs   6.5 yds
	Model	Series 2	Series 3	Series 4	Series 5	Series 6	Series 7	Series 8	COM	
	<b>861-20-1 S</b>	\$3,531	\$3,743	\$4,094	\$4,461	\$4,898	\$5,338	\$5,890	\$3,743	
	<b>861-20-1 P</b>	\$3,981	\$4,193	\$4,544	\$4,911	\$5,348	\$5,788	\$6,340	\$4,193	
	<b>50.5" W, Two seat with divider arm</b>									81 lbs   7 yds
	Model	Series 2	Series 3	Series 4	Series 5	Series 6	Series 7	Series 8	COM	
	<b>861-25-1 S</b>	\$3,911	\$4,139	\$4,517	\$4,912	\$5,382	\$5,857	\$6,451	\$4,139	
	<b>861-25-1 P</b>	\$4,408	\$4,636	\$5,014	\$5,409	\$5,879	\$6,354	\$6,948	\$4,636	
	<b>54.5" W, Two seat</b>									78 lbs   7 yds
	Model	Series 2	Series 3	Series 4	Series 5	Series 6	Series 7	Series 8	COM	
	<b>861-20-2 S</b>	\$3,515	\$3,743	\$4,121	\$4,516	\$4,986	\$5,461	\$6,055	\$3,743	
	<b>861-20-2 P</b>	\$3,965	\$4,193	\$4,571	\$4,966	\$5,436	\$5,911	\$6,505	\$4,193	
	<b>54.5" W, Settee</b>									72 lbs   6.25 yds
	Model	Series 2	Series 3	Series 4	Series 5	Series 6	Series 7	Series 8	COM	
	<b>861-2 S</b>	\$3,540	\$3,743	\$4,081	\$4,434	\$4,853	\$5,277	\$5,807	\$3,743	
	<b>861-2 P</b>	\$3,990	\$4,193	\$4,531	\$4,884	\$5,303	\$5,727	\$6,257	\$4,193	
	<b>54.5" W, Two seat with divider arm</b>									85 lbs   7.25 yds
	Model	Series 2	Series 3	Series 4	Series 5	Series 6	Series 7	Series 8	COM	
	<b>861-25-2 S</b>	\$3,903	\$4,139	\$4,531	\$4,940	\$5,427	\$5,918	\$6,533	\$4,139	
	<b>861-25-2 P</b>	\$4,400	\$4,636	\$5,028	\$5,437	\$5,924	\$6,415	\$7,030	\$4,636	
	<b>58.5" W, Two seat</b>									82 lbs   9.5 yds
	Model	Series 2	Series 3	Series 4	Series 5	Series 6	Series 7	Series 8	COM	
	<b>861-20-3 S</b>	\$3,983	\$4,293	\$4,806	\$5,342	\$5,980	\$6,624	\$7,430	\$4,293	
	<b>861-20-3 P</b>	\$4,499	\$4,809	\$5,322	\$5,858	\$6,496	\$7,140	\$7,946	\$4,809	
	<b>58.5" W, Two seat with divider arm</b>									89 lbs   9.5 yds
	Model	Series 2	Series 3	Series 4	Series 5	Series 6	Series 7	Series 8	COM	
	<b>861-25-3 S</b>	\$3,876	\$4,186	\$4,699	\$5,235	\$5,873	\$6,517	\$7,323	\$4,186	
	<b>861-25-3 P</b>	\$4,379	\$4,689	\$5,202	\$5,738	\$6,376	\$7,020	\$7,826	\$4,689	

Lounge Seating

Multiple & Tandem Seating

Side, Stacking & Folding Chairs

Occasional Tables



## Brava Classic Lounge Seating

	<b>72.75" W, Three seat</b>									100 lbs   8.5 yds
	Model	Series 2	Series 3	Series 4	Series 5	Series 6	Series 7	Series 8	COM	
	<b>861-30-1 S</b>	\$4,607	\$4,884	\$5,343	\$5,823	\$6,394	\$6,970	\$7,691	\$4,884	
	<b>861-30-1 P</b>	\$5,194	\$5,471	\$5,930	\$6,410	\$6,981	\$7,557	\$8,278	\$5,471	
	<b>78.75" W, Three seat</b>									106 lbs   9 yds
	Model	Series 2	Series 3	Series 4	Series 5	Series 6	Series 7	Series 8	COM	
	<b>861-30-2 S</b>	\$4,613	\$4,906	\$5,392	\$5,900	\$6,504	\$7,115	\$7,878	\$4,906	
	<b>861-30-2 P</b>	\$5,202	\$5,495	\$5,981	\$6,489	\$7,093	\$7,704	\$8,467	\$5,495	
	<b>78.75" W, Three seat with divider arms</b>									120 lbs   10 yds
	Model	Series 2	Series 3	Series 4	Series 5	Series 6	Series 7	Series 8	COM	
	<b>861-35-2 S</b>	\$5,579	\$5,905	\$6,445	\$7,010	\$7,681	\$8,359	\$9,207	\$5,905	
	<b>861-35-2 P</b>	\$6,288	\$6,614	\$7,154	\$7,719	\$8,390	\$9,068	\$9,916	\$6,614	
	<b>80.75" W, Three seat</b>									109 lbs   10 yds
	Model	Series 2	Series 3	Series 4	Series 5	Series 6	Series 7	Series 8	COM	
	<b>861-30-3 S</b>	\$4,580	\$4,906	\$5,446	\$6,011	\$6,682	\$7,360	\$8,208	\$4,906	
	<b>861-30-3 P</b>	\$5,169	\$5,495	\$6,035	\$6,600	\$7,271	\$7,949	\$8,797	\$5,495	
	<b>80.75" W, Sofa</b>									96 lbs   8 yds
	Model	Series 2	Series 3	Series 4	Series 5	Series 6	Series 7	Series 8	COM	
	<b>861-3 S</b>	\$4,623	\$4,884	\$5,316	\$5,768	\$6,305	\$6,847	\$7,526	\$4,884	
	<b>861-3 P</b>	\$5,210	\$5,471	\$5,903	\$6,355	\$6,892	\$7,434	\$8,113	\$5,471	
	<b>80.75" W, Three seat with divider arms</b>									123 lbs   11 yds
	Model	Series 2	Series 3	Series 4	Series 5	Series 6	Series 7	Series 8	COM	
	<b>861-35-3 S</b>	\$5,547	\$5,905	\$6,499	\$7,120	\$7,859	\$8,604	\$9,537	\$5,905	
	<b>861-35-3 P</b>	\$6,256	\$6,614	\$7,208	\$7,829	\$8,568	\$9,313	\$10,246	\$6,614	
	<b>84.75" W, Three seat</b>									112 lbs   12.5 yds
	Model	Series 2	Series 3	Series 4	Series 5	Series 6	Series 7	Series 8	COM	
	<b>861-30-4 S</b>	\$4,558	\$4,965	\$5,640	\$6,346	\$7,185	\$8,032	\$9,093	\$4,965	
	<b>861-30-4 P</b>	\$5,154	\$5,561	\$6,236	\$6,942	\$7,781	\$8,628	\$9,689	\$5,561	
	<b>84.75" W, Three seat with divider arms</b>									126 lbs   12.75 yds
	Model	Series 2	Series 3	Series 4	Series 5	Series 6	Series 7	Series 8	COM	
	<b>861-35-4 S</b>	\$5,543	\$5,959	\$6,647	\$7,367	\$8,223	\$9,088	\$10,169	\$5,959	
	<b>861-35-4 P</b>	\$6,259	\$6,675	\$7,363	\$8,083	\$8,939	\$9,804	\$10,885	\$6,675	

# Brava Platform Lounge Seating



## More Information

Illustrated Glossary ▶ 409

Fabrics ▶ 421

Flammability (CTB-133) ▶ 429

Finishes ▶ 426

Ordering and Warranties ▶ 432

## Standard Features

- Solid maple frame
- Mortise and tenon joinery
- Spring seat construction
- Clean-out design
- Replaceable components
- Upholstered arms
- Non-marring 7/8" rubber-cushioned glides
- Nemschoff healthcare wood finish
- GREENGUARD Gold Certified
- Limited Lifetime Warranty

## Available Options

- Moisture barrier + \$69 per seat or back
- Black urethane arm caps + \$116
- Desert or Pewter urethane arm caps + \$210
- Wood arm caps + \$116
- CTB-133 + \$83/yd
- Two fabrics + \$64
- Three (or more) fabrics + \$90
- Arm with literature storage (LSF, RSF, both sides) + \$495 per arm

## Specification Decisions

- Select fabric
  - Select standard wood finish
  - Add wood or urethane arm caps
  - Add moisture barrier
  - Add CTB-133
  - Apply multiple fabrics
  - Add arm with literature storage
- Model numbers with **S** indicate standard seat and back covers, and model numbers with **P** indicate removable covers.

## Flammability Types

- Type 6 (with arms)
- Type 5 (without arms)
- Type 4 (Bench)

## Coordinating Products

- [Brava Classic Lounge Seating](#)
- [Brava 862 Multiple Seating](#)
- [Brava 863 Multiple Seating](#)
- [Brava Side Chair](#)
- [Brava Tables](#)
- [Brava Adjustable Back Chair](#)
- [Brava CompactComfort Recliner](#)
- [Brava Patient Chair](#)
- [Brava Glider](#)
- [Brava Flop Sofa](#)
- [Brava Sleep Settee](#)

## Key Dimensions

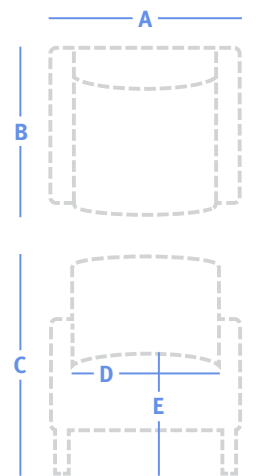









<b>A</b>	Overall Width	See price table
<b>B</b>	Overall Depth	28.5"
<b>C</b>	Overall Height	32"
<b>D</b>	Seat Width	
	Chair:	21.5", 26"
	Two Seat:	26", 47.5"
	Three Seat:	73.5", 78"
<b>E</b>	Seat Height	18.75"
<b>F</b>	Arm Height	25"

# Brava Platform Lounge Seating

	<b>26.5" W, Chair without arms</b>									36 lbs   3.25 yds
	Model	Series 2	Series 3	Series 4	Series 5	Series 6	Series 7	Series 8	COM	
	<b>860-11 S</b>	\$1,847	\$1,953	\$2,129	\$2,312	\$2,531	\$2,751	\$3,027	\$1,953	
	<b>860-11 P</b>	\$2,082	\$2,188	\$2,364	\$2,547	\$2,766	\$2,986	\$3,262	\$2,188	
	<b>28.5" W, Chair</b>									52 lbs   4.75 yds
	Model	Series 2	Series 3	Series 4	Series 5	Series 6	Series 7	Series 8	COM	
	<b>860-10 S</b>	\$2,429	\$2,584	\$2,841	\$3,109	\$3,428	\$3,750	\$4,153	\$2,584	
	<b>860-10 P</b>	\$2,740	\$2,895	\$3,152	\$3,420	\$3,739	\$4,061	\$4,464	\$2,895	
	<b>52.5" W, Two seat without arms</b>									68 lbs   6.5 yds
	Model	Series 2	Series 3	Series 4	Series 5	Series 6	Series 7	Series 8	COM	
	<b>860-21 S</b>	\$3,433	\$3,645	\$3,996	\$4,363	\$4,800	\$5,240	\$5,792	\$3,645	
	<b>860-21 P</b>	\$3,871	\$4,083	\$4,434	\$4,801	\$5,238	\$5,678	\$6,230	\$4,083	
	<b>54.5" W, Two seat</b>									84 lbs   6.75 yds
	Model	Series 2	Series 3	Series 4	Series 5	Series 6	Series 7	Series 8	COM	
	<b>860-20 S</b>	\$4,094	\$4,314	\$4,679	\$5,060	\$5,513	\$5,971	\$6,543	\$4,314	
	<b>860-20 P</b>	\$4,612	\$4,832	\$5,197	\$5,578	\$6,031	\$6,489	\$7,061	\$4,832	
	<b>54.5" W, Settee</b>									78 lbs   6.25 yds
	Model	Series 2	Series 3	Series 4	Series 5	Series 6	Series 7	Series 8	COM	
	<b>860-2 S</b>	\$4,062	\$4,265	\$4,603	\$4,956	\$5,375	\$5,799	\$6,329	\$4,265	
	<b>860-2 P</b>	\$4,574	\$4,777	\$5,115	\$5,468	\$5,887	\$6,311	\$6,841	\$4,777	
	<b>54.5" W, Two seat with divider arm</b>									91 lbs   7.25 yds
	Model	Series 2	Series 3	Series 4	Series 5	Series 6	Series 7	Series 8	COM	
	<b>860-25 S</b>	\$4,369	\$4,605	\$4,997	\$5,406	\$5,893	\$6,384	\$6,999	\$4,605	
	<b>860-25 P</b>	\$4,922	\$5,158	\$5,550	\$5,959	\$6,446	\$6,937	\$7,552	\$5,158	
	<b>52.25" W, One seat without arms, with LSF table, literature caddy and literature recess</b>									78 lbs   3.25 yds
	Model	Series 2	Series 3	Series 4	Series 5	Series 6	Series 7	Series 8	COM	
	<b>860-21LD S</b>	\$3,231	\$3,337	\$3,513	\$3,696	\$3,915	\$4,135	\$4,411	\$3,337	
	<b>860-21LD P</b>	\$3,632	\$3,738	\$3,914	\$4,097	\$4,316	\$4,536	\$4,812	\$3,738	
	<b>52.25" W, One seat without arms, with RSF table, literature caddy and literature recess</b>									78 lbs   3.25 yds
	Model	Series 2	Series 3	Series 4	Series 5	Series 6	Series 7	Series 8	COM	
	<b>860-21RD S</b>	\$3,231	\$3,337	\$3,513	\$3,696	\$3,915	\$4,135	\$4,411	\$3,337	
	<b>860-21RD P</b>	\$3,632	\$3,738	\$3,914	\$4,097	\$4,316	\$4,536	\$4,812	\$3,738	
	<b>52.25" W, One seat without arms, with LSF table and literature recess</b>									78 lbs   3.25 yds
	Model	Series 2	Series 3	Series 4	Series 5	Series 6	Series 7	Series 8	COM	
	<b>860-21LT S</b>	\$3,231	\$3,337	\$3,513	\$3,696	\$3,915	\$4,135	\$4,411	\$3,337	
	<b>860-21LT P</b>	\$3,632	\$3,738	\$3,914	\$4,097	\$4,316	\$4,536	\$4,812	\$3,738	
	<b>52.25" W, One seat without arms, with RSF table and literature recess</b>									78 lbs   3.25 yds
	Model	Series 2	Series 3	Series 4	Series 5	Series 6	Series 7	Series 8	COM	
	<b>860-21RT S</b>	\$3,231	\$3,337	\$3,513	\$3,696	\$3,915	\$4,135	\$4,411	\$3,337	
	<b>860-21RT P</b>	\$3,632	\$3,738	\$3,914	\$4,097	\$4,316	\$4,536	\$4,812	\$3,738	

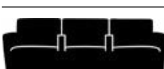
## Brava Platform Lounge Seating

	<b>53.25" W, One seat with RSF table, literature caddy and literature recess</b> <span style="float: right;">87 lbs   3.5 yds</span>								
	Model	Series 2	Series 3	Series 4	Series 5	Series 6	Series 7	Series 8	COM
	<b>860-20RD S</b>	\$3,889	\$4,003	\$4,192	\$4,390	\$4,625	\$4,862	\$5,159	\$4,003
	<b>860-20RD P</b>	\$4,370	\$4,484	\$4,673	\$4,871	\$5,106	\$5,343	\$5,640	\$4,484
	<b>53.25" W, One seat with LSF table, literature caddy and literature recess</b> <span style="float: right;">87 lbs   3.5 yds</span>								
	Model	Series 2	Series 3	Series 4	Series 5	Series 6	Series 7	Series 8	COM
	<b>860-20LD S</b>	\$3,889	\$4,003	\$4,192	\$4,390	\$4,625	\$4,862	\$5,159	\$4,003
	<b>860-20LD P</b>	\$4,370	\$4,484	\$4,673	\$4,871	\$5,106	\$5,343	\$5,640	\$4,484
	<b>53.25" W, One seat with RSF table and literature recess</b> <span style="float: right;">87 lbs   3.5 yds</span>								
	Model	Series 2	Series 3	Series 4	Series 5	Series 6	Series 7	Series 8	COM
	<b>860-20RT S</b>	\$3,889	\$4,003	\$4,192	\$4,390	\$4,625	\$4,862	\$5,159	\$4,003
	<b>860-20RT P</b>	\$4,370	\$4,484	\$4,673	\$4,871	\$5,106	\$5,343	\$5,640	\$4,484
	<b>53.25" W, One seat with LSF table and literature recess</b> <span style="float: right;">87 lbs   3.5 yds</span>								
	Model	Series 2	Series 3	Series 4	Series 5	Series 6	Series 7	Series 8	COM
	<b>860-20LT S</b>	\$3,889	\$4,003	\$4,192	\$4,390	\$4,625	\$4,862	\$5,159	\$4,003
	<b>860-20LT P</b>	\$4,370	\$4,484	\$4,673	\$4,871	\$5,106	\$5,343	\$5,640	\$4,484
	<b>79" W, Sofa without arms</b> <span style="float: right;">100 lbs   9.5 yds</span>								
	Model	Series 2	Series 3	Series 4	Series 5	Series 6	Series 7	Series 8	COM
	<b>860-31 S</b>	\$5,287	\$5,597	\$6,110	\$6,646	\$7,284	\$7,928	\$8,734	\$5,597
	<b>860-31 P</b>	\$5,959	\$6,269	\$6,782	\$7,318	\$7,956	\$8,600	\$9,406	\$6,269
	<b>80.75" W, Three seat</b> <span style="float: right;">117 lbs   9 yds</span>								
	Model	Series 2	Series 3	Series 4	Series 5	Series 6	Series 7	Series 8	COM
	<b>860-30 S</b>	\$5,886	\$6,179	\$6,665	\$7,173	\$7,777	\$8,388	\$9,151	\$6,179
	<b>860-30 P</b>	\$6,628	\$6,921	\$7,407	\$7,915	\$8,519	\$9,130	\$9,893	\$6,921
	<b>80.75" W, Sofa with continuous cushion</b> <span style="float: right;">104 lbs   8 yds</span>								
	Model	Series 2	Series 3	Series 4	Series 5	Series 6	Series 7	Series 8	COM
	<b>860-3 S</b>	\$5,923	\$6,184	\$6,616	\$7,068	\$7,605	\$8,147	\$8,826	\$6,184
	<b>860-3 P</b>	\$6,666	\$6,927	\$7,359	\$7,811	\$8,348	\$8,890	\$9,569	\$6,927
	<b>80.75" W, Three seat with divider arms</b> <span style="float: right;">131 lbs   10 yds</span>								
	Model	Series 2	Series 3	Series 4	Series 5	Series 6	Series 7	Series 8	COM
	<b>860-35 S</b>	\$6,301	\$6,627	\$7,167	\$7,732	\$8,403	\$9,081	\$9,929	\$6,627
	<b>860-35 P</b>	\$7,097	\$7,423	\$7,963	\$8,528	\$9,199	\$9,877	\$10,725	\$7,423
	<b>78.25" W, Two seat without arms, with LSF table, literature caddy and literature recess</b> <span style="float: right;">110 lbs   6.5 yds</span>								
	Model	Series 2	Series 3	Series 4	Series 5	Series 6	Series 7	Series 8	COM
	<b>860-31LD S</b>	\$5,088	\$5,300	\$5,651	\$6,018	\$6,455	\$6,895	\$7,447	\$5,300
	<b>860-31LD P</b>	\$5,724	\$5,936	\$6,287	\$6,654	\$7,091	\$7,531	\$8,083	\$5,936
	<b>80.75" W, Two seat without arms, with center table, literature caddy and literature recess</b> <span style="float: right;">110 lbs   6.5 yds</span>								
	Model	Series 2	Series 3	Series 4	Series 5	Series 6	Series 7	Series 8	COM
	<b>860-31CD S</b>	\$5,088	\$5,300	\$5,651	\$6,018	\$6,455	\$6,895	\$7,447	\$5,300
	<b>860-31CD P</b>	\$5,724	\$5,936	\$6,287	\$6,654	\$7,091	\$7,531	\$8,083	\$5,936

Lounge Seating

Multiple & Tandem Seating

Side, Stacking & Folding Chairs

Occasional Tables

## Brava Platform Lounge Seating

	<b>78.25" W, Two seat without arms, with LSF table and literature recess</b> <span style="float: right;">110 lbs   6.5 yds</span>
	Model Series 2 Series 3 Series 4 Series 5 Series 6 Series 7 Series 8 COM
	<b>860-31LT S</b> \$5,088 \$5,300 \$5,651 \$6,018 \$6,455 \$6,895 \$7,447 \$5,300 <b>860-31LT P</b> \$5,724 \$5,936 \$6,287 \$6,654 \$7,091 \$7,531 \$8,083 \$5,936
	<b>80.75" W, Two seat without arms, with center table and literature recess</b> <span style="float: right;">110 lbs   6.5 yds</span>
	Model Series 2 Series 3 Series 4 Series 5 Series 6 Series 7 Series 8 COM
	<b>860-31CT S</b> \$5,088 \$5,300 \$5,651 \$6,018 \$6,455 \$6,895 \$7,447 \$5,300 <b>860-31CT P</b> \$5,724 \$5,936 \$6,287 \$6,654 \$7,091 \$7,531 \$8,083 \$5,936
	<b>80.75" W, Two seat without arms with center surface and literature caddy</b> <span style="float: right;">100 lbs   6.5 yds</span>
	Model Series 2 Series 3 Series 4 Series 5 Series 6 Series 7 Series 8 COM
	<b>860-31CV S</b> \$5,088 \$5,300 \$5,651 \$6,018 \$6,455 \$6,895 \$7,447 \$5,300 <b>860-31CV P</b> \$5,724 \$5,936 \$6,287 \$6,654 \$7,091 \$7,531 \$8,083 \$5,936
	<b>78.25" W, Two seat without arms, with RSF table, literature caddy and literature recess</b> <span style="float: right;">110 lbs   6.5 yds</span>
	Model Series 2 Series 3 Series 4 Series 5 Series 6 Series 7 Series 8 COM
	<b>860-31RD S</b> \$5,088 \$5,300 \$5,651 \$6,018 \$6,455 \$6,895 \$7,447 \$5,300 <b>860-31RD P</b> \$5,724 \$5,936 \$6,287 \$6,654 \$7,091 \$7,531 \$8,083 \$5,936
	<b>78.25" W, Two seat without arms, with RSF table and literature recess</b> <span style="float: right;">110 lbs   6.5 yds</span>
	Model Series 2 Series 3 Series 4 Series 5 Series 6 Series 7 Series 8 COM
	<b>860-31RT S</b> \$5,088 \$5,300 \$5,651 \$6,018 \$6,455 \$6,895 \$7,447 \$5,300 <b>860-31RT P</b> \$5,724 \$5,936 \$6,287 \$6,654 \$7,091 \$7,531 \$8,083 \$5,936
	<b>79.25" W, Two seat with LSF table and literature recess</b> <span style="float: right;">119 lbs   5.75 yds</span>
	Model Series 2 Series 3 Series 4 Series 5 Series 6 Series 7 Series 8 COM
	<b>860-30LT S</b> \$5,699 \$5,886 \$6,197 \$6,521 \$6,907 \$7,297 \$7,785 \$5,886 <b>860-30LT P</b> \$6,406 \$6,593 \$6,904 \$7,228 \$7,614 \$8,004 \$8,492 \$6,593
	<b>80.75" W, Two seat with center table, literature caddy and literature recess</b> <span style="float: right;">128 lbs   6.75 yds</span>
	Model Series 2 Series 3 Series 4 Series 5 Series 6 Series 7 Series 8 COM
	<b>860-30CD S</b> \$5,840 \$6,060 \$6,425 \$6,806 \$7,259 \$7,717 \$8,289 \$6,060 <b>860-30CD P</b> \$6,568 \$6,788 \$7,153 \$7,534 \$7,987 \$8,445 \$9,017 \$6,788
	<b>79.25" W, Two seat with LSF table, literature caddy and literature recess</b> <span style="float: right;">119 lbs   5.75 yds</span>
	Model Series 2 Series 3 Series 4 Series 5 Series 6 Series 7 Series 8 COM
	<b>860-30LD S</b> \$5,699 \$5,886 \$6,197 \$6,521 \$6,907 \$7,297 \$7,785 \$5,886 <b>860-30LD P</b> \$6,406 \$6,593 \$6,904 \$7,228 \$7,614 \$8,004 \$8,492 \$6,593
	<b>80.75" W, Two seat with center table and literature recess</b> <span style="float: right;">128 lbs   6.75 yds</span>
	Model Series 2 Series 3 Series 4 Series 5 Series 6 Series 7 Series 8 COM
	<b>860-30CT S</b> \$5,840 \$6,060 \$6,425 \$6,806 \$7,259 \$7,717 \$8,289 \$6,060 <b>860-30CT P</b> \$6,568 \$6,788 \$7,153 \$7,534 \$7,987 \$8,445 \$9,017 \$6,788
	<b>80.75" W, Two seat with center surface and literature caddy</b> <span style="float: right;">118 lbs   6.75 yds</span>
	Model Series 2 Series 3 Series 4 Series 5 Series 6 Series 7 Series 8 COM
	<b>860-30CV S</b> \$5,840 \$6,060 \$6,425 \$6,806 \$7,259 \$7,717 \$8,289 \$6,060 <b>860-30CV P</b> \$6,568 \$6,788 \$7,153 \$7,534 \$7,987 \$8,445 \$9,017 \$6,788

## Brava Platform Lounge Seating



### 79.25" W, Two seat with RSF table and literature recess

118 lbs | 5.75 yds

Model	Series 2	Series 3	Series 4	Series 5	Series 6	Series 7	Series 8	COM
<b>860-30RT S</b>	\$5,699	\$5,886	\$6,197	\$6,521	\$6,907	\$7,297	\$7,785	\$5,886
<b>860-30RT P</b>	\$6,406	\$6,593	\$6,904	\$7,228	\$7,614	\$8,004	\$8,492	\$6,593



### 79.25" W, Two seat with RSF table, literature caddy and literature recess

118 lbs | 5.75 yds

Model	Series 2	Series 3	Series 4	Series 5	Series 6	Series 7	Series 8	COM
<b>860-30RD S</b>	\$5,699	\$5,886	\$6,197	\$6,521	\$6,907	\$7,297	\$7,785	\$5,886
<b>860-30RD P</b>	\$6,406	\$6,593	\$6,904	\$7,228	\$7,614	\$8,004	\$8,492	\$6,593

## Brava Platform Lounge Bench

### Standard Features

Same standard features as Brava Platform Lounge Seating

### Available Options

Same options as Brava Platform Lounge Seating

### Key Dimensions

- Overall Width: See price table
- Overall Depth: 27"
- Overall Height: 18.75"



### 26.5" W, Bench

38 lbs | 2 yds

Model	Series 2	Series 3	Series 4	Series 5	Series 6	Series 7	Series 8	COM
<b>860-B1 S</b>	\$1,834	\$1,899	\$2,007	\$2,120	\$2,255	\$2,390	\$2,560	\$1,899
<b>860-B1 P</b>	\$2,062	\$2,127	\$2,235	\$2,348	\$2,483	\$2,618	\$2,788	\$2,127



### 52.5" W, Bench

60 lbs | 3.75 yds

Model	Series 2	Series 3	Series 4	Series 5	Series 6	Series 7	Series 8	COM
<b>860-B2 S</b>	\$2,294	\$2,416	\$2,619	\$2,831	\$3,082	\$3,337	\$3,655	\$2,416
<b>860-B2 P</b>	\$2,584	\$2,706	\$2,909	\$3,121	\$3,372	\$3,627	\$3,945	\$2,706



### 78.5" W, Bench

87 lbs | 5.5 yds

Model	Series 2	Series 3	Series 4	Series 5	Series 6	Series 7	Series 8	COM
<b>860-B3 S</b>	\$2,863	\$3,042	\$3,339	\$3,650	\$4,019	\$4,392	\$4,858	\$3,042
<b>860-B3 P</b>	\$3,229	\$3,408	\$3,705	\$4,016	\$4,385	\$4,758	\$5,224	\$3,408

# Brooklyn Lounge Seating



## Standard Features

- Solid maple frame
- Mortise and tenon joinery
- Spring seat construction
- Clean-out design
- Replaceable components
- Wood arm caps
- Wallsaver legs
- Non-marring 7/8" rubber-cushioned glides
- Nemschoff healthcare wood finish
- GREENGUARD Gold Certified
- Limited Lifetime Warranty

## Available Options

- Moisture barrier + \$69 per seat or back
- Black urethane arm caps + \$116
- CTB-133 + \$83/yd
- Two fabrics + \$64
- Three (or more) fabrics + \$90

## Specification Decisions

- Select fabric
- Select standard wood finish
- Add urethane arm caps
- Add moisture barrier
- Add CTB-133
- Apply multiple fabrics

Model numbers with **S** indicate standard seat and back covers, and model numbers with **P** indicate removable covers.

## Flammability Type

- Type 6

## Coordinating Products

- [Brooklyn Tables](#)
- [Brooklyn Patient Chair](#)

## Key Dimensions

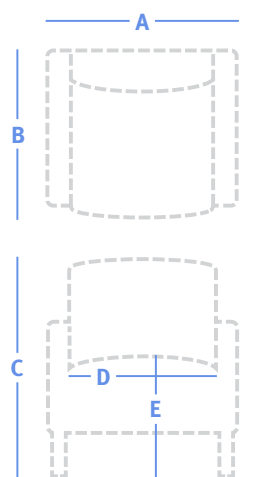

<b>A</b>	Overall Width	See price table
<b>B</b>	Overall Depth	28.25"
<b>C</b>	Overall Height	34"
<b>D</b>	Seat Width	
	Chair:	21.5", 23.25", 27.25"
	Settee / Two Seat:	21.5", 46.5", 56"
	Sofa / Three Seat:	21.5", 70.75", 83"
<b>E</b>	Seat Height	18.75"
<b>F</b>	Arm Height	24.5", 25.5"

### More Information

Illustrated Glossary ▶ 409









Fabrics ▶ 421

Flammability (CTB-133) ▶ 429

Finishes ▶ 426

Ordering and Warranties ▶ 432

## Brooklyn Lounge Seating

	<b>26.75" W, Chair</b>									48 lbs   3.25 yds
	Model	Series 2	Series 3	Series 4	Series 5	Series 6	Series 7	Series 8	COM	
	<b>770-1 S</b>	\$1,662	\$1,768	\$1,944	\$2,127	\$2,346	\$2,566	\$2,842	\$1,768	
	<b>770-1 P</b>	\$1,875	\$1,981	\$2,157	\$2,340	\$2,559	\$2,779	\$3,055	\$1,981	
	<b>29.5" W, Chair</b>									87 lbs   6 yds
	Model	Series 2	Series 3	Series 4	Series 5	Series 6	Series 7	Series 8	COM	
	<b>776-10 S</b>	\$2,517	\$2,712	\$3,036	\$3,375	\$3,778	\$4,185	\$4,694	\$2,712	
	<b>776-10 P</b>	\$2,843	\$3,038	\$3,362	\$3,701	\$4,104	\$4,511	\$5,020	\$3,038	
	<b>33.5" W, Chair</b>									89 lbs   6 yds
	Model	Series 2	Series 3	Series 4	Series 5	Series 6	Series 7	Series 8	COM	
	<b>776-1 S</b>	\$2,707	\$2,902	\$3,226	\$3,565	\$3,968	\$4,375	\$4,884	\$2,902	
	<b>776-1 P</b>	\$3,056	\$3,251	\$3,575	\$3,914	\$4,317	\$4,724	\$5,233	\$3,251	
	<b>51.5" W, Settee</b>									82 lbs   4.5 yds
	Model	Series 2	Series 3	Series 4	Series 5	Series 6	Series 7	Series 8	COM	
	<b>770-2 S</b>	\$2,491	\$2,637	\$2,880	\$3,134	\$3,436	\$3,742	\$4,123	\$2,637	
	<b>770-2 P</b>	\$2,808	\$2,954	\$3,197	\$3,451	\$3,753	\$4,059	\$4,440	\$2,954	
	<b>51.5" W, Settee with intervening arm and leg</b>									87 lbs   5.25 yds
	Model	Series 2	Series 3	Series 4	Series 5	Series 6	Series 7	Series 8	COM	
	<b>770-22 S</b>	\$2,894	\$3,065	\$3,349	\$3,645	\$3,998	\$4,354	\$4,799	\$3,065	
	<b>770-22 P</b>	\$3,262	\$3,433	\$3,717	\$4,013	\$4,366	\$4,722	\$5,167	\$3,433	
	<b>62.25" W, Settee</b>									145 lbs   9.25 yds
	Model	Series 2	Series 3	Series 4	Series 5	Series 6	Series 7	Series 8	COM	
	<b>776-2 S</b>	\$4,409	\$4,710	\$5,210	\$5,732	\$6,353	\$6,980	\$7,765	\$4,710	
	<b>776-2 P</b>	\$4,975	\$5,276	\$5,776	\$6,298	\$6,919	\$7,546	\$8,331	\$5,276	
	<b>76" W, Sofa</b>									115 lbs   6 yds
	Model	Series 2	Series 3	Series 4	Series 5	Series 6	Series 7	Series 8	COM	
	<b>770-3 S</b>	\$3,434	\$3,629	\$3,953	\$4,292	\$4,695	\$5,102	\$5,611	\$3,629	
	<b>770-3 P</b>	\$3,870	\$4,065	\$4,389	\$4,728	\$5,131	\$5,538	\$6,047	\$4,065	
	<b>76" W, Sofa with intervening arms and legs</b>									125 lbs   7.75 yds
	Model	Series 2	Series 3	Series 4	Series 5	Series 6	Series 7	Series 8	COM	
	<b>770-33 S</b>	\$4,218	\$4,470	\$4,889	\$5,326	\$5,846	\$6,372	\$7,029	\$4,470	
	<b>770-33 P</b>	\$4,755	\$5,007	\$5,426	\$5,863	\$6,383	\$6,909	\$7,566	\$5,007	
	<b>89.25" W, Sofa</b>									195 lbs   12.25 yds
	Model	Series 2	Series 3	Series 4	Series 5	Series 6	Series 7	Series 8	COM	
	<b>776-3 S</b>	\$6,073	\$6,472	\$7,133	\$7,825	\$8,647	\$9,478	\$10,517	\$6,472	
	<b>776-3 P</b>	\$6,850	\$7,249	\$7,910	\$8,602	\$9,424	\$10,255	\$11,294	\$7,249	

Lounge Seating

Multiple & Tandem Seating

Side, Stacking & Folding Chairs

Occasional Tables



# Cities Small Crosstown Lounge Seating



## Standard Features

- Solid maple frame
- Mortise and tenon joinery
- Spring seat construction
- Wipe-out design
- Replaceable components
- Wood arm caps
- Non-marring 7/8" rubber-cushioned glides
- Nemschoff healthcare wood finish
- GREENGUARD Gold Certified
- Limited Lifetime Warranty

## Available Options

- Moisture barrier + \$69 per seat or back
- Five arm cap styles + \$0
- Four foot styles + \$0
- Four back styles + \$0
- Two arm styles + \$0
- CTB-133 + \$83/yd
- Two fabrics + \$64
- Three (or more) fabrics + \$90
- Attached table (LSF, RSF – see price table)

## Specification Decisions

- Select fabric
- Select standard wood finish
- Add moisture barrier
- Add CTB-133
- Apply multiple fabrics
- Add attached table
- Select arm cap style

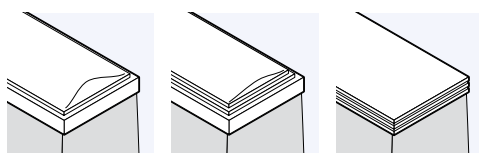

**C** Chicago      **L** Los Angeles      **N** New Orleans

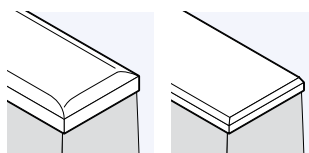

**Y** New York      **W** Williamsburg

- Select foot style

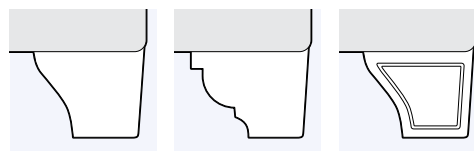

**B** Boston      **C** Chicago      **P** Philadelphia

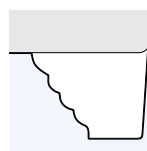

**S** San Francisco

- Select back style. All styles have a wipe-out feature.

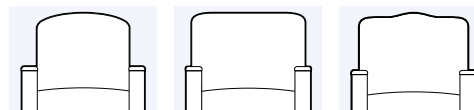

**A** Arcade back      **D** T-back      **K** Camel T-back

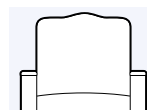

**Q** Camel square back

- Select arm style

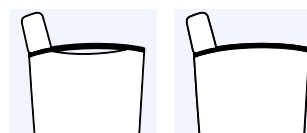

**E** Elliptical arm      **C** Closed arm

Model numbers with **S** indicate standard seat and back covers, and model numbers with **P** indicate removable covers.

## Flammability Types

- Type 8
- Type 3 (Bench)

### More Information

Illustrated Glossary ▶ 409

Fabrics ▶ 421

Flammability (CTB-133) ▶ 429

Finishes ▶ 426

Ordering and Warranties ▶ 432

# Cities Small Crosstown Lounge Seating

Lounge Seating

Multiple & Tandem Seating

Side, Stacking & Folding Chairs

Occasional Tables

## Coordinating Products

- [Cities Medium Crosstown Lounge Seating](#)
- [Cities Small Downtown Lounge Seating](#)
- [Cities Medium Downtown Lounge Seating](#)
- [Cities Small Uptown Lounge Seating](#)
- [Cities Medium Uptown Lounge Seating](#)
- [Cities Side Chair](#)
- [Cities Tables](#)
- [Cities Crosstown Patient Chair](#)
- [Cities Downtown Patient Chair](#)
- [Cities Uptown Patient Chair](#)
- [Cities Uptown CompactComfort Recliner](#)
- [Cities Crosstown Rocker](#)
- [Cities Downtown Rocker](#)
- [Cities Uptown Rocker](#)
- [Cities Downtown Glider](#)
- [Cities Uptown Glider](#)
- [SleepOver Sofa](#)
- [SleepOver Settee](#)

## Key Dimensions

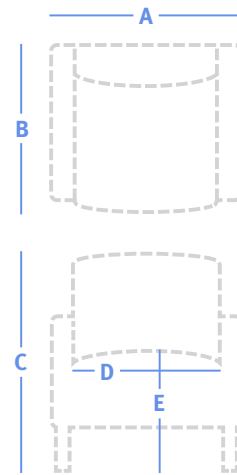

<b>A</b>	Overall Width	See price table
<b>B</b>	Overall Depth	26"
<b>C</b>	Overall Height	33"
<b>D</b>	Seat Width	
	Chair:	19.5", 23.5"
	Two Seat:	39"
	Three Seat:	58.5"
	Four Seat:	78"
<b>E</b>	Seat Height	18.5"
<b>F</b>	Arm Height	25.5"

	<b>26.5" W, Chair</b>									35 lbs   3.5 yds
	Model	Series 2	Series 3	Series 4	Series 5	Series 6	Series 7	Series 8	COM	
	<b>Cities-SCXXXX-10SX</b>	\$1,262	\$1,376	\$1,565	\$1,763	\$1,998	\$2,235	\$2,532	\$1,376	
	<b>Cities-SCXXXX-10PX</b>	\$1,428	\$1,542	\$1,731	\$1,929	\$2,164	\$2,401	\$2,698	\$1,542	
	<b>30.5" W, Chair</b>									35 lbs   3.75 yds
	Model	Series 2	Series 3	Series 4	Series 5	Series 6	Series 7	Series 8	COM	
	<b>Cities-SCXXXX-1WSX</b>	\$1,442	\$1,564	\$1,767	\$1,979	\$2,230	\$2,485	\$2,803	\$1,564	
	<b>Cities-SCXXXX-1WPX</b>	\$1,630	\$1,752	\$1,955	\$2,167	\$2,418	\$2,673	\$2,991	\$1,752	
	<b>47" W, Two seat</b>									64 lbs   5 yds
	Model	Series 2	Series 3	Series 4	Series 5	Series 6	Series 7	Series 8	COM	
	<b>Cities-SCXXXX-20SX</b>	\$2,045	\$2,208	\$2,478	\$2,761	\$3,096	\$3,435	\$3,859	\$2,208	
	<b>Cities-SCXXXX-20PX</b>	\$2,310	\$2,473	\$2,743	\$3,026	\$3,361	\$3,700	\$4,124	\$2,473	
	<b>49" W, Two seat with intervening arm and leg</b>									70 lbs   5.75 yds
	Model	Series 2	Series 3	Series 4	Series 5	Series 6	Series 7	Series 8	COM	
	<b>Cities-SCXXXX-22SX</b>	\$2,439	\$2,626	\$2,937	\$3,261	\$3,647	\$4,037	\$4,525	\$2,626	
	<b>Cities-SCXXXX-22PX</b>	\$2,755	\$2,942	\$3,253	\$3,577	\$3,963	\$4,353	\$4,841	\$2,942	

## Cities Small Crosstown Lounge Seating

	<b>67" W, Three seat</b>									92 lbs   6.5 yds
	Model	Series 2	Series 3	Series 4	Series 5	Series 6	Series 7	Series 8	COM	
	<b>Cities-SCXXXX-30SX</b>	\$2,727	\$2,939	\$3,290	\$3,657	\$4,094	\$4,534	\$5,086	\$2,939	
	<b>Cities-SCXXXX-30PX</b>	\$3,080	\$3,292	\$3,643	\$4,010	\$4,447	\$4,887	\$5,439	\$3,292	
	<b>67" W, Three seat with intervening arms and legs</b>									104 lbs   8.25 yds
	Model	Series 2	Series 3	Series 4	Series 5	Series 6	Series 7	Series 8	COM	
	<b>Cities-SCXXXX-33SX</b>	\$3,437	\$3,706	\$4,152	\$4,617	\$5,171	\$5,731	\$6,430	\$3,706	
	<b>Cities-SCXXXX-33PX</b>	\$3,882	\$4,151	\$4,597	\$5,062	\$5,616	\$6,176	\$6,875	\$4,151	
	<b>95" W, Four seat with intervening arms and legs</b>									140 lbs   10.5 yds
	Model	Series 2	Series 3	Series 4	Series 5	Series 6	Series 7	Series 8	COM	
	<b>Cities-SCXXXX-44SX</b>	\$4,529	\$4,871	\$5,438	\$6,031	\$6,736	\$7,448	\$8,338	\$4,871	
	<b>Cities-SCXXXX-44PX</b>	\$5,114	\$5,456	\$6,023	\$6,616	\$7,321	\$8,033	\$8,923	\$5,456	

## Cities Small Crosstown Bench

### Standard Features

Same standard features as Cities Small Crosstown Lounge Seating

### Available Options

Same options as Cities Small Crosstown Lounge Seating

### Key Dimensions

- Overall Width: See price table
- Overall Depth: 23"
- Overall Height: 18.75"

	<b>25.5" W, Bench</b>									33 lbs   2.75 yds
	Model	Series 2	Series 3	Series 4	Series 5	Series 6	Series 7	Series 8	COM	
	<b>Cities-SCXX0X-B1S0</b>	\$1,005	\$1,094	\$1,243	\$1,398	\$1,583	\$1,769	\$2,002	\$1,094	
	<b>Cities-SCXX0X-B1P0</b>	\$1,137	\$1,226	\$1,375	\$1,530	\$1,715	\$1,901	\$2,134	\$1,226	
	<b>45.5" W, Bench</b>									39 lbs   3.75 yds
	Model	Series 2	Series 3	Series 4	Series 5	Series 6	Series 7	Series 8	COM	
	<b>Cities-SCXX0X-B2S0</b>	\$1,311	\$1,433	\$1,636	\$1,848	\$2,099	\$2,354	\$2,672	\$1,433	
	<b>Cities-SCXX0X-B2P0</b>	\$1,483	\$1,605	\$1,808	\$2,020	\$2,271	\$2,526	\$2,844	\$1,605	
	<b>65.5" W, Bench</b>									45 lbs   4.5 yds
	Model	Series 2	Series 3	Series 4	Series 5	Series 6	Series 7	Series 8	COM	
	<b>Cities-SCXX0X-B3S0</b>	\$1,627	\$1,773	\$2,016	\$2,270	\$2,572	\$2,878	\$3,259	\$1,773	
	<b>Cities-SCXX0X-B3P0</b>	\$1,840	\$1,986	\$2,229	\$2,483	\$2,785	\$3,091	\$3,472	\$1,986	

## Cities Small Crosstown Lounge Seating

### Cities Spanner Tables

#### Standard Features

- Same standard features as Cities Small Uptown Lounge Seating, plus:
- Laminate or veneer tops
- Straight table apron on Crosstown
- Dry-construction joinery

#### Available Options

- Five tabletop edge styles + \$0

#### Specification Decisions

- Select standard wood finish
- Select standard laminate
- Select edge style



**C** Chicago



**L** Los Angeles

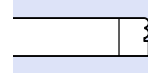

**N** New Orleans

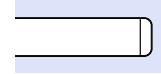

**Y** New York

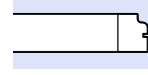

**W** Williamsburg

#### 19.5" W, Spanner table with legs

24 lbs

Model	Price	Depth	Height
<b>Cities-SUX000-S10X</b>	\$841	19.5"	

#### 19.5" W, Spanner table without legs

24 lbs

Model	Price	Depth	Height
<b>Cities-SUX000-S00X</b>	\$534	19.5"	

#### 27.25" W, Corner spanner table with legs

29 lbs

Model	Price	Depth	Height
<b>Cities-SUX000-C10X</b>	\$1,444	27.25"	

# Cities Medium Crosstown Lounge Seating



## Standard Features

- Solid maple frame
- Mortise and tenon joinery
- Spring seat construction
- Wipe-out design
- Replaceable components
- Wood arm caps
- 5/8" x 2" bar glides
- Nemschoff healthcare wood finish
- GREENGUARD Gold Certified
- Limited Lifetime Warranty

## Available Options

- Moisture barrier + \$69 per seat or back
- Five arm cap styles + \$0
- Four foot styles + \$0
- Four back styles + \$0
- Two arm styles + \$0
- CTB-133 + \$83/yd
- Two fabrics + \$64
- Three (or more) fabrics + \$90

## Specification Decisions

- Select fabric
- Select standard wood finish
- Add moisture barrier
- Add CTB-133
- Apply multiple fabrics
- Select arm cap style

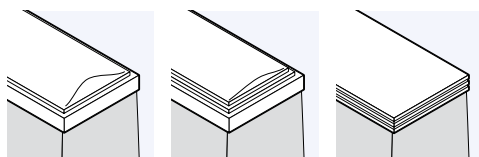

**C** Chicago      **L** Los Angeles      **N** New Orleans

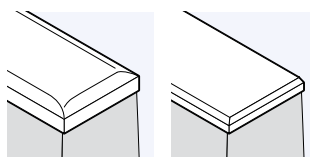

**Y** New York      **W** Williamsburg

- Select foot style

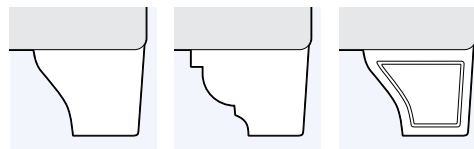

**B** Boston      **C** Chicago      **P** Philadelphia

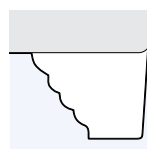

**S** San Francisco

- Select back style

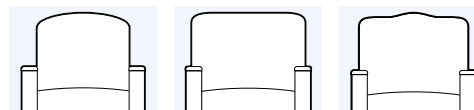

**A** Arcade back with wipe-out      **D** T-back with wipe-out      **K** Camel T-back with wipe-out  
**R** Arcade back without wipe-out      **T** T-back without wipe-out      **L** Camel T-back without wipe-out

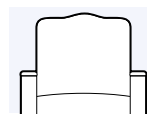

**Q** Camel square back with wipe-out

**M** Camel square back without wipe-out

- Select arm style



**E** Elliptical arm      **C** Closed arm

Model numbers with **S** indicate standard seat and back covers, and model numbers with **P** indicate removable covers.

## Flammability Type

- Type 6

### More Information

Illustrated Glossary ▶ 409

Fabrics ▶ 421

Flammability (CTB-133) ▶ 429

Finishes ▶ 426

Ordering and Warranties ▶ 432

# Cities Medium Crosstown Lounge Seating

Lounge Seating

Multiple & Tandem Seating

Side, Stacking & Folding Chairs

Occasional Tables

## Coordinating Products

- [Cities Small Crosstown Lounge Seating](#)
- [Cities Small Downtown Lounge Seating](#)
- [Cities Medium Downtown Lounge Seating](#)
- [Cities Small Uptown Lounge Seating](#)
- [Cities Medium Uptown Lounge Seating](#)
- [Cities Side Chair](#)
- [Cities Tables](#)
- [Cities Crosstown Patient Chair](#)
- [Cities Downtown Patient Chair](#)
- [Cities Uptown Patient Chair](#)
- [Cities Uptown CompactComfort Recliner](#)
- [Cities Crosstown Rocker](#)
- [Cities Downtown Rocker](#)
- [Cities Uptown Rocker](#)
- [Cities Downtown Glider](#)
- [Cities Uptown Glider](#)
- [SleepOver Sofa](#)
- [SleepOver Settee](#)

## Key Dimensions

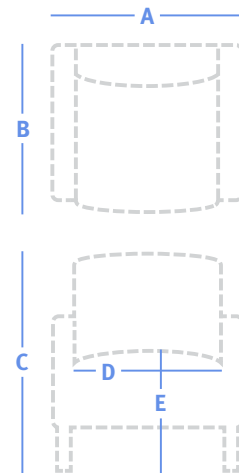

<b>A</b>	Overall Width	See price table
<b>B</b>	Overall Depth	27.25"
<b>C</b>	Overall Height	32.5"
<b>D</b>	Seat Width	
	Chair:	19.25"
	Two Seat:	21.25", 42.5"
	Three Seat:	63.75"
<b>E</b>	Seat Height	18.5"
<b>F</b>	Arm Height	25.75"



### 28" W, Chair

51 lbs | 4.5 yds

Model	Series 2	Series 3	Series 4	Series 5	Series 6	Series 7	Series 8	COM
<b>Cities-MCXXXX-10S0</b>	\$2,170	\$2,316	\$2,559	\$2,813	\$3,115	\$3,421	\$3,802	\$2,316
<b>Cities-MCXXXX-10P0</b>	\$2,448	\$2,594	\$2,837	\$3,091	\$3,393	\$3,699	\$4,080	\$2,594



### 50" W, Two seat

85 lbs | 6 yds

Model	Series 2	Series 3	Series 4	Series 5	Series 6	Series 7	Series 8	COM
<b>Cities-MCXXXX-20S0</b>	\$3,616	\$3,811	\$4,135	\$4,474	\$4,877	\$5,284	\$5,793	\$3,811
<b>Cities-MCXXXX-20P0</b>	\$4,074	\$4,269	\$4,593	\$4,932	\$5,335	\$5,742	\$6,251	\$4,269



### 53" W, Two seat with intervening arm and leg

109 lbs | 7.5 yds

Model	Series 2	Series 3	Series 4	Series 5	Series 6	Series 7	Series 8	COM
<b>Cities-MCXXXX-22S0</b>	\$4,001	\$4,245	\$4,650	\$5,074	\$5,577	\$6,086	\$6,722	\$4,245
<b>Cities-MCXXXX-22P0</b>	\$4,511	\$4,755	\$5,160	\$5,584	\$6,087	\$6,596	\$7,232	\$4,755

## Cities Medium Crosstown Lounge Seating



### 71.5" W, Three seat

131 lbs | 7.75 yds

Model	Series 2	Series 3	Series 4	Series 5	Series 6	Series 7	Series 8	COM
<b>Cities-MCXXXX-30S0</b>	\$4,737	\$4,989	\$5,408	\$5,845	\$6,365	\$6,891	\$7,548	\$4,989
<b>Cities-MCXXXX-30P0</b>	\$5,336	\$5,588	\$6,007	\$6,444	\$6,964	\$7,490	\$8,147	\$5,588



### 77" W, Three seat with intervening arms and legs

147 lbs | 10.75 yds

Model	Series 2	Series 3	Series 4	Series 5	Series 6	Series 7	Series 8	COM
<b>Cities-MCXXXX-33S0</b>	\$5,642	\$5,992	\$6,573	\$7,179	\$7,901	\$8,630	\$9,542	\$5,992
<b>Cities-MCXXXX-33P0</b>	\$6,362	\$6,712	\$7,293	\$7,899	\$8,621	\$9,350	\$10,262	\$6,712

# Cities Small Downtown Lounge Seating



## More Information

Illustrated Glossary ▶ 409

Fabrics ▶ 421

Flammability (CTB-133) ▶ 429

Finishes ▶ 426

Ordering and Warranties ▶ 432

## Standard Features

- Solid maple frame
- Mortise and tenon joinery
- Spring seat construction
- Wipe-out design
- Replaceable components
- Wood arm caps
- Non-marring 7/8" rubber-cushioned glides
- Nemschoff healthcare wood finish
- GREENGUARD Gold Certified
- Limited Lifetime Warranty
- See nemschoff.com for weight ratings (BDXXAX-OB30, BDXXAX-OB40)

## Available Options

- Moisture barrier + \$69 per seat or back
- Five arm cap styles + \$0
- Four foot styles + \$0
- Three back styles + \$0
- Two rail styles + \$0
- CTB-133 + \$83/yd
- Two fabrics + \$64
- Three (or more) fabrics + \$90
- Attached tables (LSF, RSF – see price table)

## Specification Decisions

- Select fabric
- Select standard wood finish
- Add moisture barrier
- Add CTB-133
- Apply multiple fabrics
- Add attached table
- Select arm cap style

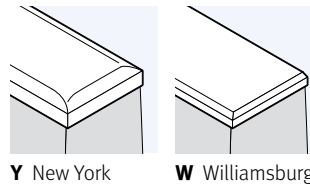

- Select foot style

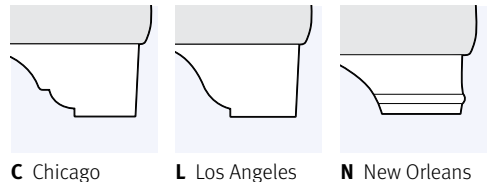

**C** Chicago    **L** Los Angeles    **N** New Orleans

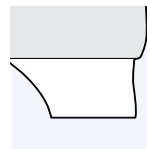

**W** Williamsburg

- Select back style. All styles have a wipe-out feature.

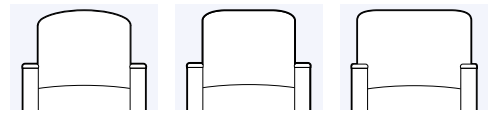

**A** Arcade back    **B** Square back    **D** T-back

- Select rail style

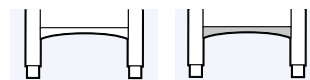

**U** Upholstered    **W** Wood

Model numbers with **S** indicate standard seat and back covers, and model numbers with **P** indicate removable covers.

## Flammability Types

- Type 8
- Type 3 (Bench)



# Cities Small Downtown Lounge Seating

## Coordinating Products

- [Cities Small Crosstown Lounge Seating](#)
- [Cities Medium Crosstown Lounge Seating](#)
- [Cities Medium Downtown Lounge Seating](#)
- [Cities Small Uptown Lounge Seating](#)
- [Cities Medium Uptown Lounge Seating](#)
- [Cities Side Chair](#)
- [Cities Tables](#)
- [Cities Crosstown Patient Chair](#)
- [Cities Downtown Patient Chair](#)
- [Cities Uptown Patient Chair](#)
- [Cities Uptown CompactComfort Recliner](#)
- [Cities Crosstown Rocker](#)
- [Cities Downtown Rocker](#)
- [Cities Uptown Rocker](#)
- [Cities Downtown Glider](#)
- [Cities Uptown Glider](#)
- [SleepOver Sofa](#)
- [SleepOver Settee](#)

## Key Dimensions

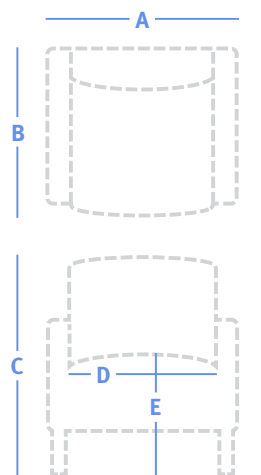

<b>A</b>	Overall Width	See price table
<b>B</b>	Overall Depth	23.75"
<b>C</b>	Overall Height	33.5"
<b>D</b>	Seat Width	
	Chair:	19.5", 23.5", 30", 40"
	Two Seat:	19.5", 39"
	Three Seat:	19.5", 58.5"
<b>E</b>	Seat Height	18.5"
<b>F</b>	Arm Height	25.25"

	<b>24.5" W, Chair</b>									35 lbs   3.5 yds
	Model	Series 2	Series 3	Series 4	Series 5	Series 6	Series 7	Series 8	COM	
	<b>Cities-SDXXXX-10SX</b>	\$1,262	\$1,376	\$1,565	\$1,763	\$1,998	\$2,235	\$2,532	\$1,376	
	<b>Cities-SDXXXX-10PX</b>	\$1,428	\$1,542	\$1,731	\$1,929	\$2,164	\$2,401	\$2,698	\$1,542	
	<b>28.5" W, Chair</b>									38 lbs   3.75 yds
	Model	Series 2	Series 3	Series 4	Series 5	Series 6	Series 7	Series 8	COM	
	<b>Cities-SDXXXX-1WSX</b>	\$1,442	\$1,564	\$1,767	\$1,979	\$2,230	\$2,485	\$2,803	\$1,564	
	<b>Cities-SDXXXX-1WPX</b>	\$1,638	\$1,752	\$1,941	\$2,139	\$2,374	\$2,611	\$2,908	\$1,752	
	<b>34.5" W, Plus chair</b>									59 lbs   5 yds
	Model	Series 2	Series 3	Series 4	Series 5	Series 6	Series 7	Series 8	COM	
	<b>Cities-BDXXAX-OB30</b>	\$3,324	\$3,487	\$3,757	\$4,040	\$4,375	\$4,714	\$5,138	\$3,487	
	<b>44.5" W, Plus chair</b>									64 lbs   5.25 yds
	Model	Series 2	Series 3	Series 4	Series 5	Series 6	Series 7	Series 8	COM	
	<b>Cities-BDXXAX-OB40</b>	\$3,822	\$3,993	\$4,277	\$4,573	\$4,926	\$5,282	\$5,727	\$3,993	

## Cities Small Downtown Lounge Seating

	<b>44" W, Two seat</b> <span style="float: right;">64 lbs   5 yds</span>
	Model                      Series 2    Series 3    Series 4    Series 5    Series 6    Series 7    Series 8    COM
	<b>Cities-SDXXXX-20SX</b> \$2,045    \$2,208    \$2,478    \$2,761    \$3,096    \$3,435    \$3,859    \$2,208
	<b>Cities-SDXXXX-20PX</b> \$2,310    \$2,473    \$2,743    \$3,026    \$3,361    \$3,700    \$4,124    \$2,473
	<b>46.5" W, Two seat with intervening arm and leg</b> <span style="float: right;">70 lbs   5.75 yds</span>
	Model                      Series 2    Series 3    Series 4    Series 5    Series 6    Series 7    Series 8    COM
	<b>Cities-SDXXXX-22SX</b> \$2,439    \$2,626    \$2,937    \$3,261    \$3,647    \$4,037    \$4,525    \$2,626
	<b>Cities-SDXXXX-22PX</b> \$2,755    \$2,942    \$3,253    \$3,577    \$3,963    \$4,353    \$4,841    \$2,942
	<b>64" W, Three seat</b> <span style="float: right;">92 lbs   6.5 yds</span>
	Model                      Series 2    Series 3    Series 4    Series 5    Series 6    Series 7    Series 8    COM
	<b>Cities-SDXXXX-30SX</b> \$2,727    \$2,939    \$3,290    \$3,657    \$4,094    \$4,534    \$5,086    \$2,939
	<b>Cities-SDXXXX-30PX</b> \$3,080    \$3,292    \$3,643    \$4,010    \$4,447    \$4,887    \$5,439    \$3,292
	<b>69" W, Three seat with intervening arms and legs</b> <span style="float: right;">104 lbs   8.5 yds</span>
	Model                      Series 2    Series 3    Series 4    Series 5    Series 6    Series 7    Series 8    COM
	<b>Cities-SDXXXX-33SX</b> \$3,429    \$3,706    \$4,165    \$4,645    \$5,216    \$5,792    \$6,513    \$3,706
	<b>Cities-SDXXXX-33PX</b> \$3,874    \$4,151    \$4,610    \$5,090    \$5,661    \$6,237    \$6,958    \$4,151
	<b>91" W, Four seat with intervening arms and legs</b> <span style="float: right;">140 lbs   11 yds</span>
	Model                      Series 2    Series 3    Series 4    Series 5    Series 6    Series 7    Series 8    COM
	<b>Cities-SDXXXX-44SX</b> \$4,513    \$4,871    \$5,465    \$6,086    \$6,825    \$7,570    \$8,503    \$4,871
	<b>Cities-SDXXXX-44PX</b> \$5,098    \$5,456    \$6,050    \$6,671    \$7,410    \$8,155    \$9,088    \$5,456

Lounge Seating

Multiple & Tandem Seating

Side, Stacking & Folding Chairs

Occasional Tables

## Cities Small Downtown Benches

### Standard Features

Same standard features as Cities Small Downtown Lounge Seating

### Available Options

Same options as Cities Small Downtown Lounge Seating

### Key Dimensions

- Overall Width: See price table
- Overall Depth: 23"
- Overall Height: 20"

	<b>24.5" W, Bench</b> <span style="float: right;">33 lbs   2.25 yds</span>
	Model                      Series 2    Series 3    Series 4    Series 5    Series 6    Series 7    Series 8    COM
	<b>Cities-SDXX0X-B1S0</b> \$1,021    \$1,094    \$1,216    \$1,343    \$1,494    \$1,647    \$1,837    \$1,094
	<b>Cities-SDXX0X-B1P0</b> \$1,153    \$1,226    \$1,348    \$1,475    \$1,626    \$1,779    \$1,969    \$1,226
	<b>44.75" W, Bench</b> <span style="float: right;">39 lbs   3.25 yds</span>
	Model                      Series 2    Series 3    Series 4    Series 5    Series 6    Series 7    Series 8    COM
	<b>Cities-SDXX0X-B2S0</b> \$1,327    \$1,433    \$1,609    \$1,792    \$2,011    \$2,231    \$2,507    \$1,433
	<b>Cities-SDXX0X-B2P0</b> \$1,499    \$1,605    \$1,781    \$1,964    \$2,183    \$2,403    \$2,679    \$1,605
	<b>65" W, Bench</b> <span style="float: right;">45 lbs   4 yds</span>
	Model                      Series 2    Series 3    Series 4    Series 5    Series 6    Series 7    Series 8    COM
	<b>Cities-SDXX0X-B3S0</b> \$1,643    \$1,773    \$1,989    \$2,215    \$2,484    \$2,755    \$3,094    \$1,773
	<b>Cities-SDXX0X-B3P0</b> \$1,856    \$1,986    \$2,202    \$2,428    \$2,697    \$2,968    \$3,307    \$1,986

# Cities Small Downtown Lounge Seating

## Cities Spanner Tables

### Standard Features

- Same standard features as Cities Small Uptown Lounge Seating, plus:
- Laminate or veneer tops
- Straight table apron on Downtown
- Dry-construction joinery

### Available Options

- Five tabletop edge styles + \$0

### Specification Decisions

- Select standard wood finish
- Select standard laminate
- Select edge style

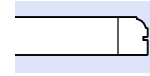

**C** Chicago

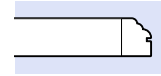

**L** Los Angeles

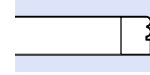

**N** New Orleans

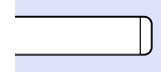

**Y** New York

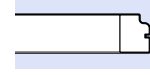

**W** Williamsburg

### 19.5" W, Spanner table with legs

24 lbs

Model	Price	Depth	Height
<b>Cities-SUX000-S10X</b>	\$841	19.5"	

### 19.5" W, Spanner table without legs

24 lbs

Model	Price	Depth	Height
<b>Cities-SUX000-S00X</b>	\$534	19.5"	

### 27.25" W, Corner spanner table with legs

29 lbs

Model	Price	Depth	Height
<b>Cities-SUX000-C10X</b>	\$1,444	27.25"	

# Cities Medium Downtown Lounge Seating



## More Information

Illustrated Glossary ▶ 409

Fabrics ▶ 421

Flammability (CTB-133) ▶ 429

Finishes ▶ 426

Ordering and Warranties ▶ 432

## Standard Features

- Solid maple frame
- Mortise and tenon joinery
- Spring seat construction
- Wipe-out design
- Replaceable components
- Wood arm caps
- Non-marring 7/8" rubber-cushioned glides
- Nemschoff healthcare wood finish
- GREENGUARD Gold Certified
- Limited Lifetime Warranty

## Available Options

- Moisture barrier + \$69 per seat or back
- Black urethane arm caps + \$116
- Six arm cap styles + \$0
- Six back styles + \$0
- Two rail styles + \$0
- CTB-133 + \$83/yd
- Two fabrics + \$64
- Three (or more) fabrics + \$90

## Specification Decisions

- Select fabric
- Select standard wood finish
- Add moisture barrier
- Add CTB-133
- Apply multiple fabrics
- Select arm cap style

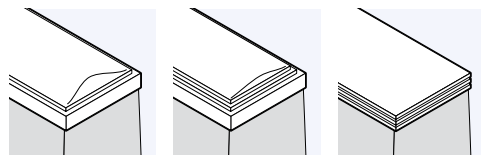

**C** Chicago      **L** Los Angeles      **N** New Orleans

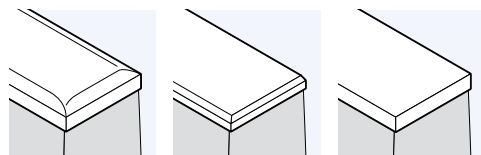

**Y** New York      **W** Williamsburg      **U** Optional Black Urethane

- Select foot style

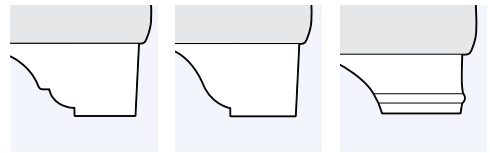

**C** Chicago      **L** Los Angeles      **N** New Orleans

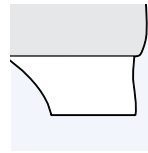

**W** Williamsburg

- Select back style

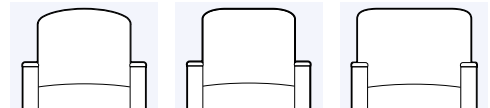

**A** Arcade back with wipe-out      **B** Square back with wipe-out      **D** T-back with wipe-out

**R** Arcade back without wipe-out      **S** Square back without wipe-out      **T** T-back without wipe-out

- Select rail style

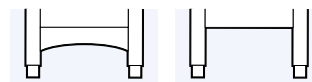

**U** Upholstered      **O** Without rail

Model numbers with **S** indicate standard seat and back covers, and model numbers with **P** indicate removable covers.

## Flammability Type

- Type 8

# Cities Medium Downtown Lounge Seating

## Coordinating Products

- [Cities Small Crosstown Lounge Seating](#)
- [Cities Medium Crosstown Lounge Seating](#)
- [Cities Small Downtown Lounge Seating](#)
- [Cities Small Uptown Lounge Seating](#)
- [Cities Medium Uptown Lounge Seating](#)
- [Cities Side Chair](#)
- [Cities Tables](#)
- [Cities Crosstown Patient Chair](#)
- [Cities Downtown Patient Chair](#)
- [Cities Uptown Patient Chair](#)
- [Cities Uptown CompactComfort Recliner](#)
- [Cities Crosstown Rocker](#)
- [Cities Downtown Rocker](#)
- [Cities Uptown Rocker](#)
- [Cities Downtown Glider](#)
- [Cities Uptown Glider](#)
- [SleepOver Sofa](#)
- [SleepOver Settee](#)

## Key Dimensions

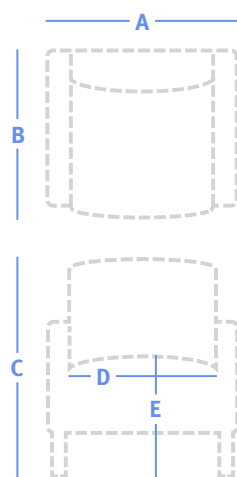

<b>A</b>	Overall Width	See price table
<b>B</b>	Overall Depth	28.25"
<b>C</b>	Overall Height	31.5"
<b>D</b>	Seat Width	
	Chair:	22.5"
	Two Seat:	22.5", 43"
	Three Seat:	64.5"
<b>E</b>	Seat Height	18.5"
<b>F</b>	Arm Height	24.5"

	<b>29.5" W, Chair</b>									71 lbs   4.5 yds
	Model	Series 2	Series 3	Series 4	Series 5	Series 6	Series 7	Series 8	COM	
	<b>Cities-MDXXXX-10S0</b>	\$2,170	\$2,316	\$2,559	\$2,813	\$3,115	\$3,421	\$3,802	\$2,316	
	<b>Cities-MDXXXX-10P0</b>	\$2,448	\$2,594	\$2,837	\$3,091	\$3,393	\$3,699	\$4,080	\$2,594	
	<b>48.5" W, Two seat</b>									101 lbs   6.75 yds
	Model	Series 2	Series 3	Series 4	Series 5	Series 6	Series 7	Series 8	COM	
	<b>Cities-MDXXXX-20S0</b>	\$3,550	\$3,770	\$4,135	\$4,516	\$4,969	\$5,427	\$5,999	\$3,770	
	<b>Cities-MDXXXX-20P0</b>	\$4,003	\$4,223	\$4,588	\$4,969	\$5,422	\$5,880	\$6,452	\$4,223	
	<b>51.5" W, Two seat with intervening arm and leg</b>									109 lbs   7.75 yds
	Model	Series 2	Series 3	Series 4	Series 5	Series 6	Series 7	Series 8	COM	
	<b>Cities-MDXXXX-22S0</b>	\$3,972	\$4,224	\$4,643	\$5,080	\$5,600	\$6,126	\$6,783	\$4,224	
	<b>Cities-MDXXXX-22P0</b>	\$4,479	\$4,731	\$5,150	\$5,587	\$6,107	\$6,633	\$7,290	\$4,731	
	<b>70" W, Three seat</b>									131 lbs   8.75 yds
	Model	Series 2	Series 3	Series 4	Series 5	Series 6	Series 7	Series 8	COM	
	<b>Cities-MDXXXX-30S0</b>	\$4,644	\$4,929	\$5,402	\$5,896	\$6,483	\$7,076	\$7,819	\$4,929	
	<b>Cities-MDXXXX-30P0</b>	\$5,236	\$5,521	\$5,994	\$6,488	\$7,075	\$7,668	\$8,411	\$5,521	
	<b>75.5" W, Three seat with intervening arms and legs</b>									147 lbs   11 yds
	Model	Series 2	Series 3	Series 4	Series 5	Series 6	Series 7	Series 8	COM	
	<b>Cities-MDXXXX-33S0</b>	\$5,614	\$5,972	\$6,566	\$7,187	\$7,926	\$8,671	\$9,604	\$5,972	
	<b>Cities-MDXXXX-33P0</b>	\$6,331	\$6,689	\$7,283	\$7,904	\$8,643	\$9,388	\$10,321	\$6,689	

# Cities Small Uptown Lounge Seating



## More Information

Illustrated Glossary ▶ 409

Fabrics ▶ 421

Flammability (CTB-133) ▶ 429

Finishes ▶ 426

Ordering and Warranties ▶ 432

## Standard Features

- Solid maple frame
- Mortise and tenon joinery
- Spring seat construction
- Wipe-out design
- Replaceable components
- Wood arm caps
- Non-marring 7/8" rubber-cushioned glides
- Nemschoff healthcare wood finish
- GREENGUARD Gold Certified
- Limited Lifetime Warranty
- See nemschoff.com for weight ratings (BUXOAX-OB30, BUXOAX-OB40, SUXOXX-OB2)

## Available Options

- Moisture barrier + \$69 per seat or back
- Five arm cap styles + \$0
- Three back styles + \$0
- Two rail styles + \$0
- CTB-133 + \$83/yd
- Two fabrics + \$64
- Three (or more) fabrics + \$90
- Attached table (LSF, RSF – see price table)

## Specification Decisions

- Select fabric
- Select standard wood finish
- Add moisture barrier
- Add CTB-133
- Apply multiple fabrics
- Add attached table
- Select arm cap style

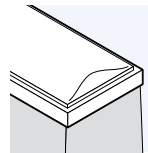

**C** Chicago

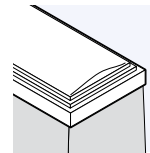

**L** Los Angeles

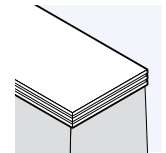

**N** New Orleans

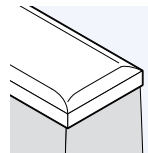

**Y** New York

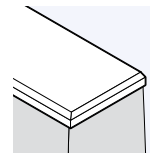

**W** Williamsburg

- Select back style

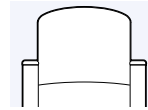

**A** Arcade back

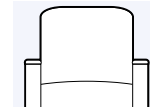

**B** Square back

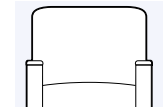

**D** T-back

- Select rail style

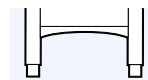

**U** Upholstered

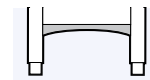

**W** Wood

Model numbers with **S** indicate standard seat and back covers, and model numbers with **P** indicate removable covers.

## Flammability Type

- Type 3
- Type 4 (Plus models)

# Cities Small Uptown Lounge Seating

## Coordinating Products

- [Cities Small Crosstown Lounge Seating](#)
- [Cities Medium Crosstown Lounge Seating](#)
- [Cities Small Downtown Lounge Seating](#)
- [Cities Medium Downtown Lounge Seating](#)
- [Cities Medium Uptown Lounge Seating](#)
- [Cities Side Chair](#)
- [Cities Tables](#)
- [Cities Crosstown Patient Chair](#)
- [Cities Downtown Patient Chair](#)
- [Cities Uptown Patient Chair](#)
- [Cities Uptown CompactComfort Recliner](#)
- [Cities Crosstown Rocker](#)
- [Cities Downtown Rocker](#)
- [Cities Uptown Rocker](#)
- [Cities Downtown Glider](#)
- [Cities Uptown Glider](#)
- [SleepOver Sofa](#)
- [SleepOver Settee](#)

## Key Dimensions

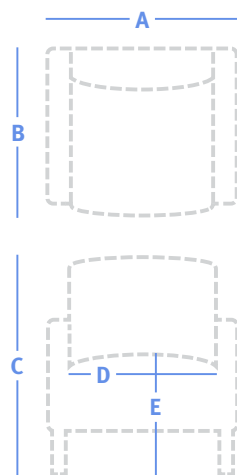

<b>A</b>	Overall Width	See price table
<b>B</b>	Overall Depth	24"
<b>C</b>	Overall Height	33.75"
<b>D</b>	Seat Width	
	Chair:	19.5", 23.5", 29.75", 39.75", 40"
	Two Seat:	39", 39.75"
	Three Seat:	58.5", 60"
	Four Seat:	78"
<b>E</b>	Seat Height	18.5"
<b>F</b>	Arm Height	25"

	<b>24.5" W, Chair</b>									35 lbs   2.5 yds
	Model	Series 2	Series 3	Series 4	Series 5	Series 6	Series 7	Series 8	COM	
	<b>Cities-SUX0XX-10SX</b>	\$1,295	\$1,376	\$1,511	\$1,653	\$1,820	\$1,990	\$2,202	\$1,376	
	<b>Cities-SUX0XX-10PX</b>	\$1,461	\$1,542	\$1,677	\$1,819	\$1,986	\$2,156	\$2,368	\$1,542	
	<b>28.5" W, Chair</b>									38 lbs   3 yds
	Model	Series 2	Series 3	Series 4	Series 5	Series 6	Series 7	Series 8	COM	
	<b>Cities-SUX0XX-1WSX</b>	\$1,467	\$1,564	\$1,726	\$1,896	\$2,097	\$2,301	\$2,555	\$1,564	
	<b>Cities-SUX0XX-1WPX</b>	\$1,655	\$1,752	\$1,914	\$2,084	\$2,285	\$2,489	\$2,743	\$1,752	
	<b>34" W, Plus chair</b>									59 lbs   4 yds
	Model	Series 2	Series 3	Series 4	Series 5	Series 6	Series 7	Series 8	COM	
	<b>Cities-BUXOAX-OB30</b>	\$3,357	\$3,487	\$3,703	\$3,929	\$4,198	\$4,469	\$4,808	\$3,487	
	<b>44" W, Plus chair</b>									64 lbs   4 yds
	Model	Series 2	Series 3	Series 4	Series 5	Series 6	Series 7	Series 8	COM	
	<b>Cities-SUX0XX-OB2</b>	\$2,688	\$2,818	\$3,034	\$3,260	\$3,529	\$3,800	\$4,139	\$2,818	

## Cities Small Uptown Lounge Seating

	<b>44" W, Plus chair</b>									64 lbs   4.25 yds
	Model	Series 2	Series 3	Series 4	Series 5	Series 6	Series 7	Series 8	COM	
	<b>Cities-BUXOAX-OB40</b>	\$3,855	\$3,993	\$4,223	\$4,463	\$4,748	\$5,036	\$5,397	\$3,993	
	<b>44" W, Two seat</b>									64 lbs   4.25 yds
	Model	Series 2	Series 3	Series 4	Series 5	Series 6	Series 7	Series 8	COM	
	<b>Cities-SUX0XX-20SX</b>	\$2,070	\$2,208	\$2,438	\$2,678	\$2,963	\$3,251	\$3,612	\$2,208	
	<b>Cities-SUX0XX-20PX</b>	\$2,335	\$2,473	\$2,703	\$2,943	\$3,228	\$3,516	\$3,877	\$2,473	
	<b>46.5" W, Two seat with intervening arm and leg</b>									70 lbs   4.5 yds
	Model	Series 2	Series 3	Series 4	Series 5	Series 6	Series 7	Series 8	COM	
	<b>Cities-SUX0XX-22SX</b>	\$2,480	\$2,626	\$2,869	\$3,123	\$3,425	\$3,731	\$4,112	\$2,626	
	<b>Cities-SUX0XX-22PX</b>	\$2,796	\$2,942	\$3,185	\$3,439	\$3,741	\$4,047	\$4,428	\$2,942	
	<b>64" W, Three seat</b>									92 lbs   5.75 yds
	Model	Series 2	Series 3	Series 4	Series 5	Series 6	Series 7	Series 8	COM	
	<b>Cities-SUX0XX-30SX</b>	\$2,752	\$2,939	\$3,250	\$3,574	\$3,960	\$4,350	\$4,838	\$2,939	
	<b>Cities-SUX0XX-30PX</b>	\$3,105	\$3,292	\$3,603	\$3,927	\$4,313	\$4,703	\$5,191	\$3,292	
	<b>69" W, Three seat with intervening arms and legs</b>									104 lbs   6.75 yds
	Model	Series 2	Series 3	Series 4	Series 5	Series 6	Series 7	Series 8	COM	
	<b>Cities-SUX0XX-33SX</b>	\$3,486	\$3,706	\$4,071	\$4,452	\$4,905	\$5,363	\$5,935	\$3,706	
	<b>Cities-SUX0XX-33PX</b>	\$3,931	\$4,151	\$4,516	\$4,897	\$5,350	\$5,808	\$6,380	\$4,151	
	<b>91" W, Four seat with intervening arms and legs</b>									140 lbs   8.75 yds
	Model	Series 2	Series 3	Series 4	Series 5	Series 6	Series 7	Series 8	COM	
	<b>Cities-SUX0XX-44SX</b>	\$4,586	\$4,871	\$5,344	\$5,838	\$6,425	\$7,018	\$7,761	\$4,871	
	<b>Cities-SUX0XX-44PX</b>	\$5,171	\$5,456	\$5,929	\$6,423	\$7,010	\$7,603	\$8,346	\$5,456	

## Cities Small Uptown Benches

### Standard Features

Same standard features as Cities Small Uptown Lounge Seating

### Available Options

Same options as Cities Small Uptown Lounge Seating

### Key Dimensions

- Overall Width: See price table
- Overall Depth: 22.75"
- Overall Height: 20"

	<b>23.75" W, Bench</b>									33 lbs   1.25 yds
	Model	Series 2	Series 3	Series 4	Series 5	Series 6	Series 7	Series 8	COM	
	<b>Cities-SUX00X-B1S0</b>	\$1,054	\$1,094	\$1,162	\$1,233	\$1,316	\$1,401	\$1,507	\$1,094	
	<b>Cities-SUX00X-B1P0</b>	\$1,186	\$1,226	\$1,294	\$1,365	\$1,448	\$1,533	\$1,639	\$1,226	
	<b>44" W, Bench</b>									39 lbs   2.25 yds
	Model	Series 2	Series 3	Series 4	Series 5	Series 6	Series 7	Series 8	COM	
	<b>Cities-SUX00X-B2S0</b>	\$1,360	\$1,433	\$1,555	\$1,682	\$1,833	\$1,986	\$2,176	\$1,433	
	<b>Cities-SUX00X-B2P0</b>	\$1,532	\$1,605	\$1,727	\$1,854	\$2,005	\$2,158	\$2,348	\$1,605	



## Cities Small Uptown Lounge Seating

64.25" W, Bench									45 lbs   3.25 yds
Model	Series 2	Series 3	Series 4	Series 5	Series 6	Series 7	Series 8	COM	
<b>Cities-SUX00X-B3S0</b>	\$1,667	\$1,773	\$1,949	\$2,132	\$2,351	\$2,571	\$2,847	\$1,773	
<b>Cities-SUX00X-B3P0</b>	\$1,880	\$1,986	\$2,162	\$2,345	\$2,564	\$2,784	\$3,060	\$1,986	

## Cities Spanner Tables

### Standard Features

- Same standard features as Cities Small Uptown Lounge Seating, plus:
- Laminate or veneer tops
- Crowned table apron on Uptown
- Dry-construction joinery

### Available Options

- Five tabletop edge styles + \$0

### Specification Decisions

- Select standard wood finish
- Select standard laminate
- Select edge style



**C** Chicago



**L** Los Angeles

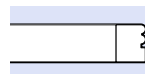

**N** New Orleans

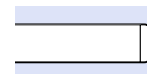

**Y** New York

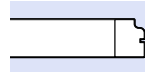

**W** Williamsburg

### 19.5" W, Spanner table with legs

24 lbs

Model	Price	Depth	Height
<b>Cities-SUX000-S10X</b>	\$841	19.5"	

### 19.5" W, Spanner table without legs

24 lbs

Model	Price	Depth	Height
<b>Cities-SUX000-S00X</b>	\$534	19.5"	

### 27.25" W, Corner spanner table with legs

29 lbs

Model	Price	Depth	Height
<b>Cities-SUX000-C10X</b>	\$1,444	27.25"	

# Cities Medium Uptown Lounge Seating



## More Information

Illustrated Glossary ▶ 409

Fabrics ▶ 421

Flammability (CTB-133) ▶ 429

Finishes ▶ 426

Ordering and Warranties ▶ 432

## Standard Features

- Solid maple frame
- Mortise and tenon joinery
- Spring seat construction
- Wipe-out design
- Replaceable components
- Wood arm caps
- Non-marring 7/8" rubber-cushioned glides
- Nemschoff healthcare wood finish
- GREENGUARD Gold Certified
- Limited Lifetime Warranty

## Available Options

- Moisture barrier + \$69 per seat or back
- Five arm cap styles + \$0
- Six back styles + \$0
- Upholstered rail + \$0
- CTB-133 + \$83/yd
- Two fabrics + \$64
- Three (or more) fabrics + \$90

## Specification Decisions

- Select fabric
- Select standard wood finish
- Add moisture barrier
- Add CTB-133
- Apply multiple fabrics

- Select arm cap style

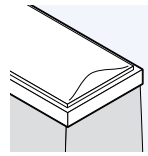

**C** Chicago

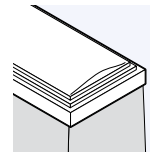

**L** Los Angeles

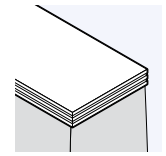

**N** New Orleans

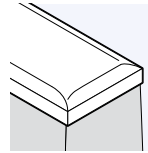

**Y** New York

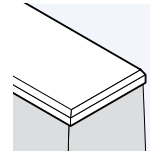

**W** Williamsburg

- Select back style

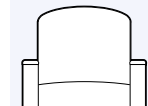

**A** Arcade back with wipe-out

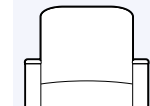

**B** Square back with wipe-out

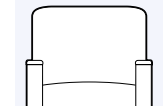

**D** T-back with wipe-out

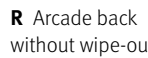

**R** Arcade back without wipe-out

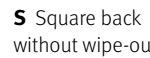

**S** Square back without wipe-out

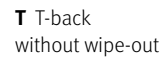

**T** T-back without wipe-out

- Select rail style

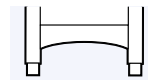

**U** Upholstered

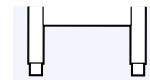

**O** Without rail

Model numbers with **S** indicate standard seat and back covers, and model numbers with **P** indicate removable covers.

## Flammability Type

- Type 4

# Cities Medium Uptown Lounge Seating

## Coordinating Products

- [Cities Small Crosstown Lounge Seating](#)
- [Cities Medium Crosstown Lounge Seating](#)
- [Cities Small Downtown Lounge Seating](#)
- [Cities Medium Downtown Lounge Seating](#)
- [Cities Small Uptown Lounge Seating](#)
- [Cities Side Chair](#)
- [Cities Tables](#)
- [Cities Crosstown Patient Chair](#)
- [Cities Downtown Patient Chair](#)
- [Cities Uptown Patient Chair](#)
- [Cities Uptown CompactComfort Recliner](#)
- [Cities Crosstown Rocker](#)
- [Cities Downtown Rocker](#)
- [Cities Uptown Rocker](#)
- [Cities Downtown Glider](#)
- [Cities Uptown Glider](#)
- [SleepOver Sofa](#)
- [SleepOver Settee](#)

## Key Dimensions

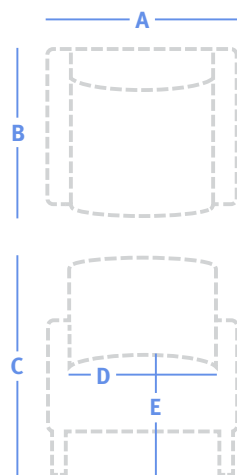

<b>A</b>	Overall Width	See price table
<b>B</b>	Overall Depth	28.5"
<b>C</b>	Overall Height	31.25"
<b>D</b>	Seat Width	
	Chair:	22"
	Two Seat:	42.5", 43"
	Three Seat:	64.5"
<b>E</b>	Seat Height	18.5"
<b>F</b>	Arm Height	23.75"

	<b>28.5" W, Chair</b>									71 lbs   4 yds
	Model	Series 2	Series 3	Series 4	Series 5	Series 6	Series 7	Series 8	COM	
	<b>Cities-MUX0XX-10S0</b>	\$2,186	\$2,316	\$2,532	\$2,758	\$3,027	\$3,298	\$3,637	\$2,316	
	<b>Cities-MUX0XX-10P0</b>	\$2,464	\$2,594	\$2,810	\$3,036	\$3,305	\$3,576	\$3,915	\$2,594	
	<b>48.5" W, Two seat</b>									101 lbs   6 yds
	Model	Series 2	Series 3	Series 4	Series 5	Series 6	Series 7	Series 8	COM	
	<b>Cities-MUX0XX-20S0</b>	\$3,575	\$3,770	\$4,094	\$4,433	\$4,836	\$5,243	\$5,752	\$3,770	
	<b>Cities-MUX0XX-20P0</b>	\$4,028	\$4,223	\$4,547	\$4,886	\$5,289	\$5,696	\$6,205	\$4,223	
	<b>51.5" W, Two seat with intervening arm and leg</b>									109 lbs   7 yds
	Model	Series 2	Series 3	Series 4	Series 5	Series 6	Series 7	Series 8	COM	
	<b>Cities-MUX0XX-22S0</b>	\$3,996	\$4,224	\$4,602	\$4,997	\$5,467	\$5,942	\$6,536	\$4,224	
	<b>Cities-MUX0XX-22P0</b>	\$4,503	\$4,731	\$5,109	\$5,504	\$5,974	\$6,449	\$7,043	\$4,731	
	<b>70" W, Three seat</b>									131 lbs   8.25 yds
	Model	Series 2	Series 3	Series 4	Series 5	Series 6	Series 7	Series 8	COM	
	<b>Cities-MUX0XX-30S0</b>	\$4,660	\$4,929	\$5,375	\$5,840	\$6,394	\$6,954	\$7,653	\$4,929	
	<b>Cities-MUX0XX-30P0</b>	\$5,252	\$5,521	\$5,967	\$6,432	\$6,986	\$7,546	\$8,245	\$5,521	
	<b>75.5" W, Three seat with intervening arms and legs</b>									147 lbs   10.25 yds
	Model	Series 2	Series 3	Series 4	Series 5	Series 6	Series 7	Series 8	COM	
	<b>Cities-MUX0XX-33S0</b>	\$5,638	\$5,972	\$6,526	\$7,104	\$7,792	\$8,487	\$9,357	\$5,972	
	<b>Cities-MUX0XX-33P0</b>	\$6,355	\$6,689	\$7,243	\$7,821	\$8,509	\$9,204	\$10,074	\$6,689	

# Evita Lounge Seating



## More Information

Illustrated Glossary ▶ 409

Fabrics ▶ 421

Flammability (CTB-133) ▶ 429

Finishes ▶ 426

Ordering and Warranties ▶ 432

## Standard Features

- Solid maple frame
- Mortise and tenon joinery
- Spring seat construction
- Clean-out design
- Replaceable components
- Non-marring ¾" rubber-cushioned glides
- Nemschoff healthcare wood finish
- GREENGUARD Gold Certified
- Limited Lifetime Warranty

## Available Options

- Moisture barrier + \$69 per seat or back
- CTB-133 + \$83/yd
- Two fabrics + \$64
- Three (or more) fabrics + \$90
- Attached table (LSF, RSF – see price table)

## Specification Decisions

- Select fabric
- Select standard wood finish
- Add moisture barrier
- Add CTB-133
- Apply multiple fabrics
- Add attached table

Model numbers with **S** indicate standard seat and back covers, and model numbers with **P** indicate removable covers.

## Flammability Types

- Type 8
- Type 3 (Bench)

## Coordinating Products

- [Evita Tables](#)

## Key Dimensions

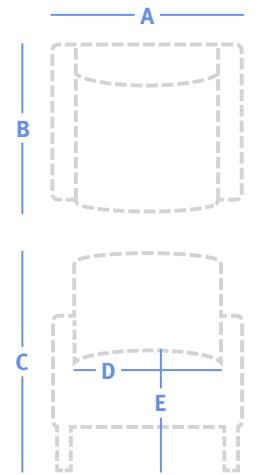

<b>A</b>	Overall Width	See price table
<b>B</b>	Overall Depth	25.75"
<b>C</b>	Overall Height	32.75"
<b>D</b>	Seat Width	
	Chair:	19.5"
	Two Seat:	39"
	Three Seat:	60"
	Four Seat:	78"
<b>E</b>	Seat Height	18.75"
<b>F</b>	Arm Height	25.25"

## Evita Lounge Seating

	<b>25" W, Chair</b>									34 lbs   3 yds
	Model	Series 2	Series 3	Series 4	Series 5	Series 6	Series 7	Series 8	COM	
	<b>2800-10 S</b>	\$1,237	\$1,334	\$1,496	\$1,666	\$1,867	\$2,071	\$2,325	\$1,334	
	<b>2800-10 P</b>	\$1,398	\$1,495	\$1,657	\$1,827	\$2,028	\$2,232	\$2,486	\$1,495	

	<b>45" W, Two seat</b>									55 lbs   4.25 yds
	Model	Series 2	Series 3	Series 4	Series 5	Series 6	Series 7	Series 8	COM	
	<b>2800-20 S</b>	\$1,790	\$1,928	\$2,158	\$2,398	\$2,683	\$2,971	\$3,332	\$1,928	
	<b>2800-20 P</b>	\$2,022	\$2,160	\$2,390	\$2,630	\$2,915	\$3,203	\$3,564	\$2,160	

	<b>47" W, Two seat with intervening arm and leg</b>									61 lbs   5 yds
	Model	Series 2	Series 3	Series 4	Series 5	Series 6	Series 7	Series 8	COM	
	<b>2800-22 S</b>	\$2,152	\$2,315	\$2,585	\$2,868	\$3,203	\$3,542	\$3,966	\$2,315	
	<b>2800-22 P</b>	\$2,430	\$2,593	\$2,863	\$3,146	\$3,481	\$3,820	\$4,244	\$2,593	

	<b>65" W, Three seat</b>									75 lbs   5.75 yds
	Model	Series 2	Series 3	Series 4	Series 5	Series 6	Series 7	Series 8	COM	
	<b>2800-30 S</b>	\$2,301	\$2,488	\$2,799	\$3,123	\$3,509	\$3,899	\$4,387	\$2,488	
	<b>2800-30 P</b>	\$2,600	\$2,787	\$3,098	\$3,422	\$3,808	\$4,198	\$4,686	\$2,787	

	<b>69" W, Three seat with intervening arms and legs</b>									86 lbs   7 yds
	Model	Series 2	Series 3	Series 4	Series 5	Series 6	Series 7	Series 8	COM	
	<b>2800-33 S</b>	\$3,041	\$3,269	\$3,647	\$4,042	\$4,512	\$4,987	\$5,581	\$3,269	
	<b>2800-33 P</b>	\$3,434	\$3,662	\$4,040	\$4,435	\$4,905	\$5,380	\$5,974	\$3,662	

	<b>87" W, Four seat with one intervening arm and leg</b>									101 lbs   8 yds
	Model	Series 2	Series 3	Series 4	Series 5	Series 6	Series 7	Series 8	COM	
	<b>2800-40 S</b>	\$3,072	\$3,333	\$3,765	\$4,217	\$4,754	\$5,296	\$5,975	\$3,333	
	<b>2800-40 P</b>	\$3,472	\$3,733	\$4,165	\$4,617	\$5,154	\$5,696	\$6,375	\$3,733	

	<b>91" W, Four seat with intervening arms and legs</b>									112 lbs   9 yds
	Model	Series 2	Series 3	Series 4	Series 5	Series 6	Series 7	Series 8	COM	
	<b>2800-44 S</b>	\$3,900	\$4,193	\$4,679	\$5,187	\$5,791	\$6,402	\$7,165	\$4,193	
	<b>2800-44 P</b>	\$4,404	\$4,697	\$5,183	\$5,691	\$6,295	\$6,906	\$7,669	\$4,697	

# Evita Lounge Seating

Lounge Seating

Multiple & Tandem Seating

Side, Stacking & Folding Chairs

Occasional Tables

## Evita Benches

### Standard Features

Same standard features as Evita Lounge Seating

### Available Options

Same options as Evita Lounge Seating

### Key Dimensions

- Overall Width: See price table
- Overall Depth: 22"
- Overall Height: 18.75"

	25" W, Bench								28 lbs   1.25 yds
	Model	Series 2	Series 3	Series 4	Series 5	Series 6	Series 7	Series 8	COM
	<b>2800-B1 S</b>	\$1,059	\$1,099	\$1,167	\$1,238	\$1,321	\$1,406	\$1,512	\$1,099
	<b>2800-B1 P</b>	\$1,191	\$1,231	\$1,299	\$1,370	\$1,453	\$1,538	\$1,644	\$1,231

	45" W, Bench								52 lbs   2.25 yds
	Model	Series 2	Series 3	Series 4	Series 5	Series 6	Series 7	Series 8	COM
	<b>2800-B2 S</b>	\$1,369	\$1,442	\$1,564	\$1,691	\$1,842	\$1,995	\$2,185	\$1,442
	<b>2800-B2 P</b>	\$1,543	\$1,616	\$1,738	\$1,865	\$2,016	\$2,169	\$2,359	\$1,616

## Evita Spanner Table

### Standard Features

- Solid maple frame
- Laminate or veneer top

### Specification Decisions

- Select standard wood finish or laminate

	19.5" W, Spanner table; laminate				24 lbs
	Model	Price	Depth	Height	
	<b>2800-ST</b>	\$461	21.25"	14.75"	

	19.5" W, Spanner table; veneer				24 lbs
	Model	Price	Depth	Height	
	<b>2800-STV</b>	\$561	21.25"	14.75"	

	28" W, Corner coffee table with support legs; laminate top				29 lbs
	Model	Price	Depth	Height	
	<b>2800-CT</b>	\$1,305	28"	14.75"	

	28" W, Corner coffee table with support legs; veneer top				29 lbs
	Model	Price	Depth	Height	
	<b>2800-CTV</b>	\$1,593	28"	14.75"	

# Florabella Lounge Seating



## Standard Features

- Heavy-duty steel construction
- Grey urethane legs
- Wipe-out design
- Replaceable components
- Grey urethane arm caps
- Non-marring glides
- GREENGUARD Gold Certified
- Limited Lifetime Warranty

## Available Options

- Moisture barrier + \$69 per seat or back
- Wood legs + \$275
- Wood arm caps + \$116
- Upholstered arm caps + \$116
- Two fabrics + \$64
- Three (or more) fabrics + \$90

## Specification Decisions

- Select fabric
- Add moisture barrier
- Apply multiple fabrics
- Add wood legs and specify wood finish
- Add wood or upholstered arm caps

CTB-133 not available

## Coordinating Products

- [Florabella Tables](#)

## Key Dimensions

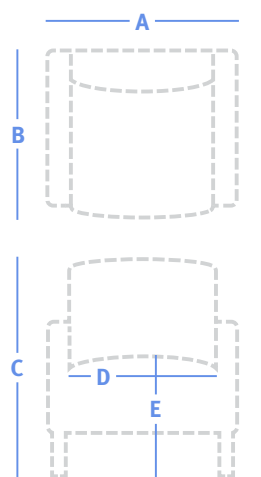

<b>A</b>	Overall Width	See price table
<b>B</b>	Overall Depth	31.5"
<b>C</b>	Overall Height	30.5"
<b>D</b>	Seat Width	
	Chair:	23"
	Settee:	45"
	Sofa:	67"
<b>E</b>	Seat Height	17.5"
<b>F</b>	Arm Height	24"

### More Information

Illustrated Glossary ▶ 409

Fabrics ▶ 421

Finishes ▶ 426

Ordering and Warranties ▶ 432

	<b>31.5" W, Chair</b>									55 lbs   4 yds
	Model	Series 2	Series 3	Series 4	Series 5	Series 6	Series 7	Series 8	COM	
	<b>FLBL-00001</b>	\$2,372	\$2,436	\$2,717	\$2,867	\$2,949	\$3,057	\$3,126	\$2,436	

	<b>53.5" W, Settee</b>									85 lbs   5.75 yds
	Model	Series 2	Series 3	Series 4	Series 5	Series 6	Series 7	Series 8	COM	
	<b>FLBL-00002</b>	\$3,096	\$3,188	\$3,591	\$3,808	\$3,925	\$4,080	\$4,179	\$3,188	

	<b>75.5" W, Sofa</b>									115 lbs   7.5 yds
	Model	Series 2	Series 3	Series 4	Series 5	Series 6	Series 7	Series 8	COM	
	<b>FLBL-00003</b>	\$3,373	\$3,494	\$4,020	\$4,302	\$4,456	\$4,658	\$4,787	\$3,494	

# Franklin Lounge Seating



## More Information

Illustrated Glossary ▶ 409

Fabrics ▶ 421

Flammability (CTB-133) ▶ 429

Finishes ▶ 426

Ordering and Warranties ▶ 432

## Standard Features

- Solid maple frame
- Mortise and tenon joinery
- Spring seat construction
- Replaceable components
- Non-marring 5/8" x 2" plastic bar glides
- Nemschoff healthcare wood finish
- GREENGUARD Gold Certified
- Limited Lifetime Warranty

## Available Options

- Moisture barrier + \$69 per seat or back
- Non-marring 7/8" rubber-cushioned glides + \$0
- CTB-133 + \$83/yd
- Two fabrics + \$64
- Three (or more) fabrics + \$90

## Specification Decisions

- Select fabric
- Select standard wood finish
- Add moisture barrier
- Add CTB-133
- Apply multiple fabrics

Model numbers with **S** indicate standard seat and back covers, and model numbers with **P** indicate removable covers.

## Flammability Types

- Type 4
- Type 3 (Bench)

## Key Dimensions

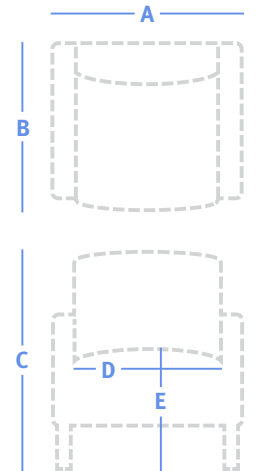

<b>A</b>	Overall Width	See price table
<b>B</b>	Overall Depth	27.75"
<b>C</b>	Overall Height	30.5"
<b>D</b>	Seat Width	
	Chair:	22.5"
	Two Seat:	44.75", 45"
	Three Seat:	66.25", 67.5"
<b>E</b>	Seat Height	18.5"
<b>F</b>	Arm Height	23.25"



### 30.75" W, Chair

85 lbs | 4.75 yds

Model	Series 2	Series 3	Series 4	Series 5	Series 6	Series 7	Series 8	COM
<b>774-10 S</b>	\$2,525	\$2,680	\$2,937	\$3,205	\$3,524	\$3,846	\$4,249	\$2,680
<b>774-10 P</b>	\$2,847	\$3,002	\$3,259	\$3,527	\$3,846	\$4,168	\$4,571	\$3,002



### 50.75" W, Two seat

130 lbs | 7 yds

Model	Series 2	Series 3	Series 4	Series 5	Series 6	Series 7	Series 8	COM
<b>774-20 S</b>	\$4,124	\$4,352	\$4,730	\$5,125	\$5,595	\$6,070	\$6,664	\$4,352
<b>774-20 P</b>	\$4,647	\$4,875	\$5,253	\$5,648	\$6,118	\$6,593	\$7,187	\$4,875



### 57" W, Two seat with intervening arm and leg

153 lbs | 8 yds

Model	Series 2	Series 3	Series 4	Series 5	Series 6	Series 7	Series 8	COM
<b>774-22 S</b>	\$4,390	\$4,651	\$5,083	\$5,535	\$6,072	\$6,614	\$7,293	\$4,651
<b>774-22 P</b>	\$4,949	\$5,210	\$5,642	\$6,094	\$6,631	\$7,173	\$7,852	\$5,210



## Franklin Lounge Seating

	71.5" W, Three seat <span style="float: right;">144 lbs   9.25 yds</span>								
	Model	Series 2	Series 3	Series 4	Series 5	Series 6	Series 7	Series 8	COM
<b>774-30 S</b>	\$5,677	\$5,978	\$6,478	\$7,000	\$7,621	\$8,248	\$9,033	\$5,978	
<b>774-30 P</b>	\$6,395	\$6,696	\$7,196	\$7,718	\$8,339	\$8,966	\$9,751	\$6,696	

	83.5" W, Three seat with intervening arms and legs <span style="float: right;">202 lbs   11.25 yds</span>								
	Model	Series 2	Series 3	Series 4	Series 5	Series 6	Series 7	Series 8	COM
<b>774-33 S</b>	\$6,072	\$6,439	\$7,047	\$7,682	\$8,437	\$9,200	\$10,154	\$6,439	
<b>774-33 P</b>	\$6,845	\$7,212	\$7,820	\$8,455	\$9,210	\$9,973	\$10,927	\$7,212	

## Franklin Bench

### Standard Features

Same standard features as Franklin Lounge Seating

### Available Options

Same options as Franklin Lounge Seating, plus:

Plastic rubber-cushioned glides + \$0

### Key Dimensions

- Overall Width: See price table
- Overall Depth: 23"
- Overall Height: 20.5"

	45.5" W, Bench <span style="float: right;">39 lbs   3.25 yds</span>								
	Model	Series 2	Series 3	Series 4	Series 5	Series 6	Series 7	Series 8	COM
<b>774-B2 S</b>	\$1,453	\$1,559	\$1,735	\$1,918	\$2,137	\$2,357	\$2,633	\$1,559	
<b>774-B2 P</b>	\$1,641	\$1,747	\$1,923	\$2,106	\$2,325	\$2,545	\$2,821	\$1,747	

# Hadleigh Lounge Seating



## More Information

Illustrated Glossary ▶ 409

Fabrics ▶ 421

Flammability (CTB-133) ▶ 429

Finishes ▶ 426

Ordering and Warranties ▶ 432

## Standard Features

- Solid maple frame
- Mortise and tenon joinery
- Spring seat construction
- Replaceable components
- Clean-out design
- Wood arm caps
- Non-marring 7/8" rubber-cushioned glides
- Nemschoff healthcare wood finish
- GREENGUARD Gold Certified
- Limited Lifetime Warranty

## Available Options

- Moisture barrier + \$69 per seat or back
- CTB-133 + \$83/yd
- Two fabrics + \$64
- Three (or more) fabrics + \$90

## Specification Decisions

- Select fabric
- Select standard wood finish
- Add moisture barrier
- Add CTB-133
- Apply multiple fabrics

Model numbers with **S** indicate standard seat and back covers, and model numbers with **P** indicate removable covers.

## Flammability Types

- Type 4
- Type 3 (Bench)

## Coordinating Products

- [Hadleigh Tables](#)
- [Hadleigh Adjustable Back Chair](#)
- [Hadleigh Casegoods](#)

## Key Dimensions

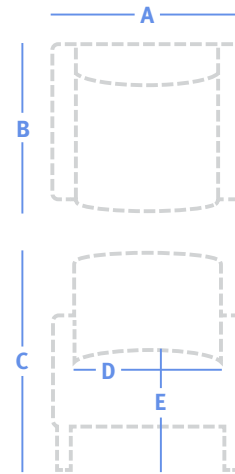

<b>A</b>	Overall Width	See price table
<b>B</b>	Overall Depth	25"
<b>C</b>	Overall Height	32.75"
<b>D</b>	Seat Width	
	Chair:	21.25"
	Two Seat:	42.5", 43.25"
	Three Seat:	63.75", 65"
<b>E</b>	Seat Height	18.75"
<b>F</b>	Arm Height	25.25"



### 28" W, Chair

28 lbs | 1.75 yds

Model	Series 2	Series 3	Series 4	Series 5	Series 6	Series 7	Series 8	COM
<b>280-10 S</b>	\$1,564	\$1,621	\$1,716	\$1,815	\$1,932	\$2,051	\$2,199	\$1,621
<b>280-10 P</b>	\$1,759	\$1,816	\$1,911	\$2,010	\$2,127	\$2,246	\$2,394	\$1,816



### 49.75" W, Two seat

58 lbs | 3.5 yds

Model	Series 2	Series 3	Series 4	Series 5	Series 6	Series 7	Series 8	COM
<b>280-20 S</b>	\$2,492	\$2,606	\$2,795	\$2,993	\$3,228	\$3,465	\$3,762	\$2,606
<b>280-20 P</b>	\$2,805	\$2,919	\$3,108	\$3,306	\$3,541	\$3,778	\$4,075	\$2,919

## Hadleigh Lounge Seating



### 50.75" W, Two seat with divider arm

31 lbs | 3.5 yds

Model	Series 2	Series 3	Series 4	Series 5	Series 6	Series 7	Series 8	COM
<b>280-25 S</b>	\$2,978	\$3,092	\$3,281	\$3,479	\$3,714	\$3,951	\$4,248	\$3,092
<b>280-25 P</b>	\$3,350	\$3,464	\$3,653	\$3,851	\$4,086	\$4,323	\$4,620	\$3,464



### 71.75" W, Three seat

83 lbs | 5 yds

Model	Series 2	Series 3	Series 4	Series 5	Series 6	Series 7	Series 8	COM
<b>280-30 S</b>	\$3,284	\$3,447	\$3,717	\$4,000	\$4,335	\$4,674	\$5,098	\$3,447
<b>280-30 P</b>	\$3,698	\$3,861	\$4,131	\$4,414	\$4,749	\$5,088	\$5,512	\$3,861



### 73.5" W, Three seat with divider arms

86 lbs | 5 yds

Model	Series 2	Series 3	Series 4	Series 5	Series 6	Series 7	Series 8	COM
<b>280-35 S</b>	\$4,312	\$4,475	\$4,745	\$5,028	\$5,363	\$5,702	\$6,126	\$4,475
<b>280-35 P</b>	\$4,849	\$5,012	\$5,282	\$5,565	\$5,900	\$6,239	\$6,663	\$5,012

## Hadleigh Bench

### Standard Features

Same standard features as Hadleigh Lounge Seating

### Available Options

Same options as Hadleigh Lounge Seating

### Key Dimensions

- Overall Width: See price table
- Overall Depth: 18"
- Overall Height: 18.75"



### 44" W, Bench

30 lbs | 1.5 yds

Model	Series 2	Series 3	Series 4	Series 5	Series 6	Series 7	Series 8	COM
<b>280-B2 S</b>	\$1,009	\$1,057	\$1,138	\$1,223	\$1,324	\$1,426	\$1,553	\$1,057
<b>280-B2 P</b>	\$1,136	\$1,184	\$1,265	\$1,350	\$1,451	\$1,553	\$1,680	\$1,184

# Harmon Lounge Seating



## More Information

Illustrated Glossary ▶ 409

Fabrics ▶ 421

Flammability (CTB-133) ▶ 429

Finishes ▶ 426

Ordering and Warranties ▶ 432

## Standard Features

- Solid maple frame
- Mortise and tenon joinery
- Spring seat construction
- Clean-out design
- Replaceable components
- Wood arms with wood insets
- Wallsaver legs
- Non-marring 7/8" rubber-cushioned glides
- Nemschoff healthcare wood finish
- GREENGUARD Gold Certified
- Limited Lifetime Warranty

## Available Options

- Moisture barrier + \$69 per seat or back
- Wood back + \$233
- Upholstered back with wood slats + \$233
- Urethane arm insets + \$116
- Upholstered arm insets + \$116
- CTB-133 + \$83/yd
- Two fabrics + \$64
- Three (or more) fabrics + \$90

## Specification Decisions

- Select fabric
- Select standard wood finish
- Add moisture barrier
- Add CTB-133
- Apply multiple fabrics
- Add arm inset style
- Add back style

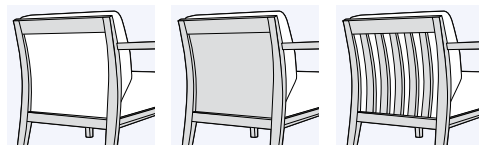

Upholstered back

Wood back

Upholstered back with wood slats

Model numbers with **S** indicate standard seat and back covers, and model numbers with **P** indicate removable covers.

## Flammability Type

- Type 4

## Coordinating Products

- [Harmon Patient Chair](#)

## Key Dimensions

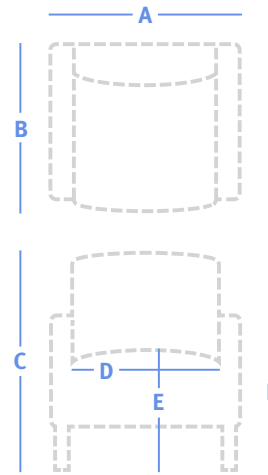

<b>A</b>	Overall Width	See price table
<b>B</b>	Overall Depth	29.75"
<b>C</b>	Overall Height	32"
<b>D</b>	Seat Width	
	Chair:	24"
	Settee:	43.5"
	Sofa:	65.5"
<b>E</b>	Seat Height	18.25"
<b>F</b>	Arm Height	25.75"

## Harmon Lounge Seating

	<b>27" W, Chair</b> <span style="float: right;">36 lbs   2.25 yds</span>								
	Model	Series 2	Series 3	Series 4	Series 5	Series 6	Series 7	Series 8	COM
	<b>708-1 S</b>	\$1,997	\$2,070	\$2,192	\$2,319	\$2,470	\$2,623	\$2,813	\$2,070
	<b>708-1 P</b>	\$2,246	\$2,319	\$2,441	\$2,568	\$2,719	\$2,872	\$3,062	\$2,319
	<b>46.5" W, Settee</b> <span style="float: right;">54 lbs   3 yds</span>								
	Model	Series 2	Series 3	Series 4	Series 5	Series 6	Series 7	Series 8	COM
	<b>708-2 S</b>	\$3,143	\$3,240	\$3,402	\$3,572	\$3,773	\$3,977	\$4,231	\$3,240
	<b>708-2 P</b>	\$3,532	\$3,629	\$3,791	\$3,961	\$4,162	\$4,366	\$4,620	\$3,629
	<b>68.5" W, Sofa</b> <span style="float: right;">73 lbs   4 yds</span>								
	Model	Series 2	Series 3	Series 4	Series 5	Series 6	Series 7	Series 8	COM
	<b>708-3 S</b>	\$4,200	\$4,330	\$4,546	\$4,772	\$5,041	\$5,312	\$5,651	\$4,330
	<b>708-3 P</b>	\$4,720	\$4,850	\$5,066	\$5,292	\$5,561	\$5,832	\$6,171	\$4,850

# Iris Lounge Seating



## More Information

Illustrated Glossary ▶ 409

Fabrics ▶ 421

Flammability (CTB-133) ▶ 429

Finishes ▶ 426

Ordering and Warranties ▶ 432

## Standard Features

- Solid maple frame
- Mortise and tenon joinery
- Spring seat construction
- Replaceable components
- Non-marring 7/8" rubber-cushioned glides
- Detachable seat cushion
- Nemschoff healthcare wood finish
- GREENGUARD Gold Certified
- Limited Lifetime Warranty

## Available Options

- Moisture barrier + \$69 per seat or back
- CTB-133 + \$83/yd
- Two fabrics + \$64
- Three (or more) fabrics + \$90

## Specification Decisions

- Select fabric
- Select standard wood finish
- Add moisture barrier
- Add CTB-133
- Apply multiple fabrics

## Flammability Type

- Type 7

## Key Dimensions

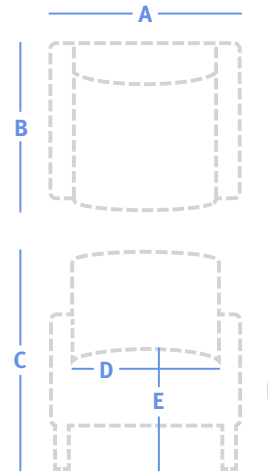

<b>A</b>	Overall Width	See price table
<b>B</b>	Overall Depth	32"
<b>C</b>	Overall Height	40"
<b>D</b>	Seat Width	
	Chair:	27"
	Settee:	50"
<b>E</b>	Seat Height	18.5"
<b>F</b>	Arm Height	23.5"



### 31" W, Chair with arms

56 lbs | 5.5 yds

Model	Series 2	Series 3	Series 4	Series 5	Series 6	Series 7	Series 8	COM
<b>971-1</b>	\$3,360	\$3,539	\$3,836	\$4,147	\$4,516	\$4,889	\$5,355	\$3,539



### 31" W, Chair without arms

50 lbs | 5.5 yds

Model	Series 2	Series 3	Series 4	Series 5	Series 6	Series 7	Series 8	COM
<b>970-1</b>	\$2,941	\$3,120	\$3,417	\$3,728	\$4,097	\$4,470	\$4,936	\$3,120



### 54" W, Settee with arms

78 lbs | 7.75 yds

Model	Series 2	Series 3	Series 4	Series 5	Series 6	Series 7	Series 8	COM
<b>971-2</b>	\$5,780	\$6,032	\$6,451	\$6,888	\$7,408	\$7,934	\$8,591	\$6,032



### 54" W, Settee without arms

84 lbs | 7.75 yds

Model	Series 2	Series 3	Series 4	Series 5	Series 6	Series 7	Series 8	COM
<b>970-2</b>	\$5,363	\$5,615	\$6,034	\$6,471	\$6,991	\$7,517	\$8,174	\$5,615

# Lauderdale Lounge Seating



## Standard Features

- Solid maple frame
- Spring seat construction
- Clean-out design
- Replaceable components
- Wood arm caps
- Detachable seat and back cushion
- Non-marring 7/8" rubber-cushioned glides
- Nemschoff healthcare wood finish
- GREENGUARD Gold Certified
- Limited Lifetime Warranty

## Available Options

- Moisture barrier + \$69 per seat or back
- Black urethane arm caps + \$116
- Fully upholstered arms + \$116
- CTB-133 + \$83/yd
- Two fabrics + \$64
- Three (or more) fabrics + \$90

## Specification Decisions

- Select fabric
- Select standard wood finish
- Add moisture barrier
- Add CTB-133
- Apply multiple fabrics
- Add urethane arm caps
- Add upholstered arms

Model numbers with **S** indicate standard seat and back covers, and model numbers with **P** indicate removable covers.

## Flammability Type

- Type 6

## Coordinating Products

- [Lauderdale Tables](#)

## Key Dimensions

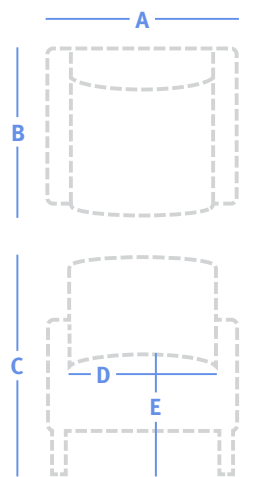

<b>A</b>	Overall Width	See price table
<b>B</b>	Overall Depth	26.5"
<b>C</b>	Overall Height	32"
<b>D</b>	Seat Width	
	Chair:	21.25", 25"
	Settee / Two Seat:	21.25", 45.25", 48"
	Sofa / Three Seat:	21.25", 69.25", 70"
<b>E</b>	Seat Height	18.5"
<b>F</b>	Arm Height	25.25"

### More Information

Illustrated Glossary ▶ 409

Fabrics ▶ 421

Flammability (CTB-133) ▶ 429

Finishes ▶ 426

Ordering and Warranties ▶ 432

# Lauderdale Lounge Seating

	<b>26.75" W, Chair</b>									59 lbs   2.75 yds
	Model	Series 2	Series 3	Series 4	Series 5	Series 6	Series 7	Series 8	COM	
	<b>771-1 S</b>	\$2,153	\$2,242	\$2,391	\$2,546	\$2,731	\$2,917	\$3,150	\$2,242	
	<b>771-1 P</b>	\$2,423	\$2,512	\$2,661	\$2,816	\$3,001	\$3,187	\$3,420	\$2,512	
	<b>32" W, Chair</b>									78 lbs   4.5 yds
	Model	Series 2	Series 3	Series 4	Series 5	Series 6	Series 7	Series 8	COM	
	<b>775-1 S</b>	\$2,338	\$2,484	\$2,727	\$2,981	\$3,283	\$3,589	\$3,970	\$2,484	
	<b>775-1 P</b>	\$2,637	\$2,783	\$3,026	\$3,280	\$3,582	\$3,888	\$4,269	\$2,783	
	<b>50.75" W, Settee</b>									91 lbs   4.25 yds
	Model	Series 2	Series 3	Series 4	Series 5	Series 6	Series 7	Series 8	COM	
	<b>771-2 S</b>	\$3,524	\$3,662	\$3,892	\$4,132	\$4,417	\$4,705	\$5,066	\$3,662	
	<b>771-2 P</b>	\$3,964	\$4,102	\$4,332	\$4,572	\$4,857	\$5,145	\$5,506	\$4,102	
	<b>55" W, Settee</b>									100 lbs   6 yds
	Model	Series 2	Series 3	Series 4	Series 5	Series 6	Series 7	Series 8	COM	
	<b>775-2 S</b>	\$3,874	\$4,069	\$4,393	\$4,732	\$5,135	\$5,542	\$6,051	\$4,069	
	<b>775-2 P</b>	\$4,363	\$4,558	\$4,882	\$5,221	\$5,624	\$6,031	\$6,540	\$4,558	
	<b>50.75" W, Two seat with intervening arm and leg</b>									97 lbs   5 yds
	Model	Series 2	Series 3	Series 4	Series 5	Series 6	Series 7	Series 8	COM	
	<b>771-22 S</b>	\$3,865	\$4,028	\$4,298	\$4,581	\$4,916	\$5,255	\$5,679	\$4,028	
	<b>771-22 P</b>	\$4,349	\$4,512	\$4,782	\$5,065	\$5,400	\$5,739	\$6,163	\$4,512	
	<b>74.75" W, Sofa</b>									103 lbs   5.75 yds
	Model	Series 2	Series 3	Series 4	Series 5	Series 6	Series 7	Series 8	COM	
	<b>771-3 S</b>	\$4,724	\$4,911	\$5,222	\$5,546	\$5,932	\$6,322	\$6,810	\$4,911	
	<b>771-3 P</b>	\$5,314	\$5,501	\$5,812	\$6,136	\$6,522	\$6,912	\$7,400	\$5,501	
	<b>77" W, Sofa</b>									116 lbs   8 yds
	Model	Series 2	Series 3	Series 4	Series 5	Series 6	Series 7	Series 8	COM	
	<b>775-3 S</b>	\$5,086	\$5,347	\$5,779	\$6,231	\$6,768	\$7,310	\$7,989	\$5,347	
	<b>775-3 P</b>	\$5,728	\$5,989	\$6,421	\$6,873	\$7,410	\$7,952	\$8,631	\$5,989	
	<b>74.75" W, Three seat with intervening arms and legs</b>									111 lbs   7.25 yds
	Model	Series 2	Series 3	Series 4	Series 5	Series 6	Series 7	Series 8	COM	
	<b>771-33 S</b>	\$5,412	\$5,648	\$6,040	\$6,449	\$6,936	\$7,427	\$8,042	\$5,648	
	<b>771-33 P</b>	\$6,090	\$6,326	\$6,718	\$7,127	\$7,614	\$8,105	\$8,720	\$6,326	

Lounge Seating

Multiple & Tandem Seating

Side, Stacking & Folding Chairs

Occasional Tables



# Leonard II Lounge Seating



## Standard Features

- Solid maple frame
- Spring seat construction
- Replaceable components
- Wood arm caps
- Non-marring 7/8" x 2" plastic bar glides
- Nemschoff healthcare wood finish
- GREENGUARD Gold Certified
- Limited Lifetime Warranty

## Available Options

- Moisture barrier + \$69 per seat or back
- Classic upholstered bottom panel (Chair) + \$94
- Classic upholstered bottom panel (Two seat) + \$174
- Classic upholstered bottom panel (Three seat) + \$253
- Fully upholstered arms + \$116
- Black urethane arm caps + \$116
- CTB-133 + \$83/yd
- Two fabrics + \$64
- Three (or more) fabrics + \$90

## Specification Decisions

- Select fabric
- Select standard wood finish
- Add moisture barrier
- Add classic panel
- Add upholstered arms or urethane arm caps
- Add CTB-133
- Apply multiple fabrics

Model numbers with **S** indicate standard seat and back covers, and model numbers with **P** indicate removable covers.

## Flammability Type

- Type 6

## Coordinating Products

- [Leonard II Recliner](#)
- [Leonard II Sleep Double Sofa and Sleep Settee](#)

## Key Dimensions

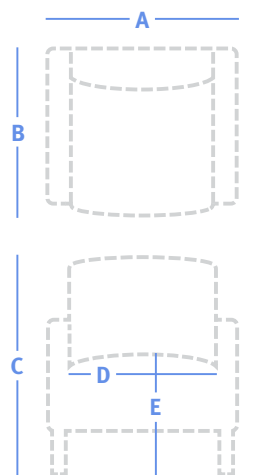

<b>A</b>	Overall Width	See price table
<b>B</b>	Overall Depth	31.75"
<b>C</b>	Overall Height	34.25"
<b>D</b>	Seat Width	
	Chair:	25"
	Two Seat:	50"
	Three Seat:	75"
<b>E</b>	Seat Height	18"
<b>F</b>	Arm Height	25"

### More Information

- Illustrated Glossary ▶ 409
- Fabrics ▶ 421
- Flammability (CTB-133) ▶ 429
- Finishes ▶ 426
- Ordering and Warranties ▶ 432

## Leonard II Lounge Seating



### 32.5" W, Chair

72 lbs | 6 yds

Model	Series 2	Series 3	Series 4	Series 5	Series 6	Series 7	Series 8	COM
<b>814-10 S</b>	\$2,125	\$2,320	\$2,644	\$2,983	\$3,386	\$3,793	\$4,302	\$2,320
<b>814-10 P</b>	\$2,404	\$2,599	\$2,923	\$3,262	\$3,665	\$4,072	\$4,581	\$2,599



### 57" W, Two seat

104 lbs | 9 yds

Model	Series 2	Series 3	Series 4	Series 5	Series 6	Series 7	Series 8	COM
<b>814-20 S</b>	\$3,393	\$3,686	\$4,172	\$4,680	\$5,284	\$5,895	\$6,658	\$3,686
<b>814-20 P</b>	\$3,836	\$4,129	\$4,615	\$5,123	\$5,727	\$6,338	\$7,101	\$4,129



### 82.25" W, Three seat

136 lbs | 11.25 yds

Model	Series 2	Series 3	Series 4	Series 5	Series 6	Series 7	Series 8	COM
<b>814-30 S</b>	\$4,547	\$4,914	\$5,522	\$6,157	\$6,912	\$7,675	\$8,629	\$4,914
<b>814-30 P</b>	\$5,137	\$5,504	\$6,112	\$6,747	\$7,502	\$8,265	\$9,219	\$5,504

Lounge Seating

Multiple & Tandem Seating

Side, Stacking & Folding Chairs

Occasional Tables

# Marco Grande II Lounge Seating



## Standard Features

- Solid maple frame
- Spring seat construction
- Clean-out design
- Replaceable components
- Wood arms
- Non-marring 7/8" rubber-cushioned glides
- Nemschoff healthcare wood finish
- GREENGUARD Gold Certified
- Limited Lifetime Warranty

## Available Options

- Moisture barrier + \$69 per seat or back
- CTB-133 + \$83/yd
- Two fabrics + \$64
- Three (or more) fabrics + \$90

## Specification Decisions

- Select fabric
- Select standard wood finish
- Add moisture barrier
- Add CTB-133
- Apply multiple fabrics

Model numbers with **S** indicate standard seat and back covers, and model numbers with **P** indicate removable covers.

## Flammability Types

- Type 4
- Type 2 (Ottoman)

## Coordinating Products

- [Marco Multiple Seating](#)
- [Marco Grande Tables](#)
- [Marco Patient Chair](#)
- [Marco Glider](#)

## Key Dimensions

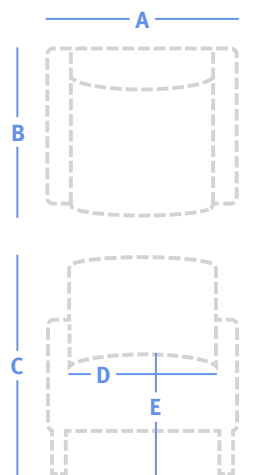

<b>A</b>	Overall Width	See price table
<b>B</b>	Overall Depth	32"
<b>C</b>	Overall Height	32.5"
<b>D</b>	Seat Width	
	Chair:	24.25"
	Settee:	45.25", 48.25"
	Sofa:	68.25", 72"
<b>E</b>	Seat Height	18.5"
<b>F</b>	Arm Height	24.25"

### More Information

Illustrated Glossary ▶ 409

Fabrics ▶ 421

Flammability (CTB-133) ▶ 429

Finishes ▶ 426

Ordering and Warranties ▶ 432

## Marco Grande II Lounge Seating

	<b>28.75" W, Chair</b> <span style="float: right;">40 lbs   3 yds</span>								
	Model	Series 2	Series 3	Series 4	Series 5	Series 6	Series 7	Series 8	COM
	<b>736-1 S</b>	\$1,875	\$1,972	\$2,134	\$2,304	\$2,505	\$2,709	\$2,963	\$1,972
	<b>736-1 P</b>	\$2,112	\$2,209	\$2,371	\$2,541	\$2,742	\$2,946	\$3,200	\$2,209
	<b>53" W, Settee</b> <span style="float: right;">72 lbs   5 yds</span>								
	Model	Series 2	Series 3	Series 4	Series 5	Series 6	Series 7	Series 8	COM
	<b>736-2 S</b>	\$3,033	\$3,196	\$3,466	\$3,749	\$4,084	\$4,423	\$4,847	\$3,196
	<b>736-2 P</b>	\$3,417	\$3,580	\$3,850	\$4,133	\$4,468	\$4,807	\$5,231	\$3,580
	<b>53" W, Settee with divider arm</b> <span style="float: right;">74 lbs   5 yds</span>								
	Model	Series 2	Series 3	Series 4	Series 5	Series 6	Series 7	Series 8	COM
	<b>736-25 S</b>	\$3,346	\$3,509	\$3,779	\$4,062	\$4,397	\$4,736	\$5,160	\$3,509
	<b>736-25 P</b>	\$3,768	\$3,931	\$4,201	\$4,484	\$4,819	\$5,158	\$5,582	\$3,931
	<b>77" W, Sofa</b> <span style="float: right;">102 lbs   7 yds</span>								
	Model	Series 2	Series 3	Series 4	Series 5	Series 6	Series 7	Series 8	COM
	<b>736-3 S</b>	\$4,150	\$4,378	\$4,756	\$5,151	\$5,621	\$6,096	\$6,690	\$4,378
	<b>736-3 P</b>	\$4,676	\$4,904	\$5,282	\$5,677	\$6,147	\$6,622	\$7,216	\$4,904
	<b>77" W, Sofa with divider arms</b> <span style="float: right;">106 lbs   7 yds</span>								
	Model	Series 2	Series 3	Series 4	Series 5	Series 6	Series 7	Series 8	COM
	<b>736-35 S</b>	\$4,870	\$5,098	\$5,476	\$5,871	\$6,341	\$6,816	\$7,410	\$5,098
	<b>736-35 P</b>	\$5,482	\$5,710	\$6,088	\$6,483	\$6,953	\$7,428	\$8,022	\$5,710

## Marco Grande II Ottoman

### Standard Features

Same standard features as Marco Grande II Lounge Seating

### Available Options

Same options as Marco Grande II Lounge Seating

### Key Dimensions

- Overall Width: See price table
- Overall Depth: 17"
- Overall Height: 14.5"

	<b>22.5" W, Ottoman</b> <span style="float: right;">12 lbs   1.75 yds</span>								
	Model	Series 2	Series 3	Series 4	Series 5	Series 6	Series 7	Series 8	COM
	<b>736-59</b>	\$413	\$470	\$565	\$664	\$781	\$900	\$1,048	\$470

# Marsack Lounge Seating



## Standard Features

- Spring seat construction
- Clean-out design
- Replaceable components
- Black urethane arm caps
- Laminate-wrapped side panels
- Ultra-heavy
- Non-marring 5/8" x 2" plastic bar glides
- GREENGUARD Gold Certified
- Limited Lifetime Warranty

## Available Options

- Moisture barrier + \$69 per seat or back
- CTB-133 + \$83/yd
- Two fabrics + \$64
- Three (or more) fabrics + \$90

## Specification Decisions

- Select fabric
- Select standard laminate finish
- Add moisture barrier
- Add CTB-133
- Apply multiple fabrics

Model numbers with **S** indicate standard seat and back covers, and model numbers with **P** indicate removable covers.

## Flammability Type

- Type 4

## Coordinating Products

- [Marsack Tables](#)
- [Marsack III Behavioral Health Seating](#)

## Key Dimensions

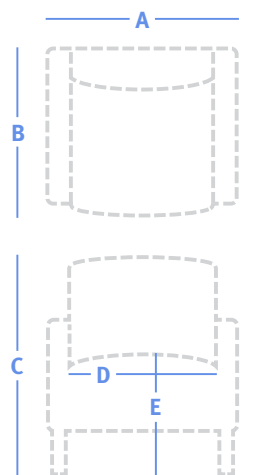

<b>A</b>	Overall Width	See price table
<b>B</b>	Overall Depth	29.5"
<b>C</b>	Overall Height	32.5"
<b>D</b>	Seat Width	
	Chair:	23"
	Settee:	46"
	Sofa:	69"
<b>E</b>	Seat Height	18.75"
<b>F</b>	Arm Height	24.5"

### More Information

Illustrated Glossary ▶ 409

Fabrics ▶ 421

Flammability (CTB-133) ▶ 429

Finishes ▶ 426

Ordering and Warranties ▶ 432

## Marsack Lounge Seating

Lounge Seating

Multiple & Tandem Seating

Side, Stacking & Folding Chairs

Occasional Tables

	<b>29" W, Chair</b>									92 lbs   2.25 yds
	Model	Series 2	Series 3	Series 4	Series 5	Series 6	Series 7	Series 8	COM	
	<b>700-10 S</b>	\$2,243	\$2,316	\$2,438	\$2,565	\$2,716	\$2,869	\$3,059	\$2,316	
	<b>700-10 P</b>	\$2,521	\$2,594	\$2,716	\$2,843	\$2,994	\$3,147	\$3,337	\$2,594	
	<b>49.5" W, Settee</b>									128 lbs   3.5 yds
	Model	Series 2	Series 3	Series 4	Series 5	Series 6	Series 7	Series 8	COM	
	<b>700-20 S</b>	\$3,656	\$3,770	\$3,959	\$4,157	\$4,392	\$4,629	\$4,926	\$3,770	
	<b>700-20 P</b>	\$4,109	\$4,223	\$4,412	\$4,610	\$4,845	\$5,082	\$5,379	\$4,223	
	<b>52.25" W, Settee with divider arm</b>									141 lbs   4.25 yds
	Model	Series 2	Series 3	Series 4	Series 5	Series 6	Series 7	Series 8	COM	
	<b>700-25 S</b>	\$4,105	\$4,243	\$4,473	\$4,713	\$4,998	\$5,286	\$5,647	\$4,243	
	<b>700-25 P</b>	\$4,615	\$4,753	\$4,983	\$5,223	\$5,508	\$5,796	\$6,157	\$4,753	
	<b>70.5" W, Sofa</b>									156 lbs   6.5 yds
	Model	Series 2	Series 3	Series 4	Series 5	Series 6	Series 7	Series 8	COM	
	<b>700-30 S</b>	\$4,717	\$4,929	\$5,280	\$5,647	\$6,084	\$6,524	\$7,076	\$4,929	
	<b>700-30 P</b>	\$5,309	\$5,521	\$5,872	\$6,239	\$6,676	\$7,116	\$7,668	\$5,521	
	<b>76.5" W, Sofa with divider arms</b>									188 lbs   6.25 yds
	Model	Series 2	Series 3	Series 4	Series 5	Series 6	Series 7	Series 8	COM	
	<b>700-35 S</b>	\$5,829	\$6,032	\$6,370	\$6,723	\$7,142	\$7,566	\$8,096	\$6,032	
	<b>700-35 P</b>	\$6,553	\$6,756	\$7,094	\$7,447	\$7,866	\$8,290	\$8,820	\$6,756	

### Marsack Bench

#### Standard Features



Same standard features as Marsack Lounge Seating

#### Available Options

Same options as Marsack Lounge Seating

#### Key Dimensions

- Overall Width: See price table
- Overall Depth: 26.5"
- Overall Height: 18.75"

	<b>26" W, Bench</b>									49 lbs   1.5 yds
	Model	Series 2	Series 3	Series 4	Series 5	Series 6	Series 7	Series 8	COM	
	<b>700-B1 S</b>	\$1,233	\$1,281	\$1,362	\$1,447	\$1,548	\$1,650	\$1,777	\$1,281	
	<b>700-B1 P</b>	\$1,387	\$1,435	\$1,516	\$1,601	\$1,702	\$1,804	\$1,931	\$1,435	
	<b>46.5" W, Bench</b>									65 lbs   2.5 yds
	Model	Series 2	Series 3	Series 4	Series 5	Series 6	Series 7	Series 8	COM	
	<b>700-B2 S</b>	\$1,596	\$1,677	\$1,812	\$1,954	\$2,121	\$2,291	\$2,503	\$1,677	
	<b>700-B2 P</b>	\$1,798	\$1,879	\$2,014	\$2,156	\$2,323	\$2,493	\$2,705	\$1,879	

# Maurice Lounge Seating



## Standard Features

- Solid maple frame
- Mortise and tenon joinery
- Spring seat construction
- Clean-out design
- Non-marring 7/8" plastic glides
- Nemschoff healthcare wood finish
- GREENGUARD Gold Certified
- Limited Lifetime Warranty

## Available Options

- Moisture barrier + \$69 per seat or back
- CTB-133 + \$83/yd
- Two fabrics + \$64
- Three (or more) fabrics + \$90

## Specification Decisions

- Select fabric
  - Select standard wood finish
  - Add moisture barrier
  - Add CTB-133
  - Apply multiple fabrics
- Model numbers with **S** indicate standard seat and back covers, and model numbers with **P** indicate removable covers.

## Flammability Type

- Type 7

## Key Dimensions

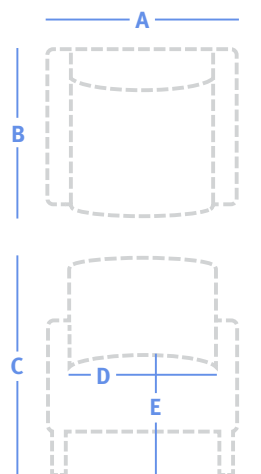

<b>A</b>	Overall Width	See price table
<b>B</b>	Overall Depth	34"
<b>C</b>	Overall Height	37.5"
<b>D</b>	Seat Width	
	Chair:	21.25"
	Settee:	41.75"
	Sofa:	64.5"
<b>E</b>	Seat Height	18.5"
<b>F</b>	Arm Height	26.5"

### More Information

Illustrated Glossary ▶ 409

Fabrics ▶ 421

Flammability (CTB-133) ▶ 429

Finishes ▶ 426

Ordering and Warranties ▶ 432



### 34.25" W, Chair

45 lbs | 7.25 yds

Model	Series 2	Series 3	Series 4	Series 5	Series 6	Series 7	Series 8	COM
<b>905-10 S</b>	\$1,909	\$2,145	\$2,537	\$2,946	\$3,433	\$3,924	\$4,539	\$2,145
<b>905-10 P</b>	\$2,167	\$2,403	\$2,795	\$3,204	\$3,691	\$4,182	\$4,797	\$2,403



### 54.5" W, Settee

66 lbs | 10 yds

Model	Series 2	Series 3	Series 4	Series 5	Series 6	Series 7	Series 8	COM
<b>905-20 S</b>	\$2,691	\$3,017	\$3,557	\$4,122	\$4,793	\$5,471	\$6,319	\$3,017
<b>905-20 P</b>	\$3,054	\$3,380	\$3,920	\$4,485	\$5,156	\$5,834	\$6,682	\$3,380



### 77.25" W, Sofa

86 lbs | 12 yds

Model	Series 2	Series 3	Series 4	Series 5	Series 6	Series 7	Series 8	COM
<b>905-30 S</b>	\$3,419	\$3,810	\$4,458	\$5,135	\$5,941	\$6,755	\$7,773	\$3,810
<b>905-30 P</b>	\$3,877	\$4,268	\$4,916	\$5,593	\$6,399	\$7,213	\$8,231	\$4,268

# Mod Pod Lounge System



## More Information

- Illustrated Glossary ▶ 409
- Fabrics ▶ 421
- Flammability (CTB-133) ▶ 429
- Finishes ▶ 426
- Ordering and Warranties ▶ 432

## Standard Features

- Hexagon-shaped seats
- Wipe-out design
- Powder-coated legs
- Veneer table tops
- GREENGUARD Gold Certification
- Limited Lifetime Warranty

## Available Options

- Moisture barrier + \$69 per seat or back
- Attached veneer tables (See price table)
- Laminate or fusion maple or black Durawrap tops + \$0
- Anodized aluminum or black connection bracket set for seat-to-seat attachment (CBMOD) + \$314
- CTB-133 + \$83/yd
- Two fabrics + \$64
- Three (or more) fabrics + \$90
- Removable covers + \$107

## Specification Decisions

- Select powder coat finish (MST Metallic Silver Textured, XTT Titanium Textured)
- Select fabric
- Add moisture barrier
- Add CTB-133
- Apply multiple fabrics
- Add removable covers
- Create a seating configuration plan. List unit model numbers from left to right.
- Add connecting brackets for seat-to-seat connections or select seats, tables and accessory units. Specify side to attach tables (LSF, RSF). Tables include brackets.
- Select laminate, Fusion maple, or Black Durawrap for table tops, if required.
- Follow the online quoting system to determine if male or female connections are needed with each item.

For more details about configuring and ordering this lounge system, visit our website [nemschoff.com/products/mod-pod-lounge-system](http://nemschoff.com/products/mod-pod-lounge-system) choose Design Resources > Literature > Pricing.



Example Mod Pod Lounge configuration plan

Unit	Model #	Description	Ganging
A	MOD	Chair	Ganged RSF
B	MODST	Spanner Table	Ganged RSF & LSF
C	MOD	Chair	Ganged RSF & LSF
D	MODST	Spanner Table	Ganged RSF & LSF
E	MOD	Chair	Ganged RSF & LSF
F	MODST	Spanner Table	Ganged RSF & LSF
G	MOD	Chair	Ganged LSF

Furniture ships inside a protective bag to which a shipping label is affixed. Any site-specific installation instructions (location designation or place in specific configuration — with ganged or modular components) will be on the label. Do not remove the protective bag prior to product being staged in the indicated location on site.

## Flammability Type

- Type 5

## Key Dimensions

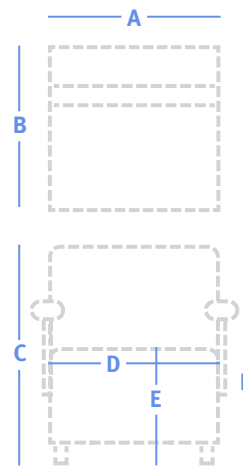

<b>A</b>	Overall Width	See price table
<b>B</b>	Overall Depth	30"
<b>C</b>	Overall Height	33.5"
<b>D</b>	Seat Width	
	Chair:	24"
	Settee:	48"
	Bench:	48"
<b>E</b>	Seat Height	19"
<b>F</b>	Arm Height	25"



## Mod Pod Lounge

	<b>24" W, Chair</b>									43 lbs   2.5 yds
	Model	Series 2	Series 3	Series 4	Series 5	Series 6	Series 7	Series 8	COM	
	<b>MOD</b>	\$1,457	\$1,497	\$1,673	\$1,767	\$1,818	\$1,885	\$1,928	\$1,497	

	<b>24" W, Chair with casters</b>									43 lbs   3 yds
	Model	Series 2	Series 3	Series 4	Series 5	Series 6	Series 7	Series 8	COM	
	<b>MOD-C</b>	\$1,413	\$1,461	\$1,672	\$1,785	\$1,846	\$1,927	\$1,978	\$1,461	

	<b>48" W, Settee</b>									70 lbs   4.25 yds
	Model	Series 2	Series 3	Series 4	Series 5	Series 6	Series 7	Series 8	COM	
	<b>MODLS</b>	\$2,138	\$2,206	\$2,504	\$2,664	\$2,751	\$2,866	\$2,939	\$2,206	

	<b>48" W, Bench</b>									49 lbs   3.5 yds
	Model	Series 2	Series 3	Series 4	Series 5	Series 6	Series 7	Series 8	COM	
	<b>MODB/48</b>	\$1,579	\$1,635	\$1,881	\$2,012	\$2,084	\$2,178	\$2,239	\$1,635	

	<b>Gusset</b>									15 lbs   .25 yds
	Model	Series 2	Series 3	Series 4	Series 5	Series 6	Series 7	Series 8	COM	
	<b>GMOD</b>	\$73	\$77	\$95	\$104	\$110	\$116	\$121	\$77	

## Mod Pod Arm

### Specification Decisions

- Select powder coat finish
- Select LSF or RSF (EAMOD)

	<b>Right or left end arm with female connecting bracket</b>									4 lbs
	Model	Price								
	<b>EAMOD</b>	\$380								

	<b>Inner arm with male and female connecting brackets</b>									4 lbs
	Model	Price								
	<b>IAMOD</b>	\$446								

# Mod Pod Lounge System

Lounge Seating

Multiple & Tandem Seating

Side, Stacking & Folding Chairs

Occasional Tables

## Mod Pod Tables

### Available Options

- Standard laminate
- Fusion maple or Black Durawrap

### Specification Decisions

- Select powder coat finish
- Select wood or add laminate or Durawrap tabletop material

	<b>21.75" W, End table with one bracket</b>		15 lbs
	Model	Price	
	<b>MODET</b>	\$1,019	
	<b>21.75" W, Inner table with two brackets</b>		12 lbs
	Model	Price	
	<b>MODIT</b>	\$900	
	<b>13.75" W, Spanner table with two brackets</b>		10 lbs
	Model	Price	
	<b>MODST</b>	\$710	
	<b>29.5" W, Corner table with two brackets</b>		17 lbs
	Model	Price	
	<b>MODCT</b>	\$1,080	

# Monarch Lounge Seating



## Standard Features

- Solid hardwood frame
- Mortise and tenon joinery
- Spring seat construction
- Clean-out design
- Replaceable components
- Black urethane arm caps
- Wallsaver legs
- Non-marring 7/8" nylon glides
- Nemschoff healthcare wood finish
- GREENGUARD Gold Certified
- Limited Lifetime Warranty

## Available Options

- Moisture barrier + \$69 per seat or back
- Wood arm caps + \$116
- CTB-133 + \$83/yd
- Two fabrics + \$64
- Three (or more) fabrics + \$90

## Specification Decisions

- Select fabric
- Select standard wood finish
- Add moisture barrier
- Add CTB-133
- Apply multiple fabrics
- Add wood arm caps

Model numbers with **S** indicate standard seat and back covers, and model numbers with **P** indicate removable covers.

## Flammability Type

- Type 4

## Coordinating Products

- [Monarch Multiple Seating](#)
- [Monarch Stack Chair](#)
- [Monarch Tables](#)
- [Monarch Patient Chair](#)
- [Monarch Sleep Chair and Settee](#)

## Key Dimensions

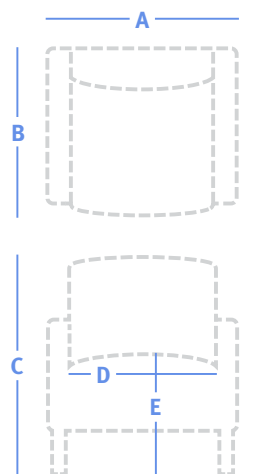

<b>A</b>	Overall Width	See price table
<b>B</b>	Overall Depth	28.25"
<b>C</b>	Overall Height	32.5"
<b>D</b>	Seat Width	
	Chair:	22"
	Two Seat:	44"
	Three Seat:	66"
<b>E</b>	Seat Height	18.75"
<b>F</b>	Arm Height	26"

### More Information

Illustrated Glossary ▶ 409

Fabrics ▶ 421

Flammability (CTB-133) ▶ 429

Finishes ▶ 426

Ordering and Warranties ▶ 432

## Monarch Lounge Seating



### 25.5" W, Chair

42 lbs | 3.25 yds

Model	Series 2	Series 3	Series 4	Series 5	Series 6	Series 7	Series 8	COM
<b>894-10 S</b>	\$1,094	\$1,200	\$1,376	\$1,559	\$1,778	\$1,998	\$2,274	\$1,200
<b>894-10 P</b>	\$1,238	\$1,344	\$1,520	\$1,703	\$1,922	\$2,142	\$2,418	\$1,344



### 47.5" W, Two seat

67 lbs | 5 yds

Model	Series 2	Series 3	Series 4	Series 5	Series 6	Series 7	Series 8	COM
<b>894-20 S</b>	\$1,515	\$1,678	\$1,948	\$2,231	\$2,566	\$2,905	\$3,329	\$1,678
<b>894-20 P</b>	\$1,717	\$1,880	\$2,150	\$2,433	\$2,768	\$3,107	\$3,531	\$1,880



### 69.5" W, Three seat

88 lbs | 7 yds

Model	Series 2	Series 3	Series 4	Series 5	Series 6	Series 7	Series 8	COM
<b>894-30 S</b>	\$2,179	\$2,407	\$2,785	\$3,180	\$3,650	\$4,125	\$4,719	\$2,407
<b>894-30 P</b>	\$2,468	\$2,696	\$3,074	\$3,469	\$3,939	\$4,414	\$5,008	\$2,696

Lounge Seating

Multiple & Tandem Seating

Side, Stacking & Folding Chairs

Occasional Tables

# Oliver Lounge Seating



## Standard Features

- Solid maple frame
- Mortise and tenon joinery
- Spring seat construction
- Clean-out design
- Replaceable components
- Non-marring 7/8" plastic glides
- Nemschoff healthcare wood finish
- GREENGUARD Gold Certified
- Limited Lifetime Warranty

## Available Options

- Moisture barrier + \$69 per seat or back
- CTB-133 + \$83/yd
- Two fabrics + \$64
- Three (or more) fabrics + \$90

## Specification Decisions

- Select fabric
- Select standard wood finish
- Add moisture barrier
- Add CTB-133
- Apply multiple fabrics

Model numbers with **S** indicate standard seat and back covers, and model numbers with **P** indicate removable covers.

## Flammability Type

- Type 3

## Coordinating Products

- [Oliver Recliner](#)
- [Oliver Sleep Settee](#)
- [Olivia Tables](#)
- [Olivia Patient Chair](#)
- [Olivia Glider](#)

## Key Dimensions

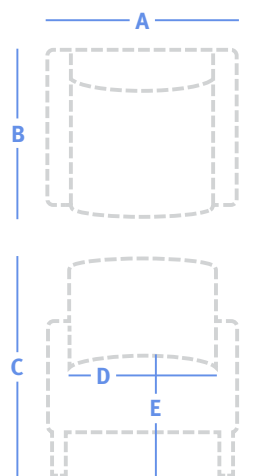

<b>A</b>	Overall Width	See price table
<b>B</b>	Overall Depth	29.75"
<b>C</b>	Overall Height	35"
<b>D</b>	Seat Width	
	Chair:	22"
	Settee:	41"
	Sofa:	62.5"
<b>E</b>	Seat Height	18.75"
<b>F</b>	Arm Height	24.75"

### More Information

- Illustrated Glossary ▶ 409
- Fabrics ▶ 421
- Flammability (CTB-133) ▶ 429
- Finishes ▶ 426
- Ordering and Warranties ▶ 432



### 27.75" W, Chair

30 lbs | 2.25 yds

Model	Series 2	Series 3	Series 4	Series 5	Series 6	Series 7	Series 8	COM
<b>902-10 S</b>	\$2,102	\$2,175	\$2,297	\$2,424	\$2,575	\$2,728	\$2,918	\$2,175
<b>902-10 P</b>	\$2,363	\$2,436	\$2,558	\$2,685	\$2,836	\$2,989	\$3,179	\$2,436



### 47.75" W, Settee

50 lbs | 4.25 yds

Model	Series 2	Series 3	Series 4	Series 5	Series 6	Series 7	Series 8	COM
<b>902-20 S</b>	\$3,071	\$3,209	\$3,439	\$3,679	\$3,964	\$4,252	\$4,613	\$3,209
<b>902-20 P</b>	\$3,457	\$3,595	\$3,825	\$4,065	\$4,350	\$4,638	\$4,999	\$3,595



### 70" W, Sofa

70 lbs | 5.25 yds

Model	Series 2	Series 3	Series 4	Series 5	Series 6	Series 7	Series 8	COM
<b>902-30 S</b>	\$3,990	\$4,161	\$4,445	\$4,741	\$5,094	\$5,450	\$5,895	\$4,161
<b>902-30 P</b>	\$4,490	\$4,661	\$4,945	\$5,241	\$5,594	\$5,950	\$6,395	\$4,661

# Olivia Lounge Seating



## More Information

Illustrated Glossary ▶ 409

Fabrics ▶ 421

Flammability (CTB-133) ▶ 429

Finishes ▶ 426

Ordering and Warranties ▶ 432

## Standard Features

- Solid maple frame
- Spring seat construction
- Clean-out design
- Replaceable components
- Upholstered arms
- Non-marring 7/8" rubber-cushioned glides
- Nemschoff healthcare wood finish
- GREENGUARD Gold Certified
- Limited Lifetime Warranty
- See nemschoff.com for weight ratings (903-510B)

## Available Options

- Moisture barrier + \$69 per seat or back
- CTB-133 + \$83/yd
- Two fabrics + \$64
- Three (or more) fabrics + \$90

## Specification Decisions

- Select fabric
- Select standard wood finish
- Add moisture barrier
- Add CTB-133
- Apply multiple fabrics

Model numbers with **S** indicate standard seat and back covers, and model numbers with **P** indicate removable covers.

## Flammability Type

- Type 6

## Coordinating Products

- [Olivia Tables](#)
- [Olivia Patient Chair](#)
- [Olivia Glider](#)
- [Oliver Lounge](#)

## Key Dimensions

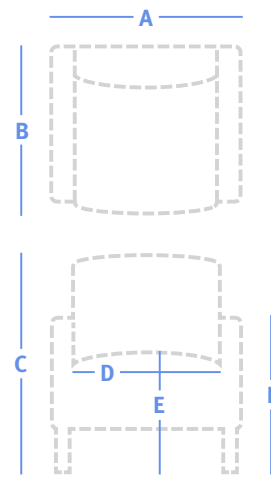

<b>A</b>	Overall Width	See price table
<b>B</b>	Overall Depth	30"
<b>C</b>	Overall Height	35"
<b>D</b>	Seat Width	
	Chair:	21.25", 29.5"
	Settee:	39", 41"
	Sofa:	58.5", 62.5"
<b>E</b>	Seat Height	18.75"
<b>F</b>	Arm Height	25.25"

## Olivia Lounge Seating

		<b>28" W, Chair</b>								34 lbs   3.5 yds
Model		Series 2	Series 3	Series 4	Series 5	Series 6	Series 7	Series 8	COM	
<b>903-10 S</b>		\$1,900	\$2,014	\$2,203	\$2,401	\$2,636	\$2,873	\$3,170	\$2,014	
<b>903-10 P</b>		\$2,142	\$2,256	\$2,445	\$2,643	\$2,878	\$3,115	\$3,412	\$2,256	

		<b>38" W, Plus chair</b>								50 lbs   5.25 yds
Model		Series 2	Series 3	Series 4	Series 5	Series 6	Series 7	Series 8	COM	
<b>903-510B</b>		\$3,549	\$3,720	\$4,004	\$4,300	\$4,653	\$5,009	\$5,454	\$3,720	

		<b>47.75" W, Settee</b>								52 lbs   6 yds
Model		Series 2	Series 3	Series 4	Series 5	Series 6	Series 7	Series 8	COM	
<b>903-20 S</b>		\$2,715	\$2,910	\$3,234	\$3,573	\$3,976	\$4,383	\$4,892	\$2,910	
<b>903-20 P</b>		\$3,065	\$3,260	\$3,584	\$3,923	\$4,326	\$4,733	\$5,242	\$3,260	

		<b>47.75" W, Settee with divider arm</b>								55 lbs   6.75 yds
Model		Series 2	Series 3	Series 4	Series 5	Series 6	Series 7	Series 8	COM	
<b>903-25 S</b>		\$3,062	\$3,282	\$3,647	\$4,028	\$4,481	\$4,939	\$5,511	\$3,282	
<b>903-25 P</b>		\$3,456	\$3,676	\$4,041	\$4,422	\$4,875	\$5,333	\$5,905	\$3,676	

		<b>70" W, Sofa</b>								72 lbs   8.25 yds
Model		Series 2	Series 3	Series 4	Series 5	Series 6	Series 7	Series 8	COM	
<b>903-30 S</b>		\$3,469	\$3,738	\$4,184	\$4,649	\$5,203	\$5,763	\$6,462	\$3,738	
<b>903-30 P</b>		\$3,918	\$4,187	\$4,633	\$5,098	\$5,652	\$6,212	\$6,911	\$4,187	

		<b>70" W, Sofa with divider arms</b>								78 lbs   9 yds
Model		Series 2	Series 3	Series 4	Series 5	Series 6	Series 7	Series 8	COM	
<b>903-35 S</b>		\$4,206	\$4,499	\$4,985	\$5,493	\$6,097	\$6,708	\$7,471	\$4,499	
<b>903-35 P</b>		\$4,746	\$5,039	\$5,525	\$6,033	\$6,637	\$7,248	\$8,011	\$5,039	

# Ottoman Lounge Seating



## More Information

Illustrated Glossary ▶ 409

Fabrics ▶ 421

Flammability (CTB-133) ▶ 429

Finishes ▶ 426

Ordering and Warranties ▶ 432

## Standard Features

- Solid hardwood frame
- Nemschoff healthcare wood finish
- GREENGUARD Gold Certified
- Limited Lifetime Warranty

## Available Options

- Moisture barrier + \$69 per seat
- CTB-133 + \$83/yd
- Two fabrics + \$64

## Specification Decisions

- Select fabric
- Select standard wood finish
- Add CTB-133
- Apply multiple fabrics

## Flammability Type

- Type 4

## Key Dimensions

- Overall Width: See price table
- Overall Height: 17" (Round)
- Overall Height: 13" (Square)

	<b>23"W x 23"D, Square ottoman</b>									30 lbs   2 yds
	Model	Series 2	Series 3	Series 4	Series 5	Series 6	Series 7	Series 8	COM	
	<b>1722/23</b>	\$994	\$1,018	\$1,124	\$1,180	\$1,211	\$1,251	\$1,277	\$1,018	
	<b>24" dia, Round ottoman</b>									30 lbs   1.5 yds
	Model	Series 2	Series 3	Series 4	Series 5	Series 6	Series 7	Series 8	COM	
	<b>1723/24</b>	\$950	\$986	\$1,144	\$1,229	\$1,275	\$1,335	\$1,374	\$986	
	<b>36" dia, Round ottoman</b>									45 lbs   2.25 yds
	Model	Series 2	Series 3	Series 4	Series 5	Series 6	Series 7	Series 8	COM	
	<b>1723/36</b>	\$1,190	\$1,250	\$1,513	\$1,654	\$1,731	\$1,832	\$1,897	\$1,250	

Lounge Seating

Multiple & Tandem Seating

Side, Stacking & Folding Chairs

Occasional Tables



# Pamona Lounge Seating



## Standard Features

- Mortise and tenon joinery
- Spring seat construction
- Clean-out design
- Replaceable components
- Upholstered arms
- Powder-coated metal legs
- Wallsaver legs
- Non-marring 1" glides
- GREENGUARD Gold Certified
- Limited Lifetime Warranty

## Available Options

- Moisture barrier + \$69 per seat or back
- Wood arm caps + \$116
- Black urethane arm caps + \$116
- CTB-133 + \$83/yd
- Two fabrics + \$64
- Three (or more) fabrics + \$90

## Specification Decisions

- Select fabric
  - Select powder coat finish
  - Add moisture barrier
  - Add CTB-133
  - Apply multiple fabrics
  - Add wood or urethane arm caps
- Model numbers with **S** indicate standard seat and back covers, and model numbers with **P** indicate removable covers.

## Flammability Type

- Type 6

## Coordinating Products

- [Pamona Tables](#)
- [Pamona Recliner](#)
- [Pamona Flop Sofa](#)

## Key Dimensions

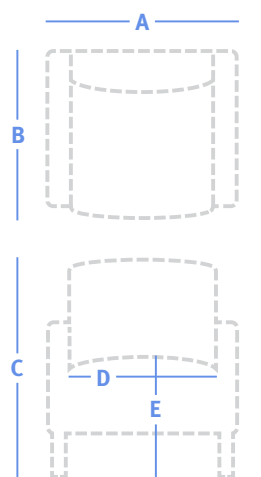

<b>A</b>	Overall Width	See price table
<b>B</b>	Overall Depth	30.75"
<b>C</b>	Overall Height	33.25"
<b>D</b>	Seat Width	
	Chair:	24"
	Settee:	46.75"
	Sofa:	64.75"
<b>E</b>	Seat Height	18.25"
<b>F</b>	Arm Height	25"

### More Information

Illustrated Glossary ▶ 409

Fabrics ▶ 421

Flammability (CTB-133) ▶ 429

Finishes ▶ 426

Ordering and Warranties ▶ 432

## Pamona Lounge Seating

 	<b>31.25" W, Chair</b> <span style="float: right;">51 lbs   5 yds</span>								
	Model	Series 2	Series 3	Series 4	Series 5	Series 6	Series 7	Series 8	COM
	<b>797-1 S</b>	\$1,848	\$2,011	\$2,281	\$2,564	\$2,899	\$3,238	\$3,662	\$2,011
	<b>797-1 P</b>	\$2,090	\$2,253	\$2,523	\$2,806	\$3,141	\$3,480	\$3,904	\$2,253
	<b>54" W, Settee</b> <span style="float: right;">62 lbs   6.5 yds</span>								
	Model	Series 2	Series 3	Series 4	Series 5	Series 6	Series 7	Series 8	COM
	<b>797-2 S</b>	\$2,692	\$2,904	\$3,255	\$3,622	\$4,059	\$4,499	\$5,051	\$2,904
	<b>797-2 P</b>	\$3,041	\$3,253	\$3,604	\$3,971	\$4,408	\$4,848	\$5,400	\$3,253
	<b>72" W, Sofa</b> <span style="float: right;">73 lbs   8 yds</span>								
	Model	Series 2	Series 3	Series 4	Series 5	Series 6	Series 7	Series 8	COM
	<b>797-3 S</b>	\$3,487	\$3,748	\$4,180	\$4,632	\$5,169	\$5,711	\$6,390	\$3,748
	<b>797-3 P</b>	\$3,937	\$4,198	\$4,630	\$5,082	\$5,619	\$6,161	\$6,840	\$4,198

Lounge Seating

Multiple & Tandem Seating

Side, Stacking & Folding Chairs

Occasional Tables

# Riva Lounge Seating



## Standard Features

- Spring seat construction
- Clean-out design
- Brushed metal legs
- Non-marring 1" glides
- Loose seat and back cushion
- GREENGUARD Gold Certified
- Limited Lifetime Warranty

## Available Options

- Moisture barrier + \$69 per seat or back
- CTB-133 + \$83/yd
- Two fabrics + \$64
- Three (or more) fabrics + \$90
- Bolsters (see price table)

## Specification Decisions

- Select fabric
- Add moisture barrier
- Add CTB-133
- Apply multiple fabrics
- Add bolsters

## Flammability Type

- Type 7

## Coordinating Products

- Riva Tables

## Key Dimensions

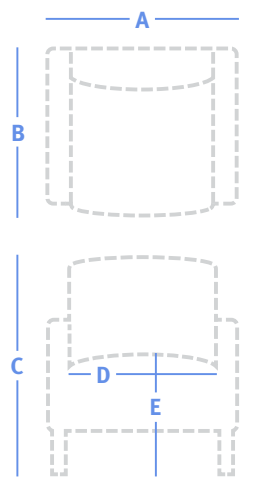

<b>A</b>	Overall Width	See price table
<b>B</b>	Overall Depth	31"
<b>C</b>	Overall Height	32"
<b>D</b>	Seat Width	
	Chair:	25"
	Two Seat:	50"
	Three Seat:	75.5"
<b>E</b>	Seat Height	18"
<b>F</b>	Arm Height	27"

### More Information

- Illustrated Glossary ▶ 409
- Fabrics ▶ 421
- Flammability (CTB-133) ▶ 429
- Finishes ▶ 426
- Ordering and Warranties ▶ 432

	<b>32.25" W, Chair</b>										61 lbs   9 yds
	Model	Series 2	Series 3	Series 4	Series 5	Series 6	Series 7	Series 8	COM		
	<b>812-10</b>	\$2,259	\$2,479	\$2,844	\$3,225	\$3,678	\$4,136	\$4,708	\$2,479		

	<b>59" W, Two seat</b>										95 lbs   12 yds
	Model	Series 2	Series 3	Series 4	Series 5	Series 6	Series 7	Series 8	COM		
	<b>812-20</b>	\$3,639	\$3,957	\$4,484	\$5,034	\$5,689	\$6,350	\$7,177	\$3,957		

	<b>83.25" W, Three seat</b>										140 lbs   17.5 yds
	Model	Series 2	Series 3	Series 4	Series 5	Series 6	Series 7	Series 8	COM		
	<b>812-30</b>	\$4,861	\$5,285	\$5,987	\$6,721	\$7,594	\$8,475	\$9,578	\$5,285		

## Riva Lounge Seating

Lounge Seating

Multiple & Tandem Seating

Side, Stacking & Folding Chairs

Occasional Tables

### Riva Benches

#### Standard Features

Same standard features as Riva Lounge Seating

#### Available Options

Same options as Riva Lounge Seating

#### Key Dimensions

- Overall Width: See price table
- Overall Height: 18"

	24" W, Square bench <span style="float: right;">30 lbs   1.5 yds</span>								
	Model	Series 2	Series 3	Series 4	Series 5	Series 6	Series 7	Series 8	COM
	<b>812-B1</b>	\$1,629	\$1,677	\$1,758	\$1,843	\$1,944	\$2,046	\$2,173	\$1,677

	36" W, Square bench <span style="float: right;">51 lbs   2.75 yds</span>								
	Model	Series 2	Series 3	Series 4	Series 5	Series 6	Series 7	Series 8	COM
	<b>812-B2</b>	\$1,924	\$2,013	\$2,162	\$2,317	\$2,502	\$2,688	\$2,921	\$2,013

	44" W x 16" D, Bench <span style="float: right;">41 lbs   2.25 yds</span>								
	Model	Series 2	Series 3	Series 4	Series 5	Series 6	Series 7	Series 8	COM
	<b>812-B3</b>	\$1,691	\$1,764	\$1,886	\$2,013	\$2,164	\$2,317	\$2,507	\$1,764

### Riva Bolster

#### Key Dimensions

- Overall Width: 24"

	Bolster <span style="float: right;">2 lbs   1 yd</span>								
	Model	Series 2	Series 3	Series 4	Series 5	Series 6	Series 7	Series 8	COM
	<b>812-Riva Bolster</b>	\$141	\$165	\$206	\$248	\$299	\$350	\$413	\$165

# Sophia Lounge Seating



## Standard Features

- Solid maple frame
- Mortise and tenon joinery
- Spring seat construction
- Clean-out design
- Replaceable components
- Wood arm caps
- Curved stainless-look metal legs
- Non-marring 2 1/4" plastic glides
- Nemschoff healthcare wood finish
- GREENGUARD Gold Certified
- Limited Lifetime Warranty

## Available Options

- Moisture barrier + \$69 per seat or back
- CTB-133 + \$83/yd
- Two fabrics + \$64
- Three (or more) fabrics + \$90

## Specification Decisions

- Select fabric
- Select standard wood finish
- Add moisture barrier
- Add CTB-133
- Apply multiple fabrics

Model numbers with **S** indicate standard seat and back covers, and model numbers with **P** indicate removable covers.

## Flammability Type

- Type 6

## Key Dimensions

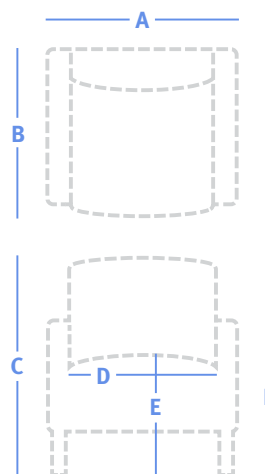

<b>A</b>	Overall Width	See price table
<b>B</b>	Overall Depth	28"
<b>C</b>	Overall Height	30.75"
<b>D</b>	Seat Width	
	Chair:	22"
	Settee:	44"
	Sofa:	66"
<b>E</b>	Seat Height	18"
<b>F</b>	Arm Height	23.5"

### More Information

Illustrated Glossary ▶ 409

Fabrics ▶ 421

Flammability (CTB-133) ▶ 429

Finishes ▶ 426

Ordering and Warranties ▶ 432



### 28.5" W, Chair

50 lbs | 4 yds

Model	Series 2	Series 3	Series 4	Series 5	Series 6	Series 7	Series 8	COM
<b>815-10 S</b>	\$1,639	\$1,769	\$1,985	\$2,211	\$2,480	\$2,751	\$3,090	\$1,769
<b>815-10 P</b>	\$1,852	\$1,982	\$2,198	\$2,424	\$2,693	\$2,964	\$3,303	\$1,982



### 50.5" W, Two seat

80 lbs | 6 yds

Model	Series 2	Series 3	Series 4	Series 5	Series 6	Series 7	Series 8	COM
<b>815-20 S</b>	\$2,640	\$2,835	\$3,159	\$3,498	\$3,901	\$4,308	\$4,817	\$2,835
<b>815-20 P</b>	\$2,981	\$3,176	\$3,500	\$3,839	\$4,242	\$4,649	\$5,158	\$3,176



### 53" W, Two seat with intervening arm and leg

90 lbs | 7.25 yds

Model	Series 2	Series 3	Series 4	Series 5	Series 6	Series 7	Series 8	COM
<b>815-22 S</b>	\$3,136	\$3,372	\$3,764	\$4,173	\$4,660	\$5,151	\$5,766	\$3,372
<b>815-22 P</b>	\$3,541	\$3,777	\$4,169	\$4,578	\$5,065	\$5,556	\$6,171	\$3,777

## Sophia Lounge Seating



### 72.5" W, Three seat

107 lbs | 7.75 yds

Model	Series 2	Series 3	Series 4	Series 5	Series 6	Series 7	Series 8	COM
<b>815-30 S</b>	\$3,524	\$3,776	\$4,195	\$4,632	\$5,152	\$5,678	\$6,335	\$3,776
<b>815-30 P</b>	\$3,978	\$4,230	\$4,649	\$5,086	\$5,606	\$6,132	\$6,789	\$4,230



### 77.5" W, Three seat with intervening arms and legs

127 lbs | 9.75 yds

Model	Series 2	Series 3	Series 4	Series 5	Series 6	Series 7	Series 8	COM
<b>815-33 S</b>	\$4,439	\$4,757	\$5,284	\$5,834	\$6,489	\$7,150	\$7,977	\$4,757
<b>815-33 P</b>	\$5,010	\$5,328	\$5,855	\$6,405	\$7,060	\$7,721	\$8,548	\$5,328

Lounge Seating

Multiple & Tandem Seating

Side, Stacking & Folding Chairs

Occasional Tables

# Steps Lounge System



## Standard Features

- Spring seat construction
- Clean-out design
- Replaceable components
- Removable covers
- Upholstered arms (select models)
- Powder-coated metal legs
- Adjustable 1¼" glides
- Nemschoff healthcare wood finish
- GREENGUARD Gold Certified
- Limited Lifetime Warranty

## Available Options

- Moisture barrier + \$69 per seat or back
- Black urethane arm caps + \$116
- Wood arm caps + \$116
- CTB-133 + \$83/yd
- Two fabrics + \$64
- Three (or more) fabrics + \$90

## Specification Decisions

- Select fabric
- Select powder coat finish
- Add moisture barrier
- Add CTB-133
- Apply multiple fabrics
- Add wood arm caps
- Add urethane arm caps
- Add intervening arms
- Select seats, tables and accessory units. Specify side to attach tables (LSF, RSF).

- Select seat style



Straight seat



Outside wedge



Inside wedge

- Select back height



Low back



Mid back



High back

- Select arm style



Armless

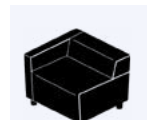

Arm left



Arm right



Two arms (straight configurations only)

- Create a seating configuration plan. List unit model numbers from left to right.
- Determine placement for tables or accessories. List seats, tables, accessory units and required ganging in the order they will appear. Ganging is determined when facing the unit. Designate either right-side facing (RSF) or left-side facing (LSF).

### More Information

Illustrated Glossary ▶ 409

Fabrics ▶ 421

Flammability (CTB-133) ▶ 429

Finishes ▶ 426

Ordering and Warranties ▶ 432

# Steps Lounge System

Lounge Seating

Multiple & Tandem Seating

Side, Stacking & Folding Chairs

Occasional Tables

## Specification Decisions, continued

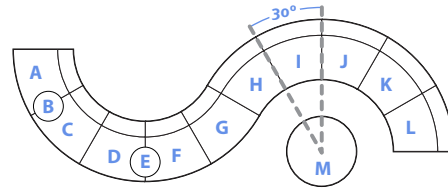

Example Steps Lounge configuration plan

Unit	Model #	Description	Ganging
A	866-OWA	Seat	Ganged RSF
B	866-TA	Table	Between two arm-less units ONLY
C	866-OWA	Seat	Ganged RSF & LSF
D	866-OWB	Seat	Ganged RSF & LSF
E	866-TA	Table	Between two arm-less units only
F	866-OWB	Seat	Ganged RSF & LSF
G	866-OWB	Seat	Ganged RSF & LSF
H	866-IWC	Seat	Ganged RSF & LSF
I	866-IWC	Seat	Ganged RSF & LSF
J	866-IWC	Seat	Ganged RSF & LSF
K	866-IWB	Seat	Ganged RSF & LSF
L	866-IWB	Seat	Ganged LSF
M	866-32	Ottoman	n/a

For more details about configuring and ordering this lounge system, visit our website [nemschoff.com/products/steps-lounge-system](http://nemschoff.com/products/steps-lounge-system) choose Design Resources > Literature > Pricing.

Furniture ships inside a protective bag to which a shipping label is affixed. Any site-specific installation instructions (location designation or place in specific configuration — with ganged or modular components) will be on the label. Do not remove the protective bag prior to product being staged in the indicated location on-site.

## Flammability Type

- Type 6

## Key Dimensions

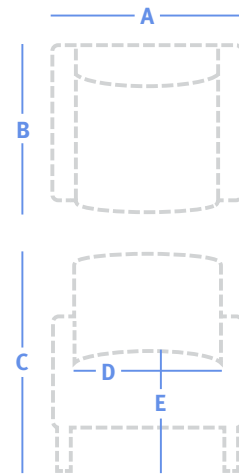



<b>A</b>	Overall Width	See price table
<b>B</b>	Overall Depth	30.5"
<b>C</b>	Overall Height	
	Low-Back (A):	25.25"
	Mid-Back (B):	33"
	High-Back (C):	44"
<b>D</b>	Seat Width	
	Straight Seat:	32"
	Inside Wedge:	20.25" (front) 40" (rear)
	Outside Wedge:	40" (front) 20.25" (rear)
<b>E</b>	Seat Height	18"
<b>F</b>	Arm Height	25.25"



# Steps Lounge System

## Steps Lounge Low Back

	<b>25.25" H, Low back straight seat without arms</b> <span style="float: right;">4.75 yds</span>								
	Model	Series 2	Series 3	Series 4	Series 5	Series 6	Series 7	Series 8	COM
	<b>866-STA</b>	\$1,185	\$1,340	\$1,597	\$1,865	\$2,184	\$2,506	\$2,909	\$1,340

	<b>25.25" H, Low back straight seat with left arm</b> <span style="float: right;">6.25 yds</span>								
	Model	Series 2	Series 3	Series 4	Series 5	Series 6	Series 7	Series 8	COM
	<b>866-STAL</b>	\$1,297	\$1,500	\$1,838	\$2,191	\$2,610	\$3,034	\$3,564	\$1,500

	<b>25.25" H, Low back straight seat with right arm</b> <span style="float: right;">6.25 yds</span>								
	Model	Series 2	Series 3	Series 4	Series 5	Series 6	Series 7	Series 8	COM
	<b>866-STAR</b>	\$1,297	\$1,500	\$1,838	\$2,191	\$2,610	\$3,034	\$3,564	\$1,500

	<b>25.25" H, Low back straight seat with left and right arms</b> <span style="float: right;">8 yds</span>								
	Model	Series 2	Series 3	Series 4	Series 5	Series 6	Series 7	Series 8	COM
	<b>866-STALR</b>	\$1,400	\$1,661	\$2,093	\$2,545	\$3,082	\$3,624	\$4,303	\$1,661

	<b>25.25" H, Low back outside wedge without arms</b> <span style="float: right;">3.25 yds</span>								
	Model	Series 2	Series 3	Series 4	Series 5	Series 6	Series 7	Series 8	COM
	<b>866-OWA</b>	\$1,234	\$1,340	\$1,516	\$1,699	\$1,918	\$2,138	\$2,414	\$1,340

	<b>25.25" H, Low back outside wedge with left arm</b> <span style="float: right;">4.75 yds</span>								
	Model	Series 2	Series 3	Series 4	Series 5	Series 6	Series 7	Series 8	COM
	<b>866-OWAL</b>	\$1,345	\$1,500	\$1,757	\$2,025	\$2,344	\$2,666	\$3,069	\$1,500

	<b>25.25" H, Low back outside wedge with right arm</b> <span style="float: right;">4.75 yds</span>								
	Model	Series 2	Series 3	Series 4	Series 5	Series 6	Series 7	Series 8	COM
	<b>866-OWAR</b>	\$1,345	\$1,500	\$1,757	\$2,025	\$2,344	\$2,666	\$3,069	\$1,500

	<b>25.25" H, Low back inside wedge without arms</b> <span style="float: right;">4.25 yds</span>								
	Model	Series 2	Series 3	Series 4	Series 5	Series 6	Series 7	Series 8	COM
	<b>866-IWA</b>	\$1,202	\$1,340	\$1,570	\$1,810	\$2,095	\$2,383	\$2,744	\$1,340

	<b>25.25" H, Low back inside wedge with left arm</b> <span style="float: right;">5.75 yds</span>								
	Model	Series 2	Series 3	Series 4	Series 5	Series 6	Series 7	Series 8	COM
	<b>866-IWAL</b>	\$1,313	\$1,500	\$1,811	\$2,135	\$2,521	\$2,911	\$3,399	\$1,500

	<b>25.25" H, Low back inside wedge with right arm</b> <span style="float: right;">5.75 yds</span>								
	Model	Series 2	Series 3	Series 4	Series 5	Series 6	Series 7	Series 8	COM
	<b>866-IWAR</b>	\$1,313	\$1,500	\$1,811	\$2,135	\$2,521	\$2,911	\$3,399	\$1,500

# Steps Lounge System

Lounge Seating

Multiple & Tandem Seating

Side, Stacking & Folding Chairs

Occasional Tables

## Steps Lounge Mid Back

	<b>33" H, Mid back inside wedge with left arm</b> <span style="float: right;">80 lbs. 7 yds</span>								
	Model	Series 2	Series 3	Series 4	Series 5	Series 6	Series 7	Series 8	COM
	<b>866-IWBL</b>	\$1,433	\$1,661	\$2,039	\$2,434	\$2,904	\$3,379	\$3,973	\$1,661
	<b>33" H, Mid back inside wedge with right arm</b> <span style="float: right;">80 lbs. 7 yds</span>								
	Model	Series 2	Series 3	Series 4	Series 5	Series 6	Series 7	Series 8	COM
	<b>866-IWBR</b>	\$1,433	\$1,661	\$2,039	\$2,434	\$2,904	\$3,379	\$3,973	\$1,661
	<b>33" H, Mid back inside wedge without arms</b> <span style="float: right;">72 lbs. 5.5 yds</span>								
	Model	Series 2	Series 3	Series 4	Series 5	Series 6	Series 7	Series 8	COM
	<b>866-IWB</b>	\$1,321	\$1,500	\$1,797	\$2,108	\$2,477	\$2,850	\$3,316	\$1,500
	<b>33" H, Mid back outside wedge with left arm</b> <span style="float: right;">72 lbs. 5.5 yds</span>								
	Model	Series 2	Series 3	Series 4	Series 5	Series 6	Series 7	Series 8	COM
	<b>866-OWBL</b>	\$1,482	\$1,661	\$1,958	\$2,269	\$2,638	\$3,011	\$3,477	\$1,661
	<b>33" H, Mid back outside wedge with right arm</b> <span style="float: right;">5.5 yds</span>								
	Model	Series 2	Series 3	Series 4	Series 5	Series 6	Series 7	Series 8	COM
	<b>866-OWBR</b>	\$1,482	\$1,661	\$1,958	\$2,269	\$2,638	\$3,011	\$3,477	\$1,661
	<b>33" H, Mid back outside wedge without arms</b> <span style="float: right;">3.75 yds</span>								
	Model	Series 2	Series 3	Series 4	Series 5	Series 6	Series 7	Series 8	COM
	<b>866-OWB</b>	\$1,378	\$1,500	\$1,703	\$1,915	\$2,166	\$2,421	\$2,739	\$1,500
	<b>33" H, Mid back straight seat with left arm</b> <span style="float: right;">7.5 yds</span>								
	Model	Series 2	Series 3	Series 4	Series 5	Series 6	Series 7	Series 8	COM
	<b>866-STBL</b>	\$1,417	\$1,661	\$2,066	\$2,490	\$2,993	\$3,502	\$4,138	\$1,661
	<b>33" H, Mid back straight seat with right arm</b> <span style="float: right;">7.5 yds</span>								
	Model	Series 2	Series 3	Series 4	Series 5	Series 6	Series 7	Series 8	COM
	<b>866-STBR</b>	\$1,417	\$1,661	\$2,066	\$2,490	\$2,993	\$3,502	\$4,138	\$1,661
	<b>33" H, Mid back straight seat with left and right arms</b> <span style="float: right;">7.5 yds</span>								
	Model	Series 2	Series 3	Series 4	Series 5	Series 6	Series 7	Series 8	COM
	<b>866-STBLR</b>	\$1,577	\$1,821	\$2,226	\$2,650	\$3,153	\$3,662	\$4,298	\$1,821
	<b>33" H, Mid back straight seat without arms</b> <span style="float: right;">64 lbs. 5.75 yds</span>								
	Model	Series 2	Series 3	Series 4	Series 5	Series 6	Series 7	Series 8	COM
	<b>866-STB</b>	\$1,313	\$1,500	\$1,811	\$2,135	\$2,521	\$2,911	\$3,399	\$1,500

# Steps Lounge System

## Steps Lounge High Back

	<b>44" H, High back inside wedge with left arm</b> <span style="float: right;">8.5 yds</span>								
	Model	Series 2	Series 3	Series 4	Series 5	Series 6	Series 7	Series 8	COM
	<b>866-IWCL</b>	\$1,544	\$1,821	\$2,280	\$2,760	\$3,331	\$3,907	\$4,628	\$1,821

	<b>44" H, High back inside wedge with right arm</b> <span style="float: right;">8.5 yds</span>								
	Model	Series 2	Series 3	Series 4	Series 5	Series 6	Series 7	Series 8	COM
	<b>866-IWCR</b>	\$1,544	\$1,821	\$2,280	\$2,760	\$3,331	\$3,907	\$4,628	\$1,821

	<b>44" H, High back inside wedge without arms</b> <span style="float: right;">6.75 yds</span>								
	Model	Series 2	Series 3	Series 4	Series 5	Series 6	Series 7	Series 8	COM
	<b>866-IWC</b>	\$1,441	\$1,661	\$2,026	\$2,407	\$2,860	\$3,318	\$3,890	\$1,661

	<b>44" H, High back outside wedge with left arm</b> <span style="float: right;">7 yds</span>								
	Model	Series 2	Series 3	Series 4	Series 5	Series 6	Series 7	Series 8	COM
	<b>866-OWCL</b>	\$1,593	\$1,821	\$2,199	\$2,594	\$3,064	\$3,539	\$4,133	\$1,821

	<b>44" H, High back outside wedge with right arm</b> <span style="float: right;">7 yds</span>								
	Model	Series 2	Series 3	Series 4	Series 5	Series 6	Series 7	Series 8	COM
	<b>866-OWCR</b>	\$1,593	\$1,821	\$2,199	\$2,594	\$3,064	\$3,539	\$4,133	\$1,821

	<b>44" H, High back outside wedge without arms</b> <span style="float: right;">4.75 yds</span>								
	Model	Series 2	Series 3	Series 4	Series 5	Series 6	Series 7	Series 8	COM
	<b>866-OWC</b>	\$1,506	\$1,661	\$1,918	\$2,186	\$2,505	\$2,827	\$3,230	\$1,661

	<b>44" H, High back straight seat with left arm</b> <span style="float: right;">8.75 yds</span>								
	Model	Series 2	Series 3	Series 4	Series 5	Series 6	Series 7	Series 8	COM
	<b>866-STCL</b>	\$1,536	\$1,821	\$2,294	\$2,788	\$3,375	\$3,968	\$4,711	\$1,821

	<b>44" H, High back straight seat with right arm</b> <span style="float: right;">8.75 yds</span>								
	Model	Series 2	Series 3	Series 4	Series 5	Series 6	Series 7	Series 8	COM
	<b>866-STCR</b>	\$1,536	\$1,821	\$2,294	\$2,788	\$3,375	\$3,968	\$4,711	\$1,821

	<b>44" H, High back straight seat with left and right arms</b> <span style="float: right;">8.75 yds</span>								
	Model	Series 2	Series 3	Series 4	Series 5	Series 6	Series 7	Series 8	COM
	<b>866-STCLR</b>	\$1,697	\$1,982	\$2,455	\$2,949	\$3,536	\$4,129	\$4,872	\$1,982

	<b>44" H, High back straight seat without arms</b> <span style="float: right;">71 lbs. 7.25 yds</span>								
	Model	Series 2	Series 3	Series 4	Series 5	Series 6	Series 7	Series 8	COM
	<b>866-STC</b>	\$1,425	\$1,661	\$2,053	\$2,462	\$2,949	\$3,440	\$4,055	\$1,661

# Steps Lounge System

Lounge Seating

Multiple & Tandem Seating

Side, Stacking & Folding Chairs

Occasional Tables

## Steps Lounge Intermediate Arm

### Standard Features

Same standard features as Steps Lounge System

### Available Options

Same options as Steps Lounge System

### Key Dimensions

- Overall Width: see price table
- Overall Depth: 16.5"
- Overall Height: 8"
- Arm Height: 26.25" (when applied to seat)



### 4" W, Intermediate arm .75 yds

Model	Series 2	Series 3	Series 4	Series 5	Series 6	Series 7	Series 8	COM
<b>866-A</b>	\$619	\$643	\$684	\$726	\$777	\$828	\$891	\$643

## Steps Benches

### Standard Features

Same standard features as Steps Lounge System

### Available Options

Same options as Steps Lounge System

### Key Dimensions

- Overall Width: See price table
- Overall Height: 18.25"
- Overall Depth: 30.5"



### 32" W, Straight bench 3 yds

Model	Series 2	Series 3	Series 4	Series 5	Series 6	Series 7	Series 8	COM
<b>866-B</b>	\$1,037	\$1,126	\$1,275	\$1,430	\$1,615	\$1,801	\$2,034	\$1,126



### 36" W, Inner wedge bench 2.5 yds

Model	Series 2	Series 3	Series 4	Series 5	Series 6	Series 7	Series 8	COM
<b>866-BW</b>	\$1,037	\$1,126	\$1,275	\$1,430	\$1,615	\$1,801	\$2,034	\$1,126

## Steps Ottoman

### Standard Features

Same standard features as Steps Lounge System

### Available Options

Same options as Steps Lounge System

### Key Dimensions

- Overall Width: See price table
- Overall Height: 18"



### 32.5" dia, Ottoman 2.5 yds

Model	Series 2	Series 3	Series 4	Series 5	Series 6	Series 7	Series 8	COM
<b>866-32</b>	\$1,090	\$1,179	\$1,328	\$1,483	\$1,668	\$1,854	\$2,087	\$1,179



### 42.5" dia, Ottoman 3.75 yds

Model	Series 2	Series 3	Series 4	Series 5	Series 6	Series 7	Series 8	COM
<b>866-42</b>	\$1,362	\$1,500	\$1,730	\$1,970	\$2,255	\$2,543	\$2,904	\$1,500

# Steps Lounge System

## Steps Tables

### Standard Features

- Powder-coated legs
- Laminate top
- Non-marring glides
- 866-T8 is an offset table support to provide an over-the-lap work surface.

### Specification Decisions

- Select laminate or veneer tabletop
- Select powder coat finish

### Inline table power module

Model	Price	Height
<b>866-T0</b>	\$162	0"



### 20" dia, Round end table

Model	Price	Height
<b>866-T7</b>	\$1,233	24.25"



### 20" dia, Round end table with offset base

Model	Price	Height
<b>866-T8</b>	\$1,018	24.25"



### 32" W, square inline table

Model	Price	Depth	Height
<b>866-ST32</b>	\$1,393	26.75"	17"



### 30-degree inline table

Model	Price	Depth	Height
<b>866-WT30</b>	\$750	26.75"	17"



### 55" W, 90-degree inline table

Model	Price	Depth	Height
<b>866-RCT</b>	\$1,071	26.75"	17"



### Tablet table - between two armless units only

Model	Price	Depth	Height
<b>866-TA</b>	\$469	14"	22.25"

# Valor Lounge Seating



## More Information

Illustrated Glossary ▶ 409

Fabrics ▶ 421

Flammability (CTB-133) ▶ 429

Finishes ▶ 426

Ordering and Warranties ▶ 432

## Standard Features

- Heavy-duty steel construction
- Powder-coated metal frame
- Spring seat construction
- Clean-out design
- Replaceable components
- Black urethane arms
- Non-marring 1<sup>3</sup>/<sub>16</sub>" glides
- GREENGUARD Gold Certified
- Limited Lifetime Warranty

## Available Options

- Moisture barrier + \$69 per seat or back
- Wallsaver glides + \$0
- CTB-133 + \$83/yd
- Two fabrics + \$64
- Three (or more) fabrics + \$90
- Wood arm caps + \$116

## Specification Decisions

- Select fabric
- Select powder coat finish
- Add moisture barrier
- Add CTB-133
- Apply multiple fabrics
- Add wallsaver glides
- Add wood arm caps

Model numbers with **S** indicate standard seat and back covers, and model numbers with **P** indicate removable covers.

## Flammability Type

- Type 8

## Coordinating Products

- [Valor Multiple Seating](#)
- [Valor Stack Chair](#)
- [Valor Tables](#)
- [Valor Patient Chair](#)

## Key Dimensions

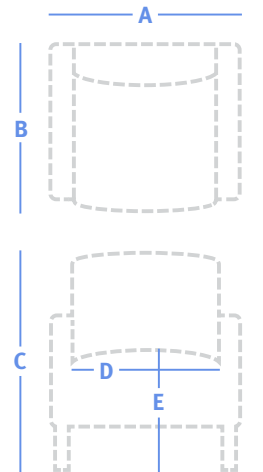

<b>A</b>	Overall Width	See price table
<b>B</b>	Overall Depth	28"
<b>C</b>	Overall Height	32.75"
<b>D</b>	Seat Width	
	Chair:	21.5"
	Two Seat:	44"
	Three Seat:	66"
<b>E</b>	Seat Height	18"
<b>F</b>	Arm Height	25.5"

## Valor Lounge Seating



### 26" W, Chair

60 lbs | 2.75 yds

Model	Series 2	Series 3	Series 4	Series 5	Series 6	Series 7	Series 8	COM
<b>892-10 S</b>	\$1,057	\$1,146	\$1,295	\$1,450	\$1,635	\$1,821	\$2,054	\$1,146
<b>892-10 P</b>	\$1,195	\$1,284	\$1,433	\$1,588	\$1,773	\$1,959	\$2,192	\$1,284



### 48" W, Two seat

85 lbs | 4.5 yds

Model	Series 2	Series 3	Series 4	Series 5	Series 6	Series 7	Series 8	COM
<b>892-20 S</b>	\$1,627	\$1,773	\$2,016	\$2,270	\$2,572	\$2,878	\$3,259	\$1,773
<b>892-20 P</b>	\$1,840	\$1,986	\$2,229	\$2,483	\$2,785	\$3,091	\$3,472	\$1,986



### 70" W, Three seat

130 lbs | 6.25 yds

Model	Series 2	Series 3	Series 4	Series 5	Series 6	Series 7	Series 8	COM
<b>892-30 S</b>	\$2,092	\$2,295	\$2,633	\$2,986	\$3,405	\$3,829	\$4,359	\$2,295
<b>892-30 P</b>	\$2,368	\$2,571	\$2,909	\$3,262	\$3,681	\$4,105	\$4,635	\$2,571

# Work Haven Lounge Seating



### More Information

- Illustrated Glossary ▶ 409
- Fabrics ▶ 421
- Flammability (CTB-133) ▶ 429
- Finishes ▶ 426
- Ordering and Warranties ▶ 432

### Standard Features

- Solid hardwood frame
- Upholstered arms
- Black wood legs or casters (see price table)
- Laminate tablet arm (select models)
- Nemschoff healthcare wood finish
- GREENGUARD Gold Certified
- Limited Lifetime Warranty

### Available Options

- Moisture barrier + \$69 per seat or back
- Veneer tablet arm + \$122
- Grommet for tablet storage + \$93
- CTB-133 + \$83/yd
- Two fabrics + \$64
- Three (or more) fabrics + \$90

### Specification Decisions

- Select fabric
- Select tablet arm receptacle location
- Select veneer, laminate or Black Durawrap on tablet arm (LSF, RSF)
- Add moisture barrier
- Add CTB-133
- Apply multiple fabrics
- Add grommet on tablet arm
- Add storage shelf

### Flammability Type

- Type 6

### Key Dimensions

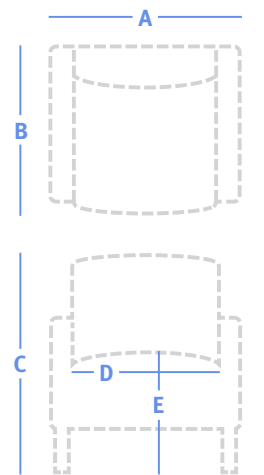

<b>A</b>	Overall Width	See price table
<b>B</b>	Overall Depth	29.5"
<b>C</b>	Overall Height	34"
<b>D</b>	Seat Width	
	Chair:	20"
	Settee:	40"
<b>E</b>	Seat Height	18.5"
<b>F</b>	Arm Height	25"



#### 29" W, Chair with casters

79 lbs | 5 yds

Model	Series 2	Series 3	Series 4	Series 5	Series 6	Series 7	Series 8	COM
<b>170/29</b>	\$1,620	\$1,700	\$2,051	\$2,239	\$2,341	\$2,476	\$2,562	\$1,700



#### 29" W, Chair with casters and laminate tablet arm

79 lbs | 5 yds

Model	Series 2	Series 3	Series 4	Series 5	Series 6	Series 7	Series 8	COM
<b>170/29TA</b>	\$2,099	\$2,179	\$2,530	\$2,718	\$2,820	\$2,955	\$3,041	\$2,179



## Workhaven Lounge Seating

	<b>29" W, Chair with casters and laminate shelf</b>									79 lbs   5 yds
	Model	Series 2	Series 3	Series 4	Series 5	Series 6	Series 7	Series 8	COM	
	<b>170/29SH</b>	\$1,869	\$1,949	\$2,300	\$2,488	\$2,590	\$2,725	\$2,811	\$1,949	

	<b>29" W, Chair with casters, laminate tablet arm and laminate shelf</b>									79 lbs   5 yds
	Model	Series 2	Series 3	Series 4	Series 5	Series 6	Series 7	Series 8	COM	
	<b>170/29SHTA</b>	\$2,345	\$2,425	\$2,776	\$2,964	\$3,066	\$3,201	\$3,287	\$2,425	

	<b>29" W, Chair</b>									79 lbs   5 yds
	Model	Series 2	Series 3	Series 4	Series 5	Series 6	Series 7	Series 8	COM	
	<b>171/29</b>	\$1,620	\$1,700	\$2,051	\$2,239	\$2,341	\$2,476	\$2,562	\$1,700	

	<b>29" W, Chair with laminate tablet arm</b>									79 lbs   5 yds
	Model	Series 2	Series 3	Series 4	Series 5	Series 6	Series 7	Series 8	COM	
	<b>171/29TA</b>	\$2,099	\$2,179	\$2,530	\$2,718	\$2,820	\$2,955	\$3,041	\$2,179	

	<b>29" W, Chair with laminate shelf</b>									79 lbs   5 yds
	Model	Series 2	Series 3	Series 4	Series 5	Series 6	Series 7	Series 8	COM	
	<b>171/29 SH</b>	\$1,869	\$1,949	\$2,300	\$2,488	\$2,590	\$2,725	\$2,811	\$1,949	

	<b>29" W, Chair with laminate tablet arm and laminate shelf</b>									79 lbs   5 yds
	Model	Series 2	Series 3	Series 4	Series 5	Series 6	Series 7	Series 8	COM	
	<b>171/29SHTA</b>	\$2,345	\$2,425	\$2,776	\$2,964	\$3,066	\$3,201	\$3,287	\$2,425	

	<b>49" W, Settee</b>									124 lbs   6.75 yds
	Model	Series 2	Series 3	Series 4	Series 5	Series 6	Series 7	Series 8	COM	
	<b>171/49</b>	\$2,793	\$2,902	\$3,375	\$3,630	\$3,768	\$3,949	\$4,066	\$2,902	

# 2600 Series Multiple Seating



### More Information

- Illustrated Glossary ▶ 409
- Fabrics ▶ 421
- Flammability (CTB-133) ▶ 429
- Finishes ▶ 426
- Ordering and Warranties ▶ 432

### Standard Features

- Solid maple frame
- Mortise and tenon joinery
- Spring seat construction
- Clean-out design
- Replaceable components
- 5/8" x 2" plastic bar glides
- Wood arms
- Sled base
- Structural steel support beneath the seat
- Nemschoff healthcare wood finish
- GREENGUARD Gold Certified
- Limited Lifetime Warranty

### Available Options

- Moisture barrier + \$69 per seat or back
- Four back styles + \$0
- CTB-133 + \$83/yd
- Two fabrics + \$64
- Three (or more) fabrics + \$90
- Attached tables – LSF or RSF (see price table)

### Specification Decisions

- Select fabric
- Select standard wood finish
- Select a back style

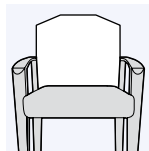

**M** Bevel

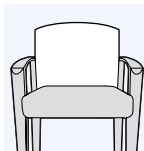

**P** Crown

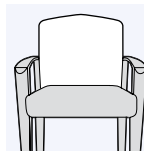

**S** Arcade

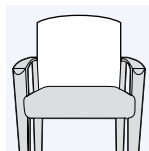

**Q** Square

- Add moisture barrier
- Add CTB-133
- Apply multiple fabrics
- Add attached table

Model numbers with **S** indicate standard seat and back covers, and model numbers with **P** indicate removable covers.

### Flammability Type

- Type 3

### Coordinating Products

- 2000 Series Tables

### Key Dimensions

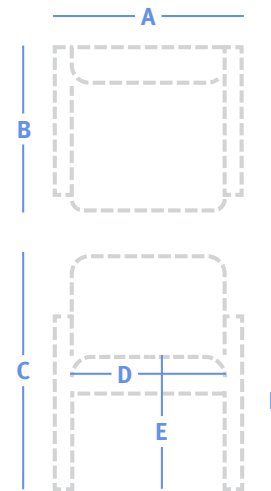

<b>A</b>	Overall Width	See price table
<b>B</b>	Overall Depth	25"
<b>C</b>	Overall Height	33.25"
<b>D</b>	Seat Width	
	Chair:	20"
	Two Seat:	34.25", 40.25"
	Three Seat:	59.25"
	Four Seat:	80"
<b>E</b>	Seat Height	18.5"
<b>F</b>	Arm Height	25.25"

## 2600 Series Multiple Seating

	<b>23.75" W, Chair</b>									35 lbs   1.75 yds
	Model	Series 2	Series 3	Series 4	Series 5	Series 6	Series 7	Series 8	COM	
	<b>2600X-10 S</b>	\$1,065	\$1,122	\$1,217	\$1,316	\$1,433	\$1,552	\$1,700	\$1,122	
	<b>2600X-10 P</b>	\$1,200	\$1,257	\$1,352	\$1,451	\$1,568	\$1,687	\$1,835	\$1,257	
	<b>44.5" W, Two seat</b>									64 lbs   3 yds
	Model	Series 2	Series 3	Series 4	Series 5	Series 6	Series 7	Series 8	COM	
	<b>2600X-20 S</b>	\$1,617	\$1,714	\$1,876	\$2,046	\$2,247	\$2,451	\$2,705	\$1,714	
	<b>2600X-20 P</b>	\$1,823	\$1,920	\$2,082	\$2,252	\$2,453	\$2,657	\$2,911	\$1,920	
	<b>46" W, Two seat with intervening arm and leg</b>									70 lbs   3 yds
	Model	Series 2	Series 3	Series 4	Series 5	Series 6	Series 7	Series 8	COM	
	<b>2600X-22 S</b>	\$1,886	\$1,983	\$2,145	\$2,315	\$2,516	\$2,720	\$2,974	\$1,983	
	<b>2600X-22 P</b>	\$2,124	\$2,221	\$2,383	\$2,553	\$2,754	\$2,958	\$3,212	\$2,221	
	<b>46" W, Two seat with divider arm</b>									67 lbs   3.25 yds
	Model	Series 2	Series 3	Series 4	Series 5	Series 6	Series 7	Series 8	COM	
	<b>2600X-25 S</b>	\$1,807	\$1,913	\$2,089	\$2,272	\$2,491	\$2,711	\$2,987	\$1,913	
	<b>2600X-25 P</b>	\$2,037	\$2,143	\$2,319	\$2,502	\$2,721	\$2,941	\$3,217	\$2,143	
	<b>64.5" W, Three seat</b>									92 lbs   4.75 yds
	Model	Series 2	Series 3	Series 4	Series 5	Series 6	Series 7	Series 8	COM	
	<b>2600X-30 S</b>	\$2,122	\$2,277	\$2,534	\$2,802	\$3,121	\$3,443	\$3,846	\$2,277	
	<b>2600X-30 P</b>	\$2,396	\$2,551	\$2,808	\$3,076	\$3,395	\$3,717	\$4,120	\$2,551	
	<b>68" W, Three seat with intervening arms and legs</b>									104 lbs   4.75 yds
	Model	Series 2	Series 3	Series 4	Series 5	Series 6	Series 7	Series 8	COM	
	<b>2600X-33 S</b>	\$2,687	\$2,842	\$3,099	\$3,367	\$3,686	\$4,008	\$4,411	\$2,842	
	<b>2600X-33 P</b>	\$3,029	\$3,184	\$3,441	\$3,709	\$4,028	\$4,350	\$4,753	\$3,184	
	<b>68" W, Three seat with divider arms</b>									98 lbs   4.75 yds
	Model	Series 2	Series 3	Series 4	Series 5	Series 6	Series 7	Series 8	COM	
	<b>2600X-35 S</b>	\$2,517	\$2,672	\$2,929	\$3,197	\$3,516	\$3,838	\$4,241	\$2,672	
	<b>2600X-35 P</b>	\$2,838	\$2,993	\$3,250	\$3,518	\$3,837	\$4,159	\$4,562	\$2,993	
	<b>86.5" W, Four seat with one intervening arm and leg</b>									122 lbs   6 yds
	Model	Series 2	Series 3	Series 4	Series 5	Series 6	Series 7	Series 8	COM	
	<b>2600X-40 S</b>	\$3,002	\$3,197	\$3,521	\$3,860	\$4,263	\$4,670	\$5,179	\$3,197	
	<b>2600X-40 P</b>	\$3,386	\$3,581	\$3,905	\$4,244	\$4,647	\$5,054	\$5,563	\$3,581	
	<b>90" W, Four seat with intervening arms and legs</b>									140 lbs   6 yds
	Model	Series 2	Series 3	Series 4	Series 5	Series 6	Series 7	Series 8	COM	
	<b>2600X-44 S</b>	\$3,556	\$3,751	\$4,075	\$4,414	\$4,817	\$5,224	\$5,733	\$3,751	
	<b>2600X-44 P</b>	\$4,007	\$4,202	\$4,526	\$4,865	\$5,268	\$5,675	\$6,184	\$4,202	
	<b>90" W, Four seat with divider arms and one intervening leg</b>									131 lbs   6 yds
	Model	Series 2	Series 3	Series 4	Series 5	Series 6	Series 7	Series 8	COM	
	<b>2600X-45 S</b>	\$3,257	\$3,452	\$3,776	\$4,115	\$4,518	\$4,925	\$5,434	\$3,452	
	<b>2600X-45 P</b>	\$3,672	\$3,867	\$4,191	\$4,530	\$4,933	\$5,340	\$5,849	\$3,867	

## 2600 Series Multiple Seating

### 2600 Series Benches

#### Standard Features

Same standard features as the 2600 Series Multiple Seating

#### Available Options

Same options as 2600 Series Multiple Seating

#### Key Dimensions

- Overall Width: See price table
- Overall Depth: 24"
- Overall Height: 21.5"
- Seat Height: 18.5"

	24" W, Bench									28 lbs   1.5 yds
	Model	Series 2	Series 3	Series 4	Series 5	Series 6	Series 7	Series 8	COM	
	<b>2600-B1 S</b>	\$823	\$871	\$952	\$1,037	\$1,138	\$1,240	\$1,367	\$871	
	<b>2600-B1 P</b>	\$928	\$976	\$1,057	\$1,142	\$1,243	\$1,345	\$1,472	\$976	

	44.5" W, Bench									52 lbs   2.5 yds
	Model	Series 2	Series 3	Series 4	Series 5	Series 6	Series 7	Series 8	COM	
	<b>2600-B2 S</b>	\$1,112	\$1,193	\$1,328	\$1,470	\$1,637	\$1,807	\$2,019	\$1,193	
	<b>2600-B2 P</b>	\$1,256	\$1,337	\$1,472	\$1,614	\$1,781	\$1,951	\$2,163	\$1,337	

### 2600 Series Spanner Tables

#### Standard Features

- Solid maple legs
- Laminate top with wood edge
- Wood rail
- Nemschoff healthcare wood finish
- GREENGUARD Gold Certified
- Limited Lifetime Warranty

#### Specification Decisions

- Select standard wood finish
  - Select standard laminate
  - Select LSF or RSF (2600-CT)
- 26/TE is only applicable to a spanner table at the end of a run.

	26" W, Truncated spanner corner table				29 lbs
	Model	Price	Depth	Height	
	<b>2600-CT</b>	\$1,065	26"	–	

	19.5" W, Spanner table				24 lbs
	Model	Price	Depth	Height	
	<b>2600-ST</b>	\$478	19.5"	–	

Optional leg for use with spanner table (at end of run)				
Model	Price	Depth	Height	
<b>26/TE</b>	\$288	–	–	

# 2700 Series Multiple Seating



## Standard Features

- Solid maple frame
- Mortise and tenon joinery
- Spring seat construction
- Clean-out design
- Replaceable components
- Wood arms
- Non-marring 7/8" rubber-cushioned glides
- Nemschoff healthcare wood finish
- GREENGUARD Gold Certified
- Limited Lifetime Warranty
- See nemschoff.com for weight ratings (2700S-OB30, 2700S-OB40, 2700-OB2)

- Add moisture barrier
- Add CTB-133
- Apply multiple fabrics
- Add attached table
- Add laminate arm caps
- Add wallsaver legs

Model numbers with **S** indicate standard seat and back covers, and model numbers with **P** indicate removable covers.

## Flammability Type

- Type 3
- Type 4 (Plus model)

## Coordinating Products

- [2000 Series Tables](#)

## Key Dimensions

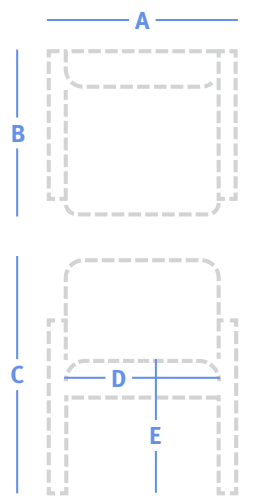

<b>A</b>	Overall Width	See price table
<b>B</b>	Overall Depth	24.5", 25.5" (OB30), 25" (OB40)
<b>C</b>	Overall Height	33.5", 32" (OB30), 33.25" (OB40)
<b>D</b>	Seat Width	Chair: 20", 30", 40" Two Seat: 20", 40" Three Seat: 20", 60" Four Seat: 20", 80"
<b>E</b>	Seat Height	18.5"
<b>F</b>	Arm Height	25.5"

## More Information

- Illustrated Glossary ▶ 409
- Fabrics ▶ 421
- Flammability (CTB-133) ▶ 429
- Finishes ▶ 426
- Ordering and Warranties ▶ 432

## Available Options

- Moisture barrier + \$69 per seat or back
- Laminate arm caps + \$116
- Wallsaver legs + \$120 (excluding Plus models)
- CTB-133 + \$83/yd
- Two fabrics + \$64
- Three (or more) fabrics + \$90
- Attached tables – LSF or RSF (see price table)

## Specification Decisions

- Select fabric
- Select standard wood finish
- Select a back style

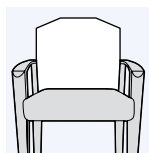

**M** Bevel

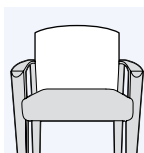

**P** Crown

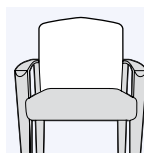



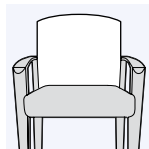





**S** Arcade





**Q** Square

## 2700 Series Multiple Seating

	<b>23.75" W, Chair</b> <span style="float: right;">35 lbs   1.75 yds</span>
	Model                      Series 2    Series 3    Series 4    Series 5    Series 6    Series 7    Series 8    COM
	<b>2700X-10 S</b> \$1,065    \$1,122    \$1,217    \$1,316    \$1,433    \$1,552    \$1,700    \$1,122
<b>2700X-10 P</b> \$1,200    \$1,257    \$1,352    \$1,451    \$1,568    \$1,687    \$1,835    \$1,257	
	<b>34" W, Plus chair</b> <span style="float: right;">37 lbs   3 yds</span>
	Model                      Series 2    Series 3    Series 4    Series 5    Series 6    Series 7    Series 8    COM
	<b>2700S-OB30</b> \$2,424    \$2,521    \$2,683    \$2,853    \$3,054    \$3,258    \$3,512    \$2,521
	<b>44" W, Plus chair</b> <span style="float: right;">42 lbs   3.25 yds</span>
	Model                      Series 2    Series 3    Series 4    Series 5    Series 6    Series 7    Series 8    COM
	<b>2700S-OB40</b> \$2,703    \$2,809    \$2,985    \$3,168    \$3,387    \$3,607    \$3,883    \$2,809
	<b>44.5" W, Plus chair</b> <span style="float: right;">66 lbs   3.25 yds</span>
	Model                      Series 2    Series 3    Series 4    Series 5    Series 6    Series 7    Series 8    COM
	<b>2700-OB2</b> \$2,091    \$2,197    \$2,373    \$2,556    \$2,775    \$2,995    \$3,271    \$2,197
	<b>44.5" W, Two seat</b> <span style="float: right;">64 lbs   3 yds</span>
	Model                      Series 2    Series 3    Series 4    Series 5    Series 6    Series 7    Series 8    COM
	<b>2700X-20 S</b> \$1,617    \$1,714    \$1,876    \$2,046    \$2,247    \$2,451    \$2,705    \$1,714
<b>2700X-20 P</b> \$1,823    \$1,920    \$2,082    \$2,252    \$2,453    \$2,657    \$2,911    \$1,920	
	<b>46" W, Two seat with intervening arm and leg</b> <span style="float: right;">70 lbs   3 yds</span>
	Model                      Series 2    Series 3    Series 4    Series 5    Series 6    Series 7    Series 8    COM
	<b>2700X-22 S</b> \$1,886    \$1,983    \$2,145    \$2,315    \$2,516    \$2,720    \$2,974    \$1,983
<b>2700X-22 P</b> \$2,124    \$2,221    \$2,383    \$2,553    \$2,754    \$2,958    \$3,212    \$2,221	
	<b>46" W, Two seat with divider arm</b> <span style="float: right;">67 lbs   3.25 yds</span>
	Model                      Series 2    Series 3    Series 4    Series 5    Series 6    Series 7    Series 8    COM
	<b>2700X-25 S</b> \$1,807    \$1,913    \$2,089    \$2,272    \$2,491    \$2,711    \$2,987    \$1,913
<b>2700X-25 P</b> \$2,037    \$2,143    \$2,319    \$2,502    \$2,721    \$2,941    \$3,217    \$2,143	
	<b>64.5" W, Three seat</b> <span style="float: right;">92 lbs   4.75 yds</span>
	Model                      Series 2    Series 3    Series 4    Series 5    Series 6    Series 7    Series 8    COM
	<b>2700X-30 S</b> \$2,122    \$2,277    \$2,534    \$2,802    \$3,121    \$3,443    \$3,846    \$2,277
<b>2700X-30 P</b> \$2,396    \$2,551    \$2,808    \$3,076    \$3,395    \$3,717    \$4,120    \$2,551	
	<b>68" W, Three seat with intervening arms and legs</b> <span style="float: right;">104 lbs   4.75 yds</span>
	Model                      Series 2    Series 3    Series 4    Series 5    Series 6    Series 7    Series 8    COM
	<b>2700X-33 S</b> \$2,687    \$2,842    \$3,099    \$3,367    \$3,686    \$4,008    \$4,411    \$2,842
<b>2700X-33 P</b> \$3,029    \$3,184    \$3,441    \$3,709    \$4,028    \$4,350    \$4,753    \$3,184	
	<b>68" W, Three seat with divider arms</b> <span style="float: right;">98 lbs   4.75 yds</span>
	Model                      Series 2    Series 3    Series 4    Series 5    Series 6    Series 7    Series 8    COM
	<b>2700X-35 S</b> \$2,517    \$2,672    \$2,929    \$3,197    \$3,516    \$3,838    \$4,241    \$2,672
<b>2700X-35 P</b> \$2,838    \$2,993    \$3,250    \$3,518    \$3,837    \$4,159    \$4,562    \$2,993	

## 2700 Series Multiple Seating

	<b>86.5" W, Four seat with one intervening arm and leg</b> <span style="float: right;">122 lbs   6 yds</span>								
	Model	Series 2	Series 3	Series 4	Series 5	Series 6	Series 7	Series 8	COM
	<b>2700X-40 S</b>	\$3,002	\$3,197	\$3,521	\$3,860	\$4,263	\$4,670	\$5,179	\$3,197
	<b>2700X-40 P</b>	\$3,386	\$3,581	\$3,905	\$4,244	\$4,647	\$5,054	\$5,563	\$3,581

	<b>90" W, Four seat with intervening arms and legs</b> <span style="float: right;">140 lbs   6 yds</span>								
	Model	Series 2	Series 3	Series 4	Series 5	Series 6	Series 7	Series 8	COM
	<b>2700X-44 S</b>	\$3,556	\$3,751	\$4,075	\$4,414	\$4,817	\$5,224	\$5,733	\$3,751
	<b>2700X-44 P</b>	\$4,007	\$4,202	\$4,526	\$4,865	\$5,268	\$5,675	\$6,184	\$4,202

	<b>90" W, Four seat with divider arms and one intervening leg</b> <span style="float: right;">131 lbs   6 yds</span>								
	Model	Series 2	Series 3	Series 4	Series 5	Series 6	Series 7	Series 8	COM
	<b>2700X-45 S</b>	\$3,257	\$3,452	\$3,776	\$4,115	\$4,518	\$4,925	\$5,434	\$3,452
	<b>2700X-45 P</b>	\$3,672	\$3,867	\$4,191	\$4,530	\$4,933	\$5,340	\$5,849	\$3,867

### 2700 Series Benches

**Standard Features**

Same standard features as the 2700 Series Multiple Seating

**Available Options**

Same options as 2700 Series Multiple Seating

**Key Dimensions**

- Overall Width: See price table
- Overall Depth: 24"
- Overall Height: 21.5"

	<b>24" W, Bench</b> <span style="float: right;">28 lbs   1.5 yds</span>								
	Model	Series 2	Series 3	Series 4	Series 5	Series 6	Series 7	Series 8	COM
	<b>2700-B1 S</b>	\$823	\$871	\$952	\$1,037	\$1,138	\$1,240	\$1,367	\$871
	<b>2700-B1 P</b>	\$928	\$976	\$1,057	\$1,142	\$1,243	\$1,345	\$1,472	\$976

	<b>44.5" W, Bench</b> <span style="float: right;">52 lbs   2.5 yds</span>								
	Model	Series 2	Series 3	Series 4	Series 5	Series 6	Series 7	Series 8	COM
	<b>2700-B2 S</b>	\$1,112	\$1,193	\$1,328	\$1,470	\$1,637	\$1,807	\$2,019	\$1,193
	<b>2700-B2 P</b>	\$1,256	\$1,337	\$1,472	\$1,614	\$1,781	\$1,951	\$2,163	\$1,337

## 2700 Series Multiple Seating

### 2700 Series Spanner Tables

#### Standard Features

- Solid maple legs
- Laminate top with wood edge
- Wood rail
- Nemschoff healthcare wood finish
- GREENGUARD Gold Certified
- Limited Lifetime Warranty

#### Specification Decisions

- Select standard wood finish
  - Select standard laminate
  - Select table attachment option (LSF, RSF)
- 27/TE is only applicable to a spanner table at the end of a run.



#### 26" W, Truncated spanner corner table 29 lbs

Model	Price	Depth	Height
<b>2700-CT</b>	\$1,065	26"	–



#### 19.5" W, Spanner table 24 lbs

Model	Price	Depth	Height
<b>2750-ST</b>	\$478	19.5"	–

#### Optional leg for use with spanner table (at end of run)

Model	Price	Depth	Height
<b>27/TE</b>	\$288	–	–



# 2750 Series Multiple Seating



## Standard Features

- Solid maple frame
- Mortise and tenon joinery
- Spring seat construction
- Clean-out design
- Replaceable components
- Black urethane arm caps
- Non-marring 7/8" rubber-cushioned glides
- Nemschoff healthcare wood finish
- GREENGUARD Gold Certified
- Limited Lifetime Warranty

## Available Options

- Moisture barrier + \$69 per seat or back
- Wallsaver legs + \$120
- Pewter or Desert urethane arm caps +\$210
- Divider arm + \$203
- CTB-133 + \$83/yd
- Two fabrics + \$64
- Three (or more) fabrics + \$90
- Attached tables (LSF, RSF –see price table)

## Specification Decisions

- Select fabric
- Select standard wood finish
- Select a back style

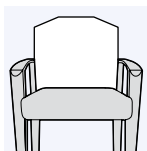

**M** Bevel

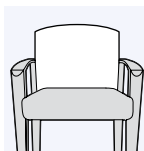

**P** Crown

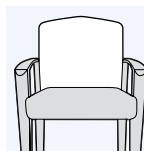

**S** Arcade

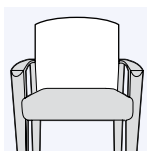

**Q** Square

- Add urethane arm cap
- Add divider arm
- Add moisture barrier
- Add CTB-133
- Apply multiple fabrics
- Add attached table

Model numbers with **S** indicate standard seat and back covers, and model numbers with **P** indicate removable covers.

## Flammability Type

- Type 3

## Coordinating Products

- [2750 Series Patient Chairs](#)
- [2000 Series Tables](#)

## Key Dimensions

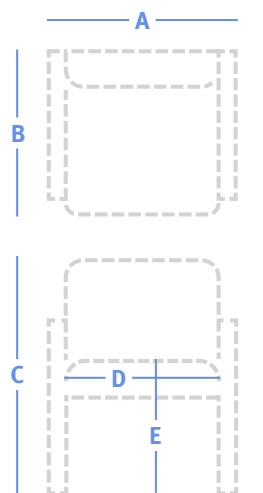

<b>A</b>	Overall Width	See price table
<b>B</b>	Overall Depth	24.5"
<b>C</b>	Overall Height	33.25"
<b>D</b>	Seat Width	
	Chair:	20"
	Two Seat:	20", 40"
	Three Seat:	20", 60"
	Four Seat:	20", 80"
<b>E</b>	Seat Height	18.5"
<b>F</b>	Arm Height	26"

### More Information

Illustrated Glossary ▶ 409

Fabrics ▶ 421

Flammability (CTB-133) ▶ 429

Finishes ▶ 426

Ordering and Warranties ▶ 432

## 2750 Series Multiple Seating

	<b>23.75" W, Chair</b>									35 lbs   1.75 yds
	Model	Series 2	Series 3	Series 4	Series 5	Series 6	Series 7	Series 8	COM	
	<b>2750X-10 S</b>	\$1,065	\$1,122	\$1,217	\$1,316	\$1,433	\$1,552	\$1,700	\$1,122	
	<b>2750X-10 P</b>	\$1,200	\$1,257	\$1,352	\$1,451	\$1,568	\$1,687	\$1,835	\$1,257	
	<b>44.5" W, Two seat</b>									64 lbs   3 yds
	Model	Series 2	Series 3	Series 4	Series 5	Series 6	Series 7	Series 8	COM	
	<b>2750X-20 S</b>	\$1,617	\$1,714	\$1,876	\$2,046	\$2,247	\$2,451	\$2,705	\$1,714	
	<b>2750X-20 P</b>	\$1,823	\$1,920	\$2,082	\$2,252	\$2,453	\$2,657	\$2,911	\$1,920	
	<b>46" W, Two seat with intervening arm and leg</b>									70 lbs   3 yds
	Model	Series 2	Series 3	Series 4	Series 5	Series 6	Series 7	Series 8	COM	
	<b>2750X-22 S</b>	\$1,886	\$1,983	\$2,145	\$2,315	\$2,516	\$2,720	\$2,974	\$1,983	
	<b>2750X-22 P</b>	\$2,124	\$2,221	\$2,383	\$2,553	\$2,754	\$2,958	\$3,212	\$2,221	
	<b>64.5" W, Three seat</b>									92 lbs   4.75 yds
	Model	Series 2	Series 3	Series 4	Series 5	Series 6	Series 7	Series 8	COM	
	<b>2750X-30 S</b>	\$2,122	\$2,277	\$2,534	\$2,802	\$3,121	\$3,443	\$3,846	\$2,277	
	<b>2750X-30 P</b>	\$2,396	\$2,551	\$2,808	\$3,076	\$3,395	\$3,717	\$4,120	\$2,551	
	<b>68" W, Three seat with intervening arms and legs</b>									104 lbs   4.75 yds
	Model	Series 2	Series 3	Series 4	Series 5	Series 6	Series 7	Series 8	COM	
	<b>2750X-33 S</b>	\$2,686	\$2,841	\$3,098	\$3,366	\$3,685	\$4,007	\$4,410	\$2,841	
	<b>2750X-33 P</b>	\$3,027	\$3,182	\$3,439	\$3,707	\$4,026	\$4,348	\$4,751	\$3,182	
	<b>86.5" W, Four seat with one intervening arm and leg</b>									122 lbs   6 yds
	Model	Series 2	Series 3	Series 4	Series 5	Series 6	Series 7	Series 8	COM	
	<b>2750X-40 S</b>	\$3,002	\$3,197	\$3,521	\$3,860	\$4,263	\$4,670	\$5,179	\$3,197	
	<b>2750X-40 P</b>	\$3,386	\$3,581	\$3,905	\$4,244	\$4,647	\$5,054	\$5,563	\$3,581	
	<b>90" W, Four seat with intervening arms and legs</b>									140 lbs   6 yds
	Model	Series 2	Series 3	Series 4	Series 5	Series 6	Series 7	Series 8	COM	
	<b>2750X-44 S</b>	\$3,556	\$3,751	\$4,075	\$4,414	\$4,817	\$5,224	\$5,733	\$3,751	
	<b>2750X-44 P</b>	\$4,007	\$4,202	\$4,526	\$4,865	\$5,268	\$5,675	\$6,184	\$4,202	

## 2750 Series Multiple Seating

### 2750 Series Benches

#### Standard Features

Same standard features as the 2750 Series Multiple Seating

#### Available Options

Same options as 2750 Series Multiple Seating

#### Key Dimensions

- Overall Width: See price table
- Overall Depth: 24"
- Overall Height: 21.5"
- Seat Height: 18.5"
- Arm Height: 21.5"

		24" W, Bench								28 lbs   1.5 yds
	Model	Series 2	Series 3	Series 4	Series 5	Series 6	Series 7	Series 8	COM	
	<b>2750-B1 S</b>	\$822	\$870	\$951	\$1,036	\$1,137	\$1,239	\$1,366	\$870	
	<b>2750-B1 P</b>	\$927	\$975	\$1,056	\$1,141	\$1,242	\$1,344	\$1,471	\$975	

		44.5" W, Bench								52 lbs   2.5 yds
	Model	Series 2	Series 3	Series 4	Series 5	Series 6	Series 7	Series 8	COM	
	<b>2750-B2 S</b>	\$1,111	\$1,192	\$1,327	\$1,469	\$1,636	\$1,806	\$2,018	\$1,192	
	<b>2750-B2 P</b>	\$1,255	\$1,336	\$1,471	\$1,613	\$1,780	\$1,950	\$2,162	\$1,336	

### 2750 Series Spanner Tables

#### Standard Features

- Solid maple legs
- Laminate top with wood edge
- Wood rail
- Nemschoff healthcare wood finish
- GREENGUARD Gold Certified
- Limited Lifetime Warranty

#### Specification Decisions

- Select standard wood finish
  - Select standard laminate
  - Select table attachment option
- 27/TE is only applicable to a spanner table at the end of a run.

		26" W, Truncated spanner corner table				29 lbs
	Model	Price	Depth	Height		
	<b>2750-CT</b>	\$1,065	26"	-		

		19.5" W, Spanner table				24 lbs
	Model	Price	Depth	Height		
	<b>2750-ST</b>	\$478	19.5"	-		

		Optional leg for use with spanner table (at end of run)			
	Model	Price	Depth	Height	
	<b>27-TE</b>	\$478	-	-	

# 2770 Series Multiple Seating



### More Information

- Illustrated Glossary ▶ 409
- Fabrics ▶ 421
- Flammability (CTB-133) ▶ 429
- Finishes ▶ 426
- Ordering and Warranties ▶ 432

### Standard Features

- Solid maple frame
- Mortise and tenon joinery
- Spring seat construction
- Clean-out design
- Replaceable components
- Wood arms
- Brushed metal accent rail
- Non-marring 7/8" rubber-cushioned glides
- Nemschoff healthcare wood finish
- GREENGUARD Gold Certified
- Limited Lifetime Warranty

### Available Options

- Moisture barrier + \$69 per seat or back
- Wallsaver legs + \$120
- Divider arm + \$203
- CTB-133 + \$83/yd
- Two fabrics + \$64
- Three (or more) fabrics + \$90
- Add attached tables (LSF, RSF –see price table)

### Specification Decisions

- Select fabric
- Select standard wood finish
- Select a back style

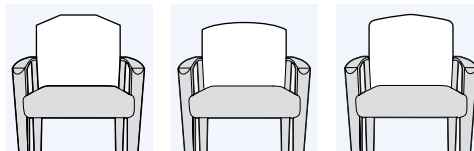

**M** Bevel      **P** Crown      **S** Arcade

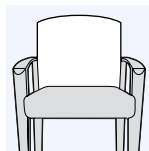

**Q** Square

- Add divider arm
- Add moisture barrier
- Add CTB-133
- Apply multiple fabrics
- Add attached table (LSF, RSF)
- Add wallsaver legs

Model numbers with **S** indicate standard seat and back covers, and model numbers with **P** indicate removable covers.

### Flammability Type

- Type 3

### Coordinating Products

- [2750 Series Patient Chairs](#)
- [2000 Series Tables](#)

### Key Dimensions

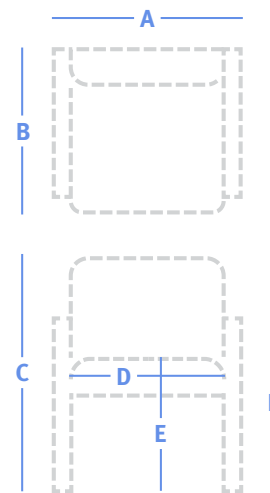

<b>A</b>	Overall Width	See price table
<b>B</b>	Overall Depth	24.5"
<b>C</b>	Overall Height	32.75"
<b>D</b>	Seat Width	
	Chair:	20"
	Two Seat:	20", 40"
	Three Seat:	20", 60.5"
	Four Seat:	20", 80"
<b>E</b>	Seat Height	18.5"
<b>F</b>	Arm Height	25.5"

## 2770 Series Multiple Seating

	<b>23.75" W, Chair</b>									31 lbs   1.75 yds
	Model	Series 2	Series 3	Series 4	Series 5	Series 6	Series 7	Series 8	COM	
	<b>2770X-10 S</b>	\$1,313	\$1,370	\$1,465	\$1,564	\$1,681	\$1,800	\$1,948	\$1,370	
	<b>2770X-10 P</b>	\$1,478	\$1,535	\$1,630	\$1,729	\$1,846	\$1,965	\$2,113	\$1,535	
	<b>44.5" W, Two seat</b>									48 lbs   3 yds
	Model	Series 2	Series 3	Series 4	Series 5	Series 6	Series 7	Series 8	COM	
	<b>2770X-20 S</b>	\$1,951	\$2,048	\$2,210	\$2,380	\$2,581	\$2,785	\$3,039	\$2,048	
	<b>2770X-20 P</b>	\$2,197	\$2,294	\$2,456	\$2,626	\$2,827	\$3,031	\$3,285	\$2,294	
	<b>46" W, Two seat with intervening arm and leg</b>									54 lbs   3 yds
	Model	Series 2	Series 3	Series 4	Series 5	Series 6	Series 7	Series 8	COM	
	<b>2770X-22 S</b>	\$2,259	\$2,356	\$2,518	\$2,688	\$2,889	\$3,093	\$3,347	\$2,356	
	<b>2770X-22 P</b>	\$2,542	\$2,639	\$2,801	\$2,971	\$3,172	\$3,376	\$3,630	\$2,639	
	<b>68" W, Three seat</b>									68 lbs   4.75 yds
	Model	Series 2	Series 3	Series 4	Series 5	Series 6	Series 7	Series 8	COM	
	<b>2770X-30 S</b>	\$2,536	\$2,691	\$2,948	\$3,216	\$3,535	\$3,857	\$4,260	\$2,691	
	<b>2770X-30 P</b>	\$2,859	\$3,014	\$3,271	\$3,539	\$3,858	\$4,180	\$4,583	\$3,014	
	<b>68" W, Three seat with intervening arms and legs</b>									80 lbs   4.75 yds
	Model	Series 2	Series 3	Series 4	Series 5	Series 6	Series 7	Series 8	COM	
	<b>2770X-33 S</b>	\$3,183	\$3,338	\$3,595	\$3,863	\$4,182	\$4,504	\$4,907	\$3,338	
	<b>2770X-33 P</b>	\$3,584	\$3,739	\$3,996	\$4,264	\$4,583	\$4,905	\$5,308	\$3,739	
	<b>86.5" W, Four seat with one intervening arm and leg</b>									122 lbs   6 yds
	Model	Series 2	Series 3	Series 4	Series 5	Series 6	Series 7	Series 8	COM	
	<b>2770X-40 S</b>	\$3,463	\$3,658	\$3,982	\$4,321	\$4,724	\$5,131	\$5,640	\$3,658	
	<b>2770X-40 P</b>	\$3,902	\$4,097	\$4,421	\$4,760	\$5,163	\$5,570	\$6,079	\$4,097	
	<b>90" W, Four seat with intervening arms and legs</b>									140 lbs   6 yds
	Model	Series 2	Series 3	Series 4	Series 5	Series 6	Series 7	Series 8	COM	
	<b>2770-44 S</b>	\$4,183	\$4,378	\$4,702	\$5,041	\$5,444	\$5,851	\$6,360	\$4,378	
	<b>2770-44 P</b>	\$4,709	\$4,904	\$5,228	\$5,567	\$5,970	\$6,377	\$6,886	\$4,904	

## 2770 Series Multiple Seating

### 2770 Series Benches

#### Standard Features

Same standard features as 2770 Series Multiple Seating

#### Available Options

Same options as 2770 Series Multiple Seating, plus:

Divider arm + \$203 (2770-B2)

#### Key Dimensions

- Overall Width: See price table
- Overall Depth: 24.5"
- Overall Height: 25.25"
- Seat Height: 18.5"
- Arm Height: 25.25"

	23.75" W, Bench <span style="float: right;">24 lbs   1.5 yds</span>								
	Model	Series 2	Series 3	Series 4	Series 5	Series 6	Series 7	Series 8	COM
	<b>2770-B1 S</b>	\$1,008	\$1,056	\$1,137	\$1,222	\$1,323	\$1,425	\$1,552	\$1,056
	<b>2770-B1 P</b>	\$1,135	\$1,183	\$1,264	\$1,349	\$1,450	\$1,552	\$1,679	\$1,183

	44.5" W, Bench <span style="float: right;">36 lbs   2.5 yds</span>								
	Model	Series 2	Series 3	Series 4	Series 5	Series 6	Series 7	Series 8	COM
	<b>2770-B2 S</b>	\$1,365	\$1,446	\$1,581	\$1,723	\$1,890	\$2,060	\$2,272	\$1,446
	<b>2770-B2 P</b>	\$1,539	\$1,620	\$1,755	\$1,897	\$2,064	\$2,234	\$2,446	\$1,620

### 2770 Series Spanner Tables

#### Standard Features

- Solid maple legs
- Laminate top with wood edge
- Wood rail
- Nemschoff healthcare wood finish
- GREENGUARD Gold Certified
- Limited Lifetime Warranty

#### Specification Decisions

- Select standard wood finish
  - Select standard laminate
  - Select table attachment option
- 27/TE is only applicable to a spanner table at the end of a run.

	26" W, Truncated spanner corner table <span style="float: right;">29 lbs</span>			
	Model	Price	Depth	Height
	<b>2770-CT</b>	\$1,065	26"	–

	19.5" W, Spanner table <span style="float: right;">24 lbs</span>			
	Model	Price	Depth	Height
	<b>2770-ST</b>	\$478	19.5"	–

Optional leg for use with spanner table (at end of run)				
Model	Price	Depth	Height	
<b>27/TE</b>	\$288	–	–	

# Anderson Multiple Seating



## Standard Features

- Heavy-duty steel construction
- Powder-coated frame
- Wipe-out design
- Replaceable components
- Wood arm caps
- Non-marring 1" adjustable glides
- Arcade back
- GREENGUARD Gold Certified
- Limited Lifetime Warranty
- See nemschoff.com for weight ratings (FX600-OB30, FX600-OB40)

## Available Options

- Moisture barrier + \$69 per seat or back
- Black urethane arm caps + \$116
- Square back + \$0
- CTB-133 + \$83/yard
- Two fabrics + \$64
- Three (or more) fabrics + \$90
- Attached tables (LSF, RSF –see price table)

## Specification Decisions

- Select fabric
- Select standard wood finish
- Select powder coat finish
- Add moisture barrier
- Add CTB-133
- Apply multiple fabrics
- Add urethane arm caps
- Add Square back

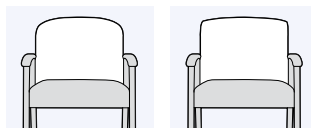

Arcade back

Square back

- Add attached table

## Flammability Type

- Type 3
- Type 4 (Plus models)

## Key Dimensions

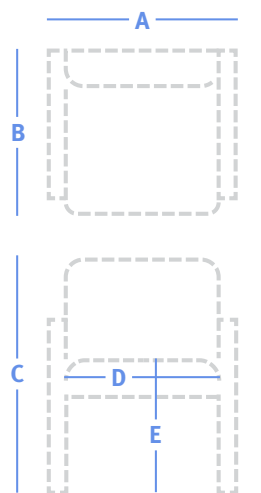

<b>A</b>	Overall Width	See price table
<b>B</b>	Overall Depth	26", 25.75" (OB30, OB40)
<b>C</b>	Overall Height	33", 32" (OB30, OB40)
<b>D</b>	Seat Width	Chair: 20.5", 30", 40" Two seat: 40.5", 41.5" Three seat: 62.25", 63"
<b>E</b>	Seat Height	18.75", 19" (OB30, OB40)
<b>F</b>	Arm Height	24.5"

### More Information

Illustrated Glossary ▶ 409

Fabrics ▶ 421

Flammability (CTB-133) ▶ 429

Finishes ▶ 426

Ordering and Warranties ▶ 432

## Anderson Multiple Seating

Lounge Seating

Multiple & Tandem Seating

Side, Stacking & Folding Chairs

Occasional Tables



### 24" W, Chair

32 lbs | 1.5 yds

Model	Series 2	Series 3	Series 4	Series 5	Series 6	Series 7	Series 8	COM
<b>FX600-10</b>	\$818	\$866	\$947	\$1,030	\$1,131	\$1,223	\$1,349	\$866



### 34" W, Plus chair

40 lbs | 3.5 yds

Model	Series 2	Series 3	Series 4	Series 5	Series 6	Series 7	Series 8	COM
<b>FX600-OB30</b>	\$1,503	\$1,616	\$1,803	\$1,999	\$2,233	\$2,448	\$2,742	\$1,616



### 44" W, Plus chair

44 lbs | 3.75 yds

Model	Series 2	Series 3	Series 4	Series 5	Series 6	Series 7	Series 8	COM
<b>FX600-OB40</b>	\$1,674	\$1,795	\$1,996	\$2,205	\$2,456	\$2,686	\$3,001	\$1,795



### 45.5" W, Two seat

50 lbs | 2.75 yds

Model	Series 2	Series 3	Series 4	Series 5	Series 6	Series 7	Series 8	COM
<b>FX600-20</b>	\$1,299	\$1,387	\$1,534	\$1,688	\$1,872	\$2,041	\$2,272	\$1,387



### 46.25" W, Two seat with intervening arm and leg

52 lbs | 2.75 yds

Model	Series 2	Series 3	Series 4	Series 5	Series 6	Series 7	Series 8	COM
<b>FX600-22</b>	\$1,471	\$1,559	\$1,706	\$1,860	\$2,044	\$2,213	\$2,444	\$1,559



### 66.25" W, Three seat

93 lbs | 4.25 yds

Model	Series 2	Series 3	Series 4	Series 5	Series 6	Series 7	Series 8	COM
<b>FX600-30</b>	\$1,682	\$1,819	\$2,047	\$2,284	\$2,568	\$2,829	\$3,186	\$1,819



### 68.25" W, Three seat with intervening arms and legs

97 lbs | 4.25 yds

Model	Series 2	Series 3	Series 4	Series 5	Series 6	Series 7	Series 8	COM
<b>FX600-33</b>	\$2,201	\$2,338	\$2,566	\$2,803	\$3,087	\$3,348	\$3,705	\$2,338

## Spanner Table

### Standard Features

- Heavy-duty steel construction
- Powder-coated metal frame
- Self-edged laminate top
- Adjustable 1" glides

### Specification Decisions

- Select standard wood finish
- Select standard laminate
- Select powder coat finish
- Select table attachment option

### 26.25" W, Carlson corner spanner table

28 lbs

Model	Price	Depth	Height
<b>FX620-CT</b>	\$625	26.25"	16"



# Auburn Multiple Seating



## Standard Features

- Solid hardwood frame
- Wipe-out design
- Replaceable components
- Wood arms with extended profile
- Non-marring 3/4" glides
- Laminate tabletops on select models
- Nemschoff healthcare wood finish
- GREENGUARD Gold Certified
- Limited Lifetime Warranty
- See nemschoff.com for weight ratings (A18, A38)

## Available Options

- Moisture barrier + \$69 per seat or back
- Panel arms (open wood arm models) + \$137 per pair
- Removable covers + \$174 per chair seat and back + \$346 per settee seat and back
- CTB-133 + \$83/yd
- Two fabrics + \$64
- Three (or more) fabrics + \$90

## Specification Decisions

- Select fabric
- Select standard wood finish
- Add moisture barrier
- Add CTB-133
- Apply multiple fabrics
- Add attached table (LSF, RSF)
- Add removable covers
- Add veneer or laminate top
- Add panel arms

## Flammability Types

- Type 3
- Type 8 (with panel arms)
- Type 4 (Plus models)

## Coordinating Products

- [Auburn Tables](#)
- [Auburn Recliner](#)
- [Auburn Glider](#)

## Key Dimensions

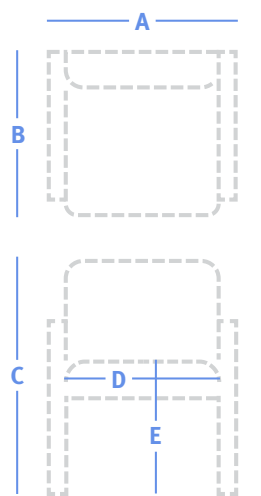

<b>A</b>	Overall Width	See price table
<b>B</b>	Overall Depth	24"
<b>C</b>	Overall Height	31.5"
<b>D</b>	Seat Width	
	Chair:	19.5", 22", 30", 31"
	Two Seat:	19.5", 39", 44"
	Three Seat:	19.5", 58.5", 66"
	Four Seat:	19.5", 78", 88"
	Five Seat:	19.5", 97.5", 110"
<b>E</b>	Seat Height	18", 17.5" (A18, A38)
<b>F</b>	Arm Height	25"

### More Information

Illustrated Glossary ▶ 409

Fabrics ▶ 421

Flammability (CTB-133) ▶ 429

Finishes ▶ 426

Ordering and Warranties ▶ 432

# Auburn Multiple Seating

Lounge Seating

Multiple & Tandem Seating

Side, Stacking & Folding Chairs

Occasional Tables

## Open Wood Arms

	<b>23" W, Chair, open wood arms</b> <span style="float: right;">28 lbs   1.5 yds</span>								
	Model	Series 2	Series 3	Series 4	Series 5	Series 6	Series 7	Series 8	COM
	<b>A10</b>	\$1,182	\$1,206	\$1,312	\$1,368	\$1,399	\$1,439	\$1,465	\$1,206
	<b>25.5" W, Chair, open wood arms</b> <span style="float: right;">33 lbs   1.75 yds</span>								
	Model	Series 2	Series 3	Series 4	Series 5	Series 6	Series 7	Series 8	COM
	<b>A15</b>	\$1,346	\$1,374	\$1,497	\$1,563	\$1,599	\$1,646	\$1,676	\$1,374
	<b>33.5" W, Plus chair</b> <span style="float: right;">44 lbs   2.25 yds</span>								
	Model	Series 2	Series 3	Series 4	Series 5	Series 6	Series 7	Series 8	COM
	<b>A18</b>	\$2,159	\$2,195	\$2,353	\$2,438	\$2,484	\$2,544	\$2,583	\$2,195
	<b>34.5" W, Plus chair</b> <span style="float: right;">48 lbs   4.25 yds</span>								
	Model	Series 2	Series 3	Series 4	Series 5	Series 6	Series 7	Series 8	COM
	<b>A38</b>	\$2,183	\$2,251	\$2,549	\$2,709	\$2,796	\$2,911	\$2,984	\$2,251
	<b>44" W, Two seat, open wood arms</b> <span style="float: right;">57 lbs   3 yds</span>								
	Model	Series 2	Series 3	Series 4	Series 5	Series 6	Series 7	Series 8	COM
	<b>AS10-2</b>	\$2,272	\$2,320	\$2,531	\$2,644	\$2,705	\$2,786	\$2,837	\$2,320
	<b>49" W, Two seat, open wood arms</b> <span style="float: right;">67 lbs   3.25 yds</span>								
	Model	Series 2	Series 3	Series 4	Series 5	Series 6	Series 7	Series 8	COM
	<b>AS15-2</b>	\$2,592	\$2,644	\$2,872	\$2,995	\$3,061	\$3,149	\$3,205	\$2,644
	<b>44" W, Two seat with intervening arm and leg, open wood arms</b> <span style="float: right;">48 lbs   3 yds</span>								
	Model	Series 2	Series 3	Series 4	Series 5	Series 6	Series 7	Series 8	COM
	<b>A10-2</b>	\$2,062	\$2,110	\$2,321	\$2,434	\$2,495	\$2,576	\$2,627	\$2,110
	<b>49" W, Two seat with intervening arm and leg, open wood arms</b> <span style="float: right;">53 lbs   3.25 yds</span>								
	Model	Series 2	Series 3	Series 4	Series 5	Series 6	Series 7	Series 8	COM
	<b>A15-2</b>	\$2,351	\$2,403	\$2,631	\$2,754	\$2,820	\$2,908	\$2,964	\$2,403
	<b>44" W, Settee, open wood arms</b> <span style="float: right;">51 lbs   3.25 yds</span>								
	Model	Series 2	Series 3	Series 4	Series 5	Series 6	Series 7	Series 8	COM
	<b>AS10-2-LS</b>	\$1,951	\$2,003	\$2,231	\$2,354	\$2,420	\$2,508	\$2,564	\$2,003
	<b>49" W, Settee, open wood arms</b> <span style="float: right;">61 lbs   3.5 yds</span>								
	Model	Series 2	Series 3	Series 4	Series 5	Series 6	Series 7	Series 8	COM
	<b>AS15-2-LS</b>	\$2,347	\$2,403	\$2,649	\$2,780	\$2,852	\$2,946	\$3,007	\$2,403

## Auburn Multiple Seating

	<b>66" W, Three seat, open wood arms</b> <span style="float: right;">81 lbs   4.5 yds</span>								
	Model	Series 2	Series 3	Series 4	Series 5	Series 6	Series 7	Series 8	COM
	<b>AS10-3</b>	\$3,243	\$3,315	\$3,631	\$3,800	\$3,892	\$4,013	\$4,091	\$3,315

	<b>73" W, Three seat, open wood arms</b> <span style="float: right;">96 lbs   4.75 yds</span>								
	Model	Series 2	Series 3	Series 4	Series 5	Series 6	Series 7	Series 8	COM
	<b>AS15-3</b>	\$3,701	\$3,777	\$4,110	\$4,289	\$4,386	\$4,514	\$4,596	\$3,777

	<b>66" W, Three seat with intervening arms and legs, open wood arms</b> <span style="float: right;">69 lbs   4.5 yds</span>								
	Model	Series 2	Series 3	Series 4	Series 5	Series 6	Series 7	Series 8	COM
	<b>A10-3</b>	\$2,943	\$3,015	\$3,331	\$3,500	\$3,592	\$3,713	\$3,791	\$3,015

	<b>73" W, Three seat with intervening arms and legs, open wood arms</b> <span style="float: right;">74 lbs   4.75 yds</span>								
	Model	Series 2	Series 3	Series 4	Series 5	Series 6	Series 7	Series 8	COM
	<b>A15-3</b>	\$3,358	\$3,434	\$3,767	\$3,946	\$4,043	\$4,171	\$4,253	\$3,434

	<b>66" W, Chair with Settee, open wood arms</b> <span style="float: right;">73 lbs   4.75 yds</span>								
	Model	Series 2	Series 3	Series 4	Series 5	Series 6	Series 7	Series 8	COM
	<b>AS10-3-CH-LS</b>	\$3,510	\$3,586	\$3,919	\$4,098	\$4,195	\$4,323	\$4,405	\$3,586

	<b>73" W, Chair with Settee, open wood arms</b> <span style="float: right;">88 lbs   5.25 yds</span>								
	Model	Series 2	Series 3	Series 4	Series 5	Series 6	Series 7	Series 8	COM
	<b>AS15-3-CH-LS</b>	\$4,002	\$4,086	\$4,454	\$4,652	\$4,759	\$4,901	\$4,991	\$4,086

	<b>66" W, Two seat with spanner table, open wood arms</b> <span style="float: right;">77 lbs   3 yds</span>								
	Model	Series 2	Series 3	Series 4	Series 5	Series 6	Series 7	Series 8	COM
	<b>AS10-3-IT</b>	\$3,188	\$3,236	\$3,447	\$3,560	\$3,621	\$3,702	\$3,753	\$3,236

	<b>73" W, Two seat with spanner table, open wood arms</b> <span style="float: right;">87 lbs   3.25 yds</span>								
	Model	Series 2	Series 3	Series 4	Series 5	Series 6	Series 7	Series 8	COM
	<b>AS15-3-IT</b>	\$3,633	\$3,685	\$3,913	\$4,036	\$4,102	\$4,190	\$4,246	\$3,685

	<b>87" W, Four seat, open wood arms</b> <span style="float: right;">104 lbs   6 yds</span>								
	Model	Series 2	Series 3	Series 4	Series 5	Series 6	Series 7	Series 8	COM
	<b>AS10-4</b>	\$4,215	\$4,311	\$4,732	\$4,958	\$5,081	\$5,242	\$5,345	\$4,311

	<b>97" W, Four seat, open wood arms</b> <span style="float: right;">124 lbs   6.25 yds</span>								
	Model	Series 2	Series 3	Series 4	Series 5	Series 6	Series 7	Series 8	COM
	<b>AS15-4</b>	\$4,809	\$4,909	\$5,347	\$5,583	\$5,711	\$5,879	\$5,987	\$4,909

## Auburn Multiple Seating

Lounge Seating

Multiple & Tandem Seating

Side, Stacking & Folding Chairs

Occasional Tables

	<b>87" W, Four seat with intervening arms and legs, open wood arms</b>									90 lbs   6 yds
Model	Series 2	Series 3	Series 4	Series 5	Series 6	Series 7	Series 8	COM		
<b>A10-4</b>	\$3,822	\$3,918	\$4,339	\$4,565	\$4,688	\$4,849	\$4,952	\$3,918		

	<b>97" W, Four seat with intervening arms and legs, open wood arms</b>									95 lbs   6.25 yds
Model	Series 2	Series 3	Series 4	Series 5	Series 6	Series 7	Series 8	COM		
<b>A15-4</b>	\$4,362	\$4,462	\$4,900	\$5,136	\$5,264	\$5,432	\$5,540	\$4,462		

	<b>87" W, Two seat with Settee, open wood arms</b>									102 lbs   6.25 yds
Model	Series 2	Series 3	Series 4	Series 5	Series 6	Series 7	Series 8	COM		
<b>AS10-4-2CH-LS</b>	\$4,471	\$4,571	\$5,009	\$5,245	\$5,373	\$5,541	\$5,649	\$4,571		

	<b>97" W, Two seat with Settee, open wood arms</b>									122 lbs   7 yds
Model	Series 2	Series 3	Series 4	Series 5	Series 6	Series 7	Series 8	COM		
<b>AS15-4-2CH-LS</b>	\$5,092	\$5,205	\$5,696	\$5,959	\$6,103	\$6,291	\$6,412	\$5,205		

	<b>87" W, Three seat with spanner table, open wood arms</b>									100 lbs   4.5 yds
Model	Series 2	Series 3	Series 4	Series 5	Series 6	Series 7	Series 8	COM		
<b>AS10-4-IT</b>	\$4,135	\$4,207	\$4,523	\$4,692	\$4,784	\$4,905	\$4,983	\$4,207		

	<b>97" W, Three seat with spanner table, open wood arms</b>									115 lbs   4.75 yds
Model	Series 2	Series 3	Series 4	Series 5	Series 6	Series 7	Series 8	COM		
<b>AS15-4-IT</b>	\$4,714	\$4,790	\$5,123	\$5,302	\$5,399	\$5,527	\$5,609	\$4,790		

	<b>87" W, Chair and Settee with spanner table, open wood arms</b>									94 lbs   4.75 yds
Model	Series 2	Series 3	Series 4	Series 5	Series 6	Series 7	Series 8	COM		
<b>AS10-4-CH-IT-LS</b>	\$3,089	\$3,165	\$3,498	\$3,677	\$3,774	\$3,902	\$3,984	\$3,165		

	<b>97" W, Chair and Settee with spanner table, open wood arms</b>									94 lbs   5 yds
Model	Series 2	Series 3	Series 4	Series 5	Series 6	Series 7	Series 8	COM		
<b>AS15-4-CH-IT-LS</b>	\$5,247	\$5,327	\$5,678	\$5,866	\$5,968	\$6,103	\$6,189	\$5,327		

	<b>108" W, Five seat with intervening arms and legs, open wood arms</b>									112 lbs   7.5 yds
Model	Series 2	Series 3	Series 4	Series 5	Series 6	Series 7	Series 8	COM		
<b>A10-5</b>	\$4,700	\$4,821	\$5,347	\$5,629	\$5,783	\$5,985	\$6,114	\$4,821		

	<b>120.5" W, Five seat with intervening arms and legs, open wood arms</b>									117 lbs   7.75 yds
Model	Series 2	Series 3	Series 4	Series 5	Series 6	Series 7	Series 8	COM		
<b>A15-5</b>	\$5,105	\$5,230	\$5,773	\$6,065	\$6,224	\$6,433	\$6,566	\$5,230		

# Auburn Multiple Seating

## Fully Upholstered Arm Panels

	<b>23" W, Chair, fully upholstered arm panels</b> <span style="float: right;">58 lbs   3.5 yds</span>								
	Model	Series 2	Series 3	Series 4	Series 5	Series 6	Series 7	Series 8	COM
	<b>A30</b>	\$1,320	\$1,376	\$1,622	\$1,753	\$1,825	\$1,919	\$1,980	\$1,376

	<b>25.5" W, Chair, fully upholstered arm panels</b> <span style="float: right;">63 lbs   3.75 yds</span>								
	Model	Series 2	Series 3	Series 4	Series 5	Series 6	Series 7	Series 8	COM
	<b>A35</b>	\$1,508	\$1,568	\$1,831	\$1,972	\$2,049	\$2,150	\$2,215	\$1,568

	<b>44" W, Two seat, fully upholstered arm panels</b> <span style="float: right;">100 lbs   5.5 yds</span>								
	Model	Series 2	Series 3	Series 4	Series 5	Series 6	Series 7	Series 8	COM
	<b>AS30-2</b>	\$2,335	\$2,423	\$2,809	\$3,016	\$3,128	\$3,277	\$3,371	\$2,423

	<b>49" W, Two seat, fully upholstered arm panels</b> <span style="float: right;">110 lbs   5.75 yds</span>								
	Model	Series 2	Series 3	Series 4	Series 5	Series 6	Series 7	Series 8	COM
	<b>AS35-2</b>	\$2,469	\$2,561	\$2,964	\$3,181	\$3,298	\$3,453	\$3,552	\$2,561

	<b>44" W, Two seat with intervening arm and leg, fully upholstered arm panels</b> <span style="float: right;">95 lbs   5.75 yds</span>								
	Model	Series 2	Series 3	Series 4	Series 5	Series 6	Series 7	Series 8	COM
	<b>A30-2</b>	\$2,327	\$2,419	\$2,822	\$3,039	\$3,156	\$3,311	\$3,410	\$2,419

	<b>49" W, Two seat with intervening arm and leg, fully upholstered arm panels</b> <span style="float: right;">105 lbs   6 yds</span>								
	Model	Series 2	Series 3	Series 4	Series 5	Series 6	Series 7	Series 8	COM
	<b>A35-2</b>	\$2,657	\$2,753	\$3,174	\$3,400	\$3,523	\$3,684	\$3,787	\$2,753

	<b>40.5" W, Settee, fully upholstered arm panels</b> <span style="float: right;">83 lbs   4.75 yds</span>								
	Model	Series 2	Series 3	Series 4	Series 5	Series 6	Series 7	Series 8	COM
	<b>AS30-2-LS</b>	\$2,347	\$2,423	\$2,756	\$2,935	\$3,032	\$3,160	\$3,242	\$2,423

	<b>49" W, Settee, fully upholstered arm panels</b> <span style="float: right;">93 lbs   5 yds</span>								
	Model	Series 2	Series 3	Series 4	Series 5	Series 6	Series 7	Series 8	COM
	<b>AS35-2-LS</b>	\$2,684	\$2,764	\$3,115	\$3,303	\$3,405	\$3,540	\$3,626	\$2,764

	<b>66" W, Three seat, fully upholstered arm panels</b> <span style="float: right;">128 lbs   7.5 yds</span>								
	Model	Series 2	Series 3	Series 4	Series 5	Series 6	Series 7	Series 8	COM
	<b>AS30-3</b>	\$2,966	\$3,087	\$3,613	\$3,895	\$4,049	\$4,251	\$4,380	\$3,087

## Auburn Multiple Seating

Lounge Seating

Multiple & Tandem Seating

Side, Stacking & Folding Chairs

Occasional Tables



73" W, Three seat with intervening arms and legs, fully upholstered arm panels									143 lbs   7.75 yds
Model	Series 2	Series 3	Series 4	Series 5	Series 6	Series 7	Series 8	COM	
<b>AS35-3</b>	\$3,675	\$3,800	\$4,343	\$4,635	\$4,794	\$5,003	\$5,136	\$3,800	



66" W, Three seat with intervening arms and legs, fully upholstered arm panels									132 lbs   7.5 yds
Model	Series 2	Series 3	Series 4	Series 5	Series 6	Series 7	Series 8	COM	
<b>A30-3</b>	\$3,340	\$3,461	\$3,987	\$4,269	\$4,423	\$4,625	\$4,754	\$3,461	



73" W, Three seat with intervening arms and legs, fully upholstered arm panels									147 lbs   7.75 yds
Model	Series 2	Series 3	Series 4	Series 5	Series 6	Series 7	Series 8	COM	
<b>A35-3</b>	\$3,821	\$3,946	\$4,489	\$4,781	\$4,940	\$5,149	\$5,282	\$3,946	



60" W, Chair with settee, fully upholstered arm panels									109 lbs   7.5 yds
Model	Series 2	Series 3	Series 4	Series 5	Series 6	Series 7	Series 8	COM	
<b>AS30-3-CH-LS</b>	\$3,433	\$3,554	\$4,080	\$4,362	\$4,516	\$4,718	\$4,847	\$3,554	



73" W, Chair with settee, fully upholstered arm panels									124 lbs   7.75 yds
Model	Series 2	Series 3	Series 4	Series 5	Series 6	Series 7	Series 8	COM	
<b>AS35-3-CH-LS</b>	\$3,898	\$4,023	\$4,566	\$4,858	\$5,017	\$5,226	\$5,359	\$4,023	



66" W, Two seat with spanner table, fully upholstered arm panels									125 lbs   5 yds
Model	Series 2	Series 3	Series 4	Series 5	Series 6	Series 7	Series 8	COM	
<b>AS30-3-IT</b>	\$3,343	\$3,423	\$3,774	\$3,962	\$4,064	\$4,199	\$4,285	\$3,423	



73" W, Two seat with spanner table, fully upholstered arm panels									135 lbs   5.25 yds
Model	Series 2	Series 3	Series 4	Series 5	Series 6	Series 7	Series 8	COM	
<b>AS35-3-IT</b>	\$3,528	\$3,612	\$3,980	\$4,178	\$4,285	\$4,427	\$4,517	\$3,612	



87" W, Four seat, fully upholstered arm panels									156 lbs   9.25 yds
Model	Series 2	Series 3	Series 4	Series 5	Series 6	Series 7	Series 8	COM	
<b>AS30-4</b>	\$4,009	\$4,158	\$4,806	\$5,155	\$5,344	\$5,593	\$5,753	\$4,158	



97" W, Four seat, fully upholstered arm panels									176 lbs   9.5 yds
Model	Series 2	Series 3	Series 4	Series 5	Series 6	Series 7	Series 8	COM	
<b>AS35-4</b>	\$4,590	\$4,743	\$5,409	\$5,767	\$5,961	\$6,217	\$6,381	\$4,743	



87" W, Four seat with intervening arms and legs, fully upholstered arm panels									170 lbs   10.25 yds
Model	Series 2	Series 3	Series 4	Series 5	Series 6	Series 7	Series 8	COM	
<b>A30-4</b>	\$4,340	\$4,505	\$5,223	\$5,610	\$5,819	\$6,095	\$6,272	\$4,505	

## Auburn Multiple Seating

	<b>97" W, Four seat with intervening arms and legs, fully upholstered arm panels</b>								190 lbs   10.5 yds
	Model	Series 2	Series 3	Series 4	Series 5	Series 6	Series 7	Series 8	COM
	<b>A35-4</b>	\$4,961	\$5,130	\$5,866	\$6,261	\$6,476	\$6,759	\$6,940	\$5,130

	<b>79.5" W, Two seat with Settee, fully upholstered arm panels</b>								148 lbs   9 yds
	Model	Series 2	Series 3	Series 4	Series 5	Series 6	Series 7	Series 8	COM
	<b>AS30-4-2CH-LS</b>	\$4,234	\$4,379	\$5,010	\$5,349	\$5,533	\$5,775	\$5,930	\$4,379

	<b>97" W, Two seat with Settee, fully upholstered arm panels</b>								168 lbs   9.25 yds
	Model	Series 2	Series 3	Series 4	Series 5	Series 6	Series 7	Series 8	COM
	<b>AS35-4-2CH-LS</b>	\$4,815	\$4,964	\$5,612	\$5,961	\$6,150	\$6,399	\$6,559	\$4,964

	<b>108" W, Five seat with intervening arms and legs, fully upholstered arm panels</b>								208 lbs   12.25 yds
	Model	Series 2	Series 3	Series 4	Series 5	Series 6	Series 7	Series 8	COM
	<b>A30-5</b>	\$5,350	\$5,547	\$6,405	\$6,867	\$7,118	\$7,447	\$7,659	\$5,547

	<b>120.5" W, Five seat with intervening arms and legs, fully upholstered arm panels</b>								233 lbs   12.5 yds
	Model	Series 2	Series 3	Series 4	Series 5	Series 6	Series 7	Series 8	COM
	<b>A35-5</b>	\$6,123	\$6,324	\$7,200	\$7,671	\$7,927	\$8,263	\$8,479	\$6,324

	<b>60" W, Chair and Settee with spanner table, fully upholstered arm panels</b>								150 lbs   7 yds
	Model	Series 2	Series 3	Series 4	Series 5	Series 6	Series 7	Series 8	COM
	<b>AS30-4-CH-IT-LS</b>	\$4,367	\$4,480	\$4,971	\$5,234	\$5,378	\$5,566	\$5,687	\$4,480

	<b>97" W, Chair and Settee with spanner table, fully upholstered arm panels</b>								165 lbs   7.25 yds
	Model	Series 2	Series 3	Series 4	Series 5	Series 6	Series 7	Series 8	COM
	<b>AS35-4-CH-IT-LS</b>	\$4,963	\$5,080	\$5,588	\$5,861	\$6,010	\$6,205	\$6,330	\$5,080

	<b>87" W, Three seat with spanner table, fully upholstered arm panels</b>								167 lbs   7.75 yds
	Model	Series 2	Series 3	Series 4	Series 5	Series 6	Series 7	Series 8	COM
	<b>AS30-4-IT</b>	\$4,122	\$4,247	\$4,790	\$5,082	\$5,241	\$5,450	\$5,583	\$4,247

	<b>97" W, Three seat with spanner table, fully upholstered arm panels</b>								182 lbs   8 yds
	Model	Series 2	Series 3	Series 4	Series 5	Series 6	Series 7	Series 8	COM
	<b>AS35-4-IT</b>	\$4,709	\$4,838	\$5,399	\$5,700	\$5,864	\$6,079	\$6,217	\$4,838

## Auburn Multiple Seating

Lounge Seating

Multiple & Tandem Seating

Side, Stacking & Folding Chairs

Occasional Tables

### Auburn Spanner Tables

#### Specification Decisions

- Select standard wood finish
- Select standard laminate
- Specify table attachment (LSF, RSF)

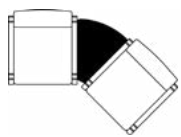

#### 45-degree-radius corner table

18 lbs

Model	Price	Depth	Height
<b>ARCT45-10</b>	\$829	18.75"	14.75"

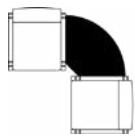

#### 90-degree-radius corner table

21 lbs

Model	Price	Depth	Height
<b>ARCT-10</b>	\$829	18.75"	14.75"



#### 21.75" W, Spanner end table

15 lbs

Model	Price	Depth	Height
<b>AET-10</b>	\$1,151	20.5"	14.75"

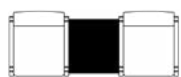

#### 19.5" W, Spanner table

18 lbs

Model	Price	Depth	Height
<b>AIT-10</b>	\$532	18.75"	14.75"

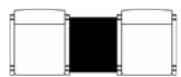

#### 22" W, Spanner table

18 lbs

Model	Price	Depth	Height
<b>AIT-15</b>	\$532	18.75"	14.75"

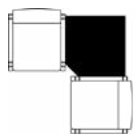

#### 28" W, Spanner corner table

28 lbs

Model	Price	Depth	Height
<b>ASCT-10</b>	\$779	18.75"	14.75"
<b>ASCT-30</b>	\$829	18.75"	16"



# Auburn Multiple Seating

## Auburn Benches

### Features and Options

Same standard features as Auburn Multiple Seating

### Key Dimensions

- Overall Width: See price table
- Overall Height: 18"
- Overall Depth: 20.5"

		<b>44" W, Bench</b>								53 lbs   1.75 yds
	Model	Series 2	Series 3	Series 4	Series 5	Series 6	Series 7	Series 8	COM	
	<b>A10B/44</b>	\$1,743	\$1,771	\$1,894	\$1,960	\$1,996	\$2,043	\$2,073	\$1,771	

		<b>49" W, Bench</b>								58 lbs   2 yds
	Model	Series 2	Series 3	Series 4	Series 5	Series 6	Series 7	Series 8	COM	
	<b>A15B/55</b>	\$1,837	\$1,869	\$2,010	\$2,085	\$2,126	\$2,180	\$2,214	\$1,869	

		<b>66" W, Bench</b>								73 lbs   2.5 yds
	Model	Series 2	Series 3	Series 4	Series 5	Series 6	Series 7	Series 8	COM	
	<b>A10B/66</b>	\$2,497	\$2,537	\$2,713	\$2,807	\$2,858	\$2,925	\$2,968	\$2,537	

		<b>73" W, Bench</b>								80 lbs   2.75 yds
	Model	Series 2	Series 3	Series 4	Series 5	Series 6	Series 7	Series 8	COM	
	<b>A15B/73</b>	\$2,849	\$2,893	\$3,086	\$3,190	\$3,246	\$3,320	\$3,367	\$2,893	

		<b>44" W, Bench, fully upholstered side panels</b>								57 lbs   3.25 yds
	Model	Series 2	Series 3	Series 4	Series 5	Series 6	Series 7	Series 8	COM	
	<b>AS30B/44</b>	\$1,891	\$1,943	\$2,171	\$2,294	\$2,360	\$2,448	\$2,504	\$1,943	

		<b>66" W, Bench, fully upholstered side panels</b>								79 lbs   4.25 yds
	Model	Series 2	Series 3	Series 4	Series 5	Series 6	Series 7	Series 8	COM	
	<b>AS30B/66</b>	\$2,600	\$2,668	\$2,966	\$3,126	\$3,213	\$3,328	\$3,401	\$2,668	

		<b>49" W, Bench, fully upholstered side panels</b>								59 lbs   3.75 yds
	Model	Series 2	Series 3	Series 4	Series 5	Series 6	Series 7	Series 8	COM	
	<b>AS35B/49</b>	\$2,151	\$2,211	\$2,474	\$2,615	\$2,692	\$2,793	\$2,858	\$2,211	

		<b>73" W, Bench, fully upholstered side panels</b>								81 lbs   4.75 yds
	Model	Series 2	Series 3	Series 4	Series 5	Series 6	Series 7	Series 8	COM	
	<b>AS35B/73</b>	\$2,965	\$3,041	\$3,374	\$3,553	\$3,650	\$3,778	\$3,860	\$3,041	

# Brava 862 Multiple Seating



## More Information

- Illustrated Glossary ▶ 409
- Fabrics ▶ 421
- Flammability (CTB-133) ▶ 429
- Finishes ▶ 426
- Ordering and Warranties ▶ 432

## Standard Features

- Solid maple frame
- Mortise and tenon joinery
- Spring seat construction
- Clean-out design
- Replaceable components
- Removable covers (862C-OB30, 862C-OB40)
- Upholstered arms
- Wallsaver legs
- Non-marring 7/8" rubber-cushioned glides
- Nemschoff healthcare wood finish
- GREENGUARD Gold Certified
- Limited Lifetime Warranty
- See nemschoff.com for weight ratings (862C-OB30, 862C-OB40)

## Available Options

- Moisture barrier + \$69 per seat or back
- Black urethane arm caps + \$116
- Desert or Pewter urethane arm caps + \$210
- Wood arm caps + \$116
- CTB-133 + \$83/yd
- Two fabrics + \$64
- Three (or more) fabrics + \$90

## Specification Decisions

- Select fabric
  - Select standard wood finish
  - Add moisture barrier
  - Add CTB-133
  - Apply multiple fabrics
  - Add urethane or wood arm caps
- Model numbers with **S** indicate standard seat and back covers, and model numbers with **P** indicate removable covers.

## Flammability Type

- Type 6

## Coordinating Products

- [Brava Classic Lounge Seating](#)
- [Brava Platform Lounge Seating](#)
- [Brava 863 Multiple Seating](#)
- [Brava Side Chair](#)
- [Brava Tables](#)
- [Brava Adjustable Back Chair](#)
- [Brava CompactComfort Recliner](#)
- [Brava Patient Chair](#)
- [Brava Glider](#)
- [Brava Flop Sofa](#)
- [Brava Sleep Settee](#)

## Key Dimensions

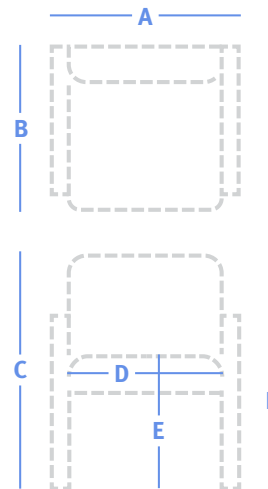

<b>A</b>	Overall Width	See price table
<b>B</b>	Overall Depth	26", 25.75" (OB30, OB40)
<b>C</b>	Overall Height	32" or 42.5"
<b>D</b>	Seat Width	
	Chair:	21.75", 29.25", 39.25"
	Two Seat:	43", 43.5"
	Three Seat:	64.25", 65.25"
<b>E</b>	Seat Height	18.75", 19.25" (OB30, OB40)
<b>F</b>	Arm Height	26.5"

## Brava 862 Multiple Seating

	26.5" W, Chair <span style="float: right;">34 lbs   3 yds</span>								
	Model	Series 2	Series 3	Series 4	Series 5	Series 6	Series 7	Series 8	COM
	<b>862-10C S</b>	\$1,976	\$2,073	\$2,235	\$2,405	\$2,606	\$2,810	\$3,064	\$2,073
	<b>862-10C P</b>	\$2,225	\$2,322	\$2,484	\$2,654	\$2,855	\$3,059	\$3,313	\$2,322

	34.75" W, Plus chair <span style="float: right;">46 lbs   3.75 yds</span>								
	Model	Series 2	Series 3	Series 4	Series 5	Series 6	Series 7	Series 8	COM
	<b>862C-OB30</b>	\$4,355	\$4,477	\$4,680	\$4,892	\$5,143	\$5,398	\$5,716	\$4,477

	44.75" W, Plus chair <span style="float: right;">51 lbs   3.75 yds</span>								
	Model	Series 2	Series 3	Series 4	Series 5	Series 6	Series 7	Series 8	COM
	<b>862C-OB40</b>	\$5,016	\$5,138	\$5,341	\$5,553	\$5,804	\$6,059	\$6,377	\$5,138

	47.75" W, Two seat <span style="float: right;">64 lbs   4.5 yds</span>								
	Model	Series 2	Series 3	Series 4	Series 5	Series 6	Series 7	Series 8	COM
	<b>862-20C S</b>	\$3,271	\$3,417	\$3,660	\$3,914	\$4,216	\$4,522	\$4,903	\$3,417
	<b>862-20C P</b>	\$3,682	\$3,828	\$4,071	\$4,325	\$4,627	\$4,933	\$5,314	\$3,828

	50.25" W, Two seat with intervening arm and leg <span style="float: right;">71 lbs   5 yds</span>								
	Model	Series 2	Series 3	Series 4	Series 5	Series 6	Series 7	Series 8	COM
	<b>862-22C S</b>	\$3,659	\$3,822	\$4,092	\$4,375	\$4,710	\$5,049	\$5,473	\$3,822
	<b>862-22C P</b>	\$4,118	\$4,281	\$4,551	\$4,834	\$5,169	\$5,508	\$5,932	\$4,281

	26.5" W, High back chair <span style="float: right;">35 lbs   3.25 yds</span>								
	Model	Series 2	Series 3	Series 4	Series 5	Series 6	Series 7	Series 8	COM
	<b>862-10H S</b>	\$2,244	\$2,350	\$2,526	\$2,709	\$2,928	\$3,148	\$3,424	\$2,350
	<b>862-10H P</b>	\$2,526	\$2,632	\$2,808	\$2,991	\$3,210	\$3,430	\$3,706	\$2,632

	47.75" W, High back two seat <span style="float: right;">65 lbs   4.75 yds</span>								
	Model	Series 2	Series 3	Series 4	Series 5	Series 6	Series 7	Series 8	COM
	<b>862-20H S</b>	\$3,539	\$3,694	\$3,951	\$4,219	\$4,538	\$4,860	\$5,263	\$3,694
	<b>862-20H P</b>	\$3,983	\$4,138	\$4,395	\$4,663	\$4,982	\$5,304	\$5,707	\$4,138

	50.25" W, High back two seat with intervening arm and leg <span style="float: right;">72 lbs   5.75 yds</span>								
	Model	Series 2	Series 3	Series 4	Series 5	Series 6	Series 7	Series 8	COM
	<b>862-22H S</b>	\$3,910	\$4,097	\$4,408	\$4,732	\$5,118	\$5,508	\$5,996	\$4,097
	<b>862-22H P</b>	\$4,402	\$4,589	\$4,900	\$5,224	\$5,610	\$6,000	\$6,488	\$4,589

	69" W, Three seat <span style="float: right;">93 lbs   6 yds</span>								
	Model	Series 2	Series 3	Series 4	Series 5	Series 6	Series 7	Series 8	COM
	<b>862-30C S</b>	\$4,502	\$4,697	\$5,021	\$5,360	\$5,763	\$6,170	\$6,679	\$4,697
	<b>862-30C P</b>	\$5,066	\$5,261	\$5,585	\$5,924	\$6,327	\$6,734	\$7,243	\$5,261

	74" W, Three seat with intervening arms and legs <span style="float: right;">106 lbs   7.25 yds</span>								
	Model	Series 2	Series 3	Series 4	Series 5	Series 6	Series 7	Series 8	COM
	<b>862-33C S</b>	\$5,267	\$5,503	\$5,895	\$6,304	\$6,791	\$7,282	\$7,897	\$5,503
	<b>862-33C P</b>	\$5,928	\$6,164	\$6,556	\$6,965	\$7,452	\$7,943	\$8,558	\$6,164

## Brava 862 Multiple Seating



### 69" W, High back three seat

94 lbs | 7 yds

Model	Series 2	Series 3	Series 4	Series 5	Series 6	Series 7	Series 8	COM
<b>862-30H S</b>	\$4,744	\$4,972	\$5,350	\$5,745	\$6,215	\$6,690	\$7,284	\$4,972
<b>862-30H P</b>	\$5,341	\$5,569	\$5,947	\$6,342	\$6,812	\$7,287	\$7,881	\$5,569



### 74" W, High back three seat with intervening arms and legs

107 lbs | 8.25 yds

Model	Series 2	Series 3	Series 4	Series 5	Series 6	Series 7	Series 8	COM
<b>862-33H S</b>	\$5,510	\$5,779	\$6,225	\$6,690	\$7,244	\$7,804	\$8,503	\$5,779
<b>862-33H P</b>	\$6,204	\$6,473	\$6,919	\$7,384	\$7,938	\$8,498	\$9,197	\$6,473

Lounge Seating

Multiple & Tandem Seating

Side, Stacking & Folding Chairs

Occasional Tables

# Brava 863 Multiple Seating



## Standard Features

- Solid maple frame
- Mortise and tenon joinery
- Spring seat construction
- Replaceable components
- Removable covers (863C-OB30, 863C-OB40)
- Clean-out design
- Wood arms
- Wallsaver legs
- Non-marring 7/8" rubber-cushioned glides
- Nemschoff healthcare wood finish
- GREENGUARD Gold Certified
- Limited Lifetime Warranty
- See nemschoff.com for weight ratings (862C-OB30, 862C-OB40)

## Available Options

- Moisture barrier + \$69 per seat or back
- Black urethane arm caps + \$116
- Desert or Pewter urethane arm caps + \$210
- CTB-133 + \$83/yd
- Two fabrics + \$64
- Three (or more) fabrics + \$90

## Specification Decisions

- Select fabric
- Select standard wood finish
- Add moisture barrier
- Add CTB-133
- Apply multiple fabrics
- Add urethane arm caps

Model numbers with **S** indicate standard seat and back covers, and model numbers with **P** indicate removable covers.

## Flammability Types

- Type 4
- Type 5 (High back)

## Coordinating Products

- [Brava Classic Lounge Seating](#)
- [Brava Platform Lounge Seating](#)
- [Brava 862 Multiple Seating](#)
- [Brava Side Chair](#)
- [Brava Tables](#)
- [Brava Adjustable Back Chair](#)
- [Brava CompactComfort Recliner](#)
- [Brava Patient Chair](#)
- [Brava Glider](#)
- [Brava Flop Sofa](#)
- [Brava Sleep Settee](#)

## Key Dimensions

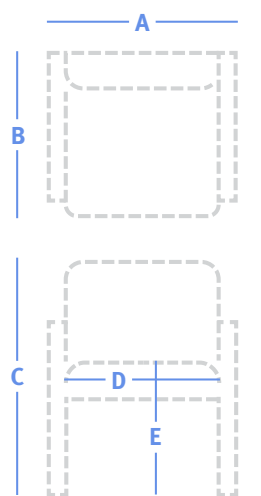

<b>A</b>	Overall Width	See price table
<b>B</b>	Overall Depth	26", 25.75" (OB30, OB40)
<b>C</b>	Overall Height	32" or 42.5"
<b>D</b>	Seat Width	
	Chair:	21.75", 30", 40"
	Two Seat:	43", 43.5"
	Three Seat:	64.5", 65.25"
<b>E</b>	Seat Height	18.75", 19.25" (OB30, OB40)
<b>F</b>	Arm Height	26.5"

### More Information

Illustrated Glossary ▶ 409





Fabrics ▶ 421

Flammability (CTB-133) ▶ 429

Finishes ▶ 426

Ordering and Warranties ▶ 432

## Brava 863 Multiple Seating

	<b>25.75" W, Chair</b> <span style="float: right;">33 lbs   1.75 yds</span>								
	Model	Series 2	Series 3	Series 4	Series 5	Series 6	Series 7	Series 8	COM
	<b>863-10C S</b>	\$1,813	\$1,870	\$1,965	\$2,064	\$2,181	\$2,300	\$2,448	\$1,870
	<b>863-10C P</b>	\$2,038	\$2,095	\$2,190	\$2,289	\$2,406	\$2,525	\$2,673	\$2,095
	<b>34" W, Plus chair</b> <span style="float: right;">46 lbs   2.75 yds</span>								
	Model	Series 2	Series 3	Series 4	Series 5	Series 6	Series 7	Series 8	COM
	<b>863C-OB30</b>	\$3,953	\$4,042	\$4,191	\$4,346	\$4,531	\$4,717	\$4,950	\$4,042
	<b>44" W, Plus chair</b> <span style="float: right;">51 lbs   2.75 yds</span>								
	Model	Series 2	Series 3	Series 4	Series 5	Series 6	Series 7	Series 8	COM
	<b>863C-OB40</b>	\$4,551	\$4,640	\$4,789	\$4,944	\$5,129	\$5,315	\$5,548	\$4,640
	<b>47" W, Two seat</b> <span style="float: right;">63 lbs   3.25 yds</span>								
	Model	Series 2	Series 3	Series 4	Series 5	Series 6	Series 7	Series 8	COM
	<b>863-20C S</b>	\$3,111	\$3,217	\$3,393	\$3,576	\$3,795	\$4,015	\$4,291	\$3,217
	<b>863-20C P</b>	\$3,498	\$3,604	\$3,780	\$3,963	\$4,182	\$4,402	\$4,678	\$3,604
	<b>49.5" W, Two seat with intervening arm and leg</b> <span style="float: right;">69 lbs   3.25 yds</span>								
	Model	Series 2	Series 3	Series 4	Series 5	Series 6	Series 7	Series 8	COM
	<b>863-22C S</b>	\$3,514	\$3,620	\$3,796	\$3,979	\$4,198	\$4,418	\$4,694	\$3,620
	<b>863-22C P</b>	\$3,949	\$4,055	\$4,231	\$4,414	\$4,633	\$4,853	\$5,129	\$4,055
	<b>25.75" W, High back chair</b> <span style="float: right;">34 lbs   2 yds</span>								
	Model	Series 2	Series 3	Series 4	Series 5	Series 6	Series 7	Series 8	COM
	<b>863-10H S</b>	\$2,082	\$2,147	\$2,255	\$2,368	\$2,503	\$2,638	\$2,808	\$2,147
	<b>863-10H P</b>	\$2,340	\$2,405	\$2,513	\$2,626	\$2,761	\$2,896	\$3,066	\$2,405
	<b>47" W, High back two seat</b> <span style="float: right;">64 lbs   4 yds</span>								
	Model	Series 2	Series 3	Series 4	Series 5	Series 6	Series 7	Series 8	COM
	<b>863-20H S</b>	\$3,362	\$3,492	\$3,708	\$3,934	\$4,203	\$4,474	\$4,813	\$3,492
	<b>863-20H P</b>	\$3,782	\$3,912	\$4,128	\$4,354	\$4,623	\$4,894	\$5,233	\$3,912
	<b>49.5" W, High back two seat with intervening arm and leg</b> <span style="float: right;">70 lbs   4 yds</span>								
	Model	Series 2	Series 3	Series 4	Series 5	Series 6	Series 7	Series 8	COM
	<b>863-22H S</b>	\$3,767	\$3,897	\$4,113	\$4,339	\$4,608	\$4,879	\$5,218	\$3,897
	<b>863-22H P</b>	\$4,235	\$4,365	\$4,581	\$4,807	\$5,076	\$5,347	\$5,686	\$4,365
	<b>68.25" W, Three seat</b> <span style="float: right;">91 lbs   5 yds</span>								
	Model	Series 2	Series 3	Series 4	Series 5	Series 6	Series 7	Series 8	COM
	<b>863-30C S</b>	\$4,332	\$4,495	\$4,765	\$5,048	\$5,383	\$5,722	\$6,146	\$4,495
	<b>863-30C P</b>	\$4,872	\$5,035	\$5,305	\$5,588	\$5,923	\$6,262	\$6,686	\$5,035
	<b>73.25" W, Three seat with intervening arms and legs</b> <span style="float: right;">103 lbs   5 yds</span>								
	Model	Series 2	Series 3	Series 4	Series 5	Series 6	Series 7	Series 8	COM
	<b>863-33C S</b>	\$5,138	\$5,301	\$5,571	\$5,854	\$6,189	\$6,528	\$6,952	\$5,301
	<b>863-33C P</b>	\$5,775	\$5,938	\$6,208	\$6,491	\$6,826	\$7,165	\$7,589	\$5,938

## Brava 863 Multiple Seating



### 68.25" W, High back three seat

92 lbs | 6 yds

Model	Series 2	Series 3	Series 4	Series 5	Series 6	Series 7	Series 8	COM
<b>863-30H S</b>	\$4,575	\$4,770	\$5,094	\$5,433	\$5,836	\$6,243	\$6,752	\$4,770
<b>863-30H P</b>	\$5,148	\$5,343	\$5,667	\$6,006	\$6,409	\$6,816	\$7,325	\$5,343



### 73.25" W, High back three seat with intervening arms and legs

104 lbs | 6 yds

Model	Series 2	Series 3	Series 4	Series 5	Series 6	Series 7	Series 8	COM
<b>863-33H S</b>	\$5,383	\$5,578	\$5,902	\$6,241	\$6,644	\$7,051	\$7,560	\$5,578
<b>863-33H P</b>	\$6,053	\$6,248	\$6,572	\$6,911	\$7,314	\$7,721	\$8,230	\$6,248

# Capella Multiple Seating



### More Information

- Illustrated Glossary ▶ 409
- Fabrics ▶ 421
- Flammability (CTB-133) ▶ 429
- Finishes ▶ 426
- Ordering and Warranties ▶ 432

### Standard Features

- Solid maple frame
- Mortise and tenon joinery
- Spring seat construction
- Replaceable components
- Upholstered arms
- Non-marring 7/8" rubber-cushioned glides
- Nemschoff healthcare wood finish
- GREENGUARD Gold Certified
- Limited Lifetime Warranty

### Available Options

- Moisture barrier + \$69 per seat or back
- CTB-133 + \$83/yd
- Two fabrics + \$64
- Three (or more) fabrics + \$90

### Specification Decisions

- Select fabric
- Select standard wood finish
- Add moisture barrier
- Add CTB-133
- Apply multiple fabrics

Model numbers with **S** indicate standard seat and back covers, and model numbers with **P** indicate removable covers.

### Flammability Type

- Type 6

### Coordinating Products

- [Auburn Benches](#)
- [Capella Tables](#)
- [Capella Patient Chair](#)
- [Capella Adjustable Back Chair](#)
- [Capella CompactComfort Recliner](#)
- [Capella Glider](#)
- [Capella Adjustable Back Glider](#)

### Key Dimensions

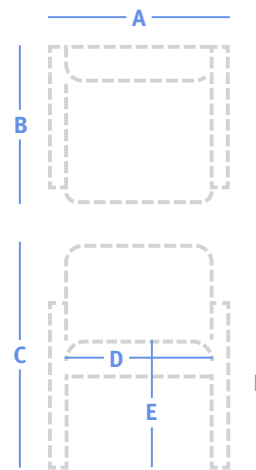

<b>A</b>	Overall Width	See price table
<b>B</b>	Overall Depth	24.25"
<b>C</b>	Overall Height	34.75"
<b>D</b>	Seat Width	
	Chair:	20"
	Settee:	20", 40.5"
	Sofa:	20", 61.5"
<b>E</b>	Seat Height	18.75"
<b>F</b>	Arm Height	25"



Welcoming & Waiting

## Capella Multiple Seating

	<b>25" W, Chair</b>									24 lbs   2.5 yds
	Model	Series 2	Series 3	Series 4	Series 5	Series 6	Series 7	Series 8	COM	
	<b>740-10 S</b>	\$1,530	\$1,611	\$1,746	\$1,888	\$2,055	\$2,225	\$2,437	\$1,611	
	<b>740-10 P</b>	\$1,724	\$1,805	\$1,940	\$2,082	\$2,249	\$2,419	\$2,631	\$1,805	
	<b>46" W, Two seat</b>									38 lbs   3.75 yds
	Model	Series 2	Series 3	Series 4	Series 5	Series 6	Series 7	Series 8	COM	
	<b>740-20 S</b>	\$2,462	\$2,584	\$2,787	\$2,999	\$3,250	\$3,505	\$3,823	\$2,584	
	<b>740-20 P</b>	\$2,773	\$2,895	\$3,098	\$3,310	\$3,561	\$3,816	\$4,134	\$2,895	
	<b>46.75" W, Two seat with intervening arm and leg</b>									42 lbs   4.25 yds
	Model	Series 2	Series 3	Series 4	Series 5	Series 6	Series 7	Series 8	COM	
	<b>740-22 S</b>	\$2,936	\$3,074	\$3,304	\$3,544	\$3,829	\$4,117	\$4,478	\$3,074	
	<b>740-22 P</b>	\$3,305	\$3,443	\$3,673	\$3,913	\$4,198	\$4,486	\$4,847	\$3,443	
	<b>66.75" W, Three seat</b>									52 lbs   5.5 yds
	Model	Series 2	Series 3	Series 4	Series 5	Series 6	Series 7	Series 8	COM	
	<b>740-30 S</b>	\$3,261	\$3,440	\$3,737	\$4,048	\$4,417	\$4,790	\$5,256	\$3,440	
	<b>740-30 P</b>	\$3,674	\$3,853	\$4,150	\$4,461	\$4,830	\$5,203	\$5,669	\$3,853	
	<b>68.25" W, Three seat with intervening arms and legs</b>									62 lbs   6 yds
	Model	Series 2	Series 3	Series 4	Series 5	Series 6	Series 7	Series 8	COM	
	<b>740-33 S</b>	\$4,143	\$4,338	\$4,662	\$5,001	\$5,404	\$5,811	\$6,320	\$4,338	
	<b>740-33 P</b>	\$4,664	\$4,859	\$5,183	\$5,522	\$5,925	\$6,332	\$6,841	\$4,859	

Patient Areas

Specialty

## Capella Bench

### Standard Features

Same standard features as Capella Multiple Seating

### Available Options

Same available options as Capella Multiple Seating

### Key Dimensions

- Overall Width: See price table
- Overall Depth: 21.75"
- Overall Height: 24.25"
- Seat Height: 19.25"

	<b>46.25" W, Bench</b>									39 lbs   2 yds
	Model	Series 2	Series 3	Series 4	Series 5	Series 6	Series 7	Series 8	COM	
	<b>740-B2 S</b>	\$1,612	\$1,677	\$1,785	\$1,898	\$2,033	\$2,168	\$2,338	\$1,677	
	<b>740-B2 P</b>	\$1,814	\$1,879	\$1,987	\$2,100	\$2,235	\$2,370	\$2,540	\$1,879	

Reference

# Horizon Multiple Seating



## More Information

Illustrated Glossary ▶ 409

Fabrics ▶ 421

Flammability (CTB-133) ▶ 429

Finishes ▶ 426

Ordering and Warranties ▶ 432

## Standard Features

- Solid hardwood frame
- Wipe-out design
- Replaceable components
- Wood arms
- Non-marring ¾" glides
- Nemschoff healthcare wood finish
- GREENGUARD Gold Certified
- Limited Lifetime Warranty
- See nemschoff.com for weight ratings (H18, H38)

## Available Options

- Moisture barrier + \$69 per seat or back
- Panel arms + \$137
- Black urethane arm caps + \$116
- Removable covers + \$174 per chair seat and back + \$346 per settee seat and back
- CTB-133 + \$83/yd
- Two fabrics + \$64
- Three (or more) fabrics + \$90

## Specification Decisions

- Select fabric
- Select standard wood finish
- Add moisture barrier
- Add CTB-133
- Apply multiple fabrics
- Add attached table (LSF, RSF)
- Add removable covers
- Add urethane arm caps
- Add panel arms

## Flammability Type

- Type 4
- Type 8 (with panel arms)

## Coordinating Products

- [Horizon Tables](#)
- [Horizon Recliner](#)
- [Horizon Patient Chair](#)



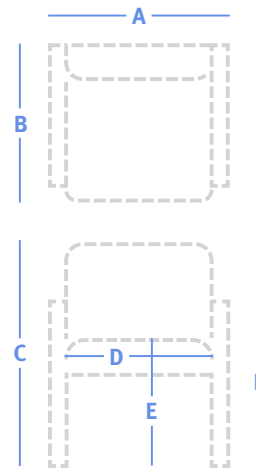







## Key Dimensions



<b>A</b>	Overall Width	See price table
<b>B</b>	Overall Depth	25"
<b>C</b>	Overall Height	31.5"
<b>D</b>	Seat Width	
	Chair:	19.5", 22", 30"
	Two Seat	39", 44"
	Three Seat:	58.5", 66"
<b>E</b>	Seat Height	18", 17.5" (H18, H38)
<b>F</b>	Arm Height	25"

Welcoming & Waiting

## Horizon Multiple Seating

	<b>23" W, Chair</b>									26 lbs   1.75 yds
	Model	Series 2	Series 3	Series 4	Series 5	Series 6	Series 7	Series 8	COM	
	<b>723</b>	\$1,053	\$1,081	\$1,204	\$1,270	\$1,306	\$1,353	\$1,383	\$1,081	
	<b>25.5" W, Chair</b>									27 lbs   2 yds
	Model	Series 2	Series 3	Series 4	Series 5	Series 6	Series 7	Series 8	COM	
	<b>823</b>	\$1,187	\$1,219	\$1,360	\$1,435	\$1,476	\$1,530	\$1,564	\$1,219	
	<b>33.5" W, Plus chair with open arms</b>									43 lbs   2.5 yds
	Model	Series 2	Series 3	Series 4	Series 5	Series 6	Series 7	Series 8	COM	
	<b>H18</b>	\$1,782	\$1,822	\$1,998	\$2,092	\$2,143	\$2,210	\$2,253	\$1,822	
	<b>39" W, Two seat</b>									56 lbs   2.75 yds
	Model	Series 2	Series 3	Series 4	Series 5	Series 6	Series 7	Series 8	COM	
	<b>722-2</b>	\$2,100	\$2,144	\$2,337	\$2,441	\$2,497	\$2,571	\$2,618	\$2,144	
	<b>49" W, Two seat</b>									58 lbs   3.25 yds
	Model	Series 2	Series 3	Series 4	Series 5	Series 6	Series 7	Series 8	COM	
	<b>822-2</b>	\$2,269	\$2,321	\$2,549	\$2,672	\$2,738	\$2,826	\$2,882	\$2,321	
	<b>44" W, Two seat with intervening arm and leg</b>									46 lbs   2.75 yds
	Model	Series 2	Series 3	Series 4	Series 5	Series 6	Series 7	Series 8	COM	
	<b>723-2</b>	\$1,842	\$1,886	\$2,079	\$2,183	\$2,239	\$2,313	\$2,360	\$1,886	
	<b>49" W, Two seat with intervening arm and leg</b>									48 lbs   3.25 yds
	Model	Series 2	Series 3	Series 4	Series 5	Series 6	Series 7	Series 8	COM	
	<b>823-2</b>	\$2,078	\$2,130	\$2,358	\$2,481	\$2,547	\$2,635	\$2,691	\$2,130	
	<b>44" W, Settee</b>									50 lbs   3 yds
	Model	Series 2	Series 3	Series 4	Series 5	Series 6	Series 7	Series 8	COM	
	<b>722-2-LS</b>	\$1,884	\$1,932	\$2,143	\$2,256	\$2,317	\$2,398	\$2,449	\$1,932	
	<b>49" W, Settee</b>									52 lbs   3.5 yds
	Model	Series 2	Series 3	Series 4	Series 5	Series 6	Series 7	Series 8	COM	
	<b>822-2-LS</b>	\$2,676	\$2,732	\$2,978	\$3,109	\$3,181	\$3,275	\$3,336	\$2,732	
	<b>66" W, Three seat</b>									76 lbs   3.75 yds
	Model	Series 2	Series 3	Series 4	Series 5	Series 6	Series 7	Series 8	COM	
	<b>722-3</b>	\$2,851	\$2,911	\$3,174	\$3,315	\$3,392	\$3,493	\$3,558	\$2,911	

Patient Areas

Specialty

Reference

## Horizon Multiple Seating

Lounge Seating

Multiple & Tandem Seating

Side, Stacking & Folding Chairs

Occasional Tables



73" W, Three seat									79 lbs   4.25 yds
Model	Series 2	Series 3	Series 4	Series 5	Series 6	Series 7	Series 8	COM	
<b>822-3</b>	\$3,250	\$3,318	\$3,616	\$3,776	\$3,863	\$3,978	\$4,051	\$3,318	



66" W, Three seat with intervening arms and legs									66 lbs   3.75 yds
Model	Series 2	Series 3	Series 4	Series 5	Series 6	Series 7	Series 8	COM	
<b>723-3</b>	\$2,635	\$2,695	\$2,958	\$3,099	\$3,176	\$3,277	\$3,342	\$2,695	



73" W, Three seat with intervening arms and legs									69 lbs   4.25 yds
Model	Series 2	Series 3	Series 4	Series 5	Series 6	Series 7	Series 8	COM	
<b>823-3</b>	\$2,976	\$3,044	\$3,342	\$3,502	\$3,589	\$3,704	\$3,777	\$3,044	



66" W, Chair with Settee									73 lbs   4 yds
Model	Series 2	Series 3	Series 4	Series 5	Series 6	Series 7	Series 8	COM	
<b>722-3-CH-LS</b>	\$3,015	\$3,079	\$3,360	\$3,510	\$3,592	\$3,700	\$3,769	\$3,079	



73" W, Chair with Settee									76 lbs   4.5 yds
Model	Series 2	Series 3	Series 4	Series 5	Series 6	Series 7	Series 8	COM	
<b>822-3-CH-LS</b>	\$3,416	\$3,488	\$3,804	\$3,973	\$4,065	\$4,186	\$4,264	\$3,488	



66" W, Two seat with spanner table									76 lbs   2.75 yds
Model	Series 2	Series 3	Series 4	Series 5	Series 6	Series 7	Series 8	COM	
<b>722-3-IT</b>	\$2,947	\$2,991	\$3,184	\$3,288	\$3,344	\$3,418	\$3,465	\$2,991	



73" W, Two seat with spanner table									79 lbs   3.25 yds
Model	Series 2	Series 3	Series 4	Series 5	Series 6	Series 7	Series 8	COM	
<b>822-3-IT</b>	\$3,355	\$3,407	\$3,635	\$3,758	\$3,824	\$3,912	\$3,968	\$3,407	



87" W, Four seat									96 lbs   4.75 yds
Model	Series 2	Series 3	Series 4	Series 5	Series 6	Series 7	Series 8	COM	
<b>722-4</b>	\$3,705	\$3,781	\$4,114	\$4,293	\$4,390	\$4,518	\$4,600	\$3,781	



97" W, Four seat									100 lbs   5.5 yds
Model	Series 2	Series 3	Series 4	Series 5	Series 6	Series 7	Series 8	COM	
<b>822-4</b>	\$4,220	\$4,308	\$4,694	\$4,901	\$5,013	\$5,162	\$5,256	\$4,308	



87" W, Four seat with intervening arms and legs									86 lbs   4.75 yds
Model	Series 2	Series 3	Series 4	Series 5	Series 6	Series 7	Series 8	COM	
<b>723-4</b>	\$3,424	\$3,500	\$3,833	\$4,012	\$4,109	\$4,237	\$4,319	\$3,500	

## Horizon Multiple Seating

	<b>97" W, Four seat with intervening arms and legs</b>									90 lbs   5.5 yds
	Model	Series 2	Series 3	Series 4	Series 5	Series 6	Series 7	Series 8	COM	
	<b>823-4</b>	\$3,868	\$3,956	\$4,342	\$4,549	\$4,661	\$4,810	\$4,904	\$3,956	

	<b>87" W, Chair and Settee with spanner table</b>									93 lbs   4 yds
	Model	Series 2	Series 3	Series 4	Series 5	Series 6	Series 7	Series 8	COM	
	<b>722-4-CH-IT-LS</b>	\$3,868	\$3,932	\$4,213	\$4,363	\$4,445	\$4,553	\$4,622	\$3,932	

	<b>97" W, Chair and Settee with spanner table</b>									97 lbs   4.5 yds
	Model	Series 2	Series 3	Series 4	Series 5	Series 6	Series 7	Series 8	COM	
	<b>822-4-CH-IT-LS</b>	\$4,388	\$4,460	\$4,776	\$4,945	\$5,037	\$5,158	\$5,236	\$4,460	

	<b>87" W, Three seat with spanner table</b>									96 lbs   3.75 yds
	Model	Series 2	Series 3	Series 4	Series 5	Series 6	Series 7	Series 8	COM	
	<b>722-4-IT</b>	\$3,696	\$3,756	\$4,019	\$4,160	\$4,237	\$4,338	\$4,403	\$3,756	

	<b>97" W, Three seat with spanner table</b>									100 lbs   4.25 yds
	Model	Series 2	Series 3	Series 4	Series 5	Series 6	Series 7	Series 8	COM	
	<b>822-4-IT</b>	\$4,215	\$4,283	\$4,581	\$4,741	\$4,828	\$4,943	\$5,016	\$4,283	

	<b>87" W, Two seat with Settee</b>									93 lbs   5 yds
	Model	Series 2	Series 3	Series 4	Series 5	Series 6	Series 7	Series 8	COM	
	<b>722-4-2CH-LS</b>	\$3,772	\$3,852	\$4,203	\$4,391	\$4,493	\$4,628	\$4,714	\$3,852	

	<b>97" W, Two seat with Settee</b>									97 lbs   5.75 yds
	Model	Series 2	Series 3	Series 4	Series 5	Series 6	Series 7	Series 8	COM	
	<b>822-4-2CH-LS</b>	\$4,270	\$4,362	\$4,765	\$4,982	\$5,099	\$5,254	\$5,353	\$4,362	

	<b>108" W, Five seat with intervening arms and legs</b>									106 lbs   5.75 yds
	Model	Series 2	Series 3	Series 4	Series 5	Series 6	Series 7	Series 8	COM	
	<b>723-5</b>	\$4,215	\$4,307	\$4,710	\$4,927	\$5,044	\$5,199	\$5,298	\$4,307	

	<b>120.5" W, Five seat with intervening arms and legs</b>									111 lbs   6.5 yds
	Model	Series 2	Series 3	Series 4	Series 5	Series 6	Series 7	Series 8	COM	
	<b>823-5</b>	\$4,764	\$4,869	\$5,325	\$5,570	\$5,703	\$5,878	\$5,990	\$4,869	

# Horizon Multiple Seating

## Horizon Benches

### Standard Features

Same standard features as Horizon Multiple Seating

### Available Options

Same available options as Horizon Multiple Seating

### Key Dimensions

- Overall Width: See price table
- Overall Depth: 20.5"
- Overall Height: 18"

	<b>44" W, Bench</b>									33 lbs   1.75 yds
	Model	Series 2	Series 3	Series 4	Series 5	Series 6	Series 7	Series 8	COM	
	<b>723B/44</b>	\$1,472	\$1,500	\$1,623	\$1,689	\$1,725	\$1,772	\$1,802	\$1,500	
	<b>66" W, Bench</b>									45 lbs   2.5 yds
	Model	Series 2	Series 3	Series 4	Series 5	Series 6	Series 7	Series 8	COM	
	<b>723B/66</b>	\$2,109	\$2,149	\$2,325	\$2,419	\$2,470	\$2,537	\$2,580	\$2,149	
	<b>49" W, Bench</b>									35 lbs   2 yds
	Model	Series 2	Series 3	Series 4	Series 5	Series 6	Series 7	Series 8	COM	
	<b>823B/49</b>	\$1,675	\$1,707	\$1,848	\$1,923	\$1,964	\$2,018	\$2,052	\$1,707	
	<b>73" W, Bench</b>									47 lbs   2.75 yds
	Model	Series 2	Series 3	Series 4	Series 5	Series 6	Series 7	Series 8	COM	
	<b>823B/73</b>	\$2,404	\$2,448	\$2,641	\$2,745	\$2,801	\$2,875	\$2,922	\$2,448	

# Horizon Multiple Seating

## Horizon Tables

### Standard Features

- Wood tops
- Laminate tops (select models)
- Non-marring ¾" glides
- Nemschoff healthcare wood finish
- GREENGUARD Gold Certified
- Limited Lifetime Warranty

### Specification Decisions

- Select standard wood finish
- Select table attachment option (LSF, RSF)
- Add standard laminate



### 21.25" W, Spanner end table

20 lbs

Model	Price	Depth	Height
<b>HET-723</b>	\$986	20.5"	14.75"



### 23.75" W, Spanner end table

21 lbs

Model	Price	Depth	Height
<b>HET-823</b>	\$1,129	20.5"	14.75"



### 19.5" W, Spanner table

18 lbs

Model	Price	Depth	Height
<b>HIT-723</b>	\$549	14.75"	18.75"



### 22" W, Spanner table

18 lbs

Model	Price	Depth	Height
<b>HIT-823</b>	\$549	14.75"	18.75"

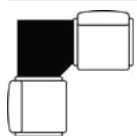

### 28" W, Spanner corner table

28 lbs

Model	Price	Depth	Height
<b>HSCT-723</b>	\$803	14.75"	18.75"
<b>HRCT-723</b>	\$851	14.75"	18.75"

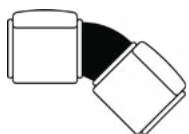

### 45-degree-radius corner table

18 lbs

Model	Price	Depth	Height
<b>HRCT45-723</b>	\$851	14.75"	18.75"

# Marco Multiple Seating



### More Information

Illustrated Glossary ▶ 409

Fabrics ▶ 421

Flammability (CTB-133) ▶ 429

Finishes ▶ 426

Ordering and Warranties ▶ 432

### Standard Features

- Solid maple frame
- Mortise and tenon joinery
- Spring seat construction
- Clean-out design
- Replaceable components
- Wood arms
- Wallsaver legs
- Non-marring 7/8" rubber-cushioned glides
- Nemschoff healthcare wood finish
- GREENGUARD Gold Certified
- Limited Lifetime Warranty
- See nemschoff.com for weight ratings (735-OB30, 735-OB40)

### Available Options

- Moisture barrier + \$69 per seat or back
- CTB-133 + \$83/yd
- Two fabrics + \$64
- Three (or more) fabrics + \$90

### Specification Decisions

- Select fabric
- Select standard wood finish
- Add moisture barrier
- Add CTB-133
- Apply multiple fabrics

Model numbers with **S** indicate standard seat and back covers, and model numbers with **P** indicate removable covers.

### Flammability Type

- Type 3
- Type 4 (Plus models)

### Coordinating Products

- [Marco Grande II Lounge Seating](#)
- [Marco Grande Tables](#)
- [Marco Patient Chair](#)
- [Marco Glider](#)



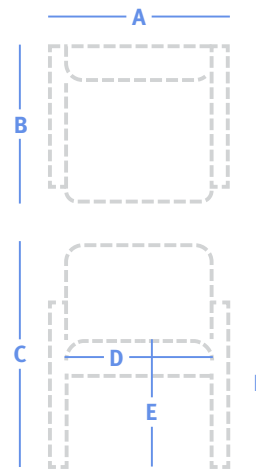



### Key Dimensions



<b>A</b>	Overall Width	See price table
<b>B</b>	Overall Depth	26.5"
<b>C</b>	Overall Height	34.25", 36.5" (OB30, OB40)
<b>D</b>	Seat Width	Chair: 20", 30", 40" Two Seat: 20", 40" Three Seat: 20", 60"
<b>E</b>	Seat Height	18.75", 19.25" (OB30, OB40)
<b>F</b>	Arm Height	25"



## Marco Multiple Seating

	<b>23.75" W, Chair</b>									26 lbs   2.5 yds
	Model	Series 2	Series 3	Series 4	Series 5	Series 6	Series 7	Series 8	COM	
	<b>735-10 S</b>	\$1,255	\$1,336	\$1,471	\$1,613	\$1,780	\$1,950	\$2,162	\$1,336	
	<b>735-10 P</b>	\$1,416	\$1,497	\$1,632	\$1,774	\$1,941	\$2,111	\$2,323	\$1,497	
	<b>33.5" W, Plus chair</b>									38 lbs   3.25 yds
	Model	Series 2	Series 3	Series 4	Series 5	Series 6	Series 7	Series 8	COM	
	<b>735-OB30</b>	\$2,784	\$2,890	\$3,066	\$3,249	\$3,468	\$3,688	\$3,964	\$2,890	
	<b>43.5" W, Plus chair</b>									43 lbs   3.5 yds
	Model	Series 2	Series 3	Series 4	Series 5	Series 6	Series 7	Series 8	COM	
	<b>735-OB40</b>	\$3,197	\$3,311	\$3,500	\$3,698	\$3,933	\$4,170	\$4,467	\$3,311	
	<b>44" W, Two seat</b>									48 lbs   4.75 yds
	Model	Series 2	Series 3	Series 4	Series 5	Series 6	Series 7	Series 8	COM	
	<b>735-20 S</b>	\$1,989	\$2,144	\$2,401	\$2,669	\$2,988	\$3,310	\$3,713	\$2,144	
	<b>735-20 P</b>	\$2,247	\$2,402	\$2,659	\$2,927	\$3,246	\$3,568	\$3,971	\$2,402	
	<b>45.75" W, Two seat with intervening arm</b>									54 lbs   4.75 yds
	Model	Series 2	Series 3	Series 4	Series 5	Series 6	Series 7	Series 8	COM	
	<b>735-22 S</b>	\$2,394	\$2,549	\$2,806	\$3,074	\$3,393	\$3,715	\$4,118	\$2,549	
	<b>735-22 P</b>	\$2,700	\$2,855	\$3,112	\$3,380	\$3,699	\$4,021	\$4,424	\$2,855	
	<b>64" W, Three seat</b>									72 lbs   7 yds
	Model	Series 2	Series 3	Series 4	Series 5	Series 6	Series 7	Series 8	COM	
	<b>735-30 S</b>	\$2,624	\$2,852	\$3,230	\$3,625	\$4,095	\$4,570	\$5,164	\$2,852	
	<b>735-30 P</b>	\$2,967	\$3,195	\$3,573	\$3,968	\$4,438	\$4,913	\$5,507	\$3,195	
	<b>66.5" W, Three seat with intervening arms and legs</b>									80 lbs   7 yds
	Model	Series 2	Series 3	Series 4	Series 5	Series 6	Series 7	Series 8	COM	
	<b>735-33 S</b>	\$3,453	\$3,681	\$4,059	\$4,454	\$4,924	\$5,399	\$5,993	\$3,681	
	<b>735-33 P</b>	\$3,895	\$4,123	\$4,501	\$4,896	\$5,366	\$5,841	\$6,435	\$4,123	

# Mayfield Multiple Seating



### More Information

- Illustrated Glossary ▶ 409
- Fabrics ▶ 421
- Flammability (CTB-133) ▶ 429
- Finishes ▶ 426
- Ordering and Warranties ▶ 432

### Standard Features

- Solid hardwood frame
- Mortise and tenon joinery
- Clean-out design
- Replaceable components
- Wood arm caps
- Arcade back
- Wallsaver legs
- Non-marring 7/8" rubber-cushioned glides
- Nemschoff healthcare wood finish
- GREENGUARD Gold Certified
- Limited Lifetime Warranty
- See nemschoff.com for weight ratings (FX200-OB30, FX200-OB40)

### Available Options

- Moisture barrier + \$69 per seat or back
- Black urethane arm caps + \$116
- Square back + \$0
- CTB-133 + \$83/yd
- Two fabrics + \$64
- Three (or more) fabrics + \$90
- Attached tables (LSF or RSF – see price table)

### Specification Decisions

- Select fabric
- Select standard wood finish
- Add moisture barrier
- Add CTB-133
- Apply multiple fabrics
- Add attached table
- Add Square back
- Add urethane arm caps

### Flammability Type

- Type 3
- Type 4 (Plus models)

### Coordinating Products

- [Rockwood Tables](#)

### Key Dimensions

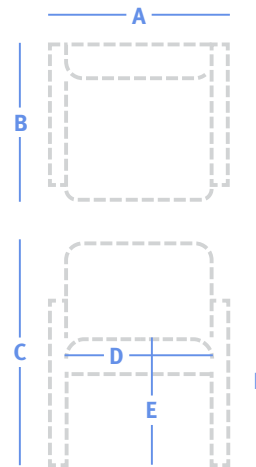

<b>A</b>	Overall Width	See price table
<b>B</b>	Overall Depth	23.75", 25.75" (OB30, OB40)
<b>C</b>	Overall Height	33", 32" (OB30, OB40)
<b>D</b>	Seat Width	Chair: 20.75", 30", 40" Settee: 20.75", 41" Three Seat: 20.75", 63"
<b>E</b>	Seat Height	18.75"
<b>F</b>	Arm Height	24.5"

## Mayfield Multiple Seating

	<b>23.75" W, Chair</b>									23 lbs   1.5 yds
	Model	Series 2	Series 3	Series 4	Series 5	Series 6	Series 7	Series 8	COM	
	<b>FX200-10</b>	\$855	\$903	\$984	\$1,067	\$1,168	\$1,260	\$1,386	\$903	

	<b>34" W, Plus chair</b>									37 lbs   3.5 yds
	Model	Series 2	Series 3	Series 4	Series 5	Series 6	Series 7	Series 8	COM	
	<b>FX200-OB30</b>	\$1,524	\$1,637	\$1,824	\$2,020	\$2,254	\$2,469	\$2,763	\$1,637	

	<b>44" W, Plus chair</b>									42 lbs   3.75 yds
	Model	Series 2	Series 3	Series 4	Series 5	Series 6	Series 7	Series 8	COM	
	<b>FX200-OB40</b>	\$1,695	\$1,816	\$2,017	\$2,226	\$2,477	\$2,707	\$3,022	\$1,816	

	<b>45" W, Two seat</b>									41 lbs   2.75 yds
	Model	Series 2	Series 3	Series 4	Series 5	Series 6	Series 7	Series 8	COM	
	<b>FX200-20</b>	\$1,357	\$1,445	\$1,592	\$1,746	\$1,930	\$2,099	\$2,330	\$1,445	

	<b>45.75" W, Two seat with intervening arm and leg</b>									43 lbs   2.75 yds
	Model	Series 2	Series 3	Series 4	Series 5	Series 6	Series 7	Series 8	COM	
	<b>FX200-22</b>	\$1,537	\$1,625	\$1,772	\$1,926	\$2,110	\$2,279	\$2,510	\$1,625	

	<b>66" W, Three seat</b>									84 lbs   4.25 yds
	Model	Series 2	Series 3	Series 4	Series 5	Series 6	Series 7	Series 8	COM	
	<b>FX200-30</b>	\$1,761	\$1,898	\$2,126	\$2,363	\$2,647	\$2,908	\$3,265	\$1,898	

	<b>67.75" W, Three seat with intervening arms and legs</b>									88 lbs   4.25 yds
	Model	Series 2	Series 3	Series 4	Series 5	Series 6	Series 7	Series 8	COM	
	<b>FX200-33</b>	\$2,302	\$2,439	\$2,667	\$2,904	\$3,188	\$3,449	\$3,806	\$2,439	

### Spanner Table

#### Standard Features

- Solid maple frame
- Laminate top
- Non-marring 7/8" glides

#### Specification Decisions

- Select standard wood finish
- Select standard laminate
- Select table attachment option (LSF, RSF)

	<b>26.25" W, Rockwood corner spanner table</b>				28 lbs
	Model	Price	Depth	Height	
	<b>FX120-CT</b>	\$585	26.25"	16"	

# Meridian Multiple Seating



### More Information

- Illustrated Glossary ▶ 409
- Fabrics ▶ 421
- Flammability (CTB-133) ▶ 429
- Finishes ▶ 426
- Ordering and Warranties ▶ 432

### Standard Features

- Solid hardwood frame
- Wipe-out design
- Replaceable components
- Wood arms
- Non-marring ¾" glides
- Nemschoff healthcare wood finish
- GREENGUARD Gold Certified
- Limited Lifetime Warranty
- See nemschoff.com for weight ratings (M18)

### Available Options

- Moisture barrier + \$69 per seat or back
- Panel arms + \$137
- Black urethane arm caps + \$116
- Removable covers + \$174 per chair seat and back + \$346 per settee seat and back
- CTB-133 + \$83/yd
- Two fabrics + \$64
- Three (or more) fabrics + \$90
- Attached tables (LSF, RSF –see price table)

### Specification Decisions

- Select fabric
- Select standard wood finish
- Add moisture barrier
- Add CTB-133
- Apply multiple fabrics
- Add attached table
- Add removable covers
- Add urethane arm caps
- Add panel arms

### Flammability Types

- Type 3
- Type 8 (with panel arms)

### Coordinating Products

- Meridian Patient Chair
- Meridian Tables
- Meridian Behavioral Health Seating

### Key Dimensions

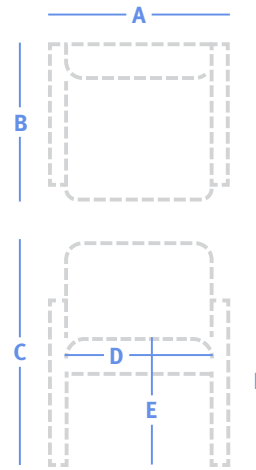

<b>A</b>	Overall Width	See price table
<b>B</b>	Overall Depth	25.5"
<b>C</b>	Overall Height	31.5"
<b>D</b>	Seat Width	
	Chair:	19.5", 22", 30"
	Two Seat:	39", 44"
<b>E</b>	Seat Height	18"
<b>F</b>	Arm Height	25"

## Meridian Multiple Seating

	<b>23" W, Chair</b>									26 lbs   1.75 yds
	Model	Series 2	Series 3	Series 4	Series 5	Series 6	Series 7	Series 8	COM	
	<b>M10</b>	\$1,089	\$1,117	\$1,240	\$1,306	\$1,342	\$1,389	\$1,419	\$1,117	

	<b>25.5" W, Chair</b>									27 lbs   2 yds
	Model	Series 2	Series 3	Series 4	Series 5	Series 6	Series 7	Series 8	COM	
	<b>M15</b>	\$1,165	\$1,197	\$1,338	\$1,413	\$1,454	\$1,508	\$1,542	\$1,197	

	<b>33.5" W, Plus chair</b>									43 lbs   2.5 yds
	Model	Series 2	Series 3	Series 4	Series 5	Series 6	Series 7	Series 8	COM	
	<b>M18</b>	\$1,557	\$1,597	\$1,773	\$1,867	\$1,918	\$1,985	\$2,028	\$1,597	

	<b>44" W, Two seat</b>									56 lbs   2.75 yds
	Model	Series 2	Series 3	Series 4	Series 5	Series 6	Series 7	Series 8	COM	
	<b>MS10-2</b>	\$2,117	\$2,161	\$2,354	\$2,458	\$2,514	\$2,588	\$2,635	\$2,161	

	<b>49" W, Two seat</b>									58 lbs   3.25 yds
	Model	Series 2	Series 3	Series 4	Series 5	Series 6	Series 7	Series 8	COM	
	<b>MS15-2</b>	\$2,374	\$2,426	\$2,654	\$2,777	\$2,843	\$2,931	\$2,987	\$2,426	

	<b>44" W, Two seat with intervening arm and leg</b>									46 lbs   2.75 yds
	Model	Series 2	Series 3	Series 4	Series 5	Series 6	Series 7	Series 8	COM	
	<b>M10-2</b>	\$1,909	\$1,953	\$2,146	\$2,250	\$2,306	\$2,380	\$2,427	\$1,953	











	<b>49" W, Two seat with intervening arm and leg</b>									48 lbs   3.25 yds
	Model	Series 2	Series 3	Series 4	Series 5	Series 6	Series 7	Series 8	COM	
	<b>M15-2</b>	\$2,045	\$2,097	\$2,325	\$2,448	\$2,514	\$2,602	\$2,658	\$2,097	

	<b>44" W, Settee</b>									50 lbs   3 yds
	Model	Series 2	Series 3	Series 4	Series 5	Series 6	Series 7	Series 8	COM	
	<b>MS10-2-LS</b>	\$1,859	\$1,907	\$2,118	\$2,231	\$2,292	\$2,373	\$2,424	\$1,907	

	<b>49" W, Settee</b>									52 lbs   3.5 yds
	Model	Series 2	Series 3	Series 4	Series 5	Series 6	Series 7	Series 8	COM	
	<b>MS15-2-LS</b>	\$2,150	\$2,206	\$2,452	\$2,583	\$2,655	\$2,749	\$2,810	\$2,206	

	<b>66" W, Three seat</b>									76 lbs   3.75 yds
	Model	Series 2	Series 3	Series 4	Series 5	Series 6	Series 7	Series 8	COM	
	<b>MS10-3</b>	\$3,005	\$3,065	\$3,328	\$3,469	\$3,546	\$3,647	\$3,712	\$3,065	

## Meridian Multiple Seating

	<b>73" W, Three seat</b> 79 lbs   4.25 yds								
	Model	Series 2	Series 3	Series 4	Series 5	Series 6	Series 7	Series 8	COM
	<b>MS15-3</b>	\$3,394	\$3,462	\$3,760	\$3,920	\$4,007	\$4,122	\$4,195	\$3,462
	<b>66" W, Three seat with intervening arms and legs</b> 66 lbs   3.75 yds								
	Model	Series 2	Series 3	Series 4	Series 5	Series 6	Series 7	Series 8	COM
	<b>M10-3</b>	\$2,727	\$2,787	\$3,050	\$3,191	\$3,268	\$3,369	\$3,434	\$2,787
	<b>73" W, Three seat with intervening arms and legs</b> 69 lbs   4.25 yds								
	Model	Series 2	Series 3	Series 4	Series 5	Series 6	Series 7	Series 8	COM
	<b>M15-3</b>	\$2,924	\$2,992	\$3,290	\$3,450	\$3,537	\$3,652	\$3,725	\$2,992
	<b>66" W, Chair with Settee</b> 73 lbs   4 yds								
	Model	Series 2	Series 3	Series 4	Series 5	Series 6	Series 7	Series 8	COM
	<b>MS10-3-CH-LS</b>	\$3,181	\$3,245	\$3,526	\$3,676	\$3,758	\$3,866	\$3,935	\$3,245
	<b>73" W, Chair with Settee</b> 76 lbs   4.5 yds								
	Model	Series 2	Series 3	Series 4	Series 5	Series 6	Series 7	Series 8	COM
	<b>MS15-3-CH-LS</b>	\$3,600	\$3,672	\$3,988	\$4,157	\$4,249	\$4,370	\$4,448	\$3,672
	<b>66" W, Two seat with spanner table</b> 76 lbs   2.75 yds								
	Model	Series 2	Series 3	Series 4	Series 5	Series 6	Series 7	Series 8	COM
	<b>MS10-3-IT</b>	\$3,105	\$3,149	\$3,342	\$3,446	\$3,502	\$3,576	\$3,623	\$3,149
	<b>73" W, Two seat with spanner table</b> 79 lbs   3.25 yds								
	Model	Series 2	Series 3	Series 4	Series 5	Series 6	Series 7	Series 8	COM
	<b>MS15-3-IT</b>	\$3,536	\$3,588	\$3,816	\$3,939	\$4,005	\$4,093	\$4,149	\$3,588
	<b>87" W, Four seat</b> 96 lbs   4.75 yds								
	Model	Series 2	Series 3	Series 4	Series 5	Series 6	Series 7	Series 8	COM
	<b>MS10-4</b>	\$3,909	\$3,985	\$4,318	\$4,497	\$4,594	\$4,722	\$4,804	\$3,985
	<b>97" W, Four seat</b> 100 lbs   5.5 yds								
	Model	Series 2	Series 3	Series 4	Series 5	Series 6	Series 7	Series 8	COM
	<b>MS15-4</b>	\$4,083	\$4,171	\$4,557	\$4,764	\$4,876	\$5,025	\$5,119	\$4,171
	<b>87" W, Four seat with intervening arms and legs</b> 86 lbs   4.75 yds								
	Model	Series 2	Series 3	Series 4	Series 5	Series 6	Series 7	Series 8	COM
	<b>M10-4</b>	\$3,366	\$3,442	\$3,775	\$3,954	\$4,051	\$4,179	\$4,261	\$3,442

## Meridian Multiple Seating

	<b>97" W, Four seat with intervening arms and legs</b> <span style="float: right;">90 lbs   5.5 yds</span>								
	Model	Series 2	Series 3	Series 4	Series 5	Series 6	Series 7	Series 8	COM
	<b>M15-4</b>	\$3,801	\$3,889	\$4,275	\$4,482	\$4,594	\$4,743	\$4,837	\$3,889

	<b>87" W, Three seat with spanner table</b> <span style="float: right;">96 lbs   3.75 yds</span>								
	Model	Series 2	Series 3	Series 4	Series 5	Series 6	Series 7	Series 8	COM
	<b>MS10-4-IT</b>	\$3,900	\$3,960	\$4,223	\$4,364	\$4,441	\$4,542	\$4,607	\$3,960

	<b>97" W, Three seat with spanner table</b> <span style="float: right;">100 lbs   4.25 yds</span>								
	Model	Series 2	Series 3	Series 4	Series 5	Series 6	Series 7	Series 8	COM
	<b>MS15-4-IT</b>	\$4,443	\$4,511	\$4,809	\$4,969	\$5,056	\$5,171	\$5,244	\$4,511

	<b>87" W, Chair and Settee with spanner table</b> <span style="float: right;">93 lbs   4 yds</span>								
	Model	Series 2	Series 3	Series 4	Series 5	Series 6	Series 7	Series 8	COM
	<b>MS10-4-CH-IT-LS</b>	\$4,325	\$4,389	\$4,670	\$4,820	\$4,902	\$5,010	\$5,079	\$4,389

	<b>97" W, Chair and Settee with spanner table</b> <span style="float: right;">97 lbs   4.5 yds</span>								
	Model	Series 2	Series 3	Series 4	Series 5	Series 6	Series 7	Series 8	COM
	<b>MS15-4-CH-IT-LS</b>	\$4,627	\$4,699	\$5,015	\$5,184	\$5,276	\$5,397	\$5,475	\$4,699

	<b>87" W, Two seat with Settee</b> <span style="float: right;">93 lbs   5 yds</span>								
	Model	Series 2	Series 3	Series 4	Series 5	Series 6	Series 7	Series 8	COM
	<b>MS10-4-2CH-LS</b>	\$3,979	\$4,059	\$4,410	\$4,598	\$4,700	\$4,835	\$4,921	\$4,059

	<b>97" W, Two seat with Settee</b> <span style="float: right;">97 lbs   5.75 yds</span>								
	Model	Series 2	Series 3	Series 4	Series 5	Series 6	Series 7	Series 8	COM
	<b>MS15-4-2CH-LS</b>	\$4,415	\$4,507	\$4,910	\$5,127	\$5,244	\$5,399	\$5,498	\$4,507

	<b>108" W, Five seat with intervening arms and legs</b> <span style="float: right;">106 lbs   5.75 yds</span>								
	Model	Series 2	Series 3	Series 4	Series 5	Series 6	Series 7	Series 8	COM
	<b>M10-5</b>	\$4,144	\$4,236	\$4,639	\$4,856	\$4,973	\$5,128	\$5,227	\$4,236

	<b>120.5" W, Five seat with intervening arms and legs</b> <span style="float: right;">111 lbs   6.5 yds</span>								
	Model	Series 2	Series 3	Series 4	Series 5	Series 6	Series 7	Series 8	COM
	<b>M15-5</b>	\$4,682	\$4,787	\$5,243	\$5,488	\$5,621	\$5,796	\$5,908	\$4,787

# Meridian Multiple Seating

## Meridian Spanner Tables

### Standard Features

- Wood tabletops
- Laminate tabletops (select models)
- Non-marring ¾" glides
- Nemschoff healthcare wood finish
- GREENGUARD Gold Certified
- Limited Lifetime Warranty

### Specification Decisions

- Select standard wood finish
- Select table attachment option (LSF, RSF)
- Add standard laminate



### 21.25" W, Spanner end table

20 lbs

Model	Price	Depth	Height
<b>MET-10</b>	\$1,036	20.5"	14.75"



### 23.75" W, Spanner end table

21 lbs

Model	Price	Depth	Height
<b>MET-15</b>	\$1,164	20.5"	14.75"

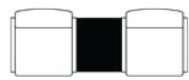

### 19.5" W, Spanner table

16 lbs

Model	Price	Depth	Height
<b>MIT-10</b>	\$573	20.5"	14.75"

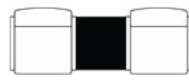

### 20.5" W, Spanner table

16 lbs

Model	Price	Depth	Height
<b>MIT-15</b>	\$647	20.5"	14.75"

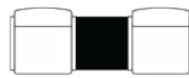

### 21" W, Spanner end table

18 lbs

Model	Price	Depth	Height
<b>MLIT-30</b>	\$682	25"	18.75"

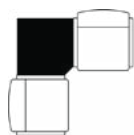

### 28" W, Spanner corner table

28 lbs

Model	Price	Depth	Height
<b>MSCT-10</b>	\$751	18.75"	14.75"
<b>MRCT-10</b>	\$837	18.75"	14.75"

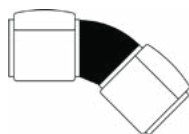

### 45-degree-radius corner table

18 lbs

Model	Price	Depth	Height
<b>MRCT45-10</b>	\$837	18.75"	14.75"



# Monarch Multiple Seating



## Standard Features

- Solid hardwood frame
- Mortise and tenon joinery
- Memory foam seat
- Wipe-out design
- Replaceable components
- Black urethane arm caps
- Wallsaver legs
- Non-marring 7/8" glides
- Nemschoff healthcare wood finish
- GREENGUARD Gold Certified
- Limited Lifetime Warranty
- See nemschoff.com for weight ratings (893-OB30, 893-OB40)

## Available Options

- Moisture barrier + \$69 per seat or back
- Wood arm caps + \$116
- CTB-133 + \$83/yd
- Two fabrics + \$64
- Three (or more) fabrics + \$90

## Specification Decisions

- Select fabric
  - Select standard wood finish
  - Add moisture barrier
  - Add CTB-133
  - Apply multiple fabrics
  - Add wood arm caps
- Model numbers with **S** indicate standard seat and back covers, and model numbers with **P** indicate removable covers.

## Flammability Type

- Type 3
- Type 4 (Plus models)

## Coordinating Products

- [Monarch Lounge Seating](#)
- [Monarch Stack Chair](#)
- [Monarch Tables](#)
- [Auburn Benches](#)
- [Monarch Sleep Chair and Settee](#)

## Key Dimensions

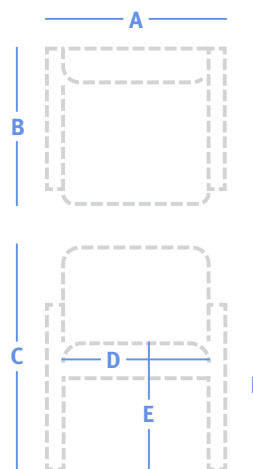

<b>A</b>	Overall Width	See price table
<b>B</b>	Overall Depth	24.5"
<b>C</b>	Overall Height	33.5", 34.5" (OB30, OB40)
<b>D</b>	Seat Width	Chair: 20.25" Two Seat: 20.25", 40.5" Three Seat: 20.25", 60.75"
<b>E</b>	Seat Height	18.75"
<b>F</b>	Arm Height	27"

### More Information

- Illustrated Glossary ▶ 409
- Fabrics ▶ 421
- Flammability (CTB-133) ▶ 429
- Finishes ▶ 426
- Ordering and Warranties ▶ 432

		22.75" W, Chair								25 lbs   1.5 yds
		Model	Series 2	Series 3	Series 4	Series 5	Series 6	Series 7	Series 8	COM
	<b>893-10 S</b>		\$800	\$848	\$929	\$1,014	\$1,115	\$1,217	\$1,344	\$848
	<b>893-10 P</b>		\$902	\$950	\$1,031	\$1,116	\$1,217	\$1,319	\$1,446	\$950
		22.75" W, Chair without arms								25 lbs   1.5 yds
		Model	Series 2	Series 3	Series 4	Series 5	Series 6	Series 7	Series 8	COM
	<b>893-11 S</b>		\$722	\$770	\$851	\$936	\$1,037	\$1,139	\$1,266	\$770
	<b>893-11 P</b>		\$815	\$863	\$944	\$1,029	\$1,130	\$1,232	\$1,359	\$863

## Monarch Multiple Seating

	<b>32.5" W, Plus chair</b> <span style="float: right;">38 lbs   2.25 yds</span>								
	Model	Series 2	Series 3	Series 4	Series 5	Series 6	Series 7	Series 8	COM
	<b>893-OB30</b>	\$1,180	\$1,253	\$1,375	\$1,502	\$1,653	\$1,806	\$1,996	\$1,253
	<b>42.5" W, Plus chair</b> <span style="float: right;">47 lbs   2.5 yds</span>								
	Model	Series 2	Series 3	Series 4	Series 5	Series 6	Series 7	Series 8	COM
	<b>893-OB40</b>	\$1,279	\$1,360	\$1,495	\$1,637	\$1,804	\$1,974	\$2,186	\$1,360
	<b>22.75" W, Two seat</b> <span style="float: right;">51 lbs   2.5 yds</span>								
	Model	Series 2	Series 3	Series 4	Series 5	Series 6	Series 7	Series 8	COM
	<b>893-20 S</b>	\$1,321	\$1,402	\$1,537	\$1,679	\$1,846	\$2,016	\$2,228	\$1,402
	<b>893-20 P</b>	\$1,490	\$1,571	\$1,706	\$1,848	\$2,015	\$2,185	\$2,397	\$1,571
	<b>44.25" W, Two seat with intervening arm and leg</b> <span style="float: right;">51 lbs   2.5 yds</span>								
	Model	Series 2	Series 3	Series 4	Series 5	Series 6	Series 7	Series 8	COM
	<b>893-22 S</b>	\$1,425	\$1,506	\$1,641	\$1,783	\$1,950	\$2,120	\$2,332	\$1,506
	<b>893-22 P</b>	\$1,606	\$1,687	\$1,822	\$1,964	\$2,131	\$2,301	\$2,513	\$1,687
	<b>45.75" W, Three seat</b> <span style="float: right;">77 lbs   3.5 yds</span>								
	Model	Series 2	Series 3	Series 4	Series 5	Series 6	Series 7	Series 8	COM
	<b>893-30 S</b>	\$1,879	\$1,993	\$2,182	\$2,380	\$2,615	\$2,852	\$3,149	\$1,993
	<b>893-30 P</b>	\$2,119	\$2,233	\$2,422	\$2,620	\$2,855	\$3,092	\$3,389	\$2,233
	<b>68.25" W, Three seat with intervening arms and legs</b> <span style="float: right;">77 lbs   3.5 yds</span>								
	Model	Series 2	Series 3	Series 4	Series 5	Series 6	Series 7	Series 8	COM
	<b>893-33 S</b>	\$2,109	\$2,223	\$2,412	\$2,610	\$2,845	\$3,082	\$3,379	\$2,223
	<b>893-33 P</b>	\$2,376	\$2,490	\$2,679	\$2,877	\$3,112	\$3,349	\$3,646	\$2,490

## Monarch Bench

### Standard Features

Same standard features as Monarch Multiple Seating

### Available Options

Same available options as Monarch Multiple Seating

### Key Dimensions

- Overall Width: See price table
- Overall Depth: 24.5"
- Overall Height: 33.5"
- Seat Width: 40.25"
- Arm Height: 27"

	<b>42.75" W, Bench</b> <span style="float: right;">30 lbs   1.25 yds</span>								
	Model	Series 2	Series 3	Series 4	Series 5	Series 6	Series 7	Series 8	COM
	<b>893-B2 S</b>	\$996	\$1,036	\$1,104	\$1,175	\$1,258	\$1,343	\$1,449	\$1,036
	<b>893-B2 P</b>	\$1,088	\$1,161	\$1,283	\$1,410	\$1,561	\$1,714	\$1,904	\$1,161

# Pause Multiple Seating



## Standard Features

- Solid hardwood frame
- Replaceable components
- Wipe-out design
- Suspended beam structure
- Moisture barrier on seat
- Wood arms
- Reconfigurable seating positions and widths
- Removable covers (applied railroded)
- Quilted upholstery
- Non-marring ¾" glides on hardwood models
- Nemschoff healthcare wood finish
- GREENGUARD Gold Certified
- Limited Lifetime Warranty

## Available Options

- Powder-coated metal frame + \$0 MST Metallic Silver Textured or XTT Titanium Textured
- Hard rubber glides on wood models + \$29
- Wallsaver glides on wood models + \$40
- Two fabrics + \$64
- Three (or more) fabrics + \$90
- Upholstered arm caps (available on wood frame) + \$35 per cap
- Black urethane arm caps (available on metal frame) + \$72 per arm cap
- Attached tables (LSF, RSF –see price table)
- CTB-133 not available

## Specification Decisions

- Select fabric
- Select wood or metal frame
- Select standard wood finish or powder coat finish
- Apply multiple fabrics
- Add attached table
- Add wallsaver glides

## Flammability Type

- Type 4

## Key Dimensions

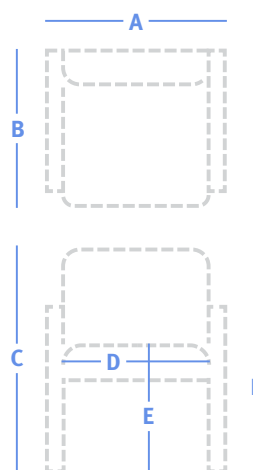

<b>A</b>	Overall Width	See price table
<b>B</b>	Overall Depth	26"
<b>C</b>	Overall Height	34"
<b>D</b>	Seat Width	
	Chair:	20", 30", 40"
	Settee:	42"
	Three Seat:	64", 86"
<b>E</b>	Seat Height	18"
<b>F</b>	Arm Height	25"

### More Information

- Illustrated Glossary ▶ 409
- Fabrics ▶ 421
- Finishes ▶ 426
- Ordering and Warranties ▶ 432

## Pause Multiple Seating

	<b>24" W, Chair</b>									46 lbs   2 yds
	Model	Series 2	Series 3	Series 4	Series 5	Series 6	Series 7	Series 8	COM	
	<b>PAUS-24010</b>	\$2,277	\$2,309	\$2,450	\$2,525	\$2,566	\$2,620	\$2,654	\$2,309	
	<b>34" W, Chair</b>									55 lbs   2.5 yds
	Model	Series 2	Series 3	Series 4	Series 5	Series 6	Series 7	Series 8	COM	
	<b>PAUS-34018</b>	\$2,470	\$2,510	\$2,686	\$2,780	\$2,831	\$2,898	\$2,941	\$2,510	
	<b>46" W, Settee</b>									65 lbs   3.25 yds
	Model	Series 2	Series 3	Series 4	Series 5	Series 6	Series 7	Series 8	COM	
	<b>PAUS-46001</b>	\$2,765	\$2,817	\$3,045	\$3,168	\$3,234	\$3,322	\$3,378	\$2,817	
	<b>46" W, Settee with divider arm</b>									68 lbs   3.25 yds
	Model	Series 2	Series 3	Series 4	Series 5	Series 6	Series 7	Series 8	COM	
	<b>PAUS-46002</b>	\$3,048	\$3,100	\$3,328	\$3,451	\$3,517	\$3,605	\$3,661	\$3,100	
	<b>68" W, Sofa</b>									85 lbs   4.5 yds
	Model	Series 2	Series 3	Series 4	Series 5	Series 6	Series 7	Series 8	COM	
	<b>PAUS-68001</b>	\$3,303	\$3,375	\$3,691	\$3,860	\$3,952	\$4,073	\$4,151	\$3,375	
	<b>68" W, Three seat with divider arm</b>									88 lbs   4.5 yds
	Model	Series 2	Series 3	Series 4	Series 5	Series 6	Series 7	Series 8	COM	
	<b>PAUS-68002</b>	\$3,721	\$3,793	\$4,109	\$4,278	\$4,370	\$4,491	\$4,569	\$3,793	
	<b>68" W, Three seat with divider arms</b>									91 lbs   4.5 yds
	Model	Series 2	Series 3	Series 4	Series 5	Series 6	Series 7	Series 8	COM	
	<b>PAUS-68003</b>	\$4,141	\$4,213	\$4,529	\$4,698	\$4,790	\$4,911	\$4,989	\$4,213	
	<b>90" W, Four seat</b>									105 lbs   5.75 yds
	Model	Series 2	Series 3	Series 4	Series 5	Series 6	Series 7	Series 8	COM	
	<b>PAUS-90001</b>	\$3,892	\$3,984	\$4,387	\$4,604	\$4,721	\$4,876	\$4,975	\$3,984	
	<b>90" W, Four seat with divider arm</b>									108 lbs   5.75 yds
	Model	Series 2	Series 3	Series 4	Series 5	Series 6	Series 7	Series 8	COM	
	<b>PAUS-90002</b>	\$4,335	\$4,427	\$4,830	\$5,047	\$5,164	\$5,319	\$5,418	\$4,427	
	<b>90" W, Four seat with two divider arms</b>									111 lbs   5.75 yds
	Model	Series 2	Series 3	Series 4	Series 5	Series 6	Series 7	Series 8	COM	
	<b>PAUS-90003</b>	\$4,779	\$4,871	\$5,274	\$5,491	\$5,608	\$5,763	\$5,862	\$4,871	

## Pause Multiple Seating

	<b>90" W, Four seat with three divider arms</b> <span style="float: right;">114 lbs   5.75 yds</span>								
	Model	Series 2	Series 3	Series 4	Series 5	Series 6	Series 7	Series 8	COM
	<b>PAUS-90004</b>	\$5,223	\$5,315	\$5,718	\$5,935	\$6,052	\$6,207	\$6,306	\$5,315

<b>2" W Adjustable arm</b>			
Model	Cost	Depth	Height
<b>PAUS-00001</b>	\$516	20.5"	11.25"

## Pause Benches

### Standard Features

Same standard features as Pause Multiple Seating

### Available Options

Same available options as Pause Multiple Seating

### Key Dimensions

- Overall Width: See price table
- Overall Depth: 24" or 26"
- Overall Height: 25"
- Seat Height: 18"
- Arm Height: 25"

	<b>46" W, Bench</b> <span style="float: right;">47 lbs   1.75 yds</span>								
	Model	Series 2	Series 3	Series 4	Series 5	Series 6	Series 7	Series 8	COM
	<b>PAUS-46000</b>	\$2,338	\$2,366	\$2,489	\$2,555	\$2,591	\$2,638	\$2,668	\$2,366

	<b>68" W, Bench</b> <span style="float: right;">60 lbs   2.25 yds</span>								
	Model	Series 2	Series 3	Series 4	Series 5	Series 6	Series 7	Series 8	COM
	<b>PAUS-68000</b>	\$3,169	\$3,205	\$3,363	\$3,448	\$3,494	\$3,554	\$3,593	\$3,205

	<b>90" W, Bench</b> <span style="float: right;">75 lbs   3 yds</span>								
	Model	Series 2	Series 3	Series 4	Series 5	Series 6	Series 7	Series 8	COM
	<b>PAUS-90000</b>	\$3,375	\$3,423	\$3,634	\$3,747	\$3,808	\$3,889	\$3,940	\$3,423

## Pause Multiple Seating

### Pause Spanner Tables

#### Standard Features

- Same standard features as Pause Multiple Seating, plus:
- Durawrap tabletops
- Gang both sides only

#### Specification Decisions

- Select standard wood finish
- Specify table attachment LSF or RSF

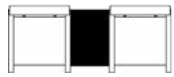

#### 13" W, Rectangular end table

13 lbs

Model	Price	Depth	Height
<b>PSTB-00010</b>	\$1,361	17.5"	–



#### 20.5" W, Square spanner table

16 lbs

Model	Price	Depth	Height
<b>PSTB-00020</b>	\$757	17.5"	–

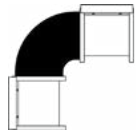

#### 34.5" W, Corner radius spanner table

19 lbs

Model	Price	Depth	Height
<b>PSTB-00090</b>	\$1,135	34.5"	20"

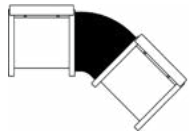

#### 20.5" W, Corner radius spanner table

13 lbs

Model	Price	Depth	Height
<b>PSTB-00045</b>	\$1,135	20.5"	18.5"

# Princeton Multiple Seating



## Standard Features

- Solid hardwood frame
- Mortise and tenon joinery
- Replaceable components
- Wipe-out design
- Wood arm caps
- Arcade back
- Non-marring 7/8" rubber-cushioned glides
- Nemschoff healthcare wood finish
- GREENGUARD Gold Certified
- Limited Lifetime Warranty
- See nemschoff.com for weight ratings (FX500-OB30, FX500-OB40)

## Available Options

- Moisture barrier + \$69 per seat or back
- Black urethane arm caps + \$116
- Square back + \$0
- CTB-133 + \$83/yd
- Two fabrics + \$64
- Three (or more) fabrics + \$90
- Attached tables (LSF, RSF –see price table)

## Specification Decisions

- Select fabric
- Select standard wood finish
- Add moisture barrier
- Add CTB-133
- Apply multiple fabrics
- Add attached table
- Add Square back

## Flammability Type

- Type 3
- Type 4 (Plus models)

## Coordinating Products

- [Rockwood Tables](#)

## Key Dimensions

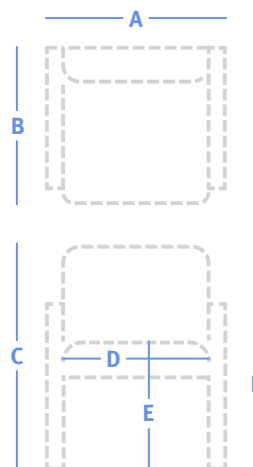

<b>A</b>	Overall Width	See price table
<b>B</b>	Overall Depth	25.5"
<b>C</b>	Overall Height	33.25", 32" (OB30, OB40)
<b>D</b>	Seat Width	
	Chair:	20.75", 30", 40"
	Two Seat:	41.5", 41.75"
	Three Seat:	62.25", 63"
<b>E</b>	Seat Height	18.75"
<b>F</b>	Arm Height	24.75"

### More Information

Illustrated Glossary ▶ 409

Fabrics ▶ 421

Flammability (CTB-133) ▶ 429

Finishes ▶ 426

Ordering and Warranties ▶ 432

## Princeton Multiple Seating

Lounge Seating

Multiple & Tandem Seating

Side, Stacking & Folding Chairs

Occasional Tables

	<b>23.75" W, Chair</b> <span style="float: right;">23 lbs   1.5 yds</span>
	Model Series 2 Series 3 Series 4 Series 5 Series 6 Series 7 Series 8 COM
	<b>FX500-10</b> \$892 \$940 \$1,021 \$1,104 \$1,205 \$1,297 \$1,423 \$940
	<b>34" W, Plus chair</b> <span style="float: right;">37 lbs   3.5 yds</span>
	Model Series 2 Series 3 Series 4 Series 5 Series 6 Series 7 Series 8 COM
	<b>FX500-OB30</b> \$1,464 \$1,577 \$1,764 \$1,960 \$2,194 \$2,409 \$2,703 \$1,577
	<b>44" W, Plus chair</b> <span style="float: right;">42 lbs   3.75 yds</span>
	Model Series 2 Series 3 Series 4 Series 5 Series 6 Series 7 Series 8 COM
	<b>FX500-OB40</b> \$1,631 \$1,752 \$1,953 \$2,162 \$2,413 \$2,643 \$2,958 \$1,752
	<b>45" W, Two seat</b> <span style="float: right;">41 lbs   2.75 yds</span>
	Model Series 2 Series 3 Series 4 Series 5 Series 6 Series 7 Series 8 COM
	<b>FX500-20</b> \$1,415 \$1,503 \$1,650 \$1,804 \$1,988 \$2,157 \$2,388 \$1,503
	<b>45.75" W, Two seat with intervening arm and leg</b> <span style="float: right;">43 lbs   2.75 yds</span>
	Model Series 2 Series 3 Series 4 Series 5 Series 6 Series 7 Series 8 COM
	<b>FX500-22</b> \$1,603 \$1,691 \$1,838 \$1,992 \$2,176 \$2,345 \$2,576 \$1,691
	<b>66" W, Three seat</b> <span style="float: right;">84 lbs   4.25 yds</span>
	Model Series 2 Series 3 Series 4 Series 5 Series 6 Series 7 Series 8 COM
	<b>FX500-30</b> \$1,837 \$1,974 \$2,202 \$2,439 \$2,723 \$2,984 \$3,341 \$1,974
	<b>67.75" W, Three seat with intervening arms and legs</b> <span style="float: right;">88 lbs   4.25 yds</span>
	Model Series 2 Series 3 Series 4 Series 5 Series 6 Series 7 Series 8 COM
	<b>FX500-33</b> \$2,400 \$2,537 \$2,765 \$3,002 \$3,286 \$3,547 \$3,904 \$2,537

### Spanner Table

#### Standard Features

- Solid maple frame
- Laminate top
- Non-marring 7/8" glides

#### Specification Decisions

- Select standard wood finish
- Select standard laminate
- Select table attachment option (LSF, RSF)



<b>26.25" W, Rockwood corner spanner table</b> <span style="float: right;">28 lbs</span>
Model Price Depth Height
<b>FX120-CT</b> \$585 26.25" 16"



# Reliant Multiple Seating



## Standard Features

- Heavy-duty metal construction
- Powder-coated frame
- Wipe-out design
- Replaceable components
- Wood arm caps
- Non-marring glides
- Plastic seat and back (select models)
- Veneer tabletops (select models)
- Nemschoff healthcare wood finish
- GREENGUARD Gold Certified
- Limited Lifetime Warranty
- See nemschoff.com for weight ratings (RE18)

## Available Options

- Moisture barrier + \$69 per seat or back
- Black urethane arm caps + \$116
- Removable covers + \$174 per chair seat and back + \$346 per settee seat and back
- CTB-133 + \$83/yd
- Two fabrics + \$64
- Three (or more) fabrics + \$90
- Attached tables (LSF, RSF – see price table)

## Specification Decisions

- Select model with plastic seat and back, or upholstered seat and back
- Select plastic seat and back color (models RE40, RES40)

**OUS** Light Sand Speckle    **OSS** Dark Sand Speckle

**7KS** Light Grey Speckle    **6KS** Dark Grey Speckle

- Select fabric
- Select standard wood finish
- Select powder coat finish
- Add moisture barrier
- Add CTB-133
- Apply multiple fabrics
- Add attached table
- Add removable covers

## Flammability Type

- Type 3
- Type 4 (Plus models)

## Coordinating Products

- [Reliant Tables](#)

## Key Dimensions

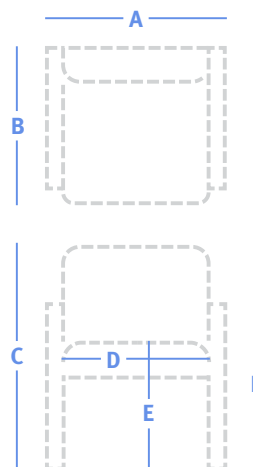

<b>A</b>	Overall Width	See price table
<b>B</b>	Overall Depth	25"
<b>C</b>	Overall Height	32"
<b>D</b>	Seat Width	
	Chair:	19.5", 22", 30"
	Two Seat:	19.5", 39", 44"
	Three Seat:	19.5", 58.5", 66"
<b>E</b>	Seat Height	17.5"
<b>F</b>	Arm Height	26"

### More Information

Illustrated Glossary ▶ 409

Fabrics ▶ 421









Flammability (CTB-133) ▶ 429

Finishes ▶ 426

Ordering and Warranties ▶ 432

## Reliant Multiple Seating

### Plastic Seat and Back (upholstered seat and back pads on select models)

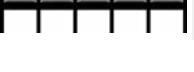
	<b>23" W, Chair, plastic seat and back</b> <span style="float: right;">33 lbs</span>
Model	Price
<b>RE40</b>	\$1,367
	<b>44" W, Two seat, plastic seat and back</b> <span style="float: right;">63 lbs</span>
Model	Price
<b>RES40-2</b>	\$2,687
	<b>44" W, Two seat with intervening arm and leg, plastic seat and back</b> <span style="float: right;">52 lbs</span>
Model	Price
<b>RE40-2</b>	\$2,417
	<b>65.5" W, Three seat, plastic seat and back</b> <span style="float: right;">83 lbs</span>
Model	Price
<b>RES40-3</b>	\$3,587
	<b>65.5" W, Three seat with intervening arms and legs, plastic seat and back</b> <span style="float: right;">72 lbs</span>
Model	Price
<b>RE40-3</b>	\$3,467
	<b>65.5" W, Two seat with spanner table, plastic seat and back</b> <span style="float: right;">82 lbs</span>
Model	Price
<b>RES40-3-IT</b>	\$3,695    –    –    –    –    –    –    –
	<b>87" W, Four seat, plastic seat and back</b> <span style="float: right;">103 lbs</span>
Model	Price
<b>RES40-4</b>	\$4,526    –    –    –    –    –    –    –
	<b>87" W, Four seat with intervening arms and legs, plastic seat and back</b> <span style="float: right;">93 lbs</span>
Model	Price
<b>RE40-4</b>	\$4,516    –    –    –    –    –    –    –
	<b>87" W, Three seat with spanner table, plastic seat and back</b> <span style="float: right;">103 lbs</span>
Model	Price
<b>RES40-4-IT</b>	\$4,661    –    –    –    –    –    –    –
	<b>108" W, Five seat with intervening arms and legs, plastic seat and back</b> <span style="float: right;">113 lbs</span>
Model	Price
<b>RE40-5</b>	\$5,568    –    –    –    –    –    –    –

# Reliant Multiple Seating

## Upholstered Seat and Back

		<b>23" W, Chair, upholstered seat and back</b>								33 lbs   1.5 yds
		Model	Series 2	Series 3	Series 4	Series 5	Series 6	Series 7	Series 8	COM
		<b>RE10</b>	\$1,246	\$1,270	\$1,376	\$1,432	\$1,463	\$1,503	\$1,529	\$1,270

		<b>25.5" W, Chair, upholstered seat and back</b>								34 lbs   1.75 yds
		Model	Series 2	Series 3	Series 4	Series 5	Series 6	Series 7	Series 8	COM
		<b>RE15</b>	\$1,413	\$1,441	\$1,564	\$1,630	\$1,666	\$1,713	\$1,743	\$1,441

		<b>33.5" W, Plus chair</b>								41 lbs   2 yds
		Model	Series 2	Series 3	Series 4	Series 5	Series 6	Series 7	Series 8	COM
		<b>RE18</b>	\$2,154	\$2,186	\$2,327	\$2,402	\$2,443	\$2,497	\$2,531	\$2,186

	<b>44" W, Two seat, upholstered seat and back</b>								63 lbs   3 yds
	Model	Series 2	Series 3	Series 4	Series 5	Series 6	Series 7	Series 8	COM
	<b>RES10-2</b>	\$2,519	\$2,567	\$2,778	\$2,891	\$2,952	\$3,033	\$3,084	\$2,567

	<b>49" W, Two seat, upholstered seat and back</b>								65 lbs   3.25 yds
	Model	Series 2	Series 3	Series 4	Series 5	Series 6	Series 7	Series 8	COM
	<b>RES15-2</b>	\$2,911	\$2,963	\$3,191	\$3,314	\$3,380	\$3,468	\$3,524	\$2,963

	<b>44" W, Two seat with intervening arm and leg, upholstered seat and back</b>								63 lbs   3 yds
	Model	Series 2	Series 3	Series 4	Series 5	Series 6	Series 7	Series 8	COM
	<b>RE10-2</b>	\$2,283	\$2,331	\$2,542	\$2,655	\$2,716	\$2,797	\$2,848	\$2,331

	<b>49" W, Two seat with intervening arm and leg, upholstered seat and back</b>								65 lbs   3.25 yds
	Model	Series 2	Series 3	Series 4	Series 5	Series 6	Series 7	Series 8	COM
	<b>RE15-2</b>	\$2,493	\$2,545	\$2,773	\$2,896	\$2,962	\$3,050	\$3,106	\$2,545

	<b>44" W, Settee, upholstered seat and back</b>								57 lbs   3.25 yds
	Model	Series 2	Series 3	Series 4	Series 5	Series 6	Series 7	Series 8	COM
	<b>RES10-2-LS</b>	\$2,279	\$2,331	\$2,559	\$2,682	\$2,748	\$2,836	\$2,892	\$2,331

	<b>49" W, Settee, upholstered seat and back</b>								59 lbs   3.5 yds
	Model	Series 2	Series 3	Series 4	Series 5	Series 6	Series 7	Series 8	COM
	<b>RES15-2-LS</b>	\$2,489	\$2,545	\$2,791	\$2,922	\$2,994	\$3,088	\$3,149	\$2,545

	<b>65.5" W, Three seat, upholstered seat and back</b>								83 lbs   4.5 yds
	Model	Series 2	Series 3	Series 4	Series 5	Series 6	Series 7	Series 8	COM
	<b>RES10-3</b>	\$3,416	\$3,488	\$3,804	\$3,973	\$4,065	\$4,186	\$4,264	\$3,488

## Reliant Multiple Seating

Lounge Seating

Multiple & Tandem Seating

Side, Stacking & Folding Chairs

Occasional Tables



73" W, Three seat, upholstered seat and back									86 lbs   4.75 yds
Model	Series 2	Series 3	Series 4	Series 5	Series 6	Series 7	Series 8	COM	
<b>RES15-3</b>	\$3,878	\$3,954	\$4,287	\$4,466	\$4,563	\$4,691	\$4,773	\$3,954	



65.5" W, Three seat with intervening arms and legs, upholstered seat and back									83 lbs   4.5 yds
Model	Series 2	Series 3	Series 4	Series 5	Series 6	Series 7	Series 8	COM	
<b>RE10-3</b>	\$3,100	\$3,172	\$3,488	\$3,657	\$3,749	\$3,870	\$3,948	\$3,172	



73" W, Three seat with intervening arms and legs, upholstered seat and back									86 lbs   4.75 yds
Model	Series 2	Series 3	Series 4	Series 5	Series 6	Series 7	Series 8	COM	
<b>RE15-3</b>	\$3,577	\$3,653	\$3,986	\$4,165	\$4,262	\$4,390	\$4,472	\$3,653	



66" W, Chair with settee, upholstered seat and back									80 lbs   4.75 yds
Model	Series 2	Series 3	Series 4	Series 5	Series 6	Series 7	Series 8	COM	
<b>RES10-3-CH-LS</b>	\$3,622	\$3,698	\$4,031	\$4,210	\$4,307	\$4,435	\$4,517	\$3,698	



73" W, Chair with settee, upholstered seat and back									83 lbs   5.25 yds
Model	Series 2	Series 3	Series 4	Series 5	Series 6	Series 7	Series 8	COM	
<b>RES15-3-CH-LS</b>	\$4,107	\$4,191	\$4,559	\$4,757	\$4,864	\$5,006	\$5,096	\$4,191	



65.5" W, Two seat with spanner table, upholstered seat and back									42 lbs   3 yds
Model	Series 2	Series 3	Series 4	Series 5	Series 6	Series 7	Series 8	COM	
<b>RES-10-3-IT</b>	\$3,547	\$3,595	\$3,806	\$3,919	\$3,980	\$4,061	\$4,112	\$3,595	



73" W, Two seat with spanner table, upholstered seat and back									86 lbs   3.25 yds
Model	Series 2	Series 3	Series 4	Series 5	Series 6	Series 7	Series 8	COM	
<b>RES15-3-IT</b>	\$4,021	\$4,073	\$4,301	\$4,424	\$4,490	\$4,578	\$4,634	\$4,073	



87" W, Four seat, upholstered seat and back									103 lbs   6 yds
Model	Series 2	Series 3	Series 4	Series 5	Series 6	Series 7	Series 8	COM	
<b>RES10-4</b>	\$4,305	\$4,401	\$4,822	\$5,048	\$5,171	\$5,332	\$5,435	\$4,401	



97" W, Four seat, upholstered seat and back									107 lbs   6.25 yds
Model	Series 2	Series 3	Series 4	Series 5	Series 6	Series 7	Series 8	COM	
<b>RES15-4</b>	\$4,888	\$4,988	\$5,426	\$5,662	\$5,790	\$5,958	\$6,066	\$4,988	





87" W, Four seat with intervening arms and legs, upholstered seat and back									93 lbs   6 yds
Model	Series 2	Series 3	Series 4	Series 5	Series 6	Series 7	Series 8	COM	
<b>RE10-4</b>	\$4,102	\$4,198	\$4,619	\$4,845	\$4,968	\$5,129	\$5,232	\$4,198	

## Reliant Multiple Seating

	<b>97" W, Four seat with intervening arms and legs, upholstered seat and back</b> <span style="float: right;">97 lbs   6.75 yds</span>
Model	Series 2   Series 3   Series 4   Series 5   Series 6   Series 7   Series 8   COM
<b>RE15-4</b>	\$4,648   \$4,757   \$5,230   \$5,485   \$5,623   \$5,804   \$5,921   \$4,757

	<b>87" W, Two seat with settee, upholstered seat and back</b> <span style="float: right;">100 lbs   6.25 yds</span>
Model	Series 2   Series 3   Series 4   Series 5   Series 6   Series 7   Series 8   COM
<b>RES10-4-2CH-LS</b>	\$4,515   \$4,615   \$5,053   \$5,289   \$5,417   \$5,585   \$5,693   \$4,615

	<b>97" W, Two seat with settee, upholstered seat and back</b> <span style="float: right;">104 lbs   7 yds</span>
Model	Series 2   Series 3   Series 4   Series 5   Series 6   Series 7   Series 8   COM
<b>RES15-4-2CH-LS</b>	\$5,119   \$5,232   \$5,723   \$5,986   \$6,130   \$6,318   \$6,439   \$5,232

	<b>87" W, Three seat with spanner table, upholstered seat and back</b> <span style="float: right;">103 lbs   4.5 yds</span>
Model	Series 2   Series 3   Series 4   Series 5   Series 6   Series 7   Series 8   COM
<b>RES-10-4-IT</b>	\$4,461   \$4,533   \$4,849   \$5,018   \$5,110   \$5,231   \$5,309   \$4,533

	<b>97" W, Three seat with spanner table, upholstered seat and back</b> <span style="float: right;">107 lbs   4.75 yds</span>
Model	Series 2   Series 3   Series 4   Series 5   Series 6   Series 7   Series 8   COM
<b>RES15-4-IT</b>	\$5,063   \$5,139   \$5,472   \$5,651   \$5,748   \$5,876   \$5,958   \$5,139

	<b>87" W, Chair and settee with spanner table, upholstered seat and back</b> <span style="float: right;">100 lbs   4.75 yds</span>
Model	Series 2   Series 3   Series 4   Series 5   Series 6   Series 7   Series 8   COM
<b>RES10-4-CH-IT-LS</b>	\$4,653   \$4,729   \$5,062   \$5,241   \$5,338   \$5,466   \$5,548   \$4,729

	<b>97" W, Chair and settee with spanner table, upholstered seat and back</b> <span style="float: right;">104 lbs   5 yds</span>
Model	Series 2   Series 3   Series 4   Series 5   Series 6   Series 7   Series 8   COM
<b>RES15-4-CH-IT-LS</b>	\$5,272   \$5,352   \$5,703   \$5,891   \$5,993   \$6,128   \$6,214   \$5,352

## Reliant Benches

### Standard Features

Same standard features as Reliant Multiple Seating

### Available Options

- Same available options as Reliant Multiple Seating

### Key Dimensions

- Overall Width: See price table
- Overall Depth: 20.5"
- Overall Height: 17.5"

	<b>44" W, Bench, upholstered seat</b> <span style="float: right;">40 lbs   1.75 yds</span>
Model	Series 2   Series 3   Series 4   Series 5   Series 6   Series 7   Series 8   COM
<b>RE10B/44</b>	\$1,930   \$1,958   \$2,081   \$2,147   \$2,183   \$2,230   \$2,260   \$1,958

	<b>49" W, Bench, upholstered seat</b> <span style="float: right;">52 lbs   2 yds</span>
Model	Series 2   Series 3   Series 4   Series 5   Series 6   Series 7   Series 8   COM
<b>RE15B/49</b>	\$2,239   \$2,271   \$2,412   \$2,487   \$2,528   \$2,582   \$2,616   \$2,271

## Reliant Multiple Seating

	<b>66" W, Bench, upholstered seat</b> <span style="float: right;">42 lbs   2.5 yds</span>								
	Model	Series 2	Series 3	Series 4	Series 5	Series 6	Series 7	Series 8	COM
	<b>RE10B/66</b>	\$2,614	\$2,654	\$2,830	\$2,924	\$2,975	\$3,042	\$3,085	\$2,654
	<b>73" W, Bench, upholstered seat</b> <span style="float: right;">54 lbs   2.75 yds</span>								
	Model	Series 2	Series 3	Series 4	Series 5	Series 6	Series 7	Series 8	COM
	<b>RE15B/73</b>	\$3,046	\$3,090	\$3,283	\$3,387	\$3,443	\$3,517	\$3,564	\$3,090

## Reliant Spanner Tables

### Standard Features

Same standard features as Reliant Tables

### Available Options

- Laminate or veneer top + \$0

### Specification Decisions

- Select standard wood finish
- Select laminate or veneer top
- Specify table attachment option (LSF, RSF)

	<b>21.25" W, Spanner end table</b> <span style="float: right;">11 lbs</span>			
	Model	Price	Depth	Height
	<b>RET-10</b>	\$1,188	19"	15.5"
	<b>23.25" W, Spanner end table</b> <span style="float: right;">12 lbs</span>			
	Model	Price	Depth	Height
	<b>RET-15</b>	\$1,337	19"	15.5"
	<b>19.5" W, Spanner table</b> <span style="float: right;">8 lbs</span>			
	Model	Price	Depth	Height
	<b>RIT-10</b>	\$660	21"	15.5"
	<b>22" W, Spanner table</b> <span style="float: right;">8 lbs</span>			
	Model	Price	Depth	Height
	<b>RIT-15</b>	\$708	21"	15.5"
	<b>18.25" W, Corner spanner table</b> <span style="float: right;">9 lbs</span>			
	Model	Price	Depth	Height
	<b>RRCT45-10</b>	\$989	18.25"	15.5"

# Torii Multiple Seating



## Standard Features

- Solid maple frame
- Mortise and tenon joinery
- Spring seat construction
- Replaceable components
- Wipe-out design
- Swoop back
- Wood arm caps
- Non-marring 7/8" rubber-cushioned glides
- Nemschoff healthcare wood finish
- GREENGUARD Gold Certified
- Limited Lifetime Warranty
- See nemschoff.com for weight ratings (283-OB30, 283-OB40)

## Available Options

- Moisture barrier + \$69 per seat or back
- Arcade back + \$0

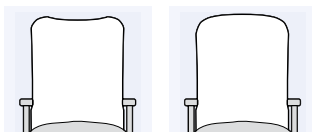

Swoop back (standard)

Arcade back

- Radius-edge arm + \$0
- CTB-133 + \$83/yd
- Two fabrics + \$64
- Three (or more) fabrics + \$90

## Specification Decisions

- Select fabric
- Select standard wood finish
- Add moisture barrier
- Add CTB-133
- Apply multiple fabrics
- Add Arcade back
- Add radius-edge

Model numbers with **S** indicate standard seat and back covers, and model numbers with **P** indicate removable covers.

## Flammability Type

- Type 3
- Type 4 (Plus models)

## Coordinating Products

- [Torii Side Chair](#)
- [Torii Tables](#)
- [Torii Patient Chair](#)
- [Torii Glider](#)
- [Torii Rocker](#)

## Key Dimensions

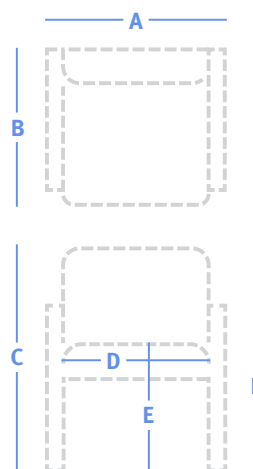

<b>A</b>	Overall Width	See price table
<b>B</b>	Overall Depth	25"
<b>C</b>	Overall Height	33"
<b>D</b>	Seat Width	
	Chair:	20", 30", 40"
	Settee:	20", 41"
	Three Seat:	20", 62.25"
<b>E</b>	Seat Height	18.25", 19" (OB30, OB40)
<b>F</b>	Arm Height	26"

### More Information

- Illustrated Glossary ▶ 409
- Fabrics ▶ 421
- Flammability (CTB-133) ▶ 429
- Finishes ▶ 426
- Ordering and Warranties ▶ 432

## Torii Multiple Seating

Lounge Seating

Multiple & Tandem Seating

Side, Stacking & Folding Chairs

Occasional Tables



### 24" W, Chair

30 lbs | 1.5 yds

Model	Series 2	Series 3	Series 4	Series 5	Series 6	Series 7	Series 8	COM
<b>283-10 S</b>	\$1,328	\$1,376	\$1,457	\$1,542	\$1,643	\$1,745	\$1,872	\$1,376
<b>283-10 P</b>	\$1,494	\$1,542	\$1,623	\$1,708	\$1,809	\$1,911	\$2,038	\$1,542



### 34.25" W, Plus chair

38 lbs | 3 yds

Model	Series 2	Series 3	Series 4	Series 5	Series 6	Series 7	Series 8	COM
<b>283-OB30</b>	\$2,854	\$2,951	\$3,113	\$3,283	\$3,484	\$3,688	\$3,942	\$2,951



### 44.25" W, Plus chair

43 lbs | 3.25 yds

Model	Series 2	Series 3	Series 4	Series 5	Series 6	Series 7	Series 8	COM
<b>283-OB40</b>	\$3,167	\$3,273	\$3,449	\$3,632	\$3,851	\$4,071	\$4,347	\$3,273



### 45.25" W, Two seat

46 lbs | 2.75 yds

Model	Series 2	Series 3	Series 4	Series 5	Series 6	Series 7	Series 8	COM
<b>283-20 S</b>	\$2,192	\$2,281	\$2,430	\$2,585	\$2,770	\$2,956	\$3,189	\$2,281
<b>283-20 P</b>	\$2,466	\$2,555	\$2,704	\$2,859	\$3,044	\$3,230	\$3,463	\$2,555



### 45.25" W, Two seat with intervening arm and leg

49 lbs | 2.75 yds

Model	Series 2	Series 3	Series 4	Series 5	Series 6	Series 7	Series 8	COM
<b>283-22 S</b>	\$2,363	\$2,452	\$2,601	\$2,756	\$2,941	\$3,127	\$3,360	\$2,452
<b>283-22 P</b>	\$2,658	\$2,747	\$2,896	\$3,051	\$3,236	\$3,422	\$3,655	\$2,747



### 66.5" W, Three seat

65 lbs | 4 yds

Model	Series 2	Series 3	Series 4	Series 5	Series 6	Series 7	Series 8	COM
<b>283-30 S</b>	\$3,433	\$3,563	\$3,779	\$4,005	\$4,274	\$4,545	\$4,884	\$3,563
<b>283-30 P</b>	\$3,861	\$3,991	\$4,207	\$4,433	\$4,702	\$4,973	\$5,312	\$3,991



### 66.5" W, Three seat with intervening arms and legs

68 lbs | 4 yds

Model	Series 2	Series 3	Series 4	Series 5	Series 6	Series 7	Series 8	COM
<b>283-33 S</b>	\$3,615	\$3,745	\$3,961	\$4,187	\$4,456	\$4,727	\$5,066	\$3,745
<b>283-33 P</b>	\$4,065	\$4,195	\$4,411	\$4,637	\$4,906	\$5,177	\$5,516	\$4,195



# Valor Multiple Seating



## Standard Features

- Heavy-duty steel construction
- Powder-coated frame
- Memory foam seat
- Dynamic flexing back
- Wipe-out design
- Replaceable components
- Black urethane arms
- Non-marring 1¼" glides
- GREENGUARD Gold Certified
- Limited Lifetime Warranty
- See nemschoff.com for weight ratings (891-OB30, 891-OB40)

## Available Options

- Moisture barrier + \$69 per seat or back
- Wallsaver glides + \$0
- CTB-133 + \$83/yard
- Two fabrics + \$64
- Three (or more) fabrics + \$90

## Specification Decisions

- Select fabric
- Select powder coat finish
- Add moisture barrier
- Add CTB-133
- Apply multiple fabrics
- Add wallsaver glides

Model numbers with **S** indicate standard seat and back covers, and model numbers with **P** indicate removable covers.

## Flammability Type

- Type 3

## Coordinating Products

- [Valor Lounge Seating](#)
- [Valor Stack Chair](#)
- [Valor Tables](#)
- [Valor Patient Chair](#)
- [Auburn Benches](#)

## Key Dimensions

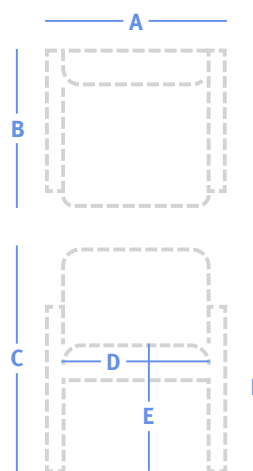

<b>A</b>	Overall Width	See price table
<b>B</b>	Overall Depth	24.5", 25.25 (OB30, OB40)
<b>C</b>	Overall Height	34"
<b>D</b>	Seat Width	Chair: 19.25", 30", 40" Two Seat: 39.5" Three Seat: 59.25"
<b>E</b>	Seat Height	18"
<b>F</b>	Arm Height	26.25"

### More Information

- Illustrated Glossary ▶ 409
- Fabrics ▶ 421
- Flammability (CTB-133) ▶ 429
- Finishes ▶ 426
- Ordering and Warranties ▶ 432

## Valor Multiple Seating

	<b>23.25" W, Chair</b>									30 lbs   1.75 yds
	Model	Series 2	Series 3	Series 4	Series 5	Series 6	Series 7	Series 8	COM	
	<b>891-10 S</b>	\$624	\$681	\$776	\$875	\$992	\$1,111	\$1,259	\$681	
	<b>891-10 P</b>	\$706	\$763	\$858	\$957	\$1,074	\$1,193	\$1,341	\$763	
	<b>33.25" W, Plus chair</b>									55 lbs   2.75 yds
	Model	Series 2	Series 3	Series 4	Series 5	Series 6	Series 7	Series 8	COM	
	<b>891-OB30</b>	\$783	\$872	\$1,021	\$1,176	\$1,361	\$1,547	\$1,780	\$872	
	<b>43.25" W, Plus chair</b>									66 lbs   2.75 yds
	Model	Series 2	Series 3	Series 4	Series 5	Series 6	Series 7	Series 8	COM	
	<b>891-OB40</b>	\$919	\$1,008	\$1,157	\$1,312	\$1,497	\$1,683	\$1,916	\$1,008	
	<b>43.25" W, Two seat</b>									63 lbs   2.75 yds
	Model	Series 2	Series 3	Series 4	Series 5	Series 6	Series 7	Series 8	COM	
	<b>891-20 S</b>	\$1,166	\$1,255	\$1,404	\$1,559	\$1,744	\$1,930	\$2,163	\$1,255	
	<b>891-20 P</b>	\$1,317	\$1,406	\$1,555	\$1,710	\$1,895	\$2,081	\$2,314	\$1,406	
	<b>45" W, Two seat with intervening arm and leg</b>									65 lbs   2.75 yds
	Model	Series 2	Series 3	Series 4	Series 5	Series 6	Series 7	Series 8	COM	
	<b>891-22 S</b>	\$1,271	\$1,360	\$1,509	\$1,664	\$1,849	\$2,035	\$2,268	\$1,360	
	<b>891-22 P</b>	\$1,435	\$1,524	\$1,673	\$1,828	\$2,013	\$2,199	\$2,432	\$1,524	
	<b>63.25" W, Three seat</b>									88 lbs   4.5 yds
	Model	Series 2	Series 3	Series 4	Series 5	Series 6	Series 7	Series 8	COM	
	<b>891-30 S</b>	\$1,575	\$1,721	\$1,964	\$2,218	\$2,520	\$2,826	\$3,207	\$1,721	
	<b>891-30 P</b>	\$1,782	\$1,928	\$2,171	\$2,425	\$2,727	\$3,033	\$3,414	\$1,928	
	<b>66.5" W, Three seat with intervening arms and legs</b>									90 lbs   4.5 yds
	Model	Series 2	Series 3	Series 4	Series 5	Series 6	Series 7	Series 8	COM	
	<b>891-33 S</b>	\$1,773	\$1,919	\$2,162	\$2,416	\$2,718	\$3,024	\$3,405	\$1,919	
	<b>891-33 P</b>	\$2,004	\$2,150	\$2,393	\$2,647	\$2,949	\$3,255	\$3,636	\$2,150	

## Valor Bench

### Standard Features

Same standard features as Valor Multiple Seating

### Available Options

Same available options as Valor Multiple Seating

### Key Dimensions

- Overall Width: See price table
- Overall Depth: 24.5"
- Overall Height: 26.25"
- Seat Height: 19.5"
- Arm Height: 26.25"

	<b>43.25" W, Bench</b>									70 lbs   1.25 yds
	Model	Series 2	Series 3	Series 4	Series 5	Series 6	Series 7	Series 8	COM	
	<b>891-B2 S</b>	\$996	\$1,036	\$1,104	\$1,175	\$1,258	\$1,343	\$1,449	\$1,036	
	<b>891-B2 P</b>	\$1,121	\$1,161	\$1,229	\$1,300	\$1,383	\$1,468	\$1,574	\$1,161	

# Altair Side Chair



## Standard Features

- Solid maple frame
- Mortise and tenon joinery
- Spring seat construction
- Wipe-out design
- Non-marring 7/8" rubber-cushioned glides
- Nemschoff healthcare wood finish
- GREENGUARD Gold Certified
- Limited Lifetime Warranty

## Available Options

- Moisture barrier + \$69 per seat or back
- CTB-133 + \$83/yd
- Two fabrics + \$64
- Three (or more) fabrics + \$90

## Specification Decisions

- Select fabric
  - Select standard wood finish
  - Add moisture barrier
  - Add CTB-133
  - Apply multiple fabrics
- Model numbers with **S** indicate standard seat and back covers, and model numbers with **P** indicate removable covers.

## Flammability Type

- Type 1

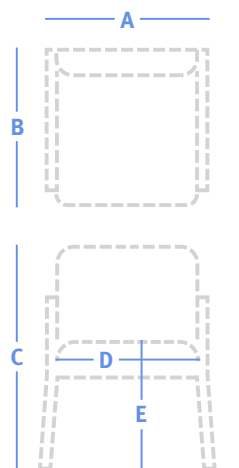

## Key Dimensions



<b>A</b>	Overall Width	See price table
<b>B</b>	Overall Depth	22.75"
<b>C</b>	Overall Height	31.5"
<b>D</b>	Seat Width	18", 22"
<b>E</b>	Seat Height	18.5"
<b>F</b>	Arm Height	24.5"

### More Information

- Illustrated Glossary ▶ 409
- Fabrics ▶ 421
- Flammability (CTB-133) ▶ 429
- Finishes ▶ 426
- Ordering and Warranties ▶ 432

		20.5" W, Side chair								18 lbs   1 yd
Model		Series 2	Series 3	Series 4	Series 5	Series 6	Series 7	Series 8	COM	
	<b>309-91 S</b>	\$895	\$927	\$981	\$1,038	\$1,105	\$1,173	\$1,258	\$927	
	<b>309-91 P</b>	\$1,007	\$1,039	\$1,093	\$1,150	\$1,217	\$1,285	\$1,370	\$1,039	
		20.5" W, Side chair with arms								18 lbs   1 yd
Model		Series 2	Series 3	Series 4	Series 5	Series 6	Series 7	Series 8	COM	
	<b>309-92 S</b>	\$989	\$1,021	\$1,075	\$1,132	\$1,199	\$1,267	\$1,352	\$1,021	
	<b>309-92 P</b>	\$1,112	\$1,144	\$1,198	\$1,255	\$1,322	\$1,390	\$1,475	\$1,144	
		24.5" W, Plus chair								22 lbs   1.5 yds
Model		Series 2	Series 3	Series 4	Series 5	Series 6	Series 7	Series 8	COM	
	<b>309-OB91 S</b>	\$1,106	\$1,154	\$1,235	\$1,320	\$1,421	\$1,523	\$1,650	\$1,154	
	<b>309-OB91 P</b>	\$1,245	\$1,293	\$1,374	\$1,459	\$1,560	\$1,662	\$1,789	\$1,293	

# Brava Side Chair



### More Information

- Illustrated Glossary ▶ 409
- Fabrics ▶ 421
- Flammability (CTB-133) ▶ 429
- Finishes ▶ 426
- Ordering and Warranties ▶ 432

### Standard Features

- Solid maple frame
- Mortise and tenon joinery
- Spring seat construction
- Non-marring 7/8" rubber-cushioned glides
- Nemschoff healthcare wood finish
- GREENGUARD Gold Certified
- Limited Lifetime Warranty

### Available Options

- Moisture barrier + \$69 per seat or back
- CTB-133 + \$83/yd
- Two fabrics + \$64
- Three (or more) fabrics + \$90

### Specification Decisions

- Select fabric
- Select standard wood finish
- Add moisture barrier
- Add CTB-133
- Apply multiple fabrics

Model numbers with **S** indicate standard seat and back covers, and model numbers with **P** indicate removable covers.

### Flammability Type

- Type 4

### Coordinating Products

- [Brava Classic Lounge Seating](#)
- [Brava Platform Lounge Seating](#)
- [Brava 862 Multiple Seating](#)
- [Brava 863 Multiple Seating](#)
- [Brava Tables](#)
- [Brava Adjustable Back Chair](#)
- [Brava CompactComfort Recliner](#)
- [Brava Patient Chair](#)
- [Brava Glider](#)
- [Brava Flop Sofa](#)
- [Brava Sleep Settee](#)

### Key Dimensions

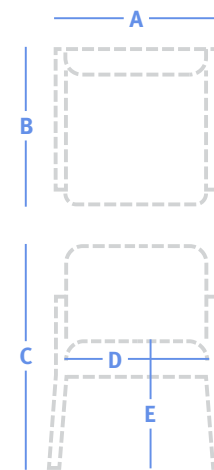

<b>A</b>	Overall Width	See price table
<b>B</b>	Overall Depth	23"
<b>C</b>	Overall Height	32.25"
<b>D</b>	Seat Width	19"
<b>E</b>	Seat Height	19"



### 19" W, Side chair

19 lbs | 1.75 yds

Model	Series 2	Series 3	Series 4	Series 5	Series 6	Series 7	Series 8	COM
<b>862-91 S</b>	\$1,281	\$1,338	\$1,433	\$1,532	\$1,649	\$1,768	\$1,916	\$1,338
<b>862-91 P</b>	\$1,442	\$1,499	\$1,594	\$1,693	\$1,810	\$1,929	\$2,077	\$1,499

# Capella Side Chair



## Standard Features

- Solid maple frame
- Mortise and tenon joinery
- Spring seat construction
- Non-marring 7/8" rubber-cushioned glides
- Nemschoff healthcare wood finish
- GREENGUARD Gold Certified
- Limited Lifetime Warranty

## Coordinating Products

- [Capella Multiple Seating](#)
- [Capella Tables](#)
- [Capella Patient Chair](#)
- [Capella Adjustable Back Chair](#)
- [Capella CompactComfort Recliner](#)
- [Capella Glider](#)
- [Capella Adjustable Back Glider](#)

## Available Options

- Moisture barrier + \$69 per seat or back
- CTB-133 + \$83/yd
- Two fabrics + \$64
- Three (or more) fabrics + \$90

## Key Dimensions

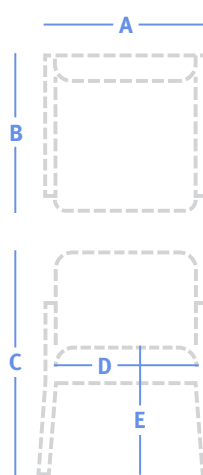

<b>A</b>	Overall Width	See price table
<b>B</b>	Overall Depth	23.5", 19.25"
<b>C</b>	Overall Height	32", 43.25"
<b>D</b>	Seat Width	18.25", 19"
<b>E</b>	Seat Height	18.5"

## More Information

- Illustrated Glossary ▶ 409
- Fabrics ▶ 421
- Flammability (CTB-133) ▶ 429
- Finishes ▶ 426
- Ordering and Warranties ▶ 432

## Specification Decisions

- Select fabric
- Select standard wood finish
- Add moisture barrier
- Add CTB-133
- Apply multiple fabrics

Model numbers with **S** indicate standard seat and back covers, and model numbers with **P** indicate removable covers.

## Flammability Type

- Type 4

		19" W, Side chair								19 lbs   1.75 yds
Model		Series 2	Series 3	Series 4	Series 5	Series 6	Series 7	Series 8	COM	
	<b>740-91 S</b>	\$1,228	\$1,285	\$1,380	\$1,479	\$1,596	\$1,715	\$1,863	\$1,285	
	<b>740-91 P</b>	\$1,383	\$1,440	\$1,535	\$1,634	\$1,751	\$1,870	\$2,018	\$1,440	

		18.25" W, Bar stool								18.5 lbs   1.75 yds
Model		Series 2	Series 3	Series 4	Series 5	Series 6	Series 7	Series 8	COM	
	<b>740-28 S</b>	\$1,509	\$1,566	\$1,661	\$1,760	\$1,877	\$1,996	\$2,144	\$1,566	
	<b>740-28 P</b>	\$1,697	\$1,754	\$1,849	\$1,948	\$2,065	\$2,184	\$2,332	\$1,754	

# Cities Side Chair



## More Information

Illustrated Glossary ▶ 409

Fabrics ▶ 421

Flammability (CTB-133) ▶ 429

Finishes ▶ 426

Ordering and Warranties ▶ 432

## Standard Features

- Solid maple frame
- Mortise and tenon joinery
- Spring seat construction
- Wipe-out design
- Replaceable components
- Wood arm caps
- Wallsaver legs
- Non-marring 7/8" rubber-cushioned glides
- Nemschoff healthcare wood finish
- GREENGUARD Gold Certified
- Limited Lifetime Warranty

## Available Options

- Moisture barrier + \$69 per seat or back
- Three arm cap styles + 0
- Two back styles + 0
- CTB-133 + \$83/yd
- Two fabrics + \$64
- Three (or more) fabrics + \$90

## Specification Decisions

- Select fabric
- Select standard wood finish
- Select wood arm cap style

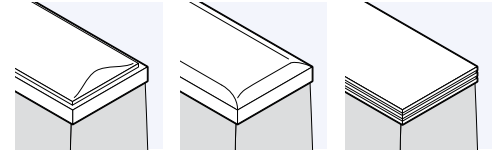

**C** Chicago

**Y** New York

**N** New Orleans

- Select back style

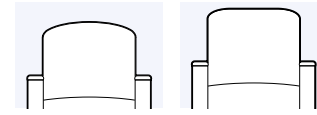

**A** Arcade back

**S** Square back

- Add moisture barrier
- Add CTB-133
- Apply multiple fabrics

Model numbers with **S** indicate standard seat and back covers, and model numbers with **P** indicate removable covers.

## Flammability Type

- Type 3

# Cities Side Chair

## Coordinating Products

- [Cities Small Crosstown Lounge Seating](#)
- [Cities Medium Crosstown Lounge Seating](#)
- [Cities Small Downtown Lounge Seating](#)
- [Cities Medium Downtown Lounge Seating](#)
- [Cities Small Uptown Lounge Seating](#)
- [Cities Medium Uptown Lounge Seating](#)
- [Cities Tables](#)
- [Cities Crosstown Patient Chair](#)
- [Cities Downtown Patient Chair](#)
- [Cities Uptown Patient Chair](#)
- [Cities Uptown CompactComfort Recliner](#)
- [Cities Crosstown Rocker](#)
- [Cities Downtown Rocker](#)
- [Cities Uptown Rocker](#)
- [Cities Downtown Glider](#)
- [Cities Uptown Glider](#)
- [SleepOver Sofa](#)
- [SleepOver Settee](#)

## Key Dimensions

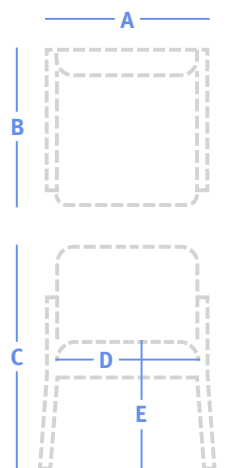

<b>A</b>	Overall Width	See price table
<b>B</b>	Overall Depth	27.5"
<b>C</b>	Overall Height	32.5"
<b>D</b>	Seat Width	19.5"
<b>E</b>	Seat Height	18.25"
<b>F</b>	Arm Height	25.5"



### 23.75" W, Side chair with arms

35 lbs | 1.5 yds

Model	Series 2	Series 3	Series 4	Series 5	Series 6	Series 7	Series 8	COM
<b>Cities-SGXX-92 S</b>	\$1,324	\$1,372	\$1,453	\$1,538	\$1,639	\$1,741	\$1,868	\$1,372
<b>Cities-SGXX-92 P</b>	\$1,489	\$1,537	\$1,618	\$1,703	\$1,804	\$1,906	\$2,033	\$1,537

# Dex Folding Chair



### More Information

- Illustrated Glossary ▶ 409
- Fabrics ▶ 421
- Flammability (CTB-133) ▶ 429
- Finishes ▶ 426
- Ordering and Warranties ▶ 432

### Standard Features

- Engineered wood
- Mortise and tenon joinery
- Wallsaver leg
- Secure folding mechanism without pinch points
- Non-marring 1" rubber-cushioned glides
- 5" profile when folded
- Nemschoff healthcare wood finish
- GREENGUARD Gold Certified
- Limited Lifetime Warranty

### Available Options

- Moisture barrier + \$69 per seat or back
- Wall mount bracket (holds two chairs) + \$24
- Hook for hanging chair + \$36
- CTB-133 + \$83/yd

### Specification Decisions

- Select fabric, if required
- Select standard wood finish
- Add moisture barrier
- Add CTB-133
- Add hook
- Add wall mount bracket

Model numbers with **S** indicate standard seat and back covers, and model numbers with **P** indicate removable covers.

Can be hung on the Herman Miller Compass rail

### Flammability Type

- Type 1

### Coordinating Products

- [Dex Stack Chair](#)

### Key Dimensions

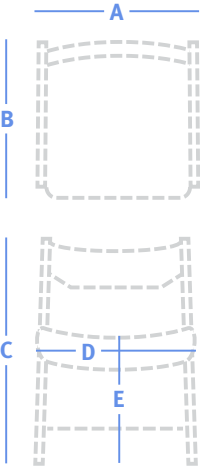

<b>A</b>	Overall Width	See price table
<b>B</b>	Overall Depth	24.75"
<b>C</b>	Overall Height	33.5"
<b>D</b>	Seat Width	18"
<b>E</b>	Seat Height	18"

	21.25" W, Folding chair with upholstered seat and back									18.5 lbs   1 yd
	Model	Series 2	Series 3	Series 4	Series 5	Series 6	Series 7	Series 8	COM	
	<b>68-91U S</b>	\$574	\$606	\$660	\$717	\$784	\$852	\$937	\$606	
	<b>68-91U P</b>	\$647	\$679	\$733	\$790	\$857	\$925	\$1,010	\$679	

	21.25" W, Folding chair with wood seat and upholstered back									18.5 lbs   0.5 yd
	Model	Series 2	Series 3	Series 4	Series 5	Series 6	Series 7	Series 8	COM	
	<b>68-91UB S</b>	\$602	\$618	\$645	\$674	\$707	\$741	\$784	\$618	
	<b>68-91UB P</b>	\$677	\$693	\$720	\$749	\$782	\$816	\$859	\$693	



## Dex Folding Chair

21.25" W, Folding chair with upholstered seat and wood back										18.5 lbs   0.75 yd
Model	Series 2	Series 3	Series 4	Series 5	Series 6	Series 7	Series 8	COM		
<b>68-91US S</b>	\$606	\$630	\$671	\$713	\$764	\$815	\$878	\$630		
<b>68-91US P</b>	\$682	\$706	\$747	\$789	\$840	\$891	\$954	\$706		

21.25" W, Folding chair with wood seat and back										18.5 lbs
Model	Price									
<b>68-91W</b>	\$554									

# Dex Stack Chair



## More Information

Illustrated Glossary ▶ 409

Fabrics ▶ 421

Flammability (CTB-133) ▶ 429

Finishes ▶ 426

Ordering and Warranties ▶ 432

## Standard Features

- Solid maple frame
- Mortise and tenon joinery
- Wallsaver legs
- Non-marring 1" rubber-cushioned glides
- Stacks up to three high
- Nemschoff healthcare wood finish
- GREENGUARD Gold Certified
- Limited Lifetime Warranty

## Available Options

- Moisture barrier + \$69 per seat or back
- Black urethane arm caps + \$116
- CTB-133 + \$83/yd

## Specification Decisions

- Select fabric, if required
- Select standard wood finish
- Add moisture barrier
- Add CTB-133
- Add urethane arm caps

Model numbers with **S** indicate standard seat and back covers, and model numbers with **P** indicate removable covers.

## Flammability Type

- Type 1

## Coordinating Products

- [Dex Folding Chair](#)

## Key Dimensions

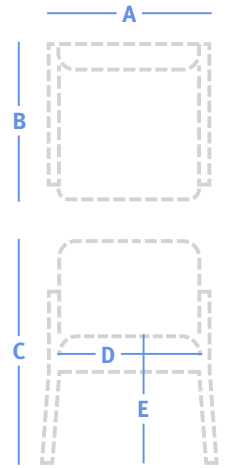

<b>A</b>	Overall Width	See price table
<b>B</b>	Overall Depth	22.5"
<b>C</b>	Overall Height	33.75"
<b>D</b>	Seat Width	18.25", 21.5"
<b>E</b>	Seat Height	18.25"
<b>F</b>	Arm Height	25.75"

Icon	Model	Series 2	Series 3	Series 4	Series 5	Series 6	Series 7	Series 8	COM	Weight
	<b>25.5" W, Stack chair with upholstered seat and wood back</b> <span style="float: right;">21.5 lbs   0.75 yd</span>									
	68-92US S	\$787	\$811	\$852	\$894	\$945	\$996	\$1,059	\$811	
	68-92US P	\$885	\$909	\$950	\$992	\$1,043	\$1,094	\$1,157	\$909	
	<b>25.5" W, Stack chair with upholstered seat and back</b> <span style="float: right;">21.5 lbs   1 yd</span>									
	68-92U S	\$719	\$751	\$805	\$862	\$929	\$997	\$1,082	\$751	
	68-92U P	\$810	\$842	\$896	\$953	\$1,020	\$1,088	\$1,173	\$842	
	<b>25.5" W, Stack chair with wood seat and upholstered back</b> <span style="float: right;">18.5 lbs   1 yd</span>									
	68-92UB S	\$753	\$785	\$839	\$896	\$963	\$1,031	\$1,116	\$785	
	68-92UB P	\$848	\$880	\$934	\$991	\$1,058	\$1,126	\$1,211	\$880	
	<b>25.5" W, Stack chair with wood seat and back</b> <span style="float: right;">18.5 lbs</span>									
	68-92W	\$723		22.5"		33.5"				

# Diane Side Chair



## Standard Features

- Solid hardwood frame
- Non-marring 1" rubber-cushioned glides
- Nemschoff healthcare wood finish
- GREENGUARD Gold Certified
- Limited Lifetime Warranty

## Available Options

- Moisture barrier + \$69 per seat or back
- CTB-133 + \$83/yd

## Specification Decisions

- Select fabric
- Select standard wood finish
- Add moisture barrier
- Add CTB-133

Model numbers with **S** indicate standard seat and back covers, and model numbers with **P** indicate removable covers.

## Flammability Type

- Type 1

## Key Dimensions

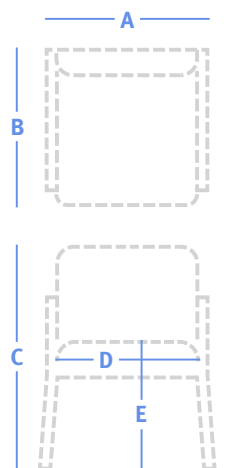

<b>A</b>	Overall Width	See price table
<b>B</b>	Overall Depth	22.75"
<b>C</b>	Overall Height	33.5"
<b>D</b>	Seat Width	19"
<b>E</b>	Seat Height	18"
<b>F</b>	Arm Height	23" (front) - 26" (rear)

### More Information

Illustrated Glossary ▶ 409

Fabrics ▶ 421

Flammability (CTB-133) ▶ 429

Finishes ▶ 426

Ordering and Warranties ▶ 432



### 22.5" W, Side chair with arms

19.25 lbs | 1 yd

Model	Series 2	Series 3	Series 4	Series 5	Series 6	Series 7	Series 8	COM
<b>236-10 S</b>	\$1,013	\$1,045	\$1,099	\$1,156	\$1,223	\$1,291	\$1,376	\$1,045
<b>236-10 P</b>	\$1,139	\$1,171	\$1,225	\$1,282	\$1,349	\$1,417	\$1,502	\$1,171

# Monarch Stack Chair

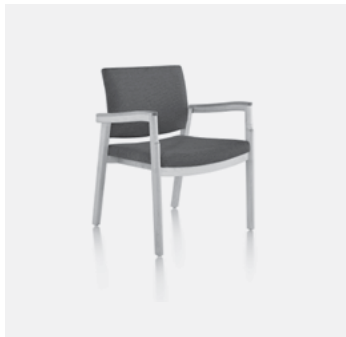

### More Information

- Illustrated Glossary ▶ 409
- Fabrics ▶ 421
- Flammability (CTB-133) ▶ 429
- Finishes ▶ 426
- Ordering and Warranties ▶ 432

### Standard Features

- Solid hardwood frame
- Mortise and tenon joinery
- Memory foam seat
- Wipe-out design
- Replaceable components
- Black urethane arm caps
- Wallsaver legs
- Non-marring 7/8" glides
- Stacks up to three high
- Nemschoff healthcare wood finish
- GREENGUARD Gold Certified
- Limited Lifetime Warranty

### Available Options

- Moisture barrier + \$69 per seat or back
- Wood arm caps + \$116
- CTB-133 + \$83/yd
- Two fabrics + \$64
- Three (or more) fabrics + \$90

### Specification Decisions

- Select fabric
- Select standard wood finish
- Add moisture barrier
- Add CTB-133
- Add wood arm caps
- Apply multiple fabrics

Model numbers with **S** indicate standard seat and back covers, and model numbers with **P** indicate removable covers.

### Flammability Type

- Type 3



### Coordinating Products

- [Monarch Lounge Seating](#)
- [Monarch Multiple Seating](#)
- [Monarch Tables](#)
- [Monarch Patient Chair](#)
- [Monarch Sleep Chair and Settee](#)

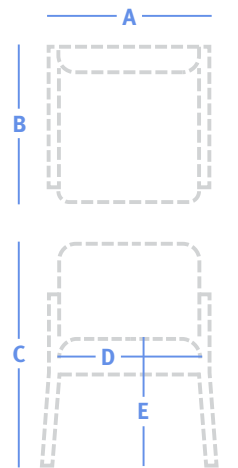
### Key Dimensions



<b>A</b>	Overall Width	See price table
<b>B</b>	Overall Depth	24.5"
<b>C</b>	Overall Height	33.5"
<b>D</b>	Seat Width	22"
<b>E</b>	Seat Height	18.75"
<b>F</b>	Arm Height	27"

 	<b>24.5" W, Stack chair</b> <span style="float: right;">22 lbs   1.5 yds</span>								
		Model	Series 2	Series 3	Series 4	Series 5	Series 6	Series 7	Series 8
	<b>893-92 S</b>	\$789	\$837	\$918	\$1,003	\$1,104	\$1,206	\$1,333	\$837
	<b>893-92 P</b>	\$890	\$938	\$1,019	\$1,104	\$1,205	\$1,307	\$1,434	\$938

# Revive Side Chair



## Standard Features

- Powder-coated metal frame
- Clean-out design
- Wood arm caps
- 2.5-degree back flex
- Non-marring glides
- GREENGUARD Gold Certified
- Limited Lifetime Warranty

## Available Options

- Moisture barrier + \$69 per seat or back
- Black urethane arm caps + \$116
- CTB-133 + \$83/yd
- Two fabrics + \$64
- Three (or more) fabrics + \$90
- Wood or laminate infill panel + \$137

## Specification Decisions

- Select fabric
- Select powder-coated finish
- Add moisture barrier
- Add CTB-133
- Apply multiple fabrics
- Add urethane arm caps
- Add infill panel

## Flammability Types

- Type 5
- Type 6 (with arm panel)

## Coordinating Products

- [Revive Patient Chair](#)
- [Revive Casegoods](#)
- [Revive Daystands](#)
- [Revive Display System](#)

## Key Dimensions

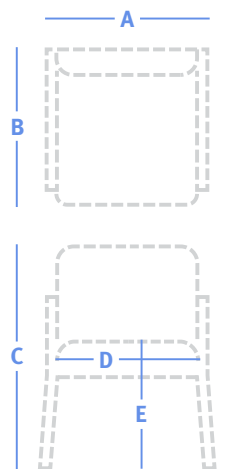

<b>A</b>	Overall Width	See price table
<b>B</b>	Overall Depth	22.5"
<b>C</b>	Overall Height	33"
<b>D</b>	Seat Width	20.5"
<b>E</b>	Seat Height	18.5"
<b>F</b>	Arm Height	24"

### More Information

- Illustrated Glossary ▶ 409
- Fabrics ▶ 421
- Flammability (CTB-133) ▶ 429
- Finishes ▶ 426
- Ordering and Warranties ▶ 432



25" W, Side chair with arms and upholstered seat and back, open arm									20.5 lbs   2.5 yds
Model	Series 2	Series 3	Series 4	Series 5	Series 6	Series 7	Series 8	COM	
<b>RV12</b>	\$1,585	\$1,625	\$1,801	\$1,895	\$1,946	\$2,013	\$2,056	\$1,625	



25" W, Side chair with arms and upholstered seat, back, arm panel									20.5 lbs   3 yds
Model	Series 2	Series 3	Series 4	Series 5	Series 6	Series 7	Series 8	COM	
<b>RV12SPA</b>	\$1,621	\$1,669	\$1,880	\$1,993	\$2,054	\$2,135	\$2,186	\$1,669	



25" W, Side chair with arms and upholstered seat and back, short arm panel									20.5 lbs   3.5 yds
Model	Series 2	Series 3	Series 4	Series 5	Series 6	Series 7	Series 8	COM	
<b>RV12HPA</b>	\$1,654	\$1,710	\$1,956	\$2,087	\$2,159	\$2,253	\$2,314	\$1,710	

# Romeo/Juliet Stack Chair



### More Information

- Illustrated Glossary ▶ 409
- Fabrics ▶ 421
- Flammability (CTB-133) ▶ 429
- Finishes ▶ 426
- Ordering and Warranties ▶ 432

### Standard Features

- Solid hardwood front legs
- Powder-coated metal back legs (MST Textured metallic silver, BK Black)
- Curved wood back
- Stacks up to eight high (Romeo models or Juliet models)
- Wallsaver legs (Juliet)
- Non-marring glides
- Nemschoff healthcare wood finish
- GREENGUARD Gold Certified
- Limited Lifetime Warranty

### Available Options

- Moisture barrier + \$69 per seat or back
- CTB-133 + \$83

### Specification Decisions

- Select fabric
  - Select standard wood finish
  - Select powder-coated finish
- Romeo and Juliet chairs do not stack together.

### Flammability Type

- Type 1

### Key Dimensions

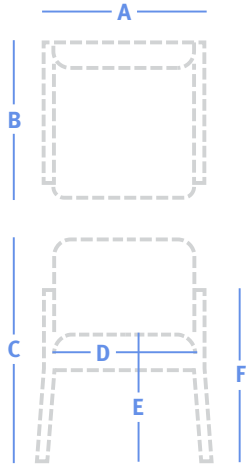

<b>A</b>	Overall Width	See price table
<b>B</b>	Overall Depth	23.5"
<b>C</b>	Overall Height	33"
<b>D</b>	Seat Width	18"
<b>E</b>	Seat Height	18.5"
<b>F</b>	Arm Height	26"

	<b>22" W, Romeo stack chair with wood seat and back</b>	19 lbs
Model	Price	
<b>110</b>	\$1,010	

	<b>22" W, Romeo stack chair with upholstered seat and wood back</b>	19 lbs   0.75 yd						
Model	Series 2	Series 3	Series 4	Series 5	Series 6	Series 7	Series 8	COM
<b>111</b>	\$1,101	\$1,113	\$1,166	\$1,194	\$1,210	\$1,230	\$1,243	\$1,113

	<b>22" W, Juliet stack chair with upholstered seat and wood back</b>	19 lbs   0.75 yd						
Model	Series 2	Series 3	Series 4	Series 5	Series 6	Series 7	Series 8	COM
<b>114</b>	\$1,101	\$1,113	\$1,166	\$1,194	\$1,210	\$1,230	\$1,243	\$1,113

	<b>22" W, Juliet stack chair with wood seat and back</b>	19 lbs
Model	Price	
<b>115</b>	\$1,010	

# Torii Side Chair



## Standard Features

- Solid maple frame
- Mortise and tenon joinery
- Spring seat construction
- Wipe-out design
- Replaceable components
- Non-marring 7/8" rubber-cushioned glides
- Nemschoff healthcare wood finish
- GREENGUARD Gold Certified
- Limited Lifetime Warranty

## Available Options

- Moisture barrier + \$69 per seat or back
- CTB-133 + \$83/yd
- Two fabrics + \$64
- Three (or more) fabrics + \$90

## Specification Decisions

- Select fabric
- Select standard wood finish
- Add moisture barrier
- Add CTB-133
- Apply multiple fabrics

Model numbers with **S** indicate standard seat and back covers, and model numbers with **P** indicate removable covers.

## Flammability Type

- Type 1

## Coordinating Products

- [Torii Multiple Seating](#)
- [Torii Tables](#)
- [Torii Patient Chair](#)
- [Torii Glider](#)
- [Torii Rocker](#)

## Key Dimensions

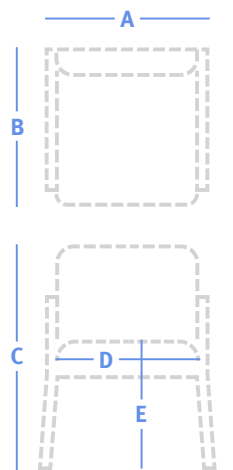

<b>A</b>	Overall Width	See price table
<b>B</b>	Overall Depth	23.25"
<b>C</b>	Overall Height	32"
<b>D</b>	Seat Width	22"
<b>E</b>	Seat Height	18.75"
<b>F</b>	Arm Height	24.75"

### More Information

Illustrated Glossary ▶ 409

Fabrics ▶ 421

Flammability (CTB-133) ▶ 429

Finishes ▶ 426

Ordering and Warranties ▶ 432

22.5" W, Side chair										20 lbs   1.5 yds
Model	Series 2	Series 3	Series 4	Series 5	Series 6	Series 7	Series 8	COM		
<b>283-91 S</b>	\$976	\$1,024	\$1,105	\$1,190	\$1,291	\$1,393	\$1,520	\$1,024		
<b>283-91 P</b>	\$1,099	\$1,147	\$1,228	\$1,313	\$1,414	\$1,516	\$1,643	\$1,147		
23.5" W, Side chair with arms										22 lbs   1.5 yds
Model	Series 2	Series 3	Series 4	Series 5	Series 6	Series 7	Series 8	COM		
<b>283-92 S</b>	\$1,084	\$1,132	\$1,213	\$1,298	\$1,399	\$1,501	\$1,628	\$1,132		
<b>283-92 P</b>	\$1,220	\$1,268	\$1,349	\$1,434	\$1,535	\$1,637	\$1,764	\$1,268		

# Valor Stack Chair



## More Information

Illustrated Glossary ▶ 409

Fabrics ▶ 421

Flammability (CTB-133) ▶ 429

Finishes ▶ 426

Ordering and Warranties ▶ 432

## Standard Features

- Heavy-duty steel construction
- Powder-coated metal frame
- Memory foam seat
- Black urethane arms
- Wipe-out design
- Replaceable components
- Nylon glides
- Stacks up to three high
- GREENGUARD Gold Certified
- Limited Lifetime Warranty

## Available Options

- Moisture barrier + \$69 per seat or back
- Wallsaver glides + \$0
- CTB-133 + \$83/yd
- Two fabrics + \$64
- Three (or more) fabrics + \$90

## Specification Decisions

- Select fabric
- Select powder-coated finish
- Add moisture barrier
- Add CTB-133
- Apply multiple fabrics
- Add wallsaver glides

Model numbers with **S** indicate standard seat and back covers, and model numbers with **P** indicate removable covers.

## Flammability Type

- Type 3

## Coordinating Products

- [Valor Lounge Seating](#)
- [Valor Multiple Seating](#)
- [Valor Tables](#)
- [Valor Patient Chair](#)

## Key Dimensions

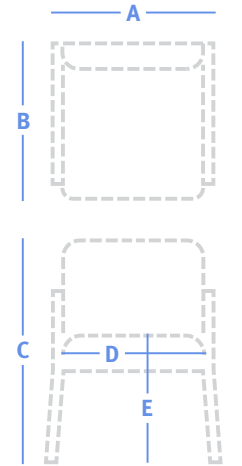

<b>A</b>	Overall Width	See price table
<b>B</b>	Overall Depth	24.5"
<b>C</b>	Overall Height	34"
<b>D</b>	Seat Width	22.75",
<b>E</b>	Seat Height	18.75"
<b>F</b>	Arm Height	26.25"

		24.75" W, Stack chair								29 lbs   1.75 yds
Model		Series 2	Series 3	Series 4	Series 5	Series 6	Series 7	Series 8	COM	
 	<b>891-91 S</b>	\$582	\$639	\$734	\$833	\$950	\$1,069	\$1,217	\$639	
	<b>891-91 P</b>	\$659	\$716	\$811	\$910	\$1,027	\$1,146	\$1,294	\$716	

		25.5" W, Stack chair with arms								36 lbs   1.75 yds
Model		Series 2	Series 3	Series 4	Series 5	Series 6	Series 7	Series 8	COM	
 	<b>891-92 S</b>	\$649	\$706	\$801	\$900	\$1,017	\$1,136	\$1,284	\$706	
	<b>891-92 P</b>	\$734	\$791	\$886	\$985	\$1,102	\$1,221	\$1,369	\$791	



# Whisk Stack Chair



## Standard Features

- Powder-coated metal frame
- Beech seat and back on select models
- Wipe-out design
- Spring seat construction
- Replaceable components
- Wood arm caps
- Wallsaver legs
- 15/16" dia black nylon glides
- Side chair (no arms) stacks up to four high
- Side chair (with arms) stacks up to three high
- Nemschoff healthcare wood finish
- GREENGUARD Gold Certified
- Limited Lifetime Warranty

## Available Options

- Moisture barrier + \$69 per seat or back
- CTB-133 + \$83/yd
- Black urethane arm caps + \$116

## Specification Decisions

- Select fabric
- Select standard wood finish
- Select powder-coated finish
- Add moisture barrier
- Add CTB-133
- Add urethane arm caps

Model numbers with **S** indicate standard seat and back covers, and model numbers with **P** indicate removable covers.

## Flammability Type

- Type 1

## Key Dimensions

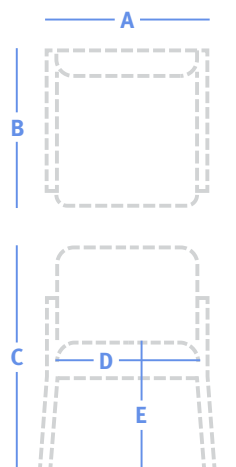

<b>A</b>	Overall Width	See price table
<b>B</b>	Overall Depth	24"
<b>C</b>	Overall Height	32.5"
<b>D</b>	Seat Width	22"
<b>E</b>	Seat Height	18.75"
<b>F</b>	Arm Height	26.25"

### More Information

- Illustrated Glossary ▶ 409
- Fabrics ▶ 421
- Flammability (CTB-133) ▶ 429
- Finishes ▶ 426
- Ordering and Warranties ▶ 432



### 24" W, Side chair with upholstered seat and wood back

22 lbs | 1 yd

Model	Series 2	Series 3	Series 4	Series 5	Series 6	Series 7	Series 8	COM
<b>67-91 S</b>	\$667	\$699	\$753	\$810	\$877	\$945	\$1,030	\$699
<b>67-91 P</b>	\$751	\$783	\$837	\$894	\$961	\$1,029	\$1,114	\$783



### 24" W, Side chair with upholstered seat and back

22 lbs | 1.5 yds

Model	Series 2	Series 3	Series 4	Series 5	Series 6	Series 7	Series 8	COM
<b>67-91U S</b>	\$612	\$660	\$741	\$826	\$927	\$1,029	\$1,156	\$660
<b>67-91U P</b>	\$692	\$740	\$821	\$906	\$1,007	\$1,109	\$1,236	\$740

## Whisk Stack Chair



### 24" W, Side chair with arms and upholstered seat and wood back

22 lbs | 1 yd

Model	Series 2	Series 3	Series 4	Series 5	Series 6	Series 7	Series 8	COM
<b>67-92 S</b>	\$769	\$801	\$855	\$912	\$979	\$1,047	\$1,132	\$801
<b>67-92 P</b>	\$866	\$898	\$952	\$1,009	\$1,076	\$1,144	\$1,229	\$898



### 24" W, Side chair with arms and upholstered seat and back

22 lbs | 1.5 yds

Model	Series 2	Series 3	Series 4	Series 5	Series 6	Series 7	Series 8	COM
<b>67-92U S</b>	\$708	\$756	\$837	\$922	\$1,023	\$1,125	\$1,252	\$756
<b>67-92U P</b>	\$799	\$847	\$928	\$1,013	\$1,114	\$1,216	\$1,343	\$847

Lounge Seating

Multiple & Tandem Seating

Side, Stacking & Folding Chairs

Occasional Tables

## 2000 Series Tables



### Standard Features

- Solid maple frame
- Replaceable components
- Laminate or veneer top with wood edge
- 7/8" rubber-cushioned glides on the end tables
- Brushed metal accent side rail (2770)
- Nemschoff healthcare wood finish
- GREENGUARD Gold Certified
- Limited Lifetime Warranty

### Coordinating Products

- [2600 Series Multiple Seating](#)
- [2700 Series Multiple Seating](#)
- [2750 Series Multiple Seating](#)
- [2770 Series Multiple Seating](#)

### Specification Decisions











- Select standard wood finish or laminate
- See 2600 Series, 2700 Series, 2750 Series and 2700 Series Multiple Seating for spanner tables

### More Information

- Illustrated Glossary ▶ 409
- Finishes ▶ 426
- Ordering and Warranties ▶ 432

	<b>26.25" W, Corner coffee table; laminate top</b> <span style="float: right;">29 lbs</span>			
	Model	Price	Depth	Height
	<b>2000-T4</b>	\$1,104	26.25"	17.75"
	<b>26.25" W, Corner coffee table; veneer top</b> <span style="float: right;">29 lbs</span>			
	Model	Price	Depth	Height
	<b>2000-T4V</b>	\$1,346	26.25"	17.75"
	<b>24" W, Square end table; laminate top</b> <span style="float: right;">30 lbs</span>			
	Model	Price	Depth	Height
	<b>2XXX-T1</b>	\$1,186	20"	20"
	<b>24" W, Square end table; veneer top</b> <span style="float: right;">30 lbs</span>			
	Model	Price	Depth	Height
	<b>2XXX-T1V</b>	\$1,447	20"	20"
	<b>44.5" W, Square end table; laminate top</b> <span style="float: right;">42 lbs</span>			
	Model	Price	Depth	Height
	<b>2XXX-T2</b>	\$1,748	20"	20"

## 2000 Series Tables

 	<b>44.5" W, Square end table; veneer top</b> <span style="float: right;">42 lbs</span>								
	<table border="1"> <thead> <tr> <th>Model</th> <th>Price</th> <th>Depth</th> <th>Height</th> </tr> </thead> <tbody> <tr> <td><b>2XXX-T2V</b></td> <td>\$2,131</td> <td>20"</td> <td>20"</td> </tr> </tbody> </table>	Model	Price	Depth	Height	<b>2XXX-T2V</b>	\$2,131	20"	20"
Model	Price	Depth	Height						
<b>2XXX-T2V</b>	\$2,131	20"	20"						
 	<b>30" W, Triangle end table; laminate top</b>								
	<table border="1"> <thead> <tr> <th>Model</th> <th>Price</th> <th>Depth</th> <th>Height</th> </tr> </thead> <tbody> <tr> <td><b>2XXX-T3</b></td> <td>\$1,521</td> <td>24"</td> <td>20.5"</td> </tr> </tbody> </table>	Model	Price	Depth	Height	<b>2XXX-T3</b>	\$1,521	24"	20.5"
Model	Price	Depth	Height						
<b>2XXX-T3</b>	\$1,521	24"	20.5"						
 	<b>30" W, Triangle end table; veneer top</b>								
	<table border="1"> <thead> <tr> <th>Model</th> <th>Price</th> <th>Depth</th> <th>Height</th> </tr> </thead> <tbody> <tr> <td><b>2XXX-T3V</b></td> <td>\$1,855</td> <td>24"</td> <td>20.5"</td> </tr> </tbody> </table>	Model	Price	Depth	Height	<b>2XXX-T3V</b>	\$1,855	24"	20.5"
Model	Price	Depth	Height						
<b>2XXX-T3V</b>	\$1,855	24"	20.5"						
 	<b>22" W, Square table with metal accent rail; laminate top</b> <span style="float: right;">32 lbs</span>								
	<table border="1"> <thead> <tr> <th>Model</th> <th>Price</th> <th>Depth</th> <th>Height</th> </tr> </thead> <tbody> <tr> <td><b>2770-T1</b></td> <td>\$1,277</td> <td>20"</td> <td>20"</td> </tr> </tbody> </table>	Model	Price	Depth	Height	<b>2770-T1</b>	\$1,277	20"	20"
Model	Price	Depth	Height						
<b>2770-T1</b>	\$1,277	20"	20"						
 	<b>22" W, Square table with metal accent rail; veneer top</b> <span style="float: right;">32 lbs</span>								
	<table border="1"> <thead> <tr> <th>Model</th> <th>Price</th> <th>Depth</th> <th>Height</th> </tr> </thead> <tbody> <tr> <td><b>2770-T1V</b></td> <td>\$1,557</td> <td>20"</td> <td>20"</td> </tr> </tbody> </table>	Model	Price	Depth	Height	<b>2770-T1V</b>	\$1,557	20"	20"
Model	Price	Depth	Height						
<b>2770-T1V</b>	\$1,557	20"	20"						

Lounge Seating

Multiple & Tandem Seating

Side, Stacking & Folding Chairs

Occasional Tables

# Auburn Tables

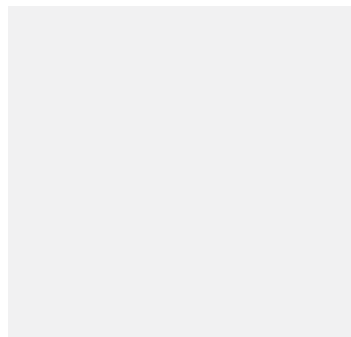

## Standard Features

- Solid hardwood frame
- Laminate or veneer top with wood edge
- Nemschoff healthcare wood finish
- GREENGUARD Gold Certified
- Limited Lifetime Warranty

## Coordinating Products

- [Auburn Multiple Seating](#)
- [Auburn Recliner](#)
- [Auburn Glider](#)

## Specification Decisions

- Select standard wood finish
  - Select standard laminate, if required
  - Select table top material (laminate or veneer)
- See Auburn Multiple Seating for spanner tables

### More Information

[Illustrated Glossary](#) ▶ 409

[Finishes](#) ▶ 426

[Ordering and Warranties](#) ▶ 432

		<b>23.5" W, Rectangular coffee table</b>				20 lbs
	Model	Price	Depth	Height		
	<b>AT-10-1</b>	\$1,424	20.5"	14.75"		
	<b>AT-10-2</b>	\$1,424	20.5"	16"		

		<b>42.5" W, Rectangular coffee table</b>				33 lbs
	Model	Price	Depth	Height		
	<b>AT-10-3</b>	\$2,017	20.5"	14.75"		
	<b>AT-10-4</b>	\$2,017	20.5"	16"		

# Brava Tables



### More Information

Illustrated Glossary ▶ 409

Finishes ▶ 426

Ordering and Warranties ▶ 432

### Standard Features

- Solid maple frame
- Laminate or veneer top with wood edge
- 7/8" rubber-cushioned glides
- Nemschoff healthcare wood finish
- GREENGUARD Gold Certified
- Limited Lifetime Warranty

- [Brava Side Chair](#)
- [Brava Adjustable Back Chair](#)
- [Brava CompactComfort Recliner](#)
- [Brava Patient Chair](#)
- [Brava Glider](#)
- [Brava Flop Sofa](#)
- [Brava Sleep Settee](#)

### Specification Decisions

- Select standard wood finish or laminate

### Coordinating Products

- [Brava Classic Lounge Seating](#)
- [Brava Platform Lounge Seating](#)
- [Brava 862 Multiple Seating](#)
- [Brava 863 Multiple Seating](#)



#### 44" W, Rectangular coffee table; laminate top

27 lbs

Model	Price	Depth	Height
<b>861-T9</b>	\$1,502	18"	14.5"



#### 44" W, Rectangular coffee table; veneer top

27 lbs

Model	Price	Depth	Height
<b>861-T9V</b>	\$1,832	18"	14.5"



#### 27.25" W, Square end table; laminate top

25 lbs

Model	Price	Depth	Height
<b>861-T6</b>	\$1,286	27.25"	18"



#### 27.25" W, Square end table; veneer top

25 lbs

Model	Price	Depth	Height
<b>861-T6V</b>	\$1,568	27.25"	18"

# Brooklyn Tables



## Standard Features

- Solid maple frame
- Replaceable components
- Laminate or veneer top with wood edge
- Nemschoff healthcare wood finish
- GREENGUARD Gold Certified
- Limited Lifetime Warranty

## Specification Decisions

- Select standard wood finish or laminate

## Coordinating Products

- [Brooklyn Lounge Seating](#)
- [Brooklyn Patient Chair](#)

### More Information

[Illustrated Glossary](#) ▶ 409

[Finishes](#) ▶ 426

[Ordering and Warranties](#) ▶ 432

Model	Price	Depth	Height	
<b>42" W, Rectangular coffee table</b>				38 lbs
 <b>776-T9</b>	\$1,533	18"	14.5"	
<b>24" W, Square end table</b>				30 lbs
 <b>776-T6</b>	\$1,220	24"	18"	

# Capella Tables



## Standard Features

- Solid maple legs
- Replaceable components
- Laminate or veneer top with wood edge
- Nemschoff healthcare wood finish
- GREENGUARD Gold Certified
- Limited Lifetime Warranty

## Coordinating Products

- [Capella Multiple Seating](#)
- [Capella Side Chair](#)
- [Capella Patient Chair](#)
- [Capella Adjustable Back Chair](#)
- [Capella CompactComfort Recliner](#)
- [Capella Glider](#)
- [Capella Adjustable Back Glider](#)

## Specification Decisions

- Select standard wood finish or laminate

### More Information

[Illustrated Glossary](#) ▶ 409

[Finishes](#) ▶ 426

[Ordering and Warranties](#) ▶ 432

	<b>20" W, Square end table; laminate top</b>				24 lbs
	Model	Price	Depth	Height	
	<b>740-T6</b>	\$1,245	20"	18"	
	<b>20" W, Square end table; veneer top</b>				24 lbs
	Model	Price	Depth	Height	
	<b>740-T6V</b>	\$1,518	20"	18"	
	<b>42" W, Rectangular coffee table; laminate top</b>				30 lbs
	Model	Price	Depth	Height	
	<b>740-T9</b>	\$1,502	18"	14.5"	
	<b>42" W, Rectangular coffee table; veneer top</b>				30 lbs
	Model	Price	Depth	Height	
	<b>740-T9V</b>	\$1,831	18"	14.5"	



# Carlson Tables



## Standard Features

- Heavy-duty steel construction
- Replaceable components
- Powder-coated metal legs
- Self-edged laminate top
- Adjustable 1" glides
- GREENGUARD Gold Certified
- Limited Lifetime Warranty

## Coordinating Products

- [Anderson Multiple Seating](#)

### More Information

[Illustrated Glossary](#) ▶ 409

[Finishes](#) ▶ 426

[Ordering and Warranties](#) ▶ 432

## Specification Decisions

- Select standard laminate
  - Select powder-coat finish
- See Anderson Multiple Seating for spanner tables



### 19.5" W, Square coffee table

24 lbs

Model	Price	Depth	Height
<b>FX620-T1</b>	\$890	19.5"	16"



### 48" W, Rectangular coffee table

30 lbs

Model	Price	Depth	Height
<b>FX620-T2</b>	\$1,076	18"	16"



### 26.25" W, Corner coffee table

28 lbs

Model	Price	Depth	Height
<b>FX620-T4</b>	\$924	26.25"	16"

# Cities Tables



### More Information

Illustrated Glossary ▶ 409

Finishes ▶ 426

Ordering and Warranties ▶ 432

### Standard Features

- Solid maple frame
- Replaceable components
- Laminate or veneer top with wood edge
- Crowned table apron (Downtown, Uptown)
- Straight apron (Crosstown)
- Nemschoff healthcare wood finish
- GREENGUARD Gold Certified
- Limited Lifetime Warranty

### Available Options

- Five table top edge styles + \$0

### Specification Decisions

- Select standard wood finish or laminate
- Select edge style:

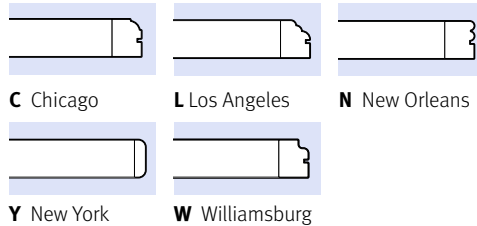

### Coordinating Products

- [Cities Small Crosstown Lounge Seating](#)
- [Cities Medium Crosstown Lounge Seating](#)
- [Cities Small Downtown Lounge Seating](#)
- [Cities Medium Downtown Lounge Seating](#)
- [Cities Small Uptown Lounge Seating](#)
- [Cities Medium Uptown Lounge Seating](#)
- [Cities Side Chair](#)
- [Cities Crosstown Patient Chair](#)
- [Cities Downtown Patient Chair](#)
- [Cities Uptown Patient Chair](#)
- [Cities Uptown CompactComfort Recliner](#)
- [Cities Crosstown Rocker](#)
- [Cities Downtown Rocker](#)
- [Cities Uptown Rocker](#)
- [Cities Downtown Glider](#)
- [Cities Uptown Glider](#)
- [SleepOver Sofa](#)
- [SleepOver Settee](#)

See Cities Lounge Seating for spanner tables

	<b>19.5" W, Square coffee table; laminate top</b>	24 lbs								
	<table border="1"> <thead> <tr> <th>Model</th> <th>Price</th> <th>Depth</th> <th>Height</th> </tr> </thead> <tbody> <tr> <td><b>Cities-SUX000-S200</b></td> <td>\$1,096</td> <td>19.5"</td> <td>17"</td> </tr> </tbody> </table>	Model	Price	Depth	Height	<b>Cities-SUX000-S200</b>	\$1,096	19.5"	17"	
Model	Price	Depth	Height							
<b>Cities-SUX000-S200</b>	\$1,096	19.5"	17"							
	<b>27" W, Corner coffee table; laminate top</b>	29 lbs								
	<table border="1"> <thead> <tr> <th>Model</th> <th>Price</th> <th>Depth</th> <th>Height</th> </tr> </thead> <tbody> <tr> <td><b>Cities-SUX000-C200</b></td> <td>\$1,710</td> <td>27"</td> <td>17"</td> </tr> </tbody> </table>	Model	Price	Depth	Height	<b>Cities-SUX000-C200</b>	\$1,710	27"	17"	
Model	Price	Depth	Height							
<b>Cities-SUX000-C200</b>	\$1,710	27"	17"							
	<b>19.5" W, Square coffee table; laminate top</b>	24 lbs								
	<table border="1"> <thead> <tr> <th>Model</th> <th>Price</th> <th>Depth</th> <th>Height</th> </tr> </thead> <tbody> <tr> <td><b>Cities-SXX000-T000</b></td> <td>\$1,128</td> <td>19.5"</td> <td>16"</td> </tr> </tbody> </table>	Model	Price	Depth	Height	<b>Cities-SXX000-T000</b>	\$1,128	19.5"	16"	
Model	Price	Depth	Height							
<b>Cities-SXX000-T000</b>	\$1,128	19.5"	16"							
	<b>19.5" W, Square coffee table; veneer top</b>	24 lbs								
	<table border="1"> <thead> <tr> <th>Model</th> <th>Price</th> <th>Depth</th> <th>Height</th> </tr> </thead> <tbody> <tr> <td><b>Cities-SXX000-T000V</b></td> <td>\$1,375</td> <td>19.5"</td> <td>16"</td> </tr> </tbody> </table>	Model	Price	Depth	Height	<b>Cities-SXX000-T000V</b>	\$1,375	19.5"	16"	
Model	Price	Depth	Height							
<b>Cities-SXX000-T000V</b>	\$1,375	19.5"	16"							

## Cities Tables



### 24" W, Square end table; laminate top

38 lbs

Model	Price	Depth	Height
<b>Cities-SXX000-T100</b>	\$1,245	24"	20"



### 24" W, Square end table; veneer top

38 lbs

Model	Price	Depth	Height
<b>Cities-SXX000-T100V</b>	\$1,518	24"	20"



### 30" W, Square end table; laminate top

41 lbs

Model	Price	Depth	Height
<b>Cities-SXX000-T200</b>	\$1,314	30"	24"



### 30" W, Square end table; veneer top

41 lbs

Model	Price	Depth	Height
<b>Cities-SXX000-T200V</b>	\$1,604	30"	24"



### 36" W, Square coffee table; laminate top

53 lbs

Model	Price	Depth	Height
<b>Cities-SXX000-T300</b>	\$1,473	36"	16"



### 36" W, Square coffee table; veneer top

53 lbs

Model	Price	Depth	Height
<b>Cities-SXX000-T300V</b>	\$1,797	36"	16"



### 42" W, Square coffee table; laminate top

57 lbs

Model	Price	Depth	Height
<b>Cities-SXX000-T400</b>	\$1,685	42"	16"



### 42" W, Square coffee table; veneer top

57 lbs

Model	Price	Depth	Height
<b>Cities-SXX000-T400V</b>	\$2,056	42"	16"

# Cubes & Cylinders Tables



## Standard Features

- High-density particleboard
- Non-marring 7/8" rubber-cushioned glides
- Nemschoff healthcare wood finish
- GREENGUARD Gold Certified
- Limited Lifetime Warranty

### More Information

Illustrated Glossary ▶ 409

Finishes ▶ 426

Ordering and Warranties ▶ 432

## Cubes Tables

### Standard Features

Same standard features, plus:

- Laminate or veneer top and exterior surfaces

### Available Options

- 3" black plinth base (1" offset) + \$113
- 3" matching plinth base (1" offset) + \$113
- RADIUS wood edge (select models)

### Specification Decisions

- Specify cube height (16", 18", 21", or 24")
- Select standard laminate
- Add plinth base (black or matching)

### Key Dimensions

- Laminate Cubes

Product	Weight (lbs)
15" W, cube	Height x 1.9
24" W, cube	Height x 2.5
30" W, cube	Height x 3.8

15" W, Cube; laminate				
Model	Price	Depth	Height	
195-CB4 Cube	\$494	30"	16", 18", 21", 24"	

15" W, Cube with radius top edge; laminate				
Model	Price	Depth	Height	
195-CBR4 Cube	\$1,196	30"	16", 18", 21", 24"	

## Cubes & Cylinders Tables



### 24" W, Cube; laminate

Model	Price	Depth	Height
<b>195-CB5 Cube</b>	\$517	24"	16", 18", 21", 24"



### 24" W, Cube with radius top edge; laminate

Model	Price	Depth	Height
<b>195-CBR5 Cube</b>	\$1,229	24"	16", 18", 21", 24"



### 30" W, Cube; laminate

Model	Price	Depth	Height
<b>195-CB6 Cube</b>	\$621	30"	16", 18", 21", 24"



### 30" W, Cube with radius top edge; laminate

Model	Price	Depth	Height
<b>195-CBR6 Cube</b>	\$1,501	30"	16", 18", 21", 24"

## Cylinders Tables

### Standard Features

Same standard features, plus:

- Laminate top and exterior surfaces

### Available Options

- 3" black plinth base (1" offset) + \$116
- 3" matching plinth base (1" offset) + \$11

### Specification Decisions

- Specify cylinder height (16", 18", 21", or 24")
- Select standard laminate
- Add plinth base (black or matching)

### Key Dimensions

- Laminate Cylinders

Product	Weight (lbs)
18" dia, cylinder	Height x 1.3
24" dia, cylinder	Height x 2.1
30" dia, cylinder	Height x 3.3
35" dia, cylinder	Height x 4.3

- Maple veneer Cylinders

Product	Weight (lbs)
18" dia, cylinder	Height x 1.9
24" dia, cylinder	Height x 2.5
30" dia, cylinder	Height x 3.8



### 18" dia, Cylinder; laminate

Model	Price	Height
<b>195-CY18 Cylinder</b>	\$737	16", 18", 21", 24"



### 18" dia, Cylinder; maple veneer

Model	Price	Height
<b>195-CW18M Cylinder</b>	\$1,460	16", 18", 21", 24"

## Cubes & Cylinders Tables

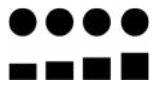

### 24" dia, Cylinder; laminate

Model	Price	Height
<b>195-CY24 Cylinder</b>	\$887	16", 18", 21", 24"

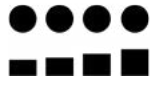

### 24" dia, Cylinder; maple veneer

Model	Price	Height
<b>195-CW24M Cylinder</b>	\$1,743	16", 18", 21", 24"

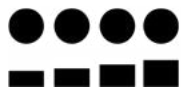

### 30" dia, Cylinder; laminate

Model	Price	Height
<b>195-CY30 Cylinder</b>	\$1,085	16", 18", 21", 24"

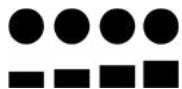

### 30" dia, Cylinder; maple veneer

Model	Price	Height
<b>195-CW30M Cylinder</b>	\$1,777	16", 18", 21", 24"

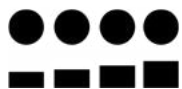

### 35" dia, Cylinder; laminate

Model	Price	Height
<b>195-CY35 Cylinder</b>	\$1,306	16", 18", 21", 24"

Lounge Seating

Multiple & Tandem Seating

Side, Stacking & Folding Chairs

Occasional Tables

# Evita Tables



## Standard Features

- Solid maple legs
- Replaceable components
- Laminate or veneer top with wood edge
- 3/4" rubber-cushioned glides
- Nemschoff healthcare wood finish
- GREENGUARD Gold Certified
- Limited Lifetime Warranty

## Specification Decisions

- Select standard wood finish or laminate
- See Evita Lounge Seating for spanner tables

## Coordinating Products

- [Evita Lounge Seating](#)

### More Information

- Illustrated Glossary ▶ 409
- Finishes ▶ 426
- Ordering and Warranties ▶ 432

 	<b>24.5" W, Rectangular end table; laminate top</b>				24 lbs
	Model	Price	Depth	Height	
	<b>2800-T1</b>	\$940	21.5"	16.75"	
 	<b>24.5" W, Rectangular end table; veneer top</b>				24 lbs
	Model	Price	Depth	Height	
	<b>2800-T1V</b>	\$1,147	21.5"	16.75"	
 	<b>17.75" W Oval end table; laminate top</b>				13 lbs
	Model	Price	Depth	Height	
	<b>2800-7</b>	\$1,041	12.75"	22.5"	
	<b>2800-8</b>	\$1,247	24"	22.5"	
 	<b>17.75" W Oval end table; veneer top</b>				14 lbs
	Model	Price	Depth	Height	
	<b>2800-7V</b>	\$1,270	12.75"	22.5"	
	<b>2800-8V</b>	\$1,408	24"	22.5"	

# Florabella Tables



## More Information

Illustrated Glossary ▶ 409

Finishes ▶ 426

Ordering and Warranties ▶ 432

## Standard Features

- Solid maple legs with grey urethane sleeves
- Laminate table top with wood edge
- Nemschoff healthcare wood finish
- GREENGUARD Gold Certified
- Limited Lifetime Warranty

## Specification Decisions

- Select standard wood finish
- Select standard laminate

## Coordinating Products

- [Florabella Lounge Seating](#)

	<b>24" dia, Round coffee table</b> <span style="float: right;">22 lbs</span>			
	Model	Price	Height	
	<b>FLBL-00005</b>	\$1,855	17.5"	
	<b>24" dia, Round end table</b> <span style="float: right;">24 lbs</span>			
	Model	Price	Height	
	<b>FLBL-00004</b>	\$1,772	23.5"	
	<b>60" W, Oval coffee table</b> <span style="float: right;">48 lbs</span>			
	Model	Price	Depth	Height
	<b>FLBL-00006</b>	\$1,961	29"	17.5"



# Hadleigh Tables



## Standard Features

- Solid maple frame
- Laminate or veneer top with wood edge
- 7/8" rubber-cushioned glides
- Nemschoff healthcare wood finish
- GREENGUARD Gold Certified
- Limited Lifetime Warranty

## Coordinating Products

- [Hadleigh Lounge Seating](#)
- [Hadleigh Adjustable Back Chair](#)
- [Hadleigh Casegoods](#)

## Specification Decisions

- Select standard wood finish or laminate

### More Information

[Illustrated Glossary](#) ▶ 409

[Finishes](#) ▶ 426

[Ordering and Warranties](#) ▶ 432



### 21.75" W, Square end table; laminate top

27 lbs

Model	Price	Depth	Height
<b>280-T5</b>	\$908	21.75"	18"
<b>280-T6</b>	\$932	21.75"	21"



### 21.75" W, Square end table; veneer top

27 lbs

Model	Price	Depth	Height
<b>280-T5V</b>	\$1,108	21.75"	18"
<b>280-T6V</b>	\$1,138	21.75"	21"



### 44" W, Rectangular coffee table; laminate top

40 lbs

Model	Price	Depth	Height
<b>280-T9</b>	\$1,056	18"	16.5"



### 44" W, Rectangular coffee table; veneer top

40 lbs

Model	Price	Depth	Height
<b>280-T9V</b>	\$1,288	18"	16.5"

# Horizon Tables

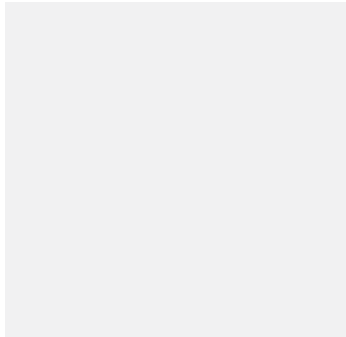

## Standard Features

- Solid hardwood frame
- Laminate or veneer top with wood edge
- Nemschoff healthcare wood finish
- GREENGUARD Gold Certified
- Limited Lifetime Warranty

## Specification Decisions

- Select standard wood finish or laminate
- See Horizon Multiple Seating for spanner tables

## Coordinating Products

- [Horizon Multiple Seating](#)
- [Horizon Recliner](#)
- [Horizon Patient Chair](#)

### More Information

[Illustrated Glossary](#) ▶ 409

[Finishes](#) ▶ 426

[Ordering and Warranties](#) ▶ 432



### 23" W, Rectangular coffee table

15 lbs



Model	Price	Depth	Height
<b>721-1</b>	\$1,322	20.5"	14.75"



### 42" W, Rectangular coffee table

28 lbs



Model	Price	Depth	Height
<b>721-3</b>	\$1,916	20.5"	14.75"

# Hudson Tables



## Standard Features

- Brushed stainless look base
- Laminate or veneer top
- Nemschoff healthcare wood finish
- GREENGUARD Gold Certified
- Limited Lifetime Warranty

## Specification Decisions

- Select standard wood finish or laminate

### More Information

- Illustrated Glossary ▶ 409
- Finishes ▶ 426
- Ordering and Warranties ▶ 432

	<b>20" W, Square coffee table; laminate top</b>				35 lbs
	Model	Price	Depth	Height	
	<b>802-5</b>	\$1,623	20"	17"	
	<b>20" W, Square coffee table; veneer top</b>				35 lbs
	Model	Price	Depth	Height	
	<b>802-5V</b>	\$1,704	20"	17"	
	<b>40" W, Rectangular coffee table; laminate top</b>				49 lbs
	Model	Price	Depth	Height	
	<b>802-9</b>	\$1,823	18"	13"	
	<b>40" W, Rectangular coffee table; veneer top</b>				49 lbs
	Model	Price	Depth	Height	
	<b>802-9V</b>	\$1,957	18"	13"	

# Lauderdale Tables



## More Information

Illustrated Glossary ▶ 409

Finishes ▶ 426

Ordering and Warranties ▶ 432

## Standard Features

- Solid maple frame
- Replaceable componenets
- Laminate top with solid maple edge
- Nemschoff healthcare wood finish
- GREENGUARD Gold Certified
- Limited Lifetime Warranty

## Specification Decisions

- Select standard wood finish
- Select standard laminate

## Coordinating Products

- [Lauderdale Lounge Seating](#)



### 24" W, Square end table

28 lbs

Model	Price	Depth	Height
<b>775-T6</b>	\$1,501	24"	18"



### 42" W, Rectangular coffee table

35 lbs

Model	Price	Depth	Height
<b>775-T9</b>	\$1,993	18"	14.5"

Lounge Seating

Multiple & Tandem Seating

Side, Stacking & Folding Chairs

Occasional Tables

# Marco Grande Tables



## Standard Features

- Solid maple legs
- Replaceable components
- Laminate or veneer top with wood edge
- Nemschoff healthcare wood finish
- GREENGUARD Gold Certified
- Limited Lifetime Warranty

## Coordinating Products

- [Marco Grande II Lounge Seating](#)
- [Marco Multiple Seating](#)
- [Marco Patient Chair](#)
- [Marco Glider](#)

## Specification Decisions

- Select standard wood finish or laminate

### More Information

[Illustrated Glossary](#) ▶ 409

[Finishes](#) ▶ 426

[Ordering and Warranties](#) ▶ 432

	<b>19" W, Square end table; laminate top</b> <span style="float: right;">15 lbs</span>
Model	Price      Depth      Height
<b>732-6</b>	\$1,214      19"      19"

	<b>19" W, Square end table; veneer top</b> <span style="float: right;">15 lbs</span>
Model	Price      Depth      Height
<b>732-6V</b>	\$1,481      19"      19"

	<b>19" dia, Round end table; laminate top</b> <span style="float: right;">14 lbs</span>
Model	Price      Height
<b>732-7</b>	\$984      19"

	<b>19" dia, Round end table; veneer top</b> <span style="float: right;">14 lbs</span>
Model	Price      Height
<b>732-7V</b>	\$1,200      19"

	<b>48" W, Rectangular coffee table; laminate top</b> <span style="float: right;">33 lbs</span>
Model	Price      Depth      Height
<b>732-9</b>	\$1,876      18"      14.5"

	<b>48" W, Rectangular coffee table; veneer top</b> <span style="float: right;">33 lbs</span>
Model	Price      Depth      Height
<b>732-9V</b>	\$2,289      18"      14.5"

# Marsack Tables

Lounge Seating

Multiple & Tandem Seating

Side, Stacking & Folding Chairs

Occasional Tables

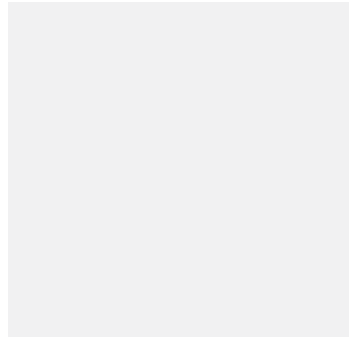

## Standard Features

- Heavy-duty construction
- Replaceable components
- Laminate top
- Laminate-wrapped side panels
- GREENGUARD Gold Certified
- Limited Lifetime Warranty

## Coordinating Products

- [Marsack Lounge Seating](#)
- [Marsack III Behavioral Health Seating](#)

## Specification Decisions

- Select standard laminate

### More Information

[Illustrated Glossary](#) ▶ 409

[Finishes](#) ▶ 426

[Ordering and Warranties](#) ▶ 432



26" W, Rectangular end table				52 lbs
Model	Price	Depth	Height	
<b>700-T1</b>	\$1,399	26.5"	18.5"	

# Meridian Tables



## Standard Features

- Solid hardwood frame
- Replaceable components
- Veneer top with wood edge
- Nemschoff healthcare wood finish
- GREENGUARD Gold Certified
- Limited Lifetime Warranty

## Coordinating Products

- [Meridian Multiple Seating](#)
- [Meridian Patient Chair](#)
- [Meridian Behavioral Health Seating](#)

## Available Options

- Laminate top with wood edge + \$0

## Specification Decisions

- Select standard wood finish or laminate

See Meridian Multiple Seating for spanner tables

### More Information

[Illustrated Glossary](#) ▶ 409

[Finishes](#) ▶ 426

[Ordering and Warranties](#) ▶ 432

	<b>23" W, Rectangular coffee table</b> <span style="float: right;">18 lbs</span>			
	Model	Price	Depth	Height
	<b>MT-10-1</b>	\$1,215	20.5"	14.75"
	<b>MT-10-2</b>	\$1,215	20.5"	16"

	<b>23.5" W, Square coffee table</b> <span style="float: right;">20 lbs</span>			
	Model	Price	Depth	Height
	<b>MT-10-3</b>	\$1,215	23.5"	14.75"
	<b>MT-10-4</b>	\$1,215	23.5"	16"

	<b>42" W, Rectangular coffee table</b> <span style="float: right;">31 lbs</span>			
	Model	Price	Depth	Height
	<b>MT-10-5</b>	\$1,812	20.5"	14.75"
	<b>MT-10-6</b>	\$1,809	20.5"	16"

	<b>23.5" W, Square end table</b> <span style="float: right;">22 lbs</span>			
	Model	Price	Depth	Height
	<b>MLT-30-1</b>	\$1,301	23.5"	18.75"

	<b>30" W, Square end table</b> <span style="float: right;">24 lbs</span>			
	Model	Price	Depth	Height
	<b>MLT-30-2</b>	\$1,417	30"	18.75"

# Monarch Tables



### More Information

Illustrated Glossary ▶ 409

Finishes ▶ 426

Ordering and Warranties ▶ 432

### Standard Features

- Solid hardwood frame
- Laminate top with wood edge
- 7/8" rubber-cushioned glides
- Nemschoff healthcare wood finish
- GREENGUARD Gold Certified
- Limited Lifetime Warranty

### Available Options

- Veneer top with wood edge + \$255

### Specification Decisions

- Select standard wood finish
- Select standard laminate
- Add veneer top

### Coordinating Products

- [Monarch Lounge Seating](#)
- [Monarch Multiple Seating](#)
- [Monarch Stack Chair](#)
- [Monarch Patient Chair](#)
- [Monarch Sleep Chair and Settee](#)



#### 20" W, Square end table

Model	Price	Depth	Height
<b>893-T5</b>	\$490	20"	18"

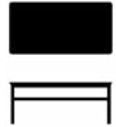

#### 40" W, Rectangular coffee table

Model	Price	Depth	Height
<b>893-T9</b>	\$628	20"	16"



# Olivia Tables



## Standard Features

- Solid maple frame
- Replaceable components
- Laminate or veneer top with wood edge
- Nemschoff healthcare wood finish
- GREENGUARD Gold Certified
- Limited Lifetime Warranty

## Coordinating Products

- [Olivia Lounge Seating](#)
- [Olivia Patient Chair](#)
- [Olivia Glider](#)

## Specification Decisions

- Select standard wood finish or laminate

### More Information

[Illustrated Glossary](#) ▶ 409

[Finishes](#) ▶ 426

[Ordering and Warranties](#) ▶ 432



### 20" W, Square end table; laminate top

24 lbs

Model	Price	Depth	Height
<b>903-5</b>	\$1,245	20"	18"



### 20" W, Square end table; veneer top

24 lbs

Model	Price	Depth	Height
<b>903-5V</b>	\$1,518	20"	18"



### 42" W, Rectangular coffee table; laminate top

30 lbs

Model	Price	Depth	Height
<b>903-9</b>	\$1,502	18"	14.5"



### 42" W, Rectangular coffee table; veneer top

30 lbs

Model	Price	Depth	Height
<b>903-9V</b>	\$1,832	18"	14.5"

# Palisade Tables



### More Information

Illustrated Glossary ▶ 409

Finishes ▶ 426

Ordering and Warranties ▶ 432

### Standard Features

- Replaceable components
- Durawrap top
- Titanium powder-coated metal column and base
- U-shaped base
- Non-marring 2” glides
- Nemschoff healthcare wood finish
- GREENGUARD Gold Certified
- Limited Lifetime Warranty

### Available Options

- Solid surface top + \$623
- Wood base + \$164

### Specification Decisions

- Select standard Durawrap
- Add solid surface top, select color
- Add wood base, select finish

### Coordinating Products

- [Palisade Caseloads](#)
- [Palisade Coatrack](#)
- [Palisade Flop Sofa](#)
- [Palisade Stools](#)

14" W, Rectangular mobile table				21 lbs
Model	Price	Depth	Height	
<b>867-T7</b>	\$759	19.5"	25.75"	



# Pamona Tables



## Standard Features

- Powder-coated metal frame
- Replaceable components
- Laminate, veneer or solid surface tops (see price table)
- Nemschoff healthcare wood finish
- GREENGUARD Gold Certified
- Limited Lifetime Warranty

## Coordinating Products

- [Pamona Lounge Seating](#)
- [Pamona Recliner](#)
- [Pamona Flop Sofa](#)

### More Information

Illustrated Glossary ▶ 409

Finishes ▶ 425

Ordering and Warranties ▶ 429

## Specification Decisions

- Select powder-coat finish for frame
- Select standard wood finish, laminate or solid surface top

	<b>25" W, Rectangular coffee table; laminate top</b>				48 lbs
	Model	Price	Depth	Height	
	<b>797-T11</b>	\$1,487	42"	16.5"	
	<b>25" W, Rectangular coffee table; veneer top</b>				48 lbs
	Model	Price	Depth	Height	
	<b>797-T11V</b>	\$1,782	42"	16.5"	
	<b>25" W, Rectangular coffee table; solid surface top</b>				60 lbs
	Model	Price	Depth	Height	
	<b>797-T11SS</b>	\$2,321	42"	16.5"	
	<b>46" W, Rectangular coffee table; laminate top</b>				52 lbs
	Model	Price	Depth	Height	
	<b>797-T9</b>	\$1,321	24"	16.5"	
	<b>46" W, Rectangular coffee table; veneer top</b>				52 lbs
	Model	Price	Depth	Height	
	<b>797-T9V</b>	\$1,618	24"	16.5"	
	<b>46" W, Rectangular coffee table; solid surface top</b>				67 lbs
	Model	Price	Depth	Height	
	<b>797-T9SS</b>	\$2,157	24"	16.5"	

## Pamona Tables

Lounge Seating

Multiple & Tandem Seating

Side, Stacking & Folding Chairs

Occasional Tables

● I	<b>18" dia, Round end table; laminate top</b>				20 lbs
	Model	Price		Height	
	<b>797-T7</b>	\$1,095		22"	
● I	<b>18" dia, Round end table; veneer top</b>				20 lbs
	Model	Price		Height	
	<b>797-T7V</b>	\$1,337		22"	
● I	<b>18" dia, Round end table; solid surface top</b>				23 lbs
	Model	Price		Height	
	<b>797-T7SS</b>	\$1,713		22"	
● I	<b>22" dia, Round end table; laminate top</b>				23 lbs
	Model	Price		Height	
	<b>797-T8</b>	\$1,148		22"	
● I	<b>22" dia, Round end table; veneer top</b>				23 lbs
	Model	Price		Height	
	<b>797-T8V</b>	\$1,407		22"	
● I	<b>22" dia, Round end table; solid surface top</b>				28 lbs
	Model	Price		Height	
	<b>797-T8SS</b>	\$1,768		22"	
■ I	<b>18" W, Square end table; laminate top</b>				21 lbs
	Model	Price	Depth	Height	
	<b>797-T5</b>	\$1,152	18"	22"	
■ I	<b>18" W, Square end table; veneer top</b>				21 lbs
	Model	Price	Depth	Height	
	<b>797-T5V</b>	\$1,394	18"	22"	
■ I	<b>18" W, Square end table; solid surface top</b>				25 lbs
	Model	Price	Depth	Height	
	<b>797-T5SS</b>	\$1,771	18"	22"	
■ I	<b>22" W, Square end table; laminate top</b>				25 lbs
	Model	Price	Depth	Height	
	<b>797-T6</b>	\$1,267	22"	22"	

## Pamona Tables

	<b>22" W, Square end table; veneer top</b> <span style="float: right;">25 lbs</span>		
Model	Price	Depth	Height

	<b>797-T6V</b> <span style="float: right;">\$1,525</span>	22"	22"
---	---	-----	-----

	<b>22" W, Square end table; solid surface top</b> <span style="float: right;">31 lbs</span>		
Model	Price	Depth	Height

	<b>797-T6SS</b> <span style="float: right;">\$1,886</span>	22"	22"
---	--	-----	-----

	<b>18" W, Rectangular dining table; laminate top</b> <span style="float: right;">60 lbs</span>		
Model	Price	Depth	Height

	<b>797-T10</b> <span style="float: right;">\$1,453</span>	54"	30"
---	---	-----	-----

	<b>18" W, Rectangular dining table; veneer top</b> <span style="float: right;">60 lbs</span>		
Model	Price	Depth	Height

	<b>797-T10V</b> <span style="float: right;">\$1,776</span>	54"	30"
---	--	-----	-----

	<b>18" W, Rectangular dining table; solid surface top</b> <span style="float: right;">72 lbs</span>		
Model	Price	Depth	Height

	<b>797-T10SS</b> <span style="float: right;">\$2,315</span>	54"	30"
---	---	-----	-----

# Parsons Tables



## Standard Features

- Replaceable components
- 7/8" nylon glides
- Nemschoff healthcare wood finish
- GREENGUARD Gold Certified
- Limited Lifetime Warranty

### More Information

Illustrated Glossary ▶ 409

Finishes ▶ 425

Ordering and Warranties ▶ 429

## Parsons 3-Sided Tables

### Standard Features

- Same standard features as Parsons Tables, plus:
- Laminate top and side panels

### Available Options

- Veneer top and side panels +\$330 (803-T5A), +\$400 (803-T6A, 803-T9A)

### Specification Decisions

- Select laminate (or optional veneer) for side panels
- Select laminate (or optional veneer) for top edge
- Select laminate for top

	<b>18" W, 3-sided Square end table</b>				59.5 lbs.
	Model	Price	Depth	Height	
	<b>803-T5A</b>	\$720	18"	20"	
	<b>24" W, 3-sided Square end table</b>				79 lbs.
	Model	Price	Depth	Height	
	<b>803-T6A</b>	\$860	24"	20"	
	<b>40" W, 3-sided Console table</b>				58 lbs.
	Model	Price	Depth	Height	
	<b>803-T9A</b>	\$880	14"	29"	

## Parsons Tables

### Parsons 4-Sided Tables

#### Standard Features

- Same standard features as Parsons Tables, plus:
- Laminate top and side panels

#### Available Options

- Veneer top and side panels +\$375 (803-T5B), +\$475 (803-T6B, 803-T9B)
- Solid surface top +\$424 (803-T5B), +\$702 (803-T6B), +\$627 (803-T9B)

#### Specification Decisions

- Select laminate (or optional veneer) for side and bottom panels
- Select laminate (or optional veneer) for top



#### 18" W, 4-sided Square end table

67 lbs.

Model	Price	Depth	Height
<b>803-T5B</b>	\$800	18"	20"



#### 24" W, 4-sided Square end table

90 lbs.

Model	Price	Depth	Height
<b>803-T6B</b>	\$1,010	24"	20"



#### 40" W, 4-sided Console table

65.5 lbs.

Model	Price	Depth	Height
<b>803-T9B</b>	\$1,035	14"	29"

### Parsons 6-Sided Tables

#### Standard Features

- Same standard features as Parsons Tables, plus:
- Laminate top and side panels
- Laminate infill panels

#### Available Options

- Veneer top and side panels +\$375 (803-T5B), +\$475 (803-T6B, 803-T9B)
- Solid surface top +\$424 (803-T5B), +\$702 (803-T6B), +\$627 (803-T9B)
- Veneer infill panel +\$0
- Three power outlets and two USB ports (black or white); one year warranty +\$360

#### Specification Decisions

- Select laminate (or optional veneer) for side and bottom panels
- Select laminate (or optional veneer) for top
- Select laminate (or optional veneer) for infill panel
- Add power (select color)



#### 18" W, 6-sided Square end table

76 lbs.

Model	Price	Depth	Height
<b>803-T5C</b>	\$880	18"	20"



#### 24" W, 6-sided Square end table

102 lbs.

Model	Price	Depth	Height
<b>803-T6C</b>	\$1,100	24"	20"



#### 40" W, 6-sided Console table

74 lbs.

Model	Price	Depth	Height
<b>803-T9C</b>	\$1,120	14"	29"

# Parsons Tables

Lounge Seating

Multiple & Tandem Seating

Side, Stacking & Folding Chairs

Occasional Tables

## Parsons Dining Table

### Standard Features

- Same standard features as Parsons Tables, plus:
- Laminate top with solid wood legs

### Specification Decisions

- Select wood finish for legs
- Select laminate for top edge
- Select laminate for top



### 36" W, Square dining table

72 lbs.

Model	Price	Depth	Height
<b>803-T10</b>	\$1,050	36"	29"



# Reliant Tables



## Standard Features

- Powder-coated metal legs
- Replaceable components
- Veneer top with solid wood edge
- Solid maple apron
- Nemschoff healthcare wood finish
- GREENGUARD Gold Certified
- Limited Lifetime Warranty

## Specification Decisions

- Select powder-coat finish
  - Select standard wood finish, laminate or Durawrap
- See Reliant Multiple Seating for spanner tables

### More Information

- Illustrated Glossary ▶ 409
- Finishes ▶ 426
- Ordering and Warranties ▶ 432

## Available Options

- Laminate top with wood edge + \$0
- Durawrap top + \$0

■ ☐	<b>20" W, Square coffee table</b> <span style="float: right;">16 lbs</span>			
	Model	Price	Depth	Height
	<b>RLT-16-1</b>	\$1,509	20"	15.5"
■ ☐	<b>24" W, Square coffee table</b> <span style="float: right;">18 lbs</span>			
	Model	Price	Depth	Height
	<b>RLT-16-3</b>	\$1,605	24"	15.5"
■ ☐	<b>30" W, Square coffee table</b> <span style="float: right;">32 lbs</span>			
	Model	Price	Depth	Height
	<b>RLT-16-5</b>	\$1,907	30"	15.5"
■ ☐	<b>36" W, Square coffee table</b> <span style="float: right;">46 lbs</span>			
	Model	Price	Depth	Height
	<b>RLT-16-7</b>	\$2,088	36"	15.5"
■ ☐	<b>20" W, Rectangular coffee table</b> <span style="float: right;">32 lbs</span>			
	Model	Price	Depth	Height
	<b>RLT-16-9</b>	\$1,907	42"	15.5"
	<b>RLT-16-11</b>	\$2,088	54"	15.5"
■ ☐	<b>28" W, Rectangular coffee table</b> <span style="float: right;">19 lbs</span>			
	Model	Price	Depth	Height
	<b>RSCT-10</b>	\$934	18.25"	15.5"
	<b>RRCT-10</b>	\$989	18.25"	15.5"
● ☐	<b>24" dia, Round coffee table</b> <span style="float: right;">16 lbs</span>			
	Model	Price	Height	
	<b>RLT-17-1</b>	\$1,839	15.5"	





















## Reliant Tables

Lounge Seating

Multiple & Tandem Seating

Side, Stacking & Folding Chairs

Occasional Tables

	<b>30" dia, Round coffee table</b> <span style="float: right;">28 lbs</span>			
	Model	Price	Height	
	<b>RLT-17-3</b>	\$1,992	15.5"	
	<b>36" dia, Round coffee table</b> <span style="float: right;">42 lbs</span>			
	Model	Price	Height	
	<b>RLT-17-5</b>	\$2,088	15.5"	
	<b>20" W, Square end table</b> <span style="float: right;">16 lbs</span>			
	Model	Price	Depth	Height
	<b>RLT-16-2</b>	\$1,509	20"	21"
	<b>24" W, Square end table</b> <span style="float: right;">18 lbs</span>			
	Model	Price	Depth	Height
	<b>RLT-16-4</b>	\$1,605	24"	21"
	<b>30" W, Square end table</b> <span style="float: right;">32 lbs</span>			
	Model	Price	Depth	Height
	<b>RLT-16-6</b>	\$1,907	30"	21"
	<b>36" W, Square end table</b> <span style="float: right;">46 lbs</span>			
	Model	Price	Depth	Height
	<b>RLT-16-8</b>	\$2,088	36"	21"
	<b>20" W, Rectangular end table</b> <span style="float: right;">32 lbs</span>			
	Model	Price	Depth	Height
	<b>RLT-16-10</b>	\$1,907	42"	21"
	<b>RLT-16-12</b>	\$2,088	54"	21"
	<b>24" dia, Round end table</b> <span style="float: right;">16 lbs</span>			
	Model	Price	Height	
	<b>RLT-17-2</b>	\$1,839	21"	
	<b>30" dia, Round end table</b> <span style="float: right;">28 lbs</span>			
	Model	Price	Height	
	<b>RLT-17-4</b>	\$1,992	21"	
	<b>36" dia, Round end table</b> <span style="float: right;">42 lbs</span>			
	Model	Price	Height	
	<b>RLT-17-6</b>	\$2,088	21"	

# Riva Tables



## Standard Features

- Brushed metal base and legs
- Replaceable components
- Laminate or veneer top with wood edge
- Nemschoff healthcare wood finish
- GREENGUARD Gold Certified
- Limited Lifetime Warranty

## Specification Decisions

- Select standard wood or laminate finish

## Coordinating Products

- [Riva Lounge Seating](#)

### More Information

Illustrated Glossary ▶ 409

Finishes ▶ 426

Ordering and Warranties ▶ 432

	<b>20" W, Square end table; laminate top</b>				27 lbs
	Model	Price	Depth	Height	
	<b>812-5</b>	\$1,329	20"	17"	
	<b>20" W, Square end table; veneer top</b>				27 lbs
	Model	Price	Depth	Height	
	<b>812-5V</b>	\$1,620	20"	17"	
	<b>48" W, Rectangular coffee table; laminate top</b>				40 lbs
	Model	Price	Depth	Height	
	<b>812-9</b>	\$1,528	18"	14.5"	
	<b>48" W, Rectangular coffee table; veneer top</b>				40 lbs
	Model	Price	Depth	Height	
	<b>812-9V</b>	\$1,863	18"	14.5"	

# Rockwood Tables



## Standard Features

- Solid maple frame
- Replaceable components
- Laminate top
- Non-marring 7/8" glides
- Nemschoff healthcare wood finish
- GREENGUARD Gold Certified
- Limited Lifetime Warranty

## Coordinating Products

- [Mayfield Multiple Seating](#)
- [Princeton Multiple Seating](#)

### More Information

[Illustrated Glossary](#) ▶ 409

[Finishes](#) ▶ 426

[Ordering and Warranties](#) ▶ 432

## Specification Decisions

- Select standard wood finish
- Select standard laminate

See Mayfield and Princeton Multiple Seating for spanner tables

 	<b>19.5" W, Square end table</b>				24 lbs
	Model	Price	Depth	Height	
	<b>FX120-T1</b>	\$833	19.5"	16"	
 	<b>26.25" W, Corner end table</b>				28 lbs
	Model	Price	Depth	Height	
	<b>FX120-T4</b>	\$864	26.25"	16"	
 	<b>48" W, Rectangular coffee table</b>				30 lbs
	Model	Price	Depth	Height	
	<b>FX120-T2</b>	\$1,008	18"	16"	

# Torii Tables



## Standard Features

- Solid maple frame
- Replaceable components
- Laminate or veneer top with wood edge
- Cove style edge
- 7/8" rubber-cushioned glides
- Nemschoff healthcare wood finish
- GREENGUARD Gold Certified
- Limited Lifetime Warranty

## Specification Decisions

- Select standard wood finish or laminate
- Add radius edge

## Coordinating Products

- [Torii Multiple Seating](#)
- [Torii Side Chair](#)
- [Torii Patient Chair](#)
- [Torii Glider](#)

## Available Options









- Radius edge + \$0

### More Information

Illustrated Glossary ▶ 409

Finishes ▶ 426

Ordering and Warranties ▶ 432

 	<b>21.25" W, Square end table; laminate top</b>				28 lbs
	Model	Price	Depth	Height	
	<b>283-6</b>	\$899	21.25"	16"	
 	<b>21.25" W, Square end table; veneer top</b>				28 lbs
	Model	Price	Depth	Height	
	<b>283-6V</b>	\$1,096	21.25"	16"	
 	<b>28" W, Square end table; laminate top</b>				36 lbs
	Model	Price	Depth	Height	
	<b>283-7</b>	\$989	28"	16"	
 	<b>28" W, Square end table; veneer top</b>				36 lbs
	Model	Price	Depth	Height	
	<b>283-7V</b>	\$1,206	28"	16"	

# Valor Tables



### More Information

Illustrated Glossary ▶ 409

Finishes ▶ 426

Ordering and Warranties ▶ 432

### Standard Features

- Heavy-duty steel construction
- Powder-coated metal legs
- Replaceable components
- Laminate with wood edge
- Non-marring 7/8" glides
- Nemschoff healthcare wood finish
- GREENGUARD Gold Certified
- Limited Lifetime Warranty

### Available Options

- Veneer with wood edge + \$255

### Specification Decisions

- Select powder-coat finish
- Select standard wood finish or laminate

### Coordinating Products

- [Valor Lounge Seating](#)
- [Valor Multiple Seating](#)
- [Valor Stack Chair](#)
- [Valor Patient Chair](#)



#### 20" W, Square end table

35 lbs

Model	Price	Depth	Height
<b>891-T5</b>	\$490	20"	18"



#### 22" W, Square end table

35 lbs

Model	Price	Depth	Height
<b>891-T6</b>	\$514	22"	18"



#### 40" W, Rectangular coffee table

Model	Price	Depth	Height
<b>891-T9</b>	\$628	20"	16"

Lounge Seating

Multiple & Tandem Seating

Side, Stacking & Folding Chairs

Occasional Tables

# Custom Tables

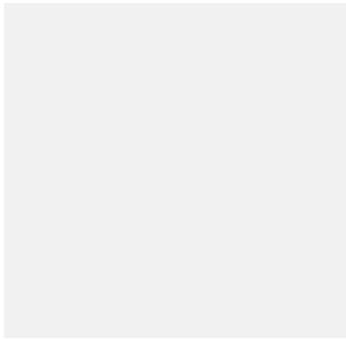

## Standard Features

- 1.25" thick, high-pressure laminate tops on high-density core
- Five table base choices
- Self-leveling glides or rubber-cushioned glides (select bases)
- Choice of leg and edge detail
- 3" radiused corners
- Choice of straight or curved rail (select tables)
- Select bases are wheelchair accessible
- Nemschoff healthcare wood finish
- GREENGUARD Gold Certified
- Limited Lifetime Warranty

### More Information

- Illustrated Glossary ▶ 409
- Finishes ▶ 425
- Hardware ▶ 427
- Ordering and Warranties ▶ 432

## Specification Decisions

### Table Tops

- Select standard wood finish or laminate
- Corner type: Square or Radiused  
3" radiused corner available only with Edge Detail A, D, E, or EE. Square corner not available with Edge Detail D.
- Edge style:

<b>A</b> Square corner, laminate	<b>C</b> Chicago 1" W Wood	<b>D</b> Vinyl
<b>E</b> 1.25" W Wood	<b>EE</b> 1.75" W Wood	<b>L</b> Los Angeles 1" W Wood
<b>N</b> New Orleans 1" W Wood	<b>W</b> Williamsburg 1" W Wood	<b>Y</b> New York 0.375" W Wood

- Edge wood: **M** (Maple) or **O** (Oak)
- Edge finish or color (for D-edge, select vinyl color)
- Top overhang: 1.5" or 0.3125"(square tables only)

### Table Bases

#### Occasional Table Base

Available for round, square and rectangular Table Tops where the longest side is less than 60".

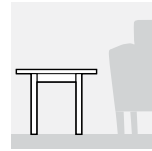

- TL** 16"H
- TM** 20"H
- TH** 24"H
- TS** 27"H
- TC** 29.5"H

#### Conference and Dining Table Base

Available for most Table Tops. See pricing table for details.

<b>4</b> 29½"H Maple base	<b>5</b> 29.5"H Maple base	<b>8/8L</b> 29.5"H, rail, square leg
<b>9</b> 29.5"H, no rail, square leg	<b>9T</b> 29.5"H, no rail, tapered leg	<b>4H</b> Accessible 31.5"H, Maple base
<b>9H</b> Accessible 31.5"H, no rail, square leg	<b>9TH</b> Accessible 31.5"H, no rail, tapered leg	

#### Table Base rail detail

Straight rail	Curved rail

Rails are available for table bases TL, TM, TH, TS, TC, 8, and 8L.

#### Table Base leg style:

<b>P</b> Leg	<b>S</b> Leg	<b>T</b> Leg

- Table Base leg finish  
Select standard wood finish

# Custom Tables

Lounge Seating

Multiple & Tandem Seating

Side, Stacking & Folding Chairs

Occasional Tables

## Custom Tables | Table Tops

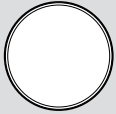

Round Table Top											
Diameter	A-Edge	C-Edge	D-Edge	E-Edge	EE-Edge	L-Edge	N-Edge	W-Edge	Y-Edge	Weight	Base Options
24"	184	1107	185	1105	1259	1107	1107	1107	1107	18 lbs	Occasional
30"	224	1161	250	1192	1424	1161	1161	1161	1161	24 lbs	Occasional, 4, 4H, 8, 9, 9H, 9T, 9TH
36"	279	1321	338	1335	1606	1321	1321	1321	1321	36 lbs	Occasional, 4, 4H, 8, 9, 9H, 9T, 9TH
42"	471	1617	529	1615	1863	1617	1617	1617	1617	47 lbs	Occasional, 4, 4H, 8, 9, 9H, 9T, 9TH
48"	483	1779	568	1753	2035	1779	1779	1779	1779	62 lbs	Occasional, 8, 9, 9H, 9T, 9TH
54"	792	2056	872	2366	2750	2056	2056	2056	2056	78 lbs	Occasional, 8, 9, 9H, 9T, 9TH
60"	792	2549	872	2366	2736	2549	2549	2549	2549	90 lbs	Occasional, 8, 9, 9H, 9T, 9TH



Square Table Top, Radiused Corner								Weight	Base Options
Size	A-Edge	D-Edge	E-Edge	EE-Edge					
18"	183	132	1052	1165				13 lbs	Occasional
21"	177	149	1064	1176				18 lbs	Occasional
24"	206	161	1105	1176				23 lbs	Occasional
30"	260	226	1243	1379				31 lbs	Occasional, 4, 4H, 8, 9, 9H, 9T, 9TH
36"	321	275	1383	1562				40 lbs	Occasional, 4, 4H, 8, 9, 9H, 9T, 9TH
42"	513	449	1541	1766				60 lbs	Occasional, 8, 9, 9H, 9T, 9TH
48"	529	495	1745	1970				79 lbs	Occasional, 5, 8L, 9, 9H, 9T, 9TH

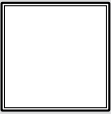

Square Table Top, Square Corner										
Size	A-Edge	C-Edge	E-Edge	EE-Edge	L-Edge	N-Edge	W-Edge	Y-Edge	Weight	Base Options
18"	124	488	557	590	488	488	488	488	13 lbs	Occasional
21"	129	507	575	639	507	507	507	507	18 lbs	Occasional
24"	144	558	595	660	558	558	558	558	23 lbs	Occasional
30"	196	689	726	836	689	689	689	689	31 lbs	Occasional, 4, 4H, 8, 9, 9H, 9T, 9TH
36"	258	925	867	1383	925	925	925	925	40 lbs	Occasional, 4, 4H, 8, 9, 9H, 9T, 9TH
42"	448	1074	1028	1223	1074	1012	1074		60 lbs	Occasional, 8, 9, 9H, 9T, 9TH
48"	464	1202	1228	1424	1202	1202	1202	1202	79 lbs	Occasional, 5, 8L, 9, 9H, 9T, 9TH



# Custom Tables

## Custom Tables | Table Tops

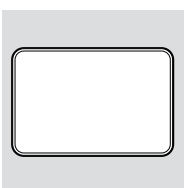

### Rectangular Table Top, Radiused Corner

Size	A-Edge	D-Edge	E-Edge	EE-Edge	Weight	Base Options
18"x21"	187	145	1056	1171	15 lbs	Occasional
18"x24"	199	152	1066	1167	18 lbs	Occasional
18"x30"	224	185	1133	1245	21 lbs	Occasional
18"x36"	249	210	1169	1324	24 lbs	Occasional
18"x48"	303	290	1308	1460	38 lbs	Occasional
21"x24"	202	155	1088	1201	21 lbs	Occasional
21"x30"	226	187	1154	1267	24 lbs	Occasional
21"x36"	253	219	1193	1348	27 lbs	Occasional
21"x48"	313	295	1335	1487	38 lbs	Occasional
24"x30"	230	196	1181	1296	25 lbs	Occasional
24"x36"	260	225	1219	1379	30 lbs	Occasional
30"x36"	285	261	1301	1481	43 lbs	Occasional, 8, 9, 9H, 9T, 9TH
30"x42"	350	331	1359	1547	47 lbs	Occasional, 8, 9, 9H, 9T, 9TH
30"x48"	364	347	1427	1624	49 lbs	Occasional, 8, 9, 9H, 9T, 9TH
30"x60"	427	449	1676	1918	61 lbs	5, 8, 9, 9H, 9T, 9TH
30"x72"	490	536	1866	2095	74 lbs	5, 8, 9, 9H, 9T, 9TH
36"x120"	1145	1096	2968	3364	148 lbs	5, 8L, 9, 9H, 9T, 9TH
36"x42"	405	393	1476	1673	52 lbs	Occasional, 8, 9, 9H, 9T, 9TH
36"x48"	414	405	1534	1739	59 lbs	Occasional, 8, 9, 9H, 9T, 9TH
36"x60"	486	515	1779	2016	89 lbs	5, 8, 9, 9H, 9T, 9TH
36"x72"	553	592	2013	2240	99 lbs	5, 8, 9, 9H, 9T, 9TH
36"x84"	717	755	2700	2982	117 lbs	5, 8L, 9, 9H, 9T, 9TH
36"x96"	717	755	2700	2982	139 lbs	5, 8L, 9, 9H, 9T, 9TH

# Custom Tables

Lounge Seating

Multiple & Tandem Seating

Side, Stacking & Folding Chairs

Occasional Tables

## Custom Tables | Table Tops

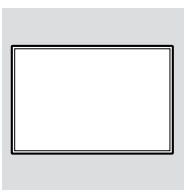

### Rectangular Table Top, Square Corner

Size	A-Edge	C-Edge	E-Edge	EE-Edge	L-Edge	N-Edge	W-Edge	Y-Edge	Weight	Base Options
18"x21"	128	486	563	649	486	486	486	486	15 lbs	Occasional
18"x24"	132	492	572	658	492	492	492	492	18 lbs	Occasional
18"x30"	160	593	639	718	593	593	593	593	21 lbs	Occasional
18"x36"	186	688	674	799	688	688	688	688	24 lbs	Occasional
18"x48"	239	865	816	936	865	865	865	865	38 lbs	Occasional
21"x24"	135	546	586	667	546	546	546	546	21 lbs	Occasional
21"x30"	162	551	655	733	551	551	551	551	24 lbs	Occasional
21"x36"	197	656	688	816	656	656	656	656	27 lbs	Occasional
21"x48"	248	815	833	954	815	815	815	815	38 lbs	Occasional
24"x30"	165	621	667	748	621	621	621	621	25 lbs	Occasional
24"x36"	197	705	706	836	705	705	705	705	30 lbs	Occasional
30"x36"	226	758	789	932	758	758	758	758	43 lbs	Occasional, 8, 9, 9H, 9T, 9TH
30"x42"	281	879	842	994	879	879	879	879	47 lbs	Occasional, 8, 9, 9H, 9T, 9TH
30"x48"	299	936	913	1458	936	936	936	936	49 lbs	Occasional, 8, 9, 9H, 9T, 9TH
30"x60"	361	1115	1158	1374	1115	1115	1115	1115	61 lbs	5, 8, 9, 9H, 9T, 9TH
30"x72"	427	1473	1348	1551	1473	1473	1473	1473	74 lbs	5, 8, 9, 9H, 9T, 9TH
36"x120"	1082	2729	2452	2820	2729	2729	2729	2729	148 lbs	5, 8L, 9, 9H, 9T, 9TH
36"x42"	339	990	960	1126	990	990	990	990	52 lbs	Occasional, 8, 9, 9H, 9T, 9TH
36"x48"	352	988	1018	1194	988	988	988	988	59 lbs	Occasional, 8, 9, 9H, 9T, 9TH
36"x60"	423	1210	1168	1468	1210	1210	1210	1210	89 lbs	5, 8, 9, 9H, 9T, 9TH
36"x72"	488	1481	1499	1694	1481	1481	1481	1481	99 lbs	5, 8, 9, 9H, 9T, 9TH
36"x84"	656	2020	2182	2436	2020	2020	2020	2020	117 lbs	5, 8L, 9, 9H, 9T, 9TH
36"x96"	656	2333	2182	2436	2333	2333	2333	2333	139 lbs	5, 8L, 9, 9H, 9T, 9TH

## Custom Tables

### Custom Tables | Occasional Bases



Models	Price
<b>TL</b> 16"H	All sizes are \$449
<b>TM</b> 20"H	
<b>TH</b> 24"H	
<b>TS</b> 27"H	
<b>TC</b> 29.5"H	

### Custom Tables | Conference and Dining Bases

- Select a straight or curved rail with 8 and 8L.
- 4H, 9H, and 9TH are wheelchair accessible.
- Bases 8 and 8L come with bar glides. All other bases have self-leveling glides.

Base	Height	Spread	Weight	Price	Top Options
<b>4</b>	29.5"	18"	18 lbs	586	Round (30", 36", 42") Square (30", 36")
<b>4H</b>	31.5"	18"	18 lbs	586	Round (30", 36", 42") Square (30", 36")
<b>5</b>	29.5"	18"	32 lbs	1071	Square (48") Rectangular (30" wide x 60" or 72"; 36" wide x 48", 60", 72", 84", or 96")
<b>5</b>	29.5"	18"	32 lbs	2045	Rectangular (36" x 120")
<b>8</b>	29.5"		15 lbs	482	Rectangular (24" wide x 30" or 36"; 30" wide x 36", 42", or 48")
<b>8</b>	29.5"		15 lbs	504	Round (30", 36", 42", 54", 60") Rectangular (30" wide x 60" or 72"; 36" wide x 42")
<b>8</b>	29.5"		15 lbs	504	Square (30", 36", 42")
<b>8</b>	29.5"		15 lbs	552	Rectangular (36" wide x 48")
<b>8</b>	29.5"		15 lbs	962	Rectangular (36" wide x 120")
<b>8L</b>	29.5"		15 lbs	553	Rectangular (36" wide x 84" or 96")
<b>9</b>	29.5"		15 lbs	323	Rectangular (24" wide x 30" or 36"; 30" wide x 36", 42", or 48")
<b>9</b>	29.5"		15 lbs	338	Round (30", 36", 42", 48", 54", 60") Square (30", 36", 42", 48") Rectangular (30" wide x 60" or 72"; 36" wide x 42", 48", 60", or 72")
<b>9</b>	29.5"		15 lbs	505	Rectangular (36" wide x 84" or 96")
<b>9</b>	29.5"		15 lbs	483	Rectangular (36" x 120")
<b>9H</b>	31.5"		15 lbs	323	Rectangular (24" wide x 30" or 36"; 30" wide x 36", 42", or 48")
<b>9H</b>	31.5"		15 lbs	338	Round (30", 36", 42", 48", 54", 60") Square (30", 36", 42", 48") Rectangular (30" wide x 60" or 72"; 36" wide x 42", 48", 60", or 72")
<b>9H</b>	31.5"		15 lbs	505	Rectangular (36" wide x 84" or 96")
<b>9H</b>	31.5"		15 lbs	483	Rectangular (36" wide x 120")
<b>9T</b>	29.5"		15 lbs	333	Rectangular (24" wide x 30" or 36"; 30" wide x 36", 42", or 48")
<b>9T</b>	29.5"		15 lbs	350	Round (30", 36", 42", 48", 54", 60") Square (30", 36", 42", 48") Rectangular (30" wide x 60" or 72"; 36" wide x 42", 48", 60", or 72")
<b>9T</b>	29.5"		15 lbs	523	Rectangular (36" wide x 84" or 96")

## Custom Tables

### Custom Tables | Conference and Dining Bases

Base	Height	Spread	Weight	Price	Top Options
<b>9T</b>	29.5"		15 lbs	500	Rectangular (36" wide x 120")
<b>9TH</b>	31.5"		15 lbs	333	Rectangular (24"wide x 30" or 36"; 30"wide x 36", 42", or 48")
<b>9TH</b>	31.5"		15 lbs	350	Round (30", 36", 42", 48", 54", 60") Square (30", 36", 42", 48") Rectangular (30" wide x 60" or 72"; 36" wide x 42", 48", 60", or 72")
<b>9TH</b>	31.5"		15 lbs	523	Rectangular (36" wide x 84" or 96")
<b>9TH</b>	31.5"		15 lbs	500	Rectangular (36" wide x 120")

Lounge Seating

Multiple & Tandem Seating

Side, Stacking & Folding Chairs

Occasional Tables

## Patient Areas

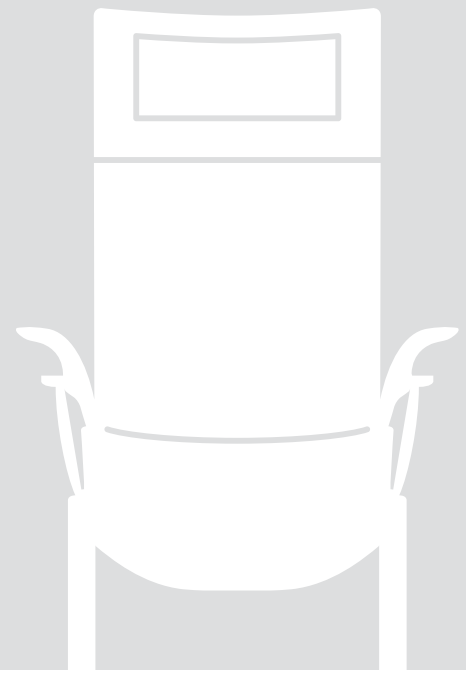

## 2750 Series Patient Chairs



### More Information

Illustrated Glossary ▶ 409

Fabrics ▶ 421

Flammability (CTB-133) ▶ 429

Finishes ▶ 426

Ordering and Warranties ▶ 432

### Standard Features

- Solid maple frame
- Mortise and tenon joinery
- Spring seat construction
- Replaceable components
- Firm, flat seat (2750-0)
- Extended hand grip (2750-0)
- Clean-out design
- Black urethane arm caps
- Retractable laminate footrest (2750-0)
- Wallsaver edge (2750-0)
- 2" Tilt and roll casters (2750-0)
- Non-marring  $\frac{7}{8}$ " plastic rubber-cushioned glides (2750-51)
- Nemschoff healthcare wood finish
- GREENGUARD Gold Certified
- Limited Lifetime Warranty

### Available Options

- Moisture barrier + \$69 per seat or back
- Desert or Pewter urethane arm caps (2750-51 only) +\$210
- CTB-133 + \$83/yard
- Two fabrics + \$64
- Three (or more) fabrics + \$90

### Specification Decisions

- Select fabric
- Select standard wood finish
- Select standard laminate (2750-0)
- Add urethane arm caps
- Add moisture barrier
- Add CTB-133
- Apply multiple fabrics

Model numbers with **S** indicate standard seat and back covers, and model numbers with **P** indicate removable covers.

### Flammability Types

- Type 5 (2750-51)
- Type 3 (2750-0)
- Type 2 (Footstool)

### Coordinating Products

- [2750 Series Multiple Seating](#)
- [2770 Series Multiple Seating](#)
- [2000 Series Tables](#)

### Key Dimensions

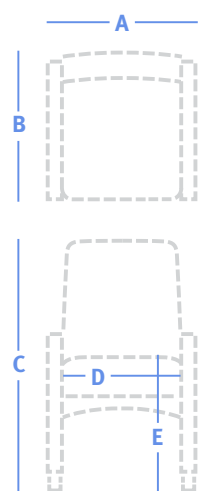

<b>A</b>	Overall Width	See price table
<b>B</b>	Overall Depth	31.5" (2750-51) 23.5" (2750-0)
<b>C</b>	Overall Height	39.5" (2750-51) 41.75" (2750-0)
<b>D</b>	Seat Width	20" (2750-51) 22" (2750-0)
<b>E</b>	Seat Height	18.5" (2750-51) 22" (2750-0)
<b>F</b>	Arm Height	25.5" (2750-51) 27" (2750-0)

### Footstool dimensions

Depth	12"
Height	12"

Welcoming & Waiting

## 2750 Series Patient Chairs



### 23.75" W, High back patient chair

38 lbs | 2 yds

Model	Series 2	Series 3	Series 4	Series 5	Series 6	Series 7	Series 8	COM
<b>2750-51 S</b>	\$1,254	\$1,319	\$1,427	\$1,540	\$1,675	\$1,810	\$1,980	\$1,319
<b>2750-51 P</b>	\$1,413	\$1,478	\$1,586	\$1,699	\$1,834	\$1,969	\$2,139	\$1,478



### 17" W, Footstool

8 lbs | 1.25 yds

Model	Series 2	Series 3	Series 4	Series 5	Series 6	Series 7	Series 8	COM
<b>2750-59 S</b>	\$315	\$355	\$423	\$494	\$577	\$662	\$768	\$355
<b>2750-59 P</b>	\$358	\$398	\$466	\$537	\$620	\$705	\$811	\$398

Patient Areas



### 29.25" W, Patient chair

41 lbs | 2 yds

Model	Series 2	Series 3	Series 4	Series 5	Series 6	Series 7	Series 8	COM
<b>2750-O S</b>	\$1,885	\$1,950	\$2,058	\$2,171	\$2,306	\$2,441	\$2,611	\$1,950
<b>2750-O P</b>	\$2,119	\$2,184	\$2,292	\$2,405	\$2,540	\$2,675	\$2,845	\$2,184

Specialty

Reference

# Brava Patient Chair



## More Information

Illustrated Glossary ▶ 409

Fabrics ▶ 421

Flammability (CTB-133) ▶ 429

Finishes ▶ 426

Ordering and Warranties ▶ 432

## Standard Features

- Solid maple frame
- Mortise and tenon joinery
- Spring seat construction
- Clean-out design
- Replaceable components
- Removable covers (862H-OB30, 862H-OB40, 863H-OB30, 863H-OB40)
- Upholstered arms
- Non-marring  $\frac{7}{8}$ " plastic rubber-cushioned glides
- Nemschoff healthcare wood finish
- GREENGUARD Gold Certified
- Limited Lifetime Warranty
- See nemschoff.com for weight ratings (862H-OB30, 862H-OB40, 863H-OB30, 863H-OB40)

## Available Options

- Moisture barrier + \$69 per seat or back
- Wood arm caps + \$116
- Black urethane arm caps + \$116
- Desert or Pewter urethane arm caps + \$210
- CTB-133 + \$83/yd
- Two fabrics + \$64
- Three (or more) fabrics + \$90

## Specification Decisions

- Select fabric
- Select standard wood finish
- Add moisture barrier
- Add CTB-133
- Apply multiple fabrics
- Add wood or urethane arm caps

Model numbers with **S** indicate standard seat and back covers, and model numbers with **P** indicate removable covers.

## Flammability Type

- Type 6
- Type 5 (863H-OB30, 863H-OB40)

## Coordinating Products

- [Brava Classic Lounge Seating](#)
- [Brava Platform Lounge Seating](#)
- [Brava 862 Multiple Seating](#)
- [Brava 863 Multiple Seating](#)
- [Brava Side Chair](#)
- [Brava Tables](#)
- [Brava Adjustable Back Chair](#)
- [Brava CompactComfort Recliner](#)
- [Brava Glider](#)
- [Brava Flop Sofa](#)
- [Brava Sleep Settee](#)

## Key Dimensions

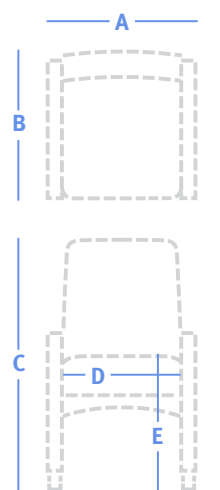

<b>A</b>	Overall Width	See price table
<b>B</b>	Overall Depth	26.5"
<b>C</b>	Overall Height	42.5"
<b>D</b>	Seat Width	21.5"
<b>E</b>	Seat Height	18.75"
<b>F</b>	Arm Height	27"



## Brava Patient Chair



### 26.5" W, High back chair

35 lbs | 3.25 yds

Model	Series 2	Series 3	Series 4	Series 5	Series 6	Series 7	Series 8	COM
<b>862-10H S</b>	\$2,244	\$2,350	\$2,526	\$2,709	\$2,928	\$3,148	\$3,424	\$2,350
<b>862-10H P</b>	\$2,526	\$2,632	\$2,808	\$2,991	\$3,210	\$3,430	\$3,706	\$2,632



### 34.75" W, High back Plus chair

46 lbs | 4.25 yds

Model	Series 2	Series 3	Series 4	Series 5	Series 6	Series 7	Series 8	COM
<b>862H-OB30</b>	\$4,933	\$5,071	\$5,301	\$5,541	\$5,826	\$6,114	\$6,475	\$5,071



### 44.75" W, High back Plus chair

51 lbs | 4.25 yds

Model	Series 2	Series 3	Series 4	Series 5	Series 6	Series 7	Series 8	COM
<b>862H-OB40</b>	\$5,684	\$5,822	\$6,052	\$6,292	\$6,577	\$6,865	\$7,226	\$5,822



### 25.75" W, High back chair

34 lbs | 2 yds

Model	Series 2	Series 3	Series 4	Series 5	Series 6	Series 7	Series 8	COM
<b>863-10H S</b>	\$2,082	\$2,147	\$2,255	\$2,368	\$2,503	\$2,638	\$2,808	\$2,147
<b>863-10H P</b>	\$2,340	\$2,405	\$2,513	\$2,626	\$2,761	\$2,896	\$3,066	\$2,405



### 34" W, High back Plus chair

46 lbs | 3.25 yds

Model	Series 2	Series 3	Series 4	Series 5	Series 6	Series 7	Series 8	COM
<b>863H-OB30</b>	\$4,530	\$4,636	\$4,812	\$4,995	\$5,214	\$5,434	\$5,710	\$4,636



### 44" W, High back Plus chair

51 lbs | 3.25 yds

Model	Series 2	Series 3	Series 4	Series 5	Series 6	Series 7	Series 8	COM
<b>863H-OB40</b>	\$5,218	\$5,324	\$5,500	\$5,683	\$5,902	\$6,122	\$6,398	\$5,324

## Brooklyn Patient Chair



### More Information

Illustrated Glossary ▶ 409

Fabrics ▶ 421

Flammability (CTB-133) ▶ 429

Finishes ▶ 426

Ordering and Warranties ▶ 432

### Standard Features

- Solid maple frame
- Mortise and tenon joinery
- Replaceable components
- Spring seat construction
- Wood arm caps
- Wallsaver legs
- Clean-out design
- Non-marring  $\frac{7}{8}$ " plastic rubber-cushioned glides
- Nemschoff healthcare wood finish
- GREENGUARD Gold Certified
- Limited Lifetime Warranty

### Available Options

- Moisture barrier + \$69 per seat or back
- Black urethane arm caps + \$116
- CTB-133 + \$83/yd
- Two fabrics + \$64
- Three (or more) fabrics + \$90

### Specification Decisions

- Select fabric
- Select standard wood finish
- Add moisture barrier
- Add CTB-133
- Apply multiple fabrics
- Add urethane arm caps

Model numbers with **S** indicate standard seat and back covers, and model numbers with **P** indicate removable covers.

### Flammability Type

- Type 6

### Coordinating Products

- [Brooklyn Tables](#)

### Key Dimensions

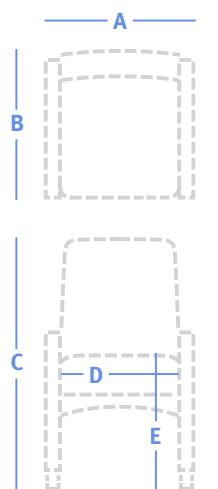

<b>A</b>	Overall Width	See price table
<b>B</b>	Overall Depth	28"
<b>C</b>	Overall Height	40"
<b>D</b>	Seat Width	20.25"
<b>E</b>	Seat Height	18.5"
<b>F</b>	Arm Height	25"



### 27" W, High back patient chair

52 lbs | 3.5 yds

Model	Series 2	Series 3	Series 4	Series 5	Series 6	Series 7	Series 8	COM
<b>776-51 S</b>	\$2,155	\$2,269	\$2,458	\$2,656	\$2,891	\$3,128	\$3,425	\$2,269
<b>776-51 P</b>	\$2,428	\$2,542	\$2,731	\$2,929	\$3,164	\$3,401	\$3,698	\$2,542

# Capella Patient Chair



## Standard Features

- Solid maple frame
- Mortise and tenon joinery
- Spring seat construction
- Clean-out design
- Replaceable components
- Upholstered arms
- Non-marring 7/8" rubber-cushioned glides
- Nemschoff healthcare wood finish
- GREENGUARD Gold Certified
- Limited Lifetime Warranty

## Available Options

- Moisture barrier + \$69 per seat or back
- CTB-133 + \$83/yd
- Two fabrics + \$64
- Three (or more) fabrics + \$90

## Specification Decisions

- Select fabric
- Select standard wood finish
- Add moisture barrier
- Add CTB-133
- Apply multiple fabrics

Model numbers with **S** indicate standard seat and back covers, and model numbers with **P** indicate removable covers.

## Flammability Types

- Type 4
- Type 2 (Footstool)

## Coordinating Products

- [Capella Multiple Seating](#)
- [Capella Side Chair](#)
- [Capella Tables](#)
- [Capella Adjustable Back Chair](#)
- [Capella CompactComfort Recliner](#)
- [Capella Glider](#)
- [Capella Adjustable Back Glider](#)

## Key Dimensions

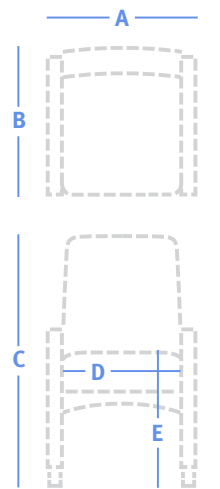

<b>A</b>	Overall Width	See price table
<b>B</b>	Overall Depth	24.75"
<b>C</b>	Overall Height	40.5"
<b>D</b>	Seat Width	20.5"
<b>E</b>	Seat Height	18.75"
<b>F</b>	Arm Height	25"

### Footstool dimensions

Depth	12"
Height	12"

## More Information

Illustrated Glossary ▶ 409

Fabrics ▶ 421

Flammability (CTB-133) ▶ 429

Finishes ▶ 426

Ordering and Warranties ▶ 432



### 25.5" W, High back patient chair

27 lbs | 2.5 yds

Model	Series 2	Series 3	Series 4	Series 5	Series 6	Series 7	Series 8	COM
<b>740-51 S</b>	\$2,099	\$2,180	\$2,315	\$2,457	\$2,624	\$2,794	\$3,006	\$2,180
<b>740-51 P</b>	\$2,361	\$2,442	\$2,577	\$2,719	\$2,886	\$3,056	\$3,268	\$2,442



### 17" W, Footstool

8 lbs | 1.25 yds

Model	Series 2	Series 3	Series 4	Series 5	Series 6	Series 7	Series 8	COM
<b>740-59 S</b>	\$315	\$355	\$423	\$494	\$577	\$662	\$768	\$355
<b>740-59 P</b>	\$358	\$398	\$466	\$537	\$620	\$705	\$811	\$398

# Centé Patient Chair



## More Information

Illustrated Glossary ▶ 409

Fabrics ▶ 421

Flammability (CTB-133) ▶ 429

Finishes ▶ 426

Ordering and Warranties ▶ 432

## Standard Features

- Powder-coated metal frame (XTT Titanium Textured)
- Wipe-out design
- Replaceable components
- Grey urethane arm caps
- Upholstered seat and back
- Seat and back suspension with soft permeable mesh fabric
- Elevated forward incline and shift control mechanism
- GREENGUARD Gold Certified
- Twelve-year Warranty

## Available Options

- Moisture barrier + \$69 per seat or back (upholstered models only)
- Tilt and roll casters + \$70
- CTB-133 (for fabric) + \$83/yard (for fabric)

## Specification Decisions

- Select Centé Mesh Fabric for the chair back :
 

<b>PK01</b> Cave	<b>PK02</b> Slate	<b>PK03</b> Khaki
<b>PK04</b> Grain	<b>PK05</b> Sage	<b>PK06</b> Pacific
- Add moisture barrier (with fabric only)
- Add CTB-133 (for fabric)
- Add rear casters

The footstool nests fully under the flex model and partially under the tilt model

## Flammability Types

- Type 5 (upholstered models)
- CNXX00003, CNXX-0002, CNXX-0001 meet CTB-133

## Key Dimensions

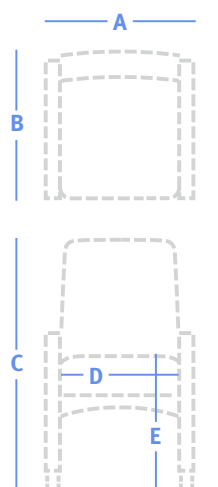

<b>A</b>	Overall Width	See price table
<b>B</b>	Overall Depth	25" - 31"
<b>C</b>	Overall Height	49"
<b>D</b>	Seat Width	20.75"
<b>E</b>	Seat Height	17.5"
<b>F</b>	Arm Height	27.5"

## Footstool dimensions

Depth	17.5"
Height	12.5"



### 28" W, Flex patient chair, mesh

51 lbs |

Model	Price
<b>CNXX-00003</b>	\$2,128



### 28" W, Flex patient chair with upholstered back

51 lbs | 1.5 yds

Model	Series 2	Series 3	Series 4	Series 5	Series 6	Series 7	Series 8	COM
<b>CNXX-00003UPB</b>	\$2,431	\$2,455	\$2,561	\$2,617	\$2,648	\$2,688	\$2,714	\$2,455



### 28" W, Flex patient chair with upholstered back and seat

51 lbs | 3.75 yds

Model	Series 2	Series 3	Series 4	Series 5	Series 6	Series 7	Series 8	COM
<b>CNXX-00003UPB/UPS</b>	\$2,566	\$2,626	\$2,889	\$3,030	\$3,107	\$3,208	\$3,273	\$2,626

Welcoming & Waiting

## Centé Patient Chair



28" W, Flex patient chair with upholstered seat									51 lbs   0.75 yd
Model	Series 2	Series 3	Series 4	Series 5	Series 6	Series 7	Series 8	COM	
<b>CNXX-00003UPS</b>	\$2,288	\$2,300	\$2,353	\$2,381	\$2,397	\$2,417	\$2,430	\$2,300	



28" W, Tilt patient chair, mesh									50 lbs
Model	Price								
<b>CNXX-00002</b>	\$3,255								

Patient Areas



28" W, Tilt patient chair with upholstered back									50 lbs   1.5 yds
Model	Series 2	Series 3	Series 4	Series 5	Series 6	Series 7	Series 8	COM	
<b>CNXX-00002UPB</b>	\$3,556	\$3,580	\$3,686	\$3,742	\$3,773	\$3,813	\$3,839	\$3,580	



28" W, Tilt patient chair with upholstered back and seat									50 lbs   3.75 yds
Model	Series 2	Series 3	Series 4	Series 5	Series 6	Series 7	Series 8	COM	
<b>CNXX-00002UPB/UPS</b>	\$3,693	\$3,753	\$4,016	\$4,157	\$4,234	\$4,335	\$4,400	\$3,753	



28" W, Tilt patient chair with upholstered seat									50 lbs   0.75 yd
Model	Series 2	Series 3	Series 4	Series 5	Series 6	Series 7	Series 8	COM	
<b>CNXX-00002UPS</b>	\$3,413	\$3,425	\$3,478	\$3,506	\$3,522	\$3,542	\$3,555	\$3,425	

Specialty



20" W, Footstool									9 lbs   1 yd
Model	Series 2	Series 3	Series 4	Series 5	Series 6	Series 7	Series 8	COM	
<b>CNXX-00001</b>	\$818	\$834	\$905	\$942	\$963	\$990	\$1,007	\$834	

Reference

# Cities Crosstown Patient Chair



## More Information

Illustrated Glossary ▶ 409

Fabrics ▶ 421

Flammability (CTB-133) ▶ 429

Finishes ▶ 426

Ordering and Warranties ▶ 432

## Standard Features

- Solid maple frame
- Mortise and tenon joinery
- Spring seat construction
- Wipe-out design
- Replaceable components
- Wood arm caps
- Closed arm style
- Non-marring  $\frac{7}{8}$ " rubber-cushioned glides
- Nemschoff healthcare wood finish
- GREENGUARD Gold Certified
- Limited Lifetime Warranty

## Available Options

- Moisture barrier + \$69 per seat or back
- Five arm cap styles + \$0
- Four foot styles + \$0
- Two back styles + \$0
- Two arm styles + \$0
- CTB-133 + \$83/yd
- Two fabrics + \$64
- Three (or more) fabrics + \$90

## Specification Decisions

- Select fabric
- Select standard wood finish
- Select arm cap style

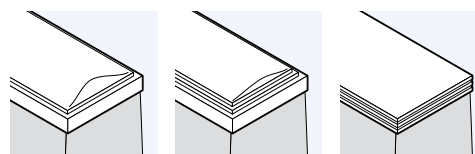

**C** Chicago

**L** Los Angeles

**N** New Orleans

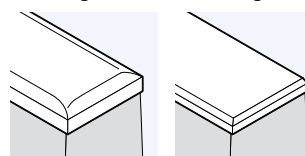

**Y** New York

**W** Williamsburg

- Select foot style

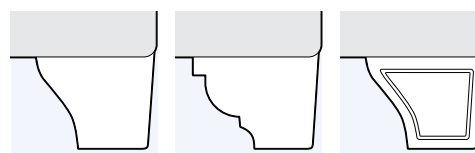

**B** Boston

**C** Chicago

**P** Philadelphia

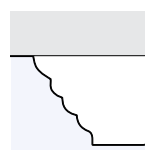

**S** San Francisco

- Select back style. All styles have a wipe-out feature.

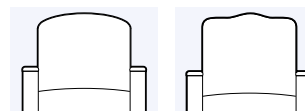

**A** Arcade back

**Q** Camel square back

- Select arm style



**E** Elliptical arm

**C** Closed arm

- Add CTB-133
- Apply multiple fabrics
- Add moisturebarrier

Model numbers with **S** indicate standard seat and back covers, and model numbers with **P** indicate removable covers.

# Cities Crosstown Patient Chair

## Flammability Types

- Type 8
- Type 2 (Footstool)

## Coordinating Products

- [Cities Small Crosstown Lounge Seating](#)
- [Cities Medium Crosstown Lounge Seating](#)
- [Cities Small Downtown Lounge Seating](#)
- [Cities Medium Downtown Lounge Seating](#)
- [Cities Small Uptown Lounge Seating](#)
- [Cities Medium Uptown Lounge Seating](#)
- [Cities Side Chair](#)
- [Cities Tables](#)
- [Cities Downtown Patient Chair](#)
- [Cities Uptown Patient Chair](#)
- [Cities Uptown CompactComfort Recliner](#)
- [Cities Crosstown Rocker](#)
- [Cities Downtown Rocker](#)
- [Cities Uptown Rocker](#)
- [Cities Downtown Glider](#)
- [Cities Uptown Glider](#)
- [SleepOver Sofa](#)
- [SleepOver Settee](#)

## Key Dimensions

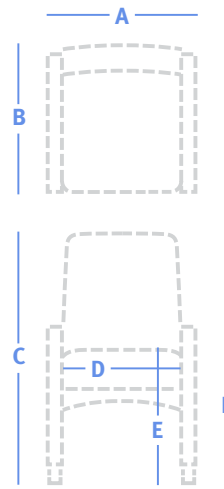

<b>A</b>	Overall Width	See price table
<b>B</b>	Overall Depth	26.5"
<b>C</b>	Overall Height	39.5"
<b>D</b>	Seat Width	19.5"
<b>E</b>	Seat Height	18.5"
<b>F</b>	Arm Height	25"

### Footstool dimensions

Depth	12"
Height	12"



### 26.5" W, High back patient chair

44 lbs | 4.5 yds

Model	Series 2	Series 3	Series 4	Series 5	Series 6	Series 7	Series 8	COM
<b>Cities-SCXXXX-51SX</b>	\$2,016	\$2,162	\$2,405	\$2,659	\$2,961	\$3,267	\$3,648	\$2,162
<b>Cities-SCXXXX-51PX</b>	\$2,276	\$2,422	\$2,665	\$2,919	\$3,221	\$3,527	\$3,908	\$2,422



### 17" W, Footstool

7 lbs | 1.25 yds

Model	Series 2	Series 3	Series 4	Series 5	Series 6	Series 7	Series 8	COM
<b>Cities-SXXXX-59SX</b>	\$315	\$355	\$423	\$494	\$577	\$662	\$768	\$355
<b>Cities-SXXXX-59PX</b>	\$358	\$398	\$466	\$537	\$620	\$705	\$811	\$398

# Cities Downtown Patient Chair



## More Information

Illustrated Glossary ▶ 409

Fabrics ▶ 421

Flammability (CTB-133) ▶ 429

Finishes ▶ 426

Ordering and Warranties ▶ 432

## Standard Features

- Solid maple frame
- Mortise and tenon joinery
- Spring seat construction
- Wipe-out design
- Replaceable components
- Wood arm caps
- Non-marring 7/8" rubber-cushioned glides
- Nemschoff healthcare wood finish
- GREENGUARD Gold Certified
- Limited Lifetime Warranty

## Available Options

- Moisture barrier + \$69 per seat or back
- Five arm cap styles + \$0
- Four foot styles + \$0
- Two back styles + \$0
- Two rail styles + \$0
- CTB-133 + \$83/yd
- Two fabrics + \$64
- Three (or more) fabrics + \$90

## Specification Decisions

- Select fabric
- Select standard wood finish
- Select arm cap style

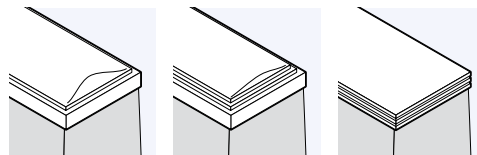

**C** Chicago      **L** Los Angeles      **N** New Orleans

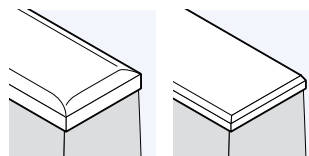

**Y** New York      **W** Williamsburg

- Select foot style

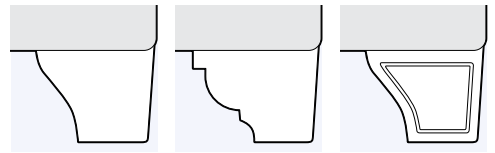

**B** Boston      **C** Chicago      **P** Philadelphia

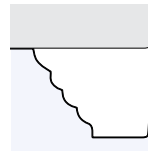

**S** San Francisco

- Select back style. All styles have a wipe-out feature.

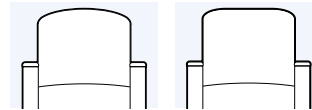

**A** Arcade back      **B** Square back

- Select rail style

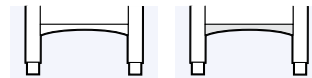

**U** Upholstered      **W** Wood

- Add CTB-133
- Apply multiple fabrics
- Add moisture barrier

Model numbers with **S** indicate standard seat and back covers, and model numbers with **P** indicate removable covers.

## Flammability Types

- Type 8
- Type 2 (Footstool)



# Cities Downtown Patient Chair

## Coordinating Products

- [Cities Small Crosstown Lounge Seating](#)
- [Cities Medium Crosstown Lounge Seating](#)
- [Cities Small Downtown Lounge Seating](#)
- [Cities Medium Downtown Lounge Seating](#)
- [Cities Small Uptown Lounge Seating](#)
- [Cities Medium Uptown Lounge Seating](#)
- [Cities Side Chair](#)
- [Cities Tables](#)
- [Cities Crosstown Patient Chair](#)
- [Cities Uptown Patient Chair](#)
- [Cities Uptown CompactComfort Recliner](#)
- [Cities Crosstown Rocker](#)
- [Cities Downtown Rocker](#)
- [Cities Uptown Rocker](#)
- [Cities Downtown Glider](#)
- [Cities Uptown Glider](#)
- [SleepOver Sofa](#)
- [SleepOver Settee](#)

## Key Dimensions

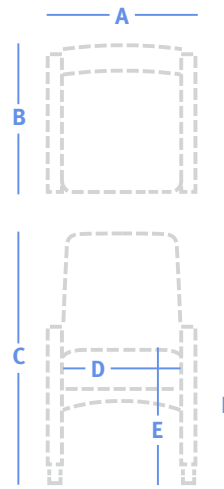

<b>A</b>	Overall Width	See price table
<b>B</b>	Overall Depth	26.5", 27.5"
<b>C</b>	Overall Height	39.5", 42"
<b>D</b>	Seat Width	19.5", 21.5"
<b>E</b>	Seat Height	18.5"
<b>F</b>	Arm Height	25", 25.5"

## Footstool dimensions

Depth	12"
Height	12"

		<b>24.5" W, High back patient chair</b>								38 lbs   4.25 yds
	Model	Series 2	Series 3	Series 4	Series 5	Series 6	Series 7	Series 8	COM	
	<b>Cities-SDXXXX-51SX</b>	\$2,024	\$2,162	\$2,392	\$2,632	\$2,917	\$3,205	\$3,566	\$2,162	
	<b>Cities-SDXXXX-51PX</b>	\$2,284	\$2,422	\$2,652	\$2,892	\$3,177	\$3,465	\$3,826	\$2,422	
		<b>28" W, High back patient chair</b>								48 lbs   5 yds
	Model	Series 2	Series 3	Series 4	Series 5	Series 6	Series 7	Series 8	COM	
	<b>Cities-MDXXXX-51SX</b>	\$2,416	\$2,579	\$2,849	\$3,132	\$3,467	\$3,806	\$4,230	\$2,579	
	<b>Cities-MDXXXX-51PX</b>	\$2,726	\$2,889	\$3,159	\$3,442	\$3,777	\$4,116	\$4,540	\$2,889	
		<b>17" W, Footstool</b>								7 lbs   1.25 yds
	Model	Series 2	Series 3	Series 4	Series 5	Series 6	Series 7	Series 8	COM	
	<b>Cities-SDXXXX-59SX</b>	\$315	\$355	\$423	\$494	\$577	\$662	\$768	\$355	
	<b>Cities-SDXXXX-59PX</b>	\$358	\$398	\$466	\$537	\$620	\$705	\$811	\$398	

# Cities Uptown Patient Chair



## More Information

Illustrated Glossary ▶ 409

Fabrics ▶ 421

Flammability (CTB-133) ▶ 429

Finishes ▶ 426

Ordering and Warranties ▶ 432

## Standard Features

- Solid maple frame
- Mortise and tenon joinery
- Spring seat construction
- Wipe-out design
- Replaceable components
- Wood arm caps
- Non-marring 7/8" rubber-cushioned glides
- Nemschoff healthcare wood finish
- GREENGUARD Gold Certified
- Limited Lifetime Warranty

## Available Options

- Moisture barrier + \$69 per seat or back
- Five arm cap styles + \$0
- Two back styles + \$0
- Two rail styles + \$0
- CTB-133 + \$83/yd
- Two fabrics + \$64
- Three (or more) fabrics + \$90

## Specification Decisions

- Select fabric
- Select standard wood finish
- Select arm cap style

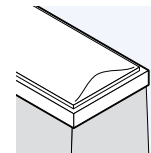

**C** Chicago

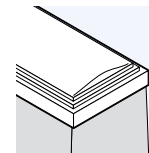

**L** Los Angeles

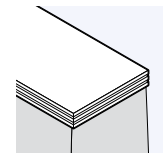

**N** New Orleans

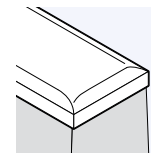

**Y** New York

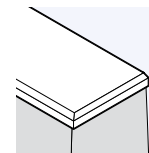

**W** Williamsburg

- Select back style. All styles have a wipe-out feature.

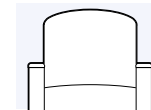

**A** Arcade back

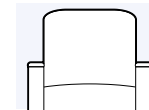

**B** Square back

- Select rail style

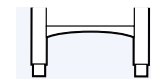

**U** Upholstered

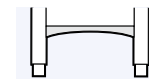

**W** Wood

- Add CTB-133
- Apply multiple fabrics
- Add moisture barrier

Model numbers with **S** indicate standard seat and back covers, and model numbers with **P** indicate removable covers.

## Flammability Types

- Type 4
- Type 2 (Footstool)

# Cities Uptown Patient Chair

## Coordinating Products

- [Cities Small Crosstown Lounge Seating](#)
- [Cities Medium Crosstown Lounge Seating](#)
- [Cities Small Downtown Lounge Seating](#)
- [Cities Medium Downtown Lounge Seating](#)
- [Cities Small Uptown Lounge Seating](#)
- [Cities Medium Uptown Lounge Seating](#)
- [Cities Side Chair](#)
- [Cities Tables](#)
- [Cities Crosstown Patient Chair](#)
- [Cities Downtown Patient Chair](#)
- [Cities Uptown CompactComfort Recliner](#)
- [Cities Crosstown Rocker](#)
- [Cities Downtown Rocker](#)
- [Cities Uptown Rocker](#)
- [Cities Downtown Glider](#)
- [Cities Uptown Glider](#)
- [SleepOver Sofa](#)
- [SleepOver Settee](#)

## Key Dimensions

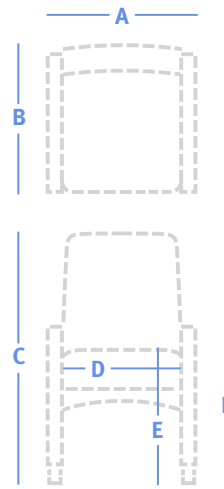

<b>A</b>	Overall Width	See price table
<b>B</b>	Overall Depth	26.5", 27.5"
<b>C</b>	Overall Height	39.5", 42"
<b>D</b>	Seat Width	19.5", 21.5"
<b>E</b>	Seat Height	18.5"
<b>F</b>	Arm Height	25"

### Footstool dimensions

Depth	12"
Height	12"

		<b>24.5" W, High back patient chair</b>								38 lbs   3.75 yds
Model		Series 2	Series 3	Series 4	Series 5	Series 6	Series 7	Series 8	COM	
	<b>Cities-SUX0XX-51SX</b>	\$2,040	\$2,162	\$2,365	\$2,577	\$2,828	\$3,083	\$3,401	\$2,162	
	<b>Cities-SUX0XX-51PX</b>	\$2,300	\$2,422	\$2,625	\$2,837	\$3,088	\$3,343	\$3,661	\$2,422	
		<b>28" W, High back patient chair</b>								48 lbs   4 yds
Model		Series 2	Series 3	Series 4	Series 5	Series 6	Series 7	Series 8	COM	
	<b>Cities-MUX0XX-51SX</b>	\$2,449	\$2,579	\$2,795	\$3,021	\$3,290	\$3,561	\$3,900	\$2,579	
	<b>Cities-MUX0XX-51PX</b>	\$2,759	\$2,889	\$3,105	\$3,331	\$3,600	\$3,871	\$4,210	\$2,889	
		<b>17" W, Footstool</b>								7 lbs   1.25 yds
Model		Series 2	Series 3	Series 4	Series 5	Series 6	Series 7	Series 8	COM	
	<b>Cities-SUX0XX-59SX</b>	\$315	\$355	\$423	\$494	\$577	\$662	\$768	\$355	
	<b>Cities-SUX0XX-59PX</b>	\$358	\$398	\$466	\$537	\$620	\$705	\$811	\$398	

# Easy Access Patient Chair



## More Information

Illustrated Glossary ▶ 409

Fabrics ▶ 421

Flammability (CTB-133) ▶ 429

Finishes ▶ 426

Ordering and Warranties ▶ 432

## Standard Features

- Solid maple frame
- Mortise and tenon joinery
- Spring seat construction
- Replaceable components
- Adjustable footrest
- Nemschoff healthcare wood finish
- GREENGUARD Gold Certified
- Limited Lifetime Warranty

## Available Options

- Moisture barrier + \$69 per seat or back
- CTB-133 + \$83/yd

- Two fabrics + \$64
- Three (or more) fabrics + \$90

## Specification Decisions

- Select fabric
- Select standard wood finish
- Add moisture barrier
- Add CTB-133
- Apply multiple fabrics

## Flammability Type

- Type 3

## Key Dimensions

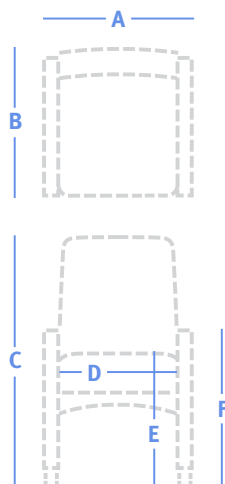

		314H	314B	2750H	314	316
<b>A</b>	Overall Width	22.25"	22.25"	22.5"	22.75"	22.75"
<b>B</b>	Overall Depth	23.75"	24.75"	23.75"	24.75"	24.75"
<b>C</b>	Overall Height	44.5"	38.75"	44.5"	38.75"	38.75"
<b>D</b>	Seat Width	18.25"	18.25"	18.25"	18.25"	18.25"
<b>E</b>	Seat Height	24.75"	24.75"	24.75"	24.75"	24.75"
<b>F</b>	Arm Height	31"	31"	31.5"	31"	31"



### 13" D Seat, pitched .5-degree toward the front

29 lbs | 1.75 yds

Model	Series 2	Series 3	Series 4	Series 5	Series 6	Series 7	Series 8	COM
<b>314B</b>	\$1,285	\$1,342	\$1,437	\$1,536	\$1,653	\$1,772	\$1,920	\$1,342



### 13" D Seat, pitched 4-degrees toward the back

29 lbs | 1.75 yds

Model	Series 2	Series 3	Series 4	Series 5	Series 6	Series 7	Series 8	COM
<b>314H</b>	\$1,285	\$1,342	\$1,437	\$1,536	\$1,653	\$1,772	\$1,920	\$1,342



### 13" D Seat, pitched 4-degrees toward the back with urethane arm caps

32 lbs | 1.75 yds

Model	Series 2	Series 3	Series 4	Series 5	Series 6	Series 7	Series 8	COM
<b>2750H</b>	\$1,576	\$1,633	\$1,728	\$1,827	\$1,944	\$2,063	\$2,211	\$1,633

## Easy Access Patient Chair



### 18" D Seat, chair with flat arm rests

29 lbs | 1.5 yds

Model	Series 2	Series 3	Series 4	Series 5	Series 6	Series 7	Series 8	COM
<b>314</b>	\$1,296	\$1,344	\$1,425	\$1,510	\$1,611	\$1,713	\$1,840	\$1,344



### 18" D Seat, chair with upholstered flat arm rests

29 lbs | 1.75 yds

Model	Series 2	Series 3	Series 4	Series 5	Series 6	Series 7	Series 8	COM
<b>316</b>	\$1,339	\$1,396	\$1,491	\$1,590	\$1,707	\$1,826	\$1,974	\$1,396

# Harmon Patient Chair



## More Information

Illustrated Glossary ▶ 409

Fabrics ▶ 421

Flammability (CTB-133) ▶ 429

Finishes ▶ 426

Ordering and Warranties ▶ 432

## Standard Features

- Solid maple frame
- Mortise and tenon joinery
- Spring seat construction
- Clean-out design
- Wood arms with wood insets
- Wallsaver legs
- Non-marring  $\frac{7}{8}$ " glides
- Upholstered back
- Nemschoff healthcare wood finish
- GREENGUARD Gold Certified
- Limited Lifetime Warranty

## Available Options

- Moisture barrier + \$69 per seat or back
- Black urethane arm inset + \$116
- Upholstered arm inset + \$116
- Wood back + \$233
- Upholstered back with slats + \$233
- CTB-133 + \$88/yard
- Two fabrics + \$64
- Three (or more) fabrics + \$90

## Specification Decisions

- Select fabric
- Select standard wood finish
- Add arm inset style
- Add back style

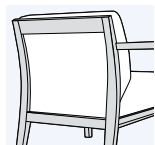

Upholstered back

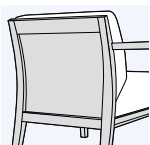

Wood back

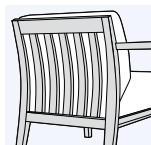

Upholstered back with wood slats

- Add CTB-133
- Apply multiple fabrics
- Add moisture barrier

Model numbers with **S** indicate standard seat and back covers, and model numbers with **P** indicate removable covers.

## Flammability Type

- Type 5

## Coordinating Products

- [Harmon Lounge Seating](#)

## Key Dimensions

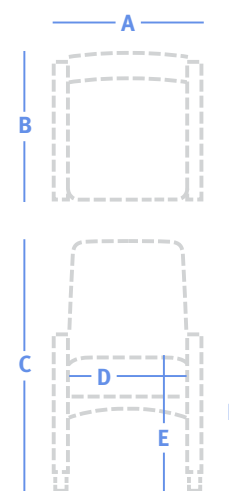

<b>A</b>	Overall Width	See price table
<b>B</b>	Overall Depth	26.5"
<b>C</b>	Overall Height	42"
<b>D</b>	Seat Width	21.5"
<b>E</b>	Seat Height	18.75"
<b>F</b>	Arm Height	26.75"



## 24.75" W, High back patient chair

41 lbs | 2.25 yds

Model	Series 2	Series 3	Series 4	Series 5	Series 6	Series 7	Series 8	COM
<b>708-51 S</b>	\$1,445	\$1,518	\$1,640	\$1,767	\$1,918	\$2,071	\$2,261	\$1,518
<b>708-51 P</b>	\$1,628	\$1,701	\$1,823	\$1,950	\$2,101	\$2,254	\$2,444	\$1,701

# Horizon Patient Chair



## Standard Features

- Solid hardwood frame
- Clean-out design
- Replaceable components
- Wood arm caps
- Laminate footrest
- Nemschoff healthcare wood finish
- GREENGUARD Gold Certified
- Limited Lifetime Warranty

## Available Options

- Moisture barrier + \$69 per seat or back
- Black urethane arm caps + \$116
- CTB-133 + \$83/yd
- Removable covers + \$174
- Two fabrics + \$64
- Three (or more) fabrics + \$90

## Specification Decisions

- Select fabric
- Select standard wood finish
- Select standard laminate
- Add moisture barrier
- Add CTB-133
- Apply multiple fabrics
- Add removable covers

## Flammability Type

- Type 3

## Coordinating Products

- [Horizon Multiple Seating](#)
- [Horizon Tables](#)
- [Horizon Recliner](#)
- [Horizon Glider](#)

## Key Dimensions

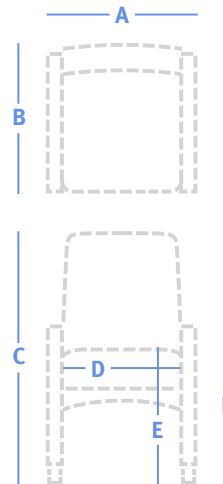

<b>A</b>	Overall Width	See price table
<b>B</b>	Overall Depth	25"
<b>C</b>	Overall Height	38.5"
<b>D</b>	Seat Width	19.5"
<b>E</b>	Seat Height	24.5"
<b>F</b>	Arm Height	32"

### More Information

Illustrated Glossary ▶ 409

Fabrics ▶ 421

Flammability (CTB-133) ▶ 429

Finishes ▶ 426

Ordering and Warranties ▶ 432



### 23" W, Patient chair

32 lbs | 1 3/4 yds

Model	Series 2	Series 3	Series 4	Series 5	Series 6	Series 7	Series 8	COM
<b>727</b>	\$1,671	\$1,699	\$1,822	\$1,888	\$1,924	\$1,971	\$2,001	\$1,699

# Marco Patient Chair



## More Information

Illustrated Glossary ▶ 409

Fabrics ▶ 421

Flammability (CTB-133) ▶ 429

Finishes ▶ 426

Ordering and Warranties ▶ 432

## Standard Features

- Solid maple frame
- Mortise and tenon joinery
- Spring seat construction
- Clean-out design
- Replaceable components
- Wood arms
- Wallsaver legs
- Non-marring 7/8" plastic rubber-cushioned glides
- Nemschoff healthcare wood finish
- GREENGUARD Gold Certified
- Limited Lifetime Warranty

## Available Options

- Moisture barrier + \$69 per seat or back
- CTB-133 + \$83/yd
- Two fabrics + \$64
- Three (or more) fabrics + \$90

## Specification Decisions

- Select fabric
- Select standard wood finish
- Add CTB-133
- Apply multiple fabrics
- Add moisture barrier

Model numbers with **S** indicate standard seat and back covers, and model numbers with **P** indicate removable covers.

## Flammability Type

- Type 4
- Type 2 (Footstool)

## Coordinating Products

- [Marco Grande II Lounge Seating](#)
- [Marco Multiple Seating](#)
- [Marco Grande Tables](#)
- [Marco Glider](#)

## Key Dimensions

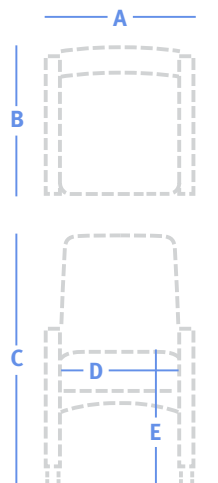

<b>A</b>	Overall Width	See price table
<b>B</b>	Overall Depth	27"
<b>C</b>	Overall Height	40.5"
<b>D</b>	Seat Width	19.75"
<b>E</b>	Seat Height	18.75"
<b>F</b>	Arm Height	25"

## Footstool dimensions

Depth	12"
Height	12"



### 23.5" W, High back patient chair

28 lbs | 2.75 yds

Model	Series 2	Series 3	Series 4	Series 5	Series 6	Series 7	Series 8	COM
<b>735-51 S</b>	\$1,704	\$1,793	\$1,942	\$2,097	\$2,282	\$2,468	\$2,701	\$1,793
<b>735-51 P</b>	\$1,920	\$2,009	\$2,158	\$2,313	\$2,498	\$2,684	\$2,917	\$2,009



### 17" W, Footstool

7 lbs | 1.25 yds

Model	Series 2	Series 3	Series 4	Series 5	Series 6	Series 7	Series 8	COM
<b>735-59 S</b>	\$255	\$295	\$363	\$434	\$517	\$602	\$708	\$295
<b>735-59 P</b>	\$291	\$331	\$399	\$470	\$553	\$638	\$744	\$331



# McKinley Patient Chair



## Standard Features

- Solid hardwood frame
- Mortise and tenon joinery
- Clean-out design
- Replaceable components
- Wood arm caps
- Wallsaver legs
- Non-marring 7/8" plastic rubber-cushioned glides
- Nemschoff healthcare wood finish
- GREENGUARD Gold Certified
- Limited Lifetime Warranty

## Available Options

- Moisture barrier + \$69 per seat or back
- Black urethane arm caps + \$116
- CTB-133 + \$83/yd
- Two fabrics + \$64
- Three (or more) fabrics + \$90

## Specification Decisions

- Select fabric
- Select standard wood finish
- Add CTB-133
- Apply multiple fabrics
- Add moisture barrier
- Add urethane arm caps

## Flammability Type

- Type 5

## Key Dimensions

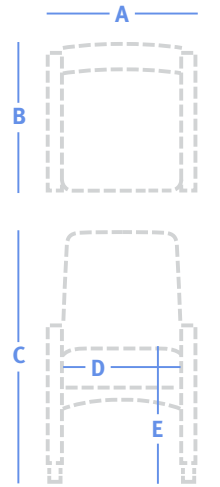

<b>A</b>	Overall Width	See price table
<b>B</b>	Overall Depth	28.5"
<b>C</b>	Overall Height	43"
<b>D</b>	Seat Width	21"
<b>E</b>	Seat Height	18.75"
<b>F</b>	Arm Height	25.75"

## More Information

Illustrated Glossary ▶ 409

Fabrics ▶ 421

Flammability (CTB-133) ▶ 429

Finishes ▶ 426

Ordering and Warranties ▶ 432



### 24" W, High back patient chair

28 lbs | 2.5 yds

Model	Series 2	Series 3	Series 4	Series 5	Series 6	Series 7	Series 8	COM
<b>FX551-1</b>	\$905	\$985	\$1,119	\$1,259	\$1,426	\$1,579	\$1,789	\$985

# Meridian Patient Chair



## More Information

Illustrated Glossary ▶ 409

Fabrics ▶ 421

Flammability (CTB-133) ▶ 429

Finishes ▶ 426

Ordering and Warranties ▶ 432

## Standard Features

- Solid hardwood frame
- Wipe-out design
- Replaceable components
- Wood arms
- Non-marring ¾" glides
- Nemschoff healthcare wood finish
- GREENGUARD Gold Certified
- Limited Lifetime Warranty

## Available Options

- Moisture barrier + \$69 per seat or back
- Black urethane arm caps + \$116
- CTB-133 + \$83/yd
- Two fabrics + \$64
- Three (or more) fabrics + \$90

## Specification Decisions

- Select fabric
- Select standard wood finish
- Add urethane arm caps
- Add CTB-133
- Apply multiple fabrics
- Add moisture barrier

## Flammability Type

- Type 5

## Coordinating Products

- [Meridian Multiple Seating](#)
- [Meridian Tables](#)
- [Meridian Behavioral Health Seating](#)

## Key Dimensions

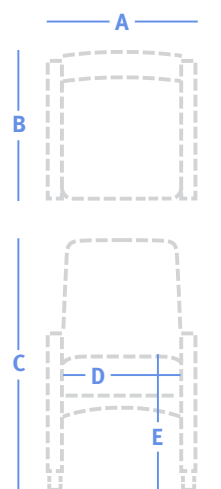

<b>A</b>	Overall Width	See price table
<b>B</b>	Overall Depth	25.5"
<b>C</b>	Overall Height	43"
<b>D</b>	Seat Width	19.5"
<b>E</b>	Seat Height	18"
<b>F</b>	Arm Height	25"

	<b>23" W, High back patient chair</b>								26 lbs   2.25 yds
	Model	Series 2	Series 3	Series 4	Series 5	Series 6	Series 7	Series 8	COM
<b>MP10</b>	\$1,097	\$1,133	\$1,291	\$1,376	\$1,422	\$1,482	\$1,521	\$1,133	
	<b>25.5" W, High back patient chair</b>								32 lbs   2.5 yds
	Model	Series 2	Series 3	Series 4	Series 5	Series 6	Series 7	Series 8	COM
<b>MP15</b>	\$1,257	\$1,297	\$1,473	\$1,567	\$1,618	\$1,685	\$1,728	\$1,297	

# Monarch Patient Chair



## Standard Features

- Solid hardwood frame
- Mortise and tenon joinery
- Memory foam seat
- Wipe-out design
- Replaceable components
- Black urethane arm caps
- Wallsaver legs
- Non-marring 7/8" glides
- Nemschoff healthcare wood finish
- GREENGUARD Gold Certified
- Limited Lifetime Warranty

## Available Options

- Moisture barrier + \$69 per seat or back
- Wood arm caps + \$116
- CTB-133 + \$83/yd
- Two fabrics + \$64
- Three (or more) fabrics + \$90

## Specification Decisions

- Select fabric
- Select standard wood finish
- Add CTB-133
- Apply multiple fabrics
- Add moisture barrier
- Add wood arm caps

Model numbers with **S** indicate standard seat and back covers, and model numbers with **P** indicate removable covers.

## Flammability Type

- Type 3

## Coordinating Products

- [Monarch Lounge Seating](#)
- [Monarch Multiple Seating](#)
- [Monarch Stack Chair](#)
- [Monarch Tables](#)
- [Monarch Sleep Chair and Settee](#)

## Key Dimensions

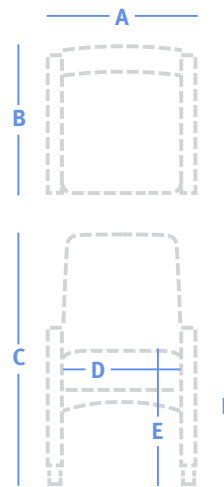

<b>A</b>	Overall Width	See price table
<b>B</b>	Overall Depth	25.5"
<b>C</b>	Overall Height	43"
<b>D</b>	Seat Width	20.25"
<b>E</b>	Seat Height	18.5"
<b>F</b>	Arm Height	27"

### More Information

- Illustrated Glossary ▶ 409
- Fabrics ▶ 421
- Flammability (CTB-133) ▶ 429
- Finishes ▶ 426
- Ordering and Warranties ▶ 432



### 22.75" W, High back patient chair

29 lbs | 1.75 yds

Model	Series 2	Series 3	Series 4	Series 5	Series 6	Series 7	Series 8	COM
<b>893-51 S</b>	\$954	\$1,011	\$1,106	\$1,205	\$1,322	\$1,441	\$1,589	\$1,011
<b>893-51 P</b>	\$1,076	\$1,133	\$1,228	\$1,327	\$1,444	\$1,563	\$1,711	\$1,133

# Nala Patient Chair



## More Information

Illustrated Glossary ▶ 409

Fabrics ▶ [www.nemschoff.com](http://www.nemschoff.com)

Flammability (CTB-133) ▶ 429

Finishes ▶ 426

Ordering and Warranties ▶ 432

## Standard Features

- Harmonic tilt (CR43)
- Fixed back, 15-degree angle (CR41)
- Seat and back suspension
- Titanium powder-coated aluminum frame (XTS)
- Dark grey urethane arm pads (G1)
- Integrated handle
- 24-degree recline range
- Seat and back suspension integrated on back of the seat
- Ships cartoned and drop-shipped
- GREENGUARD Gold Certified
- Cradle to Cradle Silver certification
- Twelve-year Warranty

## Available Options

- Moisture barrier + \$104
- Pivoting arms + \$136
- Tilt and roll casters + \$81
- Handle + \$76

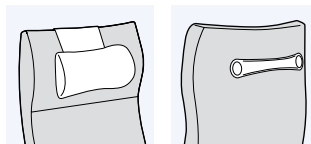

Headrest pillow      Handle

- Handle and headrest pillow + \$179
- CTB-133 (Chair) + \$324
- CTB-133 (Footstool) + \$141

## Specification Decisions

- Select Fixed back (CR41) or Harmonic tilt (CR43)
- Select fixed arms (2) or add pivoting arms (3)
- Select no tilt and roll (N) or add tilt and roll (W)
- Select no handle or pillow (N) or add handle (H) or add handle and pillow (P)

- Specify upholstery configuration



**Configuration 1**

Fabric 1: seat, inside back, outside back, headrest



**Configuration 2**

Fabric 1: seat  
Fabric 2: inside back, outside back, headrest



**Configuration 3**

Fabric 1: seat, inside back, headrest  
Fabric 2: outside back



**Configuration 4**

Fabric 1: seat, headrest  
Fabric 2: inside back, outside back



**Configuration 5**

Fabric 1: seat, inside back, outside back  
Fabric 2: headrest

### Note:

Pillow always matches seat upholstery in all configurations

- Select "Meets CTB-133 (FR)". If there is no CTB-133, skip this step
- Select no moisture barrier (NN) or add moisture barrier (6S)
- Note base finish (XTS)
- Note arm pad finish (G1)
- Select fabric 1 (see [nemschoff.com](http://nemschoff.com) for fabric options)
  - Configuration 1:* seat, inside back, outside back, headrest
  - Configuration 2:* seat
  - Configuration 3:* seat, inside back, headrest
  - Configuration 4:* seat, headrest
  - Configuration 5:* seat, inside back, outside back
- Select fabric 2 (see [nemschoff.com](http://nemschoff.com) for fabric options)
  - Configuration 1:* none
  - Configuration 2:* inside back, outside back, headrest
  - Configuration 3:* outside back
  - Configuration 4:* inside back, outside back
  - Configuration 5:* headrest

## Flammability Type

- Type 6

# Nala Patient Chair

## Complete Product Number Example

**CR433.WP4FR6SXTG13P02V601**

Model  
 Arm style  
 Tilt and roll option  
 Handle / pillow options  
 Upholstery configuration  
 CTB-133 option  
 Moisture barrier option  
 Base finish  
 Arm pad finish  
 Fabric 1  
 Fabric 2

## Key Dimensions

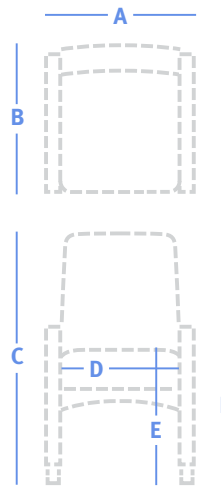

<b>A</b>	Overall Width	See price table
<b>B</b>	Overall Depth	28.5"
<b>C</b>	Overall Height	50.5"
<b>D</b>	Seat Width	22.25"
<b>E</b>	Seat Height	18" – 18.75" (lowest to highest point)
<b>F</b>	Arm Height	27.5"

### Footstool dimensions

Depth	16.5"
Height	16.5"

### Description:

Harmonic tilt, pivoting arms, tilt and roll, handle and pillow, upholstery configuration 4, meets CTB-133, moisture barrier, titanium base finish, graphite arm pad finish, 3P02 fabric 1, V601 fabric 2.



### 33" W, Fixed back patient chair

72 lbs

Model	Upholstery Configuration				
<b>CR41</b>	<b>1</b>	<b>2</b>	<b>3</b>	<b>4</b>	<b>5</b>

<i>Fabric 1 Yardage</i>	3 yds	1.5 yds	2.5 yds	2 yds	3 yds
-------------------------	-------	---------	---------	-------	-------

### Base Price

\$2,241

### *Fabric 1 Upcharge*

Grade	1	2	3	4	5
<b>1</b>	-	-	-	-	-
<b>3</b>	\$96	\$38	\$76	\$58	\$96
<b>4</b>	\$145	\$58	\$116	\$88	\$145
<b>C</b>	\$142	\$57	\$114	\$86	\$142
<b>D</b>	\$163	\$66	\$131	\$99	\$163
<b>E</b>	\$207	\$82	\$166	\$125	\$207
<b>F</b>	\$257	\$103	\$205	\$154	\$257
<b>G</b>	\$273	\$110	\$219	\$164	\$273

<i>Fabric 2 Yardage</i>	-	2.5 yds	1.5 yds	2.5 yds	1.5 yds
-------------------------	---	---------	---------	---------	---------

### *Fabric 2 Upcharge*

Grade	1	2	3	4	5
<b>1</b>	-	-	-	-	-
<b>3</b>	-	\$76	\$38	\$76	\$38
<b>4</b>	-	\$116	\$58	\$116	\$58
<b>C</b>	-	\$114	\$57	\$114	\$57
<b>D</b>	-	\$131	\$66	\$131	\$66
<b>E</b>	-	\$166	\$82	\$166	\$82
<b>F</b>	-	\$205	\$103	\$205	\$103
<b>G</b>	-	\$219	\$110	\$219	\$110

# Nala Patient Chair



**33" W, Harmonic tilt patient chair** 80 lbs

Model	Upholstery Configuration				
-------	--------------------------	--	--	--	--

CR43	1	2	3	4	5
------	---	---	---	---	---

<i>Fabric 1 Yardage</i>	3 yds	1.5 yds	2.5 yds	2 yds	3 yds
-------------------------	-------	---------	---------	-------	-------

*Fabric 1 Upcharge*

**Base Price**

\$2,597

Grade	1	-	-	-	-
-------	---	---	---	---	---

	<b>3</b>	\$96	\$38	\$76	\$58	\$96
--	----------	------	------	------	------	------

	<b>4</b>	\$145	\$58	\$116	\$88	\$145
--	----------	-------	------	-------	------	-------

	<b>C</b>	\$142	\$57	\$114	\$86	\$142
--	----------	-------	------	-------	------	-------

	<b>D</b>	\$163	\$66	\$131	\$99	\$163
--	----------	-------	------	-------	------	-------

	<b>E</b>	\$207	\$82	\$166	\$125	\$207
--	----------	-------	------	-------	-------	-------

	<b>F</b>	\$257	\$103	\$205	\$154	\$257
--	----------	-------	-------	-------	-------	-------

	<b>G</b>	\$273	\$110	\$219	\$164	\$273
--	----------	-------	-------	-------	-------	-------

<i>Fabric 2 Yardage</i>	-	2.5 yds	1.5 yds	2.5 yds	1.5 yds
-------------------------	---	---------	---------	---------	---------

*Fabric 2 Upcharge*

Grade	1	-	-	-	-
-------	---	---	---	---	---

	<b>3</b>	-	\$76	\$38	\$76	\$38
--	----------	---	------	------	------	------

	<b>4</b>	-	\$116	\$58	\$116	\$58
--	----------	---	-------	------	-------	------

	<b>C</b>	-	\$114	\$57	\$114	\$57
--	----------	---	-------	------	-------	------

	<b>D</b>	-	\$131	\$66	\$131	\$66
--	----------	---	-------	------	-------	------

	<b>E</b>	-	\$166	\$82	\$166	\$82
--	----------	---	-------	------	-------	------

	<b>F</b>	-	\$205	\$103	\$205	\$103
--	----------	---	-------	-------	-------	-------

	<b>G</b>	-	\$219	\$110	\$219	\$110
--	----------	---	-------	-------	-------	-------

Patient Chairs

Recliners

Treatment Chairs

Rockers & Gliders

Overbed Tables

Sleepover Seating

Casegoods

Display & Accessories

# Nala Patient Chair

## Nala Footstool

### Specification Decisions

- Select Nala Footstool (CR900)
- Select “Meets CTB-133 (FR)”. If there is no CTB-133, skip this step
- Note base finish (XTS)
- Select fabric (see nemschoff.com for fabric options)

Footstool does not fit under chair



**25.25" W, Footstool**

16.5 lbs

Model

**CR900**

*Fabric Yardage* 1 yd

### Base Price

\$792

### *Fabric Upcharge*

Grade	Price
<b>1</b>	-
<b>3</b>	\$38
<b>4</b>	\$58
<b>C</b>	\$57
<b>D</b>	\$66
<b>E</b>	\$82
<b>F</b>	\$103
<b>G</b>	\$110

# Olivia Patient Chair



## More Information

Illustrated Glossary ▶ 409

Fabrics ▶ 421

Flammability (CTB-133) ▶ 429

Finishes ▶ 426

Ordering and Warranties ▶ 432

## Standard Features

- Solid maple frame
- Mortise and tenon joinery
- Spring seat construction
- Clean-out design
- Non-marring 7/8" plastic rubber-cushioned glides
- Upholstered arms
- Nemschoff healthcare wood finish
- GREENGUARD Gold Certified
- Limited Lifetime Warranty

## Available Options

- Moisture barrier + \$69 per seat or back
- CTB-133 + \$83/yd
- Two fabrics + \$64
- Three (or more) fabrics + \$90

## Specification Decisions

- Select fabric
- Select standard wood finish
- Add CTB-133
- Apply multiple fabrics
- Add moisture barrier

Model numbers with **S** indicate standard seat and back covers, and model numbers with **P** indicate removable covers.

## Flammability Type

- Type 6

## Coordinating Products

- [Olivia Lounge Seating](#)
- [Olivia Tables](#)
- [Olivia Glider](#)

## Key Dimensions

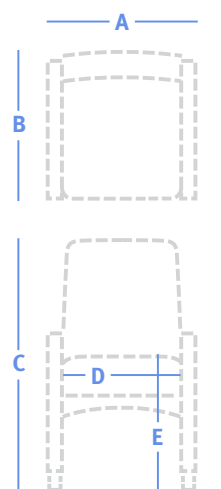

<b>A</b>	Overall Width	See price table
<b>B</b>	Overall Depth	31"
<b>C</b>	Overall Height	39.5"
<b>D</b>	Seat Width	21.25"
<b>E</b>	Seat Height	18"
<b>F</b>	Arm Height	25.5"



### 28.25" W, High back patient chair

37 lbs | 4.25 yds

Model	Series 2	Series 3	Series 4	Series 5	Series 6	Series 7	Series 8	COM
<b>903-51 S</b>	\$2,365	\$2,503	\$2,733	\$2,973	\$3,258	\$3,546	\$3,907	\$2,503
<b>903-51 P</b>	\$2,666	\$2,804	\$3,034	\$3,274	\$3,559	\$3,847	\$4,208	\$2,804



# Revive Patient Chair



## More Information

Illustrated Glossary ▶ 409

Fabrics ▶ 421

Flammability (CTB-133) ▶ 429

Finishes ▶ 426

Ordering and Warranties ▶ 432

## Standard Features

- Powder-coated metal frame
- Wipe-out design
- Wood arm caps
- Dynamic flexing back (2.5-degrees)
- Non-marring plastic glides
- GREENGUARD Gold Certified
- Limited Lifetime Warranty

## Available Options

- Laminate infill arm panel + \$137
- Wood infill arm panel + \$0
- Black urethane arm caps + \$116
- CTB-133 + \$83/yd
- Two fabrics + \$64
- Three (or more) fabrics + \$90
- Adjustable neck pillow + \$174 see price table
- Magazine holder (LSF) + \$190
- Pullout drink holder (black) + \$184
- Sliding storage tray (RSF) + \$124
- Removable covers + \$174

## Specification Decisions

- Select fabric
- Select powder coat finish
- Add CTB-133
- Apply multiple fabrics
- Add moisture barrier
- Add urethane arm caps
- Add adjustable neck pillow
- Add panel arms (V wood, L laminate)
- Add magazine holder (LSF)
- Add Pullout drink holder
- Add sliding storage tray
- Add removable covers

## Flammability Types

- Type 5 (Open arms)
- Type 6 (Arm panels)
- Type 2 (Footstool)

## Coordinating Products

- [Revive Side Chair](#)
- [Revive Casegoods](#)
- [Revive Daystands](#)
- [Revive Display System](#)
- [Revive Guest Center](#)

## Key Dimensions

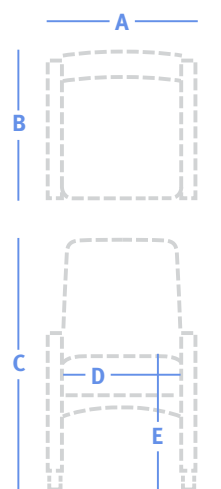







<b>A</b>	Overall Width	See price table
<b>B</b>	Overall Depth	25", 26"
<b>C</b>	Overall Height	43", 47"
<b>D</b>	Seat Width	20", 20.5"
<b>E</b>	Seat Height	18.5"
<b>F</b>	Arm Height	24"

## Footstool dimensions

	Depth	13"
	Height	12"

## Revive Patient Chair

	<b>25" W, High back patient chair</b>									32 lbs   2.5 yds
	Model	Series 2	Series 3	Series 4	Series 5	Series 6	Series 7	Series 8	COM	
	<b>RV10</b>	\$1,585	\$1,625	\$1,801	\$1,895	\$1,946	\$2,013	\$2,056	\$1,625	
	<b>25" W, High back patient chair with short panel arms</b>									37 lbs   3 yds
	Model	Series 2	Series 3	Series 4	Series 5	Series 6	Series 7	Series 8	COM	
	<b>RV10SPA</b>	\$1,621	\$1,669	\$1,880	\$1,993	\$2,054	\$2,135	\$2,186	\$1,669	
	<b>25" W, High back patient chair with panel arms</b>									37 lbs   3.5 yds
	Model	Series 2	Series 3	Series 4	Series 5	Series 6	Series 7	Series 8	COM	
	<b>RV10HPA</b>	\$1,654	\$1,710	\$1,956	\$2,087	\$2,159	\$2,253	\$2,314	\$1,710	
	<b>25" W, Mid back patient chair</b>									32 lbs   2.5 yds
	Model	Series 2	Series 3	Series 4	Series 5	Series 6	Series 7	Series 8	COM	
	<b>RV11</b>	\$1,585	\$1,625	\$1,801	\$1,895	\$1,946	\$2,013	\$2,056	\$1,625	
	<b>25" W, Mid back patient chair with short panel arms</b>									37 lbs   3 yds
	Model	Series 2	Series 3	Series 4	Series 5	Series 6	Series 7	Series 8	COM	
	<b>RV11SPA</b>	\$1,621	\$1,669	\$1,880	\$1,993	\$2,054	\$2,135	\$2,186	\$1,669	
	<b>25" W, Mid back patient chair with panel arms</b>									37 lbs   3.5 yds
	Model	Series 2	Series 3	Series 4	Series 5	Series 6	Series 7	Series 8	COM	
	<b>RV11HPA</b>	\$1,654	\$1,710	\$1,956	\$2,087	\$2,159	\$2,253	\$2,314	\$1,710	
	<b>Adjustable neck pillow</b>									2 lbs   .5 yds
	Model	Series 2	Series 3	Series 4	Series 5	Series 6	Series 7	Series 8	COM	
	-	\$174	\$182	\$218	\$236	\$247	\$260	\$269	\$182	
	<b>20" W, Footstool</b>									14 lbs   .75 yds
	Model	Series 2	Series 3	Series 4	Series 5	Series 6	Series 7	Series 8	COM	
	<b>RV70</b>	\$224	\$236	\$289	\$317	\$333	\$353	\$366	\$236	

Patient Chairs

Recliners

Treatment Chairs

Rockers &amp; Gliders

Overbed Tables

Sleepover Seating

Casegoods

Display &amp; Accessories

# Torii Patient Chair



## Standard Features

- Solid maple frame
- Mortise and tenon joinery
- Spring seat construction
- Clean-out design
- Replaceable components
- Swoop back style
- Wood arm caps
- Non-marring 7/8" plastic rubber-cushioned glides
- Nemschoff healthcare wood finish
- GREENGUARD Gold Certified
- Limited Lifetime Warranty

## Available Options

- Moisture barrier + \$69 per seat or back
- Arcade back + \$0

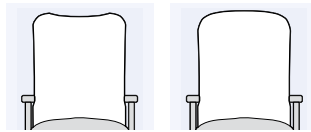

Swoop back (standard)

Arcade back

- Radius edge + \$0
- CTB-133 + \$83/yd
- Two fabrics + \$64
- Three (or more) fabrics + \$90

## Specification Decisions

- Select fabric
- Select standard wood finish
- Add CTB-133
- Apply multiple fabrics
- Add moisture barrier
- Add Arcade back

Model numbers with **S** indicate standard seat and back covers, and model numbers with **P** indicate removable covers.

## Flammability Types

- Type 5
- Type 2 (Footstool)

## Coordinating Products

- [Torii Multiple Seating](#)
- [Torii Side Chair](#)
- [Torii Tables](#)
- [Torii Glider](#)

## Key Dimensions

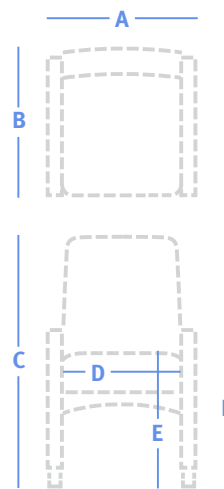

<b>A</b>	Overall Width	See price table
<b>B</b>	Overall Depth	27"
<b>C</b>	Overall Height	42"
<b>D</b>	Seat Width	19.75"
<b>E</b>	Seat Height	18.75"
<b>F</b>	Arm Height	26"

### Footstool dimensions

Depth	12"
Height	12.75"

### More Information

- Illustrated Glossary ▶ 409
- Fabrics ▶ 421
- Flammability (CTB-133) ▶ 429
- Finishes ▶ 426
- Ordering and Warranties ▶ 432



**24" W, High back patient chair** 38 lbs | 2.25 yds

Model	Series 2	Series 3	Series 4	Series 5	Series 6	Series 7	Series 8	COM
<b>283-51 S</b>	\$1,618	\$1,691	\$1,813	\$1,940	\$2,091	\$2,244	\$2,434	\$1,691
<b>283-51 P</b>	\$1,821	\$1,894	\$2,016	\$2,143	\$2,294	\$2,447	\$2,637	\$1,894



**17" W, Footstool** 8 lbs | 1.25 yds

Model	Series 2	Series 3	Series 4	Series 5	Series 6	Series 7	Series 8	COM
<b>283-59 S</b>	\$315	\$355	\$423	\$494	\$577	\$662	\$768	\$355
<b>283-59 P</b>	\$358	\$398	\$466	\$537	\$620	\$705	\$811	\$398

- Patient Chairs
- Recliners
- Treatment Chairs
- Rockers & Gliders
- Overbed Tables
- Sleeper Seating
- Casegoods
- Display & Accessories

# Valor Patient Chair



## Standard Features

- Heavy-duty steel construction
- Powder-coated metal frame
- Memory foam seat
- Wipe-out design
- Replaceable components
- Black urethane arms
- Non-marring 7/8" glides
- GREENGUARD Gold Certified
- Limited Lifetime Warranty

## Available Options

- Moisture barrier + \$69 per seat or back
- CTB-133 + \$83

## Specification Decisions

- Select fabric
- Select powder coat finish
- Add CTB-133
- Add moisture barrier

Model numbers with **S** indicate standard seat and back covers, and model numbers with **P** indicate removable covers.

## Flammability Type

- Type 3

## Coordinating Products

- [Valor Lounge Seating](#)
- [Valor Multiple Seating](#)
- [Valor Stack Chair](#)
- [Valor Tables](#)

## Key Dimensions

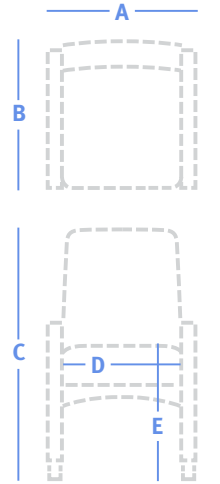

<b>A</b>	Overall Width	See price table
<b>B</b>	Overall Depth	25.25"
<b>C</b>	Overall Height	43.25"
<b>D</b>	Seat Width	20"
<b>E</b>	Seat Height	18"
<b>F</b>	Arm Height	26.25"

### More Information

- Illustrated Glossary ▶ 409
- Fabrics ▶ 421
- Flammability (CTB-133) ▶ 429
- Finishes ▶ 426
- Ordering and Warranties ▶ 432



### 23.25" W, High back patient chair

37 lbs | 2 yds

Model	Series 2	Series 3	Series 4	Series 5	Series 6	Series 7	Series 8	COM
<b>891-51 S</b>	\$747	\$812	\$920	\$1,033	\$1,168	\$1,303	\$1,473	\$812
<b>891-51 P</b>	\$845	\$910	\$1,018	\$1,131	\$1,266	\$1,401	\$1,571	\$910

## 2755 Series Adjustable Back Chair



### More Information

Illustrated Glossary ▶ 409

Fabrics ▶ 421

Flammability (CTB-133) ▶ 429

Finishes ▶ 426

Ordering and Warranties ▶ 432

### Standard Features

- Solid maple frame
- Mortise and tenon joinery
- Spring seat construction
- Replaceable components
- Black urethane arm caps
- Non-marring  $\frac{7}{8}$ " plastic rubber-cushioned glides
- Locking gas spring recline mechanism
- Infinite back adjustment within 111-degrees
- Wallsaver legs
- Wallsaver edge
- Nemschoff healthcare wood finish
- GREENGUARD Gold Certified
- Limited Lifetime Warranty; five years on mechanism

### Available Options

- Moisture barrier + \$69 per seat or back
- Desert or Pewter urethane arm caps + \$210
- CTB-133 + \$83/yd
- Two fabrics + \$64
- Three (or more) fabrics + \$90

### Specification Decisions

- Select fabric
- Select standard wood finish
- Add CTB-133
- Apply multiple fabrics
- Add moisture barrier
- Add urethane arm caps

Model numbers with **S** indicate standard seat and back covers, and model numbers with **P** indicate removable covers.

### Flammability Type

- Type 5

### Coordinating Products

- 2755 Series CompactComfort Recliner

### Key Dimensions

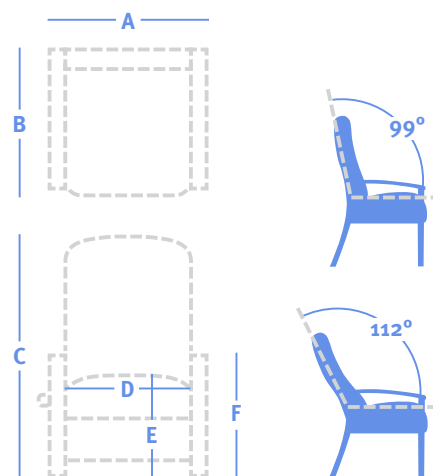

<b>A</b>	Overall Width	See price table
<b>B</b>	Overall Depth	29" 34" (reclined)
<b>C</b>	Overall Height	44.5"
<b>D</b>	Seat Width	21.5"
<b>E</b>	Seat Height	18.75"
<b>F</b>	Arm Height	26"

	<b>25.75" W, Adjustable back chair</b>									44 lbs   2.5 yds
	Model	Series 2	Series 3	Series 4	Series 5	Series 6	Series 7	Series 8	COM	
	<b>2755-52 S</b>	\$1,865	\$1,946	\$2,081	\$2,223	\$2,390	\$2,560	\$2,772	\$1,946	
	<b>2755-52 P</b>	\$2,099	\$2,180	\$2,315	\$2,457	\$2,624	\$2,794	\$3,006	\$2,180	
	<b>17" W, Footstool</b>									8 lbs   1.25 yds
	Model	Series 2	Series 3	Series 4	Series 5	Series 6	Series 7	Series 8	COM	
	<b>2750-59 S</b>	\$315	\$355	\$423	\$494	\$577	\$662	\$768	\$355	
	<b>2750-59 P</b>	\$358	\$398	\$466	\$537	\$620	\$705	\$811	\$398	

# 2755 Series CompactComfort Recliner



## Standard Features

- Solid maple frame
- Mortise and tenon joinery
- Spring seat construction
- Replaceable components
- Black urethane arm caps
- Non-marring 7/8" plastic rubber-cushioned glides
- Wallsaver legs
- Wallsaver edge
- Locking gas spring recline mechanism
- Fold-out footrest
- Infinite back adjustment within 108-degrees
- Nemschoff healthcare wood finish
- GREENGUARD Gold Certified
- Limited Lifetime Warranty; five years on mechanism

## Available Options

- Moisture barrier + \$69 per seat or back
- Tilt and roll, 2" single-wheel casters + \$286
- Desert or Pewter urethane arm caps + \$210
- CTB-133 + \$83/yd
- Two fabrics + \$64
- Three (or more) fabrics + \$90

## Specification Decisions

- Select fabric
- Select standard wood finish
- Add CTB-133
- Apply multiple fabrics
- Add moisture barrier
- Add urethane arm caps
- Add tilt and roll casters

Model numbers with **S** indicate standard seat and back covers, and model numbers with **P** indicate removable covers.

## Flammability Type

- Type 5

## Coordinating Products

- [2755 Series Adjustable Back Chair](#)

## Key Dimensions

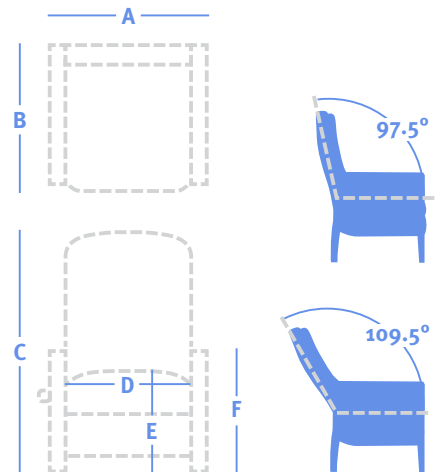

<b>A</b>	Overall Width	See price table
<b>B</b>	Overall Depth	29.5" 53.5" (reclined)
<b>C</b>	Overall Height	43.75"
<b>D</b>	Seat Width	21.5"
<b>E</b>	Seat Height	18.75"
<b>F</b>	Arm Height	26"

### More Information

- Illustrated Glossary ▶ 409
- Fabrics ▶ 421
- Flammability (CTB-133) ▶ 429
- Finishes ▶ 426
- Ordering and Warranties ▶ 432

		27.5" W, CompactComfort recliner								71 lbs   3.5 yds
Model		Series 2	Series 3	Series 4	Series 5	Series 6	Series 7	Series 8	COM	
	<b>2755-62 S</b>	\$3,060	\$3,174	\$3,363	\$3,561	\$3,796	\$4,033	\$4,330	\$3,174	
	<b>2755-62 P</b>	\$3,441	\$3,555	\$3,744	\$3,942	\$4,177	\$4,414	\$4,711	\$3,555	

		27.5" W, CompactComfort recliner with firm flat seat								71 lbs   3.5 yds
Model		Series 2	Series 3	Series 4	Series 5	Series 6	Series 7	Series 8	COM	
	<b>2755-620 S</b>	\$3,214	\$3,328	\$3,517	\$3,715	\$3,950	\$4,187	\$4,484	\$3,328	
	<b>2755-620 P</b>	\$3,614	\$3,728	\$3,917	\$4,115	\$4,350	\$4,587	\$4,884	\$3,728	

# Auburn Recliner



## More Information

Illustrated Glossary ▶ 409

Fabrics ▶ 421

Flammability (CTB-133) ▶ 429

Finishes ▶ 426

Ordering and Warranties ▶ 432

## Standard Features

- Wood arm caps with extended profile
- Nemschoff healthcare wood finish
- GREENGUARD Gold Certified
- Limited Lifetime Warranty; five years on mechanism

## Available Options

- Moisture barrier + \$69 per seat or back
- Black urethane arm caps (mounted on top of wood arm caps and include a wood reveal) + \$116
- 100-mm single-wheel swivel casters + \$259
- 11" x 16" Folding side table (Durawrap) + \$493
- CTB-133 + \$83
- Stainless steel push bar + \$232
- Magazine pouch (MG - see price table)
- Headrest pillow (HP - see price table)
- Removable covers + \$174
- Two fabrics + \$64
- Three (or more) fabrics + \$90

## Specification Decisions

- Select fabric
- Select standard wood finish
- Add CTB-133
- Apply multiple fabrics
- Add moisture barrier
- Add urethane arm caps
- Add casters
- Add folding side table (select Durawrap)
- Add push bar
- Add magazine pouch
- Add headrest pillow
- Add removable covers

## Flammability Type

- Type 6

## Coordinating Products

- [Auburn Multiple Seating](#)
- [Auburn Tables](#)
- [Auburn Glider](#)

## Key Dimensions

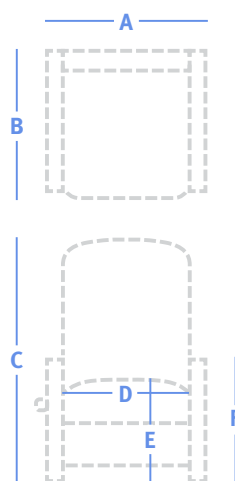

<b>A</b>	Overall Width	See price table
<b>B</b>	Overall Depth	35", 37" 67.5" (reclined)
<b>C</b>	Overall Height	43"
<b>D</b>	Seat Width	23.5"
<b>E</b>	Seat Height	18.5"
<b>F</b>	Arm Height	24.5"



## Auburn Recliner



## 29.5" W, Three-position recliner with push back

105 lbs | 6 yds

Model	Series 2	Series 3	Series 4	Series 5	Series 6	Series 7	Series 8	COM
<b>ABRN_00030</b>	\$2,253	\$2,349	\$2,770	\$2,996	\$3,119	\$3,280	\$3,383	\$2,349



## 29.5" W, Wallsaver recliner with LSF pull strap

109 lbs | 6 yds

Model	Series 2	Series 3	Series 4	Series 5	Series 6	Series 7	Series 8	COM
<b>ABRN_00050</b>	\$2,511	\$2,607	\$3,028	\$3,254	\$3,377	\$3,538	\$3,641	\$2,607



## 31.5" W, Flat-fold recliner with LSF outside handle

133 lbs | 8 yds

Model	Series 2	Series 3	Series 4	Series 5	Series 6	Series 7	Series 8	COM
<b>ABRN_00060</b>	\$3,565	\$3,694	\$4,255	\$4,556	\$4,720	\$4,935	\$5,073	\$3,694

## Headrest pillow

1.75 yds

Model	Series 2	Series 3	Series 4	Series 5	Series 6	Series 7	Series 8	COM
<b>HP</b>	\$76	\$88	\$141	\$169	\$185	\$205	\$218	\$88

## Magazine pouch

1.75 yds

Model	Series 2	Series 3	Series 4	Series 5	Series 6	Series 7	Series 8	COM
<b>MG</b>	\$64	\$76	\$129	\$157	\$173	\$193	\$206	\$76

# Brava Adjustable Back Chair



## More Information

Illustrated Glossary ▶ 409

Fabrics ▶ 421

Flammability (CTB-133) ▶ 429

Finishes ▶ 426

Ordering and Warranties ▶ 432

## Standard Features

- Solid maple frame
- Mortise and tenon joinery
- Spring seat construction
- Replaceable components
- Non-marring  $\frac{7}{8}$ " plastic rubber-cushioned glides
- Wallsaver legs and edge
- Locking gas spring recline mechanism
- Infinite back adjustment within 111-degrees
- Nemschoff healthcare wood finish
- GREENGUARD Gold Certified
- Limited Lifetime Warranty; five years on mechanism

## Available Options

- Moisture barrier + \$69 per seat or back
- Black urethane arm caps + \$116
- Desert or Pewter urethane arm caps + \$210
- Wood arm caps (862) + \$116
- CTB-133 + \$83/yd
- Two fabrics + \$64
- Three (or more) fabrics + \$90

## Specification Decisions

- Select fabric
- Select standard wood finish
- Add CTB-133
- Apply multiple fabrics
- Add moisture barrier
- Add wood or urethane arm caps

Model numbers with **S** indicate standard seat and back covers, and model numbers with **P** indicate removable covers.

## • Flammability Types

- Type 6
- Type 5 (open arms)

## Coordinating Products

- [Brava Classic Lounge Seating](#)
- [Brava Platform Lounge Seating](#)
- [Brava 862 Multiple Seating](#)
- [Brava 863 Multiple Seating](#)
- [Brava Side Chair](#)
- [Brava Tables](#)
- [Brava CompactComfort Recliner](#)
- [Brava Patient Chair](#)
- [Brava Glider](#)
- [Brava Flop Sofa](#)
- [Brava Sleep Settee](#)

## Key Dimensions

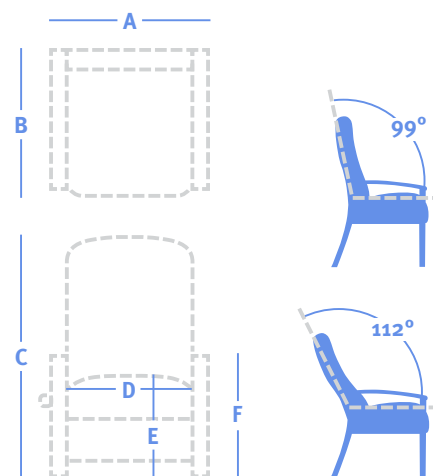

<b>A</b>	Overall Width	See price table
<b>B</b>	Overall Depth	27" 35" (reclined)
<b>C</b>	Overall Height	44"
<b>D</b>	Seat Width	20.75", 21.5"
<b>E</b>	Seat Height	18.75"
<b>F</b>	Arm Height	26.5"

## Brava Adjustable Back Chair



### 25.75" W, Adjustable back chair with open wood arms

44 lbs | 2.5 yds

Model	Series 2	Series 3	Series 4	Series 5	Series 6	Series 7	Series 8	COM
<b>863-52 S</b>	\$2,748	\$2,829	\$2,964	\$3,106	\$3,273	\$3,443	\$3,655	\$2,829
<b>863-52 P</b>	\$3,088	\$3,169	\$3,304	\$3,446	\$3,613	\$3,783	\$3,995	\$3,169



### 26.5" W, Adjustable back chair with fully upholstered arms

44 lbs | 3.5 yds

Model	Series 2	Series 3	Series 4	Series 5	Series 6	Series 7	Series 8	COM
<b>862-52 S</b>	\$2,916	\$3,030	\$3,219	\$3,417	\$3,652	\$3,889	\$4,186	\$3,030
<b>862-52 P</b>	\$3,280	\$3,394	\$3,583	\$3,781	\$4,016	\$4,253	\$4,550	\$3,394

# Brava CompactComfort Recliner



## More Information

Illustrated Glossary ▶ 409

Fabrics ▶ 421

Flammability (CTB-133) ▶ 429

Finishes ▶ 426

Ordering and Warranties ▶ 432

## Standard Features

- Solid maple frame
- Mortise and tenon joinery
- Spring seat construction
- Replaceable components
- Non-marring 7/8" plastic rubber-cushioned glides
- Wallsaver legs and edge
- Locking gas spring recline mechanism
- Infinite back adjustment within 108-degrees
- Fold-out footrest
- Nemschoff healthcare wood finish
- GREENGUARD Gold Certified
- Limited Lifetime Warranty; five years on mechanism

## Available Options

- Moisture barrier + \$69 per seat or back
- Black urethane arm caps + \$116
- Desert or Pewter urethane arm caps + \$210
- Wood arm caps (862) + \$116
- CTB-133 + \$83/yd
- Tilt and roll, 2" single wheel casters + \$286
- Two fabrics + \$64
- Three (or more) fabrics + \$90

## Specification Decisions

- Select fabric
- Select standard wood finish
- Add CTB-133
- Apply multiple fabrics
- Add moisture barrier
- Add wood or urethane arm caps
- Add tilt and roll casters

Model numbers with **S** indicate standard seat and back covers, and model numbers with **P** indicate removable covers.

## Flammability Type

- Type 6

## Coordinating Products

- [Brava Classic Lounge Seating](#)
- [Brava Platform Lounge Seating](#)
- [Brava 862 Multiple Seating](#)
- [Brava 863 Multiple Seating](#)
- [Brava Side Chair](#)
- [Brava Tables](#)
- [Brava Adjustable Back Chair](#)
- [Brava Patient Chair](#)
- [Brava Glider](#)
- [Brava Flop Sofa](#)
- [Brava Sleep Settee](#)

## Key Dimensions

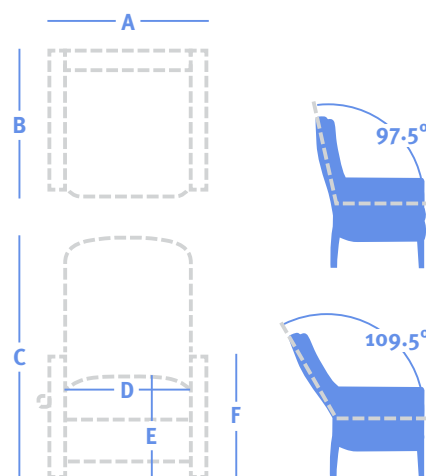

<b>A</b>	Overall Width	See price table
<b>B</b>	Overall Depth	30" 53.75" (reclined)
<b>C</b>	Overall Height	43.75"
<b>D</b>	Seat Width	21.5"
<b>E</b>	Seat Height	19"
<b>F</b>	Arm Height	26.5"

Welcoming & Waiting

## Brava CompactComfort Recliner



### 26.75" W, CompactComfort recliner with open wood arms 73 lbs | 3.25 yds

Model	Series 2	Series 3	Series 4	Series 5	Series 6	Series 7	Series 8	COM
<b>863-62 S</b>	\$3,401	\$3,507	\$3,683	\$3,866	\$4,085	\$4,305	\$4,581	\$3,507
<b>863-62 P</b>	\$3,822	\$3,928	\$4,104	\$4,287	\$4,506	\$4,726	\$5,002	\$3,928



### 27.5" W, CompactComfort recliner with fully upholstered arms 73 lbs | 4.5 yds

Model	Series 2	Series 3	Series 4	Series 5	Series 6	Series 7	Series 8	COM
<b>862-62 S</b>	\$3,562	\$3,708	\$3,951	\$4,205	\$4,507	\$4,813	\$5,194	\$3,708
<b>862-62 P</b>	\$4,007	\$4,153	\$4,396	\$4,650	\$4,952	\$5,258	\$5,639	\$4,153

Patient Areas

Specialty

Reference

# Capella Adjustable Back Chair



## More Information

Illustrated Glossary ▶ 409

Fabrics ▶ 421

Flammability (CTB-133) ▶ 429

Finishes ▶ 426

Ordering and Warranties ▶ 432

## Standard Features

- Solid maple frame
- Mortise and tenon joinery
- Spring seat construction
- Replaceable components
- Upholstered arms
- Non-marring 7/8" plastic rubber-cushioned glides
- Wallsaver edge
- Locking gas spring recline mechanism
- Infinite back adjustment within 111-degrees
- Nemschoff healthcare wood finish
- GREENGUARD Gold Certified
- Limited Lifetime Warranty; five years on mechanism

## Available Options

- Moisture barrier + \$69 per seat or back
- CTB-133 + \$83/yd
- Two fabrics + \$64
- Three (or more) fabrics + \$90

## Specification Decisions

- Select fabric
- Select standard wood finish
- Add CTB-133
- Apply multiple fabrics
- Add moisture barrier

Model numbers with **S** indicate standard seat and back covers, and model numbers with **P** indicate removable covers.

## Flammability Types

- Type 6
- Type 2 (Footstool)

## Coordinating Products

- [Capella Multiple Seating](#)
- [Capella Side Chair](#)
- [Capella Tables](#)
- [Capella Patient Chair](#)
- [Capella CompactComfort Recliner](#)
- [Capella Glider](#)
- [Capella Adjustable Back Glider](#)

## Key Dimensions

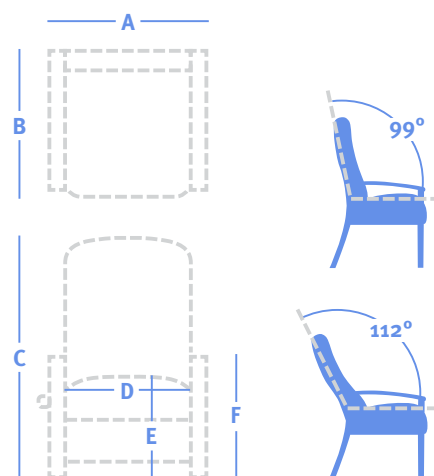

<b>A</b>	Overall Width	See price table
<b>B</b>	Overall Depth	26.75" 33.75" (reclined)
<b>C</b>	Overall Height	44.5"
<b>D</b>	Seat Width	20.5"
<b>E</b>	Seat Height	18.75"
<b>F</b>	Arm Height	24.75"

### Footstool dimensions

Depth	12"
Height	12"

	<b>27.25" W, Adjustable back chair</b>									32 lbs   2.75 yds
	Model	Series 2	Series 3	Series 4	Series 5	Series 6	Series 7	Series 8	COM	
	<b>740-52 S</b>	\$2,726	\$2,815	\$2,964	\$3,119	\$3,304	\$3,490	\$3,723	\$2,815	
	<b>740-52 P</b>	\$3,064	\$3,153	\$3,302	\$3,457	\$3,642	\$3,828	\$4,061	\$3,153	
	<b>17" W, Footstool</b>									8 lbs   1.25 yds
	Model	Series 2	Series 3	Series 4	Series 5	Series 6	Series 7	Series 8	COM	
	<b>740-59 S</b>	\$315	\$355	\$423	\$494	\$577	\$662	\$768	\$355	
	<b>740-59 P</b>	\$358	\$398	\$466	\$537	\$620	\$705	\$811	\$398	

# Capella CompactComfort Recliner



## Standard Features

- Solid maple frame
- Mortise and tenon joinery
- Spring seat construction
- Replaceable components
- Upholstered arms
- Non-marring 7/8" plastic rubber-cushioned glides
- Wallsaver edge
- Locking gas spring recline mechanism
- Infinite back adjustment within 108-degrees
- Fold-out footrest
- Nemschoff healthcare wood finish
- GREENGUARD Gold Certified
- Limited lifetime warranty; five years on mechanism

## Flammability Type

- Type 6

## Coordinating Products

- [Capella Multiple Seating](#)
- [Capella Side Chair](#)
- [Capella Tables](#)
- [Capella Patient Chair](#)
- [Capella Adjustable Back Chair](#)
- [Capella Glider](#)
- [Capella Adjustable Back Glider](#)

## Key Dimensions

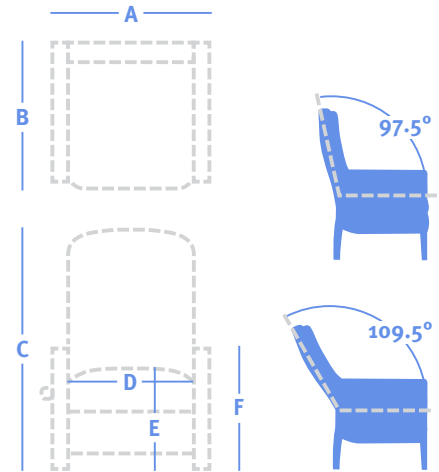

<b>A</b>	Overall Width	See price table
<b>B</b>	Overall Depth	29.25" 54.25"(reclined)
<b>C</b>	Overall Height	44"
<b>D</b>	Seat Width	20.75"
<b>E</b>	Seat Height	18.75"
<b>F</b>	Arm Height	24.75"

## More Information

- Illustrated Glossary ▶ 409
- Fabrics ▶ 421
- Flammability (CTB-133) ▶ 429
- Finishes ▶ 426
- Ordering and Warranties ▶ 432

## Available Options

- Moisture barrier + \$69 per seat or back
- Wood arm caps + \$116
- Tilt and roll, 2" single-wheel casters + \$286
- CTB-133 + \$83/yd
- Two fabrics + \$64
- Three (or more) fabrics + \$90

## Specification Decisions

- Select fabric
- Select standard wood finish
- Add CTB-133
- Apply multiple fabrics
- Add moisture barrier
- Add tilt and roll casters

Model numbers with **S** indicate standard seat and back covers, and model numbers with **P** indicate removable covers.



### 27.5" W, CompactComfort recliner

70 lbs | 5.5 yds

Model	Series 2	Series 3	Series 4	Series 5	Series 6	Series 7	Series 8	COM
<b>740-62 S</b>	\$3,462	\$3,641	\$3,938	\$4,249	\$4,618	\$4,991	\$5,457	\$3,641
<b>740-62 P</b>	\$3,899	\$4,078	\$4,375	\$4,686	\$5,055	\$5,428	\$5,894	\$4,078

## Cities Uptown CompactComfort Recliner



### More Information

Illustrated Glossary ▶ 409

Fabrics ▶ 421

Flammability (CTB-133) ▶ 429

Finishes ▶ 426

Ordering and Warranties ▶ 432

### Standard Features

- Solid maple frame
- Mortise and tenon joinery
- Spring seat construction
- Replaceable components
- Wood arm caps
- Non-marring  $\frac{7}{8}$ " plastic rubber-cushioned glides
- Wallsaver edge
- Locking gas spring recline mechanism
- Infinite back adjustment within 108-degrees
- Fold-out footrest
- Nemschoff healthcare wood finish
- GREENGUARD Gold Certified
- Limited Lifetime Warranty; five years on mechanism

### Available Options

- Moisture barrier + \$69 per seat or back
- Five arm cap styles + \$0
- CTB-133 + \$83
- Tilt and roll, 2" single-wheel casters + \$286
- Two fabrics + \$64
- Three (or more) fabrics + \$90

### Specification Decisions

- Select fabric
- Select standard wood finish
- Select arm cap style

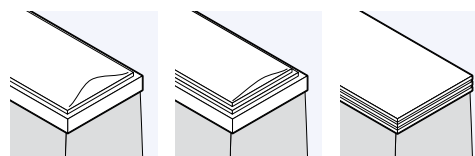

**C** Chicago

**L** Los Angeles

**N** New Orleans

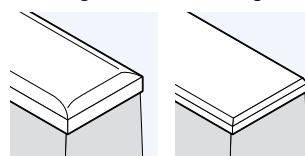

**Y** New York

**W** Williamsburg

- Add CTB-133
- Apply multiple fabrics
- Add moisture barrier
- Add tilt and roll casters

Model numbers with **S** indicate standard seat and back covers, and model numbers with **P** indicate removable covers.

### Flammability Type

- Type 6



# Cities Uptown CompactComfort Recliner

## Coordinating Products

- [Cities Small Crosstown Lounge Seating](#)
- [Cities Medium Crosstown Lounge Seating](#)
- [Cities Small Downtown Lounge Seating](#)
- [Cities Medium Downtown Lounge Seating](#)
- [Cities Small Uptown Lounge Seating](#)
- [Cities Medium Uptown Lounge Seating](#)
- [Cities Side Chair](#)
- [Cities Tables](#)
- [Cities Crosstown Patient Chair](#)
- [Cities Downtown Patient Chair](#)
- [Cities Uptown Patient Chair](#)
- [Cities Crosstown Rocker](#)
- [Cities Downtown Rocker](#)
- [Cities Uptown Rocker](#)
- [Cities Downtown Glider](#)
- [Cities Uptown Glider](#)
- [SleepOver Sofa](#)
- [SleepOver Settee](#)

## Key Dimensions

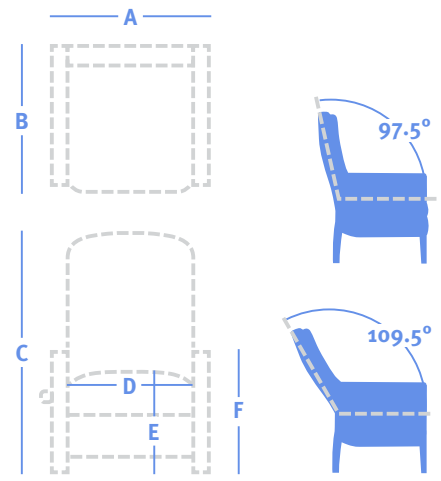

<b>A</b>	Overall Width	See price table
<b>B</b>	Overall Depth	29" 52" (reclined)
<b>C</b>	Overall Height	44"
<b>D</b>	Seat Width	20.5"
<b>E</b>	Seat Height	18.75"
<b>F</b>	Arm Height	25.25"



### 27" W, CompactComfort recliner

74 lbs | 5 yds

Model	Series 2	Series 3	Series 4	Series 5	Series 6	Series 7	Series 8	COM
<b>Cities-SUX000-62 S</b>	\$3,456	\$3,619	\$3,889	\$4,172	\$4,507	\$4,846	\$5,270	\$3,619
<b>Cities-SUX000-62 P</b>	\$3,891	\$4,054	\$4,324	\$4,607	\$4,942	\$5,281	\$5,705	\$4,054

# Consoul Recliner



## More Information

Illustrated Glossary ▶ 409

Fabrics ▶ 421

Flammability (CTB-133) ▶ 429

Finishes ▶ 426

Ordering and Warranties ▶ 432

## Standard Features

- Solid maple frame
- Mortise and tenon joinery
- Spring seat construction
- Clean-out design
- Replaceable components
- Upholstered arms
- Dual arm controls for back recline
- Infinite back recline from upright to fully flat
- Sleep surface dimensions 24.75" x 77.5"
- Independently operating footrest
- 3" swivel casters, front-locking
- Wallsaver bumper
- Nemschoff healthcare wood finish
- GREENGUARD Gold Certified
- Limited Lifetime Warranty; ten years on mechanism

## Available Options

- Moisture barrier + \$69 per seat or back
- Option package 1: Arm caps (wood or urethane) with thermoplastic (ABS) protective base + \$628
- Option package 2: Arm caps (wood or urethane) with thermoplastic (ABS) protective base and in-arm storage + \$915
- Monitor arm (LSF, RSF) + \$419
- Tablet table (LSF, RSF) laminate with wood edge + \$524
- Adjustable headrest + \$163
- CTB-133 + \$83/yd
- Two fabrics + \$64
- Three (or more) fabrics + \$90

## Specification Decisions

- Select fabric
- Select wallsaver bumper color (Black, Desert, Pewter)
- Add option package 1 or package 2
- Select standard wood finish, if required

- Select thermoplastic (ABS) color, if required (Black, Desert, Pewter)
- Add moisture barrier
- Add CTB-133
- Apply multiple fabrics
- Add monitor arm
- Add tablet table, specify laminate and wood edge color
- Add headrest

Model numbers with **S** indicate standard seat and back covers, and model numbers with **P** indicate removable covers.

## Flammability Type

- Type 6

## Coordinating Products

- [Consoul Sleep Chair and Settee](#)

## Key Dimensions

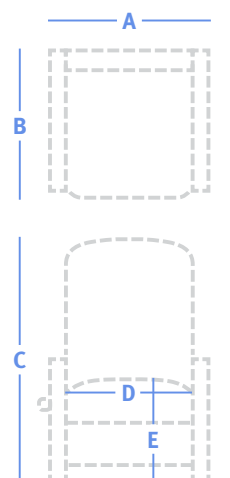

<b>A</b>	Overall Width	See price table
<b>B</b>	Overall Depth	37.75" 81" (reclined)
<b>C</b>	Overall Height	43.5"
<b>D</b>	Seat Width	24"
<b>E</b>	Seat Height	18.75"
<b>F</b>	Arm Height	26.25"



### 34" W, Recliner

147 lbs | 7.25 yds

Model	Series 2	Series 3	Series 4	Series 5	Series 6	Series 7	Series 8	COM
<b>798-66 S</b>	\$3,236	\$3,472	\$3,864	\$4,273	\$4,760	\$5,251	\$5,866	\$3,472
<b>798-66 P</b>	\$3,653	\$3,889	\$4,281	\$4,690	\$5,177	\$5,668	\$6,283	\$3,889

# Culla Recliner



## Standard Features

- Solid maple frame
- Mortise and tenon joinery
- Spring seat construction
- Replaceable components
- Wood arm caps
- Non-marring 2¼" glides
- Wallsaver edge
- Combination Glider/Recliner
- Must be 17" from wall to fully recline
- Independent footrest
- Nemschoff healthcare wood finish
- GREENGUARD Gold Certified
- Limited Lifetime Warranty; five years on mechanism

## Available Options

- Moisture barrier + \$69 per seat or back
- Black urethane arm caps + \$116
- Tilt and roll, 2" single wheel casters + \$286
- 2" twin rubber-wheel casters, front fixed with brakes, rear swivel + \$356
- CTB-133 + \$83/yd
- Two fabrics + \$64
- Three (or more) fabrics + \$90

## Specification Decisions

- Select fabric
- Select standard wood finish
- Add CTB-133

- Apply multiple fabrics
- Add moisture barrier
- Add urethane arm caps
- Add tilt and roll casters

Model numbers with **S** indicate standard seat and back covers, and model numbers with **P** indicate removable covers.

## Flammability Type

- Type 6

## Key Dimensions

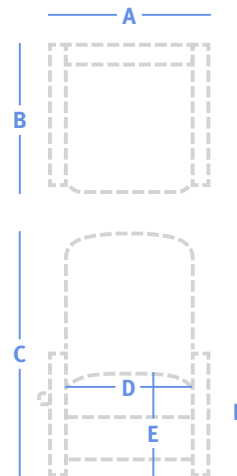

<b>A</b>	Overall Width	See price table
<b>B</b>	Overall Depth	34.5" 65" (reclined)
<b>C</b>	Overall Height	43.25"
<b>D</b>	Seat Width	23.5"
<b>E</b>	Seat Height	18.25"
<b>F</b>	Arm Height	24.5"

### More Information

- Illustrated Glossary ▶ 409
- Fabrics ▶ 421
- Flammability (CTB-133) ▶ 429
- Finishes ▶ 426
- Ordering and Warranties ▶ 432



### 33" W, Combination glider/recliner

135 lbs | 6.5 yds

Model	Series 2	Series 3	Series 4	Series 5	Series 6	Series 7	Series 8	COM
<b>287-68 S</b>	\$3,402	\$3,614	\$3,965	\$4,332	\$4,769	\$5,209	\$5,761	\$3,614
<b>287-68 P</b>	\$3,836	\$4,048	\$4,399	\$4,766	\$5,203	\$5,643	\$6,195	\$4,048

# Hadleigh Adjustable Back Chair



## More Information

Illustrated Glossary ▶ 409

Fabrics ▶ 421

Flammability (CTB-133) ▶ 429

Finishes ▶ 426

Ordering and Warranties ▶ 432

## Standard Features

- Solid maple frame
- Mortise and tenon joinery
- Spring seat construction
- Replaceable components
- Non-marring  $\frac{7}{8}$ " plastic rubber-cushioned glides
- Locking gas spring recline mechanism
- Infinite back adjustment within 111-degrees
- Wallsaver edge
- Nemschoff healthcare wood finish
- GREENGUARD Gold Certified
- Limited Lifetime Warranty; five years on mechanism

## Available Options

- Moisture barrier + \$69 per seat or back
- CTB-133 + \$83/yd
- Two fabrics + \$64
- Three (or more) fabrics + \$90

## Specification Decisions

- Select fabric
- Select standard wood finish
- Add CTB-133
- Apply multiple fabrics
- Add moisture barrier

Model numbers with **S** indicate standard seat and back covers, and model numbers with **P** indicate removable covers.

## Flammability Types

- Type 5
- Type 2 (Footstool)

## Coordinating Products

- [Hadleigh Tables](#)
- [Hadleigh Lounge Seating](#)
- [Hadleigh Casegoods](#)

## Key Dimensions

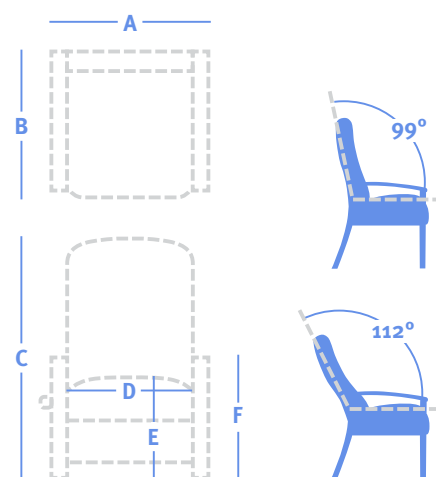

<b>A</b>	Overall Width	See price table
<b>B</b>	Overall Depth	26.5" 32.5" (reclined)
<b>C</b>	Overall Height	44"
<b>D</b>	Seat Width	21.25"
<b>E</b>	Seat Height	18.75"
<b>F</b>	Arm Height	25.25"

### Footstool dimensions

Depth	12"
Height	11.75"



### 27.75" W, Adjustable back chair

44 lbs | 2.75 yds

Model	Series 2	Series 3	Series 4	Series 5	Series 6	Series 7	Series 8	COM
<b>280-52 S</b>	\$2,167	\$2,256	\$2,405	\$2,560	\$2,745	\$2,931	\$3,164	\$2,256
<b>280-52 P</b>	\$2,438	\$2,527	\$2,676	\$2,831	\$3,016	\$3,202	\$3,435	\$2,527



### 17" W, Footstool

8 lbs | 1.25 yds

Model	Series 2	Series 3	Series 4	Series 5	Series 6	Series 7	Series 8	COM
<b>280-59 S</b>	\$315	\$355	\$423	\$494	\$577	\$662	\$768	\$355
<b>280-59 P</b>	\$358	\$398	\$466	\$537	\$620	\$705	\$811	\$398

# Horizon Recliner



## Standard Features

- Wood arm caps
- Nemschoff healthcare wood finish
- GREENGUARD Gold Certified
- Limited Lifetime Warranty; five years on mechanism

## Available Options

- Moisture barrier + \$69 per seat or back
- Black urethane arm caps + \$116
- 100-mm single-wheel swivel casters + \$259
- 11" x 16", folding table (Durawrap) + \$493
- CTB-133 + \$83
- Stainless steel push bar + \$232
- Magazine pouch (MG - see price table)
- Headrest pillow (HP - see price table)
- Removable covers + \$174
- Two fabrics + \$64
- Three (or more) fabrics + \$90

## Specification Decisions

- Select fabric
- Select standard wood finish
- Add CTB-133
- Apply multiple fabrics
- Add moisture barrier
- Add urethane arm caps
- Add casters
- Add folding side table (select Durawrap)
- Add push bar
- Add magazine pouch
- Add headrest pillow
- Add removable covers

Model numbers with **S** indicate standard seat and back covers, and model numbers with **P** indicate removable covers.

## Flammability Type

- Type 6

## Coordinating Products

- [Horizon Multiple Seating](#)
- [Horizon Tables](#)
- [Horizon Patient Chair](#)

## Key Dimensions

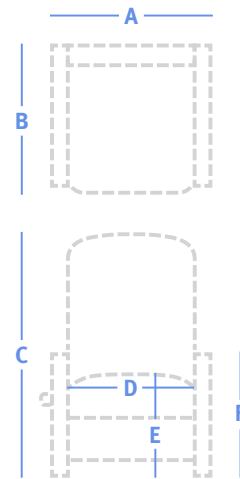

<b>A</b>	Overall Width	See price table
<b>B</b>	Overall Depth	36.5", 37.5", 38.5" 65" (reclined)
<b>C</b>	Overall Height	44.5"
<b>D</b>	Seat Width	21"
<b>E</b>	Seat Height	18.5", 18.75"
<b>F</b>	Arm Height	24"

## More Information

Illustrated Glossary ▶ 409

Fabrics ▶ 421

Flammability (CTB-133) ▶ 429

Finishes ▶ 426

Ordering and Warranties ▶ 432

## Horizon Recliner

**29" W, Three-position recliner with push back**

120 lbs | 6 yds

Model	Series 2	Series 3	Series 4	Series 5	Series 6	Series 7	Series 8	COM
<b>HRZN_00030</b>	\$2,150	\$2,246	\$2,667	\$2,893	\$3,016	\$3,177	\$3,280	\$2,246

**29" W, Wallsaver recliner with LSF pull strap**

124 lbs | 6 yds

Model	Series 2	Series 3	Series 4	Series 5	Series 6	Series 7	Series 8	COM
<b>HRZN_00050</b>	\$2,512	\$2,608	\$3,029	\$3,255	\$3,378	\$3,539	\$3,642	\$2,608

**31" W, Flat-fold recliner with LSF outside handle**

148 lbs | 8 yds

Model	Series 2	Series 3	Series 4	Series 5	Series 6	Series 7	Series 8	COM
<b>HRZN_00060</b>	\$3,550	\$3,679	\$4,240	\$4,541	\$4,705	\$4,920	\$5,058	\$3,679

**Headrest pillow**

1.75 yds

Model	Series 2	Series 3	Series 4	Series 5	Series 6	Series 7	Series 8	COM
<b>HP</b>	\$76	\$88	\$141	\$169	\$185	\$205	\$218	\$88

**Magazine pouch**

1.75 yds

Model	Series 2	Series 3	Series 4	Series 5	Series 6	Series 7	Series 8	COM
<b>MG</b>	\$64	\$76	\$129	\$157	\$173	\$193	\$206	\$76

Patient Chairs

Recliners

Treatment Chairs

Rockers &amp; Gliders

Overbed Tables

Sleepover Seating

Casegoods

Display &amp; Accessories

# Leonard II Recliner



## Standard Features

- Solid maple frame
- Mortise and tenon joinery
- Spring seat construction
- Replaceable components
- 5/8" x 2" plastic bar glides
- Wood arm caps
- Independently operating footrest
- Infinite back recline from upright to fully flat
- Wallsaver edge
- Must be 22" from wall to fully recline
- Footrest breaks away at 55 lbs
- Nemschoff healthcare wood finish
- GREENGUARD Gold Certified
- Limited Lifetime Warranty; ten years on mechanism

- Add urethane arm caps
- Add fully upholstered arms
- Remove center seam
- Add casters

Model numbers with **S** indicate standard seat and back covers, and model numbers with **P** indicate removable covers.

## Flammability Type

- Type 6

## Coordinating Products

- [Leonard II Lounge Seating](#)
- [Leonard II Sleep Double Sofa and Sleep Settee](#)

## Key Dimensions

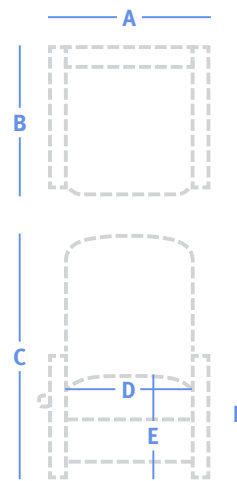

<b>A</b>	Overall Width	See price table
<b>B</b>	Overall Depth	34" 75" (reclined)
<b>C</b>	Overall Height	43.25"
<b>D</b>	Seat Width	24.75"
<b>E</b>	Seat Height	19"
<b>F</b>	Arm Height	25"

## More Information

- Illustrated Glossary ▶ 409
- Fabrics ▶ 421
- Flammability (CTB-133) ▶ 429
- Finishes ▶ 426
- Ordering and Warranties ▶ 432

## Available Options

- Moisture barrier + \$69 per seat or back
- Black urethane arm caps + \$116
- Fully upholstered arms + \$116
- Remove center seam + \$0
- 2" twin rubber-wheel casters; front wheels fixed with brakes, rear wheels swivel + \$344
- 2" twin rubber-wheel casters; front wheels fixed with brakes, rear wheels swivel with brakes + \$352
- CTB-133 + \$83/yd
- Two fabrics + \$64
- Three (or more) fabrics + \$90

## Specification Decisions

- Select fabric
- Select standard wood finish
- Add CTB-133
- Apply multiple fabrics
- Add moisture barrier

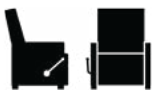

### 35" W, Recliner

105 lbs | 6.75 yds

Model	Series 2	Series 3	Series 4	Series 5	Series 6	Series 7	Series 8	COM
<b>814-62 S</b>	\$2,991	\$3,211	\$3,576	\$3,957	\$4,410	\$4,868	\$5,440	\$3,211
<b>814-62 P</b>	\$3,377	\$3,597	\$3,962	\$4,343	\$4,796	\$5,254	\$5,826	\$3,597

# Oliver Recliner



## More Information

Illustrated Glossary ▶ 409

Fabrics ▶ 421

Flammability (CTB-133) ▶ 429

Finishes ▶ 426

Ordering and Warranties ▶ 432

## Standard Features

- Solid maple frame
- Spring seat construction
- Replaceable components
- Three seated positions (902)
- Handle lever recline (904)
- Non-marring  $\frac{7}{8}$ " plastic rubber-cushioned glides
- $\frac{5}{8}$ " x 2" plastic bar glides (904)
- Wallsaver edge
- Must be 18.5" from wall to fully recline (902)
- Must be 3.5" from wall to fully recline (904)
- Nemschoff healthcare wood finish
- GREENGUARD Gold Certified
- Limited Lifetime Warranty; five years on mechanism

## Available Options

- Moisture barrier + \$69 per seat or back
- Two front swivel casters (904-66) + \$110
- Two front swivel and two rear fixed casters with brakes (904-66) + \$344
- Headcloth + \$0
- CTB-133 + \$83/yd
- Two fabrics + \$64
- Three (or more) fabrics + \$90

## Specification Decisions

- Select fabric
- Select standard wood finish
- Add CTB-133
- Apply multiple fabrics
- Add moisture barrier

- Add casters
- Add headcloth

Model numbers with **S** indicate standard seat and back covers, and model numbers with **P** indicate removable covers.

## Flammability Type

- Type 6

## Coordinating Products

- [Oliver Lounge Seating](#)
- [Oliver Sleep Settee](#)

## Key Dimensions

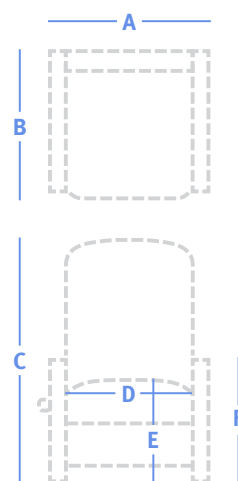

<b>A</b>	Overall Width	See price table
<b>B</b>	Overall Depth	34", 35" 63.5", 67.25" (reclined)
<b>C</b>	Overall Height	40.5"
<b>D</b>	Seat Width	21"
<b>E</b>	Seat Height	18.75"
<b>F</b>	Arm Height	25"

	<b>34" W, Recliner</b>								80 lbs   6.5 yds
	Model	Series 2	Series 3	Series 4	Series 5	Series 6	Series 7	Series 8	COM
	<b>902-62 S</b>	\$3,507	\$3,719	\$4,070	\$4,437	\$4,874	\$5,314	\$5,866	\$3,719
	<b>902-62 P</b>	\$3,954	\$4,166	\$4,517	\$4,884	\$5,321	\$5,761	\$6,313	\$4,166
	<b>34.25" W, Wallsaver recliner</b>								97 lbs   7.25 yds
	Model	Series 2	Series 3	Series 4	Series 5	Series 6	Series 7	Series 8	COM
	<b>904-66 S</b>	\$3,548	\$3,784	\$4,176	\$4,585	\$5,072	\$5,563	\$6,178	\$3,784
	<b>904-66 P</b>	\$4,003	\$4,239	\$4,631	\$5,040	\$5,527	\$6,018	\$6,633	\$4,239



# Pamona Recliner



## Standard Features

- Solid maple frame
- Mortise and tenon joinery
- Spring seat construction
- Replaceable components
- Upholstered arms
- Wallsaver edge
- Powder-coated metal legs
- 1" dia adjustable glides
- Push-back mechanism for footrest; finger-pull to recline
- Infinite recline adjustment within a comfortable range
- Nemschoff healthcare wood finish
- GREENGUARD Gold Certified
- Limited Lifetime Warranty; five years on mechanism

## Available Options

- Moisture barrier + \$69 per seat or back
- Black urethane arm caps + \$116
- Wood arm caps + \$116
- 3" twin-wheel casters; front swivel with brakes, rear swivel + \$131
- CTB-133 + \$83/yd
- Two fabrics + \$64
- Three (or more) fabrics + \$90

## Specification Decisions

- Select fabric
- Select standard wood finish
- Select powder coat finish
- Add CTB-133
- Apply multiple fabrics
- Add moisture barrier
- Add wood or urethane arm caps
- Add casters

Model numbers with **S** indicate standard seat and back covers, and model numbers with **P** indicate removable covers.

## Flammability Type

- Type 6

## Coordinating Products

- [Pamona Lounge Seating](#)
- [Pamona Tables](#)
- [Pamona Flop Sofa](#)

## Key Dimensions

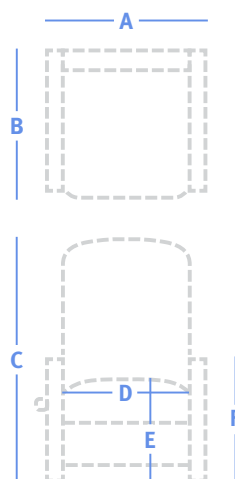

<b>A</b>	Overall Width	See price table
<b>B</b>	Overall Depth	33" 63.5" (reclined)
<b>C</b>	Overall Height	44.5"
<b>D</b>	Seat Width	22.5"
<b>E</b>	Seat Height	18.5"
<b>F</b>	Arm Height	24.75"

Seat depth: 19.0"

Back angle (upright position): 107-degrees

Back angle (first recline position): 109-degrees

Back angle (fully reclined position): 126-degrees

## More Information

Illustrated Glossary ▶ 409

Fabrics ▶ 421

Flammability (CTB-133) ▶ 429

Finishes ▶ 426

Ordering and Warranties ▶ 432



### 31.5" W, Recliner

92 lbs | 6.25 yds

Model	Series 2	Series 3	Series 4	Series 5	Series 6	Series 7	Series 8	COM
<b>797-66 S</b>	\$2,854	\$3,057	\$3,395	\$3,748	\$4,167	\$4,591	\$5,121	\$3,057
<b>797-66 P</b>	\$3,221	\$3,424	\$3,762	\$4,115	\$4,534	\$4,958	\$5,488	\$3,424

# Prísto II Recliner



## More Information

Illustrated Glossary ▶ 409

Fabrics ▶ 421

Flammability (CTB-133) ▶ 429

Finishes ▶ 426

Ordering and Warranties ▶ 432

## Standard Features

- Solid maple frame
- Mortise and tenon joinery
- Spring seat construction
- Replaceable components
- Removable seat and back covers
- Push-back mechanism
- 3" twin-wheel casters, front fixed with brakes, rear swivel
- Wood legs (PRCL-14)
- Wallsaver edge
- Must be 19" from wall to fully recline
- Nemschoff healthcare wood finish
- GREENGUARD Gold Certified
- Limited Lifetime Warranty; ten years on mechanism

## Available Options

- Square back (PRCL-14) + \$0
- Moisture barrier + \$69 per seat or back
- CTB-133 + \$83/yd
- Two fabrics + \$64
- Three (or more) fabrics + \$90
- Black urethane arm caps (PRCL-12, PRCL-13) + \$116
- Soft radius edge (PRCL-14) + \$0
- Folding side table with or without cup holder (laminated, RSF) + \$315
- Adjustable tray table (laminated, RSF) + \$716

## Specification Decisions

- Select fabric
- Select back style
- Add moisture barrier
- Add CTB-133
- Apply multiple fabrics
- Add urethane or wood arm caps
- Add soft radius edge
- Add folding side table
- Add adjustable tray table

## Flammability Type

- Type 6

## Coordinating Products

- [Prísto Caseloads](#)
- [Prísto II Caseloads](#)
- [Prísto II Treatment Chair](#)
- [Prísto IIT Treatment Chair](#)

## Key Dimensions

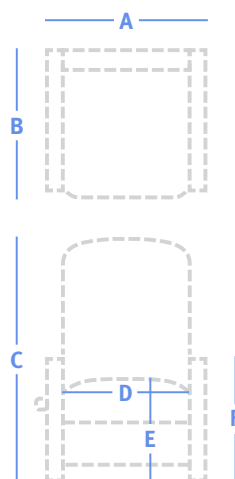

<b>A</b>	Overall Width	See price table
<b>B</b>	Overall Depth	33.5" 61.5" (reclined)
<b>C</b>	Overall Height	46"
<b>D</b>	Seat Width	23", 27.5"
<b>E</b>	Seat Height	19"
<b>F</b>	Arm Height	25.5"

## Prísto II Recliner



### 29" W, Recliner with maple arms, legs and trim

139 lbs | 6 yds

Model	Series 2	Series 3	Series 4	Series 5	Series 6	Series 7	Series 8	COM
<b>PRCL-14</b>	\$3,830	\$4,025	\$4,349	\$4,688	\$5,091	\$5,498	\$6,007	\$4,025



### 31" W, Recliner with maple arm caps and trim

139 lbs | 6.25 yds

Model	Series 2	Series 3	Series 4	Series 5	Series 6	Series 7	Series 8	COM
<b>PRCL-13</b>	\$3,822	\$4,025	\$4,363	\$4,716	\$5,135	\$5,559	\$6,089	\$4,025



### 31" W, Recliner with fully upholstered arms and trim

148 lbs | 7.5 yds

Model	Series 2	Series 3	Series 4	Series 5	Series 6	Series 7	Series 8	COM
<b>PRCL-12</b>	\$3,781	\$4,025	\$4,430	\$4,854	\$5,357	\$5,866	\$6,502	\$4,025

# Wallsaver Recliner



## More Information

Illustrated Glossary ▶ 409

Fabrics ▶ 421

Flammability (CTB-133) ▶ 429

Finishes ▶ 426

Ordering and Warranties ▶ 432

## Standard Features

- Mortise and tenon joinery
- Spring seat construction
- Replaceable components
- 41" or 47" back heights
- Three recline positions
- Non-marring 5/8" x 2" glides
- Wallsaver edge
- Must be 4" from wall to fully recline (733-66M, 772-66M, 778-66M)
- Must be 6.5" from wall to fully recline (733-66H, 772-66H, 778-66H)
- Multiple arm styles
- Nemschoff healthcare wood finish
- GREENGUARD Gold Certified
- Limited Lifetime Warranty; five years on mechanism

## Available Options

- Moisture barrier + \$69 per seat or back
- Two front swivel casters + \$107
- 2" twin rubber-wheel swivel casters; front swivel, rear with brakes + \$344
- CTB-133 + \$83/yard
- Two fabrics + \$64
- Three (or more) fabrics + \$90

## Specification Decisions

- Select fabric
- Select standard wood finish
- Add CTB-133
- Apply multiple fabrics
- Add moisture barrier
- Add casters

Model numbers with **S** indicate standard seat and back covers, and model numbers with **P** indicate removable covers.

## Flammability Type

- Type 6

## Key Dimensions

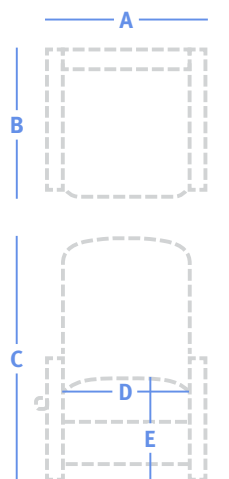

<b>A</b>	Overall Width	See price table
<b>B</b>	Overall Depth	33, 33.5", 34" 65" (M-reclined) 68" (H-reclined)
<b>C</b>	Overall Height	41", 46.75", 47"
<b>D</b>	Seat Width	23.5"
<b>E</b>	Seat Height	18.75"
<b>F</b>	Arm Height	24.5", 25", 25.25"

# Wallsaver Recliner



## 31.5" W, Wallsaver recliner with Allegro arms 90 lbs | 6.25 yds

Model	Series 2	Series 3	Series 4	Series 5	Series 6	Series 7	Series 8	COM
<b>733-66M S</b>	\$3,284	\$3,487	\$3,825	\$4,178	\$4,597	\$5,021	\$5,551	\$3,487
<b>733-66M P</b>	\$3,703	\$3,906	\$4,244	\$4,597	\$5,016	\$5,440	\$5,970	\$3,906



## 31.5" W, Wallsaver recliner with Karisma arms 90 lbs | 6 yds

Model	Series 2	Series 3	Series 4	Series 5	Series 6	Series 7	Series 8	COM
<b>772-66M S</b>	\$3,075	\$3,270	\$3,594	\$3,933	\$4,336	\$4,743	\$5,252	\$3,270
<b>772-66M P</b>	\$3,468	\$3,663	\$3,987	\$4,326	\$4,729	\$5,136	\$5,645	\$3,663



## 31.5" W, Wallsaver recliner with Prísto arms 90 lbs | 6.5 yds

Model	Series 2	Series 3	Series 4	Series 5	Series 6	Series 7	Series 8	COM
<b>778-66M S</b>	\$3,058	\$3,270	\$3,621	\$3,988	\$4,425	\$4,865	\$5,417	\$3,270
<b>778-66M P</b>	\$3,451	\$3,663	\$4,014	\$4,381	\$4,818	\$5,258	\$5,810	\$3,663



## 31.5" W, Wallsaver high back recliner with Allegro arms 90 lbs | 6.5 yds

Model	Series 2	Series 3	Series 4	Series 5	Series 6	Series 7	Series 8	COM
<b>733-66H S</b>	\$3,346	\$3,558	\$3,909	\$4,276	\$4,713	\$5,153	\$5,705	\$3,558
<b>733-66H P</b>	\$3,773	\$3,985	\$4,336	\$4,703	\$5,140	\$5,580	\$6,132	\$3,985



## 31.5" W, Wallsaver high back recliner with Karisma arms 90 lbs | 6.5 yds

Model	Series 2	Series 3	Series 4	Series 5	Series 6	Series 7	Series 8	COM
<b>772-66H S</b>	\$3,097	\$3,309	\$3,660	\$4,027	\$4,464	\$4,904	\$5,456	\$3,309
<b>772-66H P</b>	\$3,495	\$3,707	\$4,058	\$4,425	\$4,862	\$5,302	\$5,854	\$3,707



## 31.5" W, Wallsaver high back recliner with Prísto arms 90 lbs | 6.75 yds

Model	Series 2	Series 3	Series 4	Series 5	Series 6	Series 7	Series 8	COM
<b>778-66H S</b>	\$3,087	\$3,307	\$3,672	\$4,053	\$4,506	\$4,964	\$5,536	\$3,307
<b>778-66H P</b>	\$3,484	\$3,704	\$4,069	\$4,450	\$4,903	\$5,361	\$5,933	\$3,704

## Prísto II Treatment Chair



### More Information

Illustrated Glossary ▶ 409

Fabrics ▶ 421

Flammability (CTB-133) ▶ 429

Finishes ▶ 426

Ordering and Warranties ▶ 432

### Standard Features

- Mortise and tenon joinery
- Spring seat construction
- Replaceable components
- Clean-out design
- Removable covers
- Black urethane arm caps (PRCL-130B)
- Wood arm caps and trim (PRRT-13)
- Upholstered arm caps (PRRT-12)
- Three-position footrest (PRCL-130B)
- Must be 5" from wall to fully recline (PRCL-130B)
- Wallsaver edge
- 5" casters, front swivel with brakes, rear fixed
- Padded push bar (PRRT models only)
- Arcade back
- Nemschoff healthcare wood finish
- GREENGUARD Gold Certified
- Limited Lifetime Warranty; ten years on mechanism
- See nemschoff.com for weight ratings (PRCL-130B)

### Available Options

- Moisture barrier + \$69 per seat or back
- Black urethane arm caps + \$116 (PRRT-13, PRRT-12)
- Wood arm caps + \$116 (PRCL-130B)
- Fully-upholstered arms + \$116 (PRCL-130B)
- Square back + \$0
- Grey foam headrest with straps + \$323
- Folding side table with or without cup holder (RSF) (11.75" W x 22" D x 22.25" H) + \$315
- Swivel table (LSF) + \$315 (PRRT-13, PRRT-12)
- Adjustable tray table (RSF; laminate) + \$716
- Optional activation button location (front inside arm) + \$65 (PRRT-13, PRRT-12)
- Dual activation button (mid and front inside arm) + \$295
- Adjustable .5" IV rod + \$152
- IV rod holder + \$104
- Oxygen tank holder (accommodates cylinder sizes D and E) + \$212
- Fold-down arm (RSF only) + \$621 (PRRT-13, PRRT-12)

- Arm support (laminated) + \$804
- Foam arm support (for use with arm support) + \$349
- Utility hook (RSF) + \$182
- Central brake and steer caster system (factory installed) + \$691 (PRRT-13, PRRT-12)
- CTB-133 + \$83/yard
- Two fabrics + \$64
- Three (or more) fabrics + \$90

An IV rod holder is required to support adjustable IV rod, arm support and foam arm supports.

IV rods and arm supports must be used separately when using the same IV holder.

Swivel table (LSF) prevents interference with the recline lever handle

### Specification Decisions

- Select fabric
- Select standard wood finish
- Add CTB-133
- Apply multiple fabrics
- Add moisture barrier
- Add urethane arm caps
- Add square back
- Add headrest
- Add folding side table with or without cup holder (select laminate)
- Add adjustable tray table (select laminate)
- Add optional activation button
- Add dual activation buttons
- Add IV rod
- Add IV rod holder
- Add oxygen tank holder
- Add fold-down arm
- Add arm support (select laminate)
- Add foam arm support
- Add utility hook
- Add central brake and steer casters

### Flammability Type

- Type 6

# Prísto II Treatment Chair

## Coordinating Products

- [Prísto Casegoods](#)
- [Prísto II Casegoods](#)
- [Prísto II Recliner](#)
- [Prísto IIT Treatment Chair](#)

## Key Dimensions

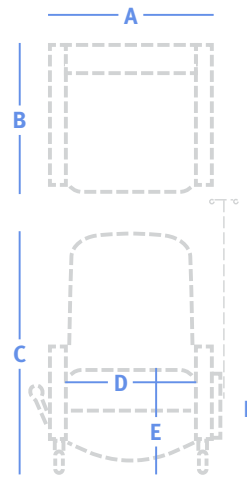

<b>A</b>	Overall Width	See price table 38.25" with arm folded down
<b>B</b>	Overall Depth	36" 76" (fully reclined)
<b>C</b>	Overall Height	47"
<b>D</b>	Seat Width	24"
<b>E</b>	Seat Height	19"
<b>F</b>	Arm Height	25.5"

	<b>34.5" W, Treatment chair with wood arm caps and trim</b> <span style="float: right;">139 lbs   6.25 yds</span>								
	Model	Series 2	Series 3	Series 4	Series 5	Series 6	Series 7	Series 8	COM
	<b>PRRT-13</b>	\$4,966	\$5,169	\$5,507	\$5,860	\$6,279	\$6,703	\$7,233	\$5,169

	<b>34.5" W, Treatment chair with upholstered arm caps and trim</b> <span style="float: right;">139 lbs   7.5 yds</span>								
	Model	Series 2	Series 3	Series 4	Series 5	Series 6	Series 7	Series 8	COM
	<b>PRRT-12</b>	\$4,925	\$5,169	\$5,574	\$5,998	\$6,501	\$7,010	\$7,646	\$5,169

	<b>37.25" W, Plus Treatment chair</b> <span style="float: right;">170 lbs   8.5 yds</span>								
	Model	Series 2	Series 3	Series 4	Series 5	Series 6	Series 7	Series 8	COM
	<b>PRCL-130B</b>	\$5,317	\$5,594	\$6,053	\$6,533	\$7,104	\$7,680	\$8,401	\$5,594

## Prísto IIT Treatment Chair



### More Information

Illustrated Glossary ▶ 409

Fabrics ▶ 421

Flammability (CTB-133) ▶ 429

Finishes ▶ 426

Ordering and Warranties ▶ 432

### Standard Features

- Spring seat construction
- Replaceable components
- Removable covers
- Wood arm caps and trim (PRTT-13 only)
- Upholstered arm caps and trim (PRTT-12 only)
- Trendelenburg
- 5" caster, front swivel with brakes, rear fixed
- Arcade back
- Nemschoff healthcare wood finish
- GREENGUARD Gold Certified
- Limited Lifetime Warranty; ten years on mechanism

### Available Options

- Moisture barrier + \$69 per seat or back
- Black urethane arm caps + \$116
- Square back + \$0
- Grey foam headrest with straps + \$323
- Folding side table with or without cup holder (RSF) (11.75" W x 22" D x 22.25" H) + \$315
- Swivel table (LSF) + \$315
- Adjustable tray table (RSF; laminate) + \$716
- Optional activation button location (front inside arm) + \$65
- Dual activation button (mid and front inside arm) + \$295
- Adjustable .5" IV rod + \$152
- IV rod holder + \$104
- Oxygen tank holder (accommodates cylinder sizes D and E) + \$212
- Fold-down arm (RSF only) + \$621
- Arm support (laminated) + \$804
- Foam arm support (use with arm support) + \$349
- Utility hook (RSF) + \$182
- Central brake and steer caster system (factory-installed) + \$691
- CTB-133 + \$83/yard
- Two fabrics + \$64
- Three (or more) fabrics + \$90

An IV rod holder is required to support adjustable IV rod, arm support and foam arm supports.

IV rods and arm supports must be used separately when using the same IV holder.

Swivel table (LSF) prevents interference with the recline lever handle.

### Specification Decisions

- Select fabric
- Add moisture barrier
- Add CTB-133
- Apply multiple fabrics
- Add urethane arm caps
- Add square back
- Add headrest
- Add folding side table with or without cup holder (select laminate)
- Add adjustable tray table (select laminate)
- Add optional activation button
- Add dual activation buttons
- Add IV rod
- Add IV rod holder
- Add fold-down arm
- Add oxygen tank holder
- Add arm support (select laminate)
- Add foam arm support
- Add utility hook
- Add central brake and steer casters

### Flammability Type

- Type 6



# Prísto IIT Treatment Chair

## Coordinating Products

- [Prísto Casegoods](#)
- [Prísto II Casegoods](#)
- [Prísto II Recliner](#)
- [Prísto II Treatment Chair](#)

## Key Dimensions

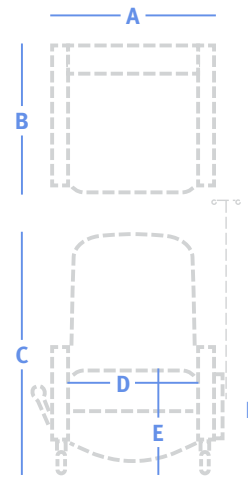

<b>A</b>	Overall Width	See price table 38.25" with arm folded down
<b>B</b>	Overall Depth	41" 79.25" (fully reclined)
<b>C</b>	Overall Height	47.5"
<b>D</b>	Seat Width	24.5"
<b>E</b>	Seat Height	19"
<b>F</b>	Arm Height	25"

	<b>34.5" W, Treatment chair with wood arm caps and trim</b>									144 lbs   6.25 yds
	Model	Series 2	Series 3	Series 4	Series 5	Series 6	Series 7	Series 8	COM	
<b>PRTT-13</b>	\$5,286	\$5,489	\$5,827	\$6,180	\$6,599	\$7,023	\$7,553	\$5,489		

	<b>34.5" W, Treatment chair with upholstered arm caps and trim</b>									144 lbs   7.5 yds
	Model	Series 2	Series 3	Series 4	Series 5	Series 6	Series 7	Series 8	COM	
<b>PRTT-12</b>	\$5,042	\$5,286	\$5,691	\$6,115	\$6,618	\$7,127	\$7,763	\$5,286		

## Serenity II Treatment Chair



### More Information

Illustrated Glossary ▶ 409

Fabrics ▶ 421

Flammability (CTB-133) ▶ 429

Finishes ▶ 426

Ordering and Warranties ▶ 432

### Standard Features

- Mortise and tenon joinery
- Spring seat construction
- Replaceable components
- Removable covers
- Black urethane arm caps
- Adjustable upholstered headrest
- Wallsaver edge
- Trendelenburg (bar is 1.25" from floor when fully reclined)
- 5" caster, front swivel with brakes, rear fixed
- GREENGUARD Gold Certified
- Limited Lifetime Warranty; ten years on mechanism

### Available Options

- Moisture barrier + \$69 per seat or back
- Grey foam headrest with straps + \$323
- Upholstered back pad (reduces seat depth by 2") + \$268
- Heat (8' cord length) + \$1,029
- Heat and massage (8' cord length) + \$1,296
- Folding side table with or without cup holder (RSF) + \$315 (11.75" W x 22" D x 22.25" H)
- Adjustable tray table (RSF; laminate) + \$716
- Slide-out footrest + \$729
- Optional activation button location (front inside arm) + \$65
- Dual activation button (mid and front inside arm) + \$295
- Adjustable .5" IV rod + \$152
- IV rod holder + \$104
- Oxygen tank holder (accommodates cylinder sizes D and E) + \$212
- Arm support (laminated) + \$804
- Foam arm support (use with arm support) + \$349
- Utility hook (RSF) + \$182
- Central brake and steer caster system (factory-installed) + \$691
- CTB-133 + \$83/yr
- Two fabrics + \$64
- Three (or more) fabrics + \$90

An IV rod holder is required to support adjustable IV rod, arm support and foam arm supports.

IV rods and arm supports must be used separately when using the same IV holder.

### Specification Decisions

- Select fabric
- Add CTB-133
- Apply multiple fabrics
- Add moisture barrier
- Add headrest
- Add upholstered back pad (not available with heat or heat and massage)
- Add heat
- Add heat and massage
- Add folding side table with or without cup holder (select laminate)
- Add adjustable tray table (select laminate)
- Add slide-out footrest
- Add optional activation button
- Add dual activation buttons
- Add IV rod
- Add IV rod holder
- Add oxygen tank holder
- Add arm support (select laminate)
- Add foam arm support
- Add utility hook
- Add central brake and steer casters

### Flammability Type

- Type 6

# Serenity II Treatment Chair

## Coordinating Products

- [Serenity IIS Treatment Chair](#)
- [Serenity III Treatment Chair](#)

## Key Dimensions

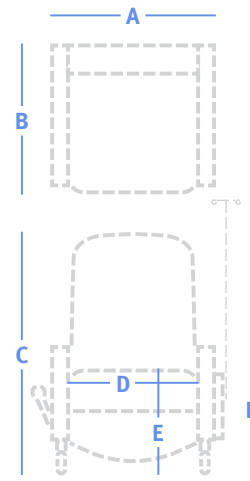

<b>A</b>	Overall Width	See price table
<b>B</b>	Overall Depth	42" 78" (fully reclined)
<b>C</b>	Overall Height	45.25"
<b>D</b>	Seat Width	24.5"
<b>E</b>	Seat Height	19.5"
<b>F</b>	Arm Height	26.5"



### 35" W, Treatment chair

134 lbs | 6.75 yds

Model	Series 2	Series 3	Series 4	Series 5	Series 6	Series 7	Series 8	COM
<b>790-12</b>	\$4,991	\$5,211	\$5,576	\$5,957	\$6,410	\$6,868	\$7,440	\$5,211

## Serenity IIS Treatment Chair



### More Information

Illustrated Glossary ▶ 409

Fabrics ▶ 421

Flammability (CTB-133) ▶ 429

Finishes ▶ 426

Ordering and Warranties ▶ 432

### Standard Features

- Mortise and tenon joinery
- Spring seat construction
- Replaceable components
- Removable covers
- Black urethane arm caps
- Wallsaver edge
- 5" caster, front swivel with brakes, rear fixed
- Nemschoff healthcare wood finish
- GREENGUARD Gold Certified
- Limited Lifetime Warranty; ten years on mechanism

### Available Options

- Moisture barrier + \$69 per seat or back
- Upholstered back pad (reduces seat depth by 2") + \$268
- Adjustable upholstered headrest + \$135
- Grey foam headrest with straps + \$323
- Heat (8' cord length) + \$1,029
- Heat and massage (8' cord length) + \$1,296
- Folding side table with or without cup holder (RSF) + \$315 (11.75" W x 22" D x 22.25" H)
- Adjustable tray table (RSF; laminate) + \$716
- Slide-out footrest + \$729
- Optional activation button location (front inside arm) + \$65
- Dual activation button (mid and front inside arm) + \$295
- Adjustable .5" IV rod + \$152
- IV rod holder + \$104
- Oxygen tank holder (accommodates cylinder sizes D and E) + \$212
- Foam arm support (for use with arm support) + \$349
- Arm support (laminated) + \$804
- Utility hook (RSF) + \$182
- Trendelenburg bar + \$295
- Push bar + \$145
- Central brake and steer caster system (factory-installed) + \$691
- CTB-133 + \$83/yard
- Two fabrics + \$64
- Three (or more) fabrics + \$90

An IV rod holder is required to support adjustable IV rod, arm support and foam arm supports.

IV rods and arm supports must be used separately when using the same IV holder.

### Specification Decisions

- Select fabric
- Add CTB-133
- Apply multiple fabrics
- Add moisture barrier
- Add headrest
- Add upholstered back pad (not available with heat or heat and massage)
- Add heat
- Add heat and massage
- Add folding side table with or without cup holder (select laminate)
- Add adjustable tray table (select laminate)
- Add slide-out footrest
- Add optional activation button
- Add dual activation buttons
- Add IV rod
- Add IV rod holder
- Add oxygen tank holder
- Add foam arm support
- Add arm support (select laminate)
- Add utility hook
- Add Trendelenburg bar
- Add push bar
- Add central brake and steer casters

### Flammability Type

- Type 6

# Serenity IIS Treatment Chair

## Coordinating Products

- [Serenity II Treatment Chair](#)
- [Serenity III Treatment Chair](#)

## Key Dimensions

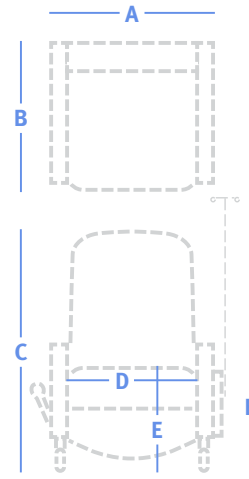

<b>A</b>	Overall Width	See price table
<b>B</b>	Overall Depth	36.5" 66.75" (fully reclined)
<b>C</b>	Overall Height	44.5"
<b>D</b>	Seat Width	22.25"
<b>E</b>	Seat Height	20.5"
<b>F</b>	Arm Height	26.5"



### 31.5" W, Treatment chair

130 lbs | 6.25 yds

Model	Series 2	Series 3	Series 4	Series 5	Series 6	Series 7	Series 8	COM
<b>792-12</b>	\$4,495	\$4,698	\$5,036	\$5,389	\$5,808	\$6,232	\$6,762	\$4,698

## Serenity III Treatment Chair



### More Information

Illustrated Glossary ▶ 409

Fabrics ▶ 421

Flammability (CTB-133) ▶ 429

Finishes ▶ 426

Ordering and Warranties ▶ 432

### Standard Features

- Mortise and tenon joinery
- Spring seat construction
- Replaceable components
- Removable covers
- Black urethane arm caps
- Wallsaver edge
- Adjustable upholstered headrest and back pad
- Slide-out footrest
- 5" caster, front swivel with brakes, rear fixed
- Nemschoff healthcare wood finish
- GREENGUARD Gold Certified
- Limited Lifetime Warranty; ten years on mechanism

### Available Options

- Moisture barrier + \$69 per seat or back
- Grey foam headrest with straps + \$323
- Wood arm caps + \$116
- Fully upholstered arms + \$116
- Heat (8' cord length) + \$1,029
- Heat and massage (8' cord length) + \$1,296
- Folding side table with or without cup holder (RSF) + \$315 (11.75" W x 22" D x 22.25" H)
- Adjustable tray table (RSF; laminate) + \$716
- Optional activation button location (front inside arm) + \$65
- Dual activation button (mid and front inside arm) + \$295
- Adjustable .5" IV rod + \$152
- IV rod holder + \$104
- Oxygen tank holder (accommodates cylinder sizes D and E) + \$212
- Arm support (laminate) + \$804
- Foam arm support (for use with arm support) + \$349
- Utility hook (RSF) + \$182
- Push bar + \$145
- Trendelenburg bar (bar is 1.25" from floor when fully reclined) + \$295
- Central brake and steer caster system (factory-installed) + \$691
- CTB-133 + \$83/yd
- Two fabrics + \$64
- Three (or more) fabrics + \$90

An IV rod holder is required to support adjustable IV rod, arm support and foam arm supports.

IV rods and arm supports must be used separately when using the same IV holder.

If heat is ordered, there will be no back pad.

### Specification Decisions

- Select fabric
- Add CTB-133
- Apply multiple fabrics
- Add moisture barrier
- Add wood arm caps
- Add fully upholstered arms
- Add heat (will not include back pad)
- Add heat and massage (will not include back pad)
- Add folding side table with or without cup holder (select laminate)
- Add adjustable tray table (select laminate)
- Add optional activation button
- Add dual activation buttons
- Add IV rod
- Add IV rod holder
- Add oxygen tank holder
- Add arm support (select laminate)
- Add foam arm support
- Add utility hook
- Add push bar
- Add Trendelenburg bar
- Add central brake and steer casters

### Flammability Type

- Type 6

# Serenity III Treatment Chair

## Coordinating Products

- [Serenity II Treatment Chair](#)
- [Serenity IIS Treatment Chair](#)

## Key Dimensions

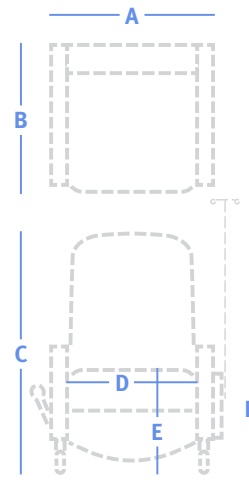

<b>A</b>	Overall Width	See price table
<b>B</b>	Overall Depth	36" 78" (fully reclined)
<b>C</b>	Overall Height	45.25"
<b>D</b>	Seat Width	24.5"
<b>E</b>	Seat Height	19.5"
<b>F</b>	Arm Height	26.5"



### 35" W, Treatment chair

130 lbs | 8.25 yds

Model	Series 2	Series 3	Series 4	Series 5	Series 6	Series 7	Series 8	COM
<b>791-12</b>	\$5,277	\$5,546	\$5,992	\$6,457	\$7,011	\$7,571	\$8,270	\$5,546

# Auburn Glider



## More Information

Illustrated Glossary ▶ 409

Fabrics ▶ 421

Flammability (CTB-133) ▶ 429

Finishes ▶ 426

Ordering and Warranties ▶ 429

## Standard Features

- Replaceable components
- Wood arm caps with pommel grip
- Nemschoff healthcare wood finish
- GREENGUARD Gold Certified
- Limited Lifetime Warranty; five years on mechanism

## Available Options

- Moisture barrier + \$69 per seat or back
- Black urethane arm caps + \$116
- Magazine pouch + \$76
- CTB-133 + \$83/yd
- Two fabrics + \$64
- Three (or more) fabrics + \$90

## Specification Decisions

- Select fabric
- Select standard wood finish
- Add CTB-133
- Apply multiple fabrics
- Add moisture barrier
- Add urethane arm caps
- Add magazine pouch

## Flammability Type

- Type 6

## Coordinating Products

- [Auburn Multiple Seating](#)
- [Auburn Tables](#)
- [Auburn Recliner](#)

## Key Dimensions

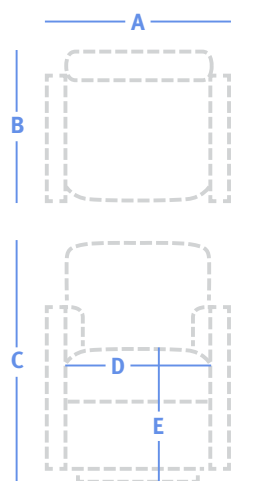

<b>A</b>	Overall Width	See price table
<b>B</b>	Overall Depth	28"
<b>C</b>	Overall Height	39.5"
<b>D</b>	Seat Width	19.5", 22"
<b>E</b>	Seat Height	18"
<b>F</b>	Arm Height	26"

		<b>23.5" W, Glider</b>								90 lbs   4.5 yds
		Model	Series 2	Series 3	Series 4	Series 5	Series 6	Series 7	Series 8	COM
		<b>AG30</b>	\$2,535	\$2,607	\$2,923	\$3,092	\$3,184	\$3,305	\$3,383	\$2,607
		<b>26" W, Glider</b>								96 lbs   4.75 yds
		Model	Series 2	Series 3	Series 4	Series 5	Series 6	Series 7	Series 8	COM
		<b>AG35</b>	\$2,867	\$2,943	\$3,276	\$3,455	\$3,552	\$3,680	\$3,762	\$2,943



# Avery Rocker



## Standard Features

- Solid maple frame
- Mortise and tenon joinery
- Spring seat construction
- Clean-out design
- Replaceable components
- Brushed metal accent rail
- Wood arm caps
- Wallsaver edge
- Nemschoff healthcare wood finish
- GREENGUARD Gold Certified
- Limited Lifetime Warranty

## Available Options

- Moisture barrier + \$69 per seat or back
- Wood accent rail (front and back) + \$112
- CTB-133 + \$83/yd
- Two fabrics + \$64
- Three (or more) fabrics + \$90

## Specification Decisions

- Select fabric
- Add CTB-133
- Apply multiple fabrics
- Add moisture barrier
- Add wood rail

Model numbers with **S** indicate standard seat and back covers, and model numbers with **P** indicate removable covers.

## Flammability Type

- Type 4

## Key Dimensions

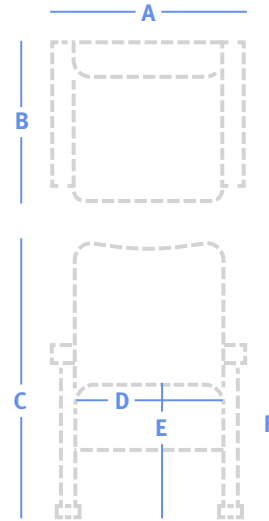

<b>A</b>	Overall Width	See price table
<b>B</b>	Overall Depth	35"
<b>C</b>	Overall Height	40.5"
<b>D</b>	Seat Width	21.5"
<b>E</b>	Seat Height	18.75"
<b>F</b>	Arm Height	25.25"

### More Information

- Illustrated Glossary ▶ 409
- Fabrics ▶ 421
- Flammability (CTB-133) ▶ 429
- Finishes ▶ 426
- Ordering and Warranties ▶ 432



### 25.25" W, Rocker

32 lbs | 2.25 yds

Model	Series 2	Series 3	Series 4	Series 5	Series 6	Series 7	Series 8	COM
<b>288-60 S</b>	\$2,164	\$2,237	\$2,359	\$2,486	\$2,637	\$2,790	\$2,980	\$2,237
<b>288-60 P</b>	\$2,433	\$2,506	\$2,628	\$2,755	\$2,906	\$3,059	\$3,249	\$2,506

# Brava Glider



## More Information

Illustrated Glossary ▶ 409

Fabrics ▶ 421

Flammability (CTB-133) ▶ 429

Finishes ▶ 426

Ordering and Warranties ▶ 432

## Standard Features

- Mortise and tenon joinery
- Spring seat construction
- Clean-out design
- Replaceable components
- Wallsaver edge
- Concealed glider mechanism
- Nemschoff healthcare wood finish
- GREENGUARD Gold Certified
- Limited Lifetime Warranty; five years on mechanism

## Available Options

- Moisture barrier + \$69 per seat or back
- Black urethane arm caps + \$116
- Desert or Pewter urethane arm caps + \$210
- Wood arm caps (862) + \$116
- CTB-133 + \$83/yd
- Two fabrics + \$64
- Three (or more) fabrics + \$90
- Passive lock + \$266
- Active lock + \$232

## Specification Decisions

- Select fabric
- Add CTB-133
- Apply multiple fabrics
- Add moisture barrier
- Add wood or urethane arm caps
- Add passive or active lock

Model numbers with **S** indicate standard seat and back covers, and model numbers with **P** indicate removable covers.

## Flammability Type

- Type 6

## Coordinating Products

- [Brava Classic Lounge Seating](#)
- [Brava Platform Lounge Seating](#)
- [Brava 862 Multiple Seating](#)
- [Brava 863 Multiple Seating](#)
- [Brava Side Chair](#)
- [Brava Tables](#)
- [Brava Adjustable Back Chair](#)
- [Brava CompactComfort Recliner](#)
- [Brava Patient Chair](#)
- [Brava Flop Sofa](#)
- [Brava Sleep Settee](#)

## Key Dimensions

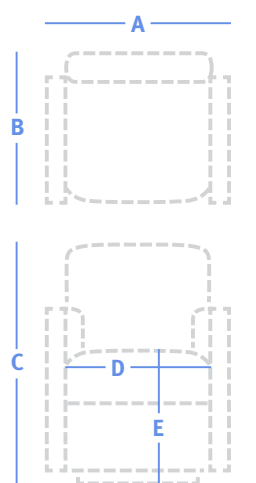

<b>A</b>	Overall Width	See price table
<b>B</b>	Overall Depth	26.25"
<b>C</b>	Overall Height	42.5"
<b>D</b>	Seat Width	20.75", 21.5"
<b>E</b>	Seat Height	18.25"
<b>F</b>	Arm Height	26.75"

## Brava Glider



### 25.5" W, Glider with open wood arms

69 lbs | 3.25 yds

Model	Series 2	Series 3	Series 4	Series 5	Series 6	Series 7	Series 8	COM
<b>863-50 S</b>	\$3,296	\$3,402	\$3,578	\$3,761	\$3,980	\$4,200	\$4,476	\$3,402
<b>863-50 P</b>	\$3,705	\$3,811	\$3,987	\$4,170	\$4,389	\$4,609	\$4,885	\$3,811



### 26.5" W, Glider with fully upholstered arms

73 lbs | 4.5 yds

Model	Series 2	Series 3	Series 4	Series 5	Series 6	Series 7	Series 8	COM
<b>862-50 S</b>	\$3,624	\$3,770	\$4,013	\$4,267	\$4,569	\$4,875	\$5,256	\$3,770
<b>862-50 P</b>	\$4,077	\$4,223	\$4,466	\$4,720	\$5,022	\$5,328	\$5,709	\$4,223

# Capella Glider



## More Information

Illustrated Glossary ▶ 409

Fabrics ▶ 421

Flammability (CTB-133) ▶ 429

Finishes ▶ 426

Ordering and Warranties ▶ 432

## Standard Features

- Mortise and tenon joinery
- Spring seat construction
- Replaceable components
- Upholstered arms
- Wallsaver edge
- Concealed glider mechanism
- GREENGUARD Gold Certified
- Limited Lifetime Warranty; five years on mechanism

## Available Options

- Moisture barrier + \$69 per seat or back
- Passive lock + \$266
- Active lock + \$232
- CTB-133 + \$83/yd
- Two fabrics + \$64
- Three (or more) fabrics + \$90

## Specification Decisions

- Select fabric
- Add CTB-133
- Apply multiple fabrics
- Add moisture barrier
- Add passive or active lock

Model numbers with **S** indicate standard seat and back covers, and model numbers with **P** indicate removable covers.

Front to back motion is approximately 4.5".

## Flammability Type

- Type 6

## Coordinating Products

- [Capella Multiple Seating](#)
- [Capella Side Chair](#)
- [Capella Tables](#)
- [Capella Patient Chair](#)
- [Capella Adjustable Back Chair](#)
- [Capella CompactComfort Recliner](#)
- [Capella Adjustable Back Glider](#)

## Key Dimensions

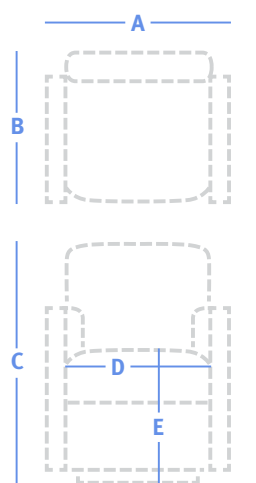

<b>A</b>	Overall Width	See price table
<b>B</b>	Overall Depth	24.5"
<b>C</b>	Overall Height	39.75"
<b>D</b>	Seat Width	20"
<b>E</b>	Seat Height	18.75"
<b>F</b>	Arm Height	25"



### 24.5" W, Glider

50 lbs | 4.75 yds

Model	Series 2	Series 3	Series 4	Series 5	Series 6	Series 7	Series 8	COM
<b>740-50CL S</b>	\$2,495	\$2,650	\$2,907	\$3,175	\$3,494	\$3,816	\$4,219	\$2,650
<b>740-50CL P</b>	\$2,813	\$2,968	\$3,225	\$3,493	\$3,812	\$4,134	\$4,537	\$2,968

# Capella Adjustable Back Glider



## Standard Features

- Mortise and tenon joinery
- Spring seat construction
- Replaceable components
- Upholstered arms
- Wallsaver edge
- Infinite back adjustment within 111 degrees
- Concealed glider mechanism
- GREENGUARD Gold Certified
- Limited Lifetime Warranty; five years on mechanism

## Flammability Type

- Type 6

## Coordinating Products

- [Capella Multiple Seating](#)
- [Capella Side Chair](#)
- [Capella Tables](#)
- [Capella Patient Chair](#)
- [Capella Adjustable Back Chair](#)
- [Capella CompactComfort Recliner](#)
- [Capella Glider](#)

## Available Options

- Moisture barrier + \$69 per seat or back
- Passive lock + \$266
- Active lock + \$232
- CTB-133 + \$83/yd
- Two fabrics + \$64
- Three (or more) fabrics + \$90

## Key Dimensions

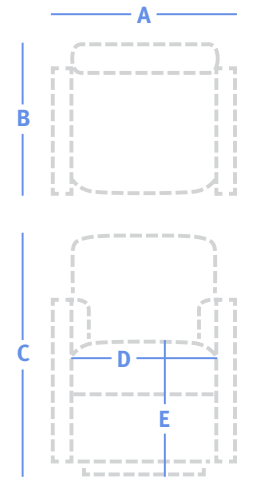

<b>A</b>	Overall Width	See price table
<b>B</b>	Overall Depth	26.75"
<b>C</b>	Overall Height	43.5"
<b>D</b>	Seat Width	20.5"
<b>E</b>	Seat Height	18.75"
<b>F</b>	Arm Height	24.75"

## More Information

- Illustrated Glossary ▶ 409
- Fabrics ▶ 421
- Flammability (CTB-133) ▶ 429
- Finishes ▶ 426
- Ordering and Warranties ▶ 432

## Specification Decisions

- Select fabric
- Add CTB-133
- Apply multiple fabrics
- Add moisture barrier
- Add passive or active lock

Model numbers with **S** indicate standard seat and back covers, and model numbers with **P** indicate removable covers.

Front to back motion is approximately 4.5".

The back must be 16" from the wall to allow for gliding motion when fully reclined.



### 26.5" W, Adjustable back glider

55 lbs | 5.5 yds

Model	Series 2	Series 3	Series 4	Series 5	Series 6	Series 7	Series 8	COM
<b>740-54 S</b>	\$3,251	\$3,430	\$3,727	\$4,038	\$4,407	\$4,780	\$5,246	\$3,430
<b>740-54 P</b>	\$3,663	\$3,842	\$4,139	\$4,450	\$4,819	\$5,192	\$5,658	\$3,842

# Cities Crosstown Rocker



## More Information

Illustrated Glossary ▶ 409

Fabrics ▶ 421

Flammability (CTB-133) ▶ 429

Finishes ▶ 426

Ordering and Warranties ▶ 432

## Standard Features

- Mortise and tenon joinery
- Spring seat construction
- Replaceable components
- Wipe-out design
- Wood arm caps
- Concealed rocking mechanism
- Non-marring  $\frac{5}{8}$ " x 2" plastic bar glides
- Wallsaver edge
- Nemschoff healthcare wood finish
- GREENGUARD Gold Certified
- Limited Lifetime Warranty

## Available Options

- Moisture barrier + \$69 per seat or back
- Five arm cap styles + \$0
- Four foot styles + \$0
- Two back style + \$0
- Two arm styles + \$0
- CTB-133 + \$83/yd
- Two fabrics + \$64
- Three (or more) fabrics + \$90

## Specification Decisions

- Select fabric
- Select standard wood finish
- Select arm cap style

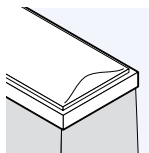

**C** Chicago

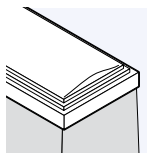

**L** Los Angeles

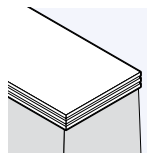

**N** New Orleans

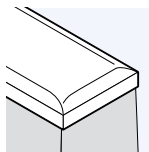

**Y** New York

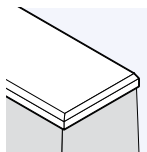

**W** Williamsburg

- Select foot style

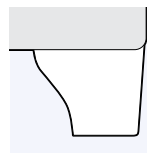

**B** Boston

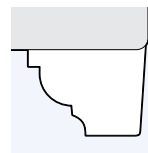

**C** Chicago

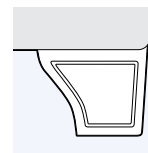

**P** Philadelphia

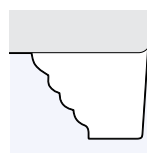

**S** San Francisco

- Select back style. All styles have a wipe-out feature.

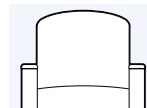

**A** Arcade back

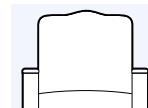

**Q** Camel square back

- Select arm style



**E** Elliptical arm

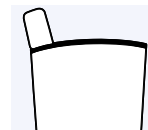

**C** Closed arm

- Add moisture barrier
- Add CTB-133
- Apply multiple fabrics

Model numbers with **S** indicate standard seat and back covers, and model numbers with **P** indicate removable covers.

## Flammability Type

- Type 6

# Cities Crosstown Rocker

## Coordinating Products

- [Cities Small Crosstown Lounge Seating](#)
- [Cities Medium Crosstown Lounge Seating](#)
- [Cities Small Downtown Lounge Seating](#)
- [Cities Medium Downtown Lounge Seating](#)
- [Cities Small Uptown Lounge Seating](#)
- [Cities Medium Uptown Lounge Seating](#)
- [Cities Side Chair](#)
- [Cities Tables](#)
- [Cities Crosstown Patient Chair](#)
- [Cities Downtown Patient Chair](#)
- [Cities Uptown Patient Chair](#)
- [Cities Uptown CompactComfort Recliner](#)
- [Cities Downtown Rocker](#)
- [Cities Uptown Rocker](#)
- [Cities Downtown Glider](#)
- [Cities Uptown Glider](#)

## Key Dimensions

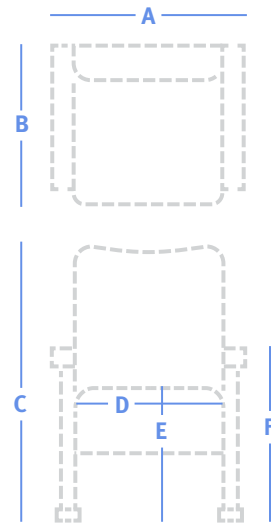

<b>A</b>	Overall Width	See price table
<b>B</b>	Overall Depth	27.5"
<b>C</b>	Overall Height	38.5"
<b>D</b>	Seat Width	19.5"
<b>E</b>	Seat Height	18.75"
<b>F</b>	Arm Height	25.5"



### 27.25" W, Rocker

49 lbs | 4 yds

Model	Series 2	Series 3	Series 4	Series 5	Series 6	Series 7	Series 8	COM
<b>Cities-SCXXX-61SX</b>	\$2,147	\$2,277	\$2,493	\$2,719	\$2,988	\$3,259	\$3,598	\$2,277
<b>Cities-SCXXX-61PX</b>	\$2,421	\$2,551	\$2,767	\$2,993	\$3,262	\$3,533	\$3,872	\$2,551

# Cities Downtown Rocker



## More Information

Illustrated Glossary ▶ 409

Fabrics ▶ 421

Flammability (CTB-133) ▶ 429

Finishes ▶ 426

Ordering and Warranties ▶ 432

## Standard Features

- Mortise and tenon joinery
- Spring seat construction
- Replaceable components
- Wipe-out design
- Wood arm caps
- Non-marring  $\frac{7}{8}$ " rubber-cushioned glides
- Wallsaver edge
- Nemschoff healthcare wood finish
- GREENGUARD Gold Certified
- Limited Lifetime Warranty

## Available Options

- Moisture barrier + \$69 per seat or back
- Five arm cap styles + \$0
- Four foot styles + \$0
- Two back styles + \$0
- Two rail styles + \$0
- CTB-133 + \$83/yd
- Two fabrics + \$64
- Three (or more) fabrics + \$90

## Specification Decisions

- Select fabric
- Select standard wood finish
- Select arm cap style

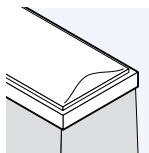

**C** Chicago

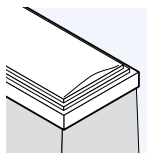

**L** Los Angeles

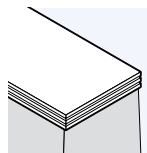

**N** New Orleans

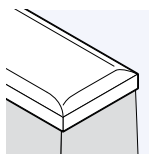

**Y** New York

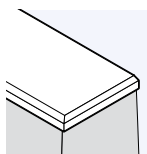

**W** Williamsburg

- Select foot style

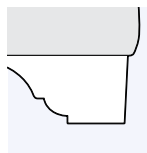

**C** Chicago

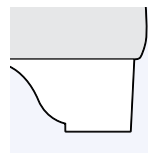

**L** Los Angeles

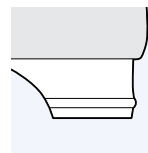

**N** New Orleans

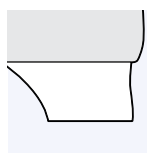

**W** Williamsburg

- Select back style. All styles have a wipe-out feature.

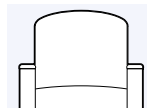

**A** Arcade back

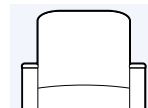

**B** Square back

- Select rail style

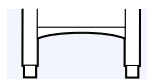

**U** Upholstered

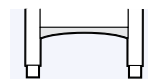

**W** Wood

- Add moisture barrier
- Add CTB-133
- Apply multiple fabrics

Model numbers with **S** indicate standard seat and back covers, and model numbers with **P** indicate removable covers.

## Flammability Type

- Type 6



# Cities Downtown Rocker

## Coordinating Products

- [Cities Small Crosstown Lounge Seating](#)
- [Cities Medium Crosstown Lounge Seating](#)
- [Cities Small Downtown Lounge Seating](#)
- [Cities Medium Downtown Lounge Seating](#)
- [Cities Small Uptown Lounge Seating](#)
- [Cities Medium Uptown Lounge Seating](#)
- [Cities Side Chair](#)
- [Cities Tables](#)
- [Cities Crosstown Patient Chair](#)
- [Cities Downtown Patient Chair](#)
- [Cities Uptown Patient Chair](#)
- [Cities Uptown CompactComfort Recliner](#)
- [Cities Crosstown Rocker](#)
- [Cities Uptown Rocker](#)
- [Cities Downtown Glider](#)
- [Cities Uptown Glider](#)

## Key Dimensions

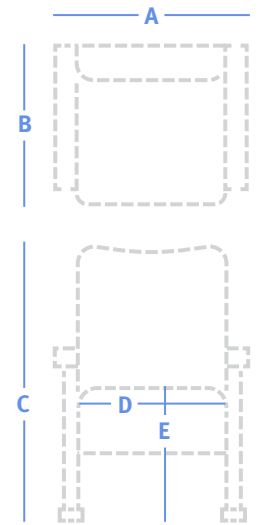

<b>A</b>	Overall Width	See price table
<b>B</b>	Overall Depth	26"
<b>C</b>	Overall Height	39.5"
<b>D</b>	Seat Width	20"
<b>E</b>	Seat Height	18.75"
<b>F</b>	Arm Height	25.5"



### 25.5" W, Rocker

40 lbs | 3.75 yds

Model	Series 2	Series 3	Series 4	Series 5	Series 6	Series 7	Series 8	COM
<b>Cities-SDXXXX-61SX</b>	\$2,155	\$2,277	\$2,480	\$2,692	\$2,943	\$3,198	\$3,516	\$2,277
<b>Cities-SDXXXX-61PX</b>	\$2,429	\$2,551	\$2,754	\$2,966	\$3,217	\$3,472	\$3,790	\$2,551

# Cities Downtown Glider



## More Information

Illustrated Glossary ▶ 409

Fabrics ▶ 421

Flammability (CTB-133) ▶ 429

Finishes ▶ 426

Ordering and Warranties ▶ 432

## Standard Features

- Mortise and tenon joinery
- Spring seat construction
- Replaceable components
- Wipe-out design
- Wood arm caps
- Concealed glider mechanism
- Wallsaver edge
- Nemschoff healthcare wood finish
- GREENGUARD Gold Certified
- Limited Lifetime Warranty; five years on mechanism

## Available Options

- Moisture barrier + \$69 per seat or back
- Five arm cap styles + \$0
- Four foot styles + \$0
- Two back styles + \$0
- Two rail styles + \$0
- Passive lock + \$266
- Active lock + \$232
- CTB-133 + \$83/yd
- Two fabrics + \$64
- Three (or more) fabrics + \$90

## Specification Decisions

- Select fabric
- Select standard wood finish
- Select arm cap style

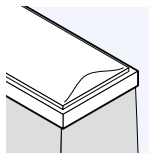

**C** Chicago

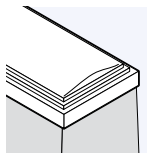

**L** Los Angeles

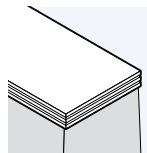

**N** New Orleans

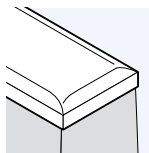

**Y** New York

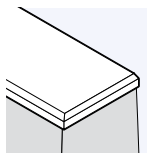

**W** Williamsburg

- Select back style. All styles have a wipe-out feature.

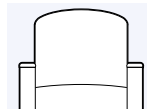

**A** Arcade back

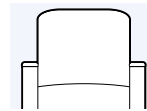

**B** Square back

- Select rail style

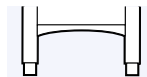

**U** Upholstered

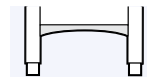

**W** Wood

- Add moisture barrier
- Add CTB-133
- Apply multiple fabrics
- Add passive or active lock

Model numbers with **S** indicate standard seat and back covers, and model numbers with **P** indicate removable covers.

## Flammability Type

- Type 6

## Coordinating Products

- [Cities Small Crosstown Lounge Seating](#)
- [Cities Medium Crosstown Lounge Seating](#)
- [Cities Small Downtown Lounge Seating](#)
- [Cities Medium Downtown Lounge Seating](#)
- [Cities Small Uptown Lounge Seating](#)
- [Cities Medium Uptown Lounge Seating](#)
- [Cities Side Chair](#)
- [Cities Tables](#)
- [Cities Crosstown Patient Chair](#)
- [Cities Downtown Patient Chair](#)
- [Cities Uptown Patient Chair](#)
- [Cities Uptown CompactComfort Recliner](#)
- [Cities Crosstown Rocker](#)
- [Cities Downtown Rocker](#)
- [Cities Uptown Rocker](#)
- [Cities Uptown Glider](#)

# Cities Downtown Glider

## Key Dimensions

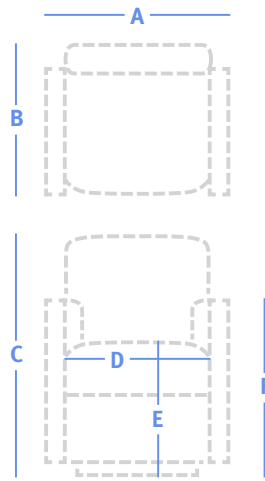

<b>A</b>	Overall Width	See price table
<b>B</b>	Overall Depth	26.5"
<b>C</b>	Overall Height	39.5"
<b>D</b>	Seat Width	20"
<b>E</b>	Seat Height	18.75"
<b>F</b>	Arm Height	25.5"



### 24" W, Glider

38 lbs | 3.75 yds

Model	Series 2	Series 3	Series 4	Series 5	Series 6	Series 7	Series 8	COM
<b>Cities-SDX0XX-50CL SX</b>	\$2,189	\$2,311	\$2,514	\$2,726	\$2,977	\$3,232	\$3,550	\$2,311
<b>Cities-SDX0XX-50CL PX</b>	\$2,467	\$2,589	\$2,792	\$3,004	\$3,255	\$3,510	\$3,828	\$2,589

## Cities Uptown Rocker



### More Information

Illustrated Glossary ▶ 409

Fabrics ▶ 421

Flammability (CTB-133) ▶ 429

Finishes ▶ 426

Ordering and Warranties ▶ 432

### Standard Features

- Morise and tenon joinery
- Spring seat construction
- Wipe-out design
- Replaceable components
- Wood arm caps
- Non-marring  $\frac{7}{8}$ " rubber-cushioned glides
- Wallsaver edge
- Nemschoff healthcare wood finish
- GREENGUARD Gold Certified
- Limited Lifetime Warranty

### Available Options

- Moisture barrier + \$69 per seat or back
- Five arm cap styles + \$0
- Two back styles + \$0
- Two rail styles + \$0
- CTB-133 + \$83/yd
- Two fabrics + \$64
- Three (or more) fabrics + \$90

### Specification Decisions

- Select fabric
- Select standard wood finish
- Select arm cap style

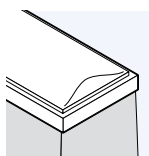

**C** Chicago

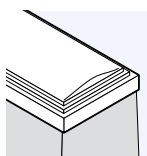

**L** Los Angeles

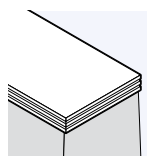

**N** New Orleans

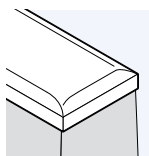

**Y** New York

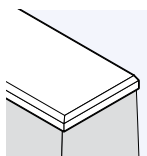

**W** Williamsburg

- Select back style. All styles have a wipe-out feature.

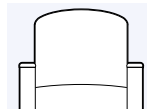

**A** Arcade back

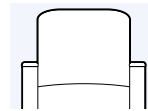

**B** Square back

- Select rail style

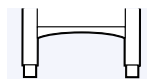

**U** Upholstered

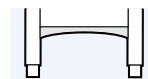

**W** Wood

- Add moisture barrier
- Add CTB-133
- Apply multiple fabrics

Model numbers with **S** indicate standard seat and back covers, and model numbers with **P** indicate removable covers.

### Flammability Type

- Type 6

# Cities Uptown Rocker

## Coordinating Products

- [Cities Small Crosstown Lounge Seating](#)
- [Cities Medium Crosstown Lounge Seating](#)
- [Cities Small Downtown Lounge Seating](#)
- [Cities Medium Downtown Lounge Seating](#)
- [Cities Small Uptown Lounge Seating](#)
- [Cities Medium Uptown Lounge Seating](#)
- [Cities Side Chair](#)
- [Cities Tables](#)
- [Cities Crosstown Patient Chair](#)
- [Cities Downtown Patient Chair](#)
- [Cities Uptown Patient Chair](#)
- [Cities Uptown CompactComfort Recliner](#)
- [Cities Crosstown Rocker](#)
- [Cities Downtown Rocker](#)
- [Cities Downtown Glider](#)
- [Cities Uptown Glider](#)

## Key Dimensions

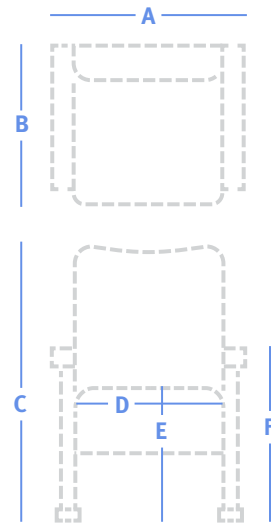

<b>A</b>	Overall Width	See price table
<b>B</b>	Overall Depth	26"
<b>C</b>	Overall Height	39.5"
<b>D</b>	Seat Width	20"
<b>E</b>	Seat Height	18.5"
<b>F</b>	Arm Height	25"



### 25.5" W, Rocker

40 lbs | 3 yds

Model	Series 2	Series 3	Series 4	Series 5	Series 6	Series 7	Series 8	COM
<b>Cities-SUX0XX-61SX</b>	\$2,226	\$2,323	\$2,485	\$2,655	\$2,856	\$3,060	\$3,314	\$2,323
<b>Cities-SUX0XX-61PX</b>	\$2,505	\$2,602	\$2,764	\$2,934	\$3,135	\$3,339	\$3,593	\$2,602

# Cities Uptown Glider

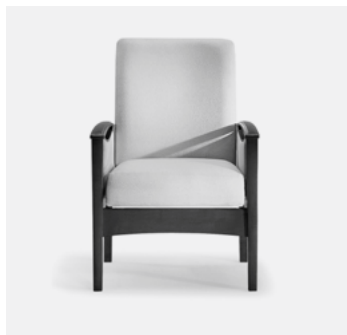

## More Information

Illustrated Glossary ▶ 409

Fabrics ▶ 421

Flammability (CTB-133) ▶ 429

Finishes ▶ 426

Ordering and Warranties ▶ 432

## Standard Features

- Mortise and tenon joinery
- Spring seat construction
- Wipe-out design
- Replaceable components
- Wood arm caps
- Concealed glider mechanism
- 2¼" dia plastic glides
- Wallsaver edge
- Nemschoff healthcare wood finish
- GREENGUARD Gold Certified
- Limited Lifetime Warranty; five years on mechanism

## Available Options

- Moisture barrier + \$69 per seat or back
- Five arm cap styles + \$0
- Two back styles + \$0
- Two rail styles + \$0
- Passive lock + \$266
- Active lock + \$232
- CTB-133 + \$83/yd
- Two fabrics + \$64
- Three (or more) fabrics + \$90

## Specification Decisions

- Select fabric
- Select standard wood finish
- Select arm cap style

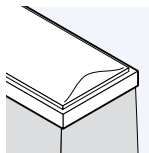

**C** Chicago

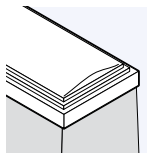

**L** Los Angeles

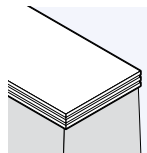

**N** New Orleans

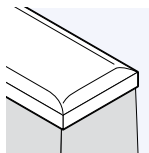

**Y** New York

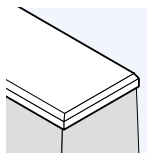

**W** Williamsburg

- Select back style. All styles have a wipe-out feature.

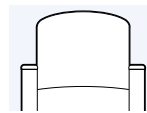

**A** Arcade back

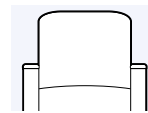

**B** Square back

- Select rail style



**U** Upholstered



**W** Wood

- Add moisture barrier
- Add CTB-133
- Apply multiple fabrics
- Add passive or active lock

Model numbers with **S** indicate standard seat and back covers, and model numbers with **P** indicate removable covers.

## Flammability Types

- Type 6
- Type 5 (MUXX0XX-50CL)

# Cities Uptown Glider



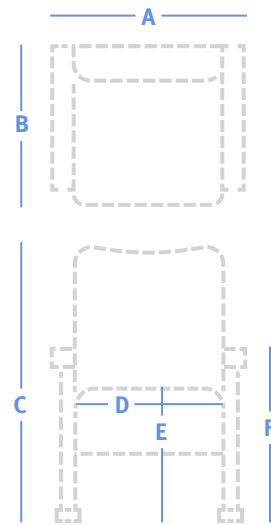

## Coordinating Products

- [Cities Small Crosstown Lounge Seating](#)
- [Cities Medium Crosstown Lounge Seating](#)
- [Cities Small Downtown Lounge Seating](#)
- [Cities Medium Downtown Lounge Seating](#)
- [Cities Small Uptown Lounge Seating](#)
- [Cities Medium Uptown Lounge Seating](#)
- [Cities Side Chair](#)
- [Cities Tables](#)
- [Cities Crosstown Patient Chair](#)
- [Cities Downtown Patient Chair](#)
- [Cities Uptown Patient Chair](#)
- [Cities Uptown CompactComfort Recliner](#)
- [Cities Crosstown Rocker](#)
- [Cities Downtown Rocker](#)
- [Cities Uptown Rocker](#)
- [Cities Downtown Glider](#)
- [SleepOver Sofa](#)
- [SleepOver Settee](#)

## Key Dimensions



<b>A</b>	Overall Width	See price table
<b>B</b>	Overall Depth	26.5"
<b>C</b>	Overall Height	39"
<b>D</b>	Seat Width	19.5", 21"
<b>E</b>	Seat Height	18.5"
<b>F</b>	Arm Height	24.5"

		<b>24" W, Glider</b>								38 lbs   3.75 yds
Model		Series 2	Series 3	Series 4	Series 5	Series 6	Series 7	Series 8	COM	
 	<b>Cities-SUX0XX-50CL SX</b>	\$2,493	\$2,615	\$2,818	\$3,030	\$3,281	\$3,536	\$3,854	\$2,615	
	<b>Cities-SUX0XX-50CL PX</b>	\$2,807	\$2,929	\$3,132	\$3,344	\$3,595	\$3,850	\$4,168	\$2,929	
		<b>28" W, Glider</b>								51 lbs   4 yds
Model		Series 2	Series 3	Series 4	Series 5	Series 6	Series 7	Series 8	COM	
 	<b>Cities-MUX0XX-50CL SX</b>	\$2,963	\$3,093	\$3,309	\$3,535	\$3,804	\$4,075	\$4,414	\$3,093	
	<b>Cities-MUX0XX-50CL PX</b>	\$3,335	\$3,465	\$3,681	\$3,907	\$4,176	\$4,447	\$4,786	\$3,465	

# Horizon Glider



## More Information

Illustrated Glossary ▶ 409

Fabrics ▶ 421

Flammability (CTB-133) ▶ 429

Finishes ▶ 425

Ordering and Warranties ▶ 432

## Standard Features

- Replaceable components
- Wood arm caps
- Nemschoff healthcare wood finish
- GREENGUARD Gold Certified
- Limited Lifetime Warranty

## Available Options

- Moisture barrier + \$69 per seat or back
- Black urethane arm caps + \$116
- Magazine pouch + \$76
- CTB-133 + \$83/yd
- Two fabrics + \$64
- Three (or more) fabrics + \$90

## Specification Decisions

- Select fabric
- Select standard wood finish
- Add CTB-133
- Apply multiple fabrics
- Add moisture barrier
- Add urethane arm caps
- Add magazine pouch

## Flammability Type

- Type 6

## Coordinating Products

- [Horizon Multiple Seating](#)
- [Horizon Tables](#)
- [Horizon Recliner](#)
- [Horizon Patient Chair](#)

## Key Dimensions

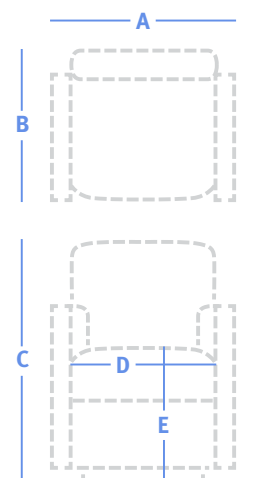

<b>A</b>	Overall Width	See price table
<b>B</b>	Overall Depth	28"
<b>C</b>	Overall Height	39.5"
<b>D</b>	Seat Width	19.5", 22"
<b>E</b>	Seat Height	18"
<b>F</b>	Arm Height	26"

	<b>23.5" W, Glider</b>									90 lbs   4.5 yds
	Model	Series 2	Series 3	Series 4	Series 5	Series 6	Series 7	Series 8	COM	
	<b>HG30</b>	\$2,334	\$2,406	\$2,722	\$2,891	\$2,983	\$3,104	\$3,182	\$2,406	
	<b>26" W, Glider</b>									96 lbs   4.75 yds
	Model	Series 2	Series 3	Series 4	Series 5	Series 6	Series 7	Series 8	COM	
	<b>HG35</b>	\$2,668	\$2,744	\$3,077	\$3,256	\$3,353	\$3,481	\$3,563	\$2,744	



# Marco Glider



## Standard Features

- Mortise and tenon joinery
- Spring seat construction
- Replaceable components
- Wood arms
- Concealed glider mechanism
- Wallsaver edge
- Nemschoff healthcare wood finish
- GREENGUARD Gold Certified
- Limited Lifetime Warranty; five years on mechanism

## Available Options

- Moisture barrier + \$69 per seat or back
- Passive lock + \$266
- Active lock + \$232
- CTB-133 + \$83/yd
- Two fabrics + \$64
- Three (or more) fabrics + \$90

## Specification Decisions

- Select fabric
- Select standard wood finish
- Add CTB-133
- Apply multiple fabrics
- Add moisture barrier
- Add passive or active lock

Model numbers with **S** indicate standard seat and back covers, and model numbers with **P** indicate removable covers.

Front to back motion is approximately 4.5" at floor level.

## Flammability Type

- Type 6

## Coordinating Products

- [Marco Grande II Lounge Seating](#)
- [Marco Multiple Seating](#)
- [Marco Grande Tables](#)
- [Marco Patient Chair](#)

## Key Dimensions

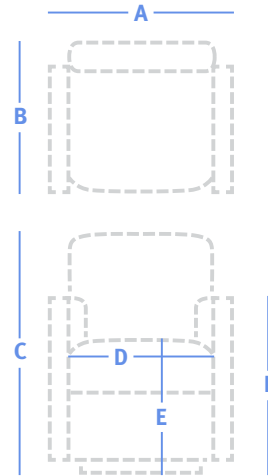

<b>A</b>	Overall Width	See price table
<b>B</b>	Overall Depth	27.5"
<b>C</b>	Overall Height	40.25"
<b>D</b>	Seat Width	19.5"
<b>E</b>	Seat Height	18.75"
<b>F</b>	Arm Height	25"

### More Information

Illustrated Glossary ▶ 409

Fabrics ▶ 421

Flammability (CTB-133) ▶ 429

Finishes ▶ 426

Ordering and Warranties ▶ 432



### 24" W, Glider

63 lbs | 4.5 yds

Model	Series 2	Series 3	Series 4	Series 5	Series 6	Series 7	Series 8	COM
<b>735-50CL S</b>	\$1,843	\$1,989	\$2,232	\$2,486	\$2,788	\$3,094	\$3,475	\$1,989
<b>735-50CL P</b>	\$2,082	\$2,228	\$2,471	\$2,725	\$3,027	\$3,333	\$3,714	\$2,228

# Olivia Glider



## More Information

Illustrated Glossary ▶ 409

Fabrics ▶ 421

Flammability (CTB-133) ▶ 429

Finishes ▶ 426

Ordering and Warranties ▶ 432

## Standard Features

- Mortise and tenon joinery
- Spring seat construction
- Clean-out design
- Replaceable components
- Upholstered arms
- Wallsaver edge
- Concealed glider mechanism
- GREENGUARD Gold Certified
- Limited Lifetime Warranty; five years on mechanism

## Available Options

- Moisture barrier + \$69 per seat or back
- Passive lock + \$266
- Active lock + \$232
- CTB-133 + \$83/yd
- Two fabrics + \$64
- Three (or more) fabrics + \$90

## Specification Decisions

- Select fabric
- Add CTB-133
- Apply multiple fabrics
- Add moisture barrier
- Add passive or active lock

Model numbers with **S** indicate standard seat and back covers, and model numbers with **P** indicate removable covers.

Front to back motion is approximately 4.5".

The back must be 7" from the wall to allow for gliding motion.

## Flammability Type

- Type 6

## Coordinating Products

- [Olivia Lounge Seating](#)
- [Olivia Tables](#)
- [Olivia Patient Chair](#)

## Key Dimensions

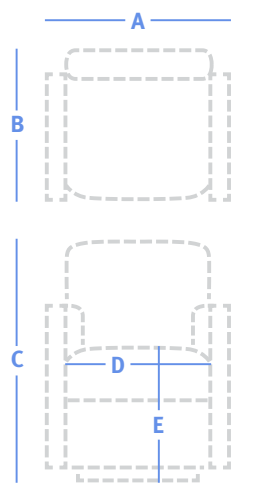

<b>A</b>	Overall Width	See price table
<b>B</b>	Overall Depth	30"
<b>C</b>	Overall Height	35"
<b>D</b>	Seat Width	21.25"
<b>E</b>	Seat Height	18.75"
<b>F</b>	Arm Height	25.25"



### 28" W, Glider

60 lbs | 5.5 yds

Model	Series 2	Series 3	Series 4	Series 5	Series 6	Series 7	Series 8	COM
<b>903-50 S</b>	\$2,453	\$2,632	\$2,929	\$3,240	\$3,609	\$3,982	\$4,448	\$2,632
<b>903-50 P</b>	\$2,769	\$2,948	\$3,245	\$3,556	\$3,925	\$4,298	\$4,764	\$2,948

# Torii Rocker



## Standard Features

- Mortise and tenon joinery
- Spring seat construction
- Clean-out design
- Replaceable components
- Wood arm caps
- Non-marring 7/8" rubber-cushioned glides
- Swoop-back style
- Wallsaver edge
- Must be 6" from the wall
- Nemschoff healthcare wood finish
- GREENGUARD Gold Certified
- Limited Lifetime Warranty

## Available Options

- Moisture barrier + \$69 per seat or back
- Arcade back + \$0
- Soft-radius edge + \$0
- CTB-133 + \$83/yd
- Two fabrics + \$64
- Three (or more) fabrics + \$90

## Specification Decisions

- Select fabric
- Select standard wood finish
- Add CTB-133
- Apply multiple fabrics
- Add moisture barrier
- Add Arcade back
- Add soft-radius edge

Model numbers with **S** indicate standard seat and back covers, and model numbers with **P** indicate removable covers.

## Flammability Type

- Type 5

## Coordinating Products

- [Torii Multiple Seating](#)
- [Torii Side Chair](#)
- [Torii Tables](#)
- [Torii Patient Chair](#)
- [Torii Glider](#)

## Key Dimensions

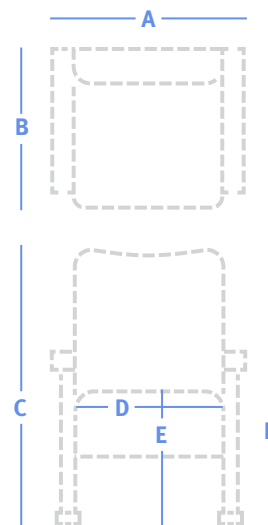

<b>A</b>	Overall Width	See price table
<b>B</b>	Overall Depth	27"
<b>C</b>	Overall Height	41.25"
<b>D</b>	Seat Width	21"
<b>E</b>	Seat Height	18.75"
<b>F</b>	Arm Height	25.75"

### More Information

- Illustrated Glossary ▶ 409
- Fabrics ▶ 421
- Flammability (CTB-133) ▶ 429
- Finishes ▶ 426
- Ordering and Warranties ▶ 432



### 25.25" W, Rocker

40 lbs | 2.25 yds

Model	Series 2	Series 3	Series 4	Series 5	Series 6	Series 7	Series 8	COM
<b>283-61 S</b>	\$1,902	\$1,975	\$2,097	\$2,224	\$2,375	\$2,528	\$2,718	\$1,975
<b>283-61 P</b>	\$2,139	\$2,212	\$2,334	\$2,461	\$2,612	\$2,765	\$2,955	\$2,212

# Torii Glider



## More Information

Illustrated Glossary ▶ 409

Fabrics ▶ 421

Flammability (CTB-133) ▶ 429

Finishes ▶ 426

Ordering and Warranties ▶ 432

## Standard Features

- Spring seat construction
- Clean-out design
- Replaceable components
- Wood arm caps
- Wallsaver edge
- Nemschoff healthcare wood finish
- GREENGUARD Gold Certified
- Limited Lifetime Warranty; five years on mechanism

## Available Options

- Moisture barrier + \$69 per seat or back
- Passive lock + \$266
- Active lock + \$232
- Arcade back + \$0
- Soft radius-edge + \$0
- CTB-133 + \$83/yd
- Two fabrics + \$64
- Three (or more) fabrics + \$90

## Specification Decisions

- Select fabric
- Select standard wood finish
- Add CTB-133
- Apply multiple fabrics
- Add moisture barrier
- Add passive or active lock
- Add Arcade back
- Add soft radius-edge

Model numbers with **S** indicate standard seat and back covers, and model numbers with **P** indicate removable covers.

Front to back motion is approximately 4.5" at floor level.

## Flammability Type

- Type 5

## Coordinating Products

- [Torii Multiple Seating](#)
- [Torii Side Chair](#)
- [Torii Tables](#)
- [Torii Patient Chair](#)
- [Torii Rocker](#)

## Key Dimensions

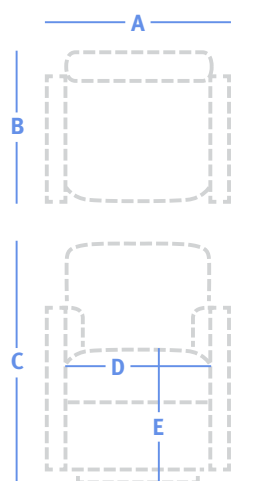

<b>A</b>	Overall Width	See price table
<b>B</b>	Overall Depth	28.5"
<b>C</b>	Overall Height	41"
<b>D</b>	Seat Width	20.75"
<b>E</b>	Seat Height	18.75"
<b>F</b>	Arm Height	25.5"



## 25.25" W, Glider

68 lbs | 2.5 yds

Model	Series 2	Series 3	Series 4	Series 5	Series 6	Series 7	Series 8	COM
<b>283-50CL S</b>	\$1,859	\$1,940	\$2,075	\$2,217	\$2,384	\$2,554	\$2,766	\$1,940
<b>283-50CL P</b>	\$2,092	\$2,173	\$2,308	\$2,450	\$2,617	\$2,787	\$2,999	\$2,173

# EZ-123 Overbed Table



## Standard Features

- Heavy-duty steel construction
- K-shaped base (Black, Pewter)
- Laminated top with molded urethane edge (EZ-123)
- Durawrap kidney-shaped top with spill-containing edge (EZ-123K)
- Large 18.5" x 34.5" top
- Adjustable gas spring mechanism with automatic lock
- 2" twin-wheel casters
- Ships assembled and blanket-wrapped
- GREENGUARD Gold Certified
- Five-year Warranty

## Available Options

- Framed vanity mirror with storage + \$190

## Specification Decisions

- Select standard laminate (EZ-123)
- Select Durawrap finish (EZ-123K)
- Select urethane edge color (EZ-123)
  - UEP** Pewter    **UEC** Cloud    **UES** Sable
- Select table base color
- Add vanity

## Key Dimensions



<b>A</b>	Width	34.5"
<b>B</b>	Depth	18.5"
<b>C</b>	Height Range	29.75" – 45.75"

## More Information

- Illustrated Glossary ▶ 409
- Finishes ▶ 426
- Hardware ▶ 427
- Ordering and Warranties ▶ 432



### 34.5" W, Overbed table

55 lbs

Model	Price
<b>EZ-123</b>	\$1,054



### 34.5" W, Overbed table with kidney-shaped top

55 lbs

Model	Price
<b>EZ-123K</b>	\$1,054

# Oasis Overbed Table



## More Information

Illustrated Glossary ▶ 409

Finishes ▶ 426

Hardware ▶ 427

Ordering and Warranties ▶ 432

## Standard Features

- Heavy-duty steel construction
- Ash grey (8D) powder-coated steel base
- Laminated top with urethane spill-containing edge
- Rounded inside tray edges
- Column mechanism with roller bearings
- 2" minimum clearance base
- Casters
- X- or U-shaped base
- Ships cartoned
- GREENGUARD Gold Certified
- Five-year Warranty

## Available Options

- Framed vanity mirror with storage + \$190
- See price table for specific model numbers

## Specification Decisions

- Select standard laminate
  - Select urethane edge color
- UEP** Pewter      **UEC** Cloud      **UES** Sable
- Add vanity

## Key Dimensions

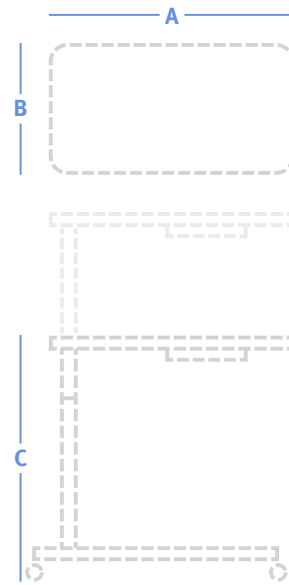

<b>A</b>	Width	44"
<b>B</b>	Depth	20"
<b>C</b>	Height Range	28.25" – 46"

Patient Chairs

Recliners

Treatment Chairs

Rockers &amp; Gliders

Overbed Tables

Sleepover Seating

Casegoods

Display &amp; Accessories

## Oasis Overbed Table

	<b>44" W, Overbed table with X base</b> <span style="float: right;">65 lbs</span>			
	Model	Price	Depth	Height Range
	<b>OAS123-X</b>	\$1,240	20"	29.75" - 45.75"

	<b>44" W, Overbed table with X base and patient tray</b> <span style="float: right;">73 lbs</span>			
	Model	Price	Depth	Height Range
	<b>OAS123-X-P</b>	\$1,348	20"	29.75" - 45.75"

	<b>44" W, Overbed table with X base and caregiver tray</b> <span style="float: right;">73 lbs</span>			
	Model	Price	Depth	Height Range
	<b>OAS123-X-N</b>	\$1,348	20"	29.75" - 45.75"

	<b>44" W, Overbed table with X base, caregiver tray, and patient tray</b> <span style="float: right;">81 lbs</span>			
	Model	Price	Depth	Height Range
	<b>OAS123-X-NP</b>	\$1,453	20"	29.75" - 45.75"

	<b>44" W, Overbed table with U base</b> <span style="float: right;">65 lbs</span>			
	Model	Price	Depth	Height Range
	<b>OAS123-U</b>	\$1,240	20"	29.75" - 45.75"

	<b>44" W, Overbed table with U base and patient tray</b> <span style="float: right;">73 lbs</span>			
	Model	Price	Depth	Height Range
	<b>OAS123-U-P</b>	\$1,348	20"	29.75" - 45.75"

	<b>44" W, Overbed table with U base and caregiver tray</b> <span style="float: right;">73 lbs</span>			
	Model	Price	Depth	Height Range
	<b>OAS123-U-N</b>	\$1,348	20"	29.75" - 45.75"

	<b>44" W, Overbed table with U base, caregiver tray, and patient tray</b> <span style="float: right;">81 lbs</span>			
	Model	Price	Depth	Height Range
	<b>OAS123-U-NP</b>	\$1,453	20"	29.75" - 45.75"

# Overbed Table



### More Information

- Illustrated Glossary ▶ 409
- Finishes ▶ 426
- Hardware ▶ 427
- Ordering and Warranties ▶ 432

### Standard Features

- Laminated top (Honey Maple, White) with urethane edge
- Chrome-plated steel base
- Casters
- Vanity mirror (FXZ26V)
- Ships with base in carton, top blanket-wrapped
- GREENGUARD Gold Certified
- Five-year Warranty

### Specification Decisions

- Select standard laminate
  - Select urethane edge color
- UEP** Pewter      **UEC** Cloud      **UES** Sable

### Key Dimensions

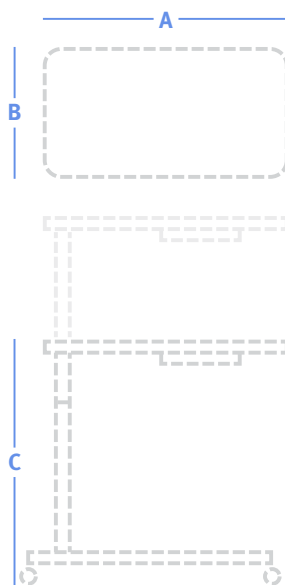

<b>A</b>	Width	30"
<b>B</b>	Depth	15"
<b>C</b>	Height Range	29.5" – 44.5"



<b>30" W, Overbed table</b>				24 lbs
Model	Price	Depth	Height Range	
<b>FXZ26</b>	\$628	15"	29.5" - 44.5"	



<b>30" W, Overbed table with vanity</b>				30 lbs
Model	Price	Depth	Height Range	
<b>FXZ26V</b>	\$798	15"	29.5" - 44.5"	

Patient Chairs

Recliners

Treatment Chairs

Rockers & Gliders

Overbed Tables

Sleeper Seating

Casegoods

Display & Accessories



# Beaumont Sleep Chair and Settee



## Standard Features

- Replaceable components
- Removable covers
- Fully upholstered arms
- Non-marring 2 ¼" glides
- Heavy-duty mechanism
- Pull-out sleep surface
- Sleep surface dimensions (Chair) 27" x 80"
- Sleep surface dimensions (Settee) 54" x 80"
- Antimicrobial surface at head and foot
- Nemschoff healthcare wood finish
- GREENGUARD Gold Certified
- Limited Lifetime Warranty; five years on mechanism

## Available Options

- Moisture barrier + \$69 per seat or back
- Wood arm caps + \$116
- Black urethane arm caps + \$116
- 2" twin-wheel casters, front fixed with brakes, back swivel + \$162
- CTB-133 + \$83/yd
- Two fabrics + \$64
- Three (or more) fabrics + \$90

## Specification Decisions

- Select fabric
- Select standard wood finish
- Add moisture barrier
- Add CTB-133
- Apply multiple fabrics
- Add casters
- Add urethane or wood arm caps

## Flammability Type

- Type 7

## Key Dimensions

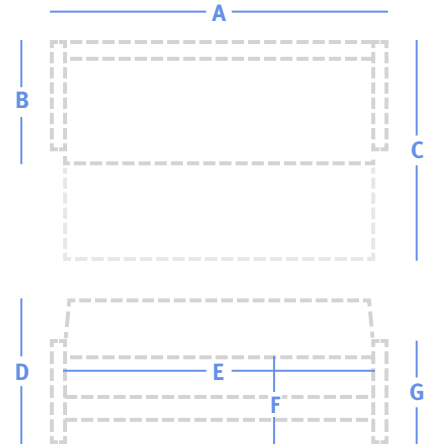

<b>A</b>	Width	See price table
<b>B</b>	Depth	36.5"
<b>C</b>	Extended Depth	85"
<b>D</b>	Overall Height	35"
<b>E</b>	Seat Width	
	Chair	27.25"
	Settee	54"
<b>F</b>	Seat Height	17.75"
<b>G</b>	Arm Height	24.5"

## More Information

Illustrated Glossary ▶ 409

Fabrics ▶ 421

Flammability (CTB-133) ▶ 429

Finishes ▶ 426

Ordering and Warranties ▶ 432



### 34.5" W, Sleep chair

131 lbs | 7.5 yds

Model	Series 2	Series 3	Series 4	Series 5	Series 6	Series 7	Series 8	COM
<b>FX153-17</b>	\$2,955	\$3,197	\$3,598	\$4,017	\$4,519	\$4,979	\$5,609	\$3,197



### 61.5" W, Sleep settee

237 lbs | 12.5 yds

Model	Series 2	Series 3	Series 4	Series 5	Series 6	Series 7	Series 8	COM
<b>FX153-27</b>	\$4,216	\$4,619	\$5,287	\$5,986	\$6,821	\$7,589	\$8,638	\$4,619

# Brava Flop Sofa



## More Information

Illustrated Glossary ▶ 409

Fabrics ▶ 421

Flammability (CTB-133) ▶ 429

Finishes ▶ 426

Ordering and Warranties ▶ 432

## Standard Features

- Mortise and tenon joinery
- Spring seat construction
- Replaceable components
- Upholstered arms
- Non-marring 7/8" rubber-cushioned glides
- Removable seat and back covers
- Back cushion flops down to convert to sleep surface (no mechanism)
- Sleep surface dimensions 78.5" x 30"
- Antimicrobial, moisture-proof and cleanable sleep surface
- Nemschoff healthcare wood finish
- GREENGUARD Gold Certified
- Limited Lifetime Warranty

## Available Options

- Moisture barrier + \$69 per seat or back
- Wood arm caps + \$116
- Black urethane arm caps + \$116
- Desert or Pewter urethane arm caps + \$210
- CTB-133 + \$83/yd
- Two fabrics + \$64
- Three (or more) fabrics + \$90

## Specification Decisions

- Select fabric
- Select standard wood finish
- Add moisture barrier
- Add CTB-133
- Apply multiple fabrics
- Add wood or urethane arm caps

## Flammability Type

- Type 7

## Coordinating Products

- [Brava Classic Lounge Seating](#)
- [Brava Platform Lounge Seating](#)
- [Brava 862 Multiple Seating](#)
- [Brava 863 Multiple Seating](#)
- [Brava Side Chair](#)
- [Brava Tables](#)
- [Brava Adjustable Back Chair](#)
- [Brava CompactComfort Recliner](#)
- [Brava Patient Chair](#)
- [Brava Glider](#)
- [Brava Sleep Settee](#)

## Key Dimensions

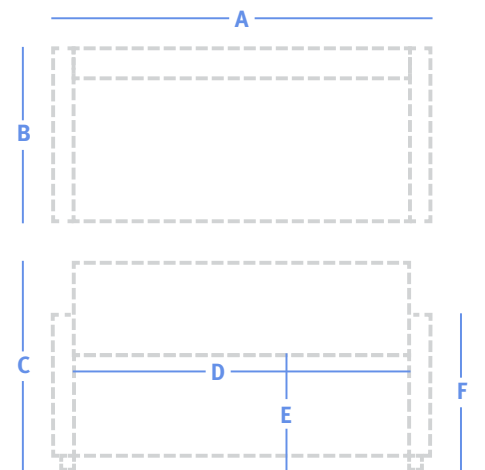

<b>A</b>	Overall Width	See price table
<b>B</b>	Overall Depth	35.25"
<b>C</b>	Overall Height	32.25"
<b>D</b>	Seat Width	71"
<b>E</b>	Seat Height	18"
<b>F</b>	Arm Height	22.5"



### 78.5" W, Flop sofa

141 lbs | 14 yds

Model	Series 2	Series 3	Series 4	Series 5	Series 6	Series 7	Series 8	COM
<b>861-37</b>	\$4,044	\$4,500	\$5,256	\$6,046	\$6,986	\$7,935	\$9,123	\$4,500

# Brava Sleep Settee



## Standard Features

- Mortise and tenon joinery
- Spring seat construction
- Replaceable components
- Upholstered arms
- Non-marring 7/8" rubber-cushioned glides
- Dual extending sides (15" on left and right)
- Sleep surface dimensions 78" x 25"
- Integral vented storage compartment
- Nemschoff healthcare wood finish
- GREENGUARD Gold Certified
- Limited Lifetime Warranty; five years on mechanism

## Available Options

- Moisture barrier + \$69 per seat or back
- Wood arm caps + \$116
- Black urethane arm caps + \$116
- Desert or Pewter urethane arm caps + \$210
- Four 2" twin-wheel swivel casters with brakes + \$430
- CTB-133 + \$83/yard
- Two fabrics + \$64
- Three (or more) fabrics + \$90

## Specification Decisions

- Select fabric
- Select standard wood finish
- Add moisture barrier
- Add CTB-133
- Apply multiple fabrics
- Add wood or urethane arm caps
- Add casters

Model numbers with **S** indicate standard seat and back covers, and model numbers with **P** indicate removable covers.

## Flammability Type

- Type 6

## Coordinating Products

- [Brava Classic Lounge Seating](#)
- [Brava Platform Lounge Seating](#)
- [Brava 862 Multiple Seating](#)
- [Brava 863 Multiple Seating](#)
- [Brava Side Chair](#)
- [Brava Tables](#)
- [Brava Adjustable Back Chair](#)
- [Brava CompactComfort Recliner](#)
- [Brava Patient Chair](#)
- [Brava Glider](#)
- [Brava Flop Sofa](#)

## Key Dimensions

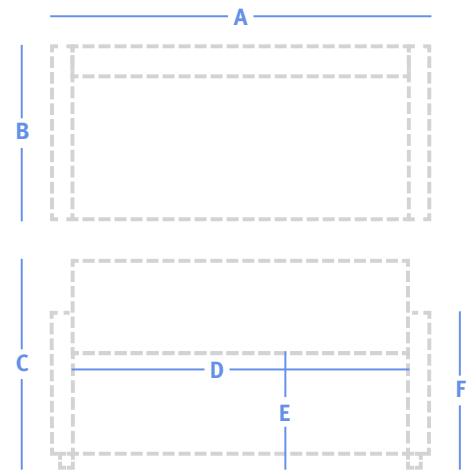

<b>A</b>	Overall Width	See price table 84.75" (extended)
<b>B</b>	Overall Depth	31.75"
<b>C</b>	Overall Height	33.5"
<b>D</b>	Seat Width	47.75"
<b>E</b>	Seat Height	19"
<b>F</b>	Arm Height	24.75"

### More Information

- Illustrated Glossary ▶ 409
- Fabrics ▶ 421
- Flammability (CTB-133) ▶ 429
- Finishes ▶ 426
- Ordering and Warranties ▶ 432



### 55.25" W, Sleep settee

183 lbs | 9.75 yds

Model	Series 2	Series 3	Series 4	Series 5	Series 6	Series 7	Series 8	COM
<b>861-27 S</b>	\$4,354	\$4,672	\$5,199	\$5,749	\$6,404	\$7,065	\$7,892	\$4,672
<b>861-27 P</b>	\$4,915	\$5,233	\$5,760	\$6,310	\$6,965	\$7,626	\$8,453	\$5,233

# Consoul Sleep Chair and Settee



## More Information

Illustrated Glossary ▶ 409

Fabrics ▶ 421

Flammability (CTB-133) ▶ 429

Finishes ▶ 426

Ordering and Warranties ▶ 432

## Standard Features

- Solid maple frame
- Spring seat construction
- Replaceable components
- Clean-out design
- Upholstered arms
- Removable covers
- Wallsaver bumper
- 3" swivel casters, front-locking
- One-hand pull to convert to a completely flat sleep surface
- Sleep surface dimensions (Chair) 24.25" x 77.5"
- Sleep surface dimensions (Settee) 54.25" x 77.5"
- Antimicrobial surface for the foot area
- Nemschoff healthcare wood finish
- GREENGUARD Gold Certified
- Limited Lifetime Warranty; ten years on mechanism

## Available Options

- Moisture barrier + \$69 per seat or back
- Option package 1: Arm caps (wood or urethane) with thermoplastic (ABS) protective base + \$628
- Option package 2: Arm caps (wood or urethane) with thermoplastic (ABS) protective base and in-arm storage + \$915
- Monitor arm (LSF, RSF) + \$419
- Tablet table (LSF, RSF; laminate with wood edge) + \$524
- CTB-133 + \$83/yd
- Two fabrics + \$64
- Three (or more) fabrics + \$90

Wood rail beneath sleep surface is dark brown walnut if alternative finish is not specified for wood arm caps.

## Specification Decisions

- Select fabric
- Select wallsaver bumper color (Black, Desert, Pewter)
- Add option package 1 or package 2
- Select standard wood finish, if required
- Select thermoplastic (ABS) color, if required (Black, Desert, Pewter)
- Add moisture barrier
- Add CTB-133
- Apply multiple fabrics
- Add monitor arm
- Add tablet table (specify laminate and wood edge color)

## Flammability Type

- Type 7

## Coordinating Products

- [Consoul Recliner](#)

## Key Dimensions

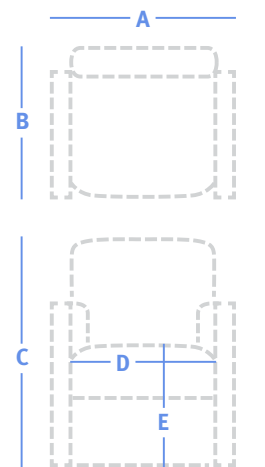

<b>A</b>	Overall Width	See price table
<b>B</b>	Overall Depth	40" 88" (extended)
<b>C</b>	Overall Height	34.5"
<b>D</b>	Seat Width	24.5", 54.25"
<b>E</b>	Seat Height	17.75"
<b>F</b>	Arm Height	26.5"

## Consoul Sleep Chair and Settee



### 35.5" W, Sleep chair

184 lbs | 7.25 yds

Model	Series 2	Series 3	Series 4	Series 5	Series 6	Series 7	Series 8	COM
<b>798-17</b>	\$3,550	\$3,786	\$4,178	\$4,587	\$5,074	\$5,566	\$6,181	\$3,786



### 62.5" W, Sleep settee

293 lbs | 16 yds

Model	Series 2	Series 3	Series 4	Series 5	Series 6	Series 7	Series 8	COM
<b>798-27</b>	\$4,590	\$5,112	\$5,976	\$6,879	\$7,953	\$9,038	\$10,395	\$5,112

# Leonard II Sleep Double Sofa and Sleep Settee



## More Information

Illustrated Glossary ▶ 409

Fabrics ▶ 421

Flammability (CTB-133) ▶ 429

Finishes ▶ 426

Ordering and Warranties ▶ 432

## Standard Features

- Spring seat construction
- Replaceable components
- Removable covers (Double sofa)
- Wood arm caps
- Non-marring 2¼" glides
- LSF or RSF extension (Settee)
- Sleep surface dimensions (Settee) 78" x 25"
- Sleep surface dimensions (Sofa) 80" x 54"
- Antimicrobial, moisture-proof and cleanable sleep surface (Double sofa)
- Integral storage compartments
- Nemschoff healthcare wood finish
- GREENGUARD Gold Certified
- Limited Lifetime Warranty; five years on mechanism

## Available Options

- Moisture barrier + \$69 per seat or back
- Classic upholstered bottom panel + \$277
- Fully upholstered arms + \$116
- Black urethane arm caps + \$116
- CTB-133 + \$83/yd
- Two fabrics + \$64
- Three (or more) fabrics + \$90

## Specification Decisions

- Select fabric
- Select standard wood finish
- Select LSF or RSF extension (Settee)
- Add moisture barrier
- Add CTB-133
- Apply multiple fabrics
- Add urethane or fully upholstered arm caps
- Add fully upholstered arms
- Add classic panel (Double sofa)

Model numbers with **S** indicate standard seat and back covers, and model numbers with **P** indicate removable covers.

Sofa uses a standard XL full sheet.

## Flammability Type

- Type 7

## Coordinating Products

- [Leonard II Lounge Seating](#)
- [Leonard II Recliner](#)

## Key Dimensions

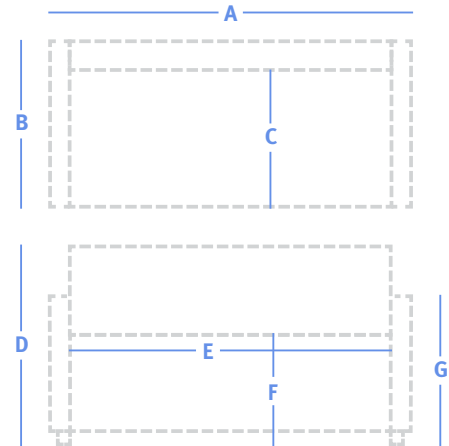

<b>A</b>	Overall Width	See price table 85" (extended Settee)
<b>B</b>	Overall Depth	35.5"
<b>C</b>	Seat Depth	31.75" 57" (extended Sofa)
<b>D</b>	Overall Height	33", 35.5"
<b>E</b>	Seat Width	47.25", 80"
<b>F</b>	Seat Height	18.75"
<b>G</b>	Arm Height	25.75"

## Leonard II Sleep Double Sofa and Sleep Settee

 		<b>88" W, Sleep double sofa</b>								278 lbs   11.25 yds
Model	Series 2	Series 3	Series 4	Series 5	Series 6	Series 7	Series 8	COM		
<b>814-37</b>	\$5,841	\$6,208	\$6,816	\$7,451	\$8,206	\$8,969	\$9,923	\$6,208		

 		<b>55.25" W, Sleep settee with LSF or RSF extension</b>								155 lbs   9.75 yds
Model	Series 2	Series 3	Series 4	Series 5	Series 6	Series 7	Series 8	COM		
<b>814-27X S</b>	\$4,211	\$4,529	\$5,056	\$5,606	\$6,261	\$6,922	\$7,749	\$4,529		
<b>814-27X P</b>	\$4,755	\$5,073	\$5,600	\$6,150	\$6,805	\$7,466	\$8,293	\$5,073		

# Merge Flop Sofa



## More Information

Illustrated Glossary ▶ 409

Fabrics ▶ 421

Flammability (CTB-133) ▶ 429

Finishes ▶ 426

Ordering and Warranties ▶ 432

## Standard Features

- Mortise and tenon joinery
- Spring seat construction
- Replaceable components
- Clean-out design
- Upholstered arms
- Continuous seat cushion
- Back cushion flops down to convert to sleep surface (no mechanism); dimensions 82" x 30"
- Laminated panel beneath back cushion and laminated back panel
- Plinth base with 2¼" plastic glides
- Antimicrobial, moisture-proof and cleanable sleep surface
- Removable covers
- GREENGUARD Gold Certified
- Limited Lifetime Warranty; five years on mechanism

## Available Options

- Moisture barrier + \$69 per seat or back
- Solid surface arm caps + \$315
- Black urethane or wood arm caps + \$116
- Upholstered back panel + \$524
- CTB-133 + \$83/yd
- Two fabrics + \$64
- Three (or more) fabrics + \$90
- Laminate front panels + \$0
- Stationary center table, laminated top + \$524
- Adjustable center table, laminated top + \$1,569
- Solid surface tabletop + \$837
- Veneer tabletop + \$158
- Storage drawer (upholstered or laminated front) + \$189
- Storage drawer (Durawrap front) + \$221
- Drawer liner + \$64 each
- Footrest (lever mounted on laminated recessed panel) + \$419
- Upholstered arm panel for footrest mount + \$0
- Concealed, front-locking casters + \$524

Weight capacity for center table (in highest position) is 55 lbs

## Specification Decisions

- Select fabric
- Select standard wood finish or laminate, if required
- Add moisture barrier
- Add CTB-133
- Apply multiple fabrics
- Add footrest (LSF, RSF or both)
- Add laminated front panels
- Add storage drawers (one, two or three)
- Add stationary or adjustable center table
- Add upholstered back panel
- Add solid-surface, urethane, or wood arm caps
- Add casters
- Add drawer liners

Each footrest adds 1" to overall width

Footrest and storage drawer cannot be ordered on the same seating position

Stationary and adjustable center table is 26.75" W x 21.25" D

Table adjusts from 19" H to 29.5" H

## Flammability Type

- Type 7



# Merge Flop Sofa

## Key Dimensions

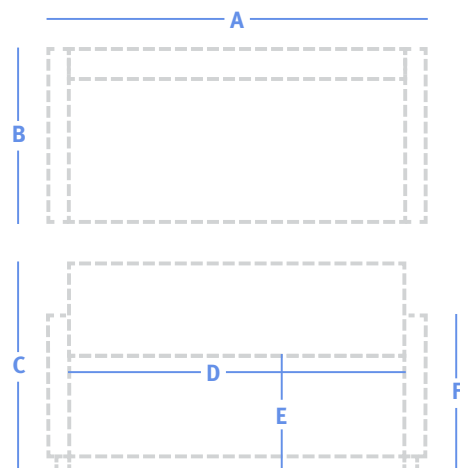

<b>A</b>	Overall Width	See price table
<b>B</b>	Overall Depth	35" 57" (extended footrest)
<b>C</b>	Overall Height	33.5"
<b>D</b>	Seat Width	74.75"
<b>E</b>	Seat Height	19"
<b>F</b>	Arm Height	23.75"

 	<b>82" W, Flop sofa</b>									376 lbs   10 yds
	Model	Series 2	Series 3	Series 4	Series 5	Series 6	Series 7	Series 8	COM	
<b>865-37</b>	\$4,216	\$4,542	\$5,082	\$5,647	\$6,318	\$6,996	\$7,844	\$4,542		

# Monarch Sleep Chair and Settee



## More Information

Illustrated Glossary ▶ 409

Fabrics ▶ 421

Flammability (CTB-133) ▶ 429

Finishes ▶ 426

Ordering and Warranties ▶ 432

## Standard Features

- Solid hardwood frame
- Mortise and tenon joinery
- Spring seat construction
- Replaceable components
- Removable covers
- Clean-out design
- Black urethane arm caps
- 2" front-locking, total-lock casters
- Sleep surface dimensions (Chair) 24.25" x 77.5"
- Sleep surface dimensions (Settee) 54.25" x 77.5"
- One-hand pull to convert to a completely flat sleep surface
- Antimicrobial surface at foot area
- Nemschoff healthcare wood finish
- GREENGUARD Gold Certified
- Limited Lifetime Warranty; five years on mechanism

## Available Options

- Moisture barrier + \$69 per seat or back
- Wood arm caps + \$116
- CTB-133 + \$83
- Two fabrics + \$64
- Three (or more) fabrics + \$90
- Tablet table (LSF, RSF; laminated with wood edge) + \$524
- Monitor arm (LSF, RSF) + \$419

## Specification Decisions

- Select fabric
- Select standard wood finish
- Add moisture barrier
- Add CTB-133
- Apply multiple fabrics
- Add wood arm caps
- Add tablet table (LSF, RSF), specify laminate and wood edge color
- Add monitor arm (Indicate LSF or RSF)

## Flammability Type

- Type 7

## Coordinating Products

- [Monarch Lounge Seating](#)
- [Monarch Multiple Seating](#)
- [Monarch Stack Chair](#)
- [Monarch Tables](#)
- [Monarch Patient Chair](#)

## Key Dimensions

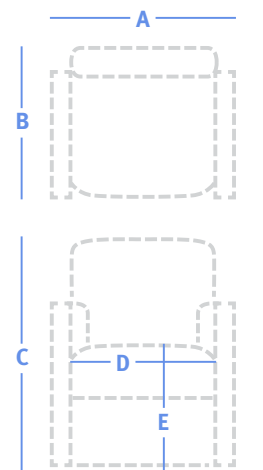

<b>A</b>	Overall Width	See price table
<b>B</b>	Overall Depth	36.75", 37.75" 86" (extended)
<b>C</b>	Overall Height	34"
<b>D</b>	Seat Width	24.25", 54.5"
<b>E</b>	Seat Height	17.5"
<b>F</b>	Arm Height	24.25"

## Monarch Sleep Chair and Settee



### 29.5" W, Sleep chair

164 lbs | 6.5 yds

Model	Series 2	Series 3	Series 4	Series 5	Series 6	Series 7	Series 8	COM
<b>894-17</b>	\$3,574	\$3,786	\$4,137	\$4,504	\$4,941	\$5,381	\$5,933	\$3,786



### 59.5" W, Sleep settee

248 lbs | 13.75 yds

Model	Series 2	Series 3	Series 4	Series 5	Series 6	Series 7	Series 8	COM
<b>894-27</b>	\$4,664	\$5,112	\$5,854	\$6,631	\$7,554	\$8,486	\$9,652	\$5,112

# Oliver Sleep Settee



## More Information

Illustrated Glossary ▶ 409

Fabrics ▶ 421

Flammability (CTB-133) ▶ 429

Finishes ▶ 426

Ordering and Warranties ▶ 432

## Standard Features

- Mortise and tenon joinery
- Spring seat construction
- Replaceable components
- Upholstered arms
- LSF or RSF extension
- Non-marring 7/8" rubber-cushioned glides
- Sleep surface dimensions 78" x 25"
- Integral storage compartment
- Nemschoff healthcare wood finish
- GREENGUARD Gold Certified
- Limited Lifetime Warranty; five years on mechanism

## Available Options

- Moisture barrier + \$69 per seat or back
- Four 2" twin-wheel swivel casters with brakes + \$430
- CTB-133 + \$83/yd
- Two fabrics + \$64
- Three (or more) fabrics + \$90

## Specification Decisions

- Select fabric
- Select standard wood finish
- Select LSF or RSF extension
- Add moisture barrier
- Add CTB-133
- Apply multiple fabrics
- Add casters

Model numbers with **S** indicate standard seat and back covers, and model numbers with **P** indicate removable covers.

## Flammability Type

- Type 6

## Coordinating Products

- [Oliver Lounge Seating](#)
- [Oliver Recliner](#)

## Key Dimensions

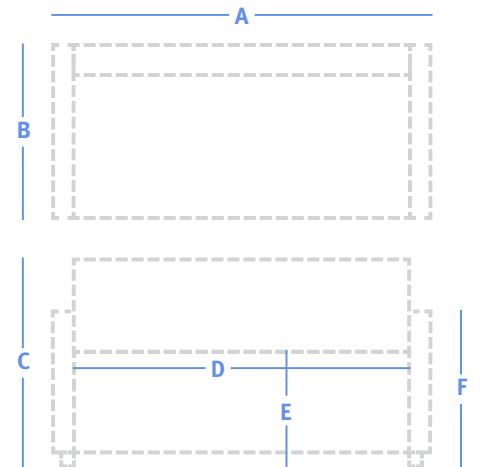

<b>A</b>	Overall Width	60.25" 89.75" Extended
<b>B</b>	Overall Depth	31.75"
<b>C</b>	Overall Height	33"
<b>D</b>	Seat Width	47.25"
<b>E</b>	Seat Height	18.5"
<b>F</b>	Arm Height	25.5"

		<b>60" W, Sleep settee with LSF or RSF extension</b>							155 lbs   10.25 yds	
	Model	Series 2	Series 3	Series 4	Series 5	Series 6	Series 7	Series 8	COM	
	<b>902-27X S</b>	\$4,114	\$4,448	\$5,002	\$5,580	\$6,268	\$6,963	\$7,833	\$4,448	
	<b>902-27X P</b>	\$4,648	\$4,982	\$5,536	\$6,114	\$6,802	\$7,497	\$8,367	\$4,982	

# Palisade Flop Sofa



## Standard Features

- Spring seat construction
- Replaceable components
- Wipe-out
- Durawrap arms and back cap
- Titanium powder-coated metal legs
- Non-marring 1" glide
- Removable seat and back covers
- Back cushion flops down to convert to sleep surface (no mechanism)
- Sleep surface dimensions 75.5" x 30"
- Antimicrobial, moisture-proof and cleanable sleep surface
- GREENGUARD Gold Certified
- Limited Lifetime Warranty
- Add power (select color)
- Add solid surface arms and back cap (select color)
- Add solid surface adjustable table (select color)
- Add wood legs (select wood finish) or casters
- Add wallsaver feature
- Add moisture barrier
- Add CTB-133
- Apply multiple fabrics

## Flammability Type

- Type 7

## Coordinating Products

- [Palisade Caseloads](#)
- [Palisade Coatrack](#)
- [Palisade Stools](#)
- [Palisade Tables](#)

## Key Dimensions

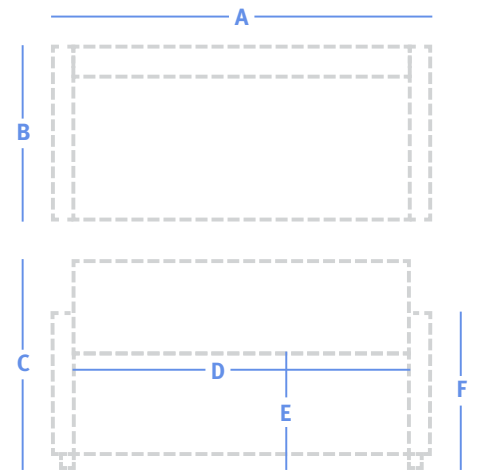

<b>A</b>	Overall Width	See price table
<b>B</b>	Overall Depth	32.75", 40.5" (-37EN)
<b>C</b>	Overall Height	33.5"
<b>D</b>	Seat Width	75"
<b>E</b>	Seat Height	18.5"
<b>F</b>	Arm Height	28.5"

## Available Options

- Moisture barrier + \$69 per seat or back
- Solid surface arms and back cap + \$796
- Solid surface adjustable table + \$592
- Silver LED dimmable task light; one year warranty (867-37LP, 867-37EN) + \$1,398 per arm
- Three power outlets and two USB ports (black or white); one year warranty (867-37LP, 867-37EN) + \$368 per arm
- Wood legs + \$261
- 3" swivel casters, front-locking + \$218
- Wallsaver feature + \$142
- CTB 133 + \$83/yd
- Two fabrics + \$64
- Three (or more) fabrics + \$90

## Specification Decisions

- Select fabric
- Select standard Durawrap
- Select utility arm on LSF, RSF, or both (867-37LP)
- Select adjustable table on LSF or RSF (867-37EN)
- Add task light

## More Information

- Illustrated Glossary ▶ 409
- Fabrics ▶ 421
- Flammability (CTB-133) ▶ 429
- Finishes ▶ 426
- Ordering and Warranties ▶ 429



### 81.75" W Flop sofa

184 lbs | 11 yds

Model	Series 2	Series 3	Series 4	Series 5	Series 6	Series 7	Series 8	COM
<b>867-37</b>	\$4,357	\$4,715	\$5,309	\$5,930	\$6,669	\$7,414	\$8,347	\$4,715

		<b>86" W Flop Sofa with utility arm</b>								211 lbs   11 yds
Model	Series 2	Series 3	Series 4	Series 5	Series 6	Series 7	Series 8	COM		
<b>867-37LP</b>	\$4,867	\$5,225	\$5,819	\$6,440	\$7,179	\$7,924	\$8,857	\$5,225		

		<b>86" W Flop Sofa with utility arm and adjustable table</b>								267 lbs   10.75 yds
Model	Series 2	Series 3	Series 4	Series 5	Series 6	Series 7	Series 8	COM		
<b>867-37EN</b>	\$6,882	\$7,232	\$7,813	\$8,419	\$9,141	\$9,870	\$10,782	\$7,232		

Patient Chairs

Recliners

Treatment Chairs

Rockers &amp; Gliders

Overbed Tables

Sleepover Seating

Casegoods

Display &amp; Accessories

# Pamona Flop Sofa



## Standard Features

- Mortise and tenon joinery
- Spring seat construction
- Replaceable components
- Removable covers
- Upholstered arms
- Powder-coated metal legs
- Wallsaver legs
- 1" plastic glides
- Back cushion flops down to convert to sleep surface (no mechanism)
- Sleep surface dimensions 30" x 80.25"
- Antimicrobial, moisture-proof and cleanable sleep surface
- GREENGUARD Gold certified
- Limited lifetime warranty; five years on mechanism

## Available Options

- Moisture barrier + \$69 per seat or back
- Black urethane arm caps + \$116
- Wood arm caps + \$116
- 3" twin wheel swivel casters with brake and directional lock on rear only; standard legs in front + \$348
- CTB-133 + \$83/yard
- Two fabrics + \$64
- Three (or more) fabrics + \$90

## Specification Decisions

- Select fabric
- Select powder coat finish
- Add moisture barrier
- Add CTB-133
- Apply multiple fabrics
- Add urethane arm caps
- Add casters

## Flammability Type

- Type 7

## Coordinating Products

- [Pamona Lounge Seating](#)
- [Pamona Tables](#)
- [Pamona Recliner](#)

## Key Dimensions

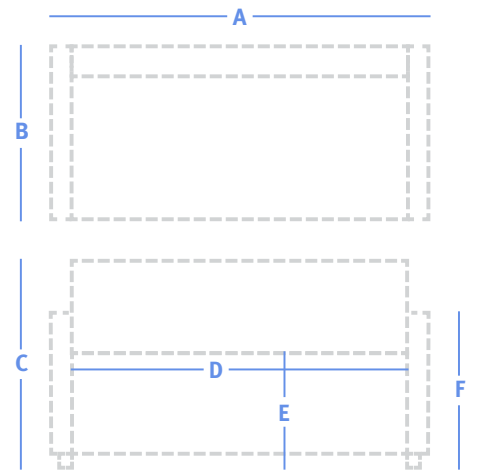

<b>A</b>	Overall Width	80.25"
<b>B</b>	Overall Depth	36"
<b>C</b>	Overall Height	32.75"
<b>D</b>	Seat Width	71"
<b>E</b>	Seat Height	18.5"
<b>F</b>	Arm Height	22.75"

### More Information

- Illustrated Glossary ▶ 409
- Fabrics ▶ 421
- Flammability (CTB-133) ▶ 429
- Finishes ▶ 426
- Ordering and Warranties ▶ 432

	80.25" W, Flop sofa								141 lbs   12 yds
Model	Series 2	Series 3	Series 4	Series 5	Series 6	Series 7	Series 8	COM	
<b>797-37</b>	\$3,521	\$3,912	\$4,560	\$5,237	\$6,043	\$6,857	\$7,875	\$3,912	

# Revive Guest Center



## More Information

Illustrated Glossary ▶ 409

Fabrics ▶ 421

Flammability (CTB-133) ▶ 429

Finishes ▶ 426

Ordering and Warranties ▶ 432

## Standard Features

- Wipe-out design
- Powder-coated legs
- Sliding sleep deck with no mechanism (except RVS36/80X2, RVS36/80X2-FP)
- Removable upholstery on sleep deck
- Upholstery applied railroaded
- Sleep surface dimensions (single) 72" x 26" (without rear storage trough) or 72" x 32" (with rear storage trough)
- Sleep surface dimensions (double) 72" x 49.75"
- Two storage drawers with laminate or veneer fronts or wood facia panel
- Rear storage trough (RVS15/72, RVS15/72-FP)
- GREENGUARD Gold Certified
- Limited Lifetime Warranty

## Available Options

- Moisture barrier + \$69 per seat or back
- Tablet arm + \$122
- Tablet arm with light receptacle + \$174
- Side table + \$393
- Infill panel (cannot be combined with caster lift) + \$193
- CTB-133 + \$83/yd
- Two fabrics + \$64
- Three (or more) fabrics + \$90
- Deck tray + \$109
- Caster lift + \$399

## Specification Decisions

- Select fabric
- Select powder-coated finish
- Select laminated or veneer finish for drawer fronts
- Add moisture barrier
- Add CTB-133
- Apply multiple fabrics
- Add lower infill panel
- Add deck tray
- Add tablet arm
- Add tablet arm with light receptacle
- Add side table

- Add caster lift  
Upholstery applied railroaded as standard.  
Caster lift cannot be combined with infill panel.  
Facia panel replaces drawers.

## Flammability Type

- Type 7

## Coordinating Products

- [Revive Side Chair](#)
- [Revive Patient Chair](#)
- [Revive Casegoods](#)
- [Revive Daystands](#)
- [Revive Display System](#)
- Arm styles

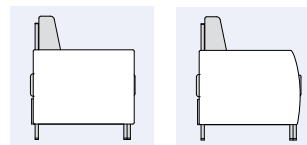

Standard arm

Arced arm

## Key Dimensions

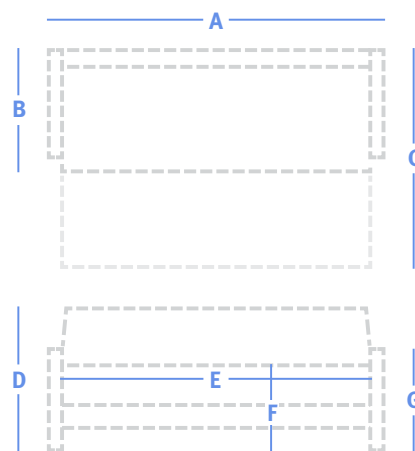



<b>A</b>	Width	See price table
<b>B</b>	Depth	28", 34"
<b>C</b>	Extended Depth	34", 46", 49.75"
<b>D</b>	Overall Height	33"
<b>E</b>	Seat Width	72"
<b>F</b>	Seat Height	17.5"
<b>G</b>	Arm Height	24"



## Revive Guest Center

	<b>72" W, Single guest center without arms</b>									200 lbs   6 yds
Model	Series 2	Series 3	Series 4	Series 5	Series 6	Series 7	Series 8	COM		
<b>RVS10/72</b>	\$3,851	\$3,919	\$4,217	\$4,377	\$4,464	\$4,579	\$4,652	\$3,919		

	<b>72" W, Single guest center without arms, with fascia panel</b>									200 lbs   6 yds
Model	Series 2	Series 3	Series 4	Series 5	Series 6	Series 7	Series 8	COM		
<b>RVS10/72-FP</b>	\$3,216	\$3,284	\$3,582	\$3,742	\$3,829	\$3,944	\$4,017	\$3,284		

	<b>72" W, Twin guest center without arms, with rear storage trough</b>									250 lbs   6 yds
Model	Series 2	Series 3	Series 4	Series 5	Series 6	Series 7	Series 8	COM		
<b>RVS15/72</b>	\$4,499	\$4,567	\$4,865	\$5,025	\$5,112	\$5,227	\$5,300	\$4,567		

	<b>72" W, Twin guest center without arms, with fascia panel and rear storage trough</b>									250 lbs   6 yds
Model	Series 2	Series 3	Series 4	Series 5	Series 6	Series 7	Series 8	COM		
<b>RVS15/72-FP</b>	\$3,862	\$3,930	\$4,228	\$4,388	\$4,475	\$4,590	\$4,663	\$3,930		

	<b>80" W, Guest center with single arm</b>									225 lbs   7 yds
Model	Series 2	Series 3	Series 4	Series 5	Series 6	Series 7	Series 8	COM		
<b>RVS30/80</b>	\$4,501	\$4,614	\$5,105	\$5,368	\$5,512	\$5,700	\$5,821	\$4,614		

	<b>80" W, Guest center with single arm and fascia panel</b>									225 lbs   8 yds
Model	Series 2	Series 3	Series 4	Series 5	Series 6	Series 7	Series 8	COM		
<b>RVS30/80-FP</b>	\$3,868	\$3,981	\$4,472	\$4,735	\$4,879	\$5,067	\$5,188	\$3,981		

	<b>80" W, Guest center with twin arms and rear storage trough</b>									250 lbs   7 yds
Model	Series 2	Series 3	Series 4	Series 5	Series 6	Series 7	Series 8	COM		
<b>RVS35/80</b>	\$4,962	\$5,075	\$5,566	\$5,829	\$5,973	\$6,161	\$6,282	\$5,075		

	<b>80" W, Guest center with twin arms, fascia panel and rear storage trough</b>									250 lbs   8 yds
Model	Series 2	Series 3	Series 4	Series 5	Series 6	Series 7	Series 8	COM		
<b>RVS35/80-FP</b>	\$4,326	\$4,439	\$4,930	\$5,193	\$5,337	\$5,525	\$5,646	\$4,439		

	<b>80" W, Guest center with single arced arm</b>									225 lbs   7 yds
Model	Series 2	Series 3	Series 4	Series 5	Series 6	Series 7	Series 8	COM		
<b>RVS31/80</b>	\$4,501	\$4,614	\$5,105	\$5,368	\$5,512	\$5,700	\$5,821	\$4,614		

	<b>80" W, Guest center with single arced arm and fascia panel</b>									225 lbs   8 yds
Model	Series 2	Series 3	Series 4	Series 5	Series 6	Series 7	Series 8	COM		
<b>RVS31/80-FP</b>	\$3,868	\$3,981	\$4,472	\$4,735	\$4,879	\$5,067	\$5,188	\$3,981		

**Revive Guest Center**

	<b>80" W, Guest center with twin arced arms and rear storage trough</b> <span style="float: right;">250 lbs   8 yds</span>								
	Model	Series 2	Series 3	Series 4	Series 5	Series 6	Series 7	Series 8	COM
	<b>RVS36/80</b>	\$4,962	\$5,075	\$5,566	\$5,829	\$5,973	\$6,161	\$6,282	\$5,075
	<b>80" W, Guest center with twin arced arms, facia panel and rear storage trough</b> <span style="float: right;">250 lbs   9.5 yds</span>								
	Model	Series 2	Series 3	Series 4	Series 5	Series 6	Series 7	Series 8	COM
	<b>RVS36/80-FP</b>	\$3,868	\$3,981	\$4,472	\$4,735	\$4,879	\$5,067	\$5,188	\$3,981
	<b>80" W, Guest center with double sleep surface and fold-down back</b> <span style="float: right;">235 lbs   9.5 yds</span>								
	Model	Series 2	Series 3	Series 4	Series 5	Series 6	Series 7	Series 8	COM
	<b>RVS36/80X2</b>	\$4,994	\$5,147	\$5,813	\$6,171	\$6,365	\$6,621	\$6,785	\$5,147
	<b>RVS36/80X2-FP</b>	\$4,407	\$4,520	\$5,011	\$5,274	\$5,418	\$5,606	\$5,727	\$4,520
	<b>72" W, Guest center bench</b> <span style="float: right;">180 lbs   3.25 yds</span>								
	Model	Series 2	Series 3	Series 4	Series 5	Series 6	Series 7	Series 8	COM
	<b>RVSB10/72</b>	\$3,259	\$3,311	\$3,539	\$3,662	\$3,728	\$3,816	\$3,872	\$3,311
	<b>72" W, Guest center bench with facia panel</b> <span style="float: right;">181 lbs   3.25 yds</span>								
	Model	Series 2	Series 3	Series 4	Series 5	Series 6	Series 7	Series 8	COM
	<b>RVSB10/72-FP</b>	\$2,624	\$2,676	\$2,904	\$3,027	\$3,093	\$3,181	\$3,237	\$2,676
	<b>72" W, Guest center bench</b> <span style="float: right;">205 lbs   4.5 yds</span>								
	Model	Series 2	Series 3	Series 4	Series 5	Series 6	Series 7	Series 8	COM
	<b>RVSB15/72</b>	\$3,333	\$3,405	\$3,721	\$3,890	\$3,982	\$4,103	\$4,181	\$3,405
	<b>72" W, Guest center bench with facia panel</b> <span style="float: right;">205 lbs   4.5 yds</span>								
	Model	Series 2	Series 3	Series 4	Series 5	Series 6	Series 7	Series 8	COM
	<b>RVSB15/72-FP</b>	\$2,702	\$2,770	\$3,068	\$3,228	\$3,315	\$3,430	\$3,503	\$2,770

Patient Chairs

Recliners

Treatment Chairs

Rockers &amp; Gliders

Overbed Tables

Sleeper Seating

Casegoods

Display &amp; Accessories

# SleepOver 1-2-3 Chair



## Standard Features

- Mortise and tenon joinery
- Spring seat construction
- Replaceable components
- Wood arm caps
- Non-marring 5/8" x 2" glides
- Sleep surface dimensions (standard) 22.75" x 72"
- Sleep surface dimensions (wide) 28.75" x 72"
- Integral storage compartment
- Removable cover on sleep surface
- Nemschoff healthcare wood finish
- GREENGUARD Gold Certified
- Limited Lifetime Warranty; five years on mechanism

## Available Options

- Moisture barrier + \$69 per seat or back
- Black urethane arm caps + \$116
- Two front 2" swivel casters + \$107
- 2" twin-wheel swivel casters, rear with brakes + \$333
- CTB-133 + \$83/yd
- Two fabrics + \$64
- Three (or more) fabrics + \$90

## Specification Decisions

- Select standard wood finish
- Select fabric
- Add moisture barrier
- Add CTB-133
- Apply multiple fabrics
- Add casters
- Add urethane arm caps

Model numbers with **S** indicate standard seat and back covers, and model numbers with **P** indicate removable covers.

## Flammability Type

- Type 6

## Coordinating Products

- [SleepOver Bench](#)
- [SleepOver Flop Sofa](#)
- [SleepOver Settee](#)
- [SleepOver Sofa](#)

## Key Dimensions

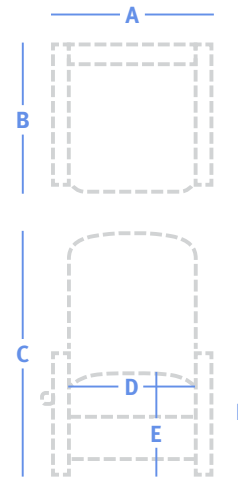

<b>A</b>	Overall Width	See price table
<b>B</b>	Overall Depth	35.25" 70.25" (extended)
<b>C</b>	Overall Height	36.75"
<b>D</b>	Seat Width	22.75", 28.75"
<b>E</b>	Seat Height	18.75"
<b>F</b>	Arm Height	24.5"

## More Information

Illustrated Glossary ▶ 409

Fabrics ▶ 421

Flammability (CTB-133) ▶ 429

Finishes ▶ 426

Ordering and Warranties ▶ 432

		<b>31.25" W, Sleep chair</b>								106 lbs   7 yds
		Model	Series 2	Series 3	Series 4	Series 5	Series 6	Series 7	Series 8	COM
	<b>780-17 S</b>		\$3,007	\$3,235	\$3,613	\$4,008	\$4,478	\$4,953	\$5,547	\$3,235
	<b>780-17 P</b>		\$3,396	\$3,624	\$4,002	\$4,397	\$4,867	\$5,342	\$5,936	\$3,624
		<b>37.25" W, Wide sleep chair</b>								118 lbs   10.5 yds
		Model	Series 2	Series 3	Series 4	Series 5	Series 6	Series 7	Series 8	COM
	<b>780-17W S</b>		\$3,224	\$3,566	\$4,133	\$4,726	\$5,431	\$6,143	\$7,033	\$3,566
	<b>780-17W P</b>		\$3,652	\$3,994	\$4,561	\$5,154	\$5,859	\$6,571	\$7,461	\$3,994

# SleepOver Bench



## More Information

Illustrated Glossary ▶ 409

Fabrics ▶ 421

Flammability (CTB-133) ▶ 429

Finishes ▶ 426

Ordering and Warranties ▶ 432

## Standard Features

- Mortise and tenon joinery
- Spring seat construction
- Replaceable components
- Upholstered arms on select models
- Non-marring 7/8" rubber-cushioned glides
- Sleep surface dimensions 76.25" x 36"
- Antimicrobial, moisture-proof and cleanable sleep surface
- Integral storage compartment
- Nemschoff healthcare wood finish
- GREENGUARD Gold Certified
- Limited Lifetime Warranty

## Available Options

- Moisture barrier + \$69 per seat or back
- Black urethane arm caps on select models + \$116
- Wood arm caps on select models + \$116
- Four 2" twin-wheel swivel casters with brakes + \$352
- CTB-133 + \$83/yd
- Two fabrics + \$64
- Three (or more) fabrics + \$90

## Specification Decisions

- Select fabric
- Add moisture barrier
- Add CTB-133
- Apply multiple fabrics
- Add casters
- Add wood or urethane arm caps

Model numbers with **S** indicate standard seat and back covers, and model numbers with **P** indicate removable covers.

## Flammability Types

- Type 4
- Type 7 (with back)

## Coordinating Products

- [SleepOver 1-2-3 Chair](#)
- [SleepOver Flop Sofa](#)
- [SleepOver Settee](#)
- [SleepOver Sofa](#)

## Key Dimensions

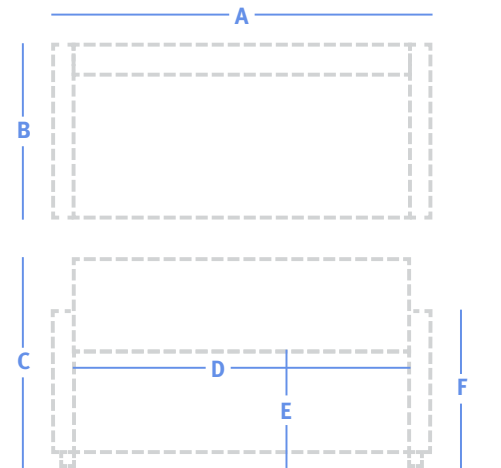

<b>A</b>	Overall Width	See price table
<b>B</b>	Overall Depth	20.25" - 24" (back)
<b>C</b>	Overall Height	24.75", 18.5", 33.5"
<b>D</b>	Seat Width	78.25"
<b>E</b>	Seat Height	18.5"
<b>F</b>	Arm Height	24.75"

## SleepOver Bench

	<b>78.25" W, Bench</b>									161 lbs   8.25 yds
	Model	Series 2	Series 3	Series 4	Series 5	Series 6	Series 7	Series 8	COM	
	<b>781-B17 S</b>	\$3,880	\$4,149	\$4,595	\$5,060	\$5,614	\$6,174	\$6,873	\$4,149	
	<b>781-B17 P</b>	\$4,378	\$4,647	\$5,093	\$5,558	\$6,112	\$6,672	\$7,371	\$4,647	
	<b>90.75" W, Bench with arms</b>									191 lbs   9 yds
	Model	Series 2	Series 3	Series 4	Series 5	Series 6	Series 7	Series 8	COM	
	<b>781-B17A S</b>	\$4,137	\$4,430	\$4,916	\$5,424	\$6,028	\$6,639	\$7,402	\$4,430	
	<b>781-B17A P</b>	\$4,669	\$4,962	\$5,448	\$5,956	\$6,560	\$7,171	\$7,934	\$4,962	
	<b>78.25" W, Bench with back</b>									217 lbs   10.25 yds
	Model	Series 2	Series 3	Series 4	Series 5	Series 6	Series 7	Series 8	COM	
	<b>781-B17B S</b>	\$4,196	\$4,530	\$5,084	\$5,662	\$6,350	\$7,045	\$7,915	\$4,530	
	<b>781-B17B P</b>	\$4,740	\$5,074	\$5,628	\$6,206	\$6,894	\$7,589	\$8,459	\$5,074	
	<b>90.75" W, Bench with arms and back</b>									247 lbs   11.5 yds
	Model	Series 2	Series 3	Series 4	Series 5	Series 6	Series 7	Series 8	COM	
	<b>781-B17AB S</b>	\$4,306	\$4,681	\$5,302	\$5,951	\$6,723	\$7,503	\$8,478	\$4,681	
	<b>781-B17AB P</b>	\$4,868	\$5,243	\$5,864	\$6,513	\$7,285	\$8,065	\$9,040	\$5,243	

# SleepOver Flop Sofa



## More Information

Illustrated Glossary ▶ 409

Fabrics ▶ 421

Flammability (CTB-133) ▶ 429

Finishes ▶ 426

Ordering and Warranties ▶ 432

## Standard Features

- Mortise and tenon joinery
- Spring seat construction
- Replaceable components
- Plinth base
- Wood legs (785-37)
- Brushed-aluminum legs (796-37)
- Removable seat and back covers
- Back cushion flops down to convert to sleep surface (no mechanism)
- Upholstered arms
- Sleep surface dimensions 78.75" x 27.5"
- Antimicrobial, moisture proof, and cleanable sleep surface
- Integral storage compartments (location based on model)
- Non-marring 2¼" glides
- GREENGUARD Gold Certified
- Limited Lifetime Warranty

## Available Options

- Moisture barrier + \$69 per seat or back
- Black urethane arm caps + \$116 (795-37)
- Desert or Pewter urethane arm caps + \$210 (795-37)
- Brushed stainless steel-look legs (785-37) + \$345
- CTB-133 + \$83/yard
- Two fabrics + \$64
- Three (or more) fabrics + \$90

## Specification Decisions

- Select fabric
- Select standard wood finish
- Add moisture barrier
- Add CTB-133
- Apply multiple fabrics

## Flammability Type

- Type 7

## Coordinating Products

- [SleepOver 1-2-3 Chair](#)
- [SleepOver Bench](#)
- [SleepOver Settee](#)
- [SleepOver Sofa](#)

## Key Dimensions

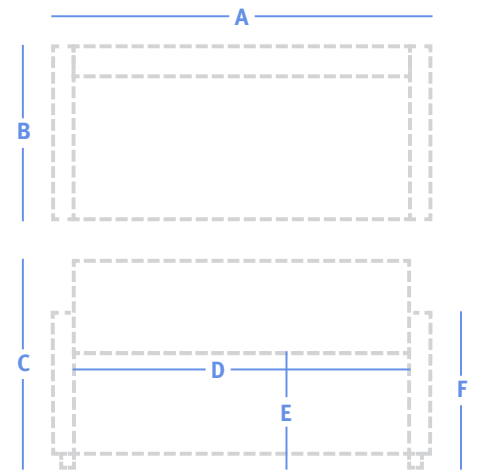



<b>A</b>	Overall Width	See price table
<b>B</b>	Overall Depth	35.5", 34", 36.25"
<b>C</b>	Overall Height	33", 34.25"
<b>D</b>	Seat Width	55"
<b>E</b>	Seat Height	18"
<b>F</b>	Arm Height	22.5"

## SleepOver Flop Sofa

		<b>79.75" W, Flop sofa with arm storage</b>								152 lbs   15 yds
Model		Series 2	Series 3	Series 4	Series 5	Series 6	Series 7	Series 8	COM	
<b>785-37</b>		\$4,316	\$4,805	\$5,615	\$6,462	\$7,469	\$8,486	\$9,758	\$4,805	

		<b>79.25" W, Flop sofa with arm storage, plinth base, and under-seat drawers</b>								202 lbs   15 yds
Model		Series 2	Series 3	Series 4	Series 5	Series 6	Series 7	Series 8	COM	
<b>793-37</b>		\$4,316	\$4,805	\$5,615	\$6,462	\$7,469	\$8,486	\$9,758	\$4,805	

		<b>79.25" W, Flop sofa with flush arm storage, plinth base, and under-seat drawers</b>								202 lbs   15 yds
Model		Series 2	Series 3	Series 4	Series 5	Series 6	Series 7	Series 8	COM	
<b>794-37</b>		\$4,316	\$4,805	\$5,615	\$6,462	\$7,469	\$8,486	\$9,758	\$4,805	

		<b>79.25" W, Flop sofa with narrow arm storage and under-seat storage</b>								202 lbs   15 yds
Model		Series 2	Series 3	Series 4	Series 5	Series 6	Series 7	Series 8	COM	
<b>795-37</b>		\$4,316	\$4,805	\$5,615	\$6,462	\$7,469	\$8,486	\$9,758	\$4,805	

		<b>81.25" W, Flop sofa with arm storage and aluminum legs</b>								152 lbs   12 yds
Model		Series 2	Series 3	Series 4	Series 5	Series 6	Series 7	Series 8	COM	
<b>796-37</b>		\$4,414	\$4,805	\$5,453	\$6,130	\$6,936	\$7,750	\$8,768	\$4,805	

# SleepOver Settee



## More Information

Illustrated Glossary ▶ 409

Fabrics ▶ 421

Flammability (CTB-133) ▶ 429

Finishes ▶ 426

Ordering and Warranties ▶ 432

## Standard Features

- Mortise and tenon joinery
- Spring seat construction
- Replaceable components
- Wood arm caps (782, 783)

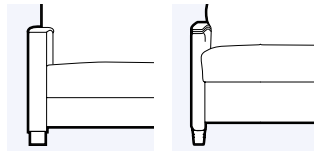

**782** Cities

**783** Concerto

- Upholstered arms (784)

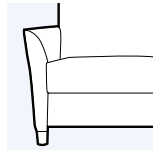

**784** Prelude

- Non-marring  $\frac{5}{8}$ " x 2" glides (except 783, 784)
- Sleep surface dimensions 78" x 25"
- Integral storage compartment
- Nemschoff healthcare wood finish
- GREENGUARD Gold Certified
- Limited Lifetime Warranty; five years on mechanism

## Available Options

- Moisture barrier + \$69 per seat or back
- 2" twin-wheel swivel casters with brakes + \$430
- Three arm cap choices (782XX-27) + \$0
- Three leg choices (782XX-27) + \$0
- Side extension for sleep surface (LSF, RSF)
- CTB-133 + \$83/yd
- Two fabrics + \$64
- Three (or more) fabrics + \$90

## Specification Decisions

- Select fabric
- Select standard wood finish
- Select arm cap style (782XX-27)

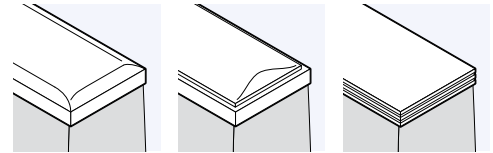

**Y** New York

**C** Chicago

**N** New Orleans

- Select foot style (782XX-27)

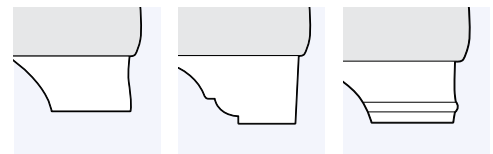

**W** Williamsburg

**C** Chicago

**N** New Orleans

- Select side extension for sleep surface
- Add moisture barrier
- Add CTB-133
- Apply multiple fabrics
- Add casters

Model numbers with **S** indicate standard seat and back covers, and model numbers with **P** indicate removable covers.

## Flammability Type

- Type 6

## Coordinating Products

- [SleepOver 1-2-3 Chair](#)
- [SleepOver Bench](#)
- [SleepOver Flop Sofa](#)
- [SleepOver Sofa](#)



# SleepOver Settee

## Key Dimensions

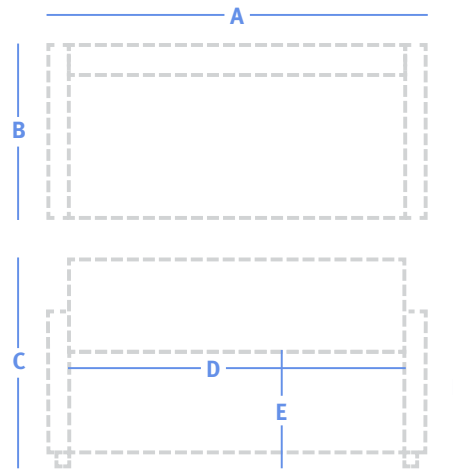

<b>A</b>	Overall Width	See price table 85" 87" Extended
<b>B</b>	Overall Depth	31.5"
<b>C</b>	Overall Height	31.5"
<b>D</b>	Seat Width	48"
<b>E</b>	Seat Height	18.5"
<b>F</b>	Arm Height	25"

	<b>55" W, Settee with Cities arm caps and foot style</b> <span style="float: right;">151 lbs   10 yds</span>								
	Model	Series 2	Series 3	Series 4	Series 5	Series 6	Series 7	Series 8	COM
	<b>782XX-27XS</b>	\$4,122	\$4,448	\$4,988	\$5,553	\$6,224	\$6,902	\$7,750	\$4,448
	<b>782XX-27XP</b>	\$4,656	\$4,982	\$5,522	\$6,087	\$6,758	\$7,436	\$8,284	\$4,982
	<b>55" W, Settee with wood Concerto arms</b> <span style="float: right;">151 lbs   9.5 yds</span>								
	Model	Series 2	Series 3	Series 4	Series 5	Series 6	Series 7	Series 8	COM
	<b>783-27XS</b>	\$4,138	\$4,448	\$4,961	\$5,497	\$6,135	\$6,779	\$7,585	\$4,448
	<b>783-27XP</b>	\$4,672	\$4,982	\$5,495	\$6,031	\$6,669	\$7,313	\$8,119	\$4,982
	<b>57" W, Settee with upholstered Prelude arm</b> <span style="float: right;">151 lbs   10 yds</span>								
	Model	Series 2	Series 3	Series 4	Series 5	Series 6	Series 7	Series 8	COM
	<b>784-27XS</b>	\$4,122	\$4,448	\$4,988	\$5,553	\$6,224	\$6,902	\$7,750	\$4,448
	<b>784-27XP</b>	\$4,656	\$4,982	\$5,522	\$6,087	\$6,758	\$7,436	\$8,284	\$4,982

# SleepOver Sofa



## More Information

Illustrated Glossary ▶ 409

Fabrics ▶ 421

Flammability (CTB-133) ▶ 429

Finishes ▶ 425

Ordering and Warranties ▶ 432

## Standard Features

- Mortise and tenon joinery
- Replaceable components
- Removable covers
- Wood arm caps (786, 787)

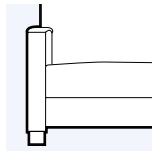

**786** Cities

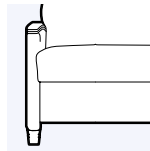

**787** Concerto

- Upholstered arms (788)

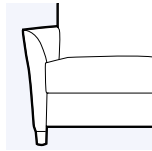

**788** Prelude

- Sleep surface 80" x 39"
- Wood storage drawers with full extension drawer glides
- Laminate drawer fronts
- 5/8" x 2" glides
- Nemschoff healthcare wood finish
- GREENGUARD Gold Certified
- Limited Lifetime Warranty; five years on mechanism

## Available Options

- Moisture barrier + \$69 per seat or back
- Three arm cap choices (786X-37) + \$0
- CTB-133 + \$83/yd
- Two fabrics + \$64
- Three (or more) fabrics + \$90

## Specification Decisions

- Select fabric
- Select standard wood finish
- Select standard laminate
- Select arm cap style (786X-37)

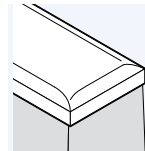

**Y** New York

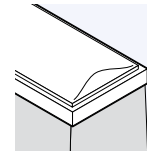

**C** Chicago

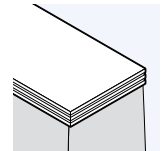

**N** New Orleans

- Add moisture barrier
- Add CTB-133
- Apply multiple fabrics

## Flammability Type

- Type 7

## Coordinating Products

- [SleepOver 1-2-3 Chair](#)
- [SleepOver Bench](#)
- [SleepOver Flop Sofa](#)
- [SleepOver Settee](#)

# SleepOver Sofa

## Key Dimensions

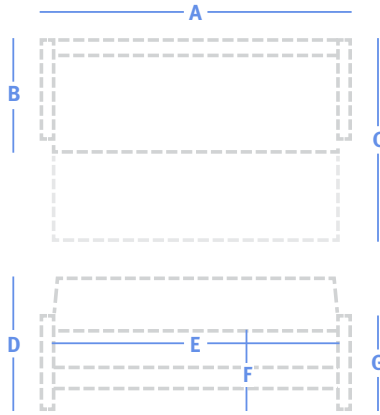

<b>A</b>	Width	See price table
<b>B</b>	Depth	30"
<b>C</b>	Extended Depth	44.5", 45.5" (786X)
<b>D</b>	Overall Height	35.25"
<b>E</b>	Seat Width	80"
<b>F</b>	Seat Height	18.5"
<b>G</b>	Arm Height	24.75"

	<b>86.5" W, Sofa with Cities arm caps</b> <span style="float: right;">249 lbs   14.5 yds</span>								
	Model	Series 2	Series 3	Series 4	Series 5	Series 6	Series 7	Series 8	COM
	<b>786X-37</b>	\$5,326	\$5,799	\$6,582	\$7,400	\$8,374	\$9,537	\$10,587	\$5,799

	<b>86.5" W, Sofa with wood Concerto arms</b> <span style="float: right;">249 lbs   13.5 yds</span>								
	Model	Series 2	Series 3	Series 4	Series 5	Series 6	Series 7	Series 8	COM
	<b>787-37</b>	\$5,359	\$5,799	\$6,528	\$7,290	\$8,196	\$9,112	\$10,257	\$5,799

	<b>88.5" W, Sofa with upholstered Prelude arm</b> <span style="float: right;">249 lbs   14.75 yds</span>								
	Model	Series 2	Series 3	Series 4	Series 5	Series 6	Series 7	Series 8	COM
	<b>788-37</b>	\$5,318	\$5,799	\$6,595	\$7,428	\$8,418	\$9,418	\$10,670	\$5,799

## Bedford Casegoods



### Standard Features

- Maple veneer case or maple veneer case with cherry inlay
- Dry construction joinery
- Replaceable components
- Nemschoff healthcare wood finish
- GREENGUARD Gold Certified
- Limited Lifetime Warranty

### More Information

Illustrated Glossary ▶ 409

Finishes ▶ 426

Hardware ▶ 427

Ordering and Warranties ▶ 429

## Bedford Bedside Cabinets and Nightstands

### Standard Features

Same standard features as Bedford Casegoods, plus:

- Laminate top with maple edges
- Wood drawer pans
- Vented back panel (bedside cabinets)
- Concealed hinges

### Available Options

- Two foot styles +\$0
- Casters + \$279
- Door and drawer pulls + \$0
- Gallery design + \$237
- OP/10 cam locks + \$35
- OP/17 plastic drawer liners + \$54 ea

### Specification Decisions

- Select standard wood finish for maple veneer
  - 40** Wheat      **43** Plum
  - 44** Wild Cherry      **45** Pecan
- Add gallery design, see [nemschoff.com](http://nemschoff.com)
- Add casters
- Add locks
- Add plastic drawer liners
- Select standard laminate
- Select foot style
  - B** Bun foot      **T** Tube foot
- Select pull style
  - 1** Bedford      **2** Bedford
  - 2C** Bedford      **3** Bedford
  - 3C** Bedford      **3N** Bedford



### 19.5" W, Bedside cabinet - one drawer, one door; maple with cherry inlay

80 lbs

Model	Price	Depth	Height
<b>BFFA01</b>	\$1,186	20"	34"



### 19.5" W, Bedside cabinet - one drawer, one door; maple

80 lbs

Model	Price	Depth	Height
<b>BFFA01A</b>	\$1,130	20"	34"

## Bedford Casegoods

	<b>19.5" W, Bedside cabinet - three drawer; maple with cherry inlay</b> <span style="float: right;">80 lbs</span>			
	Model	Price	Depth	Height
	<b>BFFA03</b>	\$1,409	20"	30"
	<b>19.5" W, Bedside cabinet - three drawer; maple</b> <span style="float: right;">80 lbs</span>			
	Model	Price	Depth	Height
	<b>BFFA03A</b>	\$1,341	20"	30"
	<b>19.5" W, Nightstand - one drawer; maple with cherry inlay</b> <span style="float: right;">64 lbs</span>			
	Model	Price	Depth	Height
	<b>BFFG01</b>	\$960	20"	22"
	<b>19.5" W, Nightstand - one drawer; maple</b> <span style="float: right;">64 lbs</span>			
	Model	Price	Depth	Height
	<b>BFFG01A</b>	\$912	20"	22"

## Bedford Chests

### Standard Features

Same standard features as Bedford Casegoods, plus:

- Laminate top with maple edges
- Wood drawer pans

### Available Options

- Two foot styles+ \$0
- Door and drawer pulls + \$0
- Gallery design + \$121
- See [page 377](#) for additional options

### Specification Decisions

- Select standard wood finish for maple veneer
- Select maple with cherry inlay finish
 



<b>40</b> Wheat	<b>43</b> Plum
<b>44</b> Wild Cherry	<b>45</b> Pecan
- Maple with Cherry Inlay (Veneer)
- Select standard laminate
- Select foot style
 

<b>B</b> Bun foot	<b>T</b> Tube foot
-------------------	--------------------

- Select pull style

- |                   |                   |
|-------------------|-------------------|
| <b>1</b> Bedford  | <b>2</b> Bedford  |
| <b>2C</b> Bedford | <b>3</b> Bedford  |
| <b>3C</b> Bedford | <b>3N</b> Bedford |

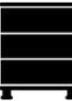
- See [page 377](#) for additional options

	<b>25.5" W, Narrow chest - three drawer; maple with cherry inlay</b> <span style="float: right;">95 lbs</span>			
	Model	Price	Depth	Height
	<b>BFFC03</b>	\$1,525	20"	30"
	<b>25.5" W, Narrow chest - three drawer; maple</b> <span style="float: right;">95 lbs</span>			
	Model	Price	Depth	Height
	<b>BFFC03A</b>	\$1,448	20"	30"
	<b>31.5" W, Chest - three drawer; maple with cherry</b> <span style="float: right;">110 lbs</span>			
	Model	Price	Depth	Height
	<b>BFFB03</b>	\$1,865	20"	30"

## Bedford Casegoods

**31.5" W, Chest - three drawer; maple**

110 lbs

Model	Price	Depth	Height
<b>BFFB03A</b>	\$1,771	20"	30"

**31.5" W, Chest - four drawer; maple with cherry inlay**

115 lbs

Model	Price	Depth	Height
<b>BFFB04</b>	\$2,169	20"	38"

**31.5" W, Chest - four drawer; maple**

115 lbs

Model	Price	Depth	Height
<b>BFFB04A</b>	\$2,062	20"	38"

## Bedford Headboards, Footboard, Headwall and Bed Locator

**Standard Features**

- Same standard features as Bedford Casegoods, plus
- Maple veneer case
- Veneer top (headwall)
- 270-degree hinges (headwall)

**Available Options**

- Gallery design (CA/H33-BFF, BFFP/3F, BFFP/3H) + \$149
- Gallery design (CA/H46-BFF) + \$190
- Gallery design (CA/H50-BFF) + \$223
- Wall-mount security fasteners (Headboards) + \$57
- Drawer and door pulls (Headwalls) + \$0
- Electric duplex - specify line or emergency power (Bed locator) + \$120
- Night light (Bed locator) + \$193
- Bed receptacle simplex (Bed locator) + \$219
- 37-pin Adapter (Bed locator) + \$319

**Specification Decisions**

- Select standard wood finish for maple veneer

- Select maple with cherry inlay finish

<b>40</b> Wheat	<b>43</b> Plum
<b>44</b> Wild Cherry	<b>45</b> Pecan

Maple with Cherry Inlay (Veneer)

- Select pull style
- Add gallery design, see [nemschoff.com](http://nemschoff.com)
- Add fasteners
- Add electrical options

Headboards that mount to adjustable bed frames include wood legs and mounting hardware.

Headboards and footboards for hospital beds can be modified in size and can include mounting holes.

Custom headwalls are available. Contact your customer service representative for pricing.

**42.75" W, Twin headboard for adjustable bed frames; maple with cherry inlay**

24 lbs

Model	Price	Depth	Height
<b>CA/H33-BFF</b>	\$732	-	35.5"

**42.75" W, Twin headboard for adjustable bed frames; maple**

24 lbs

Model	Price	Depth	Height
<b>CA/H33-BFFA</b>	\$699	-	35.5"

## Bedford Casegoods

	<b>57.75" W, Full headboard for adjustable bed frames; maple with cherry inlay</b>				33 lbs
	Model	Price	Depth	Height	
	<b>CA/H46-BFF</b>	\$909	-	35.5"	

	<b>57.75" W, Full headboard for adjustable bed frames; maple</b>				33 lbs
	Model	Price	Depth	Height	
	<b>CA/H46-BFFA</b>	\$867	-	35.5"	

	<b>63.75" W, Queen headboard for adjustable bed frames; maple with cherry inlay</b>				39 lbs
	Model	Price	Depth	Height	
	<b>CA/H50-BFF</b>	\$1,064	-	35.5"	

	<b>63.75" W, Queen headboard for adjustable bed frames; maple</b>				39 lbs
	Model	Price	Depth	Height	
	<b>CA/H50-BFFA</b>	\$1,018	-	35.5"	

	<b>39" W - 60" W, Adjustable bed frame</b>				15 lbs
	Model	Price	Depth	Height	
	<b>CA/1</b>	\$186	-	-	

	<b>35" W, Footboard for hospital beds; maple with cherry inlay</b>				20 lbs
	Model	Price	Depth	Height	
	<b>BFFP/3F</b>	\$401	-	16"	

	<b>35" W, Footboard for hospital beds; maple</b>				20 lbs
	Model	Price	Depth	Height	
	<b>BFFP/3FA</b>	\$384	-	16"	

	<b>35" W, Headboard with cherry inlay for hospital beds</b>				23 lbs
	Model	Price	Depth	Height	
	<b>BFFP/3H</b>	\$410	-	16"	

	<b>35" W, Headboard for hospital beds; maple</b>				23 lbs
	Model	Price	Depth	Height	
	<b>BFFP/3HA</b>	\$392	-	16"	

	<b>96" W, Headwall; maple with cherry inlay</b>				183 lbs
	Model	Price	Depth	Height	
	<b>BFFU/21</b>	\$14,260	14.25"	27.25"	

## Bedford Casegoods

<b>96" W, Headwall; maple</b> <span style="float: right;">183 lbs</span>				
Model	Price	Depth	Height	
<b>BFFU/21A</b>	\$13,708	14.25"	27.25"	

<b>Bed locator base unit</b> <span style="float: right;">-</span>				
Model	Price	Depth	Height	
<b>BLBU</b>	\$2,040	-	-	

## Bedford Mirror

**Standard Features**

- Solid maple frame

**Specification Decisions**

- Select standard wood finish

<b>25" W, Mirror; maple</b> <span style="float: right;">30 lbs</span>				
Model	Price	Depth	Height	
<b>BFFM39A</b>	\$317	-	45"	

## Bedford Wardrobes and Armoires

**Standard Features**

- Same standard features as Bedford Casegoods, plus:
- Maple veneer case
- Veneer top with maple edges (wardrobes 72" or higher)
- Laminate top with maple edges
- Wood drawer pans
- Concealed hinges

**Available Options**

- Two foot styles +\$0
- Add door and drawer pulls + \$0
- Wood two-drawer interior cabinet with plastic drawer pans (Wardrobes only) + \$529
- Wood drawer pans (2) for interior cabinets + \$172
- Plastic drawer liner (removable) for interior cabinet wood drawer pans + \$54 ea
- See [page 379](#) for additional options

**Specification Decisions**

- Select standard wood finish for maple veneer
- Select maple with cherry inlay finish
 

<b>40</b> Wheat	<b>43</b> Plum
<b>44</b> Wild Cherry	<b>45</b> Pecan
- Select standard laminate, if required
- Select foot style
 

<b>B</b> Bun foot	<b>T</b> Tube foot
-------------------	--------------------
- Select pull style
 

<b>1</b> Bedford	<b>2</b> Bedford
<b>2C</b> Bedford	<b>3</b> Bedford
<b>3C</b> Bedford	<b>3N</b> Bedford
- See [page 379](#) for additional options

<b>25.5" W, Wardrobe (hinged right) - fixed shelf and clothes bar; maple with cherry inlay</b> <span style="float: right;">173 lbs</span>				
Model	Price	Depth	Height	
<b>BFFW25</b>	\$2,339	24"	76"	





## Bedford Casegoods

	<b>25.5" W, Wardrobe (hinged right) - fixed shelf and clothes bar; maple</b> 173 lbs		
Model	Price	Depth	Height
<b>BFFW25A</b>	\$2,222	24"	76"

	<b>25.5" W, Wardrobe (hinged left) - fixed shelf and clothes bar; maple with cherry inlay</b> 173 lbs		
Model	Price	Depth	Height
<b>BFFW26</b>	\$2,339	24"	76"

	<b>25.5" W, Wardrobe (hinged left) - fixed shelf and clothes bar; maple</b> 173 lbs		
Model	Price	Depth	Height
<b>BFFW26A</b>	\$2,222	24"	76"

	<b>31.5" W, TV armoire - three drawers, no doors; maple with cherry inlay - TV opening: 22" W x 20.75" D x 16.75" H</b> 207 lbs		
Model	Price	Depth	Height
<b>BFFT30</b>	\$3,433	24.5"	58"

	<b>31.5" W, TV armoire - three drawers, no doors; maple - TV opening: 22" W x 20.75" D x 16.75" H</b> 207 lbs		
Model	Price	Depth	Height
<b>BFFT30A</b>	\$3,260	24.5"	58"

	<b>31.5" W, TV armoire - pocket doors, three drawers; maple with cherry inlay - TV opening: 22" W x 20.75" D x 16.75" H</b> 217 lbs		
Model	Price	Depth	Height
<b>BFFT31</b>	\$3,778	24.5"	58"

	<b>31.5" W, TV armoire - pocket doors, three drawers; maple - TV opening: 22" W x 20.75" D x 16.75" H</b> 217 lbs		
Model	Price	Depth	Height
<b>BFFT31A</b>	\$3,588	24.5"	58"

	<b>37.5" W, Wardrobe - two doors, fixed shelf, clothes bar; maple with cherry inlay</b> 213 lbs		
Model	Price	Depth	Height
<b>BFFW38</b>	\$2,771	24"	72"

	<b>37.5" W, Wardrobe - two doors, fixed shelf, clothes bar; maple</b> 213 lbs		
Model	Price	Depth	Height
<b>BFFW38A</b>	\$2,633	24"	72"

	<b>37.5" W, TV armoire - pocket doors, three drawers; maple with cherry inlay - TV opening: 28" W x 20.75" D x 21.25" H</b> 217 lbs		
Model	Price	Depth	Height
<b>BFFT39</b>	\$4,231	24.5"	58"

## Bedford Casegoods

**37.5" W, TV armoire - pocket doors, three drawers; maple - TV opening: 28" W x 20.75" D x 21.25" H** 217 lbs

Model	Price	Depth	Height
<b>BFFT39A</b>	\$4,022	24.5"	58"

**49" W, Wardrobe - two doors and center divider; maple with cherry inlay** 213 lbs

Model	Price	Depth	Height
<b>BFFW50</b>	\$3,381	24"	72"

**49" W, Wardrobe - two doors and center divider; maple** 213 lbs

Model	Price	Depth	Height
<b>BFFW50A</b>	\$3,212	24"	72"

**55" W, TV wardrobe (hinged right) - pocket doors, three drawers; maple with cherry inlay - TV opening: 28" W x 20.75" D x 21.25" H** 380 lbs

Model	Price	Depth	Height
<b>BFFT55</b>	\$6,228	24.5"	60"

**55" W, TV wardrobe (hinged right) - pocket doors, three drawers; maple - TV opening: 28" W x 20.75" D x 21.25" H** 380 lbs

Model	Price	Depth	Height
<b>BFFT55A</b>	\$5,918	24.5"	60"

**55" W, TV wardrobe (hinged left) - pocket doors, three drawers; maple with cherry inlay** 380 lbs

Model	Price	Depth	Height
<b>BFFT56</b>	\$6,228	24.5"	64"

**55" W, TV wardrobe (hinged left) - pocket doors, three drawers; maple** 380 lbs

Model	Price	Depth	Height
<b>BFFT56A</b>	\$5,918	24.5"	64"

**60" W, TV wardrobe - two side wardrobes, pocket doors, three drawers; maple with cherry inlay** 380 lbs

Model	Price	Depth	Height
<b>BFFT60</b>	\$6,576	24.5"	64"

**60" W, TV wardrobe - two side wardrobes, pocket doors, three drawers; maple** 380 lbs

Model	Price	Depth	Height
<b>BFFT60A</b>	\$6,246	24.5"	64"

Patient Chairs

Recliners

Treatment Chairs

Rockers &amp; Gliders

Overbed Tables

Sleepover Seating

Casegoods

Display &amp; Accessories

# Bedford Casegoods

## Bedford Writing Table

### Standard Features

- Same standard features as Bedford Casegoods, plus:
- Maple veneer case
- Laminate top
- Wood drawer pans

### Available Options

- Drawer and door pulls + \$0
- OP/10 cam lock + \$35

### Specification Decisions

- Select standard wood finish for maple veneer
- Select maple with cherry inlay finish
 

<b>40</b> Wheat	<b>43</b> Plum
<b>44</b> Wild Cherry	<b>45</b> Pecan
- Select laminate
- Select pull style
 

<b>1</b> Bedford	<b>2</b> Bedford
<b>2C</b> Bedford	<b>3</b> Bedford
<b>3C</b> Bedford	<b>3N</b> Bedford
- Add lock

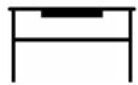

### 48" W, Writing table with lower shelf; maple with cherry inlay

120 lbs

Model	Price	Depth	Height
<b>BFFF48</b>	\$1,090	24.5"	30"

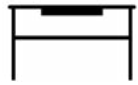

### 48" W, Writing table with lower shelf; maple

120 lbs

Model	Price	Depth	Height
<b>BFFF48A</b>	\$1,035	24.5"	30"

## Finley Casegoods



### Standard Features

- Laminate case
- Dry construction joinery
- Replaceable components
- Nemschoff healthcare wood finish
- GREENGUARD Gold Certified
- Limited Lifetime Warranty

### More Information

Illustrated Glossary ▶ 409

Finishes ▶ 426

Hardware ▶ 427

Ordering and Warranties ▶ 429

## Finley Bedside Cabinets

### Standard Features

- Same standard features as Finley Casegoods, plus:
- Durawrap tops, drawer fronts, doors, and base rails
  - Plastic drawer pans
  - Vented back panel
  - Concealed hinges

### Available Options

- Drawer and door pulls + \$0
- Casters + \$106
- Locking casters +\$186
- OP/10 cam locks + \$35
- OP/16W wood drawer pans + \$86 ea
- OP/17 plastic drawer liners (for wood drawer pans) + \$54 ea

### Specification Decisions

- Select standard laminate
- Select Durawrap
- Select pull style
- Add casters
- Add locks
- Add wood drawer pans
- Add plastic drawer liners

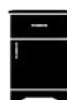

### 20" W, Bedside cabinet - one drawer, one door and adjustable shelf

64 lbs

Model	Price	Depth	Height
<b>FX702-01</b>	\$751	19.25"	29.75"

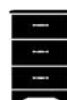

### 20" W, Bedside cabinet - three drawers

52 lbs

Model	Price	Depth	Height
<b>FX702-03</b>	\$909	19.25"	29.75"

Patient Chairs

Recliners

Treatment Chairs

Rockers &amp; Gliders

Overbed Tables

Sleepover Seating

Casegoods

Display &amp; Accessories

## Finley Casegoods

### Finley Chests

#### Standard Features



- Same standard features as Finley Casegoods, plus:
- Durawrap tops, drawer fronts, doors, and base rails
  - Plastic drawer pans

#### Available Options

- Drawer and door pulls
- See [page 377](#) for additional options

#### Specification Decisions

- Select standard laminate
- Select Durawrap
- Select pull style
- See [page 377](#) for additional options

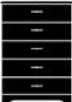
	32" W, Chest - three drawers <span style="float: right;">110 lbs</span>			
	Model	Price	Depth	Height
	<b>FX702-3</b>	\$1,109	19.25"	29.75"
	32" W, Chest - four drawers <span style="float: right;">116 lbs</span>			
	Model	Price	Depth	Height
	<b>FX702-4</b>	\$1,263	19.25"	38"
	32" W, Chest - five drawers <span style="float: right;">122 lbs</span>			
	Model	Price	Depth	Height
	<b>FX702-5</b>	\$1,417	19.25"	46"

### Finley Headboards, Footboard and Bed Locator

#### Standard Features

Same standard features as Finley Casegoods

#### Available Options

- Wall mount security fasteners (headboards) + \$57
- Electric duplex - specify line or emergency power (Bed locator) + \$120
- Night light (Bed locator) + \$193
- Bed receptacle simplex (Bed locator) + \$219
- 37-pin Adapter (Bed locator) + \$319

#### Specification Decisions

- Select standard laminate
  - Add security fasteners
  - Add electrical options
- Headboards that mount to adjustable bed frames include wood legs and mounting hardware.
- Headboards and footboards for hospital beds can be modified in size and can include mounting holes.
- Contact your customer service representative for pricing.

	42.75" W, Twin headboard for adjustable bed frames <span style="float: right;">24 lbs</span>			
	Model	Price	Depth	Height
	<b>CA/H33-FX702</b>	\$412	-	35.5"
	57.75" W, Full headboard for adjustable bed frames <span style="float: right;">33 lbs</span>			
	Model	Price	Depth	Height
	<b>CA/H46-FX702</b>	\$512	-	35.5"

## Finley Casegoods

63.75" W, Queen headboard for adjustable bed frames					39 lbs
Model	Price	Depth	Height		
<b>CA/H50-FX702</b>	\$598	-	35.5"		

39" W - 60" W, Adjustable bed frame					15 lbs
Model	Price	Depth	Height		
<b>CA/1</b>	\$186	-	-		

35" W, Headboard for hospital beds					18 lbs
Model	Price	Depth	Height		
<b>FX702-3H</b>	\$236	-	18"		

35" W, Footboard for hospital beds					15 lbs
Model	Price	Depth	Height		
<b>FX702-3F</b>	\$222	-	15"		

Bed locator base unit					-
Model	Price	Depth	Height		
<b>BLBU</b>	\$2,040	-	-		

## Finley Wardrobes and Armoires

## Standard Features

- Same standard features as Finley Casegoods, plus:
- Durawrap tops, drawer fronts, doors, and base rails
- Plastic drawer pans
- Concealed hinges<sup>3</sup>

## Available Options

- Drawer and door pulls + \$0
- Laminate two-drawer interior cabinet with plastic drawer pans (Wardrobes only) + \$468
- Wood drawer pans (2) for interior cabinets + \$172
- Plastic drawer liner (removable) for interior cabinet wood drawer pans + \$54 ea
- See [page 380](#) for additional options

## Specification Decisions

- Select standard laminate
- Select Durawrap
- Select pull styles
- See [page 380](#) for additional options

24.5" W, Wardrobe (hinged right)					173 lbs
Model	Price	Depth	Height		
<b>FX702-25</b>	\$1,283	22.75"	72"		

24.5" W, Wardrobe (hinged left)					173 lbs
Model	Price	Depth	Height		
<b>FX702-26</b>	\$1,283	22.75"	72"		

## Finley Casegoods

**38" W, TV Armoire - TV opening: 29W x 22.5D x 26.5H**

217 lbs

Model	Price	Depth	Height
<b>FX702-38</b>	\$2,266	24"	72"

**38" W, Double wardrobe**

213 lbs

Model	Price	Depth	Height
<b>FX702-39</b>	\$1,960	22.75"	72"

**51.5" W, TV wardrobe (hinged right) - TV opening: 29W x 22.5D x 26.5H**

380 lbs

Model	Price	Depth	Height
<b>FX702-43</b>	\$3,592	24"	72"

**51.5" W, TV wardrobe (hinged left) - TV opening: 29W x 22.5D x 26.5H**

380 lbs

Model	Price	Depth	Height
<b>FX702-44</b>	\$3,592	24"	72"

## Hadleigh Casegoods



### Standard Features

- Maple veneer case
- Radiused edges
- Dry construction joinery
- Replaceable components
- Nemschoff healthcare wood finish
- GREENGUARD Gold Certified
- Limited Lifetime Warranty

### Coordinating Products

- [Hadleigh Lounge Seating](#)
- [Hadleigh Tables](#)
- [Hadleigh Adjustable Back Chair](#)

### More Information

[Illustrated Glossary](#) ▶ 409

[Finishes](#) ▶ 426

[Hardware](#) ▶ 427

[Ordering and Warranties](#) ▶ 432

## Hadleigh Bedside Cabinets and Nightstand

### Standard Features

- Same standard features as Hadleigh Casegoods, plus:
- Laminate top
  - Concealed hinges
  - Vented back panel
  - Wood drawer pans

### Available Options

- Door and drawer pulls + \$0
- OP/13 casters + \$ 115
- OP/13LK locking casters + \$204
- OP/10 cam locks + \$35
- OP/17 plastic drawer liners + \$54 ea

### Specification Decisions

- Select standard wood finish
- Select standard laminate
- Select pull style
- Add casters
- Add locks
- Add plastic drawer liners

	24.75" W, Nightstand - one drawer				55 lbs
	Model	Price	Depth	Height	
	<b>HDLG/01</b>	\$1,069	20"	22"	
	24.75" W, Bedside Cabinet - one drawer and door				102 lbs
	Model	Price	Depth	Height	
	<b>HDLA/01</b>	\$1,109	20.25"	30.25"	
	24.75" W, Bedside Cabinet - three drawers				119 lbs
	Model	Price	Depth	Height	
	<b>HDLA/03</b>	\$1,272	20.25"	30.25"	



## Hadleigh Casegoods

### Hadleigh Chests

#### Standard Features

Same standard features as Hadleigh Casegoods, plus:

- Maple veneer top
- Wood drawer pans

#### Available Options

- Door and drawer pulls + \$0
- See [page 377](#) for additional options

#### Specification Decisions

- Select standard wood finish
- Select pull style
- See [page 377](#) for additional options

#### 36.75" W, Chest - three drawers

119 lbs



Model	Price	Depth	Height
<b>HDLB/3</b>	\$1,694	20.25"	30.25"

#### 36.75" W, Chest - four drawers

173 lbs



Model	Price	Depth	Height
<b>HDLB/4</b>	\$1,958	20.25"	38.25"

#### 36.75" W, Chest - five drawers

226 lbs



Model	Price	Depth	Height
<b>HDLB/5</b>	\$2,171	20.25"	46"

### Hadleigh Headboards, Footboard, Headwall and Bed locator

#### Standard Features

Same standard features as Hadleigh Casegoods, plus:

- 270-degree hinges (headwalls)

#### Available Options

- Door and drawer pulls + \$0
- Wall mount security fasteners (Headboards) + \$57
- Electric duplex - specify line or emergency power (Bed locator) + \$120
- Night light (Bed locator) + \$193
- Bed receptacle simplex (Bed locator) + \$219
- 37-pin Adapter (Bed locator) + \$319

#### Specification Decisions

- Select standard wood finish
- Select pull style
- Add fasteners
- Add electrical options

#### 42.75" W, Twin headboard for adjustable bed frames

15 lbs



Model	Price	Depth	Height
<b>CA/H33-HDL</b>	\$620	-	35.5"





#### 57.75" W, Full headboard for adjustable bed frames

24 lbs



Model	Price	Depth	Height
<b>CA/H46-HDL</b>	\$770	-	35.5"

## Hadleigh Casegoods

<b>63.75" W, Queen headboard for adjustable bed frames</b>					33 lbs
Model	Price	Depth	Height		
 <b>CA/H50-HDL</b>	\$900	-	35.5"		
<b>39" W - 60" W, Adjustable bed frame</b>					15 lbs
Model	Price	Depth	Height		
<b>CA/1</b>	\$186	-	-		
<b>38" W, Headboard for hospital beds</b>					16 lbs
Model	Price	Depth	Height		
 <b>HDLP/3H</b>	\$395	-	18"		
<b>38" W, Footboard for hospital beds</b>					14 lbs
Model	Price	Depth	Height		
 <b>HDLP/3F</b>	\$379	-	15"		
<b>95.25" W, Headwall</b>					171 lbs
Model	Price	Depth	Height		
 <b>HDLU/21</b>	\$13,929	14"	27.5"		
<b>Bed locator base unit</b>					-
Model	Price	Depth	Height		
<b>BLBU</b>	\$2,040	-	-		

## Hadleigh Wardrobes and Armoires

**Standard Features**

- Same standard features as Hadleigh Casegoods, plus:
- Maple tops
  - Concealed hinges
  - Wood drawer pans

**Available Options**

- Drawer and door pulls + \$0
- Wood two-drawer interior cabinet with plastic drawer pans (Wardrobes only) + \$529
- Wood drawer pans (2) for interior cabinets + \$172
- Plastic drawer liner (removable) for interior cabinet wood drawer pans + \$4 ea
- See [page 380](#) for additional options

**Specification Decisions**

- Select standard wood finish
- Select pull style
- See [page 380](#) for additional options

<b>32" W, Wardrobe (hinged right)</b>					227 lbs
Model	Price	Depth	Height		
 <b>HDLW/25</b>	\$2,316	26"	77"		

## Hadleigh Casegoods

**32" W, Wardrobe with (hinged left)**

227 lbs

Model	Price	Depth	Height
<b>HDLW/26</b>	\$2,316	26"	77"

**44" W, Wardrobe - two doors**

298 lbs

Model	Price	Depth	Height
<b>HDLW/38</b>	\$2,818	26"	77"

**38.25" W, TV armoire - TV opening: 24.5W x 21.5D x 27H**

338 lbs

Model	Price	Depth	Height
<b>HDLT/30</b>	\$3,616	26"	72"

**51" W, TV wardrobe (hinged right) - TV opening: 29W x 22.5D x 26.5H**

440 lbs

Model	Price	Depth	Height
<b>HDLT/50</b>	\$5,293	26"	72"

**51" W, TV wardrobe (hinged left) - TV opening: 29W x 22.5D x 26.5H**

440 lbs

Model	Price	Depth	Height
<b>HDLT/51</b>	\$5,293	26"	72"

## Montello Casegoods



### Standard Features

- Laminate case
- Dry construction joinery
- Replaceable components
- Nemschoff healthcare wood finish
- GREENGUARD Gold Certified
- Limited Lifetime Warranty

### More Information

Illustrated Glossary ▶ 409

Finishes ▶ 426

Hardware ▶ 427

Ordering and Warranties ▶ 432

## Montello Bedside Cabinets

### Standard Features

Same standard features as Montello Casegoods, plus:

- Laminate top with urethane edge (cloud, pewter, sable)
- Plastic drawer pans
- Vented back panel
- Concealed hinges
- Twin wheel 2" casters

### Available Options

- Drawer and door pulls + \$0
- Casters with brakes + \$82
- OP/10 cam locks + \$35 ea
- OP/16W wood drawer pans + \$86 ea
- OP/17 plastic drawer liners (for wood drawer pans) + \$54 ea

### Specification Decisions

- Select standard laminate
- Select pull style
- Select urethane edge color
- Add casters with brakes
- Add locks
- Add wood drawer pans
- Add plastic drawer liners



### 20.5" W, Bedside cabinet - one drawer, one door and adjustable shelf

52 lbs

Model	Price	Depth	Height
<b>FX700-01</b>	\$665	21.5"	32.5"



### 20.5" W, Bedside cabinet - three drawer

52 lbs

Model	Price	Depth	Height
<b>FX700-03</b>	\$720	21.5"	32.5"

## Montello Casegoods

### Montello Headboard, Footboard, Headwall and Bed Locator

#### Standard Features

- Same standard features as Montello Casegoods, plus:
- Laminate top (headwalls)
  - 270-degree hinges (headwalls)

#### Available Options

- Drawer and door pulls + \$0
- Wall mount security fasteners (headboards) + \$57
- Electric duplex - specify line or emergency power (Bed locator) + \$120
- Night light (Bed locator) + \$193
- Bed receptacle simplex (Bed locator) + \$219
- 37-pin Adapter (Bed locator) + \$319

#### Specification Decisions

- Select standard laminate
- Select pull style
- Add security fasteners
- Add electrical options

	<b>36" W, Headboard for hospitable beds</b>				16 lbs
	Model	Price	Depth	Height	
	<b>FX700-H</b>	\$145	-	18"	
	<b>36" W, Footboard for hospitable beds</b>				14 lbs
	Model	Price	Depth	Height	
	<b>FX700-F</b>	\$140	-	15"	
	<b>96" W, Headwall</b>				163 lbs
	Model	Price	Depth	Height	
	<b>FX700-21</b>	\$9,935	14.5"	24.25"	
	<b>Bed locator base unit</b>				-
	Model	Price	Depth	Height	
	<b>BLBU</b>	\$2,040	-	-	

## Montello Casegoods

## Montello Wardrobe and Armoire

**Standard Features**

- Same standard features as Montello Casegoods, plus:
- Laminate top
  - Plastic drawer pans
  - Concealed hinges
  - Brushed metal legs

**Available Options**

- Drawer and door pulls + \$0
- Laminate two-drawer interior cabinet with plastic drawer pans (Wardrobes only) + \$468
- Wood drawer pans (2) for interior cabinets + \$172
- Plastic drawer liner (removable) for interior cabinet wood drawer pans + \$54 ea
- See [page 380](#) for additional options

**Specification Decisions**

- Select standard laminate
- Select pull style
- Add drawer pans
- See [page 380](#) for additional options

**33.5" W, TV armoire - TV opening: 22.75" W x 21.5" D x 26.5" H**

226 lbs

Model	Price	Depth	Height
<b>FX700-30</b>	\$2,057	25"	72"

**37.5" W, Wardrobe - two doors**

213 lbs

Model	Price	Depth	Height
<b>FX700-38</b>	\$1,805	25"	72"

Patient Chairs

Recliners

Treatment Chairs

Rockers &amp; Gliders

Overbed Tables

Sleepover Seating

Casegoods

Display &amp; Accessories

# Palisade Casegoods



## Standard Features

- Laminate case
  - Dry construction joinery
  - Replaceable components
  - Titanium powder-coated legs
  - Non-marring 1" glides
  - Nemschoff healthcare wood finish
  - GREENGUARD Gold Certified
  - Limited Lifetime Warranty
- Light and power require field installation
- Coatrack ships unassembled from the Tote

## Coordinating Products

- [Palisade Coatrack](#)
- [Palisade Flop Sofa](#)
- [Palisade Stools](#)
- [Palisade Tables](#)

## More Information

- Illustrated Glossary ▶ 409
- Finishes ▶ 426
- Hardware ▶ 427
- Ordering and Warranties ▶ 429

## Palisade Daystand

### Standard Features

- Same standard features as Palisade Casegoods, plus:
- Durawrap top and shelf

### Available Options

- Veneer case + \$274
- Solid surface top + \$908
- Silver LED task light; one year warranty + \$1,245
- Three power outlets and two USB ports (black or white); one year warranty + \$368

### Specification Decisions

- Select standard laminate
- Select standard Durawrap finish
- Add veneer case (select wood finish)
- Add solid surface top (select color)
- Add task light
- Add power (select color)



### 22.5" W, Daystand

107 lbs

Model	Price	Depth	Height
<b>867-46</b>	\$1,043	25.5"	36.5"

# Palisade Casegoods

## Palisade Totes

### Standard Features

- Same standard features as Palisade Casegoods, plus:
- Open storage compartment
- Durawrap top (867-70TP)
- Titanium powder-coated column with wood pegs (867-70CR)
- 10 lb weight capacity per peg (867-70CR)

### Available Options

- Veneer case + \$210
- Solid surface top (867-70TP) + \$572
- Silver LED task light; one year warranty + \$1,245
- Three power outlets and two USB ports (black or white); one year warranty + \$368

### Specification Decisions

- Select standard laminate
- Select standard Durawrap finish
- Add veneer case (select wood finish)
- Add solid surface top (select color)
- Add task light
- Add power (select color)

		<b>18" W, Tote</b>				48 lbs
		Model	Price	Depth	Height	
		<b>867-70</b>	\$694	22"	26"	
		<b>18" W, Tote with Coatrack</b>				56 lbs
		Model	Price	Depth	Height	
		<b>867-70CR</b>	\$1,224	22"	71.5"	
		<b>18" W, Tote with Top</b>				62 lbs
		Model	Price	Depth	Height	
		<b>867-70TP</b>	\$822	22"	26"	

Patient Chairs

Recliners

Treatment Chairs

Rockers & Gliders

Overbed Tables

Sleepover Seating

Casegoods

Display & Accessories



# Perinatal Casegoods



## Standard Features

- Maple veneer case and laminated top
- Dry construction joinery
- Replaceable components
- Black urethane edge on bottom panel
- Wood drawer pans
- 5" swivel casters, two locking
- Nemschoff healthcare wood finish
- GREENGUARD Gold Certified
- Limited Lifetime Warranty

## Coordinating Products

- [Finley Casegoods](#)
- [Prague II Casegoods](#)

### More Information

- Illustrated Glossary ▶ 409
- Finishes ▶ 426
- Hardware ▶ 427
- Ordering and Warranties ▶ 432

## Perinatal Case Cart

### Standard Features

- Same standard as Perinatal Casegoods features, plus:
- Large work surface with drop-leaf extension
- Pass-through drawers
- Casters

### Available Options

- Drawer and door pulls + \$0
- OP/10 cam locks + \$35
- OP10/A cam lock with elbow catch + \$63

### Specification Decisions

- Select standard wood finish
- Select laminate
- Select pull style
- Add locks



### 36" W, Perinatal case cart

158 lbs

Model	Price	Depth	Height
<b>CSNT/20</b>	\$4,904	23"	37"

## Perinatal Monitor Unit

### Standard Features

- Same standard as Perinatal Casegoods features, plus:
- Two pullout keyboard shelves, 45.75" H
- Electrical chase

### Available Options

- Drawer and door pulls + \$0
- OP/10 cam locks + \$35
- OP10/A cam lock with elbow catch + \$63

### Specification Decisions

- Select standard wood finish
- Select laminate
- Select pull style
- Add locks



### 34.5" W, Perinatal monitor unit

229 lbs

Model	Price	Depth	Height
<b>MMNT/20</b>	\$4,041	27"	54"

## Prague II Casegoods



### Standard Features

- Laminate case
- Dry construction joinery
- Replaceable components
- Plastic drawer pans
- Nemschoff healthcare wood finish
- GREENGUARD Gold Certified
- Limited Lifetime Warranty

### More Information

Illustrated Glossary ▶ 409

Finishes ▶ 426

Hardware ▶ 427

Ordering and Warranties ▶ 432

## Prague II Bedside Cabinets

### Standard Features

- Same standard features as Prague II Casegoods, plus:
- Durawrap tops, drawer fronts, doors and base rails
  - Vented back panel
  - Concealed hinges

### Available Options

- Drawer and door pulls + \$0
- Casters + \$106
- Locking casters + \$186
- OP/10 cam locks + \$35
- OP/16W wood drawer pans + \$86
- OP/17 plastic drawer liners (for wood drawer pans) + \$54 ea

### Specification Decisions

- Select standard laminate
- Select Durawrap
- Select pull style
- Add casters
- Add locks
- Add wood drawer pans
- Add plastic drawer liners

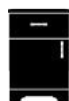

### 20" W, Bedside - one drawer, one door and adjustable shelf

64 lbs

Model	Price	Depth	Height
<b>FX704-01</b>	\$751	19.25"	29.75"

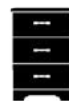

### 20" W, Bedside - three drawers

52 lbs

Model	Price	Depth	Height
<b>FX704-03</b>	\$909	19.25"	29.75"

Patient Chairs

Recliners

Treatment Chairs

Rockers &amp; Gliders

Overbed Tables

Sleepover Seating

Casegoods

Display &amp; Accessories

## Prague II Casegoods

### Prague II Chests

#### Standard Features

- Same standard features as Prague II Casegoods, plus:
- Durawrap tops, drawer fronts, doors and base rails

#### Available Options

- Drawer and door pulls + \$0
- See [page 377](#) for additional options

#### Specification Decisions

- Select standard laminate
- Select Durawrap
- Select pull style
- See [page 377](#) for additional options

#### 32" W, Chest - three drawers

110 lbs



Model	Price	Depth	Height
<b>FX704-3</b>	\$1,109	19.25"	29.75"

#### 32" W, Chest - four drawers

116 lbs



Model	Price	Depth	Height
<b>FX704-4</b>	\$1,263	19.25"	38"

#### 32" W, Chest - five drawers

122 lbs



Model	Price	Depth	Height
<b>FX704-5</b>	\$1,417	19.25"	46.25"

### Prague II Headboards, Footboard, and Bedside Locator

#### Standard Features

Same standard features as Prague II Casegoods

#### Available Options

- Wall mount security fasteners (headboards) + \$57
- Electric duplex - specify line or emergency power (Bed locator) + \$120
- Night light (Bed locator) + \$193
- Bed receptacle simplex (Bed locator) + \$219
- 37-pin Adapter (Bed locator) + \$319

#### Specification Decisions

- Select standard laminate
  - Add security fasteners
  - Add electrical options
- Headboards that mount to adjustable bed frames include wood legs and mounting hardware.
- Headboards and footboards for hospital beds can be modified in size and can include mounting holes.
- Contact your customer service representative for pricing.

#### 42.75" W, Twin headboard for adjustable bed frames

24 lbs



Model	Price	Depth	Height
<b>CA/H33-FX704</b>	\$412	-	35.5"

#### 57.75" W, Full headboard for adjustable bed frames

33 lbs



Model	Price	Depth	Height
<b>CA/H46-FX704</b>	\$512	-	35.5"

## Prague II Casegoods

63.75" W, Queen headboard for adjustable bed frames					39 lbs
Model	Price	Depth	Height		
 CA/H50-FX704	\$598\$586	-	35.5"		

39" W - 60" W, Adjustable bed frame					15 lbs
Model	Price	Depth	Height		
CA/1	\$186	-	-		

35" W, Headboard for hospital beds					18 lbs
Model	Price	Depth	Height		
 FX704-3H	\$236	-	18"		

35" W, Footboard for hospital beds					15 lbs
Model	Price	Depth	Height		
 FX704-3F	\$222	-	15"		

Bed locator for base unit					
Model	Price	Depth	Height		
BLBU	\$2,040	-	-		

## Prague II Wardrobes and Armoires

**Standard Features**

- Same standard features as Prague II Casegoods, plus:
- Durawrap tops, drawer fronts, doors and base rails
  - Concealed hinges

**Available Options**

- Drawer and door pulls + \$0
- Laminate two-drawer interior cabinet with plastic drawer pans (Wardrobes only) + \$468
- Wood drawer pans (2) for interior cabinets + \$172
- Plastic drawer liner (removable) for interior cabinet wood drawer pans + \$54 ea
- See [page 380](#) for additional options

**Specification Decisions**

- Select standard laminate
- Select Durawrap
- Select pull style
- See [page 380](#) for additional options

24.5" W, Wardrobe (hinged right)					173 lbs
Model	Price	Depth	Height		
 FX704-25	\$1,283	22.75"	72"		

24.5" W, Wardrobe (hinged left)					173 lbs
Model	Price	Depth	Height		
 FX704-26	\$1,283	22.75"	72"		

## Prague II Casegoods

**38" W, Double wardrobe**

213 lbs

Model	Price	Depth	Height
<b>FX704-39</b>	\$1,960	22.75"	72"

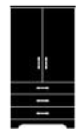
**38" W, TV armoire - TV opening: 29W x 22.5D x 26.5H**

217 lbs

Model	Price	Depth	Height
<b>FX704-38</b>	\$2,266	24"	72"

**51.5" W, TV wardrobe (hinged right) - TV opening: 29W x 22.5D x 26.5H**

380 lbs

Model	Price	Depth	Height
<b>FX704-43</b>	\$3,592	24"	72"

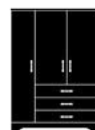
**51.5" W, TV wardrobe (hinged left) - TV opening: 29W x 22.5D x 26.5H**

380 lbs

Model	Price	Depth	Height
<b>FX704-44</b>	\$3,592	24"	72"

# Prísto Casegoods



## More Information

Illustrated Glossary ▶ 409

Finishes ▶ 426

Hardware ▶ 427

Ordering and Warranties ▶ 432

## Standard Features

- Laminate case
- Laminate top with urethane edge (Cloud, Pewter, Sable) on PRBT models
- Laminate top with HPVC edge (Alabaster, Black, Mocha, Putty) on PRLT models
- Dry construction joinery
- Replaceable components
- Vented back panel
- Concealed hinges
- Urethane pulls (Cloud, Pewter, Sable)
- Wood drawer pans on PRBT models
- Plastic drawer pans on PRLT models
- 2" twin-wheel front-locking casters
- GREENGUARD Gold Certified
- Limited Lifetime Warranty

## Available Options

- Fluted oak or maple trim + \$82
- Solid surface top + \$93
- OP/10 cam locks + \$35
- OP/16W wood drawer pans (PRLT models) + \$86 ea
- OP/17 plastic drawer liners (for wood drawer pans) + \$54 ea

## Specification Decisions

- Select standard laminate
- Select edge color
- Select pull color
- Add fluted oak or maple trim
- Add solid surface top
- Add locks
- Add wood drawer pans
- Add plastic drawer liners

## Coordinating Products

- [Prísto Casegoods](#)
- [Prísto II Casegoods](#)
- [Prísto II Recliner](#)
- [Prísto II Treatment Chair](#)
- [Prísto IIT Treatment Chair](#)

	<b>20" W, Bedside - one wood drawer, one door and adjustable shelf</b>	95 lbs								
	<table border="1"> <thead> <tr> <th>Model</th> <th>Price</th> <th>Depth</th> <th>Height</th> </tr> </thead> <tbody> <tr> <td><b>PRBT1</b></td> <td>\$1,935</td> <td>21.25"</td> <td>32.5"</td> </tr> </tbody> </table>	Model	Price	Depth	Height	<b>PRBT1</b>	\$1,935	21.25"	32.5"	
Model	Price	Depth	Height							
<b>PRBT1</b>	\$1,935	21.25"	32.5"							
	<b>20" W, Bedside - three wood drawers</b>	97 lbs								
	<table border="1"> <thead> <tr> <th>Model</th> <th>Price</th> <th>Depth</th> <th>Height</th> </tr> </thead> <tbody> <tr> <td><b>PRBT3</b></td> <td>\$2,061</td> <td>21.25"</td> <td>32.5"</td> </tr> </tbody> </table>	Model	Price	Depth	Height	<b>PRBT3</b>	\$2,061	21.25"	32.5"	
Model	Price	Depth	Height							
<b>PRBT3</b>	\$2,061	21.25"	32.5"							
	<b>20" W, Bedside - one plastic drawer, one door and adjustable shelf</b>	62 lbs								
	<table border="1"> <thead> <tr> <th>Model</th> <th>Price</th> <th>Depth</th> <th>Height</th> </tr> </thead> <tbody> <tr> <td><b>PRLT1</b></td> <td>\$1,568</td> <td>21.25"</td> <td>32.5"</td> </tr> </tbody> </table>	Model	Price	Depth	Height	<b>PRLT1</b>	\$1,568	21.25"	32.5"	
Model	Price	Depth	Height							
<b>PRLT1</b>	\$1,568	21.25"	32.5"							
	<b>20" W, Bedside - three plastic drawers</b>	67 lbs								
	<table border="1"> <thead> <tr> <th>Model</th> <th>Price</th> <th>Depth</th> <th>Height</th> </tr> </thead> <tbody> <tr> <td><b>PRLT3</b></td> <td>\$1,657</td> <td>21.25"</td> <td>32.5"</td> </tr> </tbody> </table>	Model	Price	Depth	Height	<b>PRLT3</b>	\$1,657	21.25"	32.5"	
Model	Price	Depth	Height							
<b>PRLT3</b>	\$1,657	21.25"	32.5"							

# Prísto II Casegoods



## Standard Features

- Laminate case
- Durawrap tops, drawer fronts, doors, and bottoms
- Dry construction joinery
- Replaceable components
- Wood drawer pans
- Secondary top surface with nickel-coated posts
- 2" twin-wheel front-locking casters
- Integrated pulls
- Vented back panel
- Concealed hinges
- GREENGUARD Gold Certified
- Limited Lifetime Warranty

## Specification Decisions

- Select standard laminate
- Select Durawrap for secondary top surface
- Add locks
- Add plastic drawer liners

## Coordinating Products

- [Prísto Casegoods](#)
- [Prísto II Casegoods](#)
- [Prísto II Recliner](#)
- [Prísto II Treatment Chair](#)
- [Prísto IIT Treatment Chair](#)

## More Information

- Illustrated Glossary ▶ 409
- Finishes ▶ 426
- Hardware ▶ 427
- Ordering and Warranties ▶ 432

## Available Options

- OP/10 cam locks + \$35
- OP/17 plastic drawer liners + \$54 ea



### 21" W, Bedside - one wood drawer and door

102 lbs

Model	Price	Depth	Height
<b>PRST-1</b>	\$1,419	21.75"	35.5"



### 21" W, Bedside - three drawers

106 lbs

Model	Price	Depth	Height
<b>PRST-3</b>	\$1,509	21.75"	35.5"

## Revive Casegoods



### More Information

Illustrated Glossary ▶ 409

Finishes ▶ 426

Hardware ▶ 427

Ordering and Warranties ▶ 432

### Standard Features

- Laminate case and tops
- Dry construction joinery
- Replaceable components
- Powder-coated metal legs
- Quiet, soft-closing drawers
- Full extension drawers
- Integrated drawer and door pulls
- Non-marring adjustable glides
- Nemschoff healthcare wood finish
- GREENGUARD Gold Certified
- Limited Lifetime Warranty

### Coordinating Products

- [Revive Side Chair](#)
- [Revive Patient Chair](#)
- [Revive Display System](#)
- [Revive Display System Guest Center](#)

## Revive Bedside Cabinets

### Standard Features

- Same standard features as Revive Casegoods; plus:
- Rounded corners on surfaces

### Available Options

- Drawer and door pulls + \$0
- Casters + \$0
- Plinth base + \$0
- DL Door locks + \$64
- LI Drawer locks + \$64
- Grab bar + \$389
- Lighting mount (with grab bar only) + \$123

### Specification Decisions

- Select standard laminate
- Add pull style
- Add casters or plinth base
- Add locks
- Add grab bars
- Add lighting mount

	<b>19.75" W, Bedside cabinet - three drawers</b>				100 lbs
	Model	Price	Depth	Height	
	<b>REVV-00101</b>	\$1,824	16.5"	30"	
	<b>19.75" W, Bedside cabinet (hinged right)</b>				65 lbs
	Model	Price	Depth	Height	
	<b>REVV-00102</b>	\$964	16.5"	30"	
	<b>19.75" W, Bedside cabinet (hinged left)</b>				65 lbs
	Model	Price	Depth	Height	
	<b>REVV-00103</b>	\$964	16.5"	30"	
	<b>19.75" W, Bedside - four drawers</b>				120 lbs
	Model	Price	Depth	Height	
	<b>REVV-00104</b>	\$2,622	16.5"	38.25"	



## Revive Casegoods

	<b>19.75" W, Bedside cabinet (hinged right), one shelf</b> <span style="float: right;">80 lbs</span>			
	Model	Price	Depth	Height
	<b>REVV-00105</b>	\$1,450	16.5"	38.25"

	<b>19.75" W, Bedside cabinet (hinged left), one shelf</b> <span style="float: right;">80 lbs</span>			
	Model	Price	Depth	Height
	<b>REVV-00106</b>	\$1,450	16.5"	38.25"

	<b>19.75" W, Bedside cabinet - shelf</b> <span style="float: right;">70 lbs</span>			
	Model	Price	Depth	Height
	<b>REVV-00107</b>	\$1,141	16.5"	30"

	<b>19.75" W, Bedside cabinet - one drawer</b> <span style="float: right;">75 lbs</span>			
	Model	Price	Depth	Height
	<b>REVV-00108</b>	\$1,201	16.5"	38.25"

## Revive Chests

**Standard Features**

- Same standard features as Revive Casegoods; plus:
- Rounded corners on surfaces

**Available Options**

- Drawer and door pulls + \$0
- Casters + \$0
- Plinth base + \$0
- See [page 377](#) for additional options

**Specification Decisions**

- Select standard laminate
- Add pull style
- Add plinth base
- See [page 377](#) for additional options







	<b>32" W, Chest - three drawers</b> <span style="float: right;">140 lbs</span>			
	Model	Price	Depth	Height
	<b>REVV-00201</b>	\$2,281	16.5"	30"

	<b>32" W, Chest - two doors and shelf</b> <span style="float: right;">100 lbs</span>			
	Model	Price	Depth	Height
	<b>REVV-00202</b>	\$1,215	16.5"	30"

	<b>32" W, Chest - drawer and shelf</b> <span style="float: right;">90 lbs</span>			
	Model	Price	Depth	Height
	<b>REVV-00203</b>	\$1,280	16.5"	30"

	<b>32" W, Chest - one drawer</b> <span style="float: right;">80 lbs</span>			
	Model	Price	Depth	Height
	<b>REVV-00204</b>	\$1,205	16.5"	30"

## Revive Casegoods

	<b>38.25" W, Chest - three drawers and work surface</b>	155 lbs	
Model	Price	Depth	Height
<b>REVV-00205</b>	\$2,961	16.5"	37"
	<b>38.25" W, Chest - two doors, work surface and inside shelf</b>	115 lbs	
Model	Price	Depth	Height
<b>REVV-00206</b>	\$2,034	16.5"	37"
	<b>38.25" W, Chest - one drawer and work surface</b>	105 lbs	
Model	Price	Depth	Height
<b>REVV-00207</b>	\$2,066	16.5"	37"
	<b>63.25" W, Double chest - six drawers</b>	215 lbs	
Model	Price	Depth	Height
<b>REVV-00208</b>	\$4,018	16.5"	30"
	<b>63.25" W, Chest - three LSF drawers, two doors and shelf</b>	175 lbs	
Model	Price	Depth	Height
<b>REVV-00209</b>	\$3,092	16.5"	30"
	<b>63.25" W, Chest - three RSF drawers, two doors and shelf</b>	175 lbs	
Model	Price	Depth	Height
<b>REVV-00210</b>	\$3,092	16.5"	30"
	<b>63.25" W, Chest - four doors and inside shelves</b>	135 lbs	
Model	Price	Depth	Height
<b>REVV-00211</b>	\$2,167	16.5"	30"

Patient Chairs

Recliners

Treatment Chairs

Rockers &amp; Gliders

Overbed Tables

Sleepover Seating

Casegoods

Display &amp; Accessories

# Revive Casegoods

## Revive Daystands

### Standard Features









- Same standard features as Revive Casegoods; plus:
- Rounded corners on surfaces

### Available Options

- Drawer and door pulls + \$0
- Casters + \$0
- Plinth base + \$0
- DL Door locks + \$64
- Grab bar + \$389
- Lighting mount (with grab bar only) + \$123

### Specification Decisions

- Select standard laminate
- Add pull style
- Add casters or plinth base
- Add locks
- Add grab bars
- Add lighting mount

	24" W, Daystand (hinged left)				55 lbs
	Model	Price	Depth	Height	
	<b>REVV-00501</b>	\$1,154	19.25"	24"	
	Model	Price	Depth	Height	
	<b>REVV-00502</b>	\$1,154	19.25"	24"	
	Model	Price	Depth	Height	
	<b>REVV-00503</b>	\$1,351	19.25"	24"	
	Model	Price	Depth	Height	
	<b>REVV-00504</b>	\$1,017	19.25"	24"	
	Model	Price	Depth	Height	
	<b>REVV-00505</b>	\$1,840	19.25"	28"	
	Model	Price	Depth	Height	
	<b>REVV-00506</b>	\$1,840	19.25"	28"	
	Model	Price	Depth	Height	
	<b>REVV-00507</b>	\$2,035	19.25"	28"	
	Model	Price	Depth	Height	
	<b>REVV-00508</b>	\$2,281	19.25"	34"	

## Revive Casegoods

	<b>26" W, Daystand (hinged right)</b>	83 lbs	
Model	Price	Depth	Height
<b>REVV-00509</b>	\$2,281	19.25"	34"
	<b>26" W, Daystand with drawer</b>	83 lbs	
Model	Price	Depth	Height
<b>REVV-00510</b>	\$2,090	19.25"	34"
	<b>26" W, Daystand (hinged left)</b>	85 lbs	
Model	Price	Depth	Height
<b>REVV-00511</b>	\$2,425	19.25"	40"
	<b>26" W, Daystand (hinged right)</b>	85 lbs	
Model	Price	Depth	Height
<b>REVV-00512</b>	\$2,425	19.25"	40"
	<b>26" W, Daystand with drawer</b>	85 lbs	
Model	Price	Depth	Height
<b>REVV-00513</b>	\$2,236	19.25"	40"

Patient Chairs

Recliners

Treatment Chairs

Rockers &amp; Gliders

Overbed Tables

Sleepover Seating

Casegoods

Display &amp; Accessories

# Revive Casegoods

## Revive Wardrobes and Armoires

### Standard Features

Same standard features as Revive Casegoods

### Available Options

- Drawer and door pulls + \$0
- Plinth base + \$0
- See page 381 for additional options

### Specification Decisions

- Select standard laminate
- Add plinth base
- Add pulls
- See page page 381 for additional options



### 32" W, Armoire - two doors with top shelf and three drawers - TV opening: 30" W x 17.5" H

210 lbs

Model	Price	Depth	Height
<b>REVV-00301</b>	\$3,365	18"	66"

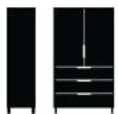

### 38" W, Armoire - two doors with top shelf and three drawers - TV opening: 30" W x 17.5" H

235 lbs

Model	Price	Depth	Height
<b>REVV-00302</b>	\$3,657	18"	66"



### 43" W, Armoire - two doors, top shelf, three drawers and RSF wardrobe - TV opening: 30" W x 17.5" H

285 lbs

Model	Price	Depth	Height
<b>REVV-00303</b>	\$4,164	22"	66"



### 43" W, Armoire - two doors, top shelf, three drawers and LSF wardrobe - TV opening: 30" W x 17.5" H

285 lbs

Model	Price	Depth	Height
<b>REVV-00304</b>	\$4,164	22"	66"



### 24.5" W, Wardrobe (hinged right) - two drawers and clothes bar

200 lbs

Model	Price	Depth	Height
<b>REVV-00401</b>	\$2,679	22"	72"



### 24.5" W, Wardrobe (hinged left) - two drawers and clothes bar

200 lbs

Model	Price	Depth	Height
<b>REVV-00402</b>	\$2,679	22"	72"



### 32" W, Wardrobe - two doors - two drawers and clothes bar

240 lbs

Model	Price	Depth	Height
<b>REVV-00403</b>	\$3,115	22"	72"



### 38" W, Wardrobe - two doors - two drawers and clothes bar

280 lbs

Model	Price	Depth	Height
<b>REVV-00404</b>	\$3,406	22"	72"

## Ten Casegoods



### Standard Features

- Maple veneer case
- Dry construction joinery
- Replaceable components
- Nemschoff healthcare wood finish
- GREENGUARD Gold Certified
- Limited Lifetime Warranty

### More Information

Illustrated Glossary ▶ 409

Finishes ▶ 426

Hardware ▶ 427

Ordering and Warranties ▶ 432

## Ten Bedside Cabinets

### Standard Features

- Same standard as Ten Casegoods features, plus:
- Laminate top with urethane edge (Cloud, Pewter, Sable)
- Wood drawers
- Concealed hinges
- Black laminate base rail

### Available Options

- Drawer and door pulls + \$0
- OP/10 cam locks + \$35
- OP/13 caster base + \$115
- OP/13LK caster base with locks + \$204
- OP/17 Plastic drawer liners + \$54 ea

### Specification Decisions

- Select standard wood finish
- Select standard laminate
- Select urethane color edge
- Select pull style
- Add OP 10 cam locks
- Add casters
- Add plastic drawer liners



### 19.5" W, Bedside cabinet - one drawer and one door

80 lbs

Model	Price	Depth	Height
<b>TENA/1</b>	\$1,097	20.75"	29.75"



### 19.5" W, Bedside cabinet - three drawers

80 lbs

Model	Price	Depth	Height
<b>TENA/3</b>	\$1,301	20.75"	29.75"

Patient Chairs

Recliners

Treatment Chairs

Rockers &amp; Gliders

Overbed Tables

Sleepover Seating

Casegoods

Display &amp; Accessories

## Ten Casegoods

### Ten Chests

#### Standard Features

Same standard as Ten Casegoods features, plus:

- Wood drawers
- Black laminate base rail

#### Available Options

- Door and drawer pulls + \$0
- See [page 378](#) for additional options

#### Specification Decisions

- Select standard wood finish
- Select standard laminate
- Select pull style
- See [page 378](#) for additional options



#### 31" W, Chest - three drawers

110 lbs

Model	Price	Depth	Height
<b>TENB/03</b>	\$1,622	19"	29.75"



#### 31" W, Chest - four drawers

115 lbs

Model	Price	Depth	Height
<b>TENB/04</b>	\$1,887	19"	38"



#### 31" W, Chest - five drawers

122 lbs

Model	Price	Depth	Height
<b>TENB/05</b>	\$2,119	19"	46.25"

### Ten Headboards, Footboard and Bed Locator

#### Standard Features

Same standard as Ten Casegoods features.

#### Available Options

- Door pull (Headwalls) + \$0
- Wall mount security fasteners (Headboards) + \$57
- Electric duplex - specify line or emergency power (Bed locator) + \$120
- Night light (Bed locator) + \$193
- Bed receptacle simplex (Bed locator) + \$219
- 37-pin Adapter (Bed locator) + \$319

#### Specification Decisions

- Select standard wood finish
  - Add door pulls
  - Add security fasteners
  - Add electrical options
- Headboards that mount to adjustable bed frames include wood legs and mounting hardware.
- Headboards and footboards for hospital beds can be modified in size and can include mounting holes.
- Contact your customer service representative for pricing.



#### 42.75" W, Twin headboard for adjustable bed frames

24 lbs

Model	Price	Depth	Height
<b>CA/H33-TEN</b>	\$563	-	37"



#### 57.75" W, Full headboard for adjustable bed frames

33 lbs

Model	Price	Depth	Height
<b>CA/H46-TEN</b>	\$699	-	37"

## Ten Casegoods

	<b>63.75" W, Queen headboard for adjustable bed frames</b>				39 lbs
	Model	Price	Depth	Height	
	<b>CA/H50-TEN</b>	\$819	-	37"	
	<b>39" W - 60" W, Adjustable bed frame</b>				15 lbs
	Model	Price	Depth	Height	
	<b>CA/1</b>	\$186	-	-	
	<b>35" W, Headboard for hospital beds</b>				23 lbs
	Model	Price	Depth	Height	
	<b>TENP/3H</b>	\$359	1"	18"	
	<b>35" W, Footboard for hospital beds</b>				20 lbs
	Model	Price	Depth	Height	
	<b>TENP/3F</b>	\$350	1"	15"	
	<b>Bed locator base unit</b>				-
	Model	Price	Depth	Height	
	<b>BLBU</b>	\$2,040	-	-	

## Ten Wardrobes

**Standard Features**

Same standard as Ten Casegoods features, plus:



- Wood drawers
- Concealed hinges
- Black laminate base rail

**Available Options**

- Drawer and door pulls + \$0
- Wood two-drawer interior cabinet with plastic drawer pans (Wardrobes only) + \$529
- Wood drawer pans (2) for interior cabinets + \$172
- Plastic drawer liner (removable) for interior cabinet wood drawer pans + \$54 ea
- See [page 381](#) for additional options

**Specification Decisions**

- Select standard wood finish
- Select pull style
- See [page 381](#) for additional options

	<b>25" W, Wardrobe (hinged right)</b>				173 lbs
	Model	Price	Depth	Height	
	<b>TENW/25</b>	\$2,035	23.5"	72"	
	<b>25" W, Wardrobe (hinged left)</b>				173 lbs
	Model	Price	Depth	Height	
	<b>TENW/26</b>	\$2,035	23.5"	72"	



## Ten Casegoods



### 37" W, Double wardrobe

213 lbs

Model	Price	Depth	Height
<b>TENW/39</b>	\$2,409	23.5"	72"



### 37" W, Double wardrobe - three lower drawers - TV opening: 30.5" W x 21.75" D x 26.25" H

217 lbs

Model	Price	Depth	Height
<b>TENT/38</b>	\$3,573	23.5"	72"



### 50" W, TV wardrobe (hinged right) - TV opening: 29" W x 22.5" D x 26.5" H

380 lbs

Model	Price	Depth	Height
<b>TENT/43</b>	\$5,414	23.5"	72"



### 50" W, TV wardrobe (hinged left) - TV opening: 29" W x 22.5" D x 26.5" H

380 lbs

Model	Price	Depth	Height
<b>TENT/44</b>	\$5,414	23.5"	72"

## Terra Casegoods



### Standard Features

- Laminate case and top with PVC edge
- Plinth base with adjustable glides
- Dry construction joinery
- Replaceable components
- Nemschoff healthcare wood finish
- GREENGUARD Gold Certified
- Limited Lifetime Warranty

### Coordinating Products

- [Terra Casegoods for Treatment Areas](#)

### More Information

Illustrated Glossary ▶ 409

Fabrics ▶ 421

Flammability (CTB-133) ▶ 429

Finishes ▶ 426

Hardware ▶ 427

Ordering and Warranties ▶ 432

## Terra Bedside Cabinets

### Standard Features

- Same standard as Terra Casegoods features, plus:
- Quiet, soft-closing drawers and doors
  - Wood drawers
  - Concealed hinges
  - Adjustable shelf

### Available Options

- Veneer case + \$210
- Drawer and door pulls + \$0
- Solid surface top + \$419
- Powder-coated legs + \$367
- Twin wheel front locking casters + \$236
- OP/10 cam locks + \$35
- OP/17 plastic drawer liners + \$64

Powder-coated legs must be field-installed and ship in a separate package

### Specification Decisions

- Select laminate or add wood finish
- Select pull style
- Add solid surface top
- Add powder-coated legs or casters
- Add locks
- Add plastic drawer liners



### 18.75" W, Bedside cabinet - one drawer, one door (hinged right)

84 lbs

Model	Price	Depth	Height
<b>TRA01</b>	\$1,105	19"	32.25"



### 18.75" W, Bedside cabinet- one drawer, one door (hinged left)

84 lbs

Model	Price	Depth	Height
<b>TRA02</b>	\$1,105	19"	32.25"



### 18.75" W, Bedside cabinet - three drawers

104 lbs

Model	Price	Depth	Height
<b>TRA03</b>	\$1,279	19"	32.25"

# Terra Casegoods

## Terra Benches

### Standard Features

Same standard as Terra Casegoods features.

### Available Options

- Powder-coated legs + \$367
- Moisture barrier + \$69

### Specification Decisions

- Select fabric
- Select laminate
- Add powder-coated legs
- Add moisture barrier

### Key Dimensions

- Overall Width: See price table
- Overall Depth: 16"
- Overall Height: 18.5"
- Seat Height: 18.5"



### 16" W, Bench

32 lbs | 1.25 yds

Model	Series 2	Series 3	Series 4	Series 5	Series 6	Series 7	Series 8	COM
<b>TRA39</b>	\$379	\$419	\$487	\$558	\$641	\$726	\$832	\$419



### 32" W, Bench

52 lbs | 1.75 yds

Model	Series 2	Series 3	Series 4	Series 5	Series 6	Series 7	Series 8	COM
<b>TRA40</b>	\$728	\$785	\$880	\$979	\$1,096	\$1,215	\$1,363	\$785



### 48" W, Bench

72 lbs | 2.25 yds

Model	Series 2	Series 3	Series 4	Series 5	Series 6	Series 7	Series 8	COM
<b>TRA41</b>	\$1,026	\$1,099	\$1,221	\$1,348	\$1,499	\$1,652	\$1,842	\$1,099

## Terra Chests

### Standard Features

Same standard as Terra Casegoods features, plus:

- Quiet, soft-closing drawers and doors (see specific models)
- Concealed hinges (models with doors)
- Adjustable shelves (see specific models)

### Available Options

- Drawer and door pulls + \$0
- Powder-coated legs + \$367
- See [page 378](#) for additional options
- Powder-coated legs must be field-installed and ship inside units

### Specification Decisions

- Select laminate or add wood finish
- Select pull style
- Add powder-coated legs
- See [page 378](#) for additional options



### 30.75" W, Chest - two drawers

99 lbs

Model	Price	Depth	Height
<b>TRA04</b>	\$1,483	20.25"	30"



### 30.75" W, Chest - one drawer and shelf

113 lbs

Model	Price	Depth	Height
<b>TRA05</b>	\$1,335	20.25"	30"



### 30.75" W, Chest - three drawers

146 lbs

Model	Price	Depth	Height
<b>TRA06</b>	\$1,704	20.25"	30"

## Terra Casegoods

	30.75" W, Narrow chest - two doors				81 lbs
	Model	Price	Depth	Height	
	<b>TRA07</b>	\$1,038	14.25"	30"	
	42.25" W, Narrow chest - two doors				114 lbs
	Model	Price	Depth	Height	
	<b>TRA08</b>	\$1,401	14.25"	30"	
	42.25" W, Chest - two doors				145 lbs
	Model	Price	Depth	Height	
	<b>TRA09</b>	\$2,000	20.25"	30"	
	42.25" W, Chest - one drawer				153 lbs
	Model	Price	Depth	Height	
	<b>TRA10</b>	\$1,801	20.25"	30"	
	42.25" W, Chest - three drawers				186 lbs
	Model	Price	Depth	Height	
	<b>TRA11</b>	\$2,300	20.25"	30"	

## Terra Desks

## Standard Features

- Same standard as Terra Casegoods features, plus:
- Quiet, soft-closing drawers and doors
- Wood drawers

## Available Options

- Veneer case + \$419
- Solid surface top + \$837
- Powder-coated legs (TRA28, 29) + \$367
- OP/10 cam locks + \$35
- Plastic drawer liners + \$64 ea

## Specification Decisions

- Select laminate or add wood finish
- Select pull style
- Add solid surface top
- Add powder-coated legs
- Add OP/10 Cam locks
- Add plastic drawer liners

	54" W, Desk - three RSF drawers				167 lbs
	Model	Price	Depth	Height	
	<b>TRA28</b>	\$1,882	20.25"	30"	
	54" W, Desk - three LSF drawers				167 lbs
	Model	Price	Depth	Height	
	<b>TRA29</b>	\$1,882	20.25"	30"	
	54" W, Desk top with side panel				53 lbs
	Model	Price	Depth	Height	
	<b>TRA30</b>	\$679	20.25"	30"	

## Terra Casegoods

### Terra Wardrobes, Armoires and Credenzas

#### Standard Features

- Same standard as Terra Casegoods features, plus:
- Quiet, soft-closing drawers and doors (see specific models)
- Concealed hinges (models with doors)
- Adjustable shelves (see specific models)
- Clothes bar

#### Available Options

- Drawer and door pulls + \$0
  - Powder-coated legs + \$367
  - See [page 382](#) for additional options
- Powder-coated legs must be field-installed and ship inside units

#### Specification Decisions

- Select laminate or add wood finish
- Select pull style
- Add powder-coated legs
- See [page 382](#) for additional options

#### 18.75" W, Wardrobe (hinged right)

100 lbs

Model	Price	Depth	Height
<b>TRA22</b>	\$1,105	20.25"	47.75"

#### 18.75" W, Wardrobe (hinged left)

100 lbs

Model	Price	Depth	Height
<b>TRA23</b>	\$1,105	20.25"	47.75"

#### 18.75" W, Wardrobe with one drawer and one door (hinged right)

117 lbs

Model	Price	Depth	Height
<b>TRA24</b>	\$1,215	20.25"	47.75"

#### 18.75" W, Wardrobe with one drawer and one door (hinged left)

117 lbs

Model	Price	Depth	Height
<b>TRA25</b>	\$1,215	20.25"	47.75"

#### 18.75" W, Narrow wardrobe (hinged right)

79 lbs

Model	Price	Depth	Height
<b>TRA26</b>	\$774	14.25"	47.75"

#### 18.75" W, Narrow wardrobe (hinged left)

79 lbs









Model	Price	Depth	Height
<b>TRA27</b>	\$774	14.25"	47.75"

#### 24.5" W, Wardrobe (hinged right)

163 lbs

Model	Price	Depth	Height
<b>TRA18</b>	\$2,208	20"	75.25"

## Terra Casegoods

	<b>24.5" W, Wardrobe (hinged left)</b>				163 lbs
	Model	Price	Depth	Height	
	<b>TRA19</b>	\$2,208	20"	75.25"	
	<b>24.5" W, Wardrobe - one drawer and one door (hinged right)</b>				183 lbs
	Model	Price	Depth	Height	
	<b>TRA20</b>	\$2,429	20"	75.25"	
	<b>24.5" W, Wardrobe - one drawer and one door (hinged left)</b>				183 lbs
	Model	Price	Depth	Height	
	<b>TRA21</b>	\$2,429	20"	75.25"	
	<b>37.25" W, Wardrobe - two doors</b>				191 lbs
	Model	Price	Depth	Height	
	<b>TRA12</b>	\$2,567	20.25"	47.75"	
	<b>37.25" W, Wardrobe - two doors, two drawers</b>				224 lbs
	Model	Price	Depth	Height	
	<b>TRA13</b>	\$2,824	20.25"	47.75"	
	<b>37.25" W, Wardrobe - left offset door and regular door</b>				192 lbs
	Model	Price	Depth	Height	
	<b>TRA14</b>	\$2,567	20.25"	47.75"	
	<b>37.25" W, Wardrobe - right offset door and regular door</b>				192 lbs
	Model	Price	Depth	Height	
	<b>TRA15</b>	\$2,567	20.25"	47.75"	
	<b>37.25" W, Narrow wardrobe - two doors</b>				151 lbs
	Model	Price	Depth	Height	
	<b>TRA16</b>	\$1,797	14.25"	47.75"	
	<b>37.25" W, Narrow wardrobe - two doors, two drawers</b>				178 lbs
	Model	Price	Depth	Height	
	<b>TRA17</b>	\$1,977	14.25"	47.75"	

Patient Chairs

Recliners

Treatment Chairs

Rockers &amp; Gliders

Overbed Tables

Sleepover Seating

Casegoods

Display &amp; Accessories

# Terra Casegoods

## Terra Pre-Configured Units

### Standard Features

- Same standard as Terra Casegoods features, plus:
- Concealed hinges
  - Adjustable shelves
  - Clothes bar

### Available Options

- Drawer and door pulls + \$0
  - Powder-coated legs + \$367
  - See [page 378](#) and [page 382](#) for additional options
- Powder-coated legs must be field-installed and ship inside units

### Specification Decisions

- Select laminate or add wood finish
- Select pull style
- Add powder-coated legs
- See [page 378](#) and [page 382](#) for additional options

66" W, Chest - two doors and RSF desk				166 lbs
Model	Price	Depth	Height	
 <b>TRA37</b>	\$3,022	20.25"	30"	

66" W, Chest - two doors and LSF desk				166 lbs
Model	Price	Depth	Height	
 <b>TRA38</b>	\$3,022	20.25"	30"	

61.25" W, Credenza - four doors				198 lbs
Model	Price	Depth	Height	
 <b>TRA33</b>	\$3,000	20.25"	30"	

61.25" W, Narrow credenza - four doors				162 lbs
Model	Price	Depth	Height	
 <b>TRA34</b>	\$2,101	14.25"	30"	

74" W, Wardrobe - four doors				382 lbs
Model	Price	Depth	Height	
 <b>TRA31</b>	\$2,311	20.25"	47.75"	

74" W, Narrow wardrobe - four doors				302 lbs
Model	Price	Depth	Height	
 <b>TRA32</b>	\$1,618	14.25"	47.75"	

87.25" W, Wardrobe (hinged right) with desk with two doors				329 lbs
Model	Price	Depth	Height	
 <b>TRA35</b>	\$4,531	20.25"	75.25"	

87.25" W, Wardrobe with door (hinged right) and three drawers				329 lbs
Model	Price	Depth	Height	
 <b>TRA36</b>	\$4,531	20.25"	75.25"	

# Terra Casegoods for Treatment Areas



## Standard Features

- Laminate case and top with PVC edge
- Plinth base with adjustable glides
- Dry construction joinery
- Replaceable components
- Nemschoff healthcare wood finish
- GREENGUARD Gold Certified
- Limited Lifetime Warranty; one year on resin panel

## Coordinating Products

- [Terra Casegoods](#)

### More Information

- Illustrated Glossary ▶ 409
- Fabrics ▶ 421
- Flammability (CTB-133) ▶ 429
- Finishes ▶ 426
- Hardware ▶ 427
- Ordering and Warranties ▶ 432

## Terra for Treatment Areas Pre-configured Units

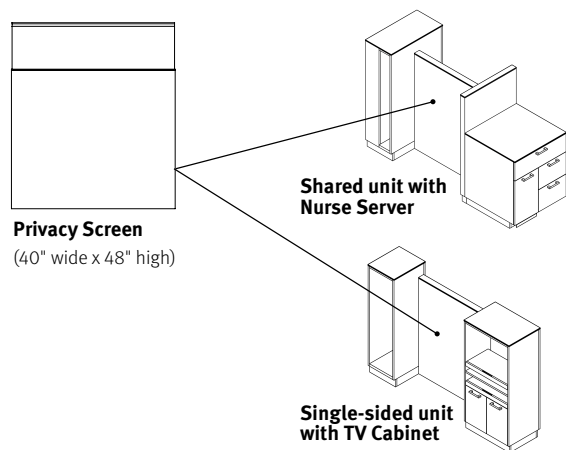

### Standard Features

Same standard features as Terra Casegoods for Treatment Areas features, plus:

- Laminate privacy panel between the end cabinets

### Available Options

- See [page 375](#) for additional options

### Specification Decisions

- Determine if a single-sided or shared configuration is required
- Select standard laminate or add wood finish
- Select pull style
- Select resin panel
- See [page 375](#) for additional options

Benches are not included

All pre-configured weights are based on a total of all units included plus an adjustable resin screen.

	80.75" W, Single-sided unit - TV cabinet and RSF wardrobe				345 lbs
	Model	Price	Depth	Height	
	<b>TRA100</b>	\$3,277	18"	54"	
	80.75" W, Single-sided unit - TV cabinet and LSF wardrobe				345 lbs
	Model	Price	Depth	Height	
	<b>TRA101</b>	\$3,277	18"	54"	



## Terra Casegoods for Treatment Areas

**84" W, Single-sided unit - TV cabinet, desk, and RSF wardrobe**

380 lbs

Model	Price	Depth	Height
<b>TRA103</b>	\$3,483	18"	54"

**84" W, Single-sided unit - TV cabinet, desk, and LSF wardrobe**

380 lbs

Model	Price	Depth	Height
<b>TRA104</b>	\$3,483	18"	54"

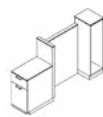
**82.5" W, Single-sided unit - nurse server and RSF wardrobe**

319 lbs

Model	Price	Depth	Height
<b>TRA106</b>	\$3,422	18"	54"

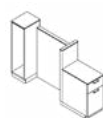
**82.5" W, Single-sided unit - nurse server and LSF wardrobe**

319 lbs

Model	Price	Depth	Height
<b>TRA107</b>	\$3,422	18"	54"

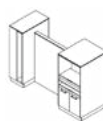
**80.75" W, Shared unit - TV cabinet and wardrobe**

600 lbs

Model	Price	Depth	Height
<b>TRA102</b>	\$4,564	30"	54"

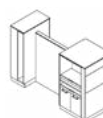
**84" W, Shared unit - TV cabinet, desk and wardrobe**

671 lbs

Model	Price	Depth	Height
<b>TRA105</b>	\$4,860	30"	54"

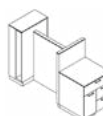
**82.5" W, Shared unit - shared nurse server and wardrobe**

628 lbs

Model	Price	Depth	Height
<b>TRA108</b>	\$4,192	30"	54"

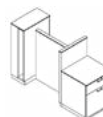
**82.5" W, Shared unit - shared nurse server, one drawer with recycle center**

548 lbs

Model	Price	Depth	Height
<b>TRA109</b>	\$3,126	30"	54"

## Terra Casegoods for Treatment Areas

## Terra Treatment Nurse Servers

**Standard Features**

- Same standard as Terra Casegoods for Treatment Areas features, plus:
- Quiet, soft-closing drawers
  - Hands-free waste disposal

**Available Options**

- Drawer and door pulls + \$0
- See [page 375](#) for additional options

**Specification Decisions**

- Select laminate or add wood finish
- Select pull style
- See [page 375](#) for additional options

**18" W, Nurse server ganged RSF with 35 quart waste disposal**

160 lbs

Model	Price	Depth	Height
<b>TRA50</b>	\$1,668	25.75"	36"

**18" W, Nurse server ganged LSF with 35 quart waste disposal**

160 lbs

Model	Price	Depth	Height
<b>TRA51</b>	\$1,668	25.75"	36"

**29" W, Shared nurse server with 35 quart waste disposal**

320 lbs

Model	Price	Depth	Height
<b>TRA52</b>	\$2,086	25.75"	36"

**29" W, Shared nurse server with recycling containers**

400 lbs

Model	Price	Depth	Height
<b>TRA53</b>	\$1,938	25.75"	36"

## Terra Treatment TV Cabinets

**Standard Features**

- Same standard as Terra Casegoods for Treatment Areas features, plus:
- See [page 375](#) for model-specific features

**Available Options**

- Drawer and door pulls + \$0
- See [page 375](#) for additional options

**Specification Decisions**

- Select laminate or add wood finish
- Select pull style
- See [page 375](#) for additional options

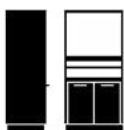
**27.75" W, TV cabinet ganged RSF**

186 lbs

Model	Price	Depth	Height
<b>TRA59</b>	\$1,523	18"	54"

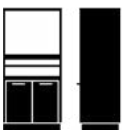
**27.75" W, TV cabinet ganged LSF**

186 lbs

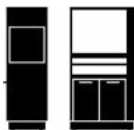

Model	Price	Depth	Height
<b>TRA60</b>	\$1,523	18"	54"

**25.75" W, Shared TV cabinet**

372 lbs

Model	Price	Depth	Height
<b>TRA63</b>	\$2,459	29.75"	54"

## Terra Casegoods for Treatment Areas

	<b>29" W, TV cabinet with desk ganged RSF</b> <span style="float: right;">221 lbs</span>			
	Model	Price	Depth	Height
	<b>TRA61</b>	\$1,729	18"	54"
	<b>29" W, TV cabinet with desk ganged LSF</b> <span style="float: right;">221 lbs</span>			
	Model	Price	Depth	Height
	<b>TRA62</b>	\$1,729	18"	54"
	<b>29" W, Shared TV cabinet with desk</b> <span style="float: right;">443 lbs</span>			
	Model	Price	Depth	Height
	<b>TRA64</b>	\$2,754	29.75"	54"

### Terra Treatment Wardrobes

#### Standard Features



- Same standard as Terra Casegoods for Treatment Areas features, plus:
- See [page 375](#) for model-specific features

#### Available Options

- See [page 375](#) for additional options

#### Specification Decisions

- Select laminate or add wood finish
- Select pull style
- See [page 375](#) for additional options

	<b>15" W, Wardrobe ganged RSF with three clothes hooks</b> <span style="float: right;">74.5 lbs</span>			
	Model	Price	Depth	Height
	<b>TRA56</b>	\$975	18"	54"
	<b>15" W, Wardrobe ganged LSF with three clothes hooks</b> <span style="float: right;">74.5 lbs</span>			
	Model	Price	Depth	Height
	<b>TRA57</b>	\$975	18"	54"
	<b>15" W, Shared wardrobe with clothes bar</b> <span style="float: right;">144 lbs</span>			
	Model	Price	Depth	Height
	<b>TRA58</b>	\$1,326	29.75"	54"

### Terra Treatment Partition

#### Standard Features

- Same standard as Terra Casegoods for Treatment Areas features, plus:
- Fixed laminate panel
  - 2" glides

#### Available Options

- 2" swivel locking casters + \$204
- Solid surface top cap + \$91
- See [page 375](#) for additional options

#### Specification Decisions

- Select standard laminate or add wood finish
- See [page 375](#) for additional options

	<b>45.5" W, Movable partition</b>			
	Model	Price	Depth	Height
	<b>TRA54</b>	\$1,057	40"	54"

## Terra Casegoods for Treatment Areas

### Terra Treatment Benches

#### Standard Features

Same standard as Terra Casegoods for Treatment Areas features

#### Available Options

- Powder-coated legs + \$367
- Moisture barrier + \$69

#### Specification Decisions

- Select fabric
- Select laminate
- Add powder-coated legs
- Add moisture barrier

		39" W, Bench								46 lbs   1.50 yds
	Model	Series 2	Series 3	Series 4	Series 5	Series 6	Series 7	Series 8	COM	
	<b>TRA67</b>	\$921	\$969	\$1,050	\$1,135	\$1,236	\$1,333	\$1,465	\$969	

		39" W, Bench with storage								53 lbs   1.50 yds
	Model	Series 2	Series 3	Series 4	Series 5	Series 6	Series 7	Series 8	COM	
	<b>TRA68</b>	\$921	\$969	\$1,050	\$1,135	\$1,236	\$1,338	\$1,338	\$969	

### Terra Casegoods for Treatment Areas Options

Preconfigured Units		Cam lock (OP/10) <sup>1</sup>	Cam lock (OP/10A) <sup>1</sup>	Power and data in the desk <sup>2</sup>	Power in the TV cabinet <sup>3</sup>	Veneer case	Solid surface top <sup>4</sup>	Resin panel (fixed) <sup>5</sup>	Resin panel (adjustable) <sup>5</sup>
TRA100	80.75" W, Single sided pre-configured unit with TV cabinet and LSF wardrobe		\$63		\$253	\$638	\$714	\$561	\$1,020
TRA101	80.75" W, Single sided pre-configured unit with TV cabinet and RSF wardrobe		\$63		\$253	\$638	\$714	\$561	\$1,020
TRA102	80.75" W, Shared pre-configured unit with TV cabinet and wardrobe		\$63		\$502	\$638	\$918	\$561	\$1,020
TRA103	84" W, Single sided pre-configured unit with TV cabinet, desk, and LSF wardrobe		\$63	\$414	\$253	\$638	\$816	\$561	\$1,020
TRA104	84" W, Single sided pre-configured unit with TV cabinet, desk, and RSF wardrobe		\$63	\$414	\$253	\$638	\$816	\$561	\$1,020
TRA105	84" W, Shared pre-configured unit with TV cabinet, desk and wardrobe		\$63	\$414	\$502	\$638	\$918	\$561	\$1,020
TRA106	82.5" W, Single sided pre-configured unit with nurse server and LSF wardrobe	\$35				\$638	\$816	\$561	\$1,020
TRA107	82.5" W, Single sided pre-configured unit with nurse server and RSF wardrobe	\$35				\$638	\$816	\$561	\$1,020
TRA108	82.5" W, Shared pre-configured unit with shared nurse server and wardrobe	\$35				\$638	\$918	\$561	\$1,020
TRA109	82.5" W, Shared pre-configured unit with shared nurse server and wardrobe	\$35				\$638	\$918	\$561	\$1,020

## Terra Casegoods for Treatment Areas Pre-Configured Units

		Cam lock (OP/10) <sup>1</sup>	Cam lock (OP/10A) <sup>1</sup>	Power and data in the desk <sup>2</sup>	Power in the TV cabinet <sup>3</sup>	Veneer case	Solid surface top <sup>4</sup>	Resin panel (fixed) <sup>5</sup>	Resin panel (adjustable) <sup>5</sup>
<b>Freestanding Models</b>									
TRA50	18" W, Nurse server ganged RSF with 35 quart waste disposal	\$35				\$204	\$510		
TRA51	18" W, Nurse server ganged LSF with 35 quart waste disposal	\$35				\$204	\$510		
TRA52	29" W, Shared nurse server with 35 quart waste disposal	\$35				\$204	\$561		
TRA53	29" W, Shared nurse server with recycling containers	\$35				\$204	\$561		
TRA54	45.5" W, Movable partition					\$204			
TRA56	15" W, Wardrobe ganged RSF with three clothes hooks					\$204	\$306		
TRA57	15" W, Wardrobe ganged LSF with three clothes hook					\$204	\$306		
TRA58	15" W, Shared wardrobe with clothes bar					\$204	\$357		
TRA59	27.75" W, TV cabinet ganged RSF		\$63	\$414	\$253	\$306	\$408		
TRA60	27.75" W, TV cabinet ganged LSF		\$63	\$414	\$253	\$306	\$561		
TRA63	25.75" W, Shared TV cabinet		\$63	\$414	\$475	\$306	\$510		
TRA61	29" W, TV cabinet with desk ganged RSF		\$63	\$414	\$253	\$306	\$561		
TRA62	29" W, TV cabinet with desk ganged LSF		\$63	\$414	\$253	\$306	\$561		
TRA64	29" W, Shared TV cabinet with desk		\$63	\$414	\$475	\$306	\$561		

### Footnotes

<sup>1</sup> For drawers and single doors (OP/10); for two drawers (OP/10A) - see Casegoods Options: Chests, Dressers and Credenzas. Includes two keys per lock and master keys are available for \$6 list.

<sup>2</sup> Located on the back ledge of the desk, includes one outlet, two USB ports and CAT6 data.

<sup>3</sup> Located on the back panel of the TV cabinet and/or behind the lowest pullout self. Once power module is included on single-side models and two are included on shared models.

<sup>4</sup> Available in Bisque (QB), Glacier white (CQ) and Cameo (58) as standard options. Contact your Customer Service Representative for additional colors.

<sup>5</sup> Available in Varia pure white, Hush Gesso or Ion Wheat as standard options. Contact your Customer Service Representative for additional patterns.

For more information see the [Terra Casegoods for Treatment Areas Product Guide](https://www.nemschoff.com) at [nemschoff.com](https://www.nemschoff.com)

## Casegood Options

## Chests, Dressers and Credenzas

		<i>Cam lock (OP/10)<sup>1</sup></i>	<i>Cam lock with elbow catch (OP/10A)<sup>1</sup></i>	<i>Castors (OP/13)<sup>2</sup></i>	<i>Locking casters (OP/13LK)<sup>2</sup></i>	<i>Wood drawer pans<sup>3</sup></i>	<i>Plastic drawer liners (removable)</i>	<i>Veneer case</i>	<i>Solid surface top<sup>4</sup></i>
<b>Bedford</b>									
BFFB03	31.5" W, Chest – three drawer; maple with cherry	\$35					\$81		
BFFB03A	31.5" W, Chest – three drawer; maple	\$35					\$81		
BFFB04	31.5" W, Chest – four drawer; maple with cherry inlay	\$35					\$81		
BFFB04A	31.5" W, Chest – four drawer; maple	\$35					\$81		
BFFC03	25.5" W, Narrow chest – three drawer; maple with cherry inlay	\$35		\$279	\$279		\$67		
BFFC03A	25.5" W, Narrow chest – three drawer; maple	\$35		\$279	\$279		\$67		
<b>Finley</b>									
FX702-3	32" W, Chest – three drawers	\$35		\$115	\$204	\$91	\$81		
FX702-4	32" W, Chest – four drawers	\$35		\$115	\$204	\$91	\$81		
FX702-5	32" W, Chest – five drawers	\$35		\$115		\$91	\$81		
<b>Hadleigh</b>									
HDLB/3	36.75" W, Chest – three drawers	\$35		\$115	\$204		\$81		
HDLB/4	36.75" W, Chest – four drawers	\$35		\$115	\$204		\$81		
HDLB/5	36.75" W, Chest – five drawers	\$35		\$115			\$81		
<b>Prague II</b>									
FX704-3	32" W, Chest – three drawers	\$35		\$115		\$91	\$81		
FX704-4	32" W, Chest – four drawers	\$35		\$115		\$91	\$81		
FX704-5	32" W, Chest – five drawers	\$35				\$91	\$81		
<b>Revive</b>									
REVV-00201	32" W, Chest – three drawers	\$64							
REVV-00202	32" W, Chest – two doors and shelf	\$64							
REVV-00203	32" W, Chest – drawer and shelf	\$64							
REVV-00204	32" W, Chest – one drawer	\$64							
REVV-00205	38.25" W, Chest – three drawers and work surface	\$64							
REVV-00206	38.25" W, Chest – two doors, work surface and inside shelf	\$64							
REVV-00207	38.25" W, Chest – one drawer and work surface	\$64							
REVV-00208	38.25" W, Double chest – six drawers	\$64							
REVV-00209	63.25" W, Chest – three LSF drawers, two doors and shelf	\$64							

Patient Chairs

Recliners

Treatment Chairs

Rockers &amp; Gliders

Overbed Tables

Sleepover Seating

Casegoods

Display &amp; Accessories

## Casegood Options

## Chests, Dressers and Credenzas

		Cam lock (OP/10) <sup>1</sup>	Cam lock with elbow catch (OP/10A) <sup>1</sup>	Casters (OP/13) <sup>2</sup>	Locking casters (OP/13LK) <sup>2</sup>	Wood drawer pans <sup>3</sup>	Plastic drawer liners (removable)	Veneer case	Solid surface top <sup>4</sup>
REVV-00210	63.25" W, Chest – three RSF drawers, two doors and shelf	\$64							
REVV-00211	63.25" W, Chest – four doors and inside shelves	\$64							
<b>Ten</b>									
TENB/03	31" W, Chest – three drawers	\$35		\$115	\$204		\$81		
TENB/04	31" W, Chest – four drawers	\$35		\$115	\$204		\$81		
TENB/05	31" W, Chest – five drawers	\$35					\$81		
<b>Terra</b>									
TRA04	30.75" W, Chest – two doors	\$61						\$419	\$524
TRA05	30.75" W, Chest – one drawer	\$35					\$84	\$419	\$524
TRA06	30.75" W, Chest – three drawers	\$35					\$84	\$419	\$524
TRA07	30.75" W, Narrow chest – two doors		\$63					\$315	\$524
TRA08	42.25" W, Narrow chest – two doors		\$63					\$315	\$681
TRA09	42.25" W, Chest – two doors	\$35						\$524	\$681
TRA10	42.25" W, Chest – one drawer	\$35						\$524	\$681
TRA11	42.25" W, Chest – three drawers	\$35						\$524	\$681
TRA33	61.25" W, Credenza – four doors		\$63					\$419	\$943
TRA34	61.25" W, Narrow credenza – four doors		\$63					\$419	\$943
TRA37	66" W, Chest – two doors and RSF desk		\$63					\$419	\$943
TRA38	66" W, Chest – two doors and LSF desk		\$63					\$419	\$943

## Footnotes

<sup>1</sup> For drawers and single doors (OP/10); for two drawers (OP/10A) - see Casegoods Options: Chests, Dressers and Credenzas. Includes two keys per lock and master keys are available for \$6 list.

<sup>2</sup> Add 2.5" to overall height (except Bedford). Casters can be field installed.

<sup>3</sup> Wood drawers are available on models that include plastic drawer pans as a standard features.

<sup>4</sup> Available in Bisque (QB), Glacier white (CQ) and Cameo (58) as standard. Contact your Customer Service Representative for additional colors.

<sup>5</sup> Available in Varia pure white, Hush Gesso or Ion Wheat as standard options. Contact your Customer Service Representative for additional patterns.

<sup>6</sup> The following types of locks are available on the models listed:

- Cam lock and chain latch: BFFW38, BFF38A, HDLW/38, FX700-38, TFNW/38

- Cam lock with elbow latch: TRA04, TRA07, TRA08, TRA33, TRA34, TRA37, TRA38, TRA59, TRA60, TRA61, TRA62, TRA63, TRA64, BFFT31, BFFT31A, BFFT39, BFFT39A, BFFT55, BFFT55A, BFFT56, BFFT56A, BFFT60, BFFT60A, FX702-38, FX702-43, FX702-44, HDLT/30, HDLT/50, HDLT51, FX700-30, FX704-38, FX704-43, FX704-44, SVNT/30, TENT/38, TENT/43, TENT/44,

- Double cam lock: REVV00301, REVV00302, REVV00303, REVV00304, REVV00403, REVV00404

## Casegood Options

## Armoires, Wardrobes, Wall and Storage Units

		Cam lock (OP/10) <sup>1</sup>	Cam lock and chain latch (OP/10A) <sup>1</sup>	Plastic drawer liners (removable)	Robe hook (OP/6)	Hangers (non-removable) (OP/9)	Pull-out swivel (OP/TVS)	Polycarbonate Mirror (11.5" w x 15.5" h) (OP/1)	Polycarbonate Mirror (13.5" w x 47.5" h) (OP/2)	Continuous hinge (special order) (OP/24)	Veneer case	Solid surface top <sup>2</sup>	Gallery Design
<b>Bedford</b>													
BFFT30	31.5" W, TV armoire – three drawers, no doors; maple with cherry inlay	\$35		\$81									\$123
BFFT30A	31.5" W, TV armoire – three drawers, no doors; maple	\$35		\$81									\$123
BFFT31	31.5" W, TV armoire – pocket doors, three drawers; maple with cherry inlay	\$35	\$63	\$81									\$123
BFFT31A	31.5" W, TV armoire – pocket doors, three drawers; maple	\$35	\$63	\$81									\$123
BFFT39	37.5" W, TV armoire – pocket doors, three drawers; maple with cherry inlay	\$35	\$63										\$123
BFFT39A	37.5" W, TV armoire – pocket doors, three drawers; maple	\$35	\$63										\$123
BFFT55	55" W, TV wardrobe (hinged right) – pocket doors, three drawers; maple with cherry inlay	\$35	\$63		\$5	\$14							\$178
BFFT55A	55" W, TV wardrobe (hinged right) – pocket doors, three drawers; maple	\$35	\$63		\$5	\$14							\$178
BFFT56	55" W, TV wardrobe (hinged left) – pocket doors, three drawers; maple with cherry inlay	\$35	\$63		\$5	\$14							\$178
BFFT56A	55" W, TV wardrobe (hinged left) – pocket doors, three drawers; maple	\$35	\$63		\$5	\$14							\$178
BFFT60	60" W, TV wardrobe – two side wardrobes, pocket doors, three drawers; maple with cherry inlay	\$35	\$63		\$5	\$14							\$178
BFFT60A	60" W, TV wardrobe – two side wardrobes, pocket doors, three drawers; maple	\$35	\$63		\$5	\$14							\$178
BFFW25	25.5" W, Wardrobe (hinged right) – fixed shelf and clothes bar; maple with cherry inlay	\$35			\$5	\$14		\$159	\$267				\$123
BFFW25A	25.5" W, Wardrobe (hinged right) – fixed shelf and clothes bar; maple	\$35			\$5	\$14		\$159	\$267				\$123
BFFW26	25.5" W, Wardrobe (hinged left) – fixed shelf and clothes bar; maple with cherry inlay	\$35			\$5	\$14		\$159	\$267				\$123
BFFW26A	25.5" W, Wardrobe (hinged left) – fixed shelf and clothes bar; maple	\$35			\$5	\$14		\$159	\$267				\$123

Patient Chairs

Recliners

Treatment Chairs

Rockers &amp; Gliders

Overbed Tables

Sleepover Seating

Casegoods

Display &amp; Accessories



## Casegood Options

## Armoires, Wardrobes, Wall and Storage Units

		Cam lock (OP/10) <sup>1</sup>	Cam lock and chain latch (OP/10A) <sup>1</sup>	Plastic drawer liners (removable)	Robe hook (OP/6)	Hangers (non-removable) (OP/9)	Pull-out swivel (OP/TVS)	Polycarbonate Mirror (11.5" w x 15.5" h) (OP/1)	Polycarbonate Mirror (13.5" w x 47.5" h) (OP/2)	Continuous hinge (special order) (OP/24)	Veneer case	Solid surface top <sup>2</sup>	Gallery Design
BFFW38	37.5" W, Wardrobe – two doors, fixed shelf, clothes bar; maple with cherry inlay		\$63		\$5	\$14		\$159	\$267				\$165
BFFW38A	37.5" W, Wardrobe – two doors, fixed shelf, clothes bar; maple		\$63		\$5	\$14		\$159	\$267				\$165
BFFW50	49" W, Wardrobe – two doors and center divider; maple with cherry inlay	\$35			\$5	\$14		\$159	\$267				\$165
BFFW50A	49" W, Wardrobe – two doors and center divider; maple	\$35			\$5	\$14		\$159	\$267				\$165
<b>Finley</b>													
FX702-25	24.5" W, Wardrobe (hinged right)	\$35						\$159	\$267				
FX702-26	24.5" W, Wardrobe (hinged left)	\$35						\$159	\$267				
FX702-39	38" W, Double wardrobe	\$35						\$159	\$267				
FX702-38	38" W, TV Armoire – TV opening: 29W x 22.5D x 26.5H	\$35	\$63										
FX702-43	51.5" W, TV wardrobe (hinged right) – TV opening: 29W x 22.5D x 26.5H	\$35	\$63										
FX702-44	51.5" W, TV wardrobe (hinged left) – TV opening: 29W x 22.5D x 26.5H	\$35	\$63										
<b>Hadleigh</b>													
HDLW/25	32" W, Wardrobe (hinged right)	\$35			\$5	\$14							
HDLW/26	32" W, Wardrobe with (hinged left)	\$35			\$5	\$14							
HDLW/38	44" W, Wardrobe – two doors		\$63		\$5	\$14							
HDLT/30	38.25" W, TV armoire – TV opening: 24.5W x 21.5D x 27H	\$35	\$63	\$81									
HDLT/50	51" W, TV wardrobe (hinged right) – TV opening: 29W x 22.5D x 26.5H	\$35	\$63	\$81	\$5	\$14							
HDLT/51	51" W, TV wardrobe (hinged left) – TV opening: 29W x 22.5D x 26.5H	\$35	\$63	\$81	\$5	\$14							
<b>Montello</b>													
FX700-30	33.5" W, TV armoire – TV opening: 22.75W x 21.5D x 26.5H	\$35	\$63	\$67									
FX700-38	37.5" W, Wardrobe – two doors		\$63		\$5			\$159	\$267				
<b>Prague II</b>													
FX704-25	24.5" W, Wardrobe (hinged right)	\$35			\$5	\$14		\$159	\$267				
FX704-26	24.5" W, Wardrobe with (hinged left)	\$35			\$5	\$14		\$159	\$267				

## Casegood Options

## Wardrobes and Armoires

		Cam lock (OP/10) <sup>1</sup>	Cam lock and chain latch (OP/10A) <sup>2</sup>	Plastic drawer liners (removable)	Robe hook (OP/6)	Hangers (non-removable) (OP/9)	Pull-out swivel (OP/TVS)	Polycarbonate Mirror (11.5" w x 15.5" h) (OP/1)	Polycarbonate Mirror (13.5" w x 47.5" h) (OP/2)	Continuous hinge (special order) (OP/24)	Veneer case	Solid surface top <sup>2</sup>	Gallery Design
FX704-39	38" W, Double wardrobe	\$35			\$5	\$14		\$159	\$267				
FX704-38	38" W, TV armoire – TV opening: 29W x 22.5D x 26.5H	\$35	\$63										
FX704-43	51.5" W, TV wardrobe (hinged right) – TV opening: 29W x 22.5D x 26.5H	\$35	\$63		\$5	\$14							
FX704-44	51.5" W, TV wardrobe (hinged left) – TV opening: 29W x 22.5D x 26.5H	\$35	\$63		\$5	\$14							
<b>Revive</b>													
REVV-00301	32" W, Armoire – two doors, top shelf and three drawers	\$64	\$64										
REVV-00302	38" W, Armoire – two doors, top shelf and three drawers	\$64	\$64										
REVV-00303	43" W, Armoire – two doors, top shelf, three drawers and RSF wardrobe	\$64	\$64										
REVV-00304	43" W, Armoire – two doors, top shelf, three drawers and LSF wardrobe	\$64	\$64										
REVV-00401	24.5" W, Wardrobe (hinged right) – two drawers and clothes bar	\$64											
REVV-00402	24.5" W, Wardrobe (hinged left) – two drawers and clothes bar	\$64											
REVV-00403	32" W, Wardrobe – two doors – two drawers and clothes bar	\$64	\$64										
REVV-00404	38" W, Wardrobe – two doors – two drawers and clothes bar	\$35	\$64										
<b>Ten</b>													
TENW/25	25" W, Wardrobe (hinged right)	\$35			\$5	\$14		\$159	\$267				
TENW/26	25" W, Wardrobe (hinged left)	\$35			\$5	\$14		\$159	\$267				
TENT/43	50" W, TV wardrobe (hinged right) – TV opening: 29W x 22.5D x 26.5H	\$35	\$63		\$5	\$14							
TENT/44	50" W, TV wardrobe (hinged left) – TV opening: 29W x 22.5D x 26.5H	\$35	\$63		\$5	\$14							
TENT/38	37" W, TV Armoire – three lower drawers	\$35	\$63										
TENW/39	37" W, Double wardrobe	\$35	\$63		\$5	\$14		\$159	\$267				

Patient Chairs

Recliners

Treatment Chairs

Rockers &amp; Gliders

Overbed Tables

Sleepover Seating

Casegoods

Display &amp; Accessories

## Casegood Options

## Wardrobes and Armoires

			Cam lock (OP/10) <sup>1</sup>	Cam lock and chain latch (OP/10A) <sup>2</sup>	Plastic drawer liners (removable)	Robe hook (OP/6)	Hangers (non-removable) (OP/9)	Pull-out swivel (OP/TVS)	Polycarbonate Mirror (11.5" w x 15.5" h) (OP/1)	Polycarbonate Mirror (13.5" w x 47.5" h) (OP/2)	Continuous hinge (special order) (OP/24)	Veneer case	Solid surface top <sup>2</sup>	Gallery Design	
<b>Terra</b>															
TRA12, 2 door	37.25" W, Wardrobe – two doors	\$35			\$64							\$315	\$576		
TRA13, 2 dr/2 door	37.25" W, Wardrobe – two doors, two drawers	\$35			\$64							\$315	\$576		
TRA14, 2 door (door offset to left)	37.25" W, Wardrobe – left offset door and regular door	\$35			\$64	\$5	\$14					\$315	\$576		
TRA15, 2 door (door offset to right)	37.25" W, Wardrobe – right offset door and regular door	\$35			\$64	\$5	\$14					\$315	\$576		
TRA16, 2 door narrow Wardrobe	37.25" W, Narrow wardrobe – two doors	\$35			\$64							\$315	\$576		
TRA17, 2 dr/2door narrow Wardrobe	37.25" W, Narrow wardrobe – two doors, two drawers	\$35										\$315	\$576		
TRA18, 1 door (hinged right)	24.5" W, Wardrobe (hinged right)	\$35				\$5	\$14		\$159	\$267		\$210			
TRA19, 1 door (hinged left)	24.5" W, Wardrobe (hinged left)	\$35				\$5	\$14		\$159	\$267		\$210			
TRA20, 1 dr/1 door (hinged right)	24.5" W, Wardrobe – one drawer and one door (hinged right)	\$35				\$5	\$14		\$159	\$267		\$210			
TRA21, 1 dr/1 door (hinged left)	24.5" W, Wardrobe – one drawer and one door (hinged left)	\$35				\$5	\$14		\$159	\$267		\$210			
TRA22, 1 door (hinged right)	18.75" W, Wardrobe (hinged right)	\$35										\$210	\$419		
TRA23, 1 door (hinged left)	18.75" W, Wardrobe (hinged left)	\$35										\$210	\$419		
TRA24, 1 dr/1 door Wardrobe (hinged right)	18.75" W, Wardrobe with one drawer and one door (hinged right)	\$35			\$64							\$210	\$419		
TRA25, 1 dr/1 door Wardrobe (hinged left)	18.75" W, Wardrobe with one drawer and one door (hinged left)	\$35			\$64							\$210	\$419		
TRA26, 1 door narrow (hinged right)	18.75" W, Narrow wardrobe (hinged right)	\$35										\$210	\$419		
TRA27, 1 door narrow (hinged left)	18.75" W, Narrow wardrobe (hinged left)	\$35										\$210	\$419		
TRA31, 4 door Wardrobe	74" W, Wardrobe – four doors	\$35	\$63									\$419	\$1,046		
TRA32, 4 door narrow Wardrobe	74" W, Narrow wardrobe – four doors	\$35	\$63									\$419	\$1,046		

## Casegood Options

## Wardrobes and Armoires

		Cam lock (OP/10) <sup>1</sup>	Cam lock and chain latch (OP/10A) <sup>2</sup>	Plastic drawer liners (removable)	Robe hook (OP/6)	Hangers (non-removable) (OP/9)	Pull-out swivel (OP/TVS)	Polycarbonate Mirror (11.5" w x 15.5" h) (OP/1)	Polycarbonate Mirror (13.5" w x 47.5" h) (OP/2)	Continuous hinge (special order) (OP/24)	Veneer case	Solid surface top <sup>2</sup>	Gallery Design
TRA35, 1 door/Wardrobe (hinged right) w/2 door Desk	87.25" W, Wardrobe (hinged right) with desk with two doors	\$35	\$63		\$5	\$14		\$159	\$267		\$419	\$1,046	
TRA36, 1 door/Wardrobe (hinged left) w/2 door Desk	87.25" W, Wardrobe with door (hinged right) and three drawers	\$35	\$63	\$84	\$5	\$14		\$159	\$267		\$419	\$1,046	

## Footnotes

<sup>1</sup> Includes two keys per lock and master keys are available for \$6 list.

<sup>2</sup> Available in Bisque (QB), Glacier white (CQ) and Cameo (58) as standard. Contact your Customer Service Representative for additional colors.

<sup>3</sup> Wood drawers are available on models that include plastic drawer pans as a standard features.

<sup>4</sup> Available in Bisque (QB), Glacier white (CQ) and Cameo (58) as standard. Contact your Customer Service Representative for additional colors.

<sup>5</sup> Available in Varia pure white, Hush Gesso or Ion Wheat as standard options. Contact your Customer Service Representative for additional patterns.

<sup>6</sup> The following types of locks are available on the models listed:

- Cam lock and chain latch: BFFW38, BFF38A, HDLW/38, FX700-38, TFNW/38
- Cam lock with elbow latch: TRA04, TRA07, TRA08, TRA33, TRA34, TRA37, TRA38, TRA59, TRA60, TRA61, TRA62, TRA63, TRA64, BFFT31, BFFT31A, BFFT39, BFFT39A, BFFT55, BFFT55A, BFFT56, BFFT56A, BFFT60, BFFT60A, FX702-38, FX702-43, FX702-44, HDLT/30, HDLT/50, HDLT51, FX700-30, FX704-38, FX704-43, FX704-44, SVNT/30, TENT/38, TENT/43, TENT/44,
- Double cam lock: REVV00301, REVV00302, REVV00303, REVV00304, REVV00403, REVV00404

Patient Chairs

Recliners

Treatment Chairs

Rockers &amp; Gliders

Overbed Tables

Sleepover Seating

Casegoods

Display &amp; Accessories

# Palisade Coatrack



## Standard Features

- Replaceable components
- Titanium powder-coated metal column and base
- Three wooden pegs (10 lb weight capacity per peg)
- Freestanding design
- Non-marring 2" glides
- Nemschoff healthcare wood finish
- GREENGUARD Gold Certified
- Limited Lifetime Warranty

## Specification Decisions

- Select standard wood finish
- Add wood base

## Coordinating Products

- [Palisade Casegoods](#)
- [Palisade Flop Sofa](#)
- [Palisade Stools](#)
- [Palisade Tables](#)

## More Information

Illustrated Glossary ▶ 409

Finishes ▶ 426

Ordering and Warranties ▶ 429

## Available Options

- Wood base + \$164

Coatrack ships unassembled from the base

		<b>Palisade Coatrack</b>				20 lbs
		Model	Price	Width	Depth	Height
		<b>867-08</b>	\$857	17.25"	17.25"	71.5"

# Revive Display System



## More Information

Illustrated Glossary ▶ 409

Finishes ▶ 426

Ordering and Warranties ▶ 429

## Standard Features

- Powder-coated finish on the rail with wood or laminated center strip
- Integrated card and photo display groove
- Protective bumpers
- End caps to secure accessories
- Wall cleats for rail-to-wall attachment
- Display systems include three hooks, 11" display shelf, magazine holder and two adjustable brackets
- Nemschoff healthcare wood finish
- GREENGUARD Gold Certified
- Limited Lifetime Warranty

## Available Options

- Tack surface for center strip
- **OU** Light Sand      **OS** Dark Sand
- **6K** Dark Grey      **7K** Light Grey
- 48" Tack surface + \$34
- 72" Tack surface + \$47
- 11" Display rail shelf (SH/11) + \$223
- 17" Display rail shelf (SH/17) + \$263
- Magazine holder (MH) + \$258
- Small marker board (MBS) + \$338
- Large marker board (MBL) + \$386
- Adjustable universal bracket (UB) + \$48
- Hook (H) + \$48

## Specification Decisions

- Select powder coat finish
- Select wood or laminate for the center strip finish
- Add tack surface for center strip
- Select tack surface finish
- Add 11" or 17" display rail shelf
- Add magazine holder
- Add small or large marker board
- Add adjustable universal brackets
- Add hooks

## Coordinating Products

- [Revive Side Chair](#)
- [Revive Patient Chair](#)
- [Revive Casegoods](#)
- [Revive Daystands](#)

	<b>48" Display system - includes hooks, display shelf, magazine holder &amp; brackets</b>			18 lbs
	Model	Price		
	<b>RVR/48-PKG-1</b>	\$1,475		
	<b>72" Display system - includes hooks, display shelf, magazine holder &amp; brackets</b>			20 lbs
	Model	Price		
	<b>RVR/72-PKG-1</b>	\$1,518		
	<b>Display system rails</b>			5 lbs
	Model	Price	Width	
	<b>RVR/48</b>	\$138	48"	
	<b>RVR/72</b>	\$180	72"	

## Specialty

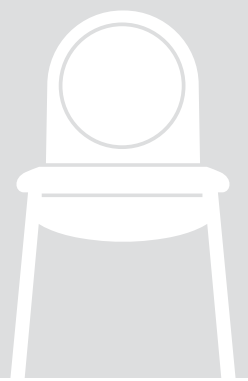

## Erica Junior Children's Furniture



### More Information

Illustrated Glossary ▶ 409

Fabrics ▶ 421

Flammability (CTB-133) ▶ 429

Standard wood and laminate finishes ▶ 426

Ordering and Warranties ▶ 432

### Standard Features

- Solid maple frame
- Mortise and tenon joinery
- Laminated top and standard black edge on the table
- Non-marring  $\frac{7}{8}$ " rubber-cushioned glides
- Nemschoff healthcare wood finish
- GREENGUARD Gold Certified
- Limited Lifetime Warranty

### Available Options

- CTB-133 + \$83/yd
- Moisture barrier + \$69 per seat or back
- E-wood edge (table) + \$933

### Specification Decisions

- Select fabric
  - Selecte laminate (tabletop)
  - Select standard wood finish or children's furniture finish
- A** Tangerine    **B** Black    **E** Lime  
**G** Grape    **H** Blueberry    **R** Cherry  
**Y** Lemon
- Add CTB-133
  - Add E-wood edge
  - Add moisture barrier

### Flammability Type

- Type 1

### Key Dimensions

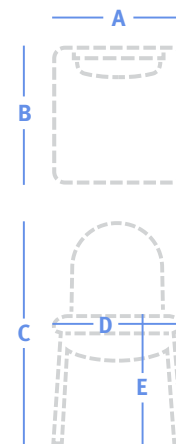

<b>A</b>	Overall Width	See price table
<b>B</b>	Overall Depth	15"
<b>C</b>	Overall Height	24"
<b>D</b>	Seat Width	13.25"
<b>E</b>	Seat Height	13.5"



#### 14.5" W, Junior side chair

14 lbs | 0.75 yds

Model	Series 2	Series 3	Series 4	Series 5	Series 6	Series 7	Series 8	COM
<b>JR/286</b>	\$615	\$639	\$680	\$722	\$773	\$824	\$887	\$639



#### 36" dia., Junior table

31 lbs

Model	Price	Height
<b>JR/286-5</b>	\$708	21.75"



## Junior 200 Children's Furniture



### Standard Features

- Solid maple frame
- Non-marring 7/8" rubber-cushioned glides
- Casters on toy box
- Laminated top with vinyl edge on table
- Nemschoff healthcare wood finish
- GREENGUARD Gold Certified
- Limited Lifetime Warranty

### Available Options

- E-wood edge (table) + \$933

### Specification Decisions

- Select fabric
- Select standard wood finish or standard children's furniture finish

- |                    |                    |                 |
|--------------------|--------------------|-----------------|
| <b>A</b> Tangerine | <b>B</b> Black     | <b>E</b> Lime   |
| <b>G</b> Grape     | <b>H</b> Blueberry | <b>R</b> Cherry |
| <b>Y</b> Lemon     |                    |                 |

- Select standard laminate, if required
- Add moisture barrier
- Add CTB-133
- Add E-wood edge

### Flammability Type

- Type 1

### Coordinating Products

- [Junior Recliner](#)[Recliner](#)

### Key Dimensions

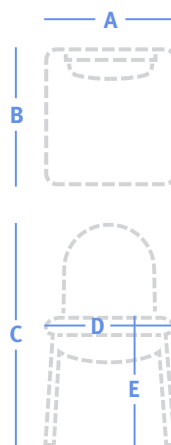

<b>A</b>	Overall Width	See price table
<b>B</b>	Overall Depth	15"
<b>C</b>	Overall Height	24"
<b>D</b>	Seat Width	14"
<b>E</b>	Seat Height	13.5"

#### More Information

Illustrated Glossary ▶ 409

Fabrics ▶ 421

Flammability (CTB-133) ▶ 429

Standard Wood and Laminate Finishes ▶ 426

Ordering and Warranties ▶ 432



#### 14.5" W, Junior side chair

14 lbs | 0.75 yds

Model	Series 2	Series 3	Series 4	Series 5	Series 6	Series 7	Series 8	COM
<b>JR/200</b>	\$615	\$639	\$680	\$722	\$773	\$824	\$887	\$639



#### 18" W, Toy box with casters

24 lbs

Model	Price	Depth	Height
<b>JR/200 TB</b>	\$551	18"	14.5"



#### 36" dia., Junior table

31 lbs

Model	Price	Height
<b>JR/200-5</b>	\$708	21.75"

## Junior Recliner



### More Information

Illustrated Glossary ▶ 409

Fabrics ▶ 421

Flammability (CTB-133) ▶ 429

Finishes ▶ 426

Ordering and Warranties ▶ 432

### Standard Features

- Solid maple frame
- Spring seat construction
- Replaceable components
- Upholstered arm caps
- Three seated positions
- Push bar with black textured powder-coated finish
- Adjustable footrest
- Field-adjustable recliner mechanism tension
- Wallsaver edge
- Must be 6" from wall to fully recline
- Four 75-mm black casters, rear with brakes
- GREENGUARD Gold Certified
- Limited Lifetime Warranty

### Available Options

- Moisture barrier + \$69 per seat or back
- Grey foam headrest + \$323
- Folding side table (LSF, RSF) + \$315
- Adjustable tray table (LSF only) + \$716
- Caster upgrade kit; factory install - 3" twin-wheel, swivel casters with brakes + \$188
- Caster upgrade kit; field install - 3" twin-wheel, swivel casters with brakes + \$422
- CTB-133 + \$83/yd

### Specification Decisions

- Select fabric
- Select standard laminate, if required
- Add moisture barrier
- Add CTB-133
- Add headrest
- Add folding side table
- Add adjustable tray table
- Add caster upgrade (factory-installed)
- Add caster upgrade (field-installed)

### Flammability Type

- Type 6

### Coordinating Products

- [Junior 200 Children's Furniture](#)

### Key Dimensions

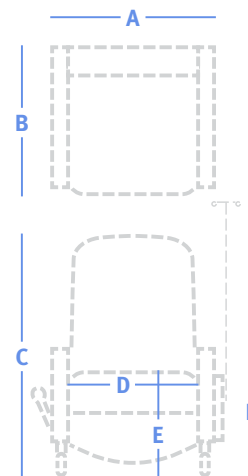

<b>A</b>	Overall Width	See price table
<b>B</b>	Overall Depth	36-63 1/2"
<b>C</b>	Overall Height	42"
<b>D</b>	Seat Width	15.75"
<b>E</b>	Seat Height	19.5"
<b>F</b>	Arm Height	24.5"



### 22.5" W, Junior recliner

138 lbs | 6 yds

Model	Series 2	Series 3	Series 4	Series 5	Series 6	Series 7	Series 8	COM
<b>PRJR12</b>	\$5,047	\$5,242	\$5,566	\$5,905	\$6,308	\$6,715	\$7,224	\$5,242

# Behavioral Health Casegoods



## Standard Features

- Laminate case with matching HPVC edge
- Maple veneer case with solid maple shelves, doors and bottoms
- Dry construction joinery
- Replaceable components
- Tamper-resistant fasteners
- Non-removable wood drawers with metal guides
- Reinforced shelves, fixed in place
- Integral drawer pulls
- Nemschoff healthcare wood finish
- GREENGUARD Gold Certified
- Limited Lifetime Warranty

## Available Options

- Three edge styles

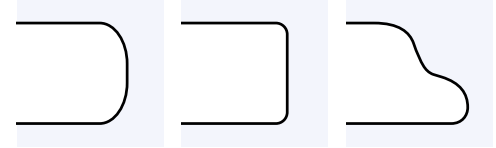

Rounded (standard)      1/8" radius      Double round

For specific options, see the appropriate product section on the following pages.

## Coordinating Products

- [High Use Behavioral Health Seating](#)
- [Marsack III Behavioral Health Seating](#)
- [Meridian Behavioral Health Seating](#)

### More Information

- Illustrated Glossary ▶ 409
- Finishes ▶ 426
- Hardware ▶ 427
- Ordering and Warranties ▶ 432

# Behavioral Health Bedside Cabinets and Nightstands

## Standard Features

- Same standard features as Behavioral Health Casegoods, plus:
- Vented back panel

## Available Options

- See [page 398](#) for additional options

## Specification Decisions

- Select standard laminate or wood finish
- Select edge detail
- See [page 398](#) for additional options

Icon	Product Name	Weight
	<b>19.25" W, Bedside cabinet - three shelves; laminate</b>	55 lbs
	Model: <b>BHBA/00M</b> Price: \$921      Depth: 19.5"      Height: 29.75"	
	<b>19.25" W, Bedside cabinet - three shelves; wood</b>	55 lbs
	Model: <b>BHBA/00W</b> Price: \$991      Depth: 19.5"      Height: 29.75"	
	<b>19.25" W, Bedside cabinet - three drawers; laminate</b>	61 lbs
	Model: <b>BHBA/03M</b> Price: \$1,082      Depth: 19.5"      Height: 29.75"	
	<b>19.25" W, Bedside cabinet - three drawers; wood</b>	61 lbs
	Model: <b>BHBA/03W</b> Price: \$1,159      Depth: 19.5"      Height: 29.75"	
	<b>19.25" W, Nightstand - one drawer; laminate</b>	45 lbs
	Model: <b>BHBG/01M</b> Price: \$881      Depth: 19.5"      Height: 21.25"	

## Behavioral Health Casegoods

	<b>19.25" W, Nightstand - one drawer; wood</b>				45 lbs
	Model	Price	Depth	Height	
	<b>BHBG/01W</b>	\$950	19.5"	21.25"	
	<b>19.25" W, Nightstand - two shelves; laminate</b>				42 lbs
	Model	Price	Depth	Height	
	<b>BHBG/00M</b>	\$541	19.5"	21.25"	
	<b>19.25" W, Nightstand - two shelves; wood</b>				42 lbs
	Model	Price	Depth	Height	
	<b>BHBG/00W</b>	\$610	19.5"	21.25"	

## Behavioral Health Chests

**Standard Features**

Same standard features as Behavioral Health Casegoods



**Available Options**

Same edges options as Behavioral Health Casegoods

- See [page 398](#) for additional options

**Specification Decisions**

- Select standard laminate or wood finish
- Select edge detail
- See [page 398](#) for additional options

	<b>31.25" W, Chest - three shelves; laminate</b>				84 lbs
	Model	Price	Depth	Height	
	<b>BHBC/01M</b>	\$769	19.5"	29.75"	
	<b>31.25" W, Chest - three shelves; wood</b>				84 lbs
	Model	Price	Depth	Height	
	<b>BHBC/01W</b>	\$904	19.5"	29.75"	
	<b>31.25" W, Chest - four shelves; laminate</b>				104 lbs
	Model	Price	Depth	Height	
	<b>BHBC/02M</b>	\$1,040	19.5"	38.25"	
	<b>31.25" W, Chest - four shelves; wood</b>				104 lbs
	Model	Price	Depth	Height	
	<b>BHBC/02W</b>	\$1,196	19.5"	38.25"	
	<b>31.25" W, Chest - three drawers; laminate</b>				95 lbs
	Model	Price	Depth	Height	
	<b>BHBC/03M</b>	\$1,374	19.5"	29.75"	

## Behavioral Health Casegoods



### 31.25" W, Chest - three drawers; wood

95 lbs

Model	Price	Depth	Height
<b>BHBC/03W</b>	\$1,403	19.5"	29.75"



### 31.25" W, Chest - four drawers; laminate

120 lbs

Model	Price	Depth	Height
<b>BHBC/04M</b>	\$1,581	19.5"	38.25"



### 31.25" W, Chest - four drawers; wood

120 lbs

Model	Price	Depth	Height
<b>BHBC/04W</b>	\$1,613	19.5"	38.25"

## Behavioral Health Wardrobes

### Standard Features

- Same standard features as Behavioral Health Casegoods, plus:
- Continuous hinges on doors
  - Sloped tops

### Available Options

- Same edges options as Behavioral Health Casegoods, plus:
- Flat top + \$0
  - See [page 398](#) for additional options

### Specification Decisions

- Select standard laminate or wood finish
- Select edge detail
- Add flat top
- See [page 398](#) for additional options



### 24.5" W, Wardrobe - one shelf, J-bar and two drawers; laminate

173 lbs

Model	Price	Depth	Height
<b>BHBW/20M</b>	\$897	22.5"	84.5"



### 24.5" W, Wardrobe - one shelf, J-bar and two drawers; wood

173 lbs

Model	Price	Depth	Height
<b>BHBW/20W</b>	\$1,133	22.5"	84.5"



### 24.5" W, Wardrobe - five shelves; laminate

191 lbs

Model	Price	Depth	Height
<b>BHBW/21M</b>	\$987	22.5"	84.5"



### 24.5" W, Wardrobe - five shelves; wood

191 lbs

Model	Price	Depth	Height
<b>BHBW/21W</b>	\$1,245	22.5"	84.5"













### 24.5" W, Wardrobe - right hinged door, one shelf, J-bar and two drawers; laminate

271 lbs

Model	Price	Depth	Height
<b>BHBW/23M</b>	\$1,610	23.75"	84.5"

## Behavioral Health Casegoods

	<b>24.5" W, Wardrobe - right hinged door, one shelf, J-bar and two drawers; wood</b> 271 lbs		
Model	Price	Depth	Height
<b>BHBW/23W</b>	\$2,036	23.75"	84.5"
	<b>24.5" W, Wardrobe - left hinged door, one shelf, J-bar and two drawers; laminate</b> 271 lbs		
Model	Price	Depth	Height
<b>BHBW/24M</b>	\$1,610	23.75"	84.5"
	<b>24.5" W, Wardrobe - left hinged door, one shelf, J-bar and two drawers; wood</b> 271 lbs		
Model	Price	Depth	Height
<b>BHBW/24W</b>	\$2,036	23.75"	84.5"
	<b>24.5" W, Wardrobe - right hinged door and five shelves; laminate</b> 239 lbs		
Model	Price	Depth	Height
<b>BHBW/25M</b>	\$1,784	23.75"	84.5"
	<b>24.5" W, Wardrobe - right hinged door and five shelves; wood</b> 239 lbs		
Model	Price	Depth	Height
<b>BHBW/25W</b>	\$2,210	23.75"	84.5"
	<b>24.5" W, Wardrobe - left hinged door and five shelves; laminate</b> 239 lbs		
Model	Price	Depth	Height
<b>BHBW/26M</b>	\$1,784	23.75"	84.5"
	<b>24.5" W, Wardrobe - left hinged door and five shelves; wood</b> 239 lbs		
Model	Price	Depth	Height
<b>BHBW/26W</b>	\$2,210	23.75"	84.5"
	<b>39.25" W, Double wardrobe - center divide, one shelf, J-bar and two drawers; laminate</b> 204 lbs		
Model	Price	Depth	Height
<b>BHBW/30M</b>	\$1,121	22.5"	84.5"
	<b>39.25" W, Double wardrobe - center divide, one shelf, J-bar and two drawers; wood</b> 204 lbs		
Model	Price	Depth	Height
<b>BHBW/30W</b>	\$1,415	22.5"	84.5"
	<b>39.25" W, Double wardrobe - five shelves and center divide; laminate</b> 251 lbs		
Model	Price	Depth	Height
<b>BHBW/31M</b>	\$1,235	22.5"	84.5"

## Behavioral Health Casegoods

	<b>39.25" W, Double wardrobe - five shelves and center divide; wood</b> <span style="float: right;">251 lbs</span>			
	Model	Price	Depth	Height
	<b>BHBW/31W</b>	\$1,557	22.5"	84.5"
	<b>39.25" W, Double wardrobe - two doors, center divide, one shelf, J-bar and two drawers; laminate</b> <span style="float: right;">414 lbs</span>			
	Model	Price	Depth	Height
	<b>BHBW/39M</b>	\$2,013	23.75"	84.5"
	<b>39.25" W, Double wardrobe - two doors, center divide, one shelf, J-bar and two drawers; wood</b> <span style="float: right;">414 lbs</span>			
	Model	Price	Depth	Height
	<b>BHBW/39W</b>	\$2,543	23.75"	84.5"
	<b>39.25" W, Double wardrobe - two doors, five shelves, and center divide; laminate</b> <span style="float: right;">331 lbs</span>			
	Model	Price	Depth	Height
	<b>BHBW/40M</b>	\$2,230	23.75"	84.5"
	<b>39.25" W, Double wardrobe - two doors, five shelves, and center divide; wood</b> <span style="float: right;">331 lbs</span>			
	Model	Price	Depth	Height
	<b>BHBW/40W</b>	\$2,763	23.75"	84.5"

## Behavioral Health Desks

### Standard Features

Same standard features as Behavioral Health Casegoods, plus:

- Wood-encased steel foot stretcher

### Available Options

Same edges options as Behavioral Health Casegoods, plus:











- Pencil drawer + \$57
- OP/41 Cam fasteners (required to attach hutch to desk) + \$53
- Hutch (requires cam fastener to attach to desk)
- See [page 398](#) for additional options

### Specification Decisions

- Select standard laminate or wood finish
- Select edge detail
- Add pencil drawer
- Add hutch and cam fastener
- See [page 398](#) for additional options

	<b>36" W, Writing table; laminate</b> <span style="float: right;">62 lbs</span>			
	Model	Price	Depth	Height
	<b>BHBD/40M</b>	\$702	24.5"	29.75"
	<b>36" W, Writing table; wood</b> <span style="float: right;">62 lbs</span>			
	Model	Price	Depth	Height
	<b>BHBD/40W</b>	\$826	24.5"	29.75"

## Behavioral Health Casegoods

	<b>44.5" W, Desk - three RSF shelves; laminate</b>				105 lbs
	Model	Price	Depth	Height	
	<b>BHBD/42M</b>	\$953	24.5"	29.75"	
	<b>44.5" W, Desk - three RSF shelves; wood</b>				105 lbs
	Model	Price	Depth	Height	
	<b>BHBD/42W</b>	\$1,097	24.5"	29.75"	
	<b>44.5" W, Desk - three LSF shelves; laminate</b>				105 lbs
	Model	Price	Depth	Height	
	<b>BHBD/43M</b>	\$953	24.5"	29.75"	
	<b>44.5" W, Desk - three LSF shelves; wood</b>				105 lbs
	Model	Price	Depth	Height	
	<b>BHBD/43W</b>	\$1,097	24.5"	29.75"	
	<b>44.5" W, Desk - three RSF drawers; laminate</b>				115 lbs
	Model	Price	Depth	Height	
	<b>BHBD/44M</b>	\$1,418	24.5"	29.75"	
	<b>44.5" W, Desk - three RSF drawers; wood</b>				115 lbs
	Model	Price	Depth	Height	
	<b>BHBD/44W</b>	\$1,770	24.5"	29.75"	
	<b>44.5" W, Desk - three LSF drawers; laminate</b>				115 lbs
	Model	Price	Depth	Height	
	<b>BHBD/45M</b>	\$1,418	24.5"	29.75"	
	<b>44.5" W, Desk - three LSF drawers; wood</b>				115 lbs
	Model	Price	Depth	Height	
	<b>BHBD/45W</b>	\$1,770	24.5"	29.75"	
	<b>36" W, Hutch; laminate</b>				
	Model	Price	Depth	Height	
	<b>BHBH/40M</b>	\$371	9.5"	29"	
	<b>36" W, Hutch; wood</b>				
	Model	Price	Depth	Height	
	<b>BHBH/40W</b>	\$491-	9.5"	29"	



## Behavioral Health Casegoods



### 44.5" W, Hutch; laminate

Model	Price	Depth	Height
<b>BHBH/45M</b>	\$436	9.5"	29.5"



### 44.5" W, Hutch; wood

Model	Price	Depth	Height
<b>BHBH/45W</b>		9.5"	29.5"

## Behavioral Health Beds

### Standard Features

Same standard features as Behavioral Health Casegoods, plus:

- Steel core for added weight and structure includes floor mount attachment (BHHD/68W only)

### Available Options

Same edges options as Behavioral Health Casegoods, plus:

- One drawer on left, right, or end with metal guides + \$142
- Two wood drawers on left or right side + \$225
- Security hold points (includes four) + \$70
- Laminate headboard + \$225
- Wood headboard + \$275
- Two upholstered seat cushions (see price table)
- Two upholstered bolster cushions (see price table)
- See [page 398](#) for additional options

### Specification Decisions

- Select standard laminate or wood finish
- Select edge detail
- Add drawers
- Add security hold points
- Add headboard
- Add upholstered seat cushion and/or bolster
- See [page 398](#) for additional options

### Flammability Type

- Type 7 (cushion)



### 37.5" W, Platform bed; laminate (40"W with security hold points)

163 lbs

Model	Price	Depth	Height
<b>BHBP/68M</b>	\$1,488	84.5"	24.5"



### 37.5" W, Platform bed; wood (40"W with security hold points)

163 lbs

Model	Price	Depth	Height
<b>BHBP/68W</b>	\$1,765	84.5"	24.5"



### 37.5" W, Heavy duty platform bed; wood (40"W with security hold points)

201 lbs

Model	Price	Depth	Height
<b>BHHD/68W</b>	\$2,033	84.5"	24.5"

## Behavioral Health Casegoods

Children's Furniture

Behavioral Health

Caregiver Stools

### 36" W, Upholstered seat cushions for behavioral health beds 6.5 yds

Model	Series 2	Series 3	Series 4	Series 5	Series 6	Series 7	Series 8	COM
<b>BH Upholstered seat cushion</b>	\$1,235	\$1,447	\$1,798	\$2,165	\$2,602	\$3,042	\$3,594	\$1,447

### 33" W, Upholstered bolster cushions for behavioral health beds 3.5 yds

Model	Series 2	Series 3	Series 4	Series 5	Series 6	Series 7	Series 8	COM
<b>BH Upholstered bolster cushion</b>	\$893	\$1,007	\$1,196	\$1,394	\$1,629	\$1,866	\$2,163	\$1,007

# Behavioral Health Casegoods

## Casegood Options

		Cam lock (OP/10) <sup>1</sup>	Wood drawer guides <sup>2</sup>	Plastic drawer liners (non-removable) <sup>3</sup>	Wall-mount attachment <sup>4</sup>	Floor-mount attachment <sup>4</sup>	Floor-free attachment <sup>4</sup>	Wall and floor-mount attachment <sup>4</sup>
BHBG/01M	19.25" W, Nightstand - one drawer; laminate	\$35	\$209	\$51	\$72		\$210	
BHBG/01W	19.25" W, Nightstand - one drawer; wood	\$35	\$209	\$51	\$72		\$210	
BHBG/00M	19.25" W, Nightstand - two shelves; laminate				\$72		\$210	
BHBG/00W	19.25" W, Nightstand - two shelves; wood				\$72		\$210	
BHBA/00M	19.25" W, Bedside cabinet - three shelves; laminate				\$72		\$210	
BHBA/00W	19.25" W, Bedside cabinet - three shelves; wood				\$72		\$210	
BHBA/03M	19.25" W, Bedside cabinet - three drawers; laminate	\$35	\$209	\$51	\$72		\$210	
BHBA/03W	19.25" W, Bedside cabinet - three drawers; laminate	\$35	\$209	\$51	\$72		\$210	
BHBC/01M	31.25" W, Chest - three shelves; laminate				\$72		\$210	
BHBC/01W	31.25" W, Chest - three shelves; wood				\$72		\$210	
BHBC/02M	31.25" W, Chest - four shelves; laminate				\$72		\$210	
BHBC/02W	31.25" W, Chest - four shelves; wood				\$72		\$210	
BHBC/03M	31.25" W, Chest - three drawers; laminate	\$35	\$209	\$75	\$72		\$210	
BHBC/03W	31.25" W, Chest - three drawers; wood	\$35	\$209	\$75	\$72		\$210	
BHBC/04M	31.25" W, Laminate chest with four drawers	\$35	\$209	\$75	\$72		\$210	
BHBC/04W	31.25" W, Wood chest with four drawers	\$35	\$209	\$75	\$72		\$210	
BHBW/20M	24.5" W, Wardrobe - one shelf, J-bar and two drawers; laminate	\$35	\$209		\$72		\$210	
BHBW/20W	24.5" W, Wardrobe - one shelf, J-bar and two drawers; wood	\$35	\$209		\$72		\$210	
BHBW/21M	24.5" W, Wardrobe - five shelves; laminate				\$72		\$210	
BHBW/21W	24.5" W, Wardrobe - five shelves; wood				\$72		\$210	
BHBW/23M	24.5" W, Wardrobe - right hinged door, one shelf, J-bar and two drawers; laminate	\$35	\$209	\$51	\$72		\$210	
BHBW/23W	24.5" W, Wardrobe - right hinged door, one shelf, J-bar and two drawers; wood	\$35	\$209	\$51	\$72		\$210	
BHBW/24M	24.5" W, Wardrobe - left hinged door, one shelf, J-bar and two drawers; laminate	\$35	\$209	\$51	\$72		\$210	
BHBW/24W	24.5" W, Wardrobe - left hinged door, one shelf, J-bar and two drawers; wood	\$35	\$209	\$51	\$72		\$210	
BHBW/25M	24.5" W, Wardrobe - right hinged door and five shelves; laminate	\$35			\$72		\$210	
BHBW/25W	24.5" W, Wardrobe - right hinged door and five shelves; wood	\$35			\$72		\$210	
BHBW/26M	24.5" W, Wardrobe - left hinged door and five shelves; laminate	\$35			\$72		\$210	

## Behavioral Health Casegoods

		Cam lock (OP/10) <sup>1</sup>	Wood drawer guides <sup>2</sup>	Plastic drawer liners (non-removable) <sup>3</sup>	Wall-mount attachment <sup>4</sup>	Floor-mount attachment <sup>4</sup>	Floor-free attachment <sup>4</sup>	Wall and floor-mount attachment <sup>4</sup>
BHBW/26W	24.5" W, Wardrobe - left hinged door and five shelves; wood	\$35			\$72		\$210	
BHBW/30M	39.25" W, Double wardrobe - center divide, one shelf, J-bar and two drawers; laminate		\$209	\$51	\$72		\$210	
BHBW/30W	39.25" W, Double wardrobe - center divide, one shelf, J-bar and two drawers; wood		\$209	\$51	\$72		\$210	
BHBW/31M	39.25" W, Double wardrobe - five shelves and center divide; laminate				\$72		\$210	
BHBW/31W	39.25" W, Double wardrobe - five shelves and center divide; wood				\$72		\$210	
BHBW/39M	39.25" W, Double wardrobe - two doors, center divide, one shelf, J-bar and two drawers; laminate	\$35	\$209	\$51	\$72		\$210	
BHBW/39W	39.25" W, Double wardrobe - two doors, center divide, one shelf, J-bar and two drawers; wood	\$35	\$209	\$51	\$72		\$210	
BHBW/40M	39.25" W, Double wardrobe - two doors, five shelves, and center divide; laminate	\$35			\$72		\$210	
BHBW/40W	39.25" W, Double wardrobe - two doors, five shelves, and center divide; wood	\$35			\$72		\$210	
BHBD/40M	36" W, Writing table; laminate							\$210
BHBD/40W	36" W, Writing table; wood							\$210
BHBD/42M	44.5" W, Desk - three RSF shelves; laminate							\$210
BHBD/42W	44.5" W, Desk - three RSF shelves; wood							\$210
BHBD/43M	44.5" W, Desk - three LSF shelves; laminate							\$210
BHBD/43W	44.5" W, Desk - three LSF shelves; wood							\$210
BHBD/44M	44.5" W, Desk - three RSF drawers; laminate	\$35	\$209	\$51				\$210
BHBD/44W	44.5" W, Desk - three RSF drawers; wood	\$35	\$209	\$51				\$210
BHBD/45M	44.5" W, Desk - three LSF drawers; laminate	\$35	\$209	\$51				\$210
BHBD/45W	44.5" W, Desk - three LSF drawers; wood	\$35	\$209	\$51				\$210
BHBP/68M	37.5" W, Platform bed; laminate	\$35	\$209	\$51		\$210		
BHBP/68W	37.5" W, Platform bed; wood	\$35	\$209	\$51		\$210		
BHHD/68W	37.5" W, Heavy duty platform bed; wood	\$35	\$209	\$51		STANDARD		

## Footnotes

<sup>1</sup> For drawers and single doors. Includes two keys per lock and master keys are available for \$6 list

<sup>2</sup> Wood drawer guides replace the standard metal drawer guides

<sup>3</sup> Plastic drawer liners are not available with wood drawer guides

<sup>4</sup> See **Mounting** in the Illustrated Glossary (page 412)

# High Use Behavioral Health Seating



## Standard Features

- Solid maple frame
- Mortise and tenon joinery
- Enclosed underside
- Wipe-out design
- Tamper resistant glides
- Nemschoff healthcare wood finish
- GREENGUARD Gold Certified
- Limited Lifetime Warranty

## Available Options

- Moisture barrier + \$69 per seat or back
- Two fabrics + \$64

## Specification Decisions

- Select fabric
- Select standard wood finish
- Add moisture barrier
- Add CTB-133
- Apply multiple fabrics

## Flammability Type

- Type 1

## Coordinating Products

- [Behavioral Health Casegoods](#)
- [Marsack III Behavioral Health Seating](#)
- [Meridian Behavioral Health Seating](#)

## Key Dimensions

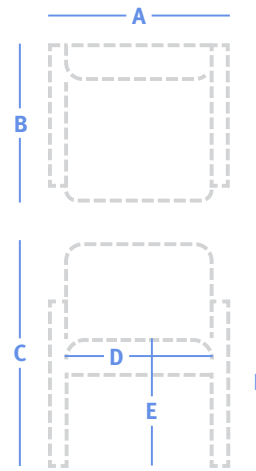

<b>A</b>	Overall Width	See price table
<b>B</b>	Overall Depth	23"
<b>C</b>	Overall Height	31"
<b>D</b>	Seat Width	18.5"
<b>E</b>	Seat Height	18"
<b>F</b>	Arm Height	25"

### More Information

- Illustrated Glossary ▶ 409
- Fabrics ▶ 421
- Flammability (CTB-133) ▶ 429
- Finishes ▶ 426
- Ordering and Warranties ▶ 432



### 22.5" W, Side chair with heavy duty sled base

20 lbs | 1.25 yds

Model	Series 2	Series 3	Series 4	Series 5	Series 6	Series 7	Series 8	COM
<b>360-91BH</b>	\$683	\$723	\$791	\$862	\$945	\$1,030	\$1,136	\$723



### 22.5" W, Side chair with arms and heavy duty sled base

24 lbs | 1.25 yds

Model	Series 2	Series 3	Series 4	Series 5	Series 6	Series 7	Series 8	COM
<b>360-90BH</b>	\$735	\$775	\$843	\$914	\$997	\$1,082	\$1,188	\$775

# Marsack III Behavioral Health Seating



## More Information

Illustrated Glossary ▶ 409

Fabrics ▶ 421

Flammability (CTB-133) ▶ 429

Finishes ▶ 426

Ordering and Warranties ▶ 432

## Standard Features

- Mortise and tenon joinery
- Replaceable components
- Wipe-out design
- Ultra-heavy
- Laminate-wrapped side panels
- Secured black urethane arm caps
- Enclosed underside
- Tamper-resistant glides
- Nemschoff healthcare wood finish
- GREENGUARD Gold Certified
- Limited Lifetime Warranty

## Available Options

- Moisture barrier + \$69 per seat or back
- Wood arm caps + \$116
- Floor mount + \$182
- CTB-133 + \$83
- Two fabrics + \$64
- Three (or more) fabrics + \$90

## Specification Decisions

- Select fabric
- Select standard laminate
- Add wood arm caps
- Select standard wood finish, if required
- Add moisture barrier
- Add CTB-133
- Apply multiple fabrics

## Flammability Type

- Type 4

## Coordinating Products

- [Marsack Lounge Seating](#)
- [Marsack Tables](#)
- [Behavioral Health Caseworks](#)
- [High Use Behavioral Health Seating](#)
- [Meridian Behavioral Health Seating](#)

## Key Dimensions

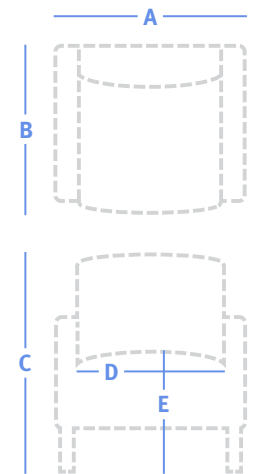

<b>A</b>	Overall Width	See price table
<b>B</b>	Overall Depth	29.5"
<b>C</b>	Overall Height	32.5"
<b>D</b>	Seat Width	
	Chair:	23"
	Two Seat:	46"
	Three Seat:	69"
<b>E</b>	Seat Height	18.75"
<b>F</b>	Arm Height	24.5"

## Marsack III Behavioral Health Seating



### 29" W, Chair

106 lbs | 3 yds

Model	Series 2	Series 3	Series 4	Series 5	Series 6	Series 7	Series 8	COM
<b>703-10BH</b>	\$2,383	\$2,464	\$2,599	\$2,741	\$2,908	\$3,078	\$3,290	\$2,464



### 49.5" W, Two seat

137 lbs | 5 yds

Model	Series 2	Series 3	Series 4	Series 5	Series 6	Series 7	Series 8	COM
<b>703-20BH</b>	\$2,716	\$2,862	\$3,105	\$3,359	\$3,661	\$3,967	\$4,348	\$2,862



### 52.25" W, Two seat with divider arm

155 lbs | 5 yds

Model	Series 2	Series 3	Series 4	Series 5	Series 6	Series 7	Series 8	COM
<b>703-25BH</b>	\$4,256	\$4,402	\$4,645	\$4,899	\$5,201	\$5,507	\$5,888	\$4,402



### 70.5" W, Three seat

181 lbs | 7 yds

Model	Series 2	Series 3	Series 4	Series 5	Series 6	Series 7	Series 8	COM
<b>703-30BH</b>	\$4,883	\$5,103	\$5,468	\$5,849	\$6,302	\$6,760	\$7,332	\$5,103



### 76.5" W, Three seat with divider arms

217 lbs | 7 yds

Model	Series 2	Series 3	Series 4	Series 5	Series 6	Series 7	Series 8	COM
<b>703-35BH</b>	\$5,963	\$6,183	\$6,548	\$6,929	\$7,382	\$7,840	\$8,412	\$6,183

# Meridian Behavioral Health Seating



### More Information

- Illustrated Glossary ▶ 409
- Fabrics ▶ 421
- Flammability (CTB-133) ▶ 429
- Finishes ▶ 426
- Ordering and Warranties ▶ 432

### Standard Features

- Solid hardwood frame
- Wipe-out design
- Ultra-heavy
- Secured wood arm caps
- Enclosed underside
- Tamper-resistant glides
- Nemschoff healthcare wood finish
- GREENGUARD Gold Certified
- Limited Lifetime Warranty

### Available Options

- Moisture barrier + \$69 per seat or back
- Fully upholstered arm + \$116
- Black urethane arm cap + \$116
- CTB-133 + \$83/yd
- Two fabrics + \$64
- Three (or more) fabrics + \$90

### Specification Decisions

- Select fabric
- Select standard wood finish
- Add upholstered arm or urethane arm caps
- Floor mount +\$182
- Add moisture barrier
- Add CTB-133
- Apply multiple fabrics

### Flammability Type

- Type 6

### Coordinating Products

- Behavioral Health Caseloads
- High Use Behavioral Health Seating
- Marsack III Behavioral Health Seating
- Meridian Multiple Seating
- Meridian Patient Chair
- Meridian Tables

### Key Dimensions

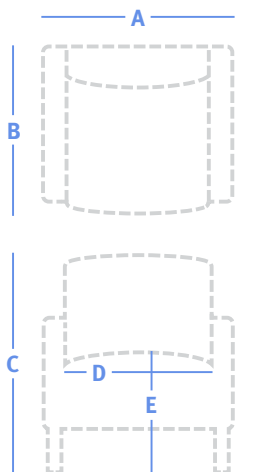

<b>A</b>	Overall Width	See price table
<b>B</b>	Overall Depth	30"
<b>C</b>	Overall Height	29"
<b>D</b>	Seat Width	
	Chair:	20.75"
	Two Seat:	20.75"
	Three Seat:	20.75"
<b>E</b>	Seat Height	18"
<b>F</b>	Arm Height	24"



Welcoming & Waiting

## Meridian Behavioral Health Seating



### 27" W, Chair

5 yds

Model	Series 2	Series 3	Series 4	Series 5	Series 6	Series 7	Series 8	COM
<b>ML30/27BH</b>	\$1,558	\$1,721	\$1,991	\$2,274	\$2,609	\$2,948	\$3,372	\$1,721



### 51.5" W, Two seat with intervening arm

9 yds

Model	Series 2	Series 3	Series 4	Series 5	Series 6	Series 7	Series 8	COM
<b>ML30/2BH</b>	\$2,630	\$2,923	\$3,409	\$3,917	\$4,521	\$5,132	\$5,895	\$2,923

Patient Areas



### 75.75" W, Three seat with intervening arms

13 yds

Model	Series 2	Series 3	Series 4	Series 5	Series 6	Series 7	Series 8	COM
<b>ML30/3BH</b>	\$3,615	\$4,039	\$4,741	\$5,475	\$6,348	\$7,229	\$8,332	\$4,039

Specialty

Reference

## Lab Stools



### More Information

Illustrated Glossary ▶ 409

Finishes ▶ 426

Hardware ▶ 427

Ordering and Warranties ▶ 429

### Standard Features

- Aluminum base with polyurethane casters (FX8602, FX8604, FX8610)
- Polished aluminum base with polyurethane casters (FX8606, FX8612)
- Adjustable aluminum foot ring (FX8608, FX8610, FX8612)
- Black composite base with polyurethane casters (FX8608)
- High-density fire-resistant foam
- Seamless upholstery
- Vinyl colors
  - 1** Black      **2** Charcoal      **3** Navy
  - 4** Tan      **5** Khaki
- Supportive backrest on mid-height and tall stools
- Backrest adjustable tilt (select models)

- Ships cartoned and drop-shipped
- GREENGUARD Gold certified
- Five-year warranty

### Available Options

- Glides + \$0
- Pressure-locking casters + \$121

### Specification Decisions

- Select vinyl
- Add glides
- Add pressure-locking casters

### Flammability Type

Flammability requirements can be accommodated as a special. Please contact your customer service representative.



#### Lab stool with D-ring seat adjustment and backrest

30 lbs | 1 yd

Model	Vinyl/COM	Seat Diameter	Base Diameter	Height Range
<b>FX8602</b>	\$728	16.25"	23.5"	16.75"-21"



#### Lab stool with D-ring seat adjustment and backrest

30 lbs | 1 yd

Model	Vinyl/COM	Seat Diameter	Base Diameter	Height Range
<b>FX8608</b>	\$837	16.25"	25"	22.5"-29.5"



#### Lab stool with dual lever for seat adjustment and backrest tilt

36 lbs | 1.5 yds

Model	Vinyl/COM	Seat Diameter	Base Diameter	Height Range
<b>FX8606</b>	\$1,308	18.5"	24"	16.25"-21.25"



#### Lab stool with dual lever for seat adjustment and backrest tilt

36 lbs | 1.5 yds

Model	Vinyl/COM	Seat Diameter	Base Diameter	Height Range
<b>FX8612</b>	\$1,436	18.5"	24"	20.25"-28"



#### Lab stool with lever-operated tilt backrest

36 lbs | 1 yd

Model	Vinyl/COM	Seat Diameter	Base Diameter	Height Range
<b>FX8604</b>	\$937	18.5"	23.5"	17"-21.25"



#### Lab stool with lever-operated tilt backrest

36 lbs | 1 yd

Model	Vinyl/COM	Seat Diameter	Base Diameter	Height Range
<b>FX8610</b>	\$1,064	18.5"	23.5"	20.25"-27.25"

# Palisade Stools



## Standard Features

- Titanium powder-coated metal column and base
- Upholstered continuous seat and back
- Footring with black, anti-slip trim
- Non-marring 2" glides
- Removeable seat and back cover with rear zipper
- Nemschoff healthcare wood finish
- GREENGUARD Gold Certified
- Limited Lifetime Warranty

## Available Options

- Moisture barrier + \$69
- CTB 133 + \$83
- Wood base + \$164

## Specification Decisions

- Select fabric
- Add moisture barrier
- Add CTB-133
- Add wood base, select finish

## Flammability Type

- Type 2

## Coordinating Products

- [Palisade Casegoods](#)
- [Palisade Coatrack](#)
- [Palisade Flop Sofa](#)
- [Palisade Tables](#)

Overall Width	See price table
Overall Height	37"
Overall Depth	21"
Seat Depth	18"
Seat Width	17"
Seat Height	24"

### More Information

- Illustrated Glossary ▶ 409
- Fabrics ▶ 421
- Flammability (CTB-133) ▶ 429
- Finishes ▶ 426
- Ordering and Warranties ▶ 429

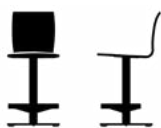

### 17.25" W, Stool

25 lbs | 1.25 yds

Model	Series 2	Series 3	Series 4	Series 5	Series 6	Series 7	Series 8	COM
<b>867-28</b>	\$912	\$952	\$1,020	\$1,091	\$1,174	\$1,259	\$1,365	\$952

## Physician Stools



### More Information

Illustrated Glossary ▶ 409

Finishes ▶ 426

Ordering and Warranties ▶ 429

### Standard Features

- Black composite base with nylon casters (FX9602)
- Aluminum base with polyurethane casters (FX9604)
- Polished aluminum base with polyurethane casters (FX9606)
- High-density fire-resistant foam
- Seamless upholstery
- Vinyl colors
  - 1** Black      **2** Charcoal      **3** Navy
  - 4** Tan        **5** Khaki
- Ships cartoned and drop-shipped
- GREENGUARD Gold certified
- Five-year Warranty

### Available Options

- Glides + \$0
- Pressure-locking casters + \$0

### Specification Decisions

- Select vinyl
- Add glides
- Add pressure-locking casters + \$121

### Flammability Type

Flammability requirements can be accommodated as a special. Please contact your customer service representative.



#### Stool with single-lever seat adjustment

18 lbs | 1 yd

Model	Vinyl/COM	Seat Diameter	Base Diameter	Height Range
<b>FX9602</b>	\$402	16.25"	23.5"	17.25"-22.5"



#### Stool with D-ring seat adjustment

19 lbs | 1 yd

Model	Vinyl/COM	Seat Diameter	Base Diameter	Height Range
<b>FX9604</b>	\$513	16.25"	23.5"	16.75"-21"



#### Stool with 360-degree hand ring seat adjustment

20 lbs | 1 yd

Model	Vinyl/COM	Seat Diameter	Base Diameter	Height Range
<b>FX9606</b>	\$571	16.25"	24"	16.25"-21"

## Reference



## Illustrated Glossary

Nemschoff furniture is rich with healthcare-appropriate features designed for comfort, durability, safety, and ease of use. This glossary explains many of them. If you would like additional information, see individual product specification pages.

### A

**Antimicrobial properties** in upholsteries prevent the spread of germs and diseases in healthcare environments. These textiles have been treated with antimicrobial agents to provide lasting protection.

**Assembly** is required on some Nemschoff products upon delivery.

- Tables 36" or larger ship with legs unattached to bases.
- Overbed Table (FX26) ships with the base, column, and top unattached.
- Treatment chair options, such as arm supports and IV Rods, ship unattached to the chair.
- Orders for Steps Lounge with a configuration of three or more units ship unattached and must be ganged in the field.
- Spanner tables, end tables, and corner tables that are attached to multiple and tandem seating ship unattached.
- Preconfigured units for Terra Casegoods for Treatment Areas ship as separate units that are connected in the field.
- All Terra Casegoods ship optional powder-coated legs inside the units, requiring field installation. Exceptions are benches and desks. The three-drawer bedside cabinet legs will ship in a separate package.
- The privacy screen in Terra Casegoods for Treatment Areas requires a finished panel to be assembled in the field.
- Most drawer and door hardware ships inside the casegood units for protection during shipment.
- Some casegoods in the Finley, Prague II, Prísto, and Ten collections have casters with stem mounts. Casters are shipped unattached and bagged in the top drawer of casegoods. They ship with temporary glides that need to be removed during installation.

### B

**Back flex** is a comfort feature of Centé patient chairs. This feature is made possible by a soft flex motion in the back of the patient chair.

### C

**Casters** are wheels attached to the legs or bases of select seating, tables, and casegoods to provide a greater range of use and mobility, including ease of movement to facilitate cleaning. Nemschoff offers four general types of standard casters including models with brakes to keep furniture in place. Variations of these types include swivel (allows furniture to move freely in any direction) and tilt-and-roll casters (enables stationary chairs to be tilted and rolled for straight-line

travel). Note: Standard caster type will be indicated for each product (see product page for details).

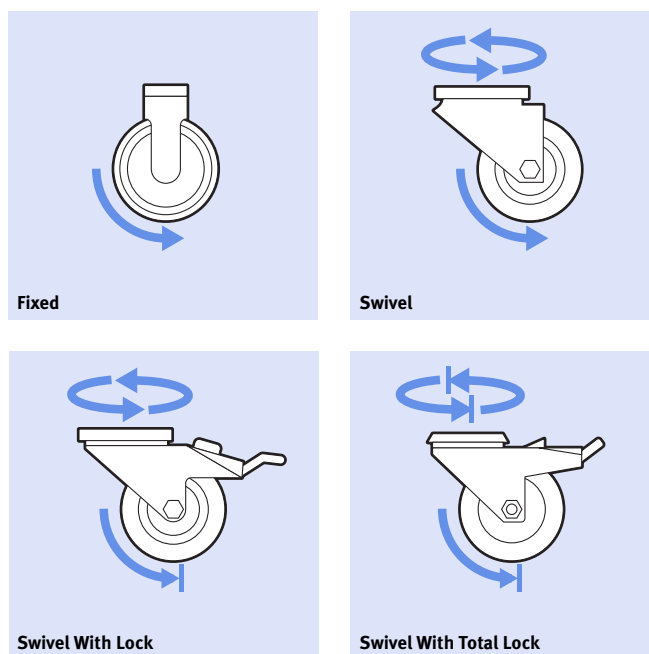

**Central Brake and Steer (CBS)** is an optional caster/wheel system used to control a Treatment Chair's mobility with a simple three-position foot pedal with red and green pedal position indicators. When the red pedal indicator is depressed, the wheels are locked to keep the chair fixed in place. When the green pedal indicator is depressed, the swivel function is locked so the chair can be pushed forward in a straight line. When the pedal is parallel to the floor, all four wheels are free to roll and swivel, letting the chair move forward, backward, and side to side.

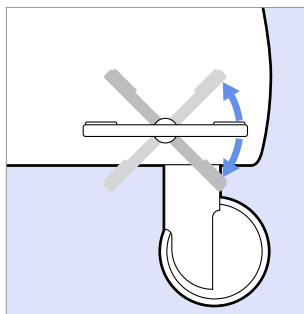

## Illustrated Glossary

**Clean-Out and Wipe-Out** designs allow for thorough, efficient cleaning of many Nemschoff seating products. A clean-out is a non-visible gap between the seat and back of a chair where crumbs and debris can be pushed through by a tool or a hand. A wipe-out is a larger, visible horizontal gap where materials can pass through easily.

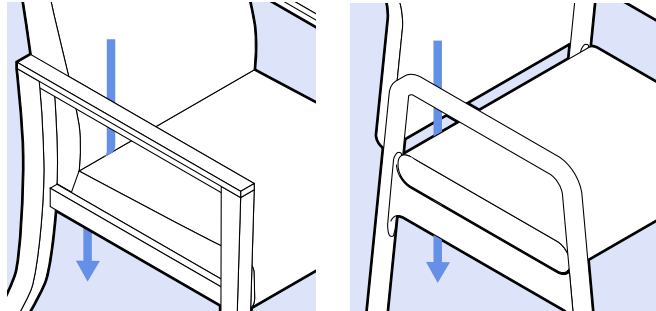

Clean-Out

Wipe-Out

**Configuration** must be specified for modular lounge seating systems like Mod Pod and Steps. To make a configuration plan:

- Select seats, tables, and accessory units.
- Determine placement for tables or accessories. List seats, tables, accessory units, and required ganging in the order they will appear, from left to right. Ganging is determined when facing the unit. Designate either right-side facing (RSF) or left-side facing (LSF).
- Follow the online quoting system to determine if male or female connections are needed with each item.

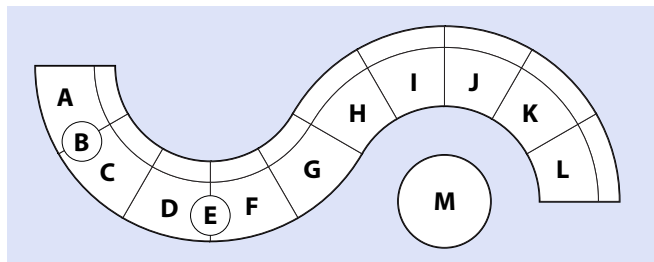

Example **configuration** plan drawing for Steps Lounge seating.

Unit	Model #	Description	Ganging
A	866-OWA	Seat	Ganged RSF
B	866-TA	Table	n/a
C	866-OWA	Seat	Ganged RSF & LSF
D	866-OWB	Seat	Ganged RSF & LSF
E	866-TA	Table	n/a
F	866-OWB	Seat	Ganged RSF & LSF
G	866-OWB	Seat	Ganged RSF & LSF
H	866-IWC	Seat	Ganged RSF & LSF
I	866-IWC	Seat	Ganged RSF & LSF
J	866-IWC	Seat	Ganged RSF & LSF
K	866-IWB	Seat	Ganged RSF & LSF
L	866-IWB	Seat	Ganged LSF
M	866-32	Ottoman	n/a

**Corner blocks** are a quality construction feature of Nemschoff seating. Most Nemschoff chair seats are constructed with full-surface, wood corner blocks that are glued, stapled, and screwed to major joints of the seat frame. This method reinforces the overall assembly, creating a stable seat that will not wiggle or squeak.

## D

**Drawer liners** are available for many casegoods with wooden drawer pans. These plastic liners provide a protective barrier to extend the longevity of the product. Standard liners can be lifted out of the drawer for easy cleaning, and are designed with radiused corners so all debris can be completely removed. The liners can also be used to move patients' belongings. Drawer liners in Behavioral Health casegoods are non-removable and tamper-resistant.

**Dry construction** (see **Replaceable components**)

**Durawrap** is a thermally fused laminate. It covers the primary face and edges of furniture in one continuous sheet, creating a unique wrap-around grain design. It is used primarily on doors, tops, drawer fronts, and base rails to seal the face and edge without a visible seam, a process which prevents moisture from getting into the core material.

## G

**Glides** are small plastic or rubber pads that are fastened to the bottoms of legs of chairs, tables, and casegoods. With proper maintenance, they act as a barrier between the furniture and the floor. Glides must be cleaned regularly to prevent the accumulation of debris, which may have an adverse effect on floor surfaces. Some glides are adjustable to facilitate leveling.

**Glider locking mechanisms** are controlled through optional active and passive locks. Active locks are manually activated by an outside lever, letting users choose when to engage or disengage them. Passive locks automatically disengage when someone sits in the chair, enabling the gliding motion. Passive locks automatically engage when the user exits the chair.

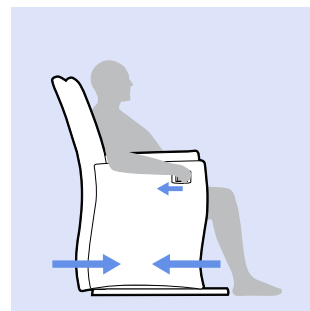

Active Locks

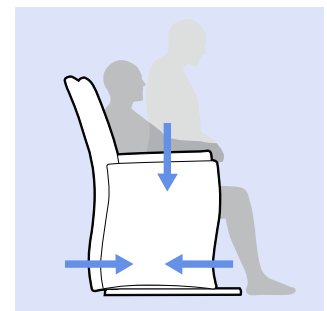

Passive Locks

## Illustrated Glossary

**GREENGUARD** is a stringent, third-party moderated certification that identifies products manufactured with low emissions of volatile organic compounds (VOCs). It is designed to protect human health by improving indoor air quality and helping consumers identify products that are made in a green and sustainable way. The GREENGUARD Gold standard is established by other criteria that deems products to be low-emission and safe, specifically in school and healthcare facilities. The majority of Nemschoff products are GREENGUARD and GREENGUARD Gold certified. Visit [greenguard.org](http://greenguard.org) for more information about GREENGUARD Certification.

## H

**Handedness** designation is an important consideration when purchasing seating and casegoods products with table, desk, or side attachments. We recommend accommodating both left-handed and right-handed users when creating your order. Handedness is determined when facing the product. When purchasing products with attachments, please specify left-side facing (LSF) attachments or right-side facing (RSF) attachments.

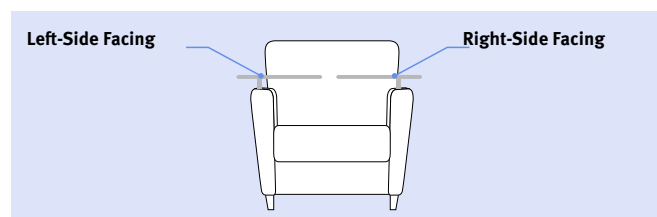

## L

**Lay flat position** allows the back and footrest of a recliner to align in a completely horizontal position. This position creates a surface suitable for sleeping, perhaps as an alternative to a cot or traditional sleep chair. (See also Recline mechanisms)

**Left-side facing (LSF)** is a term used to describe the location of a feature on a Nemschoff product. If a feature is LSF, the feature will be on the left side when facing the product. (See also **Right-side facing (RSF)** and Handedness)

**Leveling** is an important step to take during product installation to ensure that mechanical parts (like drawer guides and hinges) run true and that gaps between doors and drawer fronts are consistent. Any product larger than a chest (like wardrobes and armoires) will need to be leveled with the product's adjustable leveling glides. If a product has feet, the leveling glides will be in the foot. If a product has a plinth-style base or side panels that go to the floor, the leveling glides will be in the corner brackets that touch the floor.

**Locks** of several types are featured in Nemschoff casegoods. Some drawers have cam-style locks that are operated by inserting a key and turning. This type of lock provides security for belongings in bedside

cabinets and drawers. Double-door armoires and similar cabinets have hooked elbow locks that secure doors to the armoire from the inside. This type of latch prevents doors from unintentionally opening and closing.

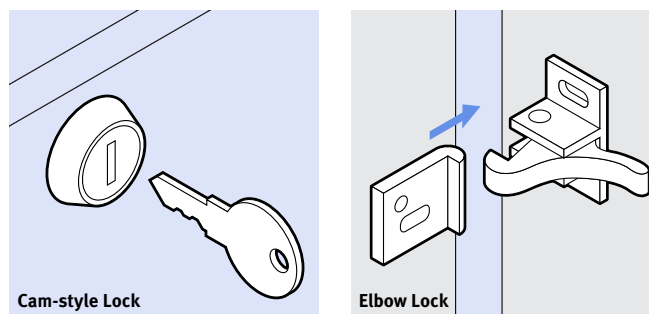

## M

**Moisture barrier** is an optional impermeable layer of material beneath seating upholstery that is designed to prevent moisture from seeping into filling materials. It provides an invisible layer of protection that helps furniture last longer without detracting from appearances.

**Mortise and tenon joinery** is a high-quality, reinforcing wood construction used in many Nemschoff products. A mortise and tenon joint is made by inserting a tenon (a projection at the end of a wooden component) into a mortise (a recess cut into another wooden component). Mortise and tenon joints fit tightly together like puzzle pieces and are glued for added strength. This type of joinery is stronger than glue, nails, or screws alone. It can withstand continual usage in a healthcare environment, providing exceptional durability.

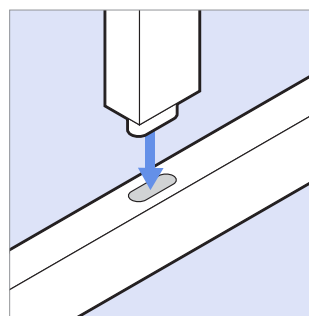



## Illustrated Glossary

**Mounting** options used for Behavioral Health furniture are available for applications where patients' access to loose furniture may present a danger to the staff or themselves. The wall-mount option anchors casegoods directly to a wall through the back panel of the casegoods unit. This option usually includes a concealed rail that can also be mounted to the floor to minimize side-to-side movement of the wall-mounted unit. The floor-mount option anchors platform beds and some seating to the floor. The wall-and floor-mount option anchors desks to both the floor and a wall. The floor-free-mount option supports elevated casegoods at the bottom and anchors the back of the cabinet to a wall.

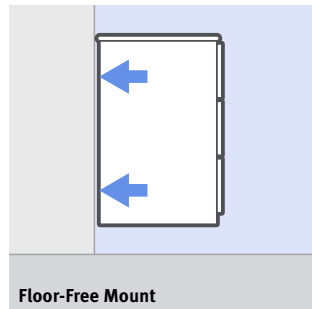
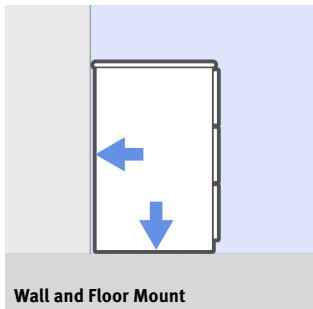
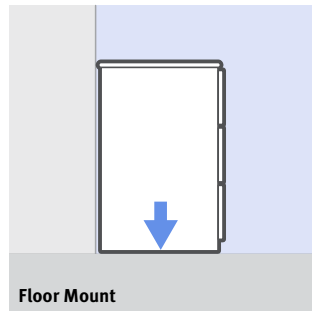
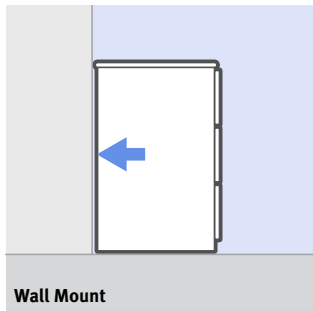

**Multiple fabrics** can be selected (up to three different fabrics per product – some offering even more) for many Nemschoff seating products. Choosing multiple fabrics allows for high-performance fabrics to be used in the specific areas where they're most needed. For example, easy-to-clean, abrasion-resistant polyurethane can be used on the seat and headrest, combined with a softer woven fabric for the back where wear is less of an issue.

Choosing multiple fabrics offers aesthetic flexibility. For example, you can create design continuity among multiple pieces by combining colors and patterns to help coordinate them. Visit [nemschoff.com](https://www.nemschoff.com) to download Multiple Fabric Drawings that will guide you through the specification process, or work with your customer service representative. Multiple Fabric Drawings must be supplied when an order is placed. For more information on associated costs, see [page 424](#).

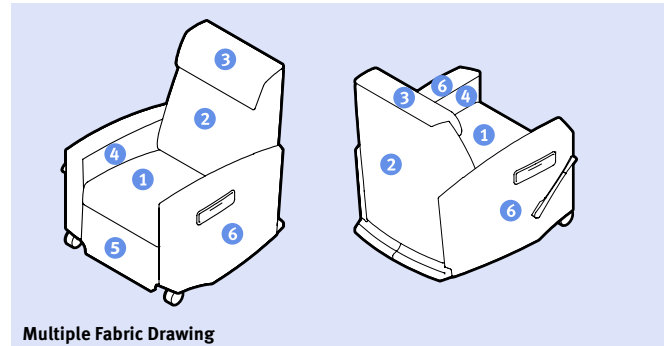

## N

**Nemschoff Healthcare Wood Finish** is a proprietary polyurethane-based formula created to address the heavy use and frequent cleaning required in the healthcare market. It is designed to be smooth, durable, scratch-resistant, and non-yellowing. It has been successfully tested against 85 hospital-grade cleaning substances including 100-percent bleach or ammonia for 16 hours. This finish protects our products from cracks caused by temperature and moisture changes, and scratches caused by heavy use, providing substantial infection control by properly sealing the wood. This special formulation is also GREENGUARD Gold certified.

## P

**Plus Seating** is designed for people of larger statures. Nemschoff's plus seating is spacious and rated to support static load maximums of either 700 or 1,000 pounds, while retaining the comfort and style of standard Nemschoff models. Most plus models are available in 30" or 40" seat widths.

# Illustrated Glossary

## R

**Recline mechanisms** help users achieve comfortable seating positions. Nemschoff offers a variety of recline mechanisms that operate in unique ways to address a range of patient and caregiver needs.

- The **three-position mechanism** offers upright, TV, and reclined positions. It operates by a user positioning his or her weight back into the chair while pushing on the arms, causing the back to recline while the footrest extends in one continuous motion. Because movement is controlled solely by the user of the chair, he or she must have the strength to activate it.
- The **independent foot and back mechanism** is the most common type of recline mechanism offered in Nemschoff products. It features a back and footrest that operate separately. The back is controlled by a release button, allowing it to move freely. A lever located on the outside arm controls the footrest. This mechanism allows for multiple postures, is the easiest to operate, and helps caregivers and guests assist a patient with chair operation.
- The **Pristo II Plus mechanism** operates with independent back and footrest positions optimized for bariatric users. The chair has a more limited back recline (120 degrees), easing the transition between the reclined and upright positions. The footrest includes three positions designed to prevent the knees of bariatric patients from being overextended.
- The **Wallsaver recline mechanism** allows a transition from an upright to fully reclined position with a minimal footprint—permitting placement as close as 4 to 6 inches from a wall (depending on model). The activation of the footrest and initial recline occur when the user pulls on a lever on the side of the chair or a loop on the inside of the arm (depending on model). Full recline occurs when the user positions his or her body weight back into the chair while pushing on the arms. To transition from a recline position to an upright position, the user moves forward in the chair, pulls forward with the arms, and then closes the footrest with the back of his or her lower legs. Because the movement is controlled primarily by the user, he or she must have the strength to operate it.
- The **Adjustable Back Chair (ABC) mechanism** offers a slight back recline, providing an extra level of comfort when compared to a stationary Patient Chair. Movement is controlled by a locking gas spring. When activated, the back reclines smoothly any position within a 112 degree range, making it practical for areas where a traditional recliner's footprint might be too big.
- The **CompactComfort mechanism** (like the Adjustable Back Chair mechanism) offers a slight back recline, letting you choose any position within a 109.5 degree range. It also features an independently operated footrest to provide even more comfortable positions. The limited angle of adjustments gives it a smaller footprint that makes it practical for many applications.

	Mechanism						Positions	
	<i>Three position</i>	<i>Independent foot and back</i>	<i>Pristo II Plus</i>	<i>Wallsaver</i>	<i>Adjustable Back Chair</i>	<i>CompactComfort</i>	<i>Lay flat</i>	<i>Trendelenburg</i>
<b>Recliners</b>								
2755 Series					•	•		
Auburn	•			•			•	
Brava					•	•		
Capella					•	•		
Cities Uptown						•		
Consoul		•					•	
Culla		•						
Horizon	•			•			•	
Leonard II		•					•	
Oliver	•							
Oliver Wallsaver	•			•				
Pamona	•							
Pristo II Plus			•					
Wallsaver	•			•				
<b>Gliders</b>								
Capella Glider					•			
<b>Treatment Chairs</b>								
Pristo II Treatment		•						
Pristo IIT		•						•
Serenity IIS		•						•
Serenity II		•						•
Serenity III		•						•
Junior Recliner	•							

## Illustrated Glossary

**Removable covers** (noted as (P) models) have seat and/or back covers that can be replaced easily on-site. The upholstery is attached with industrial-strength hook and loop fasteners that prevent the covers from slipping. (See also **Standard (S)** models.)

**Replaceable components** are a feature of many Nemschoff products. Replaceable components are able to be removed and replaced in the field, extending the useful lifetime of Nemschoff furniture and increasing return on investment. Many Nemschoff casegoods are built with dry construction, a technique that uses a series of mechanical fasteners that lock together instead of glue or screws. This allows damaged components be easily replaced in the field, extending the lifetime of products.

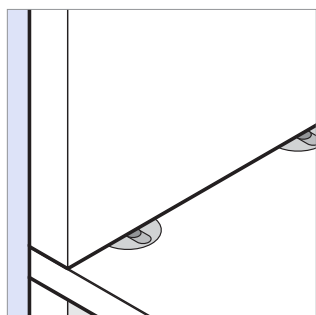

**Replaceable components** use dry construction techniques.

**Right-side facing (RSF)** is a term used to describe the location of a feature on a Nemschoff product. If a feature is RSF, the feature will be on the right side when facing the product. (See also **Left-side facing (LSF)** and **Handedness**.)

## S

**Soft-closing drawers** have track systems that prevent drawers from creating unwanted noise when closing. The track system contains a mechanism that activates as the drawer is closing, automatically guiding the drawer to the closed position while cushioning the closing force. This is a helpful feature in any setting where slamming sounds could be disruptive.

**Solid wood panels** Cross-oriented layers of solid wood panels provide strength and stiffness in both directions, creating a very stable panel that is stronger and more stable than solid wood alone and ideal for high use or behavioral health applications.

**Spring seat construction** was designed with an intense, 24/7 healthcare environment in mind. It has a unique, quiet suspension system that consists of a variety of materials designed to equalize overall support, enhancing the product comfort and durability. The springs create a smooth ride to the seat while creating an arched design that keeps the seat taut and prevents upholstery from sagging.

**Stacking chairs** are designed to be stored nested in a stable stack. They can be stacked to maximize storage space.

**Standard (S)** models have non-removable seat and back covers. If a chair is a standard model, it requires a professional upholsterer to reupholster it. (See also **Removable covers**.)

## T

**Tamper-resistant hardware** is used in most Nemschoff furniture. Screws and dry construction fittings use fasteners that cannot be loosened or removed with standard flat or Phillips screwdrivers. These specialty fasteners provide added security by minimizing tampering with furniture in the field.

**Thermoplastic (ABS)**, otherwise known as acrylonitrile butadiene styrene, is a common thermoplastic known for its resilient, impervious nature and high impact resistance. It is lightweight and resistant to extreme temperatures.

## W

**Wallsaver** is a feature designed to protect both furniture and walls from wear and tear. This feature may include a bead welt material that is sewn into the seam along the back perimeter of a chair or a sloped design of the rear legs that prevents a chair body from coming in contact with a wall. Nemschoff offers wallsaver features as standard on many seating products. (See also Wallsaver recline mechanism under **Recline mechanisms**.)

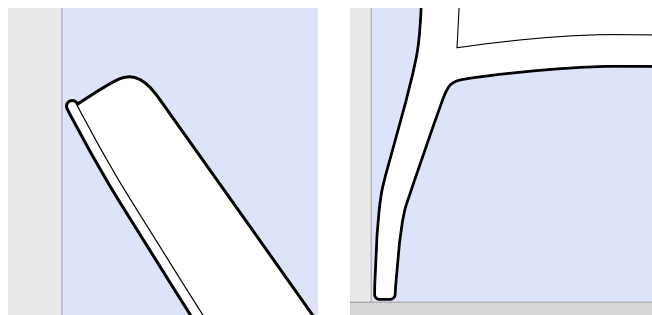

# Model Number Index

Model number includes	Page	Collection	Product
<b>67</b>	164	Whisk	Stack Chair
<b>68-91...</b>	155	Dex	Folding Chair
<b>68-92...</b>	157	Dex	Stack Chair
<b>110 111</b>	161	Romeo/Juliet	Stack Chair
<b>114 115</b>	161	Romeo/Juliet	Stack Chair
<b>170/... 171/...</b>	83	Workhaven	Lounge Seating
<b>195-C...</b>	175	Cubes & Cylinders	Tables
<b>236...</b>	158	Diane	Side Chair
<b>280-... 280-1... 280-2... 280-3...</b>	45	Hadleigh	Lounge Seating
<b>236...</b>	158	Diane	Side Chair
<b>280-... 280-1... 280-2... 280-3...</b>	45	Hadleigh	Lounge Seating
<b>280-52...</b>	255	Hadleigh	Adjustable Back Chair
<b>280-B2...</b>	45	Hadleigh	Lounge Seating Bench
<b>280-T...</b>	180	Hadleigh	Tables
<b>283-...</b>	146	Torii	Multiple Seating
<b>283-50CL...</b>	295	Torii	Glider
<b>283-51... 283-59...</b>	238	Torii	Patient Chair
<b>283-6...</b>	200	Torii	Tables
<b>283-61...</b>	295	Torii	Rocker
<b>283-7...</b>	200	Torii	Tables
<b>283</b>	162	Torii	Side Chair

Model number includes	Page	Collection	Product
<b>283-OB...</b>	146	Torii	Multiple Seating
<b>287-68...</b>	254	Culla	Recliner
<b>288-60...</b>	276	Avery	Rocker
<b>309-9... 309-OB...</b>	150	Altair	Side Chair
<b>314... 316...</b>	223	Easy Access	Patient Chairs
<b>360-9...</b>	400	High Use	Behavioral Health Seating
<b>700-...</b>	56	Marsack	Lounge Seating
<b>700-T...</b>	185	Marsack	Tables
<b>703-...</b>	401	Marsack III	Behavioral Health
<b>708-1... 708-2... 708-3...</b>	47	Harmon	Lounge Seating
<b>708-51...</b>	225	Harmon	Patient Chair
<b>721-1... 721-3...</b>	181	Horizon	Tables
<b>722-... 723-...</b>	117	Horizon	Multiple Seating
<b>727...</b>	226	Horizon	Patient Chair
<b>732-6...</b>	184	Marco Grande	Tables
<b>732-7... 732-9...</b>	184	Marco Grande	Tables
<b>733-66...</b>	263	Wallsaver	Recliner
<b>735-30... 735-33... 735-OB...</b>	123	Marco	Multiple Seating
<b>735-50...</b>	292	Marco	Glider
<b>735-51... 735-59...</b>	227	Marco	Patient Chair
<b>736-...</b>	54	Marco Grande II	Lounge Seating

## Model Number Index

Model number includes	Page	Collection	Product	Model number includes	Page	Collection	Product
<b>740-1...</b> <b>740-2...</b>	115	Capella	Multiple Seating	<b>782...</b> <b>783... 784...</b>	323	SleepOver	Settee
<b>740-28...</b>	152	Capella	Side Chair	<b>785...</b>	321	SleepOver	Flop Sofa
<b>740-30...</b> <b>740-33...</b>	115	Capella	Multiple Seating	<b>786...</b>	325	SleepOver	Sofa
<b>740-50...</b>	279	Capella	Glider	<b>790-12...</b>	269	Serenity II	Treatment Chair
<b>740-51...</b>	214	Capella	Patient Chair	<b>791-12...</b>	273	Serenity III	Treatment Chair
<b>740-52...</b>	249	Capella	Adjustable Back Chair	<b>792-12...</b>	271	Serenity IIS	Treatment Chair
<b>740-54...</b>	280	Capella	Adjustable Back Glider	<b>793-37... 794-37...</b> <b>795-37... 796-37...</b>	321	SleepOver	Flop Sofa
<b>740-59...</b>	214	Capella	Patient Chair	<b>797-1...</b> <b>797-2... 797-3...</b>	68	Pamona	Lounge Seating
<b>740-6...</b> <b>740-6V...</b>	171	Capella	Tables	<b>797-37...</b>	314	Pamona	Flop Sofa
<b>740-62...</b>	280	Capella	CompactComfort Recliner	<b>797-66...</b>	260	Pamona	Recliner
<b>740-9...</b> <b>740-9V...</b>	171	Capella	Tables	<b>797-T...</b>	190	Pamona	Tables
<b>740-91...</b>	152	Capella	Side Chair	<b>798-17...</b> <b>798-27...</b>	303	Consoul	Sleepover Seating
<b>740-B2...</b>	115	Capella	Multiple Seating Bench	<b>798-66...</b>	253	Consoul	Recliner
<b>770-...</b>	18	Brooklyn	Lounge Seating	<b>802-...</b>	182	Hudson	Tables
<b>771-...</b>	50	Lauderdale	Lounge Seating	<b>812-1... 812-2...</b> <b>812-3...</b>	70	Riva	Lounge Seating
<b>772-...</b>	263	Wallsaver	Recliner	<b>812-5...</b> <b>812-9...</b>	198	Riva	Tables
<b>774-...</b>	43	Franklin	Lounge Seating	<b>814-1...814-2...</b> <b>814-3...</b>	52	Leonard II	Lounge Seating
<b>775-...</b>	50	Lauderdale	Lounge Seating	<b>814-27...</b> <b>814-37...</b>	305	Leonard II	Sleepover Seating
<b>775-T...</b>	183	Lauderdale	Tables	<b>814-62...</b>	258	Leonard II	Recliner
<b>776-1...</b> <b>776-2... 776-3...</b>	18	Brooklyn	Lounge Seating	<b>815-1... 815-2...</b> <b>815-3...</b>	72	Sophia	Lounge Seating
<b>776-51...</b>	213	Brooklyn	Patient Chair	<b>822-...</b> <b>823...</b>	117	Horizon	Multiple Seating
<b>776-T...</b>	170	Brooklyn	Tables	<b>860-...</b>	13	Brava Platform	Lounge System
<b>778-66...</b>	263	Wallsaver	Recliner	<b>861-1...</b> <b>861-2...</b>	10	Brava Classic	Lounge Seating
<b>780-17...</b>	318	SleepOver 1-2-3	Chair	<b>861-27...</b>	301	Brava	Sleepover Seating
<b>781-B17...</b>	319	SleepOver	Bench	<b>861-3...</b>	10	Brava Classic	Lounge Seating

## Model Number Index

Model number includes	Page	Collection	Product
<b>861-37...</b>	301	Brava	Sleepover Seating
<b>861-T...</b>	169	Brava	Tables
<b>862-10...862-20... 862-30... 862C-O... 862H-O...</b>	109	Brava 862	Multiple Seating
<b>862-10H...</b>	211	Brava	Patient Chair
<b>862-50...</b>	277	Brava	Glider
<b>862-52...</b>	245	Brava	Adjustable Back Chair
<b>862-62...</b>	247	Brava	CompactComfort Recliner
<b>862-91...</b>	151	Brava	Side Chair
<b>863-10... 863-20... 863-30... 863C-OB... 863H-OB...</b>	112	Brava 863	Multiple Seating
<b>863-50...</b>	277	Brava	Glider
<b>863-52...</b>	245	Brava	Adjustable Back Chair
<b>865-37...</b>	307	Merge	Sleepover Seating
<b>866-32... 866-42...</b>	74	Steps	Lounge System Ottoman
<b>867-08</b>	384	Palisade	Display & Accessories
<b>867-28</b>	406	Palisade	Caregiver Stools
<b>867-37...</b>	312	Palisade	Sleepover Seating
<b>867-46, 867-70</b>	346	Palisade	Casegoods
<b>867-77</b>	189	Palisade	Occasional Tables
<b>866-...</b>	74	Steps	Lounge System
<b>891-1... 891-2... 891-3... 891-OB...</b>	148	Valor	Multiple Seating
<b>891-51...</b>	240	Valor	Patient Chair
<b>891-91... 891-92...</b>	163	Valor	Stack Chair
<b>891-T...</b>	201	Valor	Tables

Model number includes	Page	Collection	Product
<b>892</b>	81	Valor	Lounge Seating
<b>893-1... 893-2... 893-3... 893-OB...</b>	132	Monarch	Multiple Seating
<b>893-51...</b>	230	Monarch	Patient Chair
<b>893-92...</b>	159	Monarch	Stack Chair
<b>893-T...</b>	187	Monarch	Tables
<b>894-10... 894-20... 894-30...</b>	62	Monarch	Lounge Seating
<b>894-17... 894-27...</b>	309	Monarch	Sleepover Seating
<b>902-10... 902-20... 902-30...</b>	64	Oliver	Lounge Seating
<b>902-62...</b>	259	Oliver	Recliner
<b>903-1... 903-2... 903-3... 903-51OB...</b>	65	Olivia	Lounge Seating
<b>903-5... 903-5V...</b>	188	Olivia	Tables
<b>903-50...</b>	293	Olivia	Glider
<b>903-51...</b>	235	Olivia	Patient Chair
<b>903-9... 903-9V...</b>	188	Olivia	Tables
<b>904-66...</b>	259	Oliver	Recliner
<b>905-10... 905-20... 905-30...</b>	58	Maurice	Lounge Seating
<b>909-27...</b>	311	Oliver	Sleepover Seating
<b>970-1... 970-2...</b>	49	Iris	Lounge Seating
<b>971-1... 971-2...</b>	49	Iris	Lounge Seating
<b>1722/...</b>	67	Ottoman	Lounge Seating
<b>2XXX-T...</b>	166	2000 Series	Tables
<b>2600...</b>	85	2600 Series	Multiple Seating
<b>2700... 2700-OB...</b>	88	2700 Series	Multiple Seating
<b>2750-5...</b>	209	2750 Series	Patient Chair
<b>2750-B...</b>	92	2750 Series	Multiple Seating

# Model Number Index

Model number includes	Page	Collection	Product
<b>2750-H...</b>	223	Easy Access	Patient Chair
<b>2750X-...</b>	92	2750 Series	Multiple Seating
<b>2755-O...</b>	209	2750 Series	Patient Chair
<b>2755-52...</b>	241	2755 Series	Adjustable Back Chair
<b>2755-62...</b>	242	2755 Series	CompactComfort Recliner
<b>2770...</b>	95	2770 Series	Multiple Seating
<b>2800-1... 2800-2... 2800-3...2800-4...</b>	39	Evita	Lounge Seating
<b>2800-7... 2800-8...</b>	178	Evita	Tables
<b>2800-B...</b>	39	Evita	Lounge Seating Bench
<b>2800-CT... 2800-ST...</b>	41	Evita	Lounge Seating Spanner Tables
<b>2800-T...</b>	178	Evita	Tables
<b>A10-... A15-...A18-... A30-... A35-... A38-...</b>	100	Auburn	Multiple Seating
<b>ABRN-...</b>	243	Auburn	Recliner
<b>AET-...</b>	100	Auburn	Multiple Seating Spanner Table
<b>AG-...</b>	275	Auburn	Glider
<b>AIT-...</b>	108	Auburn	Multiple Seating Spanner Table
<b>ARCT...</b>	108	Auburn	Multiple Seating Spanner Table
<b>AS-10-... AS-15-...</b>	100	Auburn	Multiple Seating
<b>AS10-... AS15-... AS30-...AS35-...</b>	100	Auburn	Multiple Seating
<b>ASCT...</b>	108	Auburn	Multiple Seating Spanner Table
<b>AT-...</b>	168	Auburn	Tables
<b>BFF...</b>	327	Bedford	Casegoods
<b>BH...</b>	390	Behavioral Health	Casegoods
<b>Cities-MC...</b>	24	Cities Medium Crosstown	Lounge Seating
<b>Cities-MD... Cities-BD...</b>	31	Cities Medium Downtown	Lounge Seating

Model number includes	Page	Collection	Product
<b>Cities-MU... Cities-BU... Cities-SU...OB...</b>	37	Cities Medium Uptown	Lounge Seating
<b>Cities-MU...50CL...</b>	289	Cities Uptown	Glider
<b>Cities-MU...51...</b>	221	Cities Uptown	Patient Chair
<b>Cities-SC...</b>	20	Cities Small Crosstown	Lounge Seating
<b>Cities-SD...</b>	27	Cities Small Downtown	Lounge Seating
<b>Cities-SD...51...</b>	219	Cities Downtown	Patient Chair
<b>Cities-SG...</b>	153	Cities	Side Chair
<b>Cities-SU...</b>	33	Cities Small Uptown	Lounge Seating
<b>Cities-SU...50CL...</b>	289	Cities Uptown	Glider
<b>Cities-SU...51...</b>	221	Cities Uptown	Patient Chair
<b>Cities-SU...61...</b>	287	Cities Uptown	Rocker
<b>CN...</b>	215	Centé	Patient Chair
<b>CR...</b>	215	Centé	Patient Chair
<b>CSNT...</b>	348	Perinatal	Casegoods
<b>EAMOD</b>	59	Mod Pod	Lounge System
<b>EZ-123...</b>	296	EZ-123	Overbed Tables
<b>FLBL-...01, 02, 03</b>	42	Florabella	Lounge Seating
<b>FLBL-...04, 05, 06</b>	179	Florabella	Tables
<b>FX120-CT</b>	125 138	Mayfield Princeton	Multiple Seating Spanner Table
<b>FX120-T...</b>	125 138	Rockwood	Tables
<b>FX153-...</b>	300	Beaumont	Sleep Chair and Settee
<b>FX200-...</b>	125	Mayfield	Multiple Seating
<b>FX500-... FX500-OB...</b>	138	Princeton	Multiple Seating
<b>FX551-...</b>	228	McKinley	Patient Chair
<b>FX600-... FX600-OB...</b>	98	Anderson	Multiple Seating

## Model Number Index

Model number includes	Page	Collection	Product
<b>FX620-T...</b> <b>FX620-CT...</b>	172	Carlson	Tables
<b>FX700-...</b>	343	Montello	Casegoods
<b>FX702-...</b>	335	Finley	Casegoods
<b>FX704-...</b>	349	Prague II	Casegoods
<b>FX860...</b> <b>FX861...</b>	405	Caregiver Stools	Lab Stools
<b>FX960...</b>	405	Caregiver Stools	Physician Stools
<b>FXZ2...</b>	299	Overbed Tables	Overbed Table
<b>GMOD</b>	59	Mod Pod	Lounge System
<b>H</b>	385	Revive	Display System
<b>H18, H38</b>	117	Horizon	Multiple Seating
<b>HDL...</b>	339	Hadleigh	Casegoods
<b>HET-...</b>	117	Horizon	Multiple Seating Spanner Table
<b>HIT-...</b>	117	Horizon	Multiple Seating Spanner Inner Table
<b>HRCT...</b>	117	Horizon	Multiple Seating Corner Table
<b>HRZN_...</b>	256	Horizon	Recliner
<b>HSCT...</b>	117	Horizon	Multiple Seating Corner Table
<b>IMOD</b>	59	Mod Pod	Lounge System
<b>JR/200...</b>	388	Junior 200	Children's Furniture
<b>JR/286...</b>	387	Erica Junior	Children's Furniture
<b>M10... M15...</b> <b>M18</b>	127	Meridian	Multiple Seating
<b>MB...</b>	385	Revive	Display System
<b>MET-...</b>	186	Meridian	Tables
<b>MH</b>	385	Revive	Display System
<b>MIT-...</b>	127	Meridian	Multiple Seating Spanner Table
<b>ML30/...</b>	403	Meridian	Behavioral Health Seating

Model number includes	Page	Collection	Product
<b>MMNT...</b>	348	Perinatal	Casegoods
<b>MOD...</b>	59	Mod Pod	Lounge Systems
<b>MP10...</b> <b>MP15...</b>	229	Meridian	Patient Chair
<b>MRCT...</b>	127	Meridian	Multiple Seating Spanner Tables
<b>MS10-...</b> <b>MS15-...</b>	127	Meridian	Multiple Seating
<b>MSCT...</b>	127	Meridian	Multiple Seating Spanner Table
<b>MT-10...</b>	186	Meridian	Tables
<b>OAS123-...</b>	297	Oasis	Overbed Tables
<b>PAUS-...</b>	134	Pause	Multiple Seating
<b>PRBT...</b>	353	Pristo	Casegoods
<b>PRCL-...</b> <b>PRCL-...OB</b>	265	Pristo II	Treatment Chair
<b>PRJR...</b>	389	Junior	Recliner
<b>PRLT...</b>	353	Pristo	Casegoods
<b>PRRT-...</b>	265	Pristo II	Treatment Chair
<b>PRST...</b>	354	Pristo II	Casegoods
<b>PRTT-...</b>	267	Pristo IIT	Treatment Chair
<b>PTSB-...</b>	134	Pause	Multiple Seating Spanner Table
<b>RE10... RE15...</b> <b>RE18</b>	140	Reliant	Multiple Seating
<b>RE40...</b>	140	Reliant	Multiple Seating
<b>RES10-...</b> <b>RES15-...</b>	140	Reliant	Multiple Seating
<b>RES40...</b>	140	Reliant	Multiple Seating
<b>RET-...</b>	196	Reliant	Tables
<b>REV...</b>	355	Revive	Casegoods



## Model Number Index

Model number includes	Page	Collection	Product
<b>RIT...</b>	196	Reliant	Multiple Seating Spanner Tables
<b>RLT...</b>	196	Reliant	Tables
<b>RRCT...</b>	196	Reliant	Tables
<b>RSCT...</b>	196	Reliant	Tables
<b>RV10...</b>	236	Revive	Patient Chair
<b>RV11...</b>			
<b>RV12...</b>	160	Revive	Side Chair
<b>RV70</b>	236	Revive	Patient Chair
<b>RVR/...</b>	385	Revive	Display System
<b>RVS...</b>	315	Revive	Sleepover Seating
<b>SCXXXX-59...</b>	217	Cities Crosstown	Patient Chair
<b>SCXXXX-61...</b>	281	Cities Crosstown	Rocker
<b>SDX0XX-50CL...</b>	285	Cities Downtown	Glider
<b>SDX0XX-61...</b>	283	Cities Downtown	Rocker
<b>SDXXXX-59...</b>	219	Cities Downtown	Patient Chair
<b>SH/...</b>	385	Revive	Display System
<b>SUX000-62...</b>	251	Cities Uptown	CompactComfort Recliner
<b>SUX000-C200</b>	173	Cities	Tables
<b>SUX000-S200</b>			
<b>SUXXXX-59</b>	221	Cities Uptown	Patient Chair
<b>SXX000-T...</b>	173	Cities	Tables
<b>TEN...</b>	361	Ten	Casegoods
<b>TRA01 through TRA68</b>	365	Terra	Casegoods
<b>TRA100 through TRA109</b>	371	Terra	Casegoods for Treatment Areas
<b>UB</b>	385	Revive	Display System

# Fabrics

Nemschoff's Performance Fabric Program is designed for furniture used in a healthcare environment, with an emphasis on durability and cleanability. Nemschoff Performance Fabrics include more than 700 choices. More offerings are available through our Graded-In Fabrics. Both of these options offer the benefit of a streamlined, seamless ordering process. Of course, you may also specify your own fabrics through the COM option.

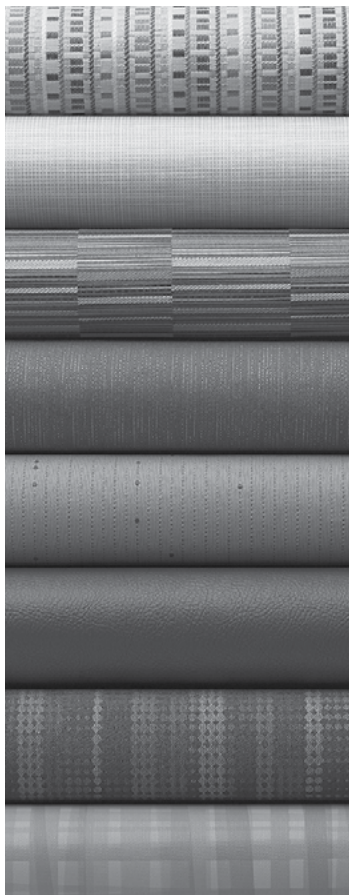

## Nemschoff Performance Fabrics

In today's 24/7 healthcare environments, furniture needs to stand up to around-the-clock use. But it also needs to provide comfortable, inviting environments for patients, families, and caregivers. The Nemschoff Performance Fabric program was designed to meet both of these needs, combining proven performance for healthcare applications with welcoming residential and hospitality aesthetics.

### Durability

All Nemschoff Performance Fabrics are vetted for durability: They must meet the minimum standard of 50,000 double rubs to stand up to the demands of a healthcare environment. Most performance fabrics rate even higher, maintaining their integrity through 500,000 double rubs or more. (All Nemschoff Performance Fabrics include a five-year warranty. For more details, see "Warranties and Certifications," [page 429](#).)

### Cleanability

Performance Fabrics often have inherent characteristics to help minimize the spread of infection. Many are made with antimicrobial materials, and most are cleanable with a diluted bleach solution and many other common healthcare cleaners.

### Sustainability

Nemschoff is also committed to sustainability, and that extends to our Performance Fabrics. We source them from materials with as little impact on the environment as possible, favoring PVC-free and solvent-free materials, as well as those that include recycled content.

### Fabric Availability

Nemschoff has partnered with Maharam, CF Stinson, Momentum, and DesignTex to offer more than 700 fabric choices, including their latest technologies for healthcare and most up-to-date designs. All Performance Fabrics have proven compatibility with Nemschoff products to ensure our high standards for fit and finish are met. You can see the full selection and order samples at: [nemschoff.com/design-resources/materials/fabrics](https://nemschoff.com/design-resources/materials/fabrics)

The program is divided into three material types: Non-Woven Upholstery, Impermeable Woven, and Woven Upholstery.

### Choosing Material Types

#### *Non-Woven Upholstery*

Appropriate for high-use zones such as patient rooms, treatment areas, or seats and headrests, these fabrics are coated with vinyl, polyurethane, or silicone. Vinyls, available in rich colors and unique textures and patterns, are a top choice where fluid spills are common or frequent cleaning and disinfecting are needed, and they are attractively priced. Our PVC-free polyurethanes also provide excellent moisture resistance or fluid barriers, but, unlike vinyl, they have a softer, more sophisticated look and feel. Silicone, the latest non-woven option, is also PVC-free, solvent-free, ink-erasable, and inherently antimicrobial.

Fabrics in this category are cleanable with a diluted bleach solution. Several options are also ink-resistant.

#### *Impermeable Woven Upholstery*

This category includes impermeable Crypton® and Woven Agion®, which are surface-treated with antimicrobial agents to inhibit the spread of infection in healthcare environments. All fabrics in this category are also GREENGUARD Gold certified.

Many of these fabrics are cleanable with a diluted bleach solution.

#### *Woven Upholstery*

Often used in Welcoming & Waiting spaces, many woven options are solution-dyed nylon and highly resistant to discoloration and fading. Most of them include a pattern, letting you create a greater visual impact in the healthcare environment. The collection has a strong focus on recycled content.

All woven Performance Fabrics can be used with harsh cleaning agents, including a bleach solution.

## Fabrics



### For more about Nemschoff Performance Fabrics

View the latest options, see pricing, and order samples at [nemschoff.com/design-resources/materials/fabrics](https://nemschoff.com/design-resources/materials/fabrics)



### Multiple Fabric option

You can specify up to three different fabrics for many Nemschoff seating products. Visit [nemschoff.com](https://nemschoff.com), and choose your product. On the product page, click the Literature link under **Design Resources**.

The Literature link will open a window where you can choose a Multiple Fabric Drawing to guide you in specifying multiple fabrics, or work with your Customer Service Representative.

For costs associated with applying Multiple Fabrics, see [page 424](#).



### For more about Graded-In Fabrics

View a full list of vendors and patterns, find a detailed guide on pricing, and learn how to determine CTB compliance and calculate the cost for treatments and barriers at: [dfabrics.nemschoff.com/dfabrics/search.asp](https://dfabrics.nemschoff.com/dfabrics/search.asp)

### Selecting Your Fabric

Nemschoff's Performance Fabric program facilitates scheduling your order upon receipt so you don't have to worry about computing and procuring the proper yardage. We also take full responsibility for ensuring the fabric meets our high quality standards. There's no need for you to follow up—Nemschoff does all the work.

### Ordering a Fabric Sample

Fabric samples can be ordered through the website, [nemschoff.com/design-resources/materials/fabrics](https://nemschoff.com/design-resources/materials/fabrics).

## Graded-In Fabrics

While Nemschoff's Performance Fabric program is designed to tailor perfectly with our furniture lines and meet the stringent requirements of healthcare, we also work closely with many textile vendors whose fabrics can be specified for our products.

### Selecting Your Fabric

This program lets you choose from thousands of patterns and colors from a wide variety of brands, while relying on us to order and inspect the fabric and assume responsibility for adequate yardage. All Graded-In fabrics are vetted for weight, appropriateness for healthcare, and compatibility with Nemschoff equipment and the upholstery process to ensure our high standards for tailoring are met.

When specifying Graded-In fabrics, due to lead times of the fabric sources, the projected completion date of your order may exceed our normal lead times. Nemschoff assumes no responsibility for defects, appearances, color inaccuracies, shortages, wear, or performance of the textiles from these suppliers.

### Ordering a Fabric Sample

Fabric samples can be ordered by visiting the specific vendor's website or contacting its customer service department.

## Customer's Own Material (COM)

While we recommend selecting from our Nemschoff Performance Fabrics (NPF) or one of our graded-in vendors for the most seamless process, we also provide the option to use COM. Nemschoff does, however, reserve the right to reject covering which is unsuitable for upholstery on our products. This may be due to inadequate weight, fit for healthcare or upholsterability on our products.

### Selecting Your Fabric

To select fabric outside of the NPF and Graded-In Fabric programs, a few steps are required in the specifications of the order.

Nemschoff provides guidelines for calculating the total yardage for COM material (see [page 423](#)). When specifying, it's important to note the required yardage is based on the application instructions of the pattern as well as managing quality issues. Nemschoff will provide yardage requirements upon receipt of order. If flaws are found in the fabric, Nemschoff will promptly notify you of the issue, and you will need to supply additional yardage.

Nemschoff assumes no responsibility for defects, appearance, color inaccuracies, shortages, wear, or performance of COM upholstery.

For information on how to determine CTB 133/ASTM E-1537 flammability standards compatibility and pricing, please refer to [page 429](#).

Note that Nemschoff will dispose of excess upholstery material at the time of shipment unless expressly requested to return it with the product shipment.

### Orders that include Customer's Own Leather (COL)

Please contact your customer service representative.

### Orders That Include COM Upholstery

Customers are responsible for ensuring delivery of COM fabric to Nemschoff. Orders for COM-upholstered products will be scheduled into production upon receipt of all COM and identification swatches. Please work with your CSR if you can supply written confirmation of fabric vendor ship dates, to ensure the best possible lead time. Since shipment of COM orders depends upon fabric availability, lead times may vary from Nemschoff's normal schedules.

When supplying COM fabrics to Nemschoff, please include:

- Fabric supplier
- Fabric name and number
- Color name and number
- A representative fabric swatch for identification purposes (be sure to mark the face side)
- Any nonstandard treatments applied to the fabric, such as Nano-Tex™ or DuraBlock®

- Written instructions on any fabric application deviations (i.e., “stripes to be applied vertically,” or “fabric cut into or across the roll”). Without these required instructions, fabric will be applied to the product based on the vendor’s standard application.

#### Getting the Fabric to Nemschoff

COM must be shipped prepaid F.O.B. to:

Nemschoff  
2218 Julson Court  
Sheboygan, WI 53081

Shipment must include:

- Customer’s purchase order number
- Nemschoff order number
- Product and model number for which the material is intended

*Important:* COM must be supplied as **continuous yardage** to ensure appropriate yields.

#### Split Orders

If a portion of your order does not require COM and you prefer that portion be scheduled right away, Nemschoff will enter the order immediately at your request. Split shipments are subject to additional shipping and handling charges.

#### Canceled or Changed Orders

Nemschoff assumes no responsibility for additional COM material due to a change of upholstery. It is your responsibility to arrange for return of material if an order is changed or canceled.

#### Determining Total Yardage Needed

To determine how many yards of COM fabric you need to provide, **follow these guidelines for 54” wide, nondirectional material:**

- If you do not have a repeat pattern, simply use the COM yardage requirement listed on the price page.
- If you have a repeat pattern, multiply the COM yardage requirement by the appropriate calculation factor, and round up to the nearest  $\frac{1}{4}$  yard.

Use a calculation factor of 1.07 if the fabric’s pattern repeat is 4" x 4" or less. Use a calculation factor of 1.12 if the repeat is up to 6" x 6". For more information, contact your customer service representative.

#### Example:

Chair model 740-10 has a yardage requirement of 2.25 yards. The COM fabric has a repeat pattern of 5" horizontal and 5" vertical.

**2.25** yardage requirement  
x **1.12** calculation factor  
= **2.52** yards  
Round up to **2.75** yards.

#### Determining if Additional Yardage is Needed

Additional yardage may be required if:

- The fabric is less than 54" wide.
- The fabric's pattern is directional or requires matching.
- The fabric requires processing such as treated upholstery or acrylic backing, which often causes shrinking. Customers are responsible for extra yardage required due to shrinkage.
- You are specifying multiple fabrics.

If any of the above conditions apply, please contact your Customer Service Representative to determine the appropriate yardage.

# Fabrics

## Determining if Your Fabric Needs a Flammability Treatment or Barrier

### Determining if Your Fabric is Compatible with CTB 133/ASTM E-1537

CTB 133 is the foundation for open-flame testing in many states and is the basis for National Standard ASTM E1537. (For more information, see “Flammability” on page 429.)

To determine if your fabric can meet the guidelines or if it will need additional barriers and/or treatment:

- 1 In the Pricebook, find your selected product.
- 2 Locate the “Flammability Type” on the product’s page in this book.
- 3 For NPF and Graded-In fabrics, find the “Flammability Class” for your fabric in the respective fabric sections of the Nemschoff website. For COM fabrics, consult the fabric’s manufacturer.
- 4 Using the chart below, find the intersection point of the Product Flammability Type and the Fabric Flammability Class to determine compliance.

Product Flammability Type	Fabric Flammability Class						
	1	2	3	4	5	6	7
1	OK	OK	OK	T/B	OK	OK	T/B
2	OK	OK	OK	T/B	OK	OK	T/B
3	OK	OK	OK	T/B	OK	T/B	×
4	OK	OK	OK	T/B	T/B	T/B	×
5	OK	OK	OK	T/B	T/B	T/B	×
6	OK	OK	OK	T/B	T/B	T/B	×
7	OK	OK	OK	T/B	T/B	×	×
8	OK	OK	OK	T/B	T/B	T/B	×

Key	
OK	Meets CTB 133 / ASTM E-1537
T/B	Requires treatment or barrier
×	Cannot meet CTB 133 / ASTM E-1537

### About Treatments and Barriers

For some product and fabric combinations, an additional treatment or barrier is needed for the product to comply with CTB 133. A treatment is a coating applied to the fabric. A barrier is an added layer of fabric beneath the upholstery layer. Nemschoff will determine which method is best-suited to the product you are specifying.

### Calculating the Cost of a Treatment or Barrier

In all cases, the cost of a treatment or barrier is \$81 per yard. To calculate the cost of a treatment or barrier, simply multiply the total yardage needed by \$81.

### Multiple Fabric Charges

An additional \$64 per unit applies to all multiple fabric orders using two fabrics and \$90 per unit using three or more fabrics.

### Changed or Canceled Orders

Any orders in production that require changes or cancellations will be charged a labor and restocking fee.

# Finishes

Our quality is more than surface deep. We offer dozens of beautiful finishes designed to withstand the rigors of healthcare environments and coordinate with other products from the Nemschoff and Herman Miller portfolios.

## About Nemschoff Finishes

### Wood & Veneer

We use veneer with a matching wood edge band to seal the core. The veneer is stained with a color of your choice and Nemschoff's Healthcare Wood Finish is applied for long-lasting performance.

### Bedford Classics

The distinctive two-toned look of Bedford Classics Maple veneer is created with an Italian Cherry perimeter. A wood edge band, your choice of stain colors, and our Nemschoff Healthcare Wood Finish provide aesthetic flexibility without compromising durability.

### Laminate

We use high-pressure laminates and melamine panels in solid colors, woodgrain, or a variety of patterns. Both materials are durable and available in identical finishes. Laminates provide extra resistance to dents, and melamine is thermally fused to resist peeling.

### Durawrap

Durawrap is a thermally-fused laminate. It covers the primary face and edges of the furniture in one continuous sheet, creating a unique wrap-around grain design. It is used primarily on doors, tops, drawer fronts, and base rails to seal the face and edge without a visible seam, a process which prevents moisture from getting into the core material.

### Solid Surface

Corian is a seamless, non-porous material that is durable, stain-resistant, certified for food contact, nontoxic and nonallergenic. It is low in pollutants and aids in infection prevention, microbial resistance, and preventing mold and mildew.

### Resin

Varia Ecoresin by 3form is a polyester-based, dynamic interlayer system that delivers design versatility and light transmission. The material is lightweight and half the density of glass, which

makes for easier installation and reconfiguration. It also has excellent chemical resistance, contains 40 percent recycled content, and is GREENGUARD certified.

### Powder Coat

Powder coat is typically applied to steel, giving you the economies of steel pricing with a wide variety of aesthetic options. This finish is extremely durable, consistent, and once cured, it emits no pollutants.

### Urethane

Urethane is a soft, durable, molded component that adds comfort and durability to arm caps, bumpers, protective edges, and some cabinet tops.

### HPVC Edge Banding

Thicker than standard vinyl banding, 3 mm HPVC edge banding provides enhanced durability, while its softer, slightly rounded edges create a more user-friendly environment.

### Thermoplastic (ABS)

Otherwise known as acrylonitrile butadiene styrene, it is a common thermoplastic known for its resilient, impervious nature and high impact resistance. It is lightweight and resistant to extreme temperatures.

# Finishes

See nemschoff.com  
to view all Finishes

## Wood & Veneer

**UL** Natural Maple

**5K** Honey Maple

**8K** Light Brown Cherry

**ED** Aged Cherry

**0Z** Medium Cherry

**UX** Walnut Cherry

**2U** Light Brown Walnut

**40** Dark Brown Walnut

**IZ** Aged Teak

## Bedford Classics

**40** Wheat

**43** Plum

**44** Wild Cherry

**45** Pecan

## Woodgrain Laminate

**HM** Natural Maple

**0G** Honey Maple

**PX** Light Brown Cherry

**HX** Aged Cherry

**WY** Medium Cherry

**HY** Walnut Cherry

**76** Light Brown Walnut

**0W** Dark Brown Walnut

**2K** Aged Teak

## Solid Laminate

**98** Studio White

**91** White

**8D** Ash Grey

**LU** Soft White

**8Q** Folkstone Grey

## Laminate, continued

**WL** Sandstone

**0X** Dark Folkstone Grey

**0V** Dark Sandstone

**0R** Light Khaki

**1K** Dark Khaki

**0U** Light Sand

**0S** Dark Sand

## Durawrap

**98** Studio White

**91** White

**8Q** Folkstone Grey

**0R** Light Khaki

**HM** Natural Maple

**0G** Honey Maple

**PX** Light Brown Cherry

**HX** Aged Cherry

**76** Light Brown Walnut

**HY** Walnut Cherry

**WY** Medium Cherry

**0W** Dark Brown Walnut

**2K** Aged Teak

## Solid Surface

**CQ** Glacier White

**58** Cameo

**QB** Bisque

## Resin

Varia Pure

Hush Gesso

Ion Wheat

## Powder Coat

**8D** Ash Grey

**LU** Soft White

**MSS** Metallic Silver

**XTS** Titanium

**MST** Metallic Silver (Textured)

**XTT** Titanium (Textured)

**G2** Graphite Satin

**3K** Nickel

**G1** Graphite (Textured)

**4K** Umber

**BK** Black

## Urethane

*For Arm Caps*

Black

Desert

Pewter

*For Top Edges*

Cloud

Sand

Sable

## HPVC Edge

Cloud

Pewter

Sable

## Thermoplastic (ABS)

Black

Desert

Pewter



# Hardware

Our extensive collection of durable, high-quality drawer and door pulls satisfies a variety of aesthetic needs. Every option shown here is compatible with our entire casegoods line. To learn more about the casegoods pull selection, contact your local Account Manager, a Nemschoff Authorized Dealer or Nemschoff Customer Service.

## Bedford



**1** Brass



**2** Cloud  
**2C** Chrome



**3** Brass  
**3C** Chrome  
**3N** Brushed Nickel

## Montello



**8** Brushed Nickel

## Sovereign



*Door Pull*  
**9K** Brass

## Pristo



**10** Cloud  
**11** Pewter  
**12** Sable



# Hardware

## Cirrus



- 13 Espresso
- 14 Ice

## Prague II



- 17 Nickel
- 17B Burnished Brass
- 17R Rubbed Bronze

## Hadleigh



- Drawer Pull*
- 15 Dark Antique

## Terra



- 18 Nickel Satin



- Door Pull*
- 15K Dark Antique



- 19 Steel

## Contemporary



- 16 Black

## Warranties & Certifications

Nemschoff is dedicated to providing safe, quality products that are specifically designed for the demands of the healthcare industry. We warrant our fabrics and products, ensure our products meet the rigorous CTB 133 flammability standard, and offer many products meeting the GREENGUARD environmental certification.

### Flammability

Nemschoff products are designed and tested for compliance with the rigorous CTB 133 flammability certification.

#### About the CTB 133 Flammability Standard

CTB 133, known formally as California Technical Bulletin 133: Flammability Test Procedure for Seating Furniture for Use in Public Occupancies, is an open-flame test procedure designed for testing furniture for use in public occupancies.

Established by the California Bureau of Home Furnishings and Thermal Insulation in 1991, the testing procedures dictate that furniture be ignited via an open flame in a specifically designed room. Numerous measurements are then taken.

#### How CTB 133 tests work

To pass CTB 133, all the following must occur:

- The upholstered product must self-extinguish within an hour.
- The temperature at the ceiling cannot increase more than 200° F.
- The temperature at 4 feet above the floor cannot increase more than 50° F.
- The opacity at 4 feet above the floor cannot exceed 75 percent.
- The carbon monoxide concentration in the room cannot exceed 1,000 ppm for more than five minutes.
- The product weight loss due to combustion cannot exceed 3 pounds in the first 10 minutes of the test.
- The rate of heat release cannot exceed 80 kW.
- The total heat release cannot exceed 25 MJ in the first 10 minutes.

#### Nemschoff and CTB 133

At Nemschoff, we've always taken a lead role in ensuring our furniture meets public safety requirements including reducing the risk of flammability. We were the first in the industry to

build a test facility compliant with CTB 133, the foundation for open-flame furniture testing in many states and the basis for National Standard ASTM E1537.

Through its extensive testing, Nemschoff continues to build its knowledge of which design elements to include, and how, when manufacturing CTB 133-compliant products.

Elements that factor into these decisions include the configuration of the product, internal construction of the product, fabric construction, type of filling material (including foam), type of thread, and type of thermobarriers (when needed).

Because of this process, the majority of Nemschoff-upholstered products are compliant with CTB 133. Please note that there are a few exceptions. If CTB 133 compliance is required, it must be noted on the purchase order to ensure the standard is met.

### Five-Year Fabric Warranty

Nemschoff offers a five-year warranty on Nemschoff Performance Fabrics. The terms of the warranty are as follows:

Seller warrants woven and non-woven upholstery on the Nemschoff Performance Fabric Program when applied to Seller's products. Warranty covers defects of material and workmanship under normal use and service for five (5) years from the date of shipment.

This warranty applies only to the original owner and the original use of the product. All Graded-In and COM upholstery default to the supplier's warranty.

This warranty is void in cases of damage in transit, negligence, abuse, abnormal usage, misuse, accidents, and improper cleaning and maintenance. Normal aging and wear of woven and non-woven upholstery are exempt from this warranty.

## Warranties & Certifications

THERE IS NO OTHER EXPRESS WARRANTY. SELLER HEREBY DISCLAIMS ALL IMPLIED WARRANTIES INCLUDING THE IMPLIED WARRANTY OF MERCHANTABILITY AND FITNESS FOR ANY PARTICULAR PURPOSE INDICATED BY BUYER TO SELLER.

There are no representations as to the capacity or performance of the products sold hereunder except as set forth in the quotation specifications, if any, and such representations are expressly conditioned upon the correctness of the data furnished by Buyer and upon the products being properly installed and maintained.

As Buyer's sole remedy under the warranty, Nemschoff, at its option, will repair or replace the material at no charge to the original owner of record. If the material is no longer in manufacture, one of comparable value will be substituted. Nemschoff will pay freight charges provided that the replacement or return has previously been authorized by the company under the terms of this warranty.

IT IS EXPRESSLY AGREED THAT THIS REMEDY OF REPAIR, REPLACEMENT OR CREDIT, AT SELLER'S OPTION, IS BUYER'S EXCLUSIVE REMEDY UNDER THIS WARRANTY. IN NO EVENT SHALL SELLER BE LIABLE FOR CONSEQUENTIAL DAMAGES.

Expenses incurred by Buyer for repair or replacement of Seller's product will not be allowed except by written permission of Seller.

### Limited Lifetime Warranty

Nemschoff offers a Limited Lifetime Warranty for all of its products. The terms of the warranty are as follows:

Seller warrants the products it manufactures against defects of material and workmanship under normal use and service for the useful life of the product from the date of shipment provided that the product is in use by the original owner and has been used for only the original purpose. This warranty is void in cases of damage in transit, negligence, user modification, abuse, abnormal usage, improper use of cleaning chemicals, misuse, accidents, and improper maintenance.

As Buyer's sole remedy under the warranty, Nemschoff, at its option, will repair or replace defective parts at no charge to the original owner of record. Nemschoff will pay freight charges provided that the replacement or return has previously been authorized by the company under the terms

of this warranty. Normal aging and wear of fabrics, filling materials, mechanisms, mechanical components, and finishes are exempt from this warranty. With proper use and maintenance, the limitations of our warranty are as follows:

- 10 years for all mechanisms and mechanical components of Serenity® and Pristo® Treatment Chairs, Consoul Sleepover Seating, and Consoul and Leonard Recliners.
- 12 years for all mechanisms and mechanical components of Nala® and Centé® Patient Chairs.
- 5 years for all other mechanisms and mechanical components.
- 5 years for Overbed Tables and Caregiver Stools.
- 1 year for Resin panel (Terra for Treatment Areas).

THERE IS NO OTHER EXPRESS WARRANTY. SELLER HEREBY DISCLAIMS ALL IMPLIED WARRANTIES INCLUDING THE IMPLIED WARRANTY OF MERCHANTABILITY AND FITNESS FOR ANY PARTICULAR PURPOSE INDICATED BY BUYER TO SELLER.

There are no representations as to the capacity or performance of the products sold hereunder except as set forth in the quotation specifications, if any, and such representations are expressly conditioned upon the correctness of the data furnished by Buyer and upon the products being properly installed and maintained.

IT IS EXPRESSLY AGREED THAT THIS REMEDY OF REPAIR, REPLACEMENT OR CREDIT, AT SELLER'S OPTION, IS BUYER'S EXCLUSIVE REMEDY UNDER THIS WARRANTY. IN NO EVENT SHALL SELLER BE LIABLE FOR CONSEQUENTIAL DAMAGES.

On equipment furnished by Seller but manufactured by others, the written warranty, if any, of the manufacturer will be assigned to Buyer. However, Seller does not adopt and does not guarantee or represent that manufacturer will comply with any of the terms of the warranty of such manufacturer.

Expenses incurred by Buyer in repairing or replacing Seller's product will not be allowed except by written permission of Seller.

Seller, in its manufacture and sale of these products, will assume no liability as to possible infringement of patents or copyrights by virtue of the use of said products in combination with other elements or structures or when manufactured to Buyer's specifications.



#### For more about care and cleaning

Learn about recommended care and cleaning procedures that can help keep your Nemschoff products eligible for warranty coverage. Visit [nemschoff.com/customer-service](https://www.nemschoff.com/customer-service) and navigate to the Maintenance Topic.

## Warranties & Certifications



### For more about **GREENGUARD Certification**

Learn more at  
[www.greenguard.org](http://www.greenguard.org)

### **GREENGUARD Certification**

GREENGUARD is a stringent, third-party moderated certification that identifies products manufactured with low emissions of volatile organic compounds (VOCs). It is designed to protect human health by improving indoor air quality and help consumers identify products that are made in a green and sustainable way. The GREENGUARD Gold standard is established by other criteria that deems products to be low-emission and safe for human use, specifically in school and healthcare facilities. Most of Nemschoff's products are GREENGUARD Gold Certified.

# Ordering

We do everything we can to make sure the ordering process for Nemschoff products is straightforward and convenient, from beginning through delivery. And when you choose products from our Pacesetter program, the delivery can be quick as well.

## Online Ordering

Nemschoff strives to make the ordering process for our products simple and easy to access for our Dealers. Purchase orders can be submitted online at [dealers.nemschoff.com](http://dealers.nemschoff.com) through your Dealer account; for a step-by-step guide, please see the information below. If you don't have a Dealer account or if you have questions about the process, please contact Customer Service at 800-203-8916.

### Step-by-Step Guide

#### 1. Log on to Nemschoff Dealer Daily

Go to [dealers.nemschoff.com](http://dealers.nemschoff.com) and enter your Dealer ID and password. If you do not have an ID and password, or you have forgotten it, click the link for help, and we will automatically email the information to you. If you are still unable to access Dealer Daily, please contact your customer service representative.

#### 2. Access Nemschoff Online Ordering

Click on "Toolbox" at the top of the Dealer Daily page to see a list of Nemschoff's online tools. Click the "Online Order" button.

#### 3. Identify the End User

Click "Create Quote — End Users" to search for customers or end users. Once you identify the correct customer, click the link in the Customer ID column.

#### 4. Select the Product Collection

You will be prompted to choose between Nemschoff and Brandrud collections. If you are not sure which collection you need, refer to [page 436](#) in the price list for a list of products.

#### 5. Identify Dealer Contact and Ship-to Address

Enter your name, email, and phone number at the prompts. Then choose a ship-to address from the list provided.

#### 6. Add New Line

Prepare to start specifying your products by clicking the "Add New Line" link.

#### 7. Identify the Product

On the Model Builder screen, select the product line. Then select the model series and specific model. Once you make these selections, the Model Builder will provide a "Build" button.

#### 8. Specify the Product

Click the "Build" button on the Model Builder screen. Look through the list of options offered for each product, and click the button next to each of your selections. The system will automatically proceed to the next option, adding your selections to the Model Builder page and updating the pricing.

#### 9. Options Complete

When you've finished choosing options, an "Options Complete" pop-up will appear. Click the "OK" button.

#### 10. Enter the Quantity

Enter the quantity and any comment information for each particular specification. Once you click "Save," the specification will be added to your quote or invoice.

#### 11. Make Changes if Needed

To change a line item, click on the link in the "Edit" column of that line number. You will be directed back to the Model Builder screen, where you can edit the quantity, comments, and date.

Some options can be changed using the "Edit" button. To clear your selections and start the specification process again, click "Re-Build." After all changes are complete, click the "Save" button.

#### 12. Print the Quote

Use the options at the bottom of your screen to choose how much information you want to print out. Selecting "Print Quote" will provide you with the list price and dealer price. "Print All" will show the list price, net price, and GPO member price. "Print Member Only" will give you the list price and GPO member price.

#### 13. Submit Your Order

Your order is now complete. Click the "Submit Quote" link at the bottom of the page.

#### 14. Confirm Your Order

A PDF of your order will be automatically sent to the email address you provided in the Dealer/Sold to email field. Please review the order detail information.

Please contact Customer Service at 800-203-8916 for additional information.

All Purchase Orders should be made out to Nemschoff.

## PaceSetter Program

Nemschoff's PaceSetter program is an option if you don't want to wait to enjoy the design, quality, and performance of Nemschoff furniture. We've chosen 36 of our most popular options and streamlined production so that they can ship to you in 15 business days or less.

### How It Works

The PaceSetter program allows ordering of up to 40 units per order (each seating position equals one unit, i.e., a three-seat unit would equal three units) in any design configuration of the available products. Contact your Customer Service Representative to ensure the upholstery is available in an expedited lead time. (For warranties, see [page 436](#). For Flammability, see [page 429](#).)



The minimum order size is \$1,500 list. Items included in the program are listed on the website at [nemschoff.com/customer-service/pacesetter-program](https://nemschoff.com/customer-service/pacesetter-program) and are indicated in the price list with the PaceSetter logo.

PaceSetter products will ship in 15 business days or less from the receipt of a clean order and fabric. If you require an expedited lead time for any product that is not included in the PaceSetter Program, contact your Customer Service Representative.

### Submitting the Order

All PaceSetter orders must be clearly marked "PaceSetter" and should be submitted online via the Nemschoff Dealer Daily. Orders must be sent separately from regular lead time orders. Orders sent by fax, mail, or email will not be accepted for PaceSetter.

### Changing the Order

Once a PaceSetter order is entered, changes will not be accepted.

### Returns

No return of furniture will be accepted without our written consent and shipping instructions.

### Freight and Delivery

All PaceSetter shipments are F.O.B. factory. Pricing does not include shipping and handling.

### Payment

Payment is due 30 days after the date of the invoice, subject to credit approval, with a finance charge of 1 to 1.5 percent monthly for late payments after maturity. Deposits are applied to the final invoice.

Please remit payment to:

Nemschoff  
3045 Eagle Way  
Chicago, IL 60678-1030

## General Terms and Conditions

### Acceptance of Terms

These terms and conditions of sale (Terms) govern all sales of products (Products) by Nemschoff Chairs, Inc. to Buyer specified in any document (Document) of which they are a part. If the Terms and conditions of any Buyer Document differ from these Terms, these Terms shall be construed as a counteroffer and not an acceptance of Buyer's terms and conditions, which are hereby rejected. These Terms constitute the agreement between Nemschoff and Buyer. Buyer's failure to dissent from these terms in writing within five (5) days of receipt thereof or Buyer's acceptance of the Products shall constitute acceptance of these Terms. No change to these Terms will be effective unless made in writing and signed by Nemschoff.

### Quotation and Prices

A price quotation is valid for sixty (60) business days except as otherwise stated in writing. Unless otherwise stated in writing by Nemschoff, all prices quoted shall be exclusive of shipping, insurance, taxes, license fees, customs duties and other related charges, and Buyer shall pay all such charges. If Nemschoff, in its sole discretion, chooses to pay any such charges, Buyer shall reimburse Nemschoff in full upon demand. Any volume-based discounts set forth in a Document will be rescinded if Buyer fails to meet the conditions for such discounts specified in the Document.

### Payment

Except as otherwise specified, all payments are due and payable in U.S. dollars within thirty (30) days from the invoice date. Nemschoff may require alternative payment terms including, without limitation, a letter of credit or payment in advance. Payments not made by the due date may incur, at the sole discretion of Nemschoff, a late payment service charge of the lesser of one and one-half percent (1½ percent) per month or the maximum rate permitted by law, computed from the date payment was due. All payments and deposits are non-refundable. Nemschoff retains a purchase money security interest or other security interest in the Products and their proceeds, including insurance proceeds, until Buyer has made payments required. Buyer agrees to take any acts (including executing and delivering all Documents) reasonably requested by Nemschoff to protect, maintain and perfect Nemschoff's security interest.

# Ordering

## Terms

Net 30 days after date of invoice, subject to credit approval, with a finance charge of 1½ percent monthly for late payments after maturity. First orders may require a 25 percent deposit with order. Deposits are applied to final invoice of order.

Please remit payment to:

Nemschoff  
3045 Eagle Way  
Chicago, IL 60678-1030

## Shipping / Delivery

Nemschoff list prices include standard surface freight to any point within the 48 contiguous United States for orders greater than \$100,000 List. For orders less than \$100,000 list, a shipping and handling charge will apply. The shipping and handling charge will be provided as part of each quotation. For orders shipped to Alaska or Hawaii, freight included is only to the point of embarkment. Shipments beyond that point are freight-collect.

Shipping and delivery dates are estimates. Specific delivery dates are available and may incur additional costs. Dates are coordinated and quoted through Nemschoff Customer Service. Nemschoff shall not be liable for any delay in delivery on or assume any liability in connection with shipment. Shipments will arrive within 10 business days after ship date.

Shipments will arrive blanket-wrapped unless otherwise specified.

International shipments must be secured with credit arrangements satisfactory to Nemschoff, in its sole discretion, prior to shipment from Nemschoff's facilities. Extra international packaging, cartoning, skidding, or other packing arrangements will be quoted and added to pricing.

All products shall be delivered F.O.B. to Nemschoff's place of shipment. Risk of loss and damage shall pass to Buyer upon Nemschoff's tender of delivery to a carrier at the F.O.B. point, and any loss or damage thereafter shall not relieve Buyer from any payment obligation. The carrier shall not be deemed an agent of Nemschoff.

If Nemschoff insures shipment, Buyer shall pay insurance costs as invoiced by Nemschoff. Notation on the carrier's bill of lading is required for all freight claims.

Furniture ships inside a protective bag to which a shipping label is affixed. Any site-specific installation instructions (location designation or place in specific configuration — with ganged or modular components) will be on the label. Do not remove the protective bag prior to product being staged in the indicated location on site.

The customer is responsible for all unloading. Drivers do not unload the truck. Your product will arrive on an 80-foot combined tractor/trailer unit which requires a loading dock. The carrier will call the customer 24 hours prior to delivery.

Customer pickups can be arranged at the customer's request and are subject to dock fees. The customer will provide loading and proper equipment to facilitate blanket-wrapped shipments.

## Shipping Delays

If the customer requests a delay of shipment of an order 30 business days or less before scheduled shipping date, the customer is responsible for storage charges. Nemschoff may transfer the merchandise to storage at the customer's risk and expense. Such transfer to storage shall be deemed delivery to customer for all purposes, including invoicing and payment.

## Changes, Delays of Production or Cancellation

Buyer's order for Product may be changed, delayed or canceled only with the prior written consent of Nemschoff. Buyer shall compensate Nemschoff for any resulting loss or damage including, without limitation, the cost of labor, materials, and overhead expenses by paying a fee of 65 percent of the value of the purchase order as of the date of cancellation. In addition, customer-initiated delays of shipments exceeding 180 days from the original delivery date will be deemed a cancellation and are subject to this cancellation policy.

## Export Control

Buyer shall comply with all applicable laws, regulations and treaties relating to the sale and destination of the Products, including without limitation, U.S. export control regulations. Buyer agrees not to sell any of the Products in any territory or country prohibited by applicable U.S. laws and to obtain representations from its customers that they will not resell or transfer any of the Products to such countries or territories. Buyer will defend, indemnify and hold Nemschoff harmless for any damages or costs to Nemschoff arising from Buyer's failure to comply with this term.

## Inspection

All Products delivered hereunder shall be deemed accepted by Buyer, unless written notice of defect of nonconformity is received by Nemschoff within 10 days of receipt of Products at Buyer's designated receiving address, provided that Buyer may only reject Products for failure to meet the Products' specifications.



## Ordering

**Remedies**

Nemschoff retains the right to terminate or delay the shipment of any order by reason of Buyer's bankruptcy or insolvency, breach of any terms, unauthorized assignment or the pendency of any proceedings against Buyer under any statute for the relief of debtors.

**Limitation of Liability**

To the extent not prohibited by applicable law: (a) Nemschoff's aggregate liability to Buyer for any claim relating to the Products is limited to the amounts Buyer has paid to Nemschoff for the Products; and (b) Nemschoff will not be liable for any indirect, punitive, special, incidental or consequential damages in connection with or arising out of these terms, the Document, the Products, or the sale, installation, maintenance, use, performance or nonperformance of the Products including — but not limited to — replacement costs, loss of business, revenue, profits, use data or other economic advantage, however they arise and even if Nemschoff has been previously advised of the possibility of such damages. The parties acknowledge that if Nemschoff provides the Products to Buyer, it does so in reliance upon the limitations of liability and the disclaimers of warranties and damages, and that these limitations and disclaimers form an essential part of the contract between the parties. Liability for damages will be thus limited and excluded even if any exclusive remedy provided for in these Terms fails of its essential purpose.

**Intellectual Property Rights**

Any Intellectual Property Right on a worldwide basis including, without limitation, patentable inventions (whether or not applied for), patents, patent rights, copyrights, work of authorship, moral rights, trademarks, service marks, trade names, trade dress, trade secrets and all applications and registrations of all of the foregoing resulting from the performance of these Terms that is conceived, developed, discovered or reduced to practice by Nemschoff, shall be the exclusive property of Nemschoff. Specifically, Nemschoff shall exclusively own all rights, title and interest (including, without limitation, all Intellectual Property Rights throughout the world) in and to the Products and any and all inventions, works of authorship, layouts, know-how, ideas or information discovered, developed, made, conceived or reduced to practice, by Nemschoff, in the course of the performance of these Terms.

**Miscellaneous**

Nothing in these Terms shall imply license or other rights with respect to any Intellectual Property Rights of Nemschoff or its suppliers, and Nemschoff reserves all such rights. All waivers of any right hereunder must be in writing and signed

by Nemschoff.

Waiver or breach by the other party of any provision of these Terms shall not be deemed a waiver of future compliance with these Terms, which shall remain in full force and effect.

If any provision of these Terms is held invalid by any U.S. law or regulation or by any U.S. court having jurisdiction, such invalidity will not affect the enforceability of other provisions.

These Terms and Buyer's rights may not be assigned by Buyer without the prior written consent of Nemschoff. Any unauthorized assignment by Buyer shall be void.

These Terms shall be governed by the laws of the state of Wisconsin without reference to any conflict-of-law rule that would cause the application of the laws of any other jurisdiction and without regard to the U.N. Convention on Contracts for the International Sale of Goods. Buyer and Nemschoff expressly agree that any unresolved disputes shall be resolved exclusively in the District Court for the Eastern District of Wisconsin or in the Circuit Court of Wisconsin, County of Milwaukee.

These terms constitute the entire agreement between Nemschoff and Buyer with respect to the Buyer's purchases of the Products and supersedes all prior agreements and understandings with respect to such purchase and may not be changed or amended, or superseded by conflicting terms and conditions submitted by Buyer except by a written instrument signed by an authorized Nemschoff representative.

**Cartoning Charges**

<b>Category A – \$93 list</b>	
Tables	Footboards
Table Bases	Bedside Cabinets
Table Tops	Mirrors
Guest Chairs	Cushions & Bolsters
Footstools	Junior Chairs
Coat Racks	Toy Boxes
Overbed Tables	Three Drawer Chests
Bookshelves	Benches
Headboards	
<b>Category B – \$172 list</b>	
Chairs	Settees & Two Seat Units
Rockers & Gliders	Four & Five Drawer Chests
Recliners	
<b>Category C – \$244 list</b>	
Sofas & Three Seat Units	Platform Beds
Desks	Treatment Chairs
Wardrobes	Double Dressers
TV Armoires	



# Ordering

## Collections by Brand

If you know which collection a Nemschoff product belongs to, this index will tell you what brand to enter when placing an order online.

### Nemschoff Collections

- |                       |                   |                        |
|-----------------------|-------------------|------------------------|
| • 2000 Series         | • Diane           | • Montello             |
| • 2600, 2700          | • Easy Access     | • Oasis Overbed Tables |
| • 2750                | • Evita           | • Oliver               |
| • 2755                | • Erica           | • Olivia               |
| • 2770                | • EZ-123          | • Overbed Tables       |
| • Altair              | • Finley          | • Pamona               |
| • Anderson            | • Franklin        | • Perinatal            |
| • Avery               | • Hadleigh        | • Prague II            |
| • Beaumont            | • Harmon          | • Princeton            |
| • Bedford             | • Hudson          | • Pristo               |
| • Behavioral Health   | • Iris            | • Riva                 |
| • Brava               | • Junior Recliner | • Rockwood             |
| • Brooklyn            | • Lauderdale      | • Serenity             |
| • Capella             | • Leonard II      | • SleepOver            |
| • Caregiver Stools    | • Marco           | • Sophia               |
| • Carlson             | • Marco Grande II | • Steps                |
| • Cities              | • Marsack         | • Ten                  |
| • Consoul             | • Maurice         | • Terra                |
| • Cubes and Cylinders | • Mayfield        | • Torii                |
| • Custom Tables       | • McKinley        | • Valor                |
| • Culla               | • Merge           | • Wallsaver            |
| • Dex                 | • Monarch         |                        |

### Brandrud Collections

- |              |                |
|--------------|----------------|
| • Auburn     | • Nala         |
| • Centé      | • Pause        |
| • Florabella | • Reliant      |
| • Horizon    | • Revive       |
| • Meridian   | • Romeo/Juliet |
| • Mod Pod    | • Work Haven   |
| • Ottoman    |                |

## Trademarks

The following are trademarks of their respective owners and may not be used or reproduced without their express written permission.

### Trademarks of Nemschoff Chairs, Inc.

ABC®  
 Centé®  
 Cities®  
 CompactComfort®  
 Consoul™  
 Dex™  
 Flop®  
 Florabella™ Collection  
 Fold-Flat Comforter®  
 Harmon™  
 Improving The Health Of Healthcare  
 Environments®  
 Monarch™  
 Nemschoff®  
 Palisade™  
 Pamona™  
 Pause®  
 Prísto®  
 Public Areas, Personal Spaces®  
 Real World R & D®  
 Revive™  
 Serenity®  
 SleepOver®  
 Terra™  
 Valor™  
 We define personal space within public areas®  
 Whisk™

### Trademarks of Herman Miller, Inc.

Durawrap™

Maharam®  
 Nala®

### Other Trademarks

Agion® is a registered trademark of Agion Technologies, Inc.

Corian® is a registered trademark of E.I. duPont de Nemours and Company Corporation.

Crypton® is a registered trademark of Crypton, Inc.

DesignTex™ is a trademark of Steelcase Inc. GREENGUARD is a registered trademark of the GREENGUARD Environmental Institute.

MOMENTUM® is a registered trademark of Momentum Textiles, Inc.

Varia Ecoresin® is a registered trademark of 3Form Inc.

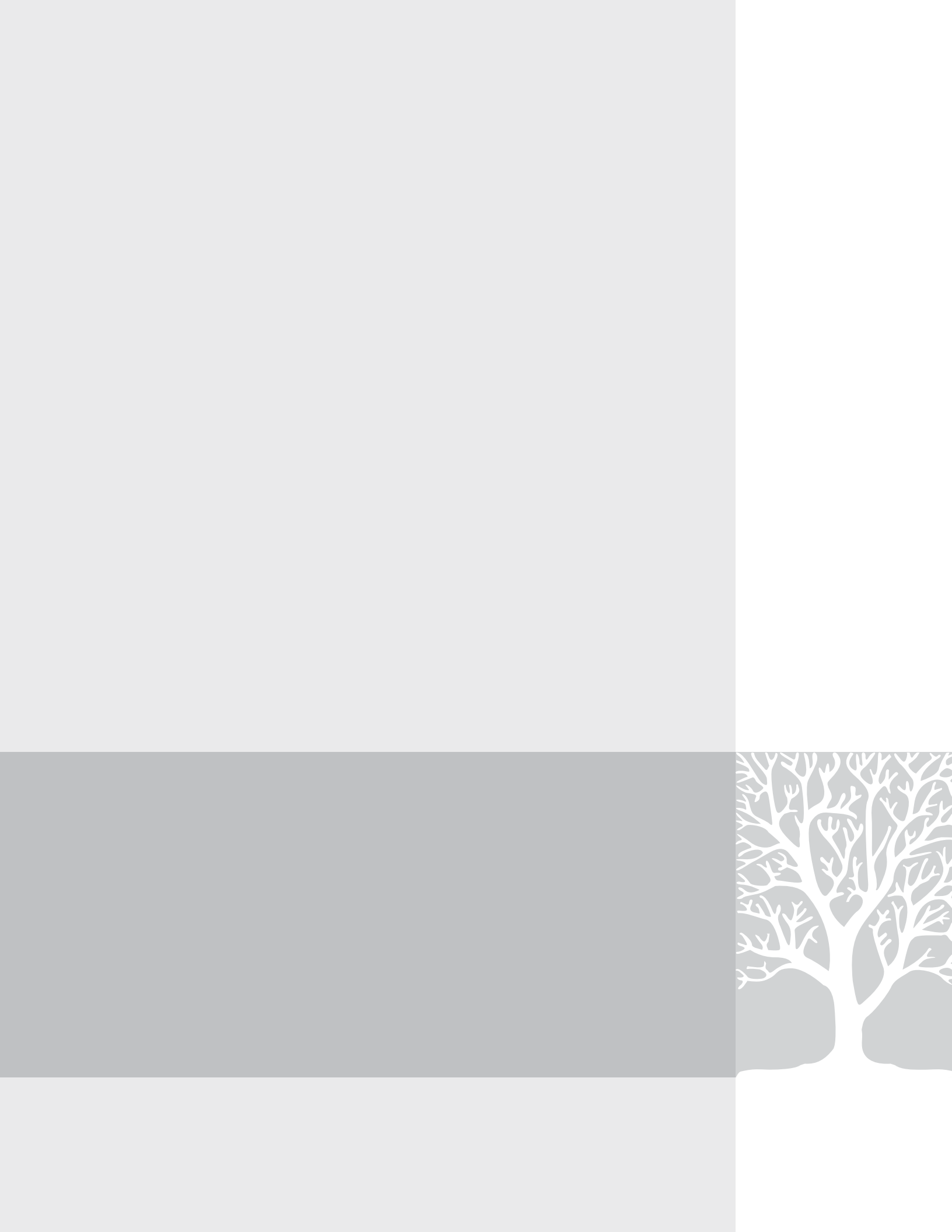



Our Customer Service  
Representatives are ready  
to answer questions  
and work with you to  
find the best solution for  
any challenge.

Nemschoff  
909 North 8th Street  
Sheboygan, WI 53081

P.O. Box 129  
Sheboygan, WI 53082-0129

Toll-Free: 800.203.8916  
Fax: 920.459.1234  
[sales@nemschoff.com](mailto:sales@nemschoff.com)