

**Quality  
Punches,  
Pilots,  
Die Buttons,  
& Retainers**

# BAILLOCK



Global leader in  
providing fabrication  
and stamping solutions

a MISUMI Group Company

[www.daytonlamina.com](http://www.daytonlamina.com)

**Improved  
performance,  
less downtime,  
longer tool life**



# Ball Lock Quality Products

## Product Applications

**Dayton Ball Lock Punches, Retainers, Die Buttons, and Accessories** are mainstays in industries with high-demand applications, including automotive and major appliance manufacturing. Because there is no need to pull a die from the press, removal and replacement of worn punches can reduce downtime and improve profitability.

**Dayton Ball Lock Punches** add longer tool life and improve finished part quality. For example, *Dayton Jektol® Punches* (slug ejection punches) provide increased punch to die button clearance; can triple the number of cycles between punch regrinds; and extend tool life.

**Dayton Ball Lock Die Buttons** include *Ball Lock, Press Fit, and EDM Die Button Blanks*.

**Dayton Ball Lock Retainers** provide many features, functions, and benefits. For example, *Dayton True Position® Retainers* (the recognized industry standard) eliminate hand fitting; reduce mounting time, and are ideally suited for both round and complex-shaped products. Other Dayton Retainers include *Multi-Position™, End and Square, Single Punch,* and our unique line of *EZ Fit™ Retainers*—a simpler, better way to reconfigure and/or replace existing retainers.

**Dayton Ball Lock Accessories** (e.g., backing plugs, ball release tools, and urethane strippers) complete the full line of Dayton Ball Lock products, and can help speed up and improve production. For example, *Dayton Punch Pullers* (left photo) are simple and easy to use. Just slide the punch puller over the punch shank, rotate the built-in wrench until it is tight, re-lease the ball, and pull down.



## Ordering Information

Each page contains detailed instructions on how to order specific Dayton Ball Lock products. Individual product drawings completely define the product—including shape, dimensions, tolerances, and concentricity. When ordering, you are asked to specify quantity, product type, shank and length codes, and point or hole size (for example).

In the example below, the type specified is “HPR.” “H” stands for heavy duty, “P” stands for punch, and “R” stands for rectangle. 50 is the shank diameter, which is coded by the first two digits of the decimal equivalent (.500”). 275 is the overall length, which is coded by inches and quarter-inches (2.75”). Finally, P.350 and W.190 represent the point or hole size dimension.

### HOW TO ORDER

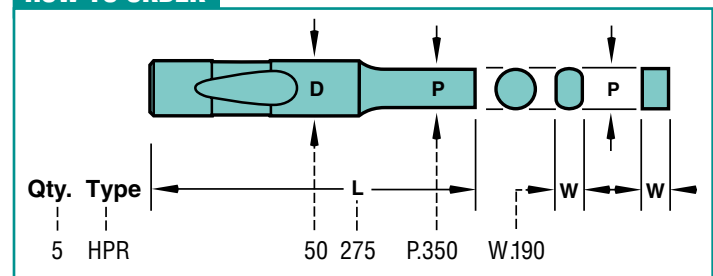

## Standard Alterations

Punches, die buttons, and retainers are available in sizes other than those listed in the catalog.

When ordering, you are asked to specify different designations for various non-standard dimensions. For example, if the P and W dimensions are outside the standard range, an “X” is placed in front of the P or W dimension, e.g., “XP” and/or “XW.” If the point length is longer or shorter than standard, designate “XB” for the point length. See the foldout tabs in the individual product sections for these and other special order designations.

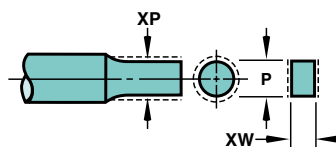

## Punches

### Standard Shapes

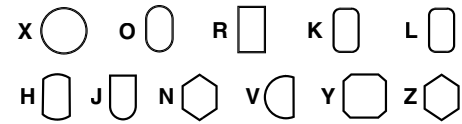

### HJ\_ Jektol<sup>®</sup>—Heavy Duty 4, 5



### HP\_ Regular—Heavy Duty 6, 7



### HPT Pilots—Heavy Duty 8, 9



### HPA Pilots—Heavy Duty 10, 11



### HJB/HPB Blanks 12



### HK\_/HZ\_—Heavy Duty 13



### LJ\_ Jektol<sup>®</sup>—Light Duty 14, 15



### LP\_ Regular—Light Duty 16, 17



### LPT Pilots—Light Duty 18, 19



### LPA Pilots—Light Duty 20, 21



## Punches (cont'd)

### LJB/LPB Blanks 22

—Light Duty  
Jektol<sup>®</sup>/Regular

### LK\_/LZ\_—Light Duty 23

Point Larger than Shank Jektol<sup>®</sup>/Regular

## Die Buttons

### LD\_ Die Buttons—Ball Lock 24



### KD\_ Die Buttons—Press Fit 25



### KDU/KDE 38



## Retainers

### HRP/LRP Retainers 26

—Heavy Duty/Light Duty  
Multi-Position<sup>™</sup>

### HRT/LRT Retainers 27

—Heavy Duty/Light Duty  
True Position<sup>®</sup> with Backing Plug

### HRTB Single Punch 28

—Heavy Duty  
True Position<sup>®</sup> with Backing Plate

### HRI/LRI Inserts 29

—Heavy Duty/Light Duty

## Retainers (cont'd)

### \_RE End 30

—Heavy Duty/Light Duty

### \_RS Square 31

—Heavy Duty/Light Duty

## Miscellaneous/Other

### Classified Shapes 32, 33



### Form Shapes 34, 35



### Accessories 36, 37



### Jektol<sup>®</sup> Data 39



### Locking Devices 40

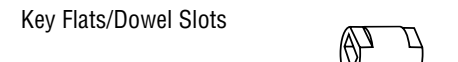

### Urethane Strippers 41



### Shear Angles 42



## Product Designation

Each page contains detailed instructions on how to order specific Dayton Ball Lock products. In addition, use the following chart to define the product as a part number.

**Example:**

<b>HPR</b>	<b>Line Product Shape</b>	<b>H</b> is for Heavy Duty <b>P</b> is for Punch (Regular) <b>R</b> is for Rectangle
<b>50</b>	<b>Shank Dia. D</b> (shank diameter) Coded by the first 2 digits of dec. equiv. (.500).	
<b>275</b>	<b>Overall Length L</b> Coded by whole number and first two digits of dec. equiv. (2.750).	
<b>Product Type</b>	<b>Series Catalog Number</b>	<b>Point or Hole Size Dimensions, As Specified</b>
HPR	50	P.350, W.190

Diameter (D) is shown on the order as a two- or three-digit code. To convert the shank diameter to the appropriate code, use the following chart.

Code	D	Code	D	Code	D
12	.1250	50	.5000	150	1.5000
18	.1875	62	.6250	175	1.7500
25	.2500	75	.7500	200	2.0000
31	.3125	87	.8750	225	2.2500
37	.3750	100	1.0000	250	2.5000
43	.4375	125	1.2500	275	2.7500

## Classified Shapes

Classified shapes (83 common shapes, no detailing required) are available on all punches, die buttons, and guide bushings, as indicated in this catalog. See pp. 32, 33 for more information and special instructions. Also, see individual product pages and p. 40 for additional information on orientation and views.

## Clearance

Normal grinding methods produce:

- .007 max. fillet on the punch — matching corner shape on the die button.
- .007 max. fillet on the die button — matching corner shape on the punch.

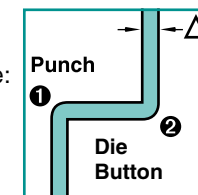

# Jektole® Punches Heavy Duty

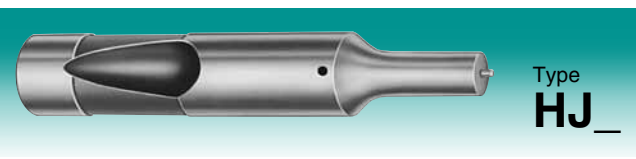

**Material**  
Steel: A2, M2, PS4, RC 60-63

Round P  $\pm .0005$   $\text{P to D}$   
Shape P, W  $\pm .0005$   $\text{P to D}$

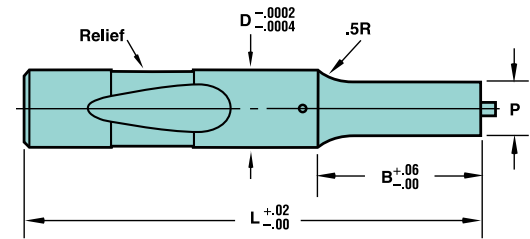

# Jektole® Punches Heavy Duty

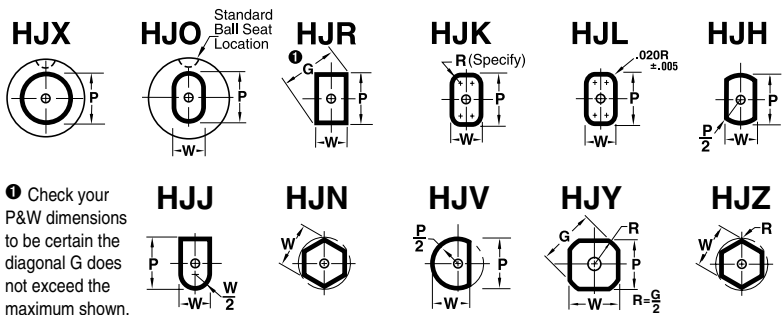

Check your P&W dimensions to be certain the diagonal G does not exceed the maximum shown.

## Features/Benefits

Jektole® punches permit doubling punch to die button clearance; produce up to three times the number of hits between sharpenings; and reduce burr heights.

### HOW TO ORDER

Specify:	Qty.	Type	D Code	L	P (or P&W)	Steel
Example:	25	HJX	37	C300	P.175	A2
	12	HJO	75	450	P.692, W.312	M2

### Standard Ball Seat Locations

Standard Ball Seat Location is at 90°. Alternate locations of 0°, 180°, or 270° can be specified at no additional cost.

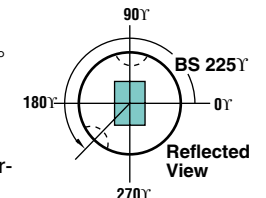

### Custom Ball Seat Locations

Custom Ball Seat Locations can be specified as "BS" and degrees counter-clockwise from 0°. For additional information, see "Locking Devices" on p. 40.

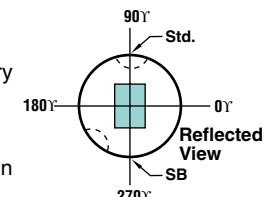

### Double Ball Seat

A second ball seat may be specified. Normally located 180° from the primary ball seat, these are used to minimize sharpening of notching punches by rotating the punch 180°. Specify "SB" and degree desired. A second ball can also be located 90° from the primary ball seat.

Not recommended for diameters under .750.



## Standard Alterations

Jektole® punches are available in sizes other than those shown in the chart to the left.

When ordering, you are asked to specify different designations for various non-standard dimensions. For example, if the P and W dimensions are outside the standard range, an "X" is placed in front of the P or W dimension, e.g., "XP" and/or "XW." If the point length is other than standard, designate "XB" as the point length. Also see "Standard Alterations" on the front of the pullout tab in this section for other special order designators.

# Standard Alterations Jektole® Punches—Heavy Duty

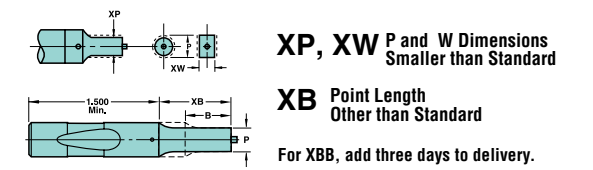

Point Length	XB										XBB
	5001-6250	6251-7500	7501-8750	8751-10000	10001-11250	11251-12500	12501-13750	13751-15000	15001-16250	16251-20000	
Code Type	Min. P (Rounds)										
37 HJX	.062	.062	.080	.080	.115	.115	.115	.115	.115	.115	
50 HJX	.158	.158	.158	.158	.158	.158	.158	.158	.158	.187	
62 HJX	.158	.158	.158	.158	.158	.158	.158	.158	.158	.187	
75 HJX	.235	.235	.235	.235	.235	.235	.235	.235	.235	.281	
87 HJX	.300	.300	.300	.300	.300	.300	.300	.300	.300	.350	
100 HJX	.350	.350	.350	.350	.350	.350	.350	.350	.350	.350	
125 HJX	.450	.450	.450	.450	.450	.450	.450	.450	.450	.450	
	Min. W (Shapes)										
37 HJ	.062	.062	.080	.080	.115	.115	.115	.115	.115	.115	
50 HJ	.158	.158	.158	.158	.158	.158	.158	.158	.158	.187	
62 HJ	.158	.158	.158	.158	.158	.158	.158	.158	.158	.187	
75 HJ	.235	.235	.235	.235	.235	.235	.235	.235	.235	.281	
87 HJ	.235	.235	.235	.235	.235	.235	.235	.235	.235	.281	
100 HJ	.235	.235	.235	.235	.235	.235	.235	.235	.235	.281	
125 HJ		.281	.281	.281	.281	.281	.281	.281	.281	.281	

**XL Overall Length Shortened**  
Stock removal from point end which shortens B length. To maintain "B", specify "XLB".

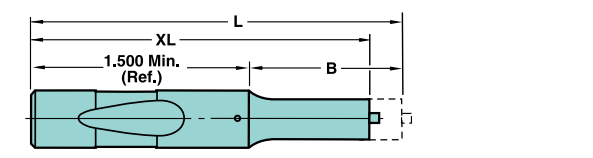

**XLB Overall Length Shortened**  
B length maintained

**XJ Smaller Jektole® Components**  
See p. 39

**XK No sidehole**  
For air injection. No cost.

**LL Precision Overall Length**  
Same as XL except overall length is held to  $\pm .001$ .

### SBR Straight Before Radius

- To determine Length of Radius Blend (LRB)
  - Calculate (D-P)/2.
  - Find (D-P)/2 value on left side of chart.
  - Follow line over to intersection point on radius blend line.
  - Read LRB value on bottom of chart.

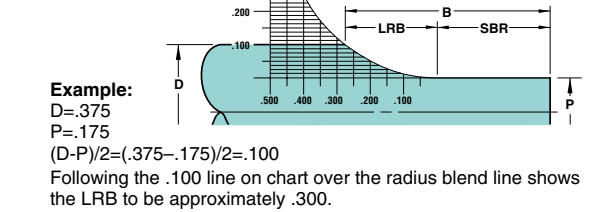

## Surface Coatings

Some catalog products can be coated to increase hardness, reduce galling, and improve wear and/or corrosion resistance.

**DayTride® (XN)**—a low-cost surface application that treats all exposed surfaces. Ideal for punches and die buttons. Provides high dimensional stability. Approx. hardness: RC73.

**DayTiN® (XNT)**—applied via PVD (physical vapor deposition). Provides extreme hardness (hard as carbide) and excellent lubricity when used with a lubricant. Not recommended for stainless steel, copper, or nickel. Approx. hardness: \*Vickers 2300.

**DayTAN™ (XAN)**—ultra-hard, high-aluminum PVD coating. Absorbs shear stress and provides high temperature resistance. Ideal for HSLA, dual phase, and TRIP steels. Approx. hardness: \*Vickers 3400.

**TiCN (XCN)**—very hard PVD, thin film. Provides ultra hardness (harder than carbide) and superior abrasive wear resistance. Approx. hardness: \*Vickers 3000.

**XNM**—PVD, solid film. Produces lower coefficient of friction than other coatings. Provides excellent lubricity. Approx. hardness: \*Vickers 2000.

**XNP**—the ultimate coating for extrusion and forming applications. Also works well in shaving operations. Tolerance is  $\pm .0002$ . Approx. hardness: \*Vickers 3100.

**DayKool™ (XCR)**—cryogenic steel conditioning process, used primarily with hard, thick materials. Improves strength, toughness, and dimensional stability.

**CrN (CRN)**—excellent adhesion, high toughness, and good corrosion resistance. Primary applications are metal forming (copper, brass, bronze), metal die casting, and plastic injection molding. Approx. hardness: \*Vickers 1800-2100.

**ZertonPlus™ (XNA)**—excellent wear resistance, thermal shock stability and hot hardness. Approx. hardness \*Vickers 3200.

**XNAPprogress (XNAP)**—ultra-hard PVD coating that absorbs shear stress; provides excellent high-temperature resistance. Ideal for stamping where tools are exposed to extreme stress profiles. A good alternative to TD coating without the dimensional changes associated with that process. Approx hardness: \*Vickers 3200.

**Diamond Like Carbon Coating (XCD)**—combines high hardness with an extremely low coefficient of friction. Good protection against abrasive & adhesive wear. Approx. hardness \*Vickers 5000.

Code / Delivery		Material
XN —DayTride®	+ 3 days	M2 & PS4
XNT —DayTiN®	+ 3 days	M2 & PS4
XAN —DayTAN™	+ 4 days	M2 & PS4
XCN —TiCN	+ 3 days	M2 & PS4
XNM	+12 days	M2 & PS4
XNP	+ 8 days	M2 & PS4
XCR —DayKool™	+ 1 day	M2 & PS4
CRN	+ 7 days	M2 & PS4
XNA —ZertonPlus™	+ 7 days	M2 & PS4
XNAP—XNAPprogress	+12 days	M2 & PS4
XCD	+ 8 days	M2 & PS4

\* Vickers used when RC exceeds 80.  
© DayTride and DayTiN are registered trademarks of Dayton Progress.  
™ DayTAN, DayKool, and ZertonPlus are trademarks of Dayton Progress.

# Regular Punches Heavy Duty

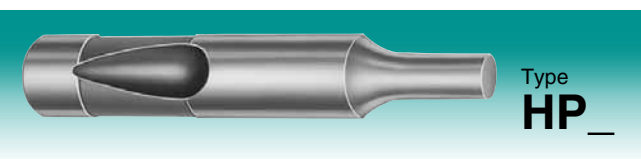

**Material**  
Steel: A2, M2, PS4, RC 60-63

Round P  $\pm .0005$   
Shape P, W  $\pm .0005$

© .0005 P to D  
© .001 P to D

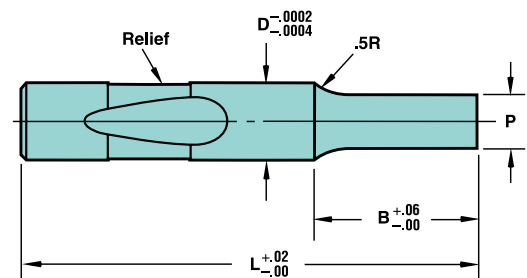

# Regular Punches Heavy Duty

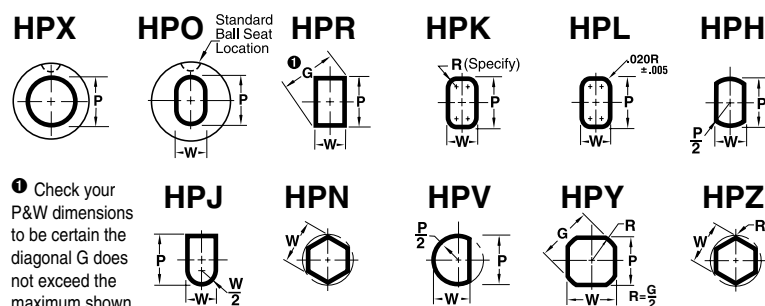

Check your P&W dimensions to be certain the diagonal G does not exceed the maximum shown.

## Features/Benefits

Regular punches provide three times better alignment than other major brands; offer longer tool life; and can significantly improve finished part quality.

### HOW TO ORDER

Specify:	Qty.	Type	D	Code	L	P (or P&W)	Steel
Example:	16	HPX	62	B375		P.370	M2
	7	HPR	50	300		P.327, W.254	A2

### Standard Ball Seat Locations

Standard Ball Seat Location is at 90°. Alternate locations of 0°, 180°, or 270° can be specified at no additional cost.

### Custom Ball Seat Locations

Custom Ball Seat Locations can be specified as "BS" and degrees counter-clockwise from 0°. For additional information, see "Locking Devices" on p. 40.

### Double Ball Seat

A second ball seat may be specified. Normally located 180° from the primary ball seat, these are used to minimize sharpening of notching punches by rotating the punch 180°. Specify "SB" and degree desired. A second ball can also be located 90° from the primary ball seat.

Not recommended for diameters under .500.

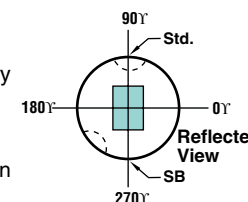
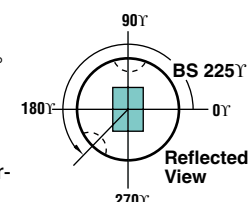

## Standard Alterations

Regular Ball Lock punches are available in sizes other than those shown in the chart to the left.

When ordering, you are asked to specify different designations for various non-standard dimensions. For example, if the P and W dimensions are outside the standard range, an "X" is placed in front of the P or W dimension, e.g., "XP" and/or "XW." If the point length is other than standard, designate "XB" as the point length. Also see "Standard Alterations" on the front of the pullout tab in this section for other special order designators.

# Standard Alterations Regular Punches—Heavy Duty

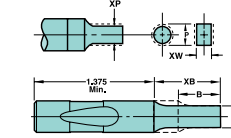

**XP, XW** P and W Dimensions Smaller than Standard

**XB** Point Length Other than Standard

For XBB and X3B, add three days to delivery.

Point Length	XB										XBB	X3B
	.5001-.6251	.6251-.7501	.7501-.8751	.8751-1.0001	1.0001-1.1251	1.1251-1.2501	1.2501-1.3751	1.3751-1.5001	1.5001-1.6251	1.6251-1.7501	1.7501-2.0001	2.0001-2.5001
Code Type	Min. P (Rounds)											
37 HPX	.050	.050	.080	.080	.106	.115	.115	.115	.115	.187	.250	.312
50 HPX	.093	.093	.093	.125	.125	.125	.125	.125	.125	.187	.250	.312
62 HPX	.125	.125	.125	.158	.158	.158	.158	.158	.158	.187	.250	.312
75 HPX	.235	.235	.235	.235	.235	.235	.235	.235	.235	.281	.375	.375
87 HPX	.300	.300	.300	.300	.300	.300	.300	.300	.300	.350	.375	.437
100 HPX	.350	.350	.350	.350	.350	.350	.350	.350	.350	.350	.375	.437
125 HPX	.450	.450	.450	.450	.450	.450	.450	.450	.450	.450	.450	.450
	Min. W (Shapes)											
37 HP	.050	.050	.080	.080	.106	.115	.115	.115	.115	.156		
50 HP	.093	.093	.093	.125	.125	.125	.125	.125	.125	.156		
62 HP	.125	.125	.125	.158	.158	.158	.158	.158	.158	.187		
75 HP	.235	.235	.235	.235	.235	.235	.235	.235	.235	.250		
87 HP	.235	.235	.235	.235	.235	.235	.235	.235	.235	.250		
100 HP	.235	.235	.235	.235	.235	.235	.235	.235	.235	.250		
125 HP	.235	.235	.235	.235	.235	.235	.235	.235	.235	.265		

### XL Overall Length Shortened

Stock removal from point end which shortens B length. To maintain "B", specify "XLB".

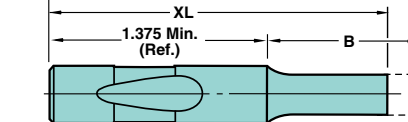

### XLB Overall Length Shortened

B length maintained

### LL Precision Overall Length

Same as XL except overall length is held to ±.001.

### SBR Straight Before Radius

To determine Length of Radius Blend (LRB)

1. Calculate (D-P)/2.
2. Find (D-P)/2 value on left side of chart.
3. Follow line over to intersection point on radius blend line.
4. Read LRB value on bottom of chart.

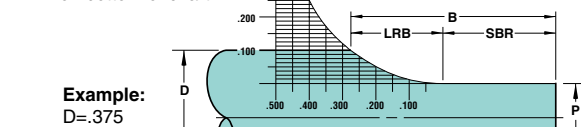

**Example:**  
D=.375  
P=.175  
(D-P)/2=(.375-.175)/2=.100  
Following the .100 line on chart over the radius blend line shows the LRB to be approximately .300.

## Surface Coatings

Some catalog products can be coated to increase hardness, reduce galling, and improve wear and/or corrosion resistance.

**DayTride® (XN)**—a low-cost surface application that treats all exposed surfaces. Ideal for punches and die buttons. Provides high dimensional stability. Approx. hardness: RC73.

**DayTiN® (XNT)**—applied via PVD (physical vapor deposition). Provides extreme hardness (hard as carbide) and excellent lubricity when used with a lubricant. Not recommended for stainless steel, copper, or nickel. Approx. hardness: \*Vickers 2300.

**DayTAN™ (XAN)**—ultra-hard, high-aluminum PVD coating. Absorbs shear stress and provides high temperature resistance. Ideal for HSLA, dual phase, and TRIP steels. Approx. hardness: \*Vickers 3400.

**TiCN (XCN)**—very hard PVD, thin film. Provides ultra hardness (harder than carbide) and superior abrasive wear resistance. Approx. hardness: \*Vickers 3000.

**XNM**—PVD, solid film. Produces lower coefficient of friction than other coatings. Provides excellent lubricity. Approx. hardness: \*Vickers 2000.

**XNP**—the ultimate coating for extrusion and forming applications. Also works well in shaving operations. Tolerance is ± .0002. Approx. hardness: \*Vickers 3100.

**DayKool™ (XCR)**—cryogenic steel conditioning process, used primarily with hard, thick materials. Improves strength, toughness, and dimensional stability.

**CrN (CRN)**—excellent adhesion, high toughness, and good corrosion resistance. Primary applications are metal forming (copper, brass, bronze), metal die casting, and plastic injection molding. Approx. hardness: \*Vickers 1800-2100.

**ZertonPlus™ (XNA)**—excellent wear resistance, thermal shock stability and hot hardness. Approx. hardness \*Vickers 3200.

**XNAProgress (XNAP)**—ultra-hard PVD coating that absorbs shear stress; provides excellent high-temperature resistance. Ideal for stamping where tools are exposed to extreme stress profiles. A good alternative to TD coating without the dimensional changes associated with that process. Approx hardness: \*Vickers 3200.

**Diamond Like Carbon Coating (XCD)**—combines high hardness with an extremely low coefficient of friction. Good protection against abrasive & adhesive wear. Approx. hardness \*Vickers 5000.

Code / Delivery		Material
XN —DayTride®	+ 3 days	M2 & PS4
XNT —DayTiN®	+ 3 days	M2 & PS4
XAN —DayTAN™	+ 4 days	M2 & PS4
XCN —TiCN	+ 3 days	M2 & PS4
XNM	+12 days	M2 & PS4
XNP	+ 8 days	M2 & PS4
XCR —DayKool™	+ 1 day	M2 & PS4
CRN	+ 7 days	M2 & PS4
XNA —ZertonPlus™	+ 7 days	M2 & PS4
XNAP—XNAProgress	+12 days	M2 & PS4
XCD	+ 8 days	M2 & PS4

\* Vickers used when RC exceeds 80.  
© DayTride and DayTiN are registered trademarks of Dayton Progress.  
™ DayTAN, DayKool, and ZertonPlus are trademarks of Dayton Progress.





# Punch Blanks Jektole® & Regular Heavy Duty

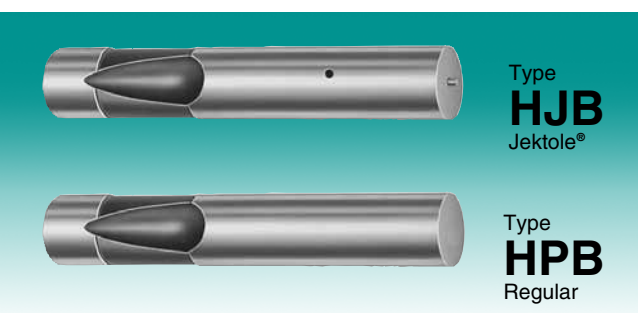

**Material**  
Steel: A2, M2, PS4, RC 60-63

Type	Shank		L													* Jektole® Group		
	D	Code	2.50	2.75	3.00	3.25	3.50	3.75	4.00	4.25	4.50	4.75	5.00	5.25	5.50		5.75	6.00
HJB	.375	37																J4
	.500	50																J6
	.625	62	250	275														J6
	.750	75			300	325	350	375	400	425	450	475	500	525	550	575	600	J9
	.875	87																J9
	1.000	100																J9
1.250	125																J12	

Type	Shank		L														* Jektole® Group							
	D	Code	2.50	2.75	3.00	3.25	3.50	3.75	4.00	4.25	4.50	4.75	5.00	5.25	5.50	5.75		6.00	6.25	6.50	6.75	7.00		
HPB	.375	37																						J4
	.500	50																						J6
	.625	62	250	275																				J6
	.750	75			300	325	350	375	400	425	450	475	500	525	550	575	600	625	650	675	700			J9
	.875	87																						J9
	1.000	100																						J9
1.250	125																						J12	

\*See p. 39 for additional information.

**HOW TO ORDER**

Specify:	Qty.	Type	D Code	L	Steel
Example:	12	HJB	50	300	M2
	5	HPB	75	400	A2



# Point Larger than Shank Jektole® & Regular Heavy Duty

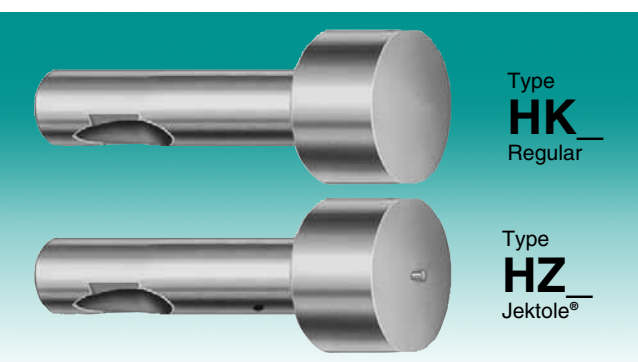

**Material**  
Steel: A2, M2, RC 60-63.  
Round P  $\pm .0005$  to D  
Shape P, W  $\pm .0005$

Check your P&W dimensions to be certain the diagonal G does not exceed the maximum shown.

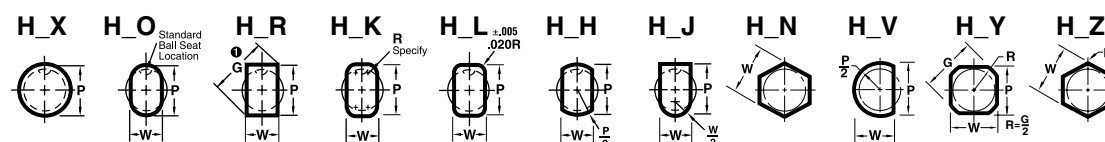

Type	Shank		Point Lgth. B	Round Range P	Shape			L										* Jektole® Group					
	D	Code			Min. XW	Min. W	Max. P/G	2.50	2.75	3.00	3.25	3.50	3.75	4.00	4.25	4.50							
HK Regular HZ Jektole®	.375	37	.62	.376-.875	.062	.125-.875																	J4
	.500	50	.75	.501-1.250	.158	.188-1.250																	J6
	.625	62	.88	.626-1.500	.158	.250-1.500	250																J6
	.750	75	.94	.751-1.500	.235	.312-1.500		275	300	325	350	375	400	425	450								J9
	.875	87	.94	.876-1.750	.235	.375-1.750																	J9
	1.000	100	.94	1.001-1.750	.235	.437-1.750																	J9
1.250	125	1.25	1.251-2.000	.281	.500-2.000																	J12	

\*See p. 39 for additional information.

### Standard Ball Seat Locations

Standard Ball Seat Location is at 90°. Alternate locations of 0°, 180°, or 270° can be specified at no additional cost.

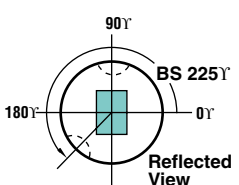

### Custom Ball Seat Locations

Custom Ball Seat Locations can be specified as "BS" and degrees counter-clockwise from 0°. For additional information, see "Locking Devices" on p. 40.

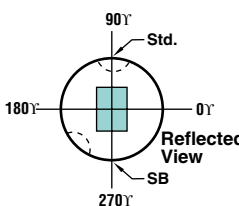

### Double Ball Seat

A second ball seat may be specified. Normally located 180° from the primary ball seat, these are used to minimize sharpening of notching punches by rotating the punch 180°. Specify "SB" and degree desired. A second ball can also be located 90° from the primary ball seat.

Not recommended for diameters under .750 for HZ and .500 for HK.



### HOW TO ORDER

Specify:	Qty.	Type	D Code	L	P (or P&W)	Steel
Example:	2	HKR	100	350	P1.350, W.500	M2

### Standard Alterations

Point Larger than Shank Ball Lock punches are available in sizes other than those shown in the chart above.

When ordering, you are asked to specify different designations for various non-standard dimensions. For example, if the P and W dimensions are outside the standard range, an "X" is placed in front of the P or W dimension, e.g., "XP" and/or "XW." If the point length is other than standard, designate "XB" as the point length. Also see "Standard Alterations" on the front of the pullout tab in this section for other special order designators.

# Standard Alterations Point Larger than Shank—Heavy Duty

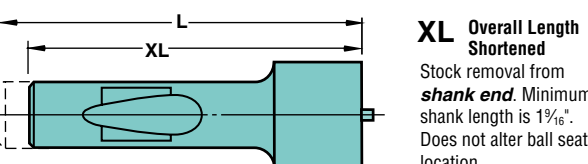
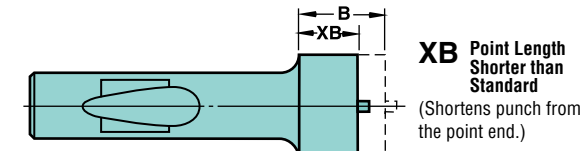

LL Precision Overall Length Same as XL except overall length is held to  $\pm .001$ .

### Surface Coatings

Some catalog products can be coated to increase hardness, reduce galling, and improve wear and/or corrosion resistance.

**DayTride® (XN)**—a low-cost surface application that treats all exposed surfaces. Ideal for punches and die buttons. Provides high dimensional stability. Approx. hardness: RC73.

**DayTiN® (XNT)**—applied via PVD (physical vapor deposition). Provides extreme hardness (hard as carbide) and excellent lubricity when used with a lubricant. Not recommended for stainless steel, copper, or nickel. Approx. hardness: \*Vickers 2300.

**DayTAN™ (XAN)**—ultra-hard, high-aluminum PVD coating. Absorbs shear stress and provides high temperature resistance. Ideal for HSLA, dual phase, and TRIP steels. Approx. hardness: \*Vickers 3400.

**TiCN (XCN)**—very hard PVD, thin film. Provides ultra hardness (harder than carbide) and superior abrasive wear resistance. Approx. hardness: \*Vickers 3000.

**XNM**—PVD, solid film. Produces lower coefficient of friction than other coatings. Provides excellent lubricity. Approx. hardness: \*Vickers 2000.

**XNP**—the ultimate coating for extrusion and forming applications. Also works well in shaving operations. Tolerance is  $\pm .0002$ . Approx. hardness: \*Vickers 3100.

**DayKool™ (XCR)**—cryogenic steel conditioning process, used primarily with hard, thick materials. Improves strength, toughness, and dimensional stability.

**CrN (CRN)**—excellent adhesion, high toughness, and good corrosion resistance. Primary applications are metal forming (copper, brass, bronze), metal die casting, and plastic injection molding. Approx. hardness: \*Vickers 1800-2100.

**ZertonPlus™ (XNA)**—excellent wear resistance, thermal shock stability and hot hardness. Approx. hardness \*Vickers 3200.

**XNAProgress (XNAP)**—ultra-hard PVD coating that absorbs shear stress; provides excellent high-temperature resistance. Ideal for stamping where tools are exposed to extreme stress profiles. A good alternative to TD coating without the dimensional changes associated with that process. Approx. hardness: \*Vickers 3200.

**Diamond Like Carbon Coating (XCD)**—combines high hardness with an extremely low coefficient of friction. Good protection against abrasive & adhesive wear. Approx. hardness \*Vickers 5000.

Code / Delivery	Material
XN —DayTride®	+ 3 days M2 & PS4
XNT —DayTiN®	+ 3 days M2 & PS4
XAN —DayTAN™	+ 4 days M2 & PS4
XCN —TiCN	+ 3 days M2 & PS4
XNM	+12 days M2 & PS4
XNP	+ 8 days M2 & PS4
XCR —DayKool™	+ 1 day M2 & PS4
CRN	+ 7 days M2 & PS4
XNA —ZertonPlus™	+ 7 days M2 & PS4
XNAP—XNAProgress	+12 days M2 & PS4
XCD	+ 8 days M2 & PS4

\* Vickers used when RC exceeds 80.  
© DayTride and DayTiN are registered trademarks of Dayton Progress.  
™ DayTAN, DayKool, and ZertonPlus are trademarks of Dayton Progress.

### Dayton Slug Control

Dayton Slug Control is a guaranteed method for reducing the risk of pulling slugs to the die surface during withdrawal of the punch. A series of grooves is designed inside the die button. There, the slugs are trapped until they fall freely through the relief. The use of Dayton Slug Control has no effect on hole size, and will not require any changes in current regrind practices.

Our guarantee: *Use Dayton Slug Control in a stamping die now pulling slugs. If, for any reason, you are not completely satisfied, we will refund the full cost of the Slug Control alteration.* (We cannot guarantee the retention of slugs when clearance exceeds 10% per side.)

### Ordering

Dayton Slug Control is easy to specify and order. Simply add the information that is unique to your application to the die button catalog number. Please specify XSC for alteration and show material thickness (inches) and clearance per side (percentage).

**HOW TO ORDER**

Catalog Number			Your Specs		
Inch	KDX	62 100 P.250	XSC	MT.0625	CS 5
Type	D	L P	Alt. Code	Mat'l Thickness (inches)	Clear Per Side (%)

For additional information, contact your Dayton distributor.



# Jektole® Punches

## Light Duty

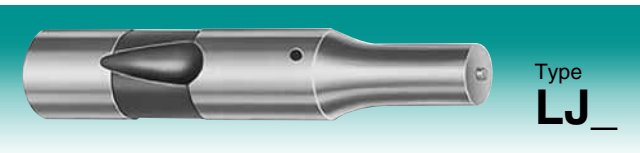

Type LJ

**Material**  
Steel: A2, M2, PS4, RC 60-63

Round P  $\pm .0005$   
Shape P, W  $\pm .0005$

© .0005 P to D  
© .001 P to D

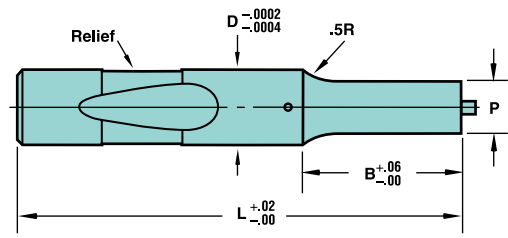

# Jektole® Punches

## Light Duty

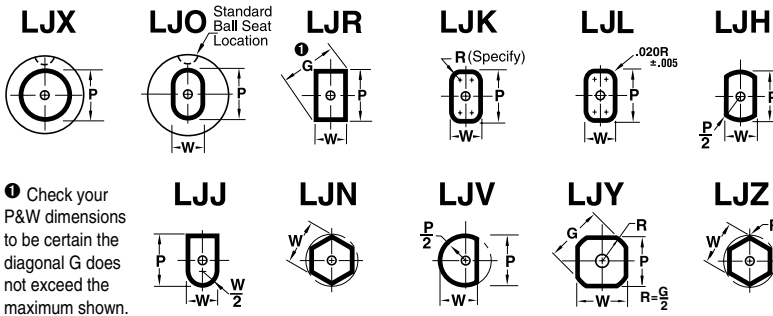

### Features/Benefits

Jektole® punches permit doubling punch to die button clearance; produce up to three times the number of hits between sharpenings; and reduce burr heights.

#### HOW TO ORDER

Specify:	Qty.	Type	D Code	L	P (or P&W)	Steel
Example:	21	LJX	37	325	P.175	A2
	15	LJR	50	400	P.327, W.254	M2

**Standard Ball Seat Locations**  
Standard Ball Seat Location is at 90°. Alternate locations of 0°, 180°, or 270° can be specified at no additional cost.

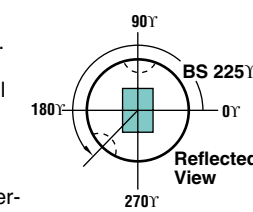

**Custom Ball Seat Locations**  
Custom Ball Seat Locations can be specified as "BS" and degrees counter-clockwise from 0°. For additional information, see "Locking Devices" on p. 40.

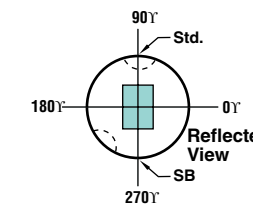

**Double Ball Seat**  
A second ball seat may be specified. Normally located 180° from the primary ball seat, these are used to minimize sharpening of notching punches by rotating the punch 180°. Specify "SB" and degree desired. A second ball can also be located 90° from the primary ball seat.

**Not recommended for diameters under .625.**



1 Day  
PS4 +2 Days

### Standard Alterations

Jektole® punches are available in sizes other than those shown in the chart to the left.

When ordering, you are asked to specify different designations for various non-standard dimensions. For example, if the P and W dimensions are outside the standard range, an "X" is placed in front of the P or W dimension, e.g., "XP" and/or "XW." If the point length is other than standard, designate "XB" as the point length. Also see "Standard Alterations" on the front of the pullout tab in this section for other special order designators.

### Surface Coatings

Some catalog products can be coated to increase hardness, reduce galling, and improve wear and/or corrosion resistance.

**DayTride® (XN)**—a low-cost surface application that treats all exposed surfaces. Ideal for punches and die buttons. Provides high dimensional stability. Approx. hardness: RC73.

**DayTIN® (XNT)**—applied via PVD (physical vapor deposition). Provides extreme hardness (hard as carbide) and excellent lubricity when used with a lubricant. Not recommended for stainless steel, copper, or nickel. Approx. hardness: \*Vickers 2300.

**DayTAN™ (XAN)**—ultra-hard, high-aluminum PVD coating. Absorbs shear stress and provides high temperature resistance. Ideal for HSLA, dual phase, and TRIP steels. Approx. hardness: \*Vickers 3400.

**TiCN (XCN)**—very hard PVD, thin film. Provides ultra hardness (harder than carbide) and superior abrasive wear resistance. Approx. hardness: \*Vickers 3000.

**XNM**—PVD, solid film. Produces lower coefficient of friction than other coatings. Provides excellent lubricity. Approx. hardness: \*Vickers 2000.

**XNP**—the ultimate coating for extrusion and forming applications. Also works well in shaving operations. Tolerance is ± .0002. Approx. hardness: \*Vickers 3100.

**DayKool™ (XCR)**—cryogenic steel conditioning process, used primarily with hard, thick materials. Improves strength, toughness, and dimensional stability.

**CrN (CRN)**—excellent adhesion, high toughness, and good corrosion resistance. Primary applications are metal forming (copper, brass, bronze), metal die casting, and plastic injection molding. Approx. hardness: \*Vickers 1800-2100.

**ZertonPlus™ (XNA)**—excellent wear resistance, thermal shock stability and hot hardness. Approx. hardness \*Vickers 3200.

**XNAProgress (XNAP)**—ultra-hard PVD coating that absorbs shear stress; provides excellent high-temperature resistance. Ideal for stamping where tools are exposed to extreme stress profiles. A good alternative to TD coating without the dimensional changes associated with that process. Approx hardness: \*Vickers 3200.

**Diamond Like Carbon Coating (XCD)**—combines high hardness with an extremely low coefficient of friction. Good protection against abrasive & adhesive wear. Approx. hardness \*Vickers 5000.

Code / Delivery	Material
XN —DayTride®	+ 3 days M2 & PS4
XNT —DayTiN®	+ 3 days M2 & PS4
XAN —DayTAN™	+ 4 days M2 & PS4
XCN —TiCN	+ 3 days M2 & PS4
XNM	+12 days M2 & PS4
XNP	+ 8 days M2 & PS4
XCR —DayKool™	+ 1 day M2 & PS4
CRN	+ 7 days M2 & PS4
XNA —ZertonPlus™	+ 7 days M2 & PS4
XNAP—XNAProgress	+12 days M2 & PS4
XCD	+ 8 days M2 & PS4

\* Vickers used when RC exceeds 80.  
© DayTride and DayTiN are registered trademarks of Dayton Progress.  
™ DayTAN, DayKool, and ZertonPlus are trademarks of Dayton Progress.

### Standard Alterations

#### Jektole® Punches—Light Duty

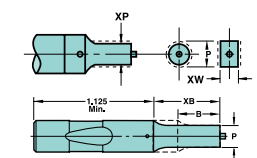

**XP, XW** P and W Dimensions  
Smaller than Standard

**XB** Point Length  
Other than Standard

For XBB, add three days to delivery.

Point Length	XB										XBB
	5001-.6250	.6251-.7500	.7501-.8750	.8751-1.0000	1.0001-1.1250	1.1251-1.2500	1.2501-1.3750	1.3751-1.5000	1.5001-1.6250	1.6251-2.0000	
Code Type	Min. P (Rounds)										
25 LJX	.050	.050	.080	.080							
37 LJX	.115	.115	.115	.115	.115	.115	.115	.115	.115		
50 LJX	.158	.158	.158	.158	.158	.158	.158	.158	.158	.187	
62 LJX	.158	.158	.158	.158	.158	.158	.158	.158	.158	.188	
75 LJX	.235	.235	.235	.235	.235	.235	.235	.235	.235	.281	
87 LJX	.300	.300	.300	.300	.300	.300	.300	.300	.300	.312	
100 LJX	.350	.350	.350	.350	.350	.350	.350	.350	.350	.350	
	Min. W (Shapes)										
25 LJL	.050	.050	.080	.080							
37 LJL	.115	.115	.115	.115	.115	.115	.115	.115	.115		
50 LJL			.158	.158	.158	.158	.158	.158	.158	.187	
62 LJL			.158	.158	.158	.158	.158	.158	.158	.188	
75 LJL			.235	.235	.235	.235	.235	.235	.235	.250	
87 LJL			.235	.235	.235	.235	.235	.235	.235	.250	
100 LJL			.235	.235	.235	.235	.235	.235	.235	.250	

**XL Overall Length Shortened**  
Stock removal from point end which shortens B length.

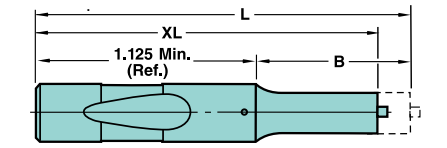

**XLB Overall Length Shortened**  
B length maintained

**LL Precision Overall Length**  
Same as XL except overall length is held to ±.001.

**WS Whistle Stop** See table for standard angles. The Whistle Stop alteration is ground through the ball seat, subject to the same limitations as other standard and custom ball seat locations.

Example: LJX50 400, P.327, M2, WS, XA 7.5°

D	A°
25,37	5°
50	7.5°
62-100	10°

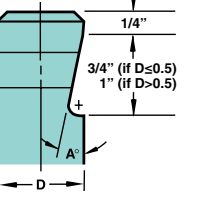

Angles of 5° and 7.5° also available on .625 and larger diameters. (Specify XA and angle after WS.)

**XJ Smaller Jektole® Components**  
See p.39.

**XK No Side Hole**  
For air ejection. No cost.

### SBR Straight Before Radius

To determine Length of Radius Blend (LRB)

- Calculate (D-P)/2.
- Find (D-P)/2 value on left side of chart.
- Follow line over to intersection point on radius blend line.
- Read LRB value on bottom of chart.

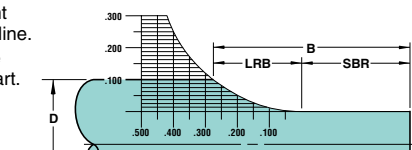

**Example:**  
D=.375  
P=.175  
(D-P)/2=(.375-.175)/2=.100  
Following the .100 line on chart over the radius blend line shows the LRB to be approximately .300.

# Regular Punches

## Light Duty

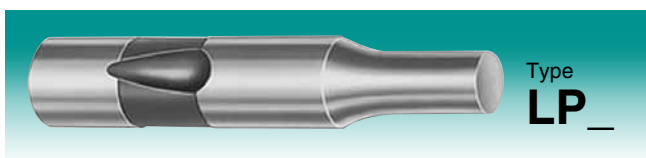

**Material**  
Steel: A2, M2, PS4, RC 60-63

Round P  $\pm .0005$   
Shape P, W  $\pm .0005$

© .0005 P to D  
© .001 P to D

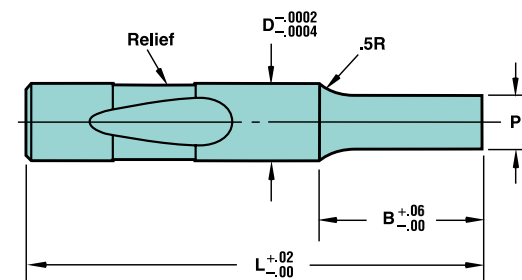

# Regular Punches

## Light Duty

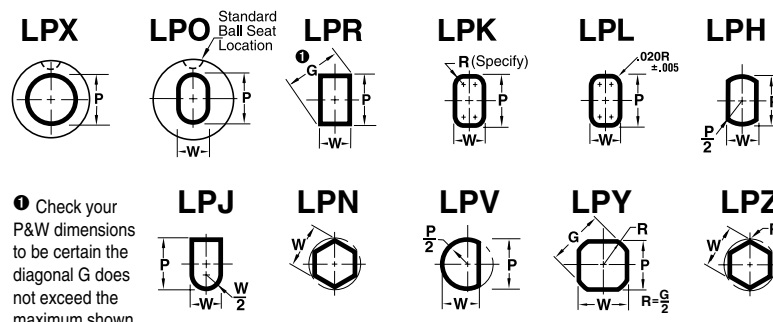

Check your P&W dimensions to be certain the diagonal G does not exceed the maximum shown.

### Features/Benefits

Regular punches provide three times better alignment than other major brands; offer longer tool life; and can significantly improve finished part quality.

#### HOW TO ORDER

Specify:	Qty.	Type	D Code	L	P (or P&W)	Steel
Example:	25	LPX	87	B275	P.740	M2
	12	LPO	100	B350	P.937, W.475	A2

#### Standard Ball Seat Locations

Standard Ball Seat Location is at 90°. Alternate locations of 0°, 180°, or 270° can be specified at no additional cost.

#### Custom Ball Seat Locations

Custom Ball Seat Locations can be specified as "BS" and degrees counter-clockwise from 0°. For additional information, see "Locking Devices" on p. 40.

#### Double Ball Seat

A second ball seat may be specified. Normally located 180° from the primary ball seat, these are used to minimize sharpening of notching punches by rotating the punch 180°. Specify "SB" and degree desired. A second ball can also be located 90° from the primary ball seat.

Not recommended for diameters under .375.



### Standard Alterations

Regular punches are available in sizes other than those shown in the chart to the left.

When ordering, you are asked to specify different designations for various non-standard dimensions. For example, if the P and W dimensions are outside the standard range, an "X" is placed in front of the P or W dimension, e.g., "XP" and/or "XW." If the point length is other than standard, designate "XB" as the point length. Also see "Standard Alterations" on the front of the pullout tab in this section for other special order designators.

### Surface Coatings

Some catalog products can be coated to increase hardness, reduce galling, and improve wear and/or corrosion resistance.

**DayTride® (XN)**—a low-cost surface application that treats all exposed surfaces. Ideal for punches and die buttons. Provides high dimensional stability. Approx. hardness: RC73.

**DayTIN® (XNT)**—applied via PVD (physical vapor deposition). Provides extreme hardness (hard as carbide) and excellent lubricity when used with a lubricant. Not recommended for stainless steel, copper, or nickel. Approx. hardness: \*Vickers 2300.

**DayTAN™ (XAN)**—ultra-hard, high-aluminum PVD coating. Absorbs shear stress and provides high temperature resistance. Ideal for HSLA, dual phase, and TRIP steels. Approx. hardness: \*Vickers 3400.

**TiCN (XCN)**—very hard PVD, thin film. Provides ultra hardness (harder than carbide) and superior abrasive wear resistance. Approx. hardness: \*Vickers 3000.

**XNM**—PVD, solid film. Produces lower coefficient of friction than other coatings. Provides excellent lubricity. Approx. hardness: \*Vickers 2000.

**XNP**—the ultimate coating for extrusion and forming applications. Also works well in shaving operations. Tolerance is  $\pm .0002$ . Approx. hardness: \*Vickers 3100.

**DayKool™ (XCR)**—cryogenic steel conditioning process, used primarily with hard, thick materials. Improves strength, toughness, and dimensional stability.

**CrN (CRN)**—excellent adhesion, high toughness, and good corrosion resistance. Primary applications are metal forming (copper, brass, bronze), metal die casting, and plastic injection molding. Approx. hardness: \*Vickers 1800-2100.

**ZertonPlus™ (XNA)**—excellent wear resistance, thermal shock stability and hot hardness. Approx. hardness \*Vickers 3200.

**XNAPProgress (XNAP)**—ultra-hard PVD coating that absorbs shear stress; provides excellent high-temperature resistance. Ideal for stamping where tools are exposed to extreme stress profiles. A good alternative to TD coating without the dimensional changes associated with that process. Approx hardness: \*Vickers 3200.

**Diamond Like Carbon Coating (XCD)**—combines high hardness with an extremely low coefficient of friction. Good protection against abrasive & adhesive wear. Approx. hardness \*Vickers 5000.

Code / Delivery	Material
XN —DayTride®	+ 3 days M2 & PS4
XNT —DayTIN®	+ 3 days M2 & PS4
XAN —DayTAN™	+ 4 days M2 & PS4
XCN —TiCN	+ 3 days M2 & PS4
XNM	+12 days M2 & PS4
XNP	+ 8 days M2 & PS4
XCR —DayKool™	+ 1 day M2 & PS4
CRN	+ 7 days M2 & PS4
XNA —ZertonPlus™	+ 7 days M2 & PS4
XNAP —XNAPProgress	+12 days M2 & PS4
XCD	+ 8 days M2 & PS4

\* Vickers used when RC exceeds 80.  
© DayTride and DayTIN are registered trademarks of Dayton Progress.  
™ DayTAN, DayKool, and ZertonPlus are trademarks of Dayton Progress.

# Standard Alterations

## Regular Punches—Light Duty

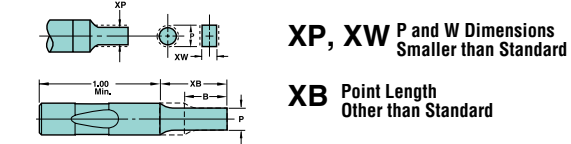

	XB										XBB	X3B	
Point Length	.5001-.6251	.7501-.8751	1.0001-1.1251	1.2501-1.3751	1.5001-1.6251	1.7501-1.8751	2.0001-2.1251	2.2501-2.3751	2.5001-2.6251	2.7501-2.8751	3.0001-3.1251	3.2501-3.3751	3.5001-3.6251
Code Type	Min. P (Rounds)												
25 LPX	.040	.040	.080	.080	.106	.115							
37 LPX	.050	.050	.080	.080	.106	.115	.115	.115	.115	.187	.250	.312	
50 LPX	.093	.093	.093	.125	.125	.125	.125	.125	.125	.187	.250	.312	
62 LPX	.125	.125	.125	.156	.156	.156	.156	.156	.156	.187	.250	.312	
75 LPX	.235	.235	.235	.235	.235	.235	.235	.235	.235	.281	.312	.375	
87 LPX	.300	.300	.300	.300	.300	.300	.300	.300	.300	.350	.375	.437	
100 LPX	.350	.350	.350	.350	.350	.350	.350	.350	.350	.350	.350	.350	.437
	Min. W (Shapes)												
25 LP	.040	.040	.080	.080	.106	.115							
37 LP	.050	.050	.080	.080	.106	.115	.115	.115	.115	.156			
50 LP	.093	.093	.093	.125	.125	.125	.125	.125	.125	.187			
62 LP	.125	.125	.125	.156	.156	.156	.156	.156	.156	.187			
75 LP	.235	.235	.235	.235	.235	.235	.235	.235	.235	.250			
87 LP	.300	.300	.300	.300	.300	.300	.300	.300	.300	.250			
100 LP	.350	.350	.350	.350	.350	.350	.350	.350	.350	.250			

#### XL Overall Length Shortened

Stock removal from point end which shortens B length.

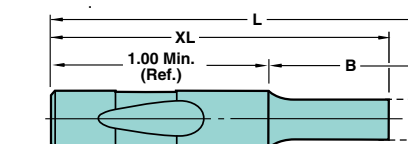

#### XLB Overall Length Shortened

B length maintained

#### LL Precision Overall Length

Same as XL except overall length is held to  $\pm .001$ .

#### WS Whistle Stop

See table for standard angles. The Whistle Stop alteration is ground through the ball seat, subject to the same limitations as other standard and custom ball seat locations.

Example: LPX37 400, P.327, M2, WS, XA 5°

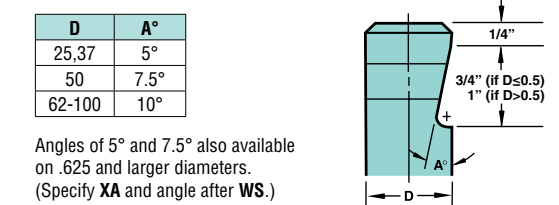

Angles of 5° and 7.5° also available on .625 and larger diameters. (Specify XA and angle after WS.)

#### SBR Straight Before Radius

To determine Length of Radius Blend (LRB)

- Calculate (D-P)/2.
- Find (D-P)/2 value on left side of chart.
- Follow line over to intersection point on radius blend line.
- Read LRB value on bottom of chart.

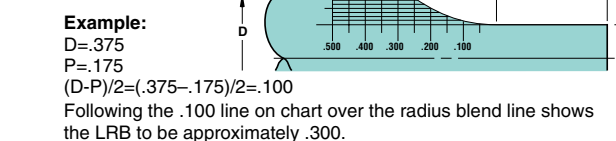

**Example:**  
D=.375  
P=.175  
(D-P)/2=(.375-.175)/2=.100  
Following the .100 line on chart over the radius blend line shows the LRB to be approximately .300.

# Regular Pilots

## Light Duty

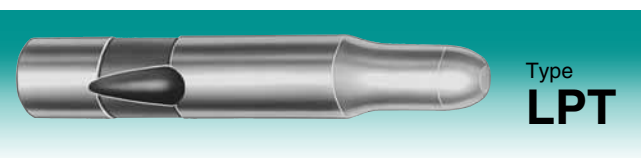

Type  
**LPT**

**Material**  
Steel: A2, M2, PS4, RC 60-63  
Round P  $^{+.0005}$ / $_{-.0000}$  © .0005 P to D  
When P=D, shank tolerance applies.

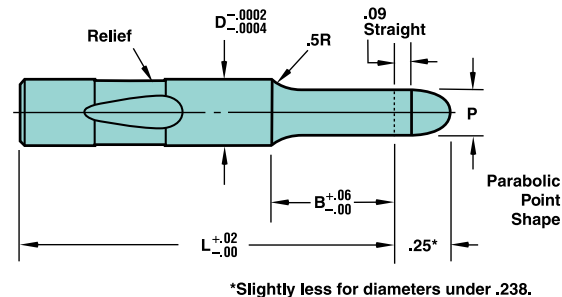

\*Slightly less for diameters under .238.

# Regular Pilots

## Light Duty

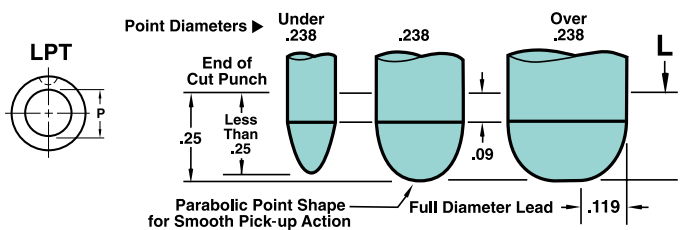

### Features/Benefits

Regular pilots are built to exact tolerances; the parabolic point shape allows for smooth pick-up action; and pilots offer a wide range of unique punching and fabrication applications.

#### HOW TO ORDER

Specify:	Qty.	Type	D Code	L	P	Steel
Example:	25	LPT	37	300	P.175	A2



1 Day  
PS4 +2 Days

### Standard Alterations

Regular pilots are available in sizes other than those shown in the chart to the left.

When ordering, you are asked to specify different designations for various non-standard dimensions. For example, if the P dimension is outside the standard range, an "X" is placed in front of the P dimension, e.g., "XP." If the point length is other than standard, designate "XB" as the point length. Also see "Standard Alterations" on the front of the pullout tab in this section for other special order designators.

# Standard Alterations

## Regular Pilots—Light Duty

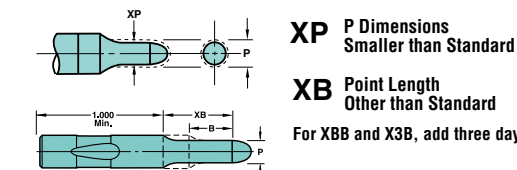

For XBB and X3B, add three days to delivery.

Point Length	XB										XBB	X3B
	5001-6250	6251-7500	7501-8750	8751-10000	10001-11250	11251-12500	12501-13750	13751-15000	15001-16250	16251-20000	20001-25000	25001-30000
Code Type	Min. P (Rounds)											
25 LPT	.050	.050	.079	.079	.105	.114						
37 LPT	.061	.061	.079	.079	.105	.114	.114	.114	.114	.186	.249	.311
50 LPT	.092	.092	.092	.124	.124	.124	.124	.124	.124	.186	.249	.311
62 LPT	.124	.124	.124	.155	.155	.155	.155	.155	.155	.186	.249	.311
75 LPT	.234	.234	.234	.234	.234	.234	.234	.234	.234	.280	.311	.374
87 LPT	.299	.299	.299	.299	.299	.299	.299	.299	.299	.349	.374	.436
100 LPT	.349	.349	.349	.349	.349	.349	.349	.349	.349	.349	.374	.436

**XL Overall Length Shortened**  
Stock removal from point end which shortens B length.

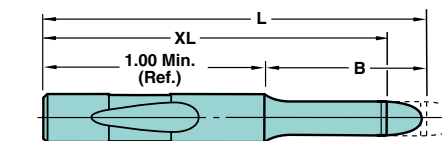

**XLB Overall Length Shortened**  
B length maintained

**WS Whistle Stop** See table for standard angles. The Whistle Stop alteration is ground through the ball seat, subject to the same limitations as other standard and custom ball seat locations.

Example: LPT62 400, P327, M2, WS, XA 10°

D	A°
25,37	5°
50	7.5°
62-100	10°

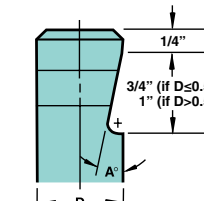

Angles of 5° and 7.5° also available on .625 and larger diameters. (Specify XA and angle after WS.)

### SBR Straight Before Radius

To determine Length of Radius Blend (LRB)

1. Calculate (D-P)/2.
2. Find (D-P)/2 value on left side of chart.
3. Follow line over to intersection point on radius blend line.
4. Read LRB value on bottom of chart.

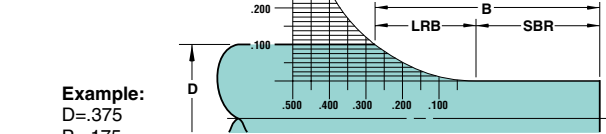

**Example:**  
D=.375  
P=.175  
(D-P)/2=(.375-.175)/2=.100  
Following the .100 line on chart over the radius blend line shows the LRB to be approximately .300.

### Surface Coatings

Some catalog products can be coated to increase hardness, reduce galling, and improve wear and/or corrosion resistance.

**DayTride® (XN)**—a low-cost surface application that treats all exposed surfaces. Ideal for punches and die buttons. Provides high dimensional stability. Approx. hardness: RC73.

**DayTiN® (XNT)**—applied via PVD (physical vapor deposition). Provides extreme hardness (hard as carbide) and excellent lubricity when used with a lubricant. Not recommended for stainless steel, copper, or nickel. Approx. hardness: \*Vickers 2300.

**DayTAN™ (XAN)**—ultra-hard, high-aluminum PVD coating. Absorbs shear stress and provides high temperature resistance. Ideal for HSLA, dual phase, and TRIP steels. Approx. hardness: \*Vickers 3400.

**TiCN (XCN)**—very hard PVD, thin film. Provides ultra hardness (harder than carbide) and superior abrasive wear resistance. Approx. hardness: \*Vickers 3000.

**XNM**—PVD, solid film. Produces lower coefficient of friction than other coatings. Provides excellent lubricity. Approx. hardness: \*Vickers 2000.

**XNP**—the ultimate coating for extrusion and forming applications. Also works well in shaving operations. Tolerance is ± .0002. Approx. hardness: \*Vickers 3100.

**DayKool™ (XCR)**—cryogenic steel conditioning process, used primarily with hard, thick materials. Improves strength, toughness, and dimensional stability.

**CrN (CRN)**—excellent adhesion, high toughness, and good corrosion resistance. Primary applications are metal forming (copper, brass, bronze), metal die casting, and plastic injection molding. Approx. hardness: \*Vickers 1800-2100.

**ZertonPlus™ (XNA)**—excellent wear resistance, thermal shock stability and hot hardness. Approx. hardness \*Vickers 3200.

**XNAPProgress (XNAP)**—ultra-hard PVD coating that absorbs shear stress; provides excellent high-temperature resistance. Ideal for stamping where tools are exposed to extreme stress profiles. A good alternative to TD coating without the dimensional changes associated with that process. Approx hardness: \*Vickers 5000.

**Diamond Like Carbon Coating (XCD)**—combines high hardness with an extremely low coefficient of friction. Good protection against abrasive & adhesive wear. Approx. hardness \*Vickers 5000.

Code / Delivery	Material
XN —DayTride® + 3 days	M2 & PS4
XNT —DayTiN® + 3 days	M2 & PS4
XAN —DayTAN™ + 4 days	M2 & PS4
XCN —TiCN + 3 days	M2 & PS4
XNM +12 days	M2 & PS4
XNP + 8 days	M2 & PS4
XCR —DayKool™ + 1 day	M2 & PS4
CRN + 7 days	M2 & PS4
XNA —ZertonPlus™ + 7 days	M2 & PS4
XNAP—XNAPProgress +12 days	M2 & PS4
XCD + 8 days	M2 & PS4

\* Vickers used when RC exceeds 80.  
© DayTride and DayTiN are registered trademarks of Dayton Progress.  
™ DayTAN, DayKool, and ZertonPlus are trademarks of Dayton Progress.



# Punch Blanks Jektole® & Regular Light Duty

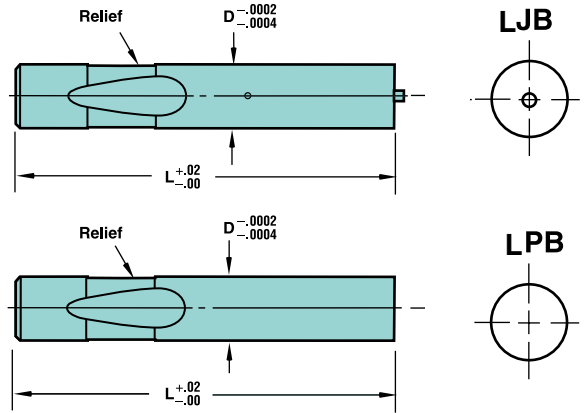
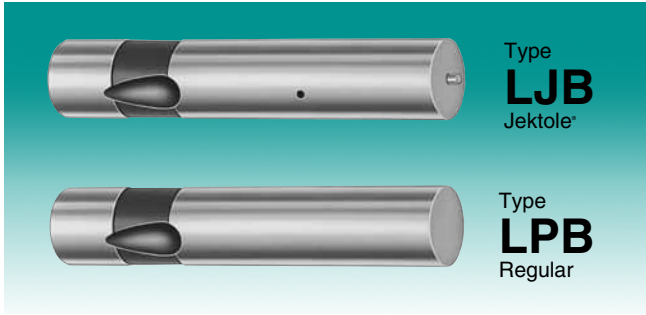

**Material**  
Steel: A2, M2, PS4, RC 60-63

Type	Shank		L																	* Jektole® Group	
	D	Code	2.00	2.25	2.50	2.75	3.00	3.25	3.50	3.75	4.00	4.25	4.50	4.75	5.00	5.25	5.50	5.75	6.00		
<b>LJB</b>	.250	25	200																		J3
	.375	37																			
	.500	50																			J6
	.625	62		225	250	275	300	325	350	375	400										J6
	.750	75										425	450	475	500						J9
	.875	87														525	550	575	600		J9
	1.000	100																			J9

Type	Shank		L																				
	D	Code	2.00	2.25	2.50	2.75	3.00	3.25	3.50	3.75	4.00	4.25	4.50	4.75	5.00	5.25	5.50	5.75	6.00	6.25	6.50	6.75	7.00
<b>LPB</b>	.250	25	200																				
	.375	37																					
	.500	50																					
	.625	62		225	250	275	300	325	350	375	400	425	450	475	500								
	.750	75														525	550	575	600				
	.875	87																		625	650	675	700
	1.000	100																					

\*See p. 39 for additional information.

**HOW TO ORDER**

Specify:	Qty.	Type	D Code	L	Steel
Example:	12	LJB	50	300	M2



# Point Larger than Shank Jektole® & Regular Light Duty

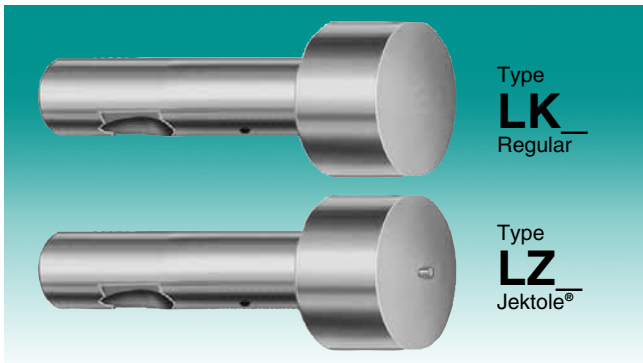

**Material**  
 Steel: A2, M2, RC 60-63  
 Round P  $\begin{matrix} +.0005 \\ -.0000 \end{matrix}$   $\begin{matrix} \text{P to D} \\ \text{P to D} \end{matrix}$   
 Shape P, W  $\pm .0005$   $\begin{matrix} \text{P to D} \\ \text{P to D} \end{matrix}$

Check your P&W dimensions to be certain the diagonal G does not exceed the maximum shown.

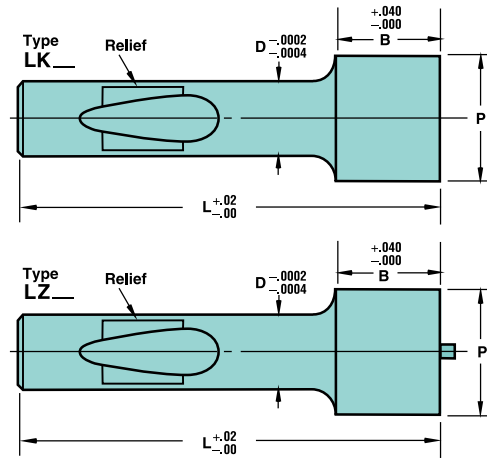
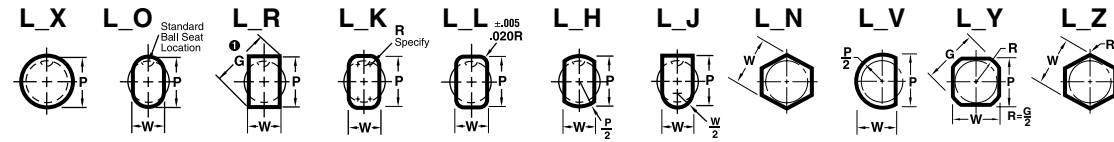

Type	Shank		Point Lgth. B	Round Range P	Shape		L								* Jektole® Group		
	D	Code			Min XW	Min. W	Max. P/G	2.50	2.75	3.00	3.25	3.50	3.75	4.00		4.25	4.50
LK Regular	.375	37	.62	.376 - .875	.062	.125 - .875											J4
LZ Jektole®	.500	50	.75	.501-1.250	.158	.188-1.250											J6
	.625	62	.88	.626-1.500	.158	.250-1.500											J6
	.750	75	.94	.751-1.500	.235	.312-1.500	250	275	300	325	350	375	400	425	450		J9
	.875	87	.94	.876-1.750	.235	.375-1.750											J9
	1.000	100	.94	1.001-1.750	.235	.437-1.750											J9

\*See p. 39 for additional information.

**Standard Ball Seat Locations**  
 Standard Ball Seat Location is at 90°. Alternate locations of 0°, 180°, or 270° can be specified at no additional cost.

**Custom Ball Seat Locations**  
 Custom Ball Seat Locations can be specified as "BS" and degrees counter-clockwise from 0°. For additional information, see "Locking Devices" on p. 40.

**Double Ball Seat**  
 A second ball seat may be specified. Normally located 180° from the primary ball seat, these are used to minimize sharpening of notching punches by rotating the punch 180°. Specify "SB" and degree desired. A second ball can also be located 90° from the primary ball seat.

Not recommended for diameters under .625 for LZ and .500 for LK.

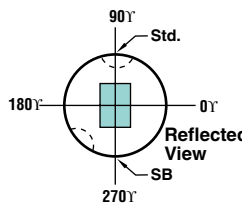
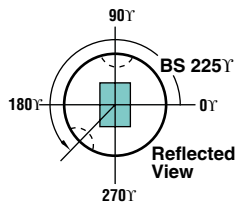

### HOW TO ORDER

Specify: Qty. Type D Code L P (or P&W) Steel  
 Example: 2 LKX 100 400 P1.300 M2

### Standard Alterations

Point Larger than Shank Ball Lock punches are available in sizes other than those shown in the chart above.

When ordering, you are asked to specify different designations for various non-standard dimensions. For example, if the P and W dimensions are outside the standard range, an "X" is placed in front of the P or W dimension, e.g., "XP" and/or "XW." If the point length is other than standard, designate "XB" as the point length. Also see "Standard Alterations" on the front of the pullout tab in this section for other special order designators.

### Standard Alterations Point Larger than Shank—Light Duty

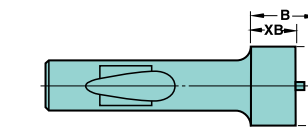

**XB Point Length Shorter than Standard**  
 (Shortens punch from the point end.)

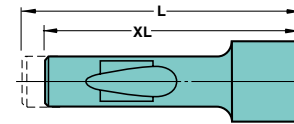

**XL Overall Length Shortened**  
 Stock removal from **shank end**. Minimum shank length is 1 3/8". Does not alter ball seat location.

**LL Precision Overall Length**  
 Same as XL except overall length is held to  $\pm .001$ .

**WS Whistle Stop** See table for standard angles. The Whistle Stop alteration is ground through the ball seat, subject to the same limitations as other standard and custom ball seat locations.

Example: LZ75 400, P1.250, M2, WS, XA 10°  
 LKR75 400, P1.250, W.350, M2, WS, XA 10°

D	A°
37	5°
50	7.5°
62-100	10°

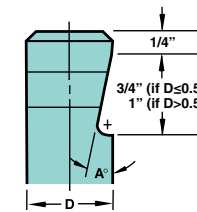

Angles of 5° and 7.5° also available on .625 and larger diameters. (Specify XA and angle after WS.)

### Surface Coatings

Some catalog products can be coated to increase hardness, reduce galling, and improve wear and/or corrosion resistance.

**DayTride® (XN)**—a low-cost surface application that treats all exposed surfaces. Ideal for punches and die buttons. Provides high dimensional stability. Approx. hardness: RC73.

**DayTiN® (XNT)**—applied via PVD (physical vapor deposition). Provides extreme hardness (hard as carbide) and excellent lubricity when used with a lubricant. Not recommended for stainless steel, copper, or nickel. Approx. hardness: \*Vickers 2300.

**DayTAN™ (XAN)**—ultra-hard, high-aluminum PVD coating. Absorbs shear stress and provides high temperature resistance. Ideal for HSLA, dual phase, and TRIP steels. Approx. hardness: \*Vickers 3400.

**TiCN (XCN)**—very hard PVD, thin film. Provides ultra hardness (harder than carbide) and superior abrasive wear resistance. Approx. hardness: \*Vickers 3000.

**XNM**—PVD, solid film. Produces lower coefficient of friction than other coatings. Provides excellent lubricity. Approx. hardness: \*Vickers 2000.

**XNP**—the ultimate coating for extrusion and forming applications. Also works well in shaving operations. Tolerance is  $\pm .0002$ . Approx. hardness: \*Vickers 3100.

**DayKool™ (XCR)**—cryogenic steel conditioning process, used primarily with hard, thick materials. Improves strength, toughness, and dimensional stability.

**CrN (CRN)**—excellent adhesion, high toughness, and good corrosion resistance. Primary applications are metal forming (copper, brass, bronze), metal die casting, and plastic injection molding. Approx. hardness: \*Vickers 1800-2100.

**ZertonPlus™ (XNA)**—excellent wear resistance, thermal shock stability and hot hardness. Approx. hardness \*Vickers 3200.

**XNAPProgress (XNAP)**—ultra-hard PVD coating that absorbs shear stress; provides excellent high-temperature resistance. Ideal for stamping where tools are exposed to extreme stress profiles. A good alternative to TD coating without the dimensional changes associated with that process. Approx. hardness: \*Vickers 3200.

**Diamond Like Carbon Coating (XCD)**—combines high hardness with an extremely low coefficient of friction. Good protection against abrasive & adhesive wear. Approx. hardness \*Vickers 5000.

Code / Delivery		Material
XN —DayTride®	+ 3 days	M2 & PS4
XNT —DayTiN®	+ 3 days	M2 & PS4
XAN —DayTAN™	+ 4 days	M2 & PS4
XCN —TiCN	+ 3 days	M2 & PS4
XNM	+12 days	M2 & PS4
XNP	+ 8 days	M2 & PS4
XCR —DayKool™	+ 1 day	M2 & PS4
CRN	+ 7 days	M2 & PS4
XNA —ZertonPlus™	+ 7 days	M2 & PS4
XNAP—XNAPProgress	+12 days	M2 & PS4
XCD	+ 8 days	M2 & PS4

\* Vickers used when RC exceeds 80.  
 © DayTride and DayTiN are registered trademarks of Dayton Progress.  
 ™ DayTAN, DayKool, and ZertonPlus are trademarks of Dayton Progress.

# Die Buttons Ball Lock

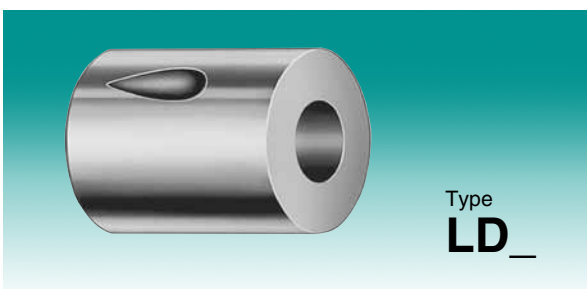

Type LD

**Material**  
Steel: A2, M2, RC 60-63  
Round P  $\pm .0005$  to  $-.0000$   $\text{\textcircled{C}} .0005$  P to D  
Shape P, W  $\pm .001$  to  $-.000$   $\text{\textcircled{C}} .001$  P to D

Body	D	Code	Min. B	Max. R	Round Range P	Shape Min. W Max. P/G	L 1.187
.5000	50		.156	.228	.064 - .195	.048 - .195	118
.6250	62		.187	.312	.126 - .285	.064 - .285	118
.7500	75		.187	.375	.196 - .345	.095 - .345	118
.8750	87		.187	.468	.286 - .435	.125 - .435	118
1.0000	100		.250	.578	.346 - .545	.125 - .545	118
1.2500	125		.250	.687	.436 - .655	.187 - .655	118
1.5000	150		.250	.812	.546 - .780	.187 - .780	118
1.7500	175		.312	1.062	.656-1.035	.187-1.035	118

**FDS**  
FIRM DELIVERY SCHEDULE  
Up to 1.5000 Dia. 2 Days  
1.7500 and larger Dia. 4 Days

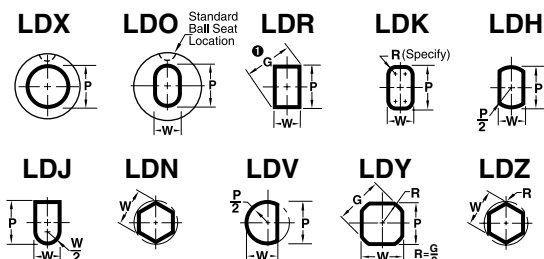
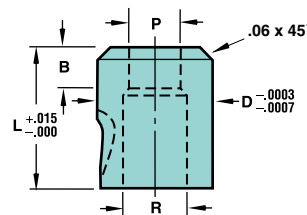

Check your P&W dimensions to be certain the diagonal G does not exceed the maximum shown.

**HOW TO ORDER**

Specify: Qty. Type D Code L P (or P&W) Steel  
Example: 10 LDX 125 118 P.625 A2

Note: The standard ball seat location is at 90°. Alternate locations of 0°, 180°, or 270° can be specified at no additional cost. For additional information, see "Locking Devices" on p. 40.

# Die Buttons Press Fit

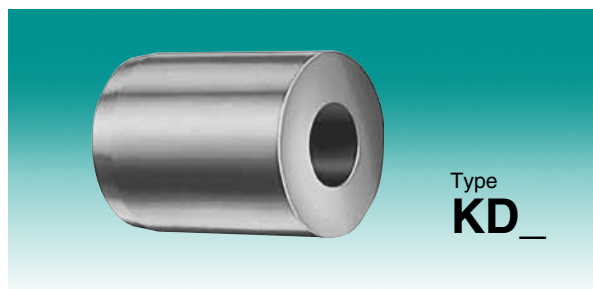

Type KD

**Material**  
Steel: A2, M2, RC 60-63  
Round P  $\pm .0005$  to  $-.0000$   $\text{\textcircled{C}} .0005$  P to D  
Shape P, W  $\pm .001$  to  $-.000$   $\text{\textcircled{C}} .001$  P to D  
 $D \leq 1.75$   $\pm .0002$  to  $-.0006$

**HOW TO ORDER**

Specify: Qty. Type D Code L P (or P&W) Steel  
Example: 5 KDR 50 100 P.250, W.093 A2

Body	D	Code	Min. B	Max. R	Round Range P	Shape Min. W Max. P/G	L							
							.750	.875	.937	1.000	1.125	1.250	1.375	1.500
.2500	25		.156	.156	.064 - .135	.048 - .135								
.3125	31		.156	.191	.064 - .171	.048 - .171								
.3750	37		.156	.228	.064 - .195	.048 - .195								
.4375	43		.156	.281	.064 - .250	.048 - .250								
.5000	50		.156	.312	.064 - .285	.064 - .285								
.6250	62		.187	.390	.136 - .365	.095 - .365								
.7500	75		.187	.468	.136 - .435	.118 - .435								
.8750	87		.187	.578	.276 - .545	.125 - .545								
1.0000	100		.250	.703	.356 - .675	.125 - .675	75	87	93	100	112	125	137	150
1.2500	125		.250	.828	.500 - .800	.187 - .800								
1.5000	150		.250	1.093	.616-1.050	.187-1.050								
1.7500	175		.312	1.430	.750-1.400	.187-1.400								
2.0000	200		.312	1.630	.875-1.600	.187-1.600								
2.2500	225		.312	1.830	1.000-1.800	.187-1.800								
2.5000	250		.312	2.030	1.125-2.000	.187-2.000								
2.7500	275		.312	2.230	1.250-2.200	.187-2.200								

**FDS**  
FIRM DELIVERY SCHEDULE  
Up to 1.5000 Dia. 2 Days  
1.7500 and larger Dia. 4 Days

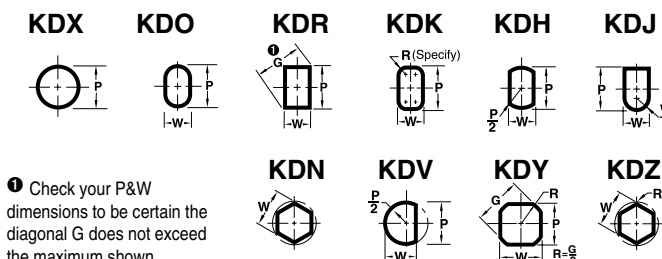
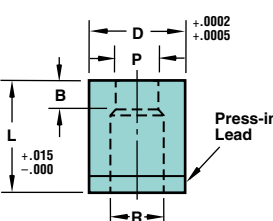

Check your P&W dimensions to be certain the diagonal G does not exceed the maximum shown.

**Standard Alterations**  
Ball Lock press fit die buttons are available in sizes other than those shown in the chart above.  
When ordering, you are asked to specify different designations for various non-standard dimensions.  
For example, if the P and W dimensions are outside the standard range, an "X" is placed in front of the P or W dimension, e.g., "XP" and/or "XW." If the point length is other than standard, designate "XB" as the land length. Also see "Standard Alterations" on the front of the pullout tab in this section for other special order designators.

# Dayton Slug Control



Dayton Slug Control is a guaranteed method for reducing the risk of pulling slugs to the die surface during withdrawal of the punch. A series of grooves is designed inside the die button. There, the slugs are trapped until they fall freely through the relief. The use of Dayton Slug Control has no effect on hole size, and will not require any changes in current regrind practices.

Our guarantee: Use Dayton Slug Control in a stamping die now pulling slugs. If, for any reason, you are not completely satisfied, we will refund the full cost of the Slug Control alteration. (We cannot guarantee the retention of slugs when clearance exceeds 10% per side.)

**Ordering**

Dayton Slug Control is easy to specify and order. Simply add the information that is unique to your application to the die button catalog number. Please specify XSC for alteration and show material thickness (inches) and clearance per side (percentage).

**HOW TO ORDER**

Inch	Catalog Number			Your Specs		
	Type	D	L	Alt. Code	Mat'l Thickness (inches)	Clear Per Side (%)
	KDX	62	100	P.250	XSC	MT.0625 CS 5

For additional information, contact your Dayton distributor.

# Standard Alterations Die Buttons

**XP, XW** P and W Dimensions Larger or Smaller than Standard

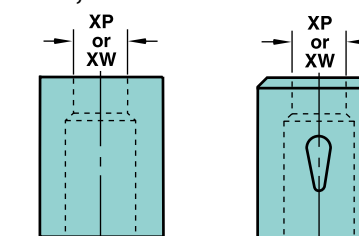

Body Code	Press Fit				Ball Lock			
	Min. P	Min. W	Max. P/G	R	Min. P	Min. W	Max. P/G	R
25	.064	.048	.167	.191				
37	.064	.048	.250	.281				
50	.064	.064	.344	.375	.064	.048	.250	.281
62	.136	.095	.453	.500	.126	.064	.344	.375
75	.136	.118	.562	.594	.150	.095	.453	.500
87	.276	.125	.656	.703	.175	.125	.562	.594
100	.356	.125	.750	.781	.200	.125	.656	.703
125	.500	.187	.935	.969	.250	.187	.750	.781
150	.616	.187	1.200	1.230	.300	.187	.935	.969
175	.750	.187	1.400	1.430	.350	.187	1.200	1.230
200	.875	.187	1.600	1.630				
225	1.000	.187	1.800	1.830				
250	1.125	.187	2.000	2.030				
275	1.250	.187	2.200	2.230				

**XL Overall Length Shortened**

Stock removal does not alter land length on KD...  
Minimum overall length = .25  
Not available on Ball Lock Die Buttons.

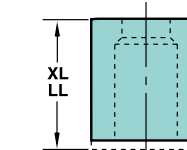

**LL Precision Overall Length**

Same as XL except overall length is held to  $\pm .001$ .  
Not available on Ball Lock Die Buttons.

**WS Whistle Stop (5° standard angle)**

The Whistle Stop alteration is ground through the ball seat, subject to the same limitations as other standard and custom ball seat locations. The XP alteration is not available with the WS alteration.  
Example: LDX75, 118, P.328, M2, WS.

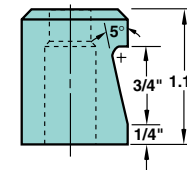

**XSC Slug Control eliminates slug pulling**

(When ordering Dayton Slug Control, please specify XSC in place of the standard die button code, as well as your specifications. See the "How to Order" example on the front of this tab.)

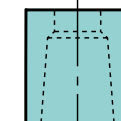

**XBL Straight Through Land**

The land length (B) equals the overall length. Can be used for bushings, guides and a variety of other applications.  
\*Round die buttons only

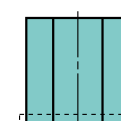

**XN +3 days DayTide** A unique wear-resistant surface treatment for M2 & PS only.

See p.38 for Die Button Blanks.

# Multi-Position™ Retainers Heavy Duty/Light Duty

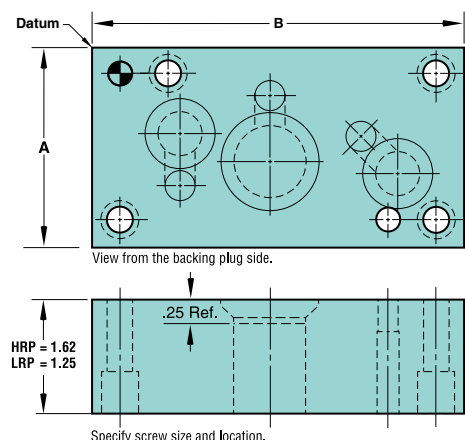
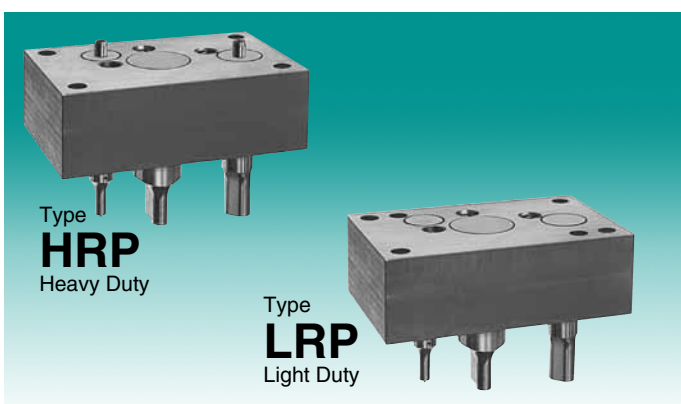

Type	W	L													
		2.50	2.75	3.00	3.25	3.50	3.75	4.00	5.00	6.00	7.00	8.00	9.00	10.00	12.00
HRP	2.00	2025	2027	2030	2032	2035	2037	2040	2050	2060	2070	2080	2090	2010	2012
LRP	2.75		2727	2730	2732	2735	2737	2740	2750	2760	2770	2780	2790	2710	2712
	3.00		3027	3030	3032	3035	3037	3040	3050	3060	3070	3080	3090	3010	3012
	4.00							4040	4050	4060	4070	4080	4090	4010	4012
	6.00							6060	6070	6080	6090	6010	6012		
	8.00							8080	8090	8010	8012				

### Ball Hole Locations

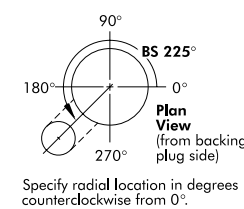

Hole Reference Re Datum Point	
Dowel Holes	±.0003
Screw Holes	±.0050
Component Holes	±.0003

Punch Shape	Ball Hole Class	Radial Tolerance
Round	B	±5°
Shape	BB	±0°5'

The Ball Hole Class B is standard, unless otherwise specified.

### Space Requirements

TYPE	D	A	B	H
HRP	.375	.57	.375	.625
	.500	.69	.500	.750
	.625	.69	.500	.875
	.750	.69	.500	1.000
	.875	.69	.500	1.125
LRP	1.000	.69	.500	1.250
	1.250	.69	.500	1.500
	.250	.44	.250	.500
	.375	.44	.250	.625
	.500	.50	.312	.750
LRP	.625	.50	.312	.875
	.750	.57	.375	1.000
	.875	.57	.375	1.125
	1.000	.57	.375	1.250

### HOW TO ORDER

Example:

Retainer	Catalog No.	Special Size
<input checked="" type="checkbox"/> HRP <input type="checkbox"/> LRP	3070	A B

Multi-Position™ Retainers						
Hole No.	Component		Location		Ball Hole Location	Backing Plug Type
	Type	Size	X Axis	Y Axis		
1	Dowel	5/16 S.F.*	.375	-.375	—	—
2	S.H.C.S	5/16	1.000	-.375	—	—
3	HJR	62	2.090	-1.375	90°	BB
4	Clear	1.281	4.250	-1.062	—	—
5	Jacksr.	STD.	0.687	-.937	—	—

\*Slip Fit

See the back of the pullout tab for additional information on Backing Plugs.

Multi-Position™ Retainers require special order forms, which are available on request. Specify all dimensions from the datum: Use the drawing above for reference.



# True Position® Retainers Heavy Duty/Light Duty

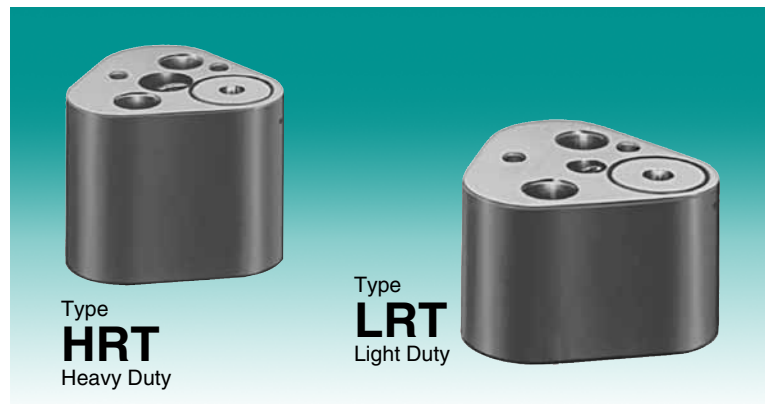

The industry standard interchangeable retainer

### HOW TO ORDER

Specify:	Qty.	Type	D
Example:	23	HRT	37
	13	LRT	62

- True Position® Retainer sets include:**
- 1 Ball
  - 1 Spring
  - 2 Screws
  - 2 Dowels
  - 1 Ball Release Set Screw

### Catalog Number

Heavy Duty	Light Duty	D	A	B	G	K	R	S	U	X	Y	Screw Size
HRT	LRT	.2500	1.75	1.72	.438	.750	.38	.47	1.060	.354	.295	5/16-18
		.3750	1.75	1.72	.438	.750	.38	.47	1.060	.354	.295	5/16-18
		.5000	2.00	1.97	.562	.750	.50	.60	1.180	.472	.256	3/8-16
		.6250	2.12	2.09	.625	.750	.56	.66	1.250	.532	.236	3/8-16
		.7500	2.38	2.34	.688	.750	.69	.79	1.320	.650	.197	3/8-16
LRT	—	.8750	2.50	2.47	.688	.750	.75	.85	1.400	.728	.197	3/8-16
		1.0000	2.75	2.72	.781	.938	.88	.97	1.600	.866	.276	1/2-13
		1.2500	2.75	2.72	.781	.938	.88	.97	1.600	.866	.276	1/2-13

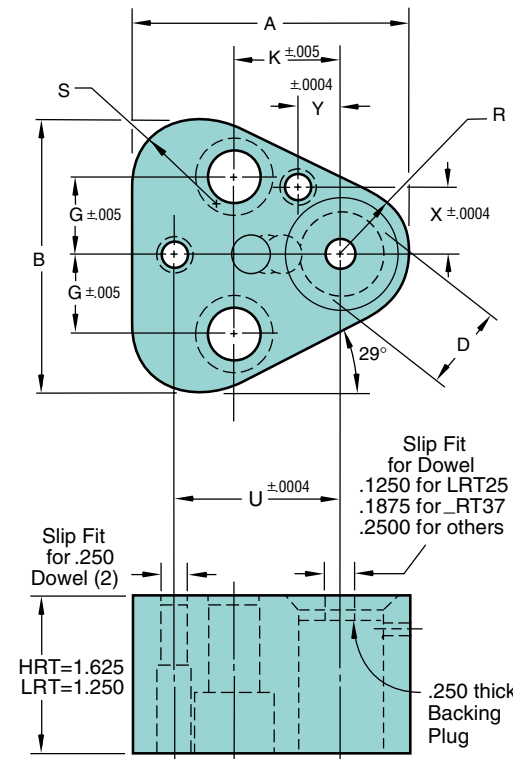

### Features/Benefits

The **in-line dowel** assures precise punch-to-die button alignment, giving you higher quality parts, longer punch life, and reduced production downtime.

The True Position® Retainer **eliminates hand fitting**, cutting mounting time by nearly 50%. Simply pull the retainer from its box, and screw it into the die set. True Position® gives you true dimensional accuracy every time.

Only **one dowel is required for round punches**, which reduces machining time by up to 50%. Shaped punches use the secondary dowel for precise alignment.

The **precision-ground ball hole** assures perfect alignment of any punch shape, even if the retainer is replaced.

The True Position® Retainer allows **complete interchangeability between Heavy Duty and Light Duty retainers** in the event of an engineering change.

Use of the True Position® Retainer can **cut retainer inventory requirements by 50%**.

# Standard Alterations Multi-Position™ Retainers

### Backing Plugs



The three Backing Plugs shown above are used with Multi-Position™, True Position®, and End and Square Retainers—both heavy duty and light duty. To determine which backing plug is used with a specific type of retainer, see “Accessories—Retainers” on p. 36.

The Type C Solid Backing Plug is standard with all Multi-Position™ Retainers. The Type A Backing Plug with dowels for location can be specified; this eliminates the need for dowels in the retainer. Die Button Retainers require a detailed drawing.

### True Position® Retainers

Don't waste time and money building a retainer for just one punch. Fitting isolated punches or pilots onto a die set is quick and easy with True Position® Retainers. These cost-effective time-savers can be mounted with screws from either top or bottom, eliminating the need to build and fit one-of-a-kind retainers.

True Position® Retainers are recognized as the standard in the industry for interchangeable retainers. All are quality built; ground top to bottom; and hardened to approximately RC 58-60.

True Position® gives you true dimensional accuracy each and every time!

### Standard Jackscrew Hole

Jackscrews make it easier to pull retainers off the dowels.

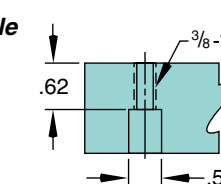

### Special Size

Any amount of material can be removed from the sides of the retainer for a custom size. Edges are saw cut ±.03.

### Clearance Holes

Clearance holes or tapped holes can be detailed, as shown in the order example.

Holes are drilled through the retainer unless otherwise specified.

**Location** ±.010

**Diameter** +.015  
-.000

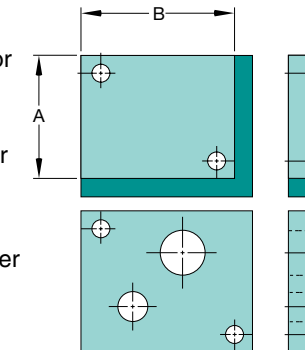

### The following alterations require detailed drawings:

#### Notches

Notches to clear other tooling can be added to any side of the retainer. Notches are saw cut ±.03.

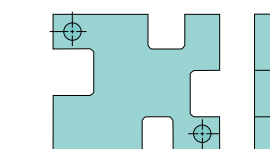

#### Angles

As with notches, angles can be added to clear other tooling in the die. Angles are saw cut ±.03.

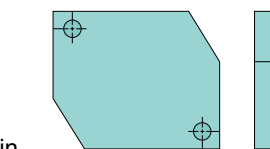



# Single Punch Retainer with Backing Plate

True Position®



- Retainer sets include:**
- 1 Ball
  - 1 Spring
  - 2 Screws
  - 2 Dowels
  - 1 Ball Release Set Screw

**HOW TO ORDER**

Specify: Qty. Code D  
Example: 23 HRTB 37

Back Plate	Code	D	A	B	G	K	R	S	U	X	Y	Screw Size
HRTB	37	.3750	1.75	1.72	.438	.750	.38	.47	1.060	.354	.295	5/16-18
HRTB	50	.5000	2.00	1.97	.562	.750	.50	.60	1.180	.472	.256	3/8-16
HRTB	62	.6250	2.12	2.09	.625	.750	.56	.66	1.250	.532	.236	3/8-16
HRTB	75	.7500	2.38	2.34	.688	.750	.69	.79	1.320	.650	.197	3/8-16
HRTB	87	.8750	2.50	2.47	.688	.750	.75	.85	1.400	.728	.197	3/8-16
HRTB	100	1.0000	2.75	2.72	.781	.938	.88	.97	1.600	.866	.276	1/2-13
HRTB	125	1.2500	2.75	2.72	.781	.938	.88	.97	1.600	.866	.276	1/2-13

## Features/Benefits

HRTB True Position® Retainers come complete with an **integrated, hardened backing plate**. With all the features of the original True Position® Retainer, the HRTB satisfies the needs of applications where more bearing surface is desired. True Position® gives you true dimensional accuracy each and every time!

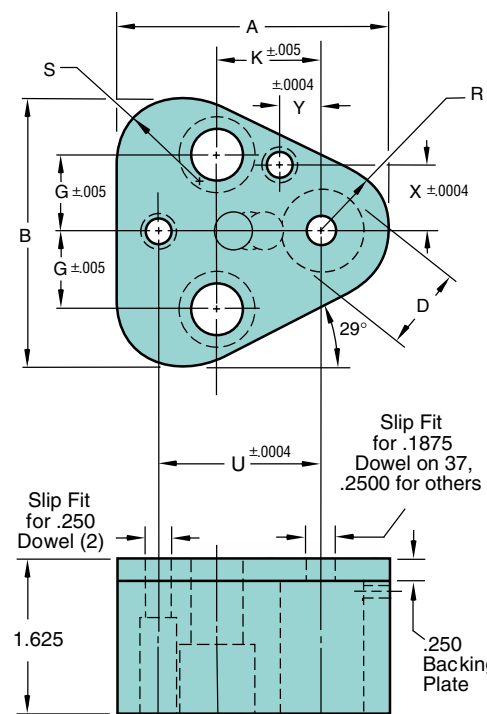

# EZ Fit™ Retainer Inserts

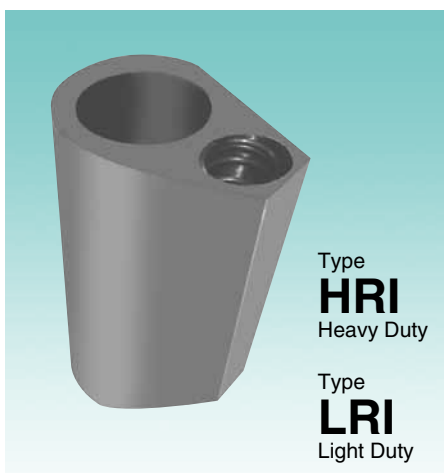

**HOW TO ORDER**

Specify: Qty. Type Code  
Example: 5 HRI 37  
12 LRI 62

**Heavy Duty**

Type	Punch Hole Dia. D	Code	A	B	K
HRI	0.3750	37	1.0630	0.6250	0.3882
	0.5000	50	1.3190	0.7500	0.5250
	0.6250	62	1.4570	0.9000	0.4698
	0.7500	75	1.6040	1.0600	0.4202
	0.8750	87	1.7320	1.1950	0.4182
	1.0000	100	1.8700	1.3200	0.4111
	1.2500	125	2.1260	1.5700	0.3951

**Light Duty**

Type	Punch Hole Dia. D	Code	A	B	K
LRI	0.2500	25	0.7750	0.4375	0.3125
	0.3750	37	0.9000	0.5625	0.3125
	0.5000	50	1.1200	0.7500	0.3125
	0.6250	62	1.2500	0.8750	0.3125
	0.7500	75	1.4700	1.0700	0.3125
	0.8750	87	1.6000	1.1950	0.3125
	1.0000	100	1.7200	1.3200	0.3125

## Features/Benefits

Dayton EZ Fit™ Ball Lock Retainer Inserts give you the ability to build, reconfigure, and custom-make retainers in-house as die specifications change. In addition, the unique single-piece teardrop shape, combined with both a straight and an angled wedge side, holds your ball lock punch securely in place. EZ Fit™ reduces costs and downtime—and simplifies tooling changeover.

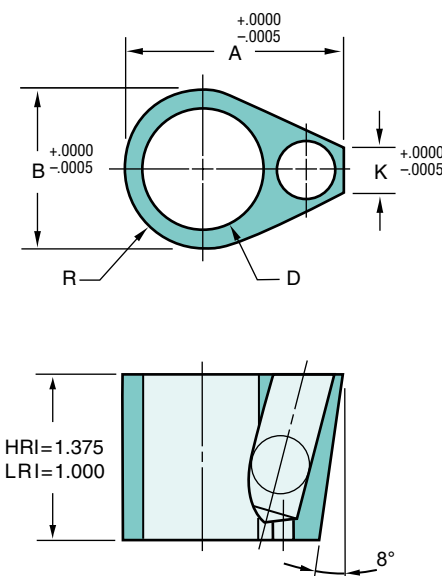

The shape shown above can be easily cut using wire EDM to assure a proper fit. The insert (utilizing both the straight and 8° angled sides) fits securely and is designed to clear the retainer by a small amount, making assembly and disassembly easier.

Each insert comes complete with wire cutting instructions that show recommended dimensions and tolerances for optimum performance.

# True Position® Retainers



The **in-line dowel assures precise punch-to-die button alignment**, giving you higher quality parts, longer punch life, and reduced production downtime.

The True Position® Retainer **eliminates hand fitting**, cutting mounting time by nearly 50%. Simply pull the retainer from its box, and screw it into the die set.

Only **one dowel is required for round punches**, which reduces machining time by up to 50%. Shaped punches use the secondary dowel for precise alignment.

The **precision-ground ball hole assures perfect alignment of any punch shape**, even if the retainer is replaced.

The True Position® Retainer allows complete **inter-changeability between Heavy Duty and Light Duty retainers** in the event of an engineering change.

Use of the True Position® Retainer can **cut retainer inventory requirements by 50%**.

## Backing Plates

The Backing Plates are standard with Dayton's HRTB True Position® Single Punch Retainers. The Backing Plate has the same function as the backing plug model True Position® Retainer, i.e., to prevent the punch shank from penetrating the punch plate.

For optimum resistance on impact HRTB Retainers have integrated, hardened Backing Plates. The Backing Plates cover the entire surface of the retainer, spreading the load over a large area.

# EZ Fit™ Retainer Inserts

## Tighter Tolerances

Dayton EZ Fit™ Retainer Inserts utilize a patented, state-of-the-art design that assures tighter, more precise tolerances than other retainer inserts on the market. The unique teardrop shape provides a single, tightly secured receptacle for the punch. One side of the piece (the flat side) is cut at an 8° angle to create a wedge shape. The hole in the retainer is wire cut to create a snug fit. (See cutaway.)

EZ Fit™ Retainer Inserts are also ideal for repairing or making engineering changes.

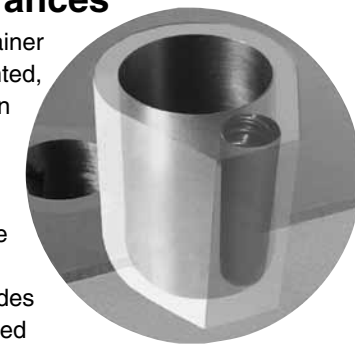

## Repair/Engineering Changes

When job specifications change, the location(s) of the punches in the die set change, and reconfigured retainers are required. This means ordering new retainers or modifying existing retainers in-house. This can slow the process; often requires specialized equipment and knowledge; and the integrity of the original retainer can be compromised.

Now—with the help of the all-new Dayton EZ Fit™ Ball Lock Retainer Insert—this process can be simplified and completed in-house at a fraction of the cost of replacing existing retainers.

## In-house Modifications

To retrofit the EZ Fit™ Insert, simply wire cut the hole to the specified size and install. (See instructions at [www.daytonlamina.com/ezfit](http://www.daytonlamina.com/ezfit) for EDM wire cutting.) The process is quick, easy, effective, and far less expensive than part replacement costs.



™ EZ Fit is a trademark of Dayton Progress Corporation. Mfg. under Patent No. 6,679,147.

# End Retainers

## Heavy Duty/Light Duty

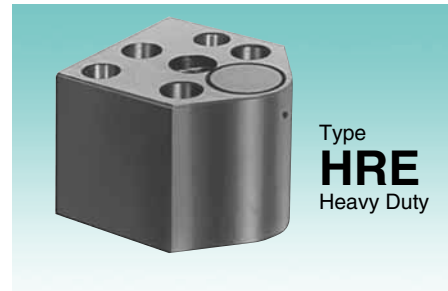

Type **HRE**  
Heavy Duty

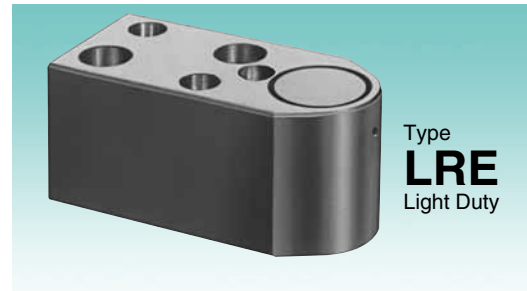

Type **LRE**  
Light Duty

**HOW TO ORDER**

**Specify:** Qty. Type D  
 Example: 15 HRE 100  
 12 LRE 87

**Retainer sets include:**

- Backing Plug
- Ball
- Spring
- Screws
- Dowels

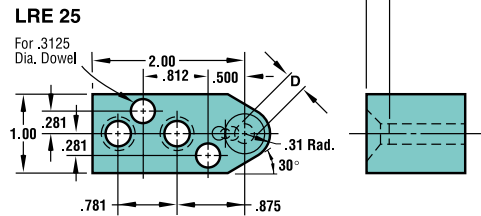
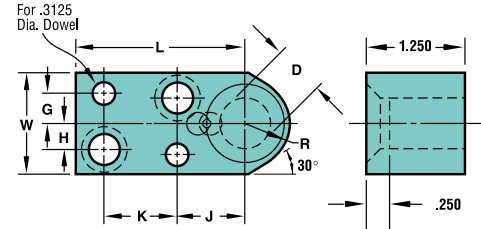
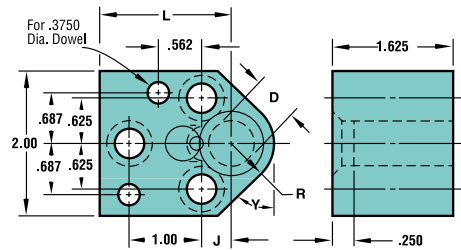

Catalog Number						
Type	D	L	J	R	Y	Screw Size
<b>HRE</b>	.5000	1.75	.375	.50	40°	3/8-16
	.6250	1.81	.438	.56	45°	3/8-16
	.7500	1.88	.500	.69	60°	3/8-16
	.8750	1.94	.562	.75	60°	3/8-16
	1.0000	2.00	.625	.81	60°	3/8-16
	1.2500	2.12	.750	1.00	—	3/8-16

Catalog Number										
Type	D	G	H	J	K	L	R	W	Screw Size	
<b>LRE</b>	.2500	See Drawing								1/4-20
	.3750	.375	.281	.906	.969	2.25	.38	1.25	3/8-16	
	.5000	.375	.281	.906	.969	2.25	.50	1.25	3/8-16	
	.6250	.375	.281	.906	.969	2.25	.56	1.25	3/8-16	
	.7500	.438	.344	1.125	1.000	2.50	.69	1.38	3/8-16	
	.8750	.438	.344	1.125	1.000	2.50	.75	1.50	3/8-16	
	1.0000	.438	.344	1.125	1.000	2.50	.81	1.62	3/8-16	



Note: Screw and Dowel Locations ± .005.

# Square Retainers

## Heavy Duty/Light Duty

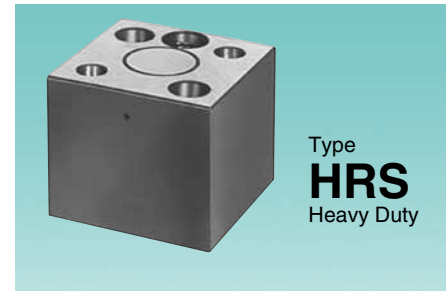

Type **HRS**  
Heavy Duty



Type **LRS**  
Light Duty

**HOW TO ORDER**

**Specify:** Qty. Type D  
 Example: 12 HRS 62  
 8 LRS 37

**Retainer sets include:**

- Backing Plug
- Ball
- Spring
- Screws
- Dowels

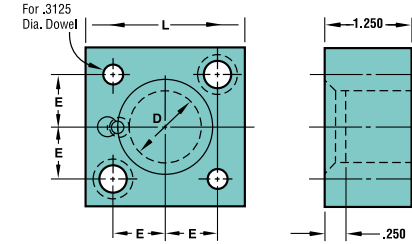
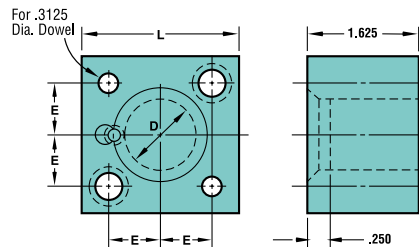

Catalog Number				
Type	D	L	E	Screw Size
<b>HRS</b>	.5000	1.88	.562	3/8-16
	.6250	2.00	.625	3/8-16
	.7500	2.12	.688	3/8-16
	.8750	2.38	.750	1/2-13
	1.0000	2.38	.750	1/2-13
	1.2500	2.62	.812	1/2-13

Catalog Number				
Type	D	L	E	Screw Size
<b>LRS</b>	.2500	1.25	.312	1/4-20
	.3750	1.38	.375	5/16-18
	.5000	1.50	.438	5/16-18
	.6250	1.62	.500	5/16-16
	.7500	1.88	.562	3/8-16
	.8750	2.00	.625	3/8-16
	1.0000	2.25	.750	3/8-16
	<b>*LRS</b>	1.2500	2.25	.750
	1.5000	2.75	1.000	3/8-16
	1.7500	2.75	1.000	3/8-16

\*May be furnished with Backing Plate instead of Backing Plug.



Note: Screw and Dowel Locations ± .005.

# Classified Shapes

Classified shapes (83 common shapes, no detailing required) are available on all punches and die buttons, as indicated in this catalog. The 83 available common shapes are shown here and on p. 33. Also, see the outside of the pullout tab for notes and drawing references.

## Ordering Information

**\*Corner Dimensions**  
Dimensions should be the theoretical sharp corners for shapes C22, C24, C34, C61, and C88. However, some reduction of these dimensions will result from fitting the punch and die button under conditions where the clearance is .0025 or less per side.

**†Shape Center**  
Shapes are centered on the punch shanks as shown. Shapes in guide bushings and die buttons are also centered as shown with the exception of shapes C22 and C34. Due to clearance, the P dimension on these shapes will not be centered.

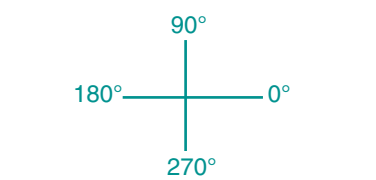

## Flatted Rounds

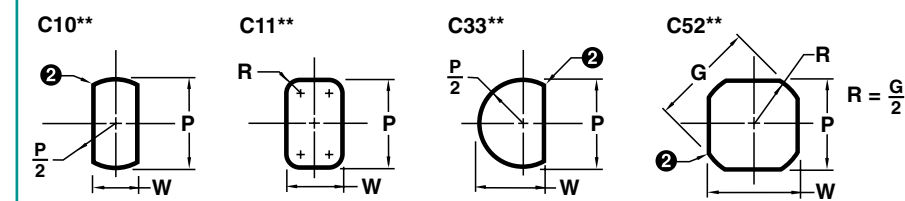

\*\* Now standard. See product pages.

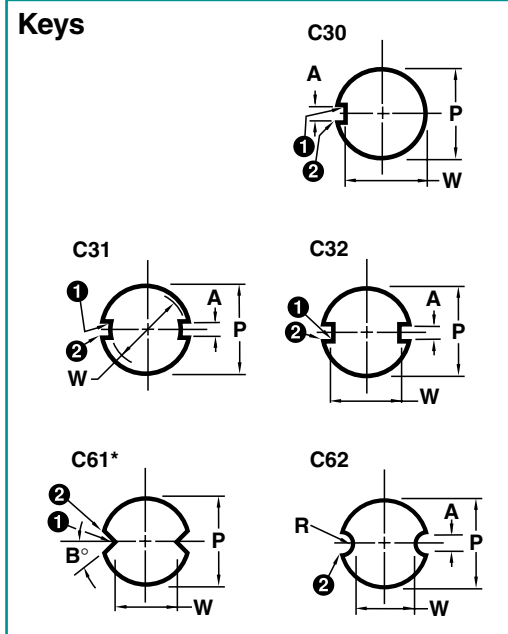

## Triangles/Trapezoids

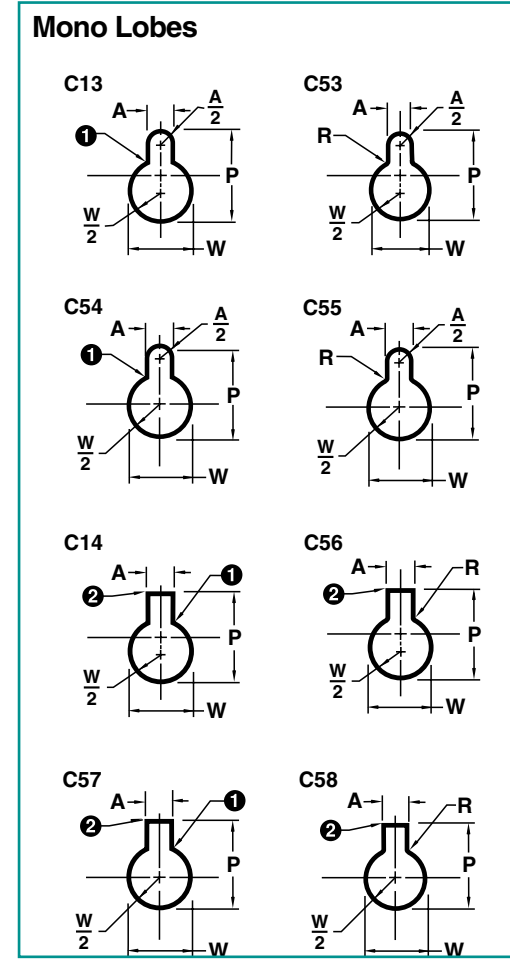
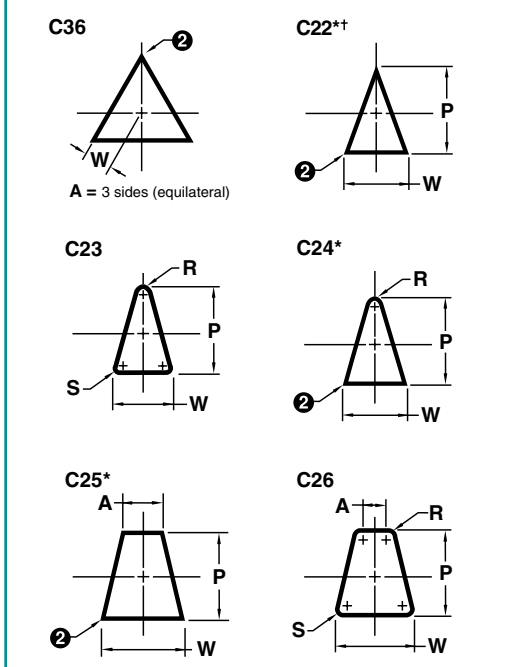

## Multi Lobes

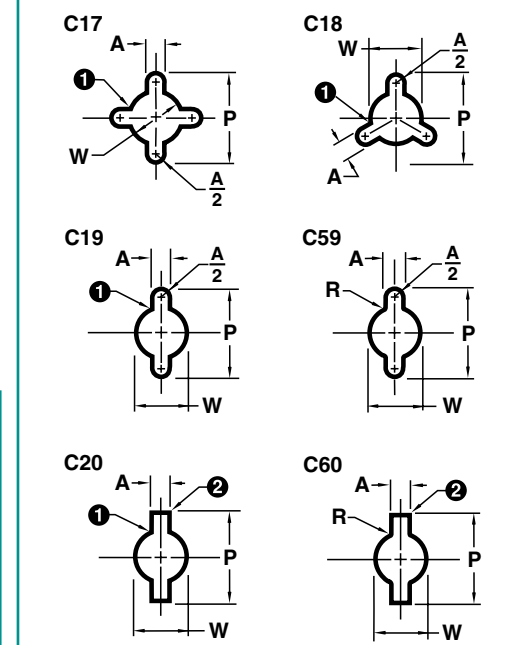

# Classified Shapes

## Miscellaneous

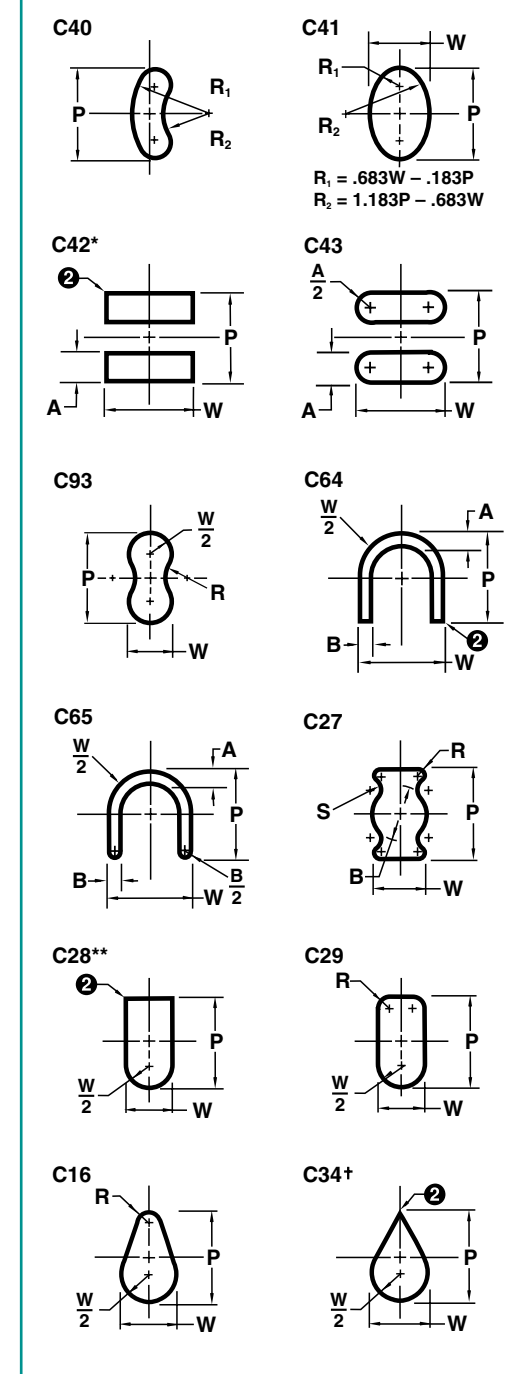

## Ts

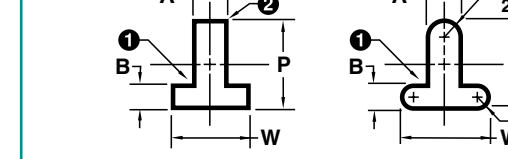

\*See "Corner Dimensions" note on p. 32.

## Us

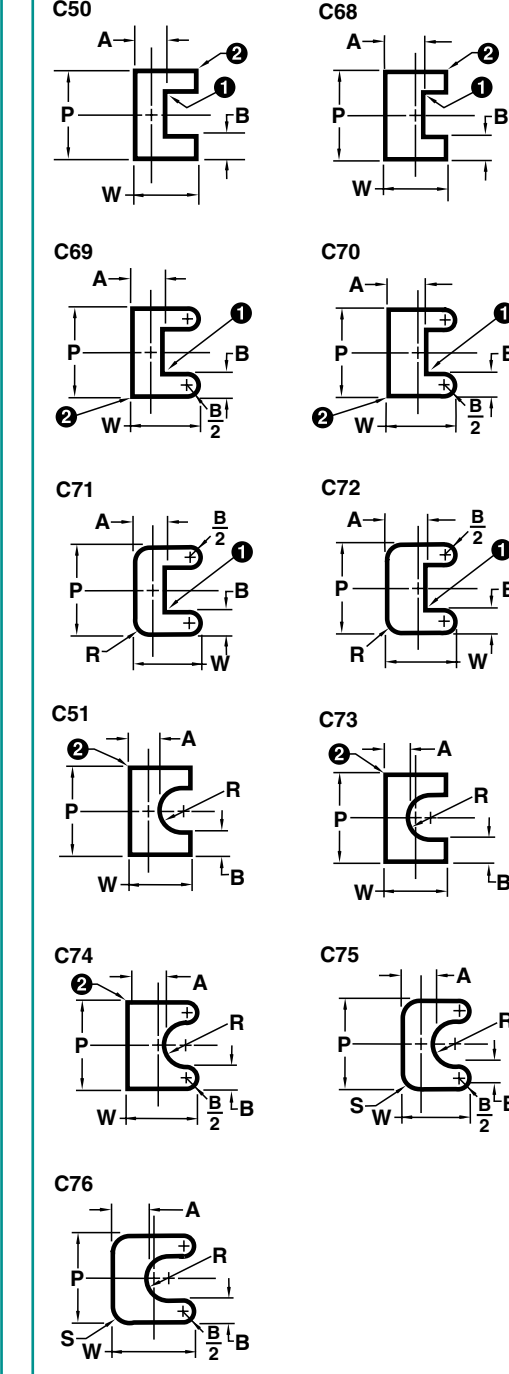

## Ls

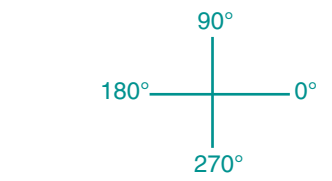
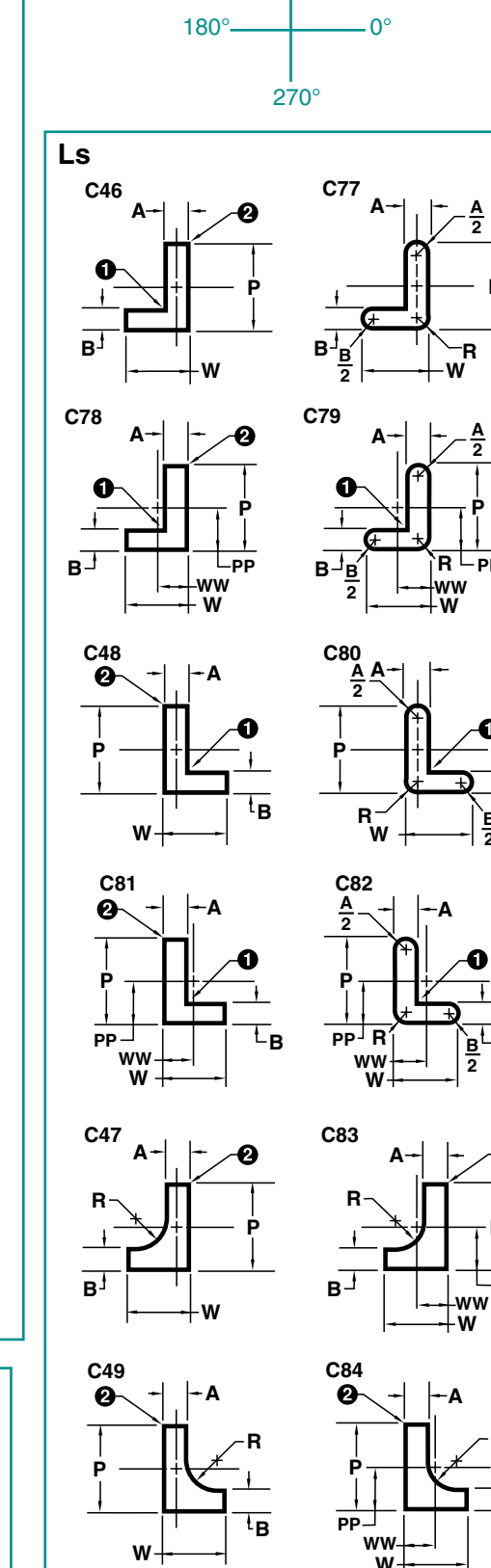

## Polygons

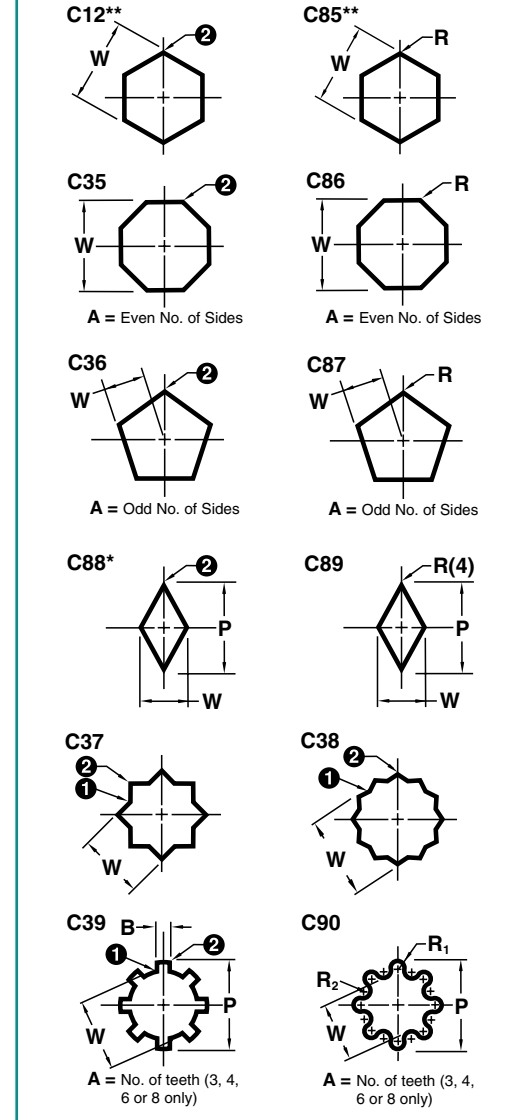

## Duo Tees

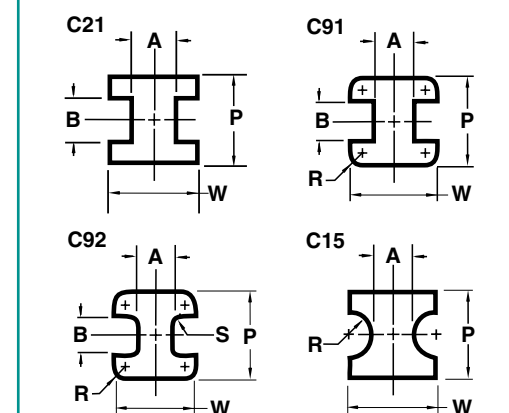

# Ball Lock

# Classified Shapes

Ordering Information

## Reflected View—Punches and Guides

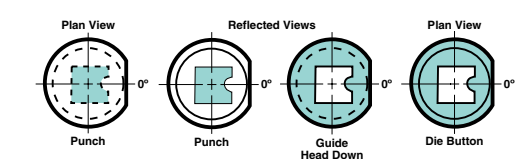

The reflected view is used for punches and guides. It is the view as seen in a mirror held below a punch or guide in its operating position. It is the same as a plan view from the head end, in which the point shape is shown dotted. A reflected view is shown with solid lines.

## Orientation and Locking

The locking device orientation is standard at 0°. For types of locking methods and custom locations, see p. 40.

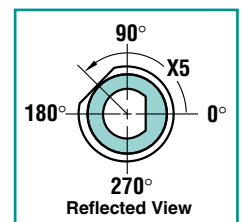

## Clearance

Normal grinding methods produce ① .007 max fillet on the punch and ② .007 max fillet on the die button with matching corner shape on the die button and punch, respectively. When ordering die buttons, please specify punch dimensions and clearance per side (Δ).

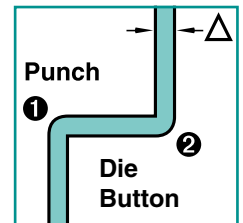

# Form Punch Shapes

Dayton Progress Form Punches are available on round punches (i.e., those designated as standard "X" shaped punches). When ordering, change the "X" designator to a "W." In addition, specify other dimensions, as shown in

the example below. Specify alterations, if applicable. The shapes shown below are standard, but are not the only shapes Dayton provides. Others are available with a detailed drawing attached to the order.

Form Punches are also available on standard punch blanks. Form Punches other than those are available as specials.



**HOW TO ORDER**

Specify:	Qty.	Type	Code	L	Steel	W Shape	P	PP	LA	Alterations
Example:	2	HPW	50	B350	M2	W201	P.1875	PP.1250	LA2.235	XNT

"P" is the point dimension of the product. The "P" dimensions are not shown below. When "P" = "D," shank tolerance applies.

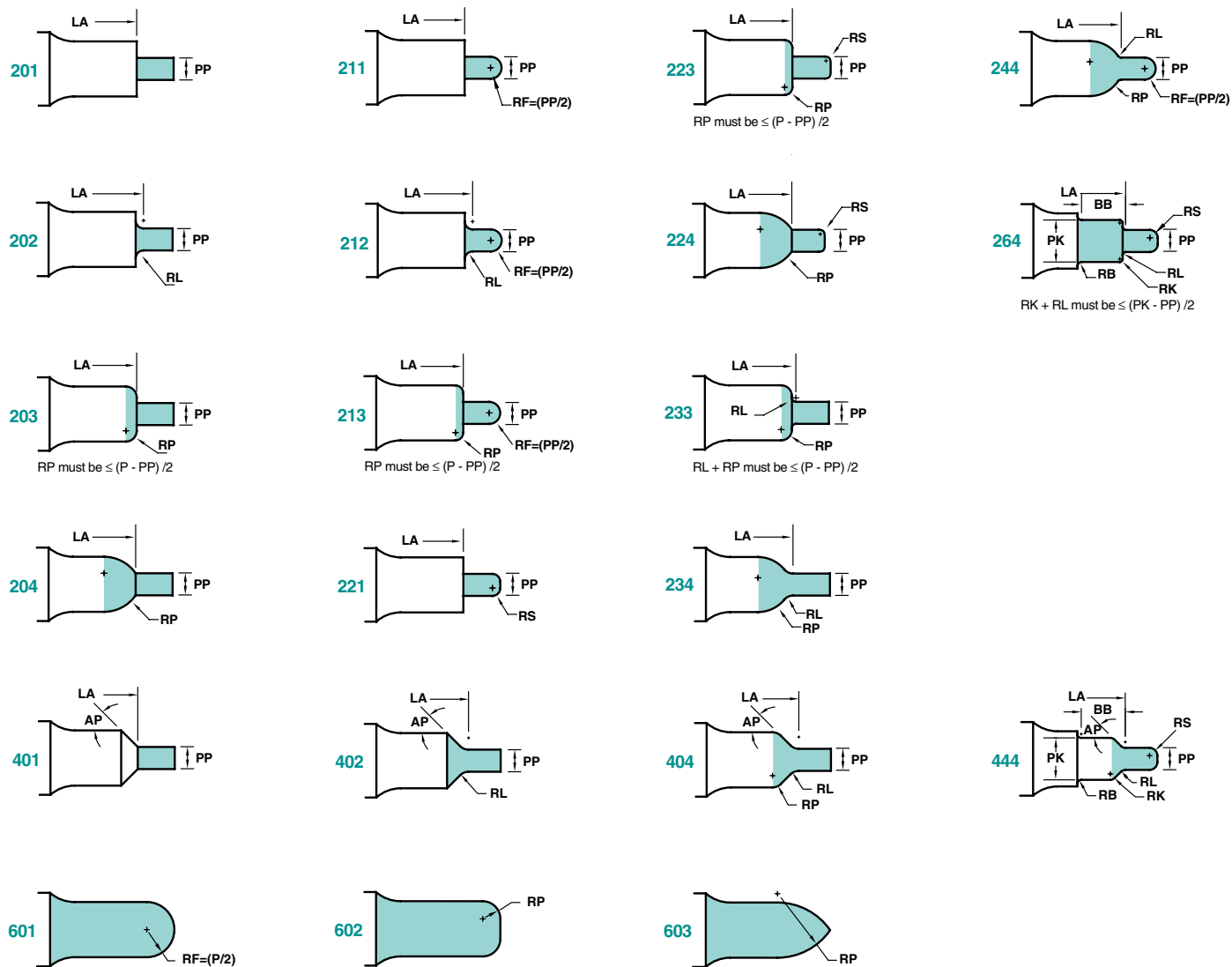
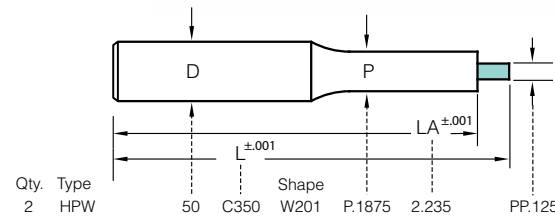

# Form Punch Shapes

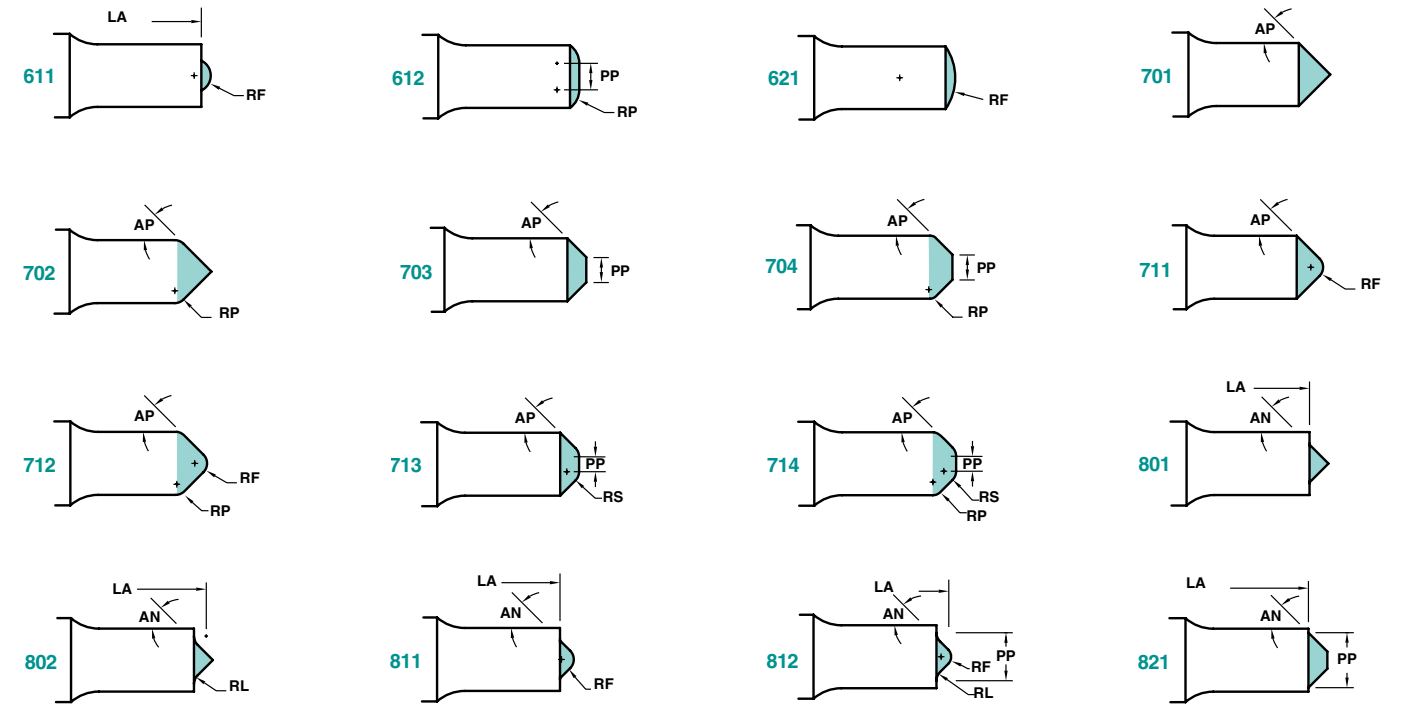

# Form Die Button Shapes

Dayton Die Buttons are available for all the Form Punches shown here, i.e., round punches designated as standard "X" shaped punches. When ordering, please

change the "X" designator to a "W." Die Buttons are available as headed or headless with a counterbore relief, or as headed or headless with a tapered relief.

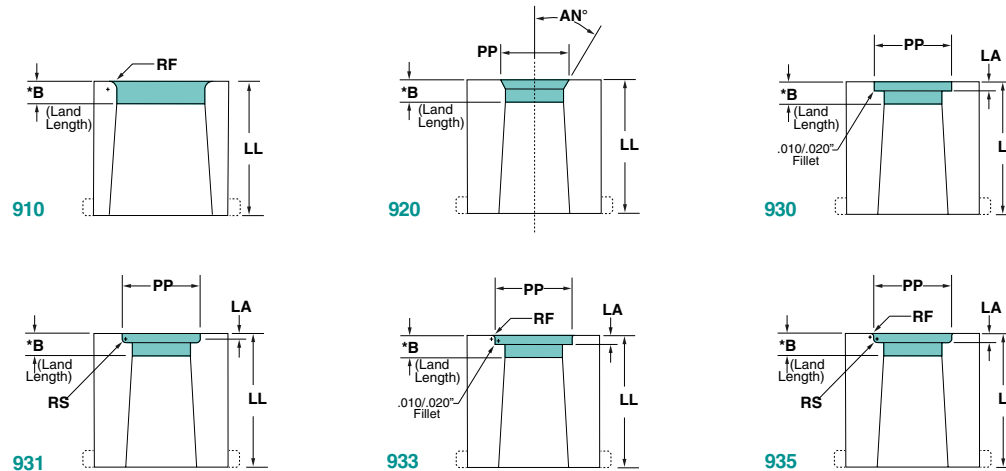

\*B (Land Length) will be per catalog standard, unless XB is ordered. O.A.L. will be held to LL tolerance, i.e., ±.001.







**HOW TO ORDER**

Specify:	Qty.	Type	Code	LL	Steel	W Shape	P	PP	LA	RS	RF	AN°	Alterations
Example:	4	LDW	125	118	M2	W935	.50	.625	.15	.05	.03		XNT



# Accessories

## Retainers

	Backing Plugs			Socket Head Cap Screw	Retainer Nut	Dowel	Ball Release Screw	Ball	Standard Spring	Extra Heavy Duty Spring	Booster Spring	Retainer Drill Bushing	
	Type A Standard in Single-hole Retainers	Type B Optional for Die Buttons	Type C Standard in Multi-Position™ Retainers										
Reg. U.S. Pat. & TM Office													
<b>Heavy Duty HRT</b> 	37	573345		574112 5/16-18 x 1 3/4	574953 5/16-18	574015 3/16 x 3/4		813109 3/8 Dia.	573922	573981	269026	572683	
	50	573426		574198 3/8-16 x 2	830097 3/8-16	574031 1/4 x 3/4	575275 10-24 x 1	813168 1/2 Dia.	573949	574007	269042	572756	
	62	573493										572837	
	75	573566										572918	
	87	573647											572985
	100	573728											573051
125	573795			574279 1/2-13 x 2	830127 1/2-13							573124	
<b>HRS</b> 	50		573434	574198 3/8-16 x 2	830097 3/8-16	817007 5/16 x 1 1/2		813168 1/2 Dia.	573949	574007	269042		
	62		573507										
	75		573574										
	87		573655	574279 1/2-13 x 2	830127 1/2-13								
	100		573736										
	125		573809										
<b>HRE</b> 	50		573434	574198 3/8-16 x 2	830097 3/8-16	817015 3/8 x 1 1/2		813168 1/2 Dia.	573949	574007	269042		
	62		573507										
	75		573574										
	87		573655										
	100		573736										
	125		573809										
<b>Light Duty LRT</b> 	25	573264		505439 5/16-18 x 1 1/2	574953 5/16-18	573973 1/8 x 3/4	575259 8-32 x 1	813028 1/4 Dia.	573876			572616	
	37	573345				574015 3/16 x 3/4		813052 5/16 Dia.				572683	
	50	573426	573442	574163 3/8-16 x 1 1/2	830097 3/8-16	574031 1/4 x 3/4		813052 5/16 Dia.	573892			572756	
	62	573493	573515										813109 3/8 Dia.
	75	573566	573582									572918	
	87	573647	573663									572985	
	100	573728	573744	574252 1/2-13 x 1 3/4	830127 1/2-13							573051	
	<b>LRS</b> 	25		573272	505226 1/4-20 x 1 1/2	830038 1/4-20	817007 5/16 x 1 1/2		813028 1/4 Dia.	573876			
37			573353	505439 5/16-18 x 1 1/2	830062 5/16-18	813052 5/16 Dia.			573892				
50			573442					813109 3/8 Dia.	573914				
62			573515			814105							
75			573582										
87			573663										
100			573744	573736	574163 3/8-16 x 1 1/2	830097 3/8-16							
125													
150													
175													
<b>LRE</b> 	25		573272	505226 1/4-20 x 1 1/2	830038 1/4-20	817007 5/16 x 1 1/2		813028 1/4 Dia.	573876				
	37		573353	574163 3/8-16 x 1 1/2	830097 3/8-16			813052 5/16 Dia.				573892	
	50		573442					813109 3/8 Dia.	573914				
	62		573515										
	75		573582										
	87		573663										
	100		573744	573736									

**HOW TO ORDER**

<b>Specify:</b>	<b>Qty.</b>	<b>Product #</b>
Example:	150	813109 (Ball for HRT with .3750 dia.)
	28	817007 (Dowel for HRS)
	43	573876 (Spring for LRE with .2500 dia.)

# Accessories

## Miscellaneous

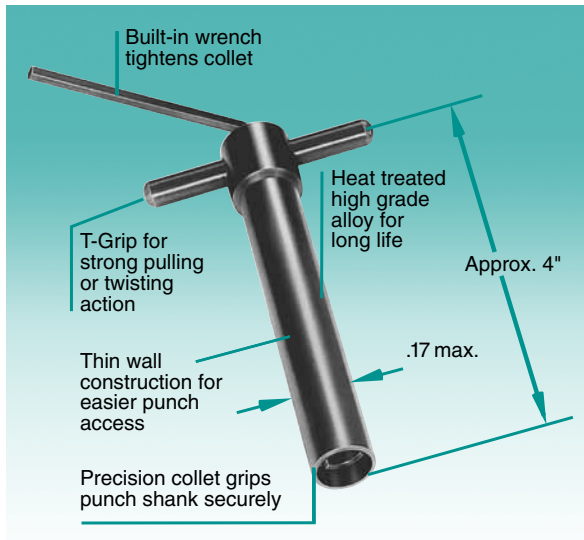

### Punch Pullers

Dayton Punch Pullers simplify and speed the removal of ball lock punches from retainers. You no longer have to improvise with vise grips or other tools that can slip from the punch, making removal difficult or hazardous.

Dayton Punch Pullers are made of high-grade alloy steel and are heat-treated and precision machined for long, reliable service. Dayton Punch Pullers, which can improve performance and save downtime, are available in shank sizes from .250" to 1.250".

#### HOW TO ORDER

**Specify: Qty. Product #**  
 Example: 3 818097 (.250 shank diameter with 1.12 max point length)

#### Removes ball lock punches quickly and easily

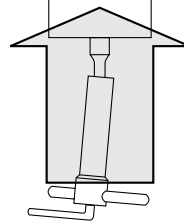

**1**  
Slide Punch Puller over the shank.

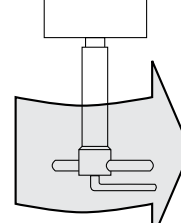

**2**  
Rotate the built-in wrench until tight.

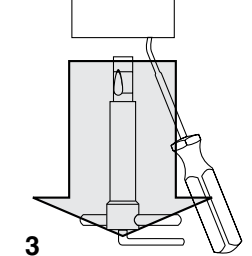

**3**  
Insert release tool and pull down.

Catalog Number	Shank Diameter In Inches	Max. Point Length
818097	.250	1.12
818119	.375	1.31
818127	.500	1.56
818135	.625	1.56
818143	.750	1.56
818151	.875	1.56
818178	1.000	1.81
818186	1.250	1.81

### Ball Release Tools



Cat. No. 818038

**Angle Tip**  
(for all retainers)



Cat. No. 818046

**Straight Tip**  
(for all retainers)



Cat. No. 818054 Light Duty  
 Cat. No. 818062 Heavy Duty

**Threaded Tip**  
(for True Position® Retainers)

#### HOW TO ORDER

**Specify: Qty. Product #**  
 Example: 2 818046 (Straight Tip)

### Shim/Backing Plate

#### HOW TO ORDER

**Specify: Qty. Product #**  
 Example: 2 URSP 1318

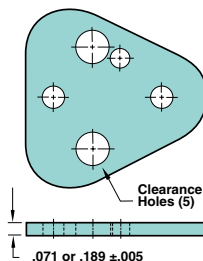

D	Thickness T	
	.189 (Rc54-56)	.071 (Soft)
25	URBP 1048	URSP 1018
37	URBP 1048	URSP 1018
50	URBP 1348	URSP 1318
62	URBP 1648	URSP 1618
75	URBP 2048	URSP 2018
87	URBP 2248	URSP 2218
100	URBP 2548	URSP 2518
125	URBP 3248	URSP 3218

# EDM Die Button Blanks

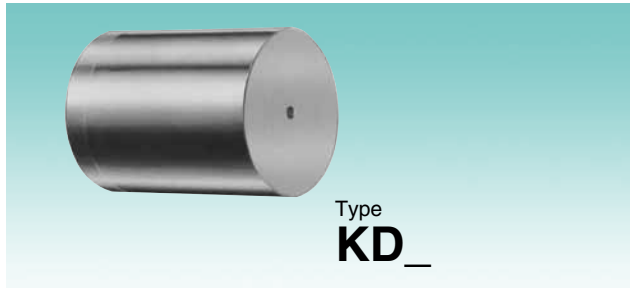

### HOW TO ORDER

Specify:	Qty.	Type	D Code	L	P	Steel
Example:	6	KDE	37	100	XP.020	M2
	5	KDU	50	112		M2

Standard "P" will be provided, unless otherwise specified.

### Material

Steel: M2, RC 60-63

Round P  $\pm .005$   $\text{\textcircled{C}}$  .005 P to D

D  $\geq 1.75$   $\begin{matrix} +.0006 \\ +.0002 \end{matrix}$

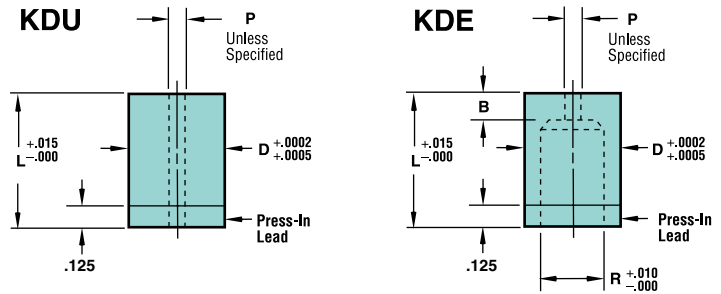

Body	K_U			K_E					.75	.87	.93	1.00	1.125	1.25	1.375	1.50
	Dia.	Std. P	Optional XP	Std. P	Optional XP	B	R									
.2500	.031	.020	—	.031	.020	—	.15	.156								
.3125	.031	.020	—	.031	.020	—	.25	.191								
.3750	.031	.020	—	.031	.020	—	.25	.228								
.4375	.031	.020	—	.031	.020	—	.25	.281								
.5000	.062	.020	—	.031	.020	—	.25	.312								
.6250	.062	.020	.031	.093	.020	.031	.25	.391								
.7500	.062	.020	.031	.093	.020	.031	.31	.468								
.8750	.062	.020	.031	.093	.020	.031	.31	.578	75	87	93	100	112	125	137	
1.0000	.062	.020	.031	.093	.020	.031	.31	.703								
1.2500	.062	.020	.031	.125	.020	.031	.37	.828								
1.5000	.062	.020	.031	.125	.020	.031	.37	1.093								
1.7500	.125	.020	.031	.125	.020	.031	.37	1.430								
2.0000	.125	.020	.031	.125	.020	.031	.37	1.630								
2.2500	.125	.020	.031	.125	.020	.031	.37	1.830								
2.5000	.125	.020	.031	.125	.020	.031	.37	2.030								
2.7500	.125	.020	.031	.125	.020	.031	.37	2.230								



D  $\leq 1.00$  1 Day  
 1.00 < D  $\leq 1.50$  2 Days  
 (with XP, add 2 Days)

D > 1.50 4 Days  
 (with or without XP)

## Features/Benefits

Select either round **KDU EDM Die Button Blanks** or round **KDE Die Button Blanks**. Relief hole (R) provides sufficient clearance for slug removal during the stamping process in both types.

**KDU Blanks** are provided with a small straight through hole. They are commonly used for wire and vertical EDM operations. There are two key advantages with this type of blank: in wire cutting, a tapered relief can be cut instead of a round straight relief; in conventional EDM applications, you can customize the size of the relief to the shape you are cutting.

**KDE Blanks** are used with conventional (vertical) EDM machines. The hole (P) is used to introduce dielectric to the spark gap for flushing away eroded particles of steel. For the fastest delivery, use the standard (P) dimension given in the chart. If an optional (P) dimension is desired, simply specify "XP," and indicate the dimension.

# Jektol<sup>®</sup> Data

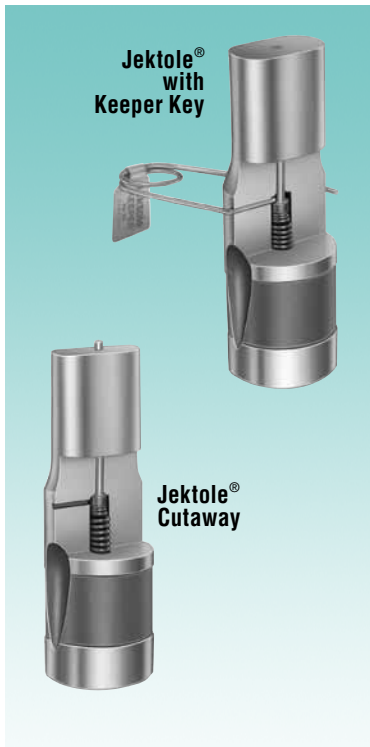

## The Engineered Clearance

Perforating punch-to-die button clearances in metal stamping dies has been universally expressed as a percentage of stock thickness, and for clarity should be articulated as percent per side ( $\Delta$  = clearance per side).

Standard practice has called for  $\Delta 5\%$ , and is commonly known as "regular clearance." Regular clearance has been applied almost universally to all applications involving the perforation of ferrous materials.

Jektol<sup>®</sup>, the **Engineered Clearance**, is approximately twice regular clearance, i.e.,  $\Delta 10\text{-}12\%$ . This means greater productivity, improved maintenance, and a better return on your tooling investment.

In addition, clearances of up to  $\Delta 50\%$  are not uncommon with some hard materials. Clearance tests have been performed by Dayton Progress to prove that increasing the clearance does not lessen hole quality—a common thought by some designers and engineers. Dayton clearance tests do, in fact, prove that the Jektol<sup>®</sup> **Engineered Clearance** provides many advantages and benefits.

## Jektol<sup>®</sup> In Production

- Requires less press tonnage
- Reduces the pressure required to strip the punch, which, in turn, reduces punch wear
- Produces minimal burr
- Doubles—often triples—piece output per grind
- Reduces total punch costs

## Jektol<sup>®</sup> In Maintenance

- Keeper Key holds pin in retracted position (see photo at left)
- Eliminates the need for disassembly before grinding
- Helps maintain proper pin extension
- Reduces downtime for regrinding

## Standard Jektol<sup>®</sup> Data

DIMENSION	J2*	J3	J4	J6	J9	J12
<b>Std. Shank Dia.</b>	D .250	.250	.375	.500 .625	.750 .875 1.000	1.250
<b>Point Hole Dia.</b>	C .020	.032	.046	.063	.094	.125
<b>Shank Hole Dia.</b>	E .086	.109	.141	.172	.221	.275
<b>Pin Extension</b>	.030	.030	.060	.060	.060	.060
<b>Keeper Key No.</b>	920045			920053		**

\* Point Diameters < .080 \*\* Keeper Key not available

## Jektol<sup>®</sup> Design Limits

DIMENSION	J2	J3	J4	J6	J9	J12
<b>Min. Shank Dia. (Light Duty)</b>	D .250	.250	.375	.500	.750	.875
<b>Min. Shank Dia. (Heavy Duty)</b>	D .375	.375	.375	.500	.750	.875
<b>Min. Point Dia.</b>	P .040	.064	.092	.126	.188	.250
<b>Max. Point Lgth.</b>	B 1.25	1.50	1.62	1.62	1.62	1.62

## Universal Jektol<sup>®</sup> Components

EJECTOR PINS	J2	J3	J4	J6	J9	J12
<b>Overall Length</b>	L 1.11	1.38	1.94	1.94	2.22	2.22
<b>Pin Diameter</b>	D .017	.027	.041	.058	.089	.120
<b>Head Diameter</b>	H .048	.073	.094	.120	.156	.188
<b>Hd. Thickness</b>	T .031	.047	.062	.062	.094	.094
SPRINGS	J2	J3	J4	J6	J9	J12
<b>Outside Dia.</b>	D .081	.104	.136	.167	.216	.270
<b>Free Length</b>	L 2.38	2.38	3.19	3.00	3.03	2.56
<b>Pressure (.12Preload)</b>	lbs. .5	.75	1	1.5	2	2.5
SCREWS	J2	J3	J4	J6	J9	J12
<b>Screw Size</b>	D #3-48	#5-40	#8-32	#10-32	1/4-28	5/16-24
<b>Screw Length</b>	L .19	.19	.19	.19	.25	.25

## Jektol<sup>®</sup> Components

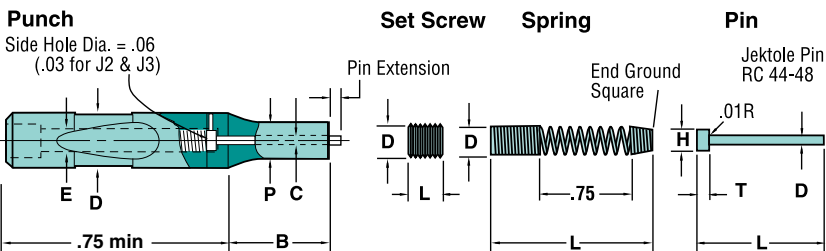



# Locking Devices

## Orientation

The standard ball seat location is at 90°. Alternate locations of 0°, 180°, or 270° may be specified at no extra cost. Custom ball seat locations may be specified as "BS" and at the degree required counter-clockwise from 0°. (See drawing on right.)

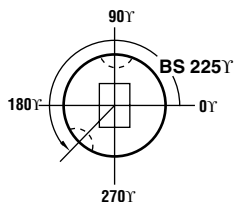

## Views

A plan view is used for the die button, and a reflected view is used for the punch. The reflected view is a mirror image (see p. 32, "Classified Shapes"), simplifies orientation: All locking devices are in the same position.

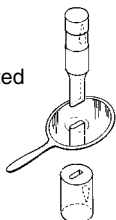

Identify as "reflected view" on the punch drawing.

## How to Specify

This page shows the most common locking devices available for press-fit die buttons—single flat, double flat, and dowel. Select the type, then add the code to the component description. (See "how to order" box on right.)

### Single Flats X2, X5, X8, X9

The standard key flat locking device is at 0°. Specify "X2" (bottom) or "X8" (top) for die buttons. Alternate locations of 90°, 180°, or 270° may be specified at no additional cost. Specify "X2" or "X8" and the degree required. Example: X2—90°.

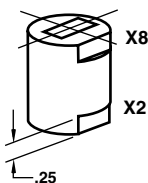

### Custom Location

Specify "X5" (bottom) or "X9" (top) and the degree required counter-clockwise from 0°. Example: X5—135°.

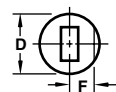

### Double Flats X3, X6

The double key flat locking device is at 0°. Specify "X3" for die buttons. Alternate locations of 90°, 180°, and 270° may be specified at no additional cost. Specify "X3" and the degree required. Example: X3—90°.

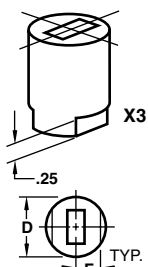

### Custom Location

Specify "X6" for die buttons and the degree required counter-clockwise from 0°. Example: X6—135°.

## F Dimension for Flats for Press-Fit Die Buttons

Body Dia.	25	37	50	62	75	87	100
F	.110	.165	.220	.270	.325	.380	.435
Body Dia.	125	150	175	200	225	250	275
F	.540	.650	.775	.900	1.025	1.150	1.275

## Location Tolerance

Flat		Dowel	
F	Radial	F	Radial
+ .0005	.001/ inch	+ .0005	0°-4'
- .0000		- .0000	

## HOW TO ORDER

Specify:	Qty.	Type	D Code	P (or P&W)	Steel	Alteration
Example:	5	KDO	87-100	P.394, W.209	A2	X2
	9	KDR	50-125	P.275, W.092	M2	X83

## Additional Flat For Punches and Die Buttons

The depth of the flat is taken from the shank, not the head, on punches.

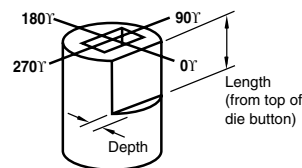

	Code	Depth	Length
Standard Location	X81	.060	.500
	X82	.060	.625
	X83	.060	.750
	X84	.060	Full Length
	X85	.093	.500
	X86	.093	.625
	X87	.093	.750
	X88	.093	Full Length
	X89		Specify Dimensions
Custom Location	X91	.060	.500
	X92	.060	.625
	X93	.060	.750
	X94	.060	Full Length
	X95	.093	.500
	X96	.093	.625
	X97	.093	.750
	X98	.093	Full Length
	X99		Specify Dimensions

## Dowel Slots X0\*, X1\*, X4, X7, X41, X71

The standard dowel locking device is at 0°. Specify "X4" (.125 dowel) or "X41" (.1875 dowel) for die buttons. Specify "X0" (F=.5D) for die buttons only.

Alternate locations of 90°, 180°, or 270° may be specified at no additional cost. Specify "X0," "X4," or "X41" and the degree required.

Example: X4—90°.

### Custom Location

Specify "X7" (.125 dowel) or "X71" (.1875 dowel) for die buttons. Specify "X1" (F=.5D) for die buttons only. Specify "X1," "X7," or "X71," and the degree required counter-clockwise from 0°.

Example: X71—135°.

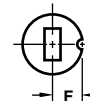
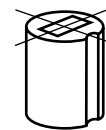

## F Dimension for Dowels for Press-Fit Die Buttons

Body Dia.	25	31	37	43	50	62-275
X0*, X1*	.1250	.1562	.1875	.2188	.2500	D/2
X4, X7	.1625	.1875	.2125	.2375	.2625	D/2
X41, X71	.1938	.2188	.2438	.2688	.2938	D/2

### Order example:

X0, X1, X4, & X7 — .1250 Dowel      X41 & X71 — .1875 Dowel

\* Available on headless die buttons only

# Urethane Strippers

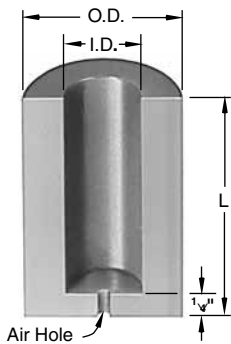

Air Hole	I.D.
1/16	3/16-1/4
3/32	5/16
1/8	3/8-1

## Features/Benefits

Dayton's durable, yet flexible, Urethane Strippers provide superior stripping over conventional strippers; develop higher load-bearing capacity due to the use of a unique curing agent; are tear- and oil-resistant; provide exceptional dampening of the punch, thus eliminating premature punch failure due to vibration; and are easy to install and replace.

Strip-shape Dayton Urethane Strippers assure positive stripping and dampen punch vibration by gripping around the punch point. The closed-end feature holds the thin stock flat during the stripping cycle, and helps eliminate the potential for rejected parts.

### HOW TO ORDER

**Specify:** Qty. Type I.D. L  
 Example: 12 USE 37 125

Catalog Number	I.D.	O.D.	L	Pressure at Deflection of		
				1/8	1/4	3/8
USE18-125 USE18-150	3/16	11/16	1 1/4 1 1/2	250 230	400 350	— —
USE25-125 USE25-150 USE25-175	1/4	3/4	1 1/4 1 1/2 1 3/4	280 275 220	475 465 375	— — 490
USE31-125 USE31-150 USE31-175 USE31-200	5/16	13/16	1 1/4 1 1/2 1 3/4 2	320 300 270 240	500 450 400 370	— — 575 600
USE37-125 USE37-150 USE37-175 USE37-200	3/8	7/8	1 1/4 1 1/2 1 3/4 2	420 385 355 310	695 625 575 515	— — 760 670
USE50-125 USE50-150 USE50-175 USE50-200 USE50-225	1/2	1	1 1/4 1 1/2 1 3/4 2 2 1/4	520 450 435 315 275	790 725 680 510 475	— — 875 650 600
USE62-125 USE62-150 USE62-175 USE62-200	5/8	1 1/8	1 1/4 1 1/2 1 3/4 2	600 520 480 440	925 835 775 730	— — 1000 935
USE75-175 USE75-200 USE75-225 USE75-250 USE75-275	3/4	1 1/2	1 3/4 2 2 1/4 2 1/2 2 3/4	500 400 350 325 300	800 700 650 600 550	1200 1100 1000 900 800
USE87-175 USE87-200 USE87-225 USE87-250 USE87-275	7/8	1 3/4	1 3/4 2 2 1/4 2 1/2 2 3/4	1500 1200 1150 900 850	2200 1900 1850 1450 1350	3400 2800 2400 1900 1800
USE100-175 USE100-200 USE100-225 USE100-250 USE100-275	1	2	1 3/4 2 2 1/4 2 1/2 2 3/4	2000 1600 1400 1200 1000	3000 2600 2300 2000 1800	3500 3400 3200 3000 2800

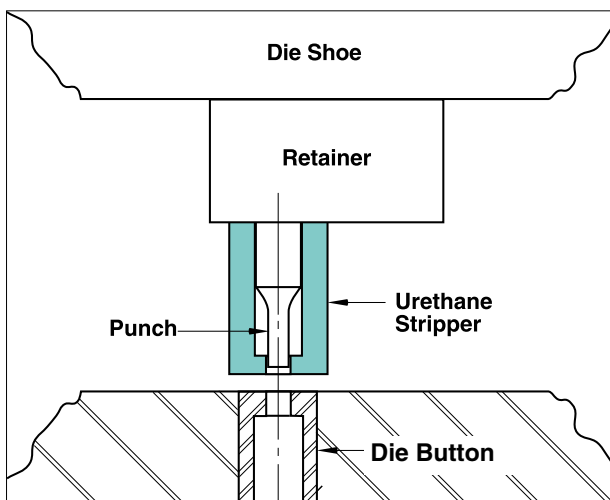
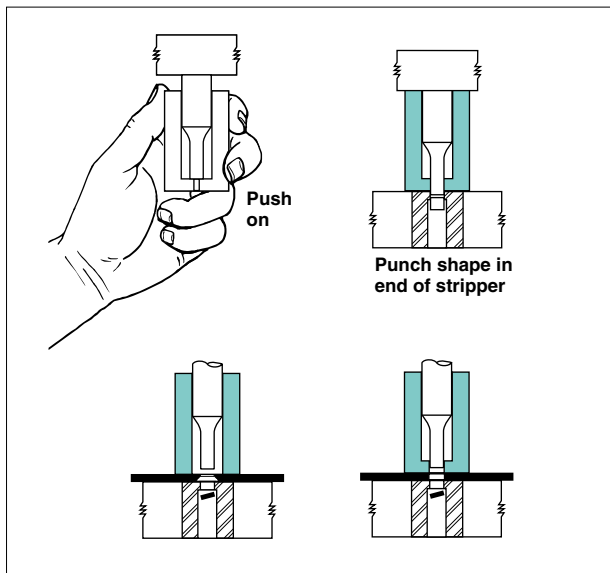

# Shear Angles

Shear Angles can be applied to all punch points. These angles are used primarily to reduce slug pulling. Single and Double Shears can be used to reduce the punching force as well as minimize slug pulling. These alterations are prepriced and do not add to the standard delivery of the product.

Shear Angles are also available on Classified Shapes, but are available as special order only.

Standard ball seat location is at 90°.

Simply add the alteration code shown next to the drawings, and the angle desired, to your punch catalog number. Tolerance on all angles is  $\pm 15$  minutes.

LL not available on XS19, XS21, XS22, and XS23.

## HOW TO ORDER

Type	Code	L	P (or P&W)	Steel	Alteration
HPL	100	C350	P.872, W.401	A2	XS23 A3°

## For Round Punches Only

### XS19 Nail Point

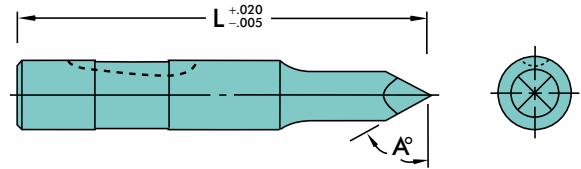

### XS20 Chamfer

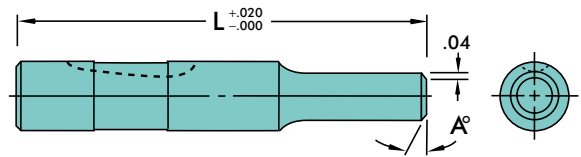

### XS21 Conical

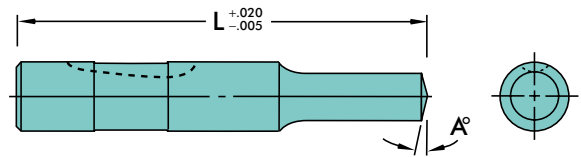

## For Round & Shape Punches

### XS22 Double Shear

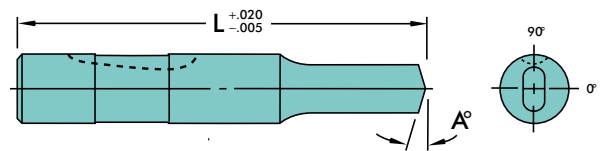

### XS23 Single Shear

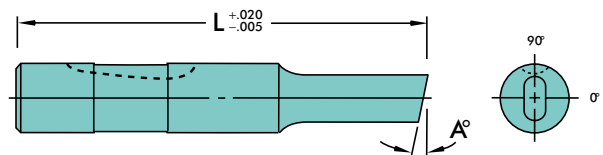

### XS24 Single Shear Angle with Flat

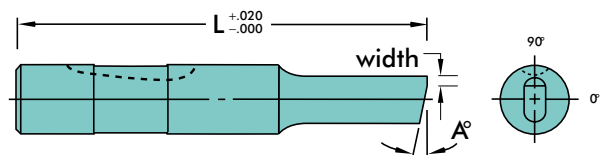

Shown as reflected view.

# VersaPlus® Premium Products

## PUNCHES

Standard features on all Dayton VersaPlus® punch products include precision concentricity between the point and the shank (resulting in better punch and die alignment); a super-smooth finish on the point (resulting in less galling and reduced maintenance costs); and state-of-the-art-coatings that provide superior hardness.

### Jektole® Punches

VersaPlus® Jektole® Punches permit doubling punch to die button clearance; produce up to three times (or more) the number of hits between sharpenings; and reduce burr heights.

### Regular Punches

VersaPlus® Regular Punches provide three times better alignment than other major brands; offer longer tool life; and can significantly improve finished part quality.

### Straight Punches

VersaPlus® Straight Punches—Jektole® and Regular—are available in a wide range of sizes; can be designed and formed to accommodate your specific punching needs; and provide longer die runs, less downtime, and reduced maintenance costs.

## PILOTS

Standard features on all Dayton VersaPlus® pilots include smoother pick-up action; less hole distortion; and state-of-the-art coatings to provide superior hardness.

### Regular Pilots

VersaPlus® Regular Pilots are built to exact tolerances; the parabolic point shape allows for smooth pick-up action; and pilots offer a wide range of unique punching and fabricating applications.

### Positive Pick-Up Pilots

VersaPlus® Positive Pick-Up Pilots provide smoother pick-up without the risk of distorting the hole; in addition, the unique design moves the stock farther than conventional pilots.

*If optimum performance is a MUST, this may be the only punch you'll ever need!*



© VersaPlus is a registered trademark of Dayton Progress.

VersaPlus® sets the new industry standard for high-performance punches and pilots. VersaPlus® means less downtime, longer production runs, and better value for your stamping dollar.

## Commitment to Quality & Customer Satisfaction

*Dayton Lamina is a leading manufacturer of tool, die and mold components for the metal-working and plastics industries. As a customer-focused, world-class supplier of choice, we provide the brands, product breadth, distribution network and technical support for all your metal forming needs.*

*Our goal is to give our customers the most innovative and value-added products and services.*



# DAYTON Lamina™

a MISUMI Group Company



Lamina® LEMPCO

\*Dayton Lamina's line of Danly products is available only to North America.

[www.daytonlamina.com](http://www.daytonlamina.com)