

# HAMMOND ORGAN

Model **B-3** mk2

**C-3** mk2

**B-3P** mk2

Thank you, and congratulations on your choice of this organ.

In order to get the most out of this instrument for many years to come, first take the time to read this manual in full.



Owner's Manual

# IMPORTANT SAFETY INSTRUCTIONS

Read these instructions.

Keep these instructions.

Heed all warnings.

Follow all instructions.

Do not use this apparatus near water.

Clean only with dry cloth.

Do not block any ventilation openings.

Install in accordance with the manufacturer's instructions.

Do not install near any heat sources such as radiators, heat registers, stoves or other apparatus (including amplifiers) that produce heat.

Do not defeat the safety purpose of the polarized or grounding-type plug. A polarized plug has two blades with one wider than the other. A grounding type plug has two blades and a third grounding prong. The wider blade or third prong is provided for your safety. If the provided plug does not fit into your outlet, consult an electrician for replacement of the obsolete outlet.

Protect the power cord from being walked on or pinched, particularly at plugs, convenience receptacles, and the point where they exit from the apparatus.

Only use attachments/accessories specified by the manufacturer.

Use only with the cart, stand, tripod, bracket, or table specified by the manufacturer, or sold with the apparatus. When cart is used: use caution when moving the cart/apparatus combination to avoid injury from tip-over.

PORTABLE CART WARNING



S3125A

Unplug this apparatus during lightning storms, or when unused for long periods of time.

Refer all servicing to qualified service personnel. Servicing is required when the apparatus has been damaged in any way, such as power-supply cord or plug is damaged, liquid has been spilled or objects have fallen into the apparatus, the apparatus has been exposed to rain or moisture, does not operate normally, or has been dropped.

Apparatus shall not be exposed to dripping or splashing and no objects filled with liquids, such as vases, shall be placed on the apparatus.

**WARNING:** To reduce the risk of fire or electric shock, do not expose this apparatus to rain or moisture.

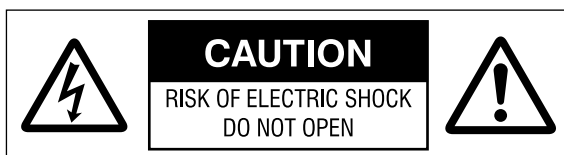

注意：感電の恐れありキャビネットをあけるな

**ATTENTION:** RISQUE DE CHOC ELECTRIQUE NE PAS OUVRIR  
**WARNING:**

TO REDUCE THE RISK OF FIRE OR ELECTRIC SHOCK,  
DO NOT EXPOSE THIS APPLIANCE TO RAIN OR MOISTURE.

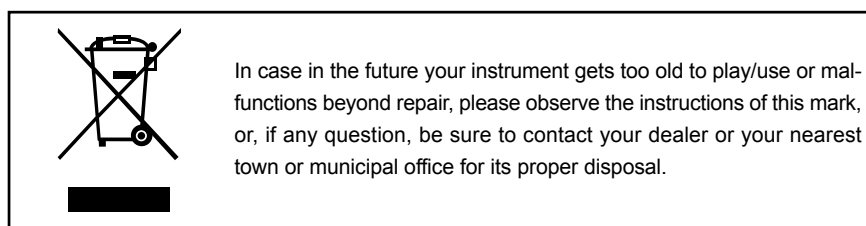
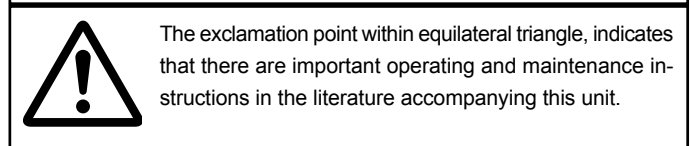
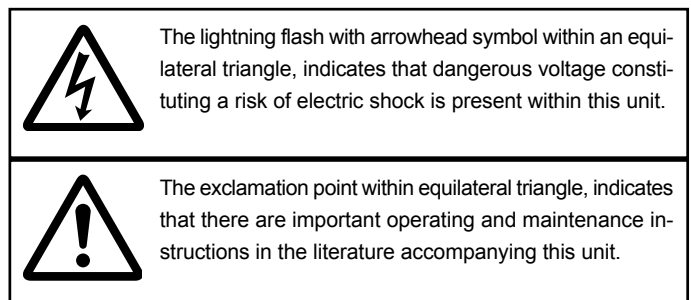

---



FOR UNITED KINGDOM:

FOR YOUR SAFETY, PLEASE READ THE FOLLOWING TEXT CAREFULLY

This appliance is supplied with a molded 3-pin mains plug for your safety and convenience.

The plug contains a 5 amp fuse.

Should the fuse need to be replaced, please ensure that the replacement fuse has a rating of 5 amps and that it is approved by ASTA or BSI to BS1362.

Check for the ASTA mark  or the BSI mark  on the body of the fuse.

If the plug contains a removable fuse cover, you must ensure that it is refitted when the fuse is replaced.

If the fuse cover is lost, the plug must not be used until a replacement cover is obtained.

A replacement fuse cover can be obtained from your local Hammond Dealer.

IF THE FITTED MOULDED PLUG IS UNSUITABLE FOR THE SOCKET OUTLET IN YOUR HOME, THEN THE FUSE SHOULD BE REMOVED AND THE PLUG CUT OFF AND DISPOSED OF SAFELY.

THERE IS A DANGER OF SEVERE ELECTRICAL SHOCK IF THE CUT-OFF PLUG IS INSERTED INTO ANY 13 AMP SOCKET.

If a new plug is to be attached to the cord, please observe the wiring code as shown below.

If in any doubt, please consult a qualified electrician.

IMPORTANT - The wires in this mains lead are coloured in accordance with the following code:

Blue: Neutral

Brown: Live

As the colours of the wires in the mains lead of this unit may not correspond with the coloured marking identifying the terminals in your plug, proceed as follows.

The wire which is coloured BLUE must be connected to the terminal in the plug which is marked with the letter N or coloured BLACK.

The wire which is coloured BROWN must be connected to the terminal in the plug which is marked with the letter L or coloured RED.

Under no circumstances should either of these wires be connected to the earth terminal of the three-pin plug, marked with the letter E or the Earth Symbol .

To replace the fuse, open the fuse compartment with a screwdriver and replace the fuse and fuse cover.

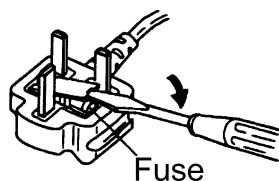

# IMPORTANT - PLEASE READ

---

The Hammond B-3 is the most popular organ evermade, and its sound is legendary. We have designed this model to be true and authentic to the exact vintage detail, as well as providing a large variety of modern features that allow greater flexibility no matter the musical style you wish to play. This Owner's Manual is designed to explain the operating features of this Hammond organ as simply and graphically as possible.

Because we want to make this manual, as well as the keyboard itself, as easy to understand as possible, the explanations in this manual are grouped by subject matter, and not in the order in which they necessarily appear in the display (the screen in the left of the keyboard front panel). For example, all functions pertaining to Drawbars are grouped together, all Percussion features are treated as a group, and so on.

Also, each feature is treated as an explanation unto itself, and does not require you to already have prior working knowledge of some other feature. The explanations are presented such that, if you follow the steps, will be identical to that shown in the manual at that stage of the explanation.

Do not be daunted by the number of steps required to perform each operation. Each step is simple. Simply bear these things in mind:

1. Read each step carefully.
2. Don't skip any of the steps.
3. Don't perform the steps out of sequence.

With these guidelines, you are well on your way to mastering all of the many sounds and features of your Hammond organ.

# BATTERY BACK UP

---

This organ uses a battery-backed RAM to remember your changes to the Parameters.

When the battery voltage becomes low, the Display will show:

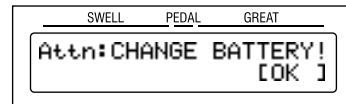
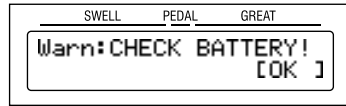

If you see these messages, you should immediately back up your parameter changes, if you have made any. If there is no battery installed in the unit, or if the battery is completely dead, the Display will show:

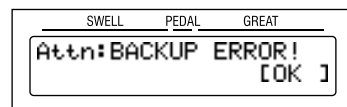

After the above message is displayed, this organ will re-initialize itself, and the factory default settings will be restored (except Presets, Leslie Cabinets and Cutsom Tone-Wheels). It is a good idea to periodically save your data to CompactFlash card.

**CAUTION:** Batteries should only be changed by your dealer or a qualified technician.

# Table Of Contents

<b>IMPORTANT SAFETY INSTRUCTIONS</b> .....	<b>2</b>	<b>ADDING EXPRESSION TO YOUR PLAYING</b> .....	<b>39</b>
<b>IMPORTANT - PLEASE READ</b> .....	<b>4</b>	Expression Pedal .....	39
<b>BATTERY BACK UP</b> .....	<b>5</b>	Foot Switch .....	39
<b>Index</b> .....	<b>8</b>	Motor Control Switch .....	39
<b>MAIN FEATURES</b> .....	<b>9</b>	<b>TRY MAKING YOUR OWN SOUND</b> .....	<b>40</b>
<b>HOW TO ASSEMBLE (B-3 mk2)</b> .....	<b>10</b>	Select the Preset Key [B] .....	40
Components .....	10	Pull out the B Drawbars .....	40
Connect the Pedalboard .....	11	Add Percussion .....	40
Attach the Leslie Speed Switch (USA only) .....	11	Add Effects .....	41
Attach the MAIN/ECHO Switch (optional) .....	12	VIBRATO AND CHORUS .....	41
Bench .....	12	OVERDRIVE .....	41
Manual Lid .....	13	LESLIE .....	41
Put on the Music Rack .....	13	REVERB .....	41
<b>HOW TO ASSEMBLE (B-3P mk2)</b> .....	<b>14</b>	EQUALIZER .....	41
Components .....	14	PEDAL SUSTAIN .....	42
Mount the Organ on the Stand .....	15	MANUAL BASS .....	42
Connect the Expression Pedal .....	16	Recording Preset Keys .....	43
Connect the Pedalboard (optional) .....	16	Ex. Memorize to "2-D" .....	43
Attach the Leslie Speed Switch .....	17	<b>SETTING UP</b> .....	<b>45</b>
Attach the MAIN/ECHO Switch (optional) .....	17	<b>SOUND ENGINE STRUCTURE</b> .....	<b>46</b>
Open the Manual Lid .....	18	System structure of this Organ .....	46
Install the Music Rack .....	18	<b>HARMONIC DRAWBARS™</b> .....	<b>48</b>
<b>NAMES AND FUNCTIONS</b> .....	<b>20</b>	Drawbars for the Swell/Great Manuals .....	49
Top View of the Organ .....	20	Relation between the Preset Keys and the Drawbars .....	49
Volume Panel .....	22	WHITE DRAWBARS .....	49
Control Panel .....	22	BLACK DRAWBARS .....	49
Power Panel (B-3 mk2, C-3 mk2) .....	23	BROWN DRAWBARS .....	49
Accessory Panel (B-3 mk2, C-3 mk2) .....	23	Drawbars for the Pedalboard .....	49
Accessory Panel (B-3P mk2) .....	24	Drawbar Registration Patterns .....	50
Power Panel (B-3P mk2) .....	24	Modern Drawbar Registrations .....	51
PEDALS .....	25	Controlling the Registration while playing a Preset .....	52
<b>HOOK-UP</b> .....	<b>27</b>	<b>PERCUSSION</b> .....	<b>53</b>
<b>BASIC HOOK-UP</b> .....	<b>28</b>	Notes .....	53
B-3 mk2, C-3 mk2 .....	28	"Percussion does not sound!" .....	53
B-3P mk2 .....	29	DRAWBAR CANCEL .....	53
<b>USING EFFECT LOOP</b> .....	<b>30</b>	SINGLE TRIGGER .....	53
<b>USING A MIDI SOUND MODULE</b> .....	<b>30</b>	<b>VIBRATO AND CHORUS</b> .....	<b>54</b>
<b>USING TWO LESLIE SPEAKERS</b> .....	<b>31</b>	<b>OVERDRIVE</b> .....	<b>55</b>
<b>REINFORCING THE BASS</b> .....	<b>31</b>	<b>LESLIE</b> .....	<b>56</b>
<b>USING NO LESLIE SPEAKER</b> .....	<b>32</b>	<b>EQUALIZER, REVERB</b> .....	<b>57</b>
<b>USING HEADPHONES</b> .....	<b>32</b>	Equalizer .....	57
<b>CONNECTING THE MIDI PEDALBOARD</b> .....	<b>33</b>	Reverb .....	57
<b>TURN ON AND PLAY</b> .....	<b>35</b>	<b>PRESETS</b> .....	<b>58</b>
<b>POWER ON</b> .....	<b>36</b>	BANK and KEY .....	58
How to power on .....	36	Using Plural Presets at the Same Time .....	59
Back-Up .....	36	Naming the BANK .....	60
Reset to the initial status .....	36	<b>VOLUME</b> .....	<b>61</b>
<b>USE OF PRESET KEYS</b> .....	<b>37</b>	[MASTER VOLUME] Knob .....	61
How to call the Preset .....	37	Expression Pedal .....	61
Ex. Select "2-G" .....	37	[VOLUME] Tablet .....	61
Play the Pedalboard .....	38	<b>Tone-Wheels and Multi-Contact Keys</b> .....	<b>62</b>

<b>USING THE CONTROL PANEL .....</b>	<b>63</b>
<b>OPERATION CONTROL PANEL .....</b>	<b>64</b>
<b>PLAY MODE .....</b>	<b>65</b>
How to read the Display .....	65
Button operation in this mode .....	65
<b>MENU MODE .....</b>	<b>66</b>
How to read the Display .....	66
Button operation in this mode .....	66
<b>FUNCTION MODE .....</b>	<b>67</b>
How to read the Display .....	67
Button operation in this mode .....	67
Example: Increase the depth of Vibrato at [V-3]. .....	68
<b>LOCK THE DISPLAY IN PLAY MODE .....</b>	<b>70</b>
<b>SETTING THE PARAMETERS .....</b>	<b>71</b>
<b>DRAWBAR .....</b>	<b>72</b>
Setting the SWELL and GREAT Manual .....	72
Setting the PEDAL Part .....	73
<b>PERCUSS (PERCUSSION) .....</b>	<b>74</b>
<b>TUNE .....</b>	<b>75</b>
<b>PRESET .....</b>	<b>76</b>
BANK NAME .....	76
PRESET LOAD .....	76
See the current value (Temporary Scope) .....	78
VIBRATO AND CHORUS .....	78
PERCUSSION .....	79
LESLIE .....	79
Other Knobs .....	79
<b>TUBE AMP (TUBE pre-AMP) .....</b>	<b>80</b>
Bias voltage and Nonlinear Distortion .....	81
<b>VIB&amp;CHO (VIBrato and CHOrus) .....</b>	<b>82</b>
Vibrato and Chorus of Hammond Organs .....	83
<b>LESLIE .....</b>	<b>84</b>
CABINET NUMBERS .....	84
LESLIE PARAMETERS .....	84
Record the Cabinets .....	87
<b>EQ/REV (EQualizer/REVerb) .....</b>	<b>88</b>
<b>MANBS (MANual BaSs) .....</b>	<b>90</b>
<b>CONTROL .....</b>	<b>91</b>
<b>CUST. TW (CUSTom Tone-Wheels) .....</b>	<b>92</b>
Record the Custom Tone-Wheels .....	94
<b>DEFAULT .....</b>	<b>95</b>
<b>SYSTEM .....</b>	<b>96</b>
<b>MIDI .....</b>	<b>97</b>
<b>ABOUT MIDI .....</b>	<b>98</b>
What is "MIDI"? .....	98
MIDI terminals on this Organ .....	98
What the MIDI can do on your Organ .....	98
<b>MIDI STRUCTURE .....</b>	<b>100</b>
<b>CONTROLLING EXTERNAL MIDI EQUIPMENT .....</b>	<b>101</b>
<b>EX. ZONE (EXternal ZONE) .....</b>	<b>102</b>

<b>SAVE THE SETUP .....</b>	<b>107</b>
<b>SAVE YOUR SETUP .....</b>	<b>108</b>
How to access the CF card slot .....	108
About the CF Card .....	108
CF CARD YOU CAN USE .....	108
CF CARD SLOT .....	108
THE CARD CAPACITY AND CONTENT TO BE SAVED .....	108
<b>INITIALIZE THE CF CARD .....</b>	<b>109</b>
<b>SETUP PROCEDURES .....</b>	<b>110</b>
How to read the Display .....	110
Save the SETUP .....	110
Change the SETUP name .....	111
Loading the SETUP .....	112
How to delete the SETUP .....	112
<b>FREQUENTLY ASKED QUESTIONS .....</b>	<b>113</b>
<b>UTILIZING NEW FUNCTIONS &amp; FEATURES .....</b>	<b>114</b>
<b>TROUBLESHOOTING .....</b>	<b>115</b>
<b>DAILY CARE AND MAINTENANCE .....</b>	<b>116</b>
<b>APPENDIX .....</b>	<b>117</b>
<b>MIDI IMPLEMENTATION CHART .....</b>	<b>118</b>
<b>PARAMETERS .....</b>	<b>119</b>
Global Parameters .....	119
Preset Parameters .....	120
Leslie Parameters .....	122
System Parameters .....	122
<b>SPECIFICATIONS .....</b>	<b>123</b>
<b>FACTORY PRESETS .....</b>	<b>124</b>
<b>SERVICE .....</b>	<b>127</b>

## IN THIS MANUAL:

**NOTE**:s and **tips** appear frequently.

The **NOTE**: is a supplementary explanation.

The **tips** are explanations of terms and applications.

---

# Index

## A

Adjust Presets 40, 95, 108

## B

Bank 37

Bend 39

## C

Chorale 56

Combination Presets 58

CompactFlash 108

Custom Tone-Wheels 92

## D

Default 95

Display Lock 70

Drawbars 40, 48, 72

## E

Echo 23, 24

Effect Loop 30

Equalizer 88, 57

Expression Pedal 39, 91

External Zones 100, 102

## F

Fold-Back 72

Foot Switch 39, 91

Footage 48

Function Mode 67

## G

Great Keyboard 21

## I

Initial Status 36

## K

Key Mode 73

## L

Leakage Noise 72

Leslie 41, 56, 84

## M

Main 23, 24

Manual Bass 42, 90

Master Tune 75

Menu Mode 66

MIDI 98

MIDI Pedalboard 33

Motor Control Switch 39, 91

## O

Overdrive 41, 55, 80

## P

Pedal Sustain 42, 73

Pedalboard 25

Percussion 74, 40, 53, 74

Play Mode 65

Preset 76

Preset Key 40

## R

Registration 40, 50, 52

Reverb 41, 57, 89

Rotary Channel 56

## S

Setup 110

Short Cut 79

Spring Reverb 91

Stationary Channel 56

Swell Keyboard 21

## T

Temporary Scope 78

Tone-Wheels 72

Transpose 75

Tremolo 56, 82

Tube Amp 55, 80

## V

Velocity 101, 104

Version 96

Vibrato 82

Vibrato and Chorus 41, 54

Volume 61



## ◆MULTI-CONTACT MANUALS

The keyboards used in this organ have been totally redesigned and 100% faithfully replicates the “Direct Analog Keying System” used on the original B-3.

## ◆TONE-WHEELS REBORN THROUGH DIGITAL TECHNOLOGY

The “Digital Tone-Wheel System” replicates the Tone-Wheel wave-forms created by the mechanical system of the original B-3. The 96 wave-forms are always in oscillation just as in the original.

## ◆ALL CONTROLS EXACTLY AS ON THE ORIGINAL

All the controls from the Panel Switches to the Preset Keys have been faithfully replicated. This organ can be played with the same technique as the original B-3.

## ◆TUBE PRE-AMPLIFIER

A pre-amp circuit using a 12AU7 tube is built in, and unique tube over-drive sounds are obtained. The bias-voltage-adjustment function enables not only general clip distortion but also nonlinear distortion.

## ◆DIGITAL LESLIE/VIBRATO

The scanner vibrato and Leslie speaker are replicated via a DSP effects section. The Vibrato & Chorus effects are the same as on the original B-3. The built-in Leslie gives the familiar Leslie sound when no actual Leslie speaker is available or when practicing with headphones.

## ◆EQUALIZER AND TONE CONTROL

A 3-band equalizer and tone-control are now built in. The equalizer can make fine or coarse tonal adjustments to the bass, treble, and mid frequency ranges. The tone-control simulates the unique circuit built in on the vintage B-3 pre-amp to obtain a gently-cut treble.

## ◆MIDI MASTER KEYBOARD

3 external zones are available on each manual and pedalboard to enable this organ to be used as a master keyboard. A MIDI pedalboard can also be used instead of the traditional pedalboard.

## ◆CompactFlash™ CARD

You can use a CompactFlash Card to save various Parameter files.

## Components

### Organ

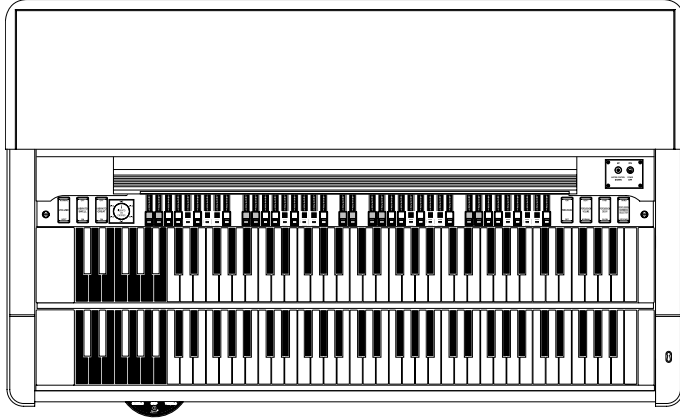

### Music Rack



### Key



### CompactFlash Card

(inserted into the organ)



### Pedalboard

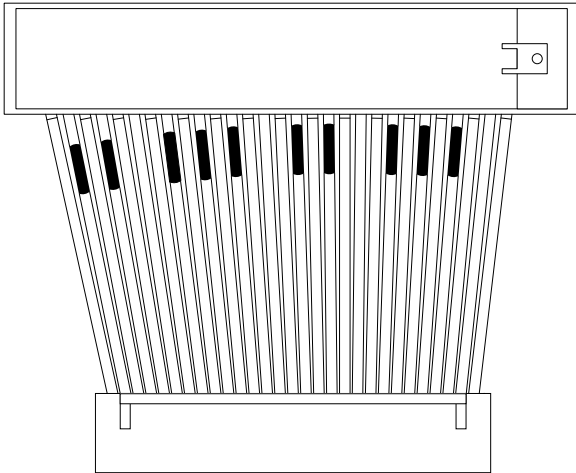

### Hexagonal Wrench



### AC Power Cord



### Bench

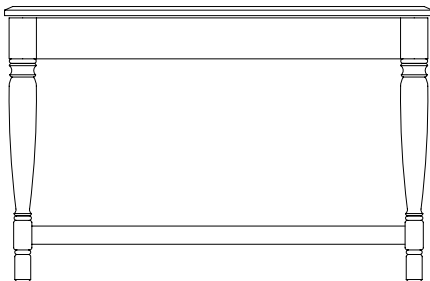

### USA Only

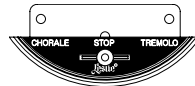

### Leslie Speed Switch



### Wire Clamp



### Tapping Screws

## Connect the Pedalboard

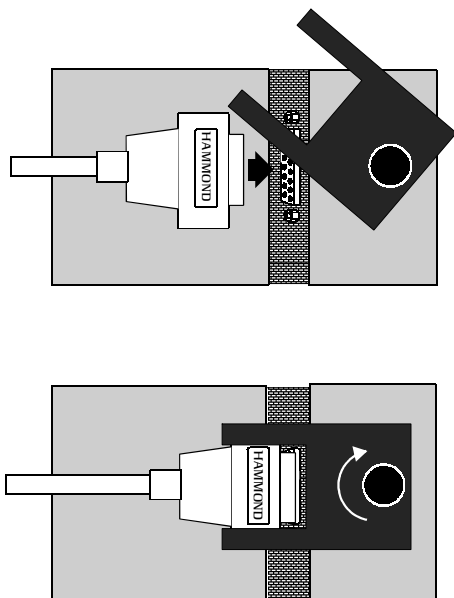

1. Place the Pedalboard on the floor in front of the organ.
2. Take the Pedal Cable out of the organ and insert the plug into the connector on the Pedalboard.
3. Hold the plug with the "Retention Hook" and lock it on by turning the screw knob.
4. Slide and push in the Pedalboard beneath the organ until it stops.

## Attach the Leslie Speed Switch (USA only)

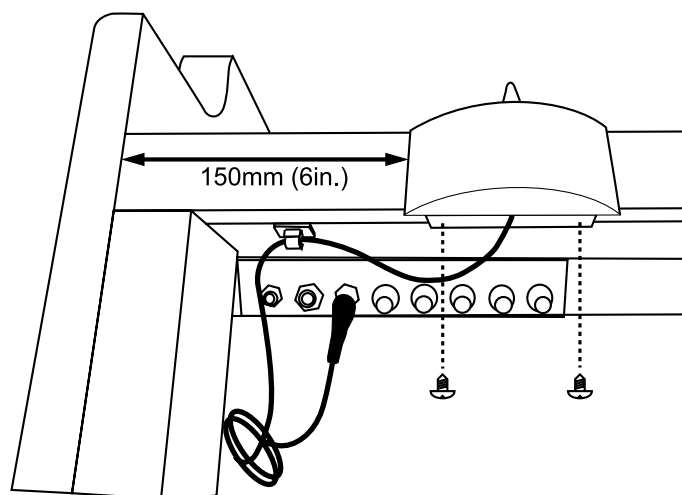

1. Locate a #2 Phillips Screw Driver.
2. Position the Leslie Speed Switch on the front left of the Great Manual. The distance it from the left sideboard must be 150 mm (6 in.) to allow for mounting the Main/Echo Switch.
3. Attach the switch from the bottom with the tapping screws supplied.
4. Insert the plug of the Leslie speed switch into the LESLIE SWITCH Jack on the Volume Panel.
5. Affix the wire clamp on the bottom of the organ and affix the cable.

## Attach the MAIN/ECHO Switch (optional)

This switch is for selecting either of the Leslie speakers if 2 are connected.

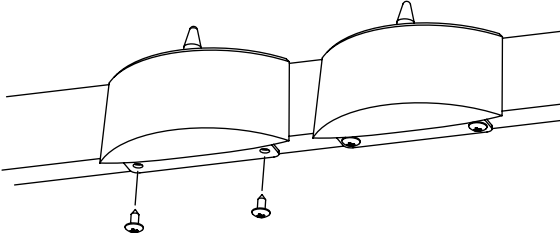

1. Locate a #2 Phillips screw driver.
2. Position the Main/Echo Switch to the front left of the Great Manual.
3. Attach with the 4mm tapping screws from underneath.
4. Insert the plug of the Main/Echo Switch cable into the MAIN/ECHO Jack on the Volume Panel.

## Bench

The space underneath the top board of the bench is provided for storing scores, music rack, etc.

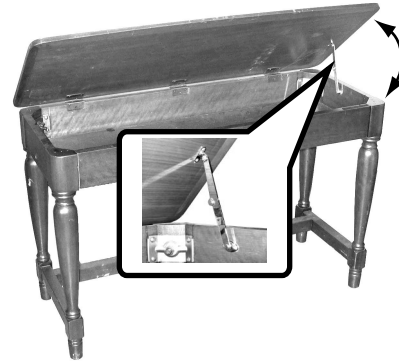

### CAUTION

Be careful not to pinch your fingers, by the folding metal arms when you close the lid.

Do not adjust the position of the bench while sitting. Avoid the risk of pinching your fingers between the lid and the box.

### ATTENTION

Don't tilt the bench when moving it to avoid books etc. from dropping out of the box.

Do not put in anything taller than 7 cm (2.7 in.) into the bench. The lid will not close and may damage the contents.

## Manual Lid

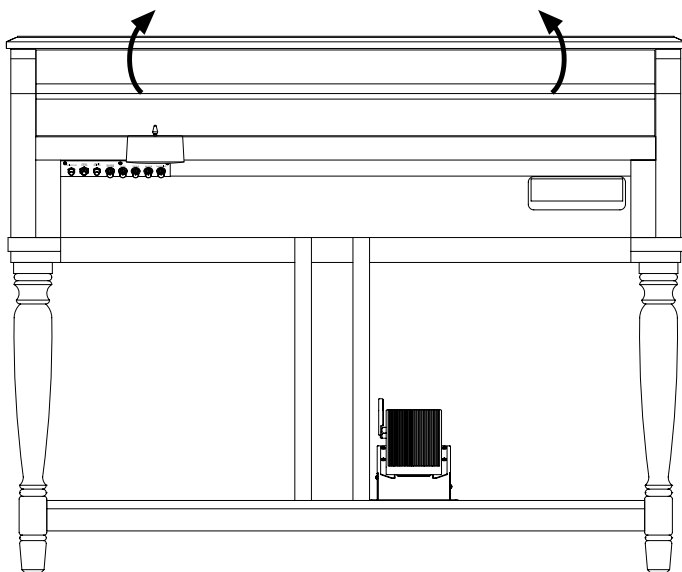

1. When you open the lid, hold and lift the front gently with both hands and fold it.
2. When you close the lid, hold the front of the folded lid with both hands and put down gently to close.

### ATTENTION

Be careful not to pinch your fingers when you open or close the lid. If the player is a small child, be sure to help him/her to open or close the lid.

Be sure to close and lock the lid before you move/carry the organ and avoid any risk of injury.

Do not leave the score or music rack on the manual when you close the lid.

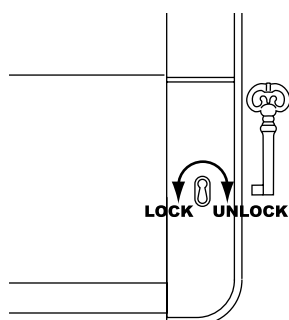

You can lock the key lid.

[B-3 mk2] The key hole is on the right side board.

[C-3 mk2] The key hole is on the front center.

## Put on the Music Rack

Insert the Music Rack into the rail whenever necessary.

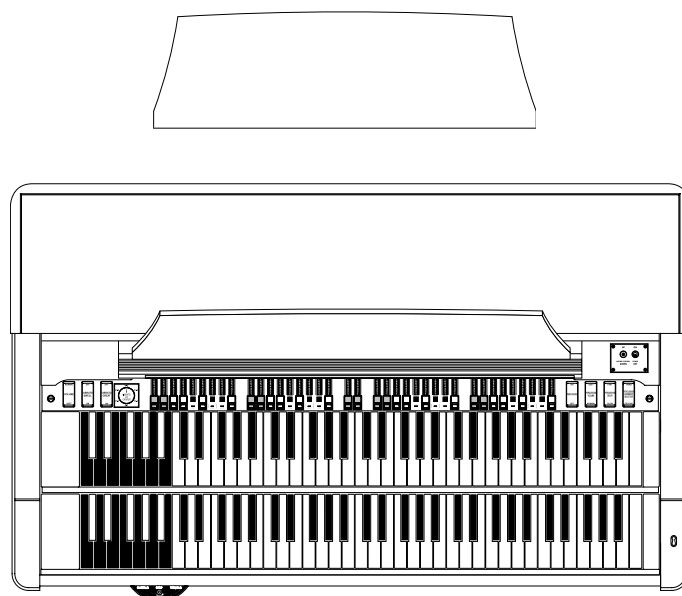

### ATTENTION

Do not put excessive pressure on the music rack.

## Components

**Organ (closed view)**

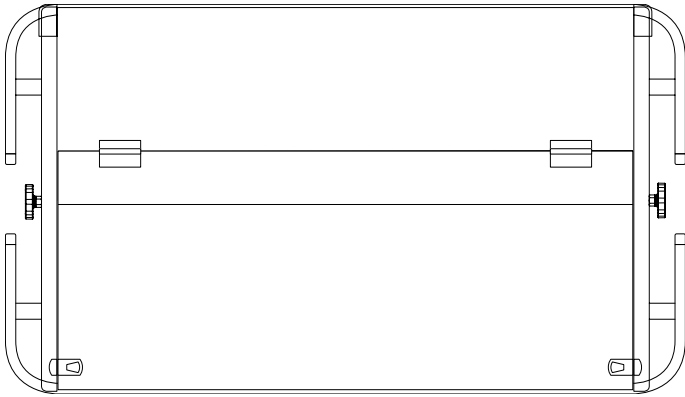

**Music Rack (inside of the lid)**

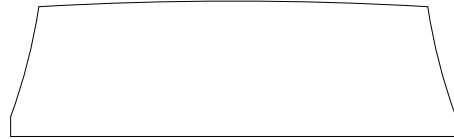

**CompactFlash Card**  
(inserted into the organ)

**Stand**

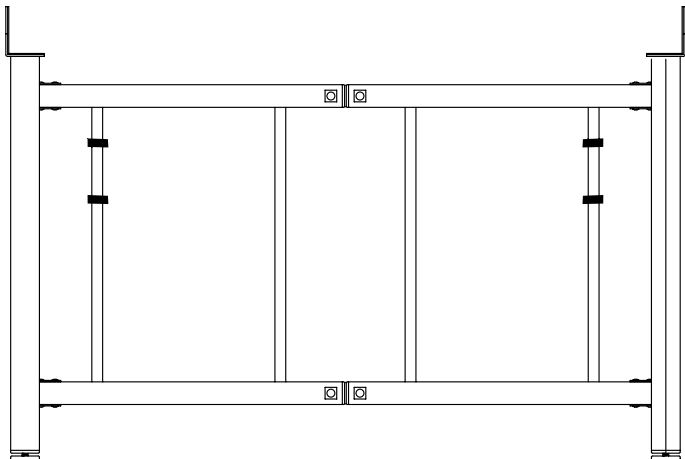

**Hexagonal Wrench**



**AC Power Cord**



**Expression Pedal**

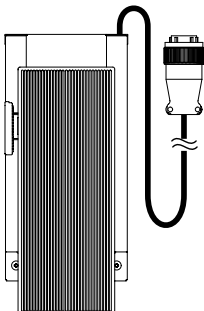

**Leslie Speed Switch, Spacer**

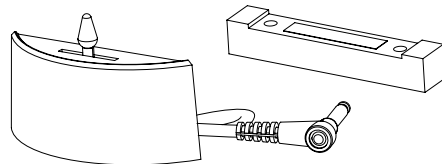

**Wire Clamp**

## Mount the Organ on the Stand

### CAUTION

The organ must be mounted on the stand by two persons using both hands.

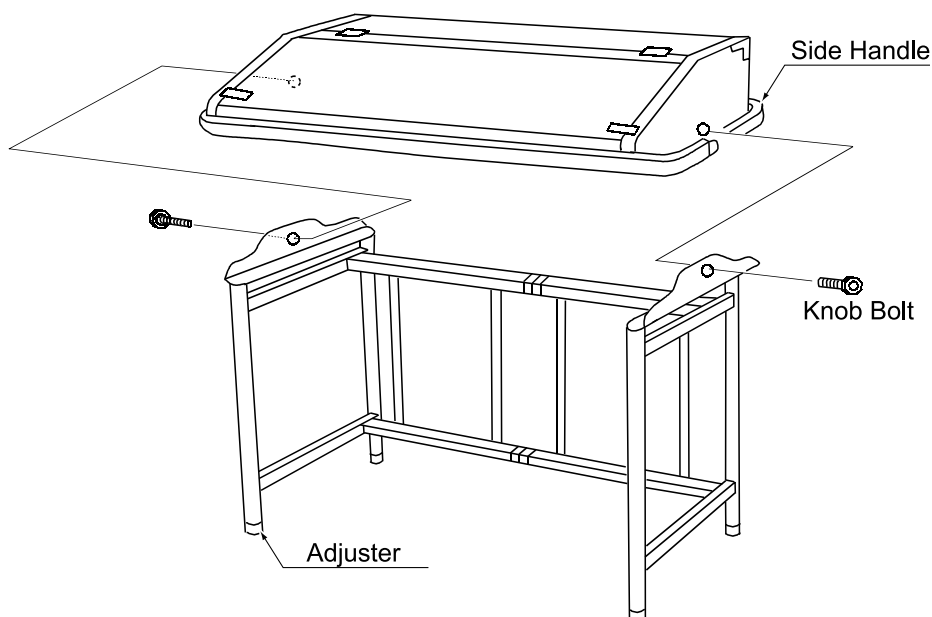

1. Remove the Knob Bolts on both sides of the organ.
2. Unfold the stand and place it in the upright position.
3. The stand must be placed flat on the floor. Turn the adjusters, if necessary, to level the stand.
4. With a helper, lift the organ gripping the side handles, then carefully mount it on the stand.

### CAUTION

Be careful not to get your fingers pinched! This could occur if they are caught between the organ and the stand.

5. After mounting the organ on the stand, insert the Knob Bolts through the screw holes on both sides of the stand and also on the organ, and tighten them securely.

Insert the Knob Bolts straight through horizontally. If the knobs are askew, they may damage the screw threads on the stand and/or the organ.

## Connect the Expression Pedal

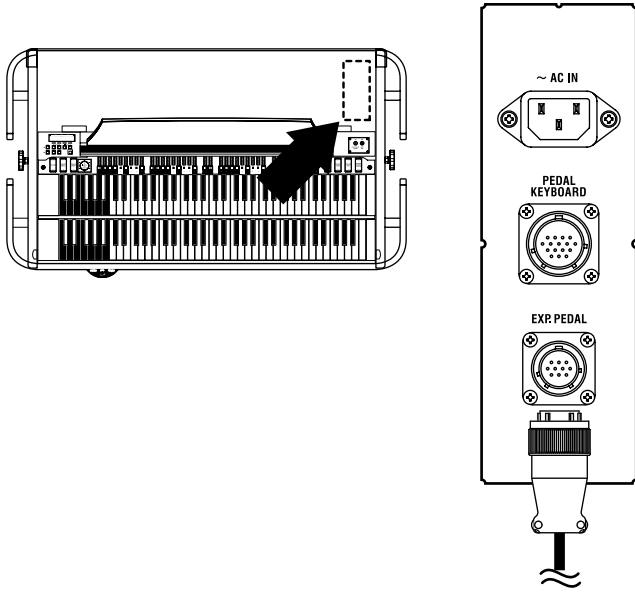

Insert the plug the cable from the Expression Pedal to the EXP.PEDAL connector on the power panel (on the bottom of the organ), matching the direction, then tighten it by turning the ring on it.

## Connect the Pedalboard (optional)

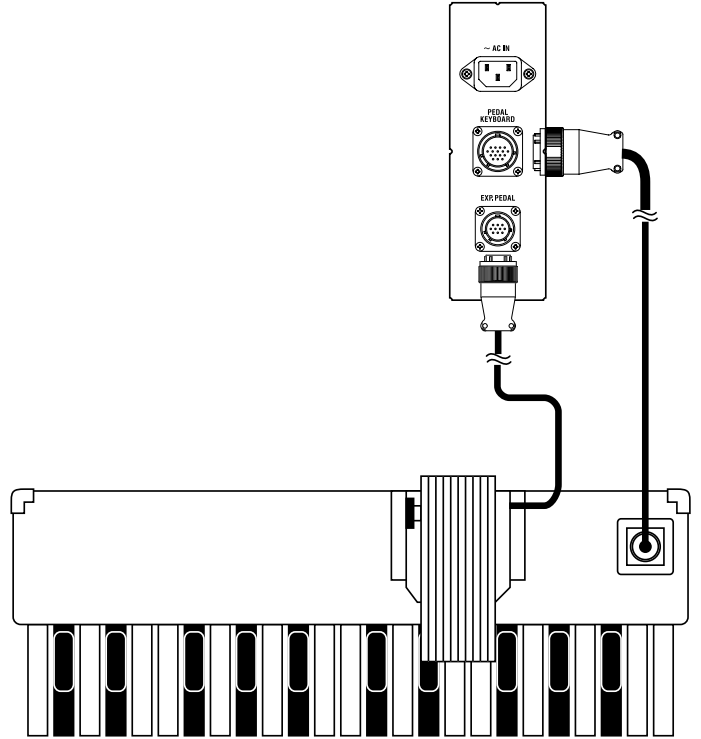

1. Insert the cable of the Pedalboard PK-25PR to the connector of the Pedalboard and the PEDALBOARD connector on the power panel (on the bottom of the organ), matching the direction, and secure it by turning the ring on the plug clockwise.
2. Insert the plug of the cable from the Expression Pedal to the EXP.PEDAL connector on the power panel (on the bottom of the organ), matching the direction, then fix it by turning the ring on the plug clockwise.



## Attach the Leslie Speed Switch

1. Remove the 2 inside knob screws on the front left of the Great Manual.

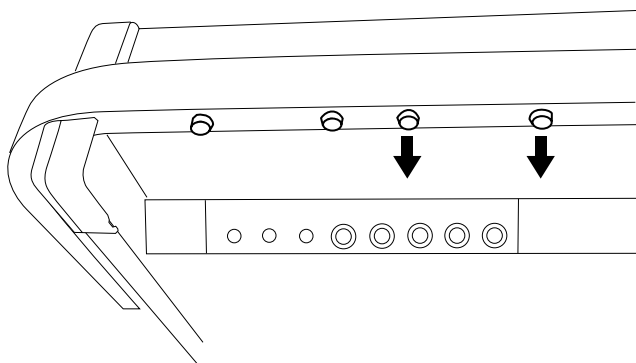

2. Put the spacer on the plate of the Leslie Speed Switch.

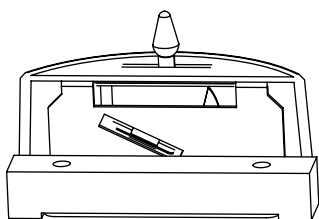

3. Attach the Leslie Speed Switch on the organ with the knob screws.
4. Insert the plug of the Leslie Speed Switch cable to the LESLIE SWITCH jack on the volume panel.

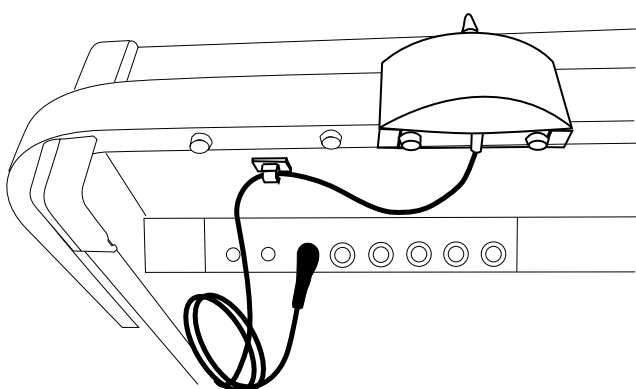

## Attach the MAIN/ECHO Switch (optional)

1. Remove the 2 outside knob screws on the front left of the Great Manual.

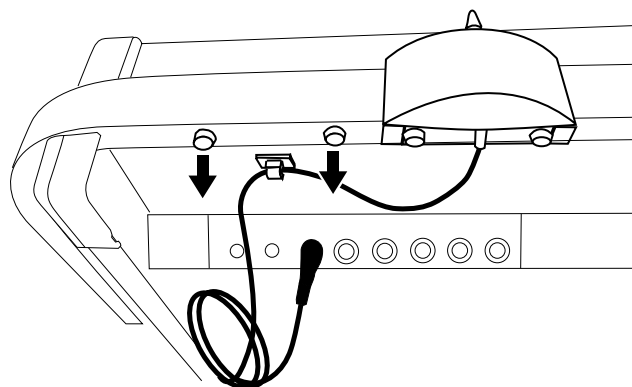

2. Put the spacer on the plate of the Main/Echo switch.

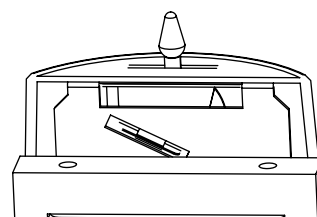

3. Attach the Main/Echo switch on the organ with the knob screws.
4. Insert the plug of the Main/Echo switch cable to the MAIN/ECHO jack on the volume panel.

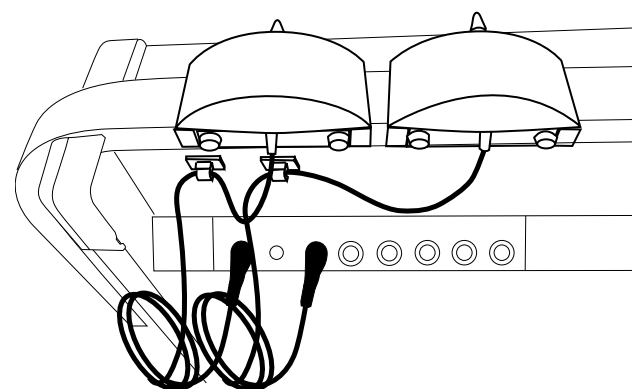

## Open the Manual Lid

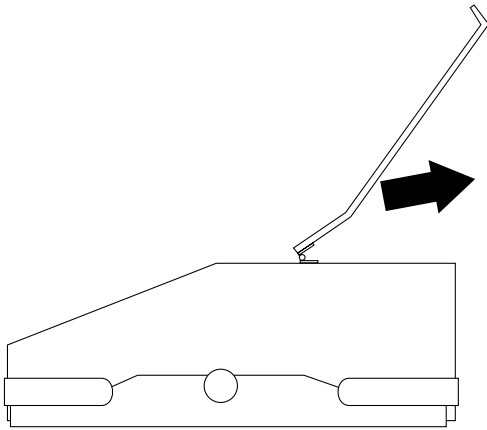
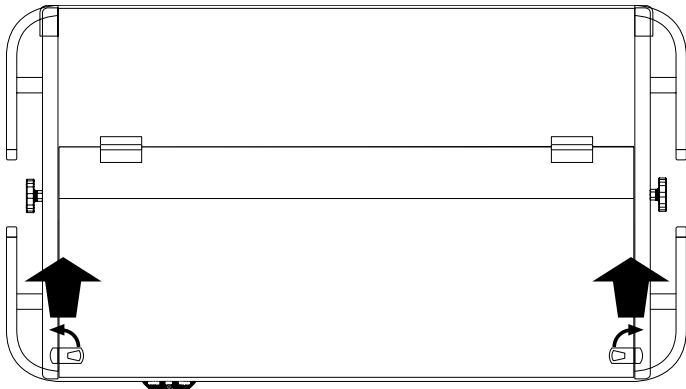

1. To open the manual lid, release the lock on both sides, then gently lift it holding the knobs on both sides with both hands. When the lid opened about 135 degrees, slide it back and off the hinge.
2. To close, hook the lid on the hinge and put it upright to 90 degrees. Hold the knobs with both hands and put it down gently. When the lid is closed, lock it again.

### ATTENTION

Do the steps above with care, and do not pinch your fingers. If a small child plays the organ, an adult must help him/her open or close the lid.

When it is necessary to move the organ, be sure to do it with the lid closed and locked.

Do not close the lid while music sheets or rack are still on the manual.

## Install the Music Rack

The Music Rack is inside the back of the manual lid.

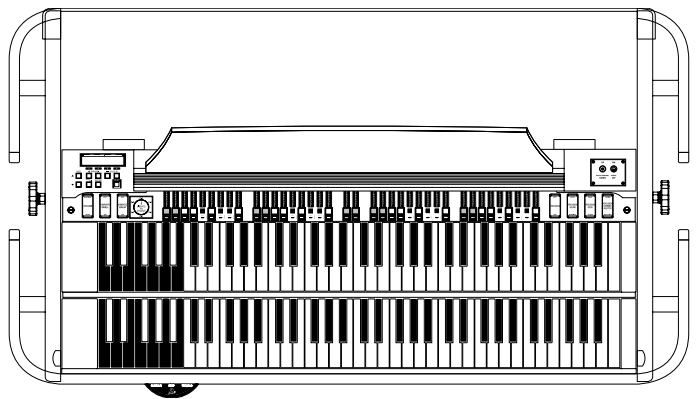
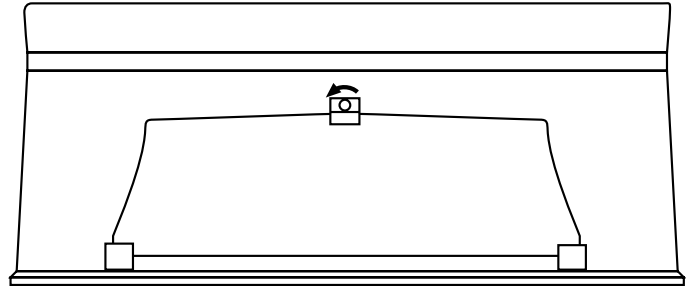

1. Turn the knob screw inside the manual lid counter-clockwise and remove the stopper.
2. Slide the music rack into the music rail.

### ATTENTION

Do not put any excessive pressure on the music rack.

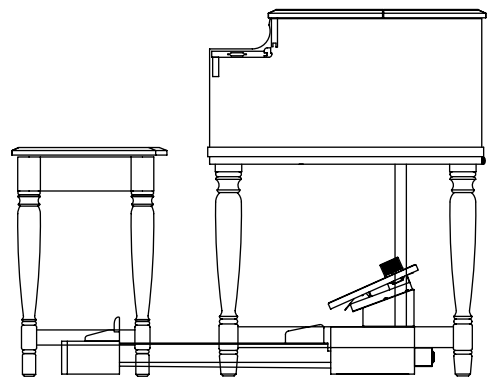

## Top View of the Organ

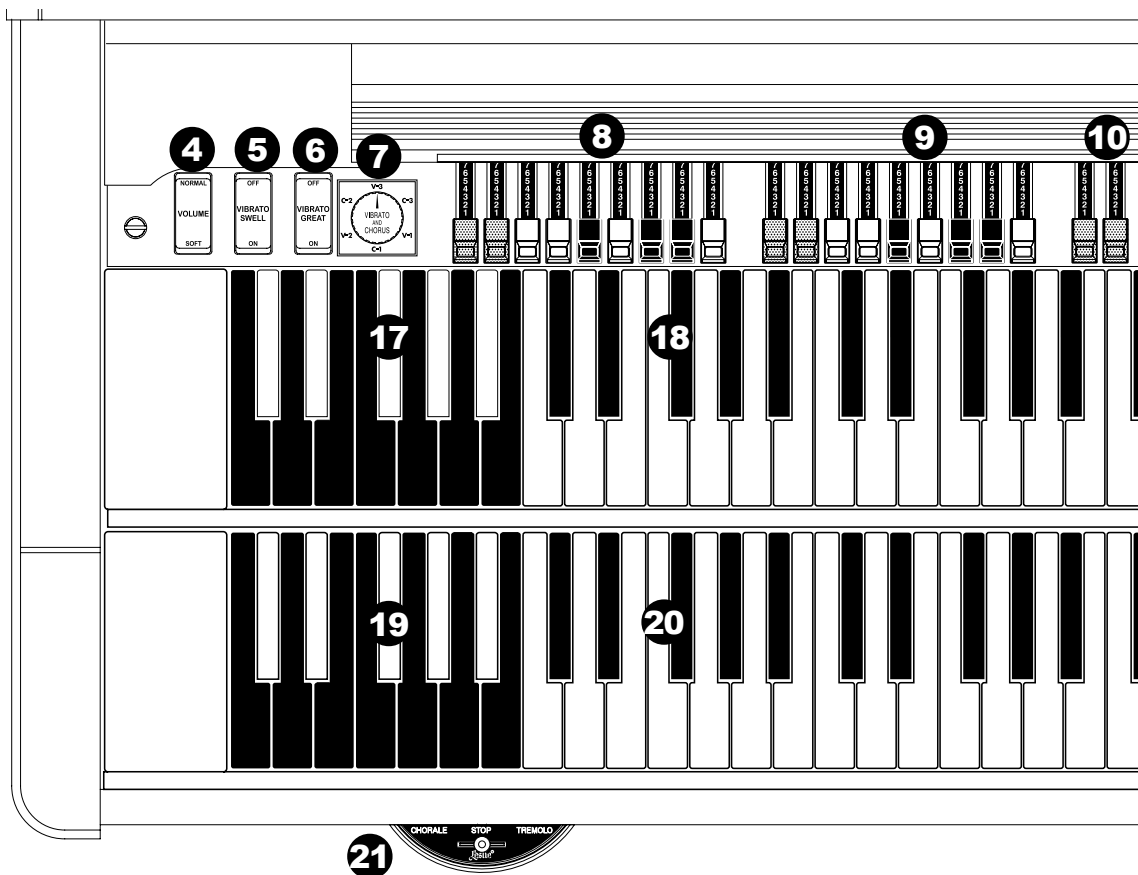

## ◆ SWITCH PLATE

1. **POWER Switch**

This switch turns the power on and off.

⚠ **CAUTION**

Even when the POWER switch is turned off, electricity is still flowing to the instrument at a minimum level. When you are not using the instrument for an extended time, make sure you unplug the power cord from the wall AC outlet.

2. **MOTOR CONTROL Switch**

This is for changing the pitch while playing. If you move it back, the pitch rises. If forward, it falls.

3. **PILOT LAMP**

Lights while the power is on.

## ◆ LEFT TABLETS

4. **VOLUME Tablet**

This is for switching the volume; NORMAL or SOFT.

5. **VIBRATO SWELL Tablet**

This is for switching the vibrato and chorus on/off on the Swell Manual Drawbars.

6. **VIBRATO GREAT Tablet**

This is for switching the vibrato & chorus on/off on the Great

and Pedal Drawbars.

7. **VIBRATO & CHORUS MODE Knob**

This is for switching the depth of vibrato and the chorus effects.

## ◆ DRAWBARS

8. **SWELL(Upper) A# Drawbars**

These are for adjusting the harmonics of the Swell(Upper) Manual, when the Preset Key [A#] of the Swell Manual is selected.

9. **SWELL(Upper) B Drawbars**

These are for adjusting the harmonics of the Swell(Upper) Manual, when the Preset Key [B] of the Swell Manual is selected.

10. **PEDAL Drawbars**

These are for adjusting the harmonics of the Pedalboard.

11. **GREAT(Lower) A# Drawbars**

These are for adjusting the harmonics of the Great(Lower) Manual, when the Preset Key [A#] of the Great Manual is selected.

12. **GREAT(Lower) B Drawbars**

These are for adjusting the harmonics of the Great(Lower) Manual, when the Preset Key [B] of the Great Manual is selected.

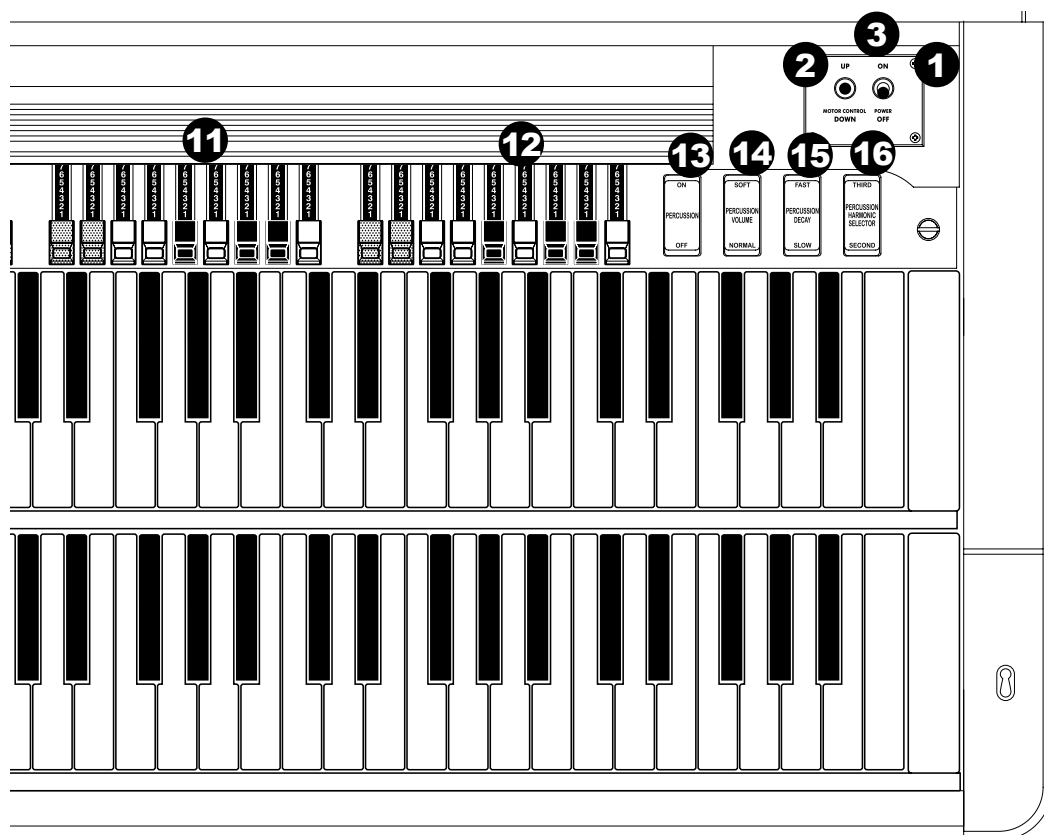

## ◆ RIGHT TABLETS

### 13. PERCUSSION Tablet

This is for switching the Percussion on/off.

### 14. PERCUSSION VOLUME Tablet

This is for switching the volume of Percussion: NORMAL/SOFT.

### 15. PERCUSSION DECAY Tablet

This is for switching the decay time of Percussion: FAST/SLOW.

### 16. PERCUSSION HARMONIC SELECTOR Tablet

This is for switching the pitch of Percussion: THIRD harmonics / SECOND harmonics.

## ◆ MANUALS

### 17. SWELL(Upper) Preset Keys

These are for selecting the Presets of the Swell(Upper) Manual.

### 18. SWELL(Upper) Manual

This is a manual with 61 notes, multi-contacts (for Drawbars & Percussion) with contacts (for MIDI OUT).

### 19. GREAT(Lower) Preset Keys

These are for selecting the Presets of the Great(Lower) Manual.

### 20. GREAT(Lower) Manual

This is a manual with 61 notes, multi-contacts (for Drawbars) with contacts (for MIDI OUT).

## ◆ LESLIE SWITCH

### 21. LESLIE SPEED SWITCH

This is for switching the speed of the external Leslie speaker or built-in Leslie effects.

## Volume Panel

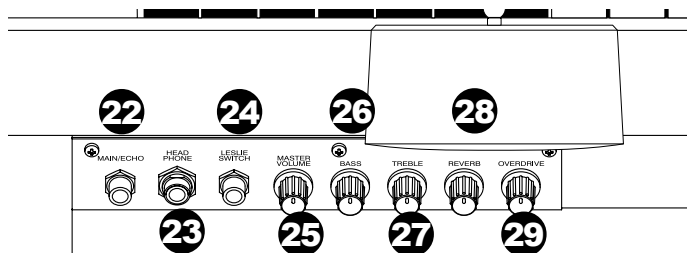

### 22. MAIN/ECHO Jack

This is for connecting the Main/Echo Switch MES-1.

### 23. HEADPHONE Jack

This is for connecting Headphones. The external Leslie speaker is turned off, when a plug is inserted to this jack.

### 24. LESLIE SWITCH Jack

This is for connecting the Leslie Speed Switch (provided).

### 25. MASTER VOLUME Knob

This is for controlling the total volume of this organ.

### 26. BASS Knob

This is for increasing/decreasing the volume of the Bass frequencies.

### 27. TREBLE Knob

This is for increasing/decreasing the volume of the Treble frequencies.

### 28. REVERB Knob

This is for adjusting the depth of the Reverb effects.

### 29. OVERDRIVE Knob

This is for adjusting the depth of the Overdrive effects.

## Control Panel

Contained in the drawer on the bottom right of the manual. [B-3 mk2 and C-3 mk2]

Located inside the lid on the left-hand-side front panel. [B-3P mk2]

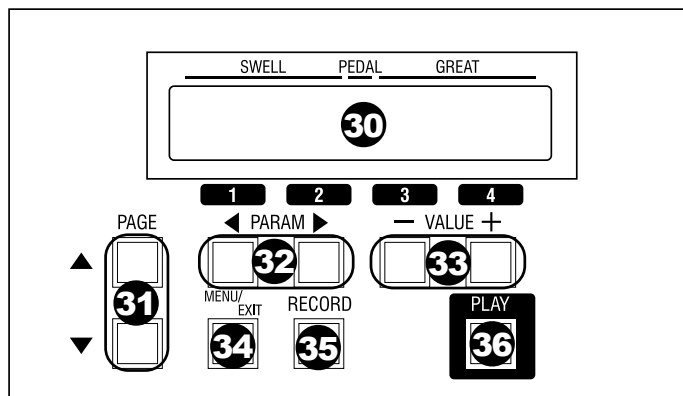

### 30. Display

Various information is displayed here.

### 31. PAGE Button

Used to scroll through the various pages of controls and parameters.

### 32. PARAM Button

This is used for selecting the parameter item to edit, also to select items #1 and #2 on the basic edit pages.

### 33. VALUE Button

This is used to increase or decrease values, also to select items #3 and #4 on the basic edit pages.

### 34. MENU/EXIT Button

This is for calling the MENU mode, A for exiting from various function modes, and jump to function modes.

### 35. RECORD Button

This is for recording Presets, also for shifting values or items.

### 36. PLAY Button

This is for jumping to the basic Play mode. It is also for using the temporary scope function, or for changing the registrations while the Preset Keys from [C#] to [A] are selected.

## Accessory Panel (B-3 mk2, C-3 mk2)

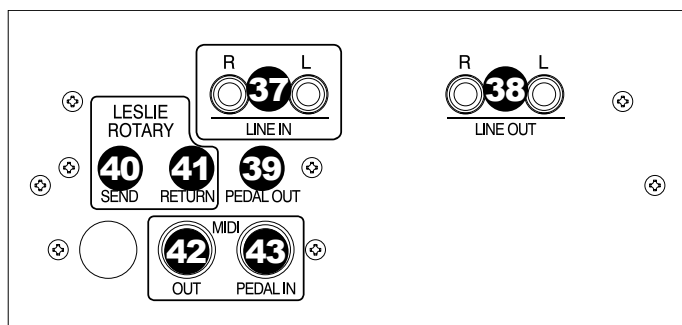

### ◆ SOUND INPUT TERMINAL

#### 37. LINE IN Jack

This is the terminal for connecting an external sound module or a CD player. The signals input to this jack are output to the LINE OUT jack, headphone jack, the stationary channel of each Leslie. (Rating Input Level: 1.23V +4dBm, Input Impedance: 5kΩ)

### ◆ SOUND OUTPUT TERMINAL

#### 38. LINE OUT Jack

The main output terminals, post internal effects (includes the built-in Leslie effect).

Use both L and R, if the connected mixer or monitor speaker is stereo, and use only L, if monaural.

When the Leslie speaker is connected, the built-in Leslie effect appears on the L output only.

#### 39. PEDAL OUT Jack

This is an independent output terminal for the Pedal part.

### ◆ EFFECT LOOP

#### 40. SEND Jack

This is a post-internal effects patch-out point.

If a plug is inserted to this jack, signals inside the organ are cut off. (Rating Output Level: 1.23V +4dBm, Output Impedance: 600Ω)

#### 41. RETURN Jack

This is a post-internal effects patch-in point.

This jack is used also as the input terminal to the rotary channel from an external sound source. (Rating Input Level: 1.23V +4dBm, Input Impedance: 10kΩ)

### ◆ MIDI TERMINAL

#### 42. MIDI OUT Jack

This is for sending playing information to external MIDI equipment such as a Synthesizer or a Sound Module.

#### 43. MIDI PEDAL IN Jack

This is the input for a MIDI Pedalboard.

## Power Panel (B-3 mk2, C-3 mk2)

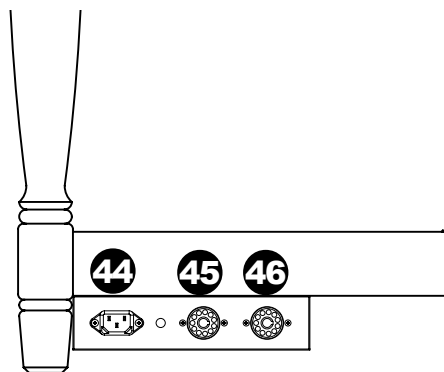

#### 42. AC Inlet

Connects the A.C. Power Cable.



CAUTION

This organ shall be connected to a MAINS socket outlet with a protective earth (ground) connection.

### ◆ LESLIE SOCKETS

#### 45. MAIN

Connect the first Leslie speaker here. If the Main/Echo switch (optional) is connected to the MAIN/ECHO jack on the Volume Panel(#22), the sound is not output unless you set the switch at the MAIN position.

#### 46. ECHO

Connect the second Leslie speaker to this. Sound is sent here, if you set the optional Main/Echo switch to the echo position when the Main/Echo switch is connected to this organ.

## Accessory Panel (B-3P mk2)

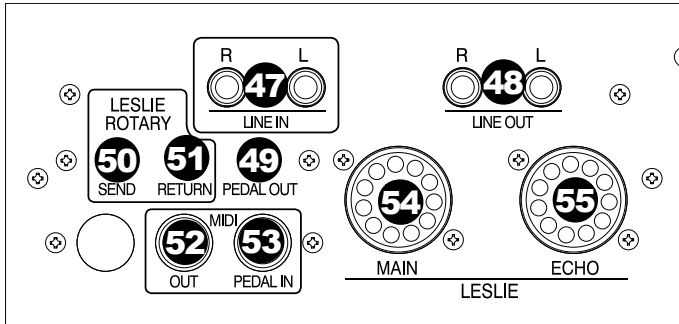

### ◆ SOUND INPUT TERMINAL

#### 47. LINE IN Jack

These jacks are for connecting an external sound module or a CD player. The signals input to this jack are output to the LINE OUT jack, and headphone jack, the stationary channel of a so-equipped Leslie Spaker. (Rating Input Level: 1.23V +4dBm, Input Impedance: 5kΩ)

### ◆ SOUND OUTPUT TERMINAL

#### 48. LINE OUT Jack

These jacks are a stereo main out for the organ post-internal effects.

Use both L and R, if the connected mixer or monitor speaker is stereo, and use only L, if monaural.

When a Leslie speaker is connected, the built-in Leslie effect appears only on the L jack.

#### 49. PEDAL OUT Jack

This is an independent output terminal for the Pedal part.

### ◆ EFFECT LOOP

#### 50. SEND Jack

This is a post-internal effects patch-out point.

When a plug is inserted to this jack, signals inside the organ are cut off. (Rating Output Level: 1.23V +4dBm, Output Impedance: 600Ω)

#### 51. RETURN Jack

This is a post-internal effects patch-in point.

This jack is used also as the input terminal to the rotary channel from an external sound engine. (Rating Input Level: 1.23V +4dBm, Input Impedance: 10kΩ)

### ◆ MIDI TERMINAL

#### 52. MIDI OUT Jack

This is for sending MIDI information to external MIDI equipment such as a Synthesizer or Sound Module.

#### 53. MIDI PEDAL IN Jack

This is the input terminal for a MIDI Pedalboard.

### ◆ LESLIE SOCKETS

#### 54. MAIN

Connect the first Leslie speaker to this socket. If the Main/Echo switch (optional) is connected to the MAIN/ECHO jack on the Volume Panel (#22), Sound is not passed unless you set the switch at the MAIN position.

#### 55. ECHO

Connect the second Leslie speaker to this socket. Sound is not passed unless you set the switch to the ECHO position when the Main/Echo switch (optional) is connected to this organ.

## Power Panel (B-3P mk2)

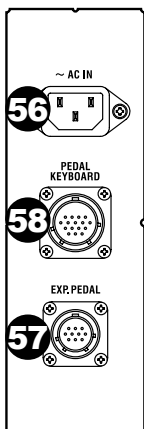

### ◆ AC INLET

#### 56. AC INLET

Connects the A.C. Power Cable.



#### CAUTION

This organ shall be connected to a MAINS socket outlet with a protective earth (ground) connection.

### ◆ PEDAL CONNECTORS

#### 57. EXP. PEDAL Connector

Connect the Expression Pedal (provided) here.

If no expression pedal is connected, the volume is set to maximum, as if the pedal were fully depressed.

#### 58. PEDALBOARD Connector

Connect the Pedalboard PK-25PR (optional) here.



## PEDALS

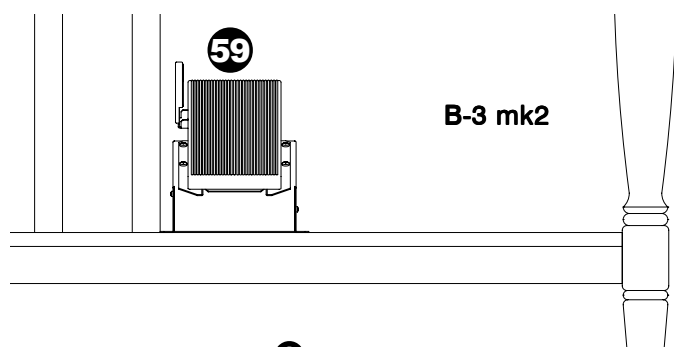

### 59. EXPRESSION Pedal

This is for changing the total volume of the organ.

The Foot Switch is attached on the bottom left.

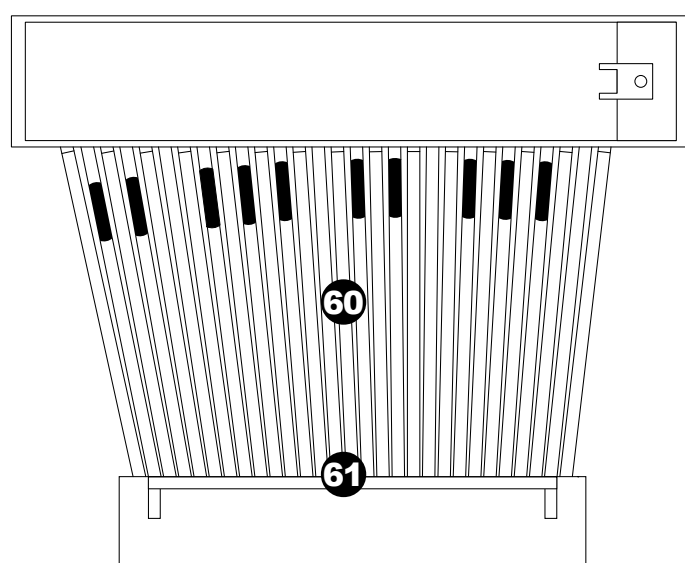
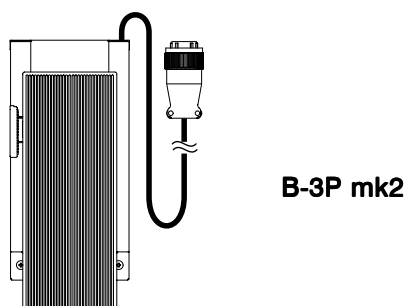

### 60. Pedalboard

25 notes. Radial flat type, non-velocity keyboard.

### 61. Foot Rest

Rest your feet when you are not playing the Pedalboard.



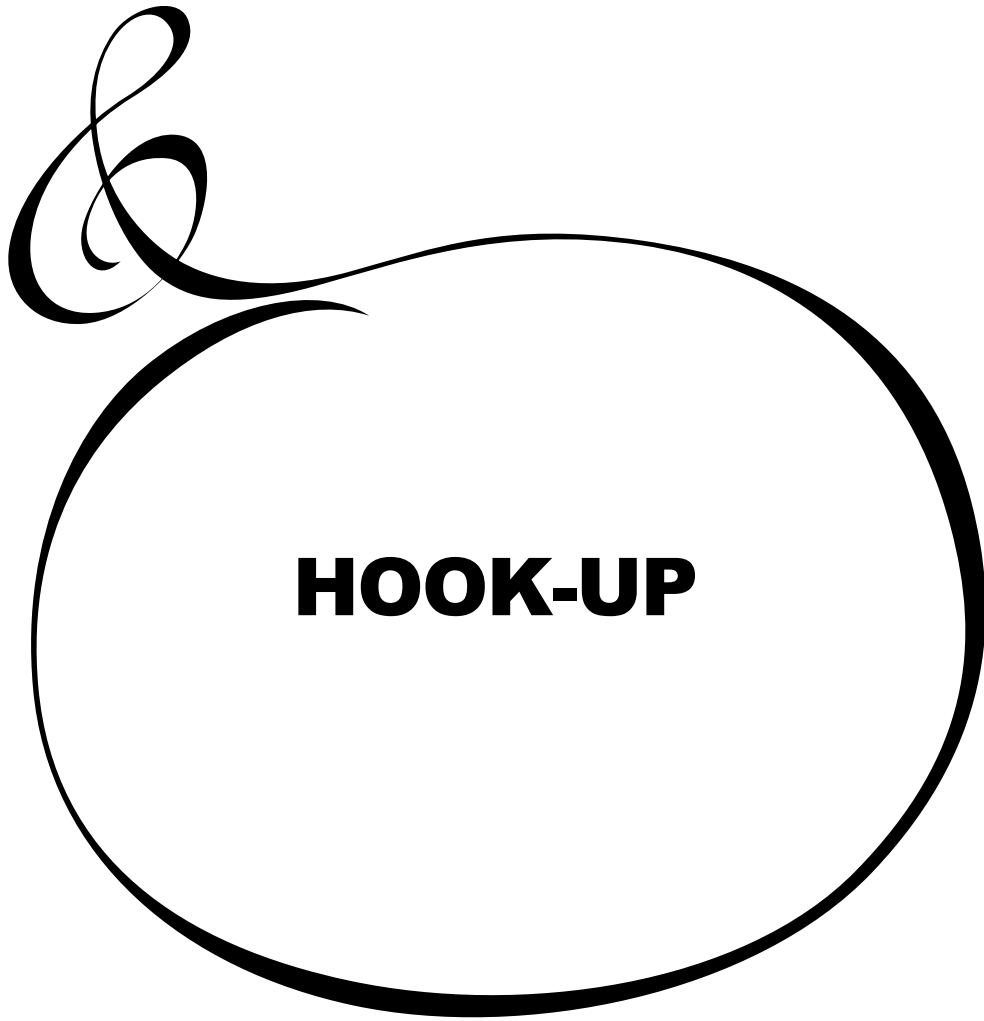

## BASIC HOOK-UP

See the figure below for connection.

This organ has no built-in speaker or amplifier. Before you connect a Leslie Speaker to the organ, be sure to turn OFF the power of the organ and the external equipment, if any is connected.

The Leslie Speaker is connected to the LESLIE/MAIN jack on the organ using the exclusive 11-pin Leslie Cable attached to the speaker or the LC-11-7M (optional).

Plug in the Leslie Cable to the jack, correctly matching the notches.

NOTE: Non-11-pin Leslie Speakers can also be connected to the organ using a special adaptor kit. Ask your Hammond Organ / Leslie dealer for details.

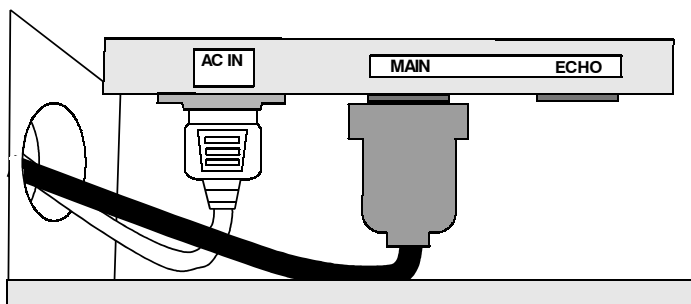
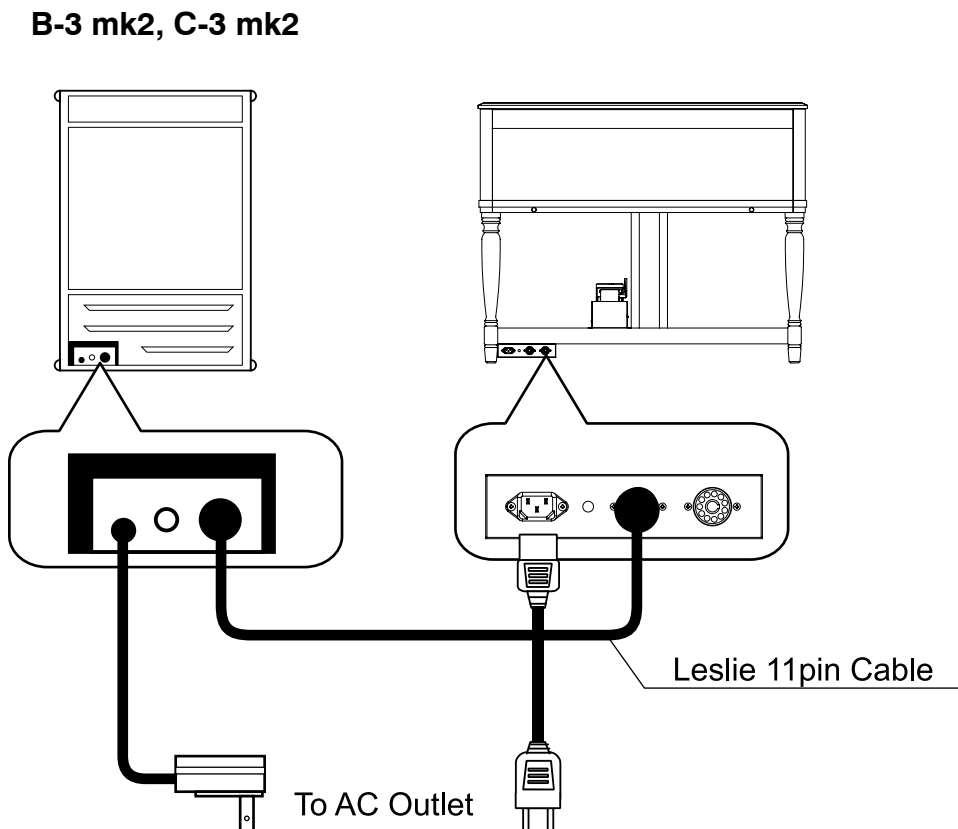

### HOLES FOR CABLES (C-3 mk2)

Drilled holes are located on the side of the cabinet of the C-3 mk2 for your convenience.

**B-3P mk2**

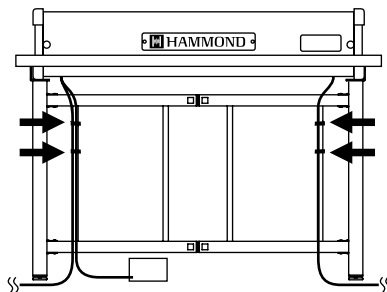
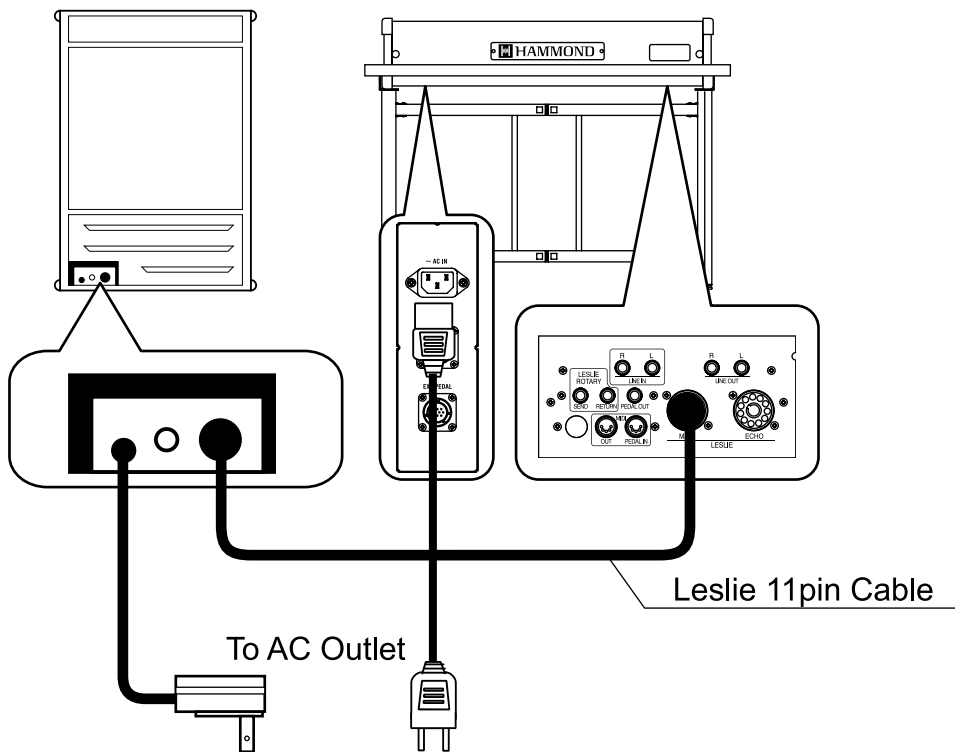

**Fasten the cables using hook-and-loop fasteners.**

## USING EFFECT LOOP

External effects may be used while a Leslie Speaker is connected to the organ using the Effect Loop.

The effects unit should have the same input/output gain and corresponding with the rating level of +4dBm.

NOTE: The Effect Loop is inserted between the built-in Effect (Leslie, Reverb, etc.) and the Master Volume.

NOTE: If using the LINE OUT jack and the HEADPHONE jack, simultaneously the Effect Loop will only function on the R (right) side.

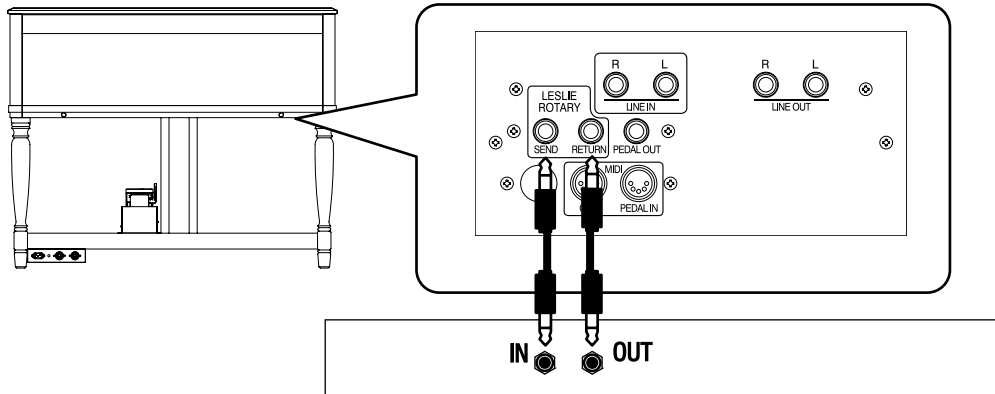

## USING A MIDI SOUND MODULE

Each Manual and the Pedalboard on this organ has 3 External Zones for controlling an external MIDI sound module. When connected to the LINE IN jacks, the external MIDI sound module output is sent to the stationary channel of the Leslie terminal (on a so-equipped Leslie), the LINE OUT jack and the headphone jack.

NOTE: Adjust the volume of the equipment connected to the LINE IN jack on the external equipment itself.

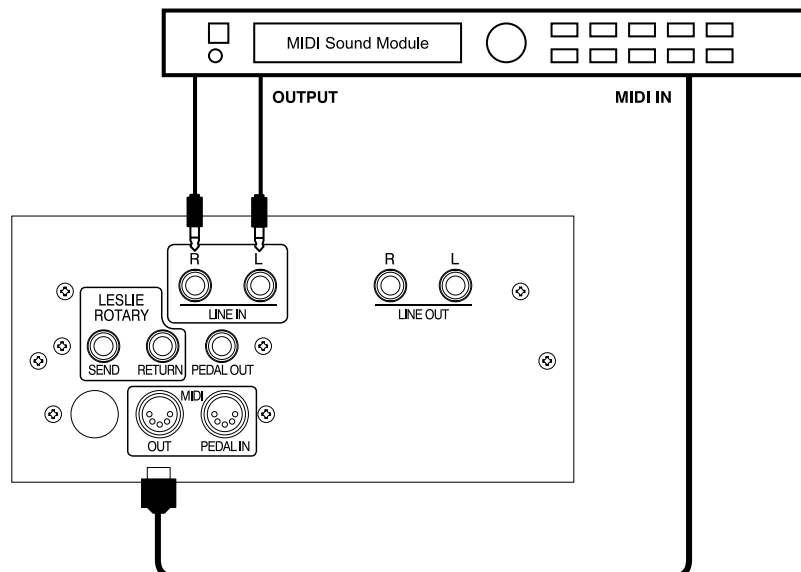

Two Leslie Speakers may be connected to this organ. Connect the first Leslie Speaker to the MAIN socket and the second to the ECHO socket. The organ sounds are usually produced from both Leslie Speakers. If you connect the MAIN/ECHO switch, you can select which Leslie sounds while you are playing.

The sound that is input from LINE IN jack will be sent out to both Leslie speakers regardless of the position of the MAIN/ECHO switch.

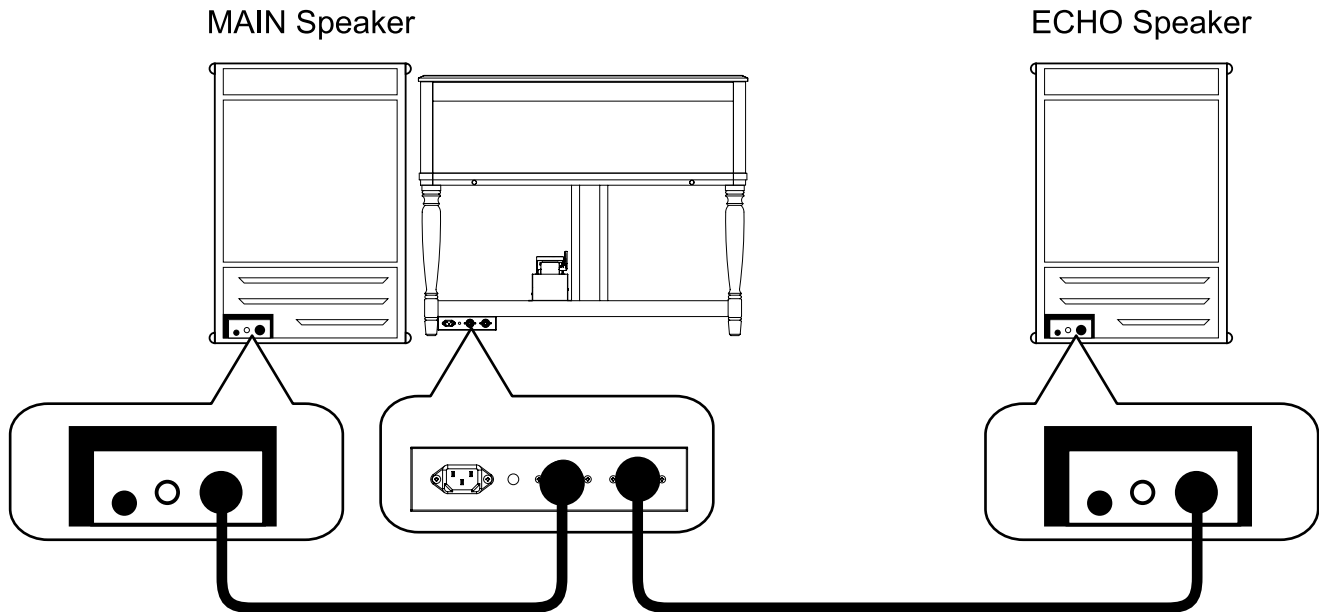

## REINFORCING THE BASS

To reinforce the bass, or if you do not wish to have the Pedals speak through the Leslie, you can send the Pedal part directly to a bass amp or PA system using the independent PEDAL OUT jack. Set your PEDAL OUT preference by the OUTPUT param-

eter of the OUTPUT on the PEDAL PART page in the SYSTEM function mode. (P. 96 #1)

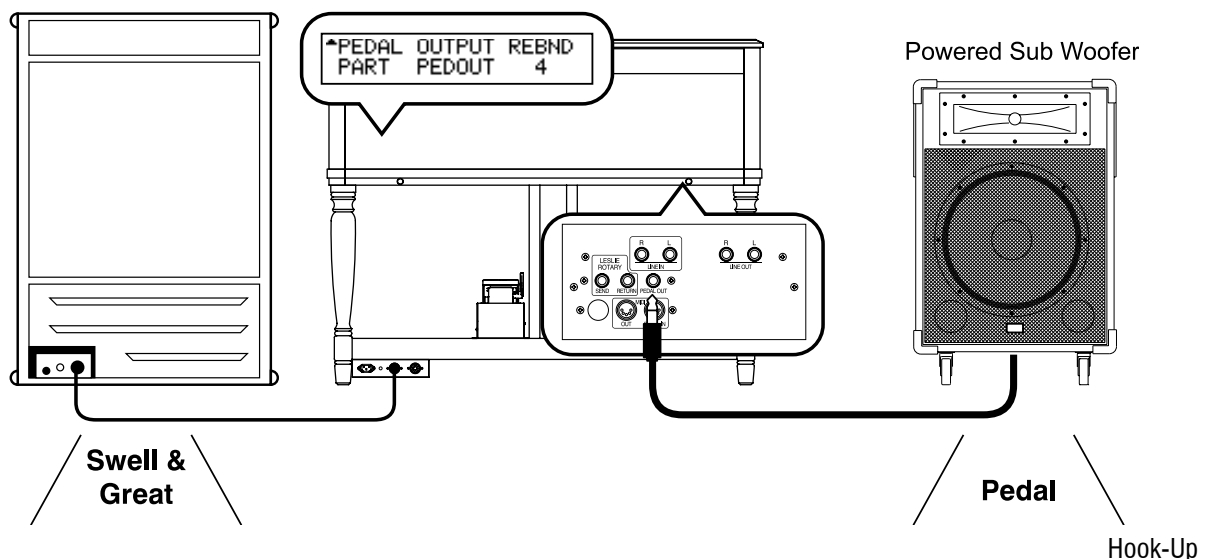

## USING NO LESLIE SPEAKER

If no Leslie Speaker is available, you can use the built-in Leslie Effect by means of the LINE OUT jack.

If the Leslie Speaker and the LINE OUT jack are used together, the built-in Leslie Effect is heard only on the L channel.

You may also use a traditional keyboard amp or PA system.

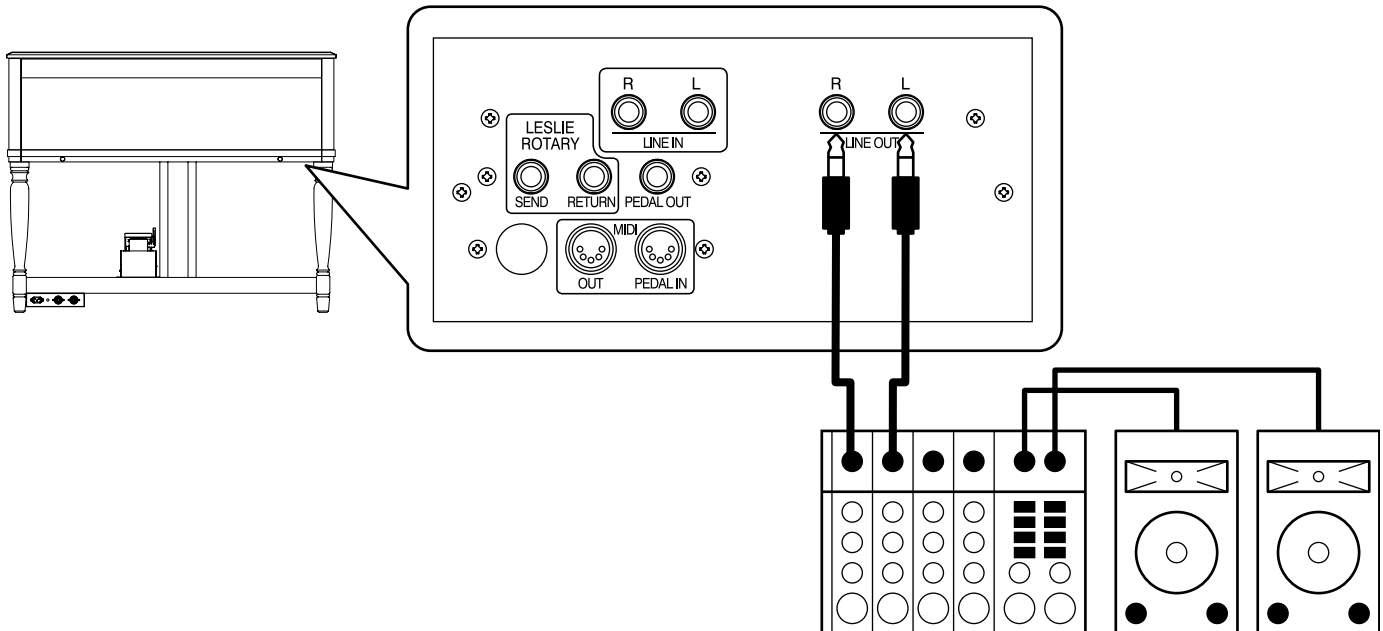

## USING HEADPHONES

You can practice silently by connecting the stereo headphones to the HEADPHONE jack of this organ.

When the plug is inserted to the HEADPHONE jack, the Leslie Speaker is turned off, and the built-in digital Leslie Effect comes online in the headphones.

### ⚠ ATTENTION

Hold the moulded part of the plug of the cord when you connect or disconnect it to avoid the risk of breaking the cable.

Do not use excessive volume with headphones, due to risk hearing damage.

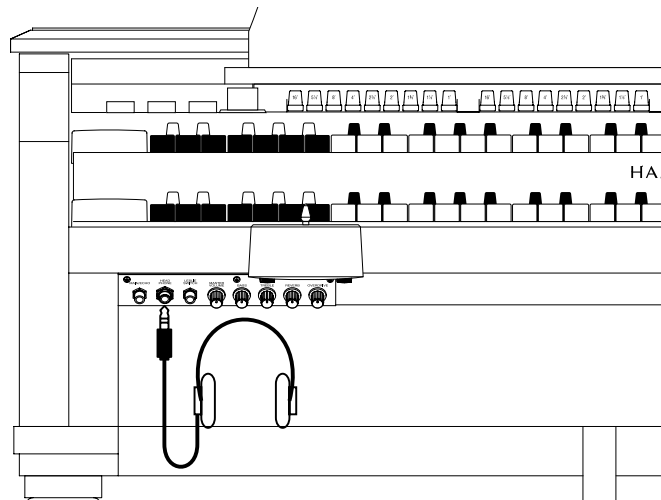



You may connect a MIDI Pedalboard, instead of the traditional Pedalboard.

All the note information received at the MIDI PEDAL IN jack is output as the Pedal Part, regardless of the MIDI channel.

The following MIDI pedalboards connectable to this organ are also available from us as optional accessories:

XPB-100 (13 notes)

XPB-200 (20 notes)

NOTE: You can attach an expression pedal (provided with the B-3P mk2) on the XPK-200.

NOTE: You can not use the functions of the XPK-100 such as transpose, control, etc., if the XPK-100 is connected.

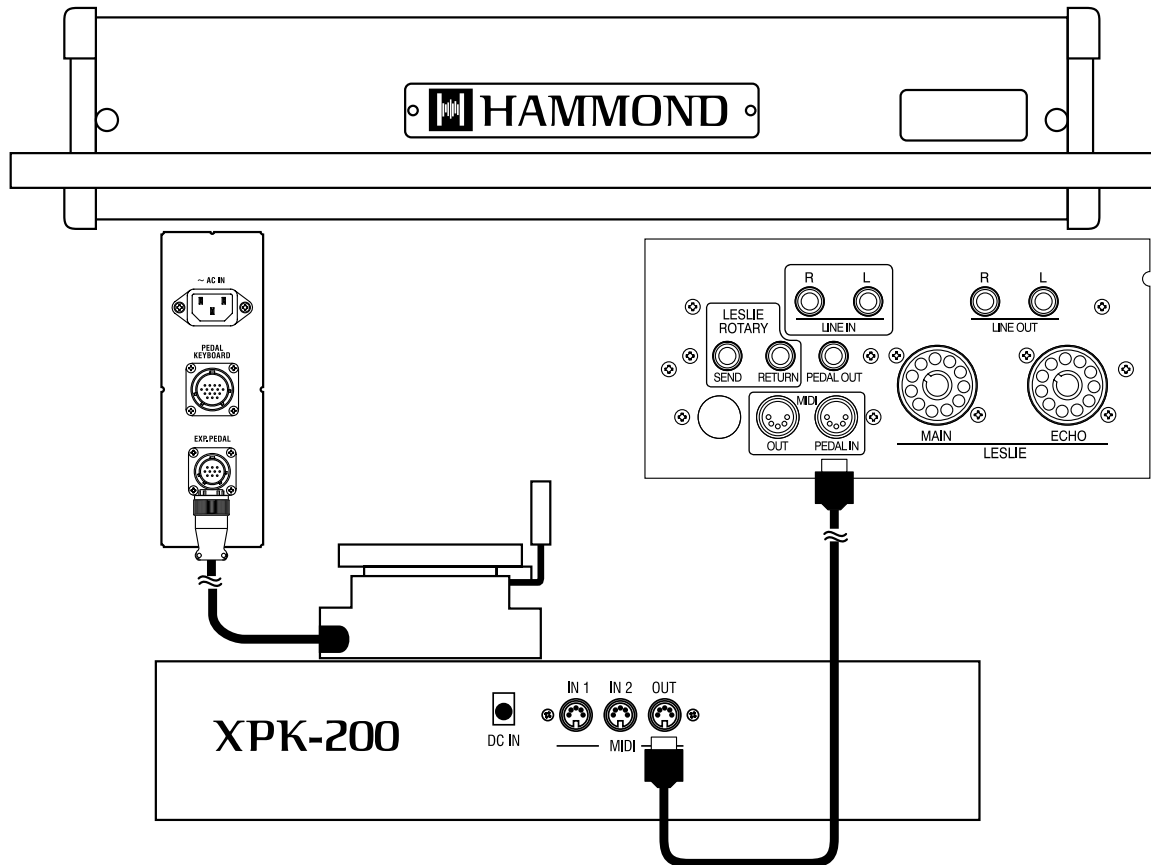



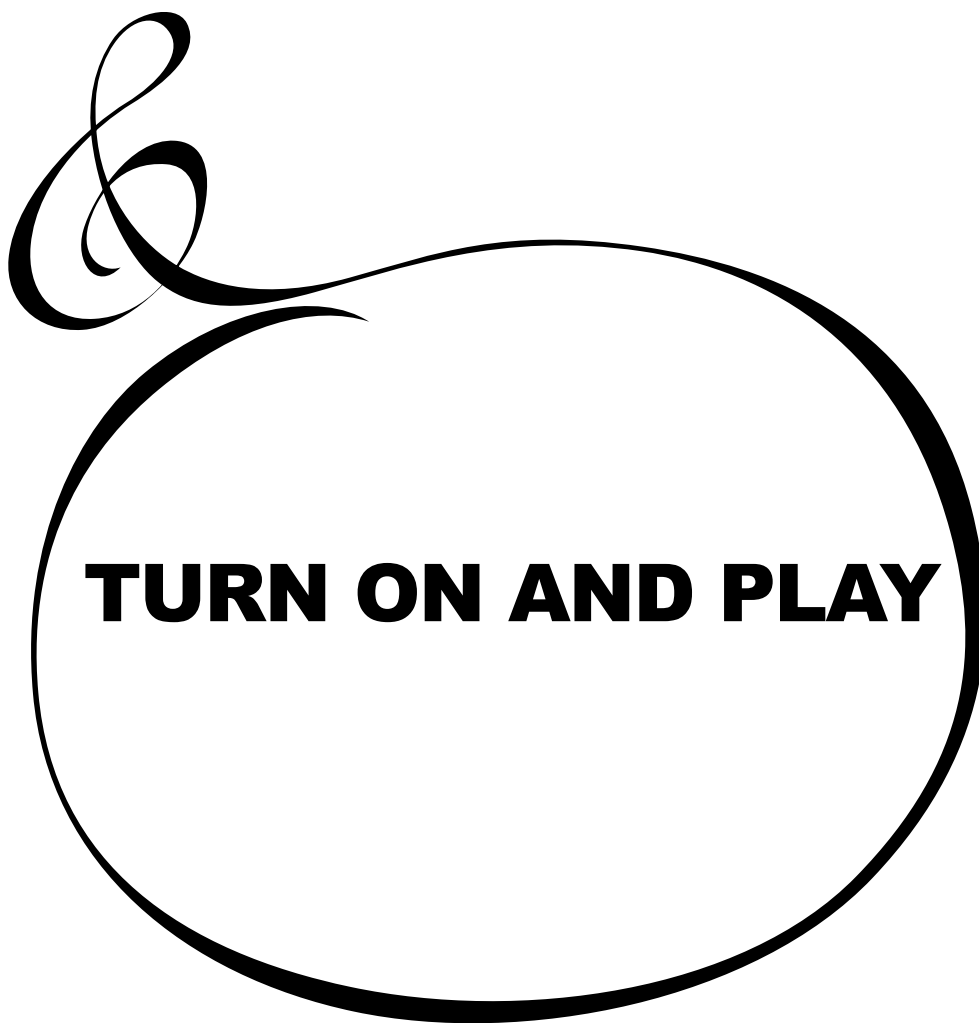

## How to power on

After connecting your organ to the power outlet, please follow this procedure before switching on the power. To avoid possible damage to your speakers, please follow this procedure exactly.

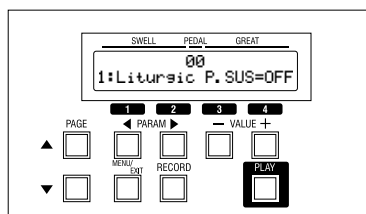
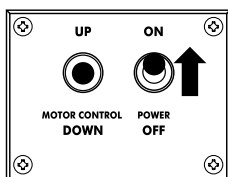
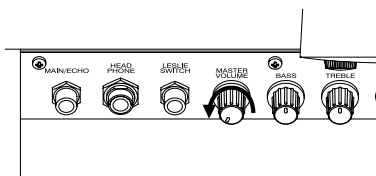

1. Set the [MASTER VOLUME] Knob at minimum.
2. Switch on the power of any external effects devices.
3. Turn on the [POWER] switch of the organ. The pilot lamp will light up and the PLAY mode (fig.) is displayed, following the title. The Leslie Speaker is automatically turned on simultaneously, if connected.
  - ❖ *It takes a few seconds to reach play mode, because of the circuit-protection devices.*
  - ❖ *The tubes require 10 to 20 seconds to warm up.*
4. Turn on the power of the amplifier etc., if any connected to the LINE OUT.
5. Holding down a key, adjust the [MASTER VOLUME] by turning the Knob.
  - ❖ *The Preset Key [B] does not produce sound when initially first turned on. Draw the B Drawbars, or press either of the Preset Keys [C#] - [A] to start.*
6. Adjust the volume of the amplifiers etc.
  - ❖ *Reverse the above steps when you switch off the power. (Switch off the power of the amplifiers etc. first.)*

## Back-Up

This organ memorizes the settings of the parameters immediately before it is switched off. The organ will start with these settings when it is switched on again.

## Reset to the initial status

To reset the organ to the initial default setting:

1. Switch off the power of the organ.
2. Holding the [RECORD] button, switch on the power.
3. Keep pressing the [RECORD] button until "Loading Default..." appears on the display.
4. When the reset is complete, PLAY mode appears on the display. (Completed)

The registrations (settings) of the Drawbars and other parameters may be recorded to the Preset Keys on the left-hand side of each manual.

The 4 Banks are loaded with a default library of Presets allowing you to play your organ immediately.

There are 5 Banks with 11 Presets in each.

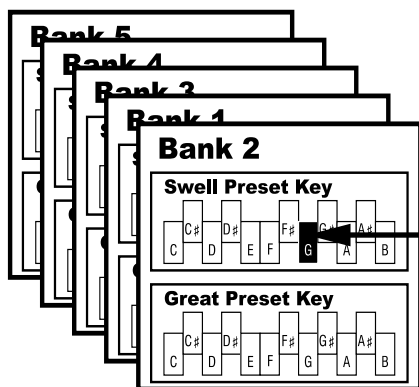

The chart on the left outlines the Bank/Preset structure.

The “Bank” is common for the entire organ, but the Preset Keys for the Swell and Great are independent of each other and are selected separately.

Let’s call this in the example below.

**NOTE:** The Preset Key [C] produces no sound but releases the Preset Key previously selected. It is called “cancel”.

## How to call the Preset

Ex. Select “2-G”

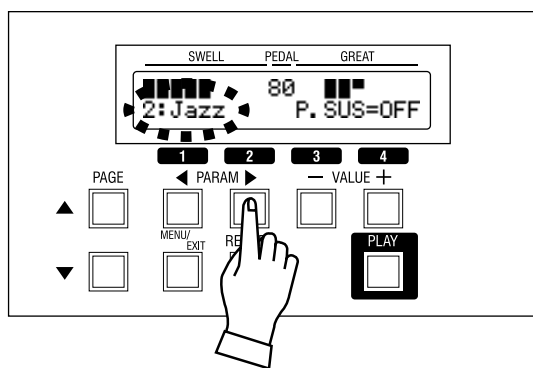

### 1. Select the BANK

Select Bank 2 using [PARAM] Buttons in the PLAY mode.

### 2. Select the KEY

Press the Preset Key [G].

The [G] key remains depressed and the contents of the Preset Key are called.

Try calling various Presets. See the Appendix “Factory Presets” (P. 124) at the back of this manual for details of the contents of each Preset.

**NOTE:** Only the Drawbar registrations were able to be called on the original B-3. The factory settings of this new organ are the same as the factory settings of the original. You can change to call other parameters by the Preset Keys. See the “PRESET” section for details. (P. 76)

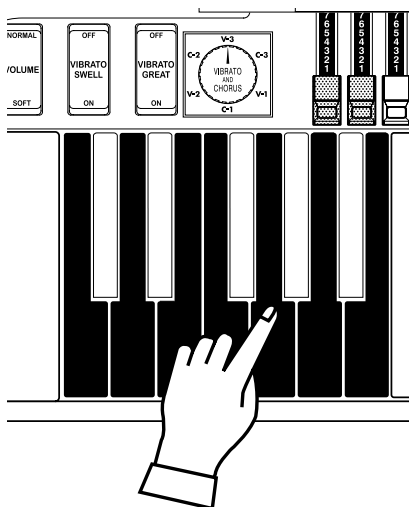

## Play the Pedalboard

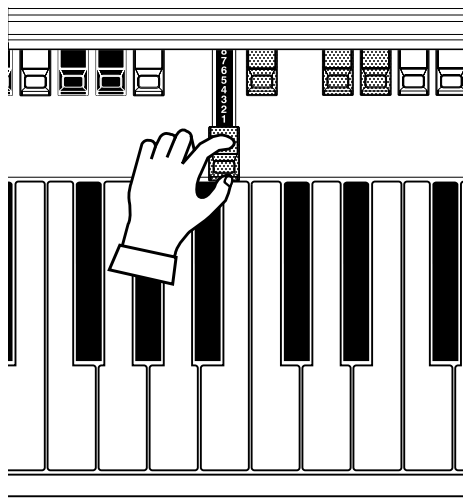

The Pedal tones are controlled by the Pedal Drawbars which are in the center of the Drawbar row. Pull out the 16' Drawbar as shown at left to the full length. Play the Pedalboard. The Drawbar to the right of the 16' is the 8'. Pull that Drawbar out and play the Pedalboard (Explanations of the Drawbars and the “foot” names are included in the next section “Creating the Settings”).

The Pedal Part settings were not called at the Preset Keys on the original B-3. The factory setting of this organ is the same way.

**NOTE: You can change to record/call out the Pedal Part settings at the Great Preset Keys. For details, see the “Preset” section. (P. 76)**

## Expression Pedal

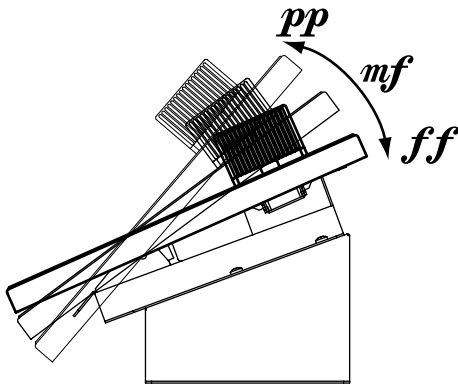

Unlike the piano, the organ does not get louder, the harder you play the keys. The organ's volume is controlled by using the expression pedal.

As you depress the pedal forward, the volume rises, and lowers when you return it.

**NOTE:** You can adjust the curve of the expression pedal. (P. 91)

## Foot Switch

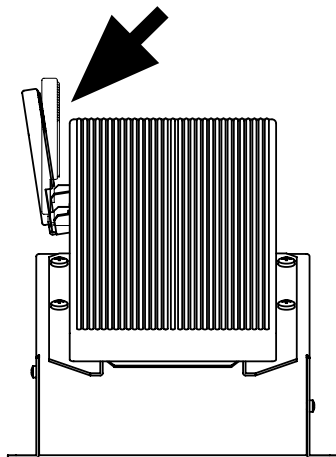

The Foot Switch, on the left side of the Expression Pedal can be programmed for various functions. "Leslie Chorale / Tremolo - Alternate" is the factory default. Every time you depress the Foot Switch, the Leslie changes speed.

**NOTE:** You can change the Foot Switch assignment. (P. 91)

## Motor Control Switch

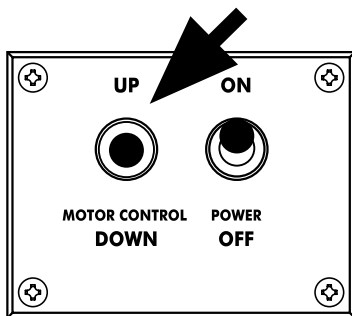

You can bend the pitch if you operate this switch while playing, same as the START and RUN switches on the original B-3. While the toggle is at the UP position, the pitch gradually goes up, and, while at the DOWN position, the pitch gradually goes down to 2 octaves lower and also the volume gradually gets smaller.

**NOTE:** You can change the time of the pitch bend. (P. 91)

### **tips** START AND RUN

The original B-3 required a two-step procedure to power up. You would first "start" the motors by holding the spring-loaded left switch, and after a few seconds, you would release the "start" switch and turn on the "run" switch. Organists discovered that if you engaged the start switch while the organ was running, it would give a distinctive "pitch bend" to the organ tone. This organ, being totally digital only needs the power switch, but to remain authentic, the motor control switch is included, and the "pitch bend" effect is duplicated.

You will be able to produce your own sound by using the exclusive features of your HAMMOND ORGAN, such as Drawbars, Percussion, Vibrato/Chorus, Overdrive, and the Leslie effects. Let's go through the first steps:

## Select the Preset Key [B]

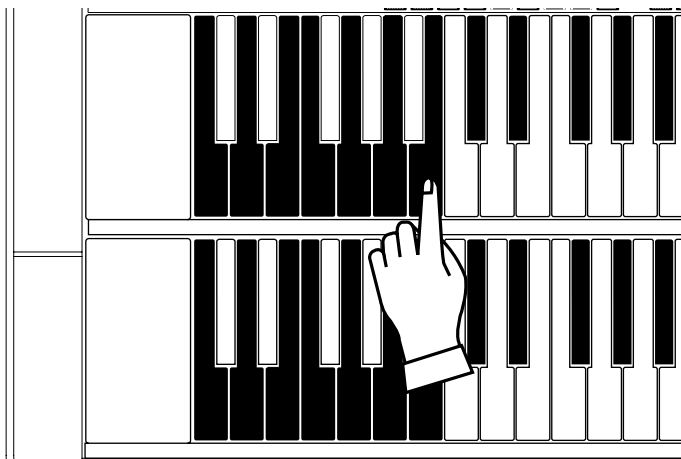

Select the Preset Key [B] first.

The Presets Key [A#] and [B] are special Presets called “Adjust Presets”, directly connected with A# Drawbars and B Drawbars respectively. That means the Drawbar registrations on the panel and the internal registration, each position of tablets or knobs and internal values correspond with each other.

Selecting these keys are helpful when you create a new registration or when you want to manually operate the Drawbars while playing.

**NOTE: You can initialize the contents to the default setting. (P. 95)**

## Pull out the B Drawbars

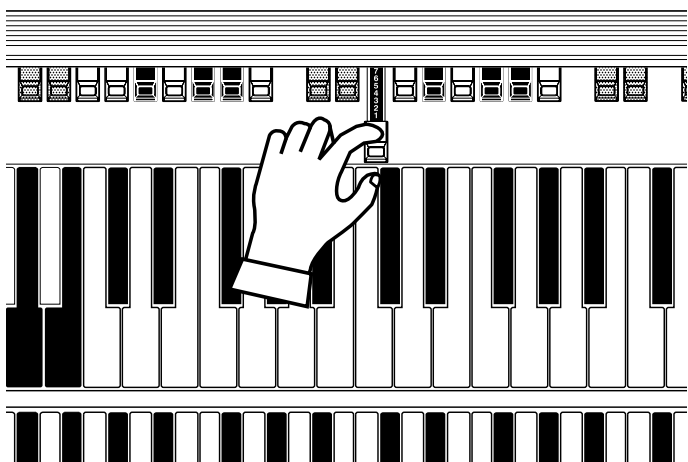

Pull out the B Drawbars on the left-hand side to any length, while playing the Swell(Upper) manual.

The tones vary corresponding to how far the Drawbars are “Pulled”. The Drawbars create the fundamental tones of this organ.

The volume increases as each Drawbar is pulled out to its full length. And decreases as it is pushed back in. The tones of the Drawbars gradually get higher in frequency from left to right.

The most popular patterns or registrations are (1) to pull out only all the three left side Drawbars to the full, (2) to pull the far-left and only the white bars to the full, or (3) to pull all the bars.

**NOTE: You can change the characteristics of the Drawbars. (P. 72)**

**NOTE: The present registration is shown on the “Play” mode display. (P. 65)**

## Add Percussion

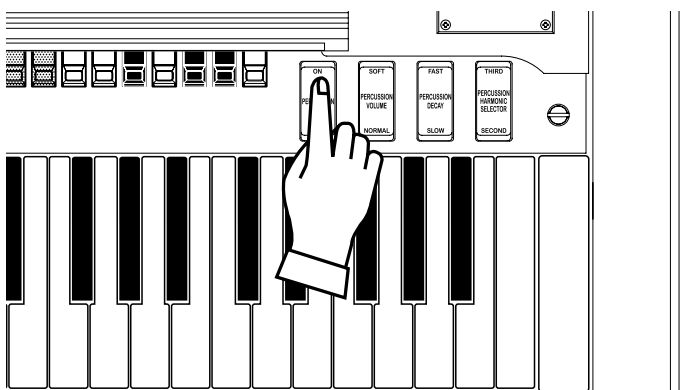

The “Percussion” referred to here is not a percussion instrument itself, but an extra voice which adds a clear-cut “attack” to the organ sound. You can add this “attack” to mix with the Drawbar sound when you want.

Percussion sounds only when using Swell Manual preset [B]. This is the same as on the vintage B-3.

Switch the percussion tab to “On”, the percussion voice will speak. An octave up(second) or a twelfth up(third) by using the [PERCUSSION HARMONIC SELECTOR] tab. Switch the decay time by [PERCUSSION DECAY] and the volume by [PERCUSSION VOLUME].

**NOTE: The volume etc. of Percussion can be finely set. (P. 74)**



## Add Effects

### VIBRATO AND CHORUS

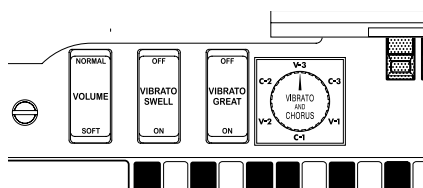

“Vibrato and Chorus” slightly changes the Drawbar pitch and adds warmth to the sound.

#### [SWELL] Tablet, [GREAT] Tablet

Switches the Vibrato/Chorus on and off for each manual.

#### [VIBRATO AND CHORUS MODE] Knob

Controls the Vibrato and Chorus Depth.

The degree of depth corresponds with the number. “V” adds Vibrato sound by changing the pitch, “C” adds the original shimmering Hammond chorus.

**NOTE: You can fine-adjust the speed etc. of the Vibrato&Chorus. (P. 82)**

### OVERDRIVE

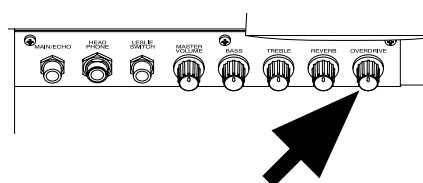

Adds tube-based distortion to the sound.

#### [OVERDRIVE] Knob

Controls the distortion amount. Full left is “clean”. The distortion effect increase as you rotate the knob clockwise.

**NOTE: Overdrive distortion can be fine-set. (P. 80)**

### LESLIE

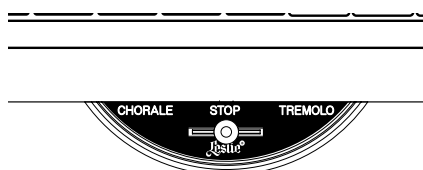

The Leslie speaker uses a rotating treble horn and a woofer firing into a rotating drum to give the organ a “3-D” sound, with motion and lively dynamics. It is the traditional partner of the Hammond Organ.

#### LESLIE SPEED Switch

This is for switching the mode of the Leslie Speaker or the built-in Leslie Effect.

At CHORALE the rotor turns slowly, at TREMOLO fast. It stops at STOP.

**NOTE: You can fine-adjust the rotation speed etc. of the internal LESLIE Effect. (P. 84)**

### REVERB

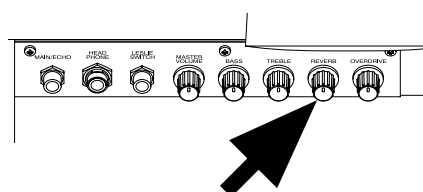

The reverb effect simulates performing in a concert-hall.

#### [REVERB] Knob

Controls the depth of the Reverb Effect. At full left the Reverb Effect is off. The effect deepens as you rotate the knob.

**NOTE: You can fine-control time etc. of Reverb. (P. 88)**

### EQUALIZER

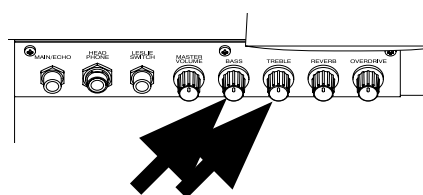

Controls the overall tone of the organ.

#### [BASS] Knob

Increases or decreases the emphasis of the Bass range of sound.

#### [TREBLE] Knob

Increases or decreases the emphasis of the Treble range of sound.

**NOTE: Each BASS, TREBLE knob can be assigned to a different band respectively. (P. 88 #6, 7)**

## PEDAL SUSTAIN

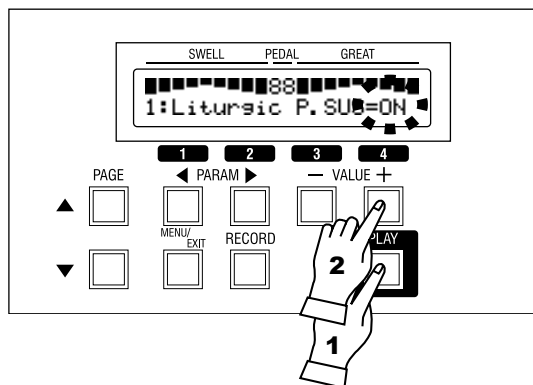

The Pedal Part sound can be set to smoothly decay after the key is released. This is called “PEDAL SUSTAIN”.

To use this “Pedal Sustain” function, refer to the control panel.

1. Press the [PLAY] button, and display “P. SUS” on the bottom right of the display.
2. Switch ON the PEDAL SUSTAIN using the [VALUE] button.

If you release your foot off the Pedalboard (or your finger from the Great Manual, if you are using the Manual Bass function, as explained later in this manual), the Pedal Part sound smoothly decays.

**NOTE:** You can change the decay time of the Pedal Sustain. (P. 73 #8)

## MANUAL BASS

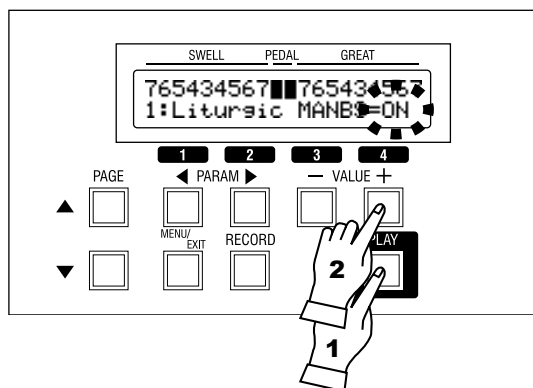

You can play Bass using the lowest keys of the Great manual. This is called “Manual Bass”.

To use the Manual Bass function, refer to the control panel.

1. Press the [PLAY] button, and display “MANBS” on the bottom right.
2. Switch ON the MANUAL BASS using the [VALUE] button.

When playing the Great manual, the lowest note (or chord) played will be sounded by the Pedal voice.



**Manual Bass**

The factory default Manual Bass range is set to “B” of the second octave.

**NOTE:** You can move the upper limit of the Manual Bass. (P. 90)

**NOTE:** You can choose sounding polyphonic (POLY) or lowest note (MONO). (P. 73 #9)

## Recording Preset Keys

You can record your Drawbar registrations in the Preset Keys. You can also freely change the preset data loaded as the factory default.

To record Drawbar registrations in the Preset Keys, refer to the control panel.

### Ex. Memorize to “2-D”

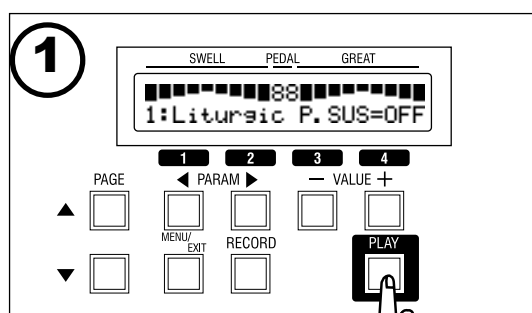

1. Go to the PLAY mode.  
Press the [PLAY] button to go to the PLAY mode.

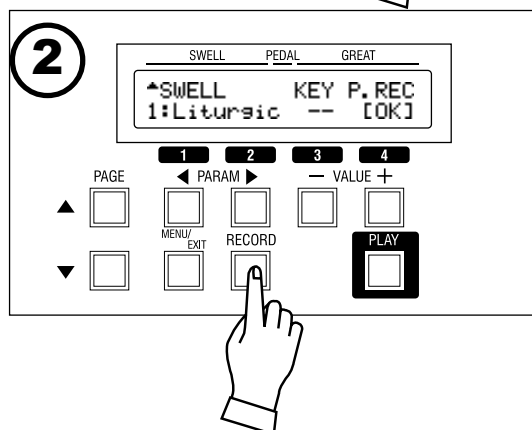

2. Go to the Record mode.  
Press the [RECORD] button and go to that mode.

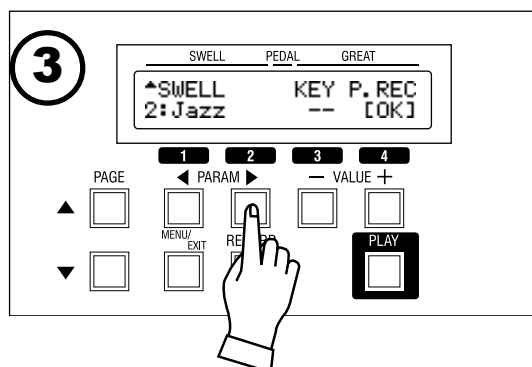

3. Designate the Bank.  
Press the [PARAM] button and select the Bank to record. For this example select “2”.

**\*to be continued to the next page.**

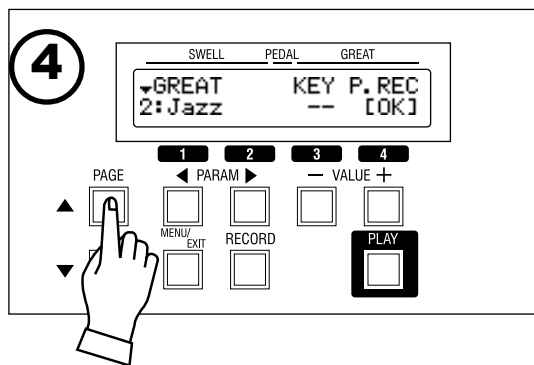

4. Select the Part to record.

Press the [PAGE] button and select either SWELL or GREAT to record the Preset. For this example select "GREAT".

**NOTE:** You can select the part to record by the Preset Key, as well.

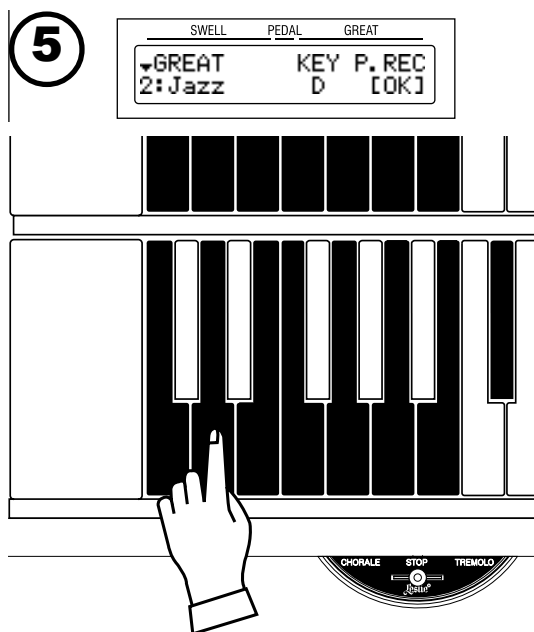

5. Select the Preset Key.

Select the Preset Key ([C#] - [A]) to record. For this example, Press [D].

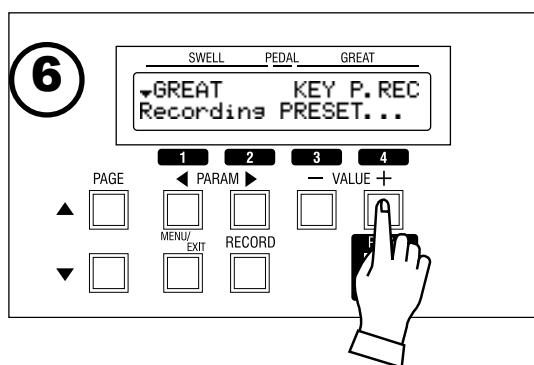

6. Commit the Preset.

Press [4] OK. The Preset is recorded and the following message appears on the display for a few seconds.

Recording PRESET...

**NOTE:** The recorded Preset data is retained when if the power is switched off.

**NOTE:** When recording the presets, not only are the Drawbar registrations saved, but also various parameters. For details, see the PRESET section. (P. 76)

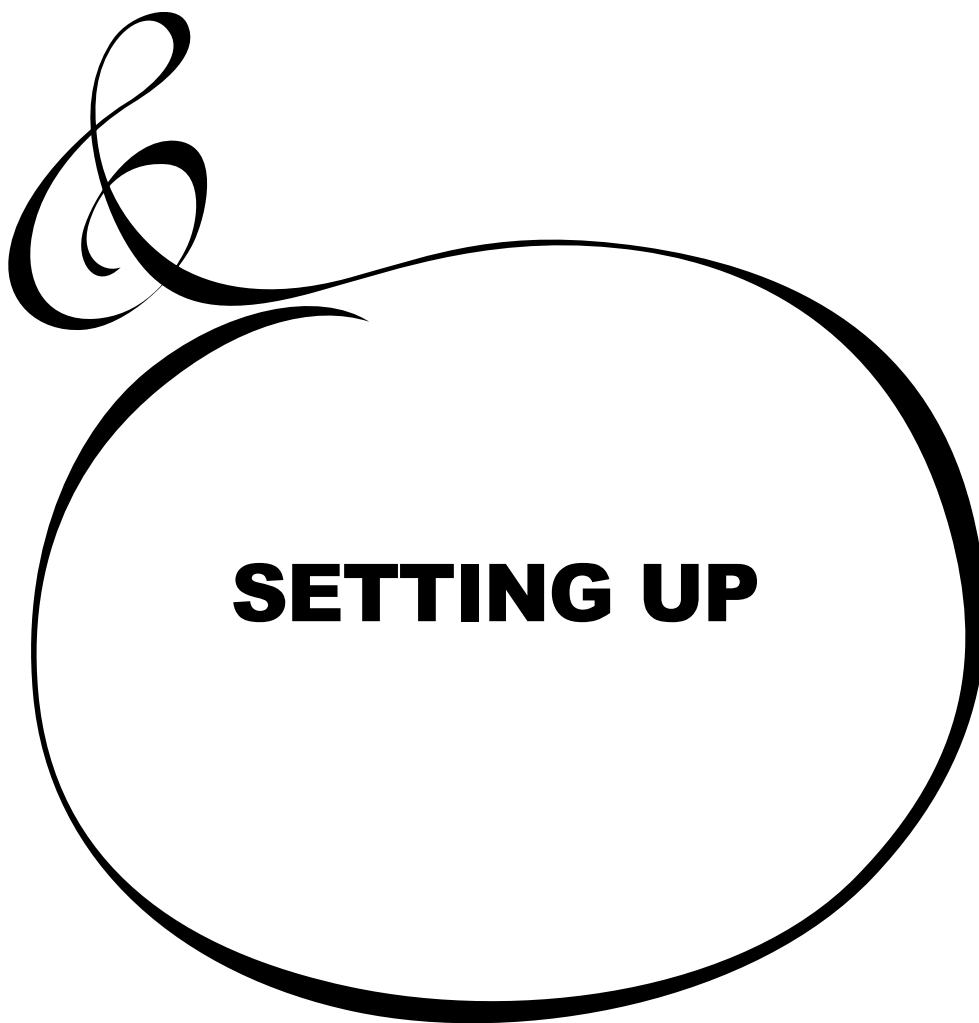

## **SETTING UP**

System structure of this Organ

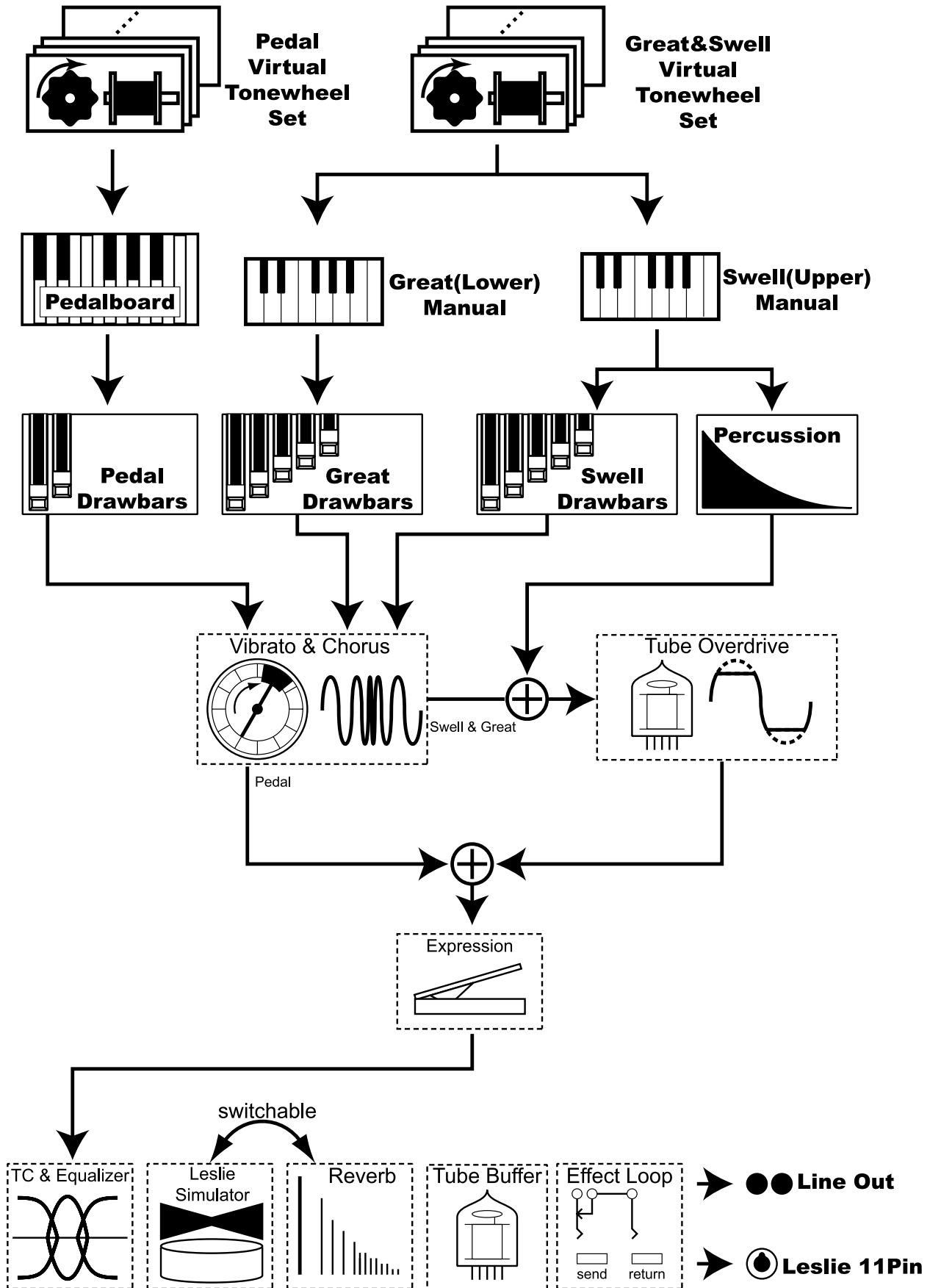

See the illustrated System Structure of your organ on the left page.

## TONE-WHEELS

The sound source or “engine” of Hammond Organ is the Virtual Tone-wheel. Generator. As on the original B-3, each of the 96 Virtual Tone-wheels are oscillating at a different pitch. There are NO moving parts inside this organ.

## KEYS

The tones of the 96 Virtual Tone-wheels are switched at the keyboard with the “Direct Analog Keying System” exactly as on the original B-3. There are 9 contacts at each key responding to each of the 9 Drawbars. When you press a key, the contacts are made to play the corresponding Drawbars to the pitch of the key depressed.

## DRAWBARS

The Drawbars represent simple harmonics. Each bar adjusts the value of each harmonic. The combinations of different harmonics create a more complex sound.

## PERCUSSION

The Percussion adds a voice with clear attack to the Swell manual. This effect is an essential part of the Hammond Sound.

## VIBRATO AND CHORUS

The classic Hammond “Chorus-Vibrato” gives depth and richness to the organ sound by slightly varying the pitch (Vibrato) or doubling the voice, just slightly out of tune (Chorus). This effect is a hallmark of the vintage B-3 sound.

**NOTE:** On this organ the mechanical scanner of the original B-3 is simulated, with no moving parts.

## TUBE PRE-AMPLIFIER

A real tube in the pre-amplifier gives this organ the “vintage” sound. By changing the amount of the drive, you can obtain various tube sound from “clean” (no clipping), to the hard-distorted fuzzy and raspy “overdrive” popular in rock music.

The Pedal Part is designed not to pass through the tube pre-amp in order to obtain a clear Bass-Pedal tone.

## EFFECTS

The built-in Effects are as follows: an Equalizer for controlling the tonal quality, a Leslie Effect for giving rotary speaker effects, a Reverb (for giving reverberation), a Tube Buffer for adding tube “warmth”. (The built-in Leslie Effect does not appear in the signal of the Leslie 11-pin terminal.)

## EFFECT LOOP

The External Effect Loop is located post-internal Effects.

### **tips** TONE-WHEEL SET

The Tone-wheel Sets are divided into the Manuals and the Pedal Part. This is to give the Pedal Part the Decay (= the sound gradually fading out while pressing the key) or Sustain Effect. (= the sound gradually fading out after the key is released).

### **tips** HARMONICS

Harmonic is a pitch of a different ratio to a certain pitch; for example, the one octave higher C to the middle C. The more Harmonics, the brighter and richer sound is obtained.

**The details are on the next pages.**

The functions introduced here will be explained in detail from the next page.

# HARMONIC DRAWBARS™

The 9 Drawbars (plus 2 for the Pedal) on this organ are used to create the basic sounds. Each Drawbar is marked with the numbers 1 - 8. If you push back the Drawbar until you cannot see any number at all, the sound of the Drawbar is not heard. If you pull it out to the fullest position the sound level is maximum.

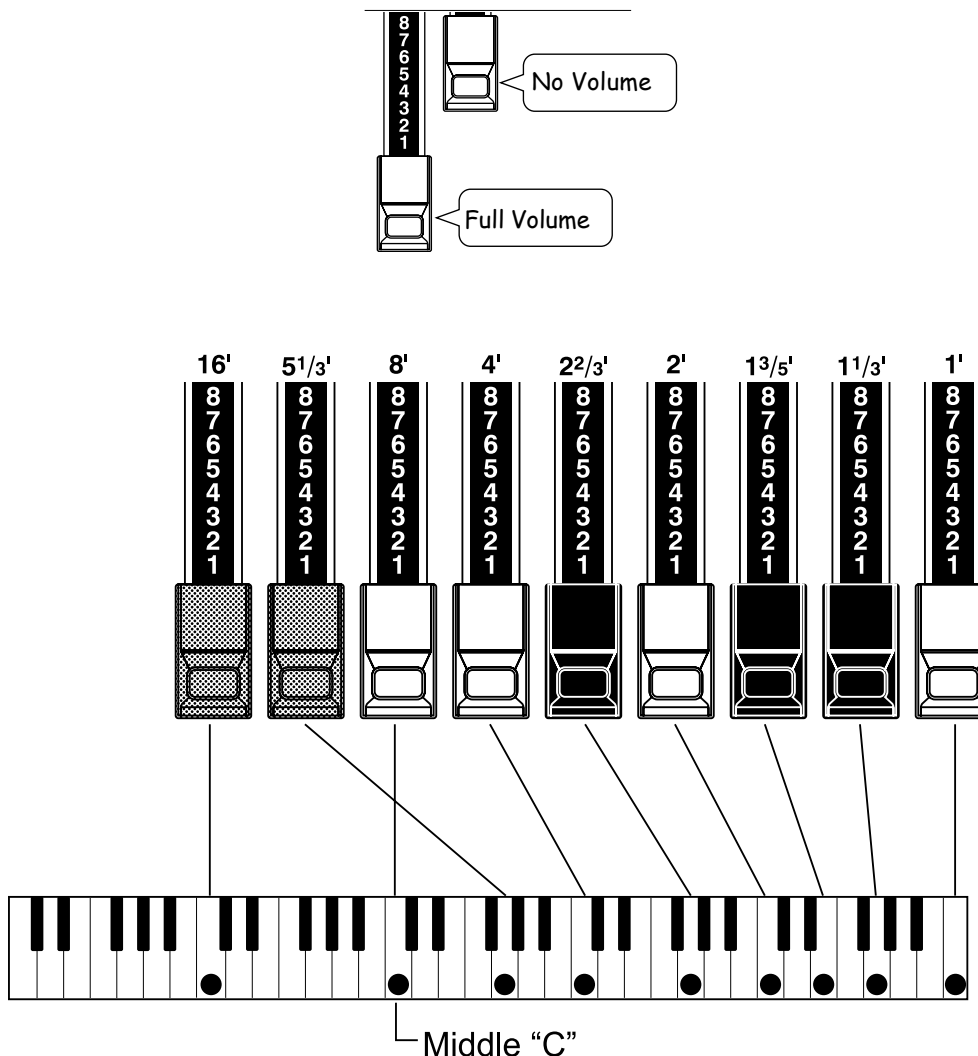

The pitch of each Drawbar is as shown above, when the middle C is depressed. The footage marked (') on the handle end of each Drawbar is originated from the length of pipes on a pipe organ.

The numbers 1 - 8 on the "bar" portion of each Drawbar indicate the volume of the sound to be produced as well as the guide to remember Drawbar settings.

Pull the fundamental (8'), the third harmonic ( $2\frac{2}{3}'$ ) plus the fifth harmonic ( $1\frac{3}{5}'$ ) Drawbars out completely and play the keyboard. Notice how the sound resembles a clarinet.

If you push the 8' Drawbar half-way, you'll notice the sound becomes more high-pitched and a bit "harder". Now pull the 8' drawbar back out fully and push the  $2\frac{2}{3}'$  and  $1\frac{3}{5}'$  in halfway. notice how the sound becomes mellower. Experiment with the Drawbars to obtain your own personal favorite sounds.

**NOTE:** You can change the characters of the Drawbars. (P. 72)



## Drawbars for the Swell/Great Manuals

### Relation between the Preset Keys and the Drawbars

The two sets of Drawbars on the left-hand side are for the Swell Manual and the two on the right-hand side are for the Great Manual. To actuate them, use the Preset Key [A#] or [B] respectively. When the other [C#] to [A] Preset Keys are selected, the Drawbar registrations are recalled inside the organ, and the tone that plays will not match the Drawbars physical settings.

**NOTE:** Even while the Preset Keys [C#] to [A] are selected, you can operate the Drawbars and the preset registration will temporarily change. (P. 52)

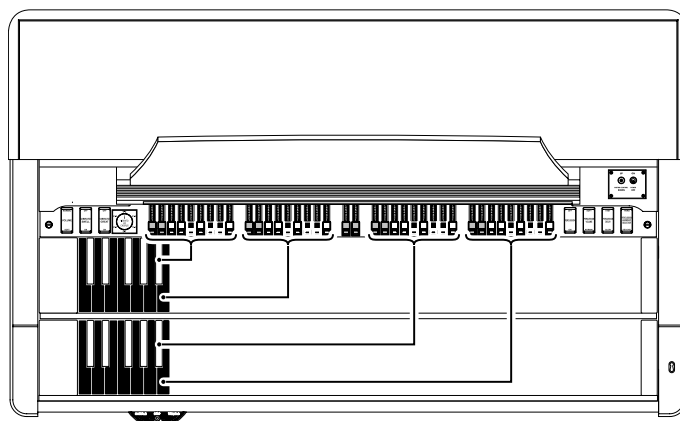

### WHITE DRAWBARS

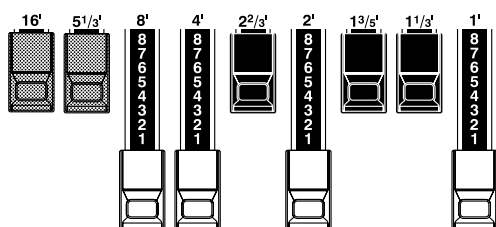

In each Drawbar set, the white Drawbar (8') on the left end correspond to the fundamental sound. Each succeeding Drawbar to right controls the next octave harmonic.

### BLACK DRAWBARS

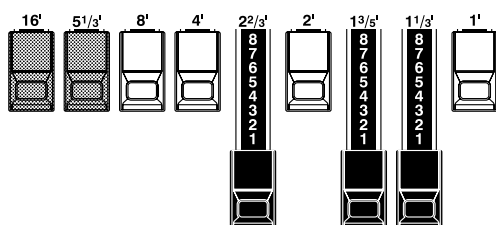

The sounds of the black Drawbars, too, play important roles in building rich tones. Their pitches are fifth and third to the fundamental. They contain the elements of all different harmonics of such as the sweet and soft horn, mellow strings and so on.

### BROWN DRAWBARS

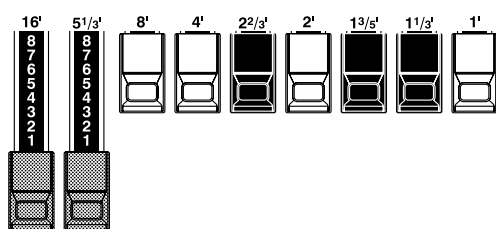

The two brown Drawbars on the far left give depth and richness to the sound. The left 16' is one octave lower than the 8', and 5 1/3' is the third harmonic of the 16' fundamental.

Normally, the tones are built on the 8' fundamental, but, if you want to add depth to the tone or to expand the playing range on the manual by one octave, the tones are built on the 16' fundamental.

## Drawbars for the Pedalboard

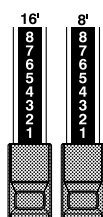

The Pedalboard plays the bass line and uses two Drawbars -16' and 8'.

The first Pedal Drawbar produces a tone at 16' pitch for a deep foundation bass, while the second Pedal Drawbar produces a tone at 8' pitch, or one octave higher.

# Drawbar Registration Patterns

The Drawbar Registration is matched by digits. It is easy to remember the typical combinations of the 9 Drawbars by their forms.

The Drawbar Registrations are grouped into the following 4 patterns:

## Flute family (2 step pattern)

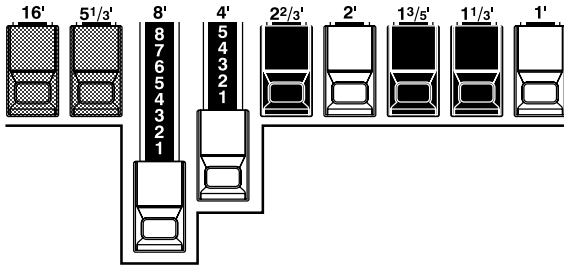

Accompaniment Flute 8' I.....	00 8460 000
Accompaniment Flute 8' II .....	00 3220 000
Accompaniment Flute 8' III ....	00 8600 000
Chorus of Flutes 16' .....	80 8605 002
Orchestral Flute 8' .....	00 3831 000
Piccolo 2' .....	00 0006 003
Stopped Flute 8' .....	00 5020 000
Tibia 8' .....	00 7030 000
Tibia 4' .....	00 0700 030
Tibia (Theater) 16' .....	80 8605 004
Wooden Open Flute 8' .....	00 8840 000

## Diapason family (check mark pattern)

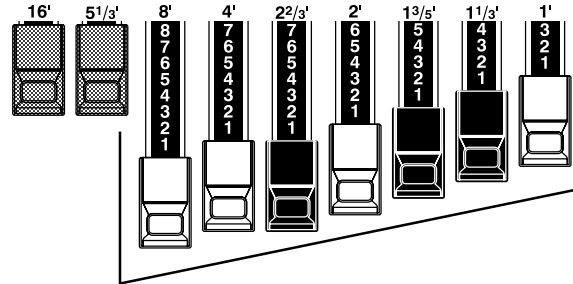

Accomp. Diapason 8' .....	00 8874 210
Chorus Diapason 8' .....	00 8686 310
Diapason 8' .....	00 7785 321
Echo Diapason 8' .....	00 4434 210
Harmonic Diapason 16' .....	85 8524 100
Harmonic Diapason 8' .....	00 8877 760
Harmonic Diapason 4' .....	00 0606 045
Horn Diapason 8' .....	00 8887 480
Open Diapason 8' .....	01 8866 430
Solo Diapason .....	01 8855 331
Wood Diapason 8' .....	00 7754 321

**NOTE:** Some of the names on this page may be unfamiliar. They represent the names of types of pipes on a pipe organ. The "Diapason" is the fundamental type of pipe on a pipe organ.

## Reed family (triangle pattern)

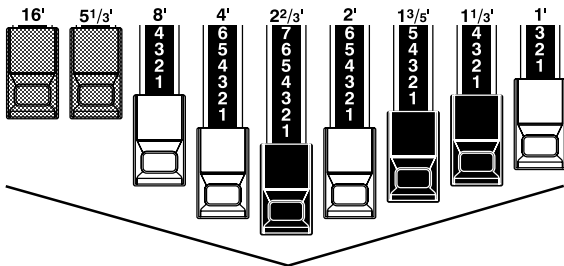

Bassoon 16' .....	44 7000 000
Clarinet 8' .....	00 6070 540
English Horn 8' .....	00 3682 210
Flugel Horn 8' .....	00 5777 530
French Horn .....	00 7654 321
Kinura 8' .....	00 0172 786
Oboe 8' .....	00 4764 210
Trombone 8' .....	01 8777 530
Trumpet 8' .....	00 6788 650
Tuba Sonora 8' .....	02 7788 640
Vox Humana 8' .....	00 4720 123

## String family (bow pattern)

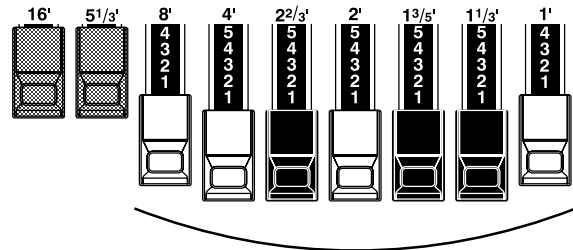

Cello 8' .....	00 3564 534
Dulciana 8' .....	00 7770 000
Gamba 8' I .....	00 3484 443
Gemshorn 8' .....	00 4741 321
Orchestral String 8' .....	00 1464 321
Salicional 8' .....	00 2453 321
Solo Viola 8' .....	00 2474 341
Solo Violin 8' .....	00 3654 324
Viola da Gamba 8' .....	00 2465 432
Violina 4' .....	00 0103 064
Violone 16' .....	26 3431 000

**NOTE:** The "Strings" and "Reeds" mentioned here are not analogous to orchestral voices. The names here refer to types of pipes found in a pipe organ and the sounds are not meant to sound as actual violins, trumpets, oboes, etc.

# Modern Drawbar Registrations

The Drawbar registrations introduced on the previous page are typically for classical music. They were created at the dawn of the Hammond Organ, when it was intended to sound like a pipe or church organ. Later on, as the Hammond Organ spread throughout Jazz, Pop, Rock and (especially) Gospel music, Some timeless registrations become common.

## Jazz

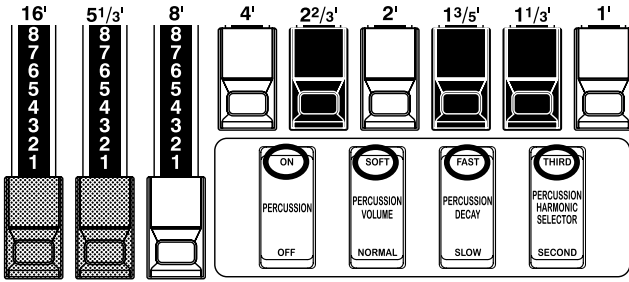

## Bluesey

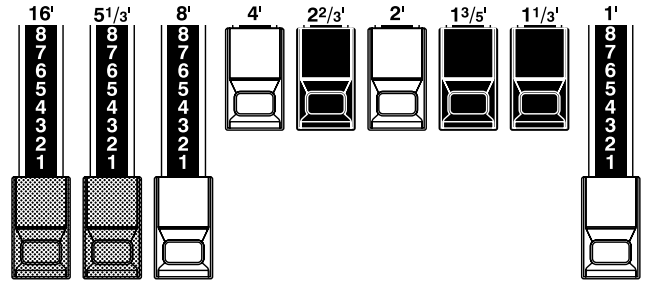

## Groovy & Funky

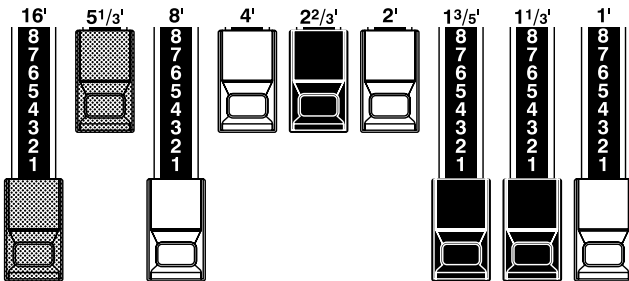

## Max Power

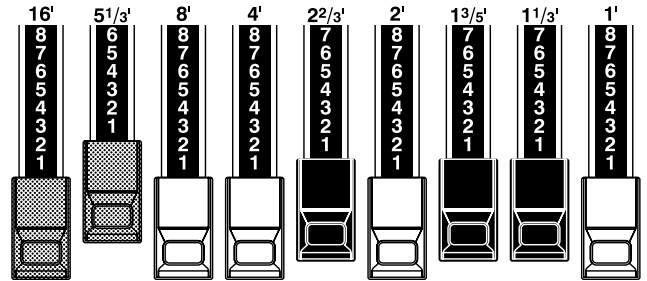

**tips** APPLICATION OF PERCUSSION

When Percussion is used, the sound of the 1' Drawbar is cancelled. This enables the technique of playing the organ switching “Jazz” or “Bluesey” by turning on/off [PERCUSSION] while the registration itself is set at “Bluesey”.

## Controlling the Registration while playing a Preset

To temporarily modify the registration by operating Drawbars, while a Preset Key is selected between [C#] and [A], operate either [A#] or [B] holding down the [PLAY] button.

In the registration, only the operated bar's footage changes. For example, draw 1' of the Swell Drawbar [A#] or [B] holding down the [PLAY] button, if you want to add 1' while playing the Preset Key [G] of the Swell Manual.

**NOTE:** Pedal Drawbars are always working regardless of Preset Keys and link Great / Pedal (P. 76 #3).

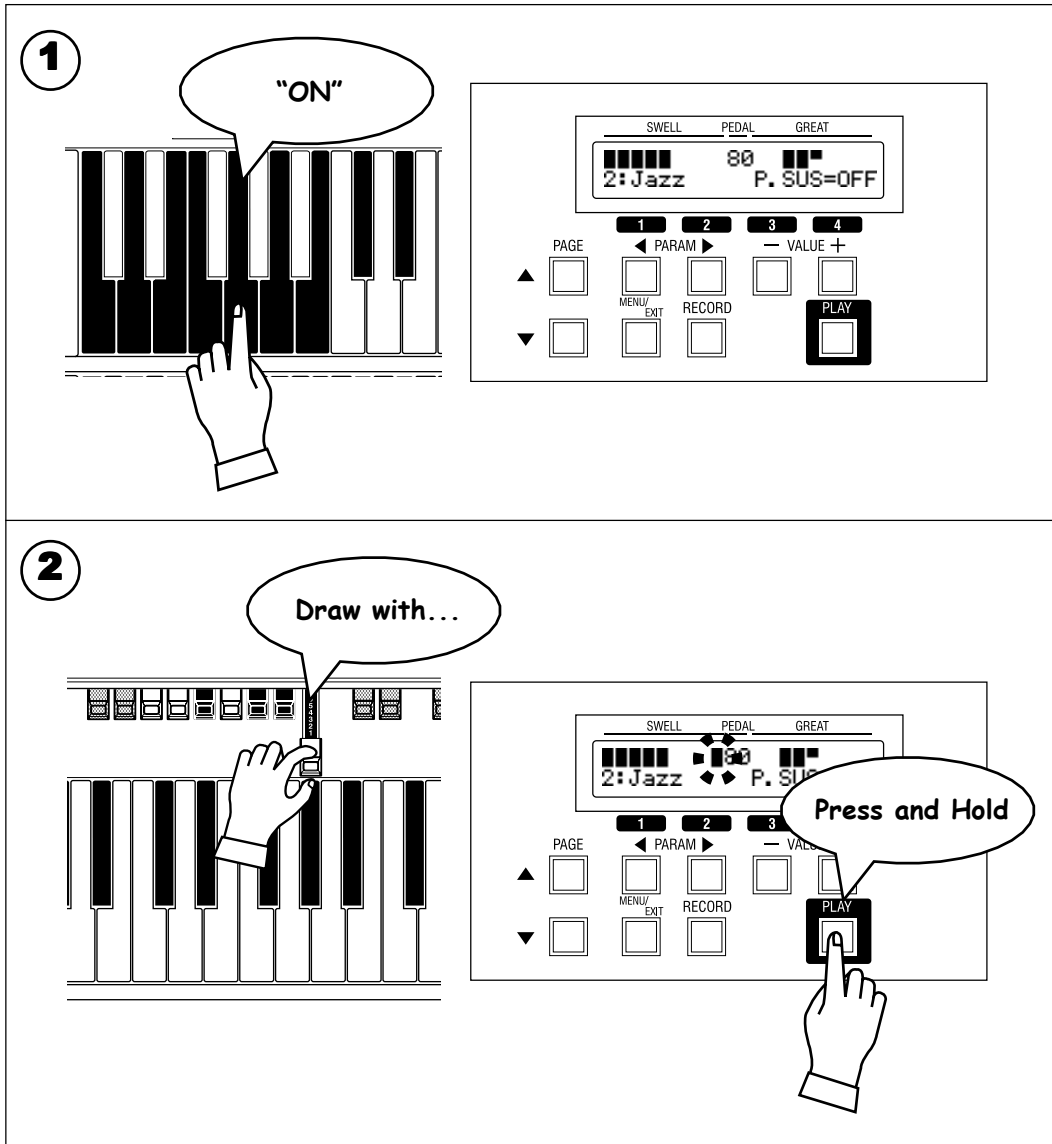

The touch-response percussion adds a clear-cut “attack” to the organ sound. It is a Hammond exclusive. Percussion is usually combined with the Drawbar sound.

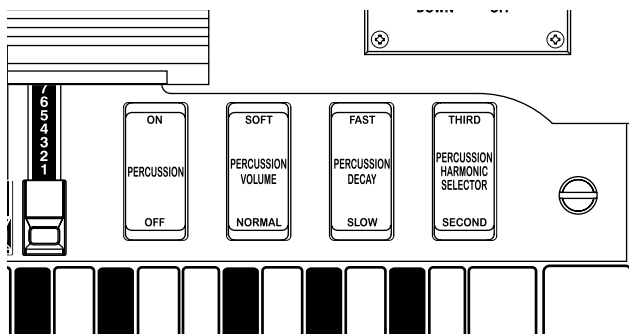

### [PERCUSSION] Tablet

Turns on the Swell (Upper) manual percussion when swell Preset [B] is selected. When percussion is activated the 1' Drawbar does not sound.

### [PERCUSSION VOLUME] Tablet

This is for controlling the Percussion volume. SOFT for lower Percussion volume, and NORMAL for higher Percussion volume with the Drawbar volume a little lower.

### [PERCUSSION DECAY] Tablet

This is for controlling the decaying speed of Percussion. SLOW for decaying slowly like a chime, and FAST for decaying rapidly as a xylophone.

### tips DECAF

Piano sound gradually fades even if you keep the key down. This is called “decay”. A violin, keeps sounding at a certain volume. This is called “sustain”.

### [PERCUSSION HARMONIC SELECTOR] Tablet

This is for setting the Percussion pitch. SECOND for the 2nd harmonic, i.e. the pitch of the 4' Drawbar. THIRD for the 3rd harmonic, i.e. the pitch of the 2 2/3' Drawbar.

**NOTE:** You can fine-set Percussion. (P. 74)

## Notes

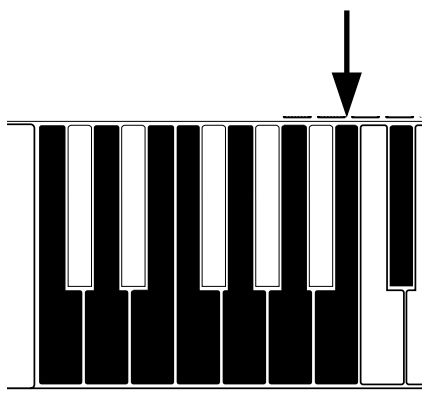

### “Percussion does not sound!”

The factory default setting: Percussion will not sound except at the Preset Key [B] (See left).

**NOTE:** You can set any Preset Key to sound Percussion. (P. 77 #7)

### DRAWBAR CANCEL

While [PERCUSSION] is on, 1' of the Swell Drawbars is disabled.

**NOTE:** You can set to play 1' Drawbar, while Percussion is on. (P. 74 #5)

### SINGLE TRIGGER

If you play legato on this organ, only the first note of Percussion is output, and it does not trigger again unless you fully release all keys held on the Swell Manual.

# VIBRATO AND CHORUS

VIBRATO adds warmth to the tone by slightly oscillating the Drawbar pitch.

CHORUS adds richness to the sound by doubling the fundamental slightly detuned.

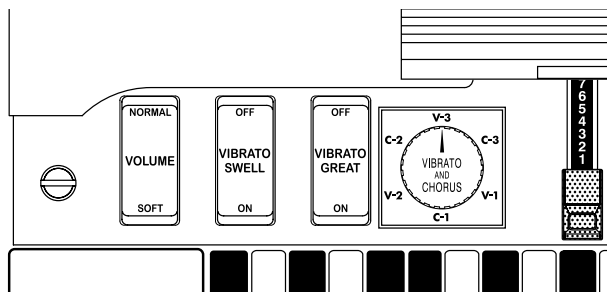

## **[VIBRATO SWELL] Tablet**

This enables the Vibrato and Chorus effects on the Swell manual.

## **[VIBRATO GREAT] Tablet**

This enables the Vibrato and Chorus effects on the Great manual.

**NOTE:** You can choose to add Vibrato & Chorus effects on the Pedalboard. (P. 82 #10)

## **[VIBRATO AND CHORUS MODE] Knob**

This knob controls the depth of Vibrato and switches ON and OFF the Chorus Effect.

- V-1: Light Vibrato
- V-2: Standard depth Vibrato
- V-3: Deepest Vibrato
- C-1: Light Chorus
- C-2: Standard depth Chorus
- C-3: Deepest Chorus

**NOTE:** You can fine-adjust the Vibrato and Chorus Effect. (P. 82)

The overdrive gives distortion to the sound by highly increasing the pre-amplifier input gain. The genuine tube circuitry allows a wide range of sound from unclipped warm and clean to a hard distorted overdrive, by varying the amount of the overdrive control.

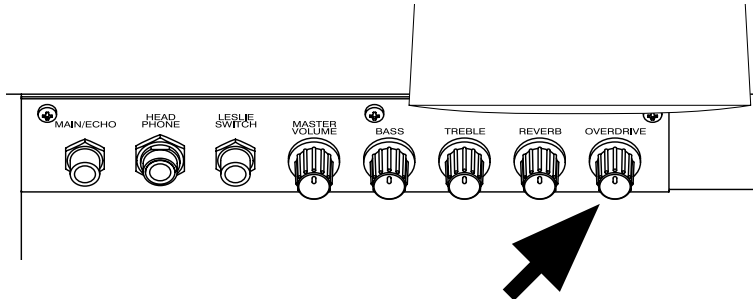

## [OVERDRIVE] Knob

This is for controlling the amount of overdrive of the tube amp circuit.

Controls the distortion amount. Full left is “clean”. The overdrive effect increases as you rotate the knob.

**NOTE:** You can fine-set the overdrive. (P. 80)

## tips TUBE AMP CIRCUIT

Tubes are rarely used in modern electric apparatuses because semi-conductors have better characteristics and tubes are inferior in many aspects.

In the matter of sound production, the qualities of a genuine tube preamp have not been surpassed or duplicated.

In this organ, a real Tube circuit is used in the preamp.

The Leslie Speaker produces its unique effect by utilizing rotors that give tremolo, vibrato and motion to the sound.

The Leslie Speaker is controlled by the Leslie Speed Switch. If no Leslie Speaker is connected, this switch controls the built-in Leslie Effect.

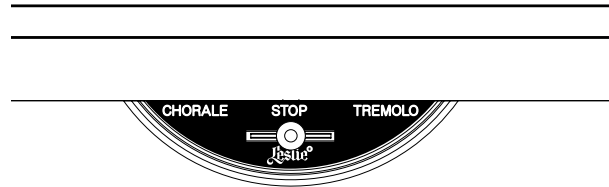

### [CHORALE]

Rotors will turn slowly, producing an effect suitable for use with hymns, classical style music and some slower songs.

### [STOP]

Rotors do not turn. Animation can be provided by using Vibrato and Chorus.

### [TREMOLO]

Rotors will speed up and rotate fast to produce a rich full sound.

**NOTE:** Some Leslie Speakers will not recognize the "stop" position.

**NOTE:** You can finely set the characteristics of the built-in Leslie effect etc. (P. 84)

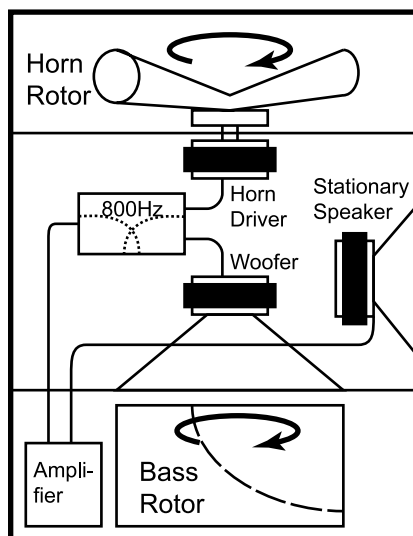

### tips WHAT IS THE LESLIE EFFECT?

In the Leslie speakers, an amplifier and two rotors are incorporated, the "Horn Rotor" for the treble and the "Bass Rotor" for the bass.

The Horn Rotor uses a horn driver, and a Woofer speaker (usually a 15") fires into the Bass rotor. Each is driven by a speed controlled motor. The motion causes the "Doppler effect" that creates the distinctive Leslie sound.

There are also models that have not only rotors but stationary speakers.

The circuit that sends the sound to the rotors is called "Rotary Channel" and the stationary speaker circuit is called "Stationary Channel".

The built-in "Virtual" Leslie simulates the sound of the Mechanical speaker. The best effect is obtained when connected to a stereophonic amp or sound system.

When a Leslie Speaker is connected, the sound of this organ is sent only to the rotary channel, and the sound input from the LINE IN jack is sent to the stationary channel.



The Equalizer and the Reverb add a final touch to the tone.

The Equalizer regulates the tonal quality. The Reverb adds the effect of playing in a concert hall.

You control their basic functions on the panel under the left side of the keydesk.

## Equalizer

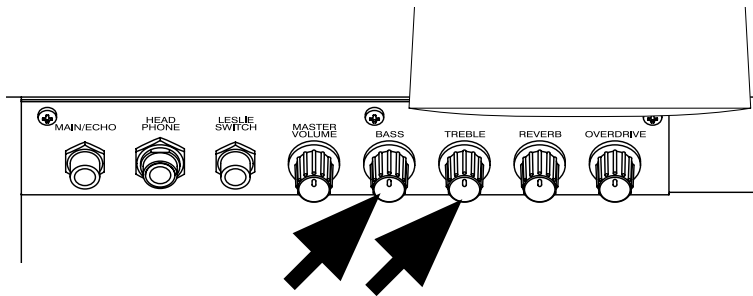

### [BASS] Knob

BASS is assigned here at the time of shipment from the factory. This increases/decreases the bass sound. About  $\pm 9$ dB is adjustable at 100Hz.

### [TREBLE] Knob

TONE is assigned here at the time of shipment from the factory. It increases/decreases the treble sound. About -9 to +3dB is adjustable at 10kHz.

**NOTE:** The Equalizer actually has 3 bands and 1 tonal function, and one function is assignable to each BASS, TREBLE knob. (P. 88)

**NOTE:** The "Tone" function here refers to the unique internal control on the vintage B-3 that gently cut the treble. This is a different function than the "Treble" EQ.

## Reverb

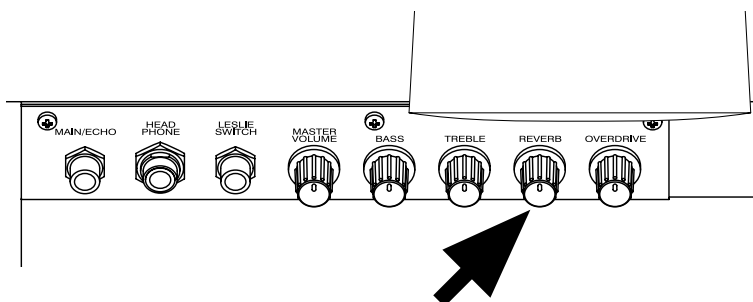

### [REVERB] Knob

This is for controlling the depth of the reverb effect. It gives no reverb effect at full counter-clockwise. The reverb gets deeper as it is turned further clockwise.

**NOTE:** You can finely set the reverb. (P. 89)

You can record all the aforementioned settings to the Presets. In the factory default setting, only the Drawbar registrations are called as on vintage B-3's.

## BANK and KEY

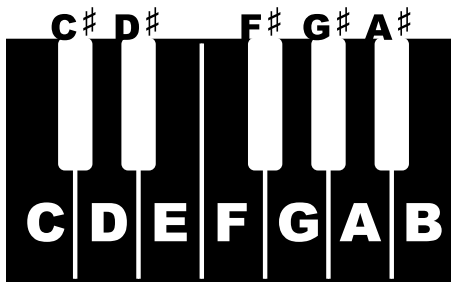
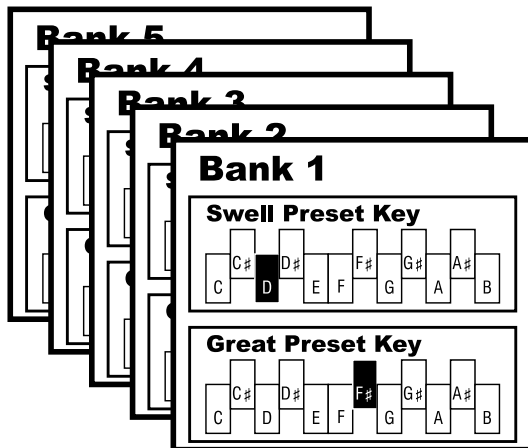

There are 5 “BANKS” of presets, each containing 12 presets corresponding to the reverse keys to the left of each manual. The SWELL and GREAT presets are independent of each other, but the BANKS are common to both manuals. You may only select one BANK at a time.

To select a “BANK”, press the [PARAM] button in the PLAY mode. Then select a “KEY” by simply pressing a Preset Key. Refer to the chart below for each Key and the name.

**NOTE:** The preset keys have no association with the “key signature” of the music that you might play.

The left-most key [C] is called “CANCEL” and used to mute the manual. No setting can be recorded to this key.

You can record the settings to all the keys [C#] to [A].

The right-hand side keys [A#] and [B] are also called “ADJUST PRESETS”, and are used for creating sounds using the Drawbars A# or B respectively.

Please refer P. 43 for recording Presets, and P. 37 for calling Presets.

### **tips** COMBINATION PRESETS

On the original B-3 organ the preset keys only stored drawbar registration information.

On this organ, various parameters such as Vibrato & Chorus and Percussion are recorded to the Preset Keys, as well as the Drawbar registrations. These are called “Combination Presets”.

**NOTE:** You can set the parameters to call on the Preset keys Bank by Bank. (P. 76)

## Using Plural Presets at the Same Time

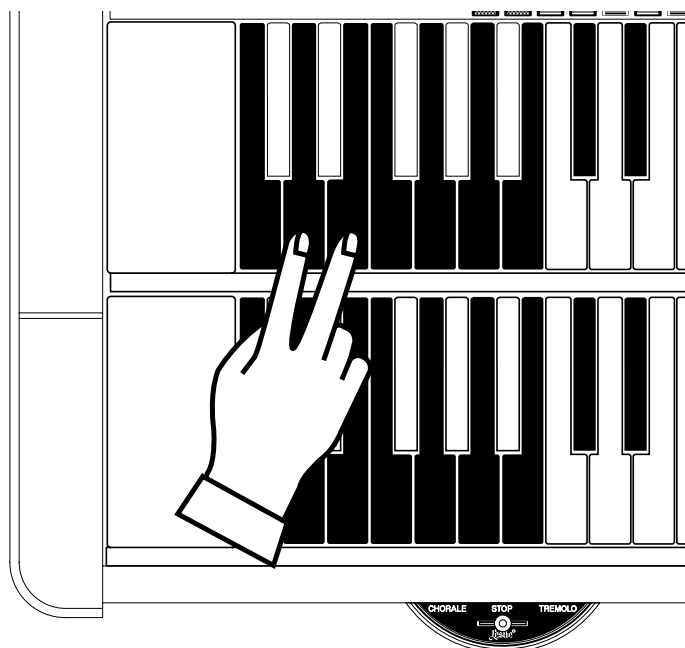

When pressing a Preset Key, the previously selected key is released. However, it does not mean you can not select more than one key.

If you select more than one Preset Key at the same time, the registrations recorded for all those keys are mixed. Try this.

If the other parameters than the registrations in the Preset Function Mode are contained in the preset, the contents of the key pressed last are called out.

In case you select all the Preset Keys by mistake and the Preset Keys do not function, press the [C] Preset Key, to release all of the Preset Keys.

## Naming the BANK

You can name each BANK. (The KEYS have no name.)

### 1 Go to MENU.

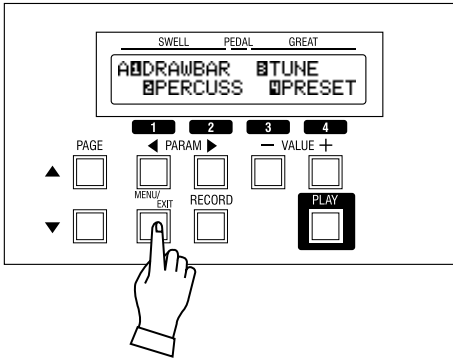

Press the [MENU/EXIT] button.

The [MENU] mode appears.

### 2 Go to the PRESET FUNCTION mode.

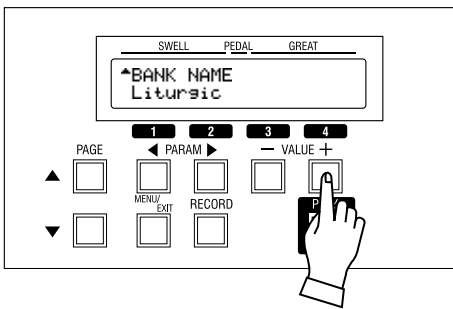

Press the [4] PRESET button, and go to the PRESET FUNCTION mode.

### 3 Input the NAME.

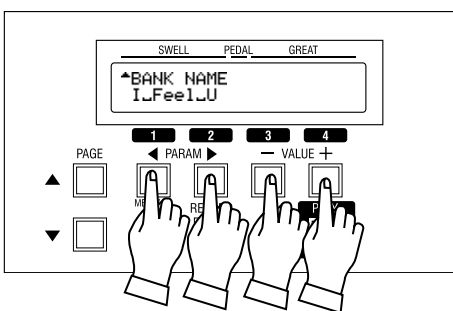

Up to 8 characters can be input.

**[PARAM] button:** moves the cursor.

**[VALUE] button:** selects the letters.

The characters available are signs, numerals, Capital and small letters.

To return to the top of each character selection, press the [VALUE] button holding down the [RECORD] button.

The Bank Name is recorded at the time of input. No recording operation is needed.

The volume of this organ is controlled in three ways.

## [MASTER VOLUME] Knob

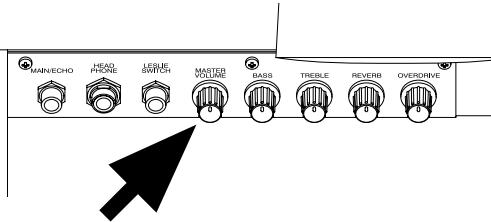

This controls the total volume of this organ (except the sound input from the LINE IN jack). This is the same as a volume knob on an ordinary electronic musical instrument or audio equipment.

## Expression Pedal

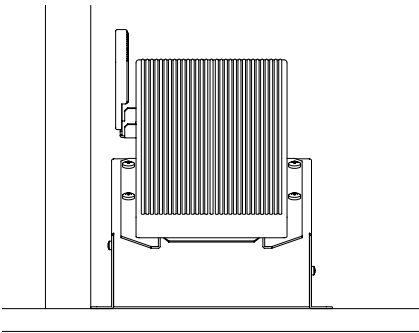

This is operated by foot. The volume increases as you fully depress the pedal. As you pull back the pedal, the volume decreases. As the volume is lowered, the tone becomes warmer as a side effect.

- NOTE:** The volume and tone change can be adjusted by the Expression Pedal.(P. 91)
- NOTE:** The Overdrive depth can be controlled by the Expression Pedal. (P. 80 #1)

## [VOLUME] Tablet

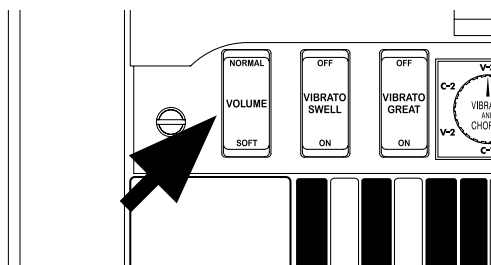

Normal volume at NORMAL. The volume is reduced to 1/3 of the normal volume at SOFT, with a small amount of Bass reinforcement.

When you play in a small room or practicing alone, you may play bass with rich deep tonal quality even at reduced volume by setting the [VOLUME] tablet at SOFT, instead of lowering the volume by using the [MASTER VOLUME] knob.

Digital Virtual Tone-Wheels and Bus-Bar Multi-contact manuals are used in this organ to replicate the sound, touch and feel of the original Hammond B-3 as faithfully as possible. Let's examine these exclusive patented features a bit deeper.

On modern electronic musical instruments, when a key is depressed, the sound engine plays. When multiple keys are pressed, the ear hears multiple notes, but this is an audio illusion. In actuality, only one voice is sounding at a time, but they are cycling so fast it sounds as if many notes are playing at once. The onboard processor "scans" the manual for the notes pressed and feeds that information to the sound engine. The technology is called "Keyscan" and "Dynamic Voice Allocation".

These technologies have worked admirably for synths, but they have problems for replicating the original B-3 sound and touch. In the mentioned technologies, there is one contact point, and even that is subject to latency.

When the Hammond Organ was born in 1934, there was no digital technology to rely on for the keying system. An ingenious mechanical system was devised using a stack of 9 contacts under each key, 9 bus-bars that ran the length of the manual, and an actuator rod which would close the contacts from top to bottom as the key was depressed.

Those bus-bars corresponded to each of the harmonics represented on the drawbars. A complex wiring harness completed the matrix, which sent the signals from the closed contacts of the manual to the drawbars, which allowed, or suppressed the tones from the ever-spinning, ever-playing Hammond Tone-Wheels.

As the Hammond Organ gained popularity, musicians noted a few curious side-effects courtesy of that mechanical action. One was a rudimentary "touch sensitivity". The actuator rod did not trip all nine contacts at once, in fact, if the key was not fully depressed, only a few contacts were closed. This put a randomness in the sound, and was almost instantly exploited by organists everywhere. Dr. Lonnie Smith wows audiences by simulating the sounds of Congas on his Hammond. Jazz, Blues and Gospel organists developed a move where they lightly "skipped" a chord up the manual, only to blaze a glissando back down. The sound was, and is, indescribable, but was an outlet for pure emotion. The great Jimmy Smith invented a registration/technique called "squabbling" that took full advantage of the manual response.

The other happy side-effect was really a defect. When you consider the Hammond Keying system, it might be easier to think of it as a whole bunch of electric switches. By nature; through age, corrosion, and contamination, electric switches become "dirty". Witness the "crackle" on older radios, or the flicker of a light. The Bus-Bar switches on Hammond were not exempt, and they started to exhibit symptoms of noise right from the start. The funny thing was, this little random chatter gave a distinctive edge to the organ's sound, very much like the pick noise on a guitar, or the resinous scrape of

the bow on a violin. The key-click, as it was called made the electric organ sound less electric, and...more organic! The sound was fresh and new. The Hammond engineers tried valiantly to correct this, but happily, they never did.

When the New B-3 was being designed, the hallmark was authenticity. But it didn't make sense to recreate the mechanical Tone-wheels of old. After all, it was just sine waves that they put out, and that's a child's game in today's digital technology. Previously, modern organ manufacturers (including Hammond) relied on looped samples of vintage instruments. Close, but no cigar. What if the entire concept of the B-3 was expressed in modern terms? 96 virtual tone wheels, each putting out their sine-wave constantly, just as the mechanical ones did, so that when keys were played, the entry point into each sine wave was random. The resultant phase relationship between the tones was chaotic, and in this case chaotic is good. The richness of tone would rival the sweetest vintage B-3. Whereas the mechanical tone generator was not the way to go, the bus-bar multi contact keying system could not be rightly duplicated in the digital realm.

Hammond-Suzuki engineers found a way to leap 1930's technology to the cutting edge by being faithful to the past with an eye on the future. They reinvented the buss-bar multi-contact keying system in such a way that the touch is indistinguishable from a vintage B-3.

Their efforts lie before you today, in your organ.

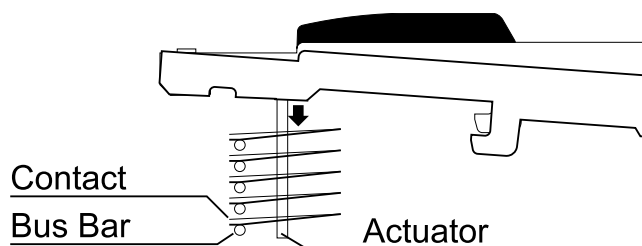

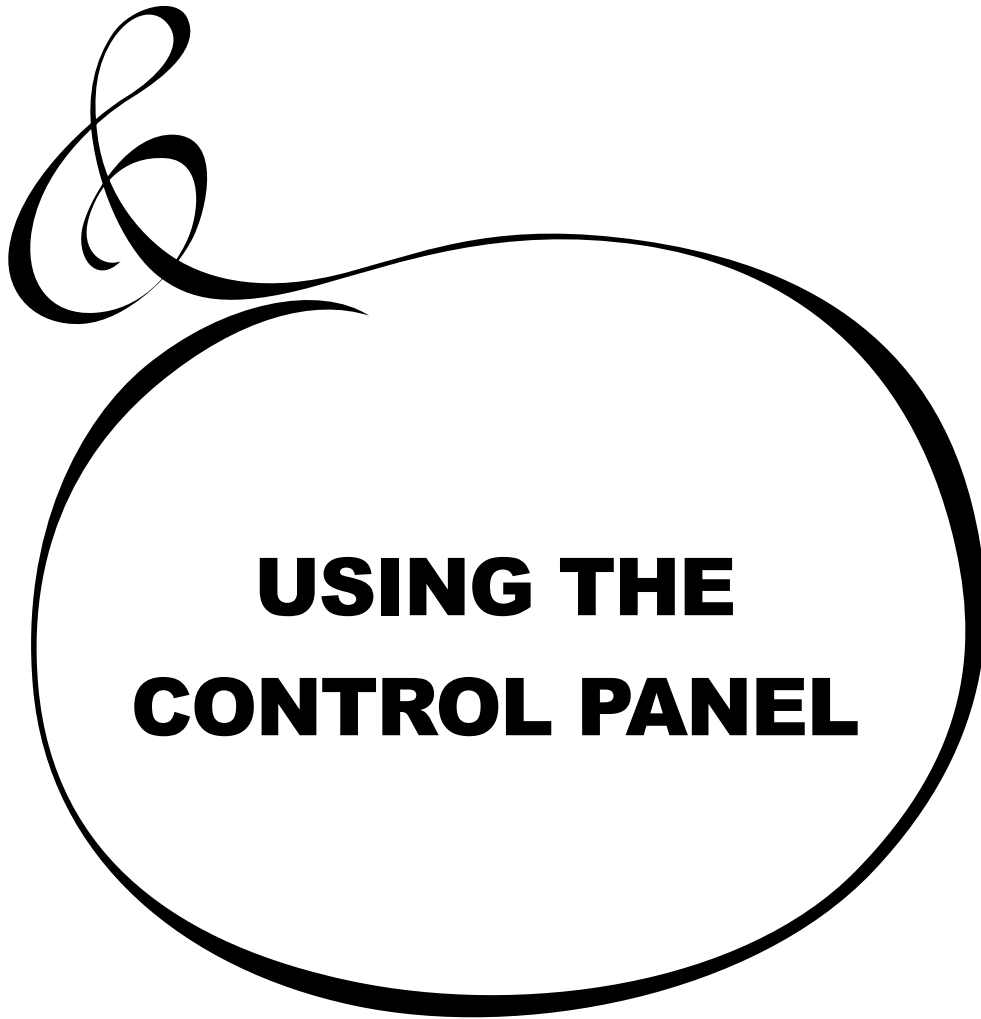

**USING THE  
CONTROL PANEL**

# OPERATION CONTROL PANEL

You can refine and tailor the settings made on the topside controls here, as well as adjust the MIDI settings and all other parameters.

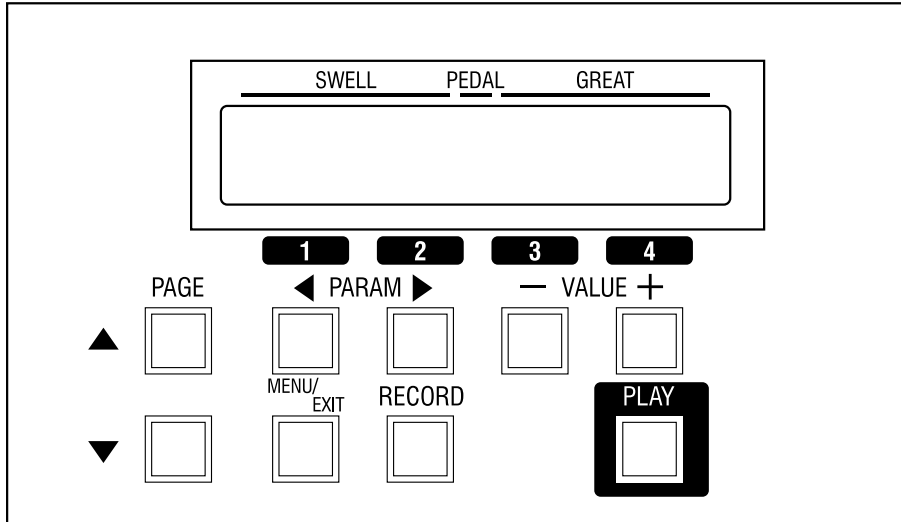

The display modes are PLAY, MENU, and FUNCTION.

The controls are explained on the following pages.

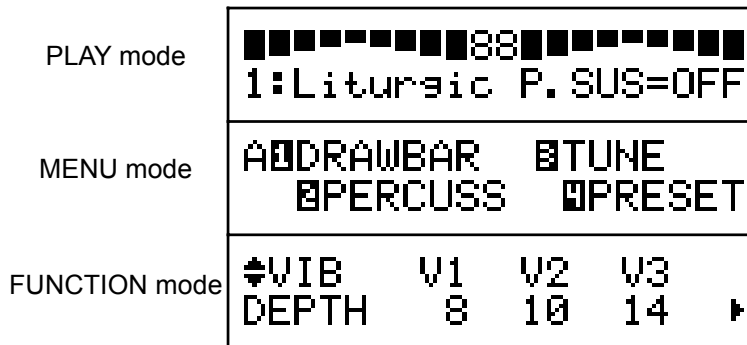



The PLAY MODE is the basic display for all the operations. The necessary information for the normal play will be displayed.

To locate this mode:

1. Immediately after powering ON and the start up process is complete, the PLAY mode is displayed.
2. If a different mode is displayed, press the [PLAY] button.

## How to read the Display

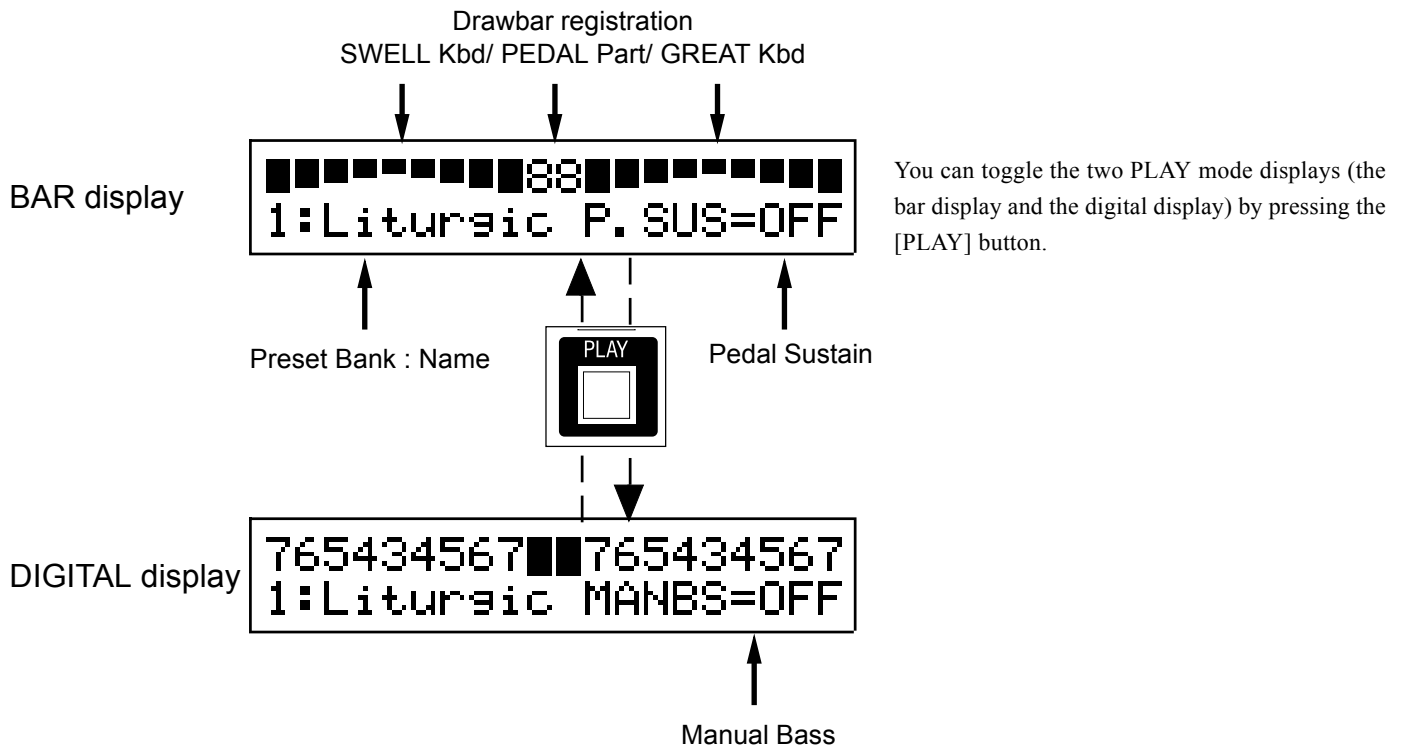

## Button operation in this mode

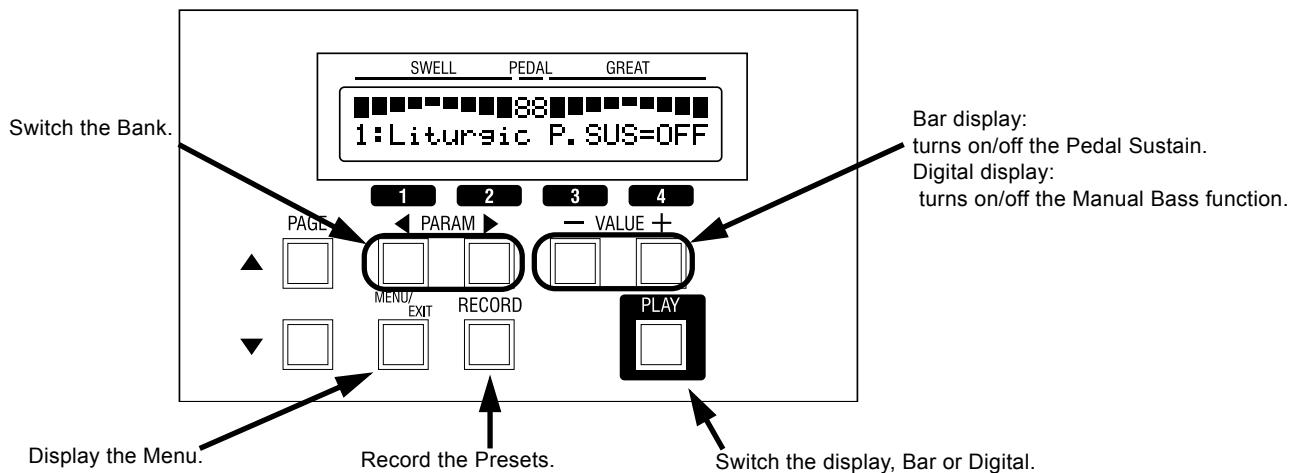

The MENU mode is the path for each function.

To locate this mode:

Press the [MENU/EXIT] button.

The FUNCTION displays are distributed over several pages. Use the [PAGE] buttons to scroll through them and reach the desired display.

## How to read the Display

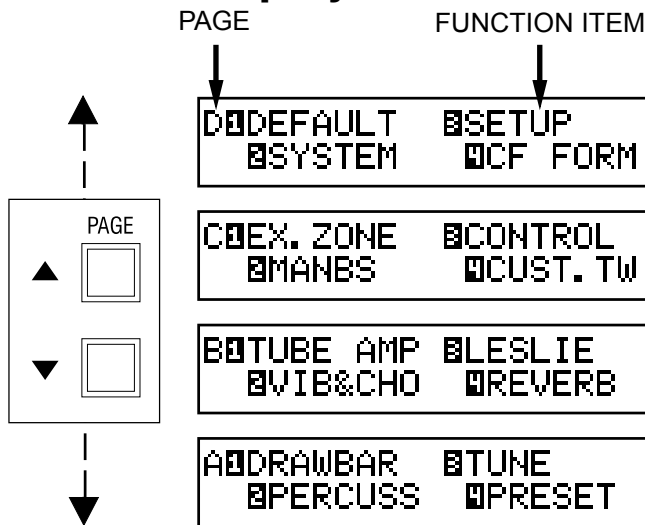

## Button operation in this mode

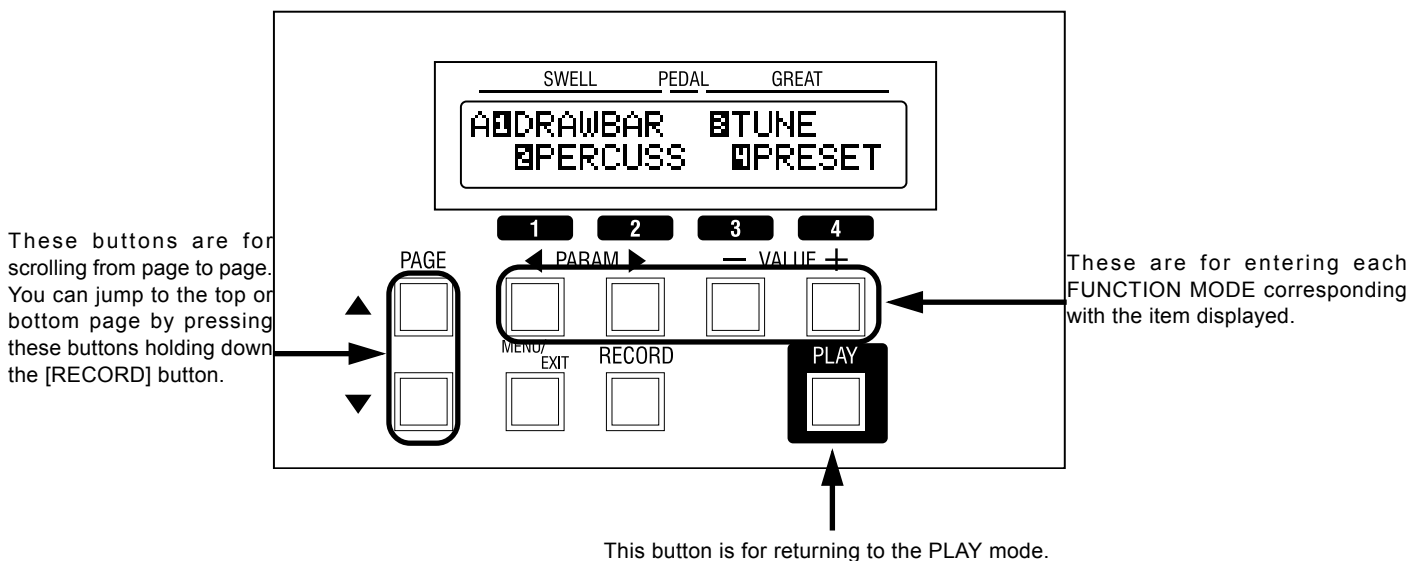

The FUNCTION MODE is where you adjust the various parameters of the organ.  
The displays generally follow the same format.

## How to read the Display

This indicates there are PAGEs above (or below).

PARAMETER

This indicates there is another section to this page on the right (or on the left).

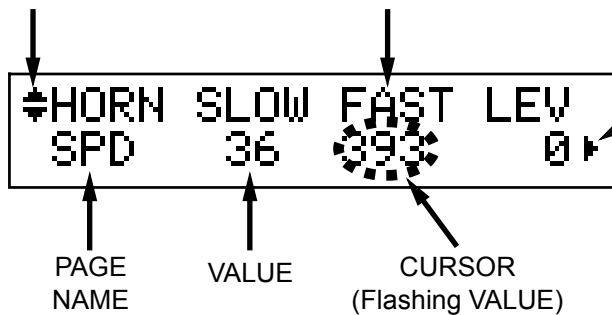

### tips CURSOR

In the display window of this organ, the CURSOR is displayed by flashing the current value.

## Button operation in this mode

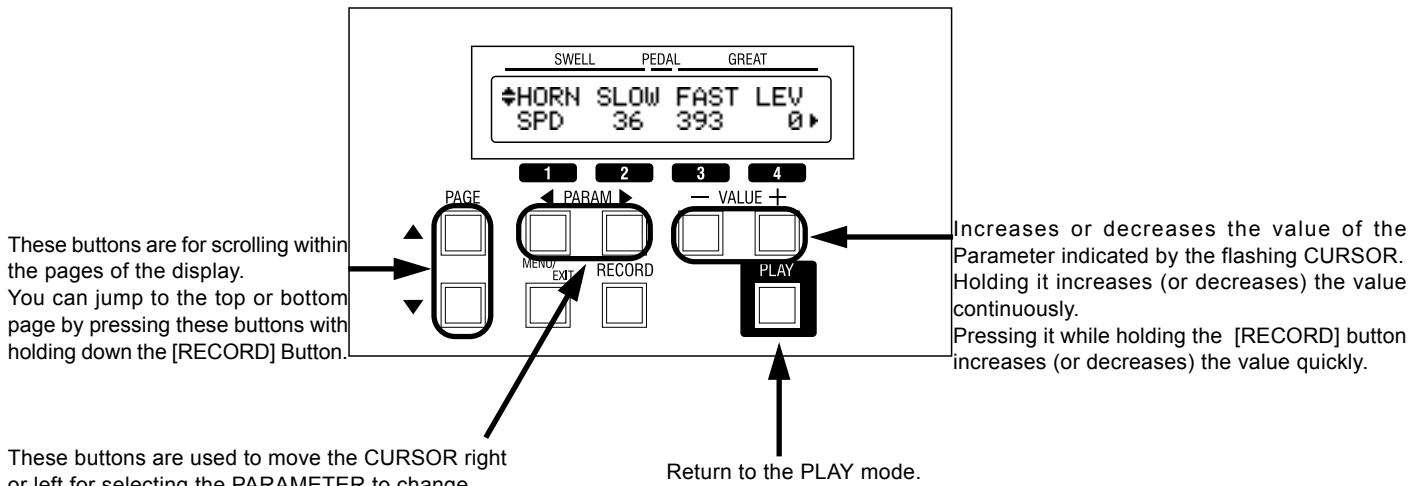

These buttons are for scrolling within the pages of the display. You can jump to the top or bottom page by pressing these buttons with holding down the [RECORD] Button.

These buttons are used to move the CURSOR right or left for selecting the PARAMETER to change. The CURSOR moves to the edge of the display and on to the next page (on the right or left), if there is one. Pressing this button holding [RECORD] button, you can move to the right or left page regardless of where the cursor is.

Increases or decreases the value of the Parameter indicated by the flashing CURSOR. Holding it increases (or decreases) the value continuously. Pressing it while holding the [RECORD] button increases (or decreases) the value quickly.

Return to the PLAY mode.

## Example: Increase the depth of Vibrato at [V-3].

- ① Locate the MENU Mode.

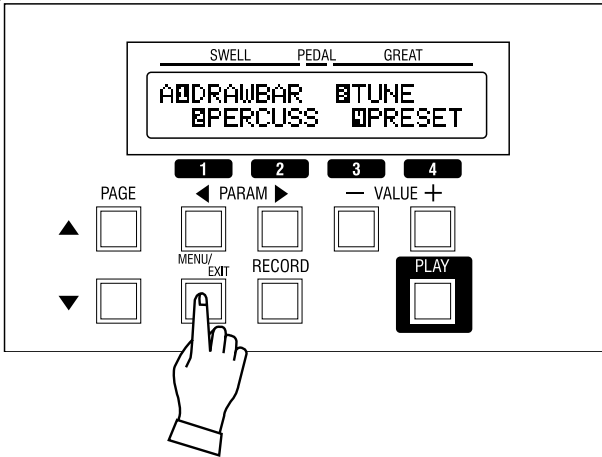

Press the [MENU/EXIT] button.

The MENU mode is displayed.

- ② Select the PAGE.

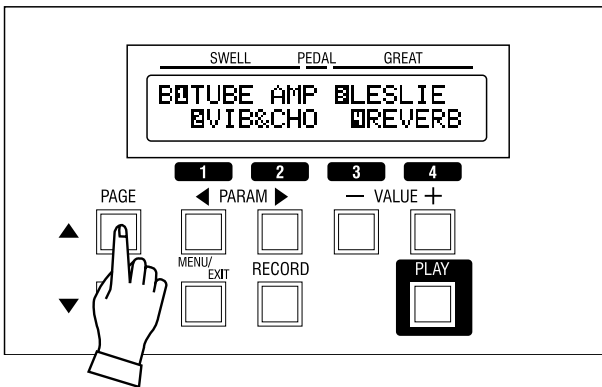

Search for the VIB&CHO page, using the [PAGE] button.

“VIB&CHO” is on PAGE B. Select PAGE [B].

- ③ Press the Number button.

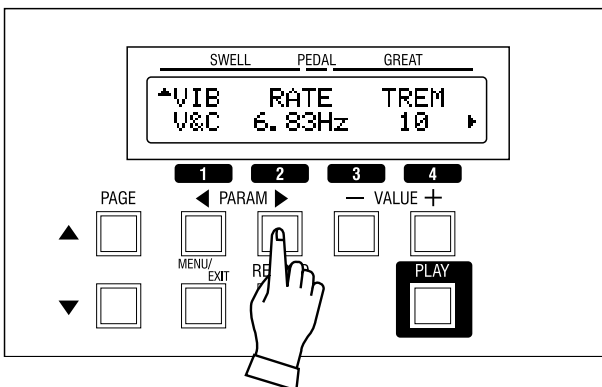

Press the [2] button for “VIB&CHO”.

This calls the first page of the Vibrato and Chorus function mode.

- 4** Move the CURSOR to the Parameter you want to change.

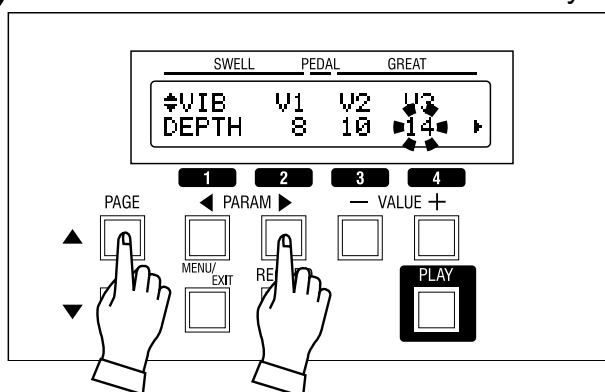

Vibrato Depth is on the “DEPTH” page. Move to that page using the [PAGE] button.

“V3” is on the right end. Move the cursor (flashing value) to “V3” using the [PARAM] button.

- 5** Change the Value.

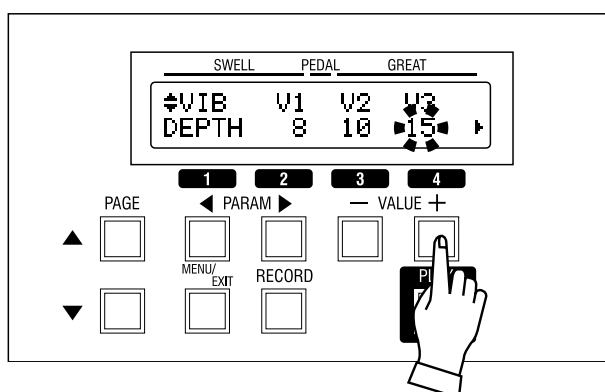

Increase the value, using the [VALUE] button.

NOTE: Repeat the operation 1 - 5, if you want to change other parameters.

- 6** Record in to the Preset Key.

The “Vibrato Depth V3” is a Preset Parameter, it will revert to the set value, if you select any Preset Key (when the PRESET - P. LOAD - ANI/OD is “ON”).

If you wish to continue using the changed value, you must record the value into the Preset Key.

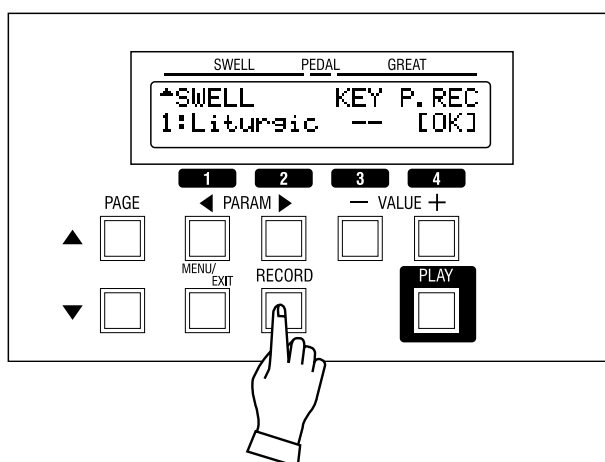

#### **tips** PRESET PARAMETERS

Preset Parameters may be recorded into each Preset Key.

They include the Parameters for setting the status of the buttons/knobs on the top panel, such as “Vibrato Depth V3” and others.

The overall common Parameters (which are not included in the Presets) are called “Global Parameters.”

## LOCK THE DISPLAY IN PLAY MODE

This advanced feature allows you to put the organ into a special playing mode whereby the Control Panel is rendered inoperative. Pressing any of the Select Touch Buttons will have no effect. This is useful when you want to place the organ in public halls, Churches or auditoriums.

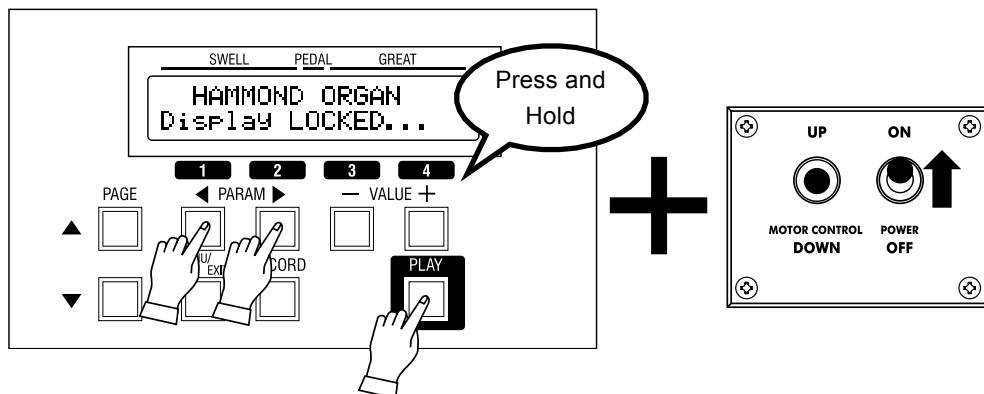

To initiate the Display Lock function, switch on the power pressing and holding both PARAM [◀], [▶] buttons and the [PLAY] button together. "Display LOCKED..." will be displayed for a few seconds. To unlock it, do the same thing as above. This time "Display UNLOCKED..." will appear for a few seconds.

NOTE: You can operate the BANK switch, Pedal Sustain and Manual Bass while the Display Lock function is on.

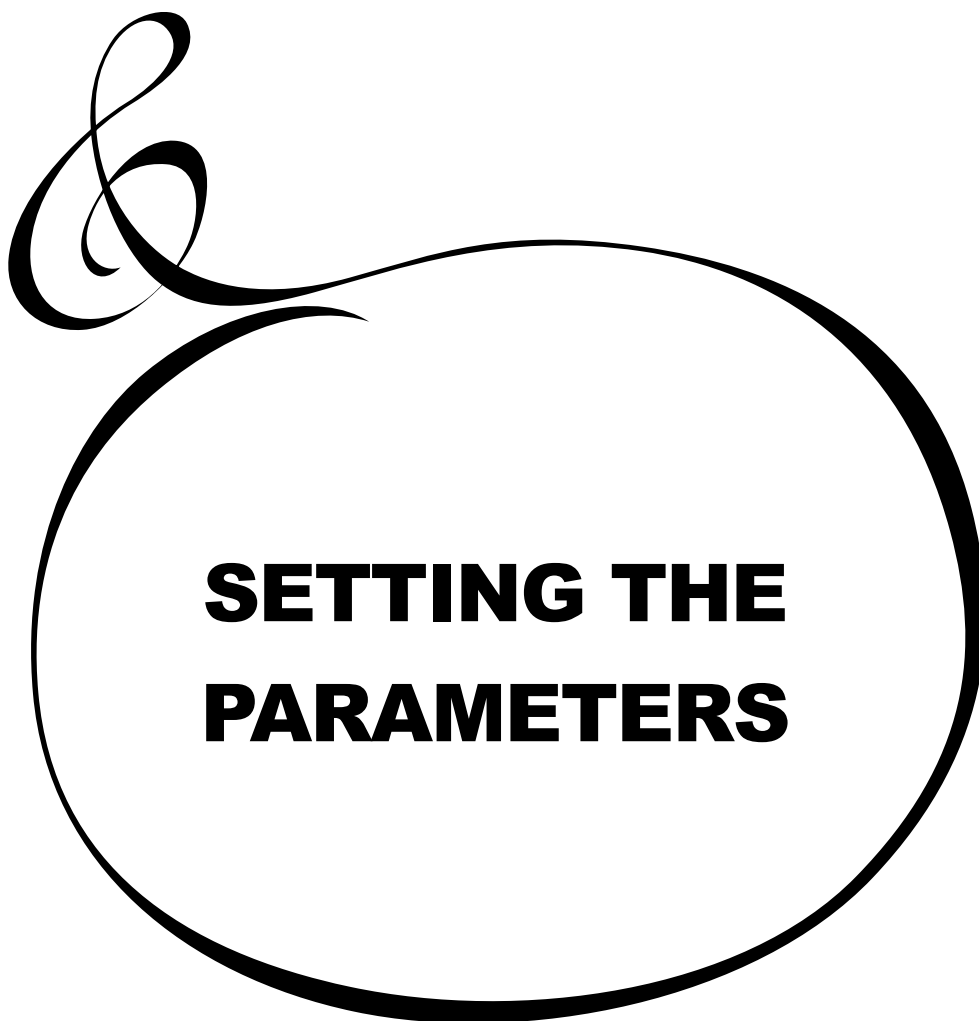

In this mode, you set the Drawbar Parameters.

To locate this mode:

Press the [MENU/EXIT] button and display MENU, press the [PAGE] button, and select PAGE A, and choose [1] DRAWBAR.

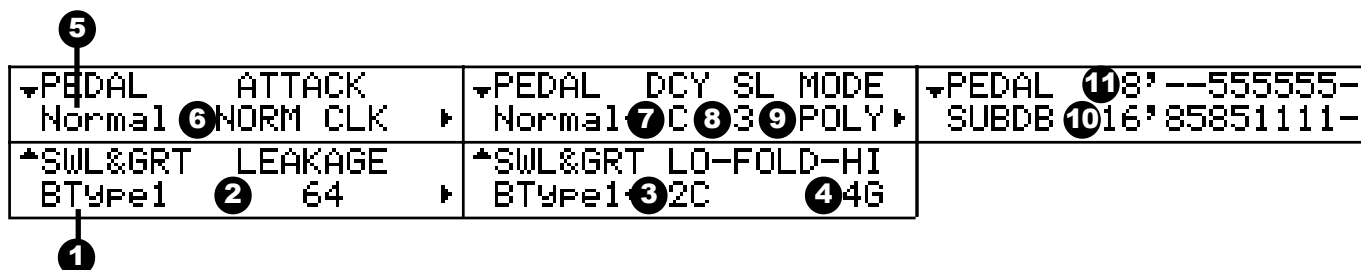

### ◆ Setting the SWELL and GREAT Manual

#### 1. TONE-WHEELS

Select the TONE-WHEEL SET (waveform) for the manuals.

##### BType1:

Traditional tone-wheel sound of the original B-3. Leakage noise is included in the waveform. You can not adjust the volume of the inherent leakage noise.

##### BType2:

Traditional tone-wheel sound of the original B-3. Leakage noise is not included in the waveform. You can add and adjust the volume of leakage noise.

**Mellow:** Transparent sine wave

#### 2. LEAKAGE

This is for setting the volume of Leakage Noise.

Setting Range is 0 to 127. The more you increase the value, the louder gets the volume.

#### 3. FOLD-BACK - LOW

This allows you to set which key the FOLD BACK of the 16' Drawbar starts. (Fold-back: Repeating the same octave in a certain range on the manual.)

The first key (= the far left key on the manual, next to the Preset Keys) is displayed as "1C". The setting range is 1C - 2C.

#### 4. FOLD-BACK - HIGH

This allows you to set which key the FOLD BACK of the 1' Drawbar starts (= repeat the same octave) in the upper-most range. The set range is 4G - 5C.

**NOTE: The FOLD-BACK sets the 1' and also 1<sup>1</sup>/<sub>3</sub>', 1<sup>2</sup>/<sub>3</sub>', 2' and 2<sup>2</sup>/<sub>3</sub>' Drawbars.**

#### **tips** TONE-WHEEL SET

Each Tone-wheel Set allows you to make fine adjustment. (P. 92)

#### **tips** LEAKAGE NOISE

On the original B-3, while the sound created by a certain tone-wheel goes through various circuits, the sounds of the other plural tone-wheels are mixed. This is called Leakage Noise. Leakage noise itself is unnecessary for synthesizing pure sounds. However, it is accepted rather as one of the unique characteristics of Hammond Organs.

Leakage Noise allows you to make finer adjustment. (P. 92)

#### **tips** FOLD-BACK

As the number of the tonewheels was limited on the original B-3, the organs were designed to repeat the same octave in the upper-most or lower-most range. This feature of this organ will simulate that.



## ◆ Setting the PEDAL Part

### 5. TONE-WHEELS

This allows you to select the Virtual Tone-wheel set (waveform) of the PEDAL Part.

- Normal:** The traditional B-3 Tone-wheel sound
- Muted:** Analog-oscillating sound represented by the X-5.
- Synth1:** Sawtooth waveform with sweep filter.
- Synth2:** Dull square waveform.

### 6. ATTACK

This allows you to set the Attack Rate and the Key-Click Volume at ATTACK and RELEASE.

- MAX CLK:** Immediate attack with loud key-click.
- NORM CLK:** Immediate attack with normal key-click.
- SOFT CLK:** Immediate attack with soft key-click.
- NO CLK:** A slightly slower attack without key-click.
- SLOW ATK:** Slow attack without key-click.

### 7. DECAY RATE

This allows you to choose whether the voice is continuously sustained, or decays while the pedal is depressed.

The setting range is 1 - 5 and C. The higher the value gets, the longer the decay time. There is no decay at C (=continuous).

### 8. SUSTAIN - LENGTH

This allows you to set the Release Rate (= the decay time after you release the key) of Pedal Sustain, when the "P.SUS" on the PLAY Mode (P. 42) is ON.

1 is the shortest, and 5 is the longest decay time.

### 9. KEY MODE

This allows you to set the Pedal Part voice mode.

- POLY:** Makes it possible to play up to 8 notes together.
- MONO:** Only the lowest note will sound, regardless of how many keys are depressed.

**NOTE:** The previously released note will be cut when you play the next one, even when the PEDAL Part is in the POLY mode and "P. SUS" is ON.

### 10. SUB-DRAWBAR 16'

This is for controlling the harmonic combination of Pedal Drawbar 16'.

It is possible to control each footage of 16', 5<sup>1</sup>/<sub>3</sub>', 8', 4', 2<sup>2</sup>/<sub>3</sub>', 2', 1<sup>3</sup>/<sub>5</sub>', 1<sup>1</sup>/<sub>3</sub>'.

### 11. SUB-DRAWBAR 8'

This is for controlling the harmonic combination of Pedal Drawbar 8'.

It is possible to control each footage of 8', 4', 2<sup>2</sup>/<sub>3</sub>', 2', 1<sup>3</sup>/<sub>5</sub>', 1<sup>1</sup>/<sub>3</sub>'.

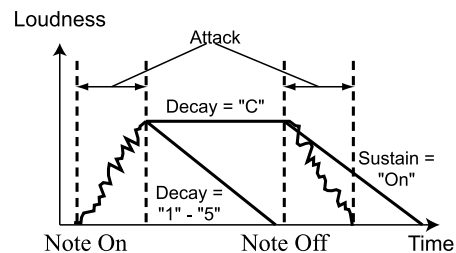

#### **tips** SUSTAIN

Not like the "Sustain" segment of a synth envelope generator. On this organ "Sustain" refers to the decay of the note after the key or pedal is released.

#### **tips** SUB-DRAWBARS

The two Pedal Drawbars, 16' and 8', of on the original B-3, did not simply produce the corresponding tone-wheel sounds but the sounds of registrations composed of several harmonics. These registrations differ from model to model depending when the organs were made. Sub-Drawbar function is for controlling the registrations of Pedal Drawbars.

**NOTE:** All the parameters in these modes are Preset Parameters. They are recorded into the Combination Preset.

In this mode, you set the parameters of the PERCUSSION.

To locate this mode:

1. Press the [MENU/EXIT] button and display MENU, then select PAGE A by the [PAGE] button and press the [2] PERCUSS button.
2. Or, move any [PERCUSSION] tablet pressing the [MENU/EXIT] button.

▼PERC DRAWB	1' CANCEL 5 ON	LEVEL 6 -3dB
◆PERC DECAY	SLOW 3 8	FAST 4 3
▲PERC LEVEL	SOFT 1 6	NORM 2 12

1. LEVEL - SOFT
2. LEVEL - NORMAL

These are for setting the Percussion volume level. SOFT is the level when the [PERCUSSION VOLUME] tablet is in “SOFT”, and NORMAL is the level when it is in “NORMAL”.

3. DECAY - SLOW
4. DECAY - FAST

These are for setting the Percussion Decay time.

SLOW is the time when the [PERCUSSION DECAY] tablet is in “SLOW”, and FAST is the time when it is in “FAST”.

The setting range is 1 - 15 and C. The higher the value gets, the longer the Decay time. At C, there is no decay (Percussion sound is continuous).

5. DRAWBAR - 1' CANCEL

This mutes the 1' of the SWELL Drawbar while using PERCUSSION.

**ON:** Mute  
**OFF:** Does not mute.

6. DRAWBAR - LEVEL

Decreases the volume of the Swell Drawbars while using PERCUSSION, and [PERCUSSION VOLUME] tablet is in “NORMAL”.

**-5dB:** Decreases the volume 5dB  
**-3dB:** Decreases the volume 3dB  
**0dB:** No decrease in volume

**NOTE:** The parameters in those modes are all Preset Parameters. They are recorded to each Combination Preset.

#### **tips** 1' CANCEL

The original B-3 had no key contact exclusive for percussion but uses the 1' contact for percussion. On this organ, this is simulated.

#### **tips** DRAWBAR LEVEL

On the original B-3, the Drawbar volume was slightly softer, when percussion was enabled. This is simulated on this organ.

In this mode, you can tune and transpose the organ for playing in ensemble with other instruments and performers.

### To locate this mode:

Press the [MENU/EXIT] button (MENU will be displayed), select PAGE A by the [PAGE] button and press the [3] TUNE button.

```
TUNE XPOSE MASTER
MAST ①+0 ②A=440
```

## 1. TRANSPOSE

You can transpose the entire keyboard by semi-tones.

The setting range is -6 to +6.

Transpose affects:

- ♦ The Organ Manuals/Pedals and Digital Tonewheel system
- ♦ The MIDI External Zones

## 2. MASTER TUNE

This is for adjusting the PITCH of the entire organ.

The setting range is A = 430 - 450 Hz.

**NOTE:** The parameters in this mode are Global Parameters. They are recorded when the value is set. Also, they are common at each Combination Preset.

In this mode, you name your Bank, and determine how to recall the Combination Presets.

To locate this mode:

Press the [MENU/EXIT] button and display MENU, then press the [PAGE] button to select PAGE A and press the [4] PRESET button.

▼P. LOAD GREAT-PEDAL LINK ② OFF ▶	▼P. LOAD SWELL GREAT RESIST ③ ON ④ ON ▶	▼P. LOAD DRAWB PERCUS DB/PC ⑤ OFF ⑥ OFF ▶
▲BANK NAME ① Liturgic		

### ◆ BANK NAME

#### 1. BANK NAME (B)

This allows you to name the current Bank using up to 8 letters.

Move the cursor by the [PARAM] button, and choose the letters by the [VALUE] button or the [VALUE] knob.

The BANK name is recorded at the time of operation, so no recording operation is needed.

### ◆ PRESET LOAD

This allows you to choose the operation of the Preset Keys.

#### 2. PRESET LOAD - LINK GREAT/PEDAL (B)

This is for setting whether or not to call out the Pedal part Preset simultaneously by the Great Preset Key.

In this mode, recording a preset on the Great (Lower) manual will also record the Pedal registration. This was not possible on vintage B-3's.

#### 3. PRESET LOAD - REGISTRATION SWELL (B)

This is for setting whether or not to call out the registration of the Swell manual by the Swell Preset Key.

#### 4. PRESET LOAD - REGISTRATION GREAT (B)

This is for setting whether or not to call out the Great Manual registration by the Great Preset Key.

#### 5. PRESET LOAD - DRAWBAR (B)

This is for setting whether or not to call out the Drawbar Parameters by the Swell Preset Key.

### tips PRESET LOAD

Only the Drawbar registrations were recorded to the Preset Keys on the original B-3. On this organ, not only the Drawbar registrations, but also various parameters will be recorded simultaneously. These are called "Combination Presets".

As the factory default, only the Drawbar registrations are called out as on the original B-3 (except Bank 4: ShowCase). But you may save various parameters that can be called out by turning on the Preset Load.

▽P. LOAD MBS S-EXT-G ZONE 7 OFF 8 OFF 9 OFF ▸	▽P. LOAD EQ/RV ANI/OD EFFECT 10 OFF 11 OFF
--	---

#### 6. PRESET LOAD - PERCUSSION (B)

This is for setting whether or not to permit the Percussion division to play while the selection of the Swell Preset Key is other than [B] and whether to call out the tablets of Percussion, or Percussion Parameter by the Swell Preset Key.

#### 7. PRESET LOAD - MANUAL BASS (B)

This is for setting whether or not to call out the Manual Bass ON/OFF, and upper limit by the Great Preset Key.

#### 8. PRESET LOAD - EXTERNAL ZONE SWELL (B)

This is for setting whether or not to call out the External Zone Parameter of the Swell manual by the Swell Preset Key.

#### 9. PRESET LOAD - EXTERNAL ZONE GREAT (B)

This is for setting whether or not to call out the External Zone Parameters of the Great manual by the Great Preset key. The External Zone Parameters of the Pedal part is also called out, if the Link-Great/Pedal is on.

#### 10. PRESET LOAD - EQUALIZER/REVERB (B)

This is for setting whether or not to call out the Parameters of the Equalizer and Reverb by the Swell Preset key.

#### 11. PRESET LOAD - ANIMATION/OVERDRIVE (B)

This is for setting whether or not to call out the tablets and parameters of Vibrato, Leslie and Overdrive by the Swell Preset Key.

**NOTE:** Each Parameter (B) of Preset Load is a Bank Parameter. It is set only for the BANK currently selected.

## See the current value (Temporary Scope)

The Combination Presets recall settings internally, and these settings will not reflect the current physical positions of the Drawbars, tablets and knobs on the organ's top panel.

By means of the Temporary Scope function, you can tell the present value of each tablet or knob as selected by the Combination Preset.

### ◆ VIBRATO AND CHORUS

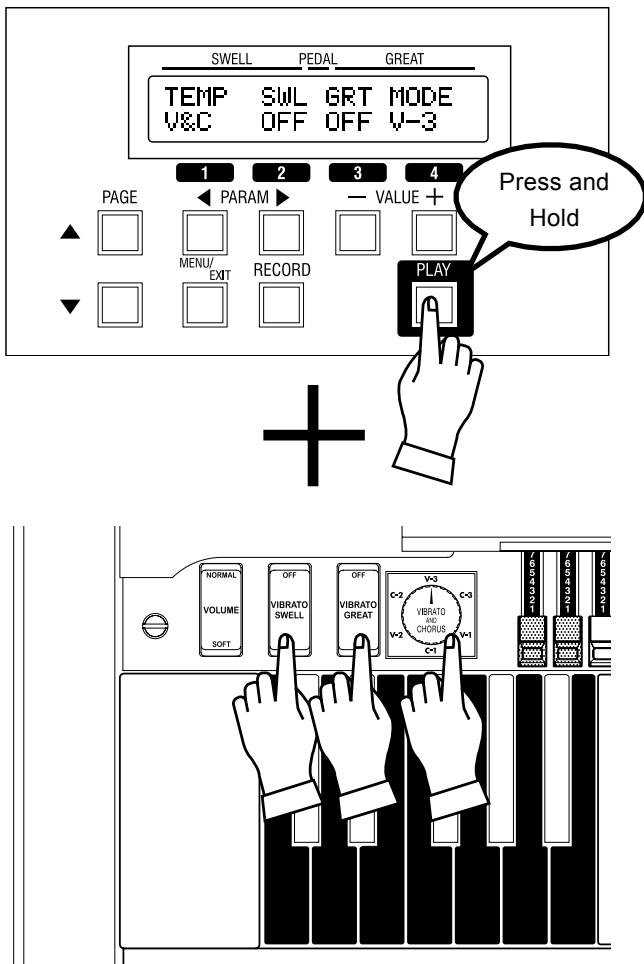

To see the value of each tablet and knob of Vibrato and Chorus, move either knob of the [VIBRATO SWELL], [VIBRATO GREAT] or [VIBRATO and CHORUS] knob, holding down the [PLAY] button on the Control Panel.

The present value of Vibrato & Chorus is displayed. Their values are not affected by the actual physical positions of the tablet or knobs.

## ◆PERCUSSION

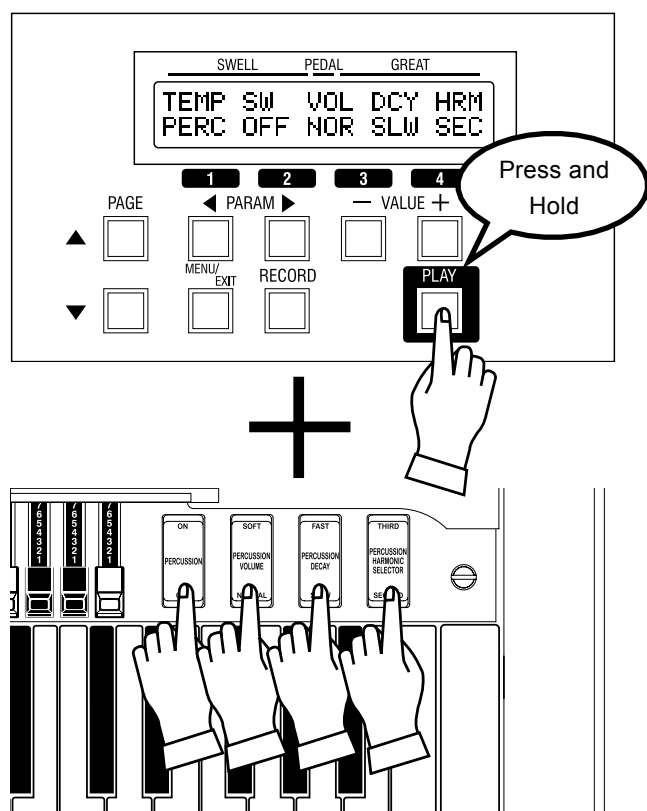

To see the present value of the Percussion tabs, move any of the [PERCUSSION], [PERCUSSION VOLUME], [PERCUSSION DECAY], [PERCUSSION HARMONIC SELECTOR] tablets, holding down the [PLAY] button on the Control Panel.

The present value of Percussion appears on the display. At this time, the present value is not affected by the current position of the tablet.

## ◆LESLIE

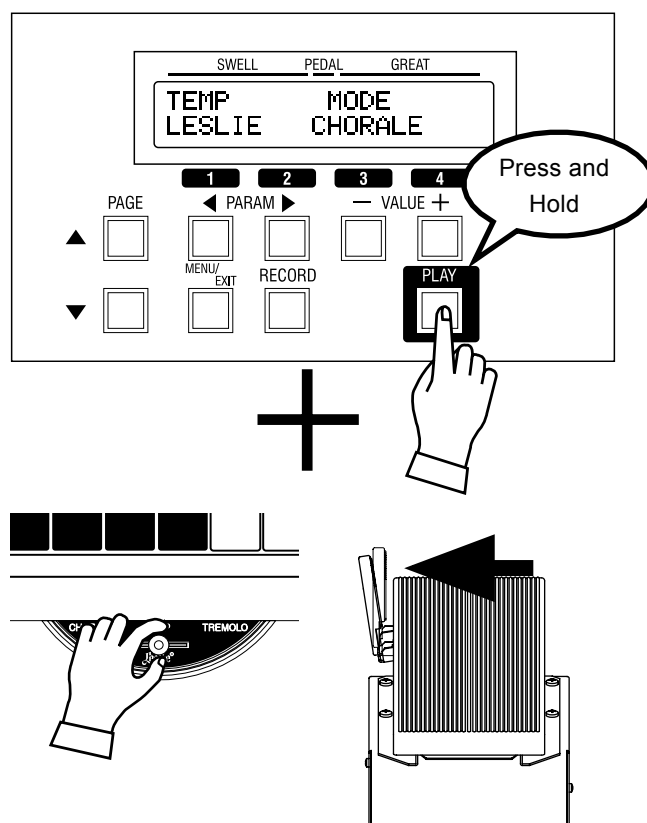

To know the present Leslie mode, operate the Leslie Speed Switch or the Foot Switch (if Leslie C/T is assigned), holding down the [PLAY] button on the Control Panel.

The present Leslie mode is displayed. The Leslie mode itself is not affected by this operation.

### ◆Other Knobs

Besides the aforementioned knobs. The [OVERDRIVE], [REVERB], [BASS], [TREBLE] knobs are on this organ. If you operate them holding down the [MENU/EXIT] button, you can short cut to the function mode relating to those knobs.

The Tube Pre-Amp settings are made in this mode.

To locate this mode:

1. Press the [MENU/EXIT] button to display the MENU, select PAGE B by the [PAGE] button, and then press the [1] TUBE AMP button.
2. Or, move [OVERDRIVE] knob pressing the [MENU/EXIT] button.

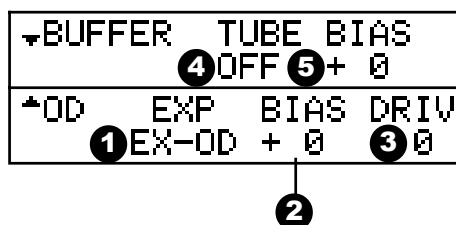

#### 1. OVERDRIVE - EXPRESSION

This is for varying the Overdrive value by operating the Expression.

##### EX-OD:

If you operate the Expression Pedal, the overdrive changes along with the volume.

##### OD-EX:

The Expression affects only the volume and not the overdrive value.

#### 2. OVERDRIVE - BIAS

This parameter finely adjusts the bias voltage of the tube 12AU7.

The setting range is -32 to +31.

#### 3. OVERDRIVE - DRIVE

This is for adjusting the Overdrive Value.

The overdrive increases as the value increases.

This is linked with the [OVERDRIVE] knob on the volume panel.

#### 4. BUFFER - TUBE AMP

This is for switching the buffer on/off by the tube 12AX7. All the signals of the Swell, Great, Pedal pass through this circuit.

**NOTE:** If you are using the LINE OUT jack and the HEADPHONE jack, the Buffer Amp works only on R (right).

#### 5. BUFFER - BIAS

This parameter finely adjusts the bias voltage of the tube 12AX7.

The setting range is -32 to +31.

**NOTE:** The parameters in these modes are Preset Parameters and are recorded to each Combination Preset.

❖ Please understand that the tone color or the depth of Overdrive varies from organ to organ even if the parameter are the same, as the characteristic of each tube is different.

#### **tips** USING THE EQUALIZER TOGETHER

If you distort the sound by overdrive or by changing the bias, new harmonics are added. By using the equalizer, a wider range of tones may be acquired.

#### **tips** BUFFER AMPLIFIER

A Buffer Amp changes the characteristics of the sounds passed through it, without modifying the gain. This organ uses a tube and a transformer in its buffer amp.



# Bias voltage and Nonlinear Distortion

To make the vacuum tube function as an audio amplifier, a minus voltage called bias voltage is added to the input terminal (called grid) as well as the audio signal.

Although, the bias voltage is generally fixed so that the distortion of the output wave-form of the tube is at the minimum, the bias voltage can be changed when the tube amplifier is overdriven on this model.

By this parameter, you can adjust the characteristic of distortion to your taste.

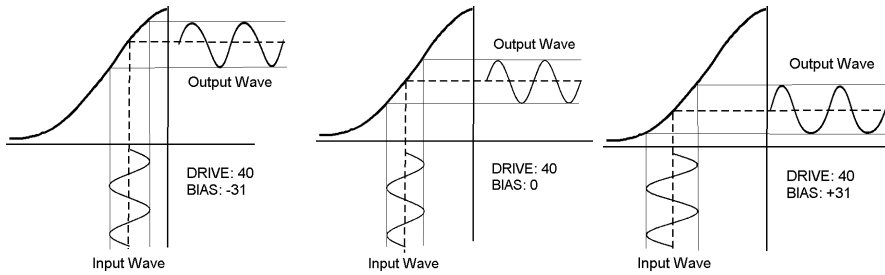

The change the bias voltage gives to the sound distortion may not be very noticeable, depending on the drive amount or the drawbar registration. The best way to check it precisely is as follows:

1. Set the Drawbar registration at "00 8000 000" (either manual).
2. Locate the TUBE AMP - OD page.
3. Set the Drive near 40. (Make sure it is not the maximum value.)
4. Move the cursor to BIAS.



5. Play the chord on the manual as shown.

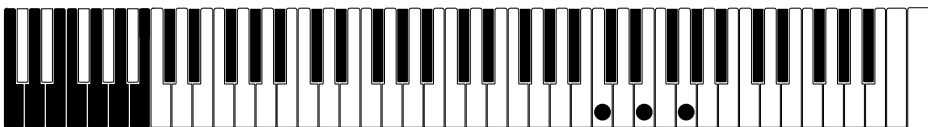

Change the value of BIAS, pressing the keys. The degree of distortion is slight near "0", but the distortion increases, if you change the value towards "+" or "-". Such a distorting sound is called "nonlinear distortion".

**NOTE:** On the original B-3, distortion occasionally would occur naturally as the instrument would age. On this organ, you can create natural-sounding distortion intentionally.

**tips GRID**

The grid is one of the poles of the tube. In the triode tube used on this model, there are 3 poles, the cathode, the plate and the grid. The electrons are attracted towards the plate if the heated cathode is loaded with voltage. By changing the voltage on the grid, the voltage flowing to the plate greatly changes.

**tips NONLINEAR DISTORTION**

An amplifier without distortion amplifies input in proportion (=linear) with output, as shown in the figure below.

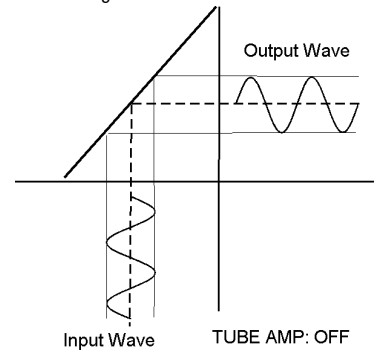

If the bias voltage is changed, input and output are not in proportion with each other, as shown in the figure on the left. The distortion caused by this is called non-linear distortion.

**tips CLIPPING DISTORTION**

If the drive is at the maximum, the end of the waveform is cut (off), as shown in the figure below. This is called clipping distortion.

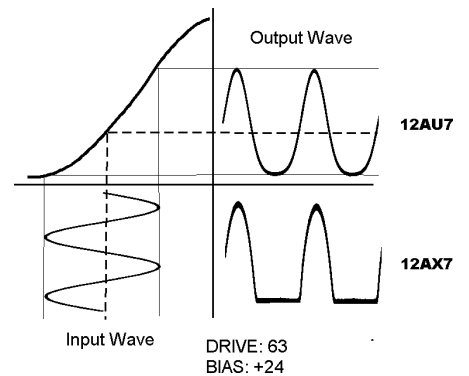

## VIB&CHO (VIBrato and CHOrus)

In this mode, you change the settings of the Vibrato and Chorus.

To locate this mode:

1. Press the [MENU/EXIT] button to display the MENU, select PAGE B by the [PAGE] button, and then press the [2] VIB&CHO button.
2. Or, move any [VIBRATO] tablet pressing the [MENU/EXIT] button.

▾VIB GREAT TAB 10 GREAT&PEDAL	
▲VIB V1 V2 V3 DEPTH 4 8 5 10 6 14	▲VIB C1 C2 C3 DEPTH 7 8 3 11 9 14
▲VIB RATE TREM V&C 1 6.83Hz 2 10	▲VIB EMPHASIS CHO. 3 9

### 1. VIBRATO - RATE

This is for setting the Speed of the Vibrato and Chorus effect.

The setting range is 6.10 - 7.25 Hz.

### 2. VIBRATO - TREMOLO

This is for setting the Tremolo (amplitude modulation) of the Vibrato and Chorus effect.

The setting range is 0 - 15.

### 3. VIBRATO - EMPHASIS

This is for setting the Emphasis (high frequency boost) of the Chorus effect (C1/C2/C3).

The setting range is 0 - 9 dB.

### 4. to 9. VIBRATO - DEPTH V1 to C3

These are for setting the Depth of the each Vibrato and Chorus effect mode.

The setting range is 0 - 15.

### 10. VIBRATO - TABLET GREAT

This is for setting on which part to put the Vibrato & Chorus effect by the [VIBRATO GREAT] tablet.

#### **GREAT & PEDAL:**

The Vibrato and Chorus effect works on the Great manual and Pedalboard.

#### **GREAT ONLY:**

The Vibrato and Chorus effect works only on the Great manual.

**NOTE:** The parameters in these modes are Preset Parameters and are recorded to each Combination Preset.

## Vibrato and Chorus of Hammond Organs

On string instruments, the vibrato effect is created by changing the string tension by one's fingers. On wind instruments, by changing the strength of breath. On electronic instruments with analog circuitry, by modulating the oscillator. As the rotation of the tone-wheels of the original B-3 was stabilized by the synchronous motor, it was not possible to provide a vibrato effect. On these models, the vibrato effect was obtained by modulating the signal post-generator.

The vibrato & chorus system of the original B-3 consisted of a 9 stage delay line using LC phase shift circuits. This produced a very short delay of about 1 ms. Tones were passed through coils, delaying the phase. Several coils were connected in tandem and when the output of each tap was passed from the top to the last by turns, the pitches gradually lowered. By taking the output of each tap from the last to the top by turns on the contrary, the pitch would gradually rise. These operations were automatically made by turning the scanner with a motor.

The scanner was used to select one of multiple input terminals by the static connection. As each terminal was selected by the "blades" which approached each other, a popping noise like that of a switch did not occur and the signals of neighboring terminals cross-faded and switched themselves.

The mode-selection of vibrato effects was made by changing the range of the connecting tap. As this system modulated the produced tonal signals and not the oscillator, the original sound could be heard without the vibrato effect. By mixing the sound with the vibrato effect and the original sound, the chorus effect was obtained.

On this model, the chorus and vibrato effects are simulated and modeled in the original fashion digitally, by the DSP, without using moving parts.

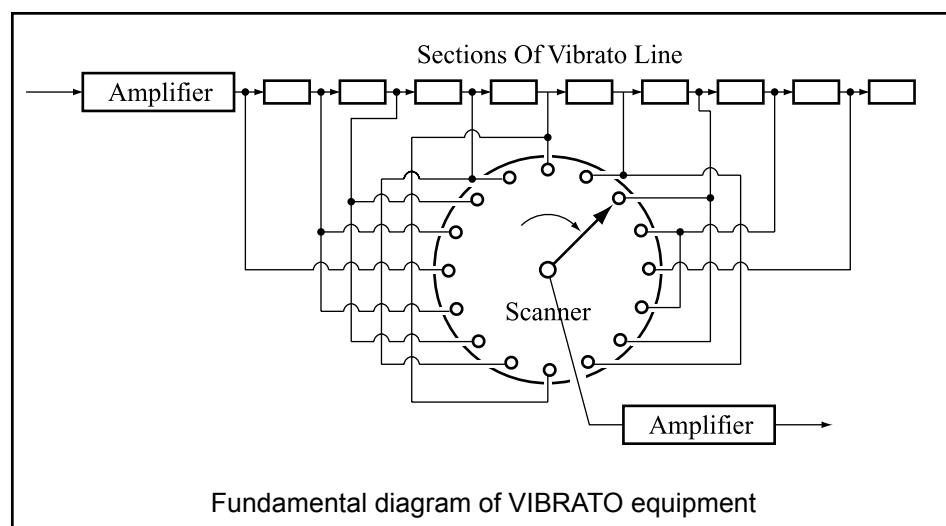

In this mode, you make the settings for the built-in Leslie Effect. There are many parameters for the built-in Leslie Effect. These individual settings are not recalled by the Combination Presets, or by bank settings. The built-in Leslie parameters are grouped in macro-settings called "CABINETS". You select the CABINET NUMBER in the Combination Presets where this selection is saved as part of the Preset.

To locate this mode:

1. Press the [MENU/EXIT] button to display the MENU. Then select PAGE B by the [PAGE] button and press [3] LESLIE.
2. Or, move Leslie Speed Switch pressing the [MENU/EXIT] button.

↘SWITCH STOP MODE 20 STOP	
↕MIC ANGLE DISTANCE 18 150° 19 0.6m	
↕BASS CHOR TREM LEV SPD 12 36 13 393 14 0 ▶	↕BASS RISE FALL BRAK TIME 15 7 16 5 17 10
↕HORN CHOR TREM LEV SPD 5 36 6 393 7 0 ▶	↕HORN RISE FALL BRAK TIME 8 2.2 9 1 10 1.2 ▶
↕HORN CHARACTER TYPE 11 MID	
↕AMP/ AMP SPEAKER SPK 3 Solid RotLarge	
↕CAB. NAME 2 147-Type 4	
↕CAB. NUMBER 1 1: 147-Type	

◆ CABINET NUMBERS

1. CABINET NUMBER

Here you select the CABINET NUMBER to use in the Combination Presets.

The setting range is 1 - 8. The "\*" will be displayed when the Leslie Parameters are changed from this Cabinet Number.

◆ LESLIE PARAMETERS

2. CABINET NAME

This is for assigning the Cabinet Names.

Move the cursor by the [PARAM] button and select letters by the [VALUE] button.

In this mode, only the present value "Temporary" changes and there is no determining operation. You must record the name by doing "Recording the Cabinet" as explained in the next paragraph. Otherwise the data will be lost.

3. AMPLIFIER

This sets the type of the virtual power amplifier.

- Solid:** Simulated Solid-State Amplifier with a flat characteristic
- Tube:** Simulated Tube Amplifier with a warm characteristic.

**tips**

**CONCEPT OF THE CABINET NUMBERS**

Each Cabinet represents one virtual Leslie Speaker prepared by the Leslie Parameter.

This parameter is the only Preset Parameter in this mode.

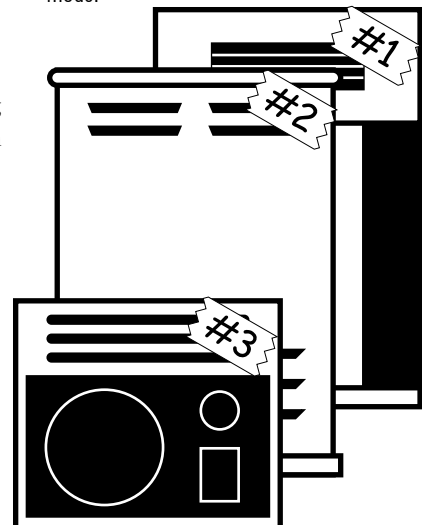

#### 4. SPEAKER

This sets the type of the virtual speaker.

**RotSmall:** A small Leslie speaker represented by Leslie 145

**RotLarge:** A large Leslie speaker represented by Leslie 122

**Station:** A stationary speaker represented by Hammond PR-40

#### 5. CHORALE SPEED - HORN

#### 12. CHORALE SPEED - BASS

Here the Speed of the virtual Rotor is set for Chorale mode.

The setting range is 0, 24 - 318 rpm. It does not rotate at 0.

#### 6. TREMOLO SPEED - HORN

#### 13. TREMOLO SPEED - BASS

Here the Speed of the virtual Rotor is set for Tremolo mode.

The setting range is 0, 24 - 453 rpm. It does not rotate at 0.

#### 7. HORN LEVEL

#### 14. BASS LEVEL

The Volume of each virtual Rotor is set. The setting range is 0 to -12dB.

#### 8. RISE TIME - HORN

#### 15. RISE TIME - BASS

Here the Time is set for the Rotor to reach the maximum Tremolo Speed, when changing from Chorale or Stop to Tremolo mode. The setting range for the Horn Rotor is 0.2 - 5.0s, and that for the Bass Rotor is 0.5 - 12.5s.

#### 9. FALL TIME - HORN

#### 16. FALL TIME - BASS

Here the Time is set for the virtual Rotor to reach the minimum Chorale speed, when changing from Tremolo to Chorale mode. The setting range for the Horn Rotor is 0.2 - 5.0s, and that for the Bass Rotor is 0.5 - 12.5s.

#### 10. BREAK TIME - HORN

#### 17. BREAK TIME - BASS

Here the Time is set for the virtual Rotor to stop, when changing from Tremolo mode to Stop mode. The setting range for the Horn Rotor is 0.2 - 5.0s, and that for the Bass Rotor is 0.5 - 12.5s.

#### 11. HORN CHARACTER

Here the Tone of the Horn Rotor is set.

“FLAT” has no boost or cut in frequencies, and the others have “peaks” in various tonal ranges.

#### 18. MIC - ANGLE

This is the parameter to set the virtual LOCATIONS of the two “microphones” for the virtual Leslie Speaker.

The ANGLE decides the distance between the two virtual mikes.

The setting range is 0 - 180 degrees. Farther settings exhibit more stereophonic characteristics.

#### 19. MIC - DISTANCE

This is the parameter to set the DISTANCE between the virtual Leslie Speaker and the “microphones”.

The setting range is 0.3 - 2.7m. The more the value increases, the less intense the sound.

**NOTE:** When you operate the parameters 2 - 19, the setting range will be lost after the power is switched off, if you do not do the recording operation of the next paragraph.

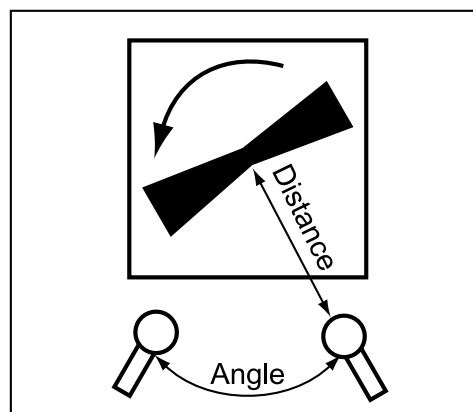
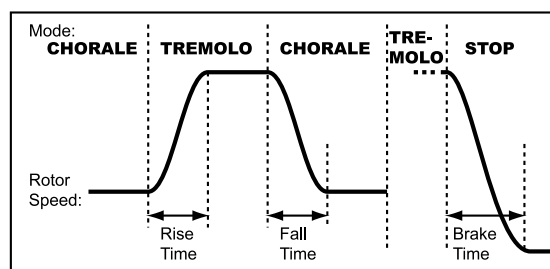

**20. STOP MODE**

This sets the mode when the Leslie Speed Switch is at “STOP”.

**STOP:**

The virtual rotors stop.

**THROUGH:**

The Leslie Effect is bypassed. (Through)

**NOTE: This parameter is a Preset Parameter. It is recorded to each Combination Preset.**

## Record the Cabinets

The Leslie parameters (2 - 20 of the previous paragraph) can be recorded with the Cabinet Numbers, enabling their choice in each Combination Preset.



Enter the desired name for the Cabinet.

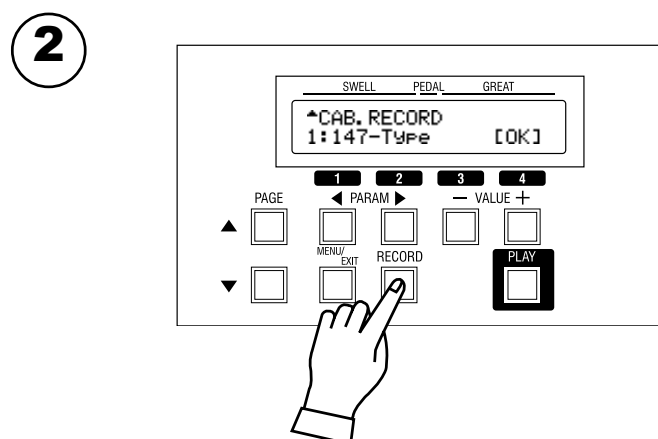

Press the [RECORD] button in the setting mode of the Leslie Parameter.

The Cabinet Selection mode is displayed.

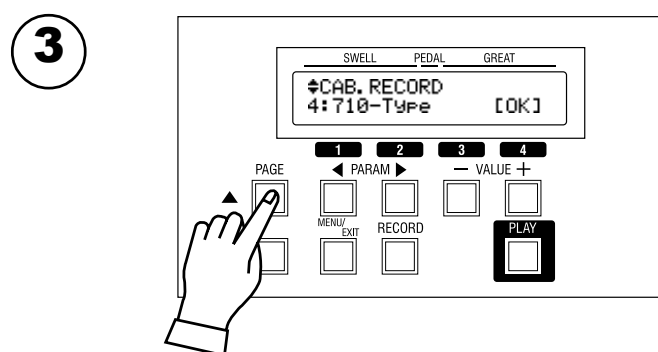

Select the Cabinet Number to record by the [PAGE] button.

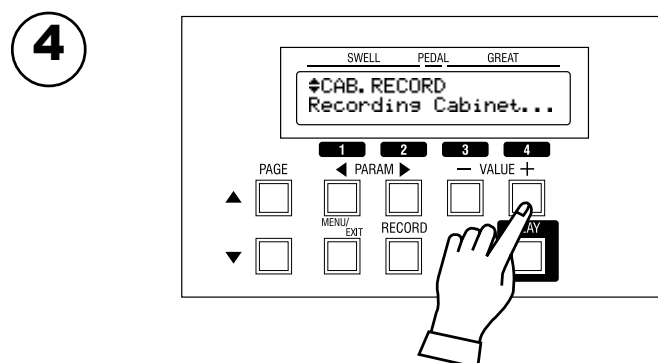

Press [4] OK, and the Cabinet's parameters are recorded.

The display during the recording the recording operation shows as illustrated.

**NOTE:** If you wish to cancel the recording, press the [MENU/EXIT] button.

# EQ/REV (EQualizer/REVerb)

In this mode, you adjust the settings for the Equalizer and Reverb.

An Equalizer is used to adjust the tonal quality. The built-in Equalizer consists of 3 bands and a recreation of the unique “tone” control that was part of the vintage B-3. The Bass and Treble bands are handled by “shelf” equalizers, and the Mid band is handled by parametric control.

The Reverb effect is for adding the atmosphere of a concert hall, room, and other chambers.

### To locate this mode:

Press the [MENU/EXIT] button for the MENU, select PAGE B by the [PAGE] button, and then press the [4] EQ/REV button.

▾REV DEPTH TYPE MAST 815 9Hall 1▶	▾REV R-TIME-D D.FB AD 1031 111000m 1296%▶	▾REV LESONREV CONN 13OF
⬆EQ BASS TREB KNOB 6BASS 7TONE		
⬆EQ TC BS G-MID-F TR 10 20 30 1.0k 50		

4

## ◆ EQUALIZER

### 1. TONE CONTROL

This is a simulated original B-3 TONE CONTROL. Its response is unique, but its basic response is to gently cut the overall treble.

The setting range is -9 to +9, and it becomes neutral when set at “0”.

“-1” corresponds to the maximum of the original B-3 tone control, “-5”, the middle, “-9”, the minimum. The tone control found on the original B-3, its value can not be set at “+”, but on this model it’s possible to boost treble to some extent.

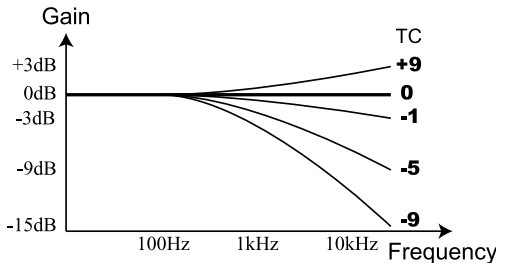

**NOTE: You can locate this page by moving [BASS] or [TREBLE] knob pressing the [MENU/EXIT] button.**

- 2. GAIN - BASS
- 3. GAIN - MIDDLE
- 5. GAIN - TREBLE

These are for doing the Boost/Cut of Bass, Mid-range and Treble respectively.

The setting range is -9 to +9. It is neutral at 0.

### 4. FREQUENCY - MIDDLE

This is for setting the Central Frequency to vary at Gain - Middle (3).

The setting range is 180Hz - 2.9kHz.

**NOTE: These parameters are Preset Parameters and are recorded to each Combination Preset.**

- 6. KNOB - BASS
- 7. KNOB - TREBLE

These sets the functions to assign to the [BASS], [TREBLE] knobs.

Bass and Middle gains can be assigned to the [BASS] knob, and Treble gain and Tone Control to the [TREBLE] knob.

**NOTE: These parameters are global parameters and are recorded at the time the value is set. It is common for each Combination Preset.**

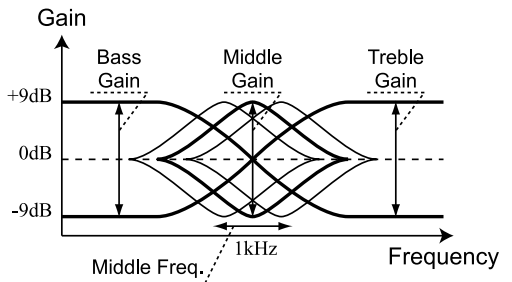

### tips THE EFFECTIVE USE OF THE MIDDLE FREQUENCY

The frequency response of the horn rotor in the Leslie speaker is not flat. It has a peak from 1kHz to 3kHz. This peak is effective in “cutting through” any ensemble playing.

If you use this organ through line out without a Leslie speaker, you can duplicate effect by setting the FREQUENCY - MIDDLE to approximately 2kHz, and the GAIN - MIDDLE to “+”.



## ◆ REVERB

### 8. REVERB - DEPTH

This sets the Depth of the Reverb Effect.

The setting range is 0 - 15. As you increase the value, it will give the effect of performing in a larger room.

**NOTE:** You can locate this page by moving [REVERB] knob pressing the [MENU/EXIT] button.

### 9. REVERB - TYPE

This sets the Types of Reverb Effect.

**Room 1:** Small room  
**Room 2:** Large room  
**Live:** Ambient room  
**Hall 1:** Large Hall  
**Hall 2:** Small Hall  
**Church:** Church  
**Plate:** Iron-plate Reverb  
**Spring:** Spring Reverb  
**Delay:** Delay  
**PanDly:** Panning Delay  
**RevDly:** Reverb + Delay

### 10. REVERB - TIME

When the Type (9) is set at Room 1 to Spring or RevDly, it sets the Time for Reverb to decay.

The setting range is 0 - 31. The higher the value, the longer the decay.

### 11. REVERB - DELAY TIME

When the Type (9) is set at Delay, PanDly, RevDly, this sets the delay time.

The setting range is 4.7 - 2000 ms. The higher the number, the longer the delay.

**NOTE:** You can set the delay time with the foot switch (P. 91 #4).

### 12. REVERB - DELAY FEEDBACK

When the Type (9) is at Delay, PanDly, RevDly, it sets the amount of Feedback. (How many times the sound repeats.)

The setting range is 0 - 96%. The higher the value, the more repeats.

### 13. LESLIE ON REVERB

This sets the routing of the Reverb and Leslie Effect.

**OF:** Leslie before Reverb  
**ON:** Reverb before Leslie

**NOTE:** These parameters are Preset Parameters and are recorded to each Combination Preset.

#### **tips** PRESET PARAMETERS

Equalizer and Reverb are Preset Parameters, designed to be actively used as one of the tone-making parameters.

If you are using the EQ and Reverb to compensate for the space you are performing in, it is advisable to switch off the PLOAD EQ/RV in the Preset function mode so, the Equalizer and the Reverb value will not change when a preset is recalled. (P. 77 #11)

This mode is for setting the highest note to that will play using the Manual Bass function.

To locate this mode:

Press the [MENU/EXIT] button for the MENU, select PAGE C by the [PAGE] button, and then press the [2] MANBS button.



#### 1. MANUAL BASS - LIMIT

Sets the highest note of the Manual Bass functions on the Great manual.

**NOTE:** In this parameter, you can set the value by pressing the [RECORD] button, while holding down a note on the Great manual.

This mode is for setting the Motor Control Switch, Foot Switch and Expression Pedal.

To locate this mode:

Press the [MENU/EXIT] button and display the MENU and select PAGE C by the [PAGE] button, and then press the [3] CONTROL button.

EXP. LEV LF-LIM-HF MIN 5 -35 6 25 7 -30	EXPR CURVE MON ESSN 8 : SDnCap 127
FOOT MODE SW 4 LESLIE C/T ALT	
MOTOR DOWN UP AMP SW 1 3.0 2 1.0 3 ON	

### ◆ MOTOR CONTROL SWITCH

1. MOTOR - DOWN (G)
2. MOTOR - UP (G)

This is for setting the time required for the pitch change, when you operate the [MOTOR CONTROL] Switch.

The setting range is 0.1 - 9.9 seconds.

**NOTE:** You can locate this page by moving Motor Control switch pressing the [MENU/EXIT] button.

3. MOTOR - AMP (G)

This is for setting the motion of the amp when you push the [MOTOR CONTROL] switch to "DOWN".

If you switch ON, the pitch and volume drop together.

### ◆ FOOT SWITCH

4. FOOT SWITCH - FUNCTION (G)

This is for setting the function of the Foot Switch.

**OFF:** Foot Switch is disabled.

**LESLIE C/T ALT, MOM:**

These are for switching Chorale/Tremolo of the Leslie Effect. At ALT, Chorale/Tremolo is alternately switched at each press of the Foot Switch, and switches to Stop if pressed for longer than 1 second. At MOM, the Leslie effect switches to Tremolo, as long as the foot switch is depressed, and switches to Chorale when you release it.

**SPRING:**

This is for producing the effect of shaking a spring reverb.

**DELAY TIME:**

This function sets the delay time (P. 89 #11) of the reverb effect (if the "delay" setting is selected), by rhythmic tapping the foot-switch. The delay time will be set to the tempo at which you tap the foot switch. By pressing and holding the foot-switch, the delay sound will be erased.

**REVERB DEPTH:**

Changes the Reverb Depth to MAXIMUM while pressing the Foot Switch regardless of the Reverb parameter setting.

**NOTE:** You can locate this page by pushing Foot switch while pressing the [MENU/EXIT] button.

### ◆ EXPRESSION PEDAL

5. EXPRESSION - MINIMUM LEVEL (G)

Sets the minimum level when the Expression pedal at its "back" position. The setting range is OFF, -40db to 0db. "OFF" renders

the organ silent, when the Expression is at minimum, "0dB" produces no reduction in volume.

6. EXPRESSION - LIMIT LF (G)
7. EXPRESSION - LIMIT HF (G)

These are for setting the levels to maintain for low and high frequencies when the Expression is minimum.

The setting range is OFF, -40dB to -5dB. This function does not work at "OFF". Otherwise the level is maintained even if the Expression is minimum.

8. EXPRESSION - CURVE (S)

This is for setting how the value varies corresponding to the depressing angle of the Expression Pedal. 1 - 3 are curves for playing while sitting on the bench, 4 - 5 are those for the playing while standing. See the bottom right figure for details.

9. EXPRESSION - MONITOR

Displays the present Expression Value.

**NOTE:** The parameters by the names with (G) on the tail are for "Global". These parameters will be recorded when set, and are common in each Combination Preset. (S) is for "System". These parameters will be recorded when set, and are common in each Combination Preset, and it does not save to setup.

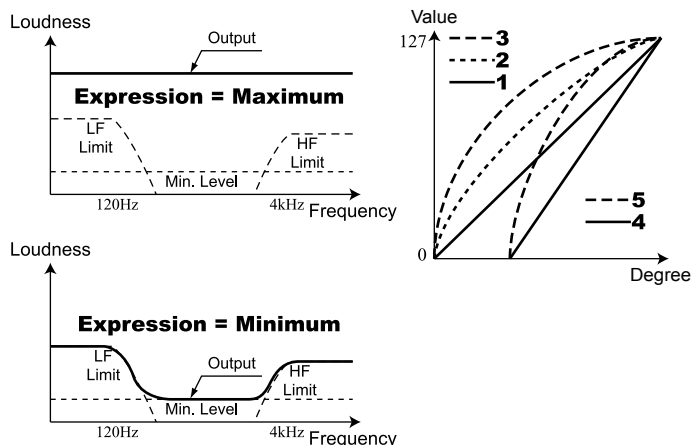

In this mode, you can regulate the tonal qualities of the virtual tone-wheel generator, wheel by wheel.

The virtual tone-wheel generator consists of 96 different pitches, where one wheel may correspond with plural notes and the “foot” designation of the Drawbars.

The relation is complicated. For example, the middle C of 8' and the C one octave lower of 4' use the identical wheel.

In this organ, you can save 2 types of settings per virtual Tone-

Wheel Set. These are called “CUSTOM TONE-WHEELS”.

The factory default gives a choice of B-3 “types”. You may create your own.

### To locate this mode:

Press the [MENU/EXIT] button and display MENU, select PAGE C by the [PAGE] button, and then press the [4] CUST. TW button.

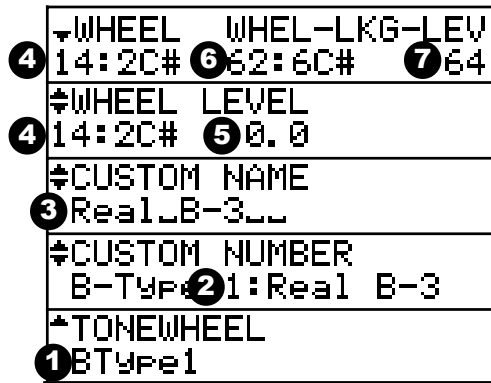

### 1. TONE-WHEEL SET

This is for selecting the Tone-Wheel set.

### 2. CUSTOM NUMBER

This is for selecting the “CUSTOM NUMBER” to use or compile. The “\*” will be displayed when the Tone-wheel parameters are changed from this Custom Number.

**NOTE: This parameter is a Global Parameter. It is not recorded into the Combination Preset.**

### 3. CUSTOM NAME

You can name the CUSTOM TONEWHEELS using up to 10 letters.

Move the cursor by the [PARAM] button and choose the letters by the [VALUE] button.

By pressing the [VALUE] button while holding down the [RECORD] button, it jumps to the top of each letter type (space, 0, A, a).

The name set here, as well as the Tonewheel parameters below, will be deleted, if you do not do the recording operation as explained on the next paragraph.

### 4. WHEEL NUMBER

Select the number of the wheel you want to adjust.

To select the Wheel Number, select the [VALUE] button, or slightly move the feet of the Drawbar while depressing the key you want to regulate. (See the illustration.)

When the Wheel Number is selected, the level for the wheel (#5) is displayed.

### tips

#### INITIAL VALUE OF THE CUSTOM NUMBER

As the initial value, the typical setting is recorded to each Custom No. 1.

For example, “Real B-3”, a simulated original B-3 in good condition, is in B-Type 1.

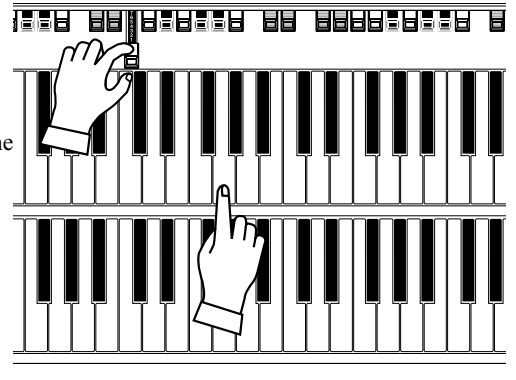

How to select the WHEEL NUMBER

## 5. LEVEL

This is for setting the volume of this wheel.

The setting range is -20 to 0dB. As you increase the value, the volume increases.

## 6. LEAKAGE WHEEL NUMBER

On this organ, you can produce the sound of each wheel: 61:6C to 91:8F# on the “fundamental” wheel: 01:1C to 60:5B; as Leakage Noise at each volume. (See the right figure.)

Select the wheels to output as leakage noise together with the fundamental sound wheel appearing on the left side of the display.

To select the Leakage Wheel Number, select it by the [VALUE] button or by slightly moving the feet of the drawbar holding down the key you want to adjust.

## 7. LEAKAGE WHEEL LEVEL

This is for adjusting the volume of the selected leakage wheel.

Setting range is 0 to 127. However, depending on the situation, the volume may not rise higher than a certain level, when increasing the value.

**NOTE:** These parameters are the Tonewheel parameter. If you do the recording operation of the next page, it works commonly to the same Tonewheel Set (in this example, “BType1”) of each Combination Preset.

**NOTE:** When you operate these parameters, if you do not do the recording operation of the next page, it is lost when you turn off the power.

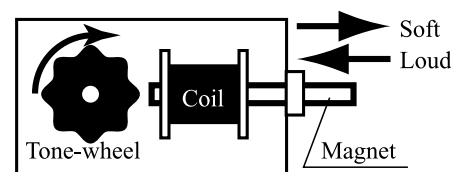

Concept of the level adjustment

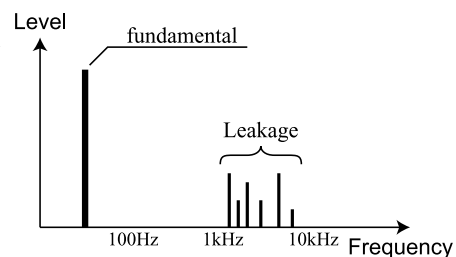

Concept of the leakage noise

## Record the Custom Tone-Wheels

The Tonewheel parameters (= 3 - 5 of the previous Section) are for determining the Custom Number for recording.



Enter the Custom Name.

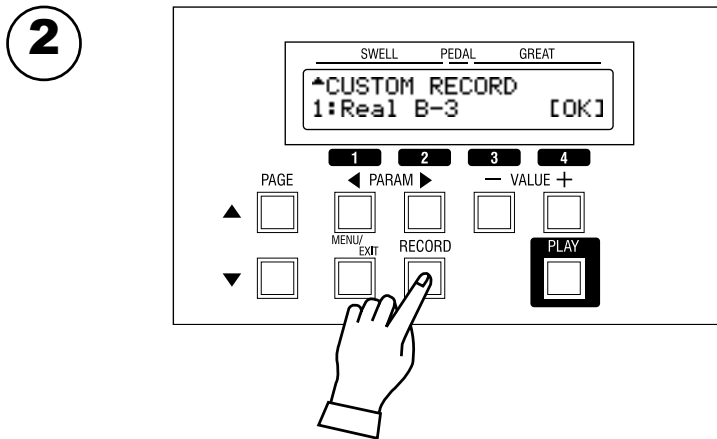

Press the [RECORD] button in the setting mode of the virtual Tonewheel parameters.

The mode for selecting the Custom Number to be recorded will be displayed.

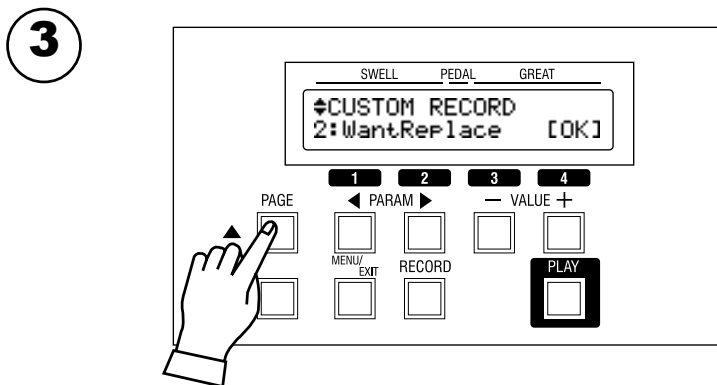

Select the Custom Number to be recorded by the [PAGE] button.

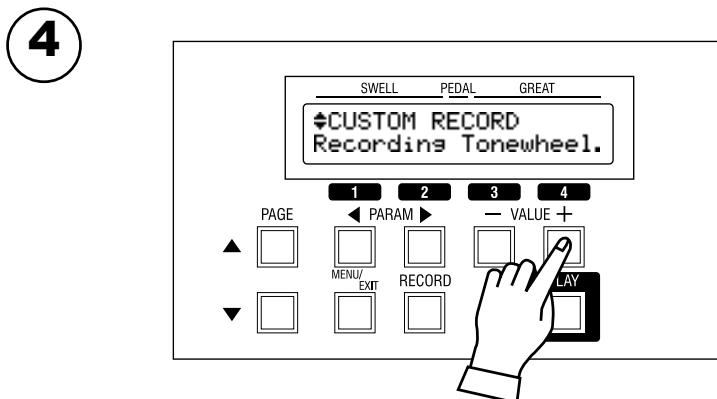

It will be recorded when you press the [4] OK button.

The display will be as illustrated, while the recording is proceeded.

**NOTE:** To cancel recording, press the [MENU/EXIT] button.

In this mode, you can totally or partially recall the factory default settings.

To locate this mode:

Press the [MENU/EXIT] button for the MENU display, select PAGE D by the [PAGE] button, and then press the [1] DEFAULT button.

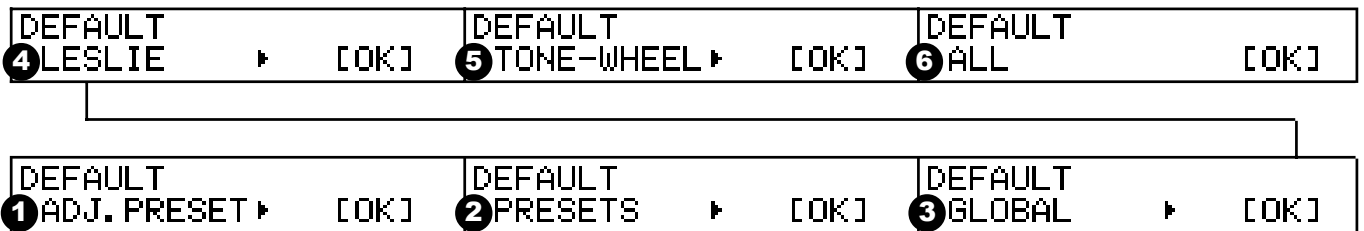

To initialize each parameter, press the [PARAM] button and then [4] OK.

1. ADJUST PRESETS

Initializes the content of the Preset Keys [A#] and [B].

2. PRESETS

Initializes the contents of all Combination Presets.

3. GLOBAL

Initializes the Global Parameters such as Master tune or assignment of the Foot Switch.

4. LESLIE

Initializes the content of all Internal Leslie cabinets.

5. TONE WHEEL

Initializes the Custom Tonewheels.

6. ALL

Initializes all parameters of this organ.

If any unstable condition occurs on this organ system, initializing “all” will usually clear the problem.

**NOTE:** You can also totally initialize your organ by switching the Power ON while pressing and holding the [RECORD] button.

In this mode, you can set the SYSTEM PARAMETERS of this organ and the display information.

To locate this mode:

Press the [MENU/EXIT] button to display the MENU, select PAGE D by the [PAGE] button, and then press the [2] SYSTEM button.

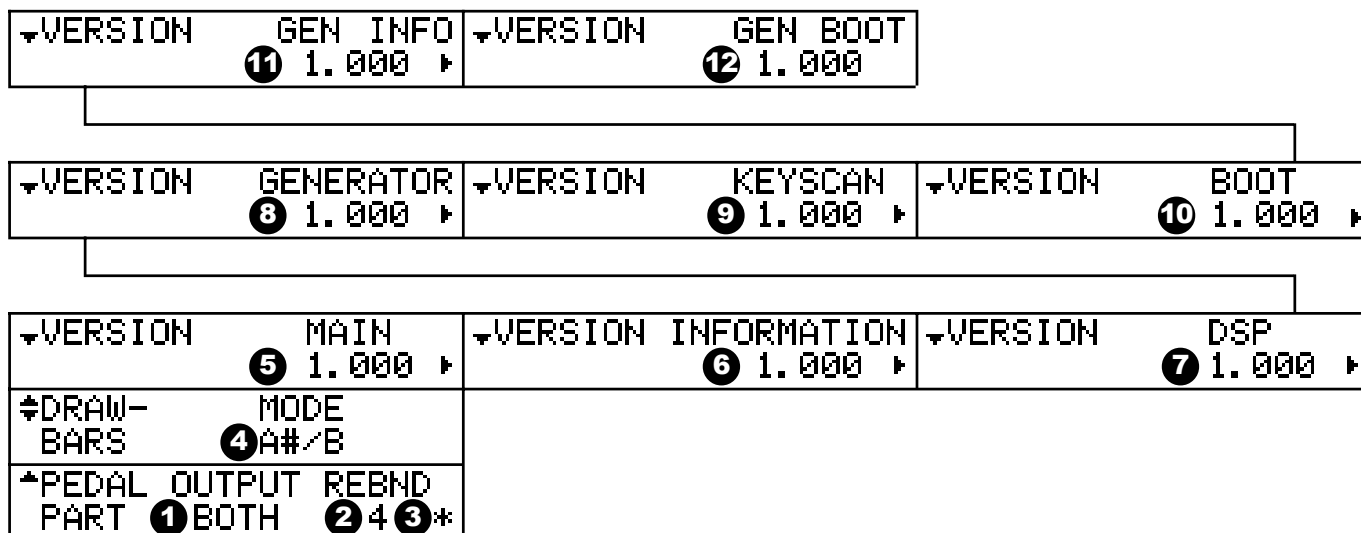

#### 1. PEDAL PART - OUTPUT

This is for setting which jack to outputs the Pedal part.

**BOTH:** Outputs the Pedal part to all the sound output jacks.

**PEDAL:** Outputs the Pedal part only to the PEDAL OUT jack.

#### 2. PEDAL PART - REBOUND TIME

The Pedalboard sometimes sounds twice caused by the “rebound” which happens when the keys are played staccato and released, depending on the condition of the sheet spring used on it. This can be avoided by adjusting the “rebound time”.

The setting range is 1 - 128 x 1.4 msec. The initial value is 40 x 1.4 msec.

**NOTE:** If the rebound time is too long, it causes a sound delay.

#### 3. PEDAL PART - MIDI MESSAGE

“\*” is displayed while the Pedal part sound is output by the MIDI message from the PEDAL MIDI IN jack.

#### 4. DRAWBARS - CONTROL MODE

This sets the condition for activating the registrations with the Manual Drawbars.

**A#/B:**

The Drawbars are active only when the Preset Keys [A#] and [B] are selected, same as the original B-3/C-3.

**ALWAYS:**

The Drawbars are active regardless which Preset Keys are selected, same as the XK-3.

#### 5. - 12. VERSIONS

These are the versions of each software built in this organ.

These are only for displaying the version number.



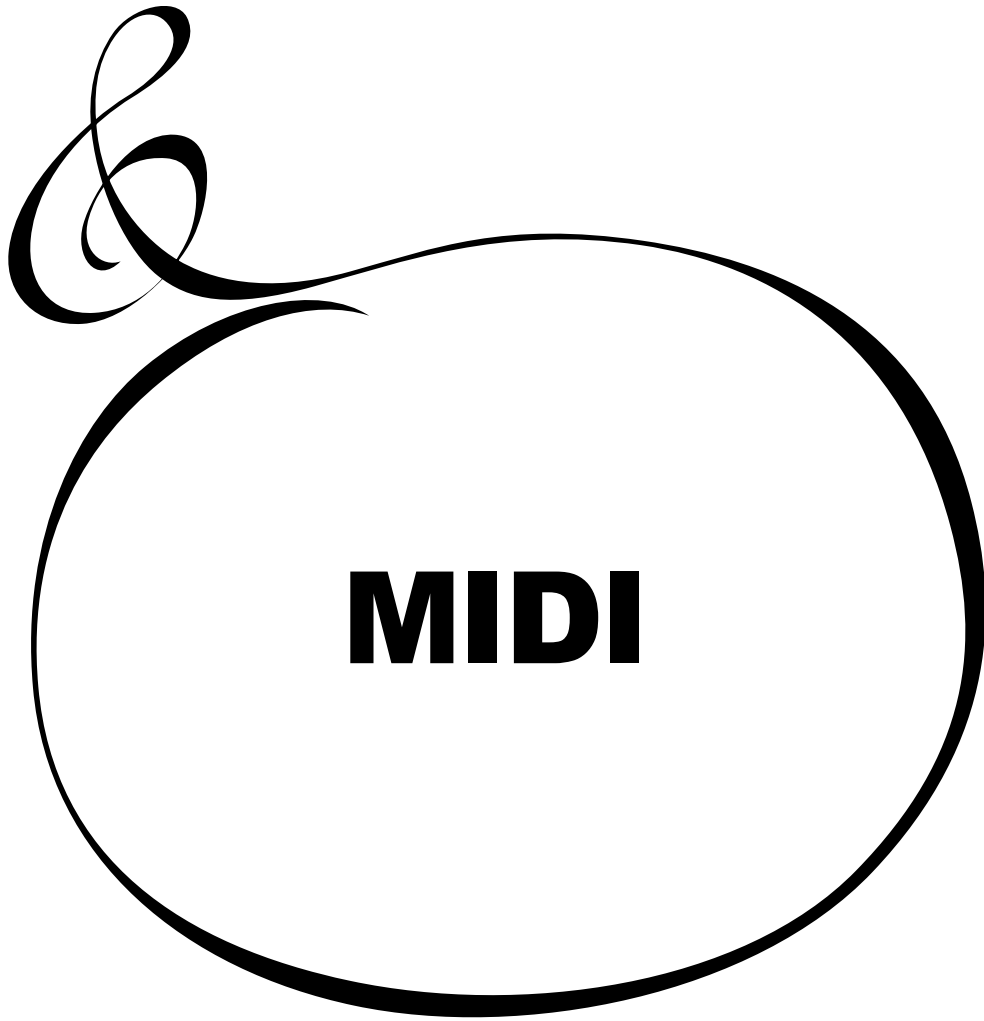

## What is “MIDI”?

MIDI is an abbreviation of **M**usical **I**nstrument **D**igital **I**nterface.

MIDI is the musical instrument industry standard for exchanging performance information between electronic musical instruments and a sequencer, effects, lighting, and sound reinforcement gear, etc.

The MIDI standard allows instruments made by different manufacturers to effectively communicate with each other.

Many types of data can be transmitted and received, including all performance information, settings of parameters, and global commands.

## MIDI terminals on this Organ

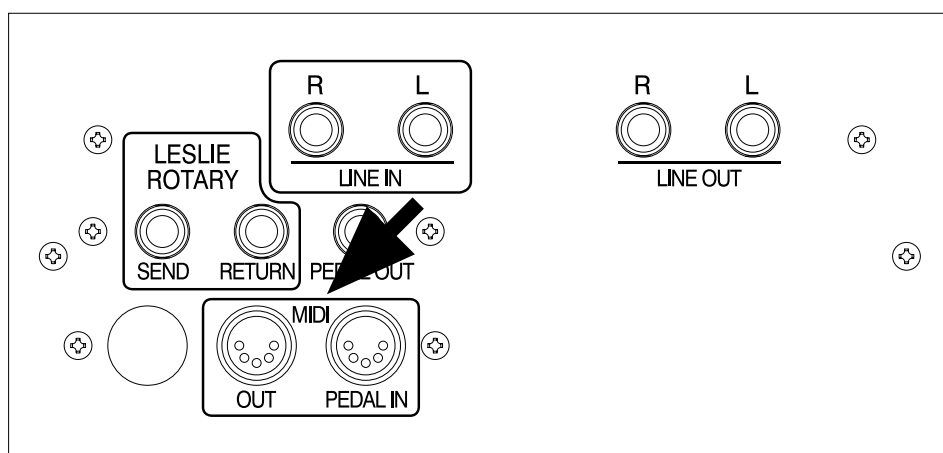

### MIDI OUT

Sends Performance Information.

### MIDI PEDAL IN

Receives the performance information of the Pedal part.

Receives only the note message and the setting is fixed at OMNI ON.

## What the MIDI can do on your Organ

On this organ, the MIDI terminals are intended to do the following:

- ♦ control an external sound generator such as a synthesizer or sampler.
- ♦ use a MIDI Pedal board instead of the traditional Pedalboard.
  - ❖ *Due to the exclusive electro-mechanical “Direct Analog Keying System”, it is impossible to “play” this organ from a remote MIDI source, such as a sequencer or MIDI controller.*

## MIDI CHANNEL

MIDI has 16 “CHANNELS”. Information divided into 16 channels can transmit through one MIDI cable.

The channel must match between the sender and the receiver. If not, the machines can not “hear” what the other “says”.

## MAJOR MIDI MESSAGE

The MIDI information is grouped into a channel message per each of the 16 channels and a system message for all channels. There are more details in the MIDI IMPLEMENTATION CHART.

## CHANNEL MESSAGE

### ◆ NOTE ON / NOTE OFF

This data tells: which key (Note Number) is played, at what Speed (Velocity) and whether played or released (Note On/Off).

The MIDI PEDAL IN jack on this organ receives only Note On/Note Off.

It does not recognize velocity commands.

### ◆ PROGRAM CHANGE

Switches the programs of External MIDI equipment.

### ◆ CONTROL CHANGE

Data will be sent corresponding to the action of the Expression Pedal, Foot Switch, etc.

## SYSTEM MESSAGE

### ◆ SYSTEM EXCLUSIVE MESSAGE

This organ does not send/receive the system exclusive message.

This organ has 3 “External Zones” on each of the Swell, Great and Pedalboards for controlling the external MIDI equipment.

## Keymap Overview

### Zones

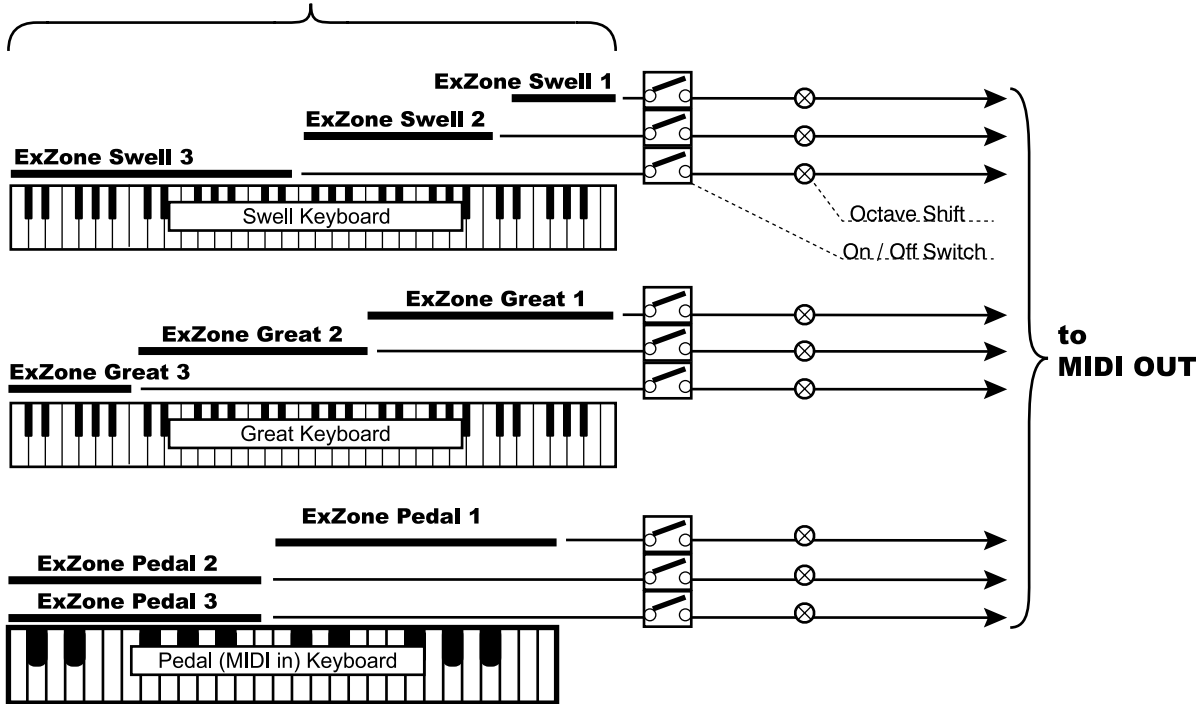

You can control external MIDI equipment with up to 3 zones per each of the Swell, Great manuals and Pedalboard.

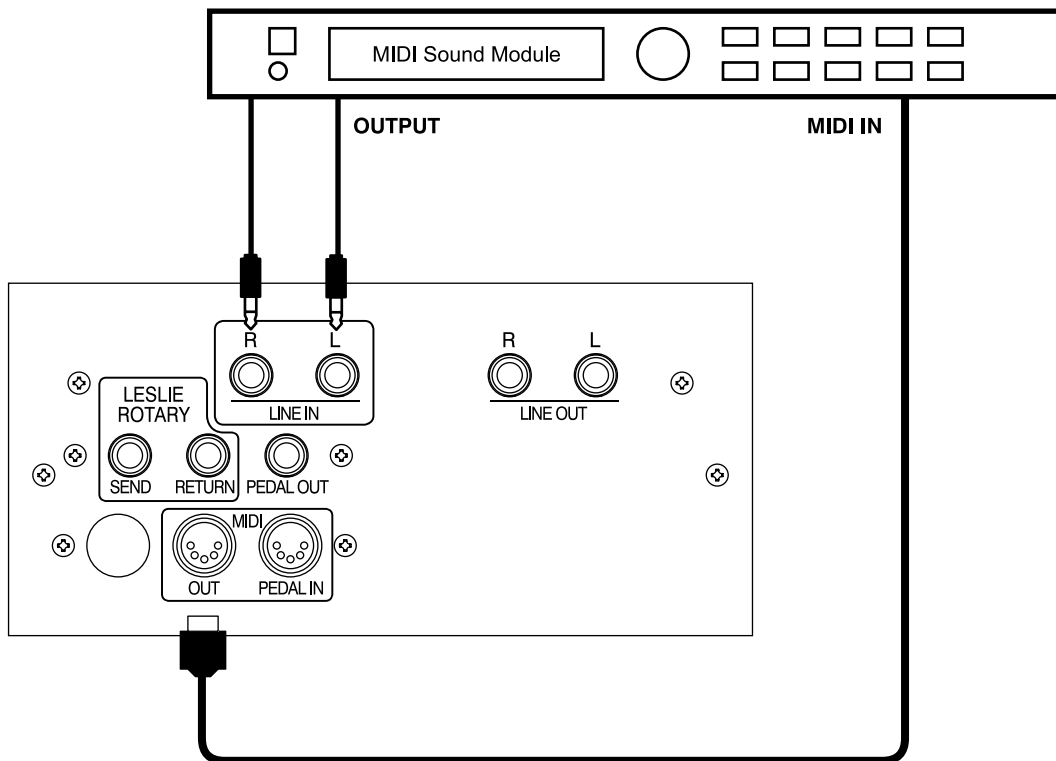

**1. Connect as shown above.**

Connect the MIDI OUT of this organ to the MIDI IN of the equipment you wish to control.

When the MIDI Pedal board is connected to the MIDI PEDAL IN jack, the performance is treated the same as the traditional Pedalboard.

**2. Set the parameters of each zone, and record it to the Combination Preset, as desired.**

Read the next page “EX. ZONE (External Zone)” for setting each zone.

**tips NOTE ON THE SOUNDING POINT**

The External Zones sound at a deeper point of the key than the Drawbar tones.

This is for outputting the velocity info. to the External Zone.

This is due to the extra velocity-sensing MIDI keyboard contact that lies below the direct analog keying system.

## EX. ZONE (EXternal ZONE)

To control external MIDI equipment, ranges on the keyboard of this organ are assigned. They are called “External Zones”.

A MIDI Pedalboard connected to the MIDI PEDAL IN can control the MIDI equipment by the Pedal EXTERNAL ZONE.

To locate this mode:

Press the [MENU/EXIT] button and display MENU, select Page C by the [PAGE] button, then press [1] EXZONE.

▼PD3 SW CH LO--HI ZONE OF 1 1C 3C ▶	▼PD3 M-BNK-L PROG PROG◀ 0 0 1 ▶	▼PD3 OCT VOL PAN VEL NOTE◀+0 100 -C- OF ▶
◄PD2 SW CH LO--HI ZONE OF 1 1C 3C ▶	◄PD2 M-BNK-L PROG PROG◀ 0 0 1 ▶	◄PD2 OCT VOL PAN VEL NOTE◀+0 100 -C- OF ▶
◄PD1 SW CH LO--HI ZONE OF 1 1C 3C ▶	◄PD1 M-BNK-L PROG PROG◀ 0 0 1 ▶	◄PD1 OCT VOL PAN VEL NOTE◀+0 100 -C- OF ▶
◄GR3 SW CH LO--HI ZONE OF 1 1C 6C ▶	◄GR3 M-BNK-L PROG PROG◀ 0 0 1 ▶	◄GR3 OCT VOL PAN VEL NOTE◀+0 100 -C- 1 ▶
◄GR2 SW CH LO--HI ZONE OF 1 1C 6C ▶	◄GR2 M-BNK-L PROG PROG◀ 0 0 1 ▶	◄GR2 OCT VOL PAN VEL NOTE◀+0 100 -C- 1 ▶
◄GR1 SW CH LO--HI ZONE OF 1 1C 6C ▶	◄GR1 M-BNK-L PROG PROG◀ 0 0 1 ▶	◄GR1 OCT VOL PAN VEL NOTE◀+0 100 -C- 1 ▶
◄SL3 SW CH LO--HI ZONE OF 1 1C 6C ▶	◄SL3 M-BNK-L PROG PROG◀ 0 0 1 ▶	◄SL3 OCT VOL PAN VEL NOTE◀+0 100 -C- 1 ▶
◄SL2 SW CH LO--HI ZONE OF 1 1C 6C ▶	◄SL2 M-BNK-L PROG PROG◀ 0 0 1 ▶	◄SL2 OCT VOL PAN VEL NOTE◀+0 100 -C- 1 ▶
▲SL1 SW CH LO--HI ZONE <b>1</b> OF <b>2</b> <b>3</b> 1C <b>4</b> 6C ▶	▲SL1 M-BNK-L PROG PROG◀ <b>5</b> 0 <b>6</b> 0 <b>7</b> 1 ▶	▲SL1 OCT VOL PAN VEL NOTE <b>8</b> +0 <b>9</b> 100 <b>10</b> C- <b>11</b> 1 ▶

There are 3 External Zones (SL1, 2, 3) for the Swell manual, 3 (GR1, 2, 3) for the Great manual and 3 (PD1, 2, 3) for the Pedalboard.

### 1. SWITCH

This switch “turns on” the selected External Zone.

### 2. MIDI CHANNEL

This is for choosing the External Zone’s transmitting MIDI channel.

The range is 1 - 16, and OFF.

### 3. MAP - LOW

### 4. MAP - HIGH

These set the playing range of the chosen External Zone on each of the Swell, Great manuals and Pedalboard.

Set the lowest note at LO and the highest one at HI. To forbid sending note data, set the HI parameter to “OFF”.

**NOTE:** For 3 and 4, you can set the value by pressing the [RECORD] button, while holding down the desired note on the manual (or pedalboard).

▼PD3 MIN-MAX CC# EXP. ◀ 40 127 11:EXP ▶	▼PD3 DAMPER MSG◀ ON
⚡PD2 MIN-MAX CC# EXP. ◀ 40 127 11:EXP ▶	⚡PD2 DAMPER MSG◀ ON
⚡PD1 MIN-MAX CC# EXP. ◀ 40 127 11:EXP ▶	⚡PD1 DAMPER MSG◀ ON
⚡GR3 MIN-MAX CC# EXP. ◀ 40 127 11:EXP ▶	⚡GR3 DAMPER MSG◀ ON
⚡GR2 MIN-MAX CC# EXP. ◀ 40 127 11:EXP ▶	⚡GR2 DAMPER MSG◀ ON
⚡GR1 MIN-MAX CC# EXP. ◀ 40 127 11:EXP ▶	⚡GR1 DAMPER MSG◀ ON
⚡SL3 MIN-MAX CC# EXP. ◀ 40 127 11:EXP ▶	⚡SL3 DAMPER MSG◀ ON
⚡SL2 MIN-MAX CC# EXP. ◀ 40 127 11:EXP ▶	⚡SL2 DAMPER MSG◀ ON
⚡SL1 MIN-MAX CC# EXP. ⑫ 40 127 11:EXP ▶	⚡SL1 DAMPER MSG◀ ⑮ON

⑬

⑭

- 5. PROGRAM - BANK MSB
- 6. PROGRAM - BANK LSB
- 7. PROGRAM - PROGRAM CHANGE

These are for setting the Bank Select and the Program Change data to be transmitted by this zone.  
Please consult the users guide/manual for your specific piece of outboard gear that you wish to control for the exact combination of commands that allow bank and program change.  
You can choose 0 - 127 in the Bank MSB and the Bank LSB, and 1 - 128 in the Program Change.

8. NOTE - OCTAVE

This is for selecting the octave to be transmitted by this zone. The octave that is transmitted may be set to be different than the octave that you may be playing.

9. NOTE - VOLUME

This is for setting the volume (= Control Change #7) of this zone. However, the set value will be null, if the CC# (item #14) is at "7.VOL".

10. NOTE - PAN

This is for setting the Pan (= Control Change #10) of this zone.

**tips** NUMBER BASE

Some MIDI modules map their presets from 0 - 127, and some from 1 - 128. If your instrument does not respond to the exact number of program change, you may need to decrease the program change number here by the value [1].

▼PD3 SW CH LO--HI ZONE OF 1 1C 3C ▶	▼PD3 M-BNK-L PROG PROG◄ 0 0 1 ▶	▼PD3 OCT VOL PAN VEL NOTE◄+0 100 -C- OF▶
⬇PD2 SW CH LO--HI ZONE OF 1 1C 3C ▶	⬇PD2 M-BNK-L PROG PROG◄ 0 0 1 ▶	⬇PD2 OCT VOL PAN VEL NOTE◄+0 100 -C- OF▶
⬇PD1 SW CH LO--HI ZONE OF 1 1C 3C ▶	⬇PD1 M-BNK-L PROG PROG◄ 0 0 1 ▶	⬇PD1 OCT VOL PAN VEL NOTE◄+0 100 -C- OF▶
⬇GR3 SW CH LO--HI ZONE OF 1 1C 6C ▶	⬇GR3 M-BNK-L PROG PROG◄ 0 0 1 ▶	⬇GR3 OCT VOL PAN VEL NOTE◄+0 100 -C- 1▶
⬇GR2 SW CH LO--HI ZONE OF 1 1C 6C ▶	⬇GR2 M-BNK-L PROG PROG◄ 0 0 1 ▶	⬇GR2 OCT VOL PAN VEL NOTE◄+0 100 -C- 1▶
⬇GR1 SW CH LO--HI ZONE OF 1 1C 6C ▶	⬇GR1 M-BNK-L PROG PROG◄ 0 0 1 ▶	⬇GR1 OCT VOL PAN VEL NOTE◄+0 100 -C- 1▶
⬇SL3 SW CH LO--HI ZONE OF 1 1C 6C ▶	⬇SL3 M-BNK-L PROG PROG◄ 0 0 1 ▶	⬇SL3 OCT VOL PAN VEL NOTE◄+0 100 -C- 1▶
⬇SL2 SW CH LO--HI ZONE OF 1 1C 6C ▶	⬇SL2 M-BNK-L PROG PROG◄ 0 0 1 ▶	⬇SL2 OCT VOL PAN VEL NOTE◄+0 100 -C- 1▶
▲SL1 SW CH LO--HI ZONE① OF ②1 ③1C ④6C ▶	▲SL1 M-BNK-L PROG PROG◄ ⑤0 ⑥0 ⑦1 ▶	▲SL1 OCT VOL PAN VEL NOTE⑧+0 ⑨100 ⑩C- ⑪1▶

#### 11. NOTE - VELOCITY

This is for setting the Velocity Curve to send to this zone.

The setting range is OF, 1 - 4. The velocity of OF is fixed at 100. At 1 - 4, the higher the value increases, the higher velocity is transmitted regardless how the key is played.

**NOTE:** As the Pedalboard of this organ has no velocity sensing function, the velocity of PD1 - 3 is fixed at OF.

#### 12. EXPRESSION - MINIMUM

#### 13. EXPRESSION - MAXIMUM

These set the range of expression to “compress” to send to this Zone.

If the expression pedal of this organ is fully returned the organ will still be heard.

With many types of external sound gear, the volumes do not react the same. This parameter allows a smooth and equal flow in the expression pedal.

You can select 0 - 63 by MIN, and 64 - 127 by MAX.

#### 14. EXPRESSION - CONTROL NUMBER

This is for setting the MIDI continuous Control Number of the Expression Pedal.

Depending on your external equipment, it may react to CC#7 (Volume) or CC#11 (Expression).

This parameter allows you to make that choice.

#### 15. MESSAGE - DAMPER

This is for setting the transmission of Damper (Control Change #64) to this zone using the Foot Switch on the Expression Pedal.

The message is sent at ON, and is not at OFF.

**NOTE:** All the parameters in these modes are Preset Parameters. They can be recorded to the Combination Presets. See the Appendix for details of the Preset Parameters.



▼PD3 MIN-MAX EXP. ◀ 40 127 11:EXP ▶	CC#	▼PD3 MSG◀	DAMPER ON
◆PD2 MIN-MAX EXP. ◀ 40 127 11:EXP ▶	CC#	◆PD2 MSG◀	DAMPER ON
◆PD1 MIN-MAX EXP. ◀ 40 127 11:EXP ▶	CC#	◆PD1 MSG◀	DAMPER ON
◆GR3 MIN-MAX EXP. ◀ 40 127 11:EXP ▶	CC#	◆GR3 MSG◀	DAMPER ON
◆GR2 MIN-MAX EXP. ◀ 40 127 11:EXP ▶	CC#	◆GR2 MSG◀	DAMPER ON
◆GR1 MIN-MAX EXP. ◀ 40 127 11:EXP ▶	CC#	◆GR1 MSG◀	DAMPER ON
◆SL3 MIN-MAX EXP. ◀ 40 127 11:EXP ▶	CC#	◆SL3 MSG◀	DAMPER ON
◆SL2 MIN-MAX EXP. ◀ 40 127 11:EXP ▶	CC#	◆SL2 MSG◀	DAMPER ON
▲SL1 MIN-MAX EXP. ⑫40 127 11:EXP ▶	CC#	▲SL1 MSG◀	DAMPER ⑬ON

⑬

⑭

PANIC FUNCTION and PARAMETER RELOAD

If any problem happens in the MIDI system, it may cause ciphering (sticking notes). Immediately after this organ and an external MIDI equipment are connected, a glitch or “MIDI hangup” may occur.

If this occurs, press PAGE [▲] and [▼] at the same time. [All Note Off] and [Reset All Controller] will be transmitted to all External Zone MIDI channels (Panic Function) and then all the EXTERNAL ZONE settings will be re-sent.



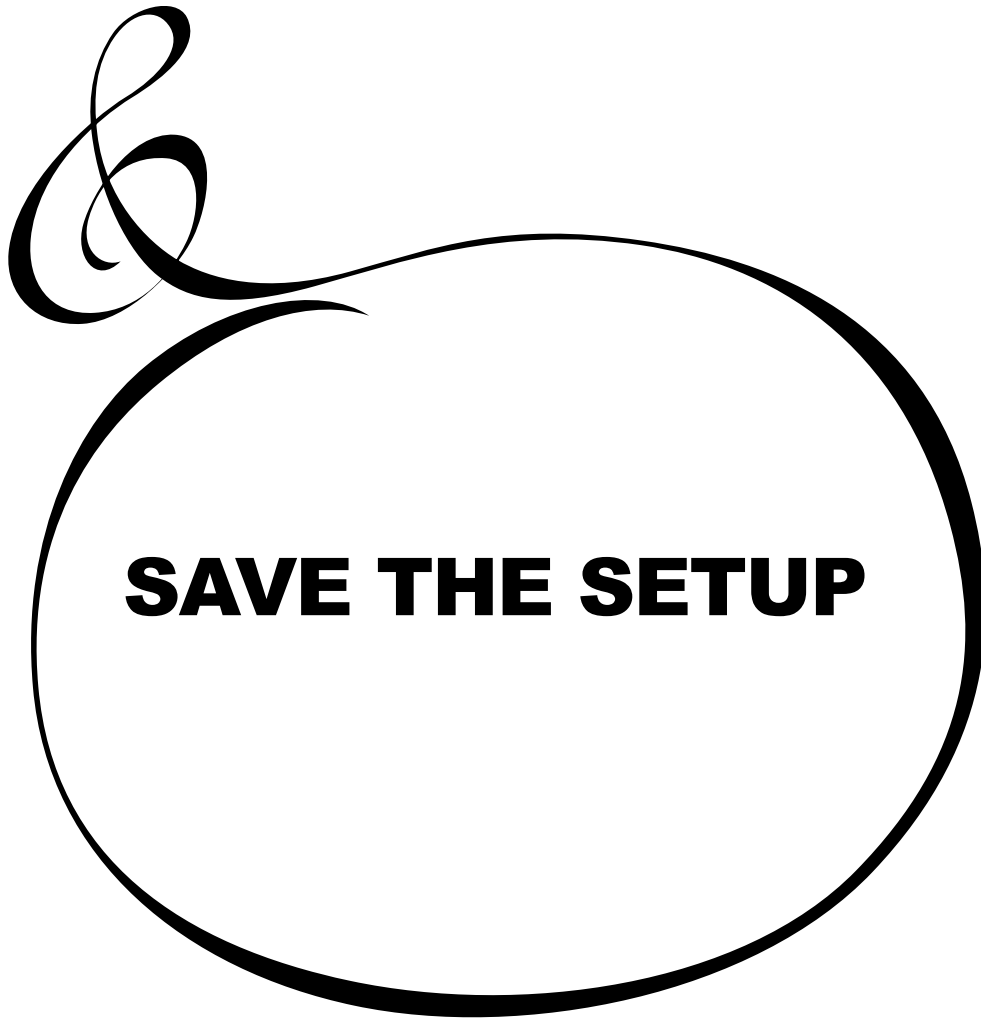

**SAVE THE SETUP**

On this organ you can save the setting of each Parameter as a file, into a CompactFlash™ card (hereinafter “CF card”) up to 99 files.

## How to access the CF card slot

B-3 mk2, C-3 mk2

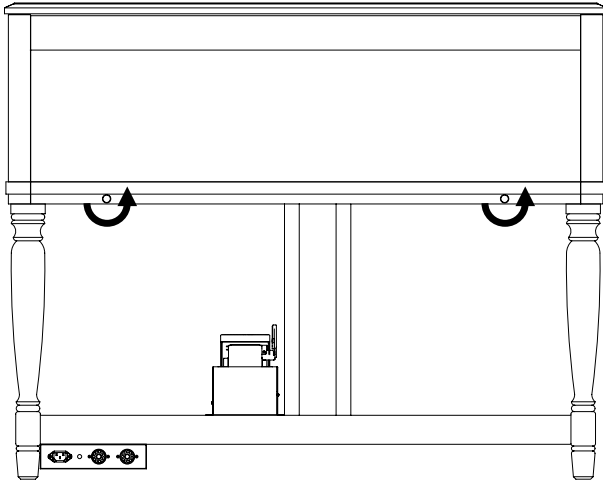

Turn and remove the knob bolts with a coin from the back of the organ. Then take off the rear panel.

B-3P mk2

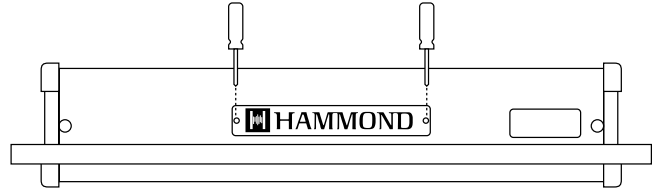

Turn the screws with the #2 Phillips screw driver and take off the HAMMOND plate on the back of the organ.

## About the CF Card

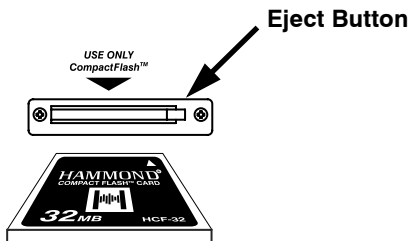

### CF CARD YOU CAN USE

The manufacturer recommends genuine Hammond 65971-02128 as your CF card.

Please consult URL: <http://www.hammondsuzuki.com> before you try to use other cards on the market.

### CF CARD SLOT

1. First please read the label on the CF card carefully and insert it correctly.
2. To take out the card, push the EJECT button on the right hand side of the slot.
3. Don't eject the card or switch the power off during initializing or setting it up.

### THE CARD CAPACITY AND CONTENT TO BE SAVED

The CF card can save:

- ◆ Combination Presets
- ◆ Global Parameters
- ◆ Custom Tonewheels
- ◆ Leslie Cabinets
- ◆ Adjust Presets [A#], [B]
- ◆ Temporary Parameters

Also, this card can save/read out all of them as a whole by the unit called “SET-UP”. The capacity of one SET-UP is approximately 44 KB.

The CF CARD must be “INITIALIZED” first (= before you use it). Perform the following, step by step, to do the initializing operation.

❖ This operation erases all data in the CF card.

1



Insert the CF card into the slot.

2

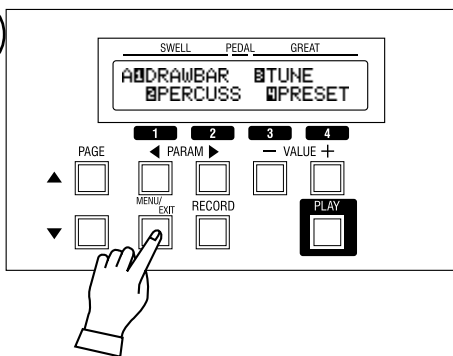

Press the [MENU/EXIT] button.

3

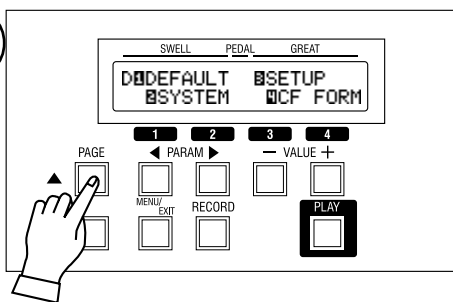

Select PAGE D by the [PAGE] button.

4

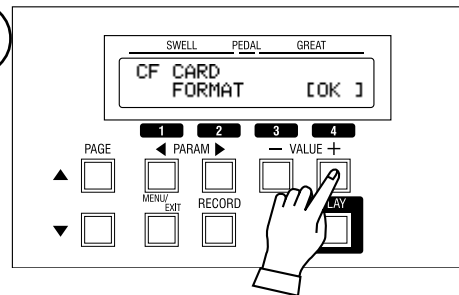

Press [4] CF FORM.

The FORMAT mode is displayed.

5

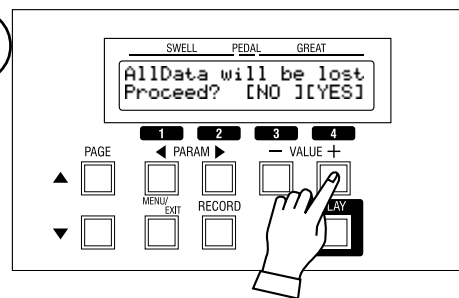

Press the [4] OK button.

The Confirmation message is displayed.

6

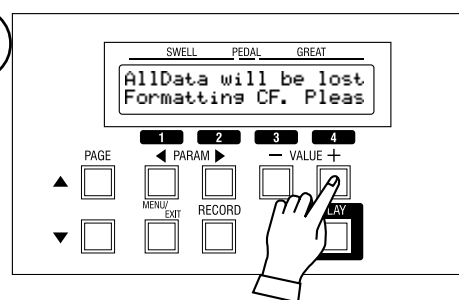

Press the [4] YES button.

The initialization starts and takes only a few seconds.

**NOTE:** To cancel initializing, press the [3] NO button.

7

To return to the PLAY mode, press [PLAY].

Save or Load the SET UP to/from the CF card in the SETUP mode. In this mode, you can do all the operations except the initialization of the CF card.

To come to this menu:

Press the [MENU] button to display the MENU, select PAGE D by the [3] SETUP button.

## How to read the Display

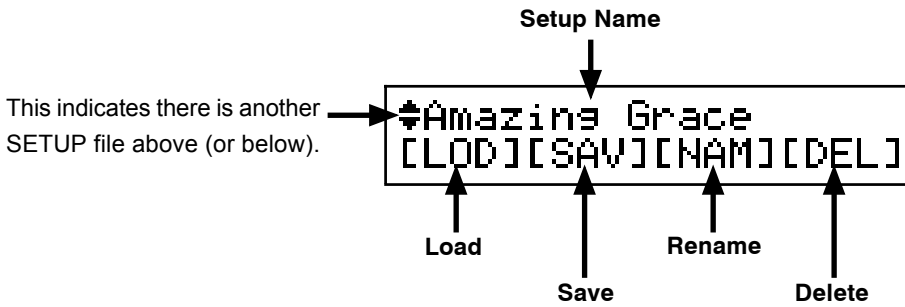

## Save the SETUP

**1**  
Check that the CF card is correctly inserted.

**2**

Amazing Grace  
[LOD][SAV][NAM][DEL]

Go to the SETUP mode.

### WHAT DOES THIS MEAN?

CF is not ready

The CF card is not correctly inserted.

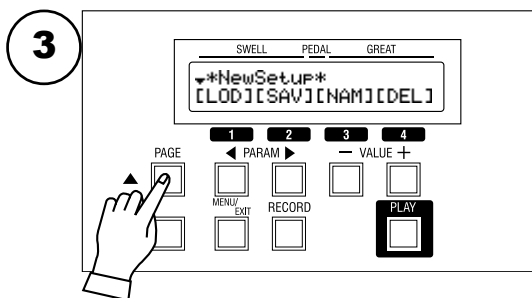

Select the SET UP NAME “NewSetup” by the [PAGE] button.

**NOTE:** “NewSetup” means a fresh save. If you select an existing SET UP NAME, it will be deleted and written over.

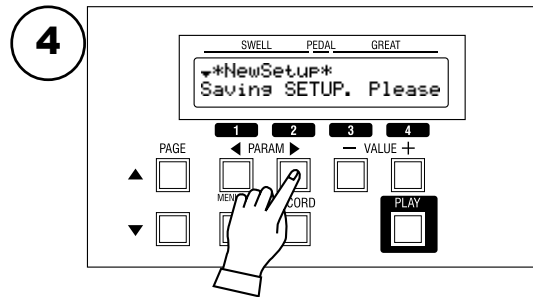

Press the [2] SAV button.

SAVE starts.

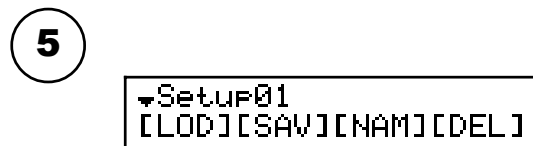

A temporary name is put to the saved SETUP “Setup xx” automatically.

## Change the SETUP name

1

```

Want To Rename
[LOD][SAV][NAM][DEL]
  
```

Select the SETUP file you want to change the name of.

2

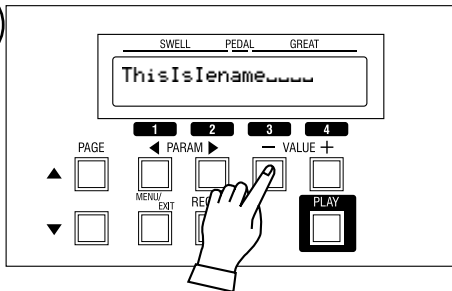

Press the [3] NAM button. This is the SETUP NAME INPUT mode.

3

Input the new SET UP NAME.

### [PARAM] BUTTON

Move the cursor.

You can use up to 16 letters.

### [VALUE] BUTTON

Choose the letters by this.

You can use Large and small characters, digits and signs/symbols.

If you press this button, holding down the [RECORD] button, you can move to the head/the first letter of each type (= space, 0, A, a).

4

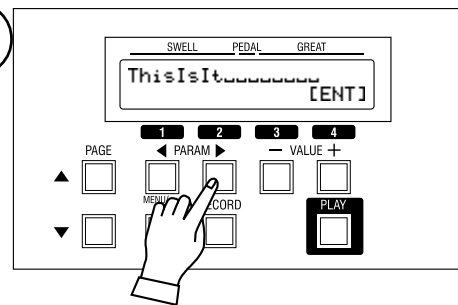

Move the cursor to the right end by the [PARAM] button. [ENT] will be displayed.

5

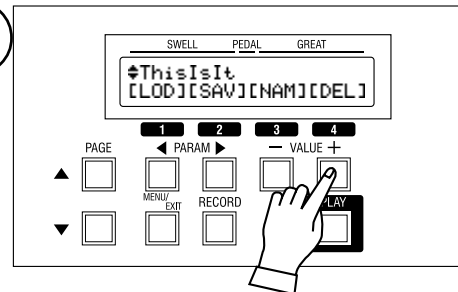

Press the [4] ENT button.

The SETUP NAME will be changed.

## Loading the SETUP

❖ After the operation, the settings already in this organ will be replaced by the newly loaded SETUP.

1

Check the CF card is correctly inserted.

2

```

Amazing Grace
[LOD][SAV][NAM][DEL]
    
```

Navigate to the SETUP mode.

3

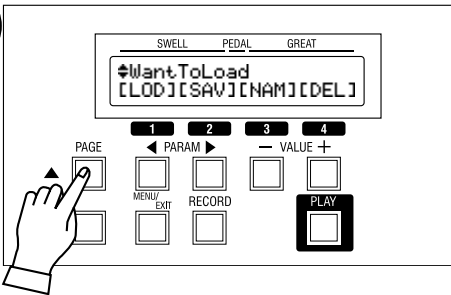

Choose the SETUP file to load by the [PARAM] button.

4

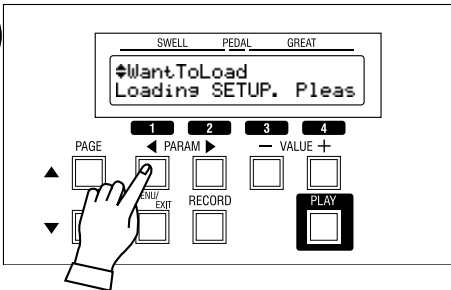

Press the [1] LOD button.

The SETUP will be loaded in a few seconds.

## How to delete the SETUP

1

Check the CF card is correctly inserted.

2

```

Amazing Grace
[LOD][SAV][NAM][DEL]
    
```

Navigate to the SETUP mode.

3

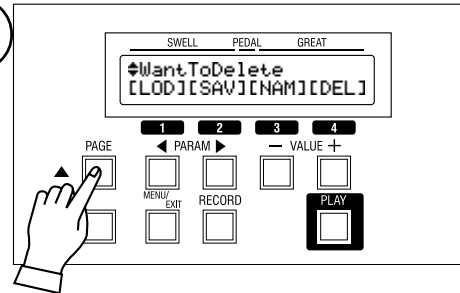

Choose the SETUP file you want to delete by the [PAGE] button.

4

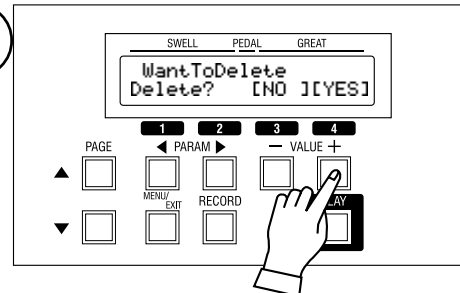

Press the [4] DEL button.

The Confirmation message will be displayed.

5

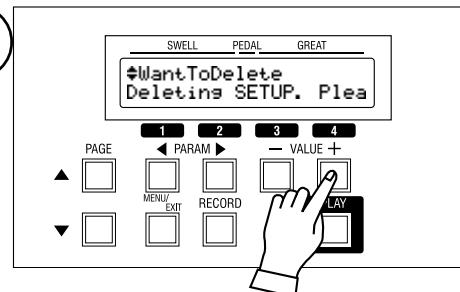

Press the [4] YES button.

The Delete operation starts.

**NOTE:** To cancel the delete action, press the [3] NO button.



A decorative graphic consisting of a large, stylized ampersand (&) on the left side, which curves into a large, thick-lined circle. The text "FREQUENTLY ASKED QUESTIONS" is centered within this circle.

**FREQUENTLY ASKED  
QUESTIONS**

**◆ How to control the leakage sound:**

- ◆ The leakage volume of the whole tone-wheel set currently selected is adjustable by the LEAKAGE Parameter in the DRAWBAR Function mode. (P. 72 #2)  
Adjustment of the leakage interval and or volume per each wheel can be made by using the Custom Tone-wheel. (P. 92)

**◆ How to turn on PEDAL SUSTAIN:**

- ◆ Press [PLAY] and display "P.SUS", then select "ON" by [VALUE]. The length of sustain effects is controlled by the SL parameter in the DRAWBAR function mode. (P. 73 #8)

**◆ How to record other parameters than drawbars to the preset keys:**

- ◆ The memory/record operation on this organ also enables you to record various parameters along with the Drawbar registrations. To set the parameter to call when the preset key is selected, set the parameters on the P. LOAD page in the PRESET function mode. (P. 76)

**◆ How to see the actual values of a preset:**

- ◆ In case the physical location of the controller and the actual value do not exactly match when you call a preset such as the [VIBRATO] tablet, you can display the actual value by operating the controller holding down the [PLAY] button. (P. 78) The actual Drawbar registration is displayed in PLAY mode.

**◆ How to locate each function mode easily?**

- ◆ You can "short-cut" to each function mode by moving some controllers (e.g. tablets, knobs) while pressing the [MENU/EXIT] button.

**◆ How to adjust the Drawbar settings while playing with the Preset C# - A:**

- ◆ To temporarily adjust the Drawbar settings while you are playing with the preset keys [C#] - [A], operate Drawbars holding down the [PLAY] button. (P. 52)

**◆ Relation between the built-in Leslie effect and the external Leslie speaker:**

- ◆ If no Leslie speaker is connected or headphones are used while a Leslie speaker is connected, the built-in Leslie effects are added to both (L & R) channels.
- ◆ If a Leslie speaker is connected, the built-in Leslie effects are added only to the L channel.

**◆ How to avoid adding Leslie effects on the Pedal part:**

- ◆ The Pedal Part sound is independently output at the PEDAL OUT jack. The built-in Leslie effects, Reverb, Tube Buffer do not function at this jack.  
By connecting the PEDAL OUT jack and the PA equipment and setting the SYSTEM-PEDAL PART OUTPUT parameter to "PEDAL", the manual part and the pedal part are separately output to the Leslie speaker and the PEDAL OUT jack respectively (P. 96 #1).

**◆ How to change the motion of the built-in Leslie effect when the Leslie mode switch is set at "STOP".**

- ◆ The default setting of the built-in Leslie effects on this organ is to bypass (thru) when the Leslie mode switch is set at "STOP", so you can enjoy the sound engine's original sound.  
To get the effect of the rotor stop of the Leslie speaker at this time, set the STOP mode at "STOP" in the LESLIE function mode. (P.86 #20)

**◆ How to totally cut off the sound when the expression pedal is returned.**

- ◆ The characteristic of the Expression Pedal can be freely changed.  
To turn off the sound completely when the Expression Pedal is returned, set all the minimum level, limit LF, limit HF at "OFF" in the CONTROL function mode. (P. 91 #5, #6, #7)

- ◆ **Malfunction of the buttons, the keys, etc.**
  - ◆ Turn off the POWER switch once, then turn it on again. If this procedure is not successful, turn off the POWER switch. While pressing the [RECORD] button, turn the POWER switch on again. (Note that in this case, all parameters return to their factory-preset status.)
- ◆ **No sound is produced when the keys are pressed.**
  - ◆ The MASTER VOLUME is at the minimum setting. ⇨  
Adjust the volume with the MASTER VOLUME control. (P. 22 #25)
  - ◆ No Preset key is selected. ⇨  
Select a Preset key.
  - ◆ A plug is inserted to the HEADPHONE jack. ⇨  
While a plug is inserted here, the Leslie speaker is disabled.
- ◆ **The Foot Switch does not work.**
  - ◆ The Foot Switch settings are not correct. ⇨  
Reset the Foot Switch correctly in the CONTROL mode. (P. 91 #4)
- ◆ **The sound does not come out immediately after switched on.**
  - ◆ A Vacuum Tube circuit is mounted in this organ. It takes approximately 10 to 20 seconds after switched on before you will hear the sound.
- ◆ **The sound is not distorted if the OVERDRIVE knob is turned.**
  - ◆ When the Overdrive Expression is at “EX-OD”, it does not distort if the Expression pedal is low. In such a case, increase the Expression pedal, or set the Overdrive Expression at “OD-EX” if you want to distort regardless of the Expression value. (P. 80 #1)
- ◆ **Leslie speaker sound is distorted.**
  - ◆ If the sound is distorted regardless of the position of the volume of the Leslie speaker when you are using a Leslie adapter (such as the 11 pin/6 pin converter), the power of this organ seems to be so large that the sound is distorted inside the Leslie adapter. In such a case, return the [MASTER VOLUME] knob to 10 o'clock position.
- ◆ **The rotor of the external Leslie speaker does not stop, if the Leslie mode is switched to [STOP].**
  - ◆ Some Leslie Speaker models do not [STOP]. [STOP] is possible on 2101/2102, 122XB, 971 and 3300 (current models).
- ◆ **Audio is interrupted when a Combination Preset is selected.**
  - ◆ Between the Combination Presets with different Tonewheel Settings, the sound will be cut off while the Tonewheel Settings are switched.
  - ◆ The sound is once cut between the presets with different key mode (MONO/POLY) on the Pedal part, for switching the sound algorithm.
- ◆ **There is excessive MIDI latency compared to the organ (Drawbar) sound.**
  - ◆ The position of the key contact for MIDI send is deeper than that of the multi-contacts for Drawbars.
  - ◆ There are too many zones to send. ⇨  
Turn [OFF] the switches of unnecessary external zones.
- ◆ **No sounds of Pedal part from the headphones.**
  - ◆ PEDAL OUTPUT set at “PEDOUT”. ⇨  
Set the PEDAL OUTPUT at “BOTH” when using the headphones (P. 96 #1).
- ◆ **Manual contact does not work well.**
  - ◆ The multi-contacts used for the manuals on this organ is designed to be used for a long time. Refer for the contact refreshing procedures to the “Instruction for keyboard contact cleaning function”.  
And, if all the contact points have been worn out and the problem is not solved any longer by refreshing the contacts, please consult your local dealer or store for further maintenance.

◆ How to care for your organ:

- ◆ When you want to clean the keys or cabinets, use only a soft cloth. If they are extremely dirty, use a barely damp cloth with a neutral detergent. Never apply alcohol, thinner or benzine.

◆ There is no MIDI IN jack for the manual part;

- ◆ Because of electro-mechanical direct analog keying mechanism is adopted on this organ, the information of each of the multi-contacts is not defined with a MIDI message.

◆ The Leslie Speed Switch cord is too long:

- ◆ A rather long cord is provided for the Leslie Speed Switch, so the player can move the unit as desired. If it is longer than desired, please bind and fix the extra portion with a wire clamp.

◆ Do I need to oil my organ?

- ◆ There is no part needing oiling on your organ.

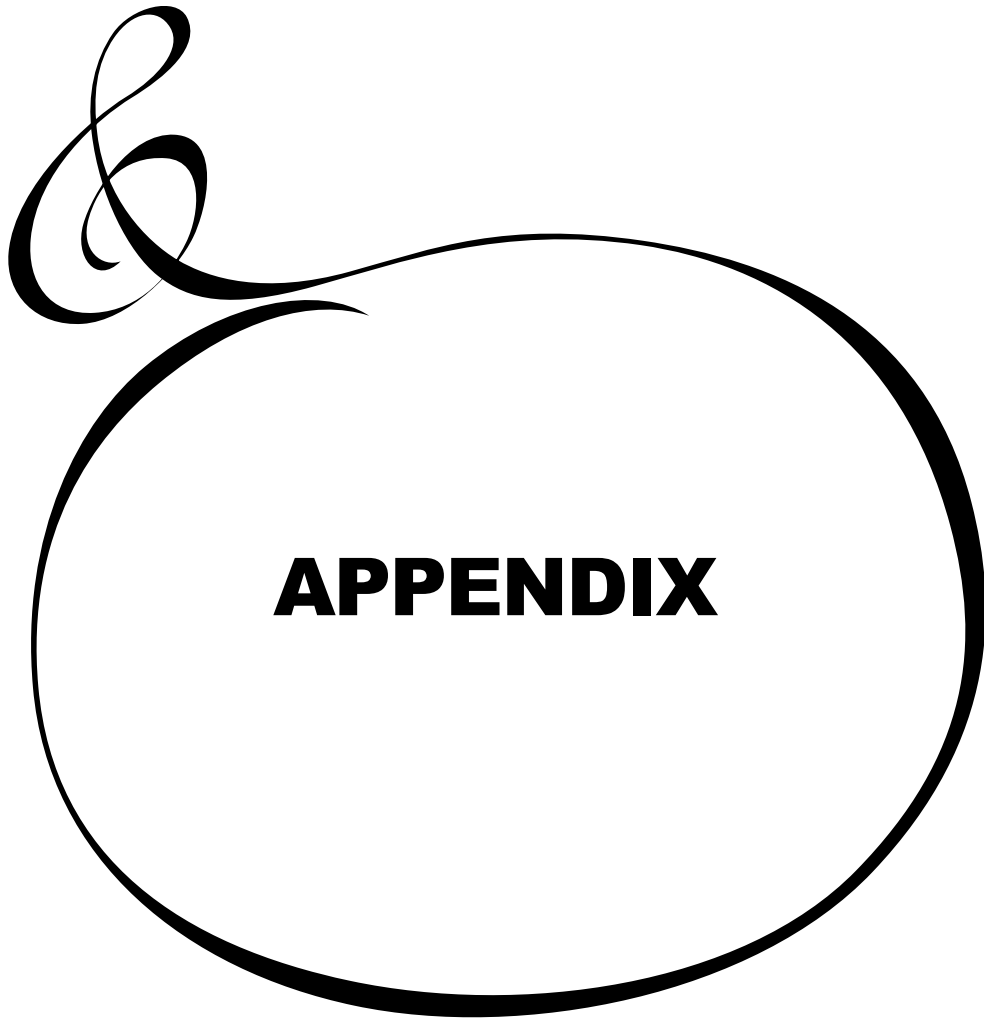

## MIDI IMPLEMENTATION CHART

[Hammond Console Organ]

Date: 9-June-2008

Model: B-3 mk2

MIDI Implementation Chart

Version: 1.0

Function		Transmitted	Recognized	Remarks
Basic Channel	Default Changed	Off 1 - 16	Omni On *****	Tx: External Zones Rx: Pedal Part
Mode	Default Messages Altered	3 X *****	1 X X	
Note Number	: True Voice	12 - 120 *****	36 - 60 36 - 60	
Velocity	Note ON Note OFF	O X	X X	
After Touch	Key's Ch's	X X	X X	
Pitch Bender		X	X	
Control Change	0, 32	O	X	Bank Select MSB, LSB
	7	O	X	Volume
	10	O	X	Pan
	11	O	X	Expression
	64	O	X	Hold 1
	121	O	X	Reset All Controllers
Program Change	: True #	O 0 - 127 *****	X X	
System Exclusive		X	X	
System Common	: Song Position : Song Select : Tune	X X X	X X X	
System Real Time	: Clock : Commands	X X	X X	
Aux Messages	: Local On/Off : All Notes Off : Active Sense : Reset	X O O X	X O O X	

Mode 1: OMNI ON, POLY  
Mode 3: OMNI OFF, POLY

Mode 2: OMNI ON, MONO  
Mode 4: OMNI OFF, MONO

O: Yes  
X: No

## Global Parameters

Category	Global Parameters		
	Parameter	Data Range	Default
Bank Name	(8 Characters)		each bank
Tune	Transpose	-6 - 0 - 6	0
	Master Tune	430 - 440 - 450	440
Expression	Min. Level	Off, -40dB - -0dB	-27dB
	Min. Limit LF	Off, -60dB - -0dB	-20dB
	Min. Limit HF		-30dB
	Curve	00 - 04 (1 - 5)	1
Foot Switch	Mode	Off Leslie C/T (alternate) Leslie C/T (momentarily) Spring Shock Delay Time Reverb Depth	Leslie C/T (alternate)
Motor Control	Bend Time Down	0.1 - 9.9s	5.0s
	Bend Time Up	0.1 - 9.9s	1.0s
	Bend Amplitude	Off / On	On
Combi. Preset Load	Link Great-Pedal (G-P)	Off / On	Off
	Manual Bass (MANBS)	Off / On	Off
	External Zone Swell (EXT-S)	Off / On	Off
	External Zone Great (EXT-G)	Off / On	Off
	Reverb, Equalizer (RV/EQ)	Off / On	Off
	Leslie, Vibrato (ANI/OD)	Off / On	Off
	Registration Swell (SWELL)	Off / On	On
	Registration Great (GREAT)	Off / On	On
	Drawbar (DRAWB)	Off / On	Off
Percussion (PERCUS)	Off / On	Off	

# Preset Parameters

Category	Combination Preset Parameters			
	Parameter	Data Range	P. load	
Swell Drawbar Effect	Leslie Mode	Choral, Stop, Tremolo	ANI/OD	
	Leslie Stop Mode	Through / Stop		
	Leslie Cabinet	1 - 8		
	Vibrato On Swell	Off / On	ANI/OD	
	Vibrato Mode	V1 - C3		
	Vibrato Rate	6.1 - 7.25Hz		
	Vibrato Tremolo	0 - 15		
	Vibrato Cho. Emphasis	0 - 9		
	Vibrato Depth V1	0 - 15		
	Vibrato Depth V2	0 - 15		
	Vibrato Depth V3	0 - 15		
	Vibrato Depth C1	0 - 15		
	Vibrato Depth C2	0 - 15		
	Vibrato Depth C3	0 - 15		
	OD Drive Level	0 - 63		ANI/OD
	OD Exp. Ctrl	Off / On		
	OD Bias	-32 - +31		
	Buffer Amp	Off / On		
	Buffer Bias	-32 - +31		
	EQ Bass Gain	-9 - 0 - +9 dB	EQ/REV	
	EQ Mid Freq	180Hz - 2.9kHz		
	EQ Mid Gain	-9 - 0 - +9 dB		
	EQ Treble Gain	-9 - 0 - +9 dB		
	EQ Tone Control	-9 - 0 - +9		
	Reverb Type	Room 1 Room 2 Live House Hall 1 Hall 2 Church Plate Spring Delay Panning Delay Reverb + Delay	EQ/REV	
	Reverb Depth	0 - 15		
	Reverb Time	0 - 31		
	Reverb Delay Feedback	0 - 96%		
	Reverb Delay Time	4.7 - 1000ms		
	Leslie On Reverb	Off / On		

Category	Combination Preset Parameters		
	Parameter	Data	P. load
Manual Bass	Manual Bass On	Off / On	MANBS
	Manual Bass Range High	1C - 6C	
External Zone	Switch	Off / On	EXT (Swell 1 - Swell 3)  EXT and G-P (Great 1 - Pedal 3)
	Channel	1 - 16, Off	
	Bank MSB	0 - 127	
	Bank LSB	0 - 127	
	Program Change	1 - 128	
	Octave Shift	-2 - 0 - +2	
	Volume	0 - 127	
	Pan	L64 - C - R63	
	Vel. Curve	Off, Normal - Easy	
	Exp. Min	0 - 63	
	Exp. Max	64 - 127	
	Exp. CC#	7, 11	
	Tx. Damper	Off / On	
	Key Range Low	1C - 5B	
	Key Range High	1C# - 6C, Off	



Category	Combination Preset Parameters		
	Parameter	Data	P. load
Swell/ Great Drawbar Voice	Tone-wheel Set	B-Type Mellow	DRAWB
	Leakage Level	0 - 127	
	Fold Back Low	1C - 2C	
	Fold Back High	4G - 5C	
Percussion Voice	Percussion On	Off / On	PERCUS
	Decay Fast	Off / On	
	Soft	Off / On	
	Harmonic	Second / Third	
	Level Soft	1 - 16	
	Level Normal	1 - 16	
	Decay Fast	1 - 15, Cont.	
	Decay Slow	1 - 15, Cont.	
	Drawbar 1' Cancel	Off / On	
	Drawbar Level	0, -3dB	
Swell Drawbars	16'	0 - 8	SWELL
	5 1/3'	0 - 8	
	8'	0 - 8	
	4'	0 - 8	
	2 2/3'	0 - 8	
	2'	0 - 8	
	1 3/5'	0 - 8	
	1 1/3'	0 - 8	
1'	0 - 8		

Category	Great Preset Parameters				
	Parameter	Data	P. load		
Great Drawbars	16'	0 - 8	GREAT		
	5 1/3'	0 - 8			
	8'	0 - 8			
	4'	0 - 8			
	2 2/3'	0 - 8			
	2'	0 - 8			
	1 3/5'	0 - 8			
	1 1/3'	0 - 8			
	1'	0 - 8			
Great Drawbar Effect	Vibrato On Great	Off / On	ANI/OD		
	Vibrato Tablet Great	Great Great and Pedal			
Pedal Drawbar Voice	Tone-wheel Set	Normal Muted Synth 1 Synth 2	DRAWB and G-P		
	Drawbar Attack	Slow Attack No Click Soft Click Normal Click Max Click			
	Sustain On	Off / On			
	Sustain Length	1 - 5			
	Pedal Key Mode	Mono / Poly			
	Decay Length	1 - 5, Cont.			
	Pedal Drawbars	16'		0 - 8	G-P
		8'		0 - 8	
Pedal Sub Drawbars	Normal 16' - 16'	0 - 8	DRAWB and G-P		
	Normal 16' - 5 1/3'	0 - 8			
	Normal 16' - 8'	0 - 8			
	Normal 16' - 4'	0 - 8			
	Normal 16' - 2 2/3'	0 - 8			
	Normal 16' - 2'	0 - 8			
	Normal 16' - 1 3/5'	0 - 8			
	Normal 16' - 1 1/3'	0 - 8			
	Normal 8' - 8'	0 - 8			
	Normal 8' - 4'	0 - 8			
	Normal 8' - 2 2/3'	0 - 8			
	Normal 8' - 2'	0 - 8			
	Normal 8' - 1 3/5'	0 - 8			
	Normal 8' - 1 1/3'	0 - 8			

## Leslie Parameters

Category	Leslie Parameters	
	Parameter	Data Range
Cabinet	Name	(10 Characters)
	Slow Speed Horn	0, 24 - 318rpm
	Slow Speed Bass	0, 24 - 318rpm
	Fast Speed Horn	0, 375 - 453rpm
	Fast Speed Bass	0, 375 - 453rpm
	Rise Time Horn	0.2 - 5.0s
	Rise Time Bass	0.5 - 12.5s
	Fall Time Horn	0.2 - 5.0s
	Fall Time Bass	0.5 - 12.5s
	Brake Time Horn	0.2 - 5.0s
	Brake Time Bass	0.5 - 12.5s
	Volume Horn	-12 - 0dB
	Volume Bass	-12 - 0dB
	Mic. Angle	0 - 180deg
	Mic. Distance	0.3 - 2.7m
	Horn Character	Flat, Mid, Deep
	Amplifier	Solidstate, Tube
Speaker	Rotary Small Rotary Large Stationary	

## System Parameters

Category	System Parameters		
	Parameter	Data Range	Default
Ext. Leslie	Horn	Mellow / Flat	Mellow
Audio	Pedal	Both / Pedal Out	Both
Key Scan	Pedal Rebound	1-128	4
Display	Lock	Off / On	Off

## Sound Generator

Swell and Great  
DTW1 Digital Tone-Wheels

Pedal  
VASE III

## Polyphony

Swell and Great  
Full

Pedal  
8

## Keyboard

Swell and Great  
61-keys (Multi Contact for Drawbars and Rubber Contact for MIDI)  
Direct Analog Keying  
Water Fall type

Pedal (except B-3P mk2)  
25-keys  
Radial Flat type

## Preset Key

Swell and Great  
12-keys (Mechanical Latch)

## Harmonic Drawbars

Swell and Great  
9 Pitches, 2 sets per keyboard  
B-type/Mellow

Pedal  
2 Pitches,  
Muted/Normal/Synth 1/Synth 2

## Percussion

Tablets  
On, Harmonic Selector, Decay, Volume

Adjustable  
Decay (Fast, Slow)  
Level (Soft, Normal)

## Effects

Internal Leslie  
Advanced Digital, 2 Rotors

Vibrato and Chorus  
Digital Scanner  
Swell On, Great On  
V1, V2, V3, C1, C2, C3  
5 Speeds (6.10 - 7.25Hz)  
Tremolo, Emphasis, Depth

Pre-amp  
Vacuum tubes  
(12AU7 for Overdrive and 12AX7 for Buffer)

Equalizer  
3 Bands and Tone Control

Reverb  
11 Programs  
with Leslie on Reverb

Sustain  
5 Lengths (Pedal)

## Coupler

Manual Bass

## Combination Presets

Common  
5 banks

Swell  
9 Presets

Great and Pedal  
9 Presets  
Switchable: Link/Independent  
Pedal

## Controllers

Switches  
Power On / Off  
Motor Control

Rotary Controllers  
Master Volume  
Overdrive  
Bass  
Treble  
Reverb

Foot Controller  
Expression Pedal (with foot switch) except B-3P mk2

## Display

20-characters, 2 lines  
with 9 control switches

## Storage

CompactFlash card slot

## MIDI

Zones  
3 (Swell), 3 (Great), 3 (Pedal)

## Connections

AC Inlet  
MIDI Pedal In, MIDI Out  
Leslie Switch, Main/Echo  
Switch  
Effect Send, Return  
Line In L, R  
Line Out L, R  
Pedal Out  
Headphones  
11-pin Leslie Main, Echo  
Expression Pedal (B-3P mk2 only)  
Pedalboard (B-3P mk2 only)

## Dimension

B-3 mk2  
console only:  
123(W) x 73(D) x 97(H)cm  
48"(W) x 29"(D) x 38"(H)  
with music rack, bench and pedalboard:  
123(W) x 126(D) x 117(H)cm  
48"(W) x 50"(D) x 46"(H)

C-3 mk2  
console only:  
125(W) x 73(D) x 97(H)cm  
49"(W) x 29"(D) x 38"(H)  
with music rack, bench and pedalboard:  
125(W) x 126(D) x 117(H)cm  
49"(W) x 50"(D) x 46"(H)

B-3P mk2  
on stand:  
123(W) x 73(D) x 117(H)cm  
48"(W) x 29"(D) x 38"(H)

## Weight

B-3 mk2  
console only:  
95 kg, 209 lbs  
with music rack, bench and pedalboard:  
132 kg, 291 lbs

C-3 mk2  
console only:  
107kg, 236 lbs  
with music rack, bench and pedalboard:  
144 kg, 318 lbs

B-3P mk2  
console only:  
65 kg, 143 lbs  
with stand:  
85 kg, 187 lbs

## Accessory

B-3 mk2, C-3 mk2  
Pedalboard, Bench  
Music Rack  
CompactFlash card  
Leslie Speed Switch  
AC Cable  
Hexagonal Wrench

B-3P mk2  
Stand, Music Rack  
Expression Pedal  
CompactFlash card  
Leslie Speed Switch  
AC Cable  
Hexagonal Wrench

## FACTORY PRESETS

**1: Liturgic****Swell Keyboard**

Key	Registration	Tone Quality	Loudness
<b>C</b>	N/A	Cancel	N/A
<b>C#</b>	00 5320 000	Stopped Flute	pp
<b>D</b>	00 4432 000	Dulciana	ppp
<b>D#</b>	00 8740 000	French Horn	mf
<b>E</b>	00 4544 222	Salicional	pp
<b>F</b>	00 5403 000	Flutes 8' & 4'	p
<b>F#</b>	00 4675 300	Oboe Horn	mf
<b>G</b>	00 5644 320	Swell Diapason	mf
<b>G#</b>	00 6876 540	Trumpet	f
<b>A</b>	32 7645 222	Full Swell	ff
<b>A#</b>	Drawbars A#	Adjust	N/A
<b>B</b>	Drawbars B	Adjust	N/A

**Great Keyboard**

Key	Registration	Tone Quality	Loudness
<b>C</b>	N/A	Cancel	N/A
<b>C#</b>	00 4545 440	Cello	mp
<b>D</b>	00 4423 220	Flute & String	mp
<b>D#</b>	00 7373 430	Clarinet	mf
<b>E</b>	00 4544 220	Diapason, Gamba and Flute	mf
<b>F</b>	00 6644 322	Great, no reeds	f
<b>F#</b>	00 5642 200	Open Diapason	f
<b>G</b>	00 6845 433	Full Great	ff
<b>G#</b>	00 8030 000	Tibia Clausa	f
<b>A</b>	42 7866 244	Full Great with 16'	fff
<b>A#</b>	Drawbars A#	Adjust	N/A
<b>B</b>	Drawbars B	Adjust	N/A

**2: Jazz****Swell Keyboard**

Key	Registration	Tone Quality
<b>C</b>	N/A	Cancel
<b>C#</b>	88 8000 000	Jimmy 1
<b>D</b>	88 8800 000	Power
<b>D#</b>	88 8800 008	Jimmy 2
<b>E</b>	80 0008 888	Squabble
<b>F</b>	80 0800 000	Walter
<b>F#</b>	88 8000 008	Groove
<b>G</b>	88 8880 000	Pop
<b>G#</b>	88 0888 080	Jackie
<b>A</b>	88 8888 888	All Nine
<b>A#</b>	Drawbars A#	Adjust
<b>B</b>	Drawbars B	Adjust

**Great Keyboard**

Key	Registration	Tone Quality
<b>C</b>	N/A	Cancel
<b>C#</b>	83 8000 000	Jimmy 1 Bass
<b>D</b>	00 8800 000	Accomp.
<b>D#</b>	84 8000 000	Jimmy 2 Bass
<b>E</b>	82 8000 000	Squabble Bass
<b>F</b>	80 8000 000	Smooth Bass
<b>F#</b>	85 8000 000	Groove Bass
<b>G</b>	00 8840 000	Pop Accomp.
<b>G#</b>	84 8010 000	Fat Bass
<b>A</b>	00 8886 540	Full Accomp.
<b>A#</b>	Drawbars A#	Adjust
<b>B</b>	Drawbars B	Adjust

**3: Theatre****Swell Keyboard**

Key	Registration	Tone Quality
<b>C</b>	N/A	Cancel
<b>C#</b>	00 8740 000	French Horn 8'
<b>D</b>	00 8408 004	Tibias 8' & 2'
<b>D#</b>	00 8080 840	Clarinet 8'
<b>E</b>	08 8800 880	Novel Solo 8'
<b>F</b>	60 8088 000	Theatre Solo 16'
<b>F#</b>	00 4685 300	Oboe Horn 8'
<b>G</b>	60 8807 006	Full Tibias 16'
<b>G#</b>	00 6888 654	Trumpet 8'
<b>A</b>	76 8878 667	Full Theatre Brass 16'
<b>A#</b>	Drawbars A#	Adjust
<b>B</b>	Drawbars B	Adjust

**Great Keyboard**

Key	Registration	Tone Quality
<b>C</b>	N/A	Cancel
<b>C#</b>	00 4545 442	Cello 8'
<b>D</b>	00 4432 000	Dulciana 8'
<b>D#</b>	00 4800 000	Vibraharp 8'
<b>E</b>	00 2500 234	Vox 8' & Tibia 4'
<b>F</b>	00 6554 322	String Accomp. 8'
<b>F#</b>	00 5642 200	Open Diapason 8'
<b>G</b>	00 7656 311	Full Accomp. 8'
<b>G#</b>	00 8030 000	Tibia 8'
<b>A</b>	84 7767 666	Bombarde 16'
<b>A#</b>	Drawbars A#	Adjust
<b>B</b>	Drawbars B	Adjust

**4: ShowCase**

**Swell Keyboard**

Key	Registration	Tone Quality
<b>C</b>	N/A	Cancel
<b>C#</b>	68 8000 000	The Gnome (Swell)
<b>D</b>	88 8800 000	Highway Star (Swell)
<b>D#</b>	85 7303 000	Born To Be Wild (Swell)
<b>E</b>	88 8888 888	Telstar (Swell)
<b>F</b>	88 8888 080	HM Soloist (Swell)
<b>F#</b>	77 7331 000	Funky Up (Swell)
<b>G</b>	80 8808 006	Full Tibias (Swell)
<b>G#</b>	88 6000 008	Groove 2 (Swell)
<b>A</b>	87 8878 668	Theatre Brass (Swell)
<b>A#</b>	Drawbars A#	Adjust
<b>B</b>	Drawbars B	Adjust

**Great Keyboard**

Key	Registration	Tone Quality
<b>C</b>	N/A	Cancel
<b>C#</b>	66 6666 888	The Gnome (Great)
<b>D</b>	00 5504 004	Highway Star (Great)
<b>D#</b>	00 5414 004	Born To Be Wild (Great)
<b>E</b>	00 5678 763	Telstar (Great)
<b>F</b>	88 8000 000	HM Soloist (Great)
<b>F#</b>	00 6600 000	Funky Up (Great)
<b>G</b>	00 8630 000	Full Tibias (Great)
<b>G#</b>	00 8855 000	Groove 2 (Great)
<b>A</b>	84 7767 666	Theatre Brass (Great)
<b>A#</b>	Drawbars A#	Adjust
<b>B</b>	Drawbars B	Adjust

This Bank introduces you this organ's advanced features.

Each Preset of this Bank calls out various parameters other than Drawbar registration, such as Leslie, Overdrive.

**5: User**

**Swell Keyboard**

Key	Registration	Tone Quality
<b>C</b>	N/A	Cancel
<b>C#</b>		
<b>D</b>		
<b>D#</b>		
<b>E</b>		
<b>F</b>		
<b>F#</b>		
<b>G</b>		
<b>G#</b>		
<b>A</b>		
<b>A#</b>	Drawbars A#	Adjust
<b>B</b>	Drawbars B	Adjust

**Great Keyboard**

Key	Registration	Tone Quality
<b>C</b>	N/A	Cancel
<b>C#</b>		
<b>D</b>		
<b>D#</b>		
<b>E</b>		
<b>F</b>		
<b>F#</b>		
<b>G</b>		
<b>G#</b>		
<b>A</b>		
<b>A#</b>	Drawbars A#	Adjust
<b>B</b>	Drawbars B	Adjust



Hammond maintains a policy of continuously improving and upgrading its instruments and therefore reserves the right to change specifications without notice. Although every attempt has been made to insure the accuracy of the descriptive contents of this Manual, total accuracy cannot be guaranteed.

Should the owner require further assistance, inquiries should first be made to your Authorized Hammond Dealer. If you still need further assistance, contact Hammond at the following addresses:

**In the United States Contact:**

HAMMOND SUZUKI USA, Inc.  
733 Annoreno Dr.  
Addison, IL 60101  
UNITED STATES

**In Europe contact:**

HAMMOND SUZUKI EUROPE  
B.V.  
IR. D.S. Tuynmanweg 4A  
4131 PN Vianen  
THE NETHERLANDS

**All other countries contact:**

HAMMOND SUZUKI Ltd.  
25-11, Ryoke 2 Chome,  
Naka-ku, Hamamatsu  
430-0852 (Shizuoka)  
JAPAN

Website:  
[www.hammondorganco.com](http://www.hammondorganco.com)

E-mail: [Info@hammondsuzuki.com](mailto:Info@hammondsuzuki.com)  
Website: [www.hammondsuzuki.com](http://www.hammondsuzuki.com)

Website: [www.suzuki-music.co.jp](http://www.suzuki-music.co.jp)

Technical materials are available and can be obtained by mailing a request to the appropriate address listed above marked ATTENTION: SERVICE DEPARTMENT.

Manufacturer:  
SUZUKI MUSICAL INSTRUMENT MFG. CO., Ltd.  
25-12, Ryoke 2 Chome, Naka-ku,  
Hamamatsu 430-0852 (Shizuoka)  
JAPAN





**INSTRUCTION** Please keep this instruction with the attached hex wrench.  
**FOR KEYBOARD CONTACT CLEANING FUNCTION (B-3mk2,C-3mk2)**

**B-3 KEY CONTACT CLEANING**

The B-3/C-3 utilizes multi-contact manuals to produce the drawbar and key click sounds the same way as the original B-3. There are a total of 1220 gold-plated contacts in both manuals. After some extended period of time, the contacts will get dirty and will need to be cleaned.

This condition can be recognized by an increase of key-click noise and intermittent/scratchy sounds from the drawbars. After this condition occurs, the following key-contact procedure needs to be followed.

**PROCEDURE OVERVIEW**

Please refer to the picture below.

There are ten bus bars that cover the distance between key 1 and key 61.

One end of the bus bars are clamped in the Bus Bar Shifter Module.

The Hex wrench is inserted into the hex opening in the center of the module.

Rotating the Hex wrench one complete turn will shift the bus bars through both the right and left limits.

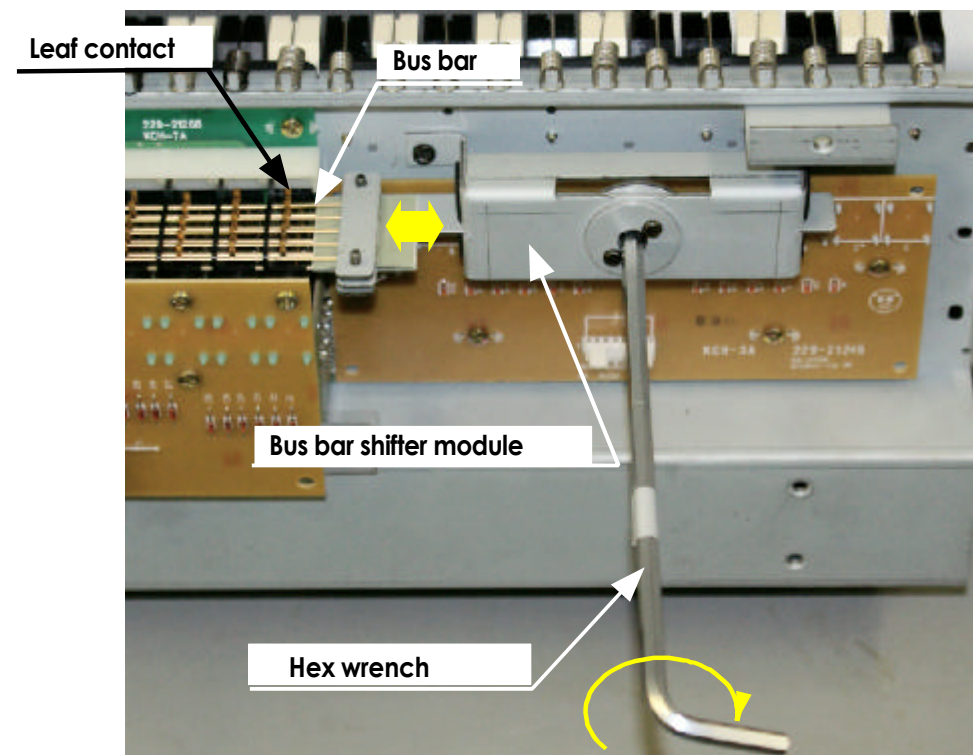

**CLEANING INSTRUCTIONS**



**Lower manual**

Step 1. Remove two(2) big screws, and the wood panel. (see above picture)

Step 2. Locate the adjustment hole behind the BASS knob as shown below. (see left picture below)

Step 3. Insert the hex wrench and rotate slowly until the shifter cam hole is located.

Step 4. Turn the wrench clockwise slowly until turning pressure increases if the wrench turns easily at first. After pressure increases, turn an additional 15 degrees.

Step 5. If turning pressure is high initially, then only turn the wrench 15 degrees and stop.

Step 6. Remove the wrench and check for key noise. If the noise is gone, the contact has been cleaned successfully.

**for Lower manual**

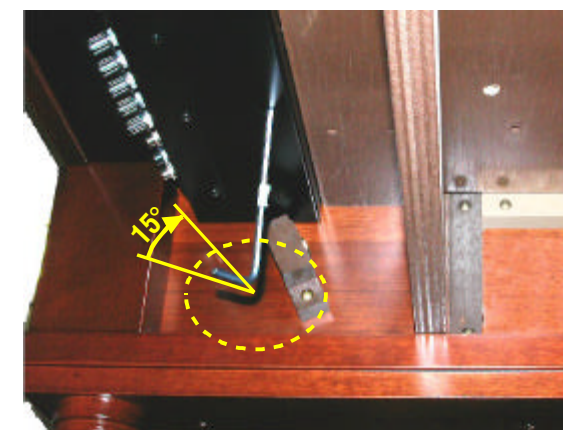

**for Upper manual**

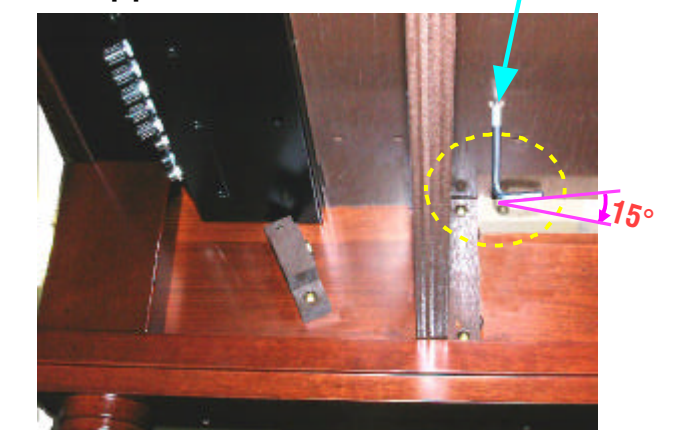

**Upper manual** (see right picture above)

Step 1. Locate the upper manual adjustment hole and insert the hex wrench until the shifter hole is located.

Step 2. Follow steps 3 to 5 above.

**INSTRUCTION** Please keep this instruction with the attached hex wrench.  
**FOR KEYBOARD CONTACT CLEANING FUNCTION (B-3Pmk2)**

**B-3 KEY CONTACT CLEANING**

The B-3/B-3P utilizes multi-contact manuals to produce the drawbar and key click sounds the same way as the original B-3. There are a total of 1220 gold-plated contacts in both manuals. After some extended period of time, the contacts will get dirty and will need to be cleaned.

This condition can be recognized by an increase of key-click noise and intermittent/scratchy sounds from the drawbars. After this condition occurs, the following key-contact procedure needs to be followed.

**PROCEDURE OVERVIEW**

Please refer to the picture below.

There are ten bus bars that cover the distance between key 1 and key 61.

One end of the bus bars are clamped in the Bus Bar Shifter Module.

The Hex wrench is inserted into the hex opening in the center of the module.

Rotating the Hex wrench one complete turn will shift the bus bars through both the right and left limits.

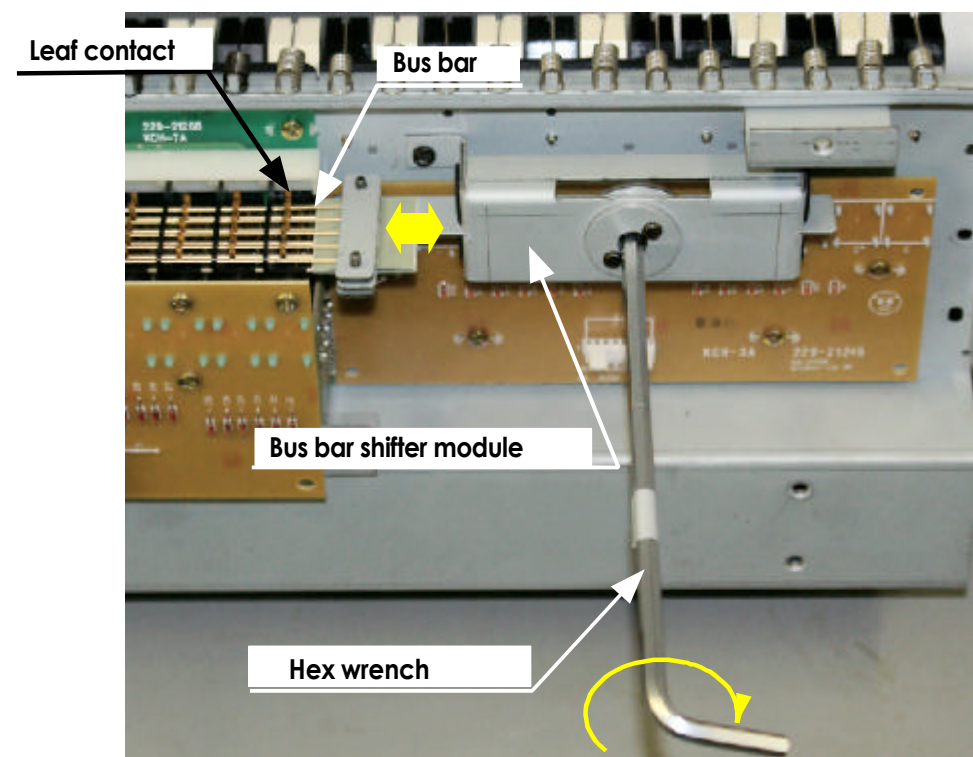

**CLEANING INSTRUCTIONS**

**Lower manual** (see left picture below)

Step 1. Locate the adjustment hole behind the BASS knob as shown below.

Step 2. Insert the hex wrench and rotate slowly until the shifter cam hole is located.

Step 3. Turn the wrench clockwise slowly until turning pressure increases if the wrench turns easily at first. After pressure increases, turn an additional 15 degrees.

Step 4. If turning pressure is high initially, then only turn the wrench 15 degrees and stop.

Step 5. Remove the wrench and check for key noise. If the noise is gone, the contact has been cleaned successfully.

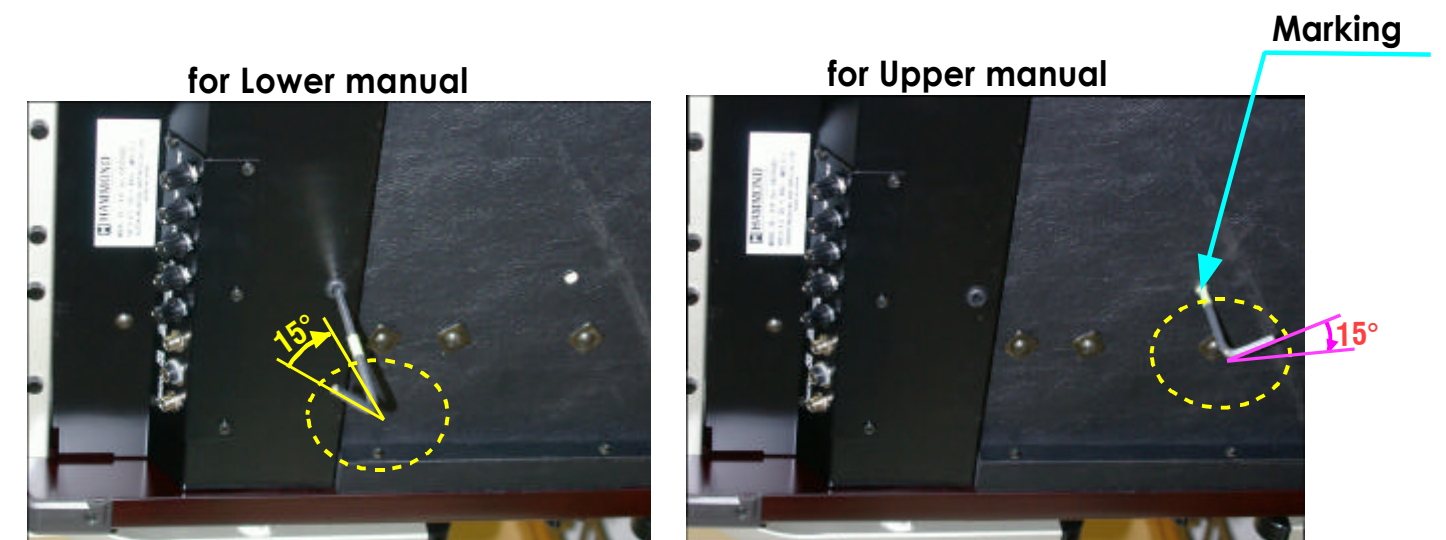

**Upper manual** (see right picture above)

Step 1. Locate the upper manual adjustment hole and insert the hex wrench until the shifter hole is located.

Step 2. Follow steps 3 to 5 above.