



Synology NAS FS3400

Hardware Installation Guide

Table of Contents

Chapter 1: Before You Start

Package Contents.....	3
Synology FS3400 at a Glance.....	4
Hardware Specification.....	5
Optional Accessories.....	6
Safety Instructions.....	8

Chapter 2: Hardware Setup

Tools and Parts for Component Installation.....	9
Install Drives.....	9
Install Memory Modules.....	11
Install PCIe Add-in Cards.....	13
Install and Remove Rail Kits.....	15
Expansion Unit Deployment and Topology.....	17
Start up Your Synology NAS.....	20
LED Indicator Table.....	22

Chapter 3: System Maintenance

Replace System Fan.....	23
Replace Power Supply Unit (PSU).....	25
Initial Troubleshooting Guide.....	25

Chapter 4: Install DSM on Synology NAS



Install DSM with Web Assistant.....	26
Learn More.....	26

Before You Start

Synology NAS FS3400 is an enterprise server consisting of both system hardware and the software operating system, DiskStation Manager (DSM). This manual will guide you through all configuration aspects of your FS3400, including the hardware components, setup procedures, system maintenance, and initial troubleshooting instructions.

Note: All images below are for illustrative purposes only, and may differ from the actual product.

Package Contents

Main unit x 1	AC power cord x 2
	
	<p data-bbox="1043 909 1331 931">Screws for 2.5" drives x 100</p> 

Synology FS3400 at a Glance

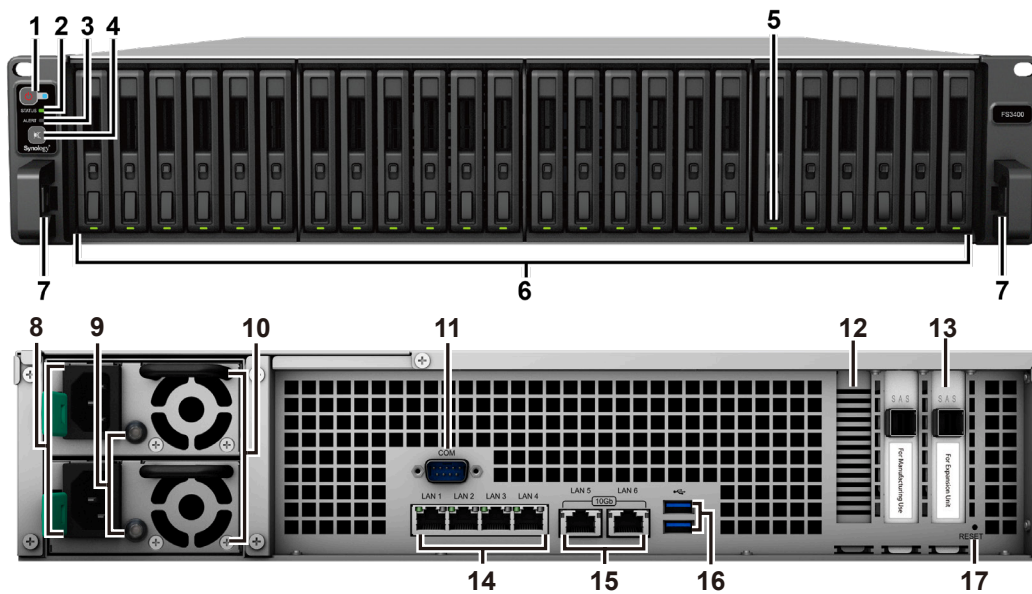

No.	Article Name	Location	Description
1	Power Button and Indicator	Front	1. Press to power on your FS3400. 2. To power off the FS3400, press and hold until you hear a beep sound and the Power LED starts blinking.
2	Status Indicator		Displays the status of the system. For more information, see "LED Indicator Table".
3	Alert Indicator		Displays warnings regarding fan or temperature. For more information, see "LED Indicator Table".
4	Beep Off Button		Press to deactivate the beeping sound that is emitted when a malfunction occurs.
5	Drive Status Indicator		Displays the status of drives. For more information, see "LED Indicator Table".
6	Drive Tray		Install drives (hard disk drives or solid state drives) here.
7	Rail Kit Release Tab		Push in and hold to release your FS3400 from the rail kit lock. ¹
8	Power Port	Back	Connect power cords here.
9	PSU Indicator and Beep Off Button		1. Displays the status of the power supply unit (PSU). For more information, see "LED Indicator Table". 2. Press to deactivate the beeping sound that is emitted when a malfunction occurs.
10	PSU Fan		Disposes of excess heat and cools the PSU.
11	Console Port		This port is reserved for manufacturing use only.
12	PCI Express Expansion Slot		Supports one PCIe x8 add-on network interface card.
13	SAS OUT Port		Connect Synology Expansion Unit to the SAS OUT port on the right side. ²
14	1GbE LAN Port		Connect RJ-45 network cables here.
15	10GBase-T LAN Port		Connect RJ-45 network cables here.
16	USB 3.0 Port		Connect external drives, USB printers, or other USB devices to your FS3400 here.
17	RESET Button		1. Press and hold until you hear a beep sound to restore the default IP address, DNS server, and password for the admin account. 2. Press and hold until you hear a beep sound, then press and hold again until you hear three beep sounds to return the FS3400 to "Not Installed" status so that DiskStation Manager (DSM) can be reinstalled.

¹ For more information about the rail kit installation, please refer to the Quick Installation Guide that comes with the rail kit.

² For more information about Synology Expansion Unit supported by your Synology NAS, please visit www.synology.com.

Hardware Specification

Item	FS3400
Internal Drive	2.5" SAS drive (SSD and HDD) or SATA SSD x 24
Maximum Internal Raw Capacity	184.32 TB (7.68 TB drive x 24)
External Device Port	<ul style="list-style-type: none"> • USB 3.0 x 2 • SAS OUT x 1
LAN Port	<ul style="list-style-type: none"> • 1GbE (RJ-45) x 4 • 10GBase-T (RJ-45) x 2
PCIe Slot	Gen3 x8 slot (x8 link) x 1
Size (H x W x D) (mm)	<ul style="list-style-type: none"> • 88 x 482 x 724 (Including rack mount kits) • 88 x 430.5 x 692 (Not including rack mount kits)
Weight (kg)	14.9
Supported Client	<ul style="list-style-type: none"> • Windows 7 onward • Mac OS X 10.10 onward
File System	<ul style="list-style-type: none"> • Internal: Btrfs, ext4 • External: Btrfs, ext4, ext3, FAT, NTFS, HFS+, exFAT¹
Supported RAID Type	<ul style="list-style-type: none"> • Basic • JBOD • RAID 0 • RAID 1 • RAID 5 • RAID 6 • RAID 10 • Synology RAID F1
Agency Certification	<ul style="list-style-type: none"> • FCC Class A • CE Class A • BSMI Class A
HDD Hibernation	Yes
Scheduled Power On/Off	Yes
Wake on LAN	Yes
Language Localization	<ul style="list-style-type: none"> • English • Deutsch • Français • Italiano • Español • Dansk • Norsk • Svensk • Nederlands • Русский • Polski • Magyar • Português do Brasil • Português Europeu • Türkçe • Český • 日本語 • 한국어 • ไทย • 繁體中文 • 简体中文
Environment Requirement	<ul style="list-style-type: none"> • Line voltage: 100V to 240V AC • Frequency: 50 / 60Hz • Operating Temperature: 32 to 95°F (0 to 35°C) • Storage Temperature: -5 to 140°F (-20 to 60°C) • Relative Humidity: 5% to 95% RH



Note: Model specifications are subject to change without notice. Please refer to www.synology.com for the latest information.

¹ Support for exFAT can be enabled by purchasing and downloading exFAT Access in Package Center.



Optional Accessories

With Synology accessories, you can customize your Synology NAS to fit different business environments without worrying about compatibility and stability. Visit www.synology.com/compatibility for more information.



- **Memory Module**

Model Name	Picture	Description
D4RD-2666-16G		16GB DDR4-2666 ECC Registered DIMM
D4RD-2666-32G		32GB DDR4-2666 ECC Registered DIMM

- **PCIe Add-in Card**

Model Name	Picture	Description
E10G18-T2		Dual-port, 10GbE RJ-45 Network Interface Card
E10G18-T1		Single-port, 10GbE RJ-45 Network Interface Card
E10G17-F2		Dual-port, 10GbE SFP+ Network Interface Card





- **Expansion Unit**

Model Name	Picture	Description
RX1217sas		2U 12-bay Rackmount type expansion unit, compatible with 3.5"/2.5" SAS/SATA drives
RX2417sas		2U 24-bay Rackmount type expansion unit, compatible with 2.5" SAS/SATA drives







- **Rail Kit**

Model Name	Picture	Description
RKS1317		Sliding rails

- **Spare Part**

Model Name	Picture	Description
Disk Tray (Type R1)		2.5" Drive Tray
FAN 80*80*32_6		System Fan Module
PSU 500W-RP Module_2		Redundant PSU Module
PSU 500W-RP SET_2		Redundant PSU Set (Cage x 1, PSU Module x 2)

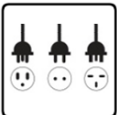
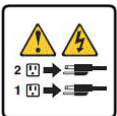
Safety Instructions

	<p>Keep away from direct sunlight and away from chemicals. Make sure the environment does not experience abrupt changes in temperature or humidity.</p>
	<p>Place the product right side up at all times.</p>
	<p>Do not place near any liquids.</p>
	<p>Before cleaning, unplug the power cord. Wipe with damp paper towels. Do not use chemical or aerosol cleaners.</p>
	<p>To prevent the unit from falling over, do not place on carts or any unstable surfaces.</p>
	<p>The power cord must plug in to the correct supply voltage. Make sure that the supplied AC voltage is correct and stable.</p>
	<p>To remove all electrical current from the device, ensure that all power cords are disconnected from the power source.</p>
	<p>Risk of explosion if battery is replaced with an incorrect type. Dispose of used batteries appropriately.</p>

Hardware Setup

Tools and Parts for Component Installation

Please prepare the tools and parts below before setting up your Synology NAS:

- A Screwdriver
- At least one 2.5" SSD (SAS/SATA) or HDD (SAS only) (please visit www.synology.com/compatibility for compatible drive models).

Warning: If you install a drive that contains data, the system will format the drive and erase all existing data. Please back up any important data before installation.

- Rail mounting kit (please see the **Optional Accessories** section to find out the suitable rail kit for cabinet installation)

Warning: We suggest mounting your Synology NAS on a cabinet before installing any drives since the heavy weight will increase the installation difficulty.

Install Drives

Please follow the steps below for drive installation:

- 1 Open the drive tray.

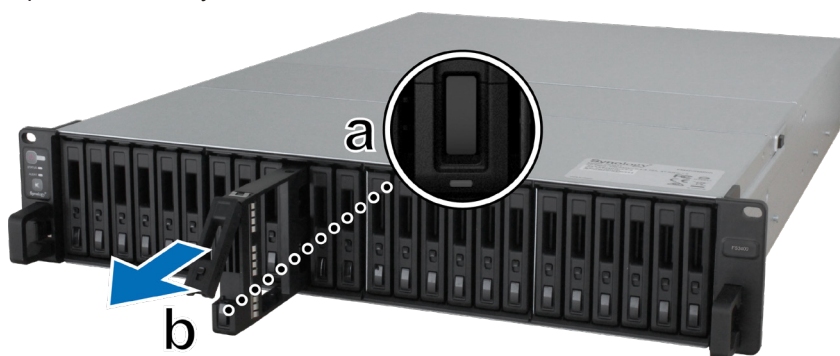

- a Find the small button located on the bottom side of the drive tray handle. Press the button down, and the drive tray handle will pop out.
- b Pull the drive tray handle out as illustrated above.

- 2 Place the drive in the drive tray. Tighten screws into the four spots indicated below to secure the drive.

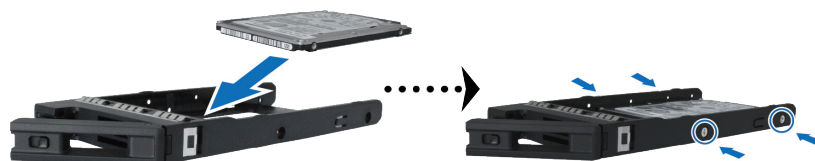

3 Insert the loaded drive tray into the empty drive bay.



Note: Make sure the tray is pushed in all the way. Otherwise, the drive might not be able to function properly.

4 Push the handle inward to secure the drive tray.

5 Push the switch on the drive tray handle to the bottom to lock the drive tray.

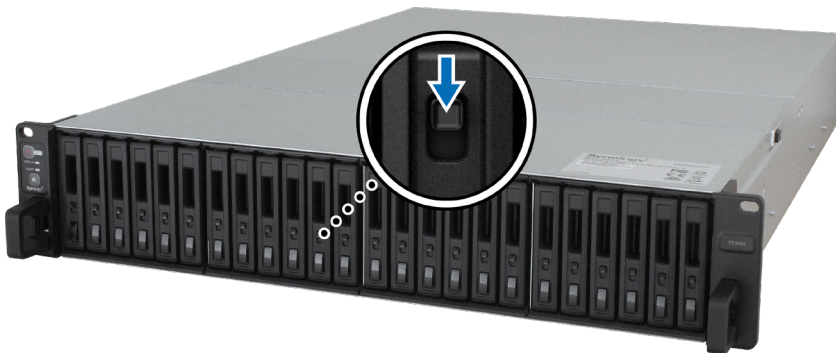

6 Repeat the steps above to assemble the other drives you have prepared.

7 Drives are numbered as shown below.



Note: We suggest installing drives of the same size to optimize drive capacity usage when creating RAID volumes.

Install Memory Modules

You must install genuine Synology memory module(s) to ensure system compatibility and reliability. Please install memory module(s) into the slots as indicated below.

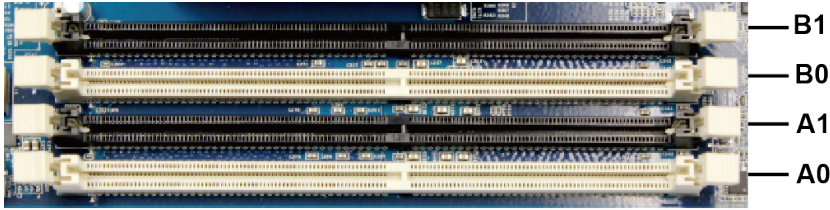

The following table shows the memory configuration for best practice. You must follow the configuration below when upgrading your memory capacity, otherwise system performance and stability may suffer.

A0	A1	B0	B1	Total Memory
16GB	-	-	-	16GB
32GB	-	-	-	32GB
16GB	-	16GB	-	32GB
16GB	16GB	16GB	-	48GB
16GB	16GB	16GB	16GB	64GB
32GB	-	32GB	-	64GB
32GB	32GB	32GB	-	96GB
32GB	32GB	32GB	32GB	128GB

Follow the steps below to install, check, or remove a memory module on your FS3400.

To install the RAM module:

- 1 Shut down your FS3400. Disconnect all cables connected to your FS3400 to prevent any possible damage.
- 2 Remove the screw on the back of FS3400. Pull the rear top cover, and put it aside.

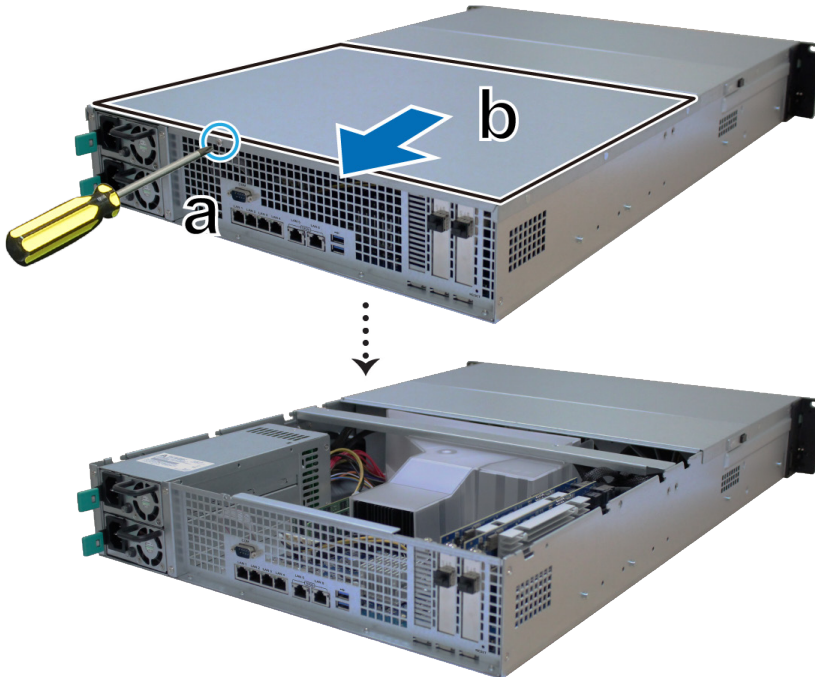

Note: When you remove the rear top cover, you are exposed to sensitive internal components. Avoid touching anything other than the memory assembly when you remove or add memory.

- 3 Insert the new memory module in the slot:
 - a Push the retaining clips on the slot out to the sides.
 - b Align the notch on the gold edge of the module with the notch in the memory slot.
 - c Push down on the memory module with firm and even pressure. The retaining clips will snap into position as the module is correctly inserted.

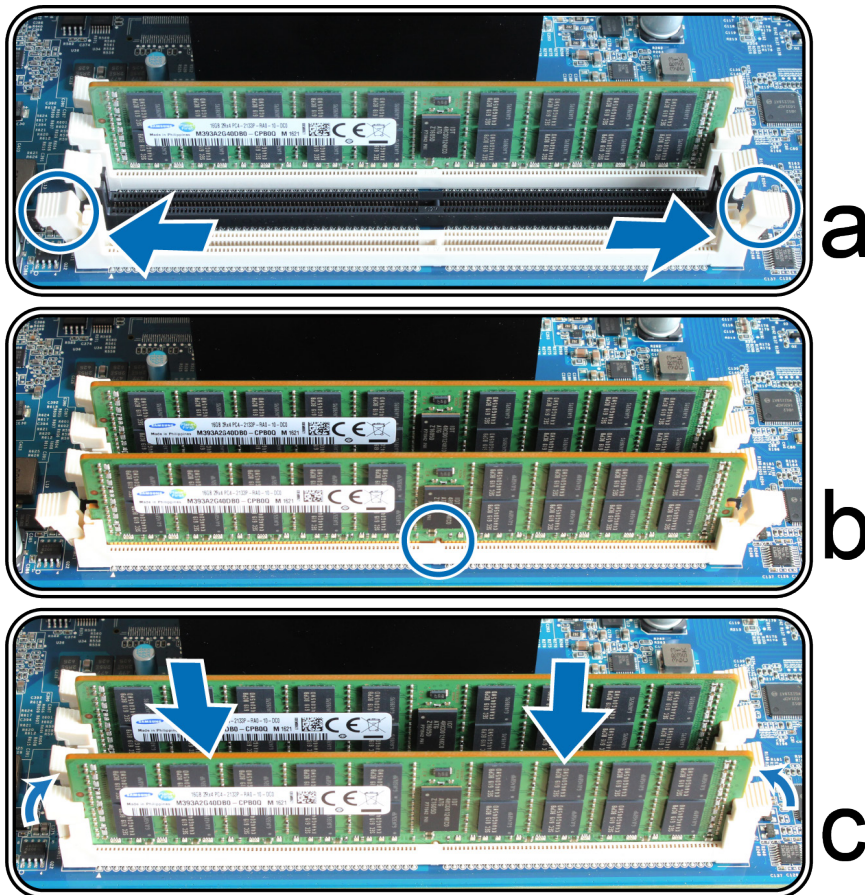

Note: Hold the memory module by its edges, and do not touch the gold connectors.

- 4 Put back the rear top cover you lifted in step 2.
 - a Align the hexagons at the side of rear top cover with the slots on the chassis' edge, and push the rear top cover back in position.

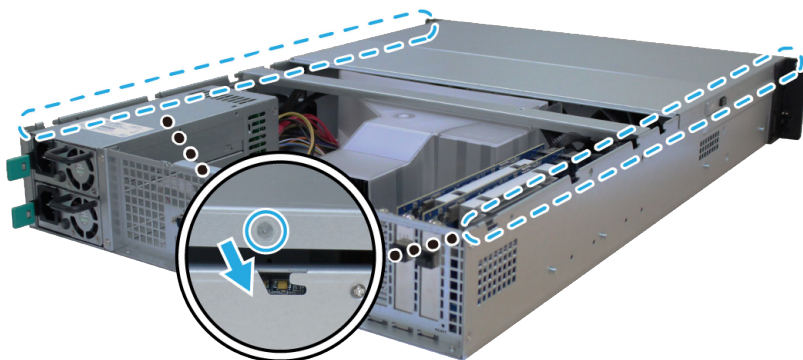

- b Put back and fasten the screw you removed in step 2.

To make sure FS3400 recognizes the new memory capacity:

- 1 Log in to DSM as **admin** or a user belonging to the **administrators** group.
- 2 Check **Total Physical Memory** in **Control Panel > Info Center**.

To remove the RAM Module:

- 1 Follow step 1 and 2 of the **To install the RAM module** section to shut down your FS3400, disconnect the cables, and then remove the rear top cover.
- 2 Cut the cable tie before removing the memory module. (The pre-installed memory module is cable tied to prevent loosening during delivery.)

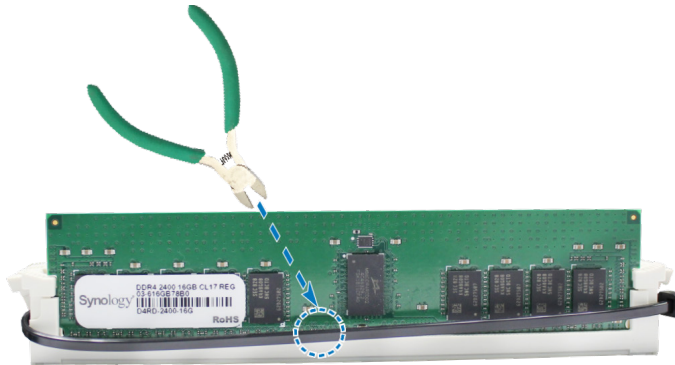

Note: Avoid touching any components of the motherboard when you cut the cable tie.

- 3 Disengage the memory retaining clips by pushing them outwards, and the module will pop out of the slot.
- 4 Follow step 4 of the **To install the RAM module** section to put back the top cover.

Install PCIe Add-in Cards

FS3400 provides one PCIe x8 slot for optional add-in card expansion, allowing network interface cards to be installed.

To install the network interface cards:

- 1 Shut down your FS3400. Disconnect all cables connected to your FS3400 to prevent any possible damages.
- 2 Open the FS3400 by following step 2 of the **To install the RAM module** section.
- 3 Install the network interface card.
 - a Remove the screw that secures the expansion slot's cover.
 - b Lift the expansion slot's cover.

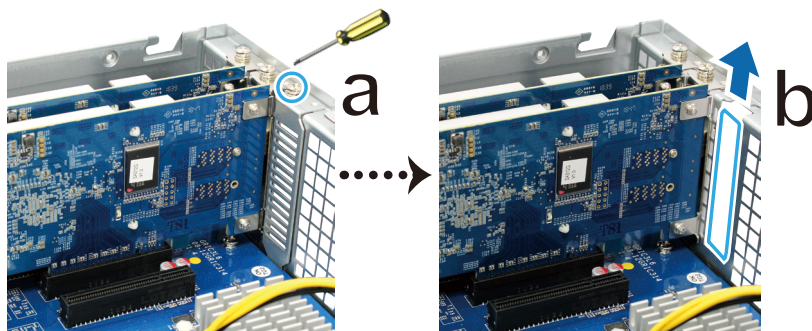

c Align the card's connector with the expansion slot, and insert the card into the slot.

C

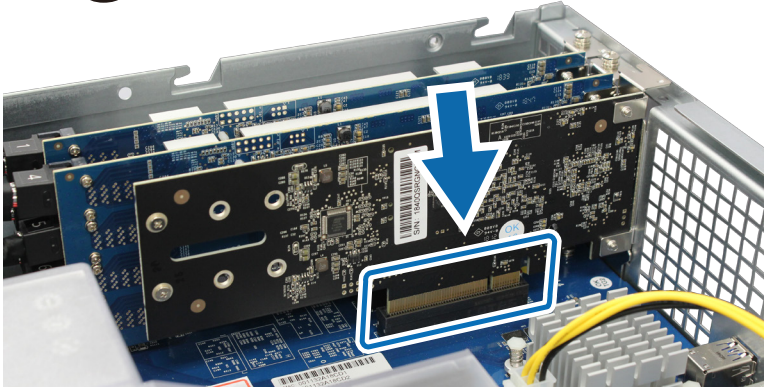

Note: Make sure the connector is fully inserted. Otherwise, the network interface card might not be able to function properly.

d Put back and fasten the screw that you removed in step 3-a so as to secure the newly inserted card.

d

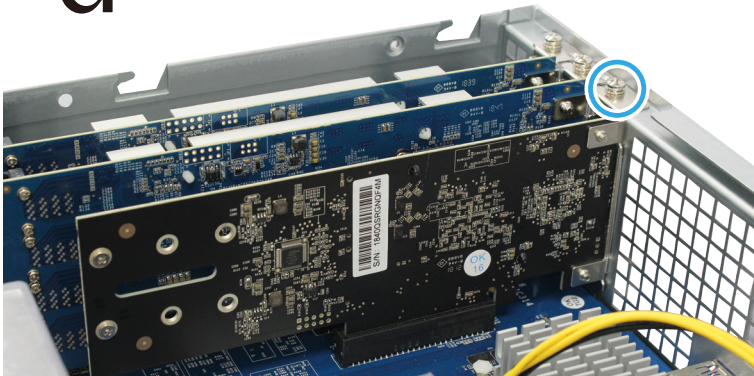

4 Repeat step 3 to install the other network interface card for your FS3400.

5 Put back the rear top cover by following step 4 of the **To install the RAM module** section.

Install and Remove Rail Kits

Here we use RKS1317 as an example to illustrate how to install or remove the rail kits. For more information about the rail kit installation, please refer to the Quick Installation Guide that comes with the rail kit.

To install the rail kit:

- 1 To install the rail kit to the rack
 - a Attach the rear end of the rail kit assembly to the rack.
 - b Slide the front latch outwards and insert the brackets into the rack holes.

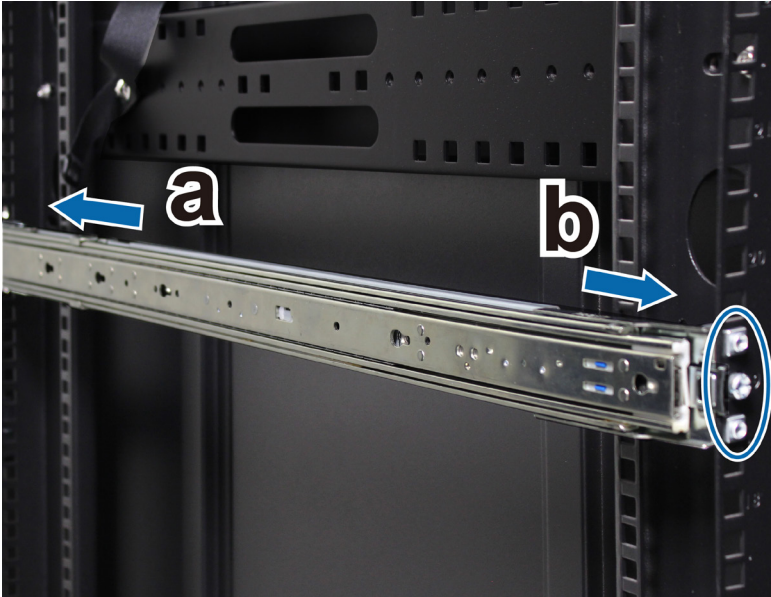

- 2 Extend and pull out the inner rail from the assembly.

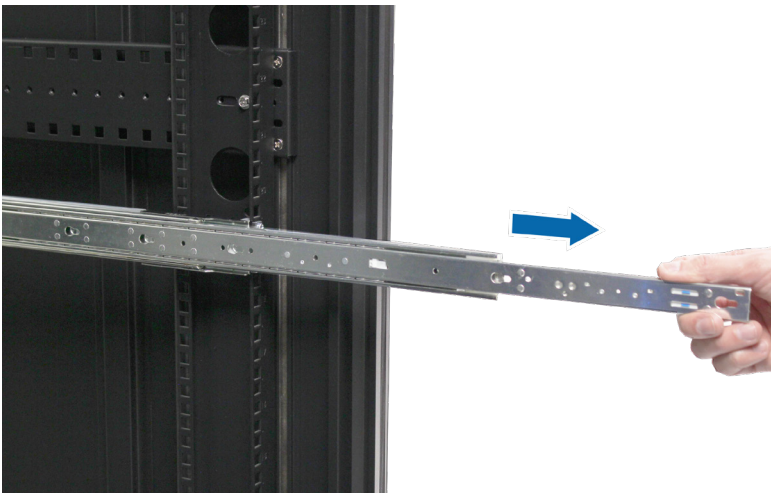

3 Align the fixing holes of the inner rail to the side of the chassis and slide backward to attach the inner rail.

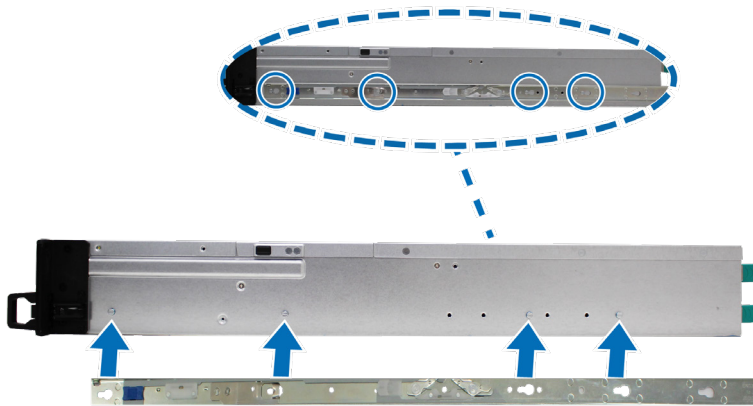

4 With the help of another person, carefully align the inner rail to the outer rail assembly.

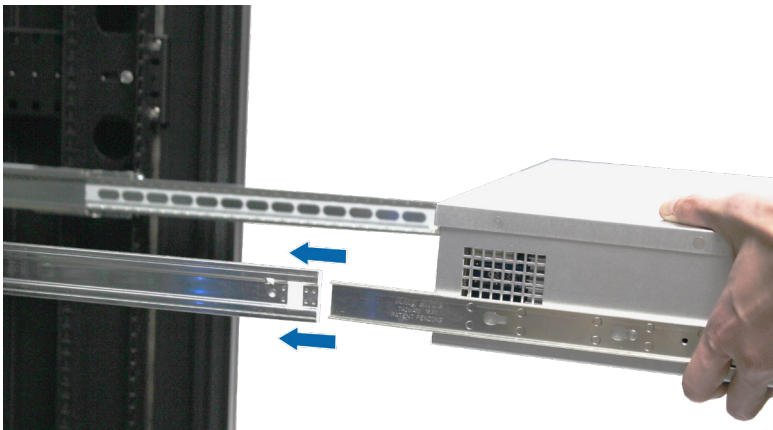

5 Push the chassis towards the rack. Use the cage nuts and screws in the rail kit package to secure the chassis to the rack if necessary.



To remove the rail kit:

- 1 To remove the chassis from the rack, hold the rail kit release tabs on the ear holders and pull out the chassis from the rack.



- 2 With the help of another person, carefully remove the chassis from the rack. Then, slide forwards to remove the inner rail from the chassis.

Expansion Unit Deployment and Topology

FS3400 supports up to two expansion units connection with RX2417sas (24-bay) and RX1217sas (12-bay), providing seamless storage expansion whenever needed. This section will guide you through how to connect the expansion units to your Synology NAS.

To connect RX1217sas/RX2417sas with FS3400:

- 1 Connect one end of the expansion cable to the SAS OUT port of your FS3400 and the other to the SAS IN port of RX1217sas/RX2417sas. Make sure the release band (in blue) of the cable faces **rightward** when plugging into the FS3400, and that of the cable faces **upward** when plugging into RX1217sas/RX2417sas; otherwise, the FS3400 and expansion unit will not be correctly connected.

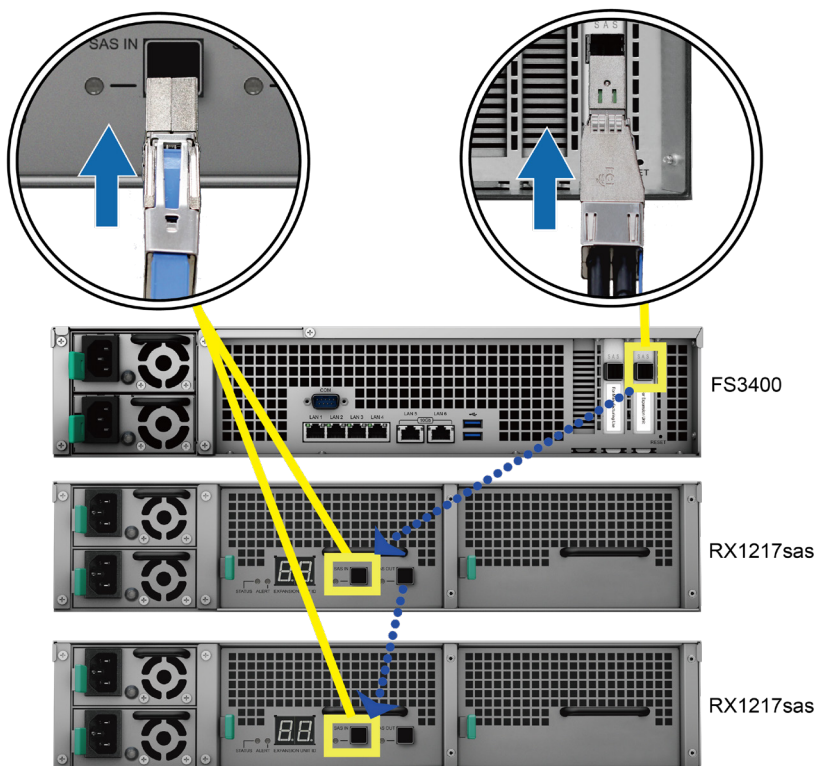

- 2 Connect one end of the power cord(s) to the power port of RX1217sas/RX2417sas, and the other to the power outlet(s). RX1217sas/RX2417sas will automatically power on once the power cords are correctly connected.

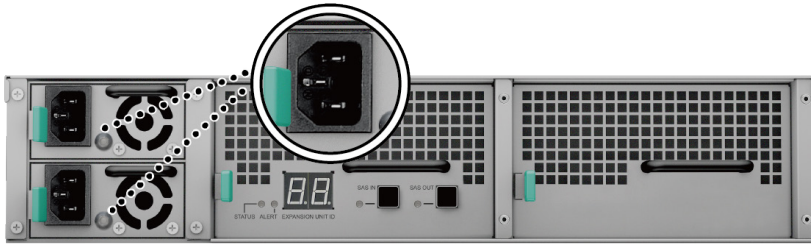

Note: Your RX1217sas/RX2417sas comes equipped with a redundant power supply system, allowing two power cords to be connected. The system may be powered on with only one power cord, but we recommend using two power cords to avoid unexpected power failures.

Important: Do not remove the expansion cable while the host device is still powered on. Doing so may result in data loss.

- 3 Press the power button on the front panel to power on your FS3400. The expansion unit ID of RX1217sas/RX2417sas connected to FS3400 will be displayed in sequence on the back panel.

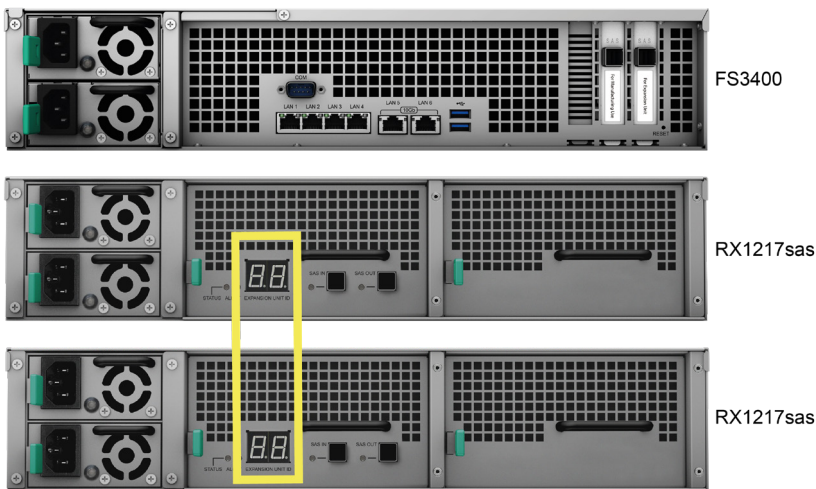

Note: Even with the Synology NAS and expansion unit(s) powered on, you can still expand with one or more expansion unit if needed. To do so, repeat above steps to connect the expansion cables and power cords of the other expansion units. Your expansion units will automatically power on if they are correctly connected, and the expansion unit ID will be displayed accordingly after a few seconds (if DSM is correctly installed in the Synology NAS server).

Start up Your Synology NAS

To start up your FS3400:

- 1 Connect one end of each power cord to the power ports located on the back of the FS3400 and the other end to a power outlet.
- 2 Connect at least one LAN cable to one of the LAN ports and the other end to your switch, router, or hub.

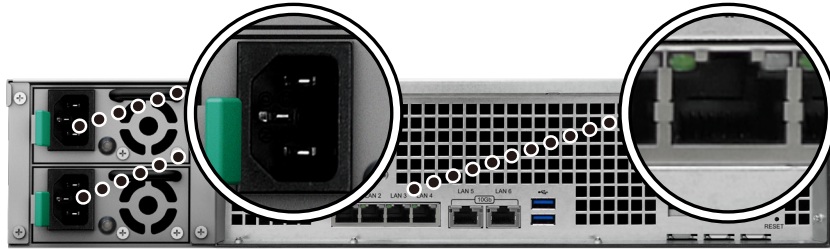

- 3 Press the power button to turn on the FS3400.



Congratulations! Your Synology NAS is now online and detectable from a network computer.

LED Indicator Table

LED Indicator	Color	Status	Description
Power	Blue	Static	Powered on
		Blinking	Booting up / Shutting down
	Off		Powered off
STATUS	Green	Static	Volume normal
	Orange	Blinking	Volume degraded / Volume crashed
			Volume not created
	Off		DSM not installed
Off		HDD hibernation	
ALERT	Orange	Blinking	Fan failure / Over temperature
	Off		System normal
Drive Status Indicator (on tray)	Green	Static	Drive ready and idle
		Blinking	Accessing drive
	Red	Static	Drive error / Port disabled ¹
	Off		No internal drive
PSU Indicator	Green	Static	Power supply unit normal
	Off		Power supply unit off
Rear 1GbE LAN (on left side of jack)	Green	Static	Network connected
		Blinking	Network active
	Off		No network
Rear 1GbE LAN (on right side of jack)	Green	Static	1 Gbps connected
	Orange	Static	100 Mbps connected
	Off		10 Mbps connected / No network
Rear 10GbE LAN (on left side of jack)	Green	Static	Network connected
		Blinking	Network active
	Off		No network
Rear 10GbE LAN (on right side of jack)	Green	Static	10 Gbps connected
	Orange		1 Gbps connected
	Off		No network

Note: Model specifications are subject to change without notice. Please refer to www.synology.com for the latest information.

¹ Please try to restart your Synology NAS or re-insert the drive(s), and then run the HDD/SSD manufacturer's diagnostic tool to check the health status of the drive(s). If you can log into DSM, please run the built-in S.M.A.R.T. test to scan the drive(s). If the problem remains unresolved, please contact Synology Technical Support for help.

System Maintenance

Replace System Fan

If a system fan malfunctions, please see the instructions below to open the case of FS3400 and replace the malfunctioning fan.

- 1 Press the small buttons located on the sides of the FS3400.



- 2 Lift to remove the fan cover.



- 3 Fans are numbered as indicated below.



4 Find the malfunctioning fan. Lift the fan upward to remove it.

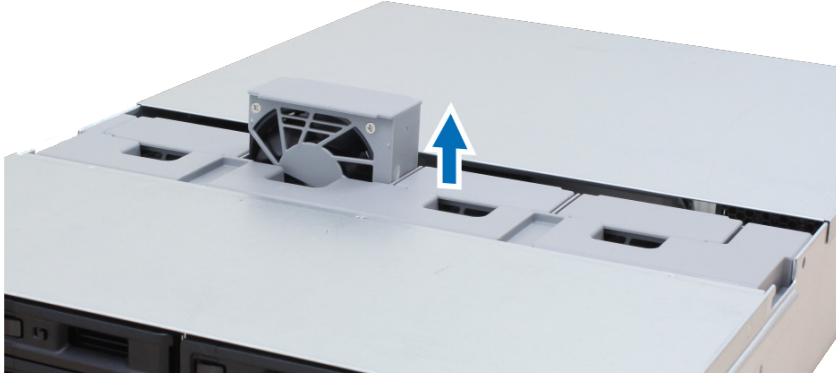

5 Prepare a new fan, and slide it into the FS3400. Make sure the fan is aligned properly as illustrated below.

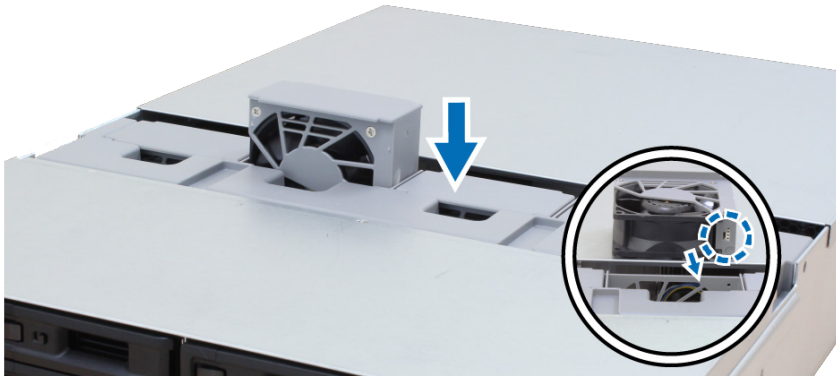

Replace Power Supply Unit (PSU)

If a PSU or its fan malfunctions, please see the instructions below to replace the malfunctioning PSU.

- 1 Unplug the power cord from the PSU to be replaced.

Note: By pressing the **Beep Off** button, you can silence the long beeping sound when you hear it.

- 2 Push the lever of the PSU at the back panel in the indicated direction.
- 3 Pull out the PSU from your FS3400.

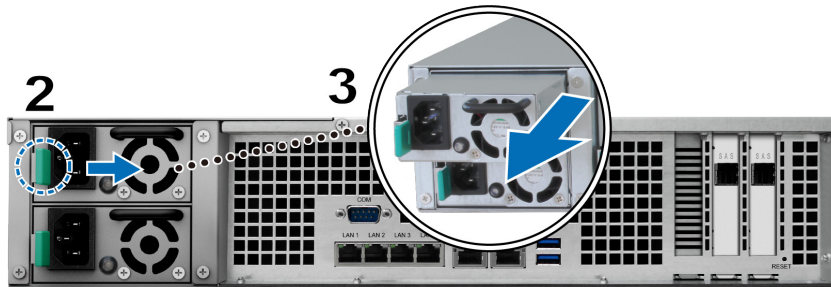

- 4 Prepare a new PSU, and push it back to the slot until you hear a click.

Initial Troubleshooting Guide

We have selected several helpful articles on frequently asked questions to help you do initial troubleshooting on your Synology NAS:

- General
 - [What can I do to troubleshoot NAS connection problems?](#)
 - [What is the width of my Synology NAS server?](#)
- Hard Disk Drive
 - [How to choose the right HDD for my Synology NAS](#)
 - [How to diagnose drives' health status when receiving bad sector warning](#)
 - [How to fix hard drive failure and retrieve the data from your hard drives](#)
- Memory
 - [Are there any requirements for installing or expanding system memory capacity?](#)
 - [How can I run a memory test on my Synology NAS?](#)
 - [Why is there a startup delay after a memory upgrade?](#)
- LED
 - [How do I recognize a hibernating Synology NAS via the LED indicators?](#)
 - [What can I do if the STATUS LED keeps flashing in orange?](#)
 - [Why am I unable to install my Synology NAS and why is the Power LED indicator flashing constantly?](#)
 - [Why are the LED indicators on the LAN ports of my Synology NAS not working?](#)
- Fan
 - [What type of fan speed modes are available on my Synology NAS?](#)

Install DSM on Synology NAS

After hardware setup is finished, please install DiskStation Manager (DSM) – Synology’s browser-based operating system – on your FS3400.

Install DSM with Web Assistant

Your FS3400 comes with a built-in tool called **Web Assistant** that helps you download the latest version of DSM from the Internet and install it on your FS3400. To use Web Assistant, please follow the steps below.

- 1 Power on your FS3400.
- 2 Open a web browser on a computer connected to the same network as the FS3400.
- 3 Enter either of the following into the address bar of your browser:
 - a find.synology.com
 - b synologynas:5000
- 4 Web Assistant will be launched in your web browser. It will search for and find the Synology NAS within the local network. The status of the FS3400 should be **Not Installed**.

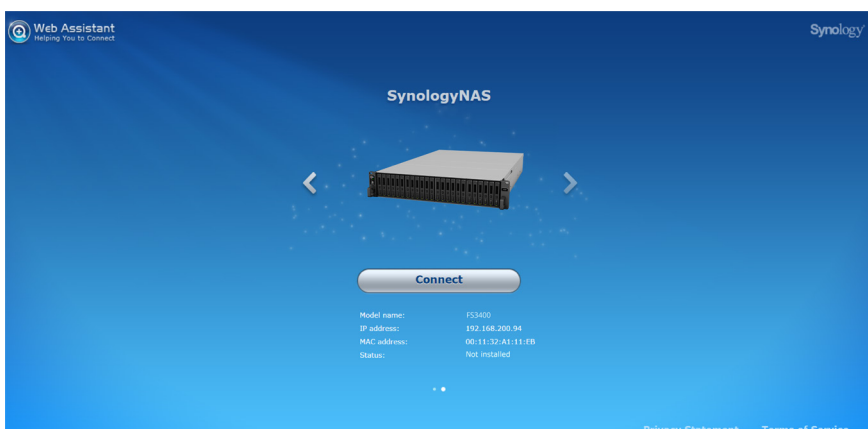

- 5 Click **Connect** to start the setup process and follow the onscreen instructions.

Note:

1. The Synology NAS must be connected to the Internet to install DSM with Web Assistant.
2. Suggested browsers: Chrome, Firefox.
3. Both the Synology NAS and the computer must be in the same local network.

- 6 If you accidentally leave the installation process before it is finished, log in to the DSM as **admin** (default administrative account name) with the password left blank.

Learn More

Congratulations! Your FS3400 is now ready for action. For more information or online resources about your FS3400, please visit www.synology.com.

SYNOLOGY, INC. END USER LICENSE AGREEMENT

IMPORTANT—READ CAREFULLY: THIS END USER LICENSE AGREEMENT ("EULA") IS A LEGAL AGREEMENT BETWEEN YOU (EITHER AN INDIVIDUAL OR A LEGAL ENTITY) AND SYNOLOGY, INC. ("SYNOLOGY") FOR THE SYNOLOGY SOFTWARE INSTALLED ONTO THE SYNOLOGY PRODUCT PURCHASED BY YOU (THE "PRODUCT"), OR LEGALLY DOWNLOADED FROM WWW.SYNOLOGY.COM, OR ANY OTHER CHANNEL PROVIDED BY SYNOLOGY ("SOFTWARE").

YOU AGREE TO BE BOUND BY THE TERMS OF THIS EULA BY USING THE PRODUCTS CONTAINING THE SOFTWARE, INSTALLING THE SOFTWARE ONTO THE PRODUCTS OR DEVICE CONNECTED TO THE PRODUCTS. IF YOU DO NOT AGREE TO THE TERMS OF THIS EULA, DO NOT USE THE PRODUCTS CONTAINING THE SOFTWARE OR DOWNLOAD THE SOFTWARE FROM WWW.SYNOLOGY.COM, OR ANY OTHER CHANNEL PROVIDED BY SYNOLOGY. INSTEAD, YOU MAY RETURN THE PRODUCT TO THE RESELLER WHERE YOU PURCHASED IT FOR A REFUND IN ACCORDANCE WITH THE RESELLER'S APPLICABLE RETURN POLICY.

Section 1. Limited Software License. Subject to the terms and conditions of this EULA, Synology grants you a limited, non-exclusive, non-transferable, personal license to install, run and use one copy of the Software loaded on the Product or on your device connected to the Product solely relating to your authorized use of the Product.

Section 2. Documentation. You may make and use a reasonable number of copies of any documentation provided with the Software; provided that such copies will only be used for internal business purposes and are not to be republished or redistributed (either in hard copy or electronic form) to any third party.

Section 3. Backup. You may make a reasonable number of copies of the Software for backup and archival purposes only.

Section 4. Updates. Any software provided to you by Synology or made available on the Synology website at www.synology.com ("Website") or any other channel provided by Synology that updates or supplements the original Software is governed by this EULA unless separate license terms are provided with such updates or supplements, in which case, such separate terms will govern.

Section 5. License Limitations. The license set forth in Sections 1, 2 and 3 applies only to the extent that you have ordered and paid for the Product and states the entirety of your rights with respect to the Software. Synology reserves all rights not expressly granted to you in this EULA. Without limiting the foregoing, you shall not authorize or permit any third party to: (a) use the Software for any purpose other than that in connection with the Product; (b) license, distribute, lease, rent, lend, transfer, assign or otherwise dispose of the Software; (c) reverse engineer, decompile, disassemble or attempt to discover the source code of or any trade secrets related to the Software, except and only to the extent that such conduct is expressly permitted by applicable law notwithstanding this limitation; (d) adapt, modify, alter, translate or create any derivative works of the Software; (e) remove, alter or obscure any copyright notice or other proprietary rights notice on the Software or Product; or (f) circumvent or attempt to circumvent any methods employed by Synology to control access to the components, features or functions of the Product or Software. Subject to the limitations specified in this Section 5, you are not prohibited from providing any services hosted by Synology NAS server to any third party for commercial purpose.

Section 6. Open Source. The Software may contain components licensed to Synology under the GNU General Public License ("GPL Components"), currently available at <http://www.gnu.org/licenses/gpl.html>. The terms of the GPL will control solely with respect to the GPL Components to the extent that this EULA conflicts with the requirements of the GPL with respect to your use of the GPL Components, and, in such event, you agree to be bound by the GPL with respect to your use of such components.

Section 7. Audit. Synology will have the right to audit your compliance with the terms of this EULA. You agree to grant Synology a right to access to your facilities, equipment, books, records and documents and to otherwise reasonably cooperate with Synology in order to facilitate any such audit by Synology or its agent authorized by Synology.

Section 8. Ownership. The Software is a valuable property of Synology and its licensors, protected by copyright and other intellectual property laws and treaties. Synology or its licensors own all rights, titles and interests in and to the Software, including but not limited to copyright and any other intellectual property rights.

Section 9. Limited Warranty. Synology provides a limited warranty that the Software will substantially conform to Synology's published specifications for the Software, if any, or otherwise set forth on the Website, for a period required by your local law. Synology will use commercially reasonable efforts to, in Synology's sole discretion, either correct any such nonconformity in the Software or replace any Software that fails to comply with the foregoing warranty, provided that you give Synology written notice of such noncompliance within the warranty period. The foregoing warranty does not apply to any noncompliance resulting from any: (w) use, reproduction, distribution or disclosure not in accordance with this EULA; (x) any customization, modification or other alteration of the Software by anyone other than Synology; (y) combination of the Software with any product, services or other items provided by anyone other than Synology; or (z) your failure to comply with this EULA.

Section 10. Support. During the period specified in the Section 9, Synology will make available to you the support services. Following the expiration of the applicable period, support for Software may be available from Synology upon written

request.

Section 11. Disclaimer of Warranties. EXCEPT AS EXPRESSLY SET FORTH ABOVE, THE SOFTWARE IS PROVIDED "AS IS" AND WITH ALL FAULTS. SYNOLOGY AND ITS SUPPLIERS HEREBY DISCLAIM ALL OTHER WARRANTIES, EXPRESS, IMPLIED OR STATUTORY, ARISING BY LAW OR OTHERWISE, INCLUDING BUT NOT LIMITED TO ANY IMPLIED WARRANTIES OF MERCHANTABILITY, FITNESS FOR A PARTICULAR PURPOSE OR USE, TITLE AND NONINFRINGEMENT, WITH REGARD TO THE SOFTWARE. WITHOUT LIMITING THE FOREGOING, SYNOLOGY DOES NOT WARRANT THAT THE SOFTWARE WILL BE FREE OF BUGS, ERRORS, VIRUSES OR OTHER DEFECTS.

Section 12. Disclaimer of Certain Damages. IN NO EVENT WILL SYNOLOGY OR ITS LICENSORS BE LIABLE FOR ANY INCIDENTAL, INDIRECT, SPECIAL, PUNITIVE, CONSEQUENTIAL OR SIMILAR DAMAGES OR LIABILITIES WHATSOEVER (INCLUDING, BUT NOT LIMITED TO LOSS OF DATA, INFORMATION, REVENUE, PROFIT OR BUSINESS) ARISING OUT OF OR RELATING TO THE USE OF OR INABILITY TO USE THE SOFTWARE OR OTHERWISE UNDER OR IN CONNECTION WITH THIS EULA OR THE SOFTWARE, WHETHER BASED ON CONTRACT, TORT (INCLUDING NEGLIGENCE), STRICT LIABILITY OR OTHER THEORY EVEN IF SYNOLOGY HAS BEEN ADVISED OF THE POSSIBILITY OF SUCH DAMAGES.

Section 13. Limitation of Liability. SYNOLOGY'S AND ITS SUPPLIERS' LIABILITY ARISING OUT OF OR RELATING TO THE USE OF OR INABILITY TO USE THE SOFTWARE OR OTHERWISE UNDER OR IN CONNECTION WITH THIS EULA OR THE SOFTWARE IS LIMITED TO THE AMOUNT ACTUALLY PAID BY YOU FOR THE PRODUCT REGARDLESS OF THE AMOUNT OF DAMAGES YOU MAY INCUR AND WHETHER BASED ON CONTRACT, TORT (INCLUDING NEGLIGENCE), STRICT LIABILITY OR OTHER THEORY. The foregoing disclaimer of warranties, disclaimer of certain damages and limitation of liability will apply to the maximum extent permitted by applicable law. The laws of some states/jurisdictions do not allow the exclusion of implied warranties or the exclusion or limitation of certain damages. To the extent that those laws apply to this EULA, the exclusions and limitations set forth above may not apply to you.

Section 14. Export Restrictions. You acknowledge that the Software is subject to U.S. export restrictions. You agree to comply with all applicable laws and regulations that apply to the Software, including without limitation the U.S. Export Administration Regulations.

Section 15. Termination. Without prejudice to any other rights, Synology may terminate this EULA if you do not abide by the terms and conditions contained herein. In such event, you must cease use of the Software and destroy all copies of the Software and all of its component parts.

Section 16. Assignment. You may not transfer or assign your rights under this EULA to any third party, except for that pre-installed in the Products. Any such transfer or assignment in violation of the foregoing restriction will be void.

Section 17. Applicable Law. Unless expressly prohibited by local law, this EULA is governed by and construed in accordance with the laws of the country, in accordance with which Synology Inc. was organized without regard to any conflict of law principles to the contrary.

Section 18. Dispute Resolution. Any dispute, controversy or claim arising out of or relating to this EULA will be resolved exclusively and finally by arbitration conducted by three neutral arbitrators in accordance with the procedures of the Arbitration Law and related enforcement rules of the country in which Synology Inc. was organized. In such cases, the arbitration will be limited solely to the dispute between you and Synology. The arbitration, or any portion of it, will not be consolidated with any other arbitration and will not be conducted on a class-wide or class action basis. The arbitration shall take place in Taipei and the arbitration proceedings shall be conducted in English or, if both parties so agree, in Mandarin Chinese. The arbitration award shall be final and binding on the parties and may be enforced in any court having jurisdiction. You understand that, in the absence of this provision, you would have had a right to litigate any such dispute, controversy or claim in a court, including the right to litigate claims on a class-wide or class-action basis, and you expressly and knowingly waive those rights and agree to resolve any disputes through binding arbitration in accordance with the provisions of this Section 18. Nothing in this Section shall be deemed to prohibit or restrict Synology from seeking injunctive relief or seeking such other rights and remedies as it may have at law or equity for any actual or threatened breach of any provision of this EULA relating to Synology's intellectual property rights.

Section 19. Attorneys' Fees. In any arbitration, mediation, or other legal action or proceeding to enforce rights or remedies under this EULA, the prevailing party will be entitled to recover, in addition to any other relief to which it may be entitled, costs and reasonable attorneys' fees.

Section 20. Severability. If any provision of this EULA is held by a court of competent jurisdiction to be invalid, illegal, or unenforceable, the remainder of this EULA will remain in full force and effect.

Section 21. Entire Agreement. This EULA sets forth the entire agreement of Synology and you with respect to the Software and the subject matter hereof and supersedes all prior and contemporaneous understandings and agreements whether written or oral. No amendment, modification or waiver of any of the provisions of this EULA will be valid unless set forth in a written instrument signed by the party to be bound thereby.

SYNOLOGY, INC. LIMITED PRODUCT WARRANTY

THIS LIMITED WARRANTY ("WARRANTY") APPLIES TO THE PRODUCTS (AS DEFINED BELOW) OF SYNOLOGY, INC. AND ITS AFFILIATES, INCLUDING SYNOLOGY AMERICA CORP, (COLLECTIVELY, "SYNOLOGY"). YOU ACCEPT AND AGREE TO BE BOUND BY THE TERMS OF THIS WARRANTY BY OPENING THE PACKAGE CONTAINING AND/OR USING THE PRODUCT. IF YOU DO NOT AGREE TO THE TERMS OF THIS WARRANTY, DO NOT USE THE PRODUCT. INSTEAD, YOU MAY RETURN THE PRODUCT TO THE RESELLER WHERE YOU PURCHASED IT FOR A REFUND IN ACCORDANCE WITH THE RESELLER'S APPLICABLE RETURN POLICY.

Section 1. Products

- (a) "Products" refer to New Products or Refurbished Products.
- (b) "New Product", includes: (1) "Category I Product" means Synology product models RS810+, RS810RP+, RX410, all FS-series models, all DS/RS NAS models with the XS+/XS suffix (except RS3413xs+) in or after 13-series, all DX/RX/RXD expansion units with 12 or more drive bays in or after 13-series, 10GbE NIC, ECC DDR4 and ECC DDR3 memory modules. (2) "Category II Product" means Synology product models RS3413xs+, RS3412xs, RS3412RPxs, RS3411xs, RS3411RPxs, RS2211+, RS2211RP+, RS411, RS409RP+, RS409+, RS409, RS408-RP, RS408, RS407, DS3612xs, DS3611xs, DS2411+, DS1511+, DS1010+, DS509+, DS508, EDS14, RX1211, RX1211RP, RX4, DX1211, DX510, DX5, NVR1218, NVR216, VS960HD, VS360HD, VS240HD, M2D17, M2D18, and all other non-ECC memory modules not included in Category I. (3) "Category III Product" means Synology product models that match the following requirements: all DS NAS models without the XS+/XS suffix and with 5 and more drive bays in or after 12-series, all RS NAS models without the XS+/XS suffix in or after 12-series, and all DX/RX expansion units with 4 or 5 drive bays in or after 12-series. (4) "Category IV Product" means all other Synology product models purchased by Customer after March 1, 2008. (5) "Category V Product" means all other Synology product models purchased by Customer before February 29, 2008 and any "spare parts" purchased directly from Synology.
- (c) "Refurbished Product" means all Synology products which have been refurbished and sold directly by Synology through Online Store, not including those sold by an authorized Synology distributor or reseller.
- (d) Other definition: "Customer" means the original person or entity purchasing the Product from Synology or an authorized Synology distributor or reseller; "Online Store" means an online shop operated by Synology or Synology's affiliate; "Software" means the Synology proprietary software that accompanies the Product when purchased by Customer, is downloaded by Customer from the Web Site, or is pre-installed on the Product by Synology, and includes any firmware, associated media, images, animations, video, audio, text and applets incorporated into the software or Product and any updates or upgrades to such software.

Section 2. Warranty Period

- (a) "Warranty Period" : The warranty period commences on the purchase date shown on the purchase receipt or invoice to be presented by Customer and ending (1) five years after such date for Category I Products; (2) three years after such date for Category II & III Products; (3) two years after such date for Category IV Products; (4) one year after such date for Category V Products; or (5) 90 days after such date for Refurbished Products, except for those sold as "as is" or with "no warranty" on Online Store. Without presenting such purchase receipt or invoice, the warranty period shall commence on the date of manufacture based on our internal record.
- (b) "Extended Warranty Period": For Customer purchasing EW201/ EW202 optional service for applicable Products specified in Section 1 (b), the Warranty Period specified in Section 2 (a) of the applicable Product registered with EW201/EW202 optional service will be extended by two years.

Section 3. Limited Warranty and Remedies

3.1 Limited Warranty. Subject to Section 3.6, Synology warrants to the Customer that each Product (a) will be free of material defects in workmanship and (b) under normal use will perform substantially in accordance with Synology's published specifications for the Product during the Warranty Period. Such limited warranty does not apply to the Software which shall be subject to the accompanying end user license agreement provided with the Product, if any. Synology provides no warranty to Refurbished Product sold as "as is" or with "no warranty" on Online Store.

3.2 Exclusive Remedy. If Customer gives notice of noncompliance with any of the warranties set forth in Section 3.1 within the applicable Warranty Period in the manner set forth below, then, upon verification of the noncompliance by Synology, Synology will, at Synology's option: (a) use commercially reasonable efforts to repair the Product, or (b) replace the noncomplying Product or part thereof upon return of the complete Product in accordance with Section 3.3 The foregoing sets forth Synology's entire liability and Customer's sole and exclusive remedy for any breach of warranty under Section 3.1 or any other defect or deficiency in the Product. Customer will reasonably assist Synology to diagnose and validate any nonconformity with the Product. The warranty set forth in Section 3.1 does not include: (1) any warranty relating to the Software; (2) physical installation or removal of the Product from Customer's site; (3) visits to Customer's site; (4) labor necessary to effect repairs or replace defective parts other than during Synology's or its contracted service providers' normal local business hours, exclusive of weekends and service providers' holidays; (5) any work with any third party equipment or software; (6) any warranty of the hard disk if installed by Customer or any other third party; or (7) any warranty of compatibility with the hard disk.

3.3 Return. Any Product returned by Customer under Section 3.2 must be assigned a Return Merchandise Authorization ("RMA") number by Synology before shipment and must be returned in accordance with Synology's then current RMA procedures. Customer may contact any authorized Synology distributor or reseller or Synology Support to obtain assistance in obtaining an RMA, and must provide proof of purchase and product serial number when asking for such assistance. For warranty claims, Customer must return the complete Product to Synology in accordance with this Section 3.3 to be eligible for coverage under this Warranty. Any Product returned without an RMA number, or any Product that has been disassembled (except under the direction of Synology) will be refused and returned to Customer at Customer's expense. Any Product that has been assigned a RMA number must be returned in the same condition as it was received from Synology to the address designated by Synology, freight pre-paid, in packaging sufficient to protect the contents thereof and with the RMA number prominently displayed on the outside of the box. Customer is responsible for insurance and risk of loss with respect to returned items until they are properly received by Synology. A Product with a RMA number must be returned within fifteen (15) days after issuance of the applicable RMA number.

3.4 Replacement by Synology. If Synology elects to replace any Product under this Warranty set forth in Section 3.1, then Synology will ship a replacement Product at Synology's expense via the shipping method selected by Synology after receipt of the nonconforming Product returned in accordance with Section 3.3 and validation by Synology that the Product does not conform to the warranty. In some countries, Synology may at its own discretion apply the Synology Replacement Service to certain Products, through which Synology will ship a replacement Product to Customer before its receipt of the nonconforming Product returned by Customer ("Synology Replacement Service").

3.5 Support. During the Warranty Period, Synology will make available to Customer the support services. Following the expiration of the applicable Warranty Period, support for Products may be available from Synology upon written request.

3.6 Exclusions. The foregoing warranties and warranty obligations do not apply to any Product that (a) has been installed or used in a manner not specified or described in the Product specifications; (b) has been repaired, modified or altered by anyone other than Synology or its agent or designee; (c) has been in any way misused, abused, or damaged; (d) has been used with items not provided by Synology other than the hardware or software for which the Product is designed; or (e) otherwise fails to conform to the Product specifications and such failure is attributable to causes not within or under Synology's control. Further, the foregoing warranties will be void if (1) Customer disassembles the Product except as authorized by Synology; (2) Customer fails to implement any correction, modification, enhancement, improvement or other update made available to Customer by Synology; or (3) Customer implements, installs or uses any correction, modification, enhancement, improvement or other update made available by any third party. The warranty set forth in Section 3 will terminate upon Customer's sale or transfer of the Product to a third party.

3.7 Disclaimer of Warranties. THE WARRANTIES, OBLIGATIONS, AND LIABILITIES OF SYNOLOGY AND THE REMEDIES OF CUSTOMER SET FORTH IN THIS WARRANTY ARE EXCLUSIVE AND IN SUBSTITUTION FOR, AND CUSTOMER HEREBY WAIVES, RELEASES AND DISCLAIMS, ALL OTHER WARRANTIES, OBLIGATIONS AND LIABILITIES OF SYNOLOGY AND ALL OTHER RIGHTS, CLAIMS AND REMEDIES OF CUSTOMER AGAINST SYNOLOGY, EXPRESS OR IMPLIED, ARISING BY LAW OR OTHERWISE, WITH RESPECT TO THE PRODUCT, ACCOMPANYING DOCUMENTATION OR SOFTWARE AND ANY OTHER GOODS OR SERVICES DELIVERED UNDER THIS WARRANTY, INCLUDING, BUT NOT LIMITED TO ANY: (A) IMPLIED WARRANTY OF MERCHANTABILITY OR FITNESS FOR A PARTICULAR PURPOSE OR USE; (B) IMPLIED WARRANTY ARISING FROM COURSE OF PERFORMANCE, COURSE OF DEALING, OR USAGE OF TRADE; (C) CLAIM OF INFRINGEMENT OR MISAPPROPRIATION; OR (D) CLAIM IN TORT (WHETHER BASED ON NEGLIGENCE, STRICT LIABILITY, PRODUCT LIABILITY OR OTHER THEORY). SYNOLOGY MAKES NO GUARANTEE AND SPECIFICALLY DISCLAIMS ANY WARRANTY THAT THE DATA OR INFORMATION STORED ON ANY SYNOLOGY PRODUCT WILL BE SECURE AND WITHOUT RISK OF DATA LOSS. SYNOLOGY RECOMMENDS THAT CUSTOMER TAKES APPROPRIATE MEASURES TO BACK UP THE DATA STORED ON THE PRODUCT. SOME STATES/JURISDICTIONS DO NOT ALLOW LIMITATIONS ON IMPLIED WARRANTIES, SO THE ABOVE LIMITATION MAY NOT APPLY TO CUSTOMER.

Section 4. Limitations of Liability

4.1 Force Majeure. Synology will not be liable for, or be considered to be in breach of or default under this Warranty on account of, any delay or failure to perform as required by this Warranty as a result of any cause or condition beyond its reasonable control (including, without limitation, any act or failure to act by Customer).

4.2 Disclaimer of Certain Damages. IN NO EVENT WILL SYNOLOGY OR ITS SUPPLIERS BE LIABLE FOR THE COST OF COVER OR FOR ANY INCIDENTAL, INDIRECT, SPECIAL, PUNITIVE, CONSEQUENTIAL OR SIMILAR DAMAGES OR LIABILITIES WHATSOEVER (INCLUDING, BUT NOT LIMITED TO LOSS OF DATA, INFORMATION, REVENUE, PROFIT OR BUSINESS) ARISING OUT OF OR RELATING TO THE USE OR INABILITY TO USE THE PRODUCT, ANY ACCOMPANYING DOCUMENTATION OR SOFTWARE AND ANY OTHER GOODS OR SERVICES PROVIDED UNDER THIS WARRANTY, WHETHER BASED ON CONTRACT, TORT (INCLUDING NEGLIGENCE), STRICT LIABILITY OR OTHER THEORY EVEN IF SYNOLOGY HAS BEEN ADVISED OF THE POSSIBILITY OF SUCH DAMAGES.

4.3 Limitation of Liability. SYNOLOGY'S AND ITS SUPPLIERS' LIABILITY ARISING OUT OF OR RELATING TO THE USE OR INABILITY TO USE THE PRODUCT, ANY ACCOMPANYING DOCUMENTATION OR SOFTWARE AND ANY OTHER GOODS OR SERVICES PROVIDED UNDER THIS WARRANTY IS LIMITED TO THE AMOUNT ACTUALLY PAID BY CUSTOMER FOR THE PRODUCT REGARDLESS OF THE AMOUNT OF DAMAGES CUSTOMER MAY INCUR AND WHETHER BASED ON CONTRACT, TORT (INCLUDING NEGLIGENCE), STRICT LIABILITY OR OTHER THEORY. The foregoing disclaimer of certain damages and limitation of liability will apply to the maximum extent permitted by applicable law. The laws of some states/jurisdictions do not allow exclusion or limitation of certain damages. To the extent that those laws apply to the Product, the exclusions and limitations set forth above may not apply to Customer.

Section 5. Miscellaneous

5.1 Proprietary Rights. The Product and any accompanying Software and documentation provided with the Product include proprietary and intellectual property rights of Synology and its third party suppliers and licensors. Synology retains and reserves all right, title, and interest in the intellectual property rights of the Product, and no title to or ownership of any intellectual property rights in or to the Product, any accompanying Software or documentation and any other goods provided under this Warranty is transferred to Customer under this Warranty. Customer will (a) comply with the terms and conditions of the Synology end user license agreement accompanying any Software furnished by Synology or an authorized Synology distributor or reseller; and (b) not attempt to reverse engineer any Product or component thereof or accompanying Software or otherwise misappropriate, circumvent or violate any of Synology's intellectual property rights.

5.2 Assignment. Customer will not assign any of its rights under this Warranty directly, by operation of law or otherwise, without the prior written consent of Synology.

5.3 No Additional Terms. Except as expressly permitted by this Warranty, neither party will be bound by, and each party specifically objects to, any term, condition or other provision that conflicts with the provisions of this Warranty that is made by the other party in any purchase order, receipt, acceptance, confirmation, correspondence or otherwise, unless each party specifically agrees to such provision in writing. Further, if this Warranty conflicts with any terms or conditions of any other agreement entered into by the parties with respect to the Product, this Warranty will prevail unless the other agreement specifically references the sections of this Warranty that it supersedes.

5.4 Applicable Law. Unless explicitly prohibited by local law, this Warranty is governed by the laws of the State of Washington, U.S.A. for the Customers residing within the United States; and by the laws of the Republic of China (Taiwan) for Customers not residing within the United States, without regard to any conflict of law principles to the contrary. The 1980 U.N. Convention on Contracts for the International Sale of Goods or any successor thereto does not apply.

5.5 Dispute Resolution. Any dispute, controversy or claim arising out of or relating to this Warranty, the Product or services provided by Synology with respect to the Product or the relationship between Customers residing within the United States and Synology will be resolved exclusively and finally by arbitration under the current commercial rules of the American Arbitration Association, except as otherwise provided below. The arbitration will be conducted before a single arbitrator, and will be limited solely to the dispute between Customer and Synology. The arbitration, or any portion of it, will not be consolidated with any other arbitration and will not be conducted on a class-wide or class action basis. The arbitration shall be held in King County, Washington, U.S.A. by submission of documents, by telephone, online or in person as determined by the arbitrator at the request of the parties. The prevailing party in any arbitration or legal action occurring within the United States or otherwise shall receive all costs and reasonable attorneys' fees, including any arbitration fee paid by the prevailing party. Any decision rendered in such arbitration proceedings will be final and binding on the parties, and judgment may be entered thereon in any court of competent jurisdiction. Customer understands that, in the absence of this provision, Customer would have had a right to litigate any such dispute, controversy or claim in a court, including the right to litigate claims on a class-wide or class-action basis, and Customer expressly and knowingly waives those rights and agrees to resolve any disputes through binding arbitration in accordance with the provisions of this Section 5.5. For Customers not residing within the United States, any dispute, controversy or claim described in this section shall be finally resolved by arbitration conducted by three neutral arbitrators in accordance with the procedures of the R.O.C. Arbitration Law and related enforcement rules. The arbitration shall take place in Taipei, Taiwan, R.O.C., and the arbitration proceedings shall be conducted in English or, if both parties so agree, in Mandarin Chinese. The arbitration award shall be final and binding on the parties and may be enforced in any court having jurisdiction. Nothing in this Section shall be deemed to prohibit or restrict Synology from seeking injunctive relief or seeking such other rights and remedies as it may have at law or equity for any actual or threatened breach of any provision of this Warranty relating to Synology's intellectual property rights.

5.6 Attorneys' Fees. In any arbitration, mediation, or other legal action or proceeding to enforce rights or remedies under this Warranty, the prevailing party will be entitled to recover, in addition to any other relief to which it may be entitled, costs and reasonable attorneys' fees.

5.7 Export Restrictions. You acknowledge that the Product may be subject to U.S. export restrictions. You will comply with all applicable laws and regulations that apply to the Product, including without limitation the U.S. Export Administration

Regulations.

5.8 Severability. If any provision of this Warranty is held by a court of competent jurisdiction to be invalid, illegal, or unenforceable, the remainder of this Warranty will remain in full force and effect.

5.9 Entire Agreement. This Warranty constitutes the entire agreement, and supersedes any and all prior agreements, between Synology and Customer related to the subject matter hereof. No amendment, modification or waiver of any of the provisions of this Warranty will be valid unless set forth in a written instrument signed by the party to be bound thereby.

FCC Declaration of Conformity

This device complies with Part 15 of the FCC Rules. Operation is subject to the following two conditions: (1) this device may not cause harmful interference, and (2) this device must accept any interference received, including interference that may cause undesired operation.

この装置は、クラス A 機器です。この装置を住宅環境で使用すると電波妨害を引き起こすことがあります。この場合には使用者が適切な対策を講ずるよう要求されることがあります。

VCCI - A