

Overview

HPE ProLiant DL320 Gen11

Are you looking to run edge AI workloads like Computer Vision that need GPU accelerators or distributed data solutions that require expandable storage? The HPE ProLiant DL320 Gen11 is a 1U 1P server with a unique compact and workload-driven modular design that is purpose-built for edge computing delivering exceptional performance at 1P economics and an excellent choice for both virtualized and containerized workloads.

Powered by 4th Gen Intel® Xeon® Scalable Processors with up to 32 cores, 270W, increased memory capability (up to 2 TB 4800 MT/s), and high-speed PCIe Gen5 supporting up to four single-wide GPUs (or two double-wide), the HPE ProLiant DL320 Gen11 server is a perfect low-cost, 1U 1P, performance solution. The HPE ProLiant Gen11 servers are engineered to optimize IT at the edge with a cloud operating experience, built-in security, and optimized performance for workloads to drive your business forward.

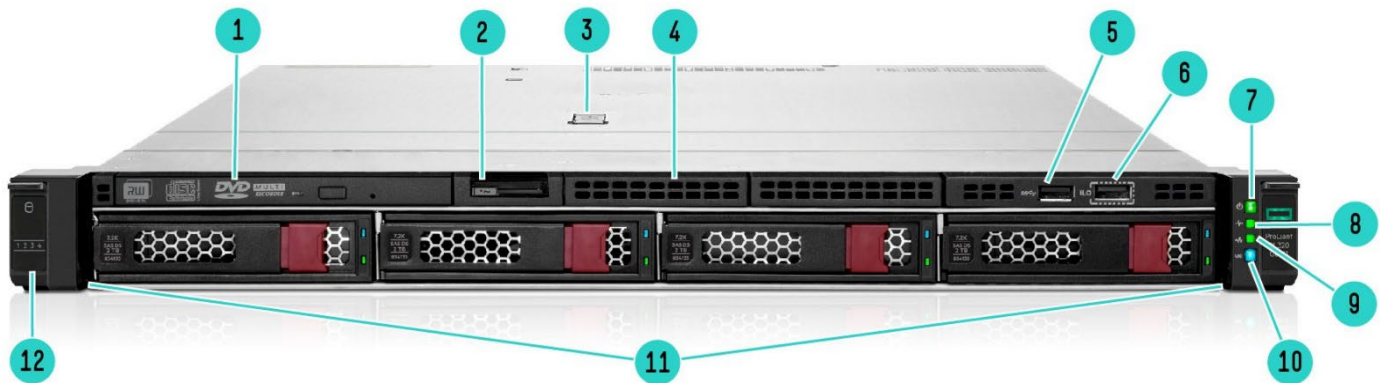

4 LFF Front View – 4 LFF + optional Optical Drive and SAS drives shown

- | | | | |
|----|---|-----|--|
| 1. | Optical Drive (optional - shown) | 7. | Power On / Standby button and system power LED |
| 2. | Serial number/iLO information pull tab | 8. | Health LED |
| 3. | Quick removal access panel | 9. | NIC Status |
| 4. | Option Display Port & USB 2.0 port bundle kit (blank shown) | 10. | Unit ID Button/LED |
| 5. | USB 3.2 Gen1 port | 11. | SAS/SATA drive bays |
| 6. | iLO Service Port | 12. | Drive support label |

Overview

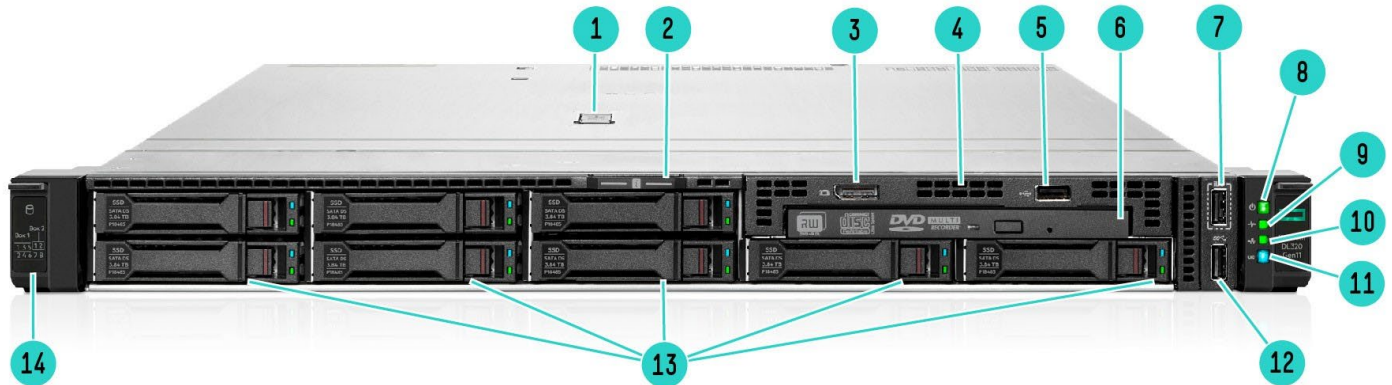

8SFF Front View - 8 SFF + optional Universal Media Bay, optical Drive, Display Port, USB2.0, and SATA Drive shown

- | | |
|--|--|
| 1. Quick removal access panel | 9. Health LED |
| 2. Serial number/iLO information pull tab | 10. NIC Status |
| 3. Display Port (optional – shown) | 11. Unit ID Button/LED |
| 4. Universal Media Bay (optional): | 12. USB 3.2 Gen1 port |
| • Option1: Optical drive bay + Display port & USB 2.0 port kit (shown) | 13. Drive bays; backplanes options |
| • Option2: 2 SFF x4 Tri-Mode 24G U.3 BC Drive Cage | • Option1: 8SFF x1 Tri-Mode 24G U.3 BC Backplane |
| 5. USB 3.2 Gen1 port (optional – shown) | • Option2: 8SFF x4 Tri-Mode 24G U.3 BC Backplane |
| 6. Optical Drive (optional– shown) | 14. Drive support label |
| 7. iLO Service Port | |
| 8. Power On / Standby button and system power LED | |

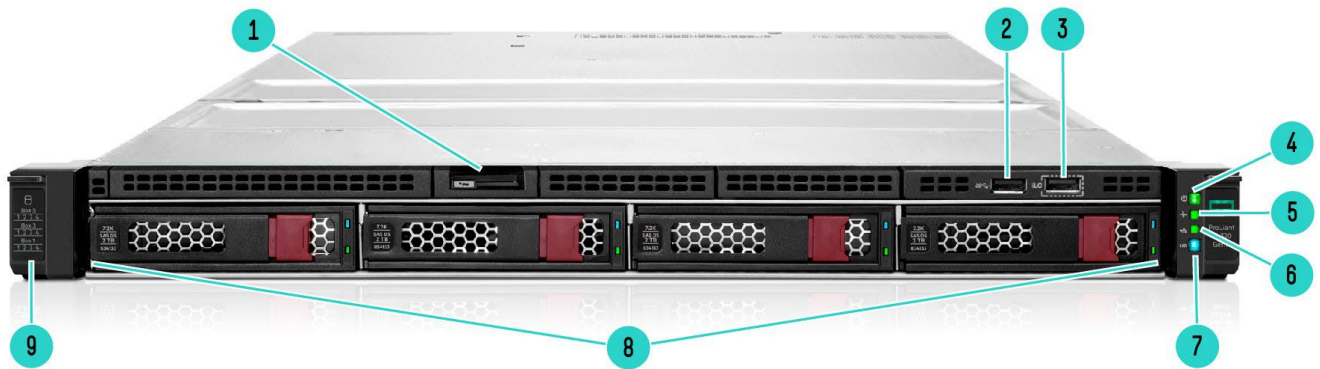

12 LFF Front View - 12 LFF + SAS drives shown

- | | |
|---|------------------------|
| 1. Serial number/iLO information pull tab | 6. NIC Status |
| 2. USB 3.2 Gen1 Port | 7. Unit ID Button/LED |
| 3. iLO Service Port | 8. SAS/SATA drive bays |
| 4. Power On/Standby button and system power LED | 9. Drive support label |
| 5. Health LED | |



Overview

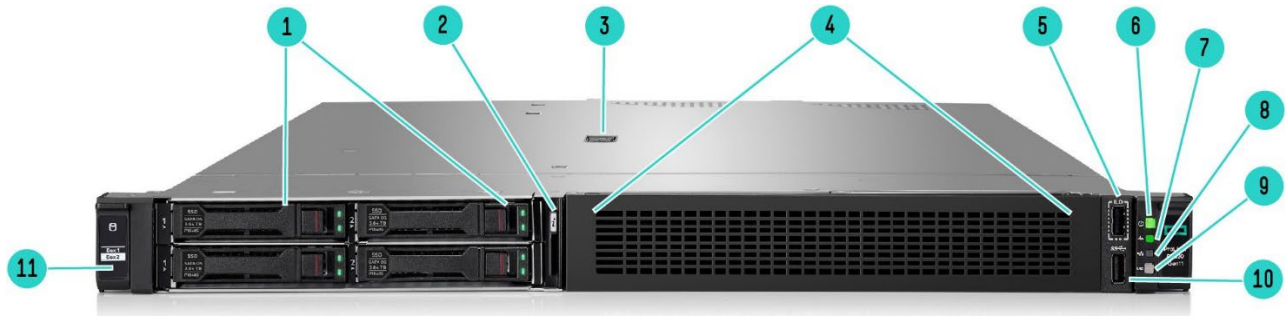

Front View – GPU CTO Server

- | | |
|---|--|
| <ol style="list-style-type: none"> 1. Drive Bays <ul style="list-style-type: none"> • Option1: 4SFF SAS/SATA/NVMe (Shown) • Option2: 8EDSFF E3.s 1T 2. Serial number/iLO information pull tab 3. Quick removal access panel 4. GPU Front Cage 5. iLO Service Port | <ol style="list-style-type: none"> 6. Power On/Standby button and system power LED 7. Health LED 8. NIC Status 9. Unit ID Button/LED 10. USB 3.2 Gen1 Port 11. Drive support label |
|---|--|

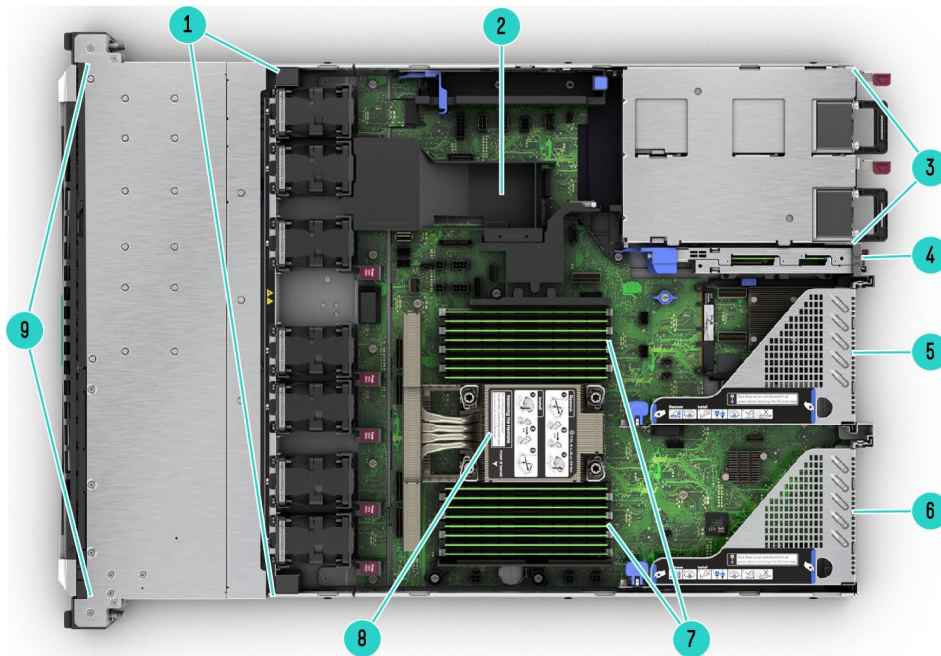

Internal View – Standard for all DL320 Gen11

- | | |
|--|--|
| <ol style="list-style-type: none"> 1. Up to 7 Hot Plug Fans 2. Two (2) M.2 module connectors (under the air baffle- not visible) 3. Redundant Power Supply (1 & 2 as shown) 4. HPE NS204i-u NVMe Hot Plug Boot Optimized Storage Device (optional – shown) | <ol style="list-style-type: none"> 5. Slot-2 PCIe5 x16 FHHL (Secondary Riser) 6. Slot-1 PCIe5 x16 FHHL (Primary Riser) 7. 16 DDR5 DIMM slots (shown) 8. Heat Sink 9. Drive Cage |
|--|--|

Notes: 1x Internal USB 3.0 port is not marked.



Overview

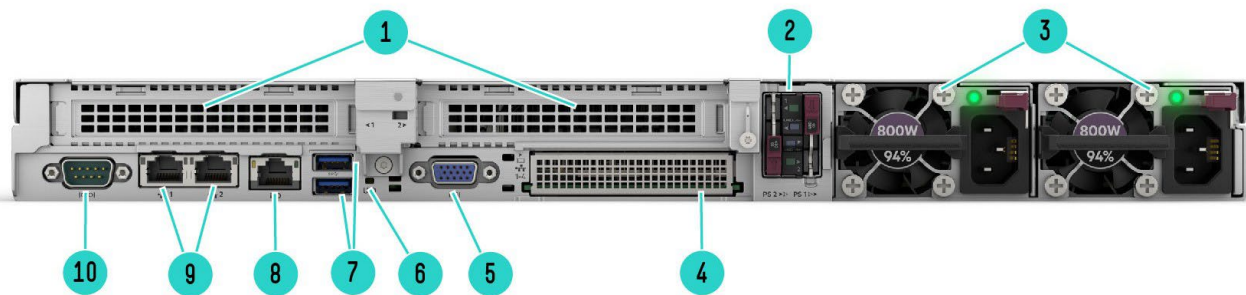

Rear View – Standard for all DL320 Gen11

- | | | | |
|----|---|-----|-------------------------------|
| 1. | Slot-1 & 2 PCIe5 x16 FHHL (Primary and Secondary Riser) | 6. | UID Indicator LED |
| 2. | HPE NS204i-u NVMe Hot Plug Boot Optimized Storage Device (optional – shown) | 7. | Two (2) USB 3.2 Gen1 ports |
| 3. | Hot-plug Power Supply 1 and 2 (1 +1 Redundancy) | 8. | Dedicated iLO management port |
| 4. | OCP 3.0 Slot: x16 PCIe 5.0 | 9. | Embedded 1GbE x2 network port |
| 5. | Video (VGA) port | 10. | Serial port (optional) |

Platform Information

Form Factor

- 1U rack

Chassis Types

- 4 LFF (P52765-B21) with optional Optical Disk Drive (use cable P54641-B21), optional Display Port/USB Kit (P48928-B21)
- 8+2 SFF SAS/SATA/NVMe (P52766-B21)
 - Option1: HPE ProLiant DL320 Gen11 8SFF x1 Tri-Mode 24G U.3 BC Backplane Kit (P52743-B21)
 - Option2: HPE ProLiant DL320 Gen11 8SFF x4 Tri-Mode 24G U.3 BC Backplane Kit (P52747-B21)
- 12 LFF (P52767-B21)
- GPU Dense (P61218-B21)
 - Option1: HPE ProLiant DL320 Gen11 8EDSFF x4 NVMe Drive Cage Kit (P61219-B21)
 - Option2: HPE ProLiant DL320 Gen11 4SFF x4 Tri-Mode 24G U.3 BC Drive Cage Kit (P61221-B21)

System Fans

- HPE ProLiant DL3X0 Gen11 1U Standard Fan Kit (P48907-B21), includes five fans.
- HPE ProLiant DL3X0 Gen11 1U High Performance Fan Kit (P48908-B21), includes seven fans.
- HPE ProLiant DL3X0 Gen11 1U 2P Standard Fan Kit (P54697-B21), includes two fans.

Notes: Generally, the High-Performance fan kit is required when >185W Processors SKUs, High-Performance NVMe drives, or certain backplanes are populated. See notes under each option category or each individual option for specifics.



Standard Features

Processors – One of the following.

The 2nd digit of the processor model number "x4xx" is used to denote the processor generation (i.e., 4=4th generation Intel Scalable Series Processors)

For more information regarding Intel Xeon processors, please see the following <http://www.intel.com/xeon>.

This table covers the public Intel offering only.

Processor Suffix	Description	Offering
H	DB and Analytics	Highest core counts. Database and Analytics usages benefit from DSA and IAA accelerators.
M	Media Transcode	Optimized around AVX frequencies to deliver better performance/watt around Media, AI, and HPC workloads.
N	Network/5G/Edge (High TPT / Low Latency)	Designed for NFV and networking workloads, such as L3 forwarding, 5G UPF, OVS DPDK, VPP FIB router, VPP IPsec, web server/NGINX, vEPC, vBNG, and vCMTS.
S	Storage and HCI	Optimized for Storage UMA use cases with increased UPI Bandwidth for vs. Mainline SKUs.
P	Cloud - IAAS	Designed for cloud IaaS environments to deliver higher frequencies at constrained TDPs.
Q	Liquid Cooling	Liquid-cooled processors with higher frequency and performance at the same TDP.
U	1 Socket Optimized	Optimized for targeted platforms adequately served by the cores, memory bandwidth, and IO capacity available from a single processor.
V	Cloud - SAAS	Optimized for orchestration efficiency that delivers higher core counts and VMs per rack.
Y	Speed Select	Intel® SST-PP increases the base frequency when fewer cores are enabled. Allows greater flexibility, deployment options, and platform longevity.

4th Generation Intel® Xeon® Scalable Processor Family (Gold)

Intel Xeon Models	Base Speed (GHz)	Cores	L3 Cache (MB)	Power (W)	UPI Links	DDR5 (MT/s)	SGX Enclave Size (GB)
Gold 6426Y Processor	2.5	16	37.5	185	3	4800	128
Gold 6442Y Processor	2.6	24	60	225	3	4800	128
Gold 6448Y Processor	2.1	32	60	225	3	4800	128
Gold 6434 Processor	3.7	8	22.5	195	3	4800	128
Gold 6444Y Processor	3.6	16	45	270	3	4800	128
Gold 6430 Processor	2.1	32	60	270	3	4800	128
Gold 6438Y+ Processor	2.0	32	60	205	3	4800	128
Gold 6414U Processor	2.0	32	60	250	0	4800	128
Gold 6438N Processor	2.0	32	60	205	3	4800	128
Gold 6421N Processor	1.8	32	60	185	0	4400	128
Gold 6454S Processor	2.2	32	60	270	4	4800	128
Gold 5415+ Processor	2.9	8	22.5	150	3	4400	128
Gold 5418Y Processor	2.0	24	45	185	3	4400	128
Gold 5420+ Processor	2.0	28	52.5	205	3	4400	128
Gold 5412U Processor	2.1	24	45	185	0	4400	128

Standard Features

Gold 5411N Processor	1.9	24	45	165	0	4400	128
Gold 5418N Processor	1.8	24	45	165	3	4000	128
Gold 5416S Processor	2.0	16	30	150	3	4400	128

4th Generation Intel® Xeon® Scalable Processor Family (Silver)

Intel Xeon Models	Base Speed (GHz)	Cores	L3 Cache (MB)	Power (W)	UPI Links	DDR5 (MT/s)	SGX Enclave Size (GB)
Silver 4410Y Processor	2.0	12	30	150	2	4000	128
Silver 4416+ Processor	2.0	20	37.5	165	2	4000	128

4th Generation Intel® Xeon® Scalable Processor Family (Bronze)

Intel Xeon Models	Base Speed (GHz)	Cores	L3 Cache (MB)	Power (W)	UPI Links	DDR5 (MT/s)	SGX Enclave Size (GB)
Bronze 3408U Processor	1.8	8	22.5	125	0	4000	64

Notes:

- Processors with TDP greater than 185 require Performance Heatsink.
- 8 Channel DDR5 @ up to 4800 MT/s depending on processor type.

Chipset

Intel C741 Chipset

Notes: For more information regarding Intel® chipsets, please see the following URL:

<https://www.intel.com/content/www/us/en/products/chipsets/server-chipsets.html>

System Management Chipset

HPE iLO 6 ASIC

Notes: Read and learn more in the [iLO QuickSpecs](#).

Memory

Type	HPE DDR5 Smart Memory Registered (RDIMM)
DIMM Slots Available	16 DIMM Slots, 8 channels, 2 DIMMs per channel
Maximum capacity (RDIMM)	2.04 TB 16 x 128 GB RDIMM @ 4800 MT/s

Notes:

All processors support up to 2TB memory.

- The maximum memory speed is limited by the processor selection.
- To realize the performance memory capabilities listed in this document, HPE DDR5 Smart Memory is required.
- For additional information, please visit the [HPE Memory QuickSpecs and Technical White Papers](#) or [HPE DDR5 Smart Memory QuickSpecs](#).

Memory Protection

Advanced ECC

Advanced ECC uses -device data correction to detect and correct single and all multibit errors within a single DRAM chip.

Online Spare

Memory online spare mode detects a degrading rank and switches operation to the spare rank.

Notes: For more information, see our [Memory RAS feature technical whitepaper](#).



Standard Features

Network Controller

The HPE ProLiant DL320 Gen11 server offers the customer Embedded Broadcom BCM5720 Ethernet 1Gb 2-port BASE-T Adapter standard with the option to upgrade with a variety of networking options.

Notes: Support document and downloads including firmware and drivers for the Broadcom BCM5720 Ethernet 1Gb 2-port BASE-T LOM Adapter can be downloaded from the supplier's support and services [webpage](#).

PCIe Expansion Slots

Expansion Slots #	Technology	Bus Width	Connector Width	Slot Form Factor
1 (Primary Riser)	PCIe 5.0	x16	x16	FHHL
2 (Secondary Riser)	PCIe 5.0	x16	x16	FHHL

Notes: Slot-1, by default, is with the riser.

OCP Expansion Slots

Expansion Slots #	Technology	Bus Width	Connector Width
1 (OCP 3.0) with Wake on LAN (WoL) and iLO sideband (shared NIC) capability	PCIe 5.0	x16	x16

Internal Storage Devices

- **Optical Drive**
Available on 8 SFF and 4 LFF CTO Servers as an option (DVD-ROM or DVD-RW)
- **Hard Drives**
None shipped standard

Graphics

Integrated Video Standard

- Video modes up to 1920 x 1200@60Hz (32 bpp)
- 16MB Video Memory

Maximum Storage

Storage	Capacity	Configuration
Hot Plug LFF SAS HDD	80.0 TB (4 x 20 TB)	HPE ProLiant DL320 Gen11 4 LFF CTO Server (P52765-B21)
Hot Plug LFF SATA HDD	80.0 TB (4 x 20 TB)	
Hot Plug LFF SAS SSD	30.72 TB (4 x 7.68 TB)	
Hot Plug LFF SATA SSD	30.72 TB (4 x 7.68 GB)	
Hot Plug SFF SAS HDD	24.0 TB (8+2 x 2.4 TB)	HPE ProLiant DL320 Gen11 8 SFF CTO Server with optional 2 SFF cage on UMB (P52766-B21)
Hot Plug SFF SATA HDD	20.0 TB (8+2 x 2.0 TB)	
Hot Plug SFF SAS SSD	153.0 TB (8+2 x 15.3 TB)	
Hot Plug SFF SATA SSD	76.8 TB (8+2 x 7.68 TB)	
Hot Plug LFF SAS HDD	240.0 TB (12 x 20 TB)	HPE ProLiant DL320 Gen11 12 LFF CTO Server (P52767-B21)
Hot Plug LFF SATA HDD	240.0 TB (12 x 20 TB)	
Hot Plug LFF SAS SSD	92.16 TB (12 x 7.68 TB)	
Hot Plug LFF SATA SSD	92.16 TB (12 x 7.68 GB)	
EDSFF NVMe SSD	61.44 TB (4 x 15.36)	HPE DL320 Gen11 GPU CTO Server (P61218-B21) with 8EDSFF Drive Cage (P61219-B21) Support for up to 4 EDSFF drives with available configs.
Hot Plug SFF SAS HDD	9.6 TB (4 x 2.4 TB)	HPE DL320 Gen11 GPU CTO Server (P61218-B21) with 4SFF Drive Cage (P61221-B21)
Hot Plug SFF SATA HDD	8.0 TB (4 x 2.0 TB)	
Hot Plug SFF SAS SSD	61.2 TB (4 x 15.3 TB)	

Standard Features

Hot Plug SFF SATA SSD	30.72 TB (4 x 7.68 TB)	On board with any of the available configurations
Hot Plug SFF NVMe PCIe SSD	153.6 TB (8+2 x 15.36 TB)	
M.2 NVMe SSD	3.84 GB (2 x 1.92 GB)	
M.2 SATA SSD	960 GB (2x 480 GB)	

Storage Controllers

NVMe Boot Devices

- HPE NS204i-u NVMe Hot Plug Boot Optimized Storage Device (P48183-B21)
- HPE ProLiant DL320 Gen11 NS204i-u NVMe Boot Kit (P52786-B21)

Notes: N204i-u Boot device includes 2x 480GB M.2 NVMe SSDs, with preconfigured hardware RAID1. For additional information, please see the [HPE OS Boot Device QuickSpecs](#)

Software RAID Controllers

The available Gen11 controllers are depicted below.

- **Intel® VROC SATA for HPE ProLiant Gen11**

Notes:

- Embedded Intel® VROC SATA for HPE ProLiant Gen11, with 14 SATA ports (10-ports accessible),
- Intel® VROC for HPE ProLiant Gen11 is an enterprise, hybrid Software RAID solution specifically designed for SSDs.
- Intel® VROC is a software-based solution utilizing Intel® CPU to RAID or HBA direct connected drives.
- RAID Support- 0/1/5/10.
- Windows and Linux OS support.
- Host Tools- Windows GUI/CLI, Linux CLI.
- UEFI Support- HII Utility, OBSE.
- iLO Support- IML, Alert, SNMP, AHS.
- iLO Redfish- Redfish Read.
- Intel® VROC SATA for HPE ProLiant Gen11 will operate in UEFI mode only. For legacy support additional storage controller will be needed.
- Intel® VROC SATA is off by default and must be enabled.

- **Intel® VROC NVMe for HPE ProLiant Gen11**

- Intel® Virtual RAID on CPU (Intel® VROC) Premium FIO Software for HPE
- Intel® Virtual RAID on CPU (Intel® VROC) Standard Software FIO for HPE

In HPE ProLiant Gen11 servers, when secure boot is enabled, Intel Virtual RAID on CPU (VROC) 8.0 Out-of-Band (OOB) management does not function with Linux kernel version 5.4 (or later). VROC OOB will not respond to any PLDM (over-MCTP-over-PCIe) requests from iLO (BMC). VROC Redfish resources will not function (e.g., Redfish actions); therefore, VROC over Redfish management is not available. This is due to a new security feature in Linux kernel version 5.4 (or later).

For more information, please visit [Customer Advisory Document ID: a00128934en_us](#) at HPE Support Center.

Notes:

- All models feature 4 x8 PCIe 5.0 connectors per socket for NVMe connectivity, provides support for up to 8 direct attach x4 NVMe bays.
- Only supported on SFF models.
- Intel® VROC for HPE ProLiant Gen11 is an enterprise, hybrid Software RAID solution specifically designed for NVMe SSDs connected directly to the CPU. Intel® VROC is a software-based solution utilizing Intel® CPU to RAID or HBA direct connected drives.
- Intel® Virtual RAID on CPU Standard for RAID 0/1/10 (S0E37A/S0E38AAE) or Premium SKU for RAID 0/1/5/10 (R7J57A/R7J59AAE) must be ordered to enable RAID support.
- Windows, Linux, VMware OS support.
- Host Tools- Windows GUI/CLI, Linux CLI.
- UEFI Support- HII Utility, OBSE.
- Active health monitoring of NVMe M.2 drives requires use of SMART tools.



Standard Features

- Intel® VROC NVMe for HPE ProLiant Gen11 will operate in UEFI mode only. For legacy support an additional Tri-Mode controller will be needed.
 - For NVMe SSDs only, no PCIe card support.
- Intel VROC for HPE ProLiant QuickSpecs**

Essential RAID Controllers

- HPE Smart Array E208e-p SR Gen10 Controller

Performance RAID Controllers

- HPE MR216i-p Gen11 x16 Lanes without Cache PCI SPDM Plug-in Storage Controller
- HPE MR216i-o Gen11 x16 Lanes without Cache OCP SPDM Storage Controller
- HPE MR408i-o Gen11 x8 Lanes 4GB Cache OCP SPDM Storage Controller
- HPE MR416i-o Gen11 x16 Lanes 8GB Cache OCP SPDM Storage Controller
- HPE MR416i-p Gen11 x16 Lanes 8GB Cache PCI SPDM Plug-in Storage Controller
- HPE SR932i-p Gen11 x32 Lanes 8GB Wide Cache PCI SPDM Plug-in Storage Controller.^{1,2}

Notes:

- ¹Requires x16 physical and electrical riser slot.
- ²If second controller is required, must select secondary FH riser. For additional details, please see:

HPE Compute MR Gen11 Controllers QuickSpecs

HPE Compute SR Gen11 Controllers QuickSpecs

Power Supply

- HPE 500W Flex Slot Platinum Hot Plug Low Halogen Power Supply Kit
Notes: Available with 94% efficiency.
- HPE 800W Flex Slot Platinum Hot Plug Low Halogen Power Supply Kit
Notes: Available with 94% efficiency.
- HPE 1000W Flex Slot Titanium Hot Plug Low Halogen Power Supply Kit
Notes: Available with 96% efficiency.
- HPE 1600W Flex Slot Platinum Hot Plug Low Halogen Power Supply Kit
Notes:
 - Available with 94% efficiency.
 - 1600W Power supplies only support high line voltage (200 VAC to 240 VAC).
- HPE 1800-2000W Flex Slot Titanium Hot Plug Low Halogen Power Supply Kit
Notes: Available with 96% efficiency.

HPE Flexible Slot (Flex Slot) Power Supplies share a common electrical and physical design that allows for hot plug, tool-less installation into HPE ProLiant Gen11 Performance Servers. Flex Slot power supplies are certified for high-efficiency operation and offer multiple power output options, allowing users to "right-size" a power supply for specific server configurations. This flexibility helps to reduce power waste, lower overall energy costs, and avoid "trapped" power capacity in the data center.

All pre-configured servers ship with a standard 6-foot IEC C-13/C-14 jumper cord (A0K02A). This jumper cord is also included with each standard AC power supply option kit. Please check the **ProLiant Power Cables** web page if a different power cord is required.

To review the power requirements for your selected system, please use the **HPE Power Advisor Tool**.

For information on power specifications and technical content, visit **HPE Server power supplies**.

European Union Erp Lot 9 Regulation

Beginning on January 1st, 2024, units sold into the European Union (EU), European Economic Area (EEA), the United Kingdom, or Switzerland must include more efficient AC power supplies: 94% for multi-output and 96% for single-output. HPE Flexible Slot power supplies are single-output, and part numbers 865438-B21, P03178-B21, and P44712-B21 are 96% efficient, thus meeting requirements.

HPE is on target to fulfil compliant systems ahead of time and will begin enforcing these requirements in advance to satisfy requests with the current power supplies by the set deadline.



Standard Features

Interfaces

Serial	1 port - Optional
Video	1 Front - Display port (optional) 1 Rear - VGA port (standard on all models) Notes: If both ports are used simultaneously, they will display the same image.
Network Ports	None. Choice of OCP or standup card, supporting a wide arrange of NIC adapters
HPE iLO Remote Mgmt Port	1 GbE Dedicated
Front iLO Service Port	1 standard
USB	4 standard on all models: 1 front(USB 3.2 Gen1), 2 rear (USB 3.2 Gen1), 1 internal (USB 2.0) +1 optional USB 2.0 front in 4LFF & 8SFF Notes: USB 3.2 Gen1 is referred to as USB 3.0 in some marketing documents.

Operating Systems and Virtualization Software

See [HPE Servers Support & Certification Matrices](#)

- [Microsoft Windows Server](#)
- [VMware ESXi](#)
- [Red Hat Enterprise Linux \(RHEL\)](#)
- [SUSE Linux Enterprise Server \(SLES\)](#)
- [Canonical Ubuntu](#)
- [Oracle Linux and Oracle VM](#)
- [Citrix](#)
- [Community Enterprise Linux \(CentOS, Alma Linux, Rocky Linux\)](#)

HPE Server UEFI/Legacy ROM

Unified Extensible Firmware Interface (UEFI) is an industry-standard that provides better manageability and more secured configuration than the legacy ROM while interacting with your server at boot time. HPE ProLiant Gen11 servers have a UEFI Class 2 implementation to support UEFI Mode.

Notes: The UEFI System Utilities tool is analogous to the HPE ROM-Based Setup Utility (RBSU) of legacy BIOS. For more information, please visit <http://www.hpe.com/servers/uefi>.

UEFI enables numerous new capabilities specific to HPE ProLiant servers, such as:

- Secure Boot and Secure Start enabled for enhanced security.
- Embedded UEFI Shell
- Operating system-specific functionality
- Mass Configuration Deployment Tool using iLO RESTful API that is Redfish API Conformant
- Support for > 2.2 TB (using GPT) boot drives.
- PXE boot support for IPv6 networks
- USB 3.0 Stack
- Workload Profiles for simple performance optimization

UEFI Boot Mode only:

- TPM 2.0 Support
- iSCSI Software Initiator Support.
- NVMe Boot Support
- HTTP/HTTPs Boot support as a PXE alternative.
- Platform Trust Technology (PTT) can be enabled.
- Boot support for option cards that only support a UEFI option ROM.

Notes:

- Enabling TPM 2.0 no longer requires TPM module option kit for Gen11. It is an embedded feature.



Standard Features

- TPM is disabled on shipments to China.
- For UEFI Boot Mode, the boot environment and OS image installations should be configured properly to support UEFI.

Industry Standard Compliance

- ACPI 6.3 Compliant
- PCIe 5.0 Compliant
- Wake on LAN (WoL) Support
- Microsoft® Logo certifications
- PXE Support
- VGA
- Display Port

Notes: This support is on the optional Universal Media Bay.

- USB 3.2 Gen1 Compliant
- USB 2.0 Compliant (via Universal Media Bay)

Notes: This support is on the optional Universal Media Bay.

- Energy Star
- SMBIOS 3.2
- Redfish API
- IPMI 2.0
- Secure Digital 4.0
- Embedded TPM 2.0 Support

Notes: Enabling TPM 2.0 no longer requires TPM module option kit for Gen11 since it is an embedded feature. TPM is disabled on shipments to China.

- Advanced Encryption Standard (AES)
- Triple Data Encryption Standard (3DES)
- SNMP v3
- TLS 1.2
- DMTF Systems Management Architecture for Server Hardware Command Line Protocol (SMASH CLP)
- Active Directory v1.0
- ASHRAE A3/A4

Notes: For additional technical and thermal details regarding ambient temperature, humidity, and feature support, please visit <https://www.hpe.com/support/ASHRAEGen11>

- UEFI (Unified Extensible Firmware Interface Forum) 2.7

Embedded Management

HPE Integrated Lights-Out (HPE iLO)

Monitor your servers for ongoing management, service alerting, reporting, and remote management with HPE iLO. Learn more at <http://www.hpe.com/info/ilo>.

UEFI

Configure and boot your servers securely with industry-standard Unified Extensible Firmware Interface (UEFI). Learn more at <http://www.hpe.com/servers/uefi>.

Intelligent Provisioning

Hassle-free server and OS provisioning for one or more servers with Intelligent Provisioning.

Learn more at <http://www.hpe.com/servers/intelligentprovisioning>.



Standard Features

iLO RESTful API

iLO RESTful API is Redfish API conformance and offers simplified server management automation, such as configuration and maintenance tasks based on modern industry standards. Learn more at <http://www.hpe.com/info/restfulapi>.

OpenBMC Support

OpenBMC Capable through iLO6 Transfer of Ownership Process.
Learn more at [OpenBMC Support](#)

Server Utilities

Active Health System

The HPE Active Health System (AHS) is an essential component of the iLO management portfolio that provides continuous, proactive health monitoring of HPE servers. Learn more at <http://www.hpe.com/servers/ahs>.

Active Health System Viewer

The Active System Health Viewer (AHSV) is deprecated as of March 2022. Users are now recommended to use the InfoSight for Servers Portal for AHS viewing capabilities. In InfoSight for Servers portal, users will also be able to view hardware configuration details, firmware and driver information, warranty and support status of a server, wellness alerts, and create support cases for servers under a valid warranty or support contract.

HPE InfoSight provides the same security assurances as AHSV. Furthermore, InfoSight can be used as an AHSV replacement even if customers do not want to share AHSV logs and telemetry data on an ongoing basis

Smart Update

Keep your servers up to date with the HPE Smart Update solution by using Smart Update Manager (SUM) to optimize the firmware and driver updates of the Service Pack for ProLiant (SPP).

Learn more at <https://www.hpe.com/us/en/servers/smart-update.html>.

iLO Amplifier Pack

Designed for large enterprise and service provider environments with hundreds of HPE servers, the iLO Amplifier Pack is a free, downloadable open virtual application (OVA) that delivers the power to discover, inventory, and update Gen8, Gen9, Gen10, and Gen10 Plus HPE servers at unmatched speed and scale. Use an iLO Advanced License to unlock full capabilities.

Learn more at <http://www.hpe.com/servers/iLOamplifierpack>.

RESTful Interface Tool

RESTful Interface tool (iLOREST) is a single scripting tool to provision using iLO RESTful API to discover and deploy servers at scale. Learn more at <http://www.hpe.com/info/resttool>.

Scripting Tools

Provision one too many servers, using your scripts to discover and deploy with Scripting Tool (STK) for Windows and Linux or Scripting Tools for Windows PowerShell. Learn more at <http://www.hpe.com/servers/powershell>.

HPE OneView Standard

HPE OneView is an on-premise, multi-generational server monitoring and management solution. HPE OneView Standard can be used for inventory, health monitoring, alerting, and reporting without additional fees. Customers can upgrade their management experience with an HPE OneView Advanced license, all provided by the same tool. Learn more at

<http://www.hpe.com/info/oneview>.



Standard Features

HPE GreenLake for Compute Ops Management

HPE is intelligently transforming compute management with an intuitive cloud operating experience through HPE GreenLake cloud platform to streamline and secure operations from edge-to-cloud. Automated key lifecycle tasks, for onboarding, updating, managing, and monitoring HPE servers, brings agility and greater efficiencies to wherever compute devices reside via a unified single browser-based interface. Manage single locations or multiple, distributed sites. Keep tens to thousands of servers secure with batch policy controls and automated updates.

Compute Ops Management is cloud-native software that is continually updated with new services, features, patches, and fixes. The management application resides in the HPE GreenLake cloud platform (access via <https://console.greenlake.hpe.com>) and leverages the HPE GreenLake architecture, security, and unified operations.

A 3-year subscription to HPE GreenLake for Compute Ops Management is added by default when ordering an HPE ProLiant Gen11 rack, tower, or micro server.

For more information, visit the HPE GreenLake for Compute Ops Management QuickSpecs:

<https://www.hpe.com/psnow/doc/a50004263enw>

Security

- UEFI Secure Boot and Secure Start support.
 - Tamper-free updates – components digitally signed and verified.
 - Immutable Silicon Root of Trust
 - Ability to rollback firmware
 - FIPS 140-2 validation
 - Secure erase of NAND/User data
 - Common Criteria certification
 - Configurable for PCI DSS compliance
 - Embedded TPM (Trusted Platform Module) 2.0. Disabled on shipments to China.
 - Advanced Encryption Standard (AES) and Triple Data Encryption Standard (3DES) on browser
 - Bezel Locking Kit option.
 - Support for Commercial National Security Algorithms (CNSA)
 - Chassis Intrusion detection option
 - Secure Recovery – recover critical firmware to a known good state on detection of compromised firmware
-

Warranty

This product is covered by a global limited warranty and supported by HPE Services and a worldwide network of Hewlett Packard Enterprise Authorized Channel Partners resellers. Hardware diagnostic support and repair are available for three years from the date of purchase. Support for software and initial setup is available for 90 days from the date of purchase. Enhancements to warranty services are available through HPE Services operational services or customized service agreements. Hard drives have either a one-year or three-year warranty; refer to the specific hard drive QuickSpecs for details.

Notes: Server Warranty includes 3-Year Parts, 3-Year Labor, and 3-Year Onsite support with next business day response. Warranty repairs may be accomplished through the use of Customer Self Repair (CSR) parts. These parts fall into two categories: 1) Mandatory CSR parts are designed for easy replacement. A travel and labor charge will result when customers decline to replace a Mandatory CSR part; 2) Optional CSR parts are also designed for easy replacement but may involve added complexity. Customers may choose to have Hewlett Packard Enterprise replace Optional CSR parts at no charge. Additional information regarding worldwide limited warranty and technical support is available at:

<https://www.hpe.com/us/en/search-results.html?page=1&q=servers%20warranty&autocomplete=0>



Optional Features

Server Management

HPE iLO Advanced

HPE iLO Advanced licenses offer smart remote functionality for all HPE ProLiant servers without compromise. The license includes the full integrated remote console, virtual keyboard, video, and mouse (KVM), multi-user collaboration, console record and replay, and GUI-based and scripted virtual media and virtual folders. You can also activate the enhanced security and power management functionality.

HPE OneView Advanced

HPE OneView Advanced offers a sophisticated level of automation to infrastructure management by taking a template-driven approach to provisioning, updating, and integrating compute, storage, and networking infrastructure. It builds upon the base features of HPE OpenView Standard and provides full-featured licenses which can be purchased for managing multiple HPE server generations.

To learn more, visit <http://www.hpe.com/info/oneview>.

HPE InfoSight for Servers

HPE InfoSight for Servers combines the cloud-based machine learning of InfoSight with the health and performance monitoring of Active Health System (AHS) and iLO to optimize performance and predict and prevent problems. The end result is an intelligent environment that modernizes IT operations and enhances the support experience by predicting and preventing the infrastructure issues that lead to application disruptions, wasted IT staff time, and missed business opportunities.

Learn more at <https://www.hpe.com/us/en/solutions/infosight.html>

HPE Insight Cluster Management Utility (CMU)

HPE Insight Cluster Management Utility is a Hyperscale management framework that includes software for the centralized provisioning, management, and monitoring of nodes and infrastructure. Learn more at <http://www.hpe.com/info/cmu>

Accelerator and GPU Information

Hewlett Packard Enterprise supports various accelerators on select HPE ProLiant servers to support different workloads. The accelerators enable seamless integration of GPU computing with HPE ProLiant servers for high-performance computing, large data center graphics, deep learning and virtual desktop deployments. These accelerators deliver all of the standard benefits of GPU computing while enabling maximum reliability and tight integration with system monitoring and management tools such as HPE Insight Cluster Management Utility.

One Config Simple (OCS/SCE)

OCS/SCE is a guided self-service tool to help sales and non-technical people provide customers with initial configurations in 3 to 5 minutes. You may then send the configuration on for configuration help or use it in your existing ordering processes. If you require "custom" rack configuration or configuration for products not available in SCE, please contact Hewlett Packard Enterprise Customer Business Center or an Authorized Partner for assistance.

<https://h22174.www2.hpe.com/SimplifiedConfig/Welcome#>

Rack and Power Infrastructure

The story may end with servers, but it starts with the foundation that makes compute go – and business grow. 'We've reinvented our entire portfolio of rack and power products to make IT infrastructure more secure, practical, and efficient. In other words, 'we've created a more robust, smarter, and simpler infrastructure to help you get the most out of your IT equipment. As an industry leader, Hewlett Packard Enterprise is uniquely positioned to address the key concerns of power, cooling, cable management, and system access.

HPE G2 Advanced and Enterprise Racks are perfect for the server room or 's modern data center, with enhanced airflow and thermal management, flexible cable management, and a 10-year Warranty to support higher-density computing.

HPE G2 PDUs offer reliable power in flexible form factors that operate at temperatures up to 60°C, include color-coded outlets and load segments, and a low-profile design for optimal access to the rack and support for dense rack environments.



Optional Features

HPE Uninterruptible Power Systems are cost-effective power protection for any workload. Some UPSs include options for remote management and extended runtime modules so your critical dense data center is covered in power outages.

HPE KVM Solutions include a console and switches designed to work reliably with your server and IT equipment. We've got a cost-effective KVM switch for your first rack and multiple connection IP switches with remote management and security capabilities to keep your data center rack up and running.

Learn more about HPE Racks, KVM, PDUs, and UPSs at [HPE Rack and Power Infrastructure](#).



Service and Support

HPE Services

No matter where you are in your digital transformation journey, you can count on HPE Services to deliver the expertise you need when, where and how you need it. From planning to deployment, ongoing operations and beyond, our experts can help you realize your digital ambitions.

<https://www.hpe.com/services>

Consulting Services

No matter where you are in your journey to hybrid cloud, experts can help you map out your next steps. From determining what workloads should live where, to handling governance and compliance, to managing costs, our experts can help you optimize your operations.

<https://www.hpe.com/services/consulting>

HPE Managed Services

HPE runs your IT operations, providing services that monitor, operate, and optimize your infrastructure and applications, delivered consistently and globally to give you unified control and let you focus on innovation.

[HPE Managed Services | HPE](#)

Operational services

Optimize your entire IT environment and drive innovation. Manage day-to-day IT operational tasks while freeing up valuable time and resources. Meet service-level targets and business objectives with features designed to drive better business outcomes.

<https://www.hpe.com/services/operational>

HPE Complete Care Service

HPE Complete Care Service is a modular, edge-to-cloud IT environment service designed to help optimize your entire IT environment and achieve agreed upon IT outcomes and business goals through a personalized experience. All delivered by an assigned team of HPE Services experts. HPE Complete Care Service provides:

- A complete coverage approach -- edge to cloud
- An assigned HPE team
- Modular and fully personalized engagement
- Enhanced Incident Management experience with priority access
- Digitally enabled and AI driven customer experience

<https://www.hpe.com/services/complecare>

HPE Tech Care Service

HPE Tech Care Service is the operational support service experience for HPE products. The service goes beyond traditional support by providing access to product specific experts, an AI driven digital experience, and general technical guidance to not only reduce risk but constantly search for ways to do things better. HPE Tech Care Service delivers a customer-centric, AI driven, and digitally enabled customer experience to move your business forward. HPE Tech Care Service is available in three response levels. Basic, which provides 9x5 business hour availability and a 2-hour response time. Essential which provides a 15-minute response time 24x7 for most enterprise level customers, and Critical which includes a 6-hour repair commitment where available and outage management response for severity 1 incidents.

<https://www.hpe.com/services/techcare>



Service and Support

HPE Lifecycle Services

HPE Lifecycle Services provide a variety of options to help maintain your HPE systems and solutions at all stages of the product lifecycle. A few popular examples include:

- Lifecycle Install and Startup Services: Various levels for physical installation and power on, remote access setup, installation and startup, and enhanced installation services with the operating system.
- HPE Firmware Update Analysis Service: Recommendations for firmware revision levels for selected HPE products, taking into account the relevant revision dependencies within your IT environment.
- HPE Firmware Update Implementation Service: Implementation of firmware updates for selected HPE server, storage, and solution products, taking into account the relevant revision dependencies within your IT environment.
- Implementation assistance services: Highly trained technical service specialists to assist you with a variety of activities, ranging from design, implementation, and platform deployment to consolidation, migration, project management, and onsite technical forums.
- HPE Service Credits: Access to prepaid services for flexibility to choose from a variety of specialized service activities, including assessments, performance maintenance reviews, firmware management, professional services, and operational best practices.

Notes: To review the list of Lifecycle Services available for your product go to:

<https://www.hpe.com/services/lifecycle>

For a list of the most frequently purchased services using service credits, see the [HPE Service Credits Menu](#)

Other Related Services from HPE Services:

HPE Education Services

Training and certification designed for IT and business professionals across all industries. Broad catalogue of course offerings to expand skills and proficiencies in topics ranging from cloud and cybersecurity to AI and DevOps. Create learning paths to expand proficiency in a specific subject. Schedule training in a way that works best for your business with flexible continuous learning options.

<https://www.hpe.com/services/training>

Defective Media Retention

An option available with HPE Complete Care Service and HPE Tech Care Service and applies only to Disk or eligible SSD/Flash Drives replaced by HPE due to malfunction.

Consult your HPE Sales Representative or Authorized Channel Partner of choice for any additional questions and services options.

Parts and Materials

HPE will provide HPE-supported replacement parts and materials necessary to maintain the covered hardware product in operating condition, including parts and materials for available and recommended engineering improvements.

Parts and components that have reached their maximum supported lifetime and/or the maximum usage limitations as set forth in the manufacturer's operating manual, product quick-specs, or the technical product data sheet will not be provided, repaired, or replaced as part of these services.

How to Purchase Services

Services are sold by Hewlett Packard Enterprise and Hewlett Packard Enterprise Authorized Service Partners:

- Services for customers purchasing from HPE or an enterprise reseller are quoted using HPE order configuration tools.
- Customers purchasing from a commercial reseller can find services at <https://ssc.hpe.com/portal/site/ssc/>



Service and Support

AI Powered and Digitally Enabled Support Experience

Achieve faster time to resolution with access to product-specific resources and expertise through a digital and data driven customer experience

Sign into the HPE Support Center experience, featuring streamlined self-serve case creation and management capabilities with inline knowledge recommendations. You will also find personalized task alerts and powerful troubleshooting support through an intelligent virtual agent with seamless transition when needed to a live support agent.

<https://support.hpe.com/hpesc/public/home/signin>

Consume IT On Your Terms

HPE GreenLake edge-to-cloud platform brings the cloud experience directly to your apps and data wherever they are—the edge, colocations, or your data center. It delivers cloud services for on-premises IT infrastructure specifically tailored to your most demanding workloads. With a pay-per-use, scalable, point-and-click self-service experience that is managed for you, HPE GreenLake edge-to-cloud platform accelerates digital transformation in a distributed, edge-to-cloud world.

- Get faster time to market
- Save on TCO, align costs to business
- Scale quickly, meet unpredictable demand
- Simplify IT operations across your data centers and clouds

To learn more about HPE Services, please contact your Hewlett Packard Enterprise sales representative or Hewlett Packard Enterprise Authorized Channel Partner. Contact information for a representative in your area can be found at "Contact HPE"

<https://www.hpe.com/us/en/contact-hpe.html>

For more information

<http://www.hpe.com/services>



Pre-Configured Models

Pre-Configured models ship with the configurations below.

- Pre-Configured models ship with the configurations below. Options can be selected from the Core or Additional options section of this QuickSpecs.
- Hewlett Packard Enterprise does not allow factory integration of options into pre-configured models. Any additional options purchased will not be shipped inside the server.
- Network Choice models do not include embedded LOM.

SKU Number	P57685-B21 P57685-291 P57685-421	P57686-B21 P57686-291 P57686-421 P57686-AA1	P57687-B21 P57687-291 P57687-421
Model Name	HPE ProLiant DL320 Gen11 3408U 1.8GHz 8-core 1P 16GB-R 4LFF 500W PS Server (-B21 & -291)	HPE ProLiant DL320 Gen11 3408U 1.8GHz 8-core 1P 16GB-R 8SFF 500W PS Server (-B21 & -291 & -AA1)	HPE ProLiant DL320 Gen11 4410Y 2.0GHz 12-core 1P 16GB-R MR408i-o 8SFF 500W PS Server (-B21 & -291)
	HPE ProLiant DL320 Gen11 3408U 1.8GHz 8-core 1P 16GB-R 4LFF 1000W PS Server (-421)	HPE ProLiant DL320 Gen11 3408U 1.8GHz 8-core 1P 16GB-R 8SFF 1000W PS Server (-421)	HPE ProLiant DL320 Gen11 4410Y 2.0GHz 12-core 1P 16GB-R MR408i-o 8SFF 1000W PS Server (-421)
Chassis	HPE ProLiant DL320 Gen11 4LFF Configure-to-order Server	HPE ProLiant DL320 Gen11 8SFF Configure-to-order Server	HPE ProLiant DL320 Gen11 8SFF Configure-to-order Server
Processor	3408U (8 core, 1.8 GHz, 125W)	3408U (8 core, 1.8 GHz, 125W)	4410Y (12 core, 2.0 GHz, 150W)
Number of Processors	One with standard heatsink		
Memory	16 GB (1x16 GB, 4800 MT/s) Notes: Runs at 4000 MT/s due to processor limitation.		
Network Controller	HPE embedded 2-port 1 GbE Ethernet adapter		
Storage Controller	Embedded SATA controller (AHCI or Intel SATA software RAID controller) (-B21 & -421)	Embedded SATA controller (AHCI or Intel SATA software RAID controller) (-B21 & -421 & -AA1)	HPE MR408i-o Gen11 x8 Lanes 4GB Cache OCP SPDM Storage Controller Notes: Smart Storage battery included
	(-291)	(-291)	
Included Hard Drives	None ship standard, 4 LFF supported	None ship standard, 8 SFF supported	None ship standard, 8 SFF supported
Optical Drive	None included (Optical Drive options available) (-B21 & -421) Optional HPE 9.5mm SATA DVD-RW Optical Drive, HPE Mobile USB DVD-RW Drive (-291)		
Expansion Slots	2 x16 FHHL PCIe Gen5; 1 OCP 3.0 Slot		
Power Supply	1x HPE 500W Flex Slot Platinum Hot Plug Low Halogen Power Supply Kit (-B21 & -291) 1x HPE 1000W Flex Slot Titanium Hot Plug Power Supply Kit (-421)		
Fans	5x Standard Fans	5x Standard Fans	7x Standard Fans

Pre-Configured Models

Management	HPE iLO 6		
Rail Kit	HPE Easy Install Rail 2 Kit	HPE Easy Install Rail 1 Kit	HPE Easy Install Rail 1 Kit
Security	TPM (Trusted Platform Module)	TPM (Trusted Platform Module) (-B21 & -291 & -421) TPM disabled for shipments to China (-AA1)	TPM (Trusted Platform Module)
Form Factor	1U Rack		
Warranty	Server warranty includes 3-year parts, 3-year labor, 3-year onsite support with next business day response.		

SKU Number	P57688-B21 P57688-291 P57688-421	P69302-005
Model Name	HPE ProLiant DL320 Gen11 5416S 2.0GHz 16-core 1P 32GB-R MR408i-o 8SFF 500W PS Server (-B21 & -291) HPE ProLiant DL320 Gen11 5416S 2.0GHz 16-core 1P 32GB-R MR408i-o 8SFF 1000W PS Server (-421)	HPE ProLiant DL320 Gen11 5416S 2.0GHz 16-core 1P 64GB-R 8SFF 800W PS AMS Server
Chassis	HPE ProLiant DL320 Gen11 8SFF Configure-to-order Server	
Processor	5416S (16 core, 2.0 GHz, 150W)	
Number of Processors	One with standard heatsink	
Memory	32 GB (1x32 GB , 4800 MT/s) Notes: Runs at 4400 MT/s due to processor limitation.	64 GB (2x32 GB , 4800 MT/s) Notes: Runs at 4400 MT/s due to processor limitation.
Network Controller	HPE embedded 2-port 1 GbE Ethernet adapter	
Storage Controller	HPE MR408i-o Gen11 x8 Lanes 4GB Cache OCP SPDM Storage Controller Notes: Smart Storage battery included	
Included Hard Drives	None ship standard, 8 SFF supported	
Optical Drive	None included (Optical Drive options available) (-B21 & -421) Optional HPE 9.5mm SATA DVD-RW Optical Drive, HPE Mobile USB DVD-RW Drive (-291)	None included (Optical Drive options available)
Expansion Slots	2 x16 FHHL PCIe Gen5; 1 OCP 3.0 Slot	
Power Supply	1x HPE 500W Flex Slot Platinum Hot Plug Low Halogen Power Supply Kit (-B21 & -291) 1x HPE 1000W Flex Slot Titanium Hot Plug Power Supply Kit (-421)	2x HPE 800W Flex Slot Platinum Hot Plug Low Halogen Power Supply Kit



Pre-Configured Models

Fans	7x Standard Fans	5x Standard Fans
Management	HPE iLO 6	
Rail Kit	HPE Easy Install Rail 1 Kit	
Security	TPM (Trusted Platform Module)	
Form Factor	1U Rack	
Warranty	Server warranty includes 3-year parts, 3-year labor, 3-year onsite support with next business day response.	

Country Code Key

- -B21 = Worldwide
- -005 = HPE Express Buy for US and Canada
- -291 = Japan
- -421 = Europe, the Middle East and Africa
- -AA1 = China

Notes: Enabling TPM 2.0 no longer requires TPM module option kit for Gen11 since It is an embedded feature.



Configuration Information

Smart Templates from HPE

HPE is releasing new Smart Template technology in the One Config Advanced (OCA) configurator. These Templates represent the CTO equivalents of the top-selling BTO configurations. They are intended to provide simple starting points to assist you in easily creating and customizing your desired Server solutions. HPE Servers that have Platform Templates developed by HPE Product Managers will have a separate tab in the HPE OCA configurator.

Workload Solutions Templates from HPE

The Workload Solutions Templates build on the Smart Templates technology to easily develop working configurations of the most compelling Workload Solutions. The templates complement the reference Builds developed by HPE. Workload Solutions templates preconfigure some of the key architecture decisions and make it easier for Sellers to get started and complete a differentiated server solution for your customer's specific workload.

Mainstream SKUs

HPE launched the Mainstream SKU initiative as a market-driven approach to Demand Steering. It is a simplified portfolio of our top-selling options that meet the current and future market trends. HPE has committed to providing a more predictable and faster experience for these options. Mainstream SKUs enjoy higher safety stock levels and have higher fulfillment service levels than non-Mainstream SKUs. Mainstream orders are fulfilled +30% faster than non-Mainstream orders, have fewer shortages, and have better recovery dates. This platform has Mainstream SKUs in the options portfolio and is eligible for an improved Mainstream experience. Mainstream SKUs are designated with a Mainstream symbol in our configurators.

Mainstream Configurations

HPE is using the new Smart Templates technology to present Mainstream configurations. All the options in a Mainstream configuration are pre-selected Mainstream SKUs to optimize the performance, predictability, and fulfillment experience. Check the Template section in our configurators for eligible Mainstream configurations.



Configuration Information

This section lists some of the steps required to configure a Factory Integrated Model. To ensure valid configurations are ordered, Hewlett Packard Enterprise recommends using an HPE-approved configurator. Contact your local sales representative for information on configurable product offerings and requirements.

- Factory Integrated Models must start with a CTO Server.
- FIO indicates that this option is only available as a factory installable option.
- Some options may not be integrated at the factory. Contact your local sales representative for additional information

Step 1: Base Configuration (choose one (1) of the following (3) configurable models from the tables below)

CTO Server	HPE ProLiant DL320 Gen11 4 LFF CTO Server	HPE ProLiant DL320 Gen11 8 SFF CTO Server	HPE ProLiant DL320 Gen11 12 LFF CTO Server	HPE ProLiant DL320 Gen11 GPU CTO Server
SKU Number	P52765-B21	P52766-B21	P52767-B21	P61218-B21
TAA SKU¹	P52765-B21#GTA	P52766-B21#GTA	P52767-B21#GTA	P61218-B21#GTA
Processor	Not included as standard			
DIMM Slots	16-DIMM slots			
Storage Controller	8 SATA ports, choice of HPE modular Smart Array and PCIe plug-in Controllers, and Intel® VROC Software RAID.			
PCIe	PCIe 5.0: 2 slots (x 16 FHHL) 1x OCP 3.0 in PCIe 5.0 (x16)			
Drive Cage – included	4 SAS/SATA LFF Direct attach for 4 LFF SATA	(8+2) SAS/SATA SFF (8+2) x2 NVMe SFF or, (8+2) x4 NVMe SFF	12 SAS/SATA LFF Direct attach support for 10 LFF SATA	4 SFF SAS/SATA/NVMe or 8 EDSFF E3.s 1T ² based on the selection
Network Controller	Two (2) Embedded Broadcom BCM5720 1 GbE networking port Choice of either OCP 3.0 or select standup network adapters for primary networking selection plus additional/optional standup network adapters			
Fans	Support for (7) High-Performance Fans			
Management	HPE iLO with Intelligent Provisioning (standard), iLO Advanced (optional), and OneView (optional)			
USB	Front: One (1) USB 3.2 Gen1 + iLO service port Rear: Two (2) USB 3.2 Gen1 ports Internal: One (1) USB 2.0 port			
	Option: One (1) Front USB 2.0 port	Option: One (1) Front USB 2.0 port		
Security	Embedded TPM 2.0 (Trusted Platform Module) Notes: – Enabling TPM 2.0 no longer requires TPM module option kit for Gen11 since It is an embedded feature. – Disabled on shipments to China			
Rail Kit	Optional Easy Install rails and CMA			
Form Factor	1U Rack			
Warranty	3-year parts, 3-year labor, 3-year onsite support with next business day response.			

Notes:

- ¹HPE offers multiple Trade Agreement Act (TAA) compliant configurations to meet the needs of US Federal Government customers. These products are either manufactured or substantially transformed in a designated country.
- ²Only 4 EDSFF supported with existing configs. Support for 8 EDSFF to follow in future launches.



Configuration Information

Step 2: Choose Options

Step 2a: Choose Processor

Processor Option Kits (Required Processor)

Notes:

- All SKUs below ship with one processor only. Adequate fans and heatsinks must be selected.
- Processor with TDP greater than 185W require High Performance Heatsink (P52756-B21) and High-Performance Fan Kit (P48908-B21).

4th Generation Intel Xeon-Gold 6

Intel Xeon-Gold 6426Y 2.5GHz 16-core 185W Processor for HPE	P49598-B21
Intel Xeon-Gold 6442Y 2.6GHz 24-core 225W Processor for HPE	P49599-B21
Intel Xeon-Gold 6448Y 2.1GHz 32-core 225W Processor for HPE	P49600-B21
Intel Xeon-Gold 6434 3.7GHz 8-core 195W Processor for HPE	P49601-B21
Intel Xeon-Gold 6444Y 3.6GHz 16-core 270W Processor for HPE	P49602-B21
Intel Xeon-Gold 6430 2.1GHz 32-core 270W Processor for HPE	P49614-B21
Intel Xeon-Gold 6438Y+ 2.0GHz 32-core 205W Processor for HPE	P49615-B21
Intel Xeon-Gold 6414U 2.0GHz 32-core 250W Processor for HPE	P49619-B21
Intel Xeon-Gold 6438N 2.0GHz 32-core 205W Processor for HPE	P49638-B21
Intel Xeon-Gold 6421N 1.8GHz 32-core 185W Processor for HPE	P49641-B21
Intel Xeon-Gold 6454S 2.2GHz 32-core 270W Processor for HPE	P49654-B21

4th Generation Intel Xeon-Gold 5

Intel Xeon-Gold 5415+ 2.9GHz 8-core 150W Processor for HPE	P49597-B21
Intel Xeon-Gold 5418Y 2.0GHz 24-core 185W Processor for HPE	P49612-B21
Intel Xeon-Gold 5420+ 2.0GHz 28-core 205W Processor for HPE	P49613-B21
Intel Xeon-Gold 5412U 2.1GHz 24-core 185W Processor for HPE	P49618-B21
Intel Xeon-Gold 5411N 1.9GHz 24-core 165W Processor for HPE	P49639-B21
Intel Xeon-Gold 5418N 1.8GHz 24-core 165W Processor for HPE	P49640-B21
Intel Xeon-Gold 5416S 2.0GHz 16-core 150W Processor for HPE	P49653-B21

4th Generation Intel Xeon-Silver

Intel Xeon-Silver 4410Y 2.0GHz 12-core 150W Processor for HPE	P49610-B21
---	------------

Notes: 64GB SGX Enclave

Intel Xeon-Silver 4416+ 2.0GHz 20-core 165W Processor for HPE	P49611-B21
---	------------

Notes: 64GB SGX Enclave

4th Generation Intel Xeon-Bronze

Intel Xeon-Bronze 3408U 1.8GHz 8-core 125W Processor for HPE	P49617-B21
--	------------

Step 2b: Choose Memory Options

Please select one or more memory DIMMs from below.

For the new Gen11 memory population rule whitepaper and optimal memory performance guidelines and memory speed table, please go to:

<http://www.hpe.com/docs/memory-population-rules>

For memory Reliability, Accessibility, and Serviceability (RAS) features whitepaper like Gen11 Fast Fault Tolerance and legacy mirrored memory feature, etc., please go to: <http://www.hpe.com/docs/memory-ras-feature>.



Configuration Information

Notes:

- HPE Server Memory compatibility for a specific server platform may vary or be limited within a server platform depending upon the specific configuration being requested. Because each server environment and requirements can vary, memory compatibility is based not only upon the server family but may also be affected by the amount and type of additional hardware options installed within a specific server configuration. For this reason, some HPE memory DIMMs may be qualified for an HPE server model or family and yet occasionally not be supported with some configurations within that server family.
- Memory DIMMs must be selected in quantities 1, 2, 4, 6, 8, 12, or 16.
- The maximum memory speed and capacity are a function of the memory type, memory configuration, and processor model.

For additional information, please see the [HPE DDR5 Smart Memory QuickSpecs](#)

Registered DIMMs DDR5 (RDIMMs)

HPE 16GB (1x16GB) Single Rank x8 DDR5-4800 CAS-40-39-39 EC8 Registered Smart Memory Kit	P43322-B21
HPE 32GB (1x32GB) Dual Rank x8 DDR5-4800 CAS-40-39-39 EC8 Registered Smart Memory Kit	P43328-B21
HPE 64GB (1x64GB) Dual Rank x4 DDR5-4800 CAS-40-39-39 EC8 Registered Smart Memory Kit	P43331-B21
HPE 96GB (1x96GB) Dual Rank x4 DDR5-4800 CAS-46-45-45 EC8 Registered Smart Memory Kit	P66675-B21
HPE 128GB (1x128GB) Quad Rank x4 DDR5-4800 CAS-46-39-39 EC8 Registered 3DS Smart Memory Kit	P43334-B21

Notes:

- 4800 MT/s memory SKUs offer a transfer rate of 4800 MT/s at 1 DIMM per channel and 4400 MT/s at 2 DIMMs per channel.
- Mixing of 3DS memory and non-3DS memory is not supported.
- 96GB and higher memory DIMMs require high performance fan kit.
- For the GPU CTO Server, 96GB and higher memory DIMMs are supported only with 25C and lower ambient temperature.

Memory Blank Kit

HPE DDR4 DIMM Blank Kit	P07818-B21
-------------------------	------------

Notes: Memory DIMM blanks must be installed in each empty slot.

Step 2c: Choose Power Supplies

Please select one or two power supplies from below.

Notes: Mixing of 2 different power supplies is NOT supported.

HPE Flex Slot Power Supplies

HPE 500W Flex Slot Platinum Hot Plug Low Halogen Power Supply Kit	865408-B21
---	------------

Notes:

- If a 500W power supply is selected with HPE ProLiant DL320 Gen11 8SFF x4 Tri-Mode 24G U.3 BC Backplane Kit (P52747-B21), then the internal controller must be selected. However, this will only support SAS/SATA drives.
- If a 500W power supply is selected with 8SFF CTO Server, NVMe drives cannot be selected, and vice versa.

HPE 1000W Flex Slot Titanium Hot Plug Power Supply Kit	P03178-B21
--	------------

HPE 800W Flex Slot Platinum Hot Plug Low Halogen Power Supply Kit	P38995-B21
---	------------

HPE 1600W Flex Slot Platinum Hot Plug Low Halogen Power Supply Kit	P38997-B21
--	------------

Notes: Only supports high line voltage (200 VAC to 240 VAC).

HPE 1800W-2200W Flex Slot Titanium Hot Plug Power Supply Kit	P44712-B21
--	------------



Configuration Information

Step 2d: Choose backplane /drive cage

No optional backplanes are available for the existing LFF CTO configurations.
8 SFF customers can select the back planes from the following options.

HPE ProLiant DL320 Gen11 8SFF x1 Tri-Mode 24G U.3 BC Backplane Kit

P52743-B21

Notes:

- If the 8SFF Drive cage is selected with PCIe Internal controller, then '8SFF TM Cable Kit (P52775-B21)' must be selected.
- If the 8SFF Drive cage is selected with OROC controller, then '8SFF OROC Cable (P52780-B21)' must be selected.
- 8SFF x1 U.3 Drive cage with Direct attach supports 8 SATA Drives only.
- If MR416i-p/MR216i-p/SR932i-p/MR416i-o/MR216i-o controller is selected along with 8SFF x1 U.3 and 2SFF x4 U.3 drive cage, then one controller is enough to support both the drive cages with the selection of '8SFF cable kit' and '2SFF TM cable kit.'
- If 'HPE NS204i-u Gen11 Hot Plug Boot Optimized is selected with 8SFF x1 U.3 drive cage, then Internal PCIe/OROC controller and PCIe/OROC cable must be selected.

HPE ProLiant DL320 Gen11 8SFF x4 Tri-Mode 24G U.3 BC Backplane Kit

P52747-B21

Notes:

- If the 8SFF Drive cage is selected with PCIe Internal controller, then '8SFF TM Cable Kit (P52775-B21)' must be selected.
- If the 8SFF Drive cage is selected with OROC controller, then '8SFF OROC Cable (P52780-B21)' must be selected.
- 8SFF x4 U.3 Drive cage with Direct attach supports 8 NVMe U.3 Drives only.
- If 8SFF x4 U.3 Drive cage is selected with 2SFF U.3 drive cage and no Internal controller or NVMe adapter (P25527-B21) is selected, then 2SFF U.3 drive cage can support SATA drives only.
- If 8SFF x4 Drive cage and 2SFF drive cage is selected with Qty=1 of Internal controller, then '8SFF cable kit' or '2SFF TM cable kit (P52776-B21)' must be selected
- If 8SFF x4 Drive cage and 2SFF drive cage is selected with Qty=2 of Internal controller, then both '8SFF cable kit' and '2SFF TM cable kit (P52776-B21)' must be selected
- If 8SFF x4 Drive cage and 2SFF Drive cage are selected along with MR408i-o controller, then '2SFF TM cable kit (P52776-B21)' must be selected.
- '2SFF Drive cage' or '1U DP/USB/ODD Blank Kit' requires the selection of an 8SFF Drive cage.
- If 8SFF x4 Drive cage and 2SFF Drive cage is selected along with SR932i-p controller, then '8SFF TM cable kit (P52775-B21)' must be selected.

HPE ProLiant DL320 Gen11 2SFF x4 Tri-Mode 24G U.3 BC Drive Cage Kit

P52751-B21

Notes:

- If the 8SFF Drive cage is selected with PCIe Internal controller, then '8SFF TM Cable Kit(P52775-B21)' must be selected.
- If the 2SFF Drive cage is selected with PCIe Internal controller or OROC controller, then the '2SFF TM Cable Kit (P52776-B21)' must be selected.
- If the 2SFF Drive cage is selected with NVMe 2p Adapter, then '2SFF Retimer Cable(P52777-B21)' must be selected.
- 2SFF U.3 Drive cage with direct attach supports either 2 NVMe U.3 drives or SATA drives.
- If MR416i-p/MR216i-p/SR932i-p/MR416i-o/MR216i-o controller is selected along with 8SFF x1 U.3 and 2SFF x4 U.3 drive cage, then one controller is enough to support both the drive cages with the selection of '8SFF cable kit' and '2SFF TM cable kit (P52776-B21).'
- If the 8SFF x4 Drive cage and 2SFF drive cage are selected with Qty=1 of the Internal controller, then '8SFF cable kit' or '2SFF TM cable kit (P52776-B21)' must be selected.
- If the 8SFF x4 Drive cage and 2SFF drive cage are selected with Qty=2 of the Internal controller, then both '8SFF cable kit' and '2SFF TM cable kit (P52776-B21)' must be selected.



Configuration Information

- If 8SFF x4 Drive cage and 2SFF Drive cage are selected along with MR408i-o controller, then '2SFF TM cable kit (P52776-B21)' must be selected.
- If the 8SFF x4 Drive cage and 2SFF Drive cage is selected along with the SR932i-p controller, then the '8SFF TM cable kit (P52775-B21)' must be selected.

HPE ProLiant DL3X0 Gen11 1U 8SFF Display Port/USB/Optical Drive Blank Kit P48926-B21

Notes:

- Either '2SFF drive cage' or '1U DP/USB/ODD Blank' can be selected.
- '2SFF Drive cage' or '1U DP/USB/ODD Blank Kit' requires an 8SFF Drive cage configuration.

HPE ProLiant DL320 Gen11 8EDSFF x4 NVMe Drive Cage Kit P61219-B21

Notes:

- Supported only with HPE ProLiant DL320 Gen11 GPU CTO Server (P61218-B21)
- Support limited for up to 4 EDSFF drives with currently supported configs.
- 8EDSFF Drive cage is to be selected with HPE ProLiant DL320 Gen11 GPU 4x Direct Connected NVMe FIO Enablement Kit (P62181-B21) and drive cage will be connected to Direct attach and can support maximum of 4 EDSFF drives only.

HPE ProLiant DL320 Gen11 4SFF x4 Tri-Mode 24G U.3 BC Drive Cage Kit P61221-B21

Notes:

- Supported only with GPU CTO Server (P61218-B21).
- If 4SFF U.3 drive cage is selected with MR416i-p controller, then HPE ProLiant DL320 Gen11 4SFF Tri-Mode Cable Kit (P62189-B21) must be selected.
- If 4SFF Drive cage is selected and MR416i-p is not selected, then HPE ProLiant DL320 Gen11 GPU 4x Direct Connected NVMe FIO Enablement Kit (P62181-B21) must be selected.
- If 4SFF U.3 Drive cage is selected with HPE ProLiant DL320 Gen11 GPU 4x Direct Connected NVMe FIO Enablement Kit (P62181-B21) then drive cage will be connected to direct attach and support a maximum of 4 NVMe U.3 drives only.

Step 3: Choose Additional Factory Integratable Options (FIO)

One of the following from each list may be selected if desired at the time of factory integration

HPE iLO Common Password FIO Setting P08040-B21

Notes:

- Replaces iLO default randomized password with an HPE-defined common password. HPE highly recommends changing this password immediately after the initial onboarding process.
- Customers who want to choose their own custom iLO default password should use the HPE Factory Express Integration Services.

HPE Bezel Lock Kit 875519-B21

Notes: Bezel lock kit requires selection of Bezel kit.

HPE ProLiant DL320 Gen11 GPU 4x Direct Connected NVMe FIO Enablement Kit P62181-B21

Notes:

- Supported only with GPU CTO Server.
- If 8EDSFF or 4SFF Drive cage is selected and MR416i-p is not selected, then "HPE DL320 G11 GPU 4xDC NVMe FIO Kit" must be selected.
- If 8EDSFF Drive cage is selected with "HPE DL320 G11 GPU 4xDC NVMe FIO Kit" then drive cage will be connected to Direct attach and can support Max=4 EDSFF drives only.
- If 4SFF U.3 Drive cage is selected with "HPE DL320 G11 GPU 4xDC NVMe FIO Kit" then drive cage will be connected to direct attach and support Max=4 NVMe U.3 drives only.
- Cannot be selected if MR416i-p controller is selected.
- Max=1 of 'GPU 4xDC NVMe FIO Kit' or '4SFF TM Cable Kit' or '2xType-p NVMe Cable Kit' can be selected



Configuration Information

- If Qty=1 of GPU is selected with GPU CTO Server, then 'GPU 4xDC NVMe FIO Kit' or '2 GPU FIO Enable Kit' must be selected. In GPU CTO Server if 'GPU 4xDC NVMe FIO Kit' then the first GPU card selected will be installed in the front of the server. This should not be considered for total PCIe selection.

HPE FIO No Smart Storage Battery

P06141-B21

Notes:

- If the 'Storage Battery Removal setting' is selected, then SR932/ MR416/ MR408 controller does not require selecting the Battery.
- 'Storage Battery Removal setting' requires selection of SR932/ MR416/ MR408 controller.
- If the 'Storage Battery Removal 'setting' is selected, then Battery cannot be selected.

HPE ProLiant DL300 Gen10 Plus Platform RAS OS Control FIO Setting

P27078-B21

HPE Smart Memory Fast Fault Tolerance FIO Setting

875293-B21

Notes:

- Enables Fast Fault Tolerance mode, an HPE Memory RAS feature introduced in HPE Gen10 servers that survives up to two DRAM failures.
- This RAS feature combines Adaptive Double DRAM Device Correction (ADDC) with HPE Advanced Error Detection Technology, resulting in significantly better memory reliability and availability than what ADDC provides on its own. For more information, see our [Memory RAS feature technical whitepaper](#).
- If 'Memory fast fault Tolerance' is selected with Single Rank DIMM, then Min=2 and Max=16 DIMM's are allowed for selection.
- If 'Memory fast fault Tolerance' is selected with Dual Rank DIMM or Quad Rank DIMM, then Min=1 and Max=16 DIMM's are allowed for selection.

HPE ProLiant DL300 Gen10 Plus Platform RAS OS Control FIO Setting

P27078-B21

Notes:

- Firmware first is ProLiant servers BIOS default selection. In this mode, monitoring functionality built into the design of the server is first on the scene of correctable problems to determine quickly and accurately 'what's wrong and how to fix it. Firmware first enables many platform-specific actions for errors, including predictive fault analysis. This technology functions independently of the operating system and does not depend on O/S-based tools.
- This SKU instructs factories to enable O/S first mode, a BIOS switch that allows experienced customers to have the operating system handle correctable hardware errors. More errors could be observed in this mode, including soft ones that do not necessarily indicate issues with the component or cause warranty replacement.

HPE Converged Infrastructure Management Software

HPE OneView w/o iLO including 3yr 24x7 Support Flexible Quantity E-LTU

P8B26AAE

HPE OneView including 3yr 24x7 Support Flexible Quantity E-LTU

E5Y35AAE

Step 4: Choose Additional Options for Factory Integration from the Core and Additional Options sections below



Core Options

HPE Processors (Please select one processor).

Notes:

- All SKUs below ship with a processor only. Adequate fans and heatsinks (standard or high performance) must be selected.
- 4800 MT/S maximum memory speed unless otherwise noted.
- 128GB SGX Enclave unless otherwise noted.
- Processors with TDP greater than 185W require High-Performance Heatsink (P52756-B21).
- Processors with TDP greater than 185W require High-Performance Fan Kit (P48908-B21).

4th Generation Intel Xeon-Gold 6

Intel Xeon-Gold 6426Y 2.5GHz 16-core 185W Processor for HPE	P49598-B21
Intel Xeon-Gold 6442Y 2.6GHz 24-core 225W Processor for HPE	P49599-B21
Intel Xeon-Gold 6448Y 2.1GHz 32-core 225W Processor for HPE	P49600-B21
Intel Xeon-Gold 6434 3.7GHz 8-core 195W Processor for HPE	P49601-B21
Intel Xeon-Gold 6444Y 3.6GHz 16-core 270W Processor for HPE	P49602-B21
Intel Xeon-Gold 6430 2.1GHz 32-core 270W Processor for HPE	P49614-B21
Intel Xeon-Gold 6438Y+ 2.0GHz 32-core 205W Processor for HPE	P49615-B21
Intel Xeon-Gold 6414U 2.0GHz 32-core 250W Processor for HPE	P49619-B21
Intel Xeon-Gold 6438N 2.0GHz 32-core 205W Processor for HPE	P49638-B21
Intel Xeon-Gold 6421N 1.8GHz 32-core 185W Processor for HPE	P49641-B21
Intel Xeon-Gold 6454S 2.2GHz 32-core 270W Processor for HPE	P49654-B21

4th Generation Intel Xeon-Gold 5

Intel Xeon-Gold 5415+ 2.9GHz 8-core 150W Processor for HPE	P49597-B21
Intel Xeon-Gold 5418Y 2.0GHz 24-core 185W Processor for HPE	P49612-B21
Intel Xeon-Gold 5420+ 2.0GHz 28-core 205W Processor for HPE	P49613-B21
Intel Xeon-Gold 5412U 2.1GHz 24-core 185W Processor for HPE	P49618-B21
Intel Xeon-Gold 5411N 1.9GHz 24-core 165W Processor for HPE	P49639-B21
Intel Xeon-Gold 5418N 1.8GHz 24-core 165W Processor for HPE	P49640-B21
Intel Xeon-Gold 5416S 2.0GHz 16-core 150W Processor for HPE	P49653-B21

4th Generation Intel Xeon-Silver

Intel Xeon-Silver 4410Y 2.0GHz 12-core 150W Processor for HPE	P49610-B21
---	------------

Notes: 64GB SGX Enclave

Intel Xeon-Silver 4416+ 2.0GHz 20-core 165W Processor for HPE	P49611-B21
---	------------

Notes: 64GB SGX Enclave

4th Generation Intel Xeon-Bronze

Intel Xeon-Bronze 3408U 1.8GHz 8-core 125W Processor for HPE	P49617-B21
--	------------

HPE Memory

To streamline the configuration process for HPE ProLiant Gen11 servers and to provide the best product availability, HPE recommends memory from the list here: <http://www.hpe.com/products/recommend>. Best product availability is limited to the US, Canada, and Latin America at this time.

Notes: HPE Server Memory compatibility for a specific server platform may vary or be limited within a server platform depending upon the specific configuration being requested. Because each server environment and requirements can vary, memory compatibility is based not only upon the server family but may also be affected by the amount and type of additional hardware options installed within a specific server configuration. For this reason, some HPE memory DIMMs may be qualified for an HPE server model or family and yet occasionally not be supported with some configurations within that server family. Maximum memory capacity and speed per processor depend on processor model selection or limitation.



Core Options

HPE DDR5 Memory

Notes: DIMMs must be selected in quantities 1, 2, 4, 6, 8, 12, or 16 per socket.

Registered DIMMs (RDIMMs)

HPE 16GB (1x16GB) Single Rank x8 DDR5-4800 CAS-40-39-39 EC8 Registered Smart Memory Kit	P43322-B21
HPE 32GB (1x32GB) Dual Rank x8 DDR5-4800 CAS-40-39-39 EC8 Registered Smart Memory Kit	P43328-B21
HPE 64GB (1x64GB) Dual Rank x4 DDR5-4800 CAS-40-39-39 EC8 Registered Smart Memory Kit	P43331-B21
HPE 96GB (1x96GB) Dual Rank x4 DDR5-4800 CAS-46-45-45 EC8 Registered Smart Memory Kit	P66675-B21
HPE 128GB (1x128GB) Quad Rank x4 DDR5-4800 CAS-46-39-39 EC8 Registered 3DS Smart Memory Kit	P43334-B21

Notes:

- Mixing of x4 and x8 DIMMs is not allowed.
- Mixing of 3DS and non-3DS DIMMs is not allowed.
- Mixing of Single Rank and Dual Rank DIMM is allowed only when the total qty of DIMM selected is 16
- If Single Rank and Dual Rank DIMMs are mixed, then the Qty of Single Rank DIMM selected must be equal to the quantity of Dual Rank DIMM.
- 128GB DIMMs require High-Performance Fan Kit (P48908-B21).

HPE DIMM blanks

HPE DDR4 DIMM Blank Kit	P07818-B21
-------------------------	------------

Optical Drives

HPE Mobile USB DVD-RW Optical Drive	701498-B21
HPE 9.5mm SATA DVD-ROM Optical Drive	726536-B21
HPE 9.5mm SATA DVD-RW Optical Drive	726537-B21

Notes:

- If Optical Drive is selected with 8SFF CTO Server, then '1U DP/USB/ODD Blank Kit' must be selected.
- If Optical Drive is selected with 4LFF CTO Server, then '4LFF ODD cable kit (P54641-B21)' must be selected.
- Not Supported with 12LFF or the GPU CTO Server.

HPE ProLiant DL3X0 Gen11 1U LFF Display Port/USB Kit	P48928-B21
--	------------

Notes: Supported only with 4LFF CTO Server

HPE Hard Disk Drives

Mission Critical - 12G SAS - SFF Drives

HPE 2.4TB SAS 12G Mission Critical 10K SFF BC 3-year Warranty 512e Self-encrypting FIPS HDD	P28618-B21
HPE 1.2TB SAS 12G Mission Critical 10K SFF BC 3-year Warranty Self-encrypting FIPS HDD	P28622-B21

Enterprise - 12G SAS - SFF Drives

HPE 2.4TB SAS 12G Mission Critical 10K SFF BC 3-year Warranty 512e Multi Vendor HDD	P28352-B21
HPE 1.8TB SAS 12G Mission Critical 10K SFF BC 3-year Warranty 512e Multi Vendor HDD	P53562-B21
HPE 1.2TB SAS 12G Mission Critical 10K SFF BC 3-year Warranty Multi Vendor HDD	P28586-B21
HPE 1TB SAS 12G Business Critical 7.2K SFF BC 1-year Warranty HDD	P53563-B21
HPE 900GB SAS 12G Mission Critical 15K SFF BC 3-year Warranty Multi Vendor HDD	P40432-B21
HPE 600GB SAS 12G Mission Critical 15K SFF BC 3-year Warranty Multi Vendor HDD	P53560-B21
HPE 600GB SAS 12G Mission Critical 10K SFF BC 3-year Warranty Multi Vendor HDD	P53561-B21
HPE 300GB SAS 12G Mission Critical 15K SFF BC 3-year Warranty Multi Vendor HDD	P28028-B21
HPE 300GB SAS 12G Mission Critical 10K SFF BC 3-year Warranty Multi Vendor HDD	P40430-B21



Core Options

Midline - 12G SAS - SFF Drives

HPE 2TB SAS 12G Business Critical 7.2K SFF BC 1-year Warranty 512e HDD P28505-B21

Midline - 6G SATA - SFF Drives

HPE 2TB SATA 6G Business Critical 7.2K SFF BC 1-year Warranty 512e HDD P28500-B21

HPE 1TB SATA 6G Business Critical 7.2K SFF BC 1-year Warranty HDD P28610-B21

Midline - 12G SAS - LFF Drives

HPE 20TB SAS 12G Business Critical 7.2K LFF LP 1-year Warranty Helium 512e ISE Multi Vendor HDD P53553-B21

HPE 18TB SAS 12G Business Critical 7.2K LFF LP 1-year Warranty Helium 512e ISE Multi Vendor HDD P37669-B21

HPE 16TB SAS 12G Business Critical 7.2K LFF LP 1-year Warranty Helium 512e ISE Multi Vendor HDD P23608-B21

HPE 14TB SAS 12G Business Critical 7.2K LFF LP 1-year Warranty Helium 512e Multi Vendor HDD P09155-B21

HPE 12TB SAS 12G Business Critical 7.2K LFF LP 1-year Warranty Helium 512e Multi Vendor HDD 881781-B21

HPE 8TB SAS 12G Business Critical 7.2K LFF LP 1-year Warranty 512e Multi Vendor HDD 834031-B21

HPE 6TB SAS 12G Business Critical 7.2K LFF LP 1-year Warranty 512e Multi Vendor HDD 861746-B21

HPE 4TB SAS 12G Business Critical 7.2K LFF LP 1-year Warranty Multi Vendor HDD 833928-B21

HPE 2TB SAS 12G Business Critical 7.2K LFF LP 1-year Warranty Multi Vendor HDD 833926-B21

Midline - 6G SATA - LFF Drives

HPE 20TB SATA 6G Business Critical 7.2K LFF LP 1-year Warranty Helium 512e ISE Multi Vendor HDD P53554-B21

HPE 18TB SATA 6G Business Critical 7.2K LFF LP 1-year Warranty Helium 512e ISE Multi Vendor HDD P37678-B21

HPE 16TB SATA 6G Business Critical 7.2K LFF LP 1-year Warranty Helium 512e ISE Multi Vendor HDD P23449-B21

HPE 14TB SATA 6G Business Critical 7.2K LFF LP 1-year Warranty Helium 512e Multi Vendor HDD P09165-B21

HPE 12TB SATA 6G Business Critical 7.2K LFF LP 1-year Warranty Helium 512e Multi Vendor HDD 881787-B21

HPE 10TB SATA 6G Business Critical 7.2K LFF LP 1-year Warranty 512e ISE Multi Vendor HDD P53557-B21

HPE 8TB SATA 6G Business Critical 7.2K LFF LP 1-year Warranty 512e Multi Vendor HDD 834028-B21

HPE 6TB SATA 6G Business Critical 7.2K LFF LP 1-year Warranty 512e Multi Vendor HDD 861742-B21

HPE 4TB SATA 6G Business Critical 7.2K LFF LP 1-year Warranty Multi Vendor HDD 861683-B21

HPE 2TB SATA 6G Business Critical 7.2K LFF LP 1-year Warranty Multi Vendor HDD 861681-B21

HPE 1TB SATA 6G Business Critical 7.2K LFF LP 1-year Warranty Multi Vendor HDD 861686-B21

HPE 7.68TB SATA 6G Very Read Optimized LFF LPC 5400 SSD P58232-B21

SSD Selection

For SSD selection guidance, please visit <https://ssd.hpe.com/>

Read Intensive – 12SAS - SFF - Solid State Drives

HPE 7.68TB SAS 12G Read Intensive SFF BC Value SAS Multi Vendor SSD P40509-B21

HPE 3.84TB SAS 12G Read Intensive SFF BC Value SAS Multi Vendor SSD P40508-B21

HPE 1.92TB SAS 12G Read Intensive SFF BC Value SAS Multi Vendor SSD P40507-B21

HPE 960GB SAS 12G Read Intensive SFF BC Value SAS Multi Vendor SSD P40506-B21

Read Intensive –24G SAS - SFF - Solid State Drives

HPE 15.36TB SAS 24G Read Intensive SFF BC Multi Vendor SSD P49045-B21

HPE 7.68TB SAS 24G Read Intensive SFF BC Multi Vendor SSD P49041-B21

HPE 3.84TB SAS 24G Read Intensive SFF BC Multi Vendor SSD P49035-B21

HPE 1.92TB SAS 24G Read Intensive SFF BC Multi Vendor SSD P49031-B21

HPE 960GB SAS 24G Read Intensive SFF BC Multi Vendor SSD P49029-B21

HPE 3.84TB SAS 24G Read Intensive SFF BC Self-encrypting FIPS PM6 SSD P41398-B21

HPE 7.68TB SAS 24G Read Intensive SFF BC Self-encrypting FIPS PM6 SSD P41399-B21

Notes: Require High-Performance Fan Kit (P48908-B21).



Core Options

Mixed Use – 12 SAS - SFF - Solid State Drives

HPE 10TB SAS 12G Business Critical 7.2K LFF LP 1-year Warranty 512e ISE Multi Vendor HDD	P53556-B21
HPE 3.84TB SAS 12G Mixed Use SFF BC Value SAS Multi Vendor SSD	P40512-B21
HPE 1.92TB SAS 12G Mixed Use SFF BC Value SAS Multi Vendor SSD	P40511-B21
HPE 960GB SAS 12G Mixed Use SFF BC Value SAS Multi Vendor SSD	P40510-B21

Mixed Use –24G SAS - SFF - Solid State Drives

HPE 6.4TB SAS 24G Mixed Use SFF BC Multi Vendor SSD	P49057-B21
HPE 3.2TB SAS 24G Mixed Use SFF BC Multi Vendor SSD	P49053-B21
HPE 1.6TB SAS 24G Mixed Use SFF BC Multi Vendor SSD	P49049-B21
HPE 800GB SAS 24G Mixed Use SFF BC Multi Vendor SSD	P49047-B21
HPE 800GB SAS 24G Mixed Use SFF BC Self-encrypting FIPS PM6 SSD	P41400-B21
HPE 1.6TB SAS 24G Mixed Use SFF BC Self-encrypting FIPS PM6 SSD	P41401-B21

Notes: Require High-Performance Fan Kit (P48908-B21).

Very Read Optimized - 6G SATA - SFF - Solid State Drives

HPE 7.68TB SATA 6G Very Read Optimized SFF BC 5400 SSD	P58228-B21
--	------------

Read Intensive - 6G SATA - SFF - Solid State Drives

HPE 7.68TB SATA 6G Read Intensive SFF BC Multi Vendor SSD	P40501-B21
HPE 3.84TB SATA 6G Read Intensive SFF BC Multi Vendor SSD	P40500-B21
HPE 3.84TB SATA 6G Read Intensive SFF BC PM893 SSD	P44010-B21
HPE 1.92TB SATA 6G Read Intensive SFF BC Multi Vendor SSD	P40499-B21
HPE 1.92TB SATA 6G Read Intensive SFF BC PM893 SSD	P44009-B21
HPE 480GB SATA 6G Read Intensive SFF BC Multi Vendor SSD	P40497-B21
HPE 480GB SATA 6G Read Intensive SFF BC PM893 SSD	P44007-B21
HPE 960GB SATA 6G Read Intensive SFF BC Multi Vendor SSD	P40498-B21
HPE 480GB SATA 6G Read Intensive SFF BC Self-encrypting 5400P SSD	P58236-B21
HPE 960GB SATA 6G Read Intensive SFF BC PM893 SSD	P44008-B21
HPE 240GB SATA 6G Read Intensive SFF BC Multi Vendor SSD	P40496-B21
HPE 1.92TB SATA 6G Read Intensive SFF BC Self-encrypting 5400P SSD	P58240-B21
HPE 960GB SATA 6G Read Intensive SFF BC PM893 SSD	P44008-B21

Mixed Use - 6G SATA - SFF - Solid State Drives

HPE 3.84TB SATA 6G Mixed Use SFF BC Multi Vendor SSD	P40505-B21
HPE 1.92TB SATA 6G Mixed Use SFF BC Multi Vendor SSD	P40504-B21
HPE 1.92TB SATA 6G Mixed Use SFF BC PM897 SSD	P44013-B21
HPE 960GB SATA 6G Mixed Use SFF BC Multi Vendor SSD	P40503-B21
HPE 960GB SATA 6G Mixed Use SFF BC PM897 SSD	P44012-B21
HPE 960GB SATA 6G Mixed Use SFF BC Self-encrypting 5400M SSD	P58244-B21
HPE 480GB SATA 6G Mixed Use SFF BC Multi Vendor SSD	P40502-B21
HPE 480GB SATA 6G Mixed Use SFF BC PM897 SSD	P44011-B21
HPE 1.92TB SATA 6G Mixed Use SFF BC Self-encrypting 5400M SSD	P58248-B21

Mixed Use - 12G SAS - LFF –Solid State Drives

HPE 960GB SAS 12G Mixed Use LFF LPC Value SAS Multi Vendor SSD	P37009-B21
--	------------

Read Intensive - 6G SATA - LFF - Solid State Drives

HPE 960GB SATA 6G Read Intensive LFF LPC Multi Vendor SSD	P47808-B21
---	------------



Core Options

Read Intensive - NVMe - SFF - Solid State Drives

HPE 15.36TB NVMe Gen4 High Performance Read Intensive SFF BC U.3 PM1733a SSD	P50224-B21
HPE 7.68TB NVMe Gen4 High Performance Read Intensive SFF BC U.3 PM1733a SSD	P50222-B21
HPE 7.68TB NVMe Gen4 Mainstream Performance Read Intensive SFF BC U.3 Static Multi Vendor SSD	P47847-B21
HPE 3.84TB NVMe Gen4 High Performance Read Intensive SFF BC U.3 PM1733a SSD	P50219-B21
HPE 3.84TB NVMe Gen4 Mainstream Performance Read Intensive SFF BC U.3 Static Multi Vendor SSD	P47846-B21
HPE 1.92TB NVMe Gen4 High Performance Read Intensive SFF BC U.3 PM1733a SSD	P50216-B21
HPE 1.9TB NVMe Gen4 Mainstream Performance Read Intensive SFF BC U.3 Static Multi Vendor SSD	P47845-B21
HPE 960GB NVMe Gen4 Mainstream Performance Read Intensive SFF BC U.3 Static Multi Vendor SSD	P47844-B21

Read Intensive - NVMe - SFF – SED Solid State Drives

HPE 1.92TB NVMe Gen5 Mainstream Performance Read Intensive E3S EC1 EDSFF CD7 SSD	P56585-B21
HPE 3.84TB NVMe Gen5 Mainstream Performance Read Intensive E3S EC1 EDSFF CD7 SSD	P56586-B21
HPE 7.68TB NVMe Gen5 Mainstream Performance Read Intensive E3S EC1 EDSFF CD7 SSD	P56587-B21

Notes:

- Requires selection of 8EDSFF Drive cage
- CD7 EDSFF drives requires selection of Gen5 Retimer card (P48833-B21) or SR932i-p controller

Read Intensive - NVMe - SFF – SED Solid State Drives

HPE 1.92TB NVMe Gen4 High Performance Read Intensive SFF BC Self-encrypting FIPS U.3 CM6 SSD	P41402-B21
HPE 3.84TB NVMe Gen4 High Performance Read Intensive SFF BC Self-encrypting FIPS U.3 CM6 SSD	P41403-B21

Notes: Require High-Performance Fan Kit (P48908-B21).

Mixed Use - NVMe - SFF - Solid State Drives

HPE 6.4TB NVMe Gen4 High Performance Mixed Use SFF BC U.3 PM1735a SSD	P50233-B21
HPE 6.4TB NVMe Gen4 Mainstream Performance Mixed Use SFF BC U.3 Static Multi Vendor SSD	P47840-B21
HPE 3.2TB NVMe Gen4 High Performance Mixed Use SFF BC U.3 PM1735a SSD	P50230-B21
HPE 3.2TB NVMe Gen4 Mainstream Performance Mixed Use SFF BC U.3 Static Multi Vendor SSD	P47839-B21
HPE 1.6TB NVMe Gen4 High Performance Mixed Use SFF BC U.3 PM1735a SSD	P50227-B21
HPE 1.6TB NVMe Gen4 Mainstream Performance Mixed Use SFF BC U.3 Static Multi Vendor SSD	P47838-B21
HPE 800GB NVMe Gen4 Mainstream Performance Mixed Use SFF BC U.3 Static Multi Vendor SSD	P47837-B21
HPE 800GB NVMe Gen4 Mainstream Performance Mixed Use SFF BC U.3 Static V2 Multi Vendor SSD	P64999-B21
HPE 960GB NVMe Gen4 Mainstream Performance Read Intensive SFF BC U.3 Static V2 Multi Vendor SSD	P64842-B21
HPE 1.6TB NVMe Gen4 High Performance Mixed Use SFF BC Self-encrypting FIPS U.3 CM6 SSD	P41404-B21
HPE 1.6TB NVMe Gen4 Mainstream Performance Mixed Use SFF BC U.3 Static V2 Multi Vendor SSD	P65007-B21
HPE 1.92TB NVMe Gen4 Mainstream Performance Read Intensive SFF BC U.3 Static V2 Multi Vendor SSD	P64844-B21
HPE 3.2TB NVMe Gen4 High Performance Mixed Use SFF BC Self-encrypting FIPS U.3 CM6 SSD	P41405-B21
HPE 3.2TB NVMe Gen4 Mainstream Performance Mixed Use SFF BC U.3 Static V2 Multi Vendor SSD	P65015-B21
HPE 7.68TB NVMe Gen4 Mainstream Performance Read Intensive SFF BC U.3 Static V2 Multi Vendor SSD	P64848-B21

Notes: Require High-Performance Fan Kit (P48908-B21).

Read Intensive - M.2 - Solid State Drives

HPE 480GB NVMe Gen3 Mainstream Performance Read Intensive M.2 Multi Vendor SSD	P40513-B21
HPE 960GB NVMe Gen3 Mainstream Performance Read Intensive M.2 Multi Vendor SSD	P40514-B21
HPE 1.92TB NVMe Gen3 Mainstream Performance Read Intensive M.2 Multi Vendor SSD	P40515-B21
HPE 240GB SATA 6G Read Intensive M.2 Multi Vendor SSD	P47817-B21
HPE 480GB SATA 6G Read Intensive M.2 Multi Vendor SSD	P47818-B21

Notes:

- Mixing of SATA M.2 and NVMe M.2 SSDs is not allowed.
- Need x7 fans (standard or performance).



Core Options

Hard Drive Blank Kits

HPE Gen9 LFF HDD Spade Blank Kit	807878-B21
HPE Small Form Factor Hard Drive Blank Kit	666987-B21

HPE Networking

1 Gigabit Ethernet adapters

Broadcom BCM5719 Ethernet 1Gb 4-port BASE-T Adapter for HPE	P51178-B21
Intel I350-T4 Ethernet 1Gb 4-port BASE-T Adapter for HPE	P21106-B21

10 Gigabit Ethernet adapters

Broadcom BCM57416 Ethernet 10Gb 2-port BASE-T Adapter for HPE	P26253-B21
Broadcom BCM57412 Ethernet 10Gb 2-port SFP+ Adapter for HPE	P26259-B21

25 Gigabit Ethernet adapters

Broadcom BCM57414 Ethernet 10/25Gb 2-port SFP28 Adapter for HPE	P26262-B21
Broadcom BCM57504 Ethernet 10/25Gb 4-port SFP28 Adapter for HPE	P26264-B21
Intel E810-XXVDA2 Ethernet 10/25Gb 2-port SFP28 Adapter for HPE	P08443-B21
Intel E810-XXVDA4 Ethernet 10/25Gb 4-port SFP28 Adapter for HPE	P08458-B21
Mellanox MCX631102AS-ADAT Ethernet 10/25Gb 2-port SFP28 Adapter for HPE	P42044-B21

Notes:

- Recommended ambient temperature with High-Performance Fan Kit (P48908-B21)
- *Conditional support, with DAC (direct attach copper) cable only

	P26264-B21	P08443-B21	P08458-B21	P42044-B21
4 LFF (P52765-B21)	25C	35C	25C	25C
8 SFF (P52766-B21)	25C	35C	25C	25C
12 LFF (P52767-B21)	25C	35C	25C	25C
GPU Dense (P61218-B21) with up to 2 Single Wide or 1 Double Wide GPU in front	25C	35C	25C	25C
GPU Dense (P61218-B21) with 2 Double Wide or 4 Single Wide GPUs in the front	25C *	25C	25C *	25C *

100 Gigabit Ethernet Adapters

Mellanox MCX623106AS-CDAT Ethernet 100Gb 2-port QSFP56 Adapter for HPE	P25960-B21
HPE Ethernet 100Gb 1-port QSFP28 PCIe3 x16 MCX515A-CCAT Adapter	P31246-B21
Intel E810-CQDA2 Ethernet 100Gb 2-port QSFP28 Adapter for HPE	P21112-B21

Notes: Recommended ambient temperature with High-Performance Fan Kit (P48908-B21)

	P25960-B21	P31246-B21	P21112-B21
4 LFF (P52765-B21)	25C	25C	25C
8 SFF (P52766-B21)	25C	25C	25C
12 LFF (P52767-B21)	Not supported	Not supported	Not supported
GPU Dense (P61218-B21) with up to 2 Single Wide or 1 Double Wide GPU in front	25C	25C	25C
GPU Dense (P61218-B21) with 2 Double Wide or 4 Single Wide GPUs in front	Not supported	Not supported	Not supported



Core Options

200 Gigabit Ethernet Adapters

Mellanox MCX623105AS-VDAT Ethernet 200Gb 1-port QSFP56 Adapter for HPE

P10180-B21

Notes: [Recommended ambient temperature with High-Performance Fan Kit \(P48908-B21\)](#)

	P10180-B21
4 LFF (P52765-B21)	25C
8 SFF (P52766-B21)	25C
12 LFF (P52767-B21)	Not supported
GPU Dense (P61218-B21) with up to 2 Single Wide L4 or 1 Double Wide GPU in front	25C
GPU Dense (P61218-B21) with 2 Double Wide or 4 Single Wide GPUs in front	Not supported

OCP 3.0 Adapters

Broadcom BCM5719 Ethernet 1Gb 4-port BASE-T OCP3 Adapter for HPE

P51181-B21

Intel I350-T4 Ethernet 1Gb 4-port BASE-T OCP3 Adapter for HPE

P08449-B21

Broadcom BCM57416 Ethernet 10Gb 2-port BASE-T OCP3 Adapter for HPE

P10097-B21

Broadcom BCM57412 Ethernet 10Gb 2-port SFP+ OCP3 Adapter for HPE

P26256-B21

Broadcom BCM57504 Ethernet 10/25Gb 4-port SFP28 OCP3 Adapter for HPE

P26269-B21

Broadcom BCM57414 Ethernet 10/25Gb 2-port SFP28 OCP3 Adapter for HPE

P10115-B21

Intel E810-XXVDA2 Ethernet 10/25Gb 2-port SFP28 OCP3 Adapter for HPE

P10106-B21

Mellanox MCX631432AS-ADAI Ethernet 10/25Gb 2-port SFP28 OCP3 Adapter for HPE

P42041-B21

Intel E810-CQDA2 Ethernet 100Gb 2-port QSFP28 OCP3 Adapter for HPE

P22767-B21

Notes: [Recommended ambient temperature with High-Performance Fan Kit \(P48908-B21\)](#)

	P26269-B21	P10106-B21	P42041-B21	P22767-B21
4 LFF (P52765-B21)	35C	35C	35C	35C
8 SFF (P52766-B21)	35C	35C	35C	35C
12 LFF (P52767-B21)	35C	35C	35C	35C
GPU Dense (P61218-B21) with up to 2 Single Wide or 1 Double Wide GPU in front	25C	35C	35C	25C
GPU Dense (P61218-B21) with 2 Double Wide or 4 Single Wide GPU in the front	25C	35C	35C	25C

Fibre Channel HBA

HPE SN1610E 32Gb 1-port Fibre Channel Host Bus Adapter

R2J62A

HPE SN1610E 32Gb 2-port Fibre Channel Host Bus Adapter

R2J63A

HPE SN1700E 64Gb 1-port Fibre Channel Host Bus Adapter

R7N77A

HPE SN1700E 64Gb 2-port Fibre Channel Host Bus Adapter

R7N78A

HPE SN1610Q 32Gb 1-port Fibre Channel Host Bus Adapter

R2E08A

HPE SN1610Q 32Gb 2-port Fibre Channel Host Bus Adapter

R2E09A

HPE SN1700Q 64Gb 1-port Fibre Channel Host Bus Adapter

R7N86A

HPE SN1700Q 64Gb 2-port Fibre Channel Host Bus Adapter

R7N87A



Core Options

HPE InfiniBand

HPE 100Gb 1-port OP101 QSFP28 x16 PCIe Gen3 with Intel Omni-Path Architecture Adapter	829335-B21
HPE InfiniBand HDR100/Ethernet 100Gb 1-port QSFP56 PCIe4 x16 MCX653105A-ECAT Adapter	P23665-B21
HPE InfiniBand HDR100/Ethernet 100Gb 2-port QSFP56 PCIe4 x16 MCX653106A-ECAT Adapter	P23666-B21

Notes:

- Recommended ambient temperature with High-Performance Fan Kit (P48908-B21)
- *Conditional support, with DAC (direct attach copper) cable only.

	829335-B21	P23665-B21	P23666-B21
4 LFF (P52765-B21)	35C	35C	25C
8 SFF (P52766-B21)	35C	35C	25C
12 LFF (P52767-B21)	35C	35C	25C
GPU Dense (P61218-B21) with up to 2 Single Wide or 1 Double Wide GPUs in front	35C	35C	25C
GPU Dense (P61218-B21) with 2 Double Wide or 4 Single Wide GPU in the front	25C	25C	25C*

HPE I/O Expansion Options

Notes:

- Slot 1: The Primary Riser shipping default in the CTO server is a x16 FHHL.
- Slot 2: The Secondary Riser in the CTO server is optional x16 FHHL.

Risers

Part number	Description	Bus width (Gen5 lanes)			
		Primary	Secondary	Slot 1	Slot 2
P52753-B21	HPE DL320 Gen11 x16 FHHL Riser Kit	D	O	x16	x16

Notes:

- D = Default on chassis; O = Optional; N = not supported or slot/connector not present.
- If the Secondary riser is not selected, then the Max PCIe card selection is limited to Qty=1. This is inclusive of all PCIe categories and sub-categories.

HPE Power Supplies

HPE Flexible Slot (Flex Slot) Power Supplies share a common electrical and physical design that allows for hot plug, tool-less installation into HPE ProLiant Servers. Flex Slot power supplies are certified for high-efficiency operation and offer multiple power output options, allowing users to "right-size" a power supply for specific server configurations. This flexibility helps to reduce power waste, lower overall energy costs, and avoid "trapped" power capacity in the data center.

Notes:

- Before making a power supply selection, it is highly recommended that the HPE Power Advisor is run to determine the right size power supply for your server configuration. The HPE Power Advisor is located at: <https://poweradvisorex.it.hpe.com/?Page=Indexv>
- HPE ProLiant servers ship with an IEC-IEC power cord for rack mounting with Power Distribution Units (PDUs). Visit [HPE Power Cords and Cables](#) for a full list of optional power cords.
- Mixing of Power supplies is not allowed.
- Flex Slot Platinum Plus power supplies support up to 94% power efficiency and include a C-14 power inlet connector that can support HPE Power Discovery Services (blue connector).
- European Union Erp Lot 9 Regulation
 - o Beginning on January 1st, 2024, units sold into the European Union (EU), European Economic Area (EEA), the United Kingdom, or Switzerland must include more efficient AC power supplies: 94% for multi-output and 96% for single

Core Options

output. HPE Flexible Slot power supplies are single-output, and part numbers 865438-B21, P03178-B21, and P44712-B21 are 96% efficient, thus meeting requirements.

- o HPE is on target to fulfil compliant systems ahead of time and will begin enforcing these requirements in advance to satisfy requests with the current power supplies by the set deadline.

HPE 500W Flex Slot Platinum Hot Plug Low Halogen Power Supply Kit	865408-B21
HPE 800W Flex Slot Platinum Hot Plug Low Halogen Power Supply Kit	P38995-B21
HPE 1000W Flex Slot Titanium Hot Plug Power Supply Kit	P03178-B21
HPE 1600W Flex Slot Platinum Hot Plug Low Halogen Power Supply Kit	P38997-B21
Notes: Only supports high line voltage (200VAC to 240VAC).	
HPE 1800W-2200W Flex Slot Titanium Hot Plug Power Supply Kit	P44712-B21
HPE 1600W Flex Slot -48VDC Hot Plug Power Supply Kit	P17023-B21
Notes: Requires selection of HPE 1600W DC PSU power lug option kit or HPE 1600W DC PSU Power Cable Kit.	
HPE 1600W -48VDC Power Cable Lug Kit	P36877-B21

Cooling Options

HPE ProLiant DL3X0 Gen11 1U Standard Fan Kit	P48907-B21
Notes: Standard Fan Kit Includes 5 fans.	
HPE ProLiant DL3X0 Gen11 1U High Performance Fan Kit	P48908-B21
Notes:	
– High Performance Fan Kit Includes 7 fans.	
– High Performance Fans required for processors with a TDP to or greater than 185W	
HPE ProLiant DL3X0 Gen11 1U 2P Standard Fan Kit	P54697-B21
Notes: 2P Standard Fan Kit Includes 2 fans.	
HPE ProLiant DL3X0 Gen11 1U Standard Heat Sink Kit	P48904-B21
HPE ProLiant DL320 Gen11 Performance Heat Sink Kit	P52756-B21
Notes: Performance Heat Sink Required for processors with a TDP to or greater than 185W.	

HPE Computation and Graphics Accelerators

NVIDIA L4 24GB PCIe Accelerator for HPE	S0K89C
---	--------

Notes:

- For best performance across common workloads, HPE recommends system main memory at least twice the memory of all GPU.
- Requires selection of High Performance Fan kit. This rule is not applicable for GPU CTO Server
- If GPU is selected with GPU CTO server then it does not occupy PCIe slot. This must be considered for total PCIe selection
- Mixing of GPU is not allowed
- If Qty=1 Single Wide GPU is selected with GPU CTO Server then 'GPU 4xDC NVMe FIO Kit' or '2 GPU FIO Enable Kit' or '4SW GPU FIO Enable Kit' must be selected
- If Qty=2 Single Wide GPU is selected with GPU CTO server then '2 GPU FIO Enable Kit' or '4SW GPU FIO Enable Kit' must be selected
- If Qty=3 or more GPU is selected then '4SW GPU FIO Enable Kit' must be selected
- 4SW GPU FIO Enable Kit requires selection of Single Wide GPU



Core Options

NVIDIA A16 64GB PCIe Non-CEC Accelerator for HPE

R8T26C

Notes:

- For best performance across common workloads, HPE recommends system main memory at least twice the memory of all GPU.
- If Qty=2 Double Wide GPU is selected with GPU CTO Server then '2 GPU FIO Enable Kit' must be selected
- If Qty=1 Double Wide GPU is selected with GPU CTO Server then 'GPU 4xDC NVMe FIO Kit' or '2 GPU FIO Enable Kit' must be selected
- Supported only with GPU CTO Server
- Max=2
- If Qty=1 of A16 GPU is selected, then Primary GPU 8p Power Cable Kit (P62201-B21) must be selected.
- If Qty=2 of A16 GPU is selected, then Primary GPU 8p Power Cable Kit (P62201-B21) and Sec GPU 8p Power Cable Kit (P62203-B21) must be selected.
- Mixing of GPU is not allowed
- If 4SW GPU FIO Enable Kit or Qty=2 of Double wide GPU is selected then this option cannot be selected

NVIDIA L40 48GB PCIe Accelerator for HPE

S0K90C

Notes:

- For best performance across common workloads, HPE recommends system main memory at least twice the memory of all GPU.
- If Qty=2 Double Wide GPU is selected with GPU CTO Server then '2 GPU FIO Enable Kit' must be selected
- If Qty=1 Double Wide GPU is selected with GPU CTO Server then 'GPU 4xDC NVMe FIO Kit' or '2 GPU FIO Enable Kit' must be selected
- Supported only with GPU CTO Server
- If GPU is selected with GPU CTO server then it does not occupy PCIe slot. This must be considered for total PCIe selection
- Max=2
- If Qty=1 of L40 GPU is selected, then Prim GPU 16p Power Cable Kit (P62205-B21) must be selected.
- If Qty=2 of L40 GPU is selected, then Primary GPU 16p Power Cable Kit (P62205-B21) and Sec GPU 16p Power Cable Kit (P62207-B21) must be selected.
- Mixing of GPU is not allowed
- If 4SW GPU FIO Enable Kit or Qty=2 of Double wide GPU is selected then this option cannot be selected

GPU Support	Ambient Temperature	Fan Kit
up to 2 L4 or 1 L40/A16 - Front	Up to 35C	High Performance Fan kit
up to 2 L4 - Rear	Up to 25C	High Performance Fan kit
2 L40/A16 or 4 L4 - Front	Up to 25C	High Performance Fan kit



Core Options

Software as a Service Management

HPE GreenLake for Compute Ops Management

Base SKU

HPE GreenLake for Compute Ops Management Enhanced 3-year Upfront ProLiant SaaS R7A11AAE

Upgrade SKUS

HPE GreenLake for Compute Ops Management Enhanced 1-year Upfront ProLiant SaaS R7A10AAE

HPE GreenLake for Compute Ops Management Enhanced 5-year Upfront ProLiant SaaS R7A12AAE

HPE OneView

HPE OneView including 3yr 24x7 Support Flexible Quantity E-LTU E5Y35AAE

HPE OneView w/o iLO including 3yr 24x7 Support Flexible Quantity E-LTU P8B26AAE

Notes: For customers purchasing HPE GreenLake for Compute Ops Management, without a hardware purchase or a BTO purchase, use this base SKU within ASQ order:

HPE GreenLake for Compute Ops Management Base SaaS R6Z73AAE

For more information, visit the HPE GreenLake for Compute Ops Management QuickSpecs:

<https://www.hpe.com/psnow/doc/a50004263enw>

Supported Servers – CTO only. No OEM. – Complete list can be found here: Latest Supported Server List:

<https://www.hpe.com/info/com-supported-servers>



Additional Options

OS Boot Device

HPE NS204i-u Gen11 NVMe Hot Plug Boot Optimized Storage Device	P48183-B21
HPE ProLiant DL320 Gen11 NS204i-u NVMe OS Boot Device Cable Kit	P52786-B21
HPE ProLiant DL320 Gen11 NS204i-u Security Lock Removal FIO Trigger System Setting	P61855-B21

Notes:

- 'NS204i-u Gen11 Hot Plug Boot Opt Dev' requires the selection of 'NS204i-u cable kit' and vice versa.
- Require High-Performance Fan Kit (P48908-B21).
- HPE NS204i-u Gen11 support is limited at 25C ambient while using GPU CTO server.
- Server must use high performance fan kit when supporting NS204i-u for all CTO Configs.
- Ambient temperature for NS204-u is 25C for GPU CTO server.

HPE Storage Controllers

Storage Controllers

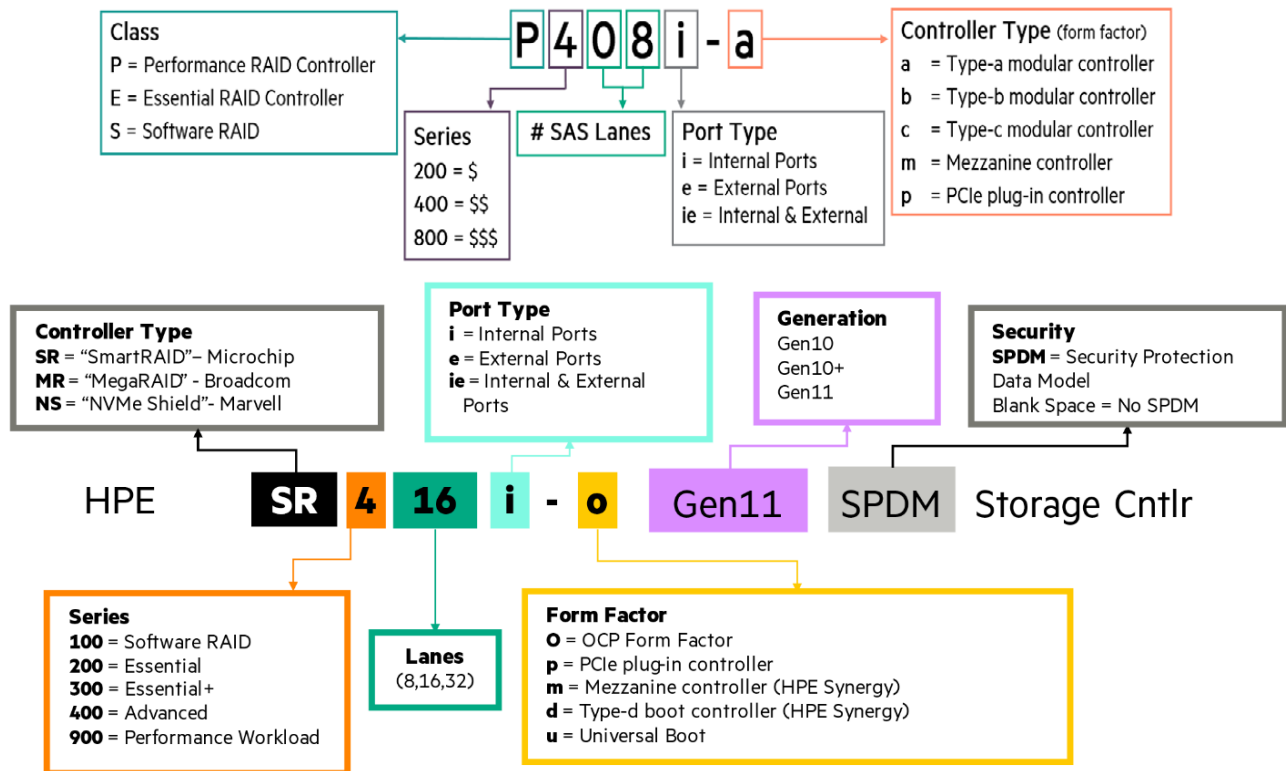

Notes:

- When selecting SR RAID controllers for external storage and MR RAID controllers for internal storage, please be aware these two products use different RAID configuration tools. Therefore, there will be a RAID configuration tool for the SR external controller and another for the MR internal controller.
- Mixing MR (Mega RAID) series internal controllers and SR (Smart RAID) series internal Controllers is not supported.
- For more information on the HPE Gen11 Storage Controller, please refer to the following:
[HPE Compute MR Gen11 Controllers Quick Spec](#)
[HPE Compute SR Gen11 Controllers Quick Spec](#)



Additional Options

Essential RAID Controllers

HPE Smart Array E208e-p SR Gen10 (8 External Lanes/No Cache) 12G SAS PCIe Plug-in Controller 804398-B21

Notes:

- This controller supports up to 8 SAS/SATA Drives (external)
For more information on the HPE Smart Array E208i-p SR Gen10 Controller, please refer to the [QuickSpecs](#)

Tri-Mode Controllers

HPE MR416i-p Gen11 x16 Lanes 8GB Cache PCI SPDM Plug-in Storage Controller P47777-B21

HPE MR416i-o Gen11 x16 Lanes 8GB Cache OCP SPDM Storage Controller P47781-B21

HPE MR216i-p Gen11 x16 Lanes without Cache PCI SPDM Plug-in Storage Controller P47785-B21

HPE MR216i-o Gen11 x16 Lanes without Cache OCP SPDM Storage Controller P47789-B21

HPE MR408i-o Gen11 x8 Lanes 4GB Cache OCP SPDM Storage Controller P58335-B21

HPE SR932i-p Gen11 x32 Lanes 8GB Wide Cache PCI SPDM Plug-in Storage Controller P47184-B21

Notes:

- Max 1 of PCIe internal controller can be selected per server.
- Max 2 of PCIe and OROC internal controllers can be selected per server.
- PCIe Internal controller is not supported with 4LFF CTO Server
- OROC controllers not supported with 12LFF CTO Server
- SR932i-p controller is the only controller supported with 8SFF x4 U.2 Drive cage.
- SR932i-p controller can be selected with GPU CTO server only if 8EDSFF drive cage is selected.
- If any controllers are selected, then "HPE 96W Smart Stg Li-ion Batt 145mm Kit" or "HPE Smart Hybrid Capacitor w/ 145mm Cable" must be selected. Vice versa.
- Internal MR-series and Internal SR-series controllers cannot be selected together. Mega RAID Tools cannot be used to script and configure Smart RAID (formerly known as Smart Array) controllers used on HPE Gen9/10/10 Plus/11 servers.
- If MR416i-p/MR216i-p/SR932i-p/MR416i-o/MR216i-o controller is selected along with 8SFF x1 U.3 and 2SFF x4 U.3 drive cage, then one controller is enough to support both the drive cages with the selection of '8SFF cable kit' and '2SFF TM cable kit.'
- If the 8SFF Drive cage is selected with PCIe Internal controller, then the '8SFF TM Cable Kit' must be selected.
- If the 8SFF Drive cage is selected with OROC controller, then '8SFF OROC Cable' must be selected.
- If 8SFF x1 U.3 Drive cage is selected and no Internal controller is selected, then the drive cage will be connected to Direct attach and support SATA Drives only.
- If 8SFF x1 U.3 Drive cage and 2SFF x4 U.3 Drive cage is selected along with Qty=1 of MR216i/MR416i/SR416i/SR932i controller, then 8SFF cable kit OR/AND 2SFF TM cable kit must be selected
- If 8SFF x4 U.3 Drive cage kit is selected and no Internal controller is selected, then the drive cage will be connected to Direct attach and support NVMe U.3 Drives only.
- If the 2SFF Drive cage is selected with PCIe Internal controller or OROC controller, then the '2SFF TM Cable Kit' must be selected.
- If 2SFF U.3 Drive cage is selected and no Internal controller is selected, then the drive cage will be connected to direct attach and supports either Qty=2 of NVMe U.3 drive or SATA drives.
- If 8SFF x4 U.3 Drive cage is selected with 2SFF U.3 drive cage and no Internal controller is selected, then 2SFF U.3 drive cage can support SATA drives only.
- If 8SFF x4 Drive cage and 2SFF drive cage is selected with Qty=1 of Internal controller, then '8SFF cable kit' or '2SFF TM cable kit' must be selected
- If 8SFF x4 Drive cage and 2SFF drive cage is selected with Qty=2 of Internal controller, then both '8SFF cable kit' and '2SFF TM cable kit' must be selected
- If 8SFF x4 Drive cage and 2SFF Drive cage are selected along with MR408i-o controller, then '2SFF TM cable kit' must be selected.



Additional Options

- If SR932i-p is selected with the 8SFF x4 drive cage, the additional 2SFF drive cage will need an extra controller or direct attach.
- MR416i-p is the only controller supported with the GPU Dense CTO server with 4SFF drive cage.
- If SR932i-p/MR416i-p/Gen5 Retimer card is selected along with GPU CTO server then secondary riser must be selected.
- SR932i-p controller can be selected with GPU CTO server only if 8EDSFF drive cage is selected.
- CD7 EDSFF drives requires selection of SR932i-p controller.
- If 8EDSFF drive cage is selected with SR932i-p controller, then 'SR932i-p NVMe Cable Kit' must be selected and defaulted.
- In GPU CTO Server, Mixing of MR416i-p/ Gen5 Retimer card/ SR932i-p controllers are not allowed.

Software RAID

Intel® Virtual RAID on CPU (Intel® VROC) Standard Software FIO for HPE

SOE37A

Notes:

- Requires UEFI, not supported on Legacy Mode.
- For NVMe SSDs only, no PCIe card support.
- Supports RAID 0/1/10

Intel Virtual RAID on CPU Standard E-RTU for HPE

SOE38AAE

Notes:

- Requires UEFI, not supported on Legacy Mode.
- For NVMe SSDs only, no PCIe card support.
- Supports RAID 0/1/10.
- Similar to Intel Virtual RAID on CPU Standard FIO Software for HPE (SOE37A) but intended for field deployments (BTO).

Intel Virtual RAID on CPU Premium FIO Software for HPE

R7J57A

Notes:

- Requires UEFI, not supported on Legacy Mode.
- For NVMe SSDs only, no PCIe card support.
- Supports RAID 0/1/5/10

Intel Virtual RAID on CPU Premium E-RTU for HPE

R7J59AAE

Notes:

- Requires UEFI, not supported on Legacy Mode.
- For NVMe SSDs only, no PCIe card support.
- Supports RAID 0/1/5/10.
- Similar to Intel Virtual RAID on CPU Premium FIO Software for HPE (R7J57A) but intended for field deployments (BTO).

NVMe Adapter

HPE DL385 Gen10 Plus 12Gb NVMe 1-port Adapter

P25526-B21

HPE DL385 Gen10 Plus 12Gb NVMe 2-port Adapter

P25527-B21

Notes: The naming is based on HPE ProLiant DL385 Gen10 Plus. However, this option incompatible with HPE ProLiant DL320 Gen11 as well.



Additional Options

HPE Cable Kits

Notes: Some options may not be integrated at the factory. To ensure only valid configurations are ordered, Hewlett Packard Enterprise recommends using an HPE-approved configurator. Contact your local sales representative for additional information.

HPE ProLiant DL320 Gen11 8SFF Tri-Mode Cable Kit	P52775-B21
HPE ProLiant DL320 Gen11 2SFF Tri-Mode Cable Kit	P52776-B21
HPE ProLiant DL320 Gen11 Retimer Card Cable Kit	P52777-B21
HPE ProLiant DL320 Gen11 8SFF OROC Cable Kit	P52780-B21
HPE DL320 Gen11 10LFF Direct Cable Kit	P59459-B21
HPE DL320 Gen11 12LFF TM Cable Kit	P60892-B21

Notes: Customers can self-install the 12LFF tri-mode cable kit. However, due to the complexity involved, HPE recommends customers to call HPE service.

HPE ProLiant DL320 Gen11 LFF Optical Cable Kit	P54641-B21
--	------------

Notes: Required if Optical Drive is selected with 4LFF CTO Server.

HPE ProLiant DL320/DL380 Gen11 PCIe Gen5 Retimer Card	P48833-B21
---	------------

Notes:

- Supported only with GPU CTO Server.
- If 4SFF U.3 drive cage is selected with Gen5 Retimer card, then 'HPE DL320 Gen11 4SFF TM Cable Kit' must be selected and defaulted.
- In GPU CTO Server, Mixing of MR416i-p/ Gen5 Retimer card/ SR932i-p controllers are not allowed.
- RAID is allowed on EDSFF drives only if Premium VROC or Standard VROC or Gen5 Retimer card is selected as Primary controller.
- If 8EDSFF Drive cage is selected with Gen5 Retimer card then HPE DL320 Gen11 2xType-p NVMe Cable Kit must be selected and defaulted.
- If 8EDSFF Drive cage is selected with Gen5 Retimer card, then Qty=2 Gen5 Retimer card must be selected and defaulted.
- CD7 EDSFF drives requires selection of Gen5 Retimer card or SR932i-p controller.
- If SR932i-p/MR416i-p/Gen5 Retimer card is selected along with GPU CTO server then secondary riser must be selected.

HPE ProLiant DL320 Gen11 GPU 4x Direct Connected NVMe FIO Enablement Kit	P62181-B21
--	------------

Notes:

- Supported only with GPU CTO Server
- If 8EDSFF or 4SFF Drive cage is selected and MR416i-p is not selected, then "HPE DL320 G11 GPU 4xDC NVMe FIO Kit" must be selected.
- If 8EDSFF Drive cage is selected with "HPE DL320 G11 GPU 4xDC NVMe FIO Kit" then drive cage will be connected to Direct attach and can support Max=4 EDSFF drives only
- If 4SFF U.3 Drive cage is selected with "HPE DL320 G11 GPU 4xDC NVMe FIO Kit" then drive cage will be connected to direct attach and support Max=4 NVMe U.3 drives only
- Cannot be selected if MR416i-p controller is selected.
- Max=1 of 'GPU 4xDC NVMe FIO Kit' or '4SFF TM Cable Kit' or '2xType-p NVMe Cable Kit' can be selected
- If Qty=1 of GPU is selected with GPU CTO Server, then 'GPU 4xDC NVMe FIO Kit' or '2 GPU FIO Enable Kit' must be selected
- In GPU CTO Server if 'GPU 4xDC NVMe FIO Kit' then the first GPU card selected will be installed in the front of the server. This should not be considered for total PCIe selection.



Additional Options

HPE ProLiant DL320 Gen11 2 GPU FIO Enablement Kit P62197-B21

Notes:

- If Qty=1 Double Wide GPU is selected with GPU CTO Server, then 'GPU 4xDC NVMe FIO Kit' or '2 GPU FIO Enable Kit' must be selected.
- If Qty=2 Double Wide GPU is selected with GPU CTO Server, then '2 GPU FIO Enable Kit' must be selected
- Can not be selected with any other GPU enablement kit.
- If '2 GPU FIO Enable Kit' is selected along with 4SFF Drive cage, then MR416i-p controller or Gen5 Retimer card and 4SFF TM Cable Kit must be selected.
- If Qty=1 Single Wide GPU is selected with GPU CTO Server, then 'GPU 4xDC NVMe FIO Kit' or '2 GPU FIO Enable Kit' or '4SW GPU FIO Enable Kit' must be selected.
- If Qty=2 Single Wide GPU is selected with GPU CTO server then '2 GPU FIO Enable Kit' or '4SW GPU FIO Enable Kit' must be selected.

HPE DL320 Gen11 Primary GPU 8p Power Cable Kit P62201-B21

HPE DL320 Gen11 Secondary GPU 8p Power Cable Kit P62203-B21

HPE DL320 Gen11 Primary GPU 16p Power Cable Kit P62205-B21

HPE DL320 Gen11 Secondary GPU 16p Power Cable Kit P62207-B21

Notes:

- P62205-B21 & P62207-B21 require selection of L40 GPU.
- If Qty=1 of L40 GPU is selected, then Primary GPU 16p Power Cable Kit (P62205-B21) must be selected.
- If Qty=2 of L40 GPU is selected, then Primary GPU 16p Power Cable Kit (P62205-B21) and Secondary GPU 8p Power Cable Kit (P62207-B21) must be selected.
- P62201-B21 & P62203-B21 require selection of A16 GPU.
- If Qty=1 of A16 GPU is selected, then Primary GPU 8p Power Cable Kit (P62201-B21) must be selected.
- If Qty=2 of A16 GPU is selected, then Primary GPU 8p Power Cable Kit (P62201-B21) and Secondary GPU 8p Power Cable Kit (P62203-B21) must be selected.

HPE ProLiant DL320 Gen11 4SFF Tri-Mode Cable Kit P62189-B21

Notes:

- Supported only with GPU CTO Server.
- If 4SFF U.3 drive cage is selected with MR416i-p controller, then 'HPE DL320 Gen11 4SFF TM Cable Kit.'
- Requires selection 4SFF U.3 Drive cage.
- Max=1 of 'GPU 4xDC NVMe FIO Kit' or '4SFF TM Cable Kit' can be selected.

HPE ProLiant DL320 Gen11 2x Type-p NVMe Cable Kit P62183-B21

Notes:

- Supported only with GPU CTO Server.
- Requires selection of Gen5 Retimer card.
- Requires selection of 8EDSFF Drive cage.
- Max=1 of these kits is allowed for selection GPU 4xDC NVMe FIO Kit or 4SFF TM Cable Ki or Gen5 Retimer cable
- If 8EDSFF Drive cage is selected with Gen5 Retimer card then HPE DL320 Gen11 2xType-p NVMe Cable Kit must be selected and defaulted

HPE ProLiant DL320 Gen11 SR932i-p NVMe Cable Kit P62185-B21

Notes:

- Supported only with GPU CTO Server.
- Requires selection of 8EDSFF Drive cage.
- Max=1 of these kits is allowed for selection GPU 4xDC NVMe FIO Kit or 4SFF TM Cable Ki or Gen5 Retimer cable



Additional Options

- If 8EDSFF drive cage is selected with SR932i-p controller, then 'SR932i-p NVMe Cable Kit' must be selected and defaulted.
- Requires selection of SR932i-p controller

RAID Settings

HPE RAID 0 Drive 1 FIO Setting	339777-B21
HPE RAID 1 Drive 1 FIO Setting	339778-B21
HPE RAID 5 Drive 1 FIO Setting	339779-B21
HPE Raid 5 w/SP Drive 1 FIO Setting	339780-B21
HPE RAID FIO Advanced Data Guarding Option	339781-B21

Notes:

- General RAID rules:
 - o Only a single set of RAID will be offered and will only be applied to all applicable drives installed in a server.
 - o RAID requires the selection of a Smart Array controller and a specific number of matching drives. (i.e., same part number).
 - o If RAID is selected, and only SAS or SATA, or NVMe drives are configured, then all drives must be the same part number. (i.e., matching drives).
 - o If RAID is selected and both SAS and SATA drives are configured, only the SAS drives will be used in the RAID set. (SAS drives must be the same part number; SATA drives can vary in part numbers).
 - o If RAID is selected and NVMe, SAS, and SATA drives are configured, then only the NVMe drives will be used in the RAID set. (NVMe drives must be the same part number; SAS & SATA drives can vary in part numbers).
 - o RAID must be selected if both Factory Installed OS and Smart Array controller (embedded or otherwise) are present.
 - o (vii) RAID 0 requires at least 1 drive.
 - o RAID 1 requires at least 2 or even number of drives.
 - o RAID 1 with Spare requires at least 3 drives.
 - o RAID 5 requires at least 3 drives.
 - o RAID 5 with Spare requires at least 4 drives.
 - o RAID 6 requires at least 4 drives.
- If SR932i-p/ MR416i-p/ MR416i-o/ MR408i-o is the Primary controller, then all RAID levels are allowed.
- If MR216i-o/MR216i-p/ Standard VROC is the primary controller, then only the following RAID levels are allowed: 0, 1.
- If Premium VROC is the primary controller, then the following RAID levels are allowed: 0, 1, 5.
- If Direct Attach is the Primary controller, then RAID is NOT allowed.
- If RAID is selected in a configuration with VROC and internal controller, then Customer Defined RAID Setting (389692-B21) must be selected.
- HPE Recommends using the below standard RAID Settings,
 - o 339777-B21 HPE RAID 0 Drive 1 FIO Setting
 - o 339778-B21 HPE RAID 1 Drive 1 FIO Setting
 - o 339779-B21 HPE RAID 5 Drive 1 FIO Setting
 - o 339780-B21 HPE RAID 5 w/SP Drive 1 FIO Setting

HPE Customer Defined RAID Setting Service	389692-B21
---	------------

Notes:

- The following RAID rules do not apply:
 - o Max of 1 RAID level per server.
 - o All integrated hard drives must match.
 - o Minimum drive quantity requirement for each RAID level.



Additional Options

- o RAID level must be selected if Factory Installed OS is present and Smart Array SAS controller (embedded or otherwise) is the primary controller.
- At least 1 hard drive must be on order.
- Preinstalled OS must be on order.
- A Customer Intent Document (CID) must be supplied if this part number is ordered.
- This Customer Intent Document should include all details about the desired RAID custom configuration (This includes Drive part numbers and quantities, RAID levels desired, which drives should be applied to each RAID level, and if a preinstalled OS has been ordered - which RAID set it should be installed on).

Embedded Management

HPE iLO Common Password FIO Setting

HPE iLO Common Password FIO Setting

P08040-B21

Notes:

- Replaces iLO default randomized password with an HPE-defined common password. HPE highly recommends changing this password immediately after the initial onboarding process.
- Customers who want to choose their own custom iLO default password should use the HPE Factory Express Integration Services.

HPE iLO Advanced

HPE iLO Advanced Electronic License with 1yr Support on iLO Licensed Features

E6U59ABE

HPE iLO Advanced 1-server License with 1yr Support on iLO Licensed Features

512485-B21

HPE iLO Advanced Flexible Quantity License with 1yr Support on iLO Licensed Features

512486-B21

HPE iLO Advanced AKA Tracking License with 1yr Support on iLO Licensed Features

512487-B21

HPE iLO Advanced Electronic License with 3yr Support on iLO Licensed Features

E6U64ABE

HPE iLO Advanced 1-server License with 3yr Support on iLO Licensed Features

BD505A

HPE iLO Advanced Flexible Quantity License with 3yr Support on iLO Licensed Features

BD506A

HPE iLO Advanced AKA Tracking License with 3yr Support on iLO Licensed Features

BD507A

HPE Converged Infrastructure Management Software

HPE OneView including 3yr 24x7 Support Flexible Quantity E-LTU

E5Y35AAE

HPE OneView w/o iLO including 3yr 24x7 Support Flexible Quantity E-LTU

P8B26AAE

Notes: Licenses ship without media. The HPE OneView Media Kit can be ordered separately or **downloaded**.

HPE Security

HPE iLO Common Password FIO Setting

P08040-B21

Notes:

- Replaces iLO default randomized password with an HPE-defined common password. HPE highly recommends changing this password immediately after the initial onboarding process.
- Customers who want to choose their own custom iLO default password should use the HPE Factory Express Integration Services.

HPE Bezel Lock Kit

875519-B21

Notes: Requires the bezel kit (P50450-B21).

HPE ProLiant Gen11 1U Common Bezel Kit

P50450-B21

HPE ProLiant DL320 Gen11 Intrusion Detection Cable Kit

P55417-B21



Additional Options

Optional Upgrades

HPE 96W Smart Storage Lithium-ion Battery with 145mm Cable Kit

P01366-B21

HPE Smart Storage Hybrid Capacitor with 145mm Cable Kit

P02377-B21

Notes: Provides backup power for multiple HPE storage controllers or other devices.

HPE Tape Backup

For the complete range of tape drives, autoloaders, libraries, and media, see:

<https://www.hpe.com/us/en/storage/storeever-tape-storage.html> For hardware and software compatibility of Hewlett Packard Enterprise tape backup products <http://www.hpe.com/storage/BURACompatibility>

HPE Racks

- Please see the [HPE Advanced Series Racks QuickSpecs](#) for information on additional rack options and rack specifications.
 - Please see the [HPE Enterprise Series Racks QuickSpecs](#) for information on additional rack options and rack specification
 - Please see the [HPE Standard Series Racks QuickSpecs](#) for information on additional rack options and rack specifications.
-

HPE Power Distribution Units (PDUs)

- Please see the [HPE Basic Power Distribution Units \(PDU\) QuickSpecs](#) for information on these products and their specifications.
 - Please see the [HPE Metered Power Distribution Units \(PDU\) QuickSpecs](#) for information on these products and their specifications. Please see the [HPE Intelligent Power Distribution Unit \(PDU\) QuickSpecs](#) for information on these products and their specifications.
 - Please see the [HPE Metered and Switched Power Distribution Units \(PDU\) QuickSpecs](#) for information on these products and their specifications.
-

Uninterruptible Power Systems (UPS)

- To learn more, please visit the [HPE Uninterruptible Power Systems \(UPS\) web page](#).
 - Please see the [HPE Direct Flow Three Phase Uninterruptible Power System QuickSpecs](#) for information on these products and their specifications.
 - Please see the [HPE Line Interactive Single-Phase UPS QuickSpecs](#) for information on these products and their specifications.
-

HPE Rack Options

Please see the [HPE KVM Switches web page](#) for information on these products and their specifications.

Easy Install Rail Kits

Easy Install rail kits contain telescoping rails, which allow for in-rack serviceability.

To assist in installing the server into the rack, an optional installation tool is available by contacting your local services representative.

Notes: Hewlett Packard Enterprise recommends that a minimum of two people are required for all Rack Server installations. Please refer to your installation instructions for proper tools and the number of people to use for any installation.

HPE DL325 Gen10 Plus Cable Management Arm

P18546-B21

Notes: DL325 Gen10+ CMA requires the selection of EI Rail Kit 9.



Additional Options

HPE ProLiant DL300 Gen10 Plus 1U Cable Management Arm for Rail Kit P26489-B21

Notes:

- Not supported with 12LFF CTO Server
- DL300 Gen10+ 1U CMA for Rail Kit' requires the selection of 'EI Rail Kit 1' or 'Easy Install Rail 2 Kit'.

HPE Easy Install Rail 1 Kit P52349-B21

Notes:

- Supported only with 8SFF CTO Server.
- DL300 Gen10+ 1U CMA for Rail Kit' requires the selection of 'EI Rail Kit 1' or 'Easy Install Rail 2 Kit'.

HPE DL3XX Gen11 Easy Install Rail 2 Kit P52351-B21

Notes:

- Supported only with 4LFF CTO Server.
- DL300 Gen10+ 1U CMA for Rail Kit' requires the selection of 'EI Rail Kit 1' or 'Easy Install Rail 2 Kit'.

HPE Easy Install Rail 9 Kit P52353-B21

Notes:

- Supported only with 12LFF CTO Server.
- DL325 Gen10+ CMA requires the selection of EI Rail Kit 9.

HPE USB and SD Options

Notes: In vSphere 7.0, VMware made changes that impact the use of an SD Card/USB media as a standalone boot device and will be removing support for them after version 7.x.

SD Card/USB media can still be used as a standalone boot option through all 7.x releases via published Customer Advisory **Usage of SD Card/USB Devices As Standalone Boot Devices Has Changed Due to System Storage Changes For VMware ESXi 7.0 (Or Later)**.

For any major release beyond VMware ESXi 7.x, VMware will require M.2 or another local persistent device as the standalone boot option.

HPE Support Service

Installation Services

HPE Install ProLiant DL320 Service U4490E

HPE Installation and Startup ProLiant DL320 Service U4491E

Tech Care

HPE 3 Year Tech Care Essential DL320 Gen11 HW Service H93M2E

HPE 3 Year Tech Care Essential wDMR DL320 Gen11 HW Service H93M3E

HPE 5 Year Tech Care Essential DL320 Gen11 HW Service H93P6E

HPE 5 Year Tech Care Essential wDMR DL320 Gen11 HW Service H93P7E



Memory

Memory Population guidelines

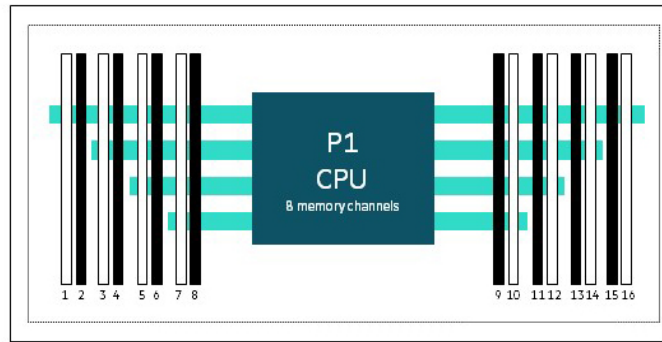

HPE ProLiant DL320 Gen10 Plus

HPE ProLiant Gen10 Plus 16 slot per CPU DIMM population order																
DIMM population order																
DIMM slot	1	2	3	4	5	6	7	8	9	10	11	12	13	14	15	16
1 DIMM										10						
2 DIMMs ¹			3							10						
4 DIMMs ¹			3				7			10				14		
6 DIMMs			3		5		7			10				14		16
8 DIMMs ^{1,2}	1		3		5		7			10		12		14		16
12 DIMMs	1	2	3		5	6	7			10	11	12		14	15	16
16 DIMMs ^{1,2}	1	2	3	4	5	6	7	8	9	10	11	12	13	14	15	16

Notes:

- Cells without entries represent configurations not supported, and if populated, the server may result in non-optimal memory performance or other unexpected behavior.
- ¹ Support Hemi (hemisphere mode).
- ² Support Software Guard Extensions (SGX).

General Memory Population Rules and Guidelines

- Install DIMMs only if the corresponding processor is installed.
- If only one processor is installed in a two-processor system, only half of the DIMM slots are available.
- To maximize performance, it is recommended to balance the total memory capacity between all installed processors.
- When two processors are installed, balance the DIMMs across the two processors.
- White DIMM slots denote the first slot to be populated in a channel.
- Mixing of DIMM types (UDIMM, RDIMM, and LRDIMM) is not supported.
- The maximum memory speed is a function of the memory type, memory configuration, and processor model.
- The maximum memory capacity is a function of the number of DIMM slots on the platform, the largest DIMM capacity qualified on the platform, and the number and model of installed processors qualified on the platform.
- For details on the HPE Server Memory Options Population Rules, visit: <http://www.hpe.com/docs/memory-population-rules>
- To realize the performance memory capabilities listed in this document, HPE DDR5 Smart Memory is required. For additional information, please see the [HPE DDR5 Smart Memory QuickSpecs](#).

Notes: The maximum memory speed is a function of the memory type, memory configuration, and processor model. For details on the HPE Server Memory speed, visit: <https://www.hpe.com/docs/memory-speed-table>



Storage

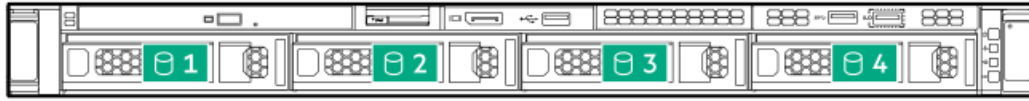

4 LFF device bay numbering



8 SFF drive bay numbering



8 SFF + 2 SFF drive bay numbering

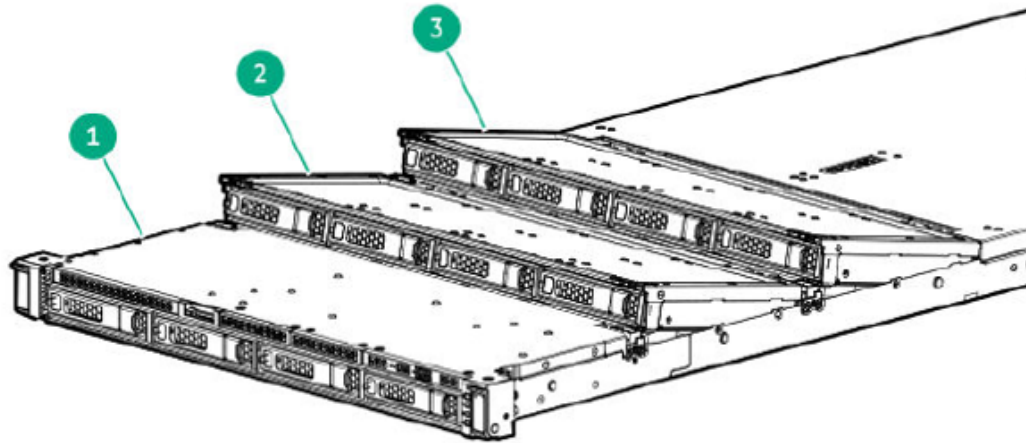

12 LFF drive bay positioning

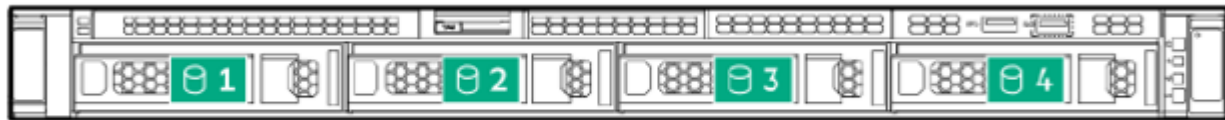

12 LFF drive bay - Box1 numbering

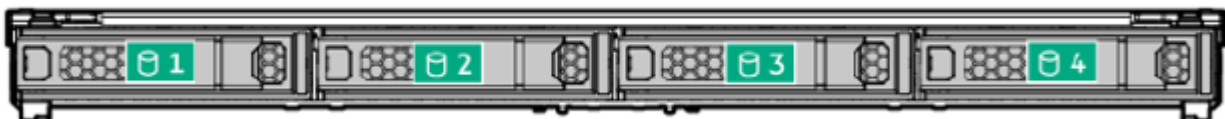

12 LFF drive bay - Box3/Box5 numbering



Technical Specifications

System Unit

Dimensions (Height x Width x Depth)

8 SFF

- 4.28 x 43.46 x 60.51 cm
1.69 x 17.11 x 23.82 in

4 LFF CTO Server

- 4.28 x 43.46 x 66.47 cm
1.69 x 17.11 x 26.17 in

12 LFF CTO Server

- 4.28 x 43.46 x 99.51 cm
1.69 x 17.11 x 39.18 in

GPU Dense CTO

- 4.28 x 43.46 x 77.42cm
1.69 x 17.11 x 30.48 in

Weight (approximate)

- **8+2 SFF minimum**
 - **12.00 kg (26.45 lb):** One Drive, one DIMM, one PCIe card, one processor, one heatsink, one power supply, five fans, and two fan blanks.
- **8+2 SFF maximum**
 - **16.71 kg (36.81 lb):** Ten drives, sixteen DIMMs, two PCIe cards. one processor, one heatsink, two power supplies, and seven fans.
- **4 LFF minimum**
 - **13.20 kg (29.10 lb):** One drive, one DIMM, one PCIe card, one processor, one heatsink, one power supply, five fans, and two fan blanks.
- **4 LFF maximum**
 - **17.70 kg (39.02 lb):** Four drives, sixteen DIMMs, and two PCIe standup cards. One processor, one heatsink, two power supplies, and seven fans.
- **12 LFF minimum**
 - **18.70 kg (41.00 lb):** One Drive, one DIMM, one PCIe card, one processor, one heatsink, one power supply, five fans, and two fan blanks.
- **12 LFF maximum**
 - **29.60 kg (65.23 lb):** Twelve drives, sixteen DIMMs, two PCIe cards. one processor, one heatsink, two power supplies, and seven fans.
- **GPU Dense minimum**
 - **14.70 kg (32.41 lb):** One Drive, one DIMM, one PCIe card, one processor, one heatsink, one power supply, five fans, and two fan blanks.
- **GPU Dense maximum**
 - **20.90 kg (46.08 lb):** Eight drives, sixteen DIMMs, two PCIe cards. one processor, one heatsink, two power supplies, and seven fans.

Input Requirements (per power supply)

Rated Input Voltage

- 1800-2200W (Titanium):
- 1600W (-48 VDC):
- 1600W (Platinum):
- 1000W (Titanium):



Technical Specifications

- 800W (Platinum):
- 500W (Platinum): 100-240 VAC

BTU Rating

Maximum

- For 1600W (Platinum) Power Supply: 5918 BTU/hr (at 200 VAC), 5891 BTU/hr (at 230 VAC)
- For 1600W (48VDC) Power Supply: 6026 BTU/hr (at -40 VDC), 6000 BTU/hr (at -48 VDC), 5989 BTU/hr (at -72 VDC)
- For 1000W (Titanium) Power Supply: 3764 BTU/hr (at 100 VAC), 3629 BTU/hr (at 200 VAC)
- For 800W (Platinum) Power Supply: 3067 BTU/hr (at 100 VAC), 2958 BTU/hr (at 200 VAC), 2949 BTU/hr (at 240 VAC) China only
- For 500W (Platinum) Power Supply: 1999 BTU/hr (at 100 VAC), 1912 BTU/hr (at 200 VAC), 1904 BTU/hr (at 240 VAC) for China only

Power Supply Output (per power supply)

Rated Steady-State Power

- For 1600W (Platinum) Power Supply: 1600 W (at 200 VAC to 240 VAC input), 1600 W (at 240 VDC input)
- For 1600W (48VDC) Power Supply: 1600 W (at -40 VDC to -72 VDC)
- For 1000W (Titanium) Power Supply: 1000 W (at 100 VAC to 127 VAC), 1000 W (at 200 VAC to 240 VAC input)
- For 800W (Platinum) Power Supply: 800 W (at 100 VAC to 127 VAC input), 800 W (at 100 VAC to 240 VAC input), 800 W (at 240 VDC input for China only)
- 3067 BTU/hr (at 100 VAC), 2958 BTU/hr (at 200 VAC), and 2949 BTU/hr (at 240 VAC), China only
- For 500W (Platinum) Power Supply: 500 W (at 100 - 127 VAC input), 500 W (at 100 - 240 VAC input), 500 W (100 VAC - 127 VAC input)

Maximum Peak Power

- For 1600W (Platinum) Power Supply: 1600 W (at 200 VAC to 240 VAC input), 1600 W (at 240 VDC input)
- For 1600W (48VDC) Power Supply: 1600 W (at -40 VDC to -72 VDC)
- For 1000W (Titanium) Power Supply: 1000 W (at 100 VAC to 127 VAC), 1000 W (at 200 VAC to 240 VAC input)
- For 800W (Platinum) Power Supply: 800 W (at 100 VAC to 127 VAC input), 800 W (at 100 VAC to 240 VAC input), 800 W (at 240 VDC input for China only)
- For 500W (Platinum) Power Supply: 500 W (at 100 - 127 VAC input), 500 W (at 100 - 240 VAC input), 500 W (100 VAC - 127 VAC input)

System Inlet Temperature

- **Standard Operating Support**

10° to 35°C (50° to 95°F) at sea level with an altitude derating of 1.0°C per every 305 m (1.8°F per every 1000 ft) above sea level to a maximum of 3050 m (10,000 ft), no direct sustained sunlight. The maximum rate of change is 20°C/hr (36°F/hr). The upper limit and rate of change may be limited by the type and number of options installed. System performance during standard operating support may be reduced if operating with a fan fault or above 30°C (86°F).

- **Extended Ambient Operating Support**

For approved hardware configurations, the supported system inlet range is extended to be: 5° to 10°C (41° to 50°F) and 35° to 40°C (95° to 104°F) at sea level with an altitude derating of 1.0°C per every 175 m (1.8°F per every 574 ft) above 900 m (2953 ft) to a maximum of 3050 m (10,000 ft). The approved hardware configurations for this system are listed at the URL: <https://www.hpe.com/support/ASHRAEGen11>

40°C to 45°C (104°F to 113°F) at sea level with an altitude derating of 1.0°C per every 125 m (1.8°F per every 410 ft) above 900 m (2953 ft) to a maximum of 3050 m (10,000 ft). The approved hardware configurations for this system are listed at the URL: <https://www.hpe.com/support/ASHRAEGen11>

System performance may be reduced if operating in the extended ambient operating range or with a fan fault.



Technical Specifications

- **Non-operating**
-30° to 60°C (-22° to 140°F). The maximum rate of change is 20°C/hr (36°F/hr).

Relative humidity (non-condensing)

- **Operating**
8% to 90% - Relative humidity (Rh), 28°C (82.4°F) maximum wet bulb temperature, non-condensing.
- **Non-operating**
5 to 95% relative humidity (Rh), 38.7°C (101.7°F) maximum wet bulb temperature, non-condensing.

Altitude

- **Operating**
3050 m (10,000 ft). This value may be limited by the type and number of options installed. The maximum allowable altitude change rate is 457 m/min (1500 ft/min).
- **Non-operating**
9144 m (30,000 ft). The maximum allowable altitude change rate is 457 m/min (1500 ft/min).

Emissions Classification (EMC)

To view the regulatory information for your product, view the Safety and Compliance Information for Server, Storage, Power, Networking, and Rack Products, available at the Hewlett Packard Enterprise Support Center:

https://support.hpe.com/hpsc/public/docDisplay?docLocale=en_US&docId=c03471072

Acoustic Noise

Listed are the declared mean A-Weighted sound power levels (LWA,m), declared average bystander position A-Weighted sound pressure levels (LpAm), and the statistical adder for verification, Kv, is a quantity to be added to the declared mean A-weighted sound power

level, LWA,m when the product is operating in a 23°C ambient environment. Noise emissions were measured in accordance with ISO 7779 (ECMA 74) and declared in accordance with ISO 9296 (ECMA 109). The listed sound levels apply to standard shipping configurations. Additional options may result in increased sound levels. Please have your HPE representative provide information from the HPE EMESC website for further technical details regarding the configurations listed below.

Test case	Entry 1 (BTO) 4LFF	Entry 2 (BTO) SFF	Mid Range (BTO) SFF	Performance (BTO) SFF
Idle				
LWA,m	4.7 B	4.7 B	4.9 B	4.9 B
LpAm	36 dBA	35 dBA	37 dBA	37 dBA
Kv	0.4 B	0.4 B	0.4 B	0.4 B
Operating				
LWA,m	5.3 B	4.9 B	5.1 B	5.2 B
LpAm	39 dBA	36 dBA	38 dBA	40 dBA
Kv	0.4 B	0.4 B	0.4 B	0.4 B

Notes:

- The Acoustics levels presented here are generated by the test configuration only. Acoustics levels will vary depending on system configuration. Values are subject to change without notification and are for reference only.
- The declared mean A-weighted sound power level, LWA,m, is computed as the arithmetic average of the measured.
- A-weighted sound power levels for a randomly selected sample rounded to the nearest 0,1 B.
- The declared mean A-weighted emission sound pressure level, LpA,m, is computed as the arithmetic average of the measured A-weighted emission sound pressure levels at the bystander positions for a randomly selected sample, rounded to the nearest 1 dB.



Technical Specifications

- The statistical adder for verification, K_v , is a quantity to be added to the declared mean A-weighted sound power level, $L_{WA,m}$, such that there will be a 95 % probability of acceptance when using the verification procedures of ISO 9296 if no more than 6,5 % of the batch of new equipment, has A-weighted sound power levels greater than $(L_{WA,m} + K_v)$.
- The quantity, $L_{WA,c}$ (formerly called $L_{WA,d}$), can be computed from the sum of $L_{WA,m}$, and K_v .
- All measurements were made to conform to ISO 7779 / ECMA-74 and declared to conform to ISO 9296 / ECMA-109.
- B, dB, abbreviations for bels and decibels, respectively, where $1 B = 10 dB$.
- The results in this declaration apply only to the model numbers listed above when operating and tested according to the indicated modes and standards. A system with additional configuration components or increased operating functionality may increase the noise emission values.
- The system under abnormal conditions may increase the noise level, and persons in the vicinity of the product [cabinet] for extended periods should consider wearing hearing protection or using other means to reduce noise exposure.

Environment-friendly Products and Approach End-of-life Management and Recycling

Hewlett Packard Enterprise offers **end-of-life product return, trade-in, and recycling programs** in many geographic areas, for our products. Products returned to Hewlett Packard Enterprise will be recycled, recovered, or disposed of in a responsible manner.

The EU WEEE directive (2002/95/EC) requires manufacturers to provide treatment information for each product type used by treatment facilities. This information (product disassembly instructions) is posted on the Hewlett Packard Enterprise website. These instructions may be used by recyclers and other WEEE treatment facilities, as well as Hewlett Packard Enterprise OEM customers who integrate and re-sell Hewlett Packard Enterprise equipment.



Summary of Changes

Date	Version History	Action	Description of Change
13-Nov-2023	Version 14	Changed	Pre-configured Models Section was updated.
06-Nov-2023	Version 13	Changed	Service and Support, , Configuration Information and Additional Options sections were updated
02-Oct-2023	Version 12	Changed	Overview and Core Options sections were updated.
05-Sep-2023	Version 11	Changed	Standard Features, Configuration Information, Core Options and Additional Options sections were updated
07-Aug-2023	Version 10	Changed	Standard Features,Core Options and Additional Options sections were updated
17-Jul-2023	Version 9	Changed	Overview section was updated.
10-Jul-2023	Version 8	Changed	Standard Features, Pre-Configured , Configuration Information and Additional Options sections were updated
05-Jun-2023	Version 7	Changed	Standard Features, Pre-Configured , Configuration Information and Additional Options sections were updated.
01-May-2023	Version 6	Changed	Standard Features, and Core Options sections were updated.
17-Apr-2023	Version 5	Changed	Overview, Standard Features, and Optional Features sections were updated.
03-Apr-2023	Version 4	Changed	Pre-Configured and Core Options section were updated.
06-Mar-2023	Version 3	Changed	Overview, Standard Features, Configuration Information, Additional Options and Technical Specifications sections were updated.
06-Feb-2023	Version 2	Changed	Overview, Core Options, and Storage Options sections were updated.
10-Jan-2023	Version 1	New	New QuickSpecs.



Copyright

Make the right purchase decision.
Contact our presales specialists.

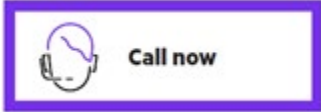
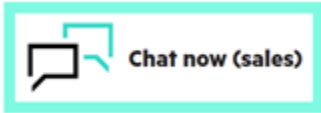

© Copyright 2023 Hewlett Packard Enterprise Development LP. The information contained herein is subject to change without notice. The only warranties for Hewlett Packard Enterprise products and services are set forth in the express warranty statements accompanying such products and services. Nothing herein should be construed as constituting an additional warranty. Hewlett Packard Enterprise shall not be liable for technical or editorial errors or omissions contained herein.

a50004315enw - 16919 - Worldwide - V14 - 13-November-2023