

790XT-G45/ 790XT-G35 series

MS-7388 (v1.x) Mainboard



Copyright Notice

The material in this document is the intellectual property of **MICRO-STAR INTERNATIONAL**. We take every care in the preparation of this document, but no guarantee is given as to the correctness of its contents. Our products are under continual improvement and we reserve the right to make changes without notice.

Trademarks

All trademarks are the properties of their respective owners.

- MSI® is registered trademark of Micro-Star Int'l Co.,Ltd.
- NVIDIA® is registered trademark of NVIDIA Corporation.
- ATI® is registered trademark of ATI Technologies, Inc.
- AMD® is registered trademarks of AMD Corporation.
- Intel® is registered trademarks of Intel Corporation.
- Windows® is registered trademarks of Microsoft Corporation.
- AMI® is registered trademark of American Megatrends, Inc.
- Award® is a registered trademark of Phoenix Technologies Ltd.
- Sound Blaster® is registered trademark of Creative Technology Ltd.
- Realtek® is registered trademark of Realtek Semiconductor Corporation.
- JMicron® is registered trademark of JMicron Technology Corporation.
- Netware® is a registered trademark of Novell, Inc.

Revision History

| Revision | Revision History | Date |
|----------|---------------------------------------|----------------|
| V1.0 | First release for K9A2 CF | September 2007 |
| V1.1 | Update spec. for K9A2 Neo | January 2008 |
| V1.2 | Update spec. for 790XT-G45/ 790XT-G35 | June 2009 |

Technical Support

If a problem arises with your system and no solution can be obtained from the user's manual, please contact your place of purchase or local distributor. Alternatively, please try the following help resources for further guidance.

- Visit the MSI website for FAQ, technical guide, BIOS updates, driver updates, and other information: <http://www.msi.com/index.php?func=service>
- Contact our technical staff at: <http://ocss.msi.com>

Safety Instructions

- Always read the safety instructions carefully.
- Keep this User's Manual for future reference.
- Keep this equipment away from humidity.
- Lay this equipment on a reliable flat surface before setting it up.
- The openings on the enclosure are for air convection hence protects the equipment from overheating. **DO NOT COVER THE OPENINGS.**
- Make sure the voltage of the power source and adjust properly 110/220V before connecting the equipment to the power inlet.
- Place the power cord such a way that people can not step on it. Do not place anything over the power cord.
- Always Unplug the Power Cord before inserting any add-on card or module.
- All cautions and warnings on the equipment should be noted.
- Never pour any liquid into the opening that could damage or cause electrical shock.
- If any of the following situations arises, get the equipment checked by service personnel:
 - The power cord or plug is damaged.
 - Liquid has penetrated into the equipment.
 - The equipment has been exposed to moisture.
 - The equipment does not work well or you can not get it work according to User's Manual.
 - The equipment has dropped and damaged.
 - The equipment has obvious sign of breakage.

DO NOT LEAVE THIS EQUIPMENT IN AN ENVIRONMENT UNCONDITIONED, STORAGE TEMPERATURE ABOVE 600 C (1400F), IT MAY DAMAGE THE EQUIPMENT.

CAUTION: Danger of explosion if battery is incorrectly replaced.

Replace only with the same or equivalent type recommended by the manufacturer.

警告使用者:

這是甲類資訊產品，在居住的環境中使用時，可能會造成無線電干擾，在這種情況下，使用者會被要求採取某些適當的對策。



廢電池請回收

For better environmental protection, waste batteries should be collected separately for recycling special disposal.

FCC-B Radio Frequency Interference Statement

This equipment has been tested and found to comply with the limits for a Class B digital device, pursuant to Part 15 of the FCC Rules. These limits are designed to provide reasonable protection against harmful interference in a residential installation. This equipment generates, uses and can radiate radio frequency energy and, if not installed and used in accordance with the instructions, may cause harmful interference to radio communications. However, there is no guarantee that interference will not occur in a particular installation. If this equipment does cause harmful interference to radio or television reception, which can be determined by turning the equipment off and on, the user is encouraged to try to correct the interference by one or more of the measures listed below.



- Reorient or relocate the receiving antenna.
- Increase the separation between the equipment and receiver.
- Connect the equipment into an outlet on a circuit different from that to which the receiver is connected.
- Consult the dealer or an experienced radio/television technician for help.

Notice 1

The changes or modifications not expressly approved by the party responsible for compliance could void the user's authority to operate the equipment.

Notice 2

Shielded interface cables and A.C. power cord, if any, must be used in order to comply with the emission limits.

VOIR LA NOTICE D'INSTALLATION AVANT DE RACCORDER AU RESEAU.

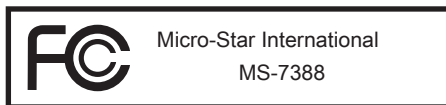

This device complies with Part 15 of the FCC Rules. Operation is subject to the following two conditions:

1. this device may not cause harmful interference, and
2. this device must accept any interference received, including interference that may cause undesired operation.

WEEE (Waste Electrical and Electronic Equipment) Statement

ENGLISH

To protect the global environment and as an environmentalist, MSI must remind you that...



Under the European Union ("EU") Directive on Waste Electrical and Electronic Equipment, Directive 2002/96/EC, which takes effect on August 13, 2005, products of "electrical and electronic equipment" cannot be discarded as municipal waste anymore and manufacturers of covered electronic equipment will be obligated to take back such products at the end of their useful life. MSI will comply with the product take back requirements at the end of life of MSI-branded products that are sold into the EU. You can return these products to local collection points.

DEUTSCH

Hinweis von MSI zur Erhaltung und Schutz unserer Umwelt

Gemäß der Richtlinie 2002/96/EG über Elektro- und Elektronik-Altgeräte dürfen Elektro- und Elektronik-Altgeräte nicht mehr als kommunale Abfälle entsorgt werden. MSI hat europaweit verschiedene Sammel- und Recyclingunternehmen beauftragt, die in die Europäische Union in Verkehr gebrachten Produkte, am Ende seines Lebenszyklus zurückzunehmen. Bitte entsorgen Sie dieses Produkt zum gegebenen Zeitpunkt ausschliesslich an einer lokalen Altgerätesammelstelle in Ihrer Nähe.

FRANÇAIS

En tant qu'écologiste et afin de protéger l'environnement, MSI tient à rappeler ceci...

Au sujet de la directive européenne (EU) relative aux déchets des équipement électriques et électroniques, directive 2002/96/EC, prenant effet le 13 août 2005, que les produits électriques et électroniques ne peuvent être déposés dans les décharges ou tout simplement mis à la poubelle. Les fabricants de ces équipements seront obligés de récupérer certains produits en fin de vie. MSI prendra en compte cette exigence relative au retour des produits en fin de vie au sein de la communauté européenne. Par conséquent vous pouvez retourner localement ces matériels dans les points de collecte.

РУССКИЙ

Компания MSI предпринимает активные действия по защите окружающей среды, поэтому напоминаем вам, что....

В соответствии с директивой Европейского Союза (ЕС) по предотвращению загрязнения окружающей среды использованным электрическим и электронным оборудованием (директива WEEE 2002/96/EC), вступающей в силу 13 августа 2005 года, изделия, относящиеся к электрическому и электронному оборудованию, не могут рассматриваться как бытовой мусор, поэтому производители вышеперечисленного электронного оборудования обязаны принимать его для переработки по окончании срока службы. MSI обязуется соблюдать требования по приему продукции, проданной под маркой MSI на территории ЕС, в переработку по окончании срока службы. Вы можете вернуть эти изделия в специализированные пункты приема.

ESPAÑOL

MSI como empresa comprometida con la protección del medio ambiente, recomienda: Bajo la directiva 2002/96/EC de la Unión Europea en materia de desechos y/o equipos electrónicos, con fecha de rígor desde el 13 de agosto de 2005, los productos clasificados como “eléctricos y equipos electrónicos” no pueden ser depositados en los contenedores habituales de su municipio, los fabricantes de equipos electrónicos, están obligados a hacerse cargo de dichos productos al termino de su período de vida. MSI estará comprometido con los términos de recogida de sus productos vendidos en la Unión Europea al final de su periodo de vida. Usted debe depositar estos productos en el punto limpio establecido por el ayuntamiento de su localidad o entregar a una empresa autorizada para la recogida de estos residuos.

NEDERLANDS

Om het milieu te beschermen, wil MSI u eraan herinneren dat...

De richtlijn van de Europese Unie (EU) met betrekking tot Vervuiling van Electriche en Electronische producten (2002/96/EC), die op 13 Augustus 2005 in zal gaan kunnen niet meer beschouwd worden als vervuiling. Fabrikanten van dit soort producten worden verplicht om producten retour te nemen aan het eind van hun levenscyclus. MSI zal overeenkomstig de richtlijn handelen voor de producten die de merknaam MSI dragen en verkocht zijn in de EU. Deze goederen kunnen geretourneerd worden op lokale inzamelingspunten.

SRPSKI

Da bi zaštitili prirodnu sredinu, i kao preduzeće koje vodi računa o okolini i prirodnoj sredini, MSI mora da vas podesti da...

Po Direktivi Evropske unije (“EU”) o odbačenoj ekelektronskoj i električnoj opremi, Direktiva 2002/96/EC, koja stupa na snagu od 13. Avgusta 2005, proizvodi koji spadaju pod “elektronsku i električnu opremu” ne mogu više biti odbačeni kao običan otpad i proizvođači ove opreme biće prinuđeni da uzmu natrag ove proizvode na kraju njihovog uobičajenog veka trajanja. MSI će poštovati zahtev o preuzimanju ovakvih proizvoda kojima je istekao vek trajanja, koji imaju MSI oznaku i koji su prodati u EU. Ove proizvode možete vratiti na lokalnim mestima za prikupljanje.

POLSKI

Aby chronić nasze środowisko naturalne oraz jako firma dbająca o ekologię, MSI przypomina, że...

Zgodnie z Dyrektywą Unii Europejskiej (“UE”) dotyczącą odpadów produktów elektrycznych i elektronicznych (Dyrektywa 2002/96/EC), która wchodzi w życie 13 sierpnia 2005, tzw. “produkty oraz wyposażenie elektryczne i elektroniczne” nie mogą być traktowane jako śmieci komunalne, tak więc producenci tych produktów będą zobowiązani do odbierania ich w momencie gdy produkt jest wycofywany z użycia. MSI wypełni wymagania UE, przyjmując produkty (sprzedawane na terenie Unii Europejskiej) wycofywane z użycia. Produkty MSI będzie można zwracać w wyznaczonych punktach zbiorczych.

TÜRKÇE

Çevreci özelliğiyle bilinen MSI dünyada çevreyi korumak için hatırlatır:

Avrupa Birliği (AB) Kararnamesi Elektrik ve Elektronik Malzeme Atığı, 2002/96/EC Kararnamesi altında 13 Ağustos 2005 tarihinden itibaren geçerli olmak üzere, elektrikli ve elektronik malzemeler diğer atıklar gibi çöpe atılmayacak ve bu elektronik cihazların üreticileri, cihazların kullanım süreleri bittikten sonra ürünleri geri toplamakla yükümlü olacaktır. Avrupa Birliği'ne satılan MSI markalı ürünlerin kullanım süreleri bittiğinde MSI ürünlerin geri alınması isteği ile işbirliği içerisinde olacaktır. Ürünlerinizi yerel toplama noktalarına bırakabilirsiniz.

ČESKY

Záleží nám na ochraně životního prostředí - společnost MSI upozorňuje...

Podle směrnice Evropské unie ("EU") o likvidaci elektrických a elektronických výrobků 2002/96/EC platné od 13. srpna 2005 je zakázáno likvidovat "elektrické a elektronické výrobky" v běžném komunálním odpadu a výrobci elektrických výrobků, na které se tato směrnice vztahuje, budou povinni odebírat takové výrobky zpět po skončení jejich životnosti. Společnost MSI splní požadavky na odebírání výrobků značky MSI, prodávaných v zemích EU, po skončení jejich životnosti. Tyto výrobky můžete odevzdat v místních sběrnách.

MAGYAR

Annak érdekében, hogy környezetünket megvédjük, illetve környezetvédőként fellépve az MSI emlékezteti Önt, hogy ...

Az Európai Unió („EU”) 2005. augusztus 13-án hatályba lépő, az elektromos és elektronikus berendezések hulladékairól szóló 2002/96/EK irányelve szerint az elektromos és elektronikus berendezések többé nem kezelhetőek lakossági hulladékként, és az ilyen elektronikus berendezések gyártói köteleessé válnak az ilyen termékek visszavételére azok hasznos élettartama végén. Az MSI betartja a termékvisszavétellel kapcsolatos követelményeket az MSI márkanév alatt az EU-n belül értékesített termékek esetében, azok élettartamának végén. Az ilyen termékeket a legközelebbi gyűjtőhelyre viheti.

ITALIANO

Per proteggere l'ambiente, MSI, da sempre amica della natura, ti ricorda che....

In base alla Direttiva dell'Unione Europea (EU) sullo Smaltimento dei Materiali Elettrici ed Elettronici, Direttiva 2002/96/EC in vigore dal 13 Agosto 2005, prodotti appartenenti alla categoria dei Materiali Elettrici ed Elettronici non possono più essere eliminati come rifiuti municipali: i produttori di detti materiali saranno obbligati a ritirare ogni prodotto alla fine del suo ciclo di vita. MSI si adegnerà a tale Direttiva ritirando tutti i prodotti marchiati MSI che sono stati venduti all'interno dell'Unione Europea alla fine del loro ciclo di vita. È possibile portare i prodotti nel più vicino punto di raccolta

CONTENTS

| | |
|------------------------------------------------------------------|------------|
| Copyright Notice..... | ii |
| Trademarks | ii |
| Revision History..... | ii |
| Technical Support..... | ii |
| Safety Instructions..... | iii |
| FCC-B Radio Frequency Interference Statement..... | iv |
| WEEE (Waste Electrical and Electronic Equipment) Statement | v |
| Chapter 1 Getting Started..... | 1-1 |
| Mainboard Specifications | 1-2 |
| Mainboard Layout | 1-4 |
| Packing Checklist..... | 1-5 |
| Chapter 2 Hardware Setup..... | 2-1 |
| Quick Components Guide | 2-2 |
| CPU (Central Processing Unit) | 2-3 |
| Memory | 2-6 |
| Power Supply | 2-8 |
| Back Panel..... | 2-9 |
| Connectors..... | 2-10 |
| Switch..... | 2-15 |
| Jumpers | 2-16 |
| Slots | 2-17 |
| LED Status Indicators | 2-18 |
| Chapter 3 BIOS Setup..... | 3-1 |
| Entering Setup | 3-2 |
| The Main Menu | 3-4 |
| Standard CMOS Features..... | 3-6 |
| Advanced BIOS Features | 3-9 |
| Integrated Peripherals..... | 3-12 |
| Power Management Setup..... | 3-14 |
| H/W Monitor | 3-16 |
| Green Power | 3-17 |
| BIOS Setting Password..... | 3-18 |
| Cell Menu | 3-19 |
| Load Fail-Safe/ Optimized Defaults | 3-25 |

| | |
|---------------------------------------------|------------|
| Appendix A Realtek Audio | A-1 |
| Installing the Realtek HD Audio Driver..... | A-2 |
| Software Configuration..... | A-4 |
| Hardware Setup..... | A-19 |
| Appendix B SB710 RAID | B-1 |
| RAID Configuration..... | B-2 |
| Appendix C Dual Core Center | C-1 |
| Activating Dual Core Center..... | C-2 |
| Main..... | C-3 |
| DOT (Dynamic OverClocking)..... | C-5 |
| Clock..... | C-6 |
| Voltage..... | C-7 |
| FAN Speed..... | C-8 |
| Temperature..... | C-9 |
| User Profile..... | C-10 |

Chapter 1

Getting Started

Thank you for choosing the **790XT-G45/ 790XT-G35** Series (MS-7388 v1.X) ATX mainboard. The **790XT-G45/ 790XT-G35** Series mainboards are based on **AMD® 790X & SB710/ SB700** chipsets for optimal system efficiency. Designed to fit the advanced **AMD®** processor in **AM2+** package processor, the **790XT-G45/ 790XT-G35** Series deliver a high performance and professional desktop platform solution.

MAINBOARD SPECIFICATIONS

Processor Support

- AMD® Phenom FX/X4/X2, Althon 64 FX/X2 and Sempron processors in AM2+ package
(For the latest information about CPU, please visit <http://www.msi.com/index.php?func=cpuform2>)

HyperTransport

- Supports Hyper Transport(HT) 3.0 Technology

Chipset

- North Bridge: AMD® 790X chipset
- South Bridge: AMD® SB710/ SB700 chipset

Memory Support

- DDR2 533/ 667/ 800/ 1066 SDRAM (16GB Max)
- 4 DDR2 DIMMs (240pin / 1.8V)
(For more information on compatible components, please visit <http://www.msi.com/index.php?func=testreport>)

LAN

- Supports LAN 10/100/1000 Fast Ethernet by Realtek® RTL 8111DL

Audio

- Chip integrated by Realtek® ALC889/ ALC888S/ ALC885
- Flexible 8-channel audio with jack sensing
- Compliant with Azalia 1.0 Spec

IDE

- 1 IDE port by AMD® SB710/ SB700
- Supports Ultra DMA 33/66/100/133, PIO & Bus Master operation mode

SATA

- 6 SATAII ports by AMD® SB710/ SB700
- Supports storage and data transfers at up to 3.0 Gb/s

RAID

- Supports RAID 0/ 1/ 0+1/ JBOD mode by AMD® SB710/ SB700

Floppy

- 1 floppy port
- Supports 1 FDD with 360KB, 720KB, 1.2MB, 1.44MB and 2.88MB

Connectors

- Back panel
 - 1 PS/2 mouse port
 - 1 PS/2 keyboard port
 - 1 Serial port
 - 6 USB 2.0 Ports
 - 1 LAN jack
 - 6 flexible audio jacks

- On-Board Connectors
 - 3 USB 2.0 connectors
 - 1 Chassis Intrusion connector
 - 1 CD-In connector
 - 1 Front Panel Audio connector
 - 1 SPDIF-Out connector
 - 1 TPM connector (optional)
 - 1 OC switch

Slots

- 2 PCI Express x16 slot
- 2 PCI Express x1 slot
- 2 PCI slots, support 3.3V/ 5V PCI bus Interface

Form Factor

- ATX (30.5cm X 21.0 cm)

Mounting

- 6 mounting holes

MAINBOARD LAYOUT

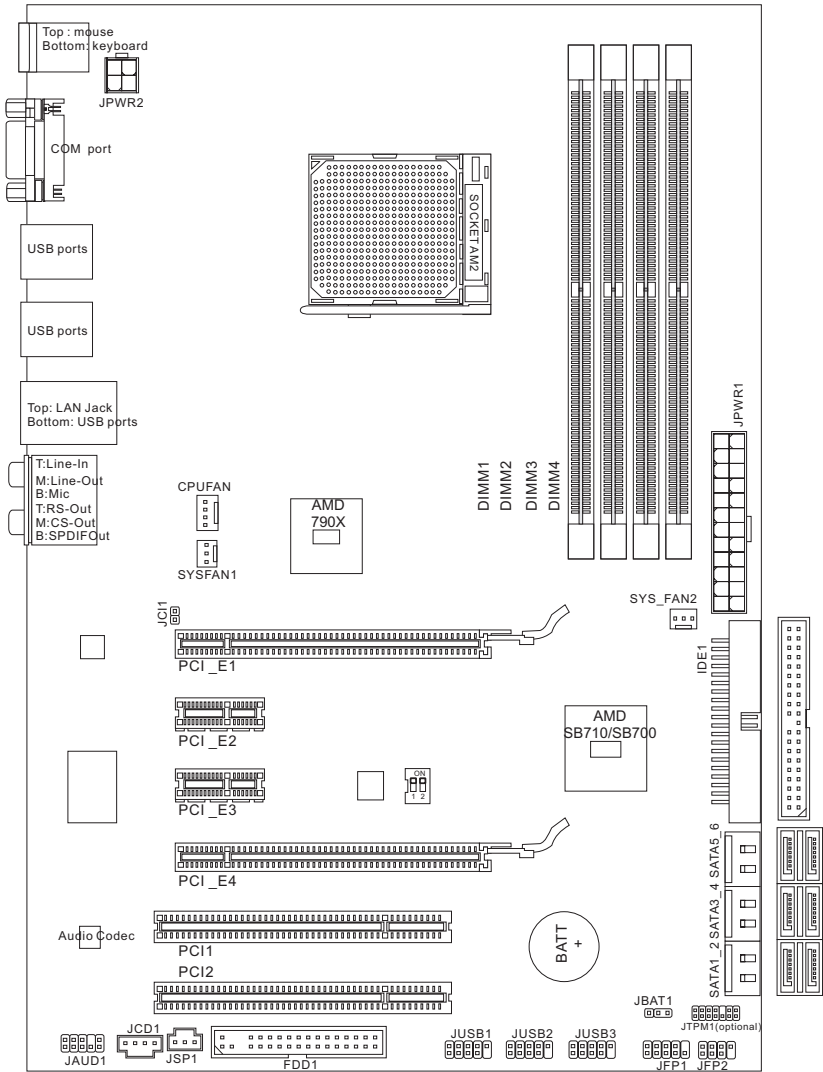

790XT-G45/ 790XT-G35 Series (MS-7388 v1.X) Mainboard

PACKING CHECKLIST



MSI mainboard



MSI Driver/Utility DVD



SATA Cable (Optional)



Power Cable



USB Bracket (Optional)

Standard Cable for
IDE Devices

Back IO Shield



User's Guide

* The pictures are for reference only and may vary from the packing contents of the product you purchased.

* If you need to purchase accessories and request the part numbers, you could search the product web page and find details on our web address below

<http://www.msi.com/index.php>

Chapter 2

Hardware Setup

This chapter provides you with the information about hardware setup procedures. While doing the installation, be careful in holding the components and follow the installation procedures. For some components, if you install in the wrong orientation, the components will not work properly.

Use a grounded wrist strap before handling computer components. Static electricity may damage the components.

QUICK COMPONENTS GUIDE

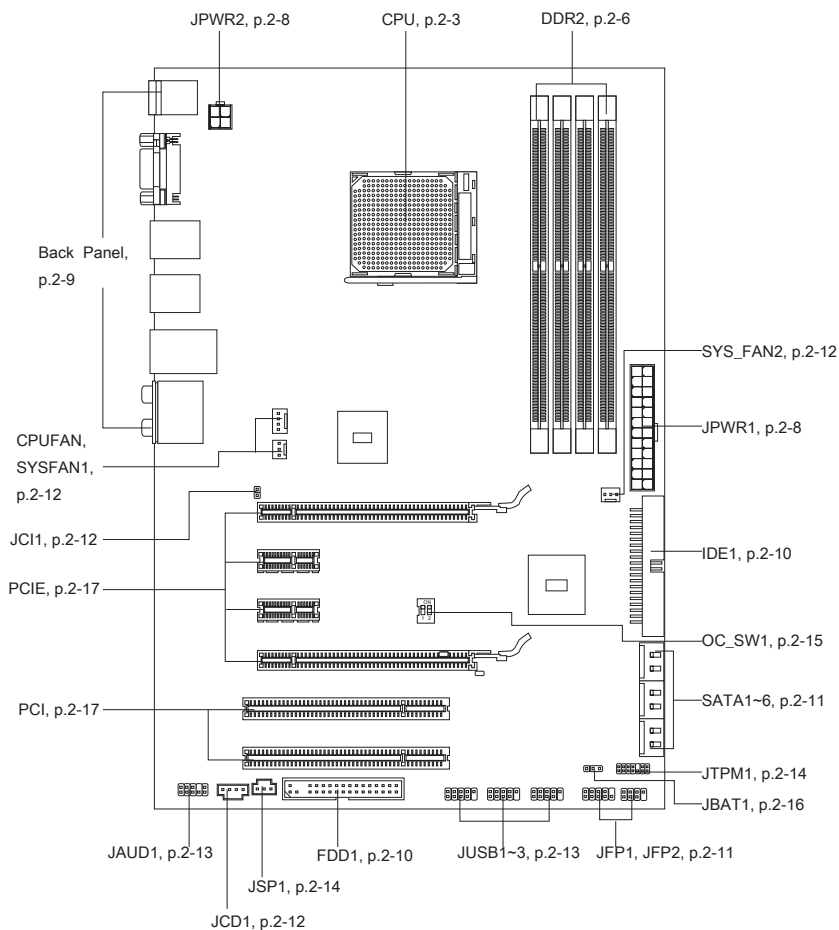

CPU (CENTRAL PROCESSING UNIT)

When you are installing the CPU, make sure to install the cooler to prevent overheating. If you do not have the CPU cooler, consult your dealer before turning on the computer. For the latest information about CPU, please visit <http://www.msi.com/index.php?func=cpuform2>

Important

Overheating

Overheating will seriously damage the CPU and system. Always make sure the cooling fan can work properly to protect the CPU from overheating. Make sure that you apply an even layer of thermal paste (or thermal tape) between the CPU and the heatsink to enhance heat dissipation.

Replacing the CPU

While replacing the CPU, always turn off the ATX power supply or unplug the power supply's power cord from the grounded outlet first to ensure the safety of CPU.

Overclocking

This mainboard is designed to support overclocking. However, please make sure your components are able to tolerate such abnormal setting, while doing overclocking. Any attempt to operate beyond product specifications is not recommended. We do not guarantee the damages or risks caused by inadequate operation or beyond product specifications.

Introduction to AM2+ CPU

The surface of CPU. Remember to apply some thermal paste on it for better heat dispersion.



Gold arrow

CPU & Cooler Installation

When you are installing the CPU, make sure the CPU has a cooler attached on the top to prevent overheating. Meanwhile, do not forget to apply some thermal paste on CPU before installing the heat sink/cooler fan for better heat dispersion.

Follow the steps below to install the CPU & cooler correctly. Wrong installation will cause the damage of your CPU & mainboard.

1. Pull the lever sideways away from the socket. Make sure to raise the lever up to a 90-degree angle.
2. Look for the gold arrow of the CPU. The gold arrow should point as shown in the picture. The CPU can only fit in the correct orientation.

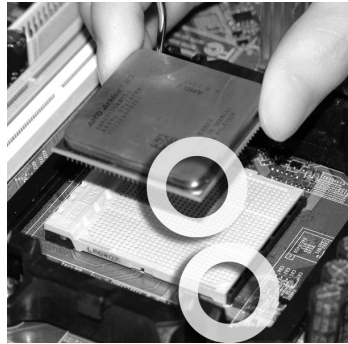
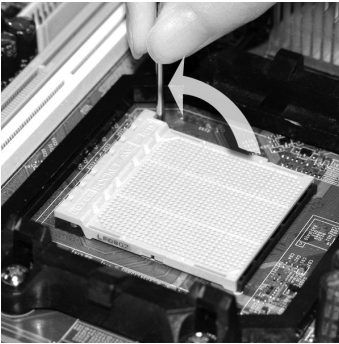

3. If the CPU is correctly installed, the pins should be completely embedded into the socket and can not be seen. Please note that any violation of the correct installation procedures may cause permanent damages to your mainboard.
4. Press the CPU down firmly into the socket and close the lever. As the CPU is likely to move while the lever is being closed, always close the lever with your fingers pressing tightly on top of the CPU to make sure the CPU is properly and completely embedded into the socket.

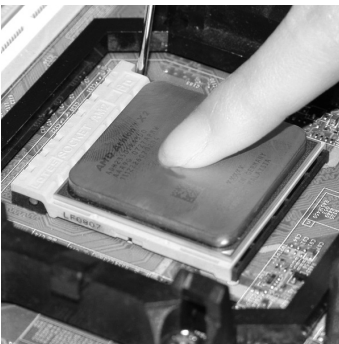

5. Position the cooling set onto the retention mechanism.
Hook one end of the clip to hook first.
6. Then press down the other end of the clip to fasten the cooling set on the top of the retention mechanism.
Locate the Fix Lever and lift up it .

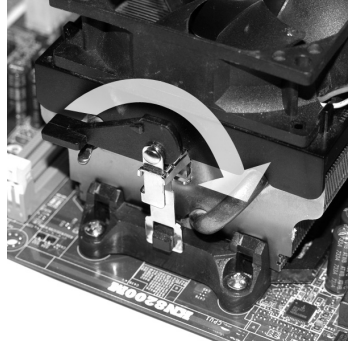
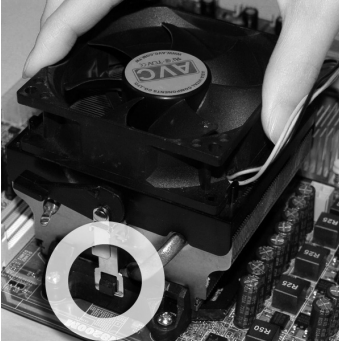

7. Fasten down the lever.
8. Attach the CPU Fan cable to the CPU fan connector on the mainboard.

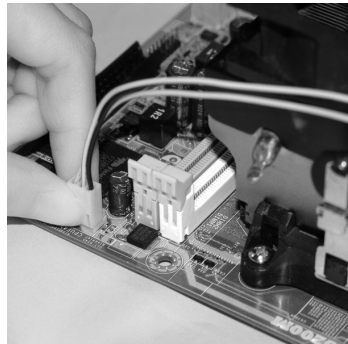
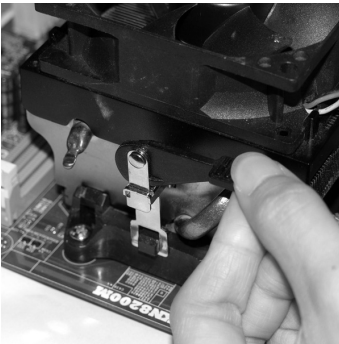

Important

- Mainboard photos shown in this section are for demonstration of the cooler installation for Socket AM2+ CPUs only. The appearance of your mainboard may vary depending on the model you purchase.
- While disconnecting the Safety Hook from the fixed bolt, it is necessary to keep an eye on your fingers, because once the Safety Hook is disconnected from the fixed bolt, the fixed lever will spring back instantly.

MEMORY

These DIMM slots are used for installing memory modules.
 For more information on compatible components, please visit
<http://www.msi.com/index.php?func=testreport>

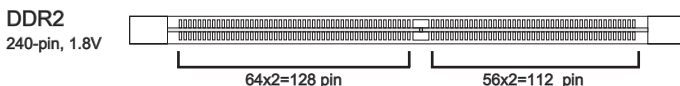

Dual-Channel mode Population Rule

In Dual-Channel mode, the memory modules can transmit and receive data with two data bus lines simultaneously. Enabling Dual-Channel mode can enhance the system performance. The following illustrations explain the population rules for Dual-Channel mode.



①

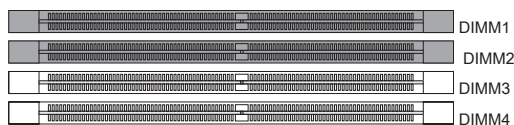

②



Important

- *DDR2 memory modules are not interchangeable with DDR and the DDR2 standard is not backwards compatible. You should always install DDR2 memory modules in the DDR2 DIMM slots.*
- *In Dual-Channel mode, make sure that you install memory modules of the **same type and density** in different channel DIMM slots.*
- *To enable successful system boot-up, always insert the memory modules into the **DIMM1 first**.*

Installing Memory Modules

1. The memory module has only one notch on the center and will only fit in the right orientation.
2. Insert the memory module vertically into the DIMM slot. Then push it in until the golden finger on the memory module is deeply inserted in the DIMM slot. The plastic clip at each side of the DIMM slot will automatically close when the memory module is properly seated.
3. Manually check if the memory module has been locked in place by the DIMM slot clips at the sides.

Important

You can barely see the golden finger if the memory module is properly inserted in the DIMM slot.

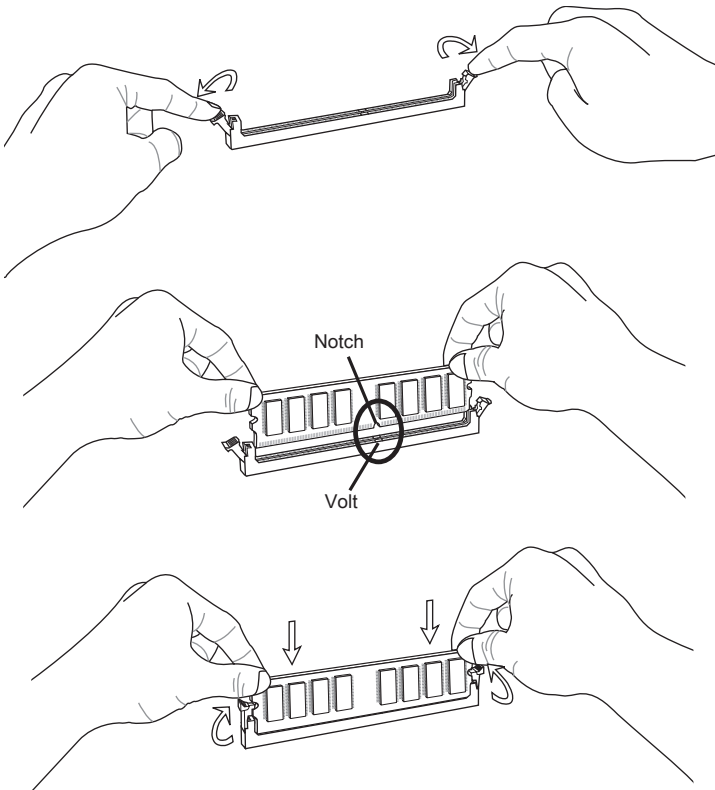

POWER SUPPLY

ATX 24-pin Power Connector: JPWR1

This connector allows you to connect an ATX 24-pin power supply. To connect the ATX 24-pin power supply, make sure the plug of the power supply is inserted in the proper orientation and the pins are aligned. Then push down the power supply firmly into the connector.

You may use the 20-pin ATX power supply as you like. If you'd like to use the 20-pin ATX power supply, please plug your power supply along with pin 1 & pin 13 (refer to the image at the right hand).

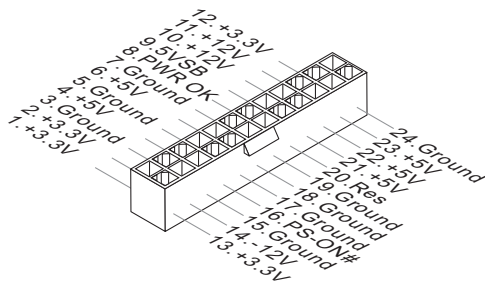

ATX 4-pin Power Connector: JPWR2

This power connector is used to provide power to the CPU.

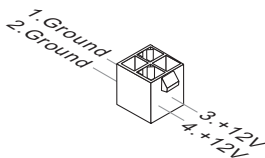

Important

- Make sure that all the connectors are connected to proper ATX power supplies to ensure stable operation of the mainboard.
- Power supply of 350 watts (and above) is highly recommended for system stability.

BACK PANEL

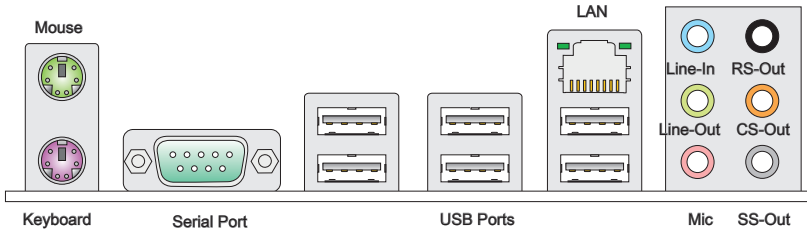

► Mouse/Keyboard

The standard PS/2® mouse/keyboard DIN connector is for a PS/2® mouse/keyboard.

► Serial Port

The serial port is a 16550A high speed communications port that sends/ receives 16 bytes FIFOs. You can attach a serial mouse or other serial devices directly to the connector.

► LAN

The standard RJ-45 LAN jack is for connection to the Local Area Network (LAN). You can connect a network cable to it.

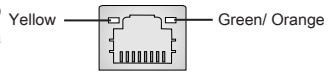

| LED | Color | LED State | Condition |
|-------|--------|------------------------|-----------------------------------------------------------------|
| Left | Yellow | Off | LAN link is not established. |
| | | On(Steady state) | LAN link is established. |
| | | On(brighter & pulsing) | The computer is communicating with another computer on the LAN. |
| Right | Green | Off | 10 Mbits/sec data rate is selected. |
| | | On | 100 Mbits/sec data rate is selected. |
| | Orange | On | 1000 Mbits/sec data rate is selected. |

► USB Ports

The USB (Universal Serial Bus) port is for attaching USB devices such as keyboard, mouse, or other USB-compatible devices.

► Audio Ports

These audio connectors are used for audio devices. It is easy to differentiate between audio effects according to the color of audio jacks.

- Line-In (Blue) - Line In, is used for external CD player, tape-player or other audio devices.
- Line-Out (Green) - Line Out, is a connector for speakers or headphones.
- Mic (Pink) - Mic, is a connector for microphones.
- RS-Out (Black) - Rear-Surround Out in 4/ 5.1/ 7.1 channel mode.
- CS-Out (Orange) - Center/ Subwoofer Out in 5.1/ 7.1 channel mode.
- SS-Out (Gray) - Side-Surround Out 7.1 channel mode.

CONNECTORS

Floppy Disk Drive Connector: FDD1

This connector supports 360KB, 720KB, 1.2MB, 1.44MB or 2.88MB floppy disk drive.

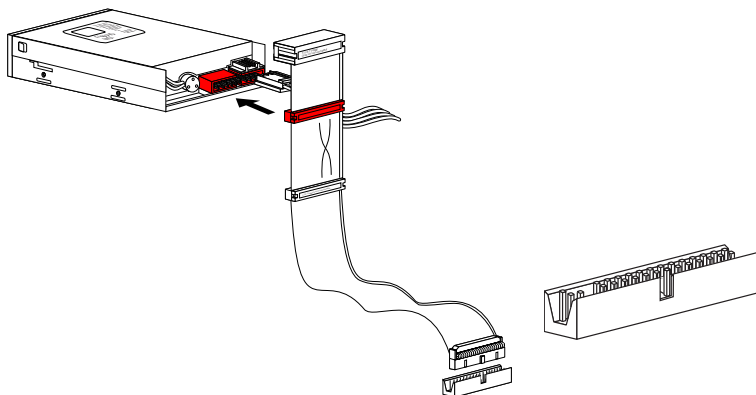

IDE Connector: IDE1

This connector supports IDE hard disk drives, optical disk drives and other IDE devices.

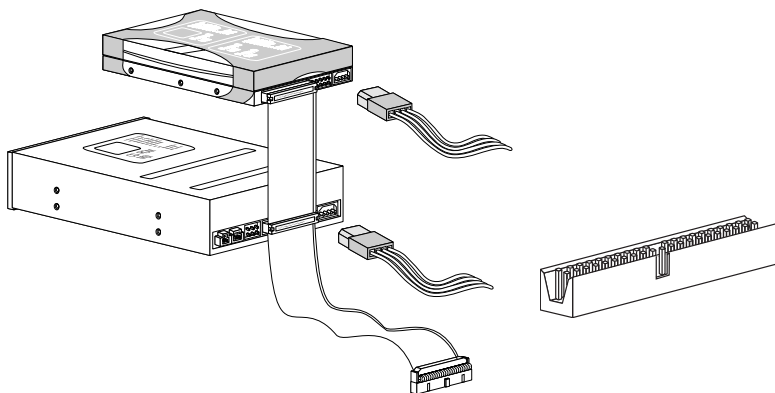

Important

If you install two IDE devices on the same cable, you must configure the drives separately to master / slave mode by setting jumpers. Refer to IDE device's documentation supplied by the vendors for jumper setting instructions.

Serial ATA Connector: SATA1~6

This connector is a high-speed Serial ATA interface port. Each connector can connect to one Serial ATA device.

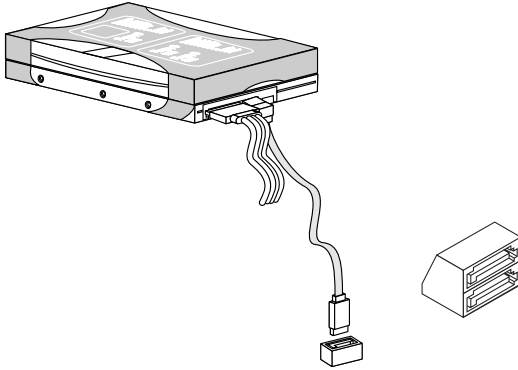

Important

- Please do not fold the Serial ATA cable into 90-degree angle. Otherwise, data loss may occur during transmission.

Front Panel Connector: JFP1, JFP2

This connector is for electrical connection to the front panel switches and LEDs. The JFP1 is compliant with Intel® Front Panel I/O Connectivity Design Guide.

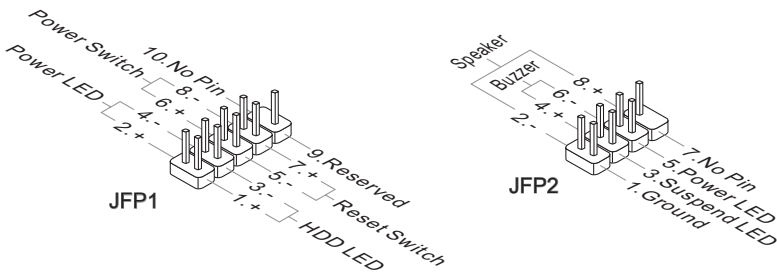

Fan Power Connectors: CPUFAN, SYSFAN1, SYS_FAN2

The fan power connectors support system cooling fan with +12V. When connecting the wire to the connectors, always note that the red wire is the positive and should be connected to the +12V; the black wire is Ground and should be connected to GND. If the mainboard has a System Hardware Monitor chipset on-board, you must use a specially designed fan with speed sensor to take advantage of the CPU fan control.

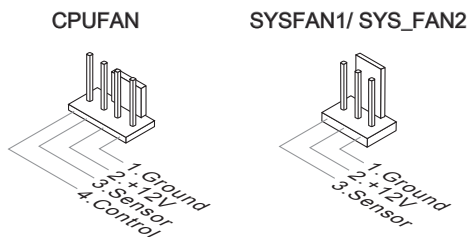

Important

- Please refer to the recommended CPU fans at processor's official website or consult the vendors for proper CPU cooling fan.
- CPUFAN supports fan control. You can install **Dual Core Center** utility that will automatically control the CPU fan speed according to the actual CPU temperature.
- Fan cooler set with 3 or 4 pins power connector are both available for CPUFAN

Chassis Intrusion Connector: JCI1

This connector connects to the chassis intrusion switch cable. If the chassis is opened, the chassis intrusion mechanism will be activated. The system will record this status and show a warning message on the screen. To clear the warning, you must enter the BIOS utility and clear the record.

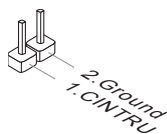

CD-In Connector: JCD1

This connector is provided for external audio input.

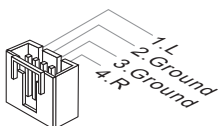

Front USB Connector: JUSB1/ JUSB2/ JUSB3

This connector, compliant with Intel® I/O Connectivity Design Guide, is ideal for connecting high-speed USB interface peripherals such as USB HDD, digital cameras, MP3 players, printers, modems and the like.

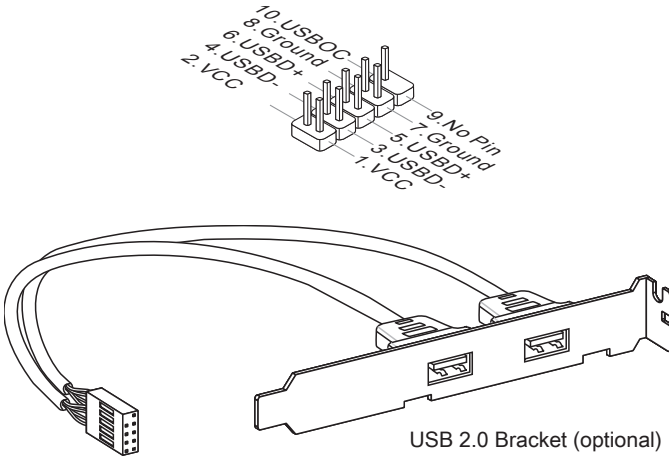

Important

Note that the pins of VCC and GND must be connected correctly to avoid possible damage.

Front Panel Audio Connector: JAUD1

This connector allows you to connect the front panel audio and is compliant with Intel® Front Panel I/O Connectivity Design Guide.

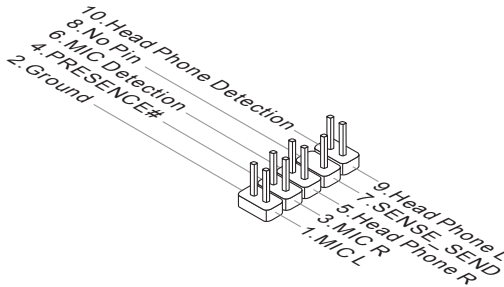

S/SPDIF-Out Connector: JSP1

This connector is used to connect S/SPDIF (Sony & Philips Digital Interconnect Format) interface for digital audio transmission.

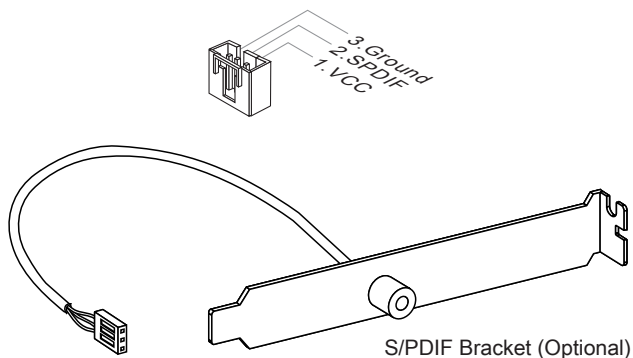

TPM Module connector: JTPM1 (optional)

This connector connects to a TPM (Trusted Platform Module) module (optional). Please refer to the TPM security platform manual for more details and usages.

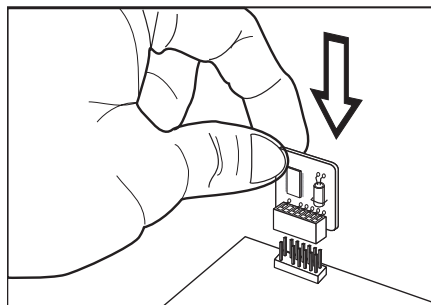
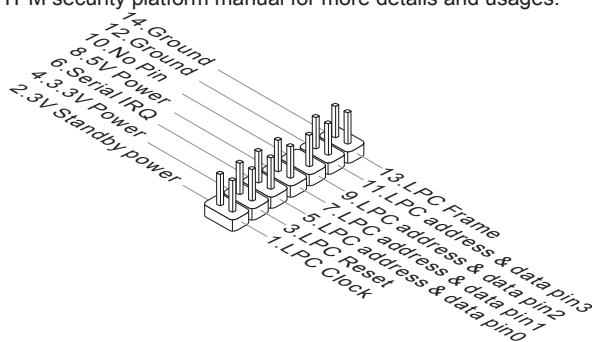

SWITCH

Overclock FSB Switch: OC_SW1

You can overclock the FSB to increase the processor frequency by changing the switch. Follow the instructions below to set the FSB.



Default



Increase 10%
speed of FSB



Increase 15%
speed of FSB



Increase 20%
speed of FSB

Important

- *Make sure that you power off the system before setting the switch.*
- *When overclocking cause system instability or crash during boot, please set the switch to default setting.*

JUMPERS

Clear CMOS Jumper: JBAT1

There is a CMOS RAM onboard that has a power supply from an external battery to keep the data of system configuration. With the CMOS RAM, the system can automatically boot OS every time it is turned on. If you want to clear the system configuration, set the jumper to clear data.



JBAT1



Keep Data



Clear Data

Important

You can clear CMOS by shorting 2-3 pin while the system is off. Then return to 1-2 pin position. Avoid clearing the CMOS while the system is on; it will damage the mainboard.

SLOTS

PCI (Peripheral Component Interconnect) Express Slot

The PCI Express slot supports the PCI Express interface expansion card.

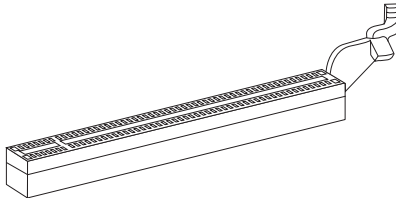

PCI Express x16 Slot

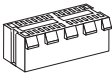

PCI Express x1 Slot

PCI (Peripheral Component Interconnect) Slot

The PCI slot supports LAN card, SCSI card, USB card, and other add-on cards that comply with PCI specifications.

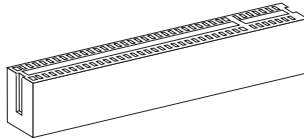

32-bit PCI Slot

Important

When adding or removing expansion cards, make sure that you unplug the power supply first. Meanwhile, read the documentation for the expansion card to configure any necessary hardware or software settings for the expansion card, such as jumpers, switches or BIOS configuration.

PCI Interrupt Request Routing

The IRQ, acronym of interrupt request line and pronounced I-R-Q, are hardware lines over which devices can send interrupt signals to the microprocessor. The PCI IRQ pins are typically connected to the PCI bus pins as follows:

| | Order1 | Order2 | Order3 | Order4 |
|-----------|--------|--------|--------|--------|
| PCI Slot1 | INT E# | INT F# | INT G# | INT H# |
| PCI Slot2 | INT F# | INT G# | INT H# | INT E# |

LED STATUS INDICATORS

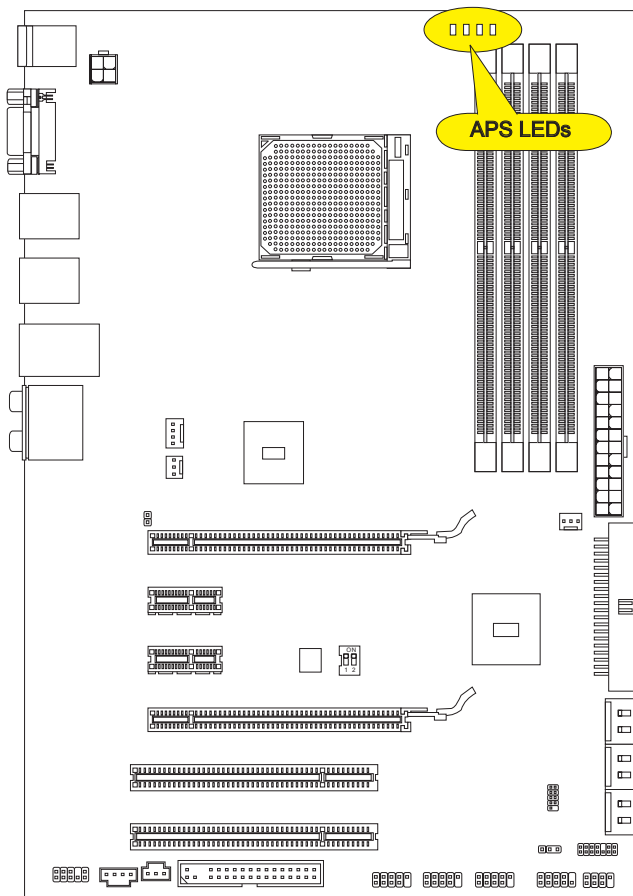

APS LEDs

These APS (Active Phase Switching) LEDs indicate the current CPU power phase mode. Follow the instructions below to read.

■ : ON, □ : OFF

■ ■ ■ ■ 4 of the LEDs will light blue when CPU is in 4 phase power mode.

■ □ □ □ 1 of the LEDs will light blue when CPU is in 1 phase power mode.

Chapter 3

BIOS Setup

This chapter provides information on the BIOS Setup program and allows you to configure the system for optimum use.

You may need to run the Setup program when:

- An error message appears on the screen during the system booting up, and requests you to run SETUP.
- You want to change the default settings for customized features.

ENTERING SETUP

Power on the computer and the system will start POST (Power On Self Test) process. When the message below appears on the screen, press key to enter Setup.

Press DEL to enter SETUP

If the message disappears before you respond and you still wish to enter Setup, restart the system by turning it OFF and On or pressing the RESET button. You may also restart the system by simultaneously pressing <Ctrl>, <Alt>, and <Delete> keys.

Important

- *The items under each BIOS category described in this chapter are under continuous update for better system performance. Therefore, the description may be slightly different from the latest BIOS and should be held for reference only.*
- *Upon boot-up, the 1st line appearing after the memory count is the BIOS version. It is usually in the format:*

A7388AMS V1.1 060909 where:

1st digit refers to BIOS maker as A = AMI, W = AWARD, and P = PHOENIX.

2nd - 5th digit refers to the model number.

6th digit refers to the chipset as I = Intel, N = NVIDIA, A = AMD and V = VIA.

7th - 8th digit refers to the customer as MS = all standard customers.

V1.1 refers to the BIOS version.

060909 refers to the date this BIOS was released.

Control Keys

| | |
|---------|-------------------------------------------------------------------|
| <↑> | Move to the previous item |
| <↓> | Move to the next item |
| <←> | Move to the item in the left hand |
| <→> | Move to the item in the right hand |
| <Enter> | Select the item |
| <Esc> | Jumps to the Exit menu or returns to the main menu from a submenu |
| <+ /PU> | Increase the numeric value or make changes |
| <- /PD> | Decrease the numeric value or make changes |
| <F1> | General Help |
| <F6> | Load Optimized Defaults |
| <F8> | Load Fail-Safe Defaults |
| <F10> | Save all the CMOS changes and exit |

Getting Help

After entering the Setup menu, the first menu you will see is the Main Menu.

Main Menu

The main menu lists the setup functions you can make changes to. You can use the arrow keys (↑ ↓) to select the item. The on-line description of the highlighted setup function is displayed at the bottom of the screen.

Sub-Menu

If you find a right pointer symbol (as shown in the right view) appears to the left of certain fields that means a sub-menu can be launched from this field. A sub-menu contains additional options for a field parameter. You can use arrow keys (↑ ↓) to highlight the field and press <Enter> to call up the sub-menu. Then you can use the control keys to enter values and move from field to field within a sub-menu. If you want to return to the main menu, just press the <Esc >.



```

▶ SATA1
▶ SATA2
▶ SATA3
▶ SATA4

```

General Help <F1>

The BIOS setup program provides a General Help screen. You can call up this screen from any menu by simply pressing <F1>. The Help screen lists the appropriate keys to use and the possible selections for the highlighted item. Press <Esc> to exit the Help screen.

THE MAIN MENU

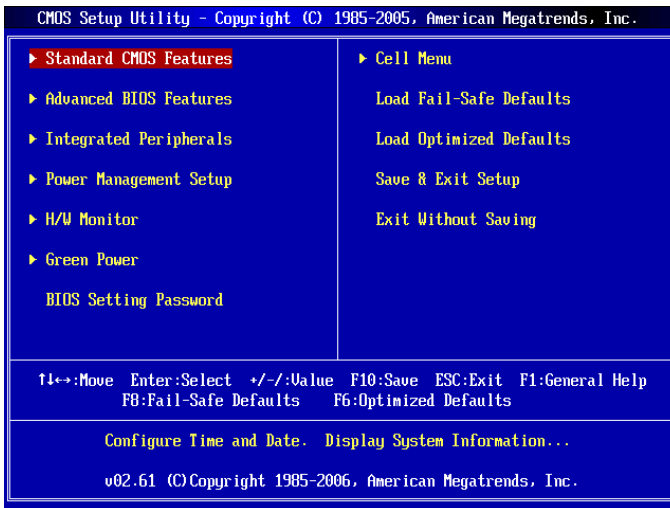

▶ **Standard CMOS Features**

Use this menu for basic system configurations, such as time, date etc.

▶ **Advanced BIOS Features**

Use this menu to setup the items of the BIOS special enhanced features.

▶ **Integrated Peripherals**

Use this menu to specify your settings for integrated peripherals.

▶ **Power Management Setup**

Use this menu to specify your settings for power management.

▶ **H/W Monitor**

This entry shows your PC health status.

▶ **Green Power**

Use this menu to specify the power phase.

▶ **BIOS Setting Password**

Use this menu to set the password for BIOS.

▶ **Cell Menu**

Use this menu to specify your settings for frequency/voltage control and overclocking.

▶ **Load Fail-Safe Defaults**

Use this menu to load the default values set by the BIOS vendor for stable system performance.

► Load Optimized Defaults

Use this menu to load the default values set by the mainboard manufacturer specifically for optimal performance of the mainboard.

► Save & Exit Setup

Save changes to CMOS and exit setup.

► Exit Without Saving

Abandon all changes and exit setup.

STANDARD CMOS FEATURES

The items in Standard CMOS Features Menu include some basic setup items. Use the arrow keys to highlight the item and then use the <PgUp> or <PgDn> keys to select the value you want in each item.

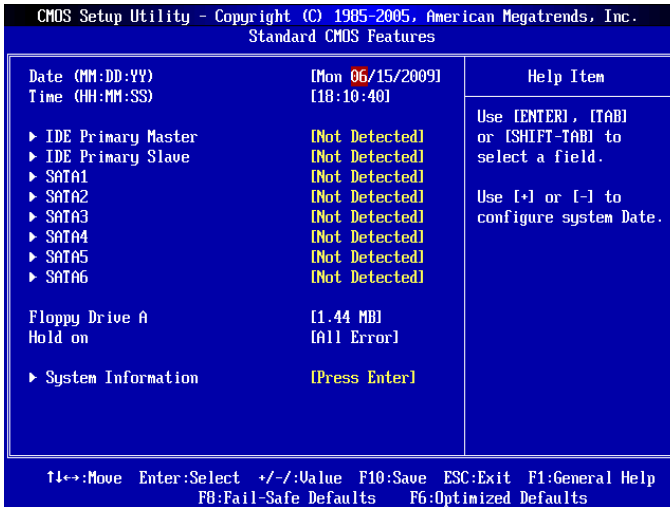

▶ Date (MM:DD:YY)

This allows you to set the system to the date that you want (usually the current date). The format is <day><month> <date> <year>.

[day] Day of the week, from Sun to Sat, determined by BIOS. Read-only.

[month] The month from Jan. through Dec.

[date] The date from 1 to 31 can be keyed by numeric function keys.

[year] The year can be adjusted by users.

▶ Time (HH:MM:SS)

This allows you to set the system time that you want (usually the current time). The time format is <hour> <minute> <second>.

► IDE Primary Master/ Slave & SATA1~6

Press <Enter> to enter the sub-menu, and the following screen appears.

| CMOS Setup Utility - Copyright (C) 1985-2005, American Megatrends, Inc. | |
|-------------------------------------------------------------------------|-----------------------------------------------------------------------------------------------------------------------------------|
| SATA4 | |
| SATA4 | Help Item |
| Device :Hard Disk | Disabled: Disables LBA Mode. Auto: Enables LBA Mode if the device supports it and the device is not already formatted with LBA |
| Vendor :Maxtor 6Y080M0 | |
| Size :81GB | |
| LBA/Large Mode [Auto] | |
| DMA Mode [Auto] | |
| Hard Disk S.M.A.R.T. [Auto] | |

► Device / Vendor / Size

It will show the device information that you connected to the SATA connector.

► LBA/Large Mode

This allows you to enable or disable the LBA Mode. Setting to Auto enables LBA mode if the device supports it and the devices is not already formatted with LBA mode disabled.

► DMA Mode

Select DMA Mode.

► Hard Disk S.M.A.R.T.

This allows you to activate the S.M.A.R.T. (Self-Monitoring Analysis & Reporting Technology) capability for the hard disks. S.M.A.R.T is a utility that monitors your disk status to predict hard disk failure. This gives you an opportunity to move data from a hard disk that is going to fail to a safe place before the hard disk becomes offline.

Important

IDE Primary Master/ Slave, SATA 1~6 are appearing when you connect the HD devices to the IDE/ SATA/ E-SATA connectors on the mainboard.

► Floppy Drive A

This item allows you to set the type of floppy drives installed.

► Halt On

The setting determines whether the system will stop if an error is detected at boot. When the system stops for the errors preset, it will halt on for 15 seconds and then automatically resume its operation. Available options are:

- | | |
|--------------|-------------------------------------------------|
| [All Errors] | The system stops when any error is detected. |
| [No Errors] | The system doesn't stop for any detected error. |

BIOS Setup

► System Information

Press <Enter> to enter the sub-menu, and the following screen appears.

| CMOS Setup Utility - Copyright (C) 1985-2005, American Megatrends, Inc. | |
|-------------------------------------------------------------------------|---------------------|
| System Information | |
| | Help Item |
| CPUID/MicroCode | 0F23/095 |
| CPU Frequency | 25.50GHz (5122x4.5) |
| BIOS Version | 02.0B3 06092009 |
| Physical Memory | 1024MB |
| Cache Size | 0KB |
| L3 Cache Size | 0KB |

This sub-menu shows the CPU information, BIOS version and memory status of your system (read only).

ADVANCED BIOS FEATURES

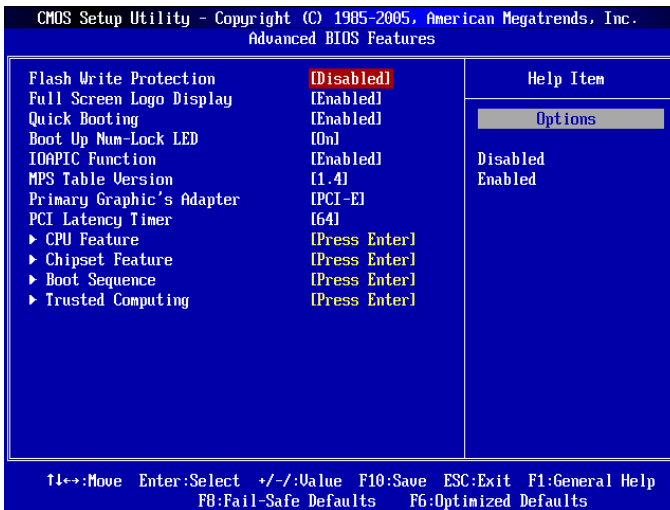

▶ Flash Write Protection

This function protects the BIOS from accidental corruption by unauthorized users or computer viruses. When enabled, the BIOS data cannot be changed when attempting to update the BIOS with a Flash utility. To successfully update the BIOS, you will need to disable this Flash BIOS Protection function. You should enable this function at all times. The only time when you need to disable it is when you want to update the BIOS. After updating the BIOS, you should immediately re-enable it to protect it against viruses.

▶ Full Screen Logo Display

This item enables this system to show the company logo on the boot-up screen. Settings are:

- [Enabled] Shows a still image (logo) on the full screen at boot.
- [Disabled] Shows the POST messages at boot.

▶ Quick Booting

Setting the item to [Enabled] allows the system to boot within 10 seconds since it will skip some check items.

▶ Boot Up Num-Lock LED

This setting is to set the Num Lock status when the system is powered on. Setting to [On] will turn on the Num Lock key when the system is powered on. Setting to [Off] will allow users to use the arrow keys on the numeric keypad.

▶ IOAPIC Function

This field is used to enable or disable the APIC (Advanced Programmable Interrupt Controller). Due to compliance with PC2001 design guide, the system is able to run in APIC mode. Enabling APIC mode will expand available IRQ resources for the system.

► MPS Table Version

This field allows you to select which MPS (Multi-Processor Specification) version to be used for the operating system. You need to select the MPS version supported by your operating system. To find out which version to use, consult the vendor of your operating system.

► Primary Graphic's Adapter

This setting specifies which graphic card is your primary graphics adapter.

► PCI Latency Timer

This item controls how long each PCI device can hold the bus before another takes over. When set to higher values, every PCI device can conduct transactions for a longer time and thus improve the effective PCI bandwidth. For better PCI performance, you should set the item to higher values.

► CPU Feature

Press <Enter> to enter the sub-menu and the following screen appears:

| CMOS Setup Utility - Copyright (C) 1985-2005, American Megatrends, Inc. | | |
|-------------------------------------------------------------------------|-----------|-----------|
| CPU Feature | | |
| SVM Support | [Enabled] | Help Item |

► SVM Support

This item is used to enable/ disable SVM.

► Chipset Feature

Press <Enter> to enter the sub-menu and the following screen appears:

| CMOS Setup Utility - Copyright (C) 1985-2005, American Megatrends, Inc. | | |
|-------------------------------------------------------------------------|------------|-----------|
| Chipset Feature | | |
| HPET | [Disabled] | Help Item |

► HPET

The HPET (High Precision Event Timers) is a component that is part of the chipset. You can to enable it, and will provide you with the means to get to it via the various ACPI methods.

► Boot Sequence

Press <Enter> to enter the sub-menu and the following screen appears:

| CMOS Setup Utility - Copyright (C) 1985-2005, American Megatrends, Inc. | | |
|-------------------------------------------------------------------------|------------------|--------------------------------------|
| Boot Sequence | | |
| 1st Boot Device | [1st FLOPPY DRI] | Help Item |
| 2nd Boot Device | [USB:Kingston D] | |
| Boot From Other Device | [Yes] | Specifies the boot sequence from the |

► 1st/ 2nd Boot Device

This item allows you to set the first/ second boot device where BIOS attempts to load the disk operating system.

► **Boot From Other Device**

Setting the option to [Yes] allows the system to try to boot from other device, if the system fails to boot from 1st boot device.

► **Trusted Computing**

Press <Enter> to enter the sub-menu and the following screen appears:



► **TCG/TPM SUPPORT**

Setting the option to [Yes] enables TPM (Trusted Platform Module) to the system.

► **Clearing the TPM**

Press Enter to clear the TPM status.

INTEGRATED PERIPHERALS

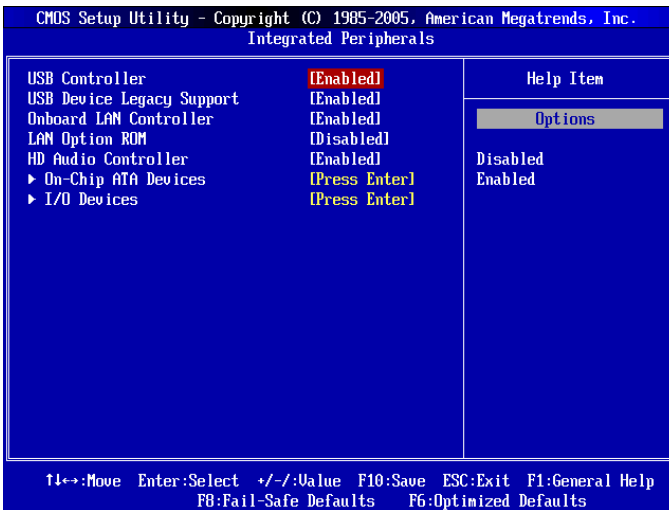

▶ USB Controller

This setting allows you to enable/disable the onboard USB 1.1/ 2.0 controller.

▶ USB Device Legacy Support

Select [Enabled] if you need to use a USB-interfaced device in the operating system.

▶ Onboard LAN Controller

This setting allows you to enable/disable the onboard LAN controller.

▶ LAN Option ROM

This item is used to decide whether to invoke the Boot ROM of the onboard LAN.

▶ HD Audio Controller

This setting is used to enable/disable the onboard audio controller.

▶ On-Chip ATA Devices

Press <Enter> to enter the sub-menu and the following screen appears:



▶ PCI IDE BusMaster

This item allows you to enable/ disable BIOS to used PCI busmastering for reading/ writing to IDE drives.

► **OnChip SATA Controller**

This item allows users to enable or disable the SATA controller.

► **RAID Mode**

This item is used to select mode for SATA connectors.

► **I/O Devices**

Press <Enter> to enter the sub-menu and the following screen appears:



► **COM Port 1**

Select an address and corresponding interrupt for the serial port.

POWER MANAGEMENT SETUP

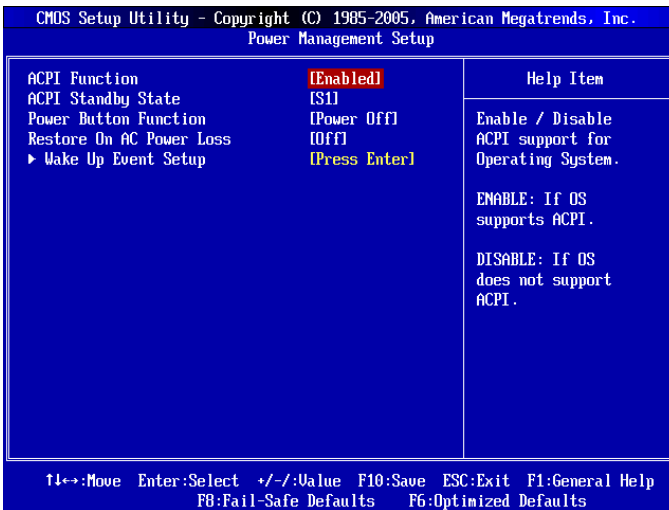

Important

S3-related functions described in this section are available only when the BIOS supports S3 sleep mode.

▶ ACPI Function

This item is to activate the ACPI (Advanced Configuration and Power Management Interface) Function. If your operating system is ACPI-aware, such as Windows 98SE/2000/ ME/ XP, select [Enabled].

▶ ACPI Standby State

This item specifies the power saving modes for ACPI function. If your operating system supports ACPI, such as Windows 2000/ XP, you can choose to enter the Standby mode in S1(POS) or S3(STR) fashion through the setting of this field. Settings are:

- [S1] The S1 sleep mode is a low power state. In this state, no system context is lost (CPU or chipset) and hardware maintains all system's context.
- [S3] The S3 sleep mode is a lower power state where the information of system configuration and open applications/files is saved to main memory that remains powered while most other hardware components turn off to save energy. The information stored in memory will be used to restore the system when a "wake up" event occurs.

► Power Button Function

This feature sets the function of the power button. Settings are:

- [Power Off] The power button functions as normal power off button.
- [Suspend] When you press the power button, the computer enters suspend/sleep mode, but if the button is pressed for more than four seconds, the computer is turned off.

► Restore On AC Power Loss

This item specifies whether your system will reboot after a power failure or interrupt occurs. Settings are:

- [Off] Always leaves the computer in the power off state.
- [On] Always leaves the computer in the power on state.
- [Last State] Restore the system to the status before power failure or interrupt occurred.

► Wake Up Event Setup

Press <Enter> and the following sub-menu appears.



► Wake Up Event By

Setting to [BIOS] activates the following fields, and use the following fields to set the wake up events. Setting to [OS], the wake up events will be defined by OS.

► Resume From S3 By USB Device

The item allows the activity of the USB device to wake up the system from S3 (Suspend to RAM) sleep state.

► Resume From S3 By PS/2 Keyboard/ Mouse

This setting determines whether the system will be awakened from what power saving modes when input signal of the PS/2 keyboard/ mouse is detected.

► Resume By PCI Device (PME#)

When set to [Enabled], the feature allows your system to be awakened from the power saving modes through any event on PME (Power Management Event).

► Resume By PCI-E Device

When set to [Enabled], the feature allows your system to be awakened from the power saving modes through any event on PCIE device.

► Resume By RTC Alarm

The field is used to enable or disable the feature of booting up the system on a scheduled time/date.

H/W MONITOR

| CMOS Setup Utility - Copyright (C) 1985-2005, American Megatrends, Inc. | | |
|-------------------------------------------------------------------------------------------------------------------|-------------------|------------------------|
| H/W Monitor | | |
| Chassis Intrusion | [Disabled] | Help Item |
| CPU Smart FAN Target | Disabled | Chassis Intrusion func |
| ----- PC Health Status ----- | | |
| CPU Temperature | 55°C/131°F | |
| System Temperature | 34°C/93°F | |
| CPU FAN Speed | 3325 RPM | |
| SYS FAN 1 Speed | 0 RPM | |
| PWR FAN 1 Speed | 0 RPM | |
| CPU Vcore | 1.216 V | |
| 3.3V | 3.328 V | |
| 5V | 4.970 V | |
| 12V | 12.056 V | |
| ↑↓←→:Move Enter:Select +/-:Value F10:Save ESC:Exit F1:General Help F8:Fail-Safe Defaults F6:Optimized Defaults | | |

► Chassis Intrusion

The field enables or disables the feature of recording the chassis intrusion status and issuing a warning message if the chassis is once opened. To clear the warning message, set the field to [Reset]. The setting of the field will automatically return to [Enabled] later.

► CPU Smart FAN Target

The mainboard provides the Smart Fan function which can control the CPU fan speed automatically depending on the current temperature to keep it with in a specific range. You can enable a fan target value here. If the current CPU fan temperature reaches to the target value, the smart fan function will be activated. It provides several sections to speed up for cooling down automatically.

► PC Health Status

- CPU/ System Temperature, CPU FAN/ SYS FAN 1/ PWR FAN 1 Speed, CPU Vcore, 3.3V, 5V, 12V

These items display the current status of all of the monitored hardware devices/components such as CPU voltage, temperatures and all fans' speeds.

GREEN POWER

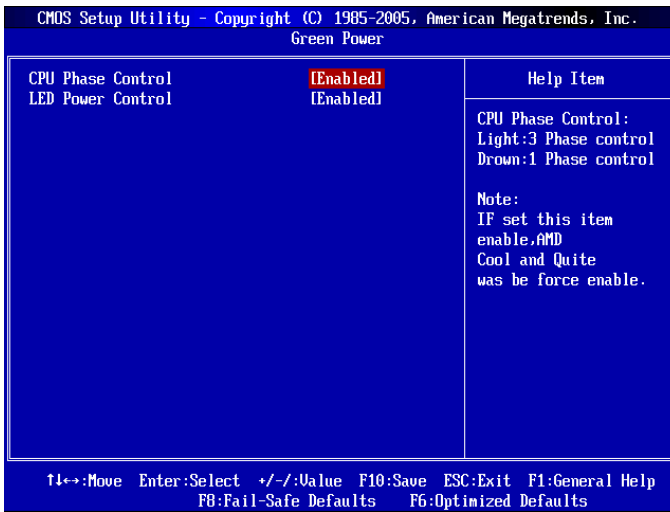

► CPU Phase Control

When set to [Enabled], the hardware will auto adjust the CPU power phase according to the loading of CPU to reach the best power saving function.

► LED Power Control

This item is used to control the power phase LEDs of the motherboard.

BIOS SETTING PASSWORD

When you select this function, a message as below will appear on the screen:

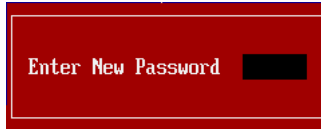

Type the password, up to six characters in length, and press <Enter>. The password typed now will replace any previously set password from CMOS memory. You will be prompted to confirm the password. Retype the password and press <Enter>. You may also press <Esc> to abort the selection and not enter a password.

To clear a set password, just press <Enter> when you are prompted to enter the password. A message will show up confirming the password will be disabled. Once the password is disabled, the system will boot and you can enter Setup without entering any password.

When a password has been set, you will be prompted to enter it every time you try to enter Setup. This prevents an unauthorized person from changing any part of your system configuration.

CELL MENU

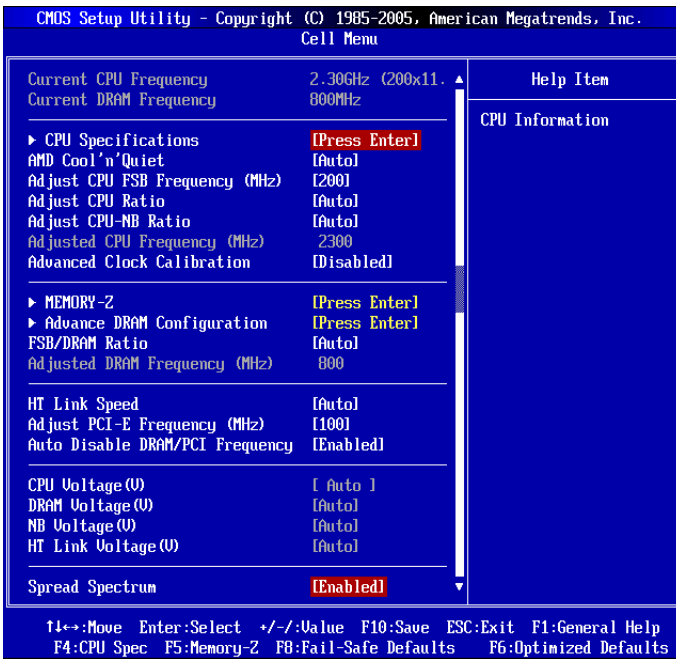

Important

Change these settings only if you are familiar with the chipset.

▶ Current CPU / DRAM Frequency

These items show the current clocks of CPU and Memory speed. Read-only.

▶ CPU Specifications

Press <Enter> to enter the sub-menu and the following screen appears. This submenu shows the information of installed CPU.

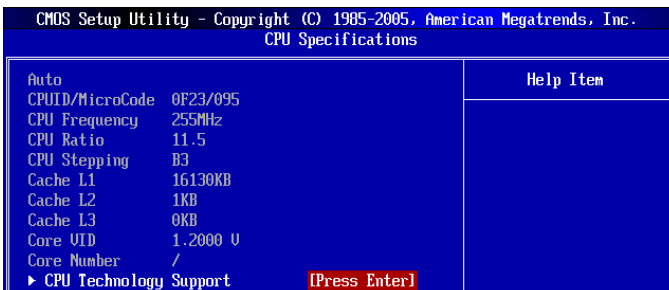

► CPU Technology Support

Press <Enter> to enter the sub-menu and the following screen appears. This sub-menu shows the technologies that the installed CPU supported.

| CMOS Setup Utility - Copyright (C) 1985-2005, American Megatrends, Inc. | | |
|-------------------------------------------------------------------------|-----|-----------|
| CPU Technology Support | | |
| | | Help Item |
| MMX (TM) | YES | |
| SSE Extensions | YES | |
| SSE2 Extensions | YES | |
| SSE3 Extensions | YES | |
| SSE4 Extensions | N/A | |
| SSE5 Extensions | N/A | |
| Page Size Extension (PSE) | YES | |
| Page Attribute Table (PAT) | YES | |
| 3D-NOW | YES | |
| SUM | YES | |

► AMD Cool'n'Quiet

The Cool'n'Quiet technology can effectively and dynamically lower CPU speed and power consumption.

Important

To ensure that Cool'n'Quiet function is activated and will be working properly, it is required to double confirm that:

- Run BIOS Setup, and select Cell Menu. Under Cell Menu, find AMD Cool'n'Quiet, and set this item to "Enabled".
- Enter Windows, and select [Start]->[Settings]->[Control Panel]->[Power Options]. Enter Power Options Properties tag, and select Minimal Power Management under Power schemes.

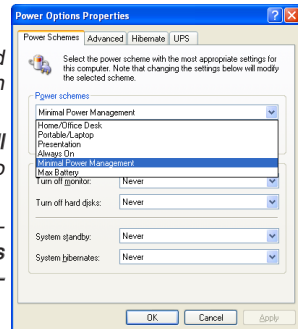

► Adjust CPU FSB Frequency (MHz)

This item allows you to select the CPU Front Side Bus clock frequency (in MHz).

► Adjust CPU Ratio

This item is used to adjust CPU clock multiplier (ratio). It is available only when the processor supports this function.

► Adjust CPU-NB Ratio

This item is used to adjust CPU-NB ratio.

► Adjusted CPU Frequency (MHz)

It shows the adjusted CPU frequency. Read-only.

► Advanced Clock Calibration

This item is for overclock. Setting to [Enabled] allows you to set the CPU Ratio higher. It is available only when the processor supports this function.

► Memory-Z

Press <Enter> to enter the sub-menu and the following screen appears.

| CMOS Setup Utility - Copyright (C) 1985-2005, American Megatrends, Inc. | |
|-------------------------------------------------------------------------|---------------|
| MEMORY-Z | |
| ► DIMM2 Memory SPD Information | [Press Enter] |
| | Help Item |

► DIMM1~4 Memory SPD Information

Press <Enter> to enter the sub-menu and the following screen appears. This sub-menu displays the information of installed memory.

| CMOS Setup Utility - Copyright (C) 1985-2005, American Megatrends, Inc. | |
|-------------------------------------------------------------------------|-----------|
| DIMM4 Memory SPD Information | |
| DIMM4 Memory SPD Information | Help Item |
| Memory Type: DDR2 SDRAM | |
| Manufacture: Nanya | |
| Part Number: NT1GT64UBHA1BY-3C | |
| Serial Number: A24B754 | |
| Memory CAS Latency Support:5 | |
| SDRAM CYCLE TIME:3.0ns | |
| MEMORY TRCD: 15.0ns (5CLK) | |
| MEMORY TRP: 15.0ns (5CLK) | |
| MEMORY TRAS: 45ns (15CLK) | |
| MEMORY TRFC: 60.0ns (20CLK) | |
| MEMORY TUR: 15.0ns (5CLK) | |
| MEMORY TWR: 7.50ns (2CLK) | |
| MEMORY TRRD: 7.50ns (2CLK) | |
| MEMORY TRTP: 7.50ns (2CLK) | |

► Advance DRAM Configuration

Press <Enter> to enter the sub-menu and the following screen appears.

| CMOS Setup Utility - Copyright (C) 1985-2005, American Megatrends, Inc. | |
|-------------------------------------------------------------------------|----------------------------------------------------------------------------------------------------------------------------------------------------------------------------------------------------------------------------------------------------------------------------------------------|
| Advance DRAM Configuration | |
| DRAM Timing Mode | [DCT 0] |
| CAS Latency (CL) | [Auto] |
| tRCD | [Auto] |
| tRP | [Auto] |
| tRAS | [Auto] |
| tRTP | [Auto] |
| tRC | [Auto] |
| tUR | [Auto] |
| tRRD | [Auto] |
| tWR | [Auto] |
| tRFC0 | [Auto] |
| tRFC1 | [Auto] |
| tRFC2 | [Auto] |
| tRFC3 | [Auto] |
| 1T/2T Memory Timing | [2T] |
| DCT Unganged Mode | [Enabled] |
| | Help Item |
| | When you change this item to Auto, system will read the data inside SPD "Serial Presence Detect" and run suitable memory timing setting. If you change this item to Both or others, then you can setup special memory timing. Normally you can see numbers 3-3-3-10 at sticker of module and |

► DRAM Timing Mode

This field has the capacity to automatically detect all of the DRAM timing. If you set

this field to [DCT 0], [DCT 1] or [Both], some fields will appear and selectable. DCT 0 controls channel A and DCT1 controls channel B.

▶ CAS Latency (CL)

When the DRAM Timing Mode sets to [DCT 0], [DCT1] or [Both], the field is adjustable. This controls the CAS latency, which determines the timing delay (in clock cycles) before SDRAM starts a read command after receiving it.

▶ tRCD

When the DRAM Timing Mode sets to [DCT 0], [DCT1] or [Both], the field is adjustable. When DRAM is refreshed, both rows and columns are addressed separately. This setup item allows you to determine the timing of the transition from RAS (row address strobe) to CAS (column address strobe). The less the clock cycles, the faster the DRAM performance.

▶ tRP

When the DRAM Timing Mode sets to [DCT 0], [DCT1] or [Both], the field is adjustable. This setting controls the number of cycles for Row Address Strobe (RAS) to be allowed to precharge. If insufficient time is allowed for the RAS to accumulate its charge before DRAM refresh may be incomplete and DRAM may fail to retain data. This item applies only when synchronous DRAM is installed in the system.

▶ tRAS

When the DRAM Timing Mode sets to [DCT 0], [DCT1] or [Both], the field is adjustable. This setting determines the time RAS takes to read from and write to a memory cell.

▶ tRTP

When the DRAM Timing Mode sets to [DCT 0], [DCT1] or [Both], the field is adjustable. This setting controls the time interval between a read and a precharge command.

▶ tRC

When the DRAM Timing Mode sets to [DCT 0], [DCT1] or [Both], the field is adjustable. The row cycle time determines the minimum number of clock cycles a memory row takes to complete a full cycle, from row activation up to the precharging of the active row.

▶ tWR

When the DRAM Timing Mode sets to [DCT 0], [DCT1] or [Both], the field is adjustable. It specifies the amount of delay (in clock cycles) that must elapse after the completion of a valid write operation, before an active bank can be precharged. This delay is required to guarantee that data in the write buffers can be written to the memory cells before precharge occurs.

▶ tRRD

When the DRAM Timing Mode sets to [DCT 0], [DCT1] or [Both], the field is adjustable. Specifies the active-to-active delay of different banks.

▶ tWTR

When the DRAM Timing Mode sets to [DCT 0], [DCT1] or [Both], the field is adjustable. This item controls the Write Data In to Read Command Delay memory timing. This constitutes the minimum number of clock cycles that must occur between the last valid write operation and the next read command to the same internal bank of

the DDR device.

▶ **tRFC0~3**

When the DRAM Timing Mode sets to [DCT 0], [DCT1] or [Both], these fields are adjustable. These settings determine the time RFC take to read from and write to memory cells.

▶ **1T/2T Memory Timing**

When the DRAM Timing Mode sets to [DCT 0], [DCT1] or [Both], the field is adjustable. This field controls the SDRAM command rate. Selecting [1T] makes SDRAM signal controller to run at 1T (T=clock cycles) rate. Selecting [2T] makes SDRAM signal controller run at 2T rate.

▶ **DCT Unganged Mode**

This feature is used to Integrate two 64-bit DCTs into a 128-bit interface.

▶ **FSB/DRAM Ratio**

This item allows you to select the ratio of FSB/ DRAM.

▶ **Adjusted DRAM Frequency (MHz)**

It shows the adjusted Memory frequency. Read-only.

▶ **HT Link Speed**

This item allows you to set the Hyper-Transport Link speed. Setting to [Auto], the system will detect the HT link speed automatically.

▶ **Adjust PCI-E Frequency (MHz)**

This field allows you to select the PCIE frequency (in MHz).

▶ **Auto Disable DIMM/PCI Frequency**

When set to [Enabled], the system will remove (turn off) clocks from empty DRAM/ PCI slots to minimize the electromagnetic interference (EMI).

▶ **CPU Voltage (V)/ DRAM Voltage (V)/ NB Voltage (V)/ HT Link Voltage (V)**

These items are used to adjust the voltage of CPU, Memory and chipset.

▶ **Spread Spectrum**

When the mainboard's clock generator pulses, the extreme values (spikes) of the pulses create EMI (Electromagnetic Interference). The Spread Spectrum function reduces the EMI generated by modulating the pulses so that the spikes of the pulses are reduced to flatter curves. If you do not have any EMI problem, leave the setting at Disabled for optimal system stability and performance. But if you are plagued by EMI, set to Enabled for EMI reduction. Remember to disable Spread Spectrum if you are overclocking because even a slight jitter can introduce a temporary boost in clock speed which may just cause your overclocked processor to lock up.

Important

- *If you do not have any EMI problem, leave the setting at [Disabled] for optimal system stability and performance. But if you are plagued by EMI, select the value of Spread Spectrum for EMI reduction.*
- *The greater the Spread Spectrum value is, the greater the EMI is reduced, and the system will become less stable. For the most suitable Spread Spectrum value, please consult your local EMI regulation.*

- Remember to disable Spread Spectrum if you are overclocking because even a slight jitter can introduce a temporary boost in clock speed which may just cause your overclocked processor to lock up.

Important

Failed Overclocking Resolution

This motherboard supports overclocking greatly. However, please make sure your peripherals and components are bearable for some special settings. Any operation that exceeds product specification is not recommended. Any risk or damage resulting from improper operation will not be under our product warranty.

Two ways to save your system from failed overclocking...

- **Reboot**

Press the Power button to reboot the system three times. Please note that, to avoid electric current to affect other devices or components, we suggest an interval of more than 10 seconds among the reboot actions.

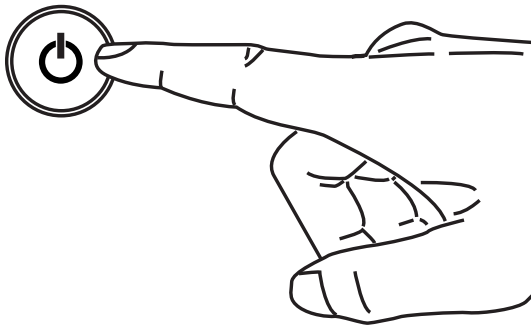

At the fourth reboot, BIOS will determine that the previous overclocking is failed and restore the default settings automatically. Please press any key to boot the system normally when the following message appears on screen.

Warning !!! The previous overclocking had failed,
and system will restore its defaults setting,
Press any key to continue.....

- **Clear CMOS**

Please refer to "Chapter 2" for more information about how to clear CMOS data.

LOAD FAIL-SAFE/ OPTIMIZED DEFAULTS

The two options on the main menu allow users to restore all of the BIOS settings to the default Fail-Safe or Optimized values. The Optimized Defaults are the default values set by the mainboard manufacturer specifically for optimal performance of the mainboard. The Fail-Safe Defaults are the default values set by the BIOS vendor for stable system performance.

When you select Load Fail-Safe Defaults, a message as below appears:



Selecting Ok and pressing Enter loads the BIOS default values for the most stable, minimal system performance.

When you select Load Optimized Defaults, a message as below appears:



Selecting Ok and pressing Enter loads the default factory settings for optimal system performance.

Appendix A

Realtek Audio

The Realtek audio provides 10-channel DAC that simultaneously supports 7.1 sound playback and 2 channels of independent stereo sound output (multiple streaming) through the Front-Out-Left and Front-Out-Right channels.

INSTALLING THE REALTEK HD AUDIO DRIVER

You need to install the HD audio driver for Realtek audio codec to function properly before you can get access to 2-, 4-, 6-, 8- channel or 7.1+2 channel audio operations. Follow the procedures described below to install the drivers for different operating systems.

Installation for Windows® XP

For Windows® XP, you must install Windows® XP Service Pack3 or later before installing the driver.

The following illustrations are based on Windows® XP environment and could look slightly different if you install the drivers in different operating systems.

1. Insert the application DVD into the DVD-ROM drive. The setup screen will automatically appear.
2. Click Realtek HD Audio Drivers button.



Important

The HD Audio Configuration software utility is under continuous update to enhance audio applications. Hence, the program screens shown here in this section may be slightly different from the latest software utility and shall be held for reference only.

3. Click Next to install the Realtek High Definition Audio Driver.

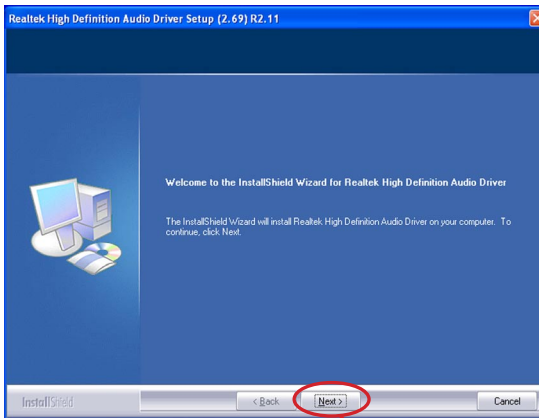

Click here

4. Click Finish to restart the system.

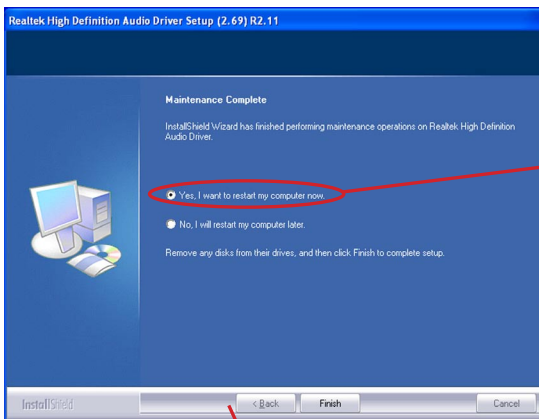

Select this option

Click here

SOFTWARE CONFIGURATION

After installing the audio driver, you are able to use the 2-, 4-, 6- or 8- channel audio feature now. Click the audio icon  from the system tray at the lower-right corner of the screen to activate the HD Audio Configuration. It is also available to enable the audio driver by clicking the **Realtek HD Audio Manager** from the Control Panel.

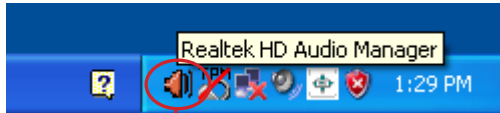

Double click

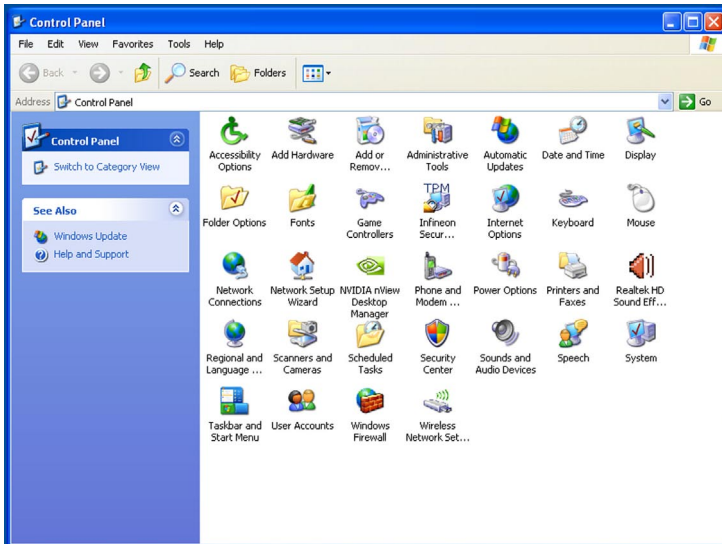

Sound Effect

Here you can select a sound effect you like from the **Environment** list.



Environment Simulation

You will be able to enjoy different sound experience by pulling down the arrow, totally 23 kinds of sound effect will be shown for selection. Realtek HD Audio Sound Manager also provides five popular settings “Stone Corridor”, “Bathroom”, “Sewer pipe”, “Arena” and “Auditorium” for quick enjoyment.

You may choose the provided sound effects, and the equalizer will adjust automatically. If you like, you may also load an equalizer setting or make an new equalizer setting to save as an new one by using the “Load EQ Setting” and “Save Preset” button, click “Reset EQ Setting” button to use the default value, or click “Delete EQ Setting” button to remove a preset EQ setting.

There are also other pre-set equalizer models for you to choose by clicking “Others” under the Equalizer part.

Equalizer Selection

Equalizer frees users from default settings; users may create their own preferred settings by utilizing this tool.

10 bands of equalizer, ranging from 100Hz to 16KHz.

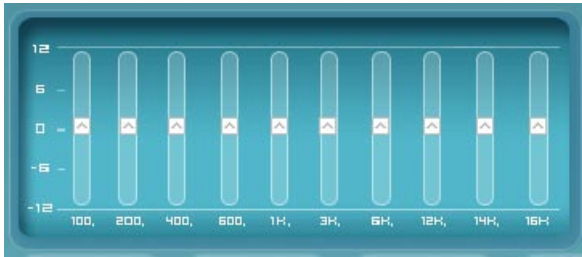

Save

The settings are saved permanently for future use

Reset

10 bands of equalizer would go back to the default setting

Enable / Disable

To disable, you can temporarily stop the sound effect without losing the settings

Load

Whenever you would like to use preload settings, simply click this, the whole list will be shown for your selection.

Delete

To delete the pre-saved settings which are created from previous steps.



Frequently Used Equalizer Setting

Realtek recognizes the needs that you might have. By leveraging our long experience at audio field, Realtek HD Audio Sound Manager provides you certain optimized equalizer settings that are frequently used for your quick enjoyment.

[How to Use It]

Other than the buttons “Pop”, “Live”, “Club” & “Rock” shown on the page, to pull down the arrow in “Others” you will find more optimized settings available to you.

Karaoke Mode

Karaoke mode brings Karaoke fun back home. Simply using the music you usually play, Karaoke mode can help you eliminate the vocal of the song or adjust the key to accommodate your range.

1. Vocal Cancellation: Single click on “Voice Cancellation” the vocal of the song would be eliminated, while the background music is still in place, and you can be that singer!
2. Key Adjustment: Using “Up / Down Arrow” to find a key which better fits your vocal range.

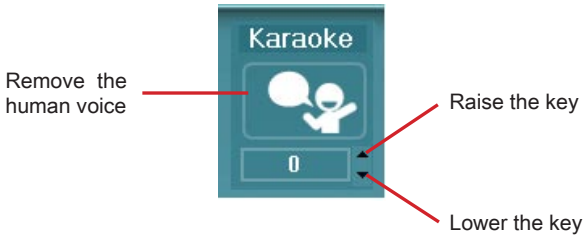

Mixer

In the Mixer part, you may adjust the volumes of the rear and front panels individually.

■ Adjust Volume

You can adjust the volume of the speakers that you plugged in front or rear panel by select the Realtek HD Audio rear output or Realtek HD Audio front output items.



Important

Before set up, please make sure the playback devices are well plugged in the jacks on the rear or front panel. The Realtek HD Audio front output item will appear after you plugging the speakers into the jacks on the front panel.

■ Multi-Stream Function

Realtek audio supports an outstanding feature called Multi-Stream, which means you may play different audio sources simultaneously and let them output respectively from the indicated rear panel or front panel. This feature is very helpful when 2 people are using the same computer together for different purposes.

Click the  button and the Mixer ToolBox menu will appear. Then check the Enable playback multi-streaming and click OK to save the setup.

Important

You have to plug audio device into the jacks on the rear and front panel first before enable the multi-stream function.

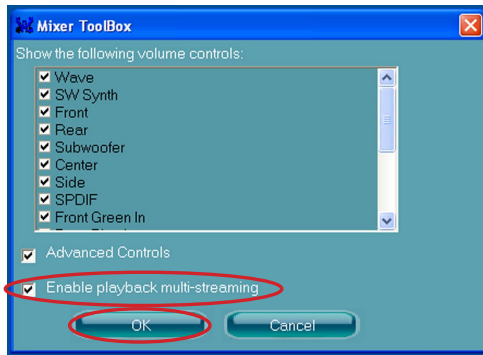

When you are playing the first audio source (for example: use Windows Media Player to play DVD/VCD), the output will be played from the rear panel, which is the default setting.

Then you must to select the **Realtek HD Audio 2nd output** from the scroll list first, and use a different program to play the second audio source (for example: use Winamp to play MP3 files). You will find that the second audio source (MP3 music) will come out from the Line-Out audio jack of Front Panel.



■ Playback control



Tool Mute

Playback device

This function is to let you freely decide which ports to output the sound. And this is essential when multi-streaming playback enabled.

- Realtek HD Audio Rear Output
- Realtek HD Audio Front Output

Mute

You may choose to mute single or multiple volume controls or to completely mute sound output.

Tool

- Show the following volume controls

This is to let you freely decide which volume control items to be displayed.

- Advanced controls
- Enable playback multi-streaming

With this function, you will be able to have an audio chat with your friends via headphone (stream 1 from front panel) while still have music (stream 2 from back panel) in play. At any given period, you can have maximum 2 streams operating simultaneously.



■ Recording control



Mute

You may choose to mute single or multiple volume controls or to completely mute sound input.

Tool

- Show the following volume controls

This is to let you freely decide which volume control items to be displayed.

- Enable recording multi-streaming

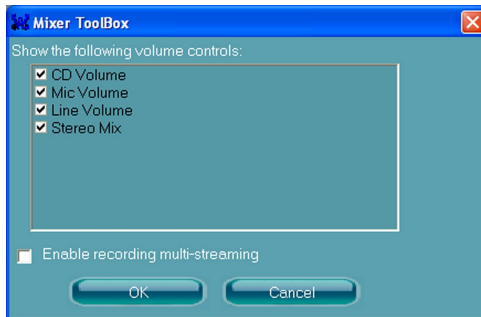

Important

Realtek audio allows you to record the CD, Line, Mic and Stereo Mix channels simultaneously, frees you from mixing efforts. At any given period, you may choose 1 of the following 4 channels to record.

Audio I/O

In this tab, you can easily configure your multi-channel audio function and speakers. You can choose a desired multi-channel operation here.

- **Headphone** for the common headphone
- **2CH Speaker** for Stereo-Speaker Output
- **4CH Speaker** for 4-Speaker Output
- **6CH Speaker** for 5.1-Speaker Output
- **8CH Speaker** for 7.1-Speaker Output

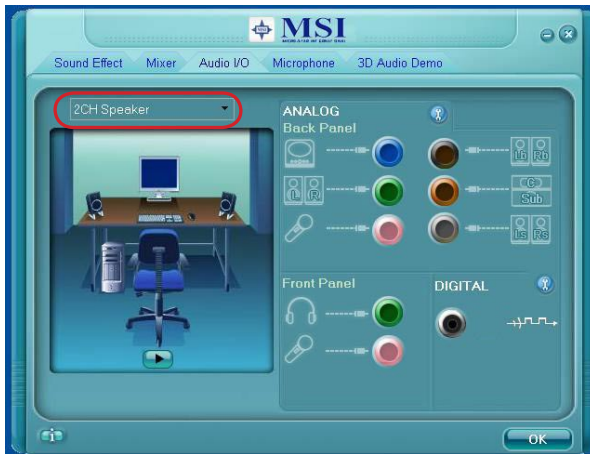

■ Speaker Configuration:

1. Plug the speakers in the corresponding jack.
2. Dialogue “connected device” will pop up for your selection. Please select the device you have plugged in.
 - If the device is being plugged into the correct jack, you will be able to find the icon beside the jack changed to the one that is same as your device.
 - If not correct, Realtek HD Audio Manager will guide you to plug the device into the correct jack.

■ Connector Settings

Click  to access connector settings.

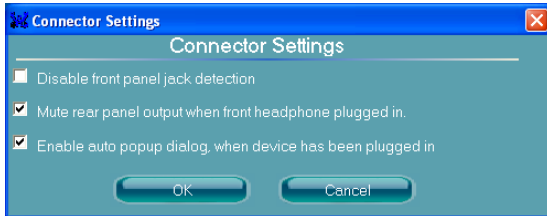

Disable front panel jack detection (optional)

Jack detection function only works with HD audio front panel. Please check if front jacks on your system are so-called AC'97 jacks. If so, please check this item to disable front panel jack detection.

Mute rear panel output when front headphone plugged in.

Enable auto popup dialogue, when device has been plugged in

Once this item checked, the dialog "Connected device" would automatically pop up when device plugged in.

S/PDIF

Short for Sony/Philips Digital Interface, a standard audio file transfer format. S/PDIF allows the transfer of digital audio signals from one device to another without having to be converted first to an analog format. Maintaining the viability of a digital signal prevents the quality of the signal from degrading when it is converted to analog.

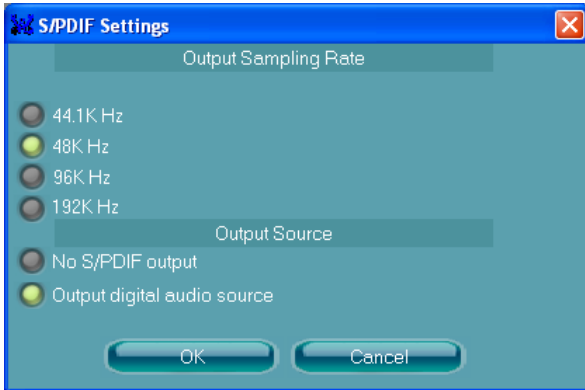

Output Sampling Rate

44.1KHz: This is recommend while playing CD.

48KHz: This is recommended while playing DVD or Dolby.

96KHz: This is recommended while playing DVD-Audio.

192KHz: This is recommended while playing High quality Audio.

Output Source

Output digital audio source: The digital audio format (such as .wav, .mp3,.midi etc) will come out through S/PDIF-Out.

S/PDIF-in to S/PDIF -out pass though mode: The data from S/PDIF-In can be real-time played from S/PDIF-Out.

Test Speakers

You can select the speaker by clicking it to test its functionality. The one you select will light up and make testing sound. If any speaker fails to make sound, then check whether the cable is inserted firmly to the connector or replace the bad speakers with good ones. Or you may click the **auto test**  button to test the sounds of each speaker automatically.

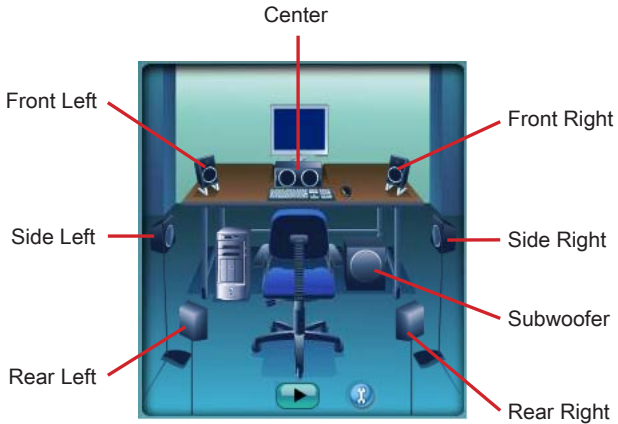

Microphone

In this tab you may set the function of the microphone. Select the **Noise Suppression** to remove the possible noise during recording, or select **Acoustic Echo Cancellation** to cancel the acoustic echo during recording.

Acoustic Echo Cancellation prevents playback sound from being recorded by microphone together with your sound. For example, you might have chance to use VOIP function through Internet with your friends. The voice of your friend will come out from speakers (playback). However, the voice of your friend might also be recorded into your microphone then go back to your friend through Internet. In that case, your friend will hear his/her own voice again. With AEC(Acoustic Echo Cancellation) enabled at your side, your friend can enjoy the benefit with less echo.



3D Audio Demo

In this tab you may adjust your 3D positional audio before playing 3D audio applications like gaming. You may also select different environment to choose the most suitable environment you like.



Information

In this tab it provides some information about this HD Audio Configuration utility, including Audio Driver Version, DirectX Version, Audio Controller & Audio Codec. You may also select the language of this utility by choosing from the **Language** list.

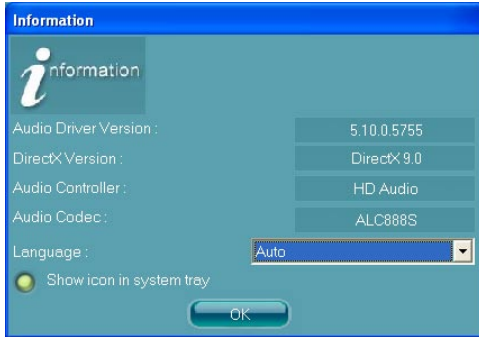

Also there is a selection **Show icon in system tray**. Switch it on and an icon  will show in the system tray. Right-click on the icon and the **Audio Accessories** dialogue box will appear which provides several multimedia features for you to take advantage of.



HARDWARE SETUP

Connecting the Speakers

When you have set the Multi-Channel Audio Function mode properly in the software utility, connect your speakers to the correct phone jacks in accordance with the setting in software utility.

- 2-Channel Mode for Stereo-Speaker Output

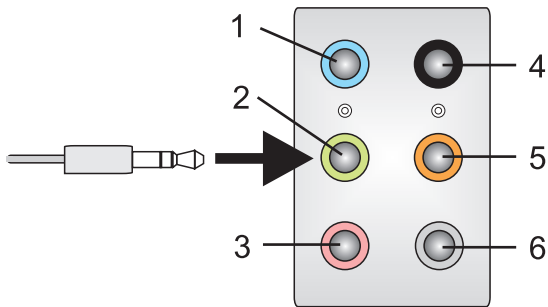

- 1] Line In
- 2] Line Out (Front channels)
- 3] MIC
- 4] No function
- 5] No function
- 6] No function

■ 4-Channel Mode for Stereo-Speaker Output

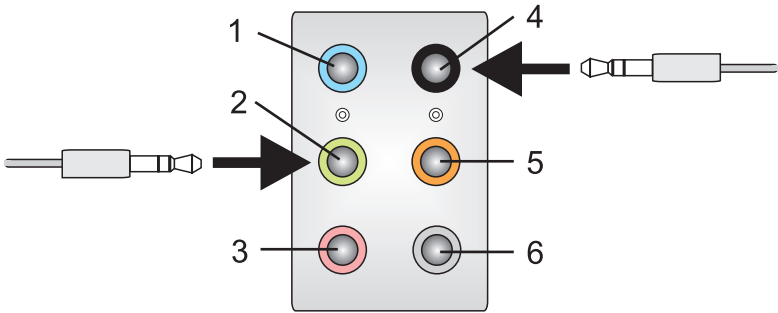

- 1] Line In
- 2] Line Out (Front channels)
- 3] MIC
- 4] Line Out (Rear channels)
- 5] No function
- 6] No function

■ 6-Channel Mode for Stereo-Speaker Output

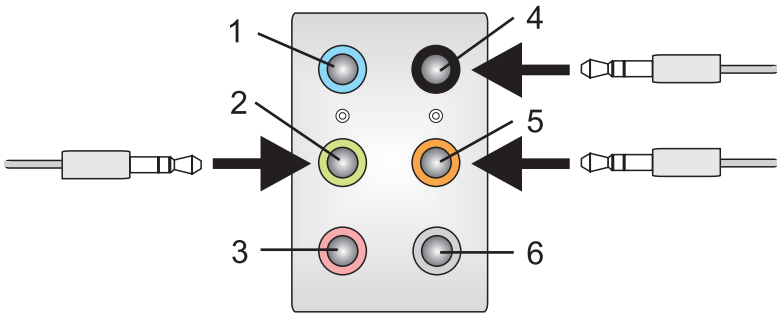

- 1] Line In
- 2] Line Out (Front channels)
- 3] MIC
- 4] Line Out (Rear channels)
- 5] Line Out (Center and Subwoofer channel)
- 6] No function

■ 8-Channel Mode for Stereo-Speaker Output

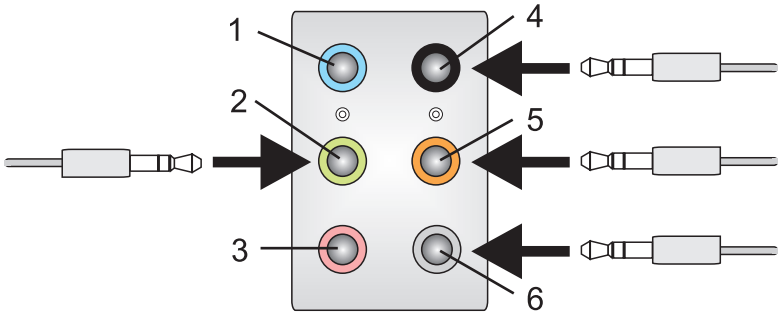

- 1] Line In
- 2] Line Out (Front channels)
- 3] MIC
- 4] Line Out (Rear channels)
- 5] Line Out (Center and Subwoofer channel)
- 6] Line Out (Side channels)

Important

To enable 7.1 channel audio-out function on Vista operating system, you have to install the Realtek Audio Driver. Or, the mainboard will support 5.1 channel audio-out only.

Appendix B

SB710 RAID

The integrate one SATA host controller separately, and support RAID function for performance and reliability.

SB710 SATA RAID (SATA1~6) provides support for RAID 0 (Striping), RAID 1 (Mirroring) & RAID 10 (Striping & Mirroring). RAID 0 greatly improves hard disk I/O performance by concurrently striping data across multiple drives. RAID 1 makes sure data is not lost if a drive fails as data is simultaneously written to two drives. Drives configured for RAID Striping are said to form a RAID 0 set, while drives configured for RAID Mirroring are said to form a RAID 1 set. RAID 10 is implemented as a mirrored array whose segments are RAID 0 arrays. RAID 10 has same fault tolerance as mirroring and reduces overhead by striping. It needs at least four drives to form a RAID 10.

RAID CONFIGURATION

Creating and deleting RAID set and performing other RAID setting up operations are done in the RAID BIOS. During bootup, a screen similar to the one below will appear for about few seconds. Press <Ctrl-F> to enter FastBuild utility.

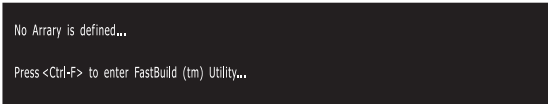

No Array is defined...
Press <Ctrl-F> to enter FastBuild (tm) Utility...

Important

Be sure to enable the RAID function for SATA device in BIOS before configuring the Fastbuild Utility.

The FastBuild menu screen will appear. The Main Menu is used to choose the operation to be performed.

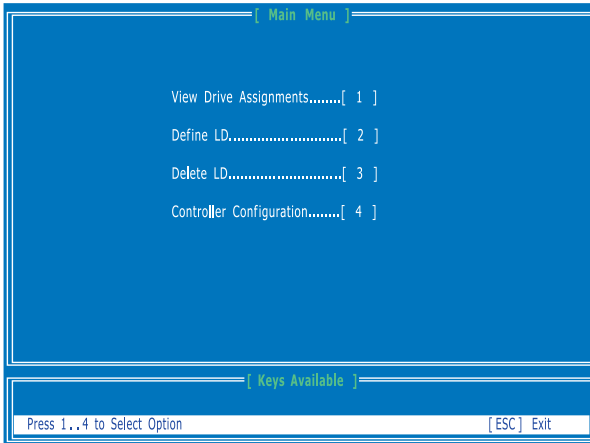

View Drives Assignments

This window displays the model number, capacities and assignment of the drives physically attached to the SATA host adapter.

| [View Drives Assignments] | | | |
|-----------------------------|--------------------|---------------|------------|
| Channel : ID | Drive Model | Capacity (MB) | Assignment |
| 1 : Mas | WDC WD800JD-00HKA0 | 80027 | |
| | Extent 1 | 79960 | Free |
| 2 : Mas | WDC WD800JD-00HKA0 | 80027 | |
| | Extent 1 | 79960 | Free |

| [Keys Available] | | |
|--------------------|------------|--------------|
| [↑] Up | [↓] Down | [ESC] Exit |

- Initialize logical drive, zero the disk drives. RAID 1 or 10 only.
 - Stripe Block Size, the default 64KB is best for most applications. RAID 0 or 10 only.
 - Gigabyte Boundary, allows use of slightly smaller replacement drives.
 - Cache Mode, WriteThru or WriteBack.
4. On the Drives Assignments window, use the arrow key to choose the hard drives which you want to make part of the LD, use the space key to change the assignment to “Y”. Then press [Ctrl+Y] to save the configuration.

| [Define LD Menu] | | | |
|------------------------|-----------|------------------------|--|
| LD No | RAID Mode | Total Drv | |
| LD 1 | RAID 1 | 2 | |
| Stripe Block : NA | | Fsat Init : OFF | |
| Gigabyte Boundary : ON | | Cache Mode : WriteThru | |

| [Drives Assignments] | | | |
|------------------------|----------------|---------------|------------|
| Channel : ID | Drive Model | Capacity (MB) | Assignment |
| 1 : Mas WDC | WD8001D-00HKA0 | 80027 | Y |
| 2 : Mas WDC | WD8001D-00HKA0 | 80027 | Y |

| [Keys Available] | | | | |
|--------------------|------------|--------------|-------------------------|-----------------|
| [↑] Up | [↓] Down | [ESC] Exit | [Space] Change Option | [Ctrl+Y] Save |

5. A message will show up on the bottom, press any key to save the configuration or press [Ctrl-Y] to allocate the RAID capacity manually.

Press Ctrl-Y to Modify Array Capacity or press any other key to use maximum capacity ...

Important

- The default capacity is the full capacity of the selected hard drives.
- If you allocate the first LD capacity manually, you can create second LD with remaining capacity of the selected hard drives.

6. The LD creation is done, the screen shows the LD information as below. Press ESC key to the main screen.

| [Define LD Menu] | | | | |
|--------------------|-----------|-----------|---------------|------------|
| LD No | RAID Mode | Total Drv | Capacity (MB) | Status |
| LD 1 | RAID 1 | 2 | 79000 | Functional |
| LD 2 | ---- | ---- | ----- | ---- |
| LD 3 | ---- | ---- | ----- | ---- |
| LD 4 | ---- | ---- | ----- | ---- |
| LD 5 | ---- | ---- | ----- | ---- |
| LD 6 | ---- | ---- | ----- | ---- |
| LD 7 | ---- | ---- | ----- | ---- |
| LD 8 | ---- | ---- | ----- | ---- |

| [Keys Available] | | | |
|--------------------|------------|--------------|------------------|
| [↑] Up | [↓] Down | [ESC] Exit | [Enter] Select |

7. Press ESC key to exit the utility, a message “System is going to REBOOT! Are You Sure?” will display, answer “Y” to exit it and the system will reboot.

| [Main Menu] | |
|----------------------------------|----------------------------------------------------------------------------|
| View Drive Assignments.....[1] | |
| Define LD.....[2] | |
| Delete LD.....[3] | |
| Con | System is going to REBOOT! Are You Sure? Y - Reboot / Any Key - Back |

| [Keys Available] | |
|-----------------------------|--------------|
| Press 1..4 to Select Option | [ESC] Exit |

Delete LD (Deleting RAID)

1. Select "Delete LD" on the main screen.
2. Choose a LD No you want to delete and press "Del" or "Alt+D" delete the RAID set.

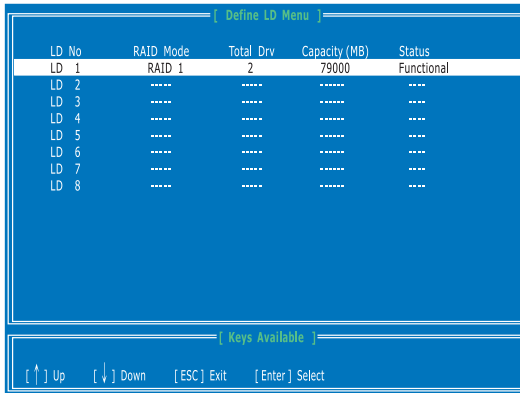

3. On the next screen, a message will display to inform you, press "Ctrl+Y" to delete the RAID set or other key to abort it. Press "Ctrl+Y" to complete the deletion.

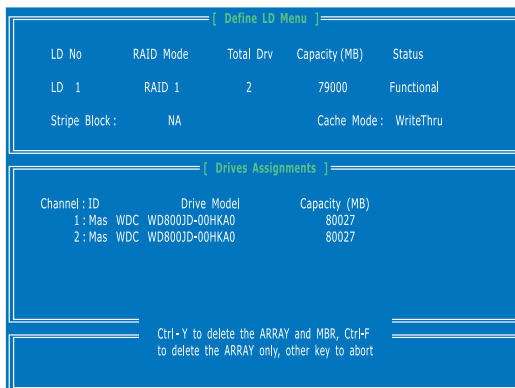

Installing the RAID Driver (for bootable RAID Array)

1. After you complete the RAID BIOS setup, boot from the Windows CD, and the Windows Setup program starts.
2. Press F6 and wait for the Windows Setup screen to appear.
3. Insert the floppy that contains the RAID driver, press the "S" key to select "Specify Additional Device".

Note: for Windows Vista, you can copy the files to a medium (floppy/ CD/ DVD or USB)

Important

Please follow the instruction below to make a SATA RAID driver for yourself.

- Insert the MSI DVD into the DVD-ROM drive.
- Click the "Browse CD" on the Setup screen.
- Copy all the contents in the :
 - for Windows XP: \\ChipSet\AMD\XPI\SBDrv\RAID7xx
 - for Windows Vista: \\ChipSet\AMD\VISTA\Package\Drivers\SBDrv\SB7xx\RAID\ x86 (for 32bit) or x64(for 64bit)
- The driver disk for RAID controller is done.

4. When prompted, insert the floppy disk and press Enter.
For Windows Vista:
During the Operating system installation, after selecting the location to install Vista click on "Load Driver" button to load RAID drive.
5. You should be shown a list of available SCSI Adapters.
6. Select the compatible RAID controller for 32-bit/ 64-bit version system and then press ENTER.
7. The next screen should confirm that you have selected the RAID controller. Press ENTER again to continue.
8. You have successfully installed the RAID driver, and Windows setup should continue.
9. Leave the disk in the floppy drive until the system reboots itself. Windows setup will need to copy the files from the floppy again after the RAID volume is formatted, and Windows setup starts copying files.

Installing the RAID Driver Under Windows (for Non-bootable RAID Array)

1. Insert the MSI DVD into the DVD-ROM drive.
2. The DVD will auto-run and the setup screen will appear.
3. Under the Driver tab, click on AMD chipset drivers by your need. The AMD chipset drivers includes RAID Driver.
4. The driver will be automatically installed.

Appendix C

Dual Core Center

Dual CoreCenter, the most useful and powerful utility that MSI has spent much research and efforts to develop, helps users to monitor or configure the hardware status of MSI Mainboard & MSI Graphics card in windows, such as CPU/GPU clock, voltage, fan speed and temperature.

Before you install the Dual CoreCenter, please make sure the system has meet the following requirements:

1. Intel Pentium4 / Celeron, AMD Athlon XP/ Sempron or compatible CPU with PCI Express slot.
2. 256MB system memory.
3. CD-ROM drive for software installation.
4. Operation system: Windows XP.
5. .Net Frame Work 2.0

ACTIVATING DUAL CORE CENTER

Once you have your Dual Core Center installed (locate the setup source file in the setup CD accompanying with your mainboard, path: Utility → MSI Utility → Dual Core Center), it will have an icon  in the system tray, a short cut icon on the desktop, and a short cut path in your Start-up menu. You may double-click on each icon to enable Dual Core Center.



short-cut icon in the system tray

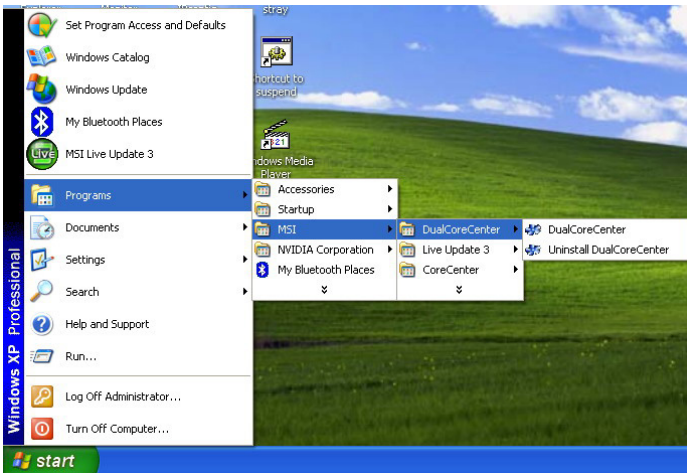

short-cut path in the start-up menu

(Path:Start → Programs → MSI → DualCoreCenter → DualCoreCenter)

Important

Dual Core Center is for reference only.

MAIN

Before using this utility, we have to remind you: only when installing the MSI V044 (V044 has to install with the version 8.26 or newer driver)/ V046 or V060 graphics card can activate the full function of this utility. If you install a graphics card of other brand, only hardware status of the MSI mainboard would be available.



Introduction:

Click each button appearing above to enter sub-menu to make further configuration or to execute the function.

MB

Click MB button to read current CPU temperature, FSB and CPU clock of mainboard will show below.

VGA

Click VGA button to read current GPU temperature, GPU clock and memory clock of graphics card will show below.

DOT

Click DOT button to enable or disable the Dynamic Overclocking Technology.

Dual Core Center

AV/ Game/ Office/ Silence/ Cool

MSI provides five common settings for different environments. The settings had been set to optimal values to reach better performance in each environment. Click the button you need.

Important

Before clicking the AV/ Game/ Office/ Silence or Cool button, select Smooth mode or Sharp mode to decide whether you want the system to reach the optimal values smoothly or quickly.

Sharp mode



Smooth mode



Clock

In this sub-menu, you can adjust and monitor the clocks of MB and graphics card.



Voltage

In this sub-menu, you can adjust and monitor the voltages of MB and graphics card.



FAN Speed

In this sub-menu, you can adjust and monitor the fan speeds of MB and graphics card.



Temperature

In this sub-menu, you can monitor the temperatures of MB and graphics card.

User Profile

In this sub-menu, you can set the values of clock, voltage and fan speed by your need and save them in a profile. You can save 3 profiles for further use.

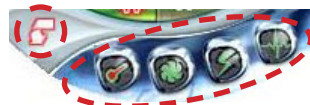

Important

Click on the icon , the clock, voltage, fan, and temperature buttons will appear beside the icon.



DOT (DYNAMIC OVERCLOCKING)

Dynamic Overclocking Technology is an automatic overclocking function, included in the MSI newly developed Dual CoreCenter Technology. It is designed to detect the loading of CPU/ GPU while running programs, and to over-clock automatically. When the motherboard detects that the loading of CPU is exceed the default threshold for a time, it will speed up the CPU and fan automatically to make the system run smoother and faster. When the graphics card detects that the loading of GPU is exceed the default threshold for a time, it will speed up the GPU, memory, fan and voltage automatically to make the system run smoother and faster. When the CPU/ GPU is temporarily suspending or staying in low loading balance, it will restore the default settings instead. Usually the Dynamic Overclocking Technology will be powered only when users' PC runs huge amount of data, like 3D games or video process, and the motherboard/ graphicd card need to be boosted up to enhance the overall performance.

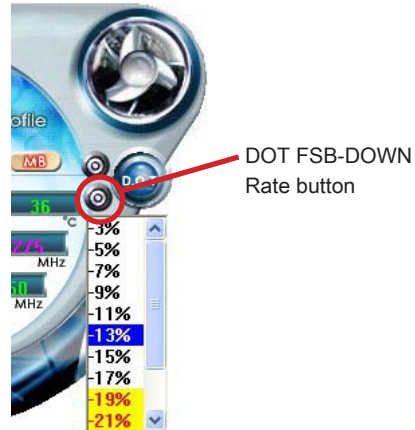
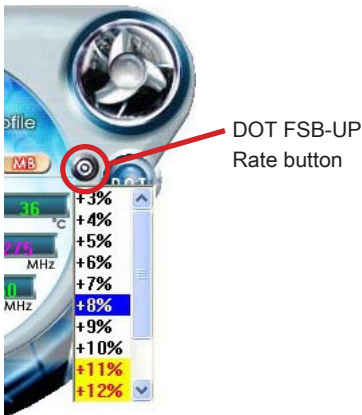

There will be several selections when you click the DOT rate button (include increase rate  and decrease rate  rate buttons), to select the DOT level, then you have to click the DOT button  to apply the DOT function.



Important

Even though the Dynamic Overclocking Technology is more stable than manual over-clocking, basically, it is still risky. We suggest user to make sure that your CPU can afford to overclock regularly first. If you find the PC appears to be unstable or reboot incidentally, it's better to lower the level of overclocking options. By the way, if you need to conduct overclocking manually, please do not to apply the DOT function.

CLOCK

In the Clock sub-menu, you can see clock status (including FSB/ CPU clock of main-board and GPU/ memory clock of graphics card) of your system. And you can select desired value for overclocking. There will be several items for you to select for overclocking after you click  button. You can click the plus sign button  to increase the clock, or click the minus sign button  to decrease the clock. And finally, click the Apply button to apply the values adjusted. If you do not want to apply the adjustments, click the Cancel button to cancel. Or click the Default button to restore the default values.

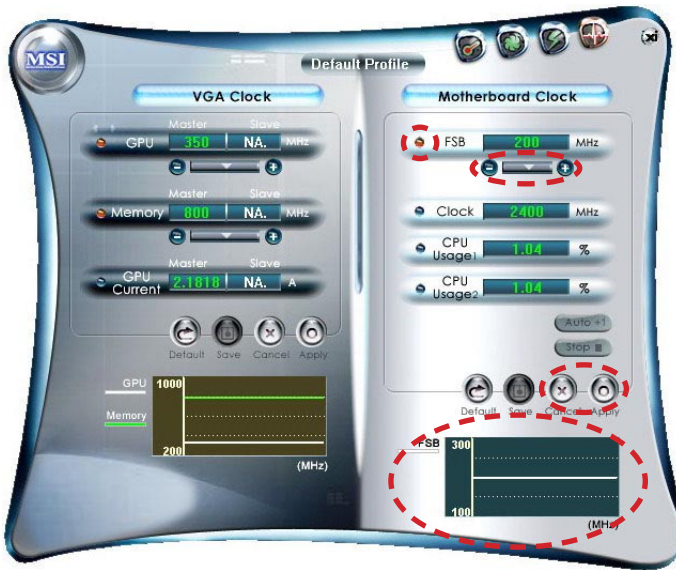



On the underside, it shows the graphs of the clocks. Only the curves of the item which the button is lit up with red color will be shown.

Important

In the user profile, clicking the Save button can save the changes to it. In the default profile, the Save button is not available.

VOLTAGE

In the Voltage sub-menu, you can see voltage status (including Vcore, memory, GPU voltage... etc.) of your system, and you can select desired value for overclocking. It will show several items to select for overclocking after you click the  button. You can click the plus sign button  to increase the voltage, or click the minus sign button  to decrease. And finally, click the Apply button to apply the adjustments. If you do not want to apply the adjustments, click the Cancel button to cancel. Or click the Default button to restore the default values.





On the underside, it shows the graphs of the voltages. Only the curves of the item which the button is lit up with red color will be shown.

Important

In the user profile, clicking the Save button can save the changes to it. In the default profile, the Save button is not available.

FAN SPEED

In the FAN Speed sub-menu, you can read fan status of your system. Select higher speed for better cooling effect. There are several sections for you to change the fan speed to a section after clicking  button. Click the plus sign button  to increase the fan speed to a section, or click the minus sign button  to decrease. Or click the Default button to restore the default values.



On the underside, it shows the graphs of the fan speed. Only the curves of the item which the button is lit up with red color will be shown.

Important

- When you set the fan speed manually, please make sure to disabled the CPU Smart FAN Target item in the BIOS.
- In the user profile, clicking the Save button can save the changes to it. In the default profile, the Save button is not available.

TEMPERATURE

In the Temperature sub-menu, you can see temperature status of your system.

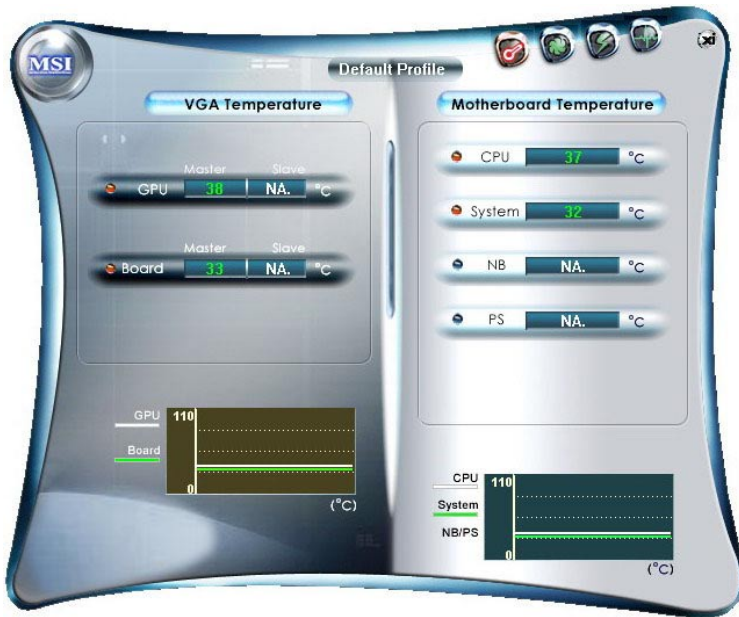



On the underside, it shows the graphs of the temperatures. Only the curves of the item which the button is lit up with red color will be shown.

USER PROFILE

In the User Profile sub-menu, click the setting button that besides the user profile bar, and the next screen will appear.





Here you can define the clock/ fan speed/ voltage by your need, click the  button to choose a value quickly, or click the plus  / minus sign  button to increase/ decrease the value.

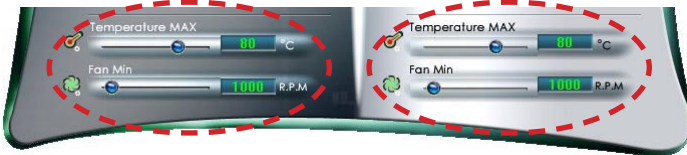

Use the draw bar to set the max system temperature. When the system temperature exceeds the threshold you defined, the system will pop up a warning message and shut down the system.

Use the draw bar to set the minimal fan speed. When the fan speed is lower than the threshold you defined, the system will pop up a warning message.



After setting all values you need, you can change the user profile name in the box then click the save button  to save all changes in a profile.



Finally, you can choose the user profile by click the button in the left side and click the Apply button to load the user profile.



