

Versão: 06 de Março 2024



CATÁLOGO DE
PRODUTOS
EM
LIQUIDAÇÃO

*O Catálogo de liquidação é atualizado constantemente.
Antes de baixar, verifique a versão com data atualizada.



ABASTEÇA SEU ESTOQUE



TSW



PRODUTOS EM LIQUIDAÇÃO



TSW



1



3



5



7



4



6



CAPACETE MTB LED | RAPTOR II

CARACTERÍSTICA *In Mold* | Regulável c/ viseira e led | 18 canais de ventilação, tela anti-inseto, Sistema de engate em "Y"

PESO APROXIMADO 223g

EMBALAGEM 18 peças

TAMANHO MÉDIO - 54 À 58

1		-
3		-
4		11850
5		-
6		11853
7		-

TAMANHO GRANDE - 57 À 61

1		-
2		-
3		11838
4		-
6		-
7		11839

FOTOS MERAMENTE ILUSTRATIVAS. AS INFORMAÇÕES/CONFIGURAÇÕES DE PRODUTOS PODERÃO SOFRER ALTERAÇÕES SEM AVISO PRÉVIO.

ENTRE EM CONTATO COM O SEU CONSULTOR OU FALE COM O NOSSO TIME DE TELEVENDAS PELO (33) 3277-3030.



PRODUTOS EM LIQUIDAÇÃO



TSW



1



2



3



4



5



7



CAPACETE MTB LED | RAPTOR III

CARACTERÍSTICA In Mold | Regulável | Viseira | Led (3 modos) | 18 canais de ventilação | Tela anti-inseto | Sistema de engate em "Y"

PESO APROXIMADO 223g

EMBALAGEM 18 peças

TAMANHO MÉDIO - 54 À 58

1		16046
2		16047
3		16048
4		16051
5		16052
7		16055

TAMANHO GRANDE - 57 À 61

3		-
4		16042
5		-
6		16044
7		-

FOTOS MERAMENTE ILUSTRATIVAS. AS INFORMAÇÕES/CONFIGURAÇÕES DE PRODUTOS PODERÃO SOFRER ALTERAÇÕES SEM AVISO PRÉVIO.

ENTRE EM CONTATO COM O SEU CONSULTOR OU FALE COM O NOSSO TIME DE TELEVENDAS PELO (33) 3277-3030.



PRODUTOS EM LIQUIDAÇÃO



TSW



CAPACETE TEAM | PLUS

CARACTERÍSTICA | *In Mold* | Regulável 17 canais de ventilação | Sistema de engate em "Y" | espuma removível e lavável | Faixa refletiva na carreira

PESO APROXIMADO | 264g

EMBALAGEM | 10 peças

TAMANHO MÉDIO - 54 À 57

4  13842

TAMANHO GRANDE - 57 À 61

1  13572



FOTOS MERAMENTE ILUSTRATIVAS. AS INFORMAÇÕES/CONFIGURAÇÕES DE PRODUTOS PODERÃO SOFRER ALTERAÇÕES SEM AVISO PRÉVIO.

ENTRE EM CONTATO COM O SEU CONSULTOR OU FALE COM O NOSSO TIME DE TELEVENDAS PELO (33) 3277-3030.



PRODUTOS EM LIQUIDAÇÃO



TSW

1



2



3



4



CAPACETE MTB | ENDURO 2021/2022

CARACTERÍSTICAS	16 canais de ventilação, Sistema de engate em Y, prático e de fácil ajuste espuma removível e lavável Viseira In Mold
TAMANHO	Único Regulável 58-61 M/L
PESO	268g
EMBALAGEM	12 peças

TAMANHO ÚNICO - 58 À 61

1		16061
2		16059
3		16056
4		16057

FOTOS MERAMENTE ILUSTRATIVAS. AS INFORMAÇÕES/CONFIGURAÇÕES DE PRODUTOS PODERÃO SOFRER ALTERAÇÕES SEM AVISO PRÉVIO.

ENTRE EM CONTATO COM O SEU CONSULTOR OU FALE COM O NOSSO TIME DE TELEVENDAS PELO (33) 3277-3030.



PRODUTOS EM LIQUIDAÇÃO



TSW

2



3



4



5



CARNEIRA PLÁSTICA para capacete

CARACTERÍSTICA	Para ajuste de capacete
MATERIAL	Nylon
EMBALAGEM	10 peças

2 TUNE 10164

4 PRO RACE 03853

3 ENDURO 11135

5 PLUS TSW/
MITSU 03853



CARNEIRA PLÁSTICA para capacete TEAM RACE

CARACTERÍSTICA	Para ajuste de capacete
MATERIAL	Nylon
EMBALAGEM	50 peças
PESO	21 gramas
	19063

FOTOS MERAMENTE ILUSTRATIVAS. AS INFORMAÇÕES/CONFIGURAÇÕES DE PRODUTOS PODERÃO SOFRER ALTERAÇÕES SEM AVISO PRÉVIO.

ENTRE EM CONTATO COM O SEU CONSULTOR OU FALE COM O NOSSO TIME DE TELEVENDAS PELO (33) 3277-3030.



PRODUTOS EM LIQUIDAÇÃO



TSW



1



2



3



4



5



8



LUVA MTB DM FLEX | Modelo 02

INTERNO Microfibra | sbr | Pontos siliconados

EXTERNO Tecido elástico | Velcro

EMBALAGEM 10 peças

P	M	G
1  12527	4  12517	2  12511
2  12528		

FOTOS MERAMENTE ILUSTRATIVAS. AS INFORMAÇÕES/CONFIGURAÇÕES DE PRODUTOS PODERÃO SOFRER ALTERAÇÕES SEM AVISO PRÉVIO.

ENTRE EM CONTATO COM O SEU CONSULTOR OU FALE COM O NOSSO TIME DE TELEVENDAS PELO (33) 3277-3030.



PRODUTOS EM LIQUIDAÇÃO



TSW



LUVA MTB DM DUAL | Modelo 02

- INTERNO** Microfibra | Tecido elástico
- EXTERNO** Tecido elástico | Velcro
- EMBALAGEM** 10 peças

P		M		G		GG	
1		1		4		4	
6		2		6			
		3					
		4					
		6					

FOTOS MERAMENTE ILUSTRATIVAS. AS INFORMAÇÕES/CONFIGURAÇÕES DE PRODUTOS PODERÃO SOFRER ALTERAÇÕES SEM AVISO PRÉVIO.

ENTRE EM CONTATO COM O SEU CONSULTOR OU FALE COM O NOSSO TIME DE TELEVENDAS PELO (33) 3277-3030.

PRODUTOS EM LIQUIDAÇÃO

TSW



CAMISA RIDE LINE

CARACTERÍSTICA Corpo: 100% microfilamento de poliéster | Mangas e Cintura: Microfilamento de poliéster + elastano e silicone | Bolso: 2 bolsos atrás e um extra com zíper | Zíper: longo frontal

PROTEÇÃO UV-30

MATERIAL 100% microfilamento poliéster

EMBALAGEM 1 peça

P		20978	P		20988	P		20992	P		-	P		21001
M		-	M		20989	M		-	M		-	M		21002
G		-	G		20990	G		-	G		-	G		21003
									GG		-			

FOTOS MERAMENTE ILUSTRATIVAS. AS INFORMAÇÕES/CONFIGURAÇÕES DE PRODUTOS PODERÃO SOFRER ALTERAÇÕES SEM AVISO PRÉVIO.

ENTRE EM CONTATO COM O SEU CONSULTOR OU FALE COM O NOSSO TIME DE TELEVENDAS PELO (33) 3277-3030.



PRODUTOS EM LIQUIDAÇÃO



TSW



CAMISA RIDE LINE

CARACTERÍSTICA

Camisa de ciclismo estruturada, ideal para quem procura conforto e estilo em uma modelagem perfeita. Tecido de alta qualidade. Elástico na borda inferior da camisa para uma melhor fixação. Gola redonda com fechamento em zíper | Manga curta

Bolsos: 2 Bolsos traseiros para acondicionar utensílios

Zíper: Zíper com Smart Lock (controle de trava do zíper) fornecendo assim controle da abertura e ventilação

MATERIAL

100% poliéster

PROTEÇÃO

UV 30

EMBALAGEM

1 peça

TAM.04 21654

TAM.06 21655

TAM.08 21656



CAMISA RIDE LINE TSW

CARACTERÍSTICA

Tecido de alta qualidade | Laterais com textura microperfuradas permitindo a respiração da pele, permitindo assim uma e secagem rápida, sendo eficiente durante a transmissão de calor |

Manga: Curta com detalhes texturizados em sua extremidade

Bolsos: Traseiros triplos reforçados e bolso com zíper

Zíper: Frontal total com Smart Lock (controle de trava do zíper) fornecendo assim controle da abertura e ventilação

PROTEÇÃO

UV 50 nas mangas e UV 30 frente/costa

MATERIAL

100% poliéster

EMBALAGEM

1 peça



P 20984

M 20985

G 20986

GG -

FOTOS MERAMENTE ILUSTRATIVAS. AS INFORMAÇÕES/CONFIGURAÇÕES DE PRODUTOS PODERÃO SOFRER ALTERAÇÕES SEM AVISO PRÉVIO.

ENTRE EM CONTATO COM O SEU CONSULTOR OU FALE COM O NOSSO TIME DE TELEVENDAS PELO (33) 3277-3030.



PRODUTOS EM LIQUIDAÇÃO





TSW



CAMISA STORM manga longa para ciclismo | PRO LINE

CARACTERÍSTICA	Ajusta melhor ao corpo para um melhor desempenho
PROTEÇÃO	UV: 50 Ação Antibacteriana
MANGAS E CINTURA	Fita elástica siliconada (Cintura)
BOLSO	Traseiro
ZÍPER	Longo Smart Lock (controle de trava do zíper)
MATERIAL	100% Poliéster
EMBALAGEM	1 peça

P	
1	 13540
2	 13506

FOTOS MERAMENTE ILUSTRATIVAS. AS INFORMAÇÕES/CONFIGURAÇÕES DE PRODUTOS PODERÃO SOFRER ALTERAÇÕES SEM AVISO PRÉVIO.

ENTRE EM CONTATO COM O SEU CONSULTOR OU FALE COM O NOSSO TIME DE TELEVENDAS PELO (33) 3277-3030.



PRODUTOS EM LIQUIDAÇÃO



TSW



CAMISA SUNNY manga longa para ciclismo | RIDE LINE

CARACTERÍSTICA	Ajusta melhor ao corpo para um melhor desempenho
PROTEÇÃO	UV: 50 Ação Antibacteriana
MANGAS E CINTURA	Fita elástica siliconada (Cintura)
BOLSO	Traseiro
ZÍPER	Longo Smart Lock (controle de trava do zíper)
MATERIAL	100% Poliéster
EMBALAGEM	1 peça

P	
1	13544
2	13548
3	13553
4	13557

M	
3	13554

G	
3	13555

GG	
1	13547
3	-

FOTOS MERAMENTE ILUSTRATIVAS. AS INFORMAÇÕES/CONFIGURAÇÕES DE PRODUTOS PODERÃO SOFRER ALTERAÇÕES SEM AVISO PRÉVIO.

ENTRE EM CONTATO COM O SEU CONSULTOR OU FALE COM O NOSSO TIME DE TELEVENDAS PELO (33) 3277-3030.

PRODUTOS EM LIQUIDAÇÃO

TSW



CAMISA ENDURENCE TSW MANGA LONGA

CARACTERÍSTICA

Camisa esportiva enduro | Tecido 100% poliéster e de alta qualidade, com ótimo desempenho térmico e punho com acabamento liso

Mangas e Cintura: Manga longa com punho liso e cintura lisa

MATERIAL

100% poliéster

EMBALAGEM

1 peça

P  21105

P  21109

M  -

M  21110

G  -

G  -

GG  21108

GG  -



FOTOS MERAMENTE ILUSTRATIVAS. AS INFORMAÇÕES/CONFIGURAÇÕES DE PRODUTOS PODERÃO SOFRER ALTERAÇÕES SEM AVISO PRÉVIO.

ENTRE EM CONTATO COM O SEU CONSULTOR OU FALE COM O NOSSO TIME DE TELEVENDAS PELO (33) 3277-3030.



PRODUTOS EM LIQUIDAÇÃO

TSW



P  19014
M  -
G  19016



P  19017
M  19018
G  19019



CAMISA ELITE TEAM RACE

CARACTERÍSTICA	Modelagem Slim Tecido com memória elástica Fita elástica siliconada na cintura
PROTEÇÃO	UV: 50+ Ação Antibacteriana
MANGAS E PERNAS	Mangas com acabamento Neo Cut (corte a laser)
BOLSO	Traseiro
ZÍPER	Longo Smart Lock (controle de trava do zíper) Puxador emborrachado

MATERIAL	84% Poliéster 14% Elastano
FORRO	Espuma D-80
SKINFIT 3 TECIDOS	Combinação estratégica com diferentes tecidos de diferentes comportamentos, melhorando absorção de suor, flexibilidade e conforto
EMBALAGEM	10 peças

FOTOS MERAMENTE ILUSTRATIVAS. AS INFORMAÇÕES/CONFIGURAÇÕES DE PRODUTOS PODERÃO SOFRER ALTERAÇÕES SEM AVISO PRÉVIO.

ENTRE EM CONTATO COM O SEU CONSULTOR OU FALE COM O NOSSO TIME DE TELEVENDAS PELO (33) 3277-3030.



PRODUTOS EM LIQUIDAÇÃO



TSW



CAMISA STORM para ciclismo | PRO LINE

CARACTERÍSTICA	Ajusta melhor ao corpo para um melhor desempenho.
PROTEÇÃO	UV: 50 Ação Antibacteriana
MANGAS E CINTURA	Fita elástica siliconada Corte a laser (manga)
BOLSO	Traseiro
ZÍPER	Longo Smart Lock (controle de trava do zíper)
MATERIAL	100% Poliéster
EMBALAGEM	1 peça

	P	M
1	13427	13428
2	13421	13422
	G	GG
1	13432	13433
2	13425	13426

FOTOS MERAMENTE ILUSTRATIVAS. AS INFORMAÇÕES/CONFIGURAÇÕES DE PRODUTOS PODERÃO SOFRER ALTERAÇÕES SEM AVISO PRÉVIO.

ENTRE EM CONTATO COM O SEU CONSULTOR OU FALE COM O NOSSO TIME DE TELEVENDAS PELO (33) 3277-3030.



PRODUTOS EM LIQUIDAÇÃO



TSW



1



2



3



4

CAMISA SUNNY para ciclismo | RIDE LINE

CARACTERÍSTICA	Ajusta melhor ao corpo para um melhor desempenho.
PROTEÇÃO	UV: 50 Ação Antibacteriana
MANGAS E CINTURA	Fita elástica siliconada (Cintura)
BOLSO	Traseiro
ZÍPER	Longo Smart Lock (controle de trava do zíper)
MATERIAL	100% Poliéster
EMBALAGEM	1 peça

P		M			
1		13435	1		13437
2		13442	2		13443
3		13450	3		13452
4		13457	4		13458
G		GG			
1		13439	1		13440
2		13445	2		13448
3		13453	3		13455
4		13460	4		13462

FOTOS MERAMENTE ILUSTRATIVAS. AS INFORMAÇÕES/CONFIGURAÇÕES DE PRODUTOS PODERÃO SOFRER ALTERAÇÕES SEM AVISO PRÉVIO.

ENTRE EM CONTATO COM O SEU CONSULTOR OU FALE COM O NOSSO TIME DE TELEVENDAS PELO (33) 3277-3030.

PRODUTOS EM LIQUIDAÇÃO

TSW



CAMISA PRO LINE

- CARACTERÍSTICA** Microfilamento de poliéster + elastano com elástico reforçado com gel personalizado | Mangas e Cintura: gel interno | Bolso: traseiro com zíper | Zíper: full
- PROTEÇÃO** UV-50
- MATERIAL** Microfilamento de poliéster + elastano
- EMBALAGEM** 1 peça

P		-	G		-	M		21055	P		21057	P		-
G		-	G		-	G		21056	M		21059	M		-
									G		21081	G		21062

FOTOS MERAMENTE ILUSTRATIVAS. AS INFORMAÇÕES/CONFIGURAÇÕES DE PRODUTOS PODERÃO SOFRER ALTERAÇÕES SEM AVISO PRÉVIO.

ENTRE EM CONTATO COM O SEU CONSULTOR OU FALE COM O NOSSO TIME DE TELEVENDAS PELO (33) 3277-3030.



PRODUTOS EM LIQUIDAÇÃO



TSW



JAQUETA PRO LINE

CARACTERÍSTICA	Jaqueta esportiva com fechamento por zíper plástico reforçado com proteção na gola Tecido 100% poliéster e flanelado de alta qualidade, com ótimo desempenho térmico Possui dois bolsos externos e punho com acabamento liso Preta e cinza
PROTEÇÃO	UV: 50
MANGAS E CINTURA	Manga longa com punho liso e cintura lisa
BOLSO	Dois bolsos na parte frontal
ZÍPER	Longo frontal com proteção na gola
MATERIAL	100% Poliéster
EMBALAGEM	1 peça

P  21117



JAQUETA PRO LINE

CARACTERÍSTICA	Jaqueta esportiva com fechamento por zíper plástico reforçado com proteção na gola Tecido 100% poliéster e flanelado de alta qualidade, com ótimo desempenho térmico Possui dois bolsos externos e punho com acabamento liso Cinza e preto
PROTEÇÃO	UV: 50
MANGAS E CINTURA	Manga longa com punho liso e cintura lisa
BOLSO	Dois bolsos na parte frontal
ZÍPER	Longo frontal com proteção na gola
MATERIAL	100% Poliéster
EMBALAGEM	1 peça

P  21113

FOTOS MERAMENTE ILUSTRATIVAS. AS INFORMAÇÕES/CONFIGURAÇÕES DE PRODUTOS PODERÃO SOFRER ALTERAÇÕES SEM AVISO PRÉVIO.

ENTRE EM CONTATO COM O SEU CONSULTOR OU FALE COM O NOSSO TIME DE TELEVENDAS PELO (33) 3277-3030.

PRODUTOS EM LIQUIDAÇÃO

TSW



BRETELLE PRO LINE

CARACTERÍSTICA Confeccionado em tecido de poliâmida + elastano
Forro de bi-densidade 80/40 | Gel interno | Abertura frontal a altura da virilha

PROTEÇÃO UV-50

MATERIAL Poliâmida + elastano

EMBALAGEM 1 peça

* Possui abertura frontal na altura da virilha



P		21063	P		21066	P		21069	P		21072	P		21075	P		21078
M		21064	M		21067	M		21070	M		21073	M		21076	M		-
G		21065	G		21068	G		21071	G		21074	G		21077	G		-

FOTOS MERAMENTE ILUSTRATIVAS. AS INFORMAÇÕES/CONFIGURAÇÕES DE PRODUTOS PODERÃO SOFRER ALTERAÇÕES SEM AVISO PRÉVIO.

ENTRE EM CONTATO COM O SEU CONSULTOR OU FALE COM O NOSSO TIME DE TELEVENDAS PELO (33) 3277-3030.



PRODUTOS EM LIQUIDAÇÃO



TSW



BRETELLE RIDE LINE

CARACTERÍSTICA	Confeccionado em tecido de poliamida + elastano Forro de bi-densidade 80/40 Gel interno
PROTEÇÃO	UV-50
MATERIAL	Poliamida + elastano
EMBALAGEM	1 peça

P		21025	P		21029	P		21033	P		21037	P		21041
M		-	M		21030	M		21034	M		21038	M		21042
GG		-				G		21035	G		21039	G		21043
			GG		-									

FOTOS MERAMENTE ILUSTRATIVAS. AS INFORMAÇÕES/CONFIGURAÇÕES DE PRODUTOS PODERÃO SOFRER ALTERAÇÕES SEM AVISO PRÉVIO.

ENTRE EM CONTATO COM O SEU CONSULTOR OU FALE COM O NOSSO TIME DE TELEVENDAS PELO (33) 3277-3030.

PRODUTOS EM LIQUIDAÇÃO

TSW



P 18999
G -



P 19002
M -
G 19004



BRETELLE ELITE TEAM RACE

CARACTERÍSTICA	Modelagem Slim Tecido com memória elástica
PROTEÇÃO	UV: 50+ Ação Antibacteriana
MANGAS E PERNAS	Pernas com acabamento convencional
BOLSO	N/A
ZÍPER	N/A

MATERIAL	Tecido 1: 77% Poliéster 23% Elastano Tecido 2: 85% Poliéster 15% Elastano
FORRO	Espuma D-80
SKINFIT 3 TECIDOS	Combinação estratégica com diferentes tecidos de diferentes comportamentos, melhorando absorção de suor, Flexibilidade e conforto
EMBALAGEM	10 peças

FOTOS MERAMENTE ILUSTRATIVAS. AS INFORMAÇÕES/CONFIGURAÇÕES DE PRODUTOS PODERÃO SOFRER ALTERAÇÕES SEM AVISO PRÉVIO.

ENTRE EM CONTATO COM O SEU CONSULTOR OU FALE COM O NOSSO TIME DE TELEVENDAS PELO (33) 3277-3030.

TSW

BRETELLE SUNNY RIDE LINE

CARACTERÍSTICA	Ajusta melhor ao corpo para um melhor desempenho
PROTEÇÃO	UV: 50 Ação Antibacteriana
MATERIAL	87% Poliéster 13% Elastano
FORRO	Ação Antibacteriana Densidade: 80 Espessura 16 mm Tamanho 350 x 210 mm
EMBALAGEM	1 peça

P 1
1  13465























PRODUTOS EM LIQUIDAÇÃO

TSW



BERMUDA RIDE LINE

CARACTERÍSTICA	Confeccionada em tecido de poliamida + elastano Forro de bi-densidade 80/40 Gel interno Bolso lateral
PROTEÇÃO	UV-50
MATERIAL	Poliamida + elastano
EMBALAGEM	1 peça

P  21005	P  21009	P  21013	P  21017	P  21021
M  -	M  -	M  -	M  -	M  -
G  -	G  -	G  -	G  -	G  -
GG  -	GG  -	GG  -	GG  -	GG  -

FOTOS MERAMENTE ILUSTRATIVAS. AS INFORMAÇÕES/CONFIGURAÇÕES DE PRODUTOS PODERÃO SOFRER ALTERAÇÕES SEM AVISO PRÉVIO.

ENTRE EM CONTATO COM O SEU CONSULTOR OU FALE COM O NOSSO TIME DE TELEVENDAS PELO (33) 3277-3030.



PRODUTOS EM LIQUIDAÇÃO



TSW



1



2

BERMUDA STORM para ciclismo | PRO LINE

CARACTERÍSTICA	Ajusta melhor ao corpo para um melhor desempenho
PROTEÇÃO	UV: 50 Ação Antibacteriana
ACABAMENTO	Fita elástica siliconada
MATERIAL	87% Poliéster 13% Elastano
FORRO	Ação Antibacteriana Densidade: 80 Espessura 16 mm Tamanho 350 x 210 mm
EMBALAGEM	1 peça

	P	G
1	13518	1 -
2	13514	
GG		
1	-	
2	-	

FOTOS MERAMENTE ILUSTRATIVAS. AS INFORMAÇÕES/CONFIGURAÇÕES DE PRODUTOS PODERÃO SOFRER ALTERAÇÕES SEM AVISO PRÉVIO.

ENTRE EM CONTATO COM O SEU CONSULTOR OU FALE COM O NOSSO TIME DE TELEVENDAS PELO (33) 3277-3030.

PRODUTOS EM LIQUIDAÇÃO

TSW



P	21871
M	-
G	-
GG	-



BERMUDA RIDE LINE TSW

CARACTERÍSTICA

Modelagem anatômica que resulta em maior conforto. Bermuda esportiva. Possui ótimo ajuste ao corpo garantindo conforto e elasticidade para prática de ciclismo

Possui bolso lateral. Confeccionada também material texturizado elástico na barra gerando maior conforto e liberdade de movimento durante a prática do exercício e melhor ajuste ao corpo

Forro com bi densidade D-80 / D-40 de espuma com ação Antibacteriana. Formato curvo e anatômico que se ajusta ao corpo do ciclista oferecendo maior conforto mesmo em pedais de longa duração

PROTEÇÃO

UV-50

MATERIAL

90% poliamida e 10% elastano

EMBALAGEM

1 peça



FORRO (Cycling Pad) | Modelo 05

CARACTERÍSTICA

Forro para roupas de ciclismo | Masculino

TECNOLOGIA

Hygroscopic Quick Dry

DENSIDADE

55+80

ESPESSURA

12 mm

MATERIAL

Warp Knitting (85% poliéster / 15% spandex)

TAMANHO

355 x 220 mm

EMBALAGEM

500 peças

13801

FOTOS MERAMENTE ILUSTRATIVAS. AS INFORMAÇÕES/CONFIGURAÇÕES DE PRODUTOS PODERÃO SOFRER ALTERAÇÕES SEM AVISO PRÉVIO.

ENTRE EM CONTATO COM O SEU CONSULTOR OU FALE COM O NOSSO TIME DE TELEVENDAS PELO (33) 3277-3030.

TSW



BERMUDA SUNNY para ciclismo | RIDE LINE

CARACTERÍSTICA Ajusta melhor ao corpo para um melhor desempenho

PROTEÇÃO UV: 50 | Ação Antibacteriana

MATERIAL 87% Poliéster
13% Elastano

FORRO Ação Antibacteriana
| Densidade: 80 |
Espessura 16 mm
| Tamanho 350 x
210 mm

EMBALAGEM 1 peça

P		
1		13522
4		13534



CALÇA SUNNY para ciclismo | RIDE LINE

CARACTERÍSTICA	Ajusta melhor ao corpo para um melhor desempenho
PROTEÇÃO	UV: 50 Ação Antibacteriana
ACABAMENTO	Zíper curto tornozelo
MATERIAL	87% Poliéster 13% Elastano
FORRO	Ação Antibacteriana Densidade: 80 Espessura 16 mm Tamanho 350 x 210 mm
EMBALAGEM	1 peça



PRODUTOS EM LIQUIDAÇÃO

TSW



M 19303
G 19306



P -
M 19314
G 19315



P 19316
M 19317
G 19318



M 19320
G 19321



M 19332
G 19333



P 19334
M 19335
G 19336



MACAQUINHO para ciclismo | SUMMER

CARACTERÍSTICA	Modelagem Slim Tecido com memória elástica
PROTEÇÃO	UV: 50 Ação Antibacteriana
MANGAS E PERNAS	Acabamento Neo Cut (corte a laser) Pernas com fita elástica siliconada
BOLSO	Traseiro
ZÍPER	Longo Smart Lock (controle de trava do zíper) Puxador emborrachado

MATERIAL	84% Poliéster 16% Elastano
FORRO	Espuma D-80
SKINFIT 3 TECIDOS	Combinação estratégica com diferentes tecidos de diferentes comportamentos melhorando absorção de suor, flexibilidade e conforto
EMBALAGEM	10 peças

FOTOS MERAMENTE ILUSTRATIVAS. AS INFORMAÇÕES/CONFIGURAÇÕES DE PRODUTOS PODERÃO SOFRER ALTERAÇÕES SEM AVISO PRÉVIO.

ENTRE EM CONTATO COM O SEU CONSULTOR OU FALE COM O NOSSO TIME DE TELEVENDAS PELO (33) 3277-3030.

TSW



MACAQUINHO WOMAN FASHION para ciclismo | MANDALA

CARACTERÍSTICA	Ajusta melhor ao corpo para um melhor desempenho Bolso traseiro Proteção UV: 50 Ação antibacteriana
MANGAS E PERNAS	Fita elástica siliconada Corte a laser
ZÍPER	Longo Smart Lock (controle de trava do zíper)
MATERIAL	100% Poliéster
FORRO	Ação Antibacteriana Densidade: 80 Espessura 16 mm Tamanho 350 x 210 mm
TAMANHO	P, M, G, GG
EMBALAGEM	1 peça

P  13564

M  13566

GG  13571

PRODUTOS EM LIQUIDAÇÃO

TSW



MACAQUINHO para ciclismo | FLOWER

CARACTERÍSTICA	Modelagem Slim Melhor ajuste ao corpo elevando o desempenho durante a atividade do ciclista Tecido com memória elástica
PROTEÇÃO	UV: 50 Ação Antibacteriana
MANGAS E PERNAS	Neo Cut (corte a laser) Fita elástica siliconada (pernas)
BOLSO	Traseiro
ZÍPER	Longo Smart Lock (controle de trava do zíper) Puxador emborrachado
MATERIAL	84% Poliéster 16% Elastano
FORRO	Espuma D-80 Forro em Gel Cool Max
SKINFIT 3 TECIDOS	Combinação estratégica com diferentes tecidos de diferentes comportamentos melhorando absorção de suor, flexibilidade e conforto
EMBALAGEM	1 peça

P 14535

G 14537

MACAQUINHO para ciclismo | ORLA

CARACTERÍSTICA	Modelagem Slim Melhor ajuste ao corpo elevando o desempenho durante a atividade do ciclista Tecido com memória elástica
PROTEÇÃO	UV: 50 Ação Antibacteriana
MANGAS E PERNAS	Neo Cut (corte a laser) Fita elástica siliconada (pernas)
BOLSO	Traseiro
ZÍPER	Longo Smart Lock (controle de trava do zíper) Puxador emborrachado
MATERIAL	84% Poliéster 16% Elastano
FORRO	Espuma D-80 Forro em Gel Cool Max
SKINFIT 3 TECIDOS	Combinação estratégica com diferentes tecidos de diferentes comportamentos melhorando absorção de suor, flexibilidade e conforto
EMBALAGEM	1 peça

P 14541

FOTOS MERAMENTE ILUSTRATIVAS. AS INFORMAÇÕES/CONFIGURAÇÕES DE PRODUTOS PODERÃO SOFRER ALTERAÇÕES SEM AVISO PRÉVIO.

ENTRE EM CONTATO COM O SEU CONSULTOR OU FALE COM O NOSSO TIME DE TELEVENDAS PELO (33) 3277-3030.

PRODUTOS EM LIQUIDAÇÃO

TSW



MACAQUINHO para ciclismo | CIBER

CARACTERÍSTICA	Modelagem Slim Melhor ajuste ao corpo elevando o desempenho durante a atividade do ciclista Tecido com memória elástica
PROTEÇÃO	UV: 50 Ação Antibacteriana
MANGAS E PERNAS	Neo Cut (corte a laser) Fita elástica siliconada (pernas)
BOLSO	Traseiro
ZÍPER	Longo Smart Lock (controle de trava do zíper) Puxador emborrachado
MATERIAL	84% Poliéster 16% Elastano
FORRO	Espuma D-80 Forro em Gel Cool Max
SKINFIT 3 TECIDOS	Combinação estratégica com diferentes tecidos de diferentes comportamentos melhorando absorção de suor, flexibilidade e conforto
EMBALAGEM	1 peça
P	14544
M	14545

MACAQUINHO para ciclismo | SKY

CARACTERÍSTICA	Modelagem Slim Melhor ajuste ao corpo elevando o desempenho durante a atividade do ciclista Tecido com memória elástica
PROTEÇÃO	UV: 50 Ação Antibacteriana
MANGAS E PERNAS	Neo Cut (corte a laser) Fita elástica siliconada (pernas)
BOLSO	Traseiro
ZÍPER	Longo Smart Lock (controle de trava do zíper) Puxador emborrachado
MATERIAL	84% Poliéster 16% Elastano
FORRO	Espuma D-80 Forro em Gel Cool Max
SKINFIT 3 TECIDOS	Combinação estratégica com diferentes tecidos de diferentes comportamentos melhorando absorção de suor, flexibilidade e conforto
EMBALAGEM	1 peça
P	14548

FOTOS MERAMENTE ILUSTRATIVAS. AS INFORMAÇÕES/CONFIGURAÇÕES DE PRODUTOS PODERÃO SOFRER ALTERAÇÕES SEM AVISO PRÉVIO.

ENTRE EM CONTATO COM O SEU CONSULTOR OU FALE COM O NOSSO TIME DE TELEVENDAS PELO (33) 3277-3030.



MACAQUINHO para ciclismo | BIRD

CARACTERÍSTICA	Modelagem Slim Melhor ajuste ao corpo elevando o desempenho durante a atividade do ciclista Tecido com memória elástica
PROTEÇÃO	UV: 50 Ação Antibacteriana
MANGAS E PERNAS	Neo Cut (corte a laser) Fita elástica siliconada (pernas)
BOLSO	Traseiro
ZÍPER	Longo Smart Lock (controle de trava do zíper) Puxador emborrachado
MATERIAL	84% Poliéster 16% Elastano
FORRO	Espuma D-80 Forro em Gel Cool Max
SKINFIT 3 TECIDOS	Combinação estratégica com diferentes tecidos de diferentes comportamentos melhorando absorção de suor, flexibilidade e conforto
EMBALAGEM	1 peça

P 14538



MACAQUINHO para ciclismo | FIBER

CARACTERÍSTICA	Modelagem Slim Melhor ajuste ao corpo elevando o desempenho durante a atividade do ciclista Tecido com memória elástica
PROTEÇÃO	UV: 50 Ação Antibacteriana
MANGAS E PERNAS	Neo Cut (corte a laser) Fita elástica siliconada (pernas)
BOLSO	Traseiro
ZÍPER	Longo Smart Lock (controle de trava do zíper) Puxador emborrachado
MATERIAL	84% Poliéster 16% Elastano
FORRO	Espuma D-80 Forro em Gel Cool Max
SKINFIT 3 TECIDOS	Combinação estratégica com diferentes tecidos de diferentes comportamentos melhorando absorção de suor, flexibilidade e conforto
EMBALAGEM	1 peça

P 14552

PRODUTOS EM LIQUIDAÇÃO

TSW



MACAQUINHO manga longa para ciclismo | FLOWER

CARACTERÍSTICA	Modelagem Slim Melhor ajuste ao corpo elevando o desempenho durante a atividade do ciclista Tecido com memória elástica
PROTEÇÃO	UV: 50 Ação Antibacteriana
MANGAS E PERNAS	Mangas longa Pernas com Neo Cut (corte a laser) Fita elástica siliconada
BOLSO	Traseiro
ZÍPER	Longo Smart Lock (controle de trava do zíper) Puxador emborrachado
MATERIAL	84% Poliéster 16% Elastano
FORRO	Espuma D-80 Forro em Gel Cool Max
SKINFIT 3 TECIDOS	Combinação estratégica com diferentes tecidos de diferentes comportamentos melhorando absorção de suor, flexibilidade e conforto
EMBALAGEM	1 peça

P 15609

M 15610

G 15611



Macaquinho manga longa para ciclismo | BIRD

CARACTERÍSTICA	Modelagem Slim Melhor ajuste ao corpo elevando o desempenho durante a atividade do ciclista Tecido com memória elástica
PROTEÇÃO	UV: 50 Ação Antibacteriana
MANGAS E PERNAS	Mangas longa Pernas com Neo Cut (corte a laser) Fita elástica siliconada
BOLSO	Traseiro
ZÍPER	Longo Smart Lock (controle de trava do zíper) Puxador emborrachado
MATERIAL	84% Poliéster 16% Elastano
FORRO	Espuma D-80 Forro em Gel Cool Max
SKINFIT 3 TECIDOS	Combinação estratégica com diferentes tecidos de diferentes comportamentos melhorando absorção de suor, flexibilidade e conforto
EMBALAGEM	1 peça

M 15613

G 15614

FOTOS MERAMENTE ILUSTRATIVAS. AS INFORMAÇÕES/CONFIGURAÇÕES DE PRODUTOS PODERÃO SOFRER ALTERAÇÕES SEM AVISO PRÉVIO.

ENTRE EM CONTATO COM O SEU CONSULTOR OU FALE COM O NOSSO TIME DE TELEVENDAS PELO (33) 3277-3030.

PRODUTOS EM LIQUIDAÇÃO

TSW



MACAQUINHO manga longa para ciclismo | ORLA

CARACTERÍSTICA	Modelagem Slim Melhor ajuste ao corpo elevando o desempenho durante a atividade do ciclista Tecido com memória elástica
PROTEÇÃO	UV: 50 Ação Antibacteriana
MANGAS E PERNAS	Mangas longa Pernas com Neo Cut (corte a laser) Fita elástica siliconada
BOLSO	Traseiro
ZÍPER	Longo Smart Lock (controle de trava do zíper) Puxador emborrachado
MATERIAL	84% Poliéster 16% Elastano
FORRO	Espuma D-80 Forro em Gel Cool Max
SKINFIT 3 TECIDOS	Combinação estratégica com diferentes tecidos de diferentes comportamentos melhorando absorção de suor, flexibilidade e conforto
EMBALAGEM	1 peça

M _____ -
G _____ 15617



MACAQUINHO manga longa para ciclismo | CIBER

CARACTERÍSTICA	Modelagem Slim Melhor ajuste ao corpo elevando o desempenho durante a atividade do ciclista Tecido com memória elástica
PROTEÇÃO	UV: 50 Ação Antibacteriana
MANGAS E PERNAS	Mangas longa Pernas com Neo Cut (corte a laser) Fita elástica siliconada
BOLSO	Traseiro
ZÍPER	Longo Smart Lock (controle de trava do zíper) Puxador emborrachado
MATERIAL	84% Poliéster 16% Elastano
FORRO	Espuma D-80 Forro em Gel Cool Max
SKINFIT 3 TECIDOS	Combinação estratégica com diferentes tecidos de diferentes comportamentos melhorando absorção de suor, flexibilidade e conforto
EMBALAGEM	1 peça

M _____ 15619
G _____ 15620

FOTOS MERAMENTE ILUSTRATIVAS. AS INFORMAÇÕES/CONFIGURAÇÕES DE PRODUTOS PODERÃO SOFRER ALTERAÇÕES SEM AVISO PRÉVIO.

ENTRE EM CONTATO COM O SEU CONSULTOR OU FALE COM O NOSSO TIME DE TELEVENDAS PELO (33) 3277-3030.

PRODUTOS EM LIQUIDAÇÃO

TSW



MACAQUINHO manga longa para ciclismo | SKY

CARACTERÍSTICA	Modelagem Slim Melhor ajuste ao corpo elevando o desempenho durante a atividade do ciclista Tecido com memória elástica
PROTEÇÃO	UV: 50 Ação Antibacteriana
MANGAS E PERNAS	Mangas longa Pernas com Neo Cut (corte a laser) Fita elástica siliconada
BOLSO	Traseiro
ZIPER	Longo Smart Lock (controle de trava do zíper) Puxador emborrachado
MATERIAL	84% Poliéster 16% Elastano
FORRO	Espuma D-80 Forro em Gel Cool Max
SKINFIT 3 TECIDOS	Combinação estratégica com diferentes tecidos de diferentes comportamentos melhorando absorção de suor, flexibilidade e conforto
EMBALAGEM	1 peça

P 15621

M 15622

G 15623



MACAQUINHO manga longa para ciclismo | FIBER

CARACTERÍSTICA	Modelagem Slim Melhor ajuste ao corpo elevando o desempenho durante a atividade do ciclista Tecido com memória elástica
PROTEÇÃO	UV: 50 Ação Antibacteriana
MANGAS E PERNAS	Mangas longa Pernas com Neo Cut (corte a laser) Fita elástica siliconada
BOLSO	Traseiro
ZIPER	Longo Smart Lock (controle de trava do zíper) Puxador emborrachado
MATERIAL	84% Poliéster 16% Elastano
FORRO	Espuma D-80 Forro em Gel Cool Max
SKINFIT 3 TECIDOS	Combinação estratégica com diferentes tecidos de diferentes comportamentos melhorando absorção de suor, flexibilidade e conforto
EMBALAGEM	1 peça

M 15625

G 15626

FOTOS MERAMENTE ILUSTRATIVAS. AS INFORMAÇÕES/CONFIGURAÇÕES DE PRODUTOS PODERÃO SOFRER ALTERAÇÕES SEM AVISO PRÉVIO.

ENTRE EM CONTATO COM O SEU CONSULTOR OU FALE COM O NOSSO TIME DE TELEVENDAS PELO (33) 3277-3030.

PRODUTOS EM LIQUIDAÇÃO

TSW



SAPATILHA MTB NEW FIT PLUS

- CARACTERÍSTICA** 3 velcros | Numeração europeia | Chave allen 4 mm
- PESO** 825g (tam.43 UE)
- EMBALAGEM** 10 peças

39	-	41	17082	41	17086	37	-	41	17096
41	-	42	17081	42	-	38	-	42	17095
42	-	43	-	43	-	39	-	43	17094
43	-	44	-	44	-	40	-	44	17093
44	17073					41	17088		
47	-					42	17087		
48	-								

FOTOS MERAMENTE ILUSTRATIVAS. AS INFORMAÇÕES/CONFIGURAÇÕES DE PRODUTOS PODERÃO SOFRER ALTERAÇÕES SEM AVISO PRÉVIO.

ENTRE EM CONTATO COM O SEU CONSULTOR OU FALE COM O NOSSO TIME DE TELEVENDAS PELO (33) 3277-3030.

PRODUTOS EM LIQUIDAÇÃO

TSW



SAPATILHA MTB NEW FIT

CARACTERÍSTICA Com 3 velcros
| Numeração
européia

EMBALAGEM 1 peça

43



-

43



-

41



07948

41



04680

44



-

44



06970

42



07947

FOTOS MERAMENTE ILUSTRATIVAS. AS INFORMAÇÕES/CONFIGURAÇÕES DE PRODUTOS PODERÃO SOFRER ALTERAÇÕES SEM AVISO PRÉVIO.

ENTRE EM CONTATO COM O SEU CONSULTOR OU FALE COM O NOSSO TIME DE TELEVENDAS PELO (33) 3277-3030.

PRODUTOS EM LIQUIDAÇÃO

TSW



40	■	-
47	■	13286
48	■	13285

SAPATILHA ROAD SMART-U2

CARACTERÍSTICA	Sistema de fechamento Atop Lacing System Alça de ajuste anatômico, faixa refletiva Numeração européia
EMBALAGEM	1 peça
PESO	645g (tam.43 UE)

MEIAS RIDE para ciclismo | MODELO 01

CARACTERÍSTICA	Tamanho único
TAMANHO	39-43
MODALIDADE	Speed e MTB
COMPRESSÃO	Suave
MATERIAL	Fibra de Poliamida 65% Poliéster, 30% Fita elástica, 5% Spandex
EMBALAGEM	10 peças

3 ■■ 13587
5 ■■ 13592



MEIAS RIDE para ciclismo | MODELO 02

CARACTERÍSTICA	Tamanho único
TAMANHO	39-43
MODALIDADE	Speed e MTB
COMPRESSÃO	Suave
MATERIAL	Fibra de Poliamida 65% Poliéster, 30% Fita elástica, 5% Spandex
EMBALAGEM	10 peças

3 ■■ 13601



FOTOS MERAMENTE ILUSTRATIVAS. AS INFORMAÇÕES/CONFIGURAÇÕES DE PRODUTOS PODERÃO SOFRER ALTERAÇÕES SEM AVISO PRÉVIO.

ENTRE EM CONTATO COM O SEU CONSULTOR OU FALE COM O NOSSO TIME DE TELEVENDAS PELO (33) 3277-3030.

PRODUTOS EM LIQUIDAÇÃO

TSW



1

2

3

4

CARAMANHOLA FAST

CARACTERÍSTICA Flexível para apertar | Tampa Inteligente (abre e fecha) | Bico removível para limpeza | Boca larga (facilita a limpeza e abastecimento) | BPA free | Alça de transporte

CAPACIDADE 650 ml

TAMANHO ø 7 cm | Altura: 24 cm

EMBALAGEM 1 peça

1 ■ 14724

2 ■ 14725

3 ■ 14726

4 ■ 14727



1

2

3

4

CARAMANHOLA PIVOT SMART

CARACTERÍSTICA Flexível para apertar | BPA free | Tampa Inteligente (abre e fecha) | Bico removível para limpeza | Boca larga (facilita a limpeza e abastecimento)

CAPACIDADE 560 ml

TAMANHO ø 7 cm | Altura 20 cm

EMBALAGEM 1 peça

1 ■ 14707

2 ■ 14708

4 ■ 14709

FOTOS MERAMENTE ILUSTRATIVAS. AS INFORMAÇÕES/CONFIGURAÇÕES DE PRODUTOS PODERÃO SOFRER ALTERAÇÕES SEM AVISO PRÉVIO.

ENTRE EM CONTATO COM O SEU CONSULTOR OU FALE COM O NOSSO TIME DE TELEVENDAS PELO (33) 3277-3030.

PRODUTOS EM LIQUIDAÇÃO

TSW



1



3



4



CARAMANHOLA PIVOT STANDARD

CARACTERÍSTICA Flexível para apertar | Protetor de bico | BPA free | Boca larga (facilita a limpeza e abastecimento)

CAPACIDADE 560 ml

TAMANHO ø 7 cm | Altura 18,5 cm

EMBALAGEM 1 peça

1  14732

3  14736

4  -

FOTOS MERAMENTE ILUSTRATIVAS. AS INFORMAÇÕES/CONFIGURAÇÕES DE PRODUTOS PODERÃO SOFRER ALTERAÇÕES SEM AVISO PRÉVIO.

ENTRE EM CONTATO COM O SEU CONSULTOR OU FALE COM O NOSSO TIME DE TELEVENDAS PELO (33) 3277-3030.



PRODUTOS EM LIQUIDAÇÃO



TSW



MOCHILA DE HIDRATAÇÃO Camuflado

CARACTERÍSTICA	Alça macia Faixa refletiva em 8 pontos Alça elástica externa Bolso frontal com zíper Refil interno
REFIL	2 litros Tampa com fechamento em rosca Tubo de 106 cm
TAMANHO	450 mm x 80 x 230 mm
PESO	567g
EMBALAGEM	5 peças
	15426



MOCHILA DE HIDRATAÇÃO Preto e Cinza

CARACTERÍSTICA	Faixa refletiva em 8 pontos Alça elástica externa Bolso frontal com zíper Refil interno
REFIL	2 litros Tampa com fechamento em rosca Tubo de 106 cm
TAMANHO	450mm x 80 x 230 mm
PESO	536g
EMBALAGEM	5 peças
	15425



MANOPLA MTB

MATERIAL	pvc.tpr
EMBALAGEM	100 peças

1 06907

FOTOS MERAMENTE ILUSTRATIVAS. AS INFORMAÇÕES/CONFIGURAÇÕES DE PRODUTOS PODERÃO SOFRER ALTERAÇÕES SEM AVISO PRÉVIO.

ENTRE EM CONTATO COM O SEU CONSULTOR OU FALE COM O NOSSO TIME DE TELEVENDAS PELO (33) 3277-3030.

PRODUTOS EM LIQUIDAÇÃO

TSW

SUPORTE PARA CARAMANHOLA Colors

PESO	32g
MATERIAL	Nylon
EMBALAGEM	10 peças

15519

-



BOLSA CELULAR GRANDE

CARACTERÍSTICA	Saida de fonde de ouvido Suporte a touch
TAMANHO	200x140x80mm
CAPACIDADE	2,24 litros
PESO	89g
EMBALAGEM	50 peças

07148

PROTECTOR DE QUADRO Modelo 02

MATERIAL	Neoprene
EMBALAGEM	1 peça

1 -

2 11494



FOTOS MERAMENTE ILUSTRATIVAS. AS INFORMAÇÕES/CONFIGURAÇÕES DE PRODUTOS PODERÃO SOFRER ALTERAÇÕES SEM AVISO PRÉVIO.

ENTRE EM CONTATO COM O SEU CONSULTOR OU FALE COM O NOSSO TIME DE TELEVENDAS PELO (33) 3277-3030.

PRODUTOS EM LIQUIDAÇÃO

TSW



PARALAMAS DIANTEIRO MTB Nylon Modelo 02

CARACTERÍSTICA Dianteiro | MTB | Resistente

FIXAÇÃO Abraçadeira de nylon

EMBALAGEM 10 peças

1  -

2  17747

3  -

FOTOS MERAMENTE ILUSTRATIVAS. AS INFORMAÇÕES/CONFIGURAÇÕES DE PRODUTOS PODERÃO SOFRER ALTERAÇÕES SEM AVISO PRÉVIO.

ENTRE EM CONTATO COM O SEU CONSULTOR OU FALE COM O NOSSO TIME DE TELEVENDAS PELO (33) 3277-3030.

PRODUTOS EM LIQUIDAÇÃO

TSW



1



2



3



PARALAMAS DIANTEIRO MTB Nylon Modelo 04

CARACTERÍSTICA	Dianteiro MTB Resistente
FIXAÇÃO	Abraçadeira de nylon
EMBALAGEM	10 peças

2		17753
3		-



BONÉ ORANGE

CARACTERÍSTICA	Fecho de velcro
MATERIAL	100% poliéster
EMBALAGEM	50 peças
FATOR	5

15143



FOTOS MERAMENTE ILUSTRATIVAS. AS INFORMAÇÕES/CONFIGURAÇÕES DE PRODUTOS PODERÃO SOFRER ALTERAÇÕES SEM AVISO PRÉVIO.

ENTRE EM CONTATO COM O SEU CONSULTOR OU FALE COM O NOSSO TIME DE TELEVENDAS PELO (33) 3277-3030.

TSW



BONÉ BLACK

CARACTERÍSTICA	Fecho de velcro
MATERIAL	100% poliéster
EMBALAGEM	50 peças
FATOR	5

15144



BONÉ GROUND

CARACTERÍSTICA	Fecho de velcro
MATERIAL	100% poliéster
EMBALAGEM	50 peças
FATOR	5

15145





BOLSA DE SELIM Modelo 04

CARACTERÍSTICA	Suporte de fixação no selim
TAMANHO	170x120x80mm
CAPACIDADE	1,632 litros
PESO	163g
EMBALAGEM	50 peças

1  07045

2  10501



BOLSA DE SELIM Modelo 03

CARACTERÍSTICA	Bolsa de Selim com isolamento interno resistente a água Fixação no canote e no trilho do selim com clips de nylon e fita regulável Fechamento principal com clip e velcros auxiliares Bolsinho interno de rede PVC
----------------	--

MATERIAL Nylon

TAMANHO Comprimento 24cm - Largura 10x13cm

PESO 160 gr

EMBALAGEM 20 peças

1  07044

2  10500

TSW

2



3



SELIM MTB 6748

CARACTERÍSTICA	Trilho de aço
PESO	350g
TAMANHO	280*143mm
EMBALAGEM	30 peças

1  11362

2  11360

3  -

4



SELIM MTB PRETO MOD. CR TSW-145

CARACTERÍSTICA	Trilho de Cromoly Vazado
PESO	243g
TAMANHO	260*130mm
EMBALAGEM	30 peças

 22666



TSW

SELIM MTB PRETO VASADO MOD. TSW-020

CARACTERÍSTICA	<ul style="list-style-type: none">• Vazado• Trilho de aço alta resistência• Material aço / polímero / espuma• Não acompanha castanha
----------------	---

PESO	308g
------	------

TAMANHO	282x147.5mm
---------	-------------

EMBALAGEM	30 peças
-----------	----------

22745



SUPORTE GUIDÃO AHEAD 90MM/7°

CARACTERÍSTICA	Ahead Set
EXTENSÃO	80mm/90mm/100mmx31.8mm/7°
MATERIAL	Alumínio
TAMANHO	100 mm, 80 mm, 90 mm
EMBALAGEM	50 peças
PESO	157 g

05821





PRODUTOS EM LIQUIDAÇÃO



TSW

SUP. GUIDÃO ALUM. MTB AHEAD 90MM

CARACTERÍSTICA

Suporte de guidão tsw
 Diâmetro do encaixe do guidão 31.8mm
 Comprimento 90mm
 Ângulo +-7°
 Cores disponíveis: preto/amarelo – preto/azul –
 preto/branco – preto/verde - preto/vermelho

MATERIAL

Alumínio

PESO

159g

EMBALAGEM

50 Unidades



17619



17620



-



-



17624



FOTOS MERAMENTE ILUSTRATIVAS. AS INFORMAÇÕES/CONFIGURAÇÕES DE PRODUTOS PODERÃO SOFRER ALTERAÇÕES SEM AVISO PRÉVIO.

ENTRE EM CONTATO COM O SEU CONSULTOR OU FALE COM O NOSSO TIME DE TELEVENDAS PELO (33) 3277-3030.

PRODUTOS EM LIQUIDAÇÃO

TSW



ROLO DE TREINO | Modelo 09

CARACTERÍSTICA	Sistema magnético Alavanca de controle de carga no guidão
COMPATIBILIDADE	700x38c (roda com pneu) / 29 x 2.10" (roda com pneu e eixo de 9 x 135 mm)
MATERIAL	Aço
EMBALAGEM	1 peça
	15217

FOTOS MERAMENTE ILUSTRATIVAS. AS INFORMAÇÕES/CONFIGURAÇÕES DE PRODUTOS PODERÃO SOFRER ALTERAÇÕES SEM AVISO PRÉVIO.

ENTRE EM CONTATO COM O SEU CONSULTOR OU FALE COM O NOSSO TIME DE TELEVENDAS PELO (33) 3277-3030.



FAROL 900 LUMENS

CARACTERÍSTICA Bateria recarregável via USB |
Autonomia
15h (20% de brilho)
6h (50% de brilho)
3h (100% de brilho)
8h (Flash rápido)
10h (Flash lento)
5 estágios
Lúmens 900
Especificidade 2 LED
Tempo de recarga 6 horas

EMBALAGEM 1 peça

08660

SUPORE FAROL PORTÁTIL para capacete

CARACTERÍSTICA Alça com velcro completa | 38cm

EMBALAGEM 1 peça

08663



FAROL LED TSW 600 LUMENS

CARACTERÍSTICA Bateria recarregável via USB
Base móvel | 5 estágios:
20% de brilho(13h)
50% de brilho(5h)
100% de brilho(2h30)
Flash rápido(10h)
Flash lento(8h)
Lúmens 600, 2 LED
Carga: 2h (dependendo da usb)

EMBALAGEM 1 peça

10980

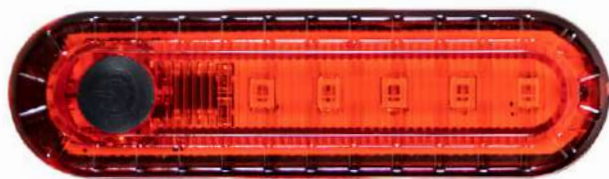

REFLETOR TRASEIRO 15 Lumens

CARACTERÍSTICA	Led vermelho Com 4 modos de iluminação Suporte para fixação no canote Cabo USB para recarga
AUTONOMIA	3h (Luz intensa) 15h (Flash alternado) 6h (Flash) 8h (Flash alternado 2)
PESO	22 g
MATERIAL	Plástico
NÍVEL DE RESISTÊNCIA À ÁGUA	IP65
TEMPO DE RECARGA	1h
EMBALAGEM	120 peças 15223

GARFO SUSPENSÃO 26" (Over com Rosca)

MATERIAL	Aço
CARACTERÍSTICA	Over Rosca Curso da Suspensão 70 mm Diâmetro da Espiga 25,4 mm Comprimento da Espiga 15 cm
FREIO	Disc Brake (Standard) V-Brake
PESO	2.39 kg
EMBALAGEM	6 peças

17871





PRODUTOS EM LIQUIDAÇÃO



TSW



GARFO 29" MTB com suspensão | Alumínio/Aço Ahead RL

MATERIAL	Aço - Kraw de Alumínio
CARACTERÍSTICA	Espiga 25cm Diâmetro 25.4mm Curso da suspensão 100mm
FREIO	Disc brake (standard) Trava Remota (Cartucho êmbolo Hidráulico SEM regulagem de retorno)
PESO APROXIMADO	29" ahead - 820g
EMBALAGEM	6 peças

← 29 →

20433

HASTE DO RETORNO 560

CARACTERÍSTICA	Haste TSW de Retorno da suspensão Salto Vermelho Kit com regulador e parafuso Compatível com suspensões TSW SALTO modelo 560 aro 29" Kit com parafuso, mola e batentes
MATERIAL	Alumínio e Aço
PESO	82 gr
EMBALAGEM	20 peças



6246

FOTOS MERAMENTE ILUSTRATIVAS. AS INFORMAÇÕES/CONFIGURAÇÕES DE PRODUTOS PODERÃO SOFRER ALTERAÇÕES SEM AVISO PRÉVIO.

ENTRE EM CONTATO COM O SEU CONSULTOR OU FALE COM O NOSSO TIME DE TELEVENDAS PELO (33) 3277-3030.

PRODUTOS EM LIQUIDAÇÃO

TSW



CUBO DIANTEIRO

CARACTERÍSTICA Cubo dianteiro | Alumínio | 32 furos com esfera | Suporte para freio a disco 6 parafusos | Eixo 9mm furado com blocagem | OLD 100mm

MATERIAL Alumínio - Eixo de aço furado

PESO 273 gr apenas o cubo
317 gr cubo + blocagem

EMBALAGEM 50 peças

DIANTEIRO 32F

20485



ABRAÇADEIRA DE SELIM MTB 34.9MM

CARACTERÍSTICA Com blocagem

MATERIAL Alumínio

EMBALAGEM 20 peças

34.9MM

1 12828



RAIO INOX PRETO

MATERIAL Inox

CARACTERÍSTICA Sem niple | 32 peças

EMBALAGEM 10 pacotes

1 274 X 2.0/1.6MM 05108

2 272 X 2.0/1.6MM 05818

FOTOS MERAMENTE ILUSTRATIVAS. AS INFORMAÇÕES/CONFIGURAÇÕES DE PRODUTOS PODERÃO SOFRER ALTERAÇÕES SEM AVISO PRÉVIO.

ENTRE EM CONTATO COM O SEU CONSULTOR OU FALE COM O NOSSO TIME DE TELEVENDAS PELO (33) 3277-3030.



PRODUTOS EM LIQUIDAÇÃO



TSW



ROAD BIKE

RODA SPEED 32 FUROS (ROSCA)

<u>MODALIDADE</u>	Road (Ciclismo de estrada)
<u>ARO</u>	700c 15 mm (interno) Válvula Fina 32 furos
<u>RAIO E NIPLES</u>	Preto

CUBO Dianteiro: 100 x 9 mm | Esfera | 32 furos | Blocação
/ Traseiro: Cubo Rosca | 7 velocidades | 130 x 9 mm
| Esfera | 32 furos | Blocação

PESO APROXIMADO 2.03kg

EMBALAGEM 1 par

17612



ARO T-7000 BLACK ROAD BIKE

<u>ARO</u>	Freio a disco Parede dupla
<u>MEDIDAS</u>	700c - 622x14.9 mm
<u>ERD</u>	575 mm
<u>FURO</u>	32 furos
<u>MATERIAL</u>	Alumínio 6061
<u>PNEU</u>	700 x 19, 700 x 30
<u>VÁLVULA</u>	Fina (Presta)
<u>PESO</u>	490g
<u>EMBALAGEM</u>	1 peça

17852

FOTOS MERAMENTE ILUSTRATIVAS. AS INFORMAÇÕES/CONFIGURAÇÕES DE PRODUTOS PODERÃO SOFRER ALTERAÇÕES SEM AVISO PRÉVIO.

ENTRE EM CONTATO COM O SEU CONSULTOR OU FALE COM O NOSSO TIME DE TELEVENDAS PELO (33) 3277-3030.

CABO CONDUÍTE DE FREIO

CARACTERÍSTICA	Cabo para freio Espiral Teflon
COMPRIMENTO	20 m
ESPESSURA	5 mm
EMBALAGEM	25 peças

14144



NÚCLEO REMOVÍVEL

PORCA DE APERTO CHANFRADA

VÁLVULAS TUBELESS PRÓ

CARACTERÍSTICA	Presta 36, 48, 60 mm Haste de válvula com núcleo removível para facilitar colocação do selante 100% Alumínio: tampa, corpo e base, mais leve e resistente
MATERIAL	Alumínio
PESO APROXIMADO	10g
EMBALAGEM	10 peças
36MM	11815
48MM	11816
60MM	-



BASE COM FURO PARA EVITAR ENTUPIÇÕES

FITA ANTI FURO BRANCA

CARACTERÍSTICA

Instalada entre o pneu e a câmara, reduz as chances de furos no pneu funcionando como uma camada extra de proteção contra objetos perfurantes

EMBALAGEM

20 peças



TAMANHO

29" x 0.5 x 40 mm

PESO APROXIMADO

57g

13755



TAMANHO

700c x 0.5 x 25 mm

PESO APROXIMADO

30g

13756

ESPAÇADOR MOVIMENTO DE DIREÇÃO 15 MM

CARACTERÍSTICA

Espaçador de movimento de direção TSW | Branco | Altura: 15 mm | Kit com 10 unidades

ESPAÇADOR

Calço para direção AHEADSET

MATERIAL

Alumínio

PESO

10 gr (a unidade)

EMBALAGEM

100 peças

4467



EIXO DIANTEIRO completo para roda T-900



<u>CARACTERÍSTICA</u>	Eixo dianteiro TSW em alumínio vazado com rolamentos Eixo dianteiro completo vazado com rolamentos OLD 100 mm Rolamento de esferas de sulco profundo Id (diâmetro interno do rolamento): 15 mm Od (diâmetro externo do rolamento): 28 mm Largura do rolamento: 7 mm
<u>COMPATIBILIDADE</u>	Compatível com suspensões que possuem eixo de 9 mm
<u>MEDIDA DO ROLAMENTO</u>	6902-2rs
<u>FECHOS DO ROLAMENTO</u>	2 selados
<u>LUBRIFICAÇÃO DO ROLAMENTO</u>	Graxa
<u>DIMENSÕES DO ROLAMENTO</u>	15 x 28 x 7 mm
<u>MATERIAL</u>	Alumínio
<u>PESO</u>	82 gr
<u>EMBALAGEM</u>	20 peças

5807



MANÔMETRO de Nylon para bomba

<u>CARACTERÍSTICA</u>	Manômetro analógico TSW Preta Bomba oficina Kit 1 unidade
<u>MATERIAL</u>	Plástico
<u>PRESSÃO MÁXIMA</u>	145PSI/ 10BAR
<u>PESO</u>	30 gr
<u>EMBALAGEM</u>	50 peças

8203



FITA DEMARCADORA

<u>CARACTERÍSTICA</u>	Leitosa
<u>TAMANHO ROLO</u>	10x00.8cm
<u>EMBALAGEM</u>	1 rolo

08061



PRODUTOS EM LIQUIDAÇÃO



TSW



TRANSBIKE FORCE 2

CARACTERÍSTICA	Transbike de engate Fixado por parafuso sextavado (24 mm) Reclinável	SINALIZAÇÃO	Luz do freio Setas Lanterna traseira
TAMANHO	107 x 56 x 88 cm	LUZES DE LED	Não
CAPACIDADE DE CARGA	30 kg	TRAVAS	Suporte de quadros e engate com trava por chave Suporte de rodas com engate rápido e ajuste micrométrico
PESO	13.63 kg	EMBALAGEM	1 peça
CONECTOR DE ENERGIA	7-Pin		
ADAPTADOR PARA 13-PIN	Não incluso		14382

EXPOSITOR para capacete

CARACTERÍSTICA	Para usar em <i>slatwall</i>
MATERIAL	Nylon
EMBALAGEM	10 peças

1  04510

2  05037



FOTOS MERAMENTE ILUSTRATIVAS. AS INFORMAÇÕES/CONFIGURAÇÕES DE PRODUTOS PODERÃO SOFRER ALTERAÇÕES SEM AVISO PRÉVIO.

ENTRE EM CONTATO COM O SEU CONSULTOR OU FALE COM O NOSSO TIME DE TELEVENDAS PELO (33) 3277-3030.

TSW

EXPOSITOR DE SAPATILHA

CARACTERÍSTICA	Peça em nylon para 1 sapatilha
EMBALAGEM	1 peça

1  06519

2  06520



PARAFUSO FIXAÇÃO superior prendedor Transbike Force

19417

ABASTEÇA SEU ESTOQUE



PRODUTOS EM LIQUIDAÇÃO

RAVA



Quadro Pressure MTB 29" Rava 2023

CARACTERÍSTICA

Cabos de marcha interno
Eixo traseiro 135 x 9mm

Observação: quadro 17" com
dois suportes de caramanhola

DIREÇÃO

Mega over semi-integrada
(44 x 44mm)

CANOTE

27.2 mm

FREIO

Disc brake standard

TUBO MOVIMENTO CENTRAL

BSA 68 mm (34.7 X 68MM)

MOVIMENTO CENTRAL

34.7 mm

PNEU

Largura máxima de 29 x 2.2
(Com cravos baixos)

MATERIAL

Alumínio 6061

PESO APROXIMADO

17" - 1930 g

EMBALAGEM

2 peças

PRETO E AMARELO

15.5" 22813

17" 22819

19" 22825

PRETO E AZUL

15.5" 22815

17" 22821

19" 22827

PRETO E BRANCO

15.5" 22817

17" 22823

19" 22829

PRETO E VERDE

15.5" 22814

17" -

19" 22826

PRETO E PINK

15.5" -

17" 22822

PRETO E VERMELHO

15.5" 22818

17" -

19" 22830

FOTOS MERAMENTE ILUSTRATIVAS. AS INFORMAÇÕES/CONFIGURAÇÕES DE PRODUTOS PODERÃO SOFRER ALTERAÇÕES SEM AVISO PRÉVIO.

ENTRE EM CONTATO COM O SEU CONSULTOR OU FALE COM O NOSSO TIME DE TELEVENDAS PELO (33) 3277-3030.

RAVA



SUGEST MOVIMENTO DE DIREÇÃO

MEGA OVER 13115



SUGEST GARFO SUSPENSÃO

29" 8527 / 8881



Quadro Pressure MTB 29" Rava 2021

DIREÇÃO Mega Over de 44 mm

CANOTE 27.2 mm

FREIO Disc brake standard

TUBO MOVIMENTO CENTRAL BSA 68 mm

MOVIMENTO CENTRAL 34.7 mm

PNEU Largura máxima de 29 x 2.2

MATERIAL Alumínio 6061

ACABAMENTO Adesivo não envernizado

PESO APROXIMADO 17" - 1800 g

EMBALAGEM 2 peças

29

17  15311

19  15316



Quadro Pressure MTB 29" Rava 2021

DIREÇÃO Mega Over de 44 mm

CANOTE 27.2 mm

FREIO Disc brake standard

TUBO MOVIMENTO CENTRAL BSA 68 mm

MOVIMENTO CENTRAL 34.7 mm

PNEU Largura máxima de 29 x 2.2

MATERIAL Alumínio 6061

ACABAMENTO Adesivo não envernizado

PESO APROXIMADO 17" - 1800 g

EMBALAGEM 2 peças

SUGEST MOVIMENTO DE DIREÇÃO

MEGA OVER 13115



SUGEST GARFO SUSPENSÃO

29" 8527 / 8881



PRODUTOS EM LIQUIDAÇÃO

RAVA



Quadro Pressure MTB 29" Rava 2021

DIREÇÃO	Mega Over de 44 mm
CANOTE	27.2 mm
FREIO	Disc brake standard
TUBO MOVIMENTO CENTRAL	BSA 68 mm
MOVIMENTO CENTRAL	34.7 mm
PNEU	Largura máxima de 29 x 2.2
MATERIAL	Alumínio 6061
ACABAMENTO	Adesivo não envernizado
PESO APROXIMADO	17" - 1800 g
EMBALAGEM	2 peças

SUGEST MOVIMENTO DE DIREÇÃO

MEGA OVER 13115



SUGEST GARFO SUSPENSÃO

29" 8527 / 8881



29

17  15313



Quadro Pressure MTB 29" Rava 2021

DIREÇÃO	Mega Over de 44 mm
CANOTE	27.2 mm
FREIO	Disc brake standard
TUBO MOVIMENTO CENTRAL	BSA 68 mm
MOVIMENTO CENTRAL	34.7 mm
PNEU	Largura máxima de 29 x 2.2
MATERIAL	Alumínio 6061
ACABAMENTO	Adesivo não envernizado
PESO APROXIMADO	17" - 1800 g
EMBALAGEM	2 peças

SUGEST MOVIMENTO DE DIREÇÃO

MEGA OVER 13115



SUGEST GARFO SUSPENSÃO

29" 8527 / 8881



29

17  15315

FOTOS MERAMENTE ILUSTRATIVAS. AS INFORMAÇÕES/CONFIGURAÇÕES DE PRODUTOS PODERÃO SOFRER ALTERAÇÕES SEM AVISO PRÉVIO.

ENTRE EM CONTATO COM O SEU CONSULTOR OU FALE COM O NOSSO TIME DE TELEVENDAS PELO (33) 3277-3030.



PRODUTOS EM LIQUIDAÇÃO



RAVA



Quadro Pressure MTB 29" | Cabeamento Interno

QUADRO	Rava MTB Pressure 29" Cabeamento da marcha interno Suporte de freio Standard Eixo traseiro 135 mm x 9 mm Blocação de rodas, canote e selim
DIREÇÃO	Mega Over semi-integrada de 44 mm
CANOTE	27.2 mm
CAIXA CENTRAL	BSA 68 mm
PNEU	Largura máxima de 29 x 2.2 (com cravos baixos)
MATERIAL	Alumínio 6061
PESO APROXIMADO	17" - 1800 g

CINZA

15.5 20052

17 20057

19 20060

LARANJA/VERMELHO

15.5 20048

17 20053

19 20058

VERDE

15.5 20049

17 20054

FLAMINGO

15.5 20050

17 20055

AZUL

15.5 20051

17 20056

19 20059

FOTOS MERAMENTE ILUSTRATIVAS. AS INFORMAÇÕES/CONFIGURAÇÕES DE PRODUTOS PODERÃO SOFRER ALTERAÇÕES SEM AVISO PRÉVIO.

ENTRE EM CONTATO COM O SEU CONSULTOR OU FALE COM O NOSSO TIME DE TELEVENDAS PELO (33) 3277-3030.

PRODUTOS EM LIQUIDAÇÃO

RAVA



KIT Quadro Pressure 29" RS

DIREÇÃO	Mega Over de 44 mm
CANOTE	27.2 mm
FREIO	Disc brake standard
TUBO MOVIMENTO CENTRAL	BSA 68 mm
MOVIMENTO CENTRAL	34.7 mm
PNEU	Largura máxima de 29 x 2.2
MATERIAL	Alumínio 6061
ACABAMENTO	Adesivo não envernizado
PESO APROXIMADO	17" - 1800 g
EMBALAGEM	7 peças

17  20551

17  20552

17  20553

17  20554

KIT de Montagem X-Time

GUIDÃO	X-Time Reto 720 x 31.8 mm 9° backsweep Alumínio
SUPORTE DE GUIDÃO	X-Time Ahead set 90 x 31.8 mm / 7° Alumínio
CANOTE	X-Time 31.6 x 350 mm Parafuso único Alumínio
ABRACADEIRA	X-Time Blocação 34.9 mm Alumínio
EMBALAGEM	20 pçs

KIT Garfo Judy

CARACTERÍSTICA	Garfo Suspensão Rock Shox Judy 29" Curso 100 mm Trava Remota Ajuste de Preload Off set 46 mm OLD 100 mm Eixo 9 mm Espiga Tapered (26.5cm) Diâmetro Máximo do Pneu 755 mm Largura Máxima do Pneu 62 mm Tamanho Máximo do Rotor 185mm Tamanho mínimo do rotor 160 mm Trava PopLoc Remote (puxador de cabo de 17 mm) Sistema de fixação do Caliper Post Mount.
MATERIAL	Alumínio e Aço
PESO	2.328 gr
EMBALAGEM	1 peça

KIT Trava Remote Rock Shox

CARACTERÍSTICA	Botão da Trava Suspensão Rock Shox Poploc Esquerda 17mm Compatível com qualquer suspensão Rock Shox como: XC30 - Recon - XC 32 - Reba - XC 28 - Judy Acompanha cabos e condutas para montagem Puxar 17 mm
MATERIAL	Alumínio
PESO	69 gr
EMBALAGEM	20 peças

FOTOS MERAMENTE ILUSTRATIVAS. AS INFORMAÇÕES/CONFIGURAÇÕES DE PRODUTOS PODERÃO SOFRER ALTERAÇÕES SEM AVISO PRÉVIO.

ENTRE EM CONTATO COM O SEU CONSULTOR OU FALE COM O NOSSO TIME DE TELEVENDAS PELO (33) 3277-3030.



PRODUTOS EM LIQUIDAÇÃO



RAVA



KIT Quadro Pressure 29"

QUADRO Rava MTB Pressure 29" | Cabeamento da marcha interno | Suporte de Freio Standard | Eixo traseiro 135 mm x 9 mm | Blocação de rodas, canote e selim

DIREÇÃO Mega Over semi-integrada de 44 mm

CANOTE 27.2 mm

CAIXA CENTRAL BSA 68 mm

PNEU Largura máxima de 29 x 2.2 (com cravos baixos)

MATERIAL Alumínio 6061

PESO APROXIMADO 17" - 1800 g

EMB. 2 pçs

KIT de Montagem X-Time

GUIDÃO X-Time | Rise bar | 720 x 31.8 mm | 9° backsweep | Rise 20 mm | Alumínio

SUPOORTE DE GUIDÃO X-Time | Ahead set | 70 x 31.8 mm / 7° | Alumínio

CANOTE X-Time | 27.2 x 350 mm | Parafuso único | Alumínio

ABRAÇADEIRA X-Time | Blocação | 31.8 mm | Alumínio

PESO 830 gr

KIT Garfo Rava

CARACTERÍSTICA Comprimento da espiga 20.2cm | Espiga Ahead Set | Curso da Suspensão 90mm | Diâmetro da Espiga 25.4mm | Freio: Disc Brake (Standard) | Kraw Alumínio | Lower Leg de aço | Eixo de 9 mm | OLD 100 mm | Preto | MTB

MATERIAL Aço - Kraw de alumínio

PESO 2.608 kg

KIT Selim MTB Rava

MODELO MTB

TRILHO Aço

TAMANHO 140 x 270 mm

PESO 294 g

LARANJA/VERMELHO	VERDE	FLAMINGO	AZUL	CINZA
15.5 20535	15.5 20536	15.5 20537	15.5 20538	15.5 20539
17 20540	17 20541	17 20542	17 20543	17 20544
19 20545			19 20546	19 20548

FOTOS MERAMENTE ILUSTRATIVAS. AS INFORMAÇÕES/CONFIGURAÇÕES DE PRODUTOS PODERÃO SOFRER ALTERAÇÕES SEM AVISO PRÉVIO.

ENTRE EM CONTATO COM O SEU CONSULTOR OU FALE COM O NOSSO TIME DE TELEVENDAS PELO (33) 3277-3030.



PRODUTOS EM LIQUIDAÇÃO



RAVA



Garfo 29" com Suspensão Rava

CARACTERÍSTICA Comprimento da espiga 20.2cm | Espiga Ahead Set | Curso da Suspensão 90mm | Diâmetro da Espiga 25.4mm | Freio: Disc Brake (Standard) | Kraw Alumínio | Lower Leg de aço | Eixo de 9 mm | OLD 100 mm | Preto | MTB

MATERIAL Aço - Kraw de alumínio

PESO 2.608 kg

EMBALAGEM 6 peças

20509



Garfo MTB 29" com Suspensão Alumínio Ahead Salto TM Preto Rava

CARACTERÍSTICA Espiga de alumínio com comprimento de 27,5cm, Curso da Suspensão 100mm, Diâmetro da Espiga 28mm, Freio: Disc brake (Post Mount), Trava manual (Cartucho Êmbolo Hidráulico SEM regulagem de retorno), Lower Leg de alumínio, OLD 100mm, Eixo 9mm, Regulagem de preload

MATERIAL Lower Leg Alumínio - Kraw de alumínio | Espiga Alumínio | Canelas Aço

PESO 2.364 g

EMBALAGEM 6 peças

12895

FOTOS MERAMENTE ILUSTRATIVAS. AS INFORMAÇÕES/CONFIGURAÇÕES DE PRODUTOS PODERÃO SOFRER ALTERAÇÕES SEM AVISO PRÉVIO.

ENTRE EM CONTATO COM O SEU CONSULTOR OU FALE COM O NOSSO TIME DE TELEVENDAS PELO (33) 3277-3030.



PRODUTOS EM LIQUIDAÇÃO



RAVA



Garfo 26" Suspensão Rava (Rosca)

CARACTERÍSTICA	Over Com rosca 70 mm de curso Freio a disco Standard / V-Brake
MATERIAL	Aço
PESO	2.39 g
EMBALAGEM	6 peças
	17870

Garfo 29" Suspensão Rava

CARACTERÍSTICA	Ahead set 1 - 1/8" 70 mm de curso Freio a disco Standard
MATERIAL	Aço
PESO	2.625 g
EMBALAGEM	6 peças
	15547



FOTOS MERAMENTE ILUSTRATIVAS. AS INFORMAÇÕES/CONFIGURAÇÕES DE PRODUTOS PODERÃO SOFRER ALTERAÇÕES SEM AVISO PRÉVIO.

ENTRE EM CONTATO COM O SEU CONSULTOR OU FALE COM O NOSSO TIME DE TELEVENDAS PELO (33) 3277-3030.

Garfo MTB 29" com Suspensão Rava

CARACTERÍSTICA

Comprimento da espiga: 20.2cm | Espiga Ahead Set | Curso da suspensão 100mm | Diâmetro da espiga: 25.4mm | Freio: Disc Brake (Standard) | Kraw alumínio | Lower leg de aço | Eixo 9mm | Old 100mm

MATERIAL

Aço

PESO

2.634 kg

EMBALAGEM

6 peças

22836



Aro 29" X32F Modelo 03 Rava

ARO

Dupla camada | Tubeless Ready | 32 furos | Preto

MEDIDAS

29" - 622x23mm

PSI MÁXIMO

80 - 40

ERD

600mm

FREIO

Disc Brake

MATERIAL

Alumínio 6063

PNEU

1.5" até 2.4"

VÁLVULA

Fina (Presta)

PESO

APROXIMADO

550g (O peso informado pode ter variação de 5% para mais ou para menos devido ao processo de extrusão.)

EMBALAGEM

10 peças

MOUNTAIN BIKE / CICLOTURISMO



32F

17231

Aro 29" X 32F Alumínio MTB Preto Rava

ARO Aro 29" | 19 mm interno
Alumínio | ETRTO 584
mm
Folha dupla | 32 Furos
Largura recomendada
da seção do pneu 1"
2.30"(mínima x máxima)
| Disc Brake

**PESO
APROXIMADO** 535g

EMBALAGEM 10 peças

IMPORTADO

20584



Aro 29" X 32F / 36F Modelo 02 Rava

MOUNTAIN BIKE/ CICLOTURISMO

ARO Dupla camada

MEDIDAS 29" - 622x19mm

PSI MÁXIMO 110 - 48

ERD 584mm

FREIO Disc brake

MATERIAL Alumínio 6063

PNEU 1.0" até 2.2"

VÁLVULA Grossa (Americana)

PESO APROX. 550g (O peso informado pode ter variação de 5% para mais ou para menos devido ao processo de extrusão.)

EMBALAGEM 10 peças



32F 17229

36F -





PRODUTOS EM LIQUIDAÇÃO



RAVA



Camisa Pro Line Rava

CARACTERÍSTICA	Microfilamento 100% poliéster
PROTEÇÃO	UV-30
EMBALAGEM	1 peça

P		21216	P		21219	P		21222
M		21217	M		21220			

FOTOS MERAMENTE ILUSTRATIVAS. AS INFORMAÇÕES/CONFIGURAÇÕES DE PRODUTOS PODERÃO SOFRER ALTERAÇÕES SEM AVISO PRÉVIO.

ENTRE EM CONTATO COM O SEU CONSULTOR OU FALE COM O NOSSO TIME DE TELEVENDAS PELO (33) 3277-3030.

PRODUTOS EM LIQUIDAÇÃO

RAVA



Camisa Ride Line Rava

CARACTERÍSTICA

Tecido de alta qualidade | Elástico na borda inferior da camisa | Gola alta com fechamento em zíper | Zíper com Smart Lock (controle de trava do zíper) fornecendo assim controle da abertura e ventilação | Manga curta

Bolsos: 3 bolsos traseiros para acondicionar utensílios

PROTEÇÃO

UV-30

MATERIAL

100% poliéster

EMBALAGEM

1 peça

P  21202

P  21208

P  21212

M  -

M  21209

M  21213

G  -

G  21210

G  -

FOTOS MERAMENTE ILUSTRATIVAS. AS INFORMAÇÕES/CONFIGURAÇÕES DE PRODUTOS PODERÃO SOFRER ALTERAÇÕES SEM AVISO PRÉVIO.

ENTRE EM CONTATO COM O SEU CONSULTOR OU FALE COM O NOSSO TIME DE TELEVENDAS PELO (33) 3277-3030.



PRODUTOS EM LIQUIDAÇÃO



RAVA



Bermuda Pro Line Rava

CARACTERÍSTICA

Microfilamento poliéster + elastano
Forro: D-40

PROTEÇÃO

UV-30

EMBALAGEM

1 peça

P  21193

P  21196

P  21199

FOTOS MERAMENTE ILUSTRATIVAS. AS INFORMAÇÕES/CONFIGURAÇÕES DE PRODUTOS PODERÃO SOFRER ALTERAÇÕES SEM AVISO PRÉVIO.

ENTRE EM CONTATO COM O SEU CONSULTOR OU FALE COM O NOSSO TIME DE TELEVENDAS PELO (33) 3277-3030.

PRODUTOS EM LIQUIDAÇÃO

RAVA



Bermuda Ride Line Rava

CARACTERÍSTICA

Bermuda esportiva | Possui ótimo ajuste ao corpo garantindo conforto e elasticidade para prática de ciclismo

Possui bolso lateral | Confeccionada também com lycra dupla na barra gerando maior conforto e liberdade de movimento durante a prática do exercício

Forro com densidade D-40 de espuma com ação antibacteriana

PROTEÇÃO

UV-50

MATERIAL

94% poliéster e 6% elastano

EMBALAGEM

1 peça

P  21174

P  21185

P  21189

FOTOS MERAMENTE ILUSTRATIVAS. AS INFORMAÇÕES/CONFIGURAÇÕES DE PRODUTOS PODERÃO SOFRER ALTERAÇÕES SEM AVISO PRÉVIO.

ENTRE EM CONTATO COM O SEU CONSULTOR OU FALE COM O NOSSO TIME DE TELEVENDAS PELO (33) 3277-3030.



PRODUTOS EM LIQUIDAÇÃO



RAVA



Capacete MTB Rava Space 3 | Brilho

CARACTERÍSTICA	In Mold Regulável Viseira
ENGATE	Sistema de engate em "Y"
VENTILAÇÃO	18 canais de ventilação
PESO APROXIMADO	180 g
EMBALAGEM	10 peças

TAMANHO MÉDIO: 54-58

1		16080
3		16078
4		16083
5		16082
6		16081
7		16077

TAMANHO GRANDE: 57-61

2		16071
3		16070
4		16075
5		16074
6		16073
7		16069

FOTOS MERAMENTE ILUSTRATIVAS. AS INFORMAÇÕES/CONFIGURAÇÕES DE PRODUTOS PODERÃO SOFRER ALTERAÇÕES SEM AVISO PRÉVIO.

ENTRE EM CONTATO COM O SEU CONSULTOR OU FALE COM O NOSSO TIME DE TELEVENDAS PELO (33) 3277-3030.

PRODUTOS EM LIQUIDAÇÃO

RAVA

Capacete Little Child Rava Play

CARACTERÍSTICA Tamanho único 56 cm

EMBALAGEM 50 peças

2  15472



Capacete com kit proteção Little Child Rava Play

CARACTERÍSTICA Tamanho único 56 cm | Acompanha kit de proteção

KIT PROTEÇÃO Par de joelheiras | Par de cotoveleiras | Par de munhequeiras

EMBALAGEM 40 peças

 15482

 15481

 15484

FOTOS MERAMENTE ILUSTRATIVAS. AS INFORMAÇÕES/CONFIGURAÇÕES DE PRODUTOS PODERÃO SOFRER ALTERAÇÕES SEM AVISO PRÉVIO.

ENTRE EM CONTATO COM O SEU CONSULTOR OU FALE COM O NOSSO TIME DE TELEVENDAS PELO (33) 3277-3030.

PRODUTOS EM LIQUIDAÇÃO

RAVA



Caramanhola Pivot Smart Rava

CARACTERÍSTICA

Flexível para apertar | BPA free | Tampa Inteligente (abre e fecha) | Bico removível para limpeza | Boca larga (facilita a limpeza e abastecimento)

CAPACIDADE

560 ml

TAMANHO

ø 7 cm | Altura: 20 cm

EMBALAGEM

01 peça

1  14711

2  14712



Caramanhola Fast Rava

CARACTERÍSTICA

Flexível para apertar | Tampa Inteligente (abre e fecha) | Bico removível para limpeza | Boca larga (facilita a limpeza e abastecimento) | BPA free | Alça de transporte

CAPACIDADE

650 ml

TAMANHO

ø 7 cm | Altura: 24 cm

EMBALAGEM

01 peça

1  14728

2  14729

FOTOS MERAMENTE ILUSTRATIVAS. AS INFORMAÇÕES/CONFIGURAÇÕES DE PRODUTOS PODERÃO SOFRER ALTERAÇÕES SEM AVISO PRÉVIO.

ENTRE EM CONTATO COM O SEU CONSULTOR OU FALE COM O NOSSO TIME DE TELEVENDAS PELO (33) 3277-3030.



Suporte para Caramanhola Rava

MATERIAL	Nylon
OBSERVAÇÃO	Parafusos não inclusos
EMBALAGEM	100 peças
	13135

Selim MTB Pictoris Rava

MODELO	MTB
TRILHO	Aço
TAMANHO	275x133 mm
PESO	396g
EMBALAGEM	25 peças



12594



PRODUTOS EM LIQUIDAÇÃO

RAVA



Protetor de Quadro RAVA

MATERIAL

EMBALAGEM 1 peça

 11497



Boné Rava

CARACTERÍSTICA Fecho de velcro

MATERIAL 100% poliéster

EMBALAGEM 50 peças

FATOR 5

15148

FOTOS MERAMENTE ILUSTRATIVAS. AS INFORMAÇÕES/CONFIGURAÇÕES DE PRODUTOS PODERÃO SOFRER ALTERAÇÕES SEM AVISO PRÉVIO.

ENTRE EM CONTATO COM O SEU CONSULTOR OU FALE COM O NOSSO TIME DE TELEVENDAS PELO (33) 3277-3030.

KIT pressure 12v

COLIGADA 6



29"
WHEELS

Urbana

Alumínio

Mega Over

12 velocidades

Disco Hidráulico

QUADRO

Quadro Rava MTB Pressure 29" | Caixa central BSA 68 mm | Suporte de Freio Standard | Eixo traseiro 135 mm x 9 mm | Largura do pneu 2.20 (com cravos baixos) | Alumínio 6061 | Cabeamento da marcha interno | Direção Mega Over semi-integrada caixa 44 mm | Tubo do canote 27.2 mm |

SUSPENSÃO DIANTEIRA

Suspensão TSW | Eixo de 9 mm | Ahead set | Trava Remota | OLD 100mm | Kraw alumínio | Lower Leg de aço

SUSPENSÃO TRASEIRA

N/A

MOVIMENTO DE DIREÇÃO

Direção Mega Over | Semi-integrada | Esferada

GUIDÃO

X-Time | Alumínio | Reto | 31.8 x 740 mm | 9° backsweep

SUPORTE DE GUIDÃO

X-Time | Ahead | Alumínio | 31.8 x 90 mm | +-7°

MANOPLA

MTB | Preta

CONJUNTO DE FREIO

X-Time | Hidráulico | Abraçadeira | Reservatório de alumínio | Óleo mineral | Caliper 2 pistões

DISCO DE FREIO

X-Time | 160 mm | 06 parafusos | Aço

ARO/RAIO

Rava | Alumínio 6063 | 622x19mm | ERD 584 mm | Parede dupla | 32F | Raio preto

CUBOS

Cubo X-Time | Rolamentado | Alumínio | Bloagem | Freehub standard | 32 furos

PNEU / CÂMARA DE AR

Pneu: Arisun Skinwall Mount Bona 29x2.10
Câmara: Arisun 29" | Válvula americana

PEDIVELA

X-Time Ponta Quadrada | Single | Coroa 32D Aço | Braço Alumínio | BCD 104mm

CORRENTE

Corrente 12S | SUMC/xtime | Missing link / Power Link

EIXO CENTRAL

34.7 x 110 mm | Ponta Quadrada | Aço | Rolamentos

CASSETE

X-TIME | Index | 12 velocidades | Aranha dos Cogs superiores de alumínio | 11/52D. (11-13-15-18-21-23-26-30-34-40-46-52)

CÂMBIO DIANTEIRO

N/A

CÂMBIO TRASEIRO

XTIME 12V | Roldanas 12D. | Corpo em Alumínio | Cage de Aço | Guia do Caço de Nylon | Tecnologia U-Pulley (onde um dente é maior que o outro para melhor encaixe na corrente)

ALAVANCA

XTIME 12V. | Alumínio/ Plástico

SELIM

Rava MTB | Trilho de aço | Vazado

CANOTE

X-Time | Alumínio | 27.2 x 350 mm | Carrinho | Parafuso único

ABRAÇADEIRA

X-Time | Alumínio | 31.8 | Bloagem

PEDAL

Inglês | Preto | Nylon

URBANA

✓

CICLOTURISMO

X

TRILHAS

X

29"
IMPORTADA

15.5 ■ 20477

17 ■ 20478

19 ■ 20479

PRODUTOS EM LIQUIDAÇÃO

RAVA



KIT Quadro Mtb Nazca

MODELO	29" Boost 148mm x 12mm Cabeamento interno Dois suportes de caramanhola
DIREÇÃO	Tapared semi-integrada (44 x 55mm)
CANOTE	Diâmetro 31.6mm Passagem de cabo para canote retrátil
FREIO	Suporte de freio traseiro Post Mount dentro do Chainstay
MOVIMENTO CENTRAL	BSA 34.7 x 73mm
EIXO	Eixo traseiro m12 x 1.5mm - 170mm
PNEU	Diâmetro máximo 2.40 (60-622) cravos baixos
MATERIAL	Alumínio 6061
PESO	1.970g ("M" incluindo eixo e acessórios)

LIMITE DE COROA

Este modelo de quadro é apenas para uma coroa.

AZUL/CINZA

15.5  22791

17  -

VERMELHO/CINZA

15.5  22790

CINZA

15.5  22792

17  -

CINZA/VERMELHO F

15.5  22793

KIT Trava

CARACTERÍSTICA

Botão da Trava Suspensão Rock Shox Poploc Esquerda 17mm | Compatível com qualquer suspensão Rock Shox como: XC30 - Recon - XC 32 - Reba - XC 28 - Judy | Acompanha cabos e conduítes para montagem | Puxar 17 mm

MATERIAL

Alumínio

PESO

69 gr

EMBALAGEM

20 peças

KIT Garfo Judy

CARACTERÍSTICA

Garfo Suspensão Rock Shox Judy 29" | Curso 100 mm | Trava Remota | Ajuste de Preload | Off set 46 mm | OLD 100 mm | Eixo 9 mm | Espiga Tapered (26.5cm) | Diâmetro Máximo do Rotor 755 mm | Largura Máxima do Pneu 62 mm | Tamanho Máximo do Rotor 185mm | Tamanho mínimo do rotor 160 mm | Trava PopLoc Remote (puxador de cabo de 17 mm) | Sistema de fixação do Caliper Post Mount.

MATERIAL

Alumínio e Aço

PESO

2.328 gr

EMBALAGEM

1 peça

KIT de Montagem

GUIDÃO

X-Time | Reto | 720 x 31.8 mm | 9° backsweep | Alumínio

SUORTE DE GUIDÃO

X-Time | Ahead set | 90 x 31.8 mm / 7° | Alumínio

CANOTE

X-Time | 31.6 x 350 mm | Parafuso único | Alumínio

ABRACADEIRA

X-Time | Blocagem | 34.9 mm | Alumínio

EMBALAGEM

20 pçs

KIT Movimento de Direção Super Over Ahead

CARACTERÍSTICA

Ahead Set Tapered | Direção 1 1/8x44mm | Integrado (c/ caixas)

MODELO

Com adaptador para garfo 30mm e 39.8mm

EXTENSÃO

1.5x1.1/8

FOTOS MERAMENTE ILUSTRATIVAS. AS INFORMAÇÕES/CONFIGURAÇÕES DE PRODUTOS PODERÃO SOFRER ALTERAÇÕES SEM AVISO PRÉVIO.

ENTRE EM CONTATO COM O SEU CONSULTOR OU FALE COM O NOSSO TIME DE TELEVENDAS PELO (33) 3277-3030.



Castanha de Selim Completa

CARACTERÍSTICA

Castanha de selim Rava | Aço de alta resistência preto | Eixo quadrado com duas porcas e dois conjuntos de abraçadeiras laterais para ua melhor fixação ao selim

MATERIAL

Aço

PESO

146 gr

EMBALAGEM

50 peças

22693

ABASTEÇA SEU ESTOQUE



metz



PRODUTOS EM LIQUIDAÇÃO



metz



PRETO/VERMELHO

15.5  19381

17  19384

19  19385



PRETO/VERDE

15.5  19386

17  19387

19  19388



PRETO/ROSA

15.5  19389

17  19390



Quadro Metz Fuse 29"

DIREÇÃO Mega Over de 44 mm

CANOTE 27.2 mm

FREIO Disc brake IS (international Standard)

TUBO MOVIMENTO CENTRAL BSA 68 mm

MOVIMENTO CENTRAL 34.7 mm

MATERIAL Alumínio

ACABAMENTO Adesivo não envernizado

PESO 1.82 kg (17")

EMBALAGEM 2 peças

FOTOS MERAMENTE ILUSTRATIVAS. AS INFORMAÇÕES/CONFIGURAÇÕES DE PRODUTOS PODERÃO SOFRER ALTERAÇÕES SEM AVISO PRÉVIO.

ENTRE EM CONTATO COM O SEU CONSULTOR OU FALE COM O NOSSO TIME DE TELEVENDAS PELO (33) 3277-3030.

ABASTEÇA SEU ESTOQUE



X-TIME



Conjunto Câmbio X-TIME 12V | Modelo 2

CARACTERÍSTICAS	Conjuntos de transmissão de 1x12 velocidades de alta precisão e durabilidade.
CASSETE	X-TIME Index 12 velocidades 11/52 dentes (11-13-15-18-21-23-26-30-34-40-46-52) possui mudança estável e suave Melhor performance e eficiência Encaixe padrão Shimano K7 Aranha os últimos COGs de alumínio. Peso: 721 g
CÂMBIO TRASEIRO	X-TIME 12 velocidades Mais resistência e segurança na fixação Roldanas com 12 dentes Rolamento selado sistema de dentes U-Pulley (onde um dente é maior que o outro para melhor encaixe na corrente). Peso: 314 g
ALAVANCAS	X-TIME 12 velocidades Estrutura em alumínio e acabamento plástico Regulador de tenção Acompanha cabo de aço (cabo de aço comum NÃO é inox). Na mesma alavanca pode-se efetuar a descida e subida das marchas impulsionando com o polegar. Peso: 144 g
CORRENTE	X-TIME Index de 12 velocidades 128 links Cromada Acompanha emenda de engate rápido (Power Link). Peso: 269 g
PEDIVELA	X-TIME 12 velocidades Single Alumínio Braço: 170 mm Coroa: Direct Mount Chainring 32 T 3 mm offset Alumínio Eixo: 120 x 24 mm (padrão Hollowtech II) Aço Eixo do pedal: 9/16 Inglês Acompanha movimento central Peso: 879 g (completo com movimento central)
EMBALAGEM	10 kits (caixa fechada) Kit com 6 peças (incluindo movimento central)

19152

Engrenagem Dupla com Braço 36/22

CARACTERÍSTICA	Engrenagem dupla Braço de alumínio com 170mm Coroas 36/22D Fixas de aço Sistema de encaixe compatível com eixo central ponta quadrada Diâmetro da rosca do pedal 9/16 (inglês) Preto
MATERIAL	Braço: Alumínio Rosca do pedal: 9/16 Coroas 36/22D: aço
CONJUNTO DE COROA	36/22D
COMPRIMENTO DO BRAÇO	170 mm
PESO	686 gr
EMBALAGEM	10 peças
	20504



Engrenagem Tripla

CARACTERÍSTICA	Engrenagem tripla Braço de alumínio com 170mm Coroas 40/30/22D fixadas por parafusos Sistema de encaixe compatível com eixo central ponta quadrada BCD 96/64mm Diâmetro da rosca do pedal 9/16 Inglês
MATERIAL	Braço: alumínio Coroa 40D: alumínio Coroas 30/22D: aço
TAMANHO DO BRAÇO	170 mm
CONJUNTO DE COROA	40/30/22D
MEDIDA DO BCD	69 mm / 64 mm
EMBALAGEM	10 peças
PESO	794 gr
	20476



Engrenagem Tripla 24/34/42D

CARACTERÍSTICA	Com braço 170mm compatível com eixo ponta quadrada
BCD	-
MATERIAL	-
COROA	Aço
EMBALAGEM	12 peças
130 MM	20107



Engrenagem Direct Single Avulsa MTB Off Set 6 mm

CARACTERÍSTICA	Compatível com Sram®, Direct mount, Off set 3 mm
MATERIAL	Alumínio 7075
DENTES	30 D, 32 D, 34 D
MEDIDA DO BCD	69 mm / 64 mm
EMBALAGEM	10 peças
PESO	30 – 57g 32 – 63g 34 – 66g
30 D	13152



Engrenagem Direct Single Avulsa MTB Off Set 3 mm

CARACTERÍSTICA	Direct mount Compátivel com Sram®
MATERIAL	Alumínio 7075
ENGENHAGENS	30 32 34 D
PESO	30 – 57 g 32 – 63 g 34 – 66 g
EMBALAGEM	10 peças
30D	-
32D	13150

FOTO ILUSTRATIVA
DA EMBALAGEM



Engrenagem Direct Single Avulsa MTB Off Set 0 mm

CARACTERÍSTICA	Direct mount Compátivel com Sram®
MATERIAL	Alumínio 7075
ENGENHAGENS	30 32 34 D
PESO	30 – 57 g 32 – 63 g 34 – 66 g
EMBALAGEM	10 peças
30D	13144

FOTO ILUSTRATIVA
DA EMBALAGEM



Engrenagem Avulsa Pedivela Triplo MTB

CARACTERÍSTICA	Material de alta resistência e rigidez, proporciona conforto e estabilidade ao pedalar
MATERIAL	Aço
ENGRENAGENS	40/30/22D
BCD	96mm
PESO	40D - 70 g 30D - 61 g 22D - 49 g
EMBALAGEM	1 peça
40D	07782
22D	07780

FOTO ILUSTRATIVA DA EMBALAGEM



Cog Avulsa 40/42v MTB

CARACTERÍSTICA	Material de alta resistência e rigidez, proporciona conforto e estabilidade ao pedalar
MATERIAL	Alumínio 7075
ENGRENAGENS	40/42D
PESO	40 - 61g 42 - 70g
EMBALAGEM	1 peça
40D	07724

FOTO ILUSTRATIVA DA EMBALAGEM



Cassete 10v Index

CARACTERÍSTICA	Cassete 10V 11/36 Dentes Estrutura em aço Padrão Standard
ESCALONAMENTO	11/13/15/17/19/21/24/28/32/36T
MATERIAL	Aço de alta resistência
EMBALAGEM	25 peças
PESO	455 gr

20506



Roda Livre 7v Index Bronze

CARACTERÍSTICA	Roda livre 7V 14/28 dentes Estrutura em aço Fixação por rosca Escalonamento 14/16/18/20/22/24/28 T
MATERIAL	Aço de alta resistência
EMBALAGEM	50 peças
PESO	424 gr

20513



Cubo Dianteiro X-Time 36 furos

CARACTERÍSTICA	Freio a disco 6 parafusos Eixo furado com blocagem Rolamento 6200rs
O.L.D	100 mm
MATERIAL	Alumínio Eixo de aço furado
PESO	335 g
EMBALAGEM	50 peças

19134





Eixo Dianteiro 3/8

CARACTERÍSTICA 3/8 aço zincado completo com caixas, colares com esferas, porcas e contra-porcas | Medidas: Eixo 145mm x 9.5mm | Colar com Esferas 3/16 | Caixas com batentes 24.4mm de diâmetro e 10mm largura externa

MATERIAL Aço

PESO 156 gr

EMBALAGEM 50 peças

19128



BLOCAGEM Eixo Dianteiro X-Time

CARACTERÍSTICA Blocação de eixo dianteiro | Preto | 1 alavanca com haste e molas | Compatível com cubos: freio a disco ou V-brake de eixo furado padrão 9 mm

ALAVANCAS Alumínio

HASTE Aço

COMPRIMENTO Dianteira 130 mm

PESO 45 gr

EMBALAGEM 50 peças

20469

Blocagem de Eixo Dianteiro

CARACTERÍSTICA	Alavancas: Alumínio Haste: Aço Preto Alavanca com haste e molas
COMPRIMENTO	Dianteira 140mm
COMPATIBILIDADE	Cubos Freio a Disco ou V-brake de eixo furado padrão 9mm
MATERIAL	Aço/alumínio
PESO	46 gr
EMBALAGEM	50 peças
	22715



Guidão X-Time SPEED - 440 MM

MATERIAL	Alumínio
TAMANHO	440 x 31.8 mm
PESO APROXIMANDO	397g
EMBALAGEM	50 peças
	16942





Guidão alum. Mtb 31.8mm **RETO** PT XT

MATERIAL	Alumínio
TAMANHO	740 x 31.8 mm
BACKSWEEP	9°
PESO APROXIMADO	296 g
EMBALAGEM	15 peças
	22750



Suporte de Guidão 100 mm/7° **X-Time**

CARACTERÍSTICA	Ahead Set
MATERIAL	Alumínio
TAMANHO	100 x 31.8 mm / 7°
PESO APROXIMANDO	180g
EMBALAGEM	50 peças
	16948

Movimento direção esf. Tapered garfo 30mm e 39.8mm preto

CARACTERÍSTICA Movimento direção tapered
Esferada
Caixa de aço
Acabamento superior em alumínio
Acompanha aranha
Cones de aço
Caixa superior ø44mm
Caixa inferior ø56mm

MATERIAL Aço

EMBALAGEM 50 peças

PESO 156g

CÓDIGO: 22804



Suporte de Guidão 90 mm/7° X-Time

CARACTERÍSTICA Ahead Set

MATERIAL Alumínio

TAMANHO 90 x 31.8 mm / 7°

PESO APROXIMANDO 176g

EMBALAGEM 50 peças

16947



Suporte de Guidão com ajuste de ângulo X-Time

CARACTERÍSTICA	Ângulação Regulável 30°/-30° Parafuso expandir (Allen)
MATERIAL	Alumínio
TAMANHO	90 x 25.4 mm
PESO APROXIMANDO	494g
EMBALAGEM	50 peças

18053 OU 17868



Abraçadeira X-Time - BK

CARACTERÍSTICA	Com Blocação
MATERIAL	Alumínio
TAMANHO	31.8 mm 34.9 mm
PESO APROXIMANDO	45 g
EMBALAGEM	200 peças

34.9 MM 16960/ 22755



34.9 MM

Conduíte para freio

CARACTERÍSTICA	Com teflon
COMPRIMENTO	20 m
ESPESSURA	5 mm
EMBALAGEM	500 peças

14161



Cabo para freio traseiro extra light

CARACTERÍSTICA 19 Fios | Extra light | Traseiro

EMBALAGEM 500 peças

14143



Fita demarcação X-TIME

EMBALAGEM 200 mts (aproximado)

09817



Suporte Caramanhola X-Time Nylon

CARACTERÍSTICA Material Nylon
Alta qualidade
Leve
Resistente
Excelente acabamento
Fixação por dois parafusos
(acompanha o suporte)

PESO +- 35 gr

MATERIAL Nylon

EMBALAGEM 10 peças

 23210

 23211

 -

 23213

 -

 23215





Caramanhola X-Time Fast - Standard

CARACTERÍSTICA Flexível para apertar | Boca larga (facilita a limpeza e abastecimento) | BPA free | Alça de transporte

CAPACIDADE 650 ml

TAMANHO ø 7 cm | Altura: 22,5 cm

EMBALAGEM 01 peça

3  15511

4  15512



3

4



Caramanhola X-Time Fast

CARACTERÍSTICA Flexível para apertar | Tampa Inteligente (abre e fecha) | Bico removível para limpeza | Boca larga (facilita a limpeza e abastecimento) | BPA free | Alça de transporte

CAPACIDADE 650 ml

TAMANHO ø 7 cm | Altura: 24 cm

EMBALAGEM 01 peça

1  14730

2  14731



Caramanhola X-Time Pivot | Smart

CARACTERÍSTICA

Flexível para apertar | BPA free |
Tampa Inteligente (abre e fecha)
| Bico removível para limpeza |
Boca larga (facilita a limpeza e
abastecimento)

CAPACIDADE

560 ml

TAMANHO

ø 7 cm | Altura: 20 cm

EMBALAGEM

01 peça

1  14713

2  14714





PRODUTOS EM LIQUIDAÇÃO



X-TIME



Display X-Time Lube

CARACTERÍSTICA	4 bandejas 500 x 400 mm
PESO SUPORTADO	120 kg
MATERIAL	Plástico
EMBALAGEM	1 peça
	13722

*Imagens meramente ilustrativas, produtos não inclusos.

FOTOS MERAMENTE ILUSTRATIVAS. AS INFORMAÇÕES/CONFIGURAÇÕES DE PRODUTOS PODERÃO SOFRER ALTERAÇÕES SEM AVISO PRÉVIO.

ENTRE EM CONTATO COM O SEU CONSULTOR OU FALE COM O NOSSO TIME DE TELEVENDAS PELO (33) 3277-3030.

PRODUTOS EM LIQUIDAÇÃO

X-TIME



*Imagens meramente ilustrativas, produtos não inclusos.

Display para balcão X-Time Lube

CARACTERÍSTICA 1 bandeja 480 x 290 mm

MATERIAL Plástico

EMBALAGEM 1 peça

13721

FOTOS MERAMENTE ILUSTRATIVAS. AS INFORMAÇÕES/CONFIGURAÇÕES DE PRODUTOS PODERÃO SOFRER ALTERAÇÕES SEM AVISO PRÉVIO.

ENTRE EM CONTATO COM O SEU CONSULTOR OU FALE COM O NOSSO TIME DE TELEVENDAS PELO (33) 3277-3030.

PRODUTOS EM LIQUIDAÇÃO

X-TIME

Graxa Sintética Azul



CARACTERÍSTICA	Resistente a água e a atritos, não contém lítio e não resseca plásticos nem borrachas
COMPOSIÇÃO	Graxa sintética, hidrocarboneto hidrogenado de grau farmacêutico e corantes, anticorrosivos e conservante
EMBALAGEM	20 peças (100g) 12 peças (500g)
500 G	15443
100 G	15442



Graxa Grip



CARACTERÍSTICA	Apresenta longa vida útil, é resistente a água, não contém lítio e também não agride peças de fibra de carbono, plásticos ou borrachas
COMPOSIÇÃO	Polímero sintético, óleo sintético de média viscosidade, óleo mineral purificado por hidrogenação com altíssima grau de pureza, agente antidesgaste, óxido inorgânico e corante
EMBALAGEM	20 peças (100g) 12 peças (500g)
100 G	15444
500 G	15445



Graxa Branca

CARACTERÍSTICA	Especialmente desenvolvida para caixas de direção, rolamentos, engrenagens, cubos, movimentos centrais Hollowtech, BB30 e similares
COMPOSIÇÃO	Óleo de base mineral, sabão de lítio, aditivos e corantes
EMBALAGEM	50 peças
200 G	13045



FOTOS MERAMENTE ILUSTRATIVAS. AS INFORMAÇÕES/CONFIGURAÇÕES DE PRODUTOS PODERÃO SOFRER ALTERAÇÕES SEM AVISO PRÉVIO.

ENTRE EM CONTATO COM O SEU CONSULTOR OU FALE COM O NOSSO TIME DE TELEVENDAS PELO (33) 3277-3030.

PRODUTOS EM LIQUIDAÇÃO

X-TIME

Protetor de Quadro Xtime

MATERIAL _____

EMBALAGEM _____

1 peça

11496



Boné X-Time

CARACTERÍSTICA _____

Fecho de velcro

MATERIAL _____

100% poliéster

EMBALAGEM _____

50 peças

FATOR _____

5

15146



Boné X-Time Lube

CARACTERÍSTICA _____

Fecho de velcro

MATERIAL _____

100% poliéster

EMBALAGEM _____

50 peças

FATOR _____

5

15147



FOTOS MERAMENTE ILUSTRATIVAS. AS INFORMAÇÕES/CONFIGURAÇÕES DE PRODUTOS PODERÃO SOFRER ALTERAÇÕES SEM AVISO PRÉVIO.

ENTRE EM CONTATO COM O SEU CONSULTOR OU FALE COM O NOSSO TIME DE TELEVENDAS PELO (33) 3277-3030.

Alavanca de Câmbio 27v MTB S9

CARACTERÍSTICA Estrutura em alumínio
visor indicador de posição

PESO APROXIMADO 309 g

EMBALAGEM 1 peça

08177



S10

Câmbio Dianteiro 20v MTB S10

CARACTERÍSTICA estrutura em alumínio com anel duplo
para dar mais resistência e segurança na
fixação

PESO APROXIMADO 161 g

EMBALAGEM 1 peça

10849/20466



Câmbio Traseiro 20v MTB S10

CARACTERÍSTICA Compatível com várias combinações
de engrenagens até 11-42D

PESO APROXIMADO 336 g

EMBALAGEM 1 peça

10848/20507





PRODUTOS EM LIQUIDAÇÃO



X-TIME



Alavanca de Câmbio 20v MTB S10

CARACTERÍSTICA	Estrutura em alumínio visor indicador de posição
PESO APROXIMADO	317 g
EMBALAGEM	1 peça
	10847/20508



Alavanca de câmbio 27 v. MTB S9

CARACTERÍSTICA	Com visor indicador de posição
PESO APROXIMADO	312 g
MATERIAL	Alumínio
EMBALAGEM	1 peça
	22703



Cassete 8v MTB S8

CARACTERÍSTICA	Mudança estável e suave, melhor performance e eficiência
CASSETE	12/14/17/19/21/24/28/32D
PESO APROXIMADO	341 g
EMBALAGEM	10 peças
	08186

FOTOS MERAMENTE ILUSTRATIVAS. AS INFORMAÇÕES/CONFIGURAÇÕES DE PRODUTOS PODERÃO SOFRER ALTERAÇÕES SEM AVISO PRÉVIO.

ENTRE EM CONTATO COM O SEU CONSULTOR OU FALE COM O NOSSO TIME DE TELEVENDAS PELO (33) 3277-3030.



Prolongador de Gancheira MTB e SPEED

CARACTERÍSTICA	Medidas 45mm x 11.5mm Parafuso M10 X 1.0 Instalação com auxílio de chave allen 6mm
MATERIAL	Alumínio
EMBALAGEM	50 peças
	10776



Prolongador de Gancheira Modelo 02

COMPATIBILIDADE	X-time RDS, RXS, Shimano
MATERIAL	Alumínio
EMBALAGEM	02 peças
	12911/20468

Conjunto Transmissão 8v MTB S8

CARACTERÍSTICA	Conjuntos de transmissão de 8 velocidades de alta precisão e durabilidade
CÂMBIO DIANTEIRO	Estrutura em alumínio com anel duplo para dar mais resistência e segurança na fixação Peso aproximado 145 g
CASSETE	12/14/17/19/21/24/28/32D Mudança estável e precisa Peso aproximado 336 g
CÂMBIO TRASEIRO	Compatível com várias combinações de engrenagens Peso aproximado 315 g
ALAVANCAS	Estrutura em alumínio Visor indicador de posição Peso aproximado 306 g
EMBALAGEM	1 conjunto

07142

FOTO ILUSTRATIVA
DA EMBALAGEM



Conjunto Transmissão 9v MTB S9

CARACTERÍSTICA	Conjuntos de transmissão de 9 velocidades de alta precisão e durabilidade
CÂMBIO DIANTEIRO	Estrutura em alumínio com anel duplo para dar mais resistência e segurança na fixação Peso aproximado 148 g
CASSETTE	11/13/15/17/21/24/28/32/36D Mudança estável e precisa Peso aproximado 441 g
CÂMBIO TRASEIRO	Compatível com várias combinações de engrenagens Peso aproximado 315 g
ALAVANCAS	estrutura em alumínio visor indicador de posição Peso aproximado 309 g
EMBALAGEM	1 conjunto

07141

FOTO ILUSTRATIVA DA EMBALAGEM





PRODUTOS EM LIQUIDAÇÃO



X-TIME



Conjunto Câmbio X-TIME S12

CARACTERÍSTICA	Conjuntos de transmissão de 1x12 velocidades de alta precisão e durabilidade
CASSETE	X-TIME Index 12 velocidade 11/52 dentes (11-13-15-18-21-23-26-30-34-40-46-52) possui mudança estável e suave, melhor performance e eficiência, encaixe padrão shimano K7 Peso: 721g
CÂMBIO TRASEIRO	X-TIME 12 velocidades; mais resistência e segurança na fixação Roldanas com 12 dentes rolamento selado sistema de dentes U-Pulley (onde um dente é maior que o outro para melhor encaixe na corrente) Peso: 311g
ALAVANCAS	X-TIME 12 velocidades estrutura em alumínio e acabamento plástico, regulador de tenção e acompanha cabo de aço (cabo de aço comum NÃO é inox). Na mesma alavanca pode-se efetuar a descida e subida das marchas impulsionando com o polegar Peso: 144g
EMBALAGEM	10 peças

19151

FOTOS MERAMENTE ILUSTRATIVAS. AS INFORMAÇÕES/CONFIGURAÇÕES DE PRODUTOS PODERÃO SOFRER ALTERAÇÕES SEM AVISO PRÉVIO.

ENTRE EM CONTATO COM O SEU CONSULTOR OU FALE COM O NOSSO TIME DE TELEVENDAS PELO (33) 3277-3030.

Câmbio Dianteiro 24v MTB S8

CARACTERÍSTICA Estrutura em alumínio com anel duplo para dar mais resistência e segurança na fixação

PESO APROXIMADO 145 g

EMBALAGEM 1 peça

08182 / 16732



S9

Câmbio Traseiro 27v MTB S9

CARACTERÍSTICA Compatível com várias combinações de engrenagens

PESO APROXIMADO 315 g

EMBALAGEM 1 peça

08178



ABASTEÇA SEU ESTOQUE



QUEST



PRODUTOS EM LIQUIDAÇÃO



QUEST



Guidão Reto com Suporte Integrado -17° | Linha Quest

CARACTERÍSTICA Suporte de guidão integrado de 80, 90, 100 ou 110 mm | 17° negativo | Diâmetro da espiga 1 1/8"

MATERIAL Carbono (UD Matt Carbon Fiber t800)

TAMANHO 800 mm

UPSWEEP 6°

BACKSWEEP 9°

RISE 0

PESO (800X90MM) 302g

EMBALAGEM 15 peças

100 MM 15102



Guidão Rise Bar | Linha Quest

MATERIAL Carbono (UD Matt Carbon Fiber t800)

TAMANHO 740 x 31.8mm

UPSWEEP 6°

BACKSWEEP 9°

RISE 20 mm

PESO 156g

EMBALAGEM 20 peças

15107

FOTOS MERAMENTE ILUSTRATIVAS. AS INFORMAÇÕES/CONFIGURAÇÕES DE PRODUTOS PODERÃO SOFRER ALTERAÇÕES SEM AVISO PRÉVIO.

ENTRE EM CONTATO COM O SEU CONSULTOR OU FALE COM O NOSSO TIME DE TELEVENDAS PELO (33) 3277-3030.

QUEST

Canote de Selim Retrátil | Linha Quest

CARACTERÍSTICA	Cabeamento interno Acionamento mecânico Micro ajuste 100 mm curso Trava remota
MATERIAL	Alumínio
TAMANHO	410 x 31,6mm
PESO	674 g
EMBALAGEM	25 peças
	16283



Suporte para Caramanhola | Linha Quest

CARACTERÍSTICA	4 espaços de parafusos para regulagem Parafusos não inclusos
MATERIAL	Carbono (UD Matt Carbon Fiber t800)
TAMANHO	132 x 92 mm
REMOÇÃO DA GARRAFA	Parte superior
PESO	28g
EMBALAGEM	25 peças
	15112



FOTOS MERAMENTE ILUSTRATIVAS. AS INFORMAÇÕES/CONFIGURAÇÕES DE PRODUTOS PODERÃO SOFRER ALTERAÇÕES SEM AVISO PRÉVIO.

ENTRE EM CONTATO COM O SEU CONSULTOR OU FALE COM O NOSSO TIME DE TELEVENDAS PELO (33) 3277-3030.

QUEST

Garfo 29 rígido mtb ahead alumínio

| Linha quest

CARACTERÍSTICA

- Garfo 29" mtb rígido
- Marca quest
- Material alumínio
- Material da espiga alumínio
- Old 100mm
- Eixo 9mm
- Comprimento da espiga 280mm
- Diâmetro do espiga 28.6mm over ahead set
- Suporte de freio post mount
- Compatível com disco 160mm
- Acabamento em preto fosco com adesivo laminado

MATERIAL

Alumínio

PESO

+865gr

EMBALAGEM

10 unidades

23226

AVISOS

Use apenas para:

- Lazer
- Cross country



Garfo 29 rígido mtb taperad alumínio

| Linha quest

CARACTERÍSTICA

- Garfo 29" mtb rígido
- Marca quest
- Material alumínio
- Material da espiga alumínio
- Espiga tapered (diâmetro superior 28.6mm / diâmetro inferior 39.8mm) 1/8 x 1.5
- Old 100mm
- Eixo 9mm
- Comprimento da espiga 280mm
- Suporte de freio post mount
- Compatível com disco 160mm
- Acabamento em preto fosco com adesivo laminado

MATERIAL

Alumínio

PESO

+895gr

EMBALAGEM

10 unidades

23227

AVISOS

Use apenas para:

- Lazer
- Cross country



QUEST

Garfo 29 rígido mtb ahead alumínio boost | Linha quest

CARACTERÍSTICA

- Garfo 29" mtb rígido
- Marca quest
- Material alumínio
- Material da espiga alumínio
- Old 110mm
- Eixo 15x110mm com blocagem (acompanha o produto)
- Rosca do eixo 1.5mm
- Comprimento da espiga 280mm
- Diâmetro do espiga 28.6mm over ahead set
- Suporte de freio post mount
- Compatível com disco 160mm
- Acabamento em preto fosco com adesivo laminado

MATERIAL

Alumínio

PESO

+959gr - peso referente ao e garfo com a blocagem

EMBALAGEM

10 unidades

23228

AVISOS

Use apenas para:

- Lazer
- Cross country



Garfo 29 rígido mtb taperad alumínio boost | Linha quest

CARACTERÍSTICA

- Garfo 29" mtb rígido
- Marca quest
- Material alumínio
- Material da espiga alumínio
- Espiga tapered (diâmetro superior 28.6mm / diâmetro inferior 39.8mm) 1/8 x 1.5
- Old 110mm
- Eixo 15x110mm com blocagem (acompanha o produto)
- Rosca do eixo 1.5mm
- Comprimento da espiga 280mm
- Suporte de freio post mount
- Compatível com disco 160mm
- Acabamento em preto fosco com adesivo laminado

MATERIAL

Alumínio

PESO

+980gr - peso referente ao e garfo com a blocagem

EMBALAGEM

10 unidades

23229

AVISOS

Use apenas para:

- Lazer
- Cross country





PRODUTOS EM LIQUIDAÇÃO



QUEST

Garfo 29 mtb c/ susp. 120mm ahead boost tap. PT | Linha quest

CARACTERÍSTICA Garfo aro 29" mtb Quest Boost Tapered Canela 36 | Suporte de freio post mount Curso total 160mm Curso de funcionamento 120mm Crown de alumínio | Espiga alumínio tapered Comprimento da espiga 200mm Diâmetro da espiga ø28.6x39.9mm Funcionamento a ar | Trava remota no guidão Acionador remoto do guidão em alumínio com abraçadeira | Acompanha cabo e condute Eixo de 15mm (ø15mm / p1.5mm) | Old 110mm

MATERIAL Alumínio

PESO +-2394 Gr

EMBALAGEM 10 unidades

23355

AVISOS Use apenas para:
• Lazer
• Cross country



Garfo 29" MTB com Suspensão Ahead PT | Linha Quest

CARACTERÍSTICA Garfo 29" MTB Quest Tapered: Garfo em alumínio de alta qualidade Canela 34 | Trava Remota no Guidão Trava em alumínio com abraçadeira Acompanha cabo e condute | Funcionamento a ar | Suporte do Freio Post Mount | Curso de 100mm | Eixo de 9mm OLD 100mm | Espiga Tapered ahead set (diâmetro superior 28.6mm / diâmetro inferior 39.8mm) 1/8 x 1.5 | Comprimento da espiga 200mm

MATERIAL Alumínio

PESO 1868Gr - incluindo trava, cabo e condute.

EMBALAGEM 10 peças

20830

AVISOS Use apenas para:
• Lazer
• Cross country



FOTOS MERAMENTE ILUSTRATIVAS. AS INFORMAÇÕES/CONFIGURAÇÕES DE PRODUTOS PODERÃO SOFRER ALTERAÇÕES SEM AVISO PRÉVIO.

ENTRE EM CONTATO COM O SEU CONSULTOR OU FALE COM O NOSSO TIME DE TELEVENDAS PELO (33) 3277-3030.

QUEST

Garfo 29" MTB com Suspensão Ahead Boost Reb. PT | Linha Quest

CARACTERÍSTICA Garfo 29" MTB Quest Boost Tapered | Garfo em alumínio de alta qualidade | Canela 34 Trava Remota no Guidão | Trava em alumínio com abraçadeira | Acompanha cabo e conduíte | Funcionamento a ar | Regulagem de retorno | Suporte do Freio Post Mount | Curso de 100mm | Eixo de 15mm | OLD 110mm | Espiga Tapered ahead set (diâmetro superior 28.6mm / diâmetro inferior 39.8mm) 1/8 x 1.5 | Comprimento da espiga 200mm

MATERIAL Alumínio

PESO 2070 Gr - incluindo Eixo, trava, cabo e conduíte.

EMBALAGEM 10 peças

20831

AVISOS Use apenas para:
• Lazer
• Cross country



Garfo 29" mtb com susp. 100mm ahead tap. boost reb PT | Linha quest

CARACTERÍSTICA Garfo aro 29" MTB Quest Boost Tapered: Canela 36 | Suporte de freio post mount | Curso total 130mm | Curso de funcionamento 100mm | Crown de alumínio | Espiga alumínio | Comprimento da espiga 200mm | Diâmetro da espiga ø28.6x39.9mm | Funcionamento a ar | Regulagem de rebound Trava remota no guidão | Acionador remoto do guidão em alumínio com abraçadeira | Acompanha cabo e conduíte | Eixo de 15mm (ø15mm / p1.5mm) | Old 110mm

MATERIAL Alumínio

PESO 2452 Gr

EMBALAGEM 10 peças

22788

AVISOS Use apenas para:
• Lazer
• Cross country



QUEST

Garfo 29 mtb c/ susp. 120mm ahead tap. boost reb. PT | Linha quest

CARACTERÍSTICA Garfo aro 29" mtb Quest boost tapered Canela 36 | Suporte de freio post mount Curso total 160mm Curso de funcionamento 120mm Crown de alumínio | Espiga alumínio Comprimento da espiga 200mm Diâmetro da espiga ø28.6x39.9mm Funcionamento a ar | Regulagem de rebound Trava remota no guidão Acionador remoto do guidão em alumínio com abraçadeira | Acompanha cabo e conduíte Eixo de 15mm (ø15mm / p1.5mm) Old 110mm

MATERIAL Alumínio

PESO +-2390gr

23357

AVISOS

Use apenas para:

- Lazer
- Cross country



Garfo 29 mtb c/ susp. 120mm ahead boost pt | Linha quest

CARACTERÍSTICA • Garfo aro 29" mtb Quest boost • Canela 36 | Suporte de freio post mount • Curso total 160mm • Curso de funcionamento 120mm • Crown de alumínio | Espiga alumínio • Comprimento da espiga 200mm • Diâmetro da espiga ø28.6mm • Funcionamento a ar | Trava remota no guidão • Acionador remoto do guidão em alumínio com abraçadeira • Acompanha cabo e conduíte | Eixo de 15mm (ø15mm / p1.5mm) | Old 110mm

MATERIAL Alumínio

PESO 2434gr

EMBALAGEM 10 unidades

23358

AVISOS

Use apenas para:

- Lazer
- Cross country



QUEST

Garfo 29 mtb c/ susp. 120mm ahead boost reb. PT | Linha quest

CARACTERÍSTICA

- Garfo aro 29" mtb Quest boost
- Canela 36 | Suporte de freio post mount
- Curso total 160mm
- Curso de funcionamento 120mm
- Crown de alumínio | Espiga alumínio
- Comprimento da espiga 200mm
- Diâmetro da espiga ø28.6mm
- Funcionamento a ar | Regulagem de rebound
- Trava remota no guidão | Acionador remoto do guidão em alumínio com abraçadeira | Acompanha cabo e conduíte
- Eixo de 15mm (ø15mm / p1.5mm)
- Old 110mm

MATERIAL

Alumínio

PESO

+2482 Gr

EMBALAGEM

10 unidades

23360

AVISOS

Use apenas para:

- Lazer
- Cross country



QUEST



GUIDÃO RETO 6° 800MM C/SUP 2° CRB PT | LINHA QUEST

CARACTERÍSTICA

Guidão reto com suporte integrado -2° | linha quest

- Guidão de carbono
- Suporte de guidão integrado de 50mm, 60mm e 70mm
- -2° Negativo

50 MM _____ 22240

MATERIAL

Material carbono ud
(ud matt carbon fiber t800)

60 MM _____ 22241

TAMANHO

• Diâmetro de fixação da espiga 28.6mm
| • tamanho 800mm

70 MM _____ 22242

UPSWEEP

6°

BACKSWEEP

6°

RISE

0

PESO

309gr - peso referente ao guidão 60mm

EMBALAGEM

15 peças

QUEST



GUIDÃO RETO 9° 800MM CRB PT | LINHA QUEST

CARACTERÍSTICA	Guidão reto linha quest • Guidão de carbono
MATERIAL	Material carbono ud (ud matt carbon fiber t800)
TAMANHO	Tamanho 800x31.8mm
UPSWEEP	0°
BACKSWEEP	9°
PESO	195g
EMBALAGEM	25 peças
	22244

QUEST

SUPORTE CARAMANHOLA CARBONO | LINHA QUEST

CARACTERÍSTICA Carbono
Design Moderno
Leve e Resistente

MATERIAL Carbono

FIXAÇÃO 2 Parafusos (não acompanham suporte)

PESO 35g

EMBALAGEM 50 peças

22248



SUPORTE CARAMANHOLA MOD.2 CRB | LINHA QUEST

CARACTERÍSTICA • Suporte caramanhola
• Fixação por dois parafusos
(não acompanham o suporte)

MATERIAL Carbono (UD Matt Carbon Fiber t800)

TAMANHO • Medidas 14 x 7.2mm

REMOÇÃO DA GARRAFA • Remoção da garrafa standard

PESO 20g

EMBALAGEM 25 peças

22249



ABASTEÇA SEU ESTOQUE



SR SUNTOUR 

PRODUTOS EM LIQUIDAÇÃO

SR SUNTOUR



**SHOCK TRASEIRO TRIAIR2 3CR TR
205 x 60 / 65 mm**

- Característica
- Shock Em Alumínio Ar
 - Curso 205 X 60mm
 - Controle De Rebound Com 8 Cliques
 - Sistema 3cr Com 3 Modos De Compressão
 - Sistema Interno De Pistão Flutuante
 - Sistema De Fixação Trunning
 - Compatível Com Downhill, Enduro, Freeride

Material Alumínio

Peso 480g

Embalagem 10 peças

21813

AVISOS

USE APENAS PARA:

- LAZER
- CROSS COUNTRY

FOTOS MERAMENTE ILUSTRATIVAS. AS INFORMAÇÕES/CONFIGURAÇÕES DE PRODUTOS PODERÃO SOFRER ALTERAÇÕES SEM AVISO PRÉVIO.

ENTRE EM CONTATO COM O SEU CONSULTOR OU FALE COM O NOSSO TIME DE TELEVENDAS PELO (33) 3277-3030.

ABASTEÇA SEU ESTOQUE



NOMAD

NOMAD

PARALAMADIANTEIRO MTB

Espec. - Compatível com bicicletas de XC, ALL MOUNTAIN, ENDURO, DOWNHILL e CROSS COUNTRY (rígidas ou full).

- Fácil instalação
- Proteção para os retentores de sua suspensão
- Elevada flexibilidade e resistência

Emb. 10pçs



VERMELHO

VERDE

AZUL

12113

ABASTEÇA SEU ESTOQUE



 **MITSU**
Sports



Raio Inox – MITSU

Característica Raio inox | Com niple cobre

255X2,0MM

00996

Embalagem

20 gz

255X2,5MM

00605

15 gz



Regulador de Maçaneta – MITSU

Material Alumínio polido

Embalagem 50 peças

GROSSO 01563



Niple 2.0 mm x aço preto – MITSU

Material	Aço
Característica	Niple aço mitsu Aço Preto Diâmetro 2mm Comprimento 12mm
Embalagem	100 unidades
Peso	128g Peso referente a grosea (144 unidades)
	13728



Niple aço 2.0 x 12mm polido - MITSU

Material	Aço
Característica	Niple aço mitsu Aço Polido Diâmetro 2mm Comprimento 12mm
Embalagem	100 unidades
Peso	126g Peso referente a grosea (144 unidades)
	20483





PRODUTOS EM LIQUIDAÇÃO



Manopla – MITSU

Característica Ponta cromada

Embalagem 100 peças



01169

Corrente Corrida S50 – MITSU

Espec. – 1/2" X 3/32" 116L – 21V. – bronze

– Index

Emb. 50 pçs



02672

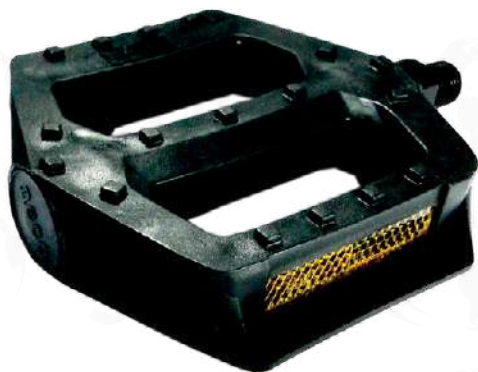

Pedal Plataforma – MITSU

Material Nylon

Embalagem 50 peças

COM ESFERA

SUÊCO 1/2



00901

INGLÊS 9/16



03294

FOTOS MERAMENTE ILUSTRATIVAS. AS INFORMAÇÕES/CONFIGURAÇÕES DE PRODUTOS PODERÃO SOFRER ALTERAÇÕES SEM AVISO PRÉVIO.

ENTRE EM CONTATO COM O SEU CONSULTOR OU FALE COM O NOSSO TIME DE TELEVENDAS PELO (33) 3277-3030.



SHUFENG



Caixa Cubo Dianteiro – SHUFENG

Característica Batente para cubo Shunfeng

Embalagem 2000 peças



00932

VELOSTEEL



Carcaça Cubo – VELOSTEEL

Característica Contra Pedal | 36 F

Embalagem 10 peças



00156



Pinhão Fixo Encaixe – VELOSTEEL

Característica Com encaixe | Bronze

Embalagem 50 peças

16D



00590

IMPORTADO

Freio V. Brake D/T – IMPORTADO

Característica Freio V Brake | Alumínio | Importado | Estrutura em alumínio | Sapatas Allen

Material Alumínio | Aço

Peso 360 gr (par)

Embalagem 25 peças

◆ 20515



ABASTEÇA SEU ESTOQUE



ROCKBROS



Óculos de Ciclismo RB-SP176

MODELO	RB-SP176
CARACTERÍSTICA	Óculos com formato anatômico e ajuste perfeito ao rosto Design ultramoderno e proposta arrojada
MATERIAL	Armação: acetato Lentes: policarbonato
GÊNERO	Unisex
OPÇÕES DE LENTES	Cinco lentes de qualidade avançada e proteção UV400, sendo uma delas polarizada
CONJUNTO	Estojo rígido Pano para limpeza das lentes Saquinho para os óculos Cartão para teste de lente polarizada
ATRIBUTO ADICIONAL	Armação interna para fixação de lente de grau
PESO	ND
EMBALAGEM	1 conjunto

1  13345

2  13346

3  13347





Óculos de Ciclismo | 10163

MODELO	10163
CARACTERÍSTICA	Unisex Lentes Polarizada Proteção UV
LENTE	Marron (redução de brilho)
MATERIAL	Armação: TR Lente: Policarbonato (PC)
ACESSÓRIOS	Estojo rígido Pano para limpeza de lentes Bolsinha para óculos Armação interna para fixação de lente de grau
EMBALAGEM	1 conjunto

16515





ÓCULOS DE CICLISMO | 0089

MODELO	0089
CARACTERÍSTICA	Unisex 5 lentes diferentes Lentes Polarizadas Proteção UV400 Perna Rígida / Headband
LENTE	Transparente Cinza / Azul / Marrom (redução de brilho) Amarela (noturna)
MATERIAL	Armação: Acetato Lente: Policarbonato
ACESSÓRIOS	Estojo rígido Pano para limpeza de lentes Bolsinha para óculos Cordão para óculos Armação interna para fixação de lente de grau
EMBALAGEM	1 conjunto 16513



Ciclo Computer | BC 18 - L21

MODELO	18 funções Sem fio EL Backlight
FUNÇÕES	Velocímetro Velocidade média (AVS) Velocidade máxima (MXS) Tendência de velocidade Comparação de velocidade Seleção de Quilômetros (KM) ou Metros (M) Odômetro (ODO) Função de salvar Odômetro Tripmeter (DST) Tempo de viagem Relógio digital Auto Scan Auto Power Off Auto start/stop Calorias Fat Burned Freeze Frame Memory (TM e AVS) Graus celsius ou Fahrenheit Temperatura
BATERIA	Duas baterias de 3v CR2032 (1 computador/ 1 transmissor)
EMBALAGEM	20 peças 16521





Bolsa traseira | Bagageiro – 3 em 1

MODELO	A8-BK
ESPEC.	Equipamento prático, resistente e de alta durabilidade 3 bolsas independentes ligadas por zíper, a maior podendo ser usada como mochila Compartimentos internos independentes Acompanha capa à prova d'água Equipamento ideal para ciclovagens
MATERIAL	PVC 600D Poliéster Nylon Malha Tecido
COR	Preto
ATRIBUTO ADICIONAL	Logo com função refletiva, para dar mais segurança
CAPACIDADE	48 litros
PESO APROXIMADO	1,5 Kg
EMB.	1 conjunto

13349



ABASTEÇA SEU ESTOQUE



**NANOBODY
TECH®**

NANOBODY TECH®



! NANOBODY TECH !

CREME REGENERADOR

Característica Ultra hidratante com tecnologia e probióticos para auxiliar a restauração e devolver a saúde á pele. Reduz os efeitos dos agressores diários, deixando uma pele mais brilhante e equilibrada.

Embalagem 100ml
20496



! NANOBODY TECH !

BÁLSAMO EM CREME

Característica Desenvolvido com a finalidade de promover sensação de conforto após a pratica de esporte, melhora consideravelmente a flexibilidade dos músculos devido à sua composição rica em ingredientes rubefacientes que melhoram a circulação periférica.

Embalagem 100ml
20498



**NANOBODY
TECH®**



[NANOBODY TECH]

SUNSCREEN 30 FPS

Característica SUNSCREEN oferece proteção contra a radiação UVA/UVB e infravermelha, prevenindo os sinais do envelhecimento da pele e evitando queimaduras solares, além de promover uma sensação de hidratação sem deixar a pele oleosa.

Embalagem 100ml

20497



NANOBODY TECH®



[NANOBODY TECH]

GEL REFRESCANTE

Característica Com a mais inovadora tecnologia para cosméticos esportivos, o GEL REFRESCANTE NBT, deve ser aplicado logo após o treino para evitar a fadiga muscular e restabelecer as funções da pele, músculos e veias.

Embalagem 100ml

20499



[NANOBODY TECH]

GEL SMOOTH SKIN

Característica Promove uma camada protetora com uma textura aveludada, oferecendo uma sensação única. Com toque sedoso fornece uma proteção sobre a pele, mantendo sua hidratação natural, deixando macia e aveludada. Proteção contra calos e bolhas.

Embalagem 100ml

20503



[NANOBODY TECH]

GEL NANOGRIP

Característica Desenvolvido para resolver problemas de sudorese excessiva em nossas mãos. Repele o Suor e melhora 100% do seu grip em menos de 30 segundos.

Embalagem 100ml

20495



ABASTEÇA SEU ESTOQUE



 **Elook**



PRODUTOS EM LIQUIDAÇÃO



CADEADO ETOOK | ET 152

Modelo	ET 152
Característica	Pequeno, leve e fácil de transportar Tranca: Código de 3 dígitos
Tamanho	1500 mm/Ø4 mm
Material	Liga de zinco
Peso	100 g
Embalagem	20 peças

17329



CADEADO ETOOK | ET 151

Modelo	ET 151
Característica	Cabo de aço com tratamento térmico especial, dificulta que seja arrebitado e cortado Suporte Easy Clip para canote de bicicleta Ø25.4 a 30.8 mm 2 Chaves
Tamanho	1500 mm/Ø12 mm
Peso	533 g
Embalagem	20 peças

17330



CADEADO ETOOK | ET 150

Modelo	ET 150
Característica	Cabo de aço com tratamento térmico especial, dificulta que seja arrebitado e cortado Suporte Easy Clip para canote de bicicleta Ø25.4 a 30.8 mm Tranca: Código de 4 dígitos
Tamanho	1500 mm/Ø12 mm
Peso	536 g
Embalagem	20 peças

17331



CADEADO ETOOK | ET 461

Modelo	ET 461
Característica	Cabo de aço (15 mm de espessura) com tratamento térmico especial, dificulta que seja arrebitado e cortado Suporte Easy Clip para canote de bicicleta Ø25.4 a 30.8 mm Tranca: Código de 4 dígitos
Tamanho	1500 mm/Ø15 mm
Peso	570 g
Embalagem	20 peças

17332



CADEADO ETOOK | ET 355

Modelo	ET 355
Característica	Pequeno e compacto Leve e Prático Corrente de elo quadrado (4 mm) Tranca: Código de 4 dígitos Aço rígido com tratamento especial, dificulta que seja estourado, serrado, cortado e perfurado Capa de tecido impermeável para proteção
Tamanho	900 mm/Ø4 mm
Peso	312 g
Embalagem	20 peças

17326



CADEADO ETOOK | ET 355-S

Modelo	ET 355s
Característica	Pequeno e leve Fácil transporte Corrente de elo quadrado (4 mm) Tranca: Código de 4 dígitos Aço rígido com tratamento especial, dificulta que seja estourado, serrado, cortado e perfurado Capa de tecido impermeável para proteção
Tamanho	450 mm/Ø4 mm
Peso	160 g
Embalagem	20 peças

17327

FOTOS MERAMENTE ILUSTRATIVAS. AS INFORMAÇÕES/CONFIGURAÇÕES DE PRODUTOS PODERÃO SOFRER ALTERAÇÕES SEM AVISO PRÉVIO.

ENTRE EM CONTATO COM O SEU CONSULTOR OU FALE COM O NOSSO TIME DE TELEVENDAS PELO (33) 3277-3030.



PRODUTOS EM LIQUIDAÇÃO



ETOOK



CADEADO ETOOK | ET 465

Modelo	ET 465
Característica	Cilindro da fechadura em liga de Zinco com 8mm de espessura Tranca: Código de 4 dígitos Aço rígido com tratamento especial, dificulta que seja estourado, serrado, cortado e perfurado Capa de tecido impermeável para proteção
Tamanho	1000 mm/Ø6 mm
Peso	900 g
Embalagem	20 peças
	17328



CADEADO ETOOK | ET 455

Modelo	ET 455
Característica	Tecnologia avançada de cilindro de fechadura com a chave de apenas 0,3-0,6 mm de espessura Aço rígido com tratamento especial, dificulta que seja estourado, serrado, cortado e perfurado Capa de tecido impermeável para proteção
Tamanho	1000 mm/Ø6 mm
Peso	900 g
Embalagem	20 peças
	17324



CADEADO ETOOK | ET 555

Modelo	ET 555
Característica	Corrente quadrada de 8 mm com capa de tecido impermeável para proteção Mecanismo de travamento automático Corpo do cilindro da fechadura com design fechado de alta proteção contra roubo Tecnologia avançada de cilindro de fechadura com a chave de apenas 0,3-0,6 mm de espessura Tampa anti-perfuração Aço especial com tratamento térmico, sua robustez e alta tenacidade dificulta que seja cortado pelo cortador hidráulico 15T, batido, serrado e perfurado Resistência à capacidade de tração de 1 tonelada
Tamanho	1100 mm/Ø8 mm
Peso	1.63 kg
Embalagem	20 peças
	17323



CADEADO ETOOK | ET 155L

Modelo	ET 155L
Característica	Tecnologia avançada de cilindro de fechadura com a chave de apenas 0,3-0,6 mm de espessura Aço rígido com tratamento especial, dificulta que seja estourado, serrado, cortado e perfurado Capa de tecido impermeável para proteção
Tamanho	1100 mm/Ø7 mm
Peso	1.03 kg
Embalagem	20 peças
	17325

FOTOS MERAMENTE ILUSTRATIVAS. AS INFORMAÇÕES/CONFIGURAÇÕES DE PRODUTOS PODERÃO SOFRER ALTERAÇÕES SEM AVISO PRÉVIO.

ENTRE EM CONTATO COM O SEU CONSULTOR OU FALE COM O NOSSO TIME DE TELEVENDAS PELO (33) 3277-3030.

ABASTEÇA SEU ESTOQUE



LOCK Kinguard

LOCK Kinguard



Cadeado Gomo 1000 mm | Mod. 01

Característica	Tranca por chave 2 chaves Tipo gomo
Tamanho	25 x 1000 mm
Peso	808 g
Embalagem	15 peças
	17310



Cadeado Gomo 1500 mm | Mod. 01

Característica	Tranca por chave 2 chaves Tipo gomo
Tamanho	25 x 1500 mm
Peso	1.04 kg
Embalagem	15 peças
	17311



Cadeado com Corrente 10 x 1200 mm | Mod. 01

Característica	Tranca por chave 2 chaves Tipo corrente de elos
Tamanho	10 x 10 x 1200 mm
Peso	2.45 kg
Embalagem	15 peças
	17317



Cadeado Gomo 1000 mm | Mod. 02

Característica	Tranca por chave 2 chaves Tipo gomo Com tampa
Tamanho	25 x 1000 mm
Peso	741 g
Embalagem	15 peças
	17312



Cadeado Gomo 1500 mm | Mod. 02

Característica	Tranca por chave 2 chaves Tipo gomo Com tampa
Tamanho	25 x 1500 mm
Peso	983 g
Embalagem	15 peças
	17313



Cadeado com Corrente 10 x 1200 mm | Mod. 02

Característica	Tranca por chave 2 chaves Tipo corrente de elos Com tampa
Tamanho	10 x 10 x 1200 mm
Peso	2.40 kg
Embalagem	15 peças
	17318

LOCK Kinguard



/// Cadeado Aço Espiral 8 x 1800 mm

Característica	Tranca por chave 2 chaves Tipo aço espiral Suporte Easy Clip com fechamento tipo braçadeira
Tamanho	8 x 1800 mm
Material	Aço
Peso	383 g
Embalagem	20 peças

17314

/// Cadeado Aço Espiral 10 x 800 mm

Característica	Tranca por chave 2 chaves Tipo aço espiral Suporte Easy Clip com fechamento tipo braçadeira
Tamanho	10 x 800 mm
Material	Aço
Peso	231 g
Embalagem	20 peças

17316

/// Cadeado Aço Espiral 12 x 1800 mm

Característica	Tranca por chave 2 chaves Tipo aço espiral Suporte Easy Clip com fechamento tipo braçadeira
Tamanho	12 x 1800 mm
Material	Aço
Peso	536 g
Embalagem	20 peças

17315

ABASTEÇA SEU ESTOQUE



**SUPPLY
WIPES**

SUPPLY WIPES



Toalhas Umedecidas Bike Wipes | Pote

CARACTERÍSTICA	Praticidade e agilidade na remoção de sujeiras grosseiras como barro, graxa e óleo Pode ser usado tanto na bicicleta quanto para limpar as sujidades na pele do ciclista
TAMANHO E QUANTIDADE	50 unidades 20x18 cm
INFLAMABILIDADE	Não Inflamável
OBSERVAÇÃO	Fácil de utilizar Não agride a pele Usar um lenço por vez Após o uso manter fechado
PESO	245 g
EMBALAGEM	12 peças
	14882

SUPPLY WIPES



Toalhas Umedecidas Desengraxante | Pote

CARACTERÍSTICA	Limpa as sujeiras mais pesadas sem a necessidade de água
	Grande eficiência na remoção de graxa, óleo, tinta, graxa etc.
TAMANHO E QUANTIDADE	35 unidades 20x18 cm
INFLAMABILIDADE	Não Inflamável
OBSERVAÇÃO	Fácil de utilizar Não agride a pele Usar um lenço por vez Após o uso descartar o lenço no lixo
PESO	315 g
EMBALAGEM	12 peças
	14883



Toalhas Umedecidas Álcool 73% | Pote

CARACTERÍSTICA	Produto destinado a limpeza e higienização em geral
TAMANHO E QUANTIDADE	35 unidades 20x18 cm
INFLAMABILIDADE	Inflamável
OBSERVAÇÃO	Fácil de utilizar Não agride a pele Usar um lenço por vez Após o uso manter fechado.
EMBALAGEM	12 peças
	14884

ABASTEÇA SEU ESTOQUE



PROMEND



PRODUTOS EM LIQUIDAÇÃO



PROMEND



MOCHILA DE HIDRATAÇÃO MODELO 01

CARACTERÍSTICA	Faixa refletiva em 8 pontos Alça elástica externa Refil interno
REFIL	2 litros Tubo de 106 cm Tampa com fechamento em rosca
MATERIAL	Interno: Fibra + EVA Externo: Nylon e poliéster
TAMANHO	430 x 280 x 80 mm
PESO	300g
EMBALAGEM	5 peças

■ 13868

■ 13869

■ 13870

■ 13871



FOTOS MERAMENTE ILUSTRATIVAS. AS INFORMAÇÕES/CONFIGURAÇÕES DE PRODUTOS PODERÃO SOFRER ALTERAÇÕES SEM AVISO PRÉVIO.

ENTRE EM CONTATO COM O SEU CONSULTOR OU FALE COM O NOSSO TIME DE TELEVENDAS PELO (33) 3277-3030.



PRODUTOS EM LIQUIDAÇÃO



PROMEND



MOCHILA DE HIDRATAÇÃO MODELO 02

CARACTERÍSTICA Faixa refletiva em 8 pontos | Alça elástica externa | Refil interno

REFÍL 2 litros | Tubo de 106 cm | Tampa com fechamento em rosca

MATERIAL Interno: Fibra + EVA | Externo: Nylon e poliéster

TAMANHO 455 x 225 x 50 mm

PESO 330g

EMBALAGEM 5 peças



13872

13873

13874

13875

13876



FOTOS MERAMENTE ILUSTRATIVAS. AS INFORMAÇÕES/CONFIGURAÇÕES DE PRODUTOS PODERÃO SOFRER ALTERAÇÕES SEM AVISO PRÉVIO.

ENTRE EM CONTATO COM O SEU CONSULTOR OU FALE COM O NOSSO TIME DE TELEVENDAS PELO (33) 3277-3030.



PRODUTOS EM LIQUIDAÇÃO



PROMEND



BOLSA DE CELULAR MODELO 02

MODELO	14E36
CARACTERÍSTICA	Fechamento em velcro
MATERIAL	Poliuretano / Poliuretano Termoplástico
TAMANHO	162 * 94mm
EMBALAGEM	10 peças

11785

FOTOS MERAMENTE ILUSTRATIVAS. AS INFORMAÇÕES/CONFIGURAÇÕES DE PRODUTOS PODERÃO SOFRER ALTERAÇÕES SEM AVISO PRÉVIO.

ENTRE EM CONTATO COM O SEU CONSULTOR OU FALE COM O NOSSO TIME DE TELEVENDAS PELO (33) 3277-3030.

ABASTEÇA SEU ESTOQUE



CHAOYANG®

Passion For Forward



CHAORYANG®

Passion For Forward



20"
WHEELS

Câmara 20 x 1.95 | Válvula americana

CARACTERÍSTICA Câmara aro 20" x 1.95/2.125 (50/54-406) Arisun | Válvula americana | Material resistente e design uniforme | Proporciona segurança e boa performance.

MATERIAL Borracha

PESO 148 gr

EMBALAGEM 20 peças

20519

ABASTEÇA SEU ESTOQUE



TRUE[®]
SPORT

FOTOS MERAMENTE ILUSTRATIVAS. AS INFORMAÇÕES/CONFIGURAÇÕES DE PRODUTOS PODERÃO SOFRER ALTERAÇÕES SEM AVISO PRÉVIO.

ENTRE EM CONTATO COM O SEU CONSULTOR OU FALE COM O NOSSO TIME DE TELEVENDAS PELO (33) 3277-3030.

TRUE[®] SPORT



TIRAS SUPORTE (LEVE BIKE) UNITÁRIO TRUE

Modelo	Tiras 34
Característica	Tira suporte (leve bike)
Fator	4
Embalagem	50 peças
	19050

ABASTEÇA SEU ESTOQUE





VACINA DE PNEU | BIKE

CARACTERÍSTICA

Com a bicicleta em movimento, o furo é vedado instantaneamente. Caso o pneu perca a pressão, basta reinflar com o furo para baixo para que haja contato com o selante e, em seguida, rodar com a bicicleta. A dosagem é única e pode ser aplicado em todos os tipos de bicicleta exceto os modelos equipados com pneus SPEED.

ESPECIFICAÇÃO

- Diâmetro máximo do objeto perfurante liso de até 2mm;
- Pneus com ou sem câmara de ar;
- Produto preventivo: aplicar antes do pneu furar;
- Ecologicamente correto: biodegradável, atóxico e não inflamável;
- Saca-válvula de metal incluso no kit;
- Aplicar usando uma pistola de silicone (não inclusa no kit);
- Pode ser aplicado em pneus com válvula SCHRADER e PRESTA com núcleo de válvula removível.

APLICAÇÃO

1. Agite o frasco por 20 segundos antes de aplicar o produto;
2. Remova o núcleo de válvula usando o saca-válvula de metal;
3. Aguarde o esvaziamento completo do pneu;
4. Corte a ponta do frasco com um estilete;
5. Rosqueie firmemente a mangueira aplicadora o frasco;
6. Injete lentamente todo conteúdo do frasco usando uma pistola aplicadora de silicone;
7. Aplique um jato de ar na válvula para eliminar resíduos do selante;
8. Reinstale o núcleo de válvula;
9. Calibre o pneu seguindo a recomendação do fabricante da bicicleta;
10. Recoloque a tampa para proteger a válvula de sujeira.

ATENÇÃO

- Veda furos somente na banda de rodagem;
- Funciona com pressão mínima de 20 PSI;
- Não veda ragos nem cortes;
- Não aplicar em pneus SPEED;
- Evitar aplicar em pneus ou câmaras de ar com remendo a frio.
- Para aplicar em pneus com válvula PRESTA, remover o bico com rosca e conectar diretamente a mangueira na válvula.

EMBALAGEM

24 peças

16294



TSW

B I K E



CATÁLOGO

B I C I C L E T A S

Versão 07 de Março 2024



VELUXE
SELECT +

CANOTE	Ø 1
FREIO DISCO	180
EIXO TRASEIRO	140
MATERIAL	ALUMINIO
LARGURA MÁXIMA	29,1
LARGURA MÁXIMA PNEU	27,5
CURSO MÁXIMO DO OILADO	150
MEDIDA SUSPENSÃO TRASEIRA	205
CURSO MÁXIMO SUSPENSÃO TRASEIRA	65
GUIA DE CORRENTE	150
PESO MÁXIMO	ATE 100

29 X 2.40

ALL QUEST



SHIMANO



BICICLETAS



Montanha

Carbono

Boost



RockShox BOOST



1x12 Shimano



Deore XT



16.68 Kg



QUADRO

29" | TSW ALL Quest | Full Suspension Carbon Toray (acabamento UD) | Monocoque | Link e triângulo traseiro carbono | Direção Tapered | Disc brake post mount | Chain guide ISCG-05 | Central BSA | Boost 148x12 mm THRU AXLE | Curso traseiro 150 mm



SUSPENSÃO DIANTEIRA

RockShox 35 SILVER TK 150 mm/160 mm | Solo Air | 15x110 mm | 29" | 51 mm offset | Coil | Dual Position Coil | Haste 35 mm



SUSPENSÃO TRASEIRA

Rock Shox Deluxe Select + | 205 x 65mm | Rebound Tune M | Compression tune L1 | 2-position compression



MOVIMENTO DE DIREÇÃO

Tapered | Semi-integrada (ZS) | Rolamentado



GUIDÃO

Quest | Alumínio | 35 x 800 mm | Upsweep 5° | Backsweep 7° | Rise 15 mm



SUPOORTE DE GUIDÃO

Quest | 35 x 45 mm/0° | Alumínio



MANOPLA

TSW Light | Preto



CONJUNTO DE FREIO

Dianteiro: Shimano SLX M7100 ou XT MT8120 pinça com 4 pistões / **Traseiro:** Shimano SLX M7100 pinça com 4 pistões ou XT MT8100 pinça com 2 pistões, Disco, Hidráulico



DISCO DE FREIO

Dianteiro: 203 mm **Traseiro:** 180 mm | Center lock, Shimano SM-RT64 ou RT-MT800 Ice Tech



ARO/RAIO

Aro: WTB Kom Trail i 35 | 35 mm interno | **Tubeless ready** | 32 Furos **Raio:** Inox com niple



CUBOS BOOST

Traseiro: Shimano Boost MT-410 | 148x12 mm | 32 furos | 12 Velocidades **Dianteiro:** Shimano Boost MT-400B | 15x110 mm | 32 furos



PNEU / CÂMARA DE AR

Pneu: 29 x 2.4" | Válvula presta 48 mm | Vittoria (Modelo disponível no estoque 2.4) **Câmara de Ar:** Arisun



PEDIVELA

Shimano MT-510 | Single | Braço 170 mm | Coroa 34 dentes



CORRENTE

Shimano Deore | 12 velocidades



EIXO CENTRAL

Shimano MT500



CASSETE

Shimano Deore M6100 | 10-51 | 12 velocidades



CÂMBIO DIANTEIRO

N/A



CÂMBIO TRASEIRO

Deore XT | 12 velocidades



ALAVANCA

Traseira | Shimano SLX | 12 velocidades



SELIM

MTB | Promend | Trilho de Cromoly



CANOTE

Quest | Retrátil | 31.6 x 385 mm | 100 mm curso | Acionamento (Mecânico) Remoto



ABRAÇADEIRA

Quest | 34.9 mm | Alumínio | Parafuso



PEDAL

N/A

15.5" NAC. 22284 - F160MM

FOTOS MERAMENTE ILUSTRATIVAS. AS INFORMAÇÕES/CONFIGURAÇÕES DE PRODUTOS PODERÃO SOFRER ALTERAÇÕES SEM AVISO PRÉVIO.

ENTRE EM CONTATO COM O SEU CONSULTOR OU FALE COM O NOSSO TIME DE TELEVENDAS PELO (33) 3277-3030.

TSW

4

ALL QUEST SHIMANO DEORE



29" WHEELS

Montanha

Carbono

Boost

RockShox BOOST

1x12 Shimano

Deore

Kg 16.68

 QUADRO	29" TSW ALL Quest, Full Suspension Carbon Toray (acabamento UD), Monoque e triângulo traseiro carbono, Direção Tapered, Disc brake post mount, Chain guide ISCG-05, Central BSA, Boost 148x12mm THRU AXLE, Curso traseiro 150mm	 PNEU / CÂMARA DE AR	Pneu: 29 x 2.4" Válvula presta 48 mm Vittoria (Modelo disponível no estoque 2.4) Câmara de Ar: Arisun
 SUSPENSÃO DIANTEIRA	RockShox 35 SILVER TK 150 mm/160 mm Solo Air 15x110 mm 29" 51 mm offset Coil Dual Position Coil Haste 35 mm	 PEDIVELA	Shimano MT-510 Single Braço 170 mm Coroa 34 dentes
 SUSPENSÃO TRASEIRA	Rock Shox Deluxe Select + 205 x 65mm Rebound Tune M Compression tune L1 2-position compression	 CORRENTE	Shimano Deore 12 velocidades
 MOVIMENTO DE DIREÇÃO	Tapered Semi-integrada (ZS) Rolamentado	 EIXO CENTRAL	Shimano MT500
 GUIDÃO	Quest Alumínio 35 x 800 mm Upsweep 5° Backsweep 7° Rise 15 mm	 CASSETTE	10-51, 12 Velocidade, Shimano Deore M6100
 SUPORTE DE GUIDÃO	Quest 35 x 45 mm/0° Alumínio	 CÂMBIO DIANTEIRO	N/A
 MANOPLA	TSW Light Preto	 CÂMBIO TRASEIRO	12 velocidades, Deore M6100
 CONJUNTO DE FREIO	Dianteiro: Shimano SLX M7100 pinça com 4 pistões Traseiro: Shimano SLX M7100 pinça com 4 pistões, Disco, Hidráulico	 ALAVANCA	12 Velocidades, Shimano Deore M6100, Traseira
 DISCO DE FREIO	Dianteiro: Center Lock, 203 mm / Traseiro 180 mm, Shimano SM-RT64	 SELIM	MTB Promend Trilho de Cromoly
 ARO/RAIO	Aro: WTB Kom Trail i 35 35 mm interno Tubeless ready 32 Furos Raio: Inox com niple	 CANOTE	Quest Retrátil 31.6 x 385 mm 100 mm curso Acionamento (Mecânico) Remoto
 CUBOS BOOST	12 Velocidades / Dianteiro: Boost, Shimano MT400B, Eixo de 15 mm, OLD 110 mm, 32 furos / Traseiro: Boost, Shimano MT 410, OLD 148 mm, Eixo de 12 mm, 32 furos, Free Hub Micro-Spline	 ABRAÇADEIRA	Quest 34.9 mm Alumínio Parafuso
		15.5" NAC.	21558 - F160MM
		17.5" NAC.	21559 - F160MM
		19" NAC.	21560 - F160MM



FULL QUEST Advanced+



SHIMANO



29" WHEELS

 Montanha

 Carbono

 Boost

 Rock Shox BOOST

 1x12 Shimano

 Shimano

 Kg 11.95

 **QUADRO** 29" | TSW Full Quest | Full Suspension | Carbono | Monocoque | Link e Triângulo traseiro carbono | Direção Tapered | Disc brake post mount | Boost 148x12mm THRU AXLE | Curso traseiro 110mm | Press-Fit

 **SUSPENSÃO DIANTEIRA** Rock Shox Sid Select + | 120 mm | Tapered | Eixo de 15 mm | Trava Remota

 **SUSPENSÃO TRASEIRA** RockShox SIDLuxe Select + | 165 x 40 mm | Trava Remota

 **MOVIMENTO DE DIREÇÃO** Tapered Integrado

 **GUIDÃO** Quest | Carbono | 800 mm | Backsweep 6° | Upsweep 3°

 **SUPORE DE GUIDÃO** Carbono | Integrado com o guidão | 2° | 70 mm

 **MANOPLA** TSW Light | Preto

 **CONJUNTO DE FREIO** Disco | Hidráulico | Shimano XT MT8100

 **DISCO DE FREIO** Shimano RT-MT900 | Center lock | 180 mm | Ice Tech

 **ARO/RAIO** WTB ST I30 light ou I35 | Alumínio | 28 furos | Parede dupla | **Tubeless Ready** | Largura interna 30 mm | Raio Inox com Niple

 **CUBOS BOOST** **Traseiro:** Shimano XTR M9111-B | 148 x 12 mm | 28 furos | 12 Velocidades / **Dianteiro:** Shimano M9110-B | 15 mm | 28 furos

 **PNEU / CÂMARA DE AR** **Pneu:** Vittoria (**Modelo disponível no estoque**) | 29" / **Câmara de Ar:** Arisun | Válvula Presta 48 mm

 **PEDIVELA** Shimano XT FC-M8100-1 | Single | Braço 170 mm | Coroa 34 Dentes

 **CORRENTE** Shimano XT M8100 | 12 Velocidades

 **EIXO CENTRAL** Shimano MT500 | Press-Fit

 **CASSETE** Shimano XTR M9100 | 10-51T | 12 Velocidades

 **CÂMBIO DIANTEIRO** N/A

 **CÂMBIO TRASEIRO** Shimano XTR M9100 | 12 Velocidades

 **ALAVANCA** Shimano XT SL-M8100 | 12 Velocidades | Traseiro

 **SELIM** Promend | MTB | Trilho de Cromoly

 **CANOTE** Quest | Carbono | 31.6 x 400 mm

 **ABRAÇADEIRA** Alumínio | 34.9 mm | Parafuso

 **PEDAL** N/A

17.5" NAC. 16856



XC (CROSS COUNTRY)/ TRAIL

Bicicletas do Grupo 03 são feitas para girar em trilhas pavimentadas ou não com maior frequência de raízes, pedras, areia e pequenas depressões, mantendo constante contato das rodas com o solo podendo perder este contato por um curto tempo. Sem saltos, sem andar em uma roda (dianteira ou traseira), sem frenagem que faça com que a roda traseira levante.

FOTOS MERAMENTE ILUSTRATIVAS. AS INFORMAÇÕES/CONFIGURAÇÕES DE PRODUTOS PODERÃO SOFRER ALTERAÇÕES SEM AVISO PRÉVIO.

ENTRE EM CONTATO COM O SEU CONSULTOR OU FALE COM O NOSSO TIME DE TELEVENDAS PELO (33) 3277-3030.

FULL QUEST STARTER-SX



SRAM



29" WHEELS

Montanha

Carbono

Boost



RockShox BOOST

1x12 Sram

Shimano

13.9 kg



QUADRO

29" | TSW Full Quest | Full Suspension | Carbono | Monocoque | Link e Triângulo traseiro carbono | Direção Tapered | Disc brake post mount | Boost 148x12mm THRU AXLE | Curso traseiro 110mm | Press-Fit



SUSPENSÃO DIANTEIRA

29" | RockShox Recon Silver RL | 120 mm | Solo Air | Tapered | 15 x 110 mm | Offset 51 mm



SUSPENSÃO TRASEIRA

RockShox Deluxe Select + | 165x 40mm | 2-position compression



MOVIMENTO DE DIREÇÃO

Tapered Integrado



GUIDÃO

Quest | Reto | Alumínio | 31.8 x 740 mm | 0 Rise | 0 upsweep | 9° Backsweep



SUPORTE DE GUIDÃO

Quest | Alumínio | 70 mm/17°



MANOPLA

TSW Light | Preto



CONJUNTO DE FREIO

Shimano Hidráulico MT 200 | Disco



DISCO DE FREIO

Shimano | 160 mm | Center lock | RT-54



ARO/RAIO

WTB ST I30 ou I35 | 32 furos | Tubeless Ready | Freio a disco | Parede dupla | 30 mm largura interna / Raio Inox com Niple



CUBOS BOOST

Dianteiro: Shimano Boost MT400B | O.L.D. 110 | Eixo de 15 mm | 32 furos / **Traseiro:** Boost MT400B | O.L.D. 148 mm | Eixo de 12 mm | 32 Furos



PNEU / CÂMARA DE AR

Pneu: Vittoria (Modelo disponível no estoque) | 29" / **Câmara de Ar:** Arisun | Válvula Presta 48 mm



PEDIVELA

Sram X1 | Single | 11/12 velocidades | DUB | Coroa 32 dentes



CORRENTE

Sram SX 12 velocidades

EIXO CENTRAL

Sram DUB | Press Fit



CASSETE

Sram SX | 12 velocidades | 11-50T



CÂMBIO DIANTEIRO

N/A



CÂMBIO TRASEIRO

Sram SX | 12 Velocidades



ALAVANCA

Sram SX | 12 Velocidades



SELIM

TSW MTB | Preto | Vazado



CANOTE

Quest | Alumínio | 31.6 x 400 mm | Slim | Micro Ajuste



ABRAÇADEIRA

Quest | Alumínio | 34.9 mm | Parafuso



PEDAL

N/A

15.5" NAC. 22292

19" NAC. 22294



GRUPO 01 GRUPO 02 GRUPO 03 GRUPO 04

XC (CROSS COUNTRY)/ TRAIL

Bicicletas do Grupo 03 são feitas para girar em trilhas pavimentadas ou não com maior frequência de raízes, pedras, areia e pequenas depressões, mantendo constante contato das rodas com o solo podendo perder este contato por um curto tempo. Sem saltos, sem andar em uma roda (dianteira ou traseira), sem frenagem que faça com que a roda traseira levante.













EVOLUTION QUEST

YUKON

GX-SM



	QUADRO	TSW YUKON 29" Alumínio 6061 Cabeamento interno Direção Tapered \varnothing 44 x 55 mm Freio a disco post mount Caixa central BSA 73 mm Eixo traseiro Boost 12 x 148mm Canote 31.6 mm Largura máxima do pneu 29 x 2.4" Peso máximo suportado de 120 kg
	SUSPENSÃO DIANTEIRA	Rock Shox Judy TK 120 mm Óleo/Ar Eixo 15 mm Trava remota
	SUSPENSÃO TRASEIRA	N/A
	MOVIMENTO DE DIREÇÃO	Tapered Semi-integrada (ZS) Esfera
	GUIDÃO	X-Time Alumínio Reto 31.8 x 740 mm 9° Backsweep
	SUPORTE DE GUIDÃO	X-Time Alumínio Ahead 70 mm 17°
	MANOPLA	TSW Light
	CONJUNTO DE FREIO	Shimano Hidráulico MT 200 Disco
	DISCO DE FREIO	Shimano RT 26 ou RT 56 160 mm Parafuso
	ARO/RAIO	WTB SI 30 Alumínio 32 furos Parede dupla Tubeless Ready Largura interna 30 mm Raio Preto 2 mm com Niple
	CUBOS	Dianteiro: Boost Eixo de 15 mm OLD 110 mm 32 furos / Traseiro: Boost OLD 148 mm Eixo de 12 mm 32 furos XD System
	PNEU / CÂMARA DE AR	Pneu: Vittoria (Modelo disponível no estoque) 29" / Câmara de Ar: Arisun Válvula Presta 48 mm
	PEDIVELA	Sram X1 Single 11/12 velocidades DUB Coroa 32 dentes
	CORRENTE	Sram SX 12 velocidades
	EIXO CENTRAL	Sram DUB BSA

	CASSETE	Sram GX EAGLE 12 velocidades 10-52T
	CÂMBIO DIANTEIRO	N/A
	CÂMBIO TRASEIRO	Sram GX EAGLE 12 Velocidades Cage com trava
	ALAVANCA	Sram GX EAGLE 12 Velocidades
	SELIM	TSW MTB Preto Vazado
	CANOTE	X-Time Alumínio 31.6 x 350 mm Slim Dois Parafusos Micro Ajuste
	ABRAÇADEIRA	X-Time 34.9 mm Blocagem
	PEDAL	Plataforma MTB Alumínio Preto
	URBANA	✓
	CICLOTURISMO	✓
	TRILHAS INTERMEDIÁRIAS	✓
	COMPETIÇÃO	✓
	PESO APROXIMADO	13.48 kg (17")

29" NACIONAL

15.5  22156















17  N/A

YUKON

SM-12



	QUADRO	TSW YUKON 29" Alumínio 6061 Cabeamento interno Direção Tapered Ø 44 x 55 mm Freio a disco post mount Caixa central BSA 73 mm Eixo traseiro Boost 12 x 148mm Canote 31.6 mm Largura máxima do pneu 29 x 2.4" Peso máximo suportado de 120 kg
	SUSPENSÃO DIANTEIRA	Rock Shox Judy TK 120 mm Óleo/Ar Eixo 15 mm Trava remota
	SUSPENSÃO TRASEIRA	N/A
	MOVIMENTO DE DIREÇÃO	Tapered Semi-integrada (ZS) Esfera
	GUIDÃO	X-Time Alumínio Reto 31.8 x 740 mm 9° Backsweep
	SUPORE DE GUIDÃO	X-Time Alumínio Ahead 70 mm 17°
	MANOPLA	TSW Light
	CONJUNTO DE FREIO	Shimano Hidráulico MT 200 Disco
	DISCO DE FREIO	Shimano RT 30 160 mm Center lock
	ARO/RAIO	Aro: TSW T10.000 Tubeless Ready Parede Dupla 29" 622 x 26mm Altura do perfil: 19,5 mm ERD 602mm 32 furos Alumínio 6061 Válvula Presta (Fina) Pneus: 1.9" até 2.6" / Raio: Preto 2 mm Niple preto
	CUBOS	Dianteiro: Boost Shimano MT400B Eixo de 15 mm OLD 110 mm 32 furos / Traseiro: Boost Shimano M7010 / MT400B OLD 148 mm Eixo de 12 mm 32 furos
	PNEU / CÂMARA DE AR	Pneu Arisun Bona/Graham Skinwall 29" / Câmara de ar Arisun Válvula presta(Fina) 48 mm
	PEDIVELA	Sram X1 Single 11/12 velocidades DUB Coroa 32 dentes

	CORRENTE	Sram SX 12 velocidades
	EIXO CENTRAL	Sram DUB BSA
	CASSETE	Sram SX 12 velocidades 11-50T
	CÂMBIO DIANTEIRO	N/A
	CÂMBIO TRASEIRO	Sram SX 12 Velocidades
	ALAVANCA	Sram SX 12 Velocidades
	SELIM	TSW MTB Preto Vazado
	CANOTE	X-Time Alumínio 31.6 x 350 mm Slim Dois Parafusos Micro Ajuste
	ABRAÇADEIRA	X-Time 34.9 mm Blocação
	PEDAL	Plataforma MTB Alumínio Preto
	URBANA	✓
	CICLOTURISMO	✓
	TRILHAS INTERMEDIÁRIAS	✓
	COMPETIÇÃO	✓
	PESO APROXIMADO	13.92 kg (17")

29" NACIONAL

15.5  22139

21  N/A

YUKON

SM-12



QUADRO

TSW YUKON 29" | Alumínio 6061 | Cabeamento interno | Direção Tapered Ø 44 x 55 mm | Freio a disco post mount | Caixa central BSA 73 mm | Eixo traseiro Boost 12 x 148mm | Canote 31.6 mm | Largura máxima do pneu 29 x 2.4" | Peso máximo suportado de 120 kg



SUSPENSÃO DIANTEIRA

Rock Shox Judy TK 120 mm | Óleo/Ar | Eixo 15 mm | Trava remota



SUSPENSÃO TRASEIRA

N/A



MOVIMENTO DE DIREÇÃO

Tapered | Semi-integrada (ZS) | Esfera



GUIDÃO

X-Time | Alumínio | Reto | 31.8 x 740 mm | 9° Backsweep



SUPORE DE GUIDÃO

X-Time | Alumínio | Ahead | 70 mm | 17°



MANOPLA

TSW Light



CONJUNTO DE FREIO

Shimano Hidráulico MT 200 | Disco



DISCO DE FREIO

Shimano RT 30 | 160 mm | Center lock



ARO/RAIO

Aro: TSW T10.000 Tubeless Ready | Parede Dupla | 29" 622 x 26mm | Altura do perfil: 19,5 mm | ERD 602mm | 32 furos | Alumínio 6061 | Válvula Presta (Fina) | Pneus: 1.9" até 2.6" / Raio: Preto | 2 mm | Niple preto



CUBOS

Dianteiro: Boost | Shimano MT400B | Eixo de 15 mm | OLD 110 mm | 32 furos / **Traseiro:** Boost | Shimano M7010 / MT400B | OLD 148 mm | Eixo de 12 mm | 32 furos



PNEU / CÂMARA DE AR

Pneu Arisun Bona/Graham | Skinwall | 29" / Câmara de ar Arisun | Válvula presta(Fina) 48 mm



PEDIVELA

Sram X1 | Single | 11/12 velocidades | DUB | Coroa 32 dentes



CORRENTE

Sram SX 12 velocidades



EIXO CENTRAL

Sram DUB | BSA



CASSETE

Sram SX | 12 velocidades | 11-50T



CÂMBIO DIANTEIRO

N/A



CÂMBIO TRASEIRO

Sram SX | 12 Velocidades



ALAVANCA

Sram SX | 12 Velocidades



SELIM

TSW MTB | Preto | Vazado



CANOTE

X-Time | Alumínio | 31.6 x 350 mm | Slim | Dois Parafusos | Micro Ajuste



ABRACADEIRA

X-Time | 34.9 mm | Blocação



PEDAL

Plataforma | MTB | Alumínio | Preto



URBANA

✓



CICLOTURISMO

✓



TRILHAS INTERMEDIÁRIAS

✓



COMPETIÇÃO

✓



PESO APROXIMADO

13.92 kg (17")

29" NACIONAL

15.5 22140

19 N/A















21 N/A



hurry **SRAM** / SHIMANO

RS-12V



	QUADRO	TSW Hurry 2022, Direção Tapered Ø 44 x 55 mm, Canote 31.6 mm, Caixa central BSA 68 mm, Freio a disco Poust Mount, Eixo traseiro 135 mm, Alumínio 6061, Largura máxima de pneu: 29 x 2.2", Peso Máximo 120 kg (Peso do ciclista + Equipamentos)
	SUSPENSÃO DIANTEIRA	Rock Shox Judy 100 mm Trava Remota Ajuste de Preload Off set 46 mm OLD 100mm
	SUSPENSÃO TRASEIRA	N/A
	MOVIMENTO DE DIREÇÃO	Tapered Semi-integrada (ZS) Esfera
	GUIDÃO	X-Time Reto Alumínio 31.8 x 740 mm 9° de Backsweep
	SUPORTE DE GUIDÃO	X-Time Ahead 70 mm 17°
	MANOPLA	MTB TSW Light
	CONJUNTO DE FREIO	Shimano MT200 Disco Hidráulico
	DISCO DE FREIO	Shimano RT-30 Center lock 160 mm
	ARO/RAIO	TSW T-9000 Tubeless Ready ERD 599 29" - 622 X 22.5mm Alumínio 6061 Dupla camada 32Furos Ilhós Válvula Fina (Presta) Raio Preto Pneu 1.5" à 2.4"
	CUBOS	Shimano TX 505 Dianteiro/Traseiro 32 furos
	PNEU / CÂMARA DE AR	Pneu: Arisun Bona 29x2.10" Câmara: 29" Válvula presta 48 mm
	PEDIVELA	SRAM SX 12V. Single 1x12 velocidades Coroa 32T. OFF Set 6mm Direct Mount Estriado - ATENÇÃO: NÃO É DUB
	CORRENTE	CN-M6100 SHIMANO 12V./SRAM SX 12V.
	EIXO CENTRAL	SRAM BSA/ Estriado

	CASSETTE	Sram SX 11-50T 12 Velocidades
	CÂMBIO DIANTEIRO	N/A
	CÂMBIO TRASEIRO	Shimano Deore RD 6100 12 velocidades Shadow plus
	ALAVANCA	Shimano Deore SL-M6100 12 Velocidades
	SELIM	TSW MTB Vazado Trilho de aço
	CANOTE	X-Time Alumínio 31.6 x 350 mm Slim Micro Ajuste
	ABRAÇADEIRA	X-Time Alumínio 34.9 mm Blocagem
	PEDAL	Inglês Alumínio Preto
	URBANA	✓
	CICLOTURISMO	✓
	TRILHAS INTERMEDIÁRIAS	✓
	COMPETIÇÃO	X
	PESO APROXIMADO	13,9 kg (17")

29" NACIONAL

15.5 ■ 21511

ATENÇÃO!

- Bicicleta 15.5" Equipada com pedivela de 170mm
- Bicicletas 17", 19" e 21" Equipadas com pedivela de 175mm
- Bicicletas 15.5" e 17" Equipadas com suporte de guidão 70mm/-17"
- Bicicletas 19" e 21" Equipadas com suporte de guidão 80mm/-17"

















hurry SRAM / SHIMANO



RS-12V



BICICLETAS

16

	QUADRO	TSW Hurry 2022, Direção Tapered Ø 44 x 55 mm, Canote 31.6 mm, Caixa central BSA 68 mm, Freio a disco Poust Mount, Eixo traseiro 135 mm, Alumínio 6061, Largura máxima de pneu: 29 x 2.2", Peso Máximo 120 kg (Peso do ciclista + Equipamentos)
	SUSPENSÃO DIANTEIRA	Rock Shox Judy 100 mm Trava Remota Ajuste de Preload Off set 46 mm OLD 100mm
	SUSPENSÃO TRASEIRA	N/A
	MOVIMENTO DE DIREÇÃO	Tapered Semi-integrada (ZS) Esfera
	GUIDÃO	X-Time Reto Alumínio 31.8 x 740 mm 9° de Backsweep
	SUPORTE DE GUIDÃO	X-Time Ahead 70 mm 17°
	MANOPLA	MTB TSW Light
	CONJUNTO DE FREIO	Shimano MT200 Disco Hidráulico
	DISCO DE FREIO	Shimano RT-30 Center lock 160 mm
	ARO/RAIO	TSW T-9000 Tubeless Ready ERD 599 29" - 622 X 22.5mm Alumínio 6061 Dupla camada 32Furos Ilhós Válvula Fina (Presta) Raio Preto Pneu 1.5" à 2.4"
	CUBOS	Shimano TX 505 Dianteiro/Traseiro 32 furos
	PNEU / CÂMARA DE AR	Pneu: Arisun Bona 29x2.10" Câmara: 29" Válvula presta 48 mm
	PEDIVELA	SRAM SX 12V. Single 1x12 velocidades Coroa 32T. OFF Set 6mm Direct Mount Estriado - ATENÇÃO: NÃO É DUB
	CORRENTE	CN-M6100 SHIMANO 12V./SRAM SX 12V.
	EIXO CENTRAL	SRAM BSA/ Estriado

	CASSETTE	Sram SX 11-50T 12 Velocidades
	CÂMBIO DIANTEIRO	N/A
	CÂMBIO TRASEIRO	Shimano Deore RD 6100 12 velocidades Shadow plus
	ALAVANCA	Shimano Deore SL-M6100 12 Velocidades
	SELIM	TSW MTB Vazado Trilho de aço
	CANOTE	X-Time Alumínio 31.6 x 350 mm Slim Micro Ajuste
	ABRAÇADEIRA	X-Time Alumínio 34.9 mm Blocagem
	PEDAL	Inglês Alumínio Preto
	URBANA	✓
	CICLOTURISMO	✓
	TRILHAS INTERMEDIÁRIAS	✓
	COMPETIÇÃO	X
	PESO APROXIMADO	13,9 kg (17")

29" NACIONAL

15.5 ■ 21512

ATENÇÃO!

- Bicicleta 15.5" Equipada com pedivela de 170mm
- Bicicletas 17", 19" e 21" Equipadas com pedivela de 175mm
- Bicicletas 15.5" e 17" Equipadas com suporte de guidão 70mm/-17"
- Bicicletas 19" e 21" Equipadas com suporte de guidão 80mm/-17"













FOTOS MERAMENTE ILUSTRATIVAS. AS INFORMAÇÕES/CONFIGURAÇÕES DE PRODUTOS PODERÃO SOFRER ALTERAÇÕES SEM AVISO PRÉVIO.

ENTRE EM CONTATO COM O SEU CONSULTOR OU FALE COM O NOSSO TIME DE TELEVENDAS PELO (33) 3277-3030.

hurry **SRAM**/SHIMANO

RS-12V



	QUADRO	TSW Hurry 2022, Direção Tapered Ø 44 x 55 mm, Canote 31.6 mm, Caixa central BSA 68 mm, Freio a disco Poust Mount, Eixo traseiro 135 mm, Alumínio 6061, Largura máxima de pneu: 29 x 2.2", Peso Máximo 120 kg (Peso do ciclista + Equipamentos)
	SUSPENSÃO DIANTEIRA	Rock Shox Judy 100 mm Trava Remota Ajuste de Preload Off set 46 mm OLD 100mm
	SUSPENSÃO TRASEIRA	N/A
	MOVIMENTO DE DIREÇÃO	Tapered Semi-integrada (ZS) Esfera
	GUIDÃO	X-Time Reto Alumínio 31.8 x 740 mm 9° de Backsweep
	SUPORE DE GUIDÃO	X-Time Ahead 70 mm 17°
	MANOPLA	MTB TSW Light
	CONJUNTO DE FREIO	Shimano MT200 Disco Hidráulico
	DISCO DE FREIO	Shimano RT-30 Center lock 160 mm
	ARO/RAIO	TSW T-9000 Tubeless Ready ERD 599 29" - 622 X 22.5mm Alumínio 6061 Dupla camada 32Furos Ilhós Válvula Fina (Presta) Raio Preto Pneu 1.5" à 2.4"
	CUBOS	Shimano TX 505 Dianteiro/Traseiro 32 furos
	PNEU / CÂMARA DE AR	Pneu: Arisun Bona 29x2.10" Câmara: 29" Válvula presta 48 mm
	PEDIVELA	SRAM SX 12V. Single 1x12 velocidades Coroa 32T. OFF Set 6mm Direct Mount Estriado - ATENÇÃO: NÃO É DUB
	CORRENTE	SHIMANO 12 Velocidades CN-M6100
	EIXO CENTRAL	SRAM BSA/ Estriado

	CASSETE	Sram SX 11-50T 12 Velocidades
	CÂMBIO DIANTEIRO	N/A
	CÂMBIO TRASEIRO	Shimano Deore RD 6100 12 velocidades Shadow plus
	ALAVANCA	Shimano Deore SL-M6100 12 Velocidades
	SELIM	TSW MTB Vazado Trilho de aço
	CANOTE	X-Time Alumínio 31.6 x 350 mm Slim Micro Ajuste
	ABRACADEIRA	X-Time Alumínio 34.9 mm Bloagem
	PEDAL	Inglês Alumínio Preto
	URBANA	✓
	CICLOTURISMO	✓
	TRILHAS INTERMEDIÁRIAS	✓
	COMPETIÇÃO	X
	PESO APROXIMADO	13,9 kg (17")

29" NACIONAL

15.5 ■ 21426

ATENÇÃO!

- Bicicleta 15.5" Equipada com pedivela de 170mm
- Bicicletas 17", 19" e 21" Equipadas com pedivela de 175mm
- Bicicletas 15.5" e 17" Equipadas com suporte de guidão 70mm/-17"
- Bicicletas 19" e 21" Equipadas com suporte de guidão 80mm/-17"



FOTOS MERAMENTE ILUSTRATIVAS. AS INFORMAÇÕES/CONFIGURAÇÕES DE PRODUTOS PODERÃO SOFRER ALTERAÇÕES SEM AVISO PRÉVIO.

ENTRE EM CONTATO COM O SEU CONSULTOR OU FALE COM O NOSSO TIME DE TELEVENDAS PELO (33) 3277-3030.

hurry SRAM / SHIMANO

RS-12V



BICICLETAS

TSW

18

	QUADRO	TSW Hurry 2022, Direção Tapered Ø 44 x 55 mm, Canote 31.6 mm, Caixa central BSA 68 mm, Freio a disco Poust Mount, Eixo traseiro 135 mm, Alumínio 6061, Largura máxima de pneu: 29 x 2.2", Peso Máximo 120 kg (Peso do ciclista + Equipamentos)
	SUSPENSÃO DIANTEIRA	Rock Shox Judy 100 mm Trava Remota Ajuste de Preload Off set 46 mm OLD 100mm
	SUSPENSÃO TRASEIRA	N/A
	MOVIMENTO DE DIREÇÃO	Tapered Semi-integrada (ZS) Esfera
	GUIDÃO	X-Time Reto Alumínio 31.8 x 740 mm 9° de Backsweep
	SUORTE DE GUIDÃO	X-Time Ahead 70 mm 17°
	MANOPLA	MTB TSW Light
	CONJUNTO DE FREIO	Shimano MT200 Disco Hidráulico
	DISCO DE FREIO	Shimano RT-30 Center lock 160 mm
	ARO/RAIO	TSW T-9000 Tubeless Ready ERD 599 29" - 622 X 22.5mm Alumínio 6061 Dupla camada 32Furos Ilhós Válvula Fina (Presta) Raio Preto Pneu 1.5" à 2.4"
	CUBOS	Shimano TX 505 Dianteiro/Traseiro 32 furos
	PNEU / CÂMARA DE AR	Pneu: Arisun Bona 29x2.10" Câmara: 29" Válvula presta 48 mm
	PEDIVELA	SRAM SX 12V. Single 1x12 velocidades Coroa 32T. OFF Set 6mm Direct Mount Estriado - ATENÇÃO: NÃO É DUB
	CORRENTE	SHIMANO 12 Velocidades CN-M6100
	EIXO CENTRAL	SRAM BSA/ Estriado

	CASSETE	Sram SX 11-50T 12 Velocidades
	CÂMBIO DIANTEIRO	N/A
	CÂMBIO TRASEIRO	Shimano Deore RD 6100 12 velocidades Shadow plus
	ALAVANCA	Shimano Deore SL-M6100 12 Velocidades
	SELIM	TSW MTB Vazado Trilho de aço
	CANOTE	X-Time Alumínio 31.6 x 350 mm Slim Micro Ajuste
	ABRACADEIRA	X-Time Alumínio 34.9 mm Blocação
	PEDAL	Inglês Alumínio Preto
	URBANA	✓
	CICLOTURISMO	✓
	TRILHAS INTERMEDIÁRIAS	✓
	COMPETIÇÃO	X
	PESO APROXIMADO	13,9 kg (17")

29" NACIONAL

15.5 ■ 21424

ATENÇÃO!

- Bicicleta 15.5" Equipada com pedivela de 170mm
- Bicicletas 17", 19" e 21" Equipadas com pedivela de 175mm
- Bicicletas 15.5" e 17" Equipadas com suporte de guidão 70mm/-17"
- Bicicletas 19" e 21" Equipadas com suporte de guidão 80mm/-17"



FOTOS MERAMENTE ILUSTRATIVAS. AS INFORMAÇÕES/CONFIGURAÇÕES DE PRODUTOS PODERÃO SOFRER ALTERAÇÕES SEM AVISO PRÉVIO.

ENTRE EM CONTATO COM O SEU CONSULTOR OU FALE COM O NOSSO TIME DE TELEVENDAS PELO (33) 3277-3030.





jump

ROCK SHOX JUDY 10v



29"
WHEELS

	QUADRO	TSW JUMP 29", Alumínio 6061, Cabeamento interno, Direção Tapered Ø 44 x 55 mm, Freio a disco post mount, Caixa central BSA 73 mm, Eixo traseiro Boost 12 x 148mm, Canote 31.6 mm, Largura máxima do pneu 29 x 2.4", Peso máximo suportado de 120 kg
	SUSPENSÃO DIANTEIRA	29" Rock Shox Judy 120 mm Óleo/Ar Tapered 15 x 110 mm Off Set 51mm Trava remota
	SUSPENSÃO TRASEIRA	N/A
	MOVIMENTO DE DIREÇÃO	Tapered Semi-integrada (ZS) Esfera Caixa de aço
	GUIDÃO	X-Time Alumínio Reto 31.8 x 740 mm 9° Backsweep
	SUPORE DE GUIDÃO	X-Time Alumínio Ahead 70 mm +-17° Diâmetro 31.8mm
	MANOPLA	TSW Light
	CONJUNTO DE FREIO	Shimano Hidráulico MT 200 Disco
	DISCO DE FREIO	Shimano RT 30 160 mm Center lock
	ARO/RAIO	Aro: TSW T10.000 Tubeless Ready, Parede Dupla, 29" 622 x 26mm, Altura do perfil: 19,5 mm, ERD 602mm, 32 furos, Alumínio 6061, Válvula Presta (Fina), Pneus: 1.9" até 2.6" / Raio: Preto, 2 mm, Niple preto
	CUBOS	Dianteiro: Boost Shimano MT400B Eixo de 15 mm OLD 110 mm 32 furos / Traseiro: Boost Shimano MT 410 OLD 148 mm Eixo de 12 mm 32 furos Free Hub Standard
	PNEU / CÂMARA DE AR	Pneu Arisun Mount Bona/Graham Skinwall 29" / Câmara de ar Arisun Válvula presta(Fina) 48 mm
	PEDIVELA	Shimano FC-M5100/ MT4100 Single 1x10 velocidades Coroa 30 dentes Braço 170mm Deore

	CORRENTE	KMC 10 velocidades
	MOVIMENTO CENTRAL	Shimano BB52 / MT 500 Padrão BSA Hollowtech II
	CASSETE	Shimano Deore CS-M4100 10 Velocidades 11-46T (11/13/15/18/21/24/28/32/37/46T)
	CÂMBIO DIANTEIRO	N/A
	CÂMBIO TRASEIRO	Shimano Deore RD-M5120 10 Velocidades
	ALAVANCA	Shimano Deore SL-M4100 10 Velocidades Traseira
	SELIM	TSW MTB Vazado
	CANOTE	X-Time Alumínio 31.6 x 350 mm Slim Dois Parafusos Micro Ajuste
	ABRACADEIRA	X-Time 34.9 mm Blocação
	PEDAL	Plataforma MTB Alumínio Preto
	URBANA	✓
	CICLOTURISMO	✓
	TRILHAS INTERMEDIÁRIAS	✓
	COMPETIÇÃO	X

29" NACIONAL

15.5  20901

17  20904

19  20907

jump

ROCK SHOX JUDY 10v

29" WHEELS



 QUADRO	TSW JUMP 29", Alumínio 6061, Cabeamento interno, Direção Tapered Ø 44 x 55 mm, Freio a disco post mount, Caixa central BSA 73 mm, Eixo traseiro Boost 12 x 148mm, Canote 31.6 mm, Largura máxima do pneu 29 x 2.4", Peso máximo suportado de 120 kg	 CORRENTE	KMC 10 velocidades
 SUSPENSÃO DIANTEIRA	29" Rock Shox Judy 120 mm Óleo/Ar Tapered 15 x 110 mm Off Set 51mm Trava remota	 MOVIMENTO CENTRAL	Shimano BB52 / MT 500 Padrão BSA Hollowtech II
 SUSPENSÃO TRASEIRA	N/A	 CASSETE	Shimano Deore CS-M4100 10 Velocidades 11-46T (11/13/15/18/21/24/28/32/37/46T)
 MOVIMENTO DE DIREÇÃO	Tapered Semi-integrada (ZS) Esfera Caixa de aço	 CÂMBIO DIANTEIRO	N/A
 GUIDÃO	X-Time Alumínio Reto 31.8 x 740 mm 9° Backsweep	 CÂMBIO TRASEIRO	Shimano Deore RD-M5120 10 Velocidades
 SUORTE DE GUIDÃO	X-Time Alumínio Ahead 70 mm +-17° Diâmetro 31.8mm	 ALAVANCA	Shimano Deore SL-M4100 10 Velocidades Traseira
 MANOPLA	TSW Light	 SELIM	TSW MTB Vazado
 CONJUNTO DE FREIO	Shimano Hidráulico MT 200 Disco	 CANOTE	X-Time Alumínio 31.6 x 350 mm Slim Dois Parafusos Micro Ajuste
 DISCO DE FREIO	Shimano RT 30 160 mm Center lock	 ABRAÇADEIRA	X-Time 34.9 mm Blocação
 ARO/RAIO	Aro: TSW T10.000 Tubeless Ready, Parede Dupla, 29" 622 x 26mm, Altura do perfil: 19,5 mm, ERD 602mm, 32 furos, Alumínio 6061, Válvula Presta (Fina), Pneus: 1.9" até 2.6" / Raio: Preto, 2 mm, Niple preto	 PEDAL	Plataforma MTB Alumínio Preto
 CUBOS	Dianteiro: Boost Shimano MT400B Eixo de 15 mm OLD 110 mm 32 furos / Traseiro: Boost Shimano MT 410 OLD 148 mm Eixo de 12 mm 32 furos Free Hub Standard	 URBANA	✓
 PNEU / CÂMARA DE AR	Pneu Arisun Mount Bona/Graham Skinwall 29" / Câmara de ar Arisun Válvula presta(Fina) 48 mm	 CICLOTURISMO	✓
 PEDIVELA	Shimano FC-M5100/ MT4100 Single 1x10 velocidades Coroa 30 dentes Braço 170mm Deore	 TRILHAS INTERMEDIÁRIAS	✓
		 COMPETIÇÃO	X

29" NACIONAL

15.5 20902























17 20905

jump

ROCK SHOX JUDY 10v

29"
WHEELS



	QUADRO	TSW JUMP 29", Alumínio 6061, Cabeamento interno, Direção Tapered Ø 44 x 55 mm, Freio a disco post mount, Caixa central BSA 73 mm, Eixo traseiro Boost 12 x 148mm, Canote 31.6 mm, Largura máxima do pneu 29 x 2.4", Peso máximo suportado de 120 kg
	SUSPENSÃO DIANTEIRA	29" Rock Shox Judy 120 mm Óleo/Ar Tapered 15 x 110 mm Off Set 51mm Trava remota
	SUSPENSÃO TRASEIRA	N/A
	MOVIMENTO DE DIREÇÃO	Tapered Semi-integrada (ZS) Esfera Caixa de aço
	GUIDÃO	X-Time Alumínio Reto 31.8 x 740 mm 9° Backsweep
	SUPORTE DE GUIDÃO	X-Time Alumínio Ahead 70 mm +-17° Diâmetro 31.8mm
	MANOPLA	TSW Light
	CONJUNTO DE FREIO	Shimano Hidráulico MT 200 Disco
	DISCO DE FREIO	Shimano RT 30 160 mm Center lock
	ARO/RAIO	Aro: TSW T10.000 Tubeless Ready, Parede Dupla, 29" 622 x 26mm, Altura do perfil: 19,5 mm, ERD 602mm, 32 furos, Alumínio 6061, Válvula Presta (Fina), Pneus: 1.9" até 2.6" / Raio: Preto, 2 mm, Niple preto
	CUBOS	Dianteiro: Boost Shimano MT400B Eixo de 15 mm OLD 110 mm 32 furos / Traseiro: Boost Shimano MT 410 OLD 148 mm Eixo de 12 mm 32 furos Free Hub Standard
	PNEU / CÂMARA DE AR	Pneu Arisun Mount Bona/Graham Skinwall 29" / Câmara de ar Arisun Válvula presta(Fina) 48 mm
	PEDIVELA	Shimano FC-M5100/ MT4100 Single 1x10 velocidades Coroa 30 dentes Braço 170mm Deore
	CORRENTE	KMC 10 velocidades
	MOVIMENTO CENTRAL	Shimano BB52 / MT 500 Padrão BSA Hollowtech II
	CASSETE	Shimano Deore CS-M4100 10 Velocidades 11-46T (11/13/15/18/21/24/28/32/37/46T)
	CÂMBIO DIANTEIRO	N/A
	CÂMBIO TRASEIRO	Shimano Deore RD-M5120 10 Velocidades
	ALAVANCA	Shimano Deore SL-M4100 10 Velocidades Traseira
	SELIM	TSW MTB Vazado
	CANOTE	X-Time Alumínio 31.6 x 350 mm Slim Dois Parafusos Micro Ajuste
	ABRAÇADEIRA	X-Time 34.9 mm Blocação
	PEDAL	Plataforma MTB Alumínio Preto
	URBANA	✓
	CICLOTURISMO	✓
	TRILHAS INTERMEDIÁRIAS	✓
	COMPETIÇÃO	X
29" NACIONAL		
15.5		20903
17		20906
19		20908
21		N/A













jump

Linha com Tapered

29"
WHEELS



	QUADRO	TSW Jump Plus 2022 Direção Tapered Ø 44 x55 mm Canote 31.6 mm Caixa central BSA 68 mm Freio a disco Poust Mount Eixo traseiro 135 mm Alumínio 6061 Largura máxima de pneu: 29 x 2.2" Peso Máximo 120 kg
	SUSPENSÃO DIANTEIRA	SR Suntour XCM 30 Tapered Ahead Set Eixo de 9 mm Trava Remota Ajuste de Preload
	SUSPENSÃO TRASEIRA	N/A
	MOVIMENTO DE DIREÇÃO	Tapered Semi-integrada (ZS) Esfera
	GUIDÃO	X-Time Reto Alumínio 31.8 x 740 mm 9° de Backsweep
	SUPORTE DE GUIDÃO	X-Time Ahead 70 mm 17°
	MANOPLA	MTB TSW Light
	CONJUNTO DE FREIO	Shimano MT200 Disco Hidráulico
	DISCO DE FREIO	Shimano RT-10 Center lock 160 mm
	ARO/RAIO	TSW T-9000 Tubeless Ready 29" Alumínio Dupla camada 32 furos Ilhós Válvula Fina (Presta) Raio Preto
	CUBOS	Shimano TX 505 Dianteiro/Traseiro 32 furos
	PNEU / CÂMARA DE AR	Pneu: Arisun Bona/Graham 29x2.10" Câmara: 29" Válvula presta 48 mm
	PEDIVELA	Shimano MT 5100/MT4100 Single 1x10 velocidades Coroa 30 dentes
	CORRENTE	10 Velocidades KMC
	MOVIMENTO CENTRAL	Shimano BB52/MT500
	CASSETTE	Shimano 10 velocidades 11-46T

	CÂMBIO DIANTEIRO	N/A
	CÂMBIO TRASEIRO	Shimano RD-M5120 10 velocidades
	ALAVANCA	Shimano Deore SL-M4100 10 velocidades Traseira
	SELIM	TSW MTB Vazado
	CANOTE	X-Time Alumínio 31.6 x 350 mm Slim Micro Ajuste
	ABRAÇADEIRA	X-Time Alumínio 34.9 mm Blocagem
	PEDAL	Inglês Alumínio Preto
	URBANA	✓
	CICLOTURISMO	✓
	TRILHAS INTERMEDIÁRIAS	✓
	COMPETIÇÃO	X
	PESO APROXIMADO	14.18 kg (17")

29" NACIONAL

15.5 ■ 20892

jump

Linha com Tapered

29" WHEELS



	QUADRO	TSW Jump Plus 2022 Direção Tapered Ø 44 x55 mm Canote 31.6 mm Caixa central BSA 68 mm Freio a disco Poust Mount Eixo traseiro 135 mm Alumínio 6061 Largura máxima de pneu: 29 x 2.2" Peso Máximo 120 kg
	SUSPENSÃO DIANTEIRA	SR Suntour XCM 30 Tapered Ahead Set Eixo de 9 mm Trava Remota Ajuste de Preload
	SUSPENSÃO TRASEIRA	N/A
	MOVIMENTO DE DIREÇÃO	Tapered Semi-integrada (ZS) Esfera
	GUIDÃO	X-Time Reto Alumínio 31.8 x 740 mm 9° de Backsweep
	SUPOORTE DE GUIDÃO	X-Time Ahead 70 mm 17°
	MANOPLA	MTB TSW Light
	CONJUNTO DE FREIO	Shimano MT200 Disco Hidráulico
	DISCO DE FREIO	Shimano RT-10 Center lock 160 mm
	ARO/RAIO	TSW T-9000 Tubeless Ready 29" Alumínio Dupla camada 32 furos Ilhós Válvula Fina (Presta) Raio Preto
	CUBOS	Shimano TX 505 Dianteiro/Traseiro 32 furos
	PNEU / CÂMARA DE AR	Pneu: Arisun Bona/Graham 29x2.10" Câmara: 29" Válvula presta 48 mm
	PEDIVELA	Shimano MT 5100/MT4100 Single 1x10 velocidades Coroa 30 dentes
	CORRENTE	10 Velocidades KMC
	MOVIMENTO CENTRAL	Shimano BB52/MT500
	CASSETTE	Shimano 10 velocidades 11-46T

	CÂMBIO DIANTEIRO	N/A
	CÂMBIO TRASEIRO	Shimano RD-M5120 10 velocidades
	ALAVANCA	Shimano Deore SL-M4100 10 velocidades Traseira
	SELIM	TSW MTB Vazado
	CANOTE	X-Time Alumínio 31.6 x 350 mm Slim Micro Ajuste
	ABRAÇADEIRA	X-Time Alumínio 34.9 mm Blocagem
	PEDAL	Inglês Alumínio Preto
	URBANA	✓
	CICLOTURISMO	✓
	TRILHAS INTERMEDIÁRIAS	✓
	COMPETIÇÃO	X
	PESO APROXIMADO	14.18 kg (17")

29" NACIONAL

17 ■ 20896

jump

ROCK SHOX JUDY

29"
WHEELS



BICICLETAS

TSW

26

	QUADRO	TSW Jump 2022, Direção Tapered Ø 44 x 55 mm, Canote 31.6 mm, Caixa central BSA 68 mm, Freio a disco Poust Mount, Eixo traseiro 135 mm, Alumínio 6061, Largura máxima de pneu: 29 x 2.2", Peso Máximo 120 kg
	SUSPENSÃO DIANTEIRA	Rock Shox Judy 100 mm Trava Remota Ajuste de Preload Off set 46 mm OLD 100mm
	SUSPENSÃO TRASEIRA	N/A
	MOVIMENTO DE DIREÇÃO	Tapered Semi-integrada (ZS) Esfera
	GUIDÃO	X-Time Reto Alumínio 31.8 x 740 mm 9° de Backsweep
	SUORTE DE GUIDÃO	X-Time Ahead 70 mm 17°
	MANOPLA	MTB TSW Light
	CONJUNTO DE FREIO	Shimano MT200 Disco Hidráulico
	DISCO DE FREIO	Shimano MT200 Disco Hidráulico
	ARO/RAIO	TSW T-9000 Tubeless Ready 29" Alumínio Dupla camada 32Furos Ilhós Válvula Fina (Presta) Raio Preto
	CUBOS	Shimano TX 505 Dianteiro/Traseiro 32 furos
	PNEU / CÂMARA DE AR	Pneu: Arisun Bona/Graham 29x2.10" Câmara: 29" Válvula presta 48 mm
	PEDIVELA	Shimano MT5100/ MT4100 Single 1x10 velocidades Coroa 30 dentes
	CORRENTE	10 Velocidades KMC
	MOVIMENTO CENTRAL	Shimano BB52/ MT 500
	CASSETE	Shimano 10 Velocidades 11-46T

	CÂMBIO DIANTEIRO	N/A
	CÂMBIO TRASEIRO	Shimano RD-M5120 10 Velocidades
	ALAVANCA	Shimano Deore SL-M4100 10 Velocidades Traseira
	SELIM	TSW MTB Vazado
	CANOTE	X-Time Alumínio 31.6 x 350 mm Slim Micro Ajuste
	ABRACADEIRA	X-Time Alumínio 34.9 mm Blocagem
	PEDAL	Inglês Alumínio Preto
	URBANA	✓
	CICLOTURISMO	✓
	TRILHAS INTERMEDIÁRIAS	✓
	COMPETIÇÃO	X
	PESO APROXIMADO	14.18 kg (17")

29" NACIONAL

15.5  21470

FOTOS MERAMENTE ILUSTRATIVAS. AS INFORMAÇÕES/CONFIGURAÇÕES DE PRODUTOS PODERÃO SOFRER ALTERAÇÕES SEM AVISO PRÉVIO.

ENTRE EM CONTATO COM O SEU CONSULTOR OU FALE COM O NOSSO TIME DE TELEVENDAS PELO (33) 3277-3030.

jump

ROCK SHOX JUDY

29"
WHEELS



QUADRO

TSW Jump 2022, Direção Tapered Ø 44 x 55 mm, Canote 31.6 mm, Caixa central BSA 68 mm, Freio a disco Poust Mount, Eixo traseiro 135 mm, Alumínio 6061, Largura máxima de pneu: 29 x 2.2", Peso Máximo 120 kg



SUSPENSÃO DIANTEIRA

Rock Shox Judy | 100 mm | Trava Remota | Ajuste de Preload | Off set 46 mm | OLD 100mm



SUSPENSÃO TRASEIRA

N/A



MOVIMENTO DE DIREÇÃO

Tapered | Semi-integrada (ZS) | Esfera



GUIDÃO

X-Time | Reto | Alumínio | 31.8 x 740 mm | 9° de Backsweep



SUPORTE DE GUIDÃO

X-Time | Ahead | 70 mm | 17°



MANOPLA

MTB | TSW Light



CONJUNTO DE FREIO

Shimano MT200 | Disco | Hidráulico



DISCO DE FREIO

Shimano MT200 | Disco | Hidráulico



ARO/RAIO

TSW T-9000 **Tubeless Ready** | 29" | Alumínio | Dupla camada | 32Furos | Ilhós | Válvula Fina (Presta) | Raio Preto



CUBOS

Shimano TX 505 | Dianteiro/Traseiro | 32 furos



PNEU / CÂMARA DE AR

Pneu: Arisun Bona/Graham 29x2.10"
Câmara: 29" | Válvula presta 48 mm



PEDIVELA

Shimano MT5100/ MT4100 | Single | 1x10 velocidades | Coroa 30 dentes



CORRENTE

10 Velocidades | KMC



MOVIMENTO CENTRAL

Shimano BB52/ MT 500



CASSETTE

Shimano | 10 Velocidades | 11-46T



CÂMBIO DIANTEIRO

N/A



CÂMBIO TRASEIRO

Shimano RD-M5120 | 10 Velocidades



ALAVANCA

Shimano Deore SL-M4100 | 10 Velocidades | Traseira



SELIM

TSW | MTB | Vazado



CANOTE

X-Time | Alumínio | 31.6 x 350 mm | Slim | Micro Ajuste



ABRAÇADEIRA

X-Time | Alumínio | 34.9 mm | Bloccagem



PEDAL

Inglês | Alumínio | Preto



URBANA

✓



CICLOTURISMO

✓



TRILHAS INTERMEDIÁRIAS

✓



COMPETIÇÃO

X



PESO APROXIMADO

14.18 kg (17")

29" NACIONAL

15.5  21471

17  N/A

19  -

21  -

jump

ROCK SHOX JUDY

29"
WHEELS



BICICLETAS

	QUADRO	TSW Jump 2022, Direção Tapered Ø 44 x 55 mm, Canote 31.6 mm, Caixa central BSA 68 mm, Freio a disco Poust Mount, Eixo traseiro 135 mm, Alumínio 6061, Largura máxima de pneu: 29 x 2.2", Peso Máximo 120 kg
	SUSPENSÃO DIANTEIRA	Rock Shox Judy 100 mm Trava Remota Ajuste de Preload Off set 46 mm OLD 100mm
	SUSPENSÃO TRASEIRA	N/A
	MOVIMENTO DE DIREÇÃO	Tapered Semi-integrada (ZS) Esfera
	GUIDÃO	X-Time Reto Alumínio 31.8 x 740 mm 9° de Backsweep
	SUPORTE DE GUIDÃO	X-Time Ahead 70 mm 17°
	MANOPLA	MTB TSW Light
	CONJUNTO DE FREIO	Shimano MT200 Disco Hidráulico
	DISCO DE FREIO	Shimano MT200 Disco Hidráulico
	ARO/RAIO	TSW T-9000 Tubeless Ready 29" Alumínio Dupla camada 32Furos Ilhós Válvula Fina (Presta) Raio Preto
	CUBOS	Shimano TX 505 Dianteiro/Traseiro 32 furos
	PNEU / CÂMARA DE AR	Pneu: Arisun Bona/Graham 29x2.10" Câmara: 29" Válvula presta 48 mm
	PEDIVELA	Shimano MT5100/ MT4100 Single 1x10 velocidades Coroa 30 dentes
	CORRENTE	10 Velocidades KMC
	MOVIMENTO CENTRAL	Shimano BB52/ MT 500
	CASSETE	Shimano 10 Velocidades 11-46T

	CÂMBIO DIANTEIRO	N/A
	CÂMBIO TRASEIRO	Shimano RD-M5120 10 Velocidades
	ALAVANCA	Shimano Deore SL-M4100 10 Velocidades Traseira
	SELIM	TSW MTB Vazado
	CANOTE	X-Time Alumínio 31.6 x 350 mm Slim Micro Ajuste
	ABRAÇADEIRA	X-Time Alumínio 34.9 mm Bloccagem
	PEDAL	Inglês Alumínio Preto
	URBANA	✓
	CICLOTURISMO	✓
	TRILHAS INTERMEDIÁRIAS	✓
	COMPETIÇÃO	X
	PESO APROXIMADO	14.18 kg (17")

29" NACIONAL

17  21475

19  N/A

FOTOS MERAMENTE ILUSTRATIVAS. AS INFORMAÇÕES/CONFIGURAÇÕES DE PRODUTOS PODERÃO SOFRER ALTERAÇÕES SEM AVISO PRÉVIO.

ENTRE EM CONTATO COM O SEU CONSULTOR OU FALE COM O NOSSO TIME DE TELEVENDAS PELO (33) 3277-3030.



stamina



	QUADRO	TSW STAMINA 2021/2022 Cabeamento interno Direção Mega Over Ø 44 mm Canote 31.6 mm Caixa central BSA 68 mm Freio a disco Poust Mount Eixo traseiro 135 mm Alumínio 6061 Largura máxima de pneu: 29 x 2.2" Peso Máximo 120 kg
	SUSPENSÃO DIANTEIRA	SR Suntour XCM 30 Ahead Eixo de 9 mm Trava Remota Ajuste de Preload
	SUSPENSÃO TRASEIRA	N/A
	MOVIMENTO DE DIREÇÃO	Mega Over
	GUIDÃO	X-Time Reto Alumínio 31.8 x 740 mm 9° de Backsweep
	SUPORTE DE GUIDÃO	X-Time Ahead 70 mm 17°
	MANOPLA	MTB TSW Light
	CONJUNTO DE FREIO	Shimano MT200 Disco Hidráulico
	DISCO DE FREIO	Shimano RT-10 Center lock 160 mm
	ARO/RAIO	Aro: TSW T6300 Freio a disco 32 furos Parede Dupla 29" - 622 x 19 mm / Raio: Preto 292/293 x 2.0 mm Niple
	CUBOS	Shimano TX 505 Dianteiro/Traseiro 32 furos
	PNEU / CÂMARA DE AR	Pneu: Arisun Bona/Graham 29x2.10" Câmara: 29" Válvula presta 48 mm
	PEDIVELA	Shimano MT2102 Duplo 22/36T
	CORRENTE	KMC 9 Velocidades
	EIXO CENTRAL	Shimano MT 500
	CASSETTE	Shimano 9 Velocidades 11-36T
	CÂMBIO DIANTEIRO	Shimano Alivio M3120

	CÂMBIO TRASEIRO	Shimano Alivio RD-M3100 9 Velocidades
	ALAVANCA	2x9 Velocidades Dianteira: Shimano Alivio SL 310002 Traseira: Shimano Alívio SL-M3100
	SELIM	TSW MTB Vazado
	CANOTE	X-Time Alumínio 31,6 x 350mm Slim Micro Ajuste
	ABRACADEIRA	X-Time Alumínio 34.9 mm Blocagem
	PEDAL	Inglês Alumínio Preto
	URBANA	✓
	CICLOTURISMO	✓
	TRILHAS INTERMEDIÁRIAS	✓
	COMPETIÇÃO	X
	PESO APROXIMADO	14.4kg (17")

29" NACIONAL

15.5 ■ N/A/21415



AQUITEM

SHIMANO

PET

SHIMANO

hunch

PLUS



BICICLETAS

TSW

32

	QUADRO	TSW Hunch Plus 29" Alumínio 6061 Direção Mega Over 44 mm Freio a Disco Eixo traseiro 135 mm Canote 17.2 mm Largura máxima de Pneu 29" x 2.2" Peso máximo até 120 kg
	SUSPENSÃO DIANTEIRA	TSW Eixo de 9 mm Ahead Trava Remota
	SUSPENSÃO TRASEIRA	N/A
	MOVIMENTO DE DIREÇÃO	Mega Over
	GUIDÃO	X-Time Reto Alumínio 31.8 x 740 mm 9° Backsweep
	SUPOORTE DE GUIDÃO	X-Time Alumínio 80 mm 7°
	MANOPLA	MTB-TSW light
	CONJUNTO DE FREIO	Disco Hidráulico Shimano EF 505
	DISCO DE FREIO	Shimano RT-10 Center lock 160 mm
	ARO/RAIO	Aro: TSW T6300 Freio a disco 32 furos Parede Dupla 29" - 622 x 19 mm / Raio: Preto 292/293 x 2.0 mm Niple
	CUBOS	Shimano TX 505 Dianteiro/Traseiro 32 Furos Alumínio
	PNEU / CÂMARA DE AR	Pneu: Arisun Bona/Graham 29" Câmara: 29" Válvula Presta 48 mm
	PEDIVELA	Shimano MT-210 Triplo 22/30/40T
	CORRENTE	KMC 9 Velocidades
	EIXO CENTRAL	Shimano MT500
	CASSETTE	Shimano 9 Velocidades 11-36T
	CÂMBIO DIANTEIRO	Shimano M2000
	CÂMBIO TRASEIRO	Shimano Alivio RD-M3100 9 Velocidades

	ALAVANCA / MANETE	Alavanca/Manete de freio Shimano EF-505 27 velocidades
	SELIM	MTB TSW Vazado
	CANOTE	X-Time 27.2 x 400 mm Slim Micro Ajuste
	ABRAÇADEIRA	X-Time 31.8 mm Blocação
	PEDAL	Plataforma MTB Alumínio
	URBANA	✓
	CICLOTURISMO	✓
	TRILHAS INTERMEDIÁRIAS	X
	COMPETIÇÃO	X
	PESO APROXIMADO	15.07 kg (17")

29" NACIONAL

15.5 21406

FOTOS MERAMENTE ILUSTRATIVAS. AS INFORMAÇÕES/CONFIGURAÇÕES DE PRODUTOS PODERÃO SOFRER ALTERAÇÕES SEM AVISO PRÉVIO.

ENTRE EM CONTATO COM O SEU CONSULTOR OU FALE COM O NOSSO TIME DE TELEVENDAS PELO (33) 3277-3030.

hunch

AQUI
TEM

SHIMANO







QUALIDADE
CONFIANÇA



#SEMPRESHIMANO



	QUADRO	TSW Hunch 29" Alumínio 6061 Direção Mega Over 44 mm Freio a Disco Eixo traseiro 135 mm Canote 17.2 mm Largura máxima de Pneu 29" x 2.2" Peso máximo até 120 kg
	SUSPENSÃO DIANTEIRA	TSW Eixo de 9 mm Ahead Trava Remota
	SUSPENSÃO TRASEIRA	N/A
	MOVIMENTO DE DIREÇÃO	Mega Over
	GUIDÃO	X-Time Reto Alumínio 31.8 x 740 mm 9° Backsweep
	SUPOORTE DE GUIDÃO	X-Time Alumínio 80 mm 7°
	MANOPLA	MTB-TSW light
	CONJUNTO DE FREIO	Disco Hidráulico Shimano EF 505
	DISCO DE FREIO	Shimano RT-10 Center lock 160 mm
	ARO/RAIO	Aro: TSW T6300 Freio a disco 32 furos Parede Dupla 29" - 622 x 19 mm / Raio: Preto 292/293 x 2.0 mm Niple
	CUBOS	Shimano TX 505 Dianteiro/Traseiro 32 Furos Alumínio
	PNEU / CÂMARA DE AR	Pneu: Arisun Bona/Graham 29" Câmara: 29" Válvula Presta 48 mm
	PEDIVELA	Shimano TY-301 Triplo 24/34/42T
	CORRENTE	KMC 8 Velocidades
	EIXO CENTRAL	34.7 122.5 mm
	CASSETTE	Shimano 8 Velocidades 11-34T
	CÂMBIO DIANTEIRO	Shimano M FD-M313 34.9 mm Com adaptador Abraçadeira alta
	CÂMBIO TRASEIRO	Shimano Altus M310 8 Velocidades

	ALAVANCA / MANETE	Alavanca/Manete de freio Shimano EF-505 24 velocidades
	SELIM	MTB TSW Vazado
	CANOTE	X-Time 27.2 x 400 mm Slim
	ABRAÇADEIRA	X-Time 31.8 mm Blocagem
	PEDAL	Plataforma MTB Alumínio
	URBANA	✓
	CICLOTURISMO	✓
	TRILHAS INTERMEDIÁRIAS	X
	COMPETIÇÃO	X

29" NACIONAL









15.5  16575

17  N/A

hunch



	QUADRO	TSW Hunch 29" Alumínio 6061 Direção Mega Over 44 mm Freio a Disco Eixo traseiro 135 mm Canote 17.2 mm Largura máxima de Pneu 29" x 2.2" Peso máximo até 120 kg
	SUSPENSÃO DIANTEIRA	TSW Eixo de 9 mm Ahead Trava Remota
	SUSPENSÃO TRASEIRA	N/A
	MOVIMENTO DE DIREÇÃO	Mega Over
	GUIDÃO	X-Time Reto Alumínio 31.8 x 740 mm 9° Backsweep
	SUPOORTE DE GUIDÃO	X-Time Alumínio 80 mm 7°
	MANOPLA	MTB-TSW light
	CONJUNTO DE FREIO	Disco Hidráulico Shimano EF 505
	DISCO DE FREIO	Shimano RT-10 Center lock 160 mm
	ARO/RAIO	Aro: TSW T6300 Freio a disco 32 furos Parede Dupla 29" - 622 x 19 mm / Raio: Preto 292/293 x 2.0 mm Niple
	CUBOS	Shimano TX 505 Dianteiro/Traseiro 32 Furos Alumínio
	PNEU / CÂMARA DE AR	Pneu: Arisun Bona/Graham 29" Câmara: 29" Válvula Presta 48 mm
	PEDIVELA	Shimano TY-301 Triplo 24/34/42T
	CORRENTE	KMC 8 Velocidades
	EIXO CENTRAL	34.7 122.5 mm
	CASSETTE	Shimano 8 Velocidades 11-34T
	CÂMBIO DIANTEIRO	Shimano M FD-M313 34.9 mm Com adaptador Abraçadeira alta
	CÂMBIO TRASEIRO	Shimano Altus M310 8 Velocidades

	ALAVANCA / MANETE	Alavanca/Manete de freio Shimano EF-505 24 velocidades
	SELIM	MTB TSW Vazado
	CANOTE	X-Time 27.2 x 400 mm Slim
	ABRÇAÇADEIRA	X-Time 31.8 mm Blocagem
	PEDAL	Plataforma MTB Alumínio
	URBANA	✓
	CICLOTURISMO	✓
	TRILHAS INTERMEDIÁRIAS	X
	COMPETIÇÃO	X

29" NACIONAL

15.5  16576



17  N/A

21  N/A

hunch

20"
WHEELS



	QUADRO	TSW Hunch aro 20" Alumínio 6061 Direção Mega Over 44 mm semi-integrada Freio a Disco Post Mount Eixo traseiro 135 mm Canote 27.2 mm Largura máxima de pneu 20" x 2.2"
	SUSPENSÃO DIANTEIRA	Suspensão TSW aro 20" Eixo de 9 mm Ahead Set Trava remota OLD 100 mm Kraw alumínio Lower Leg de aço
	SUSPENSÃO TRASEIRA	N/A
	MOVIMENTO DE DIREÇÃO	Direção mega over Semi-integrada Esferada 44 mm
	GUIDÃO	X-Time Alumínio Reto 31.8 x 650 mm 9° backsweep
	SUORTE DE GUIDÃO	X-Time Ahead Alumínio 31.8 x 70 mm +/-17°
	MANOPLA	MTB Preta TSW light
	CONJUNTO DE FREIO	X-Time Hidráulico Abraçadeira Reservatório de alumínio Óleo mineral Caliper 2 pistões
	DISCO DE FREIO	Shimano 160 mm Center-Lock Aço RT-10
	ARO/RAIO	Aro: TSW T3000 Freio a disco 32 furos Parede dupla Aro 20" Raio: Preto 185 x 2.0 mm Niple preto aço
	CUBOS	Shimano TX 505 Dianteiro/Traseiro: 32 Furos Alumínio Eixo 9 mm
	PNEU / CÂMARA DE AR	Pneu: 20 X 2.10 Skinwall Cutting Edge Arisun Câmara: Arisun 20" Válvula americana
	PEDIVELA	X-Time ponta quadrada Single Coroa 32D aço Braço alumínio Comprimento do braço 127mm
	CORRENTE	Corrente 8S KMC Com Power Link

	EIXO CENTRAL	34.7 x 115 mm Ponta quadrada Aço Rolamentos
	CASSETTE	Shimano CS-HG31-8 Mega Ranger 11/34D (11-13-15-17-20-23-26-34T)
	CÂMBIO DIANTEIRO	N/A
	CÂMBIO TRASEIRO	Shimano Altus M310 8 velocidades
	ALAVANCA / MANETE	Shimano SL-M315-8R Rapide Fire PLUS MTB 8-speed
	SELIM	Selim MTB TSW Vazado
	CANOTE	X-Time Alumínio 27.2 x 350 mm Carrinho Parafuso único
	ABRAÇADEIRA	X-Time Alumínio 31.8 Blocação
	PEDAL	Inglês Preto Alumínio
	URBANA	✓
	CICLOTURISMO	✓
	TRILHAS INTERMEDIÁRIAS	X
	COMPETIÇÃO	X
	PESO APROXIMADO	11.28 kg (10.5")





























29" NACIONAL

10.5  17199

hunch

20"
WHEELS



 QUADRO	TSW Hunch aro 20" Alumínio 6061 Direção Mega Over 44 mm semi-integrada Freio a Disco Post Mount Eixo traseiro 135 mm Canote 27.2 mm Largura máxima de pneu 20" x 2.2"	 CASSETE	34.7 x 115 mm Ponta quadrada Aço Rolamentos
 SUSPENSÃO DIANTEIRA	Suspensão TSW aro 20" Eixo de 9 mm Ahead Set Trava remota OLD 100 mm Kraw alumínio Lower Leg de aço	 CÂMBIO DIANTEIRO	Shimano CS-HG31-8 Mega Ranger 11/34D (11-13-15-17-20-23-26-34T)
 SUSPENSÃO TRASEIRA	N/A	 CÂMBIO TRASEIRO	Shimano Altus M310 8 velocidades
 MOVIMENTO DE DIREÇÃO	Direção mega over Semi-integrada Esferada 44 mm	 ALAVANCA / MANETE	N/A
 GUIDÃO	X-Time Alumínio Reto 31.8 x 650 mm 9° backsweep	 ALAVANCA / MANETE	Shimano SL-M315-8R Rapide Fire PLUS MTB 8-speed
 SUPORE DE GUIDÃO	X-Time Ahead Alumínio 31.8 x 70 mm +/-17°	 SELIM	Shimano SL-M315-8R Rapide Fire PLUS MTB 8-speed
 MANOPLA	MTB Preta TSW light	 CANOTE	Selim MTB TSW Vazado
 CONJUNTO DE FREIO	X-Time Hidráulico Abraçadeira Reservatório de alumínio Óleo mineral Caliper 2 pistões	 CANOTE	X-Time Alumínio 27.2 x 350 mm Carrinho Parafuso único
 DISCO DE FREIO	Shimano 160 mm Center-Lock Aço RT-10	 ABRAÇADEIRA	X-Time Alumínio 31.8 Blocagem
 ARO/RAIO	Aro: TSW T3000 Freio a disco 32 furos Parede dupla Aro 20" Raio: Preto 185 x 2.0 mm Niple preto aço	 PEDAL	X-Time Alumínio 31.8 Blocagem
 CUBOS	Shimano TX 505 Dianteiro/Traseiro: 32 Furos Alumínio Eixo 9 mm	 URBANA	Inglês Preto Alumínio
 PNEU / CÂMARA DE AR	Pneu: 20 X 2.10 Skinwall Cutting Edge Arisun Câmara: Arisun 20" Válvula americana	 CICLOTURISMO	✓
 PEDIVELA	X-Time ponta quadrada Single Coroa 32D aço Braço alumínio Comprimento do braço 127mm	 TRILHAS INTERMEDIÁRIAS	✓
 CORRENTE	Corrente 8S KMC Com Power Link	 COMPETIÇÃO	X
		 PESO APROXIMADO	11.28 kg (10.5")
		29" NACIONAL	
		10.5	17200



ride+



	QUADRO	TSW Ride Plus Alumínio 6061 Cabeamento interno Direção mega over Canote 27.2 mm Central BSA Geometria atualizada 2021
	SUSPENSÃO DIANTEIRA	TSW Eixo 9 mm
	SUSPENSÃO TRASEIRA	N/A
	MOVIMENTO DE DIREÇÃO	Mega Over Esferado
	GUIDÃO	Reto Alumínio 31.8 x 740 mm 9° backsweep
	SUPOORTE DE GUIDÃO	Ahead Alumínio 80 mm/7°
	MANOPLA	MTB
	CONJUNTO DE FREIO	Disco Hidráulico Shimano EF 505
	DISCO DE FREIO	Shimano Center Lock 160 mm RT-10
	ARO/RAIO	TSW T-5300 29" 32 furos
	CUBOS	Dianteiro: Shimano TX-505 Alumínio 32 furos Dianteiro/Traseiro(cassete)
	PNEU / CÂMARA DE AR	Pneu: Arisun 29" Câmara: 29" Válvula americana
	PEDIVELA	Shimano TY-301 Engrenagem Tripla com braço 170 mm 24/34/42D.
	CORRENTE	KMC 7Velocidades
	EIXO CENTRAL	34.7 C/ ROL. 122.5mm
	CASSETTE	HG 200 11-32D. 7 Velocidades
	CÂMBIO DIANTEIRO	TZ 500 Shimano Dual
	CÂMBIO TRASEIRO	Shimano TY-500 7 Velocidades

	ALAVANCA / MANETE	Alavanca/Manete de freio Shimano EF-505 21 velocidades
	SELIM	TSW MTB (vazado)
	CANOTE	TSW Alumínio 27.2 x 350 mm
	ABRAÇADEIRA	Alumínio 31.8 Blocagem
	PEDAL	Inglês Nylon Preto
	URBANA	✓
	CICLOTURISMO	✓
	TRILHAS INTERMEDIÁRIAS	X
	COMPETIÇÃO	X

29" NACIONAL

15.5 N/A

17.5 N/A

ride

AQUI
TEM

SHIMANO

QUALIDADE
CONFIANÇA



#SEMPRESHIMANO



	QUADRO	MTB RIDE 29", Alumínio 6061, Cabeamento Interno, Direção mega over semi-integrada Ø 44 x 44 mm, Suporte de freio a disco standard, Caixa central BSA 68 mm, Eixo traseiro 9 x 135mm, Canote 27.2 mm, Largura máxima do pneu 29 x 2.2" com cravo baixo, Peso máximo suportado de 110 kg - PESO DO CICLISTA + ACESSÓRIOS
	SUSPENSÃO DIANTEIRA	29" TSW 100 mm Mola Over head set (OLD) 9 x 100 mm Lower leg e garfo de aço
	SUSPENSÃO TRASEIRA	N/A
	MOVIMENTO DE DIREÇÃO	Mega over semi-integrada Ø 44 x 44 mm Esfera Caixa de aço
	GUIDÃO	X-Time Alumínio Reto 31.8 x 740 mm 9° Backsweep
	SUporte DE GUIDÃO	X-Time Alumínio Ahead 90 mm 7°
	MANOPLA	MTB preta
	CONJUNTO DE FREIO	Disco Mecânico X-Time
	DISCO DE FREIO	160 mm Parafuso Aço
	ARO/RAIO	TSW MTB 29" 32 furos Folha dupla aero
	CUBOS	X-Time Rosca Alumínio 32 furos Esfera Eixo de 9mm
	PNEU / CÂMARA DE AR	Pneu: Arisun Graham Skinwall 29" x 2.20 Câmara de ar Arisun Válvula americana
	PEDIVELA	Shimano TY-301 Engrenagem Tripla com braço 170 mm 24/34/42D.
	CORRENTE	KMC 7 Velocidades
	EIXO CENTRAL	34.7 C/ ROL. 122.5mm

	RODA LIVRE	Shimano TZ 500 7 velocidades 14-28D. Rosca Index
	CÂMBIO DIANTEIRO	TZ 500 Shimano TOP PULL Abraçadeira 31.8mm
	CÂMBIO TRASEIRO	Tourney TY200 Shimano 7 Velocidades Index
	ALAVANCA / MANETE	Alavanca/Manete de freio Shimano EF-41 21 Velocidades (3x7v)
	SELIM	TSW MTB Vazado Trilho de aço
	CANOTE	X-Time Alumínio 27.2 x 350 mm Com carrinho
	ABRAÇADEIRA	X-Time Alumínio 31.8mm Blocação
	PEDAL	Plataforma MTB Inglês 9/16 Nylon Preto
	URBANA	✓
	CICLOTURISMO	✓
	TRILHAS INTERMEDIÁRIAS	X
	COMPETIÇÃO	X

29" NACIONAL	
15.5	■ 21523
17.5	■ N/A
19	■ 21527

BICICLETAS



39

FOTOS MERAMENTE ILUSTRATIVAS. AS INFORMAÇÕES/CONFIGURAÇÕES DE PRODUTOS PODERÃO SOFRER ALTERAÇÕES SEM AVISO PRÉVIO.

ENTRE EM CONTATO COM O SEU CONSULTOR OU FALE COM O NOSSO TIME DE TELEVENDAS PELO (33) 3277-3030.

ride

AQUI TEM

SHIMANO

QUALIDADE CONFIANÇA

















#SEMPRESHIMANO















BICICLETAS



40

	QUADRO	MTB RIDE 29", Alumínio 6061, Cabeamento Interno, Direção mega over semi-integrada Ø 44 x 44 mm, Suporte de freio a disco standard, Caixa central BSA 68 mm, Eixo traseiro 9 x 135mm, Canote 27.2 mm, Largura máxima do pneu 29 x 2.2" com cravo baixo, Peso máximo suportado de 110 kg - PESO DO CICLISTA + ACESSÓRIOS
	SUSPENSÃO DIANTEIRA	29" TSW 100 mm Mola Over head set (OLD) 9 x 100 mm Lower leg e garfo de aço
	SUSPENSÃO TRASEIRA	N/A
	MOVIMENTO DE DIREÇÃO	Mega over semi-integrada Ø 44 x 44 mm Esfera Caixa de aço
	GUIDÃO	X-Time Alumínio Reto 31.8 x 740 mm 9° Backsweep
	SUporte DE GUIDÃO	X-Time Alumínio Ahead 90 mm 7°
	MANOPLA	MTB preta
	CONJUNTO DE FREIO	Disco Mecânico X-Time
	DISCO DE FREIO	160 mm Parafuso Aço
	ARO/RAIO	TSW MTB 29" 32 furos Folha dupla aero
	CUBOS	X-Time Rosca Alumínio 32 furos Esfera Eixo de 9mm
	PNEU / CÂMARA DE AR	Pneu: Arisun Graham Skinwall 29" x 2.20 / Câmara de ar Arisun Válvula americana
	PEDIVELA	Shimano TY-301 Engrenagem Tripla com braço 170 mm 24/34/42D.
	CORRENTE	KMC 7 Velocidades
	EIXO CENTRAL	34.7 C/ ROL. 122.5mm

	RODA LIVRE	Shimano TZ 500 7 velocidades 14-28D. Rosca Index
	CÂMBIO DIANTEIRO	TZ 500 Shimano TOP PULL Abraçadeira 31.8mm
	CÂMBIO TRASEIRO	Tourney TY200 Shimano 7 Velocidades Index
	ALAVANCA / MANETE	Alavanca/Manete de freio Shimano EF-41 21 Velocidades (3x7v)
	SELIM	TSW MTB Vazado Trilho de aço
	CANOTE	X-Time Alumínio 27.2 x 350 mm Com carrinho
	ABRAÇADEIRA	X-Time Alumínio 31.8mm Blocação
	PEDAL	Plataforma MTB Inglês 9/16 Nylon Preto
	URBANA	✓
	CICLOTURISMO	✓
	TRILHAS INTERMEDIÁRIAS	X
	COMPETIÇÃO	X

29" NACIONAL

15.5	■	21524
17.5	■	N/A
19	■	21528

FOTOS MERAMENTE ILUSTRATIVAS. AS INFORMAÇÕES/CONFIGURAÇÕES DE PRODUTOS PODERÃO SOFRER ALTERAÇÕES SEM AVISO PRÉVIO.

ENTRE EM CONTATO COM O SEU CONSULTOR OU FALE COM O NOSSO TIME DE TELEVENDAS PELO (33) 3277-3030.



warship



	QUADRO	Quadro 26" MTB TSW WARSHIP Alumínio Cabeamento da marcha interno Central BSA Direção Mega over 44 mm Canote 27.2 mm Freio a Disco Post Mount Eixo traseiro 135 mm -
	SUSPENSÃO DIANTEIRA	Garfo com suspensão TSW aço Trava Remota de Alumínio 100 mm de curso
	SUSPENSÃO TRASEIRA	N/A
	MOVIMENTO DE DIREÇÃO	Mega over Esferado Caixa de Aço
	GUIDÃO	X-Time Rise Bar Alumínio 31.9 x 800 mm 7° backsweep Upsweep 5° Rise 15 mm
	SUPOORTE DE GUIDÃO	X-time Alumínio 35x45 mm - 0°
	MANOPLA	MTB - TSW light preto
	CONJUNTO DE FREIO	X-time Hidráulico Base Alumínio com Alavanca de Aço
	DISCO DE FREIO	Shimano 160 mm RT-10
	ARO/RAIO	TSW T-5000 26" Aero Parede Dupla VZAN Alumínio 32 Furos Ilhós Pneu 1.5" até 2.4" Válvula Americana Raio preto (2 mm)
	CUBOS	Shimano TX505 8/9/10 Velocidades Cassete Eixo 9 mm
	PNEU / CÂMARA DE AR	Pneu: Arisun Graham 26x2.00" Câmara: 26" Chaoyang Válvula Americana
	PEDIVELA	X-Time Ponta Quadrada Single 32D Alumínio
	CORRENTE	KMC Série Z 9 velocidades
	EIXO CENTRAL	34.7 x 115 mm Quadrado Aço Rolamentos

	CASSETE	Shimano HG 200 9 velocidades 11/36 D
	CÂMBIO DIANTEIRO	N/A
	CÂMBIO TRASEIRO	Shimano Alívio 9 velocidades Shimano Shadow RD M3100
	ALAVANCA	Traseira Shimano Alívio SI3100 9 Velocidades
	SELIM	TSW MTB preto (vazado) Trilho Aço
	CANOTE	X-Time 27.2 x 400 mm Carrinho Alumínio Microajuste Slim
	ABRACADEIRA	Alumínio 34.8 mm Blocação
	PEDAL	Inglês 9/16 Alumínio Preto
	URBANA	✓
	CICLOTURISMO	x
	TRILHAS INTERMEDIÁRIAS	x
	COMPETIÇÃO	x
	PESO APROXIMADO	13.7 kg

26" NACIONAL

16537

warship



	QUADRO	Quadro 26" MTB TSW WARSHIP Alumínio Cabeamento da marcha interno Central BSA Direção Mega over 44 mm Canote 27.2 mm Freio a Disco Post Mount Eixo traseiro 135 mm -
	SUSPENSÃO DIANTEIRA	Garfo com suspensão TSW aço Trava Remota de Alumínio 100 mm de curso
	SUSPENSÃO TRASEIRA	N/A
	MOVIMENTO DE DIREÇÃO	Mega over Esferado Caixa de Aço
	GUIDÃO	X-Time Rise Bar Alumínio 31.9 x 800 mm 7° backsweep Upsweep 5° Rise 15 mm
	SUPORTE DE GUIDÃO	X-time Alumínio 35x45 mm - 0°
	MANOPLA	MTB - TSW light preto
	CONJUNTO DE FREIO	X-time Hidráulico Base Alumínio com Alavanca de Aço
	DISCO DE FREIO	Shimano 160 mm RT-10
	ARO/RAIO	TSW T-5000 26" Aero Parede Dupla VZAN Alumínio 32 Furos Ilhós Pneu 1.5" até 2.4" Válvula Americana Raio preto (2 mm)
	CUBOS	Shimano TX505 8/9/10 Velocidades Cassete Eixo 9 mm
	PNEU / CÂMARA DE AR	Pneu: Arisun Graham 26x2.00" Câmara: 26" Chaoyang Válvula Americana
	PEDIVELA	X-Time Ponta Quadrada Single 32D Alumínio
	CORRENTE	KMC Série Z 9 velocidades
	EIXO CENTRAL	34.7 x 115 mm Quadrado Aço Rolamentos

	CASSETE	Shimano HG 200 9 velocidades 11/36 D
	CÂMBIO DIANTEIRO	N/A
	CÂMBIO TRASEIRO	Shimano Alívio 9 velocidades Shimano Shadow RD M3100
	ALAVANCA	Traseira Shimano Alívio SI3100 9 Velocidades
	SELIM	TSW MTB preto (vazado) Trilho Aço
	CANOTE	X-Time 27.2 x 400 mm Carrinho Alumínio Microajuste Slim
	ABRACADEIRA	Alumínio 34.8 mm Blocação
	PEDAL	Inglês 9/16 Alumínio Preto
	URBANA	✓
	CICLOTURISMO	x
	TRILHAS INTERMEDIÁRIAS	x
	COMPETIÇÃO	x
	PESO APROXIMADO	13.7 kg

26" NACIONAL

16538

warship



 QUADRO	Quadro 26" MTB TSW WARSHIP Alumínio Cabeamento da marcha interno Central BSA Direção Mega over 44 mm Canote 27.2 mm Freio a Disco Post Mount Eixo traseiro 135 mm -	 CASSETE	Shimano HG 200 9 velocidades 11/36 D
 SUSPENSÃO DIANTEIRA	Garfo com suspensão TSW aço Trava Remota de Alumínio 100 mm de curso	 CÂMBIO DIANTEIRO	N/A
 SUSPENSÃO TRASEIRA	N/A	 CÂMBIO TRASEIRO	Shimano Alívio 9 velocidades Shimano Shadow RD M3100
 MOVIMENTO DE DIREÇÃO	Mega over Esferado Caixa de Aço	 ALAVANCA	Traseira Shimano Alívio SI3100 9 Velocidades
 GUIDÃO	X-Time Rise Bar Alumínio 31.9 x 800 mm 7° backsweep Upsweep 5° Rise 15 mm	 SELIM	TSW MTB preto (vazado) Trilho Aço
 SUPORE DE GUIDÃO	X-time Alumínio 35x45 mm - 0°	 CANOTE	X-Time 27.2 x 400 mm Carrinho Alumínio Microajuste Slim
 MANOPLA	MTB - TSW light preto	 ABRAÇADEIRA	Alumínio 34.8 mm Blocação
 CONJUNTO DE FREIO	X-time Hidráulico Base Alumínio com Alavanca de Aço	 PEDAL	Inglês 9/16 Alumínio Preto
 DISCO DE FREIO	Shimano 160 mm RT-10	 URBANA	✓
 ARO/RAIO	TSW T-5000 26" Aero Parede Dupla VZAN Alumínio 32 Furos Ilhós Pneu 1.5" até 2.4" Válvula Americana Raio preto (2 mm)	 CICLOTURISMO	x
 CUBOS	Shimano TX505 8/9/10 Velocidades Cassete Eixo 9 mm	 TRILHAS INTERMEDIÁRIAS	x
 PNEU / CÂMARA DE AR	Pneu: Arisun Graham 26x2.00" Câmara: 26" Chaoyang Válvula Americana	 COMPETIÇÃO	x
 PEDIVELA	X-Time Ponta Quadrada Single 32D Alumínio	 PESO APROXIMADO	13.7 kg
 CORRENTE	KMC Série Z 9 velocidades		
 EIXO CENTRAL	34.7 x 115 mm Quadrado Aço Rolamentos		

26" NACIONAL













17198

ride

21 velocidades
V.Brake



	QUADRO	Aro 26" TSW Alumínio Direção Mega Over de 44 mm Central BSA 68 mm Canote 27.2 mm Freio: Disco Standard(IS) e V-Brake
	GARFO	Garfo suspensão TSW Aro 26" Freio: Disco Standard(IS) e V-Brake Eixo 9 x 100 mm
	SUSPENSÃO TRASEIRA	N/A
	MOVIMENTO DE DIREÇÃO	Mega Over
	GUIDÃO	31.8 x 730 mm Alumínio Rise bar (baixo) ou 31.8 x 740 mm 9° backsweep Alumínio Reto X-Time (envio de acordo com a disponibilidade do estoque)
	SUPORTE DE GUIDÃO	X-Time 31.8 x 90 mm/+ - 7°
	MANOPLA	Manopla MTB Borracha
	CONJUNTO DE FREIO	V-Brake Alumínio
	DISCO DE FREIO	N/A
	ARO/RAIO	Aro: TSW 4300 Alumínio 6063 36 Furos Parede dupla / Raio: Preto Aço 250 x 2.0 mm
	CUBOS	Dianteiro: Aço 36 furos Esferado Eixo de 9 x 100 mm Com blocagem - Traseiro: Aço 36 furos Esferado Rosca (Roda livre) 9 x 135 mm Com Blocagem
	PNEU / CÂMARA DE AR	Pneu: Arisun Skinwall Câmara: 26" Válvula americana
	PEDIVELA	Engrenagem Tripla (42/34/24D) braço 165 mm
	CORRENTE	6/7/8v. Index corrida TEC ou 6/7v. 112L Index corrida PYC (envio de acordo com a disponibilidade do estoque)

	EIXO CENTRAL	Movimento Central 34.7mm 68x122.5mm Semi Selado Ponta quadrada
	RODA LIVRE	Roda Livre Bronze 7V. 14/28D. Index Xtime ou Shimano
	CÂMBIO DIANTEIRO	Shimano TZ500 Top pull
	CÂMBIO TRASEIRO	Shimano 7Velocidades TZ31
	MANETE/ALAVANCA	Alavanca X-TIME EZ- Fire 21V. (3x7) Com manete de freio
	SELIM	TSW Com castanha
	CANOTE	Para castanha 27.2 x 350 mm Aço
	ABRAÇADEIRA	Abraçadeira 31.8mm Alumínio Blocagem
	PEDAL	Plataforma Preto Nylon Inglês
	URBANA	✓
	CICLOTURISMO	X
	TRILHAS INTERMEDIÁRIAS	X
	COMPETIÇÃO	X

COLIGADA 01

COLIGADA 06

26" NACIONAL

















15.5  17203 | 20559

17  17206 | 20562

ride

21 velocidades
V.Brake



 QUADRO	Aro 26" TSW Alumínio Direção Mega Over de 44 mm Central BSA 68 mm Canote 27.2 mm Freio: Disco Standard(IS) e V-Brake	 EIXO CENTRAL	Movimento Central 34.7mm 68x122.5mm Semi Selado Ponta quadrada
 GARFO	Garfo suspensão TSW Aro 26" Freio: Disco Standard(IS) e V-Brake Eixo 9 x 100 mm	 RODA LIVRE	Roda Livre Bronze 7V. 14/28D. Index Xtime ou Shimano
 SUSPENSÃO TRASEIRA	N/A	 CÂMBIO DIANTEIRO	Shimano TZ500 Top pull
 MOVIMENTO DE DIREÇÃO	Mega Over	 CÂMBIO TRASEIRO	Shimano 7Velocidades TZ31
 GUIDÃO	31.8 x 730 mm Alumínio Rise bar (baixo) ou 31.8 x 740 mm 9° backsweep Alumínio Reto X-Time (envio de acordo com a disponibilidade do estoque)	 MANETE/ALAVANCA	Alavanca X-TIME EZ- Fire 21V. (3x7) Com manete de freio
 SUPORTE DE GUIDÃO	X-Time 31.8 x 90 mm/+ - 7°	 SELIM	TSW Com castanha
 MANOPLA	Manopla MTB Borracha	 CANOTE	Para castanha 27.2 x 350 mm Aço
 CONJUNTO DE FREIO	V-Brake Alumínio	 ABRAÇADEIRA	Abraçadeira 31.8mm Alumínio Blocagem
 DISCO DE FREIO	N/A	 PEDAL	Plataforma Preto Nylon Inglês
 ARO/RAIO	Aro: TSW 4300 Alumínio 6063 36 Furos Parede dupla / Raio: Preto Aço 250 x 2.0 mm	 URBANA	✓
 CUBOS	Dianteiro: Aço 36 furos Esferado Eixo de 9 x 100 mm Com blocagem - Traseiro: Aço 36 furos Esferado Rosca (Roda livre) 9 x 135 mm Com Blocagem	 CICLOTURISMO	X
 PNEU / CÂMARA DE AR	Pneu: Arisun Skinwall Câmara: 26" Válvula americana	 TRILHAS INTERMEDIÁRIAS	X
 PEDIVELA	Engrenagem Tripla (42/34/24D) braço 165 mm	 COMPETIÇÃO	X
 CORRENTE	6/7/8v. Index corrida TEC ou 6/7v. 112L Index corrida PYC (envio de acordo com a disponibilidade do estoque)		

COLIGADA 01

COLIGADA 06

26" NACIONAL

15.5 ■ 17204 | 20560

17 ■ 17207 | 20563

ride

21 velocidades
V.Brake



	QUADRO	Aro 26" TSW Alumínio Direção Mega Over de 44 mm Central BSA 68 mm Canote 27.2 mm Freio: Disco Standard(IS) e V-Brake
	GARFO	Garfo suspensão TSW Aro 26" Freio: Disco Standard(IS) e V-Brake Eixo 9 x 100 mm
	SUSPENSÃO TRASEIRA	N/A
	MOVIMENTO DE DIREÇÃO	Mega Over
	GUIDÃO	31.8 x 730 mm Alumínio Rise bar (baixo) ou 31.8 x 740 mm 9° backsweep Alumínio Reto X-Time (envio de acordo com a disponibilidade do estoque)
	SUPORTE DE GUIDÃO	X-Time 31.8 x 90 mm/+ - 7°
	MANOPLA	Manopla MTB Borracha
	CONJUNTO DE FREIO	V-Brake Alumínio
	DISCO DE FREIO	N/A
	ARO/RAIO	Aro: TSW 4300 Alumínio 6063 36 Furos Parede dupla / Raio: Preto Aço 250 x 2.0 mm
	CUBOS	Dianteiro: Aço 36 furos Esferado Eixo de 9 x 100 mm Com blocagem - Traseiro: Aço 36 furos Esferado Rosca (Roda livre) 9 x 135 mm Com Blocagem
	PNEU / CÂMARA DE AR	Pneu: Arisun Skinwall Câmara: 26" Válvula americana
	PEDIVELA	Engrenagem Tripla (42/34/24D) braço 165 mm
	CORRENTE	6/7/8v. Index corrida TEC ou 6/7v. 112L Index corrida PYC (envio de acordo com a disponibilidade do estoque)

	EIXO CENTRAL	Movimento Central 34.7mm 68x122.5mm Semi Selado Ponta quadrada
	RODA LIVRE	Roda Livre Bronze 7V. 14/28D. Index Xtime ou Shimano
	CÂMBIO DIANTEIRO	Shimano TZ500 Top pull
	CÂMBIO TRASEIRO	Shimano 7Velocidades TZ31
	MANETE/ALAVANCA	Alavanca X-TIME EZ- Fire 21V. (3x7) Com manete de freio
	SELIM	TSW Com castanha
	CANOTE	Para castanha 27.2 x 350 mm Aço
	ABRAÇADEIRA	Abraçadeira 31.8mm Alumínio Blocagem
	PEDAL	Plataforma Preto Nylon Inglês
	URBANA	✓
	CICLOTURISMO	X
	TRILHAS INTERMEDIÁRIAS	X
	COMPETIÇÃO	X

COLIGADA 01

COLIGADA 06

26" NACIONAL

15.5 N/A | 20561

17 17208 | 20565

FOTOS MERAMENTE ILUSTRATIVAS. AS INFORMAÇÕES/CONFIGURAÇÕES DE PRODUTOS PODERÃO SOFRER ALTERAÇÕES SEM AVISO PRÉVIO.

ENTRE EM CONTATO COM O SEU CONSULTOR OU FALE COM O NOSSO TIME DE TELEVENDAS PELO (33) 3277-3030.

Tcross



20"
WHEELS

	QUADRO	TSW T Cross Aro 20" Aço Caixa over Ahead Set Seat Tube 22.5 mm Suporte Freio V-Brake Cabeamento Externo
	GARFO	Rígido Aço Aro 20" Espiga Over headset
	SUSPENSÃO TRASEIRA	N/A
	MOVIMENTO DE DIREÇÃO	Over Ahead Set Esfera
	GUIDÃO	Medida 700 x 21.0 mm Aço Bmx
	SUPORTE DE GUIDÃO	Alumínio Diâmetro 22.4 mm Comprimento 40 mm
	MANOPLA	Borracha
	CONJUNTO DE FREIO	Traseiro V-Brake Aço/Sapata com Parafuso Preto Manete Nylon/Alumínio
	DISCO DE FREIO	N/A
	ARO/RAIO	Aro 20" Alumínio Folha Única Somente para V-Brake / Raio Aço 2 mm Preto
	CUBOS	Dianteiro: Aço 36 furos Sem Blocação Somente para V-Brake / Traseiro: Aço 36 furos Sem Blocação Somente para V-Brake Rosca

	PNEU / CÂMARA DE AR	Pneu: Aro 20 X 2.1" / Câmara: 20 x 1.95" Válvula americana
	PEDIVELA	Braço de Aço 145 mm Engrenagem Single 28 Dentes
	CORRENTE	Single
	MOVIMENTO CENTRAL	Monobloco Esferado
	RODA LIVRE	Single 16 Dentes Importado
	CÂMBIO DIANTEIRO	N/A
	CÂMBIO TRASEIRO	N/A
	ALAVANCA	N/A
	SELIM	Cross castanha
	CANOTE	Aço Medida 22.5 x 250 mm Sem carrinho
	ABRACADEIRA	No quadro Parafuso
	PEDAL	Plataforma Preto Nylon

20" IMPORTADA

ÚNICO ■ 17410

Tcross



20"
WHEELS

	QUADRO	TSW T Cross Aro 20" Aço Caixa over Ahead Set Seat Tube 22.5 mm Suporte Freio V-Brake Cabeamento Externo
	GARFO	Rígido Aço Aro 20" Espiga Over headset
	SUSPENSÃO TRASEIRA	N/A
	MOVIMENTO DE DIREÇÃO	Over Ahead Set Esfera
	GUIDÃO	Medida 700 x 21.0 mm Aço Bmx
	SUporte DE GUIDÃO	Alumínio Diâmetro 22.4 mm Comprimento 40 mm
	MANOPLA	Borracha
	CONJUNTO DE FREIO	Traseiro V-Brake Aço/Sapata com Parafuso Preto Manete Nylon/Aluminio
	DISCO DE FREIO	N/A
	ARO/RAIO	Aro 20" Alumínio Folha Única Somente para V-Brake / Raio Aço 2 mm Preto
	CUBOS	Dianteiro: Aço 36 furos Sem Blocação Somente para V-Brake / Traseiro: Aço 36 furos Sem Blocação Somente para V-Brake Rosca
	PNEU / CÂMARA DE AR	Pneu: Aro 20 X 2.1" / Câmara: 20 x 1.95" Válvula americana
	PEDIVELA	Braço de Aço 145 mm Engrenagem Single 28 Dentes
	CORRENTE	Single

	MOVIMENTO CENTRAL	Monobloco Esferado
	RODA LIVRE	Single 16 Dentes Importado
	CÂMBIO DIANTEIRO	N/A
	CÂMBIO TRASEIRO	N/A
	ALAVANCA	N/A
	SELIM	Cross castanha
	CANOTE	Aço Medida 22.5 x 250 mm Sem carrinho
	ABRAÇADEIRA	No quadro Parafuso
	PEDAL	Plataforma Preto Nylon

20" | IMPORTADA

ÚNICO  17411

TCROSS



16"
WHEELS

BICICLETAS

TSW

50

	QUADRO	TSW T Cross Aro 16" Aço Caixa over Head Set esferada Suporte Freio V-Brake Cabeamento Externo
	GARFO	TSW T-Cross aro 16" Aço Over Head Set
	SUSPENSÃO TRASEIRA	N/A
	MOVIMENTO DE DIREÇÃO	Caixa de direção Over Head Set esferada
	GUIDÃO	Guidão Cross 22.2 mm Aço Possui acessório de Guidão TSW
	SUporte DE GUIDÃO	Alumínio Over Head Set
	MANOPLA	Nylon
	CONJUNTO DE FREIO	Freio V-Brake de aço Manete tipo MTB de nylon com reguladores
	DISCO DE FREIO	N/A
	ARO/RAIO	Aro 16" Alumínio Folha simples Preto Raios zincados
	CUBOS	Cubos em aço Eixo de 9mm Com Porca sextavada
	PNEU / CÂMARA DE AR	Pneu: Aro 16 X 2.125" / Câmara: aro 16" Válvula americana
	PEDIVELA	Monobloco Preto 115 mm Coroa Aço 24D
	CORRENTE	Comum importada Porta corrente de Nylon
	MOVIMENTO CENTRAL	Movimento central 50 mm esferado

	RODA LIVRE	16 Dentes
	CÂMBIO DIANTEIRO	N/A
	CÂMBIO TRASEIRO	N/A
	ALAVANCA	N/A
	SELIM	Infantil Preto Com castanha
	CANOTE	Aço Medida 25.4 mm
	ABRACADEIRA	No quadro Parafuso
	PEDAL	Infantil Nylon 1/2 suco Preto

16" | IMPORTADA

ÚNICO ■ 17406

FOTOS MERAMENTE ILUSTRATIVAS. AS INFORMAÇÕES/CONFIGURAÇÕES DE PRODUTOS PODERÃO SOFRER ALTERAÇÕES SEM AVISO PRÉVIO.

ENTRE EM CONTATO COM O SEU CONSULTOR OU FALE COM O NOSSO TIME DE TELEVENDAS PELO (33) 3277-3030.

T-CROSS



16"
WHEELS

	QUADRO	TSW T Cross Aro 16" Aço Caixa over Head Set esferada Suporte Freio V-Brake Cabeamento Externo
	GARFO	TSW T-Cross aro 16" Aço Over Head Set
	SUSPENSÃO TRASEIRA	N/A
	MOVIMENTO DE DIREÇÃO	Caixa de direção Over Head Set esferada
	GUIDÃO	Guidão Cross 22.2 mm Aço Possui acessório de Guidão TSW
	SUporte DE GUIDÃO	Alumínio Over Head Set
	MANOPLA	Nylon
	CONJUNTO DE FREIO	Freio V-Brake de aço Manete tipo MTB de nylon com reguladores
	DISCO DE FREIO	N/A
	ARO/RAIO	Aro 16" Alumínio Folha simples Preto Raios zincados
	CUBOS	Cubos em aço Eixo de 9mm Com Porca sextavada
	PNEU / CÂMARA DE AR	Pneu: Aro 16 X 2.125" / Câmara: aro 16" Válvula americana
	PEDIVELA	Monobloco Preto 115 mm Coroa Aço 24D
	CORRENTE	Comum importada Porta corrente de Nylon
	MOVIMENTO CENTRAL	Movimento central 50 mm esferado

	RODA LIVRE	16 Dentes
	CÂMBIO DIANTEIRO	N/A
	CÂMBIO TRASEIRO	N/A
	ALAVANCA	N/A
	SELIM	Infantil Preto Com castanha
	CANOTE	Aço Medida 25.4 mm
	ABRAÇADEIRA	No quadro Parafuso
	PEDAL	Infantil Nylon 1/2 sueco Preto

16" IMPORTADA

ÚNICO ■ 17407

MOTION

12"
WHEELS



	QUADRO	TSW Motion Balance Aro 12" Alumínio 6061
	GARFO	TSW Rígido Aro 12" Alumínio
	CAIXA DE DIREÇÃO	Mega Over Head Set Semi-Integrado Esferado
	GUIDÃO	TSW Alumínio Reto 25.4 x 400 mm
	SUPORTE DE GUIDÃO	TSW Alumínio 60 mm/7°
	MANOPLA	Borracha
	CONJUNTO DE FREIO	Tambor Maçaneta de Nylon
	ARO/RAIO	Aro: Aço 12" / Raio: Preto 2.0 mm
	CUBOS	Aço com esfera Eixo de 9 mm
	PNEU / CÂMARA DE AR	Pneu SLIN 12 x 2.25" / Câmara com válvula americana
	CANOTE	Aço 22 mm Selim integrado
	ABRACADEIRA	Alumínio Blocação



IMPORTADA

12"  17397

12"  17398

12"  17399

12"  17401

12"  17400

FOTOS MERAMENTE ILUSTRATIVAS. AS INFORMAÇÕES/CONFIGURAÇÕES DE PRODUTOS PODERÃO SOFRER ALTERAÇÕES SEM AVISO PRÉVIO.

ENTRE EM CONTATO COM O SEU CONSULTOR OU FALE COM O NOSSO TIME DE TELEVENDAS PELO (33) 3277-3030.

TSW Posh



16"
WHEELS

16"
WHEELS



	QUADRO	TSW Posh Aro 16" Aço Porta corrente de aço inteiriço Roda lateral reforçada e emborrachada Paralamas de aço com haste Cestinha retrô nylon Suporte traseiro de nylon (Cadeirinha para bonecas) Sinalizador sonoro
	GARFO	Aço Aro 16"
	SUSPENSÃO TRASEIRA	N/A
	MOVIMENTO DE DIREÇÃO	Standard Rosca Esferas
	GUIDÃO	Curvo 25.4 mm Aço
	SUporte DE GUIDÃO	Alumínio Chanfrado
	MANOPLA	Borracha
	CONJUNTO DE FREIO	V-Brake Aço Manete: Infantil Nylon com reguladores
	DISCO DE FREIO	N/A
	ARO/RAIO	Aro: 16" Aço Folha simples Raio: Aço Preto
	CUBOS	Aço Eixo 9 mm Porca sextavada

	PNEU / CÂMARA DE AR	Pneu: Aro 16" 2.1125 Importado Câmara: Aro 16" Válvula americana
	PEDIVELA	Monobloco 115 mm Preto Coroa aço 32 D
	CORRENTE	Comum Importada
	MOVIMENTO CENTRAL	45 mm Esferado
	RODA LIVRE	16 Dentes
	CÂMBIO DIANTEIRO	N/A
	CÂMBIO TRASEIRO	N/A
	ALAVANCA	N/A
	SELIM	Infantil Castanha Branco
	CANOTE	Aço 25.4 mm
	ABRAÇADEIRA	N/A
	PEDAL	Nylon Infantil 1/2 sueco Branco

16" IMPORTADA SEM CÂMBIO

ÚNICO 18204

ÚNICO 18205

TSW Posh



20"
WHEELS



20"
WHEELS

	QUADRO	TSW Rerô Aro 20" Aço Cesta Seat tube 22.2mm Caixa standard Suporte para freio v-brake Porta corrente Descanso lateral
	GARFO	Rígido Aço Aro 20" Espiga standard Rosca Suporte para freio v-brake
	SUSPENSÃO TRASEIRA	N/A
	MOVIMENTO DE DIREÇÃO	Standard Rosca
	GUIDÃO	Passo Tropical Cromado 22.1 mm/500 mm
	SUPORTE DE GUIDÃO	Caneta Alumínio Standard Espander
	MANOPLA	Borracha
	CONJUNTO DE FREIO	V-Brake Aço Sapata Manete infantil Nylon
	DISCO DE FREIO	N/A
	ARO/RAIO	Aro: 20" Alumínio Folha Única 36 furos Raio: Aço 2 mm Preto
	CUBOS	Dianteiro: Aço 36 furos Somente para V-Brake Esferado Traseiro: Aço 36 furos Sem blocagem Somente para V-Brake Rosca



PNEU / CÂMARA DE AR

Pneu: Aro 20" | 2.10" **Câmara:** Aro 20 | 1.95" | Válvula americana



PEDIVELA

Monobloco | 140 mm / rosca fina | Aço



CORRENTE

Single



MOVIMENTO CENTRAL

Monobloco | Esferado



RODA LIVRE

Single | 16 dentes | Importado



CÂMBIO DIANTEIRO

N/A



CÂMBIO TRASEIRO

N/A



ALAVANCA

N/A



SELIM

Infantil | Castanha



CANOTE

Aço | 22.5 mm/250 mm | Cromado



ABRACADEIRA

Blocagem



PEDAL

Nylon | Infantil | Rosca fina

20" IMPORTADA

ÚNICO

18209

ÚNICO

18210

TSW retrô

16"
WHEELS



QUADRO

Quadro: TSW Retrô | Aço | Aro 16"
| **Bagageiro:** Aço retrô acolchoado |
Cestinha: Nylon retrô | **Paralamas:** Aço
pintados com haste | **Campanhia:** Nylon/
aço | **Porta corrente:** Aço inteiriço (cobre
toda a parte externa da transmissão) |
Roda lateral: Estilo retrô com suporte em
aço



GARFO

Aço P/ V-Brake com rosca



SUSPENSÃO
TRASEIRA

N/A



MOVIMENTO DE
DIREÇÃO

Esferada Standard



GUIDÃO

Aço cromado chifre de boi | 25.4 mm x
520 mm



SUPORTE DE
GUIDÃO

Chanfreado | Alumínio



MANOPLA

Nylon retrô



CONJUNTO DE
FREIO

V-Brake | Aço | Preto | **Manete:** Nylon com
reguladores



DISCO DE FREIO

N/A



ARO/RAIO

Aro: 16" | Alumínio | Preto | 28 furos tipo
aero | Folha simples | **Raio:** Aço preto
2.00 mm X 135 mm



CUBOS

Aço Preto | 28 furos | Eixo maciço com
porca



PNEU / CÂMARA
DE AR

Pneu: Aro 16" - 16 x 2.125 | Importado



PEDIVELA

Monobloco | 115mm | Aço | Preto



CORRENTE

Bronze SLC | Importado



MOVIMENTO
CENTRAL

Esferada 45 mm



RODA LIVRE

Bronze 16 dentes | Importado



CÂMBIO
DIANTEIRO

N/A



CÂMBIO
TRASEIRO

N/A



ALAVANCA

N/A



SELIM

Retrô | Castanha



CANOTE

Aço zincado | 25.4 mm x 200 mm



ABRAÇADEIRA

N/A



PEDAL

Nylon retrô 1/2

16" | IMPORTADA

ÚNICO  18206

ÚNICO  18207

ÚNICO  18208

TSW retrô

20"
WHEELS



20"
WHEELS



20"
WHEELS



QUADRO

TSW aço Retrô | Aro 20" | Aço | Bagageiro Aço retrô acolchoado | Cestinha nylon retrô | Descanso lateral de aço | Paralamas pintados c/ haste | Campanhia nylon/ aço | Porta corrente aço inteiriço (cobre toda a parte externa da transmissão)



GARFO

Aço P/ V-Brake com rosca



SUSPENSÃO TRASEIRA

N/A



MOVIMENTO DE DIREÇÃO

Esferada standard



GUIDÃO

Aço cromado chifre de boi | 25.4 mm x 520 mm



SUPORTE DE GUIDÃO

Chanfreado | Alumínio



MANOPLA

Nylon retrô



CONJUNTO DE FREIO

V-Brake | Aço | Manetes nylon com reguladores



DISCO DE FREIO

N/A



ARO/RAIO

Aro 20" | Alumínio preto | Folha simples | 28 furos tipo aero | Raio aço preto 2.00 mm X 180 mm



CUBOS

Aço preto | 28 furos | Eixo maciço com porca



PNEU / CÂMARA DE AR

Pneu: Aro 20" - 20x2.125



PEDIVELA

Monobloco | 140mm | Aço preto



CORRENTE

Bronze SLC



MOVIMENTO CENTRAL

Esferada 45mm



RODA LIVRE

Bronze 16 dentes | Importado



CÂMBIO DIANTEIRO

N/A



CÂMBIO TRASEIRO

N/A



ALAVANCA

N/A



SELIM

Retrô | Castanha



CANOTE

Aço zincado | 25.4 mm x 250 mm



ABRAÇADEIRA

Blocagem



PEDAL

Nylon retrô

20" | IMPORTADA

ÚNICO  18211

ÚNICO  18212

ÚNICO  18213















FOTOS MERAMENTE ILUSTRATIVAS. AS INFORMAÇÕES/CONFIGURAÇÕES DE PRODUTOS PODERÃO SOFRER ALTERAÇÕES SEM AVISO PRÉVIO.











ENTRE EM CONTATO COM O SEU CONSULTOR OU FALE COM O NOSSO TIME DE TELEVENDAS PELO (33) 3277-3030.

U.bend



20"
WHEELS

	QUADRO	Aro 20" Alumínio Dobrável Trava de segurança na articulação Lugar para Suporte de Caramanholas Pivotes para adaptação de Garupas Caixa de Direção Mega Over Freio a Disco Descanso lateral Urbano
	GARFO	Rígido Aço Aro 20" Espiga Over Rosca Freio a Disco
	SUSPENSÃO TRASEIRA	N/A
	MOVIMENTO DE DIREÇÃO	Mega Over Caixa semi-integrada Esfera
	GUIDÃO	Alumínio Formato em T Tubo 28.6 mm com guia
	SUPORTE DE GUIDÃO	Alumínio Trava de Segurança na articulação Abraçadeira de Alumínio para Regulagem da altura do Guidão Tubo 25,4 mm chanfrado
	MANOPLA	Borracha
	CONJUNTO DE FREIO	Disco Mecânico Alumínio Manete com abraçadeira de nylon e alavanca de alumínio
	DISCO DE FREIO	Aço 160 mm 6 parafusos
	ARO/RAIO	Aro 20" Alumínio Parede dupla Com CNC / Raio preto Aço 2.0 mm
	CUBOS	Dianteiro: Alumínio Esferado Blocagem Freio a disco / Traseiro: Alumínio Esferado Blocagem Freio a disco Rosca
	PNEU / CÂMARA DE AR	Pneu: Aro 20" 20 x 1.75" Chaoyang / Câmara: Chaoyang Válvula americana
	PEDIVELA	Engrenagem coroa única de 46 dentes Aço Braço de aço 165 mm Guia de corrente em nylon na coroa
	CORRENTE	7 velocidades Index

	MOVIMENTO CENTRAL	34.7 mm Rolamentado Eixo ponta quadrada
	RODA LIVRE	Shimano 7 velocidades Index MF-TZ500/7
	CÂMBIO DIANTEIRO	N/A
	CÂMBIO TRASEIRO	Shimano 7 velocidades Index RD-TY200
	ALAVANCA	Shimano Revoshift 7 velocidades Modelo SL-RS35
	SELIM	MTB com castanha
	CANOTE	Alumínio 31.6 x 500 mm Sem carrinho
	ABRAÇADEIRA	Alumínio Com blocagem
	PEDAL	Plataforma Preto Nylon
	URBANA	✓
	CICLOTURISMO	X
	TRILHAS INTERMEDIÁRIAS	X
	COMPETIÇÃO	X
	PESO APROXIMADO	12.51 kg















20" | IMPORTADA

ÚNICO  18069

U.bend



20"
WHEELS

 QUADRO	Aro 20" Alumínio Dobrável Trava de segurança na articulação Lugar para Suporte de Caramanholas Pivotes para adaptação de Garupas Caixa de Direção Mega Over Freio a Disco Descanso lateral Urbano
 GARFO	Rígido Aço Aro 20" Espiga Over Rosca Freio a Disco
 SUSPENSÃO TRASEIRA	N/A
 MOVIMENTO DE DIREÇÃO	Mega Over Caixa semi-integrada Esfera
 GUIDÃO	Alumínio Formato em T Tubo 28.6 mm com guia
 SUORTE DE GUIDÃO	Alumínio Trava de Segurança na articulação Abraçadeira de Alumínio para Regulagem da altura do Guidão Tubo 25,4 mm chanfrado
 MANOPLA	Borracha
 CONJUNTO DE FREIO	Disco Mecânico Alumínio Manete com abraçadeira de nylon e alavanca de alumínio
 DISCO DE FREIO	Aço 160 mm 6 parafusos
 ARO/RAIO	Aro 20" Alumínio Parede dupla Com CNC / Raio preto Aço 2.0 mm
 CUBOS	Dianteiro: Alumínio Esferado Blocagem Freio a disco / Traseiro: Alumínio Esferado Blocagem Freio a disco Rosca
 PNEU / CÂMARA DE AR	Pneu: Aro 20" 20 x 1.75" Chaoyang / Câmara: Chaoyang Válvula americana
 PEDIVELA	Engrenagem coroa única de 46 dentes Aço Braço de aço 165 mm Guia de corrente em nylon na coroa
 CORRENTE	7 velocidades Index

 MOVIMENTO CENTRAL	34.7 mm Rolamentado Eixo ponta quadrada
 RODA LIVRE	Shimano 7 velocidades Index MF-TZ500/7
 CÂMBIO DIANTEIRO	N/A
 CÂMBIO TRASEIRO	Shimano 7 velocidades Index RD-TY200
 ALAVANCA	Shimano Revoshift 7 velocidades Modelo SL-RS35
 SELIM	MTB com castanha
 CANOTE	Alumínio 31.6 x 500 mm Sem carrinho
 ABRAÇADEIRA	Alumínio Com blocagem
 PEDAL	Plataforma Preto Nylon
 URBANA	✓
 CICLOTURISMO	X
 TRILHAS INTERMEDIÁRIAS	X
 COMPETIÇÃO	X
 PESO APROXIMADO	12.51 kg

20" | IMPORTADA

ÚNICO ■ 18070

AVENIDA INDUSTRIAL 312, DISTRITO INDUSTRIAL
GOVERNADOR VALADARES - MINAS GERAIS/BRASIL

BIKE@GRUPOJPP.COM.BR

(33) 3277-3030

WWW.GRUPOJPP.COM.BR



GRUPO

JPP

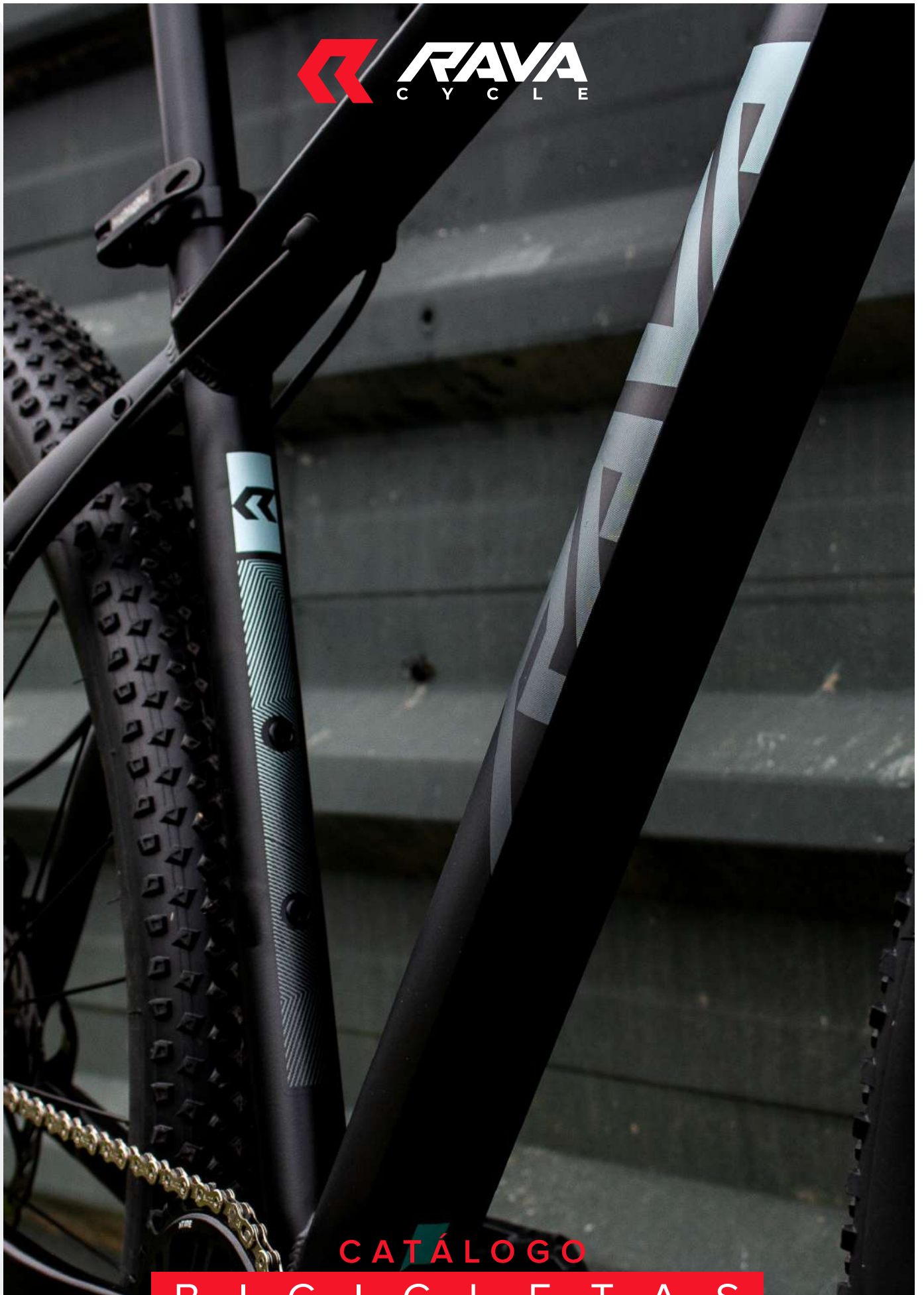

CATÁLOGO

B I C I C L E T A S

06 de Março 2024



rakban SR-DR

12V. Hidráulico



29"
WHEELS

Urbana

Alumínio

Mega Over

12 velocidades

Disco Hidráulico

Kg -



QUADRO

Quadro Rava MTB Rakan 29" | Caixa Central BSA 68 x 34.7mm | Suporte de Freio Post Mount dentro do triângulo traseiro | Eixo traseiro 135 mm x 9 mm | Largura do pneu 2.20 (com cravos baixos) | Alumínio 6061 | Cabeamento interno | Direção Mega Over semi-integrada caixa 44 mm | Tubo do canote 27.2 mm | Peso máximo suportado 120 Kg (ciclista + acessórios).



SUSPENSÃO DIANTEIRA

Suspensão Suntour XCM30 | Eixo de 9 mm | Ahead set | Trava Remota | OLD 100mm | Kraw e Lower Leg de alumínio



SUSPENSÃO TRASEIRA

N/A



MOVIMENTO DE DIREÇÃO

Direção mega over | Semi-integrada | Esferada



GUIDÃO

X-Time | Alumínio | Reto | 31.8 x 740 mm | 9° backsweep



SUPOORTE DE GUIDÃO

X-Time | Ahead | Alumínio | 31.8 x 70 mm | +/-17°



MANOPLA

MTB | Preta | Light



CONJUNTO DE FREIO

X-Time | Hidráulico | Abraçadeira | Reservatório de alumínio | Óleo mineral | Caliper 2 pistões



DISCO DE FREIO

X-Time | 160 mm | 06 parafusos | Aço



ARO/RAIO

Rava | Alumínio 6063 | 622x23mm | ERD 600 mm | Parede dupla | 32F | Raio preto | PSI máximo 80/40 | Tubeless Ready | Compatível com pneu 1.5" até 2.4"



CUBOS

Cubo X-Time | Rolamentado | Alumínio | Blocação | Freehub standard | 32 furos



PNEU / CÂMARA DE AR

Pneu: Arisun Skinwall Mount Bona 29x2.10 **Câmara:** Arisun 29" | Válvula Presta



PEDIVELA

X-Time integrado | Single | Coroa 30D. (Bicicletas 15.5" e 17") e coroa 32D. (Bicicleta 19") | Coroa Alumínio Direct | Off Set 3mm | Braço Alumínio 170mm



CORRENTE

Corrente 12S | SRAM | Power Link



MOVIMENTO CENTRAL

X-Time integrado | Rolamentos | Alumínio



CASSETE

SRAM SX | Index | 12v | Standard | 11/50D. (11/13/15/17/19/22/25/28/32/36/42/50T)



CÂMBIO DIANTEIRO

N/A



CÂMBIO TRASEIRO

Shimano Deore RD-M6100 | 12v



ALAVANCA

Shimano Deore SL-M6100 | 12v | Traseira



SELIM

Rava MTB | Trilho de aço | Vazado



CANOTE

X-Time | Alumínio | 27.2 x 350 mm | Carrinho | Parafuso único



ABRAÇADEIRA

X-Time | Alumínio | 31.8 | Blocação



PEDAL

Inglês 9/16 | Preto | Alumínio



URBANA

✓



CICLOTURISMO

✓



TRILHAS INTERMEDIÁRIAS

X



COMPETIÇÃO

X

29" NACIONAL

15.5 ■ 21465

17 ■ N/A

19 ■ N/A

FOTOS MERAMENTE ILUSTRATIVAS. AS INFORMAÇÕES/CONFIGURAÇÕES DE PRODUTOS PODERÃO SOFRER ALTERAÇÕES SEM AVISO PRÉVIO.

ENTRE EM CONTATO COM O SEU CONSULTOR OU FALE COM O NOSSO TIME DE TELEVENDAS PELO (33) 3277-3030.

RAVA

3

rakan SR-DR

12V. Hidráulico



29"
WHEELS



Urbana



Alumínio



Mega Over



12 velocidades



Disco Hidráulico



Kg



QUADRO

Quadro Rava MTB Rakan 29" | Caixa Central BSA 68 x 34.7mm | Suporte de Freio Post Mount dentro do triângulo traseiro | Eixo traseiro 135 mm x 9 mm | Largura do pneu 2.20 (com cravos baixos) | Alumínio 6061 | Cabeamento interno | Direção Mega Over semi-integrada caixa 44 mm | Tubo do canote 27.2 mm | Peso máximo suportado 120 Kg (ciclista + acessórios).



SUSPENSÃO DIANTEIRA

Suspensão Suntour XCM30 | Eixo de 9 mm | Ahead set | Trava Remota | OLD 100mm | Kraw e Lower Leg de alumínio



SUSPENSÃO TRASEIRA

N/A



MOVIMENTO DE DIREÇÃO

Direção mega over | Semi-integrada | Esferada



GUIDÃO

X-Time | Alumínio | Reto | 31.8 x 740 mm | 9° backsweep



SUPPORTO DE GUIDÃO

X-Time | Ahead | Alumínio | 31.8 x 70 mm | +/-17°



MANOPLA

MTB | Preta | Light



CONJUNTO DE FREIO

X-Time | Hidráulico | Abraçadeira | Reservatório de alumínio | Óleo mineral | Caliper 2 pistões



DISCO DE FREIO

X-Time | 160 mm | 06 parafusos | Aço



ARO/RAIO

Rava | Alumínio 6063 | 622x23mm | ERD 600 mm | Parede dupla | 32F | Raio preto | PSI máximo 80/40 | Tubeless Ready | Compatível com pneu 1.5" até 2.4"



CUBOS

Cubo X-Time | Rolamentado | Alumínio | Blocagem | Freehub standard | 32 furos



PNEU / CÂMARA DE AR

Pneu: Arisun Skinwall Mount Bona 29x2.10 **Câmara:** Arisun 29" | Válvula Presta



PEDIVELA

X-Time integrado | Single | Coroa 30D. (Bicicletas 15.5" e 17") e coroa 32D. (Bicicleta 19") | Coroa Alumínio Direct | Off Set 3mm | Braço Alumínio 170mm



CORRENTE

Corrente 12S | SRAM | Power Link



MOVIMENTO CENTRAL

X-Time integrado | Rolamentos | Alumínio



CASSETE

SRAM SX | Index | 12v | Standard | 11/50D. (11/13/15/17/19/22/25/28/32/36/42/50T)



CÂMBIO DIANTEIRO

N/A



CÂMBIO TRASEIRO

Shimano Deore RD-M6100 | 12v



ALAVANCA

Shimano Deore SL-M6100 | 12v | Traseira



SELIM

Rava MTB | Trilho de aço | Vazado



CANOTE

X-Time | Alumínio | 27.2 x 350 mm | Carrinho | Parafuso único



ABRAÇADEIRA

X-Time | Alumínio | 31.8 | Blocagem



PEDAL

Inglês 9/16 | Preto | Alumínio



URBANA

✓



CICLOTURISMO

✓



TRILHAS INTERMEDIÁRIAS

X



COMPETIÇÃO

X

29" NACIONAL

15.5 21464

17 N/A

19 N/A

FOTOS MERAMENTE ILUSTRATIVAS. AS INFORMAÇÕES/CONFIGURAÇÕES DE PRODUTOS PODERÃO SOFRER ALTERAÇÕES SEM AVISO PRÉVIO.

ENTRE EM CONTATO COM O SEU CONSULTOR OU FALE COM O NOSSO TIME DE TELEVENDAS PELO (33) 3277-3030.

rakan

12V. Hidráulico



29"
WHEELS

Urbana

Alumínio

Mega Over

12 velocidades

Disco Hidráulico

Kg 14.74



QUADRO

Quadro Rava MTB Rakan 29" | Caixa Central BSA 68 x 34.7mm | Suporte de Freio Post Mount dentro do triângulo traseiro | Eixo traseiro 135 mm x 9 mm | Largura do pneu 2.20 (com cravos baixos) | Alumínio 6061 | Cabeamento interno | Direção Mega Over semi-integrada caixa 44 mm | Tubo do canote 27.2 mm | Peso máximo suportado 120 Kg (ciclista + acessórios).



SUSPENSÃO DIANTEIRA

Suspensão Suntour XCM30 | Eixo de 9 mm | Ahead set | Trava Remota | OLD 100 mm | Kraw e Lower Leg de alumínio



SUSPENSÃO TRASEIRA

N/A



MOVIMENTO DE DIREÇÃO

Direção Mega Over | Semi-integrada | Esferada



GUIDÃO

X-Time | Alumínio | Reto | 31.8 x 740 mm | 9° Backsweep



SUporte DE GUIDÃO

X-Time | Ahead | Alumínio | 31.8 x 70 mm | +/-17°



MANOPLA

MTB | Preta | Light



CONJUNTO DE FREIO

X-Time | Hidráulico | Abraçadeira | Reservatório de alumínio | Óleo mineral | Caliper 2 pistões



DISCO DE FREIO

X-Time | 160 mm | 06 parafusos | Aço



ARO/RAIO

Rava | Alumínio 6063 | 622 x 23 mm | ERD 600 mm | Parede dupla | 32F | Raio preto | PSI máximo 80/40 | Tubeless Ready | Compatível com pneu 1.5" até 2.4"



CUBOS

Cubo X-Time | Rolamentado | Alumínio | Blocação | Freehub standard | 32 furos



PNEU / CÂMARA DE AR

Pneu: Arisun Skinwall Mount Bona 29x2.10 **Câmara:** Arisun 29" | Válvula Presta



PEDIVELA

X-Time integrado | Single | Coroa 32D Alumínio Direct | Off Set 3 mm | Braço Alumínio 170 mm



CORRENTE

Corrente 12S | SUMC | Missing link / Power Link



MOVIMENTO CENTRAL

X-Time integrado | Rolamentos | Alumínio



CASSETE

X-TIME | Index | 12 velocidades | Aranha dos Cogs superiores de alumínio | 11/52D (11-13-15-18-21-23-26-30-34-40-46-52)



CÂMBIO DIANTEIRO

N/A



CÂMBIO TRASEIRO

XTIME 12V. | Roldanas 12D. | Corpo em Alumínio | Cage de Aço | Guia do Cabo de Nylon | Tecnologia U-Pulley (onde um dente é maior que o outro para melhor encaixe na corrente)



ALAVANCA

XTIME 12V. | Alumínio/ Plástico



SELIM

Rava MTB | Trilho de aço | Vazado



CANOTE

X-Time | Alumínio | 27.2 x 350 mm | Carrinho | Parafuso único



ABRAÇADEIRA

X-Time | Alumínio | 31.8 | Blocação



PEDAL

Inglês 9/16 | Preto | Alumínio



URBANA

✓



CICLOTURISMO

✓

29" NACIONAL

15.5 19972

17 N/A

19 N/A

RAVA

5

FOTOS MERAMENTE ILUSTRATIVAS. AS INFORMAÇÕES/CONFIGURAÇÕES DE PRODUTOS PODERÃO SOFRER ALTERAÇÕES SEM AVISO PRÉVIO.

ENTRE EM CONTATO COM O SEU CONSULTOR OU FALE COM O NOSSO TIME DE TELEVENDAS PELO (33) 3277-3030.

rakran

12V. Hidráulico



29"
WHEELS



Urbana



Alumínio



Mega Over



12 velocidades



Disco Hidráulico



14.74



QUADRO

Quadro Rava MTB Rakan 29" | Caixa Central BSA 68 x 34.7mm | Suporte de Freio Post Mount dentro do triângulo traseiro | Eixo traseiro 135 mm x 9 mm | Largura do pneu 2.20 (com cravos baixos) | Alumínio 6061 | Cabeamento interno | Direção Mega Over semi-integrada caixa 44 mm | Tubo do canote 27.2 mm | Peso máximo suportado 120 Kg (ciclista + acessórios).



SUSPENSÃO DIANTEIRA

Suspensão Suntour XCM30 | Eixo de 9 mm | Ahead set | Trava Remota | OLD 100 mm | Kraw e Lower Leg de alumínio



SUSPENSÃO TRASEIRA

N/A



MOVIMENTO DE DIREÇÃO

Direção Mega Over | Semi-integrada | Esferada



GUIDÃO

X-Time | Alumínio | Reto | 31.8 x 740 mm | 9° Backsweep



SUPORTE DE GUIDÃO

X-Time | Ahead | Alumínio | 31.8 x 70 mm | +/-17°



MANOPLA

MTB | Preta | Light



CONJUNTO DE FREIO

X-Time | Hidráulico | Abraçadeira | Reservatório de alumínio | Óleo mineral | Caliper 2 pistões



DISCO DE FREIO

X-Time | 160 mm | 06 parafusos | Aço



ARO/RAIO

Rava | Alumínio 6063 | 622 x 23 mm | ERD 600 mm | Parede dupla | 32F | Raio preto | PSI máximo 80/40 | Tubeless Ready | Compatível com pneu 1.5" até 2.4"



CUBOS

Cubo X-Time | Rolamentado | Alumínio | Blocação | Freehub standard | 32 furos



PNEU / CÂMARA DE AR

Pneu: Arisun Skinwall Mount Bona 29x2.10 **Câmara:** Arisun 29" | Válvula Presta



PEDIVELA

X-Time integrado | Single | Coroa 32D Alumínio Direct | Off Set 3 mm | Braço Alumínio 170 mm



CORRENTE

Corrente 12S | SUMC | Missing link / Power Link



MOVIMENTO CENTRAL

X-Time integrado | Rolamentos | Alumínio



CASSETE

X-TIME | Index | 12 velocidades | Aranha dos Cogs superiores de alumínio | 11/52D (11-13-15-18-21-23-26-30-34-40-46-52)



CÂMBIO DIANTEIRO

N/A



CÂMBIO TRASEIRO

XTIME 12V. | Roldanas 12D. | Corpo em Alumínio | Cage de Aço | Guia do Cabo de Nylon | Tecnologia U-Pulley (onde um dente é maior que o outro para melhor encaixe na corrente)



ALAVANCA

XTIME 12V. | Alumínio/ Plástico



SELIM

Rava MTB | Trilho de aço | Vazado



CANOTE

X-Time | Alumínio | 27.2 x 350 mm | Carrinho | Parafuso único



ABRAÇADEIRA

X-Time | Alumínio | 31.8 | Blocação



PEDAL

Inglês 9/16 | Preto | Alumínio



URBANA

✓



CICLOTURISMO

✓

29" NACIONAL

15.5 ■ 19973

17 ■ N/A

19 ■ N/A

FOTOS MERAMENTE ILUSTRATIVAS. AS INFORMAÇÕES/CONFIGURAÇÕES DE PRODUTOS PODERÃO SOFRER ALTERAÇÕES SEM AVISO PRÉVIO.

ENTRE EM CONTATO COM O SEU CONSULTOR OU FALE COM O NOSSO TIME DE TELEVENDAS PELO (33) 3277-3030.



KIT pressure 12v

COLIGADA 6



29"
WHEELS

Urbana

Alumínio

Mega Over

12 velocidades

Disco Hidráulico

QUADRO Quadro Rava MTB Pressure 29" | Caixa central BSA 68 mm | Suporte de Freio Standard | Eixo traseiro 135 mm x 9 mm | Largura do pneu 2.20 (com cravos baixos) | Alumínio 6061 | Cabeamento da marcha interno | Direção Mega Over semi-integrada caixa 44 mm | Tubo do canote 27.2 mm | Blocação de rodas, canote e selim.

SUSPENSÃO DIANTEIRA Suspensão TSW | Eixo de 9 mm | Ahead set | Trava Remota | OLD 100mm | Kraw alumínio | Lower Leg de aço

SUSPENSÃO TRASEIRA N/A

MOVIMENTO DE DIREÇÃO Direção Mega Over | Semi-integrada | Esferada

GUIDÃO X-Time | Alumínio | Reto | 31.8 x 740 mm | 9° backsweep

SUPORTE DE GUIDÃO X-Time | Ahead | Alumínio | 31.8 x 90 mm | +/-7°

MANOPLA MTB | Preta

CONJUNTO DE FREIO X-Time | Hidráulico | Abraçadeira | Reservatório de alumínio | Óleo mineral | Caliper 2 pistões

DISCO DE FREIO X-Time | 160 mm | 06 parafusos | Aço

ARO/RAIO Rava | Alumínio 6063 | 622x19mm | ERD 584 mm | Parede dupla | 32F | Raio preto

CUBOS Cubo X-Time | Rolamentado | Alumínio | Blocação | Freehub standard | 32 furos

PNEU / CÂMARA DE AR **Pneu:** Arisun Skinwall Mount Bona 29x2.10 **Câmara:** Arisun 29" | Válvula americana

PEDIVELA X-Time Ponta Quadrada | Single | Coroa 32D Aço | Braço Alumínio | BCD 104mm

CORRENTE Corrente 12S | SUMC/xtime | Missing link / Power Link

MOVIMENTO CENTRAL 34.7 x 110 mm | Ponta Quadrada | Aço | Rolamentos

CASSETE X-TIME | Index | 12 velocidades | Aranha dos Cogs superiores de alumínio | 11/52D. (11-13-15-18-21-23-26-30-34-40-46-52)

CÂMBIO DIANTEIRO N/A

CÂMBIO TRASEIRO XTIME 12V | Roldanas 12D. | Corpo em Alumínio | Cage de Aço | Guia do Caço de Nylon | Tecnologia U-Pulley (onde um dente é maior que o outro para melhor encaixe na corrente)

ALAVANCA XTIME 12V. | Alumínio/ Plástico

SELIM Rava MTB | Trilho de aço | Vazado

CANOTE X-Time | Alumínio | 27.2 x 350 mm | Carrinho | Parafuso único

ABRAÇADEIRA X-Time | Alumínio | 31.8 | Blocação

PEDAL Inglês | Preto | Nylon

URBANA ✓

29" | I M P O R T A D A

15.5 ■ 20477

17 ■ 20478

19 ■ 20479

FOTOS MERAMENTE ILUSTRATIVAS. AS INFORMAÇÕES/CONFIGURAÇÕES DE PRODUTOS PODERÃO SOFRER ALTERAÇÕES SEM AVISO PRÉVIO.

ENTRE EM CONTATO COM O SEU CONSULTOR OU FALE COM O NOSSO TIME DE TELEVENDAS PELO (33) 3277-3030.

pressure

CABEAMENTO INTERNO

Edição 20v. Hidráulico



Urbana

Alumínio

Mega Over

20 velocidades

Disco Hidráulico

Kg 13.7

	QUADRO	Rava Pressure 29" Alumínio 6061 Cabeamento Interno Direção Mega Over Freio a disco standard M. Central BSA 34.7 mm / Tubo 68 mm Eixo traseiro de 135 x 9 mm Blocagem de rodas, canote e selim.
	SUSPENSÃO DIANTEIRA	Rava Aço 80 mm Eixo de 9 mm Freio a disco Standard
	SUSPENSÃO TRASEIRA	N/A
	MOVIMENTO DE DIREÇÃO	Mega Over Semi-integrada com esferas
	GUIDÃO	X-Time Alumínio Reto 31.8 x 740 mm 9° backsweep
	SUPORTE DE GUIDÃO	X-Time Ahead Alumínio 31.8 x 90 mm/7°
	MANOPLA	MTB Borracha
	CONJUNTO DE FREIO	X-Time Disco Hidráulico Dianteiro/Traseiro manete de aço
	DISCO DE FREIO	Dianteiro/Traseiro 160 mm Parafuso
	ARO/RAIO	Aro 29 x 32f alumínio mtb preto rava mod. 02 (By vzan ou by fly – de acordo com o estoque) Folha dupla tipo aero
	CUBOS	Alumínio Dianteiro/Traseiro X-time Blocagem Freehub standard para 8/9/10v. 32 furos
	PNEU / CÂMARA DE AR	Pneu: Arisun Skinwall 29x2.20 Câmara: Arisun 29" Válvula americana
	PEDIVELA	X-Time Engrenagem dupla 36-22 D. 170 mm
	CORRENTE	Corrida Tec 10v.

	EIXO CENTRAL	Eixo centro 34.7 C/ rol. 115mm selado com rolamento Ponta quadrada
	CASSETTE	Cassete 10v. Xtime, index 11-36d. Estrutura em aço, padrão standard Escalonamento 11-13-15-17-19-21-24-28-32-36d.
	CÂMBIO DIANTEIRO	X-Time 20v.
	CÂMBIO TRASEIRO	X-Time 10v.
	ALAVANCA	Dianteira/Traseira X-Time 2 x 10v. Index
	SELIM	Rava MTB Mod. 2 RV
	CANOTE	X-Time Alumínio 27.2 x 350 mm
	ABRAÇADEIRA	X-Time Alumínio 31.8 C/ Blocagem
	PEDAL	Inglês Preto Nylon Inglês
	URBANA	✓

29" NACIONAL

15'5		N/A
17		19966
19		19969

FOTOS MERAMENTE ILUSTRATIVAS. AS INFORMAÇÕES/CONFIGURAÇÕES DE PRODUTOS PODERÃO SOFRER ALTERAÇÕES SEM AVISO PRÉVIO.

ENTRE EM CONTATO COM O SEU CONSULTOR OU FALE COM O NOSSO TIME DE TELEVENDAS PELO (33) 3277-3030.

pressure

CABEAMENTO INTERNO

Edição 20v. Hidráulico



Urbana

Alumínio

Mega Over

20 velocidades

Disco Hidráulico

Kg 13.7



QUADRO

Rava Pressure 29" | Alumínio 6061 | Cabeamento Interno | Direção Mega Over | Freio a disco standard | M. Central BSA 34.7 mm / Tubo 68 mm | Eixo traseiro de 135 x 9 mm | Blocação de rodas, canote e selim.



SUSPENSÃO DIANTEIRA

Rava | Aço | 80 mm | Eixo de 9 mm | Freio a disco Standard



SUSPENSÃO TRASEIRA

N/A



MOVIMENTO DE DIREÇÃO

Mega Over | Semi-integrada com esferas



GUIDÃO

X-Time | Alumínio | Reto | 31.8 x 740 mm | 9° backsweep



SUPORE DE GUIDÃO

X-Time | Ahead | Alumínio | 31.8 x 90 mm/7°



MANOPLA

MTB | Borracha



CONJUNTO DE FREIO

X-Time | Disco | Hidráulico | Dianteiro/Traseiro | manete de aço



DISCO DE FREIO

Dianteiro/Traseiro | 160 mm | Parafuso



ARO/RAIO

Aro 29 x 32f alumínio mtb preto rava mod. 02 (By vzan ou by fly – de acordo com o estoque) | Folha dupla tipo aero



CUBOS

Alumínio | Dianteiro/Traseiro X-time | Blocação | Freehub standard para 8/9/10v. | 32 furos



PNEU / CÂMARA DE AR

Pneu: Arisun Skinwall 29x2.20 | **Câmara:** Arisun 29" | Válvula americana



PEDIVELA

X-Time | Engrenagem dupla | 36-22 D. | 170 mm



CORRENTE

Corrida | Tec | 10v.



EIXO CENTRAL

Eixo centro 34.7 C/ rol. 115mm | selado com rolamento | Ponta quadrada



CASSETTE

Cassete 10v. Xtime, index 11-36d. | Estrutura em aço, padrão standard | Escalonamento 11-13-15-17-19-21-24-28-32-36d.



CÂMBIO DIANTEIRO

X-Time 20v.



CÂMBIO TRASEIRO

X-Time 10v.



ALAVANCA

Dianteira/Traseira | X-Time 2 x 10v. | Index



SELIM

Rava MTB | Mod. 2 RV



CANOTE

X-Time | Alumínio | 27.2 x 350 mm



ABRAÇADEIRA

X-Time | Alumínio | 31.8 | C/ Blocação



PEDAL

Inglês | Preto | Nylon | Inglês



URBANA

✓

29" NACIONAL

15'5 19964

17 19967

19 19970

FOTOS MERAMENTE ILUSTRATIVAS. AS INFORMAÇÕES/CONFIGURAÇÕES DE PRODUTOS PODERÃO SOFRER ALTERAÇÕES SEM AVISO PRÉVIO.

ENTRE EM CONTATO COM O SEU CONSULTOR OU FALE COM O NOSSO TIME DE TELEVENDAS PELO (33) 3277-3030.

pressure

CABEAMENTO INTERNO

Edição 20v. Hidráulico



Urbana



Alumínio



Mega Over



























20 velocidades



Disco Hidráulico



13.7

 QUADRO	Rava Pressure 29" Alumínio 6061 Cabeamento Interno Direção Mega Over Freio a disco standard M. Central BSA 34.7 mm / Tubo 68 mm Eixo traseiro de 135 x 9 mm Blocação de rodas, canote e selim.	 EIXO CENTRAL	Eixo centro 34.7 C/ rol. 115mm selado com rolamento Ponta quadrada
 SUSPENSÃO DIANTEIRA	Rava Aço 80 mm Eixo de 9 mm Freio a disco Standard	 CASSETE	Cassete 10v. Xtime, index 11-36d. Estrutura em aço, padrão standard Escalonamento 11-13-15-17-19-21-24-28-32-36d.
 SUSPENSÃO TRASEIRA	N/A	 CÂMBIO DIANTEIRO	X-Time 20v.
 MOVIMENTO DE DIREÇÃO	Mega Over Semi-integrada com esferas	 CÂMBIO TRASEIRO	X-Time 10v.
 GUIDÃO	X-Time Alumínio Reto 31.8 x 740 mm 9° backsweep	 ALAVANCA	Dianteira/Traseira X-Time 2 x 10v. Index
 SUPORTE DE GUIDÃO	X-Time Ahead Alumínio 31.8 x 90 mm/7°	 SELIM	Rava MTB Mod. 2 RV
 MANOPLA	MTB Borracha	 CANOTE	X-Time Alumínio 27.2 x 350 mm
 CONJUNTO DE FREIO	X-Time Disco Hidráulico Dianteiro/Traseiro manete de aço	 ABRAÇADEIRA	X-Time Alumínio 31.8 C/ Blocação
 DISCO DE FREIO	Dianteiro/Traseiro 160 mm Parafuso	 PEDAL	Inglês Preto Nylon Inglês
 ARO/RAIO	Aro 29 x 32f alumínio mtb preto rava mod. 02 (By vzan ou by fly – de acordo com o estoque) Folha dupla tipo aero	 URBANA	✓
 CUBOS	Alumínio Dianteiro/Traseiro X-time Blocação Freehub standard para 8/9/10v. 32 furos	29" NACIONAL	
 PNEU / CÂMARA DE AR	Pneu: Arisun Skinwall 29x2.20 Câmara: Arisun 29" Válvula americana	15'5	■ 19965
 PEDIVELA	X-Time Engrenagem dupla 36-22 D. 170 mm	17	■ 19968
 CORRENTE	Corrida Tec 10v.	19	■ 19971

FOTOS MERAMENTE ILUSTRATIVAS. AS INFORMAÇÕES/CONFIGURAÇÕES DE PRODUTOS PODERÃO SOFRER ALTERAÇÕES SEM AVISO PRÉVIO.

ENTRE EM CONTATO COM O SEU CONSULTOR OU FALE COM O NOSSO TIME DE TELEVENDAS PELO (33) 3277-3030.

pressure

Edição
21v. Mecânico



Urbana

Alumínio

Mega Over

21 velocidades

Disco Mecânico

14.57 Kg

	QUADRO	Rava Pressure 29" Alumínio 6061 Direção Mega Over Freio a disco standard M. Central BSA 34.7 mm / Tubo 68 mm Eixo traseiro de 142 x 9 mm Adesivo não envernizado Blocagem de rodas, canote e selim.
	SUSPENSÃO DIANTEIRA	Rava Aço 80 mm Eixo de 9 mm
	SUSPENSÃO TRASEIRA	N/A
	MOVIMENTO DE DIREÇÃO	Mega Over Semi-integrada
	GUIDÃO	31.8 x 730 mm Alumínio Rise bar (baixo) ou 31.8 x 740 mm 9° backsweep Alumínio Reto X-Time (envio de acordo com a disponibilidade do estoque)
	SUPORTE DE GUIDÃO	X-Time Ahead Alumínio 31.8 x 90 mm/7°
	MANOPLA	MTB – Nylon
	CONJUNTO DE FREIO	X-Time Disco Mecânico Dianteiro/Traseiro
	DISCO DE FREIO	Parafuso 160 mm Parafuso
	ARO/RAIO	Rava Alumínio 6063 622x19mm ERD 584 mm Parede dupla 32F Raio preto
	CUBOS	Alumínio Blocagem Esfera Roda livre
	PNEU / CÂMARA DE AR	Pneu: Arisun Skinwall 29x2.20 Câmara: Arisun 29" Válvula americana
	PEDIVELA	X-Time Engrenagem tripla Braço 170 mm Alumínio Coroas 42/34/24D Aço
	CORRENTE	6/7/8v. Index corrida TEC ou 6/7v. 112L Index corrida PYC (envio de acordo com a disponibilidade do estoque)

	EIXO CENTRAL	34.7 Com rolamento 122.5 mm Ponta quadrada
	RODA LIVRE	7 velocidades 14-28D Xtime ou Shimano
	CÂMBIO DIANTEIRO	Dual Shimano TZ 500
	CÂMBIO TRASEIRO	Shimano TZ 31
	ALAVANCA	Passador de marcha/alavanca do freio Dianteira/Traseira X-Time 3 x 7v.
	SELIM	Rava MTB Trilho de aço
	CANOTE	X-Time Alumínio 27.2 x 350 mm Carrinho Parafuso único
	ABRAÇADEIRA	X-Time Alumínio 31.8 Blocagem
	PEDAL	Inglês Preto Nylon
	URBANA	✓
	CICLOTURISMO	X
	TRILHAS INTERMEDIÁRIAS	X

29" NACIONAL

15.5 19941

17 19946

FOTOS MERAMENTE ILUSTRATIVAS. AS INFORMAÇÕES/CONFIGURAÇÕES DE PRODUTOS PODERÃO SOFRER ALTERAÇÕES SEM AVISO PRÉVIO.

ENTRE EM CONTATO COM O SEU CONSULTOR OU FALE COM O NOSSO TIME DE TELEVENDAS PELO (33) 3277-3030.

pressure Edição 21v. Mecânico



Canote de acordo com o Estoque

Urbana

Alumínio

Mega Over

21 velocidades

Disco Mecânico

Kg 14.57

	QUADRO	Rava Pressure 29" Alumínio 6061 Direção Mega Over Freio a disco standard M. Central BSA 34.7 mm / Tubo 68 mm Eixo traseiro de 142 x 9 mm Adesivo não envernizado Blocação de rodas, canote e selim.
	SUSPENSÃO DIANTEIRA	Rava Aço 80 mm Eixo de 9 mm
	SUSPENSÃO TRASEIRA	N/A
	MOVIMENTO DE DIREÇÃO	Mega Over Semi-integrada
	GUIDÃO	31.8 x 730 mm Alumínio Rise bar (baixo) ou 31.8 x 740 mm 9° backsweep Alumínio Reto X-Time (envio de acordo com a disponibilidade do estoque)
	SUORTE DE GUIDÃO	X-Time Ahead Alumínio 31.8 x 90 mm/7°
	MANOPLA	MTB – Nylon
	CONJUNTO DE FREIO	X-Time Disco Mecânico Dianteiro/ Traseiro
	DISCO DE FREIO	Parafuso 160 mm Parafuso
	ARO/RAIO	Rava Alumínio 6063 622x19mm ERD 584 mm Parede dupla 32F Raio preto
	CUBOS	Alumínio Blocação Esfera Roda livre
	PNEU / CÂMARA DE AR	Pneu: Arisun Skinwall 29x2.20 Câmara: Arisun 29" Válvula americana
	PEDIVELA	X-Time Engrenagem tripla Braço 170 mm Alumínio Coroas 42/34/24D Aço
	CORRENTE	6/7/8v. Index corrida TEC ou 6/7v. 112L Index corrida PYC (envio de acordo com a disponibilidade do estoque)

	EIXO CENTRAL	34.7 Com rolamento 122.5 mm Ponta quadrada
	RODA LIVRE	7 velocidades 14-28D Xtime ou Shimano
	CÂMBIO DIANTEIRO	Dual Shimano TZ 500
	CÂMBIO TRASEIRO	Shimano TZ 31
	ALAVANCA	Passador de marcha/alavanca do freio Dianteira/Traseira X-Time 3 x 7v.
	SELIM	Rava MTB Trilho de aço
	CANOTE	X-Time Alumínio 27.2 x 350 mm Carrinho Parafuso único
	ABRAÇADEIRA	X-Time Alumínio 31.8 Blocação
	PEDAL	Inglês Preto Nylon
	URBANA	✓
	CICLOTURISMO	X
	TRILHAS INTERMEDIÁRIAS	X

29" NACIONAL

15.5 19942

17 19947

FOTOS MERAMENTE ILUSTRATIVAS. AS INFORMAÇÕES/CONFIGURAÇÕES DE PRODUTOS PODERÃO SOFRER ALTERAÇÕES SEM AVISO PRÉVIO.

ENTRE EM CONTATO COM O SEU CONSULTOR OU FALE COM O NOSSO TIME DE TELEVENDAS PELO (33) 3277-3030.

pressure

Edição
21v. Mecânico



Urbana

Alumínio

Mega Over

21 velocidades

Disco Mecânico

Kg 14.57

	QUADRO	Rava Pressure 29" Alumínio 6061 Direção Mega Over Freio a disco standard M. Central BSA 34.7 mm / Tubo 68 mm Eixo traseiro de 142 x 9 mm Adesivo não envernizado Blocação de rodas, canote e selim.
	SUSPENSÃO DIANTEIRA	Rava Aço 80 mm Eixo de 9 mm
	SUSPENSÃO TRASEIRA	N/A
	MOVIMENTO DE DIREÇÃO	Mega Over Semi-integrada
	GUIDÃO	31.8 x 730 mm Alumínio Rise bar (baixo) ou 31.8 x 740 mm 9° backsweep Alumínio Reto X-Time (envio de acordo com a disponibilidade do estoque)
	SUPORTE DE GUIDÃO	X-Time Ahead Alumínio 31.8 x 90 mm/7°
	MANOPLA	MTB – Nylon
	CONJUNTO DE FREIO	X-Time Disco Mecânico Dianteiro/Traseiro
	DISCO DE FREIO	Parafuso 160 mm Parafuso
	ARO/RAIO	Rava Alumínio 6063 622x19mm ERD 584 mm Parede dupla 32F Raio preto
	CUBOS	Alumínio Blocação Esfera Roda livre
	PNEU / CÂMARA DE AR	Pneu: Arisun Skinwall 29x2.20 Câmara: Arisun 29" Válvula americana
	PEDIVELA	X-Time Engrenagem tripla Braço 170 mm Alumínio Coroas 42/34/24D Aço
	CORRENTE	6/7/8v. Index corrida TEC ou 6/7v. 112L Index corrida PYC (envio de acordo com a disponibilidade do estoque)

	EIXO CENTRAL	34.7 Com rolamento 122.5 mm Ponta quadrada
	RODA LIVRE	7 velocidades 14-28D Xtime ou Shimano
	CÂMBIO DIANTEIRO	Dual Shimano TZ 500
	CÂMBIO TRASEIRO	Shimano TZ 31
	ALAVANCA	Passador de marcha/alavanca do freio Dianteira/Traseira X-Time 3 x 7v.
	SELIM	Rava MTB Trilho de aço
	CANOTE	X-Time Alumínio 27.2 x 350 mm Carrinho Parafuso único
	ABRAÇADEIRA	X-Time Alumínio 31.8 Blocação
	PEDAL	Inglês Preto Nylon
	URBANA	✓
	CICLOTURISMO	X
	TRILHAS INTERMEDIÁRIAS	X

29" NACIONAL

15.5 19943

17 19948

RAVA

15

FOTOS MERAMENTE ILUSTRATIVAS. AS INFORMAÇÕES/CONFIGURAÇÕES DE PRODUTOS PODERÃO SOFRER ALTERAÇÕES SEM AVISO PRÉVIO.

ENTRE EM CONTATO COM O SEU CONSULTOR OU FALE COM O NOSSO TIME DE TELEVENDAS PELO (33) 3277-3030.



Canote de acordo com o Estoque

29

Urbana

Alumínio

Mega Over

21 velocidades

Disco Mecânico

Kg 14.57

	QUADRO	Rava Pressure 29" Alumínio 6061 Direção Mega Over Freio a disco standard M. Central BSA 34.7 mm / Tubo 68 mm Eixo traseiro de 142 x 9 mm Adesivo não envernizado Blocação de rodas, canote e selim.
	SUSPENSÃO DIANTEIRA	Rava Aço 80 mm Eixo de 9 mm
	SUSPENSÃO TRASEIRA	N/A
	MOVIMENTO DE DIREÇÃO	Mega Over Semi-integrada
	GUIDÃO	31.8 x 730 mm Alumínio Rise bar (baixo) ou 31.8 x 740 mm 9° backsweep Alumínio Reto X-Time (envio de acordo com a disponibilidade do estoque)
	SUORTE DE GUIDÃO	X-Time Ahead Alumínio 31.8 x 90 mm/7°
	MANOPLA	MTB – Nylon
	CONJUNTO DE FREIO	X-Time Disco Mecânico Dianteiro/ Traseiro
	DISCO DE FREIO	Parafuso 160 mm Parafuso
	ARO/RAIO	Rava Alumínio 6063 622x19mm ERD 584 mm Parede dupla 32F Raio preto
	CUBOS	Alumínio Blocação Esfera Roda livre
	PNEU / CÂMARA DE AR	Pneu: Arisun Skinwall 29x2.20 Câmara: Arisun 29" Válvula americana
	PEDIVELA	X-Time Engrenagem tripla Braço 170 mm Alumínio Coroas 42/34/24D Aço
	CORRENTE	6/7/8v. Index corrida TEC ou 6/7v. 112L Index corrida PYC (envio de acordo com a disponibilidade do estoque)

	EIXO CENTRAL	34.7 Com rolamento 122.5 mm Ponta quadrada
	RODA LIVRE	7 velocidades 14-28D Xtime ou Shimano
	CÂMBIO DIANTEIRO	Dual Shimano TZ 500
	CÂMBIO TRASEIRO	Shimano TZ 31
	ALAVANCA	Passador de marcha/alavanca do freio Dianteira/Traseira X-Time 3 x 7v.
	SELIM	Rava MTB Trilho de aço
	CANOTE	X-Time Alumínio 27.2 x 350 mm Carrinho Parafuso único
	ABRAÇADEIRA	X-Time Alumínio 31.8 Blocação
	PEDAL	Inglês Preto Nylon
	URBANA	✓
	CICLOTURISMO	X
	TRILHAS INTERMEDIÁRIAS	X

29" NACIONAL

15.5 ■ 19944

17 ■ 19949

FOTOS MERAMENTE ILUSTRATIVAS. AS INFORMAÇÕES/CONFIGURAÇÕES DE PRODUTOS PODERÃO SOFRER ALTERAÇÕES SEM AVISO PRÉVIO.

ENTRE EM CONTATO COM O SEU CONSULTOR OU FALE COM O NOSSO TIME DE TELEVENDAS PELO (33) 3277-3030.

pressure

Edição
21v. Mecânico



Urbana

Alumínio

Mega Over

21 velocidades

Disco Mecânico

14.57

	QUADRO	Rava Pressure 29" Alumínio 6061 Direção Mega Over Freio a disco standard M. Central BSA 34.7 mm / Tubo 68 mm Eixo traseiro de 142 x 9 mm Adesivo não envernizado Blocação de rodas, canote e selim.
	SUSPENSÃO DIANTEIRA	Rava Aço 80 mm Eixo de 9 mm
	SUSPENSÃO TRASEIRA	N/A
	MOVIMENTO DE DIREÇÃO	Mega Over Semi-integrada
	GUIDÃO	31.8 x 730 mm Alumínio Rise bar (baixo) ou 31.8 x 740 mm 9° backsweep Alumínio Reto X-Time (envio de acordo com a disponibilidade do estoque)
	SUPORTE DE GUIDÃO	X-Time Ahead Alumínio 31.8 x 90 mm/7°
	MANOPLA	MTB – Nylon
	CONJUNTO DE FREIO	X-Time Disco Mecânico Dianteiro/Traseiro
	DISCO DE FREIO	Parafuso 160 mm Parafuso
	ARO/RAIO	Rava Alumínio 6063 622x19mm ERD 584 mm Parede dupla 32F Raio preto
	CUBOS	Alumínio Blocação Esfera Roda livre
	PNEU / CÂMARA DE AR	Pneu: Arisun Skinwall 29x2.20 Câmara: Arisun 29" Válvula americana
	PEDIVELA	X-Time Engrenagem tripla Braço 170 mm Alumínio Coroas 42/34/24D Aço
	CORRENTE	6/7/8v. Index corrida TEC ou 6/7v. 112L Index corrida PYC (envio de acordo com a disponibilidade do estoque)

	EIXO CENTRAL	34.7 Com rolamento 122.5 mm Ponta quadrada
	RODA LIVRE	7 velocidades 14-28D Xtime ou Shimano
	CÂMBIO DIANTEIRO	Dual Shimano TZ 500
	CÂMBIO TRASEIRO	Shimano TZ 31
	ALAVANCA	Passador de marcha/alavanca do freio Dianteira/Traseira X-Time 3 x 7v.
	SELIM	Rava MTB Trilho de aço
	CANOTE	X-Time Alumínio 27.2 x 350 mm Carrinho Parafuso único
	ABRAÇADEIRA	X-Time Alumínio 31.8 Blocação
	PEDAL	Inglês Preto Nylon
	URBANA	✓
	CICLOTURISMO	X
	TRILHAS INTERMEDIÁRIAS	X

29" NACIONAL

15.5	■	19945
17	■	19950
19	■	19953

FOTOS MERAMENTE ILUSTRATIVAS. AS INFORMAÇÕES/CONFIGURAÇÕES DE PRODUTOS PODERÃO SOFRER ALTERAÇÕES SEM AVISO PRÉVIO.

ENTRE EM CONTATO COM O SEU CONSULTOR OU FALE COM O NOSSO TIME DE TELEVENDAS PELO (33) 3277-3030.

LAND 21 velocidades V.Brake



RAVA

18

Urbana

Alumínio

Mega Over

21 velocidades

V.Brake

13.70

QUADRO	Aro 26" Rava Land Alumínio Direção Mega Over de 44 mm Central BSA 68 mm Canote 27.2 mm Freio: Disco Standard(IS) e V-Brake Blocação de rodas, canote e selim.	EIXO CENTRAL	Movimento Central 34.7mm 68x122.5mm Semi Selado Ponta quadrada
GARFO	Garfo suspensão Rava Aro 26" Freio: Disco Standard(IS) e V-Brake Eixo 9 x 100 mm	RODA LIVRE	Roda Livre Bronze 7V. 14/28D. Index Xtime ou Shimano
SUSPENSÃO TRASEIRA	N/A	CÂMBIO DIANTEIRO	Shimano TZ500 Top pull
MOVIMENTO DE DIREÇÃO	Mega Over	CÂMBIO TRASEIRO	Shimano 7Velocidades TZ31
GUIDÃO	X-Time Rise Bar 31.8 mm x 720 mm Alumínio	MANETE/ALAVANCA	Alavanca X-TIME EZ- Fire 21V. (3x7) Com manete de freio
SUPOORTE DE GUIDÃO	X-Time 31.8 x 90 mm/+ - 7°	SELIM	Rava Com castanha
MANOPLA	Manopla MTB Borracha	CANOTE	Para castanha 27.2 x 350 mm Aço
CONJUNTO DE FREIO	V-Brake Alumínio	ABRAÇADEIRA	Abraçadeira 31.8mm Alumínio Blocação
DISCO DE FREIO	N/A	PEDAL	Plataforma Preto Nylon Inglês
ARO/RAIO	Aro: Rava Parede dupla 26" 559 x 19 mm Alumínio 6063 ERD 535 mm 36 furos - Raio: Preto 250 x 2,0 mm Com Niple preto	URBANA	✓
CUBOS	Dianteiro: Aço 36 furos Esferado Eixo de 9 x 100 mm Com blocação - Traseiro: Aço 36 furos Esferado Rosca (Roda livre) 9 x 135 mm Com Blocação	CICLOTURISMO	X
PNEU / CÂMARA DE AR	Pneu: Arisun Skinwall Câmara: 26" Válvula americana	TRILHAS INTERMEDIÁRIAS	X
PEDIVELA	Engrenagem Tripla (42/34/24D) braço 165 mm		
CORRENTE	Corrente TEC 21V. Index		

COLIGADA 01

COLIGADA 06

26" NACIONAL

15.5 17209 | 20566

17 17212 | 20569

FOTOS MERAMENTE ILUSTRATIVAS. AS INFORMAÇÕES/CONFIGURAÇÕES DE PRODUTOS PODERÃO SOFRER ALTERAÇÕES SEM AVISO PRÉVIO.

ENTRE EM CONTATO COM O SEU CONSULTOR OU FALE COM O NOSSO TIME DE TELEVENDAS PELO (33) 3277-3030.

Land 21 velocidades V.Brake



Urbana

Alumínio

Mega Over

21 velocidades

V.Brake

13.70

QUADRO	Aro 26" Rava Land Alumínio Direção Mega Over de 44 mm Central BSA 68 mm Canote 27.2 mm Freio: Disco Standard(IS) e V-Brake Blocação de rodas, canote e selim.	EIXO CENTRAL	Movimento Central 34.7mm 68x122.5mm Semi Selado Ponta quadrada
GARFO	Garfo suspensão Rava Aro 26" Freio: Disco Standard(IS) e V-Brake Eixo 9 x 100 mm	RODA LIVRE	Roda Livre Bronze 7V. 14/28D. Index Xtime ou Shimano
SUSPENSÃO TRASEIRA	N/A	CÂMBIO DIANTEIRO	Shimano TZ500 Top pull
MOVIMENTO DE DIREÇÃO	Mega Over	CÂMBIO TRASEIRO	Shimano 7Velocidades TZ31
GUIDÃO	X-Time Rise Bar 31.8 mm x 720 mm Alumínio	MANETE/ALAVANCA	Alavanca X-TIME EZ- Fire 21V. (3x7) Com manete de freio
SUPOORTE DE GUIDÃO	X-Time 31.8 x 90 mm/+ - 7°	SELIM	Rava Com castanha
MANOPLA	Manopla MTB Borracha	CANOTE	Para castanha 27.2 x 350 mm Aço
CONJUNTO DE FREIO	V-Brake Alumínio	ABRAÇADEIRA	Abraçadeira 31.8mm Alumínio Blocação
DISCO DE FREIO	N/A	PEDAL	Plataforma Preto Nylon Inglês
ARO/RAIO	Aro: Rava Parede dupla 26" 559 x 19 mm Alumínio 6063 ERD 535 mm 36 furos - Raio: Preto 250 x 2,0 mm Com Niple preto	URBANA	✓
CUBOS	Dianteiro: Aço 36 furos Esferado Eixo de 9 x 100 mm Com blocação - Traseiro: Aço 36 furos Esferado Rosca (Roda livre) 9 x 135 mm Com Blocação	CICLOTURISMO	X
PNEU / CÂMARA DE AR	Pneu: Arisun Skinwall Câmara: 26" Válvula americana	TRILHAS INTERMEDIÁRIAS	X
PEDIVELA	Engrenagem Tripla (42/34/24D) braço 165 mm		
CORRENTE	Corrente TEC 21V. Index		

COLIGADA 01

COLIGADA 06

26" NACIONAL

15.5 ■ 17210 | 20567

17 ■ 17214 | 20570

FOTOS MERAMENTE ILUSTRATIVAS. AS INFORMAÇÕES/CONFIGURAÇÕES DE PRODUTOS PODERÃO SOFRER ALTERAÇÕES SEM AVISO PRÉVIO.

ENTRE EM CONTATO COM O SEU CONSULTOR OU FALE COM O NOSSO TIME DE TELEVENDAS PELO (33) 3277-3030.

RAVA

19

LAND 21 velocidades V.Brake



Urbana

Alumínio

Mega Over

21 velocidades

V.Brake

13.70

	QUADRO	Aro 26" Rava Land Alumínio Direção Mega Over de 44 mm Central BSA 68 mm Canote 27.2 mm Freio: Disco Standard(IS) e V-Brake Blocação de rodas, canote e selim.
	GARFO	Garfo suspensão Rava Aro 26" Freio: Disco Standard(IS) e V-Brake Eixo 9 x 100 mm
	SUSPENSÃO TRASEIRA	N/A
	MOVIMENTO DE DIREÇÃO	Mega Over
	GUIDÃO	X-Time Rise Bar 31.8 mm x 720 mm Alumínio
	SUPORTE DE GUIDÃO	X-Time 31.8 x 90 mm/+ - 7°
	MANOPLA	Manopla MTB Borracha
	CONJUNTO DE FREIO	V-Brake Alumínio
	DISCO DE FREIO	N/A
	ARO/RAIO	Aro: Rava Parede dupla 26" 559 x 19 mm Alumínio 6063 ERD 535 mm 36 furos - Raio: Preto 250 x 2,0 mm Com Niple preto
	CUBOS	Dianteiro: Aço 36 furos Esferado Eixo de 9 x 100 mm Com blocagem - Traseiro: Aço 36 furos Esferado Rosca (Roda livre) 9 x 135 mm Com Blocagem
	PNEU / CÂMARA DE AR	Pneu: Arisun Skinwall Câmara: 26" Válvula americana
	PEDIVELA	Engrenagem Tripla (42/34/24D) braço 165 mm
	CORRENTE	Corrente TEC 21V. Index

	EIXO CENTRAL	Movimento Central 34.7mm 68x122.5mm Semi Selado Ponta quadrada
	RODA LIVRE	Roda Livre Bronze 7V. 14/28D. Index Xtime ou Shimano
	CÂMBIO DIANTEIRO	Shimano TZ500 Top pull
	CÂMBIO TRASEIRO	Shimano 7Velocidades TZ31
	MANETE/ALAVANCA	Alavanca X-TIME EZ- Fire 21V. (3x7) Com manete de freio
	SELIM	Rava Com castanha
	CANOTE	Para castanha 27.2 x 350 mm Aço
	ABRAÇADEIRA	Abraçadeira 31.8mm Alumínio Blocação
	PEDAL	Plataforma Preto Nylon Inglês
	URBANA	✓
	CICLOTURISMO	X
	TRILHAS INTERMEDIÁRIAS	X

COLIGADA 01

COLIGADA 06

26" NACIONAL

15.5 N/A | 20568

17 - | 20571

FOTOS MERAMENTE ILUSTRATIVAS. AS INFORMAÇÕES/CONFIGURAÇÕES DE PRODUTOS PODERÃO SOFRER ALTERAÇÕES SEM AVISO PRÉVIO.

ENTRE EM CONTATO COM O SEU CONSULTOR OU FALE COM O NOSSO TIME DE TELEVENDAS PELO (33) 3277-3030.

Land

21 velocidades
Mecânico



Urbana

Alumínio

Mega Over

21 velocidades

Mecânico

Kg 14.56



QUADRO

Aro 29" | Rava Land | Alumínio 6061 | Cabeamento interno | Direção Mega Over de 44 mm esferada | Canote 27.2 | Central BSA 68 mm | Suporte de freio Standard | Eixo traseiro 135 mm x 9 mm | Largura do pneu: 2.20 | Blocação de rodas, canote e selim.



GARFO

Garfo Rava 29" | Suspensão 100 mm aço | Suporte de freio Standard | Espiga over ahead set | Eixo 9 mm | Old 100 mm



SUSPENSÃO TRASEIRA

N/A



MOVIMENTO DE DIREÇÃO

Mega Over semi-integrada 44 mm | Ahead set | Esferada | Caixa de aço | Acabamento de alumínio



GUIDÃO

31.8 x 730 mm | Alumínio | Rise bar (baixo) | ou | 31.8 x 740 mm | 9° backsweep | Alumínio | Reto | X-Time (envio de acordo com a disponibilidade do estoque)



SUPORTE DE GUIDÃO

X-Time | Preto | Alumínio | 31.8 mm x 90 mm | +- 7°



MANOPLA

Manopla MTB | Borracha



CONJUNTO DE FREIO

X-Time | Mecânico | Pinças de alumínio | Manete MTB alumínio EZ-Fire 3x7V | Cabo de aço comum | Conduíte 5 mm teflonado



DISCO DE FREIO

X-Time | 160 mm | 06 parafusos | Aço



ARO/RAIO

Aro: Rava 29"x 32F | Alumínio MTB | Preto | Mod.02 (by Vzan ou Fly - conforme estoque) | Folha dupla tipo aero | Freio a disco **Raio:** Preto | Comum



CUBOS

Eixo 9 mm | Blocação de alumínio | Agulha de aço **Dianteiro:** X-Time | Alumínio 32F | Esfera | Preto **Traseiro:** X-Time | Alumínio 32F | Rosca com esfera | Preto



PNEU / CÂMARA DE AR

Pneu: 29"x 2.20 | Skinwall Mount Graham Arisun **Câmara:** 29"x1.75/2.35 | Válvula americana Arisun



PEDIVELA

Engrenagem tripla X-Time | Braço de aço revestido com nylon | Preto | Coroa 24/34/42D | Braço 170 mm | Eixo 9/16 - Inglês



CORRENTE

6/7/8v. | Index corrida | TEC | ou | 6/7v. | 112L | Index corrida | PYC (envio de acordo com a disponibilidade do estoque)



EIXO CENTRAL

34.7 mm com rolamento 122.5 mm | Selado com rolamento | Ponta quadrada



RODA LIVRE

X-time | Index | 7V. | 14/28D | Escalonamento 14-16-18-20-22-24-28D | Xtime ou Shimano



CÂMBIO DIANTEIRO

Shimano Tourney TZ500 | Coroas 42/34/24D | Top pull | Aço | Abraçadeira 31.8 mm



CÂMBIO TRASEIRO

Shimano TZ31 | Aço e nylon | 7 velocidades |



MANETE/ALAVANCA

Alavanca: X-Time EZ- Fire | 3x7V. | Alumínio e plástico



SELIM

Rava MTB | Preto



CANOTE

X-Time | MTB com carrinho | Alumínio | 27.2 x 350 mm | Preto



ABRAÇADEIRA

X-Time | Alumínio | MTB 31.8mm | Blocação | Preto



PEDAL

Plataforma | Nylon | Inglês 9/16



URBANA

✓

29" NACIONAL

15.5 19933

17.5 19936

RAVA

21

FOTOS MERAMENTE ILUSTRATIVAS. AS INFORMAÇÕES/CONFIGURAÇÕES DE PRODUTOS PODERÃO SOFRER ALTERAÇÕES SEM AVISO PRÉVIO.

ENTRE EM CONTATO COM O SEU CONSULTOR OU FALE COM O NOSSO TIME DE TELEVENDAS PELO (33) 3277-3030.

LAND 21 velocidades Mecânico



Urbana

Alumínio

Mega Over

21 velocidades

Mecânico

Kg 14.56

QUADRO Aro 29" | Rava Land | Alumínio 6061 | Cabeamento interno | Direção Mega Over de 44 mm esferada | Canote 27.2 | Central BSA 68 mm | Suporte de freio Standard | Eixo traseiro 135 mm x 9 mm | Largura do pneu: 2.20 | Blocação de rodas, canote e selim.

GARFO Garfo Rava 29" | Suspensão 100 mm aço | Suporte de freio Standard | Espiga over ahead set | Eixo 9 mm | Old 100 mm

SUSPENSÃO TRASEIRA N/A

MOVIMENTO DE DIREÇÃO Mega Over semi-integrada 44 mm | Ahead set | Esferada | Caixa de aço | Acabamento de alumínio

GUIDÃO 31.8 x 730 mm | Alumínio | Rise bar (baixo) | ou | 31.8 x 740 mm | 9° backsweep | Alumínio | Reto | X-Time (envio de acordo com a disponibilidade do estoque)

SUPORTE DE GUIDÃO X-Time | Preto | Alumínio | 31.8 mm x 90 mm | +- 7°

MANOPLA Manopla MTB | Borracha

CONJUNTO DE FREIO X-Time | Mecânico | Pinças de alumínio | Manete MTB alumínio EZ-Fire 3x7V | Cabo de aço comum | Conduíte 5 mm teflonado

DISCO DE FREIO X-Time | 160 mm | 06 parafusos | Aço

ARO/RAIO **Aro:** Rava 29"x 32F | Alumínio MTB | Preto | Mod.02 (by Vzan ou Fly - conforme estoque) | **Folha dupla tipo aero** | **Freio a disco** **Raio:** Preto | Comum

CUBOS Eixo 9 mm | Blocação de alumínio | Agulha de aço **Dianteiro:** X-Time | Alumínio 32F | Esfera | Preto **Traseiro:** X-Time | Alumínio 32F | Rosca com esfera | Preto

PNEU / CÂMARA DE AR

Pneu: 29"x 2.20 | Skinwall Mount Graham Arisun **Câmara:** 29"x1.75/2.35 | Válvula americana Arisun

PEDIVELA Engrenagem tripla X-Time | Braço de aço revestido com nylon | Preto | Coroa 24/34/42D | Braço 170 mm | Eixo 9/16 - Inglês

CORRENTE 6/7/8v. | Index corrida | TEC | ou | 6/7v. | 112L | Index corrida | PYC (envio de acordo com a disponibilidade do estoque)

EIXO CENTRAL 34.7 mm com rolamento 122.5 mm | Selado com rolamento | Ponta quadrada

RODA LIVRE X-time | Index | 7V. | 14/28D | Escalonamento 14-16-18-20-22-24-28D | Xtime ou Shimano

CÂMBIO DIANTEIRO Shimano Tourney TZ500 | Coroa 42/34/24D | Top pull | Aço | Abraçadeira 31.8 mm

CÂMBIO TRASEIRO Shimano TZ31 | Aço e nylon | 7 velocidades |

MANETE/ALAVANCA **Alavanca:** X-Time EZ- Fire | 3x7V. | Alumínio e plástico

SELIM Rava MTB | Preto

CANOTE X-Time | MTB com carrinho | Alumínio | 27.2 x 350 mm | Preto

ABRAÇADEIRA X-Time | Alumínio | MTB 31.8mm | Blocação | Preto

PEDAL Plataforma | Nylon | Inglês 9/16

URBANA ✓

CICLOTURISMO X

29" NACIONAL

15.5 ■ 19934

17.5 ■ 19937

FOTOS MERAMENTE ILUSTRATIVAS. AS INFORMAÇÕES/CONFIGURAÇÕES DE PRODUTOS PODERÃO SOFRER ALTERAÇÕES SEM AVISO PRÉVIO.

ENTRE EM CONTATO COM O SEU CONSULTOR OU FALE COM O NOSSO TIME DE TELEVENDAS PELO (33) 3277-3030.

Land

21 velocidades
Mecânico



Urbana

Alumínio

Mega Over

21 velocidades

Mecânico

Kg 14.56



QUADRO

Aro 29" | Rava Land | Alumínio 6061 | Cabeamento interno | Direção Mega Over de 44 mm esferada | Canote 27.2 | Central BSA 68 mm | Suporte de freio Standard | Eixo traseiro 135 mm x 9 mm | Largura do pneu: 2.20 | Blocação de rodas, canote e selim.



GARFO

Garfo Rava 29" | Suspensão 100 mm aço | Suporte de freio Standard | Espiga over ahead set | Eixo 9 mm | Old 100 mm



SUSPENSÃO TRASEIRA

N/A



MOVIMENTO DE DIREÇÃO

Mega Over semi-integrada 44 mm | Ahead set | Esferada | Caixa de aço | Acabamento de alumínio



GUIDÃO

31.8 x 730 mm | Alumínio | Rise bar (baixo) | ou | 31.8 x 740 mm | 9° backsweep | Alumínio | Reto | X-Time (envio de acordo com a disponibilidade do estoque)



SUPORTE DE GUIDÃO

X-Time | Preto | Alumínio | 31.8 mm x 90 mm | +- 7°



MANOPLA

Manopla MTB | Borracha



CONJUNTO DE FREIO

X-Time | Mecânico | Pinças de alumínio | Manete MTB alumínio EZ-Fire 3x7V | Cabo de aço comum | Conduíte 5 mm teflonado



DISCO DE FREIO

X-Time | 160 mm | 06 parafusos | Aço



ARO/RAIO

Aro: Rava 29"x 32F | Alumínio MTB | Preto | Mod.02 (by Vzan ou Fly - conforme estoque) | Folha dupla tipo aero | Freio a disco **Raio:** Preto | Comum



CUBOS

Eixo 9 mm | Blocação de alumínio | Agulha de aço **Dianteiro:** X-Time | Alumínio 32F | Esfera | Preto **Traseiro:** X-Time | Alumínio 32F | Rosca com esfera | Preto



PNEU / CÂMARA DE AR

Pneu: 29"x 2.20 | Skinwall Mount Graham Arisun **Câmara:** 29"x1.75/2.35 | Válvula americana Arisun



PEDIVELA

Engrenagem tripla X-Time | Braço de aço revestido com nylon | Preto | Coroa 24/34/42D | Braço 170 mm | Eixo 9/16 - Inglês



CORRENTE

6/7/8v. | Index corrida | TEC | ou | 6/7v. | 112L | Index corrida | PYC (envio de acordo com a disponibilidade do estoque)



EIXO CENTRAL

34.7 mm com rolamento 122.5 mm | Selado com rolamento | Ponta quadrada



RODA LIVRE

X-time | Index | 7V. | 14/28D | Escalonamento 14-16-18-20-22-24-28D | Xtime ou Shimano



CÂMBIO DIANTEIRO

Shimano Tourney TZ500 | Coroas 42/34/24D | Top pull | Aço | Abraçadeira 31.8 mm



CÂMBIO TRASEIRO

Shimano TZ31 | Aço e nylon | 7 velocidades |



MANETE/ALAVANCA

Alavanca: X-Time EZ- Fire | 3x7V. | Alumínio e plástico



SELIM

Rava MTB | Preto



CANOTE

X-Time | MTB com carrinho | Alumínio | 27.2 x 350 mm | Preto



ABRAÇADEIRA

X-Time | Alumínio | MTB 31.8mm | Blocação | Preto



PEDAL

Plataforma | Nylon | Inglês 9/16



URBANA

✓



CICLOTURISMO

X

29" NACIONAL

15.5 19935

17.5 19938

RAVA

23

bolt

21 velocidades
V.Brake



Urbana

Alumínio

Mega Over

21 velocidades

V.Brake

Kg 14.60

Quadro	Aro 26" Rava Bolt Alumínio Direção Mega Over de 44 mm Central BSA 68 mm Canote 27.2 mm Freio: Disco Standard(IS) e V-Brake Eixo de 9 x 142 mm Largura máxima de pneu: 26 x 1.9" descanso lateral Blocação de rodas, canote e selim.	corrente	6/7/8v. Index corrida TEC ou 6/7v. 112L Index corrida PYC (envio de acordo com a disponibilidade do estoque)
Garfo	Garfo com suspensão Rava, Ahead set Aro 26" Freio: Disco Standard(IS) e V-Brake Eixo 9 x 100 mm	Eixo central	BSA 34.7 Semi selado 127.5 mm Ponta quadrada
suspensão traseira	N/A	Roda livre	Bronze 7 v. Index 14/28 D Xtime ou Shimano
Movimento de direção	Mega over com rosca Preto	Câmbio Dianteiro	Shimano Tourney TZ FD-TZ500
Guidão	Rise bar Alto Rava 25.4 mm Aço com regulagem de altura	Câmbio traseiro	Sem gancheira 6/7 Velocidades Shimano TZ-31 Index
Suporte de guidão	Rava Ahead Alumínio 90 mm com ajuste de ângulo Ø 25.4 mm	MANETE/ALAVANCA	X-Time Dianteira/Traseira EZ-Fire 21v. (3x7) Com maçaneta Alumínio Preta
manopla	MTB Preta	Selim	Rava Mercúrio Largo Preto/Cinza Com castanha Regulagem de altura
conjunto de freio	V-Brake Preto Dianteiro e traseiro Alumínio Sapata Orbital (Allen)	Canote	Rava Para castanha 27.2 x 350 mm Aço com regulagem de altura
disco de freio	N/A	Abraçadeira	Alumínio 31.8 Blocação
Aro/raio	Aro: Rava Parede dupla 26" 559 x 19 mm Alumínio 6063 Pneu 1.0" até 2.2" ERD 535 mm - Raio: Preto 250 x 2,0 mm Com Niple preto	Pedal	Plataforma Inglês 9/16 Nylon Preto
Cubos	Dianteiro: Aço 36 furos Esferado Eixo de 9 x 100 mm Com blocação - Traseiro: Aço 36 furos Esferado Roda livre 9 x 142 mm Com Blocação	Urbana	✓
Pneu / Câmara de ar	Pneu: Chaoyang 26" x 1,95 Banda leve Câmara: 26" x 1,95 Válvula americana	cicloturismo	X
Pedivela	Engrenagem tripla com braço 28/38/48D Preto Mitsus	trilhas intermediárias	X

26" NACIONAL

18 ■ 20550 / 20874

FOTOS MERAMENTE ILUSTRATIVAS. AS INFORMAÇÕES/CONFIGURAÇÕES DE PRODUTOS PODERÃO SOFRER ALTERAÇÕES SEM AVISO PRÉVIO.

ENTRE EM CONTATO COM O SEU CONSULTOR OU FALE COM O NOSSO TIME DE TELEVENDAS PELO (33) 3277-3030.

bolt

21 velocidades
V.Brake



Urbana

Alumínio

Mega Over

21 velocidades

V.Brake

Kg 14.60

Quadro	Aro 26" Rava Bolt Alumínio Direção Mega Over de 44 mm Central BSA 68 mm Canote 27.2 mm Freio: Disco Standard(IS) e V-Brake Eixo de 9 x 142 mm Largura máxima de pneu: 26 x 1.9" descanso lateral Blocação de rodas, canote e selim.	corrente	6/7/8v. Index corrida TEC ou 6/7v. 112L Index corrida PYC (envio de acordo com a disponibilidade do estoque)
Garfo	Garfo com suspensão Rava, Ahead set Aro 26" Freio: Disco Standard(IS) e V-Brake Eixo 9 x 100 mm	Eixo central	BSA 34.7 Semi selado 127.5 mm Ponta quadrada
suspensão traseira	N/A	Roda livre	Bronze 7 v. Index 14/28 D Xtime ou Shimano
Movimento de direção	Mega over com rosca Preto	Câmbio Dianteiro	Shimano Tourney TZ FD-TZ500
Guidão	Rise bar Alto Rava 25.4 mm Aço com regulagem de altura	Câmbio traseiro	Sem gancheira 6/7 Velocidades Shimano TZ-31 Index
Suporte de guidão	Rava Ahead Alumínio 90 mm com ajuste de ângulo Ø 25.4 mm	MANETE/ALAVANCA	X-Time Dianteira/Traseira EZ-Fire 21v. (3x7) Com maçaneta Alumínio Preta
manopla	MTB Preta	Selim	Rava Mercúrio Largo Preto/Cinza Com castanha Regulagem de altura
conjunto de freio	V-Brake Preto Dianteiro e traseiro Alumínio Sapata Orbital (Allen)	Canote	Rava Para castanha 27.2 x 350 mm Aço com regulagem de altura
disco de freio	N/A	Abraçadeira	Alumínio 31.8 Blocação
Aro/raio	Aro: Rava Parede dupla 26" 559 x 19 mm Alumínio 6063 Pneu 1.0" até 2.2" ERD 535 mm - Raio: Preto 250 x 2,0 mm Com Niple preto	Pedal	Plataforma Inglês 9/16 Nylon Preto
Cubos	Dianteiro: Aço 36 furos Esferado Eixo de 9 x 100 mm Com blocação - Traseiro: Aço 36 furos Esferado Roda livre 9 x 142 mm Com Blocação	Urbana	✓
Pneu / Câmara de ar	Pneu: Chaoyang 26" x 1,95 Banda leve Câmara: 26" x 1,95 Válvula americana	cicloturismo	X
Pedivela	Engrenagem tripla com braço 28/38/48D Preto Mits	trilhas intermediárias	X

26" NACIONAL

18 20549 / 20873

FOTOS MERAMENTE ILUSTRATIVAS. AS INFORMAÇÕES/CONFIGURAÇÕES DE PRODUTOS PODERÃO SOFRER ALTERAÇÕES SEM AVISO PRÉVIO.

ENTRE EM CONTATO COM O SEU CONSULTOR OU FALE COM O NOSSO TIME DE TELEVENDAS PELO (33) 3277-3030.

Way

21 velocidades
Mecânico



Urbana



Alumínio



Mega Over



21 velocidades



Mecânico



Kg 13.68



QUADRO

Aro 29" | MTB Rava Way | Alumínio 6061 | Direção Mega Over semi-integrada caixa 44 mm de rosca | Canote 27.2 mm | Caixa central BSA 68 mm | Suporte de freio Standard | Eixo traseiro 135 mm x 9 mm | Largura do pneu 2.20



GARFO

29" | Aço RA+A12:B16VA | Rígido | Preto | Suporte de freio Standard | Espiga over rosca | Eixo 9 mm | Old 100 mm



SUSPENSÃO TRASEIRA

N/A



MOVIMENTO DE DIREÇÃO

Mega Over semi-integrada 44 mm com rosca | Esferado | Caixa de aço | Acabamento com porca de aço



GUIDÃO

X-time | Rise Bar alto | Preto | Aço | 25.4 mm x 700 mm



SUPOORTE DE GUIDÃO

Suporte Guidão X-TIME 25.4 mm | Preto | Alumínio | Regulagem -30°/+30° | Chanfrado



MANOPLA

Manopla MTB | Borracha



CONJUNTO DE FREIO

X-TIME | Mecânico | Pinças de alumínio | Manete MTB de alumínio EZ-Fire 3x7v | Cabo de aço comum | Conduíte de 5 mm teflonado



DISCO DE FREIO

X-TIME | 160 mm | 06 parafusos | Aço



ARO/RAIO

Aro 29" x 32 F | Alumínio MTB RAVA | Preto | Folha dupla tipo aero | Freio a disco | Raio preto comum



CUBOS

Eixo 9 mm | Blocagem de alumínio (agulha de aço) **Dianteiro:** X-TIME | Alumínio | 32 furos | Esferado | Preto - **Traseiro:** X-TIME | Alumínio | 32 furos | Esferado | Rosca | Preto



PNEU / CÂMARA DE AR

Pneu: Skinwall Mount Graham Arisun | 29" x 2.20 **Câmara:** 29" x 1.75/2.35 | Válvula americana Arisun



PEDIVELA

Engrenagem X-TIME tripla | Braço de aço revestido com nylon | Preto | Coroa fixa de aço (24/34/42D) | Braço 170 mm | Eixo 9/16 | Inglês



CORRENTE

Corrente corrida 7/8V TEC | Index



EIXO CENTRAL

X-TIME 34.7 mm com rolamento 122.5 mm | Selado com rolamento | Ponta quadrada



RODA LIVRE

Roda livre 7V. X-TIME | Index 14/28D | Escalonamento 14-16-18-20-22-24-28D Xtime ou Shimano



CÂMBIO DIANTEIRO

Shimano Tourney TZ500 | Coroas 42/34/24D | Down Pull | Aço | Abraçadeira 31.8 mm



CÂMBIO TRASEIRO

Shimano Tourney TZ 31 7 V | Aço e nylon



MANETE/ALAVANCA

Alavanca X-TIME EZ- Fire 3x7 V | Alumínio e plástico



SELIM

Rava confort | Vazado | Preto | Com castanha | Aço



CANOTE

Canote selim X-TIME | Preto | 27.2 x 350 mm | Aço



ABRÇAÇADEIRA

Abraçadeira de selim X-TIME MTB 31.8mm | Alumínio | Blocagem | Preto



PEDAL

Plataforma | Nylon | Inglês 9/16



DESCANSO

Lateral | Aço | Fixado no Chainstay



URBANA

✓



CICLOTURISMO

X



TRILHAS INTERMEDIÁRIAS

X



COMPETIÇÃO

X

29" NACIONAL 16 ■ 19939 18 ■ N/A

FOTOS MERAMENTE ILUSTRATIVAS. AS INFORMAÇÕES/CONFIGURAÇÕES DE PRODUTOS PODERÃO SOFRER ALTERAÇÕES SEM AVISO PRÉVIO.

ENTRE EM CONTATO COM O SEU CONSULTOR OU FALE COM O NOSSO TIME DE TELEVENDAS PELO (33) 3277-3030.

pressure jr



20" WHEELS

Aço

Mega Over

07 velocidades

Disco Mecânico

13.08 Kg

 QUADRO	Aro 20" Rava Pressure Jr Aço Direção Mega Over M. Central BSA Freio: DiscoStandard (IS) Suporte para descanso Descanso Lateral	 PNEU / CÂMARA DE AR	Pneu: Pneu 20 x 2.1" Câmara: 20" Válvula americana
 GARFO	Garfo suspensão Rava Aro 20" Freio: Disco Standard (IS) Aço Espiga Over headset	 PEDIVELA	Engrenagem Single 40 dentes Braço 160 mm Aço
 SUSPENSÃO TRASEIRA	N/A	 CORRENTE	Tec 7 Velocidades
 MOVIMENTO DE DIREÇÃO	Mega Over Semi-integrado Esfera	 EIXO CENTRAL	Rosca 34.7 x 113 mm Ponta quadrada
 GUIDÃO	Rise bar Aço 31.8 x 620 mm	 RODA LIVRE	Roda Livre 7V. 14/28D. Index
 SUPORTE DE GUIDÃO	Alumínio 31.8 mm 90 mm	 CÂMBIO DIANTEIRO	N/A
 MANOPLA	MTB Borracha	 CÂMBIO TRASEIRO	Shimano 7 Velocidades Index RD-TZ31A
 CONJUNTO DE FREIO	Freio a disco mecânico Dianteiro/Traseiro	 ALAVANCA	Shimano Revoshift 7velocidades
 DISCO DE FREIO	160 mm Aço Parafuso	 SELIM	Rava Com castanha Trilho de aço
 ARO/RAIO	Aro: Rava 20" Parede dupla Freio a disco Alumínio Raio (Aço) Preto com niple	 CANOTE	Para castanha 27.2 x 250 mm Aço
 CUBOS	Dianteiro: Aço 36 furos Freio a disco (Parafuso) - Traseiro: Aço 36 furos Rosca (Roda livre) Freio a disco (Parafuso)	 ABRAÇADEIRA	Abraçadeira 31.8mm Blocagem
		 PEDAL	Plataforma Preto Nylon

20" IMPORTADA

ÚNICO  17412

ÚNICO  17413

ÚNICO  17414

FOTOS MERAMENTE ILUSTRATIVAS. AS INFORMAÇÕES/CONFIGURAÇÕES DE PRODUTOS PODERÃO SOFRER ALTERAÇÕES SEM AVISO PRÉVIO.

ENTRE EM CONTATO COM O SEU CONSULTOR OU FALE COM O NOSSO TIME DE TELEVENDAS PELO (33) 3277-3030.

Nina Teen



	QUADRO	Rava Nina Teen Paralamas: Nylon Cesta: Arame preto Porta corrente: Nylon inteiriço (cobre toda a parte externa da transmissão) Rodinhas: Aço reforçada e emborrachada
	GARFO	Aço Aro 20" Rosca Suporte para freio v-brake
	SUSPENSÃO TRASEIRA	N/A
	MOVIMENTO DE DIREÇÃO	Standard Esferada
	GUIDÃO	Curvado Aço Preto 25.4mm/550mm
	SUPORTE DE GUIDÃO	Chanfrado Alumínio
	MANOPLA	Nylon
	CONJUNTO DE FREIO	V-Brake Aço Manete: Nylon com reguladores
	DISCO DE FREIO	N/A
	ARO/RAIO	Aro: 20" Alumínio preto Folha simples 28 furos Raio: Aço preto 2mmx190mm

	CUBOS	Aço preto 28 furos Eixo maciço com porca
	PNEU / CÂMARA DE AR	Aro 20" 20x2.125 Importado
	PEDIVELA	Monobloco 140mm Aço Preto
	CORRENTE	Bronze Maya Importada
	MOVIMENTO CENTRAL	Esferado 50mm
	RODA LIVRE	Bronze 16 Dentes Importado
	CÂMBIO DIANTEIRO	N/A
	CÂMBIO TRASEIRO	N/A
	ALAVANCA	N/A
	SELIM	Infantil com suporte de apoio Castanha
	CANOTE	Aço preto 25.4mmx250mm
	ABRAÇADEIRA	N/A
	PEDAL	Nylon sueco 1/2

20" IMPORTADA

ÚNICO ■ 17408

ÚNICO ■ 17409

FOTOS MERAMENTE ILUSTRATIVAS. AS INFORMAÇÕES/CONFIGURAÇÕES DE PRODUTOS PODERÃO SOFRER ALTERAÇÕES SEM AVISO PRÉVIO.

ENTRE EM CONTATO COM O SEU CONSULTOR OU FALE COM O NOSSO TIME DE TELEVENDAS PELO (33) 3277-3030.

Nina Teen



QUADRO

Rava Nina Teen 16" | Aço | **Paralamas:** Nylon sem haste | **Porta corrente:** Nylon inteiriço (cobre toda a parte externa da transmissão) | **Rodinhas:** Aço reforçada e emborrachada | **Acessórios de proteção:** no suporte e na barra de guidão



GARFO

Rava | Aço | Aro 16"



SUSPENSÃO TRASEIRA

N/A



MOVIMENTO DE DIREÇÃO

Standard | Rosca | Esferada



GUIDÃO

Cross | 25.4 mm | Aço



SUporte DE GUIDÃO

Chanfrado | Aço



MANOPLA

Nylon



CONJUNTO DE FREIO

V-Brake | Aço | **Manete:** MTB de nylon com reguladores | Alumínio



DISCO DE FREIO

N/A



ARO/RAIO

Aro: 16" | Alumínio | Preto | Folha simples | 20 furos **Raio:** Zincado



CUBOS

Aço | Eixo 9 mm | Porca sextavada | 20 F



PNEU / CÂMARA DE AR

Aro 16" x 2.125 | Importado **Câmara:** Aro 16" | Válvula americana



PEDIVELA

Monobloco | 115 mm | Preto



CORRENTE

Comum | Importada



MOVIMENTO CENTRAL

Esferado | 50mm



RODA LIVRE

16 Dentes | Coroa 32 D | Aço



CÂMBIO DIANTEIRO

N/A



CÂMBIO TRASEIRO

N/A



ALAVANCA

N/A



SELIM

Infantil com suporte de apoio



CANOTE

Aço | 25.4 mm



ABRAÇADEIRA

N/A



PEDAL

Infantil | Nylon sueco 1/2 | Preto

16" IMPORTADA

ÚNICO ■ 17404

ÚNICO ■ 17405

Sunny | PRO



RAVA

30

	QUADRO	Rava Sunny-pro Balance Aro 12" Aço Apoio de nylon para os pés
	GARFO	Rava Rígido Aro 12" Aço
	CAIXA DE DIREÇÃO	Sueca Com rosca Esferada
	GUIDÃO	Aço Rise bar 25.4 x 420 mm
	SUPORTE DE GUIDÃO	Aço Tipo sueco
	MANOPLA	Borracha
	CONJUNTO DE FREIO	Tambor Maçaneta de Nylon
	ARO/RAIO	Aro: Aço 12" / Raio: Preto 2.0 mm
	CUBOS	Aço com esfera Eixo de 9 mm
	PNEU / CÂMARA DE AR	Pneu com cravo 12 x 2.25" / Câmara com válvula americana
	CANOTE	Aço 25.4 mm Selim integrado
	ABRAÇADEIRA	Alumínio Parafuso

IMPORTADA

12"  17402

12"  17403

FOTOS MERAMENTE ILUSTRATIVAS. AS INFORMAÇÕES/CONFIGURAÇÕES DE PRODUTOS PODERÃO SOFRER ALTERAÇÕES SEM AVISO PRÉVIO.





ENTRE EM CONTATO COM O SEU CONSULTOR OU FALE COM O NOSSO TIME DE TELEVENDAS PELO (33) 3277-3030.

Sunny



	QUADRO	Rava Sunny Balance Aro 12" Aço
	GARFO	Rava Rígido Aro 12" Aço
	CAIXA DE DIREÇÃO	Bucha
	GUIDÃO	Aço Reto Integrado
	MANOPLA	Borracha
	RODA	Aro 12" Nylon Pneu EVA semi-rígido
	CANOTE	Aço 25.4 mm Selim integrado

IMPORTADA

12"		17497
12"		17498
12"		17499
12"		17500





GRUPO
JPP

AVENIDA INDUSTRIAL 312, DISTRITO INDUSTRIAL
GOVERNADOR VALADARES - MINAS GERAIS/BRASIL

BIKE@GRUPOJPP.COM.BR

(33) 3277-3030

WWW.GRUPOJPP.COM.BR





metz



CATÁLOGO

B I C I C L E T A S

21 de Novembro 2023



fuse+

AQUI TEM

SHIMANO

QUALIDADE
CONFIANÇA



#SEMPRESHIMANO

29"
WHEELS



QUADRO

MTB METZ 29" | Alumínio 6061 | Cabeamento externo | Direção Mega Over semi-integrada Ø 44 x 44 mm | Suporte de freio a disco standard dentro do triângulo traseiro | Caixa central BSA 68 mm | Eixo traseiro 9 x 135mm | Canote 27.2 mm | Largura máxima do pneu 29 x 2.2" com cravo baixo | Peso máximo suportado de 110 kg (PESO DO CICLISTA + ACESSÓRIOS)



SUSPENSÃO
DIANTEIRA

29" | Rava | 100 mm | Mola | Over Head Set | (OLD) 9 x 100 mm | Lower leg | Garfo de aço



SUSPENSÃO
TRASEIRA

N/A



MOVIMENTO DE
DIREÇÃO

Mega Over semi-integrada Ø 44 x 44 mm | Esfera | Caixa de aço



GUIDÃO

X-Time | Alumínio | Reto | 31.8 x 740 mm | 9° Backsweep



SUPORTE DE
GUIDÃO

X-Time | Alumínio | Ahead | 90 mm | 7°



MANOPLA

MTB Preta



CONJUNTO DE
FREIO

Disco | Mecânico | X-Time



DISCO DE FREIO

160 mm | Parafuso | Aço



ARO/RAIO

RAVA MTB | 29" | 32 furos | Folha dupla aero | By Fly/Vzan



CUBOS

X-Time | Rosca | Alumínio | 32 furos | Esfera



PNEU / CÂMARA
DE AR

Pneu: Arisun Graham | Skinwall | 29"
Câmara de ar: Arisun | Válvula americana



PEDIVELA

Shimano TY-301 | Engrenagem tripla com braço | 170 mm | 24/34/42D.



CORRENTE

TEC | 7 velocidades



MOVIMENTO
CENTRAL

34.7 C/ ROL. 122.5mm



RODA LIVRE

Shimano TZ 500 | 7 velocidades | 14-28D. | Rosca



CÂMBIO
DIANTEIRO

TZ 500 | Shimano | TOP PULL 31.8mm



CÂMBIO TRASEIRO

Tourney T200 | Shimano | 7 velocidades



ALAVANCA

Alavanca/Manete de freio | Shimano EF-41 | 21 velocidades



SELIM

Selle Royal MTB Sport PU Trilho de Aço



CANOTE

27.2 x 350 mm | Aço | Para castanha | Importado | Regulagem de altura



ABRAÇADEIRA

X-Time | Alumínio | 31.8 | Blocagem



PEDAL

Plataforma | MTB | Inglês 9/16 | Nylon | Preto



URBANA

✓



CICLOTURISMO

X



TRILHAS
INTERMEDIÁRIAS

X



COMPETIÇÃO

X



PESO APROXIMADO 15.05 kg (17")

29" NACIONAL

15.5 20941

metz

249

FOTOS MERAMENTE ILUSTRATIVAS. AS INFORMAÇÕES/CONFIGURAÇÕES DE PRODUTOS PODERÃO SOFRER ALTERAÇÕES SEM AVISO PRÉVIO.

ENTRE EM CONTATO COM O SEU CONSULTOR OU FALE COM O NOSSO TIME DE TELEVENDAS PELO (33) 3277-3030.



fuse+

AQUI
TEM

SHIMANO

QUALIDADE
CONFIANÇA



#SEMPRESHIMANO

29"
WHEELS



metz



QUADRO

MTB METZ 29" | Alumínio 6061 | Cabeamento externo | Direção Mega Over semi-integrada Ø 44 x 44 mm | Suporte de freio a disco standard dentro do triângulo traseiro | Caixa central BSA 68 mm | Eixo traseiro 9 x 135mm | Canote 27.2 mm | Largura máxima do pneu 29 x 2.2" com cravo baixo | Peso máximo suportado de 110 kg (PESO DO CICLISTA + ACESSÓRIOS)



SUSPENSÃO
DIANTEIRA

29" | Rava | 100 mm | Mola | Over Head Set | (OLD) 9 x 100 mm | Lower leg | Garfo de aço



SUSPENSÃO
TRASEIRA

N/A



MOVIMENTO DE
DIREÇÃO

Mega Over semi-integrada Ø 44 x 44 mm | Esfera | Caixa de aço



GUIDÃO

X-Time | Alumínio | Reto | 31.8 x 740 mm | 9° Backsweep



SUPOORTE DE
GUIDÃO

X-Time | Alumínio | Ahead | 90 mm | 7°



MANOPLA

MTB Preta



CONJUNTO DE
FREIO

Disco | Mecânico | X-Time



DISCO DE FREIO

160 mm | Parafuso | Aço



ARO/RAIO

RAVA MTB | 29" | 32 furos | Folha dupla aero | By Fly/Vzan



CUBOS

X-Time | Rosca | Alumínio | 32 furos | Esfera



PNEU / CÂMARA
DE AR

Pneu: Arisun Graham | Skinwall | 29"
Câmara de ar: Arisun | Válvula americana



PEDIVELA

Shimano TY-301 | Engrenagem tripla com braço | 170 mm | 24/34/42D.



CORRENTE

TEC | 7 velocidades



MOVIMENTO
CENTRAL

34.7 C/ ROL. 122.5mm



RODA LIVRE

Shimano TZ 500 | 7 velocidades | 14-28D. | Rosca



CÂMBIO
DIANTEIRO

TZ 500 | Shimano | TOP PULL 31.8mm



CÂMBIO TRASEIRO

Tourney T200 | Shimano | 7 velocidades



ALAVANCA

Alavanca/Manete de freio | Shimano EF-41 | 21 velocidades



SELIM

Selle Royal MTB Sport PU Trilho de Aço



CANOTE

27.2 x 350 mm | Aço | Para castanha | Importado | Regulagem de altura



ABRÇAÇADEIRA

X-Time | Alumínio | 31.8 | Blocagem



PEDAL

Plataforma | MTB | Inglês 9/16 | Nylon | Preto



URBANA

✓



CICLOTURISMO

X



TRILHAS
INTERMEDIÁRIAS

X



COMPETIÇÃO

X



PESO APROXIMADO

15.05 kg (17")

29" NACIONAL

15.5

20942

FOTOS MERAMENTE ILUSTRATIVAS. AS INFORMAÇÕES/CONFIGURAÇÕES DE PRODUTOS PODERÃO SOFRER ALTERAÇÕES SEM AVISO PRÉVIO.

ENTRE EM CONTATO COM O SEU CONSULTOR OU FALE COM O NOSSO TIME DE TELEVENDAS PELO (33) 3277-3030.

fuse



29"
WHEELS



QUADRO

MTB METZ 29" | Alumínio 6061 | Cabeamento externo | Direção Mega Over semi-integrada Ø 44 x 44 mm | Suporte de freio a disco standard dentro do triângulo traseiro | Caixa central BSA 68 mm | Eixo traseiro 9 x 135mm | Canote 27.2 mm | Largura máxima do pneu 29 x 2.2" com cravo baixo | Peso máximo suportado de 110 kg (PESO DO CICLISTA + ACESSÓRIOS)



SUSPENSÃO DIANTEIRA

Garfo 29" Rava MTB com suspensão | Lower leg de aço | Kraw de alumínio | Eixo de 9 mm | Curso de 80 mm



SUSPENSÃO TRASEIRA

N/A



MOVIMENTO DE DIREÇÃO

Mega Over semi-integrada 44 mm | Esferada | Caixa de aço | Acabamento em alumínio



GUIDÃO

X-Time | Alumínio | Rise bar (baixo) | 31.8 x 740 mm



SUPORE DE GUIDÃO

X-Time | Ahead | Alumínio | 31.8 x 90 mm / +-7°



MANOPLA

MTB Preta



CONJUNTO DE FREIO

X-Time | Disco | Mecânico | Dianteiro/Traseiro



DISCO DE FREIO

X-Time | 160 mm | 06 parafusos | Aço



ARO/RAIO

Rava | Alumínio 6063 | 622x19mm | ERD 584 mm | Parede dupla | 32F | Raio preto



CUBOS

Cubo Alumínio | Eixo 9 mm | Blocação de alumínio (agulhade aço) | 32F | Roda livre rosca | Esferas | Preto



PNEU / CÂMARA DE AR

Pneu: Arisun Skinwall Mount Graham 29x2.20
Câmara de ar: Arisun 29" | Válvula americana



PEDIVELA

X-Time | Engrenagem tripla | Braço 170 mm | Coroas 42/34/24D | Aço/Nylon



CORRENTE

Tec | 6/7/8v



MOVIMENTO CENTRAL

Eixo 34.7 mm | Com rolamento | 122.5 mm | Ponta quadrada



RODA LIVRE

X-TIME | 7 velocidades | 14-28D



CÂMBIO DIANTEIRO

Shimano TZ 500 | Dual



CÂMBIO TRASEIRO

Shimano TZ 31



ALAVANCA

Passador de marcha/alavanca do freio Dianteira/Traseira | X-Time 3 x 7v.



SELIM

Selle Royal MTB Sport PU Trilho de Aço



CANOTE

27.2 x 350 mm | Aço | Para castanha | Importado | Regulagem de altura



ABRAÇADEIRA

X-Time | Alumínio | 31.8 | Blocação



PEDAL

Inglês | Preto | Nylon



URBANA

✓

29" NACIONAL

17  20917

metz

251

FOTOS MERAMENTE ILUSTRATIVAS. AS INFORMAÇÕES/CONFIGURAÇÕES DE PRODUTOS PODERÃO SOFRER ALTERAÇÕES SEM AVISO PRÉVIO.

ENTRE EM CONTATO COM O SEU CONSULTOR OU FALE COM O NOSSO TIME DE TELEVENDAS PELO (33) 3277-3030.















fuse



29"
WHEELS

METZ

252

	QUADRO	MTB METZ 29" Alumínio 6061 Cabeamento externo Direção Mega Over semi-integrada Ø 44 x 44 mm Suporte de freio a disco standard dentro do triângulo traseiro Caixa central BSA 68 mm Eixo traseiro 9 x 135mm Canote 27.2 mm Largura máxima do pneu 29 x 2.2" com cravo baixo Peso máximo suportado de 110 kg (PESO DO CICLISTA + ACESSÓRIOS)
	SUSPENSÃO DIANTEIRA	Garfo 29" Rava MTB com suspensão Lower leg de aço Kraw de alumínio Eixo de 9 mm Curso de 80 mm
	SUSPENSÃO TRASEIRA	N/A
	MOVIMENTO DE DIREÇÃO	Mega Over semi-integrada 44 mm Esferada Caixa de aço Acabamento em alumínio
	GUIDÃO	X-Time Alumínio Rise bar (baixo) 31.8 x 740 mm
	SUPOORTE DE GUIDÃO	X-Time Ahead Alumínio 31.8 x 90 mm / +-7°
	MANOPLA	MTB Preta
	CONJUNTO DE FREIO	X-Time Disco Mecânico Dianteiro/Traseiro
	DISCO DE FREIO	X-Time 160 mm 06 parafusos Aço
	ARO/RAIO	Rava Alumínio 6063 622x19mm ERD 584 mm Parede dupla 32F Raio preto
	CUBOS	Cubo Alumínio Eixo 9 mm Blocação de alumínio (agulhade aço) 32F Roda livre rosca Esferas Preto
	PNEU / CÂMARA DE AR	Pneu: Arisun Skinwall Mount Graham 29x2.20 Câmara de ar: Arisun 29" Válvula americana
	PEDIVELA	X-Time Engrenagem tripla Braço 170 mm Coroas 42/34/24D Aço/Nylon

	CORRENTE	Tec 6/7/8v
	MOVIMENTO CENTRAL	Eixo 34.7 mm Com rolamento 122.5 mm Ponta quadrada
	RODA LIVRE	X-TIME 7 velocidades 14-28D
	CÂMBIO DIANTEIRO	Shimano TZ 500 Dual
	CÂMBIO TRASEIRO	Shimano TZ 31
	ALAVANCA	Passador de marcha/alavanca do freio Dianteira/Traseira X-Time 3 x 7v.
	SELIM	Selle Royal MTB Sport PU Trilho de Aço
	CANOTE	27.2 x 350 mm Aço Para castanha Importado Regulagem de altura
	ABRAÇADEIRA	X-Time Alumínio 31.8 Blocação
	PEDAL	Inglês Preto Nylon
	URBANA	✓

29" NACIONAL

15.5  20915

FOTOS MERAMENTE ILUSTRATIVAS. AS INFORMAÇÕES/CONFIGURAÇÕES DE PRODUTOS PODERÃO SOFRER ALTERAÇÕES SEM AVISO PRÉVIO.

ENTRE EM CONTATO COM O SEU CONSULTOR OU FALE COM O NOSSO TIME DE TELEVENDAS PELO (33) 3277-3030.



GRUPO
JPP

AVENIDA INDUSTRIAL 312, DISTRITO INDUSTRIAL
GOVERNADOR VALADARES - MINAS GERAIS/BRASIL

BIKE@GRUPOJPP.COM.BR

(33) 3277-3030

WWW.GRUPOJPP.COM.BR



Versão: 07 de Fevereiro 2024

CATÁLOGO DE **COMPONENTES** E ACESSÓRIOS

*O Catálogo é atualizado constantemente.
Antes de baixar, verifique a versão com data atualizada.





 QUEST
L I N E



GUIDÃO RETO 6° 800MM C/SUP 2° CRB PT | LINHA QUEST

CARACTERÍSTICA Guidão reto com suporte integrado -2° | linha quest

- Guidão de carbono
- Suporte de guidão integrado de 50mm, 60mm e 70mm
- -2° Negativo

MATERIAL Material carbono ud (ud matt carbon fiber t800)

TAMANHO • Diâmetro de fixação da espiga 28.6mm
| • tamanho 800mm

UPSWEEP 6°

BACKSWEEP 6°

RISE 0

PESO 309gr - peso referente ao guidão 60mm

EMBALAGEM 15 peças

50 MM 22240

60 MM 22241

70 MM 22242



GUIDÃO RETO 9° 800MM CRB PT | LINHA QUEST

CARACTERÍSTICA	Guidão reto linha quest • Guidão de carbono
MATERIAL	Material carbono ud (ud matt carbon fiber t800)
TAMANHO	Tamanho 800x31.8mm
UPSWEEP	0°
BACKSWEEP	9°
PESO	195g
EMBALAGEM	25 peças

22244

FOTOS MERAMENTE ILUSTRATIVAS. AS INFORMAÇÕES/CONFIGURAÇÕES DE PRODUTOS PODERÃO SOFRER ALTERAÇÕES SEM AVISO PRÉVIO.

ENTRE EM CONTATO COM O SEU CONSULTOR OU FALE COM O NOSSO TIME DE TELEVENDAS PELO (33) 3277-3030.

QUEST

CANOTE SELIM ALUM. 31.6 X 400MM SLIM PT | LINHA QUEST

CARACTERÍSTICA	• Micro ajuste • Limite inserção 130mm
MATERIAL	Alumínio
TAMANHO	400 X 31.6mm
PESO	300 g
EMBALAGEM	25 peças
	23868



GUIDÃO ALUM. MTB 31.8 MM X 740 MM RETO PT | LINHA QUEST

MATERIAL	Alumínio	RISE	0°
CARACTERÍSTICA	Guidão de Alumínio	PESO	298g
TAMANHO	740 x 31.8 mm	EMBALAGEM	15 peças
UPSWEEP	0°		23851
BACKSWEEP	9°		



GUIDÃO ALUM. DH 35MM X 800 MM PT | LINHA QUEST

MATERIAL	Alumínio	RISE	15°
CARACTERÍSTICA	Guidão de Alumínio DH	PESO	304g
TAMANHO	800 x 35 mm	EMBALAGEM	15 peças
UPSWEEP	0°		23852
BACKSWEEP	7°		

FOTOS MERAMENTE ILUSTRATIVAS. AS INFORMAÇÕES/CONFIGURAÇÕES DE PRODUTOS PODERÃO SOFRER ALTERAÇÕES SEM AVISO PRÉVIO.

ENTRE EM CONTATO COM O SEU CONSULTOR OU FALE COM O NOSSO TIME DE TELEVENDAS PELO (33) 3277-3030.

**SUP. DE GUIDÃO ALUM. MTB AHEAD
LIGHT 80 MM 17° PT | LINHA QUEST**

MATERIAL	Alumínio
TAMANHO	70 mm 80 mm / 17°
CARACTERÍSTICA	<ul style="list-style-type: none">• Over Ahead Set• Light• Compatível com Guidão 31.8 mm
PESO	129g (referente ao suporte 80 mm)
EMBALAGEM	20 peças

23864 - 80 MM

23865 - 70 MM



**SUPOORTE DE GUIDÃO ALUM.
DH 35 X 45 MM | LINHA QUEST**

MATERIAL	Alumínio
TAMANHO	35 x 45 mm
CARACTERÍSTICA	<ul style="list-style-type: none">• Suporte de Guidão Alumínio DH• Ângulo 0°• Over ahead Set• Compatível com Guidão 35 mm
PESO	151g
EMBALAGEM	20 peças

23866



SUP. DE GUIDÃO ALUM. MTB AHEAD 80 MM 5° PT | LINHA QUEST

MATERIAL	Alumínio
TAMANHO	60 mm 70 mm 80 mm 90 mm e 100 mm
CARACTERÍSTICA	<ul style="list-style-type: none">• Suporte de Guidão Alumínio• Ângulo 5°• Over ahead Set• Compatível com Guidão 31.8 mm• Acompanha tampa de acabamento do suporte de guidão e parafuso da aranha.

PESO 151g

EMBALAGEM 20 peças

23877 - 60 MM / 5°

23878 - 70 MM / 5°

23879 - 80 MM / 5°

23880 - 90 MM / 5°

23881 - 100 MM / 5°



SUPORTE DE GUIDÃO ALUM. MTB AHEAD 50 MM PT | LINHA QUEST

MATERIAL	Alumínio
TAMANHO	50 mm 70 mm
CARACTERÍSTICA	<ul style="list-style-type: none">• Suporte de Guidão Alumínio• Over ahead Set• Compatível com Guidão 31.8 mm• Ângulo 0°• Acompanha tampa de acabamento do suporte de guidão e parafuso da aranha.

PESO 193g (peso suporte de 50 mm com tampa e parafuso)

EMBALAGEM 20 peças

23882 - 50 MM

23884 - 70 MM



FOTOS MERAMENTE ILUSTRATIVAS. AS INFORMAÇÕES/CONFIGURAÇÕES DE PRODUTOS PODERÃO SOFRER ALTERAÇÕES SEM AVISO PRÉVIO.

ENTRE EM CONTATO COM O SEU CONSULTOR OU FALE COM O NOSSO TIME DE TELEVENDAS PELO (33) 3277-3030.

SUPOORTE DE GUIDÃO ALUM. MTB AHEAD INT. 80 MM 7° PT | LINHA QUEST

MATERIAL Alumínio e Nylon

TAMANHO 80 mm | 90 mm

CARACTERÍSTICA

- Suporte de Guidão Alumínio
- Over ahead Set
- Compatível com Guidão 31.8 mm
- Ângulo 10°
- Integrado (possibilidade de passar conduites dentro da caixa de direção)
- Acompanha acabamento inferior do suporte, calço de 10mm para regulagem na espiga, cone do rolamento superior (compatível com rolamento integrado 40x52mm), acabamento superior da caixa de direção, tampa de acabamento do suporte do guidão e parafuso aranha.

PESO 243g (peso suporte de 80 mm mais acessórios)

EMBALAGEM 20 peças

23875 - 80 MM / 10°

23876 - 90 MM / 10°



SUPOORTE DE GUIDÃO ALUM. DH 35X 50 MM 12° PT | LINHA QUEST

MATERIAL Alumínio

TAMANHO 35x 50 mm

CARACTERÍSTICA

- Suporte de Guidão Alumínio DH
- Over ahead Set
- Compatível com Guidão 35 mm
- Ângulo 12°

PESO 160g

EMBALAGEM 20 peças

23885



SUPORE DE GUIDÃO ALUM. MTB 80 MM 17° PT | LINHA QUEST

MATERIAL Alumínio

TAMANHO 80 mm | 100 mm

CARACTERÍSTICA

- Suporte de Guidão Alumínio
- Over ahead Set
- Compatível com Guidão 31.8 mm
- Ângulo 17°

PESO 210g

EMBALAGEM 20 peças

23886 - 80 MM / 17°

23887 - 100 MM / 17°



MANOPLA PRETA MTB SILICONE GEL | LINHA QUEST

CARACTERÍSTICA Design moderno
| Corpo com acabamento liso |
Acompanha acabamentos do guidão

MATERIAL Silica Gel

TAMANHO 130 X 28mm (comprimento x largura)

PESO 87g (Manopla e acabamento)

EMBALAGEM 100 unidades

22087



MANOPLA PRETA MTB SILICONE GEL 3 | LINHA QUEST

CARACTERÍSTICA Design moderno
| Corpo com acabamento grip |
Acompanha acabamentos do guidão

MATERIAL Silica Gel

TAMANHO 130 X 28mm (comprimento x largura)

PESO 77g (Manopla e acabamento)

EMBALAGEM 100 unidades

22088



FOTOS MERAMENTE ILUSTRATIVAS. AS INFORMAÇÕES/CONFIGURAÇÕES DE PRODUTOS PODERÃO SOFRER ALTERAÇÕES SEM AVISO PRÉVIO.

ENTRE EM CONTATO COM O SEU CONSULTOR OU FALE COM O NOSSO TIME DE TELEVENDAS PELO (33) 3277-3030.

ABRAÇ. SELIM ALUM. MTB 34.9 PT

| Linha Quest

CARACTERÍSTICA

- Abraçadeira de aperto do canote
- Ajuste por parafuso
- Alumínio

TAMANHO • Medidas 34.9mm

MATERIAL Alumínio

PESO 24 gr

EMBALAGEM 200 peças

23873



GANCHEIRA TRASEIRA PARA QUADRO MODELO 25 | LINHA QUEST

CARACTERÍSTICA

- Gancheira para quadro de carbono QUEST
- Kit com 3 peças (Gancheira, porca, parafuso)
- Compatível com as bicicletas: TSW Full Quest TR Advanced, TSW Full Quest TR Fast, TSW Full Quest TR Starter e todas as TSW EVO Quest

TAMANHO 50x30x20mm (Porca M12X1.5)

MATERIAL Alumínio

PESO 19 gr – Kit completo

EMBALAGEM 10 peças

22971



GANCHEIRA TRASEIRA PARA QUADRO MODELO 26 | LINHA QUEST

CARACTERÍSTICA

- Gancheira para quadro de carbono QUEST
- Kit com 3 peças (Gancheira, Porca, Parafuso)
- Compatível com as bicicletas: TSW Full Quest Advanced +, TSW Full Quest Advanced, TSW Full Quest Advanced GX, TSW Full Quest Starter SX, TSW Full Quest Starter, TSW All Quest e TR01

TAMANHO 54x34x16mm (Porca M12X1.5)

MATERIAL Alumínio

PESO 15 gr – Kit completo

EMBALAGEM 10 peças

22972



FOTOS MERAMENTE ILUSTRATIVAS. AS INFORMAÇÕES/CONFIGURAÇÕES DE PRODUTOS PODERÃO SOFRER ALTERAÇÕES SEM AVISO PRÉVIO.

ENTRE EM CONTATO COM O SEU CONSULTOR OU FALE COM O NOSSO TIME DE TELEVENDAS PELO (33) 3277-3030.



KIT RODA DIANT/TRAS. ARO 29X32F MOD 04 BOOST MS PT IMP. | LINHA QUEST

MATERIAL Alumínio

ARO

- WTB kom trail i35
- Alumínio
- Acabamento anodizado
- Largura interna 35mm
- Tubeless ready
- Etrto rim size 35-622mm
- 32 furos
- Disc brake
- Largura do pneu 47mm - 72mm

CUBO DIANTEIRO

- Material alumínio
- Boost
- Eixo 15x110mm
- Eixo interno de alumínio
- Old 110mm
- 32 furos
- 02 rolamentos (medida 6804rs)
- Compatível com freio a disco 6 parafusos

CUBO TRASEIRO

- Material alumínio
- Boost
- Eixo 12x148mm
- Eixo interno de alumínio
- 32 furos
- 02 rolamentos (medida 6902-2rs)
- 02 rolamentos freehub (medidas 6802-2rs)
- Freehub padrão micro spline com 6 martelinhos
- Compatível com freio a disco 6 parafusos

RAIO

- Importado
- Sapin
- Inox
- 2.00mm
- Niple 2.00x14mm

PESO

- Roda dianteira 1.090 gr
- Roda traseira 1.220 gr
- Par 2.310GR

EMBALAGEM

01 peça

22786



KIT RODA DIANT/TRAS. ARO 29X32F MOD 05 BOOST XD PT IMP. | LINHA QUEST

MATERIAL Alumínio

ARO

- WTB kom trail i35
- Alumínio
- Acabamento anodizado
- Largura interna 35mm
- Tubeless ready
- Etrto rim size 35-622mm
- 32 furos
- Disc brake
- Largura do pneu 47mm – 72mm

CUBO DIANTEIRO

- Material alumínio
- Boost eixo 15x110mm
- Eixo interno de alumínio
- Old 110mm
- 32 furos
- 02 rolamentos (medida 6804rs)
- Compatível com freio a disco 6 parafusos

CUBO TRASEIRO

- Material alumínio
- Boost eixo 12x148mm
- Eixo interno de alumínio
- 32 furos
- 02 rolamentos (medida 61902-16-2rs)
- 02 rolamentos freehub (medidas 6802-2rs)
- Freehub padrão xd com 6 martelinhos
- Compatível com freio a disco 6 parafusos

RAIO

- Importado
- Sapin
- Inox
- 2.00mm
- Niple 2.00x14mm

PESO

- Roda dianteira 1.128gr
- Roda traseira 1.211gr
- Par 2.339gr

EMBALAGEM 01 peça

22787

QUEST

FOTOS MERAMENTE ILUSTRATIVAS. AS INFORMAÇÕES/CONFIGURAÇÕES DE PRODUTOS PODERÃO SOFRER ALTERAÇÕES SEM AVISO PRÉVIO.

ENTRE EM CONTATO COM O SEU CONSULTOR OU FALE COM O NOSSO TIME DE TELEVENDAS PELO (33) 3277-3030.



RODA D/T. 29X28F 6P. CARBON MOD. 01 BOOST XD PT IMP.

MATERIAL Carbono

ARO

- Quest Carbon Race Q30 29"
- 30mm de largura interna
- Tecnologia Hookless, sem ganchos laterais internos
- Tubeless
- 28 furos

CUBO DIANTEIRO

- Material alumínio
- Boost
- Eixo 15x110mm
- Compatível com discos 6 parafusos
- 28 Furos

CUBO TRASEIRO

- Boost
- Eixo 12x148mm
- Compatível com discos 6 parafusos
- Freehub padrão XD
- Material Alumínio

RAIO

- Importado
- Sapin laser
- Inox

PESO

- Roda dianteira 720 gr
- Roda traseira 880 gr
- Par 1.600GR

EMBALAGEM 01 kit

22837

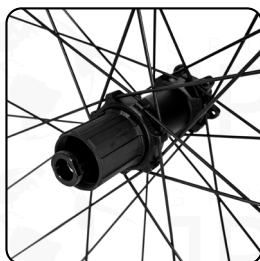

QUEST

RODA D/T. 29X28F 6P. CARBON MOD. 02 BOOST HG/MS PT IMP.

MATERIAL Carbono

ARO

- Quest Carbon Race Q30 29"
- 30mm de largura interna
- Tecnologia Hookless, sem ganchos laterais internos
- Tubeless
- 28 furos

CUBO DIANTEIRO

- Material alumínio
- Boost eixo 15x110mm
- Compatível com discos 6 parafusos
- 28 Furos

CUBO TRASEIRO

- Material alumínio
- Boost
- Eixo 12x148mm
- Compatível com discos 6 parafusos
- Freehub padrão MICRO SPLINE e HG inclusos

RAIO

- Importado
- Sapin laser
- Inox

PESO

- Dianteiro 720 gr
- Traseiro MS 890 gr
- Traseiro HG 930 gr
- Par 1.610kg/1.650kg

EMBALAGEM 01 kit

22839

FOTOS MERAMENTE ILUSTRATIVAS. AS INFORMAÇÕES/CONFIGURAÇÕES DE PRODUTOS PODERÃO SOFRER ALTERAÇÕES SEM AVISO PRÉVIO.

ENTRE EM CONTATO COM O SEU CONSULTOR OU FALE COM O NOSSO TIME DE TELEVENDAS PELO (33) 3277-3030.



RODA D/T. 29X28F 6P. CARBON SL MOD. 03 BOOST XD PT IMP.

MATERIAL Carbono

ARO

- Quest Carbon Race Q30 SL SUPER LIGHT 29"
- 30mm de largura interna
- Tecnologia Hookless, sem ganchos laterais internos
- Tubeless
- 28 furos

CUBO DIANTEIRO

- Material alumínio
- Boost eixo 15x110mm
- Compatível com discos 6 parafusos
- 28 Furos

CUBO TRASEIRO

- Boost
- Eixo 12x148mm
- Compatível com discos 6 parafusos
- Freehub padrão XD
- Material Alumínio

RAIO

- Importado
- Sapin CX RAY
- Inox aero

PESO

- Roda dianteira 630 gr
- Roda traseira 790 gr
- Par 1420gr

EMBALAGEM 01 kit

22840

FOTOS MERAMENTE ILUSTRATIVAS. AS INFORMAÇÕES/CONFIGURAÇÕES DE PRODUTOS PODERÃO SOFRER ALTERAÇÕES SEM AVISO PRÉVIO.

ENTRE EM CONTATO COM O SEU CONSULTOR OU FALE COM O NOSSO TIME DE TELEVENDAS PELO (33) 3277-3030.

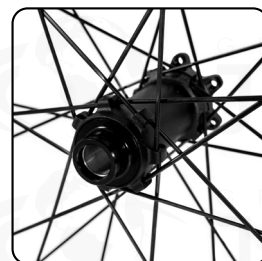

RODA D/T. 29X28F 6P. CARBON SL MOD. 04 BOOST HG/MS PT IMP.

MATERIAL Carbono

ARO

- Quest Carbon Race Q30 SL Super Light 29"
- 30mm de largura interna
- Tecnologia Hookless, sem ganchos laterais internos
- Tubeless
- 28 furos

CUBO DIANTEIRO

- Material alumínio
- Boost eixo 15x110mm
- Compatível com discos 6 parafusos
- 28 Furos

CUBO TRASEIRO

- Material alumínio
- Boost
- Eixo 12x148mm
- Compatível com discos 6 parafusos
- Freehub padrão MICRO SPLINE e HG inclusos

RAIO

- Importado
- Sapin CX RAY
- Inox aero

PESO

- Dianteiro 630 gr
- Traseiro MS 790 gr
- Traseiro HG 820 gr
- Par 1.420kg/1.450kg

EMBALAGEM 01 kit

22847

FOTOS MERAMENTE ILUSTRATIVAS. AS INFORMAÇÕES/CONFIGURAÇÕES DE PRODUTOS PODERÃO SOFRER ALTERAÇÕES SEM AVISO PRÉVIO.

ENTRE EM CONTATO COM O SEU CONSULTOR OU FALE COM O NOSSO TIME DE TELEVENDAS PELO (33) 3277-3030.

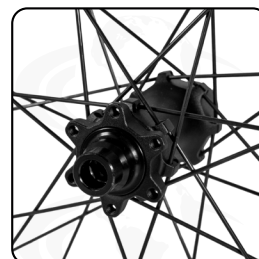

RODA D/T. 29X28F 6P. ALUM MOD. 11 BOOST XD PT NAC.

MATERIAL Alumínio

RAIO • Inox
• Importado

ARO

- WTB KOM I30 LIGHT 29"
- 30mm de largura interna
- Tubeless
- 28 furos
- ERD 606mm
- Largura do pneu 42mm - 72mm

PESO

- Roda dianteira 890 gr
- Roda traseira 1030 gr
- Par 1.920gr

CUBO DIANTEIRO

- Material alumínio
- Boost
- Eixo 15x110mm
- Compatível com discos 6 parafusos
- 28 Furos

EMBALAGEM 01kit

22848

CUBO TRASEIRO

- Boost
- Eixo 12x148mm
- Compatível com discos 6 parafusos
- Freehub padrão XD
- Material Alumínio

FOTOS MERAMENTE ILUSTRATIVAS. AS INFORMAÇÕES/CONFIGURAÇÕES DE PRODUTOS PODERÃO SOFRER ALTERAÇÕES SEM AVISO PRÉVIO.

ENTRE EM CONTATO COM O SEU CONSULTOR OU FALE COM O NOSSO TIME DE TELEVENDAS PELO (33) 3277-3030.

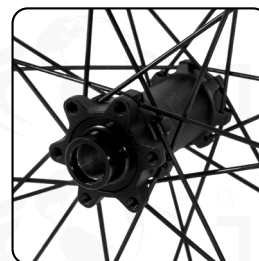

RODA D/T. 29X28F 6P. ALUM MOD. 12 BOOST XD PT NAC.

MATERIAL Alumínio

ARO

- WTB KOM I30 TEAM 29"
- 30mm de largura interna
- Tubeless
- 28 furos
- ERD 606mm
- Largura do pneu 42mm - 72mm

CUBO DIANTEIRO

- Material alumínio
- Boost 110x15
- Compatível com discos 6 parafusos
- 28 Furos

CUBO TRASEIRO

- Material alumínio
- Boost 148x12
- Compatível com discos 6 parafusos
- Freehub padrão XD

RAIO

- Importado
- Inox

PESO

- Dianteiro 940 gr
- Traseiro 1.080 gr
- Par 2.020 kg

EMBALAGEM 01 kit

22849

FOTOS MERAMENTE ILUSTRATIVAS. AS INFORMAÇÕES/CONFIGURAÇÕES DE PRODUTOS PODERÃO SOFRER ALTERAÇÕES SEM AVISO PRÉVIO.

ENTRE EM CONTATO COM O SEU CONSULTOR OU FALE COM O NOSSO TIME DE TELEVENDAS PELO (33) 3277-3030.



RODA D/T. 29X28F 6P. ALUM MOD. 13 BOOST HG/MS PT NAC.

MATERIAL Alumínio

ARO

- WTB KOM I30 LIGHT 29"
- 30mm de largura interna
- Tubeless
- 28 furos
- ERD 606mm
- Largura do pneu 42mm - 72mm

CUBO DIANTEIRO

- Material alumínio
- Boost
- Eixo 15x110mm
- Compatível com discos 6 parafusos
- 28 Furos

CUBO TRASEIRO

- Boost
- Eixo 12x148mm
- Compatível com discos 6 parafusos
- Freehub padrão MICRO SPLINE e HG inclusos
- Material Alumínio

RAIO

- Inox
- Importado

PESO

- Roda dianteira 850 gr
- Roda traseira HG 1.110gr
- Par 1.930/1.960KG

EMBALAGEM 01kit

22850



RODA D/T. 29X28F 6P. ALUM MOD. 14 BOOST HG/MS PT NAC.

MATERIAL Alumínio

ARO

- WTB KOM I30 TEAM 29"
- 30mm de largura interna
- Tubeless
- 28 furos
- ERD 606mm
- Largura do pneu 42mm - 72mm

CUBO DIANTEIRO

- Material alumínio
- Boost
- Eixo 15x110mm
- Compatível com discos 6 parafusos
- 28 Furos

CUBO TRASEIRO

- Material alumínio
- Boost
- Eixo 12x148mm
- Compatível com discos 6 parafusos
- Freehub padrão MICRO SPLINE e HG inclusos

RAIO

- Importado
- Inox

PESO

- Dianteiro 860 gr
- Traseiro MS 1080 gr
- Traseiro HG 1110 gr
- Par 1.940kg/1.970kg

EMBALAGEM 01kit

22851

FOTOS MERAMENTE ILUSTRATIVAS. AS INFORMAÇÕES/CONFIGURAÇÕES DE PRODUTOS PODERÃO SOFRER ALTERAÇÕES SEM AVISO PRÉVIO.

ENTRE EM CONTATO COM O SEU CONSULTOR OU FALE COM O NOSSO TIME DE TELEVENDAS PELO (33) 3277-3030.

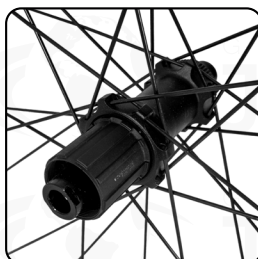

RODA D/T. 29X28F CL. ALUM MOD. 15 BOOST HG/MS PT NAC.

MATERIAL Alumínio

RAIO • Inox
• Importado

ARO

- WTB KOM I30 LIGHT 29"
- 30mm de largura interna
- Tubeless
- 28 furos
- ERD 606mm
- Largura do pneu 42mm - 72mm

PESO

- Roda dianteira 850 gr
- Roda traseira MS 1030 gr
- Traseiro HG 1060 gr
- Par 1.880/1.910 kg

CUBO DIANTEIRO

- Material alumínio
- Boost
- Eixo 15x110mm
- Compatível com discos Center Lock
- 28 Furos

EMBALAGEM 01 kit

22852

CUBO TRASEIRO

- Boost eixo 12x148mm
- Compatível com discos Center Lock
- Freehub padrão MICRO SPLINE e HG inclusos
- Material Alumínio

FOTOS MERAMENTE ILUSTRATIVAS. AS INFORMAÇÕES/CONFIGURAÇÕES DE PRODUTOS PODERÃO SOFRER ALTERAÇÕES SEM AVISO PRÉVIO.

ENTRE EM CONTATO COM O SEU CONSULTOR OU FALE COM O NOSSO TIME DE TELEVENDAS PELO (33) 3277-3030.



RODA D/T. 29X28F 6P. ALUM MOD. 14 BOOST HG/MS PT NAC.

MATERIAL Alumínio

ARO

- WTB KOM I30 TEAM 29"
- 30mm de largura interna
- Tubeless
- 28 furos
- ERD 606mm
- Largura do pneu 42mm - 72mm

CUBO DIANTEIRO

- Material alumínio
- Boost
- Eixo 15x110mm
- Compatível com discos 6 parafusos
- 28 Furos

CUBO TRASEIRO

- Material alumínio
- Boost
- Eixo 12x148mm
- Compatível com discos 6 parafusos
- Freehub padrão MICRO SPLINE e HG inclusos

RAIO

- Importado
- Inox

PESO

- Dianteiro 870 gr
- Traseiro MS 1.090 gr
- Traseiro HG 1.120 gr
- Par 1.990kg/1.960kg

EMBALAGEM

01kit

22853

FOTOS MERAMENTE ILUSTRATIVAS. AS INFORMAÇÕES/CONFIGURAÇÕES DE PRODUTOS PODERÃO SOFRER ALTERAÇÕES SEM AVISO PRÉVIO.

ENTRE EM CONTATO COM O SEU CONSULTOR OU FALE COM O NOSSO TIME DE TELEVENDAS PELO (33) 3277-3030.

CUBO D/T ALUM 28F 6P. CASSETE SPEED SH

CUBO DIANTEIRO Eixo 12x100mm
Eixo interno de alumínio
OLD 100mm
28 furos
02 rolamentos (medida 16287RS)
Compatível com disco de seis parafusos

CUBO TRASEIRO Eixo 12x142mm
Eixo interno de alumínio
28 furos
02 rolamentos (medida 16287-RS)
02 rolamentos freehub (medidas 6902-2RS)
Freehub padrão HG com 6 martelinhos
Compatível com disco de seis parafusos

MATERIAL Alumínio

PESO 460gr - peso referente ao par

22925



CUBO D/T ALUM 28F 6P. CASSETE SPEED XD

CUBO DIANTEIRO Eixo 12x100mm
Eixo interno de alumínio
OLD 100mm
28 furos
02 rolamentos (medida 16287RS)
Compatível com disco de seis parafusos

CUBO TRASEIRO Eixo 12x142mm
Eixo interno de alumínio
28 furos
02 rolamentos (medida 16287-RS)
02 rolamentos freehub (medidas 6902-2RS)
Freehub padrão XD com 6 martelinhos
Compatível com disco de seis parafusos

MATERIAL Alumínio

PESO 460gr - peso referente ao par

22924



CUBO D/T 32HX15X110/12X148MM BOOST MS PT | LINHA QUEST

CARACTERÍSTICA Par de cubo boost | linha quest

- Cubo dianteiro:
- Material alumínio
 - Boost
 - Eixo 15x110mm
 - Eixo interno de alumínio
 - Old 110mm
 - 32 Furos
 - 02 Rolamentos (medida 6804rs)
 - Compatível com freio a disco 6 parafusos

- Cubo traseiro:
- Material alumínio
 - Boost
 - Eixo 12x148mm
 - Eixo interno de alumínio
 - 32 Furos
 - 02 Rolamentos (medida 6902-2rs)
 - 02 Rolamentos freehub (medidas 6802-2rs)
 - Freehub padrão micro spline com 6 martelinhos
 - Compatível com freio a disco 6 parafusos

MATERIAL Alumínio

PESO 476gr - peso referente ao par

EMBALAGEM 10 peças

22746



CUBO BOOST | LINHA QUEST

CARACTERÍSTICA Cubo Dianteiro: Alumínio Boost | Eixo de 15 mm | OLD 110 mm | 32 furos com rolamentos
Cubo Traseiro: Alumínio Boost | OLD 148 mm | Eixo de 12 mm | 32 furos com rolamentos | Cassete XD System | Preto.

MATERIAL Alumínio

PESO 470 gr (Par)

EMBALAGEM 10 peças

20576



ARO 29" CARBON PAREDE DUPLA LIGHT 28F.

CARACTERÍSTICA	Aro de Carbono Quest Race Q30 SL Super light 28 Furos Carbono T700 E T800 Tubeless Ready Largura interna 30mm Largura Externa 36mm ETRTO RIM SIZE 30-622MM ERD 596MM Altura do aro 22mm Disc Brake Peso máximo do ciclista 110kg Compatível com válvula presta Medidas de pneu de 2,25" a 2,5" Tensão máxima de raio 130kgf Resistência de impacto 80J
-----------------------	---

FATOR DE VENDA 1

EMBALAGEM 10 unidades

MATERIAL Carbono

PESO 352gr - peso referente ao par

22929



ARO 29" CARBON PAREDE DUPLA LIGHT 32F.

CARACTERÍSTICA	Aro de Carbono Quest Race Q30 SL Super light 28 Furos Carbono T700 E T800 Tubeless Ready Largura interna 30mm Largura Externa 36mm ETRTO RIM SIZE 30-622MM ERD 596MM Altura do aro 22mm Disc Brake Peso máximo do ciclista 110kg Compatível com válvula presta Medidas de pneu de 2,25" a 2,5" Tensão máxima de raio 130kgf Resistência de impacto 80J
-----------------------	---

FATOR DE VENDA 1

EMBALAGEM 10 unidades

MATERIAL Carbono

PESO 362gr - peso referente ao par

22928



ARO 29" CARBON PAREDE DUPLA 32F.

CARACTERÍSTICA	Aro de Carbono Quest Race Q30 SL 32 Furos Carbono T700 E T800 Tubeless Ready Largura interna 30mm Largura externa 36mm ETRTO RIM SIZE 30-622MM ERD 596mm Altura do aro 20mm Disc Brake Peso máximo do ciclista 110kg Compatível com válvula presta Medidas de pneu de 2,25" a 2,5" Tensão máxima de raio 130kgf Resistência de impacto 80J
-----------------------	--

FATOR DE VENDA 1

EMBALAGEM 10 unidades

MATERIAL Carbono

PESO 392gr - peso referente ao par

22926



ARO 29" CARBON PAREDE DUPLA 28F.

CARACTERÍSTICA	Aro de Carbono Quest Race Q30 SL 28 Furos Carbono T700 E T800 Tubeless Ready Largura interna 30mm Largura Externa 36mm ETRTO RIM SIZE 30-622MM ERD 596MM Altura do aro 20mm Disc Brake Peso máximo do ciclista 110kg Compatível com válvula presta Medidas de pneu de 2,25" a 2,5" Tensão máxima de raio 130kgf Resistência de impacto 80J
-----------------------	--

FATOR DE VENDA 1

EMBALAGEM 10 unidades

MATERIAL Carbono

PESO 376gr

22927



QUEST

EIXO E FREEHUB PARA CUBO QUEST MICRO SPLINE

CARACTERÍSTICA

Eixo boost 12x148
Compatível com cubo Quest cód
22746
Freehub Micro Spline
Contém dois rolamentos e
terminais de eixo

24965



EIXO E FREEHUB PARA CUBO FORMULA XD

CARACTERÍSTICA

Eixo boost 12x148
Compatível com cubo Quest cód
20576
Freehub XD
Contém dois rolamentos e
terminais de eixo

24966



FOTOS MERAMENTE ILUSTRATIVAS. AS INFORMAÇÕES/CONFIGURAÇÕES DE PRODUTOS PODERÃO SOFRER ALTERAÇÕES SEM AVISO PRÉVIO.

ENTRE EM CONTATO COM O SEU CONSULTOR OU FALE COM O NOSSO TIME DE TELEVENDAS PELO (33) 3277-3030.

SUPORE CARAMANHOLA CARBONO | LINHA QUEST

CARACTERÍSTICA	Carbono Design Moderno Leve e Resistente
MATERIAL	Carbono
FIXAÇÃO	2 Parafusos (não acompanham suporte)
PESO	35g
EMBALAGEM	50 peças
	22248



SUPORE CARAMANHOLA MOD.2 CRB | LINHA QUEST

CARACTERÍSTICA	• Suporte caramanhola • Fixação por dois parafusos (não acompanham o suporte)
MATERIAL	Carbono (UD Matt Carbon Fiber t800)
TAMANHO	• Medidas 14 x 7.2mm
REMOÇÃO DA GARRAFA	• Remoção da garrafa standard
PESO	20g
EMBALAGEM	25 peças
	22249



QUEST



EIXO DIANTEIRO BOOST 15 X 110 MM | LINHA QUEST

CARACTERÍSTICA	Eixo Alumínio 15mm Boost com porca Corpo Alumínio maciço Diâmetro da bitola 21.5mm Largura da bitola 5mm Allen 6mm Comprimento do corpo 136mm Comprimento da rosca 20mm Comprimento total 161.5mm
MATERIAL	Alumínio
PESO	80Gr - incluindo a porca
EMBALAGEM	20 peças
	20834



PROTECTOR CABEAMENTO INTERNO 1,5MT | LINHA QUEST

CARACTERÍSTICA - Comprimento 1.5m
- Diâmetro externo 12mm
- Diâmetro interno 6mm

MATERIAL EVA

PESO 64Gr

EMBALAGEM 50 peças

23832



CARTUCHO INTERNO SUSPENSÃO | LINHA QUEST

CARACTERÍSTICA Cartucho interno para suspensão Quest: | Corpo em Aço
Porca do acionador na trava em alumínio | Acompanha parafuso inferior para fixação na lower leg | Comprimento total do eixo 580mm

MATERIAL Alumínio/ Aço

PESO 247Gr

EMBALAGEM 20 peças

20832



REPARO INTERNO SUSPENSÃO | LINHA QUEST

CARACTERÍSTICA Kit de reparo da câmara de AR para suspensão Quest: | Kit acompanha 3 peças (Porca com válvula da câmara de ar/ Válvula interna / Eixo com molas e batentes) | Corpo do eixo em Alumínio | Válvula interna em alumínio | Porca com válvula em alumínio | Bitola do eixo - Allen 6mm | Comprimento total do eixo 250mm

MATERIAL Alumínio

PESO 137Gr - Kit completo

EMBALAGEM 20 peças

20833



CANOTE SELIM ALUMÍNIO C/ REMOTE K PT | LINHA QUEST

CARACTERÍSTICA Trava remota mecânico | Cabeamento interno
Profundidade de inserção: 90mm
Fixação do selim: 2 parafusos
Alavanca com acionamento vertical

MATERIAL Alumínio

TAMANHO Diâmetro do canote: 31.6 mm

PESO 621g (canote + conduíte com cabo + alavanca)

CÓDIGO: 24346 - 31.6X295X75MM

24347 - 31.6X345X100MM

24348 - 31.6X395X125MM

24349 - 31.6X445X150MM



QUEST

EIXO DIANTEIRO BOOST 15X110MM | LINHA QUEST

CARACTERÍSTICA

- Eixo dianteiro boost
- Marca quest
- Material alumínio
- Eixo 15x110mm
- Rosca do eixo 1.5mm
- Comprimento do corpo 142mm
- Comprimento da rosca 22mm
- Comprimento total 147mm
- Diâmetro da bitola 22mm
- Largura do bitola 5mm
- Bitola allen 6mm

MATERIAL Alumínio

PESO +-64gr

EMBALAGEM 20 peças

23230



FOTOS MERAMENTE ILUSTRATIVAS. AS INFORMAÇÕES/CONFIGURAÇÕES DE PRODUTOS PODERÃO SOFRER ALTERAÇÕES SEM AVISO PRÉVIO.

ENTRE EM CONTATO COM O SEU CONSULTOR OU FALE COM O NOSSO TIME DE TELEVENDAS PELO (33) 3277-3030.

CANOTE SELIM ALUMÍNIO C/ REMOTE W PT | LINHA QUEST

CARACTERÍSTICA Trava remota mecânico | Cabeamento interno
Profundidade de inserção: 80mm
Fixação do selim: 2 parafusos.
Alavanca com acionamento horizontal.

MATERIAL Alumínio

TAMANHO Diâmetro do canote: 31.6 mm

PESO 601g (canote + conduíte com cabo + alavanca)

CÓDIGO: 24350 – 31.6X295X75MM

= 24351 – 31.6X345X100MM

24352 – 31.6X395X125MM

24353 – 31.6X445X150MM



EIXO DIANTEIRO BOOST 15X110MM C/BLOC | LINHA QUEST

CARACTERÍSTICA

- Eixo dianteiro boost com blocagem
- Marca quest
- Material alumínio
- Eixo 15x110mm
- Rosca do eixo 1.5mm
- Comprimento do corpo 142mm
- Comprimento da rosca 22mm
- Comprimento total 167.2mm
- Sistema de instalação por blocagem
- Blocagem com regulagem de posição

MATERIAL Alumínio

PESO +-77gr

EMBALAGEM 20 peças

23231



FOTOS MERAMENTE ILUSTRATIVAS. AS INFORMAÇÕES/CONFIGURAÇÕES DE PRODUTOS PODERÃO SOFRER ALTERAÇÕES SEM AVISO PRÉVIO.

ENTRE EM CONTATO COM O SEU CONSULTOR OU FALE COM O NOSSO TIME DE TELEVENDAS PELO (33) 3277-3030.

PROMEND

C A T Á L O G O





MANOPLA PROMEND | GR-515

MODELO	GR-515
CARACTERÍSTICA	Anel de alumínio (2x) Trava (2x) e tampa
MATERIAL	PU+PP+EVA+ALLOY
TAMANHO	130 x 28 mm (Guidão de 22.2 mm)
PESO	88g
EMBALAGEM	100 peças

16215



MANOPLA PROMEND | GR-513

MODELO	GR-513
CARACTERÍSTICA	Anel de alumínio Trava e tampa
MATERIAL	Espuma / ABS
TAMANHO	126 x 34 mm (Guidão de 22.2 mm)
PESO	98g
EMBALAGEM	100 peças

16216



MANOPLA PROMEND | GR-504

MODELO	GR-504
CARACTERÍSTICA	Anel de alumínio (2x), trava (2x) e tampa
MATERIAL	Borracha / Plástico
TAMANHO	135 x 55 x 35 mm (Guidão de 22.2 mm)
PESO	180g
EMBALAGEM	100 peças

16217



FITA DE GUIDÃO PROMEND | GH-081H

MODELO	GH-081H
MODALIDADE	Road bike
MATERIAL	EVA
ACABAMENTO	Plugs de fechamento
TAMANHO	2000 x 30 mm
PESO	57g
EMBALAGEM	10 peças

16218

PEDAL CLIP MTB | PD-M96

MODELO	PD-M96
CARACTERÍSTICA	Pedal com rolamento
MATERIAL	Alumínio / Chromoly
TACO	MTB SPD
TAMANHO	105 * 80 * 34.5mm
PESO	340g (par)
EMBALAGEM	1 conjunto
	11777



FOTO ILUSTRATIVA
DA EMBALAGEM



PEDAL CLIP SPEED | PD-R97

MODELO	PD-R97
CARACTERÍSTICA	Pedal com rolamento
MATERIAL	Alumínio / Chromoly
TACO	Speed SPD
PESO	298g (par)
EMBALAGEM	1 conjunto
	11778



FOTO ILUSTRATIVA
DA EMBALAGEM



SHIMANO

PEDAL CLIP SPEED | PD-R95

MODELO	PD-R95
CARACTERÍSTICA	Pedal com rolamento
MATERIAL	Alumínio / Chromoly
TACO	Speed LOOK
PESO	310g (par)
EMBALAGEM	1 conjunto 11779



FOTO ILUSTRATIVA
DA EMBALAGEM



TACO SPEED SPD

COMPATIBILIDADE	Speed SPD
EMBALAGEM	10 peças 11782



TACO SPEED LOOK

COMPATIBILIDADE	Speed LOOK
EMBALAGEM	10 peças 11783

FOTOS MERAMENTE ILUSTRATIVAS. AS INFORMAÇÕES/CONFIGURAÇÕES DE PRODUTOS PODERÃO SOFRER ALTERAÇÕES SEM AVISO PRÉVIO.

ENTRE EM CONTATO COM O SEU CONSULTOR OU FALE COM O NOSSO TIME DE TELEVENDAS PELO (33) 3277-3030.

TACO MTB SPD

COMPATIBILIDADE MTB SPD

EMBALAGEM 10 peças

11784



TACO SPEED SPD

CARACTERÍSTICA Tacos para pedais de ciclismo de Estrada | Possui parafusos e chave para instalação

Desenhados para pedais Speed (modelo compatível com Shimano)

Dimensões do Produto:
Float (flutuação): 6 graus
Altura : 2,5 cm
Largura: 8 cm
Comprimento: 7 cm
Peso: 90 gramas

Contém: 2 tacos, 6 parafusos, 6 arruelas e 1 chave allen 4mm

COMPATIBILIDADE Compatível com demais fabricantes que utilizam o sistema SPD

EMBALAGEM 10 peças

22697

FOTOS MERAMENTE ILUSTRATIVAS. AS INFORMAÇÕES/CONFIGURAÇÕES DE PRODUTOS PODERÃO SOFRER ALTERAÇÕES SEM AVISO PRÉVIO.

ENTRE EM CONTATO COM O SEU CONSULTOR OU FALE COM O NOSSO TIME DE TELEVENDAS PELO (33) 3277-3030.



PEDAL MTB | PD-M86C

MODELO	PD-M86C
CARACTERÍSTICA	Três rolamentos
MATERIAL	Alumínio / carbono
EIXO	9/16"
TAMANHO	109 * 93,5 * 12mm
PESO	281g (par)
EMBALAGEM	10 peças
	11781



PEDAL MTB | PD-M29

MODELO	PD-M29
MATERIAL	Alumínio / Chromoly
EIXO	9/16"
TAMANHO	123 * 100 * 18mm
PESO	319g (par)
EMBALAGEM	10 peças
	11780



PEDAL PROMEND | PD-R67

MODELO	PD-R67 Rolamento (3x) selado
MATERIAL	Alumínio (corpo) / CR-MO (eixo)
EIXO	9/16"
TAMANHO	105 x 91 x 18 mm
PESO	270g (par)
EMBALAGEM	10 peças
	16221



PEDAL PROMEND | PD-M28

MODELO	PD-M28
MATERIAL	Alumínio (corpo) / DU (eixo)
EIXO	9/16"
TAMANHO	130 x 105 x 16 mm
PESO	363g (par)
EMBALAGEM	10 peças
	16222

FOTOS MERAMENTE ILUSTRATIVAS. AS INFORMAÇÕES/CONFIGURAÇÕES DE PRODUTOS PODERÃO SOFRER ALTERAÇÕES SEM AVISO PRÉVIO.

ENTRE EM CONTATO COM O SEU CONSULTOR OU FALE COM O NOSSO TIME DE TELEVENDAS PELO (33) 3277-3030.



PEDAL MTB CLIP PLAT. PRETO
PD-F91 MOD. 01

MODELO	PD-F91
CARACTERÍSTICA	<ul style="list-style-type: none"> • Rolamento selado • Clip e Plataforma de Nylon • Taco padrão Shimano (acompanha o pedal) • Ajuste de tensão • MTB
MATERIAL	Aço, Alumínio e Nylon
EIXO	9/16"
TAMANHO	83 x 71 x 19,3 mm
PESO	300g (par)
EMBALAGEM	10 peças
	23577



PEDAL MTB CLIP PLAT. PRETO
PD-F91L MOD. 02

MODELO	PD-F91L
CARACTERÍSTICA	<ul style="list-style-type: none"> • Rolamento selado • Clip e Plataforma de Nylon • Taco padrão Shimano (acompanha o pedal) • Ajuste de tensão • MTB
MATERIAL	Aço, Alumínio e Nylon
EIXO	9/16"
TAMANHO	100 x 88.6 x 21 mm
PESO	360g (par)
EMBALAGEM	10 peças
	23578

PEDAL MTB ALUM. CLIP
PRETO PD-M96P MOD. 02

MODELO	PD-M96P
CARACTERÍSTICA	<ul style="list-style-type: none"> • Pedal Clip • Rolamento selado • Clip dupla face • Corpo de Nylon • Taco padrão Shimano (acompanha o pedal) • Ajuste de tensão • MTB
MATERIAL	Aço, Alumínio e Nylon
EIXO	9/16"
TAMANHO	-
PESO	332g (par)
EMBALAGEM	10 peças
	23582



PROMENDO

FOTOS MERAMENTE ILUSTRATIVAS. AS INFORMAÇÕES/CONFIGURAÇÕES DE PRODUTOS PODERÃO SOFRER ALTERAÇÕES SEM AVISO PRÉVIO.

ENTRE EM CONTATO COM O SEU CONSULTOR OU FALE COM O NOSSO TIME DE TELEVENDAS PELO (33) 3277-3030.

**PEDAL MTB ALUM. CLIP
PRETO PD-M96B MOD. 03**

MODELO PD-M96B

- CARACTERÍSTICA**
- Pedal Clip
 - Rolamento selado
 - Clip dupla face
 - Corpo de Alumínio
 - Taco padrão Shimano (acompanha o pedal)
 - Ajuste de tensão
 - MTB

MATERIAL Aço e Alumínio

EIXO 9/16"

TAMANHO 83 x 71 x 19,3 mm

PESO 373g (par)

EMBALAGEM 10 peças

23583



**PEDAL MTB ALUM. PD-M24N
MOD. 04 PRETO**

MODELO PD-M24N

- CARACTERÍSTICA**
- MTB
 - Acompanha chave allen 6mm
 - Bucha de nylon

MATERIAL Alumínio

EIXO 9/16"

TAMANHO 104 x 102 x 14 mm

PESO 380g

EMBALAGEM 10 peças

24700





PLATAFORMA DE PROTEÇÃO DO TAQUINHO PEDAL CLIP MOD.01

MATERIAL	<ul style="list-style-type: none"> • Plataforma de Nylon • Plataforma para taquinho Speed • Padrão Shimano (SPD)
TAMANHO	95 x 67 x 14 mm
PESO	56g
EMBALAGEM	25 peças
	23579



PLATAFORMA PARA PEDAL CLIP MOD.02

MATERIAL	<ul style="list-style-type: none"> • Plataforma de Nylon • Plataforma para Pedal Speed • Padrão Shimano (SPD)
TAMANHO	73 x 64 x 21 mm
PESO	48g
EMBALAGEM	25 peças
	23580



SELIM MTB CROMOLY

MODELO	SD 576
CARACTERÍSTICA	Trilho de Cromoly Vazado
TAMANHO	250*160 mm 250*142 mm
PESO	260g
EMBALAGEM	10 peças
160MM	11787
142MM	13878



SELIM MTB CARBON RACE

MODELO	SD 576-C
CARACTERÍSTICA	Trilho de carbono Vazado
TAMANHO	250*150MM
TORQUE NM	2-4N
LIMITE DE PESO	80 kg
PESO	151g
EMBALAGEM	10 peças
	11788

promano

FOTOS MERAMENTE ILUSTRATIVAS. AS INFORMAÇÕES/CONFIGURAÇÕES DE PRODUTOS PODERÃO SOFRER ALTERAÇÕES SEM AVISO PRÉVIO.

ENTRE EM CONTATO COM O SEU CONSULTOR OU FALE COM O NOSSO TIME DE TELEVENDAS PELO (33) 3277-3030.



SELIM MTB CROMOLY VAZADO EXPERT

MODELO	SD 573
CARACTERÍSTICA	Trilho de titânio Vazado
TAMANHO	270 * 145mm
PESO	232g
EMBALAGEM	10 peças
	11789



SELIM MTB VAZADO MODELO 07

MATERIAL	Plástico
TRILHO	Trilho de aço
TAMANHO	285x140 mm
PESO	180g
EMBALAGEM	70 peças
	12490



SELIM MTB VAZADO MODELO 08

REVESTIMENTO	PU
TRILHO	Trilho de aço
TAMANHO	285x140 mm
PESO	260g
EMBALAGEM	50 peças
	12491

FOTOS MERAMENTE ILUSTRATIVAS. AS INFORMAÇÕES/CONFIGURAÇÕES DE PRODUTOS PODERÃO SOFRER ALTERAÇÕES SEM AVISO PRÉVIO.

ENTRE EM CONTATO COM O SEU CONSULTOR OU FALE COM O NOSSO TIME DE TELEVENDAS PELO (33) 3277-3030.



SELIM MTB VAZADO MODELO 13

MATERIAL	PU Espuma de poliuretano
TRILHO	CR-MO
TAMANHO	255 x 140 mm
PESO	305g
EMBALAGEM	16 peças
	16225



SELIM MTB VAZADO MODELO 14

MATERIAL	PU / Espuma de poliuretano
TRILHO	Aço
TAMANHO	245 x 160 mm
PESO	305g
EMBALAGEM	16 peças
	16226



SELIM PASSEIO GEL MODELO 09

REVESTIMENTO	PU
TRILHO	Trilho de aço
TAMANHO	265x230 mm
PESO	920g
EMBALAGEM	15 peças
	12993

FOTOS MERAMENTE ILUSTRATIVAS. AS INFORMAÇÕES/CONFIGURAÇÕES DE PRODUTOS PODERÃO SOFRER ALTERAÇÕES SEM AVISO PRÉVIO.

ENTRE EM CONTATO COM O SEU CONSULTOR OU FALE COM O NOSSO TIME DE TELEVENDAS PELO (33) 3277-3030.

SELIM PASSEIO EXTRA BIG MODELO 10

REVESTIMENTO	PU
TRILHO	Trilho de aço
TAMANHO	310x275 mm
PESO	990g
EMBALAGEM	16 peças
	12994



SELIM MTB VAZADO MODELO 11

MATERIAL	PU Fibra Mirosoft Enchimento de EVA
MODELO	SD-576B
TRILHO	Aço
TAMANHO	245 x 155 mm
PESO	306g
EMBALAGEM	16 peças
	16223



FOTOS MERAMENTE ILUSTRATIVAS. AS INFORMAÇÕES/CONFIGURAÇÕES DE PRODUTOS PODERÃO SOFRER ALTERAÇÕES SEM AVISO PRÉVIO.

ENTRE EM CONTATO COM O SEU CONSULTOR OU FALE COM O NOSSO TIME DE TELEVENDAS PELO (33) 3277-3030.

SELIM MTB PRETO VAZADO MOD.12

CARACTERÍSTICAS

- Selim mtb vazado com gel
- Ergonômico
- Absorção de choque através do gel
- Ótima ventilação
- Confortável
- Base em polipropileno de alta resistência
- Espuma
- Capa laminada em pvc

MATERIAL

Polipropileno / espuma

TAMANHO

Medida 270 x 170mm

PESO

463g

EMBALAGEM

25 peças

23576



SELIM MTB PRETO MOD.15

CARACTERÍSTICAS

Selim mtb | linha promend

- Selim mtb
- Ergonômico
- Confortável
- Base em polipropileno de alta resistência
- Espuma
- Capa laminada em pvc

MATERIAL

Polipropileno / espuma

TAMANHO

Medida 275 x 137mm

PESO

333g

EMBALAGEM

25 peças

23587



FOTOS MERAMENTE ILUSTRATIVAS. AS INFORMAÇÕES/CONFIGURAÇÕES DE PRODUTOS PODERÃO SOFRER ALTERAÇÕES SEM AVISO PRÉVIO.

ENTRE EM CONTATO COM O SEU CONSULTOR OU FALE COM O NOSSO TIME DE TELEVENDAS PELO (33) 3277-3030.

SELIM MTB PRETO VAZADO MOD.16

CARACTERÍSTICAS

- Selim mtb vazado
- Ergonômico
- Ótima ventilação
- Confortável
- Base em polipropileno de alta resistência
- Espuma
- Capa laminada em pvc

MATERIAL

Polipropileno / espuma

TAMANHO

Medida 280 x 140mm

PESO

358g

EMBALAGEM

25 peças

23588



SELIM MTB PRETO VAZADO MOD.17

CARACTERÍSTICAS

- Selim mtb vazado
- Ergonômico
- Ótima ventilação
- Confortável
- Base em polipropileno de alta resistência
- Espuma
- Capa laminada em pvc

MATERIAL

Polipropileno / espuma

TAMANHO

Medida 270 x 158mm

PESO

353g

EMBALAGEM

25 peças

23589



FOTOS MERAMENTE ILUSTRATIVAS. AS INFORMAÇÕES/CONFIGURAÇÕES DE PRODUTOS PODERÃO SOFRER ALTERAÇÕES SEM AVISO PRÉVIO.

ENTRE EM CONTATO COM O SEU CONSULTOR OU FALE COM O NOSSO TIME DE TELEVENDAS PELO (33) 3277-3030.

SELIM MTB PRETO VAZADO MOD.18

CARACTERÍSTICAS

- Selim mtb vazado
- Ergonômico
- Trilho de aço
- Ótima ventilação
- Confortável
- Base em TPU de alta resistência
- Assento emborrachado

MATERIAL

Poliuretano termoplástico e aço

TAMANHO

149mm x 260mm

PESO

342g

EMBALAGEM

25 peças

24699



SELIM MTB PRETO VAZADO MOD.20

CARACTERÍSTICAS

- Selim mtb vazado
- Ergonômico
- Trilho de aço
- Ótima ventilação
- Confortável
- Excelente acabamento
- Base em PU de alta resistência
- Assento em espuma
- Mola em elástrômero

MATERIAL

Poliuretano e aço

PESO

602g

EMBALAGEM

25 peças

24721



PROMEND

FOTOS MERAMENTE ILUSTRATIVAS. AS INFORMAÇÕES/CONFIGURAÇÕES DE PRODUTOS PODERÃO SOFRER ALTERAÇÕES SEM AVISO PRÉVIO.

ENTRE EM CONTATO COM O SEU CONSULTOR OU FALE COM O NOSSO TIME DE TELEVENDAS PELO (33) 3277-3030.

SELIM MTB PRETO VAZADO MOD.21

CARACTERÍSTICAS

- Selim mtb vazado
- Ergonômico
- Trilho de aço
- Ótima ventilação
- Confortável
- Excelente acabamento
- Base em PU de alta resistência
- Assento em espuma

MATERIAL

Poliuretano e aço

PESO

406g

EMBALAGEM

25 peças

24722



SELIM MTB PRETO VAZADO MOD.22

CARACTERÍSTICAS

- Selim mtb vazado
- Ergonômico
- Trilho de aço
- Ótima ventilação
- Confortável
- Excelente acabamento
- Base em PU de alta resistência
- Assento em espuma

MATERIAL

Poliuretano e aço

TAMANHO

162mm x 250mm

PESO

258g

EMBALAGEM

25 peças

24723



FOTOS MERAMENTE ILUSTRATIVAS. AS INFORMAÇÕES/CONFIGURAÇÕES DE PRODUTOS PODERÃO SOFRER ALTERAÇÕES SEM AVISO PRÉVIO.

ENTRE EM CONTATO COM O SEU CONSULTOR OU FALE COM O NOSSO TIME DE TELEVENDAS PELO (33) 3277-3030.

SUPORTE FIX. SUP CARAMANHOLA PRETO

MODELO	FJJ-280N
CARACTERÍSTICA	Pode ser montado horizontalmente ou verticalmente, adequada para bicicletas dobráveis, MTB e Road
MATERIAL	Alumínio
TAMANHO	Diâmetro do selim ou guidão: 21 - 34 cm
PESO	34g
EMBALAGEM	50 peças
	16219



SUPORTE DE CARAMANHOLA I SJJ-25212

MODELO	SJJ-25212
CARACTERÍSTICA	Acesso Standard (meio) Incluso 2 parafusos Allen
MATERIAL	Alumínio
TAMANHO	147 x 79 x 76 mm
PESO	42g
EMBALAGEM	100 peças
	16220



SUPORTE CARAMANHOLA ALUM MOD.02

CARACTERÍSTICA	Caramanhola / Garrafa água comum Super Leve Fácil instalação Durável Resistente
MATERIAL	Alumínio
TAMANHO	145 x 76 mm
PESO	40g
EMBALAGEM	100 unidades
	23581

FOTOS MERAMENTE ILUSTRATIVAS. AS INFORMAÇÕES/CONFIGURAÇÕES DE PRODUTOS PODERÃO SOFRER ALTERAÇÕES SEM AVISO PRÉVIO.

ENTRE EM CONTATO COM O SEU CONSULTOR OU FALE COM O NOSSO TIME DE TELEVENDAS PELO (33) 3277-3030.

MOVIMENTO CENTRAL BB-91DUB SR

MODELO BB-91DUB SR

CARACTERÍSTICA

- BSA
- Padrão dub
- Compatível com caixa 68mm e 73mm
- Acompanha arruelas calço

MATERIAL Alumínio e plástico

TAMANHO Ø34.7mm

PESO 90g

EMBALAGEM 20 peças

24701



MOVIMENTO CENTRAL BB-92DUB SR

MODELO BB-92DUB SR

CARACTERÍSTICA

- Padrão dub
- Compatível com caixa 89,5mm e 92mm
- Acompanha arruelas calço

MATERIAL Alumínio e plástico

TAMANHO Ø41mm

PESO 84g

EMBALAGEM 20 peças

24702





GLIB

M5



GLIB

CAPACETE MTB M5 MIPS

Característica	In mold com mips
Aberturas de circulação de ar	14 aberturas
Sistema de fechamento	Fivela
Enchimento	Espuma removível lavável
Sistema regulagem	Orbital
Peso	310 g

CÓDIGO	25003- M5 PRETO
	25004- M5 BRANCO



FOTOS MERAMENTE ILUSTRATIVAS. AS INFORMAÇÕES/CONFIGURAÇÕES DE PRODUTOS PODERÃO SOFRER ALTERAÇÕES SEM AVISO PRÉVIO.

ENTRE EM CONTATO COM O SEU CONSULTOR OU FALE COM O NOSSO TIME DE TELEVENDAS PELO (33) 3277-3030.

SELIM MTB VAZADO MOD 1168

Material	Carbono + Couro Microfibra
Tamanho	275x153x65mm 275x143x65mm
Tipo de Fixação	Trilho oval Este tipo de trilho não é compatível com todo tipo de canote.
Material do trilho	Fibra de carbono
Material de cobertura	Couro Microfibra
Modelo	Vazado
Limite de peso	80kg
Dimensão do trilho	153mm 143mm
Torque	2-4Nm
Peso	180,5g

CÓDIGO	25008 - 153 MM
	25007 - 143 MM



SELIM MTB VAZADO MOD 1169

Material	Polímero + Náilon reforçado + Aço cromolibdênio
Tamanho	270x143x65mm
Tipo de Fixação	Trilho
Material do trilho	Aço cromolibdênio
Material de cobertura	Polímero impressão 3D
Modelo	Vazado
Dimensão do trilho	143mm
Peso	255g

CÓDIGO	25011 - 143 MM
---------------	----------------



SELIM MTB VAZADO MOD 1189

Material	Couro de Microfibras + Fibra de carbono
Tamanho	240x155x75mm 240x143x75mm
Tipo de Fixação	Trilho
Material do trilho	Fibra de carbono
Material de cobertura	Couro Microfibras
Modelo	Vazado
Limite de peso	80kg
Dimensão do trilho	153mm 143mm
Torque	2-4Nm
Peso	132g

CÓDIGO 25006 - 155 MM
25010 - 143 MM



SELIM MTB VAZADO MOD 1168

Material	Couro de Microfibras + Fibra de carbono
Tamanho	280x148x56mm
Tipo de Fixação	Trilho oval Este tipo de trilho não é compatível com todo tipo de canote.
Material do trilho	Fibra de carbono
Material de cobertura	Couro Microfibras
Modelo	Vazado
Limite de peso	80kg
Dimensão do trilho	148mm
Torque	2-4Nm
Peso	124g

CÓDIGO 25009 - 148 MM



ABRAÇADEIRA DE SELIM MTB 34.9 LIGHT PT

Material	Alumínio
Tamanho	34.9mm
Torque	6 Nm
Peso	8,6g

CÓDIGO 25015



FOTOS MERAMENTE ILUSTRATIVAS. AS INFORMAÇÕES/CONFIGURAÇÕES DE PRODUTOS PODERÃO SOFRER ALTERAÇÕES SEM AVISO PRÉVIO.

ENTRE EM CONTATO COM O SEU CONSULTOR OU FALE COM O NOSSO TIME DE TELEVENDAS PELO (33) 3277-3030.

SELIM MTB VAZADO MOD 1136

Material	Couro de Microfibr + Aço cromo molibdênio + PP
Tamanho	250x144x73mm
Tipo de Fixação	Trilho
Material do trilho	Aço cromo molibdênio
Material de cobertura	Couro de microfibr
Modelo	Vazado
Dimensão do trilho	144mm
Peso	194g

CÓDIGO 25005 - 144 MM



NIPLE ALUMÍNIO 14MM

Material	Alumínio
Tamanho	14mm
Peso	14g

CÓDIGO
 25012 - 14MM PT
 25013 - 14MM VM
 25014 - 14MM AZ



FOTOS MERAMENTE ILUSTRATIVAS. AS INFORMAÇÕES/CONFIGURAÇÕES DE PRODUTOS PODERÃO SOFRER ALTERAÇÕES SEM AVISO PRÉVIO.

ENTRE EM CONTATO COM O SEU CONSULTOR OU FALE COM O NOSSO TIME DE TELEVENDAS PELO (33) 3277-3030.





OILGRAPHE®

O LUBRIFICANTE OILGRAPHE é um produto super revolucionário e novíssimo no mercado. O fabricante tem toda uma linha de produtos fabricados com nanotecnologia, tendo como princípio ativo o grafeno, voltado ao tratamento de metais.

Lubrificante de alta performance derivado de hidrocarbonetos, grafeno, nanopartículas de grafita natural cristalina de alta pureza, carbono em alta concentração, anticorrosivos naturais, camponentes anti desgastantes e compostos antioxidantes extremamente estáveis.



OILGRAPHE®

O LUBRIFICANTE OILGRAPHE é um produto super revolucionário e novíssimo no mercado. O fabricante tem toda uma linha de produtos fabricados com nanotecnologia, tendo como princípio ativo o grafeno, voltado ao tratamento de metais.

Lubrificante de alta performance derivado de hidrocarbonetos, grafeno, nanopartículas de grafita natural cristalina de alta pureza, carbono em alta concentração, anticorrosivos naturais, componentes anti desgastantes e compostos antioxidantes extremamente estáveis.



ECONOMIA
DE ENERGIA



DIMINUI
O RUÍDO



REDUZ
CUSTOS DE
MANUTENÇÃO



HIDROFÓBICO



30ml

Código: 20195

Embalagem: 20 peças

100ml

Código: 20196

Embalagem: 20 peças

FOTOS MERAMENTE ILUSTRATIVAS. AS INFORMAÇÕES/CONFIGURAÇÕES DE PRODUTOS PODERÃO SOFRER ALTERAÇÕES SEM AVISO PRÉVIO.

ENTRE EM CONTATO COM O SEU CONSULTOR OU FALE COM O NOSSO TIME DE TELEVENDAS PELO (33) 3277-3030.

CERA WHITE MAX COM GRAFENO OILGRAPHE | 30ML



COMPOSIÇÃO

Desengraxante e lubrificante à base de pasta com partículas micrométricas e hidrocarbonetos de cadeia média.

Complementa a formulação éter e amina glicólica formando uma graxa de alta performance solúvel em água para suportar atrito, temperatura em condições extremas de utilização.

ADVERTÊNCIA

- Produto não inflamável;
- Produto não tóxico;
- Manter fora do alcance das crianças;
- Se ingerido, consulte imediatamente o centro de intoxicação ou serviço de saúde mais próximo.

APLICAÇÃO

Para obter total benefício do lubrificante White Wax 5x1, é importantíssimo aplica-lo corretamente, siga as instruções abaixo:

1. Agite bem antes de usar;
2. Aplique o White Wax 5x1 na corrente limpa e seca;
3. Pode ser usado para limpar e desengraxar;
4. Aplique na parte interior da corrente, ao mesmo tempo, que os pedais giram assegurando que o lubrificante penetre em todos os elos.

BENEFÍCIOS

- Hidrofóbico;
- 100% Livre de solventes;
- Antioxidante;
- Conserva o metal;
- Lubrificante;
- Desengraxante.

EMBALAGEM

20 peças

PESO

45 gr

20574

CERA WHITE MAX COM GRAFENO OILGRAPHE | 100ML



COMPOSIÇÃO

Desengraxante e lubrificante à base de pasta com partículas micrométricas e hidrocarbonetos de cadeia média.

Complementa a formulação éter e amina glicólica formando uma graxa de alta performance solúvel em água para suportar atrito, temperatura em condições extremas de utilização.

ADVERTÊNCIA

- Produto não inflamável;
- Produto não tóxico;
- Manter fora do alcance das crianças;
- Se ingerido, consulte imediatamente o centro de intoxicação ou serviço de saúde mais próximo.

APLICAÇÃO

Para obter total benefício do lubrificante White Wax 5x1, é importantíssimo aplica-lo corretamente, siga as instruções abaixo:

1. Agite bem antes de usar;
2. Aplique o White Wax 5x1 na corrente limpa e seca;
3. Pode ser usado para limpar e desengraxar;
4. Aplique na parte interior da corrente, ao mesmo tempo, que os pedais giram assegurando que o lubrificante penetre em todos os elos.

BENEFÍCIOS

- Hidrofóbico;
- 100% Livre de solventes;
- Antioxidante;
- Conserva o metal;
- Lubrificante;
- Desengraxante.

EMBALAGEM

20 peças

PESO

114 gr

20575



SR SUNTOUR

SR SUNTOUR

FOTOS MERAMENTE ILUSTRATIVAS. AS INFORMAÇÕES/CONFIGURAÇÕES DE PRODUTOS PODERÃO SOFRER ALTERAÇÕES SEM AVISO PRÉVIO.

ENTRE EM CONTATO COM O SEU CONSULTOR OU FALE COM O NOSSO TIME DE TELEVENDAS PELO (33) 3277-3030.

LOWER LEG XCR32 EIXO 9MM C/ KIT DE RASPADORES SUNTOUR

Característica	Diâmetro interno 32mm Old 100mm Eixo 9 x 100mm Aro 29" Suporte de freio post mount 160mm direct Acompanha kit raspadores Acompanha mancal Acompanha lubrificadores (espumas internas) Compatível com pistões rl-r (não incluso) Código do fabricante FKH128-01 Recomendação ficha técnica sf21-xcr32-atb-ds-rl-r 29"
Material	Magnésio
Peso	686gr – Kit completo
Embalagem	05 peças
Catálogo Grupo JPP	Compatível com todas as XCR's canela 32mm modelo atb 23511



LOWER LEG XCR32 C/ KIT DE RASPADORES SUNTOUR

Característica	Diâmetro interno 32mm Boost (old 110mm) Eixo 15 x 110mm Aro 29" Blocagem compatível ø15qlc32-110 alxe set (não incluso) Suporte de freio post mount 160mm direct Acompanha kit raspadores Acompanha mancal Acompanha lubrificadores (espumas internas) Compatível com pistões rl-r (não incluso) Código do fabricante FKH075-01 Recomendação ficha técnica xcr32-boost-air rlr ds 15qlc32-110 29"
Material	Magnésio
Peso	636gr – Kit completo
Embalagem	05 peças
Catálogo Grupo JPP	Compatível com todas as XCR's canela 32mm boost com pistão rl-r 23505





LOWER LEG DUROLUX38 C/ KIT DE RASPADORES SUNTOUR

Característica	Diâmetro interno 38mm Boost (old 110mm) Eixo 20 x 110mm Aro 29" Blocação compatível ø20lh-110 alxe set (não incluso) Suporte de freio post mount 203mm direct Acompanha kit raspadores Acompanha mancal Acompanha lubrificadores (espumas internas) Compatível com pistões r2c2 / air (não incluso) Código do fabricante FKH134-10 Recomendação ficha técnica durolux38-boost eq r2c2-pcs ds 20lh- 110 29"
Material	Magnésio
Peso	878gr – Kit completo
Embalagem	05 peças
Catálogo Grupo JPP	Compatível com o modelo DUROLUX 38

23513

LOWER LEG DUROLUX36 C/ KIT DE RASPADORES SUNTOUR

Característica	Diâmetro interno 36MM Boost (old 110mm) Eixo 15 x 110mm Aro 29" Blocação compatível ø15-110 15qlc2ti-110 (não incluso) Suporte de freio post mount 180mm direct Acompanha kit raspadores Acompanha mancal Acompanha lubrificadores (espumas internas) Compatível com pistões r2c2 / air (não incluso) Código do fabricante FKH031-01 Recomendação ficha técnica Durolux36-boost eq r2c2-pcs ds 15qlc2ti-110 29"
----------------	---

Material	Magnésio
Peso	748gr – Kit completo
Embalagem	05 peças
Catálogo Grupo JPP	Códigos compatíveis 21778 / 21779

23501



LOWER LEG RAIDON34 C/ KIT DE RASPADORES SUNTOUR

Característica Diâmetro interno 34mm | Boost (old 110mm) | Eixo 15 x 110mm | Aro 29" | Blocagem compatível Ø15qlc32-110 alxe set (não incluso) | Suporte de freio post mount 160mm direct | Acompanha kit raspadores | Acompanha mancal | Acompanha lubrificadores (espumas internas) | Compatível com pistões rlrc (não incluso) | Código do fabricante FKH036 | Recomendação ficha técnica sf18-axon34-ds-boost-rl-rc-pcs-15qlc2-110 29"

Material Magnésio

Peso 684gr – Kit completo

Embalagem 05 peças

Catálogo Grupo JPP Compatível com todas as AXON's canela 34mm boost com pistão rlrc

23502



LOWER LEG AXON34 C/ KIT DE RASPADORES SUNTOUR

Característica Diâmetro Interno 34mm | Boost (Old 110mm) | Eixo 15 X 110mm | Aro 29" | Blocagem Compatível Ø15qlc2ti-110 | Alxe Set (Não Incluso) | Suporte De Freio Post Mount 160mm Direct | Acompanha Kit Raspadores | Acompanha Mancal | Acompanha Lubrificadores (Espumas Internas) | Compatível Com Pistões Rlrc (Não Incluso) | Código Do Fabricante FKH078-00 | Recomendação Ficha Técnica Axon34-Werx-Boost Eq Rlrc-Pcs Ds 15qlc2ti-110 29"

Material Magnésio

Peso 624gr – Kit completo

Embalagem 05 peças

Catálogo Grupo JPP Compatível com todas as AXON's canela 34mm boost modelo Elite e Werx

23507



LOWER LEG RUX38 C/ KIT DE RASPADORES SUNTOUR

Característica	Diâmetro interno 38mm Boost (old 110mm) Eixo 20 x 110mm Aro 29" Blocagem compatível ø20-110 thru axle set (não incluso) Suporte de freio post mount 203mm direct Acompanha kit raspadores Acompanha mancal Acompanha lubrificadores (espumas internas) Compatível com pistões r2c2 / air (não incluso) Código do fabricante FKH135-10 Recomendação ficha técnica rux38-boost eq r2c2-pcs ds t 29"
Material	Magnésio
Peso	818gr – Kit completo
Embalagem	05 peças
Catálogo Grupo JPP	Compatível com o modelo RUX 38 23514



LOWER LEG AION36 C/ KIT DE RASPADORES SUNTOUR

Característica	Diâmetro interno 36mm Boost (old 110mm) Eixo 15 x 110mm Aro 29" Blocagem compatível ø15h-110 axle set (não incluso) Suporte de freio post mount 180mm direct Acompanha kit raspadores Acompanha mancal Acompanha lubrificadores (espumas internas) Compatível com pistões rlrc / air (não incluso) Código do fabricante FKH136-00 Recomendação ficha técnica sf23-aion36-boost-eq-rl-rc-pcs-ds-15h-110-29"
Material	Magnésio
Peso	826gr – Kit completo
Embalagem	05 peças
Catálogo Grupo JPP	Compatível com o modelo AION 36 23515



LOWER LEG XCR34 C/ KIT DE RASPADORES SUNTOUR

Característica Diâmetro interno 34mm | Boost (old 110mm) | Eixo 15 x 110mm | Aro 29" | Blocagem compatível ø15lh-110 axle set (não incluso) | Suporte de freio post mount 180mm direct | Acompanha kit raspadores | Acompanha mancal | Acompanha lubrificadores (espumas internas) | Compatível com pistões rl-r (não incluso) | Código do fabricante FKH141-10 | Recomendação ficha técnica sf23-xcr34-boost-air-r-2cr-ds-15lh-110-29"

Material Magnésio

Peso 775gr – Kit completo

Embalagem 05 peças

Catálogo Grupo JPP Compatível com todas as XCR's canela 34mm boost com pistão rl-r

23517



CONJUNTO SUPERIOR DO GARFO SUNTOUR

Característica Crown forjado em alumínio | Coroa em alumínio oca | Espiga tapered em alumínio (28.6 X 39.9mm) | Comprimento da espiga 270mm | Canela 38mm | Código do fabricante FKH132-10

Material Alumínio

Peso 1262gr

Embalagem 05 peças

Catálogo Grupo JPP Compatível com suspensões DUROLUX38

23367



FOTOS MERAMENTE ILUSTRATIVAS. AS INFORMAÇÕES/CONFIGURAÇÕES DE PRODUTOS PODERÃO SOFRER ALTERAÇÕES SEM AVISO PRÉVIO.

ENTRE EM CONTATO COM O SEU CONSULTOR OU FALE COM O NOSSO TIME DE TELEVENDAS PELO (33) 3277-3030.

CONJUNTO SUPERIOR DO GARFO SUNTOUR

Característica
Crown forjado em alumínio
Coroa em alumínio oca
Espiga tapered em alumínio (28.6 X 39.9mm)
Comprimento da espiga 270mm
Canela 36mm
Código do fabricante FKH030-02

Material Alumínio

Peso 1020gr

Embalagem 05 peças

Catálogo Grupo JPP Compatível com suspensões
DUROLUX36
23500



CONJUNTO SUPERIOR DO GARFO SUNTOUR

Característica
Coroa em alumínio
Espiga tapered em alumínio (28.6 X 39.9mm)
Comprimento da espiga 270mm
Canela 32mm
Código do fabricante FKH073-01

Material Alumínio

Peso 1050gr

Embalagem 05 peças

Catálogo Grupo JPP Compatível com suspensões XCR32
BOOST AIR/COIL
23504



CONJUNTO SUPERIOR DO GARFO SUNTOUR

Característica	Coroa em fibra de carbono Espiga tapered em fibra de carbono (28.6 X 39.9mm) Comprimento da espiga 270mm Canela 34mm Compatível com suspensões AXON34 werx carbon boost Código do fabricante FKH077-01
Material	Carbono
Peso	654gr
Embalagem	05 peças
Catálogo Grupo JPP	Compatível com suspensões AXON34 WERX CARBON BOOST 23506



CONJUNTO SUPERIOR DO GARFO SUNTOUR

Característica	Crown forjado em alumínio Coroa em alumínio oca Espiga tapered em alumínio (28.6 X 39.9mm) Comprimento da espiga 270mm Canela 34mm Código do fabricante FKH079-03
Material	Alumínio
Peso	762 gr
Embalagem	05 peças
Catálogo Grupo JPP	Compatível com suspensões AXON34 ELITE BOOST 23508

FOTOS MERAMENTE ILUSTRATIVAS. AS INFORMAÇÕES/CONFIGURAÇÕES DE PRODUTOS PODERÃO SOFRER ALTERAÇÕES SEM AVISO PRÉVIO.

ENTRE EM CONTATO COM O SEU CONSULTOR OU FALE COM O NOSSO TIME DE TELEVENDAS PELO (33) 3277-3030.

CONJUNTO SUPERIOR DO GARFO SUNTOUR

Característica	Coroa em alumínio Espiga tapered em alumínio (28.6 X 39.9mm) Comprimento da espiga 270mm Canela 34mm Compatível com suspensões Axon34 boost Código do fabricante FHK035-1
Material	Alumínio
Peso	845 gr
Embalagem	05 peças
Catálogo Grupo JPP	Compatível com suspensões AXON34 BOOST 23440



CONJUNTO SUPERIOR DO GARFO SUNTOUR

Característica	Coroa em alumínio Espiga tapered em aço (28.6 X 39.9mm) Comprimento da espiga 270mm Canela 32mm Código do fabricante FKH126-11
Material	Alumínio/aço
Peso	1348 gr
Embalagem	05 peças
Catálogo Grupo JPP	Compatível com suspensões XCR32 ATB AIR 23510



CONJUNTO SUPERIOR DO GARFO SUNTOUR

Característica	Coroa em alumínio Espiga tapered em alumínio (28.6 X 39.9mm) Comprimento da espiga 270mm Canela 36mm Código do fabricante FKH138
Material	Alumínio
Peso	1058 gr
Embalagem	05 peças
Catálogo Grupo JPP	Compatível com suspensões AION36 BOOST 23516



GARFO TUBO SUNTOUR

Característica	Diâmetro do tubo 38mm Comprimento 560mm Código do fabricante FPA196-02 Disponível para lado esquerdo (L) e lado direito (R)
Material	Alumínio
Peso	348 gr
Embalagem	05 peças
Catálogo Grupo JPP	Compatível com suspensões RUX38 BOOST

23532 / Lado direito

23533 / Lado esquerdo

CONJUNTO SUPERIOR DO GARFO SUNTOUR

Característica	Coroa em alumínio Espiga tapered em alumínio (28.6 X 39.9mm) Comprimento da espiga 270mm Canela 34mm Código do fabricante FKH138
Material	Alumínio
Peso	1108 gr
Embalagem	05 peças
Catálogo Grupo JPP	Compatível com suspensões XCR34 BOOST AIR 23518



FOTOS MERAMENTE ILUSTRATIVAS. AS INFORMAÇÕES/CONFIGURAÇÕES DE PRODUTOS PODERÃO SOFRER ALTERAÇÕES SEM AVISO PRÉVIO.

ENTRE EM CONTATO COM O SEU CONSULTOR OU FALE COM O NOSSO TIME DE TELEVENDAS PELO (33) 3277-3030.

CONJUNTO SUPERIOR DO GARFO SUNTOUR

Característica Coroa em alumínio
Espiga tapered em aço (28.6 X 39.9mm)
Comprimento da espiga 270mm
Canela 32mm
Código do fabricante FKH126-01

Material Alumínio/aço

Peso 1344 gr

Embalagem 05 peças

Catálogo Grupo JPP Compatível com suspensões XCR32 ATB

23509



CONJUNTO DE COROA INFERIOR C/ EPIGA SUNTOUR

Característica Crown forjado em alumínio
Coroa em alumínio oca
Espiga tapered em alumínio (28.6 X 39.9mm)
Comprimento da espiga 245mm
Canela 38mm
Código do fabricante FKH061-01

Material Alumínio

Peso 378 gr

Embalagem 05 peças

Catálogo Grupo JPP Compatível com suspensões RUX38 BOOST

23503



GARFO 29" COM SUSPENSÃO XCR32RLR-AIR 100MM TAPERED | 110X15MM PT

Característica

Crown AC4C | Tapered | Lower Leg Magnesium canela 32 | Trava no ombro em alumínio com abraçadeira - Suntour | Funcionamento a ar | Regulagem de retorno | Suporte do freio Post Mount 160mm | Curso de 100mm | Eixo de 15mm | OLD 110mm | Off set: 46 mm | Espiga alumínio Tapered ahead set (diâmetro superior 28.6mm / diâmetro inferior 39.8mm) 1/8 x 1.5

Comprimento da espiga 250mm
Abraçadeira 35mm | Acompanha calço redutor para Seat Tube 31.8mm | Montagem com abraçadeira e montagem direta tipo E. Usinagem CNC de alta qualidade.

Material

Alumínio

Peso

2395 gr - incluindo eixo, trava e cabo

Embalagem

10 peças

20582



AVISOS

USE APENAS PARA:

- LAZER
- CROSS COUNTRY

GARFO 29" MTB COM SUSPENSÃO XCM 100MM TAPERED | 100X9MM PT

Característica

Crown AC4C | Lower Leg Alumínio
Trava Remota no Guidão - Pistão | Trava em alumínio com abraçadeira - Suntour | Funcionamento a Mola | Suporte do Freio Post Mount 160mm | Curso de 100mm | Eixo de 9mm | OLD 100mm | Off set: 46 mm | Espiga Aço Tapered ahead set (diâmetro superior 28.6mm / diâmetro inferior 39.8mm) 1/8 x 1.5 | Comprimento da espiga 250mm

Material

Alumínio

Peso

2850 gr - incluindo trava e cabo

Embalagem

10 peças

20157



AVISOS

USE APENAS PARA:

- LAZER
- CROSS COUNTRY

FOTOS MERAMENTE ILUSTRATIVAS. AS INFORMAÇÕES/CONFIGURAÇÕES DE PRODUTOS PODERÃO SOFRER ALTERAÇÕES SEM AVISO PRÉVIO.

ENTRE EM CONTATO COM O SEU CONSULTOR OU FALE COM O NOSSO TIME DE TELEVENDAS PELO (33) 3277-3030.

GARFO 29" MTB COM SUSPENSÃO XCM 100MM AHEAD | 100X9MM PT

Característica Garfo suspensão Suntour | Crown AC4C
Lower Leg alumínio | Trava remota no guidão
- pistão | Trava em alumínio com abraçadeira
- Suntour | Funcionamento a mola | Suporte
do freio Post Mount 160mm | Curso de
100mm | Eixo de 9mm | OLD 100mm | Off
set: 46 mm | Espiga aço ahead set (diâmetro
28.6mm) | Comprimento da espiga 250mm

Material Alumínio

Peso 2950 gr - incluindo trava e cabo

Embalagem 10 peças

20492

AVISOS

USE APENAS PARA:

- LAZER
- CROSS COUNTRY



GARFO 29" MTB COM SUSPENSÃO XCR AIR AHEAD 9MM PT

Característica Garfo 29" MTB Suntour XCR 32:
Garfo suspensão Suntour | Crown ACA4
| Lower Leg Magnesium | Canela 32 | Trava
remota no guidão - Pistão | Trava em alumínio
com abraçadeira - Suntour | Funcionamento a ar
| Regulagem de Rebound | Suporte do freio Post
Mount 160 mm | Curso de 100 mm | Eixo de 9 mm
| OLD 100 mm | Espiga em aço aheadset
(diâmetro 28.6 mm / diâmetro 1.1/8) | Comprimento
da espiga 250 mm

Material Alumínio

Peso 2512 gr - incluindo trava

Embalagem 10 peças

21816

AVISOS

USE APENAS PARA:

- LAZER
- CROSS COUNTRY



GARFO 29" MTB COM SUSPENSÃO AXON AHEAD 15MM BOOST PT

Característica Garfo aro 29" com suspensão Suntour Axon Boost: Offset 46 mm | Boost OLD 110 mm | Espiga Tapered (1.5"to1-1/8") | Lado direito com Pistão RLRC, LORC | Trava remota | Lado esquerdo câmara de ar | Crown série A6000/ Forjada oca | Pitch 133mm | Lower Leg Magnesium | Freio Postmount | Compatível com discos até 180 mm | Blocação Axle ø15-110 15QLC2-110 | Cross Country

Material Alumínio

Peso 1942 gr (suspensão, blocagem, trava remota e paralamas)

Embalagem 10 peças

22714



AVISOS

USE APENAS PARA:

- LAZER
- CROSS COUNTRY

GARFO 29 MTB C/SUSP XCM34 100MM. TAP. 110X15MM PT

Característica Canela em aço 34mm
Lower leg em alumínio
Crown em alumínio
Boost
Off set 51mm
Regulagem de preload
Suporte de freio post mount
Compatível com disco 160mm post mount
Tamanho máximo do disco 203mm
Trava remota
Curso de 100mm
Eixo de 15mm | Old 110mm
Espiga em aço over ahead set 1.5" X 1-1/8" (diâmetro superior 28.6mm / diâmetro inferior 40mm / comprimento 270mm)
Compatível com e-bike
Casual mtb

Material Alumínio

Peso 3420g

Embalagem 10 unidades

21720



AVISOS

USE APENAS PARA:

- LAZER
- CROSS COUNTRY

FOTOS MERAMENTE ILUSTRATIVAS. AS INFORMAÇÕES/CONFIGURAÇÕES DE PRODUTOS PODERÃO SOFRER ALTERAÇÕES SEM AVISO PRÉVIO.

ENTRE EM CONTATO COM O SEU CONSULTOR OU FALE COM O NOSSO TIME DE TELEVENDAS PELO (33) 3277-3030.

GARFO 29 MTB C/SUSP XCM34 120MM. TAP. 110X15MM PT

Característica

- Canela em aço 34mm
- Lower leg em alumínio
- Crown em alumínio
- Boost
- Off set 51mm
- Regulagem de preload
- Suporte de freio post mount
- Compatível com disco 160mm post mount
- Tamanho máximo do disco 203mm
- Trava remota
- Curso de 120mm
- Eixo de 15mm | Old 110mm
- Espiga em aço over ahead set 1.5" X 1-1/8" (diâmetro superior 28.6mm / diâmetro inferior 40mm / comprimento 270mm)
- Compatível com e-bike
- Casual mtb

Material Alumínio

Peso 3420g

Embalagem 10 unidades

21721

AVISOS

USE APENAS PARA:

- LAZER
- CROSS COUNTRY



GARFO 29 MTB C/SUSP XCM32 100MM. TAP. 110X15MM PT

Característica

- Canela em aço 32mm
- Lower leg em alumínio
- Crown em alumínio
- Boost
- Off set 47mm
- Regulagem de preload
- Suporte de freio post mount
- Compatível com disco 160mm post mount
- Tamanho máximo do disco 180mm
- Trava remota
- Curso de 100mm
- Eixo de 15mm | Old 110mm
- Espiga em aço over ahead set 1.5" X 1-1/8" (diâmetro superior 28.6mm / diâmetro inferior 40mm / comprimento 270mm)
- Casual mtb

Material Alumínio / Aço

Peso 3150g

Embalagem 10 peças

21722



AVISOS

USE APENAS PARA:

- LAZER
- CROSS COUNTRY

SANITOUR

GARFO 29 MTB C/SUSP XCM 100MM. AHEAD 100X9MM PT

Característica	Canela em aço 30mm Lower leg em alumínio Crown em alumínio Off set 46mm Regulagem de preload Suporte de freio post mount Compatível com disco 160mm post mount Tamanho máximo do disco 180mm Trava remota Curso de 100mm Eixo de 9mm Old 100mm Espiga em aço over ahead set 1-1/8" (diâmetro 28.6mm / comprimento 255mm) Casual mtb
Material	Alumínio
Peso	2738g
Embalagem	10 peças 21723



AVISOS

USE APENAS PARA:

- LAZER
- CROSS COUNTRY

GARFO 29 MTB C/SUSP XCT 100MM. AHEAD 100X9MM PT

Característica	Canela em aço 30mm Lower leg em alumínio Crown em alumínio Off set 46mm Regulagem de preload Suporte de freio post mount Compatível com disco 160mm post mount Tamanho máximo do disco 180mm Trava manual Curso de 100mm Eixo de 9mm Old 100mm Espiga em aço over ahead set 1-1/8" (diâmetro 28.6mm / comprimento 255mm) Casual mtb
Material	Alumínio/ Aço
Peso	2900g
Embalagem	10 peças 21724



AVISOS

USE APENAS PARA:

- LAZER
- CROSS COUNTRY

FOTOS MERAMENTE ILUSTRATIVAS. AS INFORMAÇÕES/CONFIGURAÇÕES DE PRODUTOS PODERÃO SOFRER ALTERAÇÕES SEM AVISO PRÉVIO.

ENTRE EM CONTATO COM O SEU CONSULTOR OU FALE COM O NOSSO TIME DE TELEVENDAS PELO (33) 3277-3030.

GARFO 29 MTB C/SUSP XCT 80MM. AHEAD 100X9MM PT

Característica	Canela em aço 30mm Lower leg em alumínio Crown em alumínio Off set 46mm Regulagem de preload Suporte de freio post mount Compatível com disco 160mm post mount Tamanho máximo do disco 180mm Trava manual Curso de 80mm Eixo de 9mm Old 100mm Espiga em aço over ahead set 1-1/8" (diâmetro 28.6mm / comprimento 255mm) Casual mtb
----------------	---

Material Alumínio/ Aço

Peso 2900g

Embalagem 10 peças

21725

AVISOS

USE APENAS PARA:

- LAZER
- CROSS COUNTRY



GARFO 29 MTB C/SUSP XCE 80MM. AHEAD 100X9MM PT

Característica	Canela em aço 28mm Lower leg em alumínio Crown em alumínio Off set 46mm Regulagem de preload Suporte de freio post mount Compatível com disco 160mm post mount Tamanho máximo do disco 180mm Curso de 80mm Eixo de 9mm Old 100mm Espiga em aço over ahead set 1-1/8" (diâmetro 28.6mm / comprimento 255mm) Casual mtb
----------------	---

Material Alumínio

Peso 2660g

Embalagem 10 peças

21726

AVISOS

USE APENAS PARA:

- LAZER
- CROSS COUNTRY



FOTOS MERAMENTE ILUSTRATIVAS. AS INFORMAÇÕES/CONFIGURAÇÕES DE PRODUTOS PODERÃO SOFRER ALTERAÇÕES SEM AVISO PRÉVIO.

ENTRE EM CONTATO COM O SEU CONSULTOR OU FALE COM O NOSSO TIME DE TELEVENDAS PELO (33) 3277-3030.

GARFO 29 C/SUSP AXON32RLRC 100MM. TAP. 110X15MM PT

- Característica
- Boost (15x110mm)
 - Trava remota
 - Lower leg em magnésio (diâmetro 32)
 - Curso do amortecedor 100mm
 - Medida máxima do pneu 2.40
 - Off set 46mm
 - Espiga tapered (1.5" X 1.1/8") Alumínio
 - Comprimento da espiga 280mm
 - Lado direito pistão rlrc
 - Lado esquerdo air spring
 - Crown alumínio
 - Suporte de freio post mount 160mm direct
 - Tamanho máximo do disco 180mm
 - Blocação compatível \varnothing 15-110 15qlc2-110
 - Acompanha paralamas
 - Recomendada para cross country

Material Alumínio

Peso 1900gr - peso da suspensão e eixo

Embalagem 10 peças

23738



AVISOS

USE APENAS PARA:

- LAZER
- CROSS COUNTRY

GARFO 29 C/SUSP DH RUX38R2C2 200MM. TAP. 110X20MM PT

- Característica
- Boost (20x110mm)
 - Lower Leg Em Magnésio (Diâmetro 38)
 - Curso Do Amortecedor 200mm
 - Crown Oco
 - Medida Máxima Do Pneu 2.60
 - Off Set 50 Mm
 - Espiga Tapered (1.5" X 1.1/8") Alumínio
 - Comprimento Da Espiga 245mm
 - Lado Direito Pistão R2c2-Pcs
 - Lado Esquerdo Air Spring
 - Crown Forjado Oco
 - Suporte De Freio Post Mount 203mm Direct
 - Tamanho Máximo Do Disco 203mm
 - Blocação Compatível \varnothing 20-110 Tipo De Ferramenta/ Sem Ferramenta
 - Acompanha Paralamas
 - Recomendada Para Downhill E Freeride
 - Compatível Com E-Bike

Material Alumínio

Peso 2750gr - peso da suspensão e eixo

Embalagem 10 peças

21773



AVISOS

USE APENAS PARA:

- LAZER
- CROSS COUNTRY

FOTOS MERAMENTE ILUSTRATIVAS. AS INFORMAÇÕES/CONFIGURAÇÕES DE PRODUTOS PODERÃO SOFRER ALTERAÇÕES SEM AVISO PRÉVIO.

ENTRE EM CONTATO COM O SEU CONSULTOR OU FALE COM O NOSSO TIME DE TELEVENDAS PELO (33) 3277-3030.

GARFO 29 C/SUSP DUROLUX38R2C2 160MM. TAP. 110X20MM PT

Característica	Boost (20x110mm) Lower Leg Em Magnésio (Diâmetro 38) Curso Do Amortecedor 160mm/170mm/180mm Medida Máxima Do Pneu 2.60 Tecnologia Eq (Equalizer) Off Set 44 Mm Espiga Tapered (1.5" X 1.1/8") Alumínio Comprimento Da Espiga 270mm Lado Direito Pistão R2c2-Pcs Lado Esquerdo Air Spring Crown R2c2-Pcs Forjado Oco Suporte De Freio Post Mount 203mm Direct Tamanho Máximo Do Disco 220mm Blocação Compatível Ø20-110 20lh-110 Acompanha Paralamas Recomendada Para Enduro E Freeride Compatível Com E-Bike
Material	Alumínio
Peso	2650gr - peso da suspensão 160mm e eixo
Embalagem	10 peças



160MM: 21775

170MM: 21776

180MM: 21777

AVISOS

USE APENAS PARA:

- LAZER
- CROSS COUNTRY

GARFO 29 C/SUSP DUROLUX36R2C2 150MM. TAP. 110X15MM PT

Característica	Boost (15x110mm) Lower Leg Em Magnésio (Diâmetro 36) Curso Do Amortecedor 150mm/160mm Crown Oco Medida Máxima Do Pneu 2.60 Tecnologia Eq (Equalizer) Espiga Tapered (1.5" X 1.1/8") Alumínio Comprimento Da Espiga 270mm Lado Direito Pistão R2c2-Pcs Lado Esquerdo Air Spring Crown R2c2-Pcs Forjado Oco Suporte De Freio Post Mount 180mm Direct Tamanho Máximo Do Disco 203mm Blocação Compatível Ø15-110 15qlc2ti-110 Acompanha Paralamas Recomendada Para Enduro E Freeride Compatível Com E-Bike
Material	Alumínio
Peso	2260gr
Embalagem	10 peças



150MM: 21778

160MM: 21779

AVISOS

USE APENAS PARA:

- LAZER
- CROSS COUNTRY

SANTOUR

FOTOS MERAMENTE ILUSTRATIVAS. AS INFORMAÇÕES/CONFIGURAÇÕES DE PRODUTOS PODERÃO SOFRER ALTERAÇÕES SEM AVISO PRÉVIO.

ENTRE EM CONTATO COM O SEU CONSULTOR OU FALE COM O NOSSO TIME DE TELEVENDAS PELO (33) 3277-3030.

GARFO 29 C/SUSP AXON34RLRC 100MM. CARBON TAP. 100X15MM

Característica	Eixo (100x15mm) Trava Remota Lower Leg Em Magnésio (Diâmetro 34) Curso Do Amortecedor 100mm Medida Máxima Do Pneu 2.40 Tecnologia Eq (Equalizer) Off Set 51mm Espiga Tapered (1.5" X 1.1/8") Carbono - Acompanha Aranha Comprimento Da Espiga 270mm Lado Direito Pistão Rlrc-Pcs Lado Esquerdo Air Spring Crown Oco Em Carbono Suporte De Freio Post Mount 160mm Direct Tamanho Máximo Do Disco 180mm Blocagem Compatível Ø15-100 15qlc2ti-110 Acompanha Paralama Recomendada Para Cross Country E All Mountain
Material	Alumínio/ Carbono
Peso	1650gr - peso da suspensão 100mm e eixo
Embalagem	10 peças



100MM: 21781 110MM: 21785 120MM: 21786

AVISOS

USE APENAS PARA:

- LAZER
- CROSS COUNTRY

GARFO 29 C/SUSP AION36RLR TAP. 110X15MM PT

Característica	<ul style="list-style-type: none"> • Boost (15x110mm) • Lower Leg Em Magnésio (Diâmetro 36) • Curso Do Amortecedor 140mm/150mm/160mm • Trava Remota • Medida Máxima Do Pneu 2.40 • Tecnologia Eq (Equalizer) • Off Set 44 Mm • Espiga Tapered (1.5" X 1.1/8") Alumínio • Comprimento Da Espiga 270mm • Lado Direito Pistão Rlrc-Pcs • Lado Esquerdo Air Spring • Crown Alumínio Forjado • Suporte De Freio Post Mount 180mm Direct • Tamanho Máximo Do Disco 220mm • Blocagem Compatível Ø15-110 15lh-110 • Acompanha Paralama • Recomendada Para Enduro • Compatível Com E-Bike
Material	Alumínio
Peso	2350gr - peso da suspensão 120mm e eixo
Embalagem	10 peças



140MM: 21782

150MM: 21783

160MM: 21784

AVISOS

USE APENAS PARA:

- LAZER
- CROSS COUNTRY

FOTOS MERAMENTE ILUSTRATIVAS. AS INFORMAÇÕES/CONFIGURAÇÕES DE PRODUTOS PODERÃO SOFRER ALTERAÇÕES SEM AVISO PRÉVIO.

ENTRE EM CONTATO COM O SEU CONSULTOR OU FALE COM O NOSSO TIME DE TELEVENDAS PELO (33) 3277-3030.

GARFO 29 C/SUSP AXON34RLRC ELITE 100MM. TAP. 110X15MM P

Característica	<ul style="list-style-type: none"> • Boost (15x110mm) • Lower Leg Em Magnésio (Diâmetro 34) • Curso Do Amortecedor 100mm/110mm/120mm • Crown Oco • Medida Máxima Do Pneu 2.40 • Tecnologia Eq (Equalizer) • Off Set 44 Mm E 51mm • Espiga Tapered (1.5" X 1.1/8") Alumínio • Comprimento Da Espiga 270mm • Lado Direito Pistão Rlrc-Pcs • Lado Esquerdo Air Spring • Crown Alumínio Forjado Oco • Suporte De Freio Post Mount 160mm Direct • Tamanho Máximo Do Disco 180mm • Blocagem Compatível Ø15-110 15qlc2ti-110 • Acompanha Paralama • Recomendada Para Cross Country E All Mountain • Trava Remota – Acompanha Suspensão
Material	Alumínio
Peso	1750gr - peso da suspensão 100mm e eixo
Embalagem	10 peças



100MM: 21788 110MM: 21789 120MM: 21790

AVISOS

USE APENAS PARA:

- LAZER
- CROSS COUNTRY

GARFO 29 C/SUSP AXON34RLRC 100MM. TAP. 110X15MM PT

Característica	<ul style="list-style-type: none"> • Boost (15x110mm) • Trava Remota • Lower Leg Em Magnésio 34 • Curso Do Amortecedor 100mm/120mm • Medida Máxima Do Pneu 2.40 • Off Set 44 Mm E 51mm • Espiga Tapered (1.5" X 1.1/8") Alumínio • Comprimento Da Espiga 270mm • Lado Direito Pistão Rlrc-Pcs • Lado Esquerdo Air Spring • Crown Alumínio • Lower Leg Em Magnésio • Suporte De Freio Post Mount 180mm Direct • Tamanho Máximo Do Disco 203mm • Blocagem Compatível Ø15-110 15qlc2-110 • Acompanha Paralama • Recomendada Para Cross Country E All Mountain • Compatível Com E-Bike
Material	Alumínio
Peso	2050gr - peso da suspensão 100mm e blocagem
Embalagem	10 peças



100MM: 21791

120MM: 21792

AVISOS

USE APENAS PARA:

- LAZER
- CROSS COUNTRY

SR SUNTOUR

FOTOS MERAMENTE ILUSTRATIVAS. AS INFORMAÇÕES/CONFIGURAÇÕES DE PRODUTOS PODERÃO SOFRER ALTERAÇÕES SEM AVISO PRÉVIO.

ENTRE EM CONTATO COM O SEU CONSULTOR OU FALE COM O NOSSO TIME DE TELEVENDAS PELO (33) 3277-3030.

GARFO 29 C/SUSP XCR34RLR 100MM. TAP. 110X15MM PT

Característica

- Boost (15x110mm)
- Lower Leg Em Magnésio (Diâmetro 34)
- Trava Remota – Acompanha Trava
- Curso Do Amortecedor 100mm/120mm
- Medida Máxima Do Pneu 2.40
- Tecnologia 2cr (Compression Adjust)
- Off Set 51mm
- Espiga Tapered (1.5" X 1.1/8") Alumínio
- Comprimento Da Espiga 270mm
- Lado Direito Pistão 2cr
- Lado Esquerdo Air Spring
- Crown Ac4c
- Suporte De Freio Post Mount 180mm Direct
- Tamanho Máximo Do Disco 203mm
- Blocação Compatível Ø15-110 15lh-110
- Recomendada Para Cross Country

Material

Alumínio

Peso

2550gr - peso da suspensão 100mm e eixo

Embalagem

10 peças



100MM: 21797 120MM: 21798

AVISOS

USE APENAS PARA:

- LAZER
- CROSS COUNTRY

GARFO 29 C/SUSP XCR32RLR-AIR 120MM. TAP. 110X15MM PT

Característica

- Boost (15x110mm)
- Lower Leg Em Magnésio (Diâmetro 32)
- Trava Remota
- Curso Do Amortecedor 100mm/120mm
- Medida Máxima Do Pneu 2.40
- Off Set 46mm
- Espiga Tapered (1.5" X 1.1/8") Alumínio
- Comprimento Da Espiga 270mm
- Lado Direito Pistão Rlr
- Lado Esquerdo Air Spring
- Crown Ac4c
- Suporte De Freio Post Mount 160mm Direct
- Tamanho Máximo Do Disco 180mm
- Blocação Compatível Ø15-110 15qlc32-110
- Recomendada Para Cross Country

Material

Alumínio

Peso

2340gr - peso da suspensão 120mm e eixo

Embalagem

10 peças



100MM: 21799

120MM: 21800

AVISOS

USE APENAS PARA:

- LAZER
- CROSS COUNTRY

FOTOS MERAMENTE ILUSTRATIVAS. AS INFORMAÇÕES/CONFIGURAÇÕES DE PRODUTOS PODERÃO SOFRER ALTERAÇÕES SEM AVISO PRÉVIO.

ENTRE EM CONTATO COM O SEU CONSULTOR OU FALE COM O NOSSO TIME DE TELEVENDAS PELO (33) 3277-3030.

GARFO 29 C/SUSP XCR32RLR-COIL 100MM. TAP. 110X15MM PT

- Característica
- Boost (15x110mm)
 - Lower Leg Em Magnésio (Diâmetro 32)
 - Trava Remota – Acompanha Trava
 - Curso Do Amortecedor 100mm/120mm
 - Medida Máxima Do Pneu 2.40
 - Off Set 46mm
 - Espiga Tapered (1.5" X 1.1/8") Alumínio
 - Comprimento Da Espiga 270mm
 - Lado Direito Pistão Rlr
 - Lado Esquerdo Coil C/ Ajuste De Pré-Carga
 - Crown Ac4c
 - Suporte De Freio Post Mount 160mm Direct
 - Tamanho Máximo Do Disco 180mm
 - Blocagem Compatível Ø15-110 15qlc32-110
 - Recomendada Para Cross Country

Material Alumínio

Peso 2450gr - peso da suspensão 100mm e eixo

Embalagem 10 peças



100MM: 21801 120MM: 21802

AVISOS

USE APENAS PARA:

- LAZER
- CROSS COUNTRY

GARFO 29 C/SUSP XCR32RLR-COIL 100MM. 100X15MM PT

- Característica
- Eixo (15x100mm)
 - Lower Leg Em Magnésio (Diâmetro 32)
 - Trava Remota
 - Curso Do Amortecedor 100mm
 - Off Set 46mm
 - Espiga Aço 1.1/8"
 - Comprimento Da Espiga 255mm
 - Lado Direito Pistão Rlr
 - Lado Esquerdo Coil C/ Ajuste De Pré-Carga
 - Crown Ac4c
 - Suporte De Freio Post Mount 160mm Direct
 - Tamanho Máximo Do Disco 180mm
 - Blocagem Compatível Ø15-100 15qlc32
 - Recomendada Para Cross Country

Material Alumínio

Peso 2700gr - peso da suspensão 100mm e eixo

Embalagem 10 peças

21803



AVISOS

USE APENAS PARA:

- LAZER
- CROSS COUNTRY

SANTOUR

GARFO 29 C/SUSP XCR32-ATB-RLR AIR 100MM. 100X9MM PT

Característica

- Garfo Aro 29 Sr Suntour Xcr 32 Atb Air Em Alumínio
- Eixo 9x100mm
- Lower Leg Em Magnésio (Diâmetro 32)
- Trava Remota
- Curso Do Amortecedor 100mm
- Medida Máxima Do Pneu 2.40
- Off Set 44mm
- Espiga Tapered (1.5" X 1.1/8") Aço
- Comprimento Da Espiga 270mm
- Lado Direito Pistão Rlr
- Lado Esquerdo Air Spring
- Crown Ac4c
- Suporte De Freio Post Mount 160mm Direct
- Tamanho Máximo Do Disco 180mm
- Recomendada Para Cross Country
- Compatível Com E-Bike

Material

Alumínio

Peso

2680gr - peso da suspensão 100m

Embalagem

10 peças

21804



AVISOS

USE APENAS PARA:

- LAZER
- CROSS COUNTRY

GARFO 29 C/SUSP XCR32-ATB-RLR- COIL100MM. TAP. 100X9MM P

Característica

- Eixo 9x100mm
- Lower Leg Em Magnésio (Diâmetro 32)
- Trava Remota – Acompanha Trava
- Curso Do Amortecedor 100mm
- Medida Máxima Do Pneu 2.40
- Off Set 44mm
- Espiga Tapered (1.5" X 1.1/8") Aço
- Comprimento Da Espiga 270mm
- Lado Direito Pistão Rlr
- Lado Esquerdo Coil C/ Ajuste De Pré-Carga
- Crown Ac4c
- Suporte De Freio Post Mount 160mm Direct
- Tamanho Máximo Do Disco 180mm
- Recomendada Para Cross Country
- Compatível Com E-Bike

Material

Alumínio

Peso

2660gr - peso da suspensão 100mm

Embalagem

10 peças

21805



AVISOS

USE APENAS PARA:

- LAZER
- CROSS COUNTRY

FOTOS MERAMENTE ILUSTRATIVAS. AS INFORMAÇÕES/CONFIGURAÇÕES DE PRODUTOS PODERÃO SOFRER ALTERAÇÕES SEM AVISO PRÉVIO.

ENTRE EM CONTATO COM O SEU CONSULTOR OU FALE COM O NOSSO TIME DE TELEVENDAS PELO (33) 3277-3030.

REMOTE DUAL-L 2C-22

- Característica
- Alavanca De Bloqueio Duplo Remoto
 - Construção Em Alumínio
 - Diâmetro 22.2mm
 - Acompanha Cabo Inoxidável
 - Design Ergonômico
 - Abraçadeira Articulada
 - Instalação Do Lado Esquerdo
 - Compatível Com Todos Os Garfos E Shock Sr Suntour

Material Alumínio

Peso 83g - peso do remote com cabo

Embalagem 10 peças

21815



REMOTE SINGLE-U 3C-22

- Característica
- Alavanca De Bloqueio Remoto
 - Construção Em Alumínio
 - Diâmetro 22.2mm
 - Acompanha Cabo Inoxidável
 - Design Ergonômico
 - Abraçadeira Articulada
 - Ambidestra
 - Compatível Com Todos Os Garfos Sr Suntour

Material Alumínio

Peso 40g - peso do remote com cabo

Embalagem 10 peças

21817



REMOTE SINGLE-U 2C-32

- Característica
- Alavanca De Bloqueio Remoto
 - Construção Em Alumínio
 - Diâmetro 31.8mm
 - Acompanha Cabo Inoxidável
 - Design Ergonômico
 - Abraçadeira Articulada
 - Ambidestra
- Compatível Com Todos Os Garfos Sr Suntour

Material Alumínio

Peso 43g - peso do remote com cabo

Embalagem 10 peças

21818



REMOTE SINGLE-L 2C-22

- Característica
- Alavanca De Bloqueio Remoto
 - Construção Em Alumínio
 - Diâmetro 22.2mm
 - Acompanha Cabo Inoxidável
 - Design Ergonômico
 - Abraçadeira Articulada
 - Instalação Do Lado Esquerdo
 - Compatível Com Todos Os Garfos Sr Suntour

Material Alumínio

Peso 48g - peso do remote com cabo

Embalagem 10 peças

21819





TRUE[®]
SPORT



TRANSBIKE TRUE POP SEM ABRAÇADEIRA

Modelo	TR-40
Característica	Transporta 2 Bicicletas Sem abraçadeira
Carga Máxima	34 kg
Peso	3 kg
Embalagem	05 peças
	19037



TRANSBIKE FIRE AÇO COM SEPARADOR COM BORRACHÃO TRUE SPORTS 3 BIKES

Modelo	Transbike do reboque linha true sports
Material	Aço
Característica	<ul style="list-style-type: none">• Transbike true modelo em "v" da bola do reboque• Fitas de fixação reguláveis• Base de apoio em borracha com prendedores• Construção em aço carbono• Pintura epóx• Braços retráteis• Suporte para 3 bicicletas, sendo: 02 adultas e 01 infantil• Trava de segurança• Garras com proteção para o veículo
	Medidas 85 x 48 x 52cm
Carga Máxima	45 kg
Peso	4750 kg
Embalagem	01 peças
	22559



FOTOS MERAMENTE ILUSTRATIVAS. AS INFORMAÇÕES/CONFIGURAÇÕES DE PRODUTOS PODERÃO SOFRER ALTERAÇÕES SEM AVISO PRÉVIO.

ENTRE EM CONTATO COM O SEU CONSULTOR OU FALE COM O NOSSO TIME DE TELEVENDAS PELO (33) 3277-3030.









TRUE
SPORT



RODINHA LATERAL BICICLETA ARO 16 TRUE

Modelo	Roda lateral para bicicleta aro 16 linha true
Material	Aço
Característica	<ul style="list-style-type: none"> • Rodinha lateral p/ bicicleta aro 16" • Haste em aço • Rodinha de nylon rígido • Fixação das haste no eixo traseiro • Fixação das rodinhas por parafuso com porca travante • Trava de segurança para fixação da haste no eixo • Compatível com eixo de 9mm
Peso	514g (conjunto)
Embalagem	30 peças

	22668		22672
	22669		22673
	22670		22674
	22671		22684



SUPORTE VERTICAL DE PAREDE TRUE

Modelo	Suporte vertical de parede linha true
Material	Aço
Característica	<ul style="list-style-type: none"> • Suporte vertical de parede para bicicletas • Aço de alta resistência • Protetor de aro • Acompanha jogo de parafusos e buchas
Observação	Recomendamos o uso com pneus ≤ 2.20 (Cravo baixo)
Peso	334gr - peso do suporte c/ parafusos e buchas
Embalagem	30 peças

22586



FOTOS MERAMENTE ILUSTRATIVAS. AS INFORMAÇÕES/CONFIGURAÇÕES DE PRODUTOS PODERÃO SOFRER ALTERAÇÕES SEM AVISO PRÉVIO.

ENTRE EM CONTATO COM O SEU CONSULTOR OU FALE COM O NOSSO TIME DE TELEVENDAS PELO (33) 3277-3030.

TRANSBIKE FIRE ALUMINIO TRUE SPORTS - P/ 2 BIKES

Modelo	Transbike Fire True Sports
Característica	Alumínio Muito leve e resistente Suporte para 02 bicicletas Presilhas para fixação em borracha Base de apoio do carro emborrachada Suporte de regulagem com várias posições
Carga Máxima	45 kg
Peso	2350 kg
Embalagem	05 peças
	22561



CREMALHEIRA PAR TRUE

Modelo	CREM-001
Característica	Cremalheira par
Embalagem	25 peças

19052



KIT SUPORTE BORRACHA
MODELO 01 TRUE

Modelo	KIT BORR 1
Característica	Para tubos de 1"
Embalagem	25 peças

19053



KIT SUPORTE BORRACHA
MODELO 02 TRUE

Modelo	KIT BORR 2
Característica	Para tubos 7/8
Embalagem	25 peças

19054

FOTOS MERAMENTE ILUSTRATIVAS. AS INFORMAÇÕES/CONFIGURAÇÕES DE PRODUTOS PODERÃO SOFRER ALTERAÇÕES SEM AVISO PRÉVIO.

ENTRE EM CONTATO COM O SEU CONSULTOR OU FALE COM O NOSSO TIME DE TELEVENDAS PELO (33) 3277-3030.



SUPOORTE HORIZONTAL DE PAREDE SEM ALÇA TRUE

Característica	Ótimo para armazenamento de bicicleta em casa, garagem ou apartamento Fácil de instalar, construído com aço de alta resistência Acompanha 3 parafusos e 3 buchas para fixação Construção em aço carbono e pintura epóxi Contém argola acoplada ao suporte para fixação do cadeado
Composição	Suporta com segurança até 2 bikes, ou peso total de até 30 kg
Embalagem	01 peça
Dimensões	(A x L x C cm): 28x30x50

22552

TRUE
SPORT



TRANSBIKE ENGATE BOLA C/SEP. TIRA PT TRUE P/ 3 BIKES

Característica	<ul style="list-style-type: none"> transbike engate true sports aço com separador p/ 03 bicicletas modelo em "v" braço articulado e retrátil resistente fácil instalação presilhas para fixação em borracha pintura epóxi peso máximo recomendado 45kg acompanha fitas e garras para fixação acompanha manual p/ instalação
----------------	---

Material	Aço
Embalagem	01 peça
Peso	4.800 kg
Recomendação de uso	<ul style="list-style-type: none"> transbike para 3 bicicletas: 02 bicicletas adulto e 01 bicicleta infantil fixado na bola do reboque

22679



SUPOORTE HORIZONTAL COM ALÇA TRUE

Característica	Resistente e de fácil manuseio; prático e seguro Ótimo para armazenamento de bicicleta em casa, garagem ou apartamento Fácil de instalar, construído com aço de alta resistência Acompanha 3 parafusos e 3 buchas para fixação Construção em aço carbono e pintura epóxi Contém argola acoplada ao suporte para fixação do cadeado
Composição	Suporta com segurança até 2 bikes, ou peso total de até 30 kg Contém duas alças para melhor fixação das bicicletas
Embalagem	01 peça
Dimensões	(A x L x C cm): 28x30x50

22677

22553



FOTOS MERAMENTE ILUSTRATIVAS. AS INFORMAÇÕES/CONFIGURAÇÕES DE PRODUTOS PODERÃO SOFRER ALTERAÇÕES SEM AVISO PRÉVIO.

ENTRE EM CONTATO COM O SEU CONSULTOR OU FALE COM O NOSSO TIME DE TELEVENDAS PELO (33) 3277-3030.



TRANSBIKES POP SEM SEPARADOR 2 BIKES TRUE

Característica	Contém fitas de fixação já instaladas, modelo pré-montado, facilitando a montagem em seu veículo; todas com uma ótima qualidade, com sistema de fixação por meia argola Este modelo de Transbike não acompanha separador Construção em aço carbono e pintura epóx
Composição	4 fitas de fixação com meia argola Acompanha também mangueira para não riscar o quadro Suporta 2 bikes ou peso máximo de até 30 kg
Embalagem	01 peça
Dimensões	Largura: 50cm Profundidade 55 cm Altura 60 cm

22555



TRANSBIKE COM SEPARADOR 2 BIKES TRUE

Característica	Contém fitas de fixação já instaladas, modelo pré-montado, facilitando a montagem em seu veículo; todas com uma ótima qualidade, com sistema de fixação por meia argola Este modelo de Transbike acompanha separador Construção em aço carbono e pintura epóx
Composição	4 fitas de fixação com meia argola Acompanha também mangueira para não riscar o quadro Suporta 2 bikes ou peso máximo de até 30 kg Alojamento/separador para apoio da bike
Embalagem	01 peça
Dimensões	Largura: 50cm Profundidade: 55 cm Altura: 60 cm

22556



TRANSBIKE SAPATA 2 BIKES TRUE

Característica	Contém fitas de fixação já instaladas, modelo pré-montado, facilitando a montagem em seu veículo; todas com uma ótima qualidade, com sistema de fixação por meia argola Este modelo de Transbike acompanha separador Sapata articulável e base de apoio do veículo em borracha Construção em aço carbono e pintura epóx
Composição	4 fitas de fixação com meia argola Acompanha também mangueira para não riscar o quadro Suporta 2 bikes ou peso máximo de até 30 kg Alojamento/separador para apoio da bike
Embalagem	01 peça
Dimensões	Profundidade: 55 cm Altura: 60 cm Largura: 50 cm

22557



TRANSBIKE FIRE AÇO COM SEPARADOR COM BORRACHÃO 3 BIKES TRUE

Característica	Contém fitas de fixação já instaladas, modelo pré-montado, facilitando a montagem em seu veículo; todas com uma ótima qualidade, com sistema de fixação por meia argola Este modelo de Transbike acompanha separador Sapata articulável e base de apoio do veículo em borracha ou espuma Construção em aço carbono e pintura epóx
Composição	6 fitas de fixação com meia argola Acompanha também mangueira para não riscar o quadro Suporta 3 bikes ou peso máximo de até 45 kg Alojamento/separador para apoio da bike
Embalagem	01 peça
Dimensões	Profundidade: 60 cm Largura: 45 cm Altura: 65cm

22558

TRUE
SPORT

TRANSBIKE FIRE AÇO C/SEPARADOR C/ ESPUMA TRUE

Característica	<ul style="list-style-type: none"> • transbike fire true sports • aço • com separador p/ 02 ou 3 bicicletas • base de apoio do carro com protetor de espuma • leve e resistente • presilhas para fixação em borracha • suporte de regulagem em várias posições • peso máximo recomendado 45kg p/ transbike p/ 03 bicicletas • peso máximo recomendado 35kg p/ transbike p/ 02 bicicletas
----------------	---

Material	Aço
Embalagem	01 peça
Peso	3.200 kg

Recomendação de uso	<ul style="list-style-type: none"> • transbike para 3 bicicletas: 02 bicicletas adulto e 01 bicicleta infantil • fixado na tampa do porta-mala"
---------------------	---

2 BIKES 22675

3 BIKES 22676



TRANSBIKE SAPATA C/ SEPARADOR C/ ESPUMA TRUE P/ 2 BIKES

Característica	<ul style="list-style-type: none"> • transbike sapata true sports • aço • com separador p/ 02 bicicletas • base de apoio do carro com protetor de espuma • leve e resistente • presilhas para fixação em borracha • pintura epóx • suporte de regulagem em várias posições • peso máximo recomendado 35kg • acompanha fitas e garras para fixação • acompanha manual p/ instalação
----------------	---

Material	Aço
Embalagem	01 peça
Peso	2.250kg

Recomendação de uso	<ul style="list-style-type: none"> • fixado na tampa do porta-mala
---------------------	---

22682

TRANSBIKE POP C/SEPARADOR PT C/ES- PUMA TRUE P/ 2 BIKES

Característica	<ul style="list-style-type: none"> • transbike pop true sports • aço • com separador p/ 02 bicicletas • base de apoio do carro com protetor de espuma • leve e resistente • presilhas para fixação em borracha • pintura epóx • suporte de regulagem em várias posições • peso máximo recomendado 35kg • acompanha fitas e garras para fixação • acompanha manual p/ instalação
----------------	--

Material	Aço
Embalagem	01 peça
Peso	2.400kg

Recomendação de uso	<ul style="list-style-type: none"> • fixado na tampa do porta-mala
---------------------	---

22683



TRANSBIKE ENGATE BOLA 3 BIKES TRUE

Característica	Transbike modelo "V" Contém fitas de fixação já instaladas, modelo pré-montado, facilitando a montagem em seu veículo; todas com uma ótima qualidade, com sistema de fixação por meia argola Este modelo de Transbike acompanha separador Sapata articulável e base de apoio do veículo em borracha ou espuma Construção em aço carbono e pintura epóx Braços retráteis e com encaixe
Composição	2 fitas de fixação com meia argola Acompanha também mangueira para não riscar o quadro Suporta 3 bikes ou peso máximo de até 55 kg Alojamento/separador para apoio da bike Trava central com furação para cadeado Trava inferior com rosca
Embalagem	01 peça
Dimensões	22559



ROLO DE TREINO TRUE

Característica	Para pessoas até 100kg Regulagem de altura conforme o aro da bicicleta Não indicado para eixo passante Fixação no eixo traseiro Para aro 26 - 27,5 - 29 - 700 (speed) Para bicicletas com ou sem blocagem Construção em aço carbono pintura epóx
Composição	Com 2 rolamentos
Embalagem	01 peça
Dimensões	Altura: 65 cm Largura: 46cm
	22560



SUPORTE EXPOSITOR BICICLETA RODA TRASEIRA TRUE

Característica	Suporte confeccionado para roda traseira Construção em aço carbono Revestido com pintura epóx Para bicicletas aro 26" a 29"
Composição	Desencaixe fácil e rápido
Embalagem	01 peça

MODELO 01: 22554
MODELO 02: 22667





TRANSBIKE TETO ALUMINIO CALHA P/ 1 BIKE

Característica

- TRANSBIKE TETO TRUE SPORTS
- ALUMÍNIO
- CALHA REGULÁVEL
- COMPRIMENTO DA CALHA 130CM
- EXCELENTE ACABAMENTO
- BRAÇO ARTICULADO
- RESISTENTE
- FÁCIL INSTALAÇÃO
- PINTURA EPÓX
- ACOMPANHA FITAS E GARRAS PARA FIXAÇÃO
- ACOMPANHA MANUAL P/ INSTALAÇÃO
- COMPATÍVEL COM BICICLETAS ARO 26", 27.5" E 29"
- DISPONÍVEL NAS CORES PRETO E PRATA

Material

Alumínio

Embalagem

01 peça

Recomendação de uso

Instalar no bagageiro superior do carro (Teto)

Preto

22680

Prata

22681

FOTOS MERAMENTE ILUSTRATIVAS. AS INFORMAÇÕES/CONFIGURAÇÕES DE PRODUTOS PODERÃO SOFRER ALTERAÇÕES SEM AVISO PRÉVIO.

ENTRE EM CONTATO COM O SEU CONSULTOR OU FALE COM O NOSSO TIME DE TELEVENDAS PELO (33) 3277-3030.



SUPORTE CARAMANHOLA NYLON ROBUST TRUE

Característica	Suporte de caramanhola em nylon Ótima qualidade e um belo acabamento Confeccionado em nylon possui leveza e resistência Fixação com 2 parafusos inox
Composição	Sistema de regulagem com duas posições
Embalagem	01 peça

	22527		22533
	22528		22534
	22529		22535
	22530		22536
	22531		22537
	22532		22538



SUPORTE CARAMANHOLA NYLON / FIBRA VIDRO TRUE

Característica	Suporte de caramanhola moderno e leve Fixação com 2 parafusos inox. Sistema de regulagem com duas posições
Composição	Confeccionado em fibra de vidro Formato que reduz a possibilidade da caramanhola sair do suporte em terrenos irregulares Projetado para que a caramanhola tenha um encaixe simples e suave Construção em 30% fibra de vidro e 70% nylon
Embalagem	01 peça



	22539		22542
	22540		22543
	22541		22544
	22545		







FOTOS MERAMENTE ILUSTRATIVAS. AS INFORMAÇÕES/CONFIGURAÇÕES DE PRODUTOS PODERÃO SOFRER ALTERAÇÕES SEM AVISO PRÉVIO.

ENTRE EM CONTATO COM O SEU CONSULTOR OU FALE COM O NOSSO TIME DE TELEVENDAS PELO (33) 3277-3030.



SUPOORTE CARAMANHOLA NYLON ROBUST



Material	Nylon
Característica	<ul style="list-style-type: none"> • Suporte de caramanhola TRUE • Design moderno • Leve e resistente • Fixação por 02 parafusos (acompanham o suporte) • Sistema de fixação com regulagem de posição • Confeccionado em nylon
Peso	38gr - peso referente ao suporte com parafusos
Embalagem	100 unidades

-  22527
-  22530
-  22533
-  22537



SUPOORTE CARAMANHOLA FIBRA CARBONO

Material	Nylon / Carbono
Característica	<ul style="list-style-type: none"> • Suporte de caramanhola true • Design moderno • Leve e resistente • Fixação por 02 parafusos (acompanham o suporte) • Sistema de fixação com regulagem de posição • Confeccionado em nylon e fibra de carbono (70% / 30%)
Observação:	Confeccionado em fibra de vidro, formato que reduz a possibilidade da caramanhola sair do suporte em terrenos irregulares, projetado para que a caramanhola tenha um encaixe simples e suave, construção em 30% fibra de carbono e 70% nylon.
Peso	32gr - peso referente ao suporte com parafusos
Embalagem	100 unidades

-  22548
-  22550
-  22551



FOTOS MERAMENTE ILUSTRATIVAS. AS INFORMAÇÕES/CONFIGURAÇÕES DE PRODUTOS PODERÃO SOFRER ALTERAÇÕES SEM AVISO PRÉVIO.

ENTRE EM CONTATO COM O SEU CONSULTOR OU FALE COM O NOSSO TIME DE TELEVENDAS PELO (33) 3277-3030.



SUPORTE CARAMANHOLA FIBRA VIDRO

Material	Nylon / Fibra de Vidro
Característica	<ul style="list-style-type: none">• suporte de caramanhola true• design moderno• leve e resistente• fixação por 02 parafusos (acompanham o suporte)• sistema de fixação com regulagem de posição• confeccionado em nylon e fibra de vidro (70% / 30%)
Observação:	Confeccionado em fibra de vidro, formato que reduz a possibilidade da caramanhola sair do suporte em terrenos irregulares, projetado para que a caramanhola tenha um encaixe simples e suave, Construção em 30% fibra de vidro e 70% nylon.
Peso	36gr - peso referente ao suporte com parafusos
Embalagem	100 unidades

 22545



TRUE
SPORT



SUPORE CARAMANHOLA NYLON / FIBRA CARBONO TRUE

Característica Suporte de caramanhola com construção em 30% fibra de carbono e 70% nylon | Fixação com 2 parafusos inox | Sistema de regulagem com duas posições

Composição Formato que reduz a possibilidade da caramanhola sair do suporte em terrenos irregulares | Projetado para que a caramanhola tenha um encaixe simples e suave | Além de mais leveza e segurança

Embalagem 01 peça

22546
22547
22548

22549
22550
22551



SAPATA ARTICULÁVEL PAR TRUE



FITA COM MEIA ARGOLA TRUE

Característica Fita com sistema de fixação por meia argola

Composição Material resistente | Fácil instalação | Ganchos com borracha para proteger a lataria do carro

Embalagem 01 peça

22562

Característica Ponteira de plástico para transbikes | Ponteiras para fixar no suporte de bicicleta | Serve somente para o transbike sapata

Composição Kit com 02 unidades

Embalagem 01 peça

22563



SAPATINHA 7/8 P/ TRANSBIKE TRUE

Característica	Sapatinha fixa Compatível com modelos (Transbike Pop com separador, Transbike Pop sem separador)
Composição	Kit com 2 unidades
Embalagem	01 peça

22564



BASE DE APOIO BORRACHÃO TRUE

Característica	Base de apoio para a lata do veículo
Composição	Serve para todos os modelos de transbike em aço
Embalagem	01 peça

22565



KIT SUPORTE DE 7/8 OU 1 POLEGADA COM TIRA TRUE

Característica	Par de alças de borracha para Transbike 1 polegada Produto acoplado ao Transbike, para não arrancar o quadro da bicicleta, além de prender o quadro garantindo mais segurança no transporte Compatíveis com os modelos de transbike para 3 bikes
Composição	Base de separador com tira 1" e 7/8 um Produto em borracha de excelente qualidade Material resistente
Embalagem	01 peça

22566

22567



TIRA PARA SUPORTE PAR TRUE

Característica	Par de alças de borracha para Transbike 1 Polegada Produto acoplado ao Transbike, para não arrancar o quadro da bicicleta, além de prender o quadro garantindo mais segurança no transporte Produto em borracha de excelente qualidade Material resistente
Composição	Compatíveis com os modelos de transbike para 3 bikes
Embalagem	01 peça

22568



FOTOS MERAMENTE ILUSTRATIVAS. AS INFORMAÇÕES/CONFIGURAÇÕES DE PRODUTOS PODERÃO SOFRER ALTERAÇÕES SEM AVISO PRÉVIO.

ENTRE EM CONTATO COM O SEU CONSULTOR OU FALE COM O NOSSO TIME DE TELEVENDAS PELO (33) 3277-3030.



MANÍPULO 7/8 TRUE

Característica	Catraca com função de abertura e fechamento do transbike
Composição	Produzida para uma melhor angulação no encaixe do transbike no veículo
Embalagem	01 peça

22569



MANOPLA SOFT PRETA TRUE

Característica	Extremamente confortável, feita totalmente em borracha para uma boa aderência Proporcionando maciez e maior durabilidade Cor preta
Composição	Material feito em borracha
Embalagem	01 peça

22526



SUPORTE HORIZONTAL DE PAREDE TRUE

Característica	<ul style="list-style-type: none"> • Kit com 3 peças (2 suportes de roda / 1 suporte do pedal) • Material em Aço de Alta qualidade • Apoio das rodas 130mm cada • Acompanha parafusos e buchas para instalação • Possui proteções no suporte do pedal
Composição	Aço
Peso	661gr - Kit completo sem os parafusos
Embalagem	20 peças

22585



SUPORTE PNEU DIANTEIRO PARA ROLO DE TREINO

Característica	<ul style="list-style-type: none"> • Suporte para roda dianteira • Estabiliza e nivela a bicicleta • Material leve e resistente • Pezinho em eva
Composição	Nylon
Peso	226 gr
Embalagem	20 peças

22637

FOTOS MERAMENTE ILUSTRATIVAS. AS INFORMAÇÕES/CONFIGURAÇÕES DE PRODUTOS PODERÃO SOFRER ALTERAÇÕES SEM AVISO PRÉVIO.

ENTRE EM CONTATO COM O SEU CONSULTOR OU FALE COM O NOSSO TIME DE TELEVENDAS PELO (33) 3277-3030.

C A T Á L O G O

TSTW



TCROSS



16"
WHEELS

 QUADRO	TSW T Cross Aro 16" Aço Caixa over Head Set esferada Suporte Freio V-Brake Cabeamento Externo
 GARFO	TSW T-Cross aro 16" Aço Over Head Set
 SUSPENSÃO TRASEIRA	N/A
 MOVIMENTO DE DIREÇÃO	Caixa de direção Over Head Set esferada
 GUIDÃO	Guidão Cross 22.2 mm Aço Possui acessório de Guidão TSW
 SUPORTE DE GUIDÃO	Alumínio Over Head Set
 MANOPLA	Nylon
 CONJUNTO DE FREIO	Freio V-Brake de aço Manete tipo MTB de nylon com reguladores
 DISCO DE FREIO	N/A
 ARO/RAIO	Aro 16" Alumínio Folha simples Preto Raios zincados
 CUBOS	Cubos em aço Eixo de 9mm Com Porca sextavada
 PNEU / CÂMARA DE AR	Pneu: Aro 16 X 2.125" / Câmara: aro 16" Válvula americana
 PEDIVELA	Monobloco Preto 115 mm Coroa Aço 24D
 CORRENTE	Comum importada Porta corrente de Nylon
 MOVIMENTO CENTRAL	Movimento central 50 mm esferado

 RODA LIVRE	16 Dentes
 CÂMBIO DIANTEIRO	N/A
 CÂMBIO TRASEIRO	N/A
 ALAVANCA	N/A
 SELIM	Infantil Preto Com castanha
 CANOTE	Aço Medida 25.4 mm
 ABRAÇADEIRA	No quadro Parafuso
 PEDAL	Infantil Nylon 1/2 sueco Preto

16" IMPORTADA

ÚNICO  17406

FOTOS MERAMENTE ILUSTRATIVAS. AS INFORMAÇÕES/CONFIGURAÇÕES DE PRODUTOS PODERÃO SOFRER ALTERAÇÕES SEM AVISO PRÉVIO.

ENTRE EM CONTATO COM O SEU CONSULTOR OU FALE COM O NOSSO TIME DE TELEVENDAS PELO (33) 3277-3030.

Tcross



16"
WHEELS

	QUADRO	TSW T Cross Aro 16" Aço Caixa over Head Set esferada Suporte Freio V-Brake Cabeamento Externo
	GARFO	TSW T-Cross aro 16" Aço Over Head Set
	SUSPENSÃO TRASEIRA	N/A
	MOVIMENTO DE DIREÇÃO	Caixa de direção Over Head Set esferada
	GUIDÃO	Guidão Cross 22.2 mm Aço Possui acessório de Guidão TSW
	SUPORTE DE GUIDÃO	Alumínio Over Head Set
	MANOPLA	Nylon
	CONJUNTO DE FREIO	Freio V-Brake de aço Manete tipo MTB de nylon com reguladores
	DISCO DE FREIO	N/A
	ARO/RAIO	Aro 16" Alumínio Folha simples Preto Raios zincados
	CUBOS	Cubos em aço Eixo de 9mm Com Porca sextavada
	PNEU / CÂMARA DE AR	Pneu: Aro 16 X 2.125" / Câmara: aro 16" Válvula americana
	PEDIVELA	Monobloco Preto 115 mm Coroa Aço 24D
	CORRENTE	Comum importada Porta corrente de Nylon
	MOVIMENTO CENTRAL	Movimento central 50 mm esferado

	RODA LIVRE	16 Dentes
	CÂMBIO DIANTEIRO	N/A
	CÂMBIO TRASEIRO	N/A
	ALAVANCA	N/A
	SELIM	Infantil Preto Com castanha
	CANOTE	Aço Medida 25.4 mm
	ABRAÇADEIRA	No quadro Parafuso
	PEDAL	Infantil Nylon 1/2 sueco Preto

16" IMPORTADA

ÚNICO  17407

FOTOS MERAMENTE ILUSTRATIVAS. AS INFORMAÇÕES/CONFIGURAÇÕES DE PRODUTOS PODERÃO SOFRER ALTERAÇÕES SEM AVISO PRÉVIO.























ENTRE EM CONTATO COM O SEU CONSULTOR OU FALE COM O NOSSO TIME DE TELEVENDAS PELO (33) 3277-3030.



Tcross

20"
WHEELS



 QUADRO	TSW T Cross Aro 20" Aço Caixa over Ahead Set Seat Tube 22.5 mm Suporte Freio V-Brake Cabeamento Externo	 PNEU / CÂMARA DE AR	Pneu: Aro 20 X 2.1" / Câmara: 20 x 1.95" Válvula americana
 GARFO	Rígido Aço Aro 20" Espiga Over headset	 PEDIVELA	Braço de Aço 145 mm Engrenagem Single 28 Dentes
 SUSPENSÃO TRASEIRA	N/A	 CORRENTE	Single
 MOVIMENTO DE DIREÇÃO	Over Ahead Set Esfera	 MOVIMENTO CENTRAL	Monobloco Esferado
 GUIDÃO	Medida 700 x 21.0 mm Aço Bmx	 RODA LIVRE	Single 16 Dentes Importado
 SUPORTE DE GUIDÃO	Alumínio Diâmetro 22.4 mm Comprimento 40 mm	 CÂMBIO DIANTEIRO	N/A
 MANOPLA	Borracha	 CÂMBIO TRASEIRO	N/A
 CONJUNTO DE FREIO	Traseiro V-Brake Aço/Sapata com Parafuso Preto Manete Nylon/Alumínio	 ALAVANCA	N/A
 DISCO DE FREIO	N/A	 SELIM	Cross castanha
 ARO/RAIO	Aro 20" Alumínio Folha Única Somente para V-Brake / Raio Aço 2 mm Preto	 CANOTE	Aço Medida 22.5 x 250 mm Sem carinho
 CUBOS	Dianteiro: Aço 36 furos Sem Blocação Somente para V-Brake / Traseiro: Aço 36 furos Sem Blocação Somente para V-Brake Rosca	 ABRAÇADEIRA	No quadro Parafuso
		 PEDAL	Plataforma Preto Nylon

20" IMPORTADA

ÚNICO ■ 17410

FOTOS MERAMENTE ILUSTRATIVAS. AS INFORMAÇÕES/CONFIGURAÇÕES DE PRODUTOS PODERÃO SOFRER ALTERAÇÕES SEM AVISO PRÉVIO.

ENTRE EM CONTATO COM O SEU CONSULTOR OU FALE COM O NOSSO TIME DE TELEVENDAS PELO (33) 3277-3030.

TCROSS

20"
WHEELS



QUADRO

TSW T Cross | Aro 20" | Aço | Caixa over Ahead Set | Seat Tube 22.5 mm | Suporte Freio V-Brake | Cabeamento Externo



GARFO

Rígido | Aço | Aro 20" | Espiga Over headset



SUSPENSÃO TRASEIRA

N/A



MOVIMENTO DE DIREÇÃO

Over Ahead Set | Esfera



GUIDÃO

Medida 700 x 21.0 mm | Aço | Bmx



SUporte DE GUIDÃO

Alumínio | Diâmetro 22.4 mm | Comprimento 40 mm



MANOPLA

Borracha



CONJUNTO DE FREIO

Traseiro | V-Brake | Aço/Sapata com Parafuso | Preto | Manete Nylon/Alumínio



DISCO DE FREIO

N/A



ARO/RAIO

Aro 20" | Alumínio | Folha Única | Somente para V-Brake / Raio Aço 2 mm Preto



CUBOS

Dianteiro: Aço | 36 furos | Sem Blocação | Somente para V-Brake / Traseiro: Aço | 36 furos | Sem Blocação | Somente para V-Brake | Rosca



PNEU / CÂMARA DE AR

Pneu: Aro 20 X 2.1" / Câmara: 20 x 1.95" | Válvula americana



PEDIVELA

Braço de Aço 145 mm | Engrenagem Single | 28 Dentes



CORRENTE

Single



MOVIMENTO CENTRAL

Monobloco | Esferado



RODA LIVRE

Single | 16 Dentes | Importado



CÂMBIO DIANTEIRO

N/A



CÂMBIO TRASEIRO

N/A



ALAVANCA

N/A



SELIM

Cross | castanha



CANOTE

Aço | Medida 22.5 x 250 mm | Sem carrinho



ABRAÇADEIRA

No quadro | Parafuso



PEDAL

Plataforma | Preto | Nylon

20" | IMPORTADA

ÚNICO  17411

FOTOS MERAMENTE ILUSTRATIVAS. AS INFORMAÇÕES/CONFIGURAÇÕES DE PRODUTOS PODERÃO SOFRER ALTERAÇÕES SEM AVISO PRÉVIO.

ENTRE EM CONTATO COM O SEU CONSULTOR OU FALE COM O NOSSO TIME DE TELEVENDAS PELO (33) 3277-3030.

TSW

TSW Posh



16"
WHEELS



16"
WHEELS



QUADRO

TSW Posh | Aro 16" | Aço | Porta corrente de aço inteiriço | Roda lateral reforçada e emborrachada | Paralama de aço com haste | Cestinha retrô nylon | Suporte traseiro de nylon (Cadeirinha para bonecas) | Sinalizador sonoro



GARFO

Aço | Aro 16"



SUSPENSÃO TRASEIRA

N/A



MOVIMENTO DE DIREÇÃO

Standard | Rosca | Esferas



GUIDÃO

Curvo | 25.4 mm | Aço



SUporte DE GUIDÃO

Alumínio | Chanfrado



MANOPLA

Borracha



CONJUNTO DE FREIO

V-Brake | Aço **Manete:** Infantil | Nylon com reguladores



DISCO DE FREIO

N/A



ARO/RAIO

Aro: 16" | Aço | Folha simples **Raio:** Aço | Preto



CUBOS

Aço | Eixo 9 mm | Porca sextavada



PNEU / CÂMARA DE AR

Pneu: Aro 16" | 2.1125 | Importado
Câmara: Aro 16" | Válvula americana



PEDIVELA

Monobloco | 115 mm | Preto | Coroa aço | 32 D



CORRENTE

Comum | Importada



MOVIMENTO CENTRAL

45 mm | Esferado



RODA LIVRE

16 Dentes



CÂMBIO DIANTEIRO

N/A



CÂMBIO TRASEIRO

N/A



ALAVANCA

N/A



SELIM

Infantil | Castanha | Branco



CANOTE

Aço | 25.4 mm



ABRAÇADEIRA

N/A



PEDAL

Nylon | Infantil | 1/2 sueco | Branco

16" IMPORTADA SEM CÂMBIO

ÚNICO  18204

ÚNICO  18205

FOTOS MERAMENTE ILUSTRATIVAS. AS INFORMAÇÕES/CONFIGURAÇÕES DE PRODUTOS PODERÃO SOFRER ALTERAÇÕES SEM AVISO PRÉVIO.

ENTRE EM CONTATO COM O SEU CONSULTOR OU FALE COM O NOSSO TIME DE TELEVENDAS PELO (33) 3277-3030.

TSW Posh



20"
WHEELS



20"
WHEELS

 QUADRO	TSW rerô Aro 20" Aço Cesta Seat tube 22.2mm Caixa standard Suporte para freio v-brake Porta corrente Descanso lateral
 GARFO	Rígido Aço Aro 20" Espiga standard Rosca Suporte para freio v-brake
 SUSPENSÃO TRASEIRA	N/A
 MOVIMENTO DE DIREÇÃO	Standard Rosca
 GUIDÃO	Passeio Tropical Cromado 22.1mm/500mm
 SUporte DE GUIDÃO	Caneta Alumínio Standard Espander
 MANOPLA	Borracha
 CONJUNTO DE FREIO	V-Brake Aço Sapata Manete infantil/nylon
 DISCO DE FREIO	N/A
 ARO/RAIO	Aro 20" Alumínio Folha Única 36 furos / Raio Aço 2 mm Preto
 CUBOS	Dianteiro: Aço 36 furos Somente para V-Brake Esferado / Traseiro: Aço 36 furos Sem Blocação Somente para V-Brake Rosca

 PNEU / CÂMARA DE AR	Pneu: Aro 20" 2.10" / Câmara: Aro 20 1.95" Válvula americana
 PEDIVELA	Monobloco 140mm /rosca fina Aço
 CORRENTE	Single
 MOVIMENTO CENTRAL	Monobloco Esferado
 RODA LIVRE	Single 16 Dentes Importado
 CÂMBIO DIANTEIRO	N/A
 CÂMBIO TRASEIRO	N/A
 ALAVANCA	N/A
 SELIM	Infantil Castanha
 CANOTE	Aço 22.5mm/250mm Cromado
 ABRAÇADEIRA	blocação
 PEDAL	Nylon Infantil Rosca fina

20" | IMPORTADA

ÚNICO  18209

ÚNICO  18210

FOTOS MERAMENTE ILUSTRATIVAS. AS INFORMAÇÕES/CONFIGURAÇÕES DE PRODUTOS PODERÃO SOFRER ALTERAÇÕES SEM AVISO PRÉVIO.

ENTRE EM CONTATO COM O SEU CONSULTOR OU FALE COM O NOSSO TIME DE TELEVENDAS PELO (33) 3277-3030.



TSW retrô

20"
WHEELS



20"
WHEELS



20"
WHEELS



QUADRO

TSW aço retrô | Aro 20" | Aço | Bagageiro Aço retrô acolchoado | Cestinha nylon retrô | Descanso lateral de aço | Paralamas pintados c/ haste | Campanhia nylon/ aço | Porta corrente aço inteiriço (cobre toda a parte externa da Transmissão)



GARFO

Aço P/ V-Brake com rosca



SUSPENSÃO TRASEIRA

N/A



MOVIMENTO DE DIREÇÃO

Esferada Standard



GUIDÃO

Aço Cromado chifre de boi 25.4 mm x 520 mm



SUPORTE DE GUIDÃO

Chanfreado | Alumínio



MANOPLA

Nylon retrô



CONJUNTO DE FREIO

V-Brake | Aço | Manetes Nylon com reguladores



DISCO DE FREIO

N/A



ARO/RAIO

Aro 20" | Alumínio Preto | Folha simples | 28 furos tipo Aero | Raio Aço Preto 2.00 mm X 180 mm



CUBOS

Aço Preto | 28 furos | Eixo maciço com porca



PNEU / CÂMARA DE AR

Pneu: Aro 20" - 20x2.125



PEDIVELA

Monobloco | 140mm | Aço preto



CORRENTE

Bronze SLC



MOVIMENTO CENTRAL

Esferada 45mm



RODA LIVRE

Bronze 16 Dentes | Importado



CÂMBIO DIANTEIRO

N/A



CÂMBIO TRASEIRO

N/A



ALAVANCA

N/A



SELIM

Retrô | Castanha



CANOTE

Aço zincado | 25.4 mm x 250 mm



ABRAÇADEIRA

blocagem



PEDAL

Nylon retrô

20" | IMPORTADA

ÚNICO  18211

ÚNICO  18212

ÚNICO  18213

FOTOS MERAMENTE ILUSTRATIVAS. AS INFORMAÇÕES/CONFIGURAÇÕES DE PRODUTOS PODERÃO SOFRER ALTERAÇÕES SEM AVISO PRÉVIO.

ENTRE EM CONTATO COM O SEU CONSULTOR OU FALE COM O NOSSO TIME DE TELEVENDAS PELO (33) 3277-3030.

TSW retrô

16"
WHEELS



QUADRO

Quadro: TSW Retrô | Aço | Aro 16"
Bagageiro: Aço retrô acolchoado |
Cestinha: Nylon retrô | **Paralamas:** Aço pintados com haste | **Campanhia:** Nylon/aço | **Porta corrente:** Aço inteiro (cobre toda a parte externa da transmissão) | **Roda lateral:** Estilo retrô com suporte em aço



GARFO

Aço P/ V-Brake com rosca



SUSPENSÃO TRASEIRA

N/A



MOVIMENTO DE DIREÇÃO

Esferada Standard



GUIDÃO

Aço Cromado chifre de boi | 25.4 mm x 520 mm



SUPORTE DE GUIDÃO

Chanfreado | Alumínio



MANOPLA

Nylon retrô



CONJUNTO DE FREIO

V-Brake | Aço | Preto | **Manete:** Nylon com reguladores



DISCO DE FREIO

N/A



ARO/RAIO

Aro: 16" | Alumínio | Preto | 28 furos tipo Aero | Folha simples | **Raio:** Aço Preto 2.00 mm X 135 mm



CUBOS

Aço Preto | 28 furos | Eixo maciço com porca



PNEU / CÂMARA DE AR

Pneu: Aro 16" - 16 x 2.125 | Importado



PEDIVELA

Monobloco | 115mm | Aço | Preto



CORRENTE

Bronze SLC | Importado



MOVIMENTO CENTRAL

Esferada 45mm



RODA LIVRE

Bronze 16 Dentes | Importado



CÂMBIO DIANTEIRO

N/A



CÂMBIO TRASEIRO

N/A



ALAVANCA

N/A



SELIM

Retrô | Castanha



CANOTE

Aço zincado | 25.4 mm x 200 mm



ABRAÇADEIRA

N/A



PEDAL

Nylon retrô 1/2

16" | IMPORTADA

ÚNICO  18206

ÚNICO  18207

ÚNICO  18208

FOTOS MERAMENTE ILUSTRATIVAS. AS INFORMAÇÕES/CONFIGURAÇÕES DE PRODUTOS PODERÃO SOFRER ALTERAÇÕES SEM AVISO PRÉVIO.

ENTRE EM CONTATO COM O SEU CONSULTOR OU FALE COM O NOSSO TIME DE TELEVENDAS PELO (33) 3277-3030.



U.bend



20"
WHEELS

ACESSÓRIOS E COMPONENTES

 QUADRO	Aro 20" Alumínio Dobrável Trava de segurança na articulação Lugar para Suporte de Caramanhola Pivotes para adaptação de Garupas Caixa de Direção Mega Over Freio a Disco Descanso lateral Urbano	 PEDIVELA	Engrenagem coroa única de 46 dentes Aço Braço de aço 165 mm Guia de corrente em nylon na coroa
 GARFO	Rígido Aço Aro 20" Espiga Over Rosca Freio a Disco	 CORRENTE	7 velocidades Index
 SUSPENSÃO TRASEIRA	N/A	 MOVIMENTO CENTRAL	34.7 mm Rolamentado Eixo ponta quadrada
 MOVIMENTO DE DIREÇÃO	Mega Over Caixa semi-integrada Esfera	 RODA LIVRE	Shimano 7 velocidades Index MF-TZ500/7
 GUIDÃO	Alumínio Formato em T Tubo 28.6 mm com guia	 CÂMBIO DIANTEIRO	N/A
 SUPORTE DE GUIDÃO	Alumínio Trava de Segurança na articulação Abraçadeira de Alumínio para Regulagem da altura do Guidão Tubo 25,4 mm chanfrado	 CÂMBIO TRASEIRO	Shimano 7 velocidades Index RD-TY200
 MANOPLA	Borracha	 ALAVANCA	Shimano Revoshift 7 velocidades Modelo SL-RS35
 CONJUNTO DE FREIO	Disco Mecânico Alumínio Manete com abraçadeira de nylon e alavanca de alumínio	 SELIM	MTB com castanha
 DISCO DE FREIO	Aço 160 mm 6 parafusos	 CANOTE	Alumínio 31.6 x 500 mm Sem carrinho
 ARO/RAIO	Aro 20" Alumínio Parede dupla Com CNC / Raio preto Aço 2.0 mm	 ABRAÇADEIRA	Alumínio Com blocagem
 CUBOS	Dianteiro: Alumínio Esferado Blocagem Freio a disco / Traseiro: Alumínio Esferado Blocagem Freio a disco Rosca	 PEDAL	Plataforma Preto Nylon
 PNEU / CÂMARA DE AR	Pneu: Aro 20" 20 x 1.75" Chaoyang / Câmara: Chaoyang Válvula americana	 URBANA	✓
		 CICLOTURISMO	X
		 TRILHAS INTERMEDIÁRIAS	X
		 COMPETIÇÃO	X
		 PESO APROXIMADO	12.51 kg

20" | IMPORTADA

ÚNICO  18069

FOTOS MERAMENTE ILUSTRATIVAS. AS INFORMAÇÕES/CONFIGURAÇÕES DE PRODUTOS PODERÃO SOFRER ALTERAÇÕES SEM AVISO PRÉVIO.

ENTRE EM CONTATO COM O SEU CONSULTOR OU FALE COM O NOSSO TIME DE TELEVENDAS PELO (33) 3277-3030.

U.bend



20"
WHEELS

ACESSÓRIOS E COMPONENTES



 QUADRO	Aro 20" Alumínio Dobrável Trava de segurança na articulação Lugar para Suporte de Caramanholas Pivores para adaptação de Garupas Caixa de Direção Mega Over Freio a Disco Descanso lateral Urbano	 PEDIVELA	Engrenagem coroa única de 46 dentes Aço Braço de aço 165 mm Guia de corrente em nylon na coroa
 BARFO	Rígido Aço Aro 20" Espiga Over Rosca Freio a Disco	 CORRENTE	7 velocidades Index
 SUSPENSÃO TRASEIRA	N/A	 MOVIMENTO CENTRAL	34.7 mm Rolamentado Eixo ponta quadrada
 MOVIMENTO DE DIREÇÃO	Mega Over Caixa semi-integrada Esfera	 RODA LIVRE	Shimano 7 velocidades Index MF-TZ500/7
 GUIDÃO	Alumínio Formato em T Tubo 28.6 mm com guia	 CÂMBIO DIANTEIRO	N/A
 SUPOORTE DE GUIDÃO	Alumínio Trava de Segurança na articulação Abraçadeira de Alumínio para Regulagem da altura do Guidão Tubo 25,4 mm chanfrado	 CÂMBIO TRASEIRO	Shimano 7 velocidades Index RD-TY200
 MANOPLA	Borracha	 ALAVANCA	Shimano Revoshift 7 velocidades Modelo SL-RS35
 CONJUNTO DE FREIO	Disco Mecânico Alumínio Manete com abraçadeira de nylon e alavanca de alumínio	 SELIM	MTB com castanha
 DISCO DE FREIO	Aço 160 mm 6 parafusos	 CANOTE	Alumínio 31.6 x 500 mm Sem carrinho
 ARO/RAIO	Aro 20" Alumínio Parede dupla Com CNC / Raio preto Aço 2.0 mm	 ABRAÇADEIRA	Alumínio Com blocagem
 CUBOS	Dianteiro: Alumínio Esferado Blocagem Freio a disco / Traseiro: Alumínio Esferado Blocagem Freio a disco Rosca	 PEDAL	Plataforma Preto Nylon
 PNEU / CÂMARA DE AR	Pneu: Aro 20" 20 x 1.75" Chaoyang / Câmara: Chaoyang Válvula americana	 URBANA	✓
		 CICLOTURISMO	X
		 TRILHAS INTERMEDIÁRIAS	X
		 COMPETIÇÃO	X
		 PESO APROXIMADO	12.51 kg

20" | IMPORTADA

ÚNICO ■ 18070

FOTOS MERAMENTE ILUSTRATIVAS. AS INFORMAÇÕES/CONFIGURAÇÕES DE PRODUTOS PODERÃO SOFRER ALTERAÇÕES SEM AVISO PRÉVIO.

ENTRE EM CONTATO COM O SEU CONSULTOR OU FALE COM O NOSSO TIME DE TELEVENDAS PELO (33) 3277-3030.

Motion

ACESSÓRIOS E COMPONENTES



12"
WHEELS



 **QUADRO** TSW Motion | Balance | Aro 12" | Alumínio 6061

 **GARFO** TSW | Rígido | Aro 12" | Alumínio

 **CAIXA DE DIREÇÃO** Mega Over | Head Set | Semi-Integrado | Esferado

 **GUIDÃO** TSW | Alumínio | Reto | 25.4 x 400 mm

 **SUPORTE DE GUIDÃO** TSW | Alumínio | 60 mm/7°

 **MANOPLA** Borracha

 **CONJUNTO DE FREIO** Tambor | Maçaneta de Nylon

 **ARO/RAIO** Aro: Aço | 12" / Raio: Preto | 2.0 mm

 **CUBOS** Aço com esfera | Eixo de 9 mm

 **PNEU / CÂMARA DE AR** Pneu SLIN | 12 x 2.25" / Câmara com válvula americana

 **CANOTE** Aço | 22 mm | Selim integrado

 **ABRAÇADEIRA** Alumínio | Blocagem

IMPORTADA

12"  17397

12"  17401

12"  17400



FOTOS MERAMENTE ILUSTRATIVAS. AS INFORMAÇÕES/CONFIGURAÇÕES DE PRODUTOS PODERÃO SOFRER ALTERAÇÕES SEM AVISO PRÉVIO.

ENTRE EM CONTATO COM O SEU CONSULTOR OU FALE COM O NOSSO TIME DE TELEVENDAS PELO (33) 3277-3030.



CAPACETES TSW TEAM II

ABERTURAS DE CIRCULAÇÃO DE AR 17

CONSTRUÇÃO/ESTRUTURA Design aerodinâmico | In mold | Estrutura interna em Armor Frame

SISTEMA DE FECHAMENTO Fivela | Com espuma removível e lavável

SISTEMA REGULÁVEL Fivela e dial giratório para melhor encaixe na cabeça

ENCHIMENTO Espuma | Com espuma removível e lavável

TAMANHO 56-61

PESO 257g

1  24896

2  24897

3  24898



**ARMOR
FRAME**



CAPACETES TSW TEAM III

ABERTURAS DE CIRCULAÇÃO DE AR 22

CONSTRUÇÃO/ESTRUTURA Design moderno | In mold | Estrutura interna em Armor Frame

SISTEMA DE FECHAMENTO Fivela

SISTEMA REGULÁVEL Fivela e Dial giratório para melhor encaixe na cabeça

ENCHIMENTO Espuma | Removível e lavável

TAMANHO 54-59

PESO 241g

1  24899

2  24900

3  24901



CAPACETE TSW MTB KIDS II

ABERTURAS DE CIRCULAÇÃO DE AR 12

CONSTRUÇÃO/ESTRUTURA Estrutura robusta | Leve | Máxima proteção e conforto

SISTEMA DE FECHAMENTO Fivela

SISTEMA REGULÁVEL Fivela e Dial giratório para melhor encaixe na cabeça

ENCHIMENTO Espuma | Removível e lavável

SINALIZAÇÃO Com LED vermelho

PESO 188g

1  24968

2  24967

3  24969

4  24971

5  24970

6  24972

ESPUMA INTERNA para capacete MTB ENDURO

CARACTERÍSTICA Espuma interna para capacete MTB Enduro

EMBALAGEM 5 peças

11133



ESPUMA INTERNA para capacete KIDS

CARACTERÍSTICA Espuma interna para capacete KIDS

EMBALAGEM 5 peças

07488



ESPUMA INTERNA Capacete RAPTOR

CARACTERÍSTICA Kit espuma interna para capacete

PESO 10gr

EMBALAGEM 50 peças

19055



VISEIRA CAPACETE RAPTOR III

CARACTERÍSTICA Para ajuste de capacete modelo RAPTOR II e III

MATERIAL Nylon

PESO 15gr

EMBALAGEM 50 peças

19056



CARNEIRA PLÁSTICA para capacete RAPTOR NEW

CARACTERÍSTICA Para ajuste de capacete com led

MATERIAL Nylon

PESO 20gr

EMBALAGEM 50 peças

19057





LUVA MTB COMBAT DM

Luva MTB Ciclista DM | Modelo 01

CARACTERÍSTICA Luvas de alto desempenho e tecnologia inovadora | Super durável | Costas de alta elasticidade para conforto | Pulso super ajustado com velcro

COMPOSIÇÃO 40% Poliéster | 30% Poliuretano | 20% Nylon | 10% Elastano

PESO 46 gr com a TAG

EMBALAGEM 50 peças



PALMA

P		
1		19591
2		19592
3		19593
4		19594
5		19595
6		20006
7		20007
8		20008

M		
1		19586
2		19587
3		19588
4		19589
5		19590
6		20003
7		20004
8		20005

G		
1		19581
2		19582
3		19583
4		19584
5		19585
6		20000
7		20001
8		20002

GG		
1		19575
2		19576
3		19577
5		19578
6		19997
7		19998
8		19999



1



2



3



4

LUVA MTB COMP GEL DM

Luva MTB Ciclista DM | Modelo 02

CARACTERÍSTICA Luvas de alto desempenho, com gel e tecnologia inovadora | Super durável | Costas de alta elasticidade para conforto | Pulso super ajustado com velcro

COMPOSIÇÃO 60% Nylon | 30% Poliuretano | 10% Elastano

PESO 54 gr com a TAG

EMBALAGEM 50 peças



PALMA

P		
1		19608
2		19609
3		19610
4		19611

M		
1		19604
2		19605
3		19606
4		19607

G		
1		19600
2		19601
3		19602
4		19603

GG		
1		19596
2		19597
3		19598
4		19599

FOTOS MERAMENTE ILUSTRATIVAS. AS INFORMAÇÕES/CONFIGURAÇÕES DE PRODUTOS PODERÃO SOFRER ALTERAÇÕES SEM AVISO PRÉVIO.

ENTRE EM CONTATO COM O SEU CONSULTOR OU FALE COM O NOSSO TIME DE TELEVENDAS PELO (33) 3277-3030.



1



2



3



4



5

LUVA MTB COMP DM

Luva MTB Ciclista DM | Modelo 03

CARACTERÍSTICA Luvas de alto desempenho e tecnologia inovadora | Super durável | Costas de alta elasticidade para conforto | Pulso super ajustado com velcro

COMPOSIÇÃO 60% Nylon | 30% Poliuretano | 10% Elastano

PESO 46 gr com a TAG

EMBALAGEM 50 peças



PALMA

P		
1		19628
2		19629
3		19630
4		19631
5		19632

M		
1		19623
2		19624
3		19625
4		19626
5		19627

G		
1		19618
2		19619
3		19620
4		19621
5		19622

GG		
1		19612
2		19613
3		19614
4		19615
5		19617



1



2



3



4

ACESSÓRIOS E COMPONENTES



LUVA MTB COMP GEL DM

Luva MTB Ciclista DM | Modelo 04

CARACTERÍSTICA Luvas de alto desempenho, com gel e tecnologia inovadora | Super durável | Costas de alta elasticidade para conforto | Pulso super ajustado com velcro

COMPOSIÇÃO 60% Nylon | 30% Poliuretano | 10% Elastano

PESO 54 gr com a TAG

EMBALAGEM 50 peças

P		
1		19645
2		19646
3		19647
4		19648

M		
1		19641
2		19642
3		19643
4		19644

G		
1		19637
2		19638
3		19639
4		19640

GG		
1		19633
2		19634
4		19636

FOTOS MERAMENTE ILUSTRATIVAS. AS INFORMAÇÕES/CONFIGURAÇÕES DE PRODUTOS PODERÃO SOFRER ALTERAÇÕES SEM AVISO PRÉVIO.

ENTRE EM CONTATO COM O SEU CONSULTOR OU FALE COM O NOSSO TIME DE TELEVENDAS PELO (33) 3277-3030.



LUVA MTB COMP PRO GEL DM

Luva MTB Ciclista DM | Modelo 06

CARACTERÍSTICA Luvas de alto desempenho, com gel e tecnologia inovadora | Super durável | Costas de alta elasticidade para conforto | Pulso super ajustado com velcro

COMPOSIÇÃO 60% Nylon | 30% Poliuretano | 10% Elastano

PESO 64 gr com a TAG

EMBALAGEM 50 peças

P			
1			19681
2			19682
3			19683
4			19684
5			19685

M			
1			19676
2			19677
3			19678
4			19679
5			19680

G			
1			19671
2			19672
3			19673
4			19674

GG			
1			19667
2			19668
3			19669
4			19670



LUVA MTB COMP PRO DL

Luva MTB Ciclista DL | Modelo 05

CARACTERÍSTICA Luvas de alto desempenho e tecnologia inovadora | Dedo antiderrapante | Super durável | Costas de alta elasticidade para conforto | Pulso super ajustado com velcro

COMPOSIÇÃO 60% Nylon | 30% Poliuretano | 10% Elastano

PESO 66 gr com a TAG

EMBALAGEM 50 peças

P		
1		19664
2		19665
3		19666

M		
1		19661
2		19662
3		19663

G		
1		19658
2		19659
3		19660

GG		
1		19655
2		19656
3		19657



LUVA MTB COMP LIGHT DL

Luva MTB Ciclista DL | Modelo 07

CARACTERÍSTICA Luvas de alto desempenho e tecnologia inovadora | Dedo antiderrapante | Super durável | Costas de alta elasticidade para conforto | Pulso super ajustado com velcro | Tecido furado permitindo uma ótima ventilação | Dedo longo | Toalha na parte superior do polegar

COMPOSIÇÃO 60% Nylon | 30% Poliuretano | 10% Elastano

PESO 50 gr com a TAG

EMBALAGEM 50 peças

P		
1		19983
2		19984

M		
1		19985
2		19986
3		19987
4		19988

G		
2		19989
3		19990
4		19992

GG		
2		19993
3		19994
4		19995





1



2



3



4



5



6

LUVA MTB COMP KIDS

Luva MTB Ciclista DM | KIDS

CARACTERÍSTICA Luvas de alto desempenho e tecnologia inovadora | Super durável | Costas de alta elasticidade para conforto | Pulso super ajustado com velcro

COMPOSIÇÃO 40% Poliéster | 30% Poliuretano | 20% Nylon | 10% Elastano

PESO 36 gr com a TAG

EMBALAGEM 50 peças

PP

1  19649 4  19652

2  19650 5  19653

3  19651 6  19654



PALMA

MEIA CICLISMO RIDE MOD.01 SUAVE COMPRESSÃO PT

CARACTERÍSTICA	Tamanho único
TAMANHO	39-43
MODALIDADE	Speed e MTB
COMPRESSÃO	Suave
MATERIAL	Poliéster
PESO	60g
EMBALAGEM	10 peças

■ 23675



MEIA CICLISMO RIDE MOD.02 SUAVE COMPRESSÃO PT

CARACTERÍSTICA	Tamanho único
TAMANHO	39-43
MODALIDADE	Speed e MTB
COMPRESSÃO	Suave
MATERIAL	Poliéster
PESO	60g
EMBALAGEM	10 peças

■ 23676



MEIA CICLISMO RIDE MOD.04 SUAVE COMPRESSÃO PT/LJ

CARACTERÍSTICA	Tamanho único
TAMANHO	39-43
MODALIDADE	Speed e MTB
COMPRESSÃO	Suave
MATERIAL	Poliéster
PESO	60g
EMBALAGEM	10 peças





■ 23677





**MEIA CICLISMO RIDE MOD.05
SUAVE COMPRESSÃO**

CARACTERÍSTICA	Tamanho único
TAMANHO	39-43
MODALIDADE	Speed e MTB
COMPRESSÃO	Suave
MATERIAL	Poliéster
PESO	60g
EMBALAGEM	10 peças

- 01  23678
- 02  23679
- 03  23680
- 04  23681

TRAVA MTB pino Inferior

CARACTERÍSTICA	Trava pino para solado de sapatilha
MODELOS COMPATIVÉIS	Beauty, Cave e Hard

05270



TRAVA C/ REGULAGEM p/ sapatilhas (catraca)

CARACTERÍSTICA	Trava tsw para sapatilha Regulagem através de catraca Potão para liberação rápida Design moderno Fixação por parafuso
MATERIAL	Nylon
PESO	20 g
EMBALAGEM	100 unidades

4697



BONÉ ABA RETA (Bordado)

CARACTERÍSTICA	Fecho de velcro Aba Retá
EMBALAGEM	50 peças
FATOR	2

1  17863

2  17864



1

2



CAMISA T-DRY

CARACTERÍSTICA Dispersão do calor
 Mantém a hidratação da pele
 Retarda a exaustão - Visual opaco
 Toque especialmente frio
 Ação antibactericida
 Proteção a raios UV

MATERIAL Poliamida

EMBALAGEM 1 peça

TAMANHO

PP  20471

TAMANHO

P  20472

TAMANHO

M  20473

TAMANHO

G  20474

TAMANHO

GG  20475



CAMISA T-DRY | CINZA CHUMBO/CORES

CARACTERÍSTICA
 Dispersão do calor
 Mantém a hidratação da pele
 Retarda a exaustão - Visual opaco
 Toque especialmente frio
 Ação antibactericida
 Proteção a raios UV

MATERIAL
 Poliamida

EMBALAGEM
 1 peça

TAMANHO	TAMANHO	TAMANHO	TAMANHO	TAMANHO
PP 15804	PP 18499	PP 18505	PP 18527	PP 18528
P 15805	P 18501	P 18506	P 18508	P 18512
M 15806	M 18502	M 18507	M 18509	M 18513
G 15807	G 18503		G 18510	G 18514
GG 15808	GG 18504		GG 18511	GG 18515



CAMISA CASUAL T-DRY MOD. 01 FLUOR TSW

CARACTERÍSTICA

- Camisa casual t-dry mod. 01 Tsw
- Dispensação de calor
- Retarda a exaustão – visual opaco
- Ação bactericida
- Poliamida
- Mantém a hidratação da pele
- Toque especialmente frio
- Proteção contra raios uv
- Tamanhos disponíveis pp/p/m/g/gg

MATERIAL

100% Poliamida

EMBALAGEM

1 peça

TAMANHO

PP  24261

P  24262

M  24263

G  24264

GG  24265



EXPOSITOR para BIKE PAREDE

CARACTERÍSTICA Kit com 3 peças (2 suportes de roda / 1 suporte do pedal) | Material em Aço de Alta qualidade | Apoio das rodas 115mm cada | Acompanha parafusos e buchas para instalação

MATERIAL Aço

PESO 579Gr - Kit completo sem os parafusos

EMBALAGEM 1 peça

20577



EXPOSITOR para 5 BICICLETAS

CARACTERÍSTICA Tsw | Até 5 Bicicletas
Material: Aço | Suporte de Fixação no Pedivela (Parafuso com "borboleta")
Altura: 8,5 cm x 70,5 cm (Mínima x Máxima) | Comprimento da plataforma: 134 cm
Largura da plataforma: 6,5 cm | Comprimento do Suporte: 196 cm

MATERIAL Aço

PESO 15.600 gr

EMBALAGEM 1 peça

20573

FOTOS MERAMENTE ILUSTRATIVAS. AS INFORMAÇÕES/CONFIGURAÇÕES DE PRODUTOS PODERÃO SOFRER ALTERAÇÕES SEM AVISO PRÉVIO.

ENTRE EM CONTATO COM O SEU CONSULTOR OU FALE COM O NOSSO TIME DE TELEVENDAS PELO (33) 3277-3030.



EXPOSITOR para 3 BICICLETAS

CARACTERÍSTICA Tsw | Até 3 Bicletas
Material: Aço | Suporte de Fixação no Pedivela (Parafuso com "borboleta") |
Altura: 8,5 cm x 61 cm (Mínima x Máxima) | Comprimento da plataforma: 134 cm
Largura da plataforma: 6,5 cm | Comprimento do Suporte (Profundidade): 118 cm

MATERIAL Aço

PESO 9.100 gr

EMBALAGEM 1 peça

20572







PROTETOR TRUCKPAD 2 bikes

CARACTERÍSTICA

Costuras reforçadas e ainda conta com presilhas reguláveis para fixação na tampa traseira | Possui fitas auto colantes para fixação da bike, tornando o transporte muito mais seguro | Carrega com segurança até 2 bikes | Tecido especial em lona resinada e tripla proteção E.V.A interna | Protege completamente contra arranhões | Preto

DIMENSÕES

Medição com produto aberto sobre a mesa: 0,55m (largura) x 0,70m (comprimento)

Medição com produto colocado no veículo: 0,55m (largura) x 0,35m (altura)

EMBALAGEM

1 peça

21327



TRUCKPAD grande Modelo 03

CARACTERÍSTICA

Transporte de até 5 bicicletas

TAMANHO

Grande: 1.38 x 0.77 m

COMPATIBILIDADE

Caminhonetes: Hilux, Ford Ranger, Amarok, L200 Triton, Frontier, S10 e todas as caminhonetes da categoria. (Abertura para acesso à fechadura da caçamba de modo invertido.)

EMBALAGEM

1 peça

GRANDE

19191



TRUCKPAD grande/pequeno | Modelo 02

CARACTERÍSTICA	Grande: Transporte de até 5 bicicletas Pequeno: Transporte de até 4 bicicletas
TAMANHO	Grande: 1.35 x 0.77 m Pequeno: 1.20 x 0.70 m
COMPATIBILIDADE	Grande: Caminhonetes compatíveis: Hilux, Ford Ranger, Amarok, L200 Triton, Frontier, S10 e todas as caminhonetes da categoria. Pequeno: Pick-ups menores, Saveiro, Oroch, Toro, Strada, entre outras.
EMBALAGEM	1 peça
GRANDE	19188
PEQUENO	19189



PROTETOR DE QUADRO TSW
Modelo 01 pt/cz

PESO _____ 15 g
MATERIAL _____ Neoprene
22685



PROTETOR DE QUADRO TSW
Modelo 02 pt/cz

PESO _____ 15 g
MATERIAL _____ Neoprene
22686



PROTETOR DE QUADRO TSW
Modelo 03 pt/cz

PESO _____ 15 g
MATERIAL _____ Neoprene
22687





1



2



3



4

1 ■■■ 19479

3 ■■■ 19481

2 ■■■ 19480

4 ■■■ 19482

BOLSA PARA QUADRO

Modelo 10

02 compartimentos laterais externos com zíper de alta qualidade | 02 compartimentos externos sem zíper | **Bolsa do celular avulsa:** fixada com velcro com dois zíperes de alta qualidade e com puxadores | Isolamento interno resistente a água | Fixação no Top Tube com auxílio de velcros | Compatível com iPhones 7/ 7PLUS/8/ 8PLUS/ XR/ XS/ XS MAX - LG K11 e celulares com até 6.5"

CARACTERÍSTICA

MATERIAL PU | Couro sintético

TAMANHO Comprimento total 32cm x
Largura total 20 cm

PESO 246gr

EMBALAGEM 30 peças



BOLSA PARA GUIDÃO Modelo 11

Possui dois zíperes de alta qualidade | Isolamento interno resistente a água | Fixação no suporte de guidão com auxílio de velcros | Quebra sol | Compatível com iPhones 7/ 7PLUS/8/ 8PLUS/ XR/ XS/ XS MAX - LG K11 e celulares com até 6.5"

CARACTERÍSTICA

MATERIAL PU | Couro sintético

TAMANHO Comprimento total 20cm x
Largura total 10 cm x Altura 9cm

PESO 124gr

EMBALAGEM 30 peças

■■■ 19483

BOLSA PARA SELIM Modelo 10



Isolamento interno resistente a água |
Fixação no canote e no trilho do selim
com clips de nylon e fita regulável |
Fechamento principal com clip e
velcros auxiliares | Bolsinho interno de
rede PVC

CARACTERÍSTICA

MATERIAL PU | Couro sintético | PVC

TAMANHO Aberta: 30cm | Fechada: 25cm |
Largura: +-9x11cm

PESO 130gr

EMBALAGEM 30 peças

1  19484

2  19485

BOLSA PARA SELIM Modelo 11



Isolamento interno resistente a água |
Fixação no canote e no trilho do selim
com auxílio de velcros | Fechamento
principal com clip | Zíper de alta
qualidade com puxador

CARACTERÍSTICA

MATERIAL Tecido Oxford

TAMANHO Comprimento 18cm x Largura
+-8x10cm

PESO 77gr

EMBALAGEM 30 peças

1  19486

2  19487

BOLSA PARA SELIM Modelo 12



Isolamento interno resistente a água |
Fixação no canote e no trilho do selim
com clips de nylon e fita regulável |
Fechamento principal com zíper de alta
qualidade | Zíper auxiliar possibilitando
o aumento da bolsa

CARACTERÍSTICA

MATERIAL Tecido Oxford

TAMANHO Comprimento total 15cm x
Largura +-9x11cm

PESO 77gr

EMBALAGEM 30 peças

 19488



1



2



3



4

BOLSA PARA SELIM Modelo 13

CARACTERÍSTICA

Isolamento interno resistente a água | Fixação no canote e no trilho do selim com auxílio de velcros | Fechamento principal com dois zíperes de alta qualidade com puxadores | Dois bolsos auxiliares laterais externos com o mesmo zíper | Um bolso externo de rede PVC com elástico

MATERIAL

PU | Couro sintético

TAMANHO

Comprimento 25cm x Largura +-9x11cm

PESO

214gr

EMBALAGEM

30 peças

1		19489	3		19491
2		19490	4		19492



PARALAMAS TRASEIRO Nylon Modelo 06

CARACTERÍSTICA

Traseiro | Flexível e Resistente

FIXAÇÃO

Trilho do selim

EMBALAGEM

10 peças

17770



PARALAMAS DIANTEIRO MTB Nylon Modelo 05

CARACTERÍSTICA Dianteiro | MTB | Flexível e Resistente

FIXAÇÃO Abraçadeira de nylon

EMBALAGEM 10 peças

1  17755

2  17757

3  17756



PARALAMAS DIANTEIRO MTB Nylon Modelo 06

CARACTERÍSTICA Dianteiro | MTB | Flexível e Resistente

FIXAÇÃO Abraçadeira de nylon

EMBALAGEM 10 peças

1  17758

2  17759

3  17760



PARALAMAS DIANTEIRO MTB Nylon Modelo 07

CARACTERÍSTICA	Dianteiro MTB Flexível e Resistente
FIXAÇÃO	Abraçadeira de nylon
EMBALAGEM	10 peças

1		17761
2		17762
3		17763



PARALAMAS DIANTEIRO MTB Nylon Modelo 08

CARACTERÍSTICA	Dianteiro MTB Flexível e Resistente
FIXAÇÃO	Abraçadeira de nylon
EMBALAGEM	10 peças

1		17764
2		17765
3		17766



PARALAMAS DIANTEIRO MTB Nylon Modelo 09

CARACTERÍSTICA	Dianteiro MTB Flexível e Resistente
FIXAÇÃO	Abraçadeira de nylon
EMBALAGEM	10 peças

1		17767
2		17768
3		17769

EXPOSITOR CAPACETE NYLON

CARACTERÍSTICA

- Leve
- Excelente acabamento
- Encaixe para slatwall
- Disponível nas cores preta e laranja

MATERIAL

Nylon

PESO

220gr

EMBALAGEM

10 unidades

4510

5037



EXPOSITOR SAPATILHA E OUTROS

CARACTERÍSTICA

- Leve
- Excelente acabamento
- Encaixe para slatwall
- Disponível nas cores preta e laranja

MATERIAL

Acrílico

PESO

132gr

EMBALAGEM

10 unidades

6519

6520





CARAMANHOLA TERMICA SPIN MOD. 01

CARACTERÍSTICA

- Caramanhola térmica
- Alça de transporte
- Bico removível para limpeza
- Boca larga (facilita limpeza e abastecimento)
- Bpa free
- Tampa inteligente (abre e fecha)

CAPACIDADE

680ml

TAMANHO

25 x 7.5cm

EMBALAGEM

50 unidades

 22617

 22618

 22619

 22620

 22621



CARAMANHOLA TERMICA SPIN MOD. 02

CARACTERÍSTICA

- Caramanhola térmica
- Alça de transporte
- Bico removível para limpeza
- Boca larga (facilita limpeza e abastecimento)
- Bpa free
- Tampa inteligente (abre e fecha)

CAPACIDADE

680ml

TAMANHO

25 x 7.5cm

EMBALAGEM

50 unidades

 22622

 22623

 22624

 22625

 22626



CARAMANHOLA TERMICA SPIN MOD. 03

CARACTERÍSTICA

- Caramanhola térmica
- Alça de transporte
- Bico removível para limpeza
- Boca larga (facilita limpeza e abastecimento)
- Bpa free
- Tampa inteligente (abre e fecha)

CAPACIDADE

680ml

TAMANHO

25 x 7.5cm

EMBALAGEM

50 unidades

 22627

 22628

 22629

 22630

 22631



CARAMANHOLA TERMICA SPIN MOD. 04

CARACTERÍSTICA

- Caramanhola térmica
- Alça de transporte
- Bico removível para limpeza
- Boca larga (facilita limpeza e abastecimento)
- Bpa free
- Tampa inteligente (abre e fecha)

CAPACIDADE

680ml

TAMANHO

25 x 7.5cm

EMBALAGEM

50 unidades

 22632

 22633

 22634

 22635

 22636



CARAMANHOLA FAST NYLON MOD. 01

CARACTERÍSTICA

- Caramanhola não térmica
- Alça de transporte
- Boca larga (facilita limpeza e abastecimento)
- Bpa free

CAPACIDADE

650ml

TAMANHO

22.5 X 7.5cm

EMBALAGEM

50 unidades

 22587

 22589

 22588

 22592

 22593

 22590

 22591



CARAMANHOLA FAST NYLON MOD. 02

CARACTERÍSTICA

- Caramanhola não térmica
- Alça de transporte
- Boca larga (facilita limpeza e abastecimento)
- Bpa free

CAPACIDADE

650ml

TAMANHO

22.5 X 7.5cm

EMBALAGEM

50 unidades

	22594
	22596
	22595
	22599
	22600
	22597
	22598



CARAMANHOLA FAST NYLON MOD. 03

CARACTERÍSTICA

- Caramanhola não térmica
- Alça de transporte
- Boca larga (facilita limpeza e abastecimento)
- Bpa free

CAPACIDADE

650ml

TAMANHO

22.5 X 7.5cm

EMBALAGEM

50 unidades

	22601
	22603
	22602
	22608
	22609
	22604
	22605



CARAMANHOLA FAST NYLON MOD. 04

CARACTERÍSTICA

- Caramanhola não térmica
- Alça de transporte
- Boca larga (facilita limpeza e abastecimento)
- Bpa free

CAPACIDADE 650ml

TAMANHO 22.5 X 7.5cm

EMBALAGEM 50 unidades

-  22610
-  22612
-  22611
-  22615
-  22616
-  22613
-  22614



CARAMANHOLA TÉRMICA NYLON MOD. 01

CARACTERÍSTICA	<ul style="list-style-type: none"> • Caramanhola térmica • Nylon • Boca larga (facilita limpeza e abastecimento) • Bpa free
CAPACIDADE	400ml
TAMANHO	19.5 X 7.5cm
PESO	105g
EMBALAGEM	50 unidades

	22638
	22639
	22640
	22641
	22642
	22643
	22644
	22645

FOTOS MERAMENTE ILUSTRATIVAS. AS INFORMAÇÕES/CONFIGURAÇÕES DE PRODUTOS PODERÃO SOFRER ALTERAÇÕES SEM AVISO PRÉVIO.

ENTRE EM CONTATO COM O SEU CONSULTOR OU FALE COM O NOSSO TIME DE TELEVENDAS PELO (33) 3277-3030.



ACESSÓRIOS E COMPONENTES



CARAMANHOLA TÉRMICA NYLON MOD. 01

- CARACTERÍSTICA**
- Caramanhola térmica
 - Nylon
 - Boca larga (facilita limpeza e abastecimento)
 - Bpa free

CAPACIDADE 550ml

TAMANHO 26,5 X 7,5cm

PESO 135g

EMBALAGEM 50 unidades

	22646
	22647
	22648
	22649
	22650
	22651
	22652
	22653
	22654

FOTOS MERAMENTE ILUSTRATIVAS. AS INFORMAÇÕES/CONFIGURAÇÕES DE PRODUTOS PODERÃO SOFRER ALTERAÇÕES SEM AVISO PRÉVIO.

ENTRE EM CONTATO COM O SEU CONSULTOR OU FALE COM O NOSSO TIME DE TELEVENDAS PELO (33) 3277-3030.



1



2



3



4



5



6



7



8



SUPORTE CARAMANHOLA FIBRA VIDRO MOD. 01

CARACTERÍSTICAS

- Design moderno
- Leve e resistente
- Fixação por 02 parafusos (acompanham o suporte)
- Sistema de fixação com regulagem de posição
- Confeccionado em nylon e fibra de vidro

OBSERVAÇÕES COMPLEMENTARES

Confeccionado em fibra de vidro, Formato que reduz a possibilidade da caramanhola sair do suporte em terrenos irregulares, Projetado para que a caramanhola tenha um encaixe simples e suave, Construção em 30% fibra de vidro e 70% nylon

PESO

35gr - peso referente ao suporte com parafusos

MATERIAL

Nylon / fibra de vidro

EMBALAGEM

100 unidades

1-  226552-  226563-  226574-  226585-  226596-  226607-  226618-  22662



FOTOS MERAMENTE ILUSTRATIVAS. AS INFORMAÇÕES/CONFIGURAÇÕES DE PRODUTOS PODERÃO SOFRER ALTERAÇÕES SEM AVISO PRÉVIO.

ENTRE EM CONTATO COM O SEU CONSULTOR OU FALE COM O NOSSO TIME DE TELEVENDAS PELO (33) 3277-3030.

REFIL para Mochila de Hidratação

CARACTERÍSTICA	2 litros Tampa com fechamento em rosca Tubo de 106 cm
PESO	183g
EMBALAGEM	25 peças

15427



BOMBA DE AR PÉ alumínio com manômetro digital

CARACTERÍSTICA	Manômetro digital Válvula padrão alemão Cabo de madeira Pilha palito - não inclusa
-----------------------	--

PSI 130

EMBALAGEM 1 peça

06861



BOMBA DE AR PÉ alumínio com manômetro

CARACTERÍSTICA	Manômetro Válvula padrão alemão Cabo de madeira
-----------------------	---

PSI 130

EMBALAGEM 1 peça

06860



BOMBA DE AR alumínio mini manual/pé

CARACTERÍSTICA	Suporte para fixação quadro Conexão externa com adaptador válvula americana e presta Apoio para pé
-----------------------	--

PSI 110

MATERIAL Alumínio

EMBALAGEM 10 peças

1  07333

2  07334





BOMBA DE AR alumínio manual

CARACTERÍSTICA Suporte para fixação quadro | Conexão interna com adaptador válvula americana e presta

PSI 110

MATERIAL Alumínio/nylon

EMBALAGEM 10 peças

1  06853

2  06854

3  06855



BOMBA DE AR alumínio manual

CARACTERÍSTICA Suporte para fixação quadro | Conexão interna com adaptador válvula americana e presta

PSI 110

PESO APROXIMADO 100g

MATERIAL Alumínio/Nylon

EMBALAGEM 10 peças

1  08632

2  08633

3  08634



BOMBA DE AR alumínio manual

CARACTERÍSTICA Suporte para fixação quadro | Conexão interna com adaptador válvula americana e presta

PSI 110

MATERIAL Alumínio

EMBALAGEM 10 peças

1  04581

2  04582

3  04583



BOMBA DE AR alumínio manual

CARACTERÍSTICA Suporte para fixação quadro | Com adaptador válvula americana e presta

PSI 90

MATERIAL Alumínio/Nylon

EMBALAGEM 10 peças

1  04584



BOMBA DE AR alumínio manual mini



CARACTERÍSTICA	Suporte para fixação quadro Válvula presta
PSI	90
MATERIAL	Alumínio
EMBALAGEM	10 peças

- 1  06851
- 2  06850
- 3  06852



BOMBA DE AR alumínio manual mini

CARACTERÍSTICA	Suporte para fixação quadro Válvula presta
PSI	90
MATERIAL	Alumínio
EMBALAGEM	10 peças

- 1  09542
- 2  09541
- 3  09543



BOMBA DE AR Nylon manual

CARACTERÍSTICA	Suporte p/ fixação quadro Adaptador válvula americana e presta
MATERIAL	Nylon
EMBALAGEM	10 peças

- 1  05965



BOMBA DE AR Nylon manual

CARACTERÍSTICA	Adaptador válvula americana e presta
MATERIAL	Nylon
EMBALAGEM	10 peças

- 1  05971

CO2 PUMP

CARACTERÍSTICA Dispositivo acionador de bomba para cartucho de CO2 (cartucho de CO2 não incluso)

COMPATIBILIDADE Válvulas schrader e presta

MATERIAL Alumínio

EMBALAGEM 10 peças

13364



FAROL 180 Lumens

CARACTERÍSTICA Bateria recarregável via USB | 4 estágios | 1 LED

AUTONOMIA 1:20h (Alto)
2:40h (Baixo)
3h (Pisca rápido)
5h (Pisca lento)

LÚMENS 180

EMBALAGEM 10 peças



1  06961

2  06962

3  06963



ADAPTADOR SILICONE para farol

CARACTERÍSTICA Compatível com faróis 06.961, 06.962, 06.963 | Com parafuso de fixação

EMBALAGEM 200 peças

15237



FAROL 400 Lumens

CARACTERÍSTICA	Bateria recarregável via USB Indica nível de carga da bateria Resistente a água 1 LED T6
ESTÁGIOS	5 estágios
AUTONOMIA	8h (25% de brilho) 4h (50% de brilho) 2h (100% de brilho) 4h (Flash lento) 5h (SOS)
LÚMENS	400
BATERIA	18650 Li-ion 2200 mAh, 3,7v
CARREGADOR	Micro USB 3:00 h (1A)
TAMANHO/PESO	85x28x28mm/106g
MATERIAL	Alumínio + Plástico ABS
EMBALAGEM	50 peças

15222





FAROL 250 Lumens | PARA SUPORTE ARTICULADO

CARACTERÍSTICA	Bateria recarregável via USB Luz dianteira e traseira Encaixe para base articulada Base articulada não inclusa	
ESTÁGIOS	3 estágios para a luz dianteira 3 estágios para a luz traseira	
AUTONOMIA	Dianteira 5h (50% de brilho) 2,5h (100% de brilho) 6h (Flash)	Traseira 25h (100% de brilho) 50h ("respiração") 60h (Flash)
LÚMENS	250	
TEMPO DE RECARGA	3 h	
CARREGADOR	USB	
TAMANHO/PESO	65x32x19mm/52g	
MATERIAL	Alumínio + Plástico	
EMBALAGEM	100 peças	

15221

ADAPTADOR MULTI USO/SUPORTE ARTICULADO

CARACTERÍSTICA	Adaptador para suporte de guidão com suporte para Ciclo computador (Garmim/Bryton) e suporte articulado para Action Cam/Farol
KIT	2 chaves allen - 2 / 4 mm
PESO	69 g
MATERIAL	Alumínio/Nylon
EMBALAGEM	100 peças

15220

FAROL COM CARREGADOR USB 500 lumens preto

CARACTERÍSTICA	Estrutura em alumínio Acompanha cabo usb Indicadores de bateria Botão on/off na parte superior Capacidade da bateria 2000mah, 3.7v Dimensões 81 x 45 x 24 mm Fácil instalação
ESTÁGIOS	Flash 1 – 3hrs / flash 2 – 4hrs / flash 3 – 8 hrs
LÚMENS	500
TEMPO DE RECARGA	3 h
CARREGADOR	USB
PESO	126g
MATERIAL	Alumínio/Plástico
EMBALAGEM	100 peças

24165



FAROL COM CARREGADOR USB e refletor tras.

CARACTERÍSTICA	Kit farol e refletor Linha tsw
FAROL	Farol 350 lumens tsw Estrutura em alumínio Carregamento através do cabo usb Acompanha cabo usb Botão on/off na parte superior Capacidade da bateria 2000mah Tempo de carga 3-4hrs Estágios: 100% – 3hrs / 50% – 6hrs Fecho de luz em 3 posições Dimensões 105 x 35 x 37 mm Fácil instalação Acompanha suporte de fixação
REFLETOR	Refletor traseiro 8 lumens tsw Estrutura em plástico Carregamento através do cabo usb Acompanha cabo usb Botão on/off na parte superior Capacidade da bateria 200mah Tempo de carga 1hr 4 Modolos de sinalização Fácil instalação Dimensões 73,5 x 21 x 19,3 mm
PESO	138gr - peso referente ao kit completo
MATERIAL	Alumínio/Plástico
EMBALAGEM	100 peças

23790





REFLETOR LED

CARACTERÍSTICA	Para uso dianteiro e traseiro
TIPO DE LED	2 leds multi-uso
EMBALAGEM	25 peças

1  03384

2  03385



REFLETOR TRASEIRO 50 Lumens

CARACTERÍSTICA Led vermelho | Suporte para fixação no canote prova d'água | 2 modos com 4 níveis de brilho | Cabo USB para recarga

TIPO DE LED 44 COB LED'S

AUTONOMIA	Modo 1	Modo 2
	- 10% (brilho) - 28h	10% (brilho) - 56h
	- 25% (brilho) - 14h	25% (brilho) - 28h
	- 50% (brilho) - 7h	50% (brilho) - 14h
	100% (brilho) - 3.5h	100% (brilho) - 7h

PESO 50 g

TEMPO DE RECARGA 1-2h

EMBALAGEM 120 peças

15219



REFLETOR TRASEIRO 15 lumens

CARACTERÍSTICA Led vermelho | Com 4 modos de iluminação | Suporte para fixação no canote | Cabo USB para recarga

AUTONOMIA 4h
10h (Pisca Lento)
12h (Pisca rápido)
8h (Alternado)

EMBALAGEM 20 peças

06959



ADAPTADOR de Silicone

CARACTERÍSTICA	Multi-uso
EMBALAGEM	50 peças
	04557



ESTOJO DE FERRAMENTAS

CARACTERÍSTICA	Estojo de ferramentas para suporte de caramanhola
MATERIAL	Poliuretano (PU)
MEDIDAS	203x85x74,5mm
EMBALAGEM	1 peça
	10876



MANOPLA PRETA ANATOMICA E BAR END PRETO

CARACTERÍSTICA	Design moderno Corpo com acabamento grip	BAR END	(89mm de comprimento)
DIMENSÕES	142 X 30 X 54MM	MATERIAL	TPE (Elastômero Termoplástico)
		PESO	207g
		EMBALAGEM	100 unidades
	1 [REDACTED] 22103		



MANOPLA com anel e trava

CARACTERÍSTICA	Aro preto Com trava
MATERIAL	TPE
EMBALAGEM	60 peças

06903

06902



MANOPLA ESPUMA com anel e trava

CARACTERÍSTICA	Aro colorido Com trava
MATERIAL	Espuma
EMBALAGEM	60 peças

1 06909

2 06910

3 06911



MANOPLA com anel e trava

CARACTERÍSTICA	Aro colorido Com 2 travas Alumínio
----------------	--

1 02910

2 02912

EMBALAGEM 100 peças



MANOPLA anatômica 2 trava

CARACTERÍSTICA Aro colorido | Com 2 travas | Alumínio

EMBALAGEM 50 peças

1  03781

2  03782

3  03977



MANOPLA com trava

CARACTERÍSTICA Aro colorido | Com trava

MATERIAL TPE

EMBALAGEM 60 peças

1  06895



MANOPLA MTB

MATERIAL pvc.tpr
EMBALAGEM 100 peças

1		06905	3		06908
2		06906	4		07513

MANOPLAS



MANOPLA SOFT MTB

MATERIAL Espuma EVA
EMBALAGEM 100 peças

	07872		07875
	07873		

FOTOS MERAMENTE ILUSTRATIVAS. AS INFORMAÇÕES/CONFIGURAÇÕES DE PRODUTOS PODERÃO SOFRER ALTERAÇÕES SEM AVISO PRÉVIO.

ENTRE EM CONTATO COM O SEU CONSULTOR OU FALE COM O NOSSO TIME DE TELEVENDAS PELO (33) 3277-3030.



MANOPLA MTB LIGHT silicone

MATERIAL	Confortável Leve e com uma excelente pegada no guidão Proporciona uma pilotagem superior nos percursos mais técnicos e longos.
CARACTERÍSTICA	Plugs de fechamento
EMBALAGEM	100 peças

	12597
	12595
	12598
	12596
	10358



FITA DE GUIDÃO SPEED

CARACTERÍSTICA	Leve, fácil de envolver e ajustar
COMPRIMENTO	195 cm
ESPESSURA	2.5 mm
MODALIDADE	Road bike
ACABAMENTO	Plugs de fechamento
PESO	55g
EMBALAGEM	10 peças

14290



FITA DE GUIDÃO SPEED SLIM

CARACTERÍSTICA	Macia, fácil de envolver e ajustar
COMPRIMENTO	198 cm
ESPESSURA	3 mm
MODALIDADE	Road bike
ACABAMENTO	Plugs de fechamento
PESO	71g
EMBALAGEM	10 peças

14289



FITA DE GUIDÃO SPEED SILICONE GEL

CARACTERÍSTICA	Macia e suave, fácil de envolver e ajustar
COMPRIMENTO	200 cm
MATERIAL	Silicone antiderrapante Fibra de tecido EVA 1mm
ESPESSURA	3 mm
MODALIDADE	Road bike
ACABAMENTO	Plugs de fechamento
PESO	74g
EMBALAGEM	10 peças









1  14291

2  14292



FITA DE GUIDÃO









CARACTERÍSTICA	Speed Caixa com par
MATERIAL	EVA
EMBALAGEM	10 peças

1		06912	7		06918
2		06913	8		06919
3		06914	9		06922
4		06915			
5		06916			



FITA DE GUIDÃO

CARACTERÍSTICA	Speed Caixa com par
MATERIAL	Microfibrá
EMBALAGEM	10 peças

1		06921	7		06928
2		06923	8		06929
3		06924	9		06930
4		06925			
5		06926			



FITA WRAP para kit de reparo MTB / SPEED

CARACTERÍSTICA

Universal, funciona com qualquer tipo de bicicleta, independentemente do uso, tamanho ou material | Utilizada para levar espátula, câmara de ar, Co2, bomba e outros acessórios | Obs.: câmara de ar, espátula, Co2 e outras ferramentas não inclusos.

EMBALAGEM

10 peças

17865

Selim mtb gel preto mod. 1

MODELO

- Vazado
- estrutura do assento em polímero, espuma e couro sintético
- Excelente acabamento
- Não acompanha castanha

MATERIAL

Polímero e aço

TAMANHO

275 x 160 mm

PESO

360g

EMBALAGEM

30 peças

23275



SELIM MTB PRETO MOD. 2

CARACTERÍSTICA	Selim Tsw <ul style="list-style-type: none">• Vazado• Trilho Em Aço• Estrutura Do Assento Em Polímero, Espuma E Couro Sintético• Excelente Acabamento• Largura 160mm• Comprimento 275mm
PESO	335g
MATERIAL	Espuma/ Couro Sintético
TAMANHO	160 x 275 mm
EMBALAGEM	30 unidades

23276



26"
WHEELS

IMPORTADO

17813

KIT RODA DIANTEIRA/TRASEIRA 36 FUROS

CARACTERÍSTICA	Roda TSW Aro 26" (559 x 19 mm) com CNC Acompanha fita protetora de câmara de ar	RAIO	Aço preto 250 mm x 2,0 mm Niple preto
ARO	Parede dupla Alumínio 6063 ERD 535 mm 36 furos Pneu 1.0 à 2.2 CNC Freio V/B	MATERIAL	Aro: Alumínio Cubos e raios: Aço
CUBO	Dianteiro: Aço 36 furos Esferado Eixo 9 x 100 mm Com blocagem Traseiro: Aço 36 furos Esferado Rosca (Roda livre) 9 x 135 mm Com blocagem	EMBALAGEM	1 par

FOTOS MERAMENTE ILUSTRATIVAS. AS INFORMAÇÕES/CONFIGURAÇÕES DE PRODUTOS PODERÃO SOFRER ALTERAÇÕES SEM AVISO PRÉVIO.

ENTRE EM CONTATO COM O SEU CONSULTOR OU FALE COM O NOSSO TIME DE TELEVENDAS PELO (33) 3277-3030.

ARO 29 X 32F ALUM MTB VAL. PRESTA PT F. T10000 IMP.

CARACTERÍSTICA

- tsw t10000
- Alumínio 6061
- acabamento anodizado
- largura externa 35mm
- largura interna 30mm
- tubeless ready
- etrto rim size 30-622mm
- 32 furos
- disc brake
- largura do pneu 48mm – 66mm (1.9" – 2.6")
- disponível com válvula presta e válvula americana

MATERIAL

Alumínio

PESO

654g (sem ilhós)

EMBALAGEM

8 Unidades

■ 22833 Presta

■ 22834 Americana



SELIM E COMPONENTES



PEDIVELA COM EIXO CENTRAL 50 mm

CARACTERÍSTICA

50mm | Com braço 175mm
| 3 peças | Com movimento
central de colar

EMBALAGEM

10 peças

04477

PARAFUSO DISC BRAKE ALEN

CARACTERÍSTICA

Parafuso para fixação
de disco de freio

EMBALAGEM

100 peças

05269



FOTOS MERAMENTE ILUSTRATIVAS. AS INFORMAÇÕES/CONFIGURAÇÕES DE PRODUTOS PODERÃO SOFRER ALTERAÇÕES SEM AVISO PRÉVIO.

ENTRE EM CONTATO COM O SEU CONSULTOR OU FALE COM O NOSSO TIME DE TELEVENDAS PELO (33) 3277-3030.



VALVULA ALLOY TUBELESS

CARACTERÍSTICA

- Válvula alumínio para tubeless;
- Tampa da válvula removível;
- Tamanhos disponíveis 36mm / 48mm / 60mm / 80mm;

ORIENTAÇÕES DE INSTALAÇÃO

- Remova a tampa da válvula e a porca de travamento;
- Insira a válvula através do aro;
- Rosqueie o-ring de bloqueio na válvula;
- Aperte à mão a porca de trava;
- Parafuso na tampa da válvula.

ATENÇÃO

Nossas válvulas tubeless são adequadas universalmente para a maioria das bicicletas de montanha ou road, um kit de conversação é necessário para rodas não tubeless.

MATERIAL

Alumínio

PESO APROXIMADO

26gr (peso referente a válvula de 80mm com embalagem).

EMBALAGEM

50 peças

36MM

23688

48MM

23689

60MM

23690

80MM

23691



NÚCLEO VÁLVULAS TUBELESS

CARACTERÍSTICA

Núcleo para reparo interno válvula tubeless

COMPATIBILIDADE

Válvulas tipo Presta

EMBALAGEM

50 peças

FATOR

10

14121

PEDAL CLIP/PLATAFORMA MTB/CASUAL

CARACTERÍSTICA Pedal Clip/Plataforma com rolamento DU/Selado e ajuste de tensão

CATEGORIA MTB/Casual

FIXAÇÃO Face única

TACO MTB SPD (Shimano)

TAMANHO 103 x 80 x 18 mm

MATERIAL Alumínio / Cr-Mo

PESO 477g

EIXO 9/16

EMBALAGEM 1 conjunto

14873



RODAS E COMPONENTES



PEDAL CLIP SPEED

CARACTERÍSTICA Pedal Clip com rolamento DU/Selado e ajuste de tensão

CATEGORIA Road

FIXAÇÃO Face única

TACO Look SPD

TAMANHO 71 x 90 x 20 mm

MATERIAL Nylon / Cr-Mo

PESO 303g

EIXO 9/16

EMBALAGEM 1 conjunto

14874



FOTOS MERAMENTE ILUSTRATIVAS. AS INFORMAÇÕES/CONFIGURAÇÕES DE PRODUTOS PODERÃO SOFRER ALTERAÇÕES SEM AVISO PRÉVIO.

ENTRE EM CONTATO COM O SEU CONSULTOR OU FALE COM O NOSSO TIME DE TELEVENDAS PELO (33) 3277-3030.

PEDAL CLIP MTB

CARACTERÍSTICA	Pedal Clip com rolamento DU/ Selado e ajuste de tensão
CATEGORIA	MTB
FIXAÇÃO	Dupla face
TACO	MTB SPD (Shimano)
TAMANHO	83 x 69 x 20 mm
MATERIAL	Alumínio / Cr-Mo
PESO	348g
EIXO	9/16
EMBALAGEM	1 conjunto



14872

**CONDUÍTE FREIO
HIDRÁULICO**

CARACTERÍSTICA	Com conector 1650 mm
EMBALAGEM	20 peças

12336

**PORTA FERRAMENTAS Save Tools**



CARACTERÍSTICA	Ideal para transportar Camara de ar, ferramentas, chaves e suplementos Acabamento interno tipo EVA que elimina ruídos
MATERIAL	Plástico
COMPATIBILIDADE	Pode ser transportado no suporte de caramanholas
TAMANHO	ø 7,5 cm Altura: 13,5 cm
EMBALAGEM	1 peça
	14703
	14704



ESPÁTULA NYLON

CARACTERÍSTICA Para retirar câmara |
Formato ergonômico cabe
confortavelmente na mão |
2 peças

EMBALAGEM 10 peças

1		10875
2		10874
3		10873



CONJUNTO ACESSÓRIOS QUADRO EVO



CARACTERÍSTICA

- Conjunto acessórios quadro tsw evo
- Guia dos condutes superiores
- Guia dos condutes inferiores
- Suporte do guia de corrente em alumínio
- Guia do cabo de aço interno
- Acompanha parafusos de fixação

MATERIAL

Alumínio e nylon

EMBALAGEM

10 peças

PESO

46g

FATOR

1

COMPATÍVEL

TSW modelo Evo Quest 22/23

24161



CONJUNTO ACESSORIOS QUADRO E-BIKE

CARACTERÍSTICA	<ul style="list-style-type: none"> • Conjunto acessórios quadro tsw full e-quest • Guia dos conduites superiores • Guia dos conduites inferiores • Kit de parafusos da balança
MATERIAL	Alumínio
OBSERVAÇÃO	Não acompanha rolamentos da balança
EMBALAGEM	10 peças
PESO	240g
FATOR	1
COMPATÍVEL	TSW modelo E-Quest 22/23

24158



CONJUNTO ACESSORIOS QUADRO FULL XC

CARACTERÍSTICA	<ul style="list-style-type: none"> • Conjunto acessórios quadro tsw full xc • Guia dos conduites superiores • Guia dos conduites inferiores • Kit de parafusos da balança
MATERIAL	Alumínio e nylon
OBSERVAÇÃO	Não acompanha rolamentos da balança
EMBALAGEM	10 peças
PESO	160g
FATOR	1
COMPATÍVEL	TSW Full Quest modelo 22/23

24159



CONJUNTO ACESSORIOS QUADRO ENDURO

CARACTERÍSTICA	<ul style="list-style-type: none"> • Conjunto acessórios quadro tsw full all quest • Guia dos conduites superiores • Guia dos conduites inferiores • Kit de parafusos da balança • Suporte adaptador traseiro post mount para disco 180mm
MATERIAL	Alumínio e nylon
OBSERVAÇÃO	Não acompanha rolamentos da balança
EMBALAGEM	10 peças
PESO	274g
FATOR	1
COMPATÍVEL	TSW All Quest 2022

24160

CONJUNTO ACESSÓRIOS QUADRO EVO/2024



CARACTERÍSTICA

- Conjunto acessórios quadro Evo Quest
- Linha 2024
- Eixo traseiro boost M12 x 175L x P1.0 (01 Un)
- Abraçadeira alumínio 31.6MM com parafuso (01 un)
- Conjunto de parafusos do suporte de caramanhola (04 un)
- Tampa cega da passagem do cabo de marcha no chainstay (02 un)
- Terminal guia da passagem do cabo de marcha no chainstay (01 un)
- Acabamento emborrachado da passagem da magueira de freio (03 un) "

MATERIAL

borracha/plástico/alumínio

EMBALAGEM

10 unidades

PESO

90gr

FATOR

01 unidades

25924

CONJUNTO ACESSÓRIOS QUADRO FULL 2024



CARACTERÍSTICA

- Conjunto Acessórios Quadro Full Quest
- Linha 2024
- Eixo Traseiro Boost M12 X 175L X P1.0 (01 Un)
- Abraçadeira Alumínio 31.6mm Com Parafuso (01 Un)
- Parafuso M12 Da Balança Traseira (01 Un)
- Conjunto De Parafusos Cônicos M10 De Conexão Do Link Com Seat Stay (02 Un)
- Conjunto De Parafusos M10 De Conexão Do Link Do Seat Tube (02 Un)
- Conjunto De Arruelas Calço (02 N°2, 02 N°3, 04 Lisas)
- Conjunto De Parafusos Do Suporte De Caramanhola (04 Un) • Parafuso M10 De Fixação Do Shock No Top Tube (01 Un)
- Tampa Cega Da Passagem Do Cabo De Marcha No Chainstay (02 Un)
- Terminal Guia Da Passagem Do Cabo De Marcha No Chainstay (01 Un)
- Acabamento Emborrachado Da Passagem Da Magueira De Freio (03 Un)

MATERIAL

alumínio/plástico/borracha

EMBALAGEM

05 unidades

PESO

100gr

FATOR

01 unidades

25925





GANCHEIRA PADRÃO UDH TRAS. PARA QUADRO ALUM/CARBON MOD. 29

Gancheira udh | linha tsw
Padrão udh (tipo sram)
Alumínio
Acabamento preto
Medida do eixo 12mm
Passo da rosca 1.0mm
Comprimento da rosca 12mm

CARACTERÍSTICA

EMBALAGEM 20 peças

PESO 34g

FATOR 1

24143



GANCHEIRA TRAS. PARA QUADRO CARBON MOD. 26

Gancheira do quadro para fixação do câmbio
• Alumínio
• Acabamento preto
• Medida do eixo 12mm
• Passo da rosca 1.5mm
• Comprimento da rosca 12mm

CARACTERÍSTICA

OBSERVAÇÃO Compatível com o quadro da bicicleta full quest advanced+ e similares.

EMBALAGEM 20 peças

PESO 20g

FATOR 1

22974



GANCHEIRA TRAS. PARA QUADRO CARBON MOD. 28

Gancheira do quadro para fixação do câmbio
• Alumínio
• Acabamento preto
• Medida do eixo 12mm
• Passo da rosca 1.5mm
• Comprimento da rosca 12mm

CARACTERÍSTICA

OBSERVAÇÃO Compatível com o quadro da bicicleta tsw e-quest

EMBALAGEM 20 peças

PESO 25g

FATOR 1

24144

GANCHEIRA Modelo 01/14

CARACTERÍSTICA

Traseira | Para quadro de alumínio | Usada no **VICINI, KONA, SOLL, ASTRO, SPEED**

EMBALAGEM

5 peças

FATOR

5

01393



GANCHEIRA Modelo 02/07

CARACTERÍSTICA

Traseira | Para quadro de alumínio | Usada no **New Hunter, Storm 2012, GIANT**

EMBALAGEM

5 peças

FATOR

5

02919



GANCHEIRA Modelo 03

CARACTERÍSTICA

Traseira | Para quadro de alumínio | Usada no **Warship Freeride, KONA, KHS**

EMBALAGEM

5 peças

FATOR

5

02921



GANCHEIRA Modelo 04

CARACTERÍSTICA

Traseira | Para quadro de alumínio | Usada no **Carbono PRO RACE**

EMBALAGEM

5 peças

FATOR

5

02922



GANCHEIRA Modelo 05

CARACTERÍSTICA

Traseira | Para quadro de alumínio | Usada no **Storm 2013, AT 5.0, Elite e Hunter**

EMBALAGEM

5 peças

FATOR

5

03293



GANCHEIRA Modelo 06

CARACTERÍSTICA

Traseira | Para quadro de alumínio | Usada no **Ride, Ride 2021/2022, Posh e Warship 2014, Vulcano Pressure, Pressure 2021, Way, Way 26" 2021/2022 Nina, Bolt 2021/2022**

EMBALAGEM

5 peças

FATOR

5

03753



GANCHEIRA Modelo 08

CARACTERÍSTICA

Traseira | Para quadro de alumínio | Usada no **Jump**

EMBALAGEM

5 peças

FATOR

5

03751



GANCHEIRA Modelo 09

CARACTERÍSTICA

Traseira | Para quadro de alumínio | Usada no **Carbono FLY 27.5**

EMBALAGEM

5 peças

FATOR

5

03749



GANCHEIRA

Modelo 10

CARACTERÍSTICA Traseira | Para quadro de alumínio | Usada no **Pro Elite e Pro Elite New**

EMBALAGEM 5 peças

FATOR 5

03750



GANCHEIRA

Modelo 11

CARACTERÍSTICA Traseira | Para o quadro de alumínio | Usada no **Carbono FLY 29**

EMBALAGEM 5 peças

FATOR 5

04555

GANCHEIRA

Modelo 12

CARACTERÍSTICA Traseira | Para quadro de alumínio | Usada no **AWE, Storm e Jump 2021/2022**

EMBALAGEM 5 peças

FATOR 5

06441



GANCHEIRA

Modelo 15

CARACTERÍSTICA Traseira | Usada na **Bike Jump**

EMBALAGEM 5 peças

FATOR 5

09676

GANCHEIRA

Modelo 16

CARACTERÍSTICA Traseira | Para quadro de alumínio | **Air Borne, Avanti, Breezer, Bergamont, Coluver, Corratec, Cinelli, Centurion Cube, Da Bomb, Go Sport GT, Hasa, Intec, Kalkhoff KHS, KTM, Marin, Massi Mongoose, Nakamura Nirve, Nishiki, Orbea, Q Bike Raleigh, Saracen, Schwinn Scrapper, Univega, Vario Venzo, Viper, Wheeler**

EMBALAGEM 5 peças

FATOR 5

12061



GANCHEIRA

Modelo 17

CARACTERÍSTICA Traseira | Para quadro de alumínio | **Agang, Apollo (Australia), Atlanta, Bergamont, BMC Crescent, Carrera, Centurion, DBS, Definitive Haro bikes, Hercules, Intec KHS, kildemoes, Merida, Novara, Orange, Q Bike Shogun, Staiger, Sinus, Vario, Voodoo, VSF Fahrradmanufaktur Wheeler, Winora**

EMBALAGEM 5 peças

FATOR 5

12062

GANCHEIRA Modelo 18

CARACTERÍSTICA

Traseira | Para quadro de alumínio | TSW Ride Plus 2021/2022 , TSW Hunch / Hunch Plus 2021/2022, TSW Stamina 2019/2020, Stamina 2021/2022, TSW Hurry 2019/2020, TSW Hurry 2021/2022, Apollo (Australia), Atlanta, Author (bicyclers), Avanti, Bergamont, Bianchi, Blue (Bicycles), BMC, BH Boardman, Bulls, Carver Claud butler, Commencal Corratec, Crescent, Cresta DBS, Definitive, Diamant, Dynamics, Felt, Flanders FRW, Fiji, Fusion, Gary Fisher Ghost, Giant, GT, Haibike, Haro bikes, Hawk, Hercules, Ideal bikes Intec, Iron horse, Jamis, Jeep, K2 Kalkhoff, Kellys, KHS, Kinesis(frame), Kona, Lombardo Marin, Massi, Maxx, MBK, Merida Mongoose, Morewood, Morrison, Motobecane, Muddy Fox, useuw Musing, Nakamura, Novara, NS-Bikes, Orange, Peugeot, Planet X Q Bike, Raleigh, Redline, Schwinn Scrapper, Sensa, Staiger, Stevens Stork, Sunn, Sinus, Trek, Trenga DE, Univega, Vario, Ventana, Venzo, Villiger, Viper, Vitus, Voodoo, Wheeler, Wilier, Winora, X-Cross

EMBALAGEM

5 peças

FATOR

5

12063



GANCHEIRA Modelo 19

CARACTERÍSTICA

Traseira | Para quadro de alumínio | CMP, Commencal Cyclewolf, Da Bomb Falcon, Felt, Haibike Hercules, Vario, Winora

EMBALAGEM

5 peças

FATOR

5

12064



GANCHEIRA Modelo 20

CARACTERÍSTICA

Traseira | Para quadro de alumínio | Cube, Hercules Sinus, Winora

EMB

5 peças

FATOR

5

12065

RODAS E COMPONENTES



GANCHEIRA Modelo 21

CARACTERÍSTICA

Traseira | Para quadro de alumínio | Scott

EMBALAGEM

5 peças

FATOR

5

12066



GANCHEIRA Modelo 22

CARACTERÍSTICA

Traseira | Para quadro de alumínio | TSW Jump 2019/2020 Lapierre

EMBALAGEM

5 peças

FATOR

5

12067

GANCHEIRA Modelo 23

CARACTERÍSTICA

Traseira | 2 parafusos | Eixo passante | Eixo de 12 mm | Compatível com o TSW Yukon 2021

EMBALAGEM

5 peças

FATOR

5

14294



FOTOS MERAMENTE ILUSTRATIVAS. AS INFORMAÇÕES/CONFIGURAÇÕES DE PRODUTOS PODERÃO SOFRER ALTERAÇÕES SEM AVISO PRÉVIO.

ENTRE EM CONTATO COM O SEU CONSULTOR OU FALE COM O NOSSO TIME DE TELEVENDAS PELO (33) 3277-3030.

C A T Á L O G O

RAVA

C O M P O N E N T E S





Nina Teen



16"
WHEELS



	QUADRO	Rava Nina Teen 16" Aço Paralamas: Nylon sem haste Porta corrente: Nylon inteiriço (cobre toda a parte externa da transmissão) Rodinhas: Aço reforçada e emborrachada Acessórios de proteção: no suporte e na barra de guidão
	GARFO	Rava Aço Aro 16"
	SUSPENSÃO TRASEIRA	N/A
	MOVIMENTO DE DIREÇÃO	Standard Rosca Esferada
	GUIDÃO	Cross 25.4 mm Aço
	SUORTE DE GUIDÃO	Chanfrado Aço
	MANOPLA	Nylon
	CONJUNTO DE FREIO	V-Brake Aço Manete: MTB de nylon com reguladores Alumínio
	DISCO DE FREIO	N/A
	ARO/RAIO	Aro: 16" Alumínio Preto Folha simples 20 furos Raio: Zincado

	CUBOS	Aço Eixo 9 mm Porca sextavada 20 F
	PNEU / CÂMARA DE AR	Aro 16" x 2.125 Importado Câmara: Aro 16" Válvula americana
	PEDIVELA	Monobloco 115 mm Preto
	CORRENTE	Comum Importada
	MOVIMENTO CENTRAL	Esferado 50mm
	RODA LIVRE	16 Dentes Coroa 32 D Aço
	CÂMBIO DIANTEIRO	N/A
	CÂMBIO TRASEIRO	N/A
	ALAVANCA	N/A
	SELIM	Infantil com suporte de apoio
	CANOTE	Aço 25.4 mm
	ABRACADEIRA	N/A
	PEDAL	Infantil Nylon sueco 1/2 Preto

16" | IMPORTADA

ÚNICO  17404

ÚNICO  17405

RAVA

FOTOS MERAMENTE ILUSTRATIVAS. AS INFORMAÇÕES/CONFIGURAÇÕES DE PRODUTOS PODERÃO SOFRER ALTERAÇÕES SEM AVISO PRÉVIO.

ENTRE EM CONTATO COM O SEU CONSULTOR OU FALE COM O NOSSO TIME DE TELEVENDAS PELO (33) 3277-3030.

Nina Teen



20"
WHEELS



RAVA

	QUADRO	Rava Nina Teen Paralamas: Nylon Cesta: Arame preto Porta corrente: Nylon inteiriço (cobre toda a parte externa da transmissão Rodinhas: Aço reforçada e emborrachada
	GARFO	Aço Aro 20" Rosca Suporte para freio v-brake
	SUSPENSÃO TRASEIRA	N/A
	MOVIMENTO DE DIREÇÃO	Standard Esferada
	GUIDÃO	Curvado Aço Preto 25.4mm/550mm
	SUPORTE DE GUIDÃO	Chanfrado Alumínio
	MANOPLA	Nylon
	CONJUNTO DE FREIO	V-Brake Aço Manete: Nylon com reguladores
	DISCO DE FREIO	N/A
	ARO/RAIO	Aro: 20" Alumínio preto Folha simples 28 furos Raio: Aço preto 2mmx190mm

	CUBOS	Aço preto 28 furos Eixo maciço com porca
	PNEU / CÂMARA DE AR	Aro 20" 20x2.125 Importado
	PEDIVELA	Monobloco 140mm Aço Preto
	CORRENTE	Bronze Maya Importada
	MOVIMENTO CENTRAL	Esferado 50mm
	RODA LIVRE	Bronze 16 Dentes Importado
	CÂMBIO DIANTEIRO	N/A
	CÂMBIO TRASEIRO	N/A
	ALAVANCA	N/A
	SELIM	Infantil com suporte de apoio Castanha
	CANOTE	Aço preto 25.4mmx250mm
	ABRACADEIRA	N/A
	PEDAL	Nylon sueco 1/2

20" | IMPORTADA

ÚNICO  17408

ÚNICO  17409

FOTOS MERAMENTE ILUSTRATIVAS. AS INFORMAÇÕES/CONFIGURAÇÕES DE PRODUTOS PODERÃO SOFRER ALTERAÇÕES SEM AVISO PRÉVIO.

ENTRE EM CONTATO COM O SEU CONSULTOR OU FALE COM O NOSSO TIME DE TELEVENDAS PELO (33) 3277-3030.

pressure jr



Aço



Mega Over



07 velocidades



Disco Mecânico



13.08

 QUADRO	Aro 20" Rava Pressure Jr Aço Direção Mega Over M. Central BSA Freio: Disco Standard (IS) Suporte para descanso Descanso Lateral	 PEDIVELA	Engrenagem Single 40 dentes Braço 160 mm Aço
 GARFO	Garfo suspensão Rava Aro 20" Freio: Disco Standard (IS) Aço Espiga Over headset	 CORRENTE	Tec 7 Velocidades
 SUSPENSÃO TRASEIRA	N/A	 EIXO CENTRAL	Rosca 34.7 x 113 mm Ponta quadrada
 MOVIMENTO DE DIREÇÃO	Mega Over Semi-integrado Esfera	 RODA LIVRE	Roda Livre 7V. 14/28D. Index
 GUIDÃO	Rise bar Aço 31.8 x 620 mm	 CÂMBIO DIANTEIRO	N/A
 SUPORTE DE GUIDÃO	Alumínio 31.8 mm 90 mm	 CÂMBIO TRASEIRO	Shimano 7 Velocidades Index RD-TZ31A
 MANOPLA	MTB Borracha	 ALAVANCA	Shimano Revoshift 7 velocidades
 CONJUNTO DE FREIO	Freio a disco mecânico Dianteiro/Traseiro	 SELIM	Rava Com castanha Trilho de aço
 DISCO DE FREIO	160 mm Aço Parafuso	 CANOTE	Para castanha 27.2 x 250 mm Aço
 ARO/RAIO	Aro: Rava 20" Parede dupla Freio a disco Alumínio Raio (Aço) Preto com niple	 ABRAÇADEIRA	Abraçadeira 31.8mm Blocação
 CUBOS	Dianteiro: Aço 36 furos Freio a disco (Parafuso) - Traseiro: Aço 36 furos Rosca (Roda livre) Freio a disco (Parafuso)	 PEDAL	Plataforma Preto Nylon
 PNEU / CÂMARA DE AR	Pneu: Pneu 20 x 2.1" Câmara: 20" Válvula americana	20" IMPORTADA	
		ÚNICO	 17412
		ÚNICO	 17413
		ÚNICO	 17414

FOTOS MERAMENTE ILUSTRATIVAS. AS INFORMAÇÕES/CONFIGURAÇÕES DE PRODUTOS PODERÃO SOFRER ALTERAÇÕES SEM AVISO PRÉVIO.

ENTRE EM CONTATO COM O SEU CONSULTOR OU FALE COM O NOSSO TIME DE TELEVENDAS PELO (33) 3277-3030.

RAVA

Sunny | PRO



RAVA

	QUADRO	Rava Sunny-pro Balance Aro 12" Aço Apoio de nylon para os pés
	GARFO	Rava Rígido Aro 12" Aço
	CAIXA DE DIREÇÃO	Sueca Com rosca Esferada
	GUIDÃO	Aço Rise bar 25.4 x 420 mm
	SUPORTE DE GUIDÃO	Aço Tipo sueco
	MANOPLA	Borracha
	CONJUNTO DE FREIO	Tambor Maçaneta de Nylon
	ARO/RAIO	Aro: Aço 12" / Raio: Preto 2.0 mm
	CUBOS	Aço com esfera Eixo de 9 mm
	PNEU / CÂMARA DE AR	Pneu com cravo 12 x 2.25" / Câmara com válvula americana
	CANOTE	Aço 25.4 mm Selim integrado
	ABRAÇADEIRA	Alumínio Parafuso

IMPORTADA

12"  17402

12"  17403

FOTOS MERAMENTE ILUSTRATIVAS. AS INFORMAÇÕES/CONFIGURAÇÕES DE PRODUTOS PODERÃO SOFRER ALTERAÇÕES SEM AVISO PRÉVIO.

ENTRE EM CONTATO COM O SEU CONSULTOR OU FALE COM O NOSSO TIME DE TELEVENDAS PELO (33) 3277-3030.

Sunny



RAVA

 QUADRO	Rava Sunny Balance Aro 12" Aço
 GARFO	Rava Rígido Aro 12" Aço
 CAIXA DE DIREÇÃO	Bucha
 GUIDÃO	Aço Reto Integrado
 MANOPLA	Borracha
 RODA	Aro 12" Nylon Pneu EVA semi-rígido
 CANOTE	Aço 25.4 mm Selim integrado

IMPORTADA

12"  17497

12"  17498

12"  17499

12"  17500

FOTOS MERAMENTE ILUSTRATIVAS. AS INFORMAÇÕES/CONFIGURAÇÕES DE PRODUTOS PODERÃO SOFRER ALTERAÇÕES SEM AVISO PRÉVIO.

ENTRE EM CONTATO COM O SEU CONSULTOR OU FALE COM O NOSSO TIME DE TELEVENDAS PELO (33) 3277-3030.



FOTOS MERAMENTE ILUSTRATIVAS. AS INFORMAÇÕES/CONFIGURAÇÕES DE PRODUTOS PODERÃO SOFRER ALTERAÇÕES SEM AVISO PRÉVIO.

ENTRE EM CONTATO COM O SEU CONSULTOR OU FALE COM O NOSSO TIME DE TELEVENDAS PELO **(33) 3277-3030**.



QUADRO 29" RAVA RAGE CARBON

MODELO	29" Rava RAGE CARBON Boost 148mm Cabeamento interno Suporte para câmbio dianteiro/ guia de corrente direct mount
DIREÇÃO	Integrada (42MM X 52MM)
CANOTE	Diâmetro do tubo 31.6 mm Acompanha abraçadeira do tubo do canote
FREIO	Suporte de freio traseiro post mount dentro do chainstay
MOVIMENTO CENTRAL	Press Fit 41 x 92 mm

EIXO	Acompanha eixo traseiro Boost
PNEU	Largura máxima 29" x 2.35
MATERIAL	Carbono
PESO MÁXIMO SUPORTADO	100kg
PESO	1.357g (Peso referente ao quadro 17" com abraçadeira, gancheira e eixo traseiro)
EMBALAGEM	1 unidade

CINZA/VERMELHO

15.5  22113

17  22116

19  22117

CINZA

15.5  22118

17  22119

19  22120

RAVA

Gancheira traseira para quadro Carbon mod. Rage



CARACTERÍSTICA	Pintura anodizada Design moderno Cor preta Fixação do eixo traseiro m12 x 1.5mm Acompanha parafuso para fixação
MATERIAL	Alumínio
PESO	13 gr (Gancheira e parafuso)
EMBALAGEM	5 unidades

22121

FOTOS MERAMENTE ILUSTRATIVAS. AS INFORMAÇÕES/CONFIGURAÇÕES DE PRODUTOS PODERÃO SOFRER ALTERAÇÕES SEM AVISO PRÉVIO.

ENTRE EM CONTATO COM O SEU CONSULTOR OU FALE COM O NOSSO TIME DE TELEVENDAS PELO (33) 3277-3030.



QUADRO 29" MTB NAZCA

MODELO	29" Quadro Rava MTB Boost 148mm x 12mm Cabeamento interno Dois suportes de caramanhola
DIREÇÃO	Tapared semi-integrada (44 x 55mm)
CANOTE	Diâmetro 31.6mm Passagem de cabo para canote retrátil
FREIO	Suporte de freio traseiro Post Mount dentro do Chainstay
MOVIMENTO CENTRAL	BSA 34.7 x 73mm
EIXO	Eixo traseiro m12 x 1.5mm – 170mm
PNEU	Diâmetro máximo 2.40 (60-622) cravos baixos
MATERIAL	Alumínio 6061
PESO	1.970g (Peso referente ao quadro "M" incluindo eixo e acessórios)
EMBALAGEM	2 unidades

AZUL/CINZA

15.5  24130

17  24134

19  24138

CINZA

15.5  24131

17  24135

19  24139

21  24142

CINZA/VERMELHO F

15.5  24132

17  24136

19  24140

VERMELHO/CINZA

15.5  24129

17  24133





19  24137

21  24141





**MEIA CICLISMO RIDE MOD.06
SUAVE COMPRESSÃO**

CARACTERÍSTICA	Tamanho único
TAMANHO	39-43
MODALIDADE	Speed e MTB
COMPRESSÃO	Suave
MATERIAL	Poliéster
PESO	60g
EMBALAGEM	10 peças

- 01  23682
- 02  23683
- 03  23684
- 04  23685

**MEIA CICLISMO RIDE MOD.07
SUAVE COMPRESSÃO**

CARACTERÍSTICA	Tamanho único
TAMANHO	39-43
MODALIDADE	Speed e MTB
COMPRESSÃO	Suave
MATERIAL	Poliéster
PESO	60g
EMBALAGEM	10 peças

- 01  23686
- 02  23687



FOTOS MERAMENTE ILUSTRATIVAS. AS INFORMAÇÕES/CONFIGURAÇÕES DE PRODUTOS PODERÃO SOFRER ALTERAÇÕES SEM AVISO PRÉVIO.

ENTRE EM CONTATO COM O SEU CONSULTOR OU FALE COM O NOSSO TIME DE TELEVENDAS PELO (33) 3277-3030.

RAVA



SUPORTE CARAMANHOLA FIBRA VIDRO MOD. 01 PRETO

CARACTERÍSTICAS

Design moderno
Leve e resistente
Fixação por 02 parafusos (acompanham o suporte)
Sistema de fixação com regulagem de posição
Confeccionado em nylon e fibra de vidro

MATERIAL

Nylon / fibra de vidro

OBSERVAÇÃO



Confeccionado em fibra de vidro, Formato que reduz a possibilidade da caramanhola sair do suporte em terrenos irregulares, Projetado para que a caramanhola tenha um encaixe simples e suave, Construção em 30% fibra de vidro e 70% nylon

PESO

35gr - peso referente ao suporte com parafusos

EMBALAGEM

100 peças

- | | | |
|---|---|-------|
| 1 |  | 22663 |
| 2 |  | 22664 |
| 3 |  | 22665 |



RAVA

CAPACETE RAKAN TAM. 56-61

ABERTURAS DE CIRCULAÇÃO DE AR

14

CONSTRUÇÃO/ESTRUTURA

In mold | Design aerodinâmico | Estrutura robusta

SISTEMA DE FECHAMENTO

Fivela

SISTEMA REGULÁVEL

Fivela e Dial giratório para melhor encaixe na cabeça

ENCHIMENTO

Espuma | Removível e lavável

SINALIZAÇÃO

Com LED vermelho 3 níveis de alerta

PESO

237g

1  24911

2  24912

3  24913

>> **INFORMAÇÕES DOS ACESSÓRIOS**
Possui encaixe para GoPro

FOTOS MERAMENTE ILUSTRATIVAS. AS INFORMAÇÕES/CONFIGURAÇÕES DE PRODUTOS PODERÃO SOFRER ALTERAÇÕES SEM AVISO PRÉVIO.

ENTRE EM CONTATO COM O SEU CONSULTOR OU FALE COM O NOSSO TIME DE TELEVENDAS PELO (33) 3277-3030.



| CAPACETE SPACE IV

ABERTURAS DE CIRCULAÇÃO DE AR

18

CONSTRUÇÃO/ESTRUTURA

In mold | PC + EPS | Design aerodinâmico | Estrutura robusta

SISTEMA DE FECHAMENTO

Fivela

SISTEMA REGULÁVEL

Fivela e dial giratório para melhor encaixe na cabeça

ENCHIMENTO

Espuma removível e lavável

PESO

193g

L/M  24914/24915

L/M  24916/24917

L/M  24918/24919

L/M  24920/24921



INFORMAÇÕES DOS ACESSÓRIOS

Acompanha viseira

Kit capacete little child play + acessórios

ABERTURAS DE CIRCULAÇÃO DE AR	11
CONSTRUÇÃO	Pvc + Eps
SISTEMA DE FECHAMENTO	Fivela
SISTEMA REGULÁVEL	Sim
CONSTRU SISTEMA DE REGULAGEM	Ajustável na fivela
ESPUMA LAVÁVEL	Sim
WISEIRA	Não possui
FAIXA REFLETIVA	Não possui
CODIGO:	25018 - VM 25019 - PT



>> INFORMAÇÕES DOS ACESSÓRIOS

Joelheiras - 1 par
Cotoveleiras - 1par

Capacete little child fan c/ acessórios

ABERTURAS DE CIRCULAÇÃO DE AR	6
CONSTRUÇÃO	Pvc + Eps
SISTEMA DE FECHAMENTO	Fivela
SISTEMA REGULÁVEL	Sim
CONSTRU SISTEMA DE REGULAGEM	Ajustável na fivela
WISEIRA	Não possui
FAIXA REFLETIVA	Não possui
CODIGO:	25025 - AZ 25029 - LJ 25027 - FLOWERS 25026 - BALL CORES 25028 - MELÂNCIA



>> INFORMAÇÕES DOS ACESSÓRIOS

Joelheiras - 1 par
Cotoveleiras - 1par

FOTOS MERAMENTE ILUSTRATIVAS. AS INFORMAÇÕES/CONFIGURAÇÕES DE PRODUTOS PODERÃO SOFRER ALTERAÇÕES SEM AVISO PRÉVIO.

ENTRE EM CONTATO COM O SEU CONSULTOR OU FALE COM O NOSSO TIME DE TELEVENDAS PELO (33) 3277-3030.

RAVA

Capacete Little child play

ABERTURAS DE CIRCULAÇÃO DE AR	11
CONSTRUÇÃO	Pvc + Eps
SISTEMA DE FECHAMENTO	Fivela
SISTEMA REGULÁVEL	Sim
CONSTRUÇÃO SISTEMA DE REGULAGEM	Ajustável na fivela
ESPUMA LAVÁVEL	Sim
VISEIRA	Não possui
FAIXA REFLETIVA	Não possui
CODIGO:	25017 - PT 25016 - VM



RAVA

Capacete little child fan

ABERTURAS DE CIRCULAÇÃO DE AR	6
CONSTRUÇÃO	Pvc + Eps
SISTEMA DE FECHAMENTO	Fivela
SISTEMA REGULÁVEL	Sim
CONSTRUÇÃO SISTEMA DE REGULAGEM	Ajustável na fivela
VISEIRA	Não possui
FAIXA REFLETIVA	Não possui
CODIGO:	25020 - AZ 25024 - LJ 25022 - FLOWERS 25021 - BALL CORES 25023 - MELÂNCIA



FOTOS MERAMENTE ILUSTRATIVAS. AS INFORMAÇÕES/CONFIGURAÇÕES DE PRODUTOS PODERÃO SOFRER ALTERAÇÕES SEM AVISO PRÉVIO.

ENTRE EM CONTATO COM O SEU CONSULTOR OU FALE COM O NOSSO TIME DE TELEVENDAS PELO (33) 3277-3030.

Viseira Plástica para Capacete Space New Rava

CARACTERÍSTICA Nylon

EMBALAGEM 10 peças

12418



Carneira Plástica para Capacete Space New Rava

CARACTERÍSTICA Para ajuste de capacete

MATERIAL Nylon

EMBALAGEM 10 peças

12419



Viseira para Capacete Rava Space

- CARACTERÍSTICA**
- Viseira para capacete rava
 - Compatível com capacete rava space
 - Encaixe lateral por pressão
 - Material nylon

EMBALAGEM 10 peças

11123



RAVA

Espuma interna para capacete Space New Rava

CARACTERÍSTICA Espuma interna para capacete
Space New Rava

EMBALAGEM 5 peças

12417

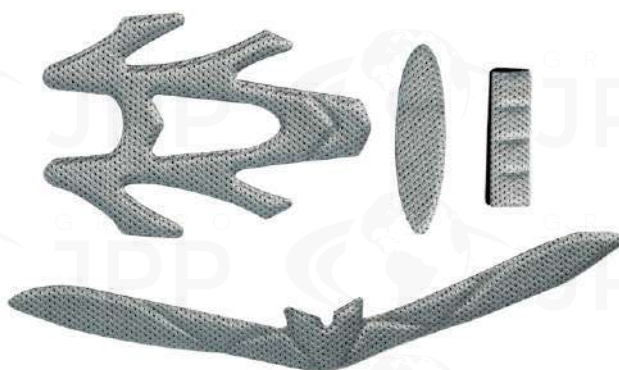

Terminal Passa Cabo Cego Quadro Rava

CARACTERÍSTICA Compatível com Jump e Storm linha
2019/2020 / Ride Plus, Hunch e
Hunch Plus, Stamina, Jump e Hurry
linha 2021/2022

MATERIAL Nylon

FATOR 20

EMBALAGEM 500 peças

17801



Terminal Passa Cabo Encaixo Quadro Rava

CARACTERÍSTICA Compatível com Jump e Storm linha
2019/2020 / Ride Plus, Hunch e
Hunch Plus, Stamina, Jump e Hurry
linha 2021/2022

MATERIAL Nylon

FATOR 20

EMBALAGEM 500 peças

17251



Terminal Passa Cabo Quadro Pt Alum. Rava

CARACTERÍSTICA

- Passagem para dois cabos
- Acompanha parafuso
- Compatível com quadro TSW Yukon

MATERIAL

Alumínio

PESO

28gr - peso referente a sacolinha com 10 unidades

FATOR

10

EMBALAGEM

100 peças

20328



Terminal Passa Cabo Quadro Duplo Pt Rava

CARACTERÍSTICA

- Passagem para dois cabos
- Fixado por pressão
- Compatível com quadro TSW Hunch e Hunch Plus

MATERIAL

Nylon

PESO

12gr - peso referente a sacolinha com 20 unidades

FATOR

20

EMBALAGEM

100 peças

20329



Terminal Passa Cabo Quadro Triplo Pt Rava

CARACTERÍSTICA

- Passagem para até 3 cabos
- Fixado por pressão

MATERIAL

Borracha

PESO

52gr - peso referente a sacolinha com 20 unidades

FATOR

20

EMBALAGEM

100 peças

24145





| Selim assento diant. Bicicleta c/ suporte



MODELO

- Selim assento dianteiro RAVA
- Selim com castanha em aço
- Suporte com proteção para chassi
- Fixação no Top Tube com Down Tube
- Acompanha ferramenta para instalação
- Suporte de Apoio para as mãos
- Suporte com apoio para os pés com presilha
- Acompanha manual de instalação

MATERIAL

Polímero e aço

PESO

1.515 Kg (Referente ao kit Completo)

EMBALAGEM

25 unidades

23831

Selim mtb gel preto mod. 3

MODELO

- Vazado
- estrutura do assento em polímero, espuma e couro sintético
- Excelente acabamento
- Não acompanha castanha

MATERIAL

Polímero e aço

TAMANHO

275 x 160 mm

PESO

358g

EMBALAGEM

30 peças

23273



Selim mtb "sedna" vazado preto

MODELO

- Vazado
- estrutura do assento em polímero, espuma e couro sintético
- Excelente acabamento
- Com castanha

MATERIAL

Polímero e aço

TAMANHO

275 x 150 mm

PESO

432g peso referente ao selim com castanha

EMBALAGEM

30 peças

23269



Selim mtb "marte" preto gel

MODELO

- Vazado
- estrutura do assento em polímero, espuma e couro sintético
- Excelente acabamento
- Com castanha

MATERIAL

Polímero e aço

TAMANHO

270 x 160 mm

PESO

532g peso referente ao selim com castanha

EMBALAGEM

30 peças

■ 23224



Selim mtb "ceres" gel preto

MODELO

- Vazado
- estrutura do assento em polímero, espuma e couro sintético
- Excelente acabamento
- Com castanha

MATERIAL

Polímero e aço

TAMANHO

275 x 160 mm

PESO

558g peso referente ao selim com castanha

EMBALAGEM

30 peças

■ 23267





| Selim Júnior Rava

MODELO Com castanha | trilhos de aço

MATERIAL Polímero e aço

TAMANHO 245 x 140 mm

PESO 253g (com castanha)

EMBALAGEM 50 peças

 23261

 23262

 23263

 23264

| Selim mtb “neptuno” preto

MODELO

- Vazado
- estrutura do assento em polímero, espuma e couro sintético
- Excelente acabamento
- Não acompanha castanha

MATERIAL Polímero e aço

TAMANHO 275 x 160 mm

PESO 462g peso referente ao selim com castanha

EMBALAGEM 30 peças

 23266



FOTOS MERAMENTE ILUSTRATIVAS. AS INFORMAÇÕES/CONFIGURAÇÕES DE PRODUTOS PODERÃO SOFRER ALTERAÇÕES SEM AVISO PRÉVIO.

ENTRE EM CONTATO COM O SEU CONSULTOR OU FALE COM O NOSSO TIME DE TELEVENDAS PELO (33) 3277-3030.

RAVA

Selim cross "eris" frestyle preto

CARACTERÍSTICA	Selim Bmx Linha Rava
	<ul style="list-style-type: none">• Selim Bmx Rava• Trilho Em Aço• Estrutura Do Assento Em Polímero, Espuma E Couro Sintético• Excelente Acabamento• Acompanha Castanha Para Fixação No Canote• Largura 148mm• Comprimento 230mm

MATERIAL	Espuma/ Couro Sintético
-----------------	-------------------------

TRILHO	Aço
---------------	-----

TAMANHO	148mm x 230mm
----------------	---------------

PESO	386g - Selim com a castanha
-------------	-----------------------------

EMBALAGEM	30 unidades
------------------	-------------

23225



Selim 02 molas c/ castanha big preto

CARACTERÍSTICA	<ul style="list-style-type: none">• Selim Rava• Trilho Em Aço• Com 02 Molas Em Aço• Estrutura Do Assento Em Polímero, Espuma E Couro Sintético• Excelente Acabamento• Acompanha Castanha Para Fixação No Canote• Largura 205mm• Comprimento 240mm
-----------------------	--

MATERIAL	Espuma/ Couro Sintético
-----------------	-------------------------

TRILHO	Aço
---------------	-----

TAMANHO	240mm x 205mm
----------------	---------------

PESO	668g - Selim com a castanha
-------------	-----------------------------

EMBALAGEM	30 unidades
------------------	-------------

23260



| Selim big c/ castanha e elastômero

CARACTERÍSTICA

- Selim Rava
- Trilho Em Aço
- Com 02 Molas Em Elastômero
- Estrutura Do Assento Em Polímero, Espuma E Couro Sintético
- Excelente Acabamento
- Acompanha Castanha Para Fixação No Canote
- Largura 205mm
- Comprimento 240mm

MATERIAL

Espuma/ Couro Sintético

TRILHO

Aço

TAMANHO

240mm x 205mm

PESO

635g - Selim com a castanha

EMBALAGEM

30 unidades

23265



| Selim mtb “mercúrio” largo preto

CARACTERÍSTICA

- Selim Rava
- Trilho Em Aço
- Vazado
- Suporte Auxiliar Na Parte De Trás
- Estrutura Do Assento Em Polímero, Espuma E Couro Sintético
- Excelente Acabamento
- Acompanha Castanha Para Fixação No Canote
- Largura 205mm
- Comprimento 268mm

MATERIAL

Espuma/ Couro Sintético

TRILHO

Aço

TAMANHO

268mm x 205mm

PESO

548g - Selim com a castanha

EMBALAGEM

30 Unidades

23268



RAVA

Selim passeio "leonis" preto

CARACTERÍSTICA

- Selim Rava
- Trilho Em Aço
- Estrutura Do Assento Em Polímero, Espuma E Couro Sintético
- Excelente Acabamento
- Acompanha Castanha Para Fixação No Canote
- Largura 185mm
- Comprimento 265mm

MATERIAL

Espuma/ Couro Sintético

TRILHO

Aço

TAMANHO

185mm x 265mm

PESO

494g - Selim com a castanha

EMBALAGEM

30 unidades

23270



Selim mtb preto mod 1

CARACTERÍSTICA

- Selim Rava
- Trilho Em Aço
- Estrutura Do Assento Em Polímero, Espuma E Couro Sintético
- Excelente Acabamento
- Largura 160mm
- Comprimento 275mm

MATERIAL

Espuma/ Couro Sintético

TRILHO

Aço

TAMANHO

160mm x 275mm

PESO

336g

EMBALAGEM

30 unidades

23271



Selim mtb preto mod 2

CARACTERÍSTICA

- Selim Rava
- Vazado
- Trilho Em Aço
- Estrutura Do Assento Em Polímero, Espuma E Couro Sintético
- Excelente Acabamento
- Largura 160mm
- Comprimento 275mm

MATERIAL

Espuma/ Couro Sintético

TRILHO

Aço

TAMANHO

160mm x 275mm

PESO

335g

EMBALAGEM

30 unidades

23272



Selim mtb gel preto mod. 4

MODELO

- Vazado
- estrutura do assento em polímero, espuma e couro sintético
- Excelente acabamento
- Não acompanha castanha

MATERIAL

Polímero e aço

TAMANHO

275 x 160 mm

PESO

360g

EMBALAGEM

30 peças

23274





26"
WHEELS

IMPORTADO

17811

KIT Roda Dianteira/Traseira 36 Furos Rava

CARACTERÍSTICA

Roda Rava aro 26" (559 x 19 mm) com CNC | Acompanha fita protetora de câmara de ar

ARO

Parede dupla | Alumínio 6063 | ERD 535 mm | 36 furos | Pneu 1.0" à 2.2" | CNC | Freio V/B

CUBO

Dianteiro: Aço | 36 furos | Esferado | Eixo 9 x 100 mm | Com blocagem

Traseiro: Aço | 36 furos | Esferado | Rosca (Roda livre) | 9 x 135 mm | Com blocagem

RAIO

Aço preto | 250 mm x 2,0 mm | Niple preto

MATERIAL

Aro: Alumínio
Cubos e raios: Aço

EMBALAGEM

1 par



29"
WHEELS

IMPORTADO

17812

KIT Roda Dianteira/Traseira 32 Furos Rava

CARACTERÍSTICA

Roda Rava aro 29" (622 x 19 mm) | Disc Brake | Acompanha fita protetora de câmara de ar

ARO

Parede dupla | Alumínio 6063 | ERD 584 mm | 32 furos | Pneu 1.0" à 2.2" | Disc Brake

CUBO

Dianteiro: Alumínio | 32 furos | Rolamento | Eixo 9 x 100 mm | Com blocagem

Traseiro: Alumínio | 32 furos | Rolamento | Free Hub (Standard 8/9/10v.) | 9 x 135 mm | Com blocagem

RAIO

Aço preto | 2.0 mm | Niple preto

MATERIAL

Aro e cubo: Alumínio
Raios: Aço

EMBALAGEM

1 par

RAVA



Kit Chaveiro Multifunção 12 Funções Rava

CARACTERÍSTICA 12 funções

FUNÇÕES Extrator de corrente | Allen 1.5, 2, 3, 4, 5, 6, 8 mm | PH 1 | Torx T25 | Fenda 1.0 x 5 mm | Canhão 7 mm

MATERIAL Alumínio

EMBALAGEM 100 peças

 3979

 4983



Alicate para Corrente Rava

CARACTERÍSTICA Trava e destrava Missing Link

EMBALAGEM 10 peças

13187



Alicate para Destravar Corrente Rava

CARACTERÍSTICA Destrava Missing Link

EMBALAGEM 10 peças

16097



Extrator de Pedivela Rava

CARACTERÍSTICA Extrator de Pedivela triplo | Ponta Quadrada

EMBALAGEM 50 Peças

22705



Kit Chaveiro Multifunção 07 Funções Rava

CARACTERÍSTICA	07 funções
FUNÇÕES	Allen 2,5, 3, 4, 5, 6 mm Chave Philips Chave de Fenda
MATERIAL	Alumínio
EMBALAGEM	100 peças
	16214
	16213



Extrator movimento central

CARACTERÍSTICA	Integrado
EMBALAGEM	50 peças
	04009



Extrator pedal TSW / RAVA

CARACTERÍSTICA	9/16 - 15 - 24mm
EMBALAGEM	50 peças
	04010



Extrator TSW / RAVA

CARACTERÍSTICA	Extrator pedal Parafuso eixo central
EMBALAGEM	50 peças
	04002



Espátula nylon

CARACTERÍSTICA	Para retirar câmara 2 peças
EMBALAGEM	50 peças
	04001

RAVA



Kit chaveiro allen

CARACTERÍSTICA 9 funções

EMBALAGEM 50 peças

04631



Alicate corte cabo tsw / rava

CARACTERÍSTICA Para corte cabo de aço

EMBALAGEM 50 peças

04011



Kit chaveiro allen

CARACTERÍSTICA 9 funções

EMBALAGEM 50 peças

04982



Extrator corrente corrida tsw / rava

CARACTERÍSTICA Extrator de corrente

EMBALAGEM 100 peças

04004



Extrator roda livre tsw / rava

CARACTERÍSTICA Chave de extrair roda livre/Cassete

EMBALAGEM 50 peças

04012



Extrator corrente tsw / rava

CARACTERÍSTICA Extrator de corrente

EMBALAGEM 100 peças

04003



Chave de raio tsw / rava

CARACTERÍSTICA 10/11/12/14/15G

EMBALAGEM 50 peças

04006



Extrator de roda tsw / rava

CARACTERÍSTICA Extrator de Roda livre 22.5mm

EMBALAGEM 50 peças

03997



Extrator de movimento central

CARACTERÍSTICA Central Selado

EMBALAGEM 100 peças

03996



Extrator de roda

CARACTERÍSTICA Extrator de Roda livre 4 Pinos

EMBALAGEM 50 peças

04000



Extrator cassete tsw / rava

CARACTERÍSTICA Extrator Cassete e Disco Center Lock 23.5mm | Com guia

EMBALAGEM 50 peças

03999



Extrator cassete tsw / rava

CARACTERÍSTICA Extrator Cassete e Disco Center Lock 23mm

EMBALAGEM 50 peças

03998



Extrator de pedivela tsw / rava

CARACTERÍSTICA Triplo - Central quadrada

EMBALAGEM 50 peças

04005

RAVA



Smart Tools Case Rava

CARACTERÍSTICA 14 peças | Para remoção e instalação de rolamentos

CONTEÚDO Allen 8 mm | Arruela | Cilindro | Engate 22/24 mm | Engate 22/30 mm | Engate 25/30 mm | Pinça | Parafuso hexagonal | Tampa hexagonal | Tampa 45 mm | Tampa 53 mm | 3 puxadores de fenda

EMBALAGEM 5 peças

13184

RAVA



FOTOS MERAMENTE ILUSTRATIVAS. AS INFORMAÇÕES/CONFIGURAÇÕES DE PRODUTOS PODERÃO SOFRER ALTERAÇÕES SEM AVISO PRÉVIO.

ENTRE EM CONTATO COM O SEU CONSULTOR OU FALE COM O NOSSO TIME DE TELEVENDAS PELO (33) 3277-3030.



Smart Tools Pocket Rava

CARACTERÍSTICA 20 funções

FUNÇÕES Chave de rosca 5, 8(2x) e 10 mm | Chave de raio(3x) | Chave de raio Mavic (2x) | Allen 2(2x), 2.5, 4, 5, 6 e 8 mm | T25 | PH2 | Fenda 5 mm | Chave de corrente

MATERIAL Alumínio

PESO 0.12 Kg

EMBALAGEM 10 peças

13186



RAVA

FOTOS MERAMENTE ILUSTRATIVAS. AS INFORMAÇÕES/CONFIGURAÇÕES DE PRODUTOS PODERÃO SOFRER ALTERAÇÕES SEM AVISO PRÉVIO.

ENTRE EM CONTATO COM O SEU CONSULTOR OU FALE COM O NOSSO TIME DE TELEVENDAS PELO (33) 3277-3030.



Suporte Oficina para Montagem de Bicicleta Rava

CARACTERÍSTICA Altura regulável: mínimo 104 cm / 198 cm máximo | Quadripé retrátil | Braço de apoio com mandíbula | Mandíbula com abertura de 75 mm | Haste de fixação | Giro 360°

COMPLEMENTOS Suporte para ferramentas | Barra de Imã | Chave allen 5 mm

CARGA SUPORTADA 30 kg

MATERIAIS Aço | Plástico | Borracha

EMBALAGEM 1 peça

18075



Porta Ferramentas Save Tools Rava

CARACTERÍSTICA Ideal para transportar câmara de ar | Ferramentas | Chaves e suplementos

MATERIAL Plástico

TAMANHO ø 7,5 cm | Altura: 13,5 cm

EMBALAGEM 01 peça

14705



Suporte Oficina para Montagem de Bicicleta Modelo 2 Rava

CARACTERÍSTICA

Suporte manutenção profissional para reparo em bicicleta;
Material principal: Aço Carbono e Polímero Termoplástico | Peso do Produto: 4.630 gramas | Fixação da bicicleta pelo quadro ou através do canote;
Encaixe em diferentes formatos de tubos até 60mm (diâmetro);
Altura Regulável de 120cm até 170cm;
Acompanha Bandeja e chave para montagem do suporte;

COMPLEMENTOS

Acompanha suporte estabilizador de guidão | De fácil montagem; Compacto quando dobrado | Liberação rápida & altura ajustável | A abraçadeira gira 360°, isso significa que o operador pode escolher o melhor ângulo para manutenção | Design inovador de duas pernas, eficiente e muito estável

CARGA SUPORTADA

27 kg

MATERIAIS

Aço Carbono e Polímero Termoplástico

EMBALAGEM

1 peça

20969



RAVA

Suporte Bicicleta vertical mod 01

CARACTERÍSTICA

- Suporte expositor RAVA
- Material Aço
- Alta qualidade
- Resistente
- Excelente Acabamento
- Fixação por parafuso
- Suporte da roda articulado
- Vertical
- Proteção para o Aro

MATERIAL

Aço

PESO

+556 Gr - incluindo parafusos

EMBALAGEM

10 peças

23219



Suporte Expositor Bicicleta Roda Traseira. Cavalete

CARACTERÍSTICA

- Suporte expositor RAVA
- Material Aço
- Alta qualidade
- Resistente
- Excelente Acabamento
- Suporte articulado
- Regulável 26"/ 27.5"/ 29"
- Horizontal
- Fixação no eixo da roda
- Fixadores do eixo de nylon

MATERIAL

Aço

PESO

+700 Gr

EMBALAGEM

10 peças

23220



Descanso Traseiro MTB Modelo 06 Rava

CARACTERÍSTICA	Fixação lateral por parafuso (chainstay) Para Bicicletas aro 26"
COMPATIBILIDADE	Compatível com bicicletas Rava Bolt, Rava Way 26" e TSW Orla
MATERIAL	Aço e nylon
PESO	247 Gr - incluindo parafusos de fixação
EMBALAGEM	50 peças 20147



Descanso central mtb modelo 01

CARACTERÍSTICA	<ul style="list-style-type: none">• Descanso central rava• Material alumínio• Alta qualidade• Resistente• Excelente acabamento
COMPATIBILIDADE	<ul style="list-style-type: none">• Fixação por parafuso (instalação no chainstay)• Sistema de regulação de altura
MATERIAL	Alumínio
PESO	+260gr
EMBALAGEM	50 peças 23216



Descanso lateral mtb modelo 04

CARACTERÍSTICA	<ul style="list-style-type: none">• Descanso lateral rava• Material aço• Alta qualidade• Resistente• Excelente acabamento
COMPATIBILIDADE	<ul style="list-style-type: none">• Fixação por parafuso (instalação no chainstay e seat stay)• Sistema de regulação de altura
MATERIAL	Aço
PESO	-
EMBALAGEM	50 peças 23217



FOTOS MERAMENTE ILUSTRATIVAS. AS INFORMAÇÕES/CONFIGURAÇÕES DE PRODUTOS PODERÃO SOFRER ALTERAÇÕES SEM AVISO PRÉVIO.

ENTRE EM CONTATO COM O SEU CONSULTOR OU FALE COM O NOSSO TIME DE TELEVENDAS PELO (33) 3277-3030.

RAVA

Terminal Passa Cabo Quadro Rava

CARACTERÍSTICA

Terminal passa cabo duplo em alumínio Rava | Kit com 5 unidades | Acompanha parafuso para instalação | Preta

COMPATIBILIDADE

Compatível com quadro TSW YUKON e RAVA CAVE BOOST

DIMENSÕES

32 x 9 x 6.5 mm (Comprimento X Largura X Altura)

MATERIAL

Alumínio

PESO

2 gr (peso da unidade)

EMBALAGEM

200 peças

20489



Descanso lateral mtb modelo 05

CARACTERÍSTICA

- Descanso lateral rava
- Material aço
- Alta qualidade
- Resistente
- Excelente acabamento

COMPATIBILIDADE

- Fixação por parafuso (instalação no chainstay)
- Sistema de regulagem de altura

MATERIAL

Aço

PESO

-

EMBALAGEM

50 peças

23218





Suporte Expositor Bicicleta Roda Tras.

CARACTERÍSTICA Base de apoio emborrachada, desmontável, suporte individual. Fenda do pneu: 60mm

COMPATIBILIDADE Bicicleta de aro 20" a 29"

DIMENSÕES 430 x 380 x 760 mm (Comprimento X Largura X Altura)

MATERIAL Aço

PESO 1.95 Kg (peso da unidade)

EMBALAGEM 1 peça

23798

C A T Á L O G O

X-TIME

T R A N S M I S S Õ E S



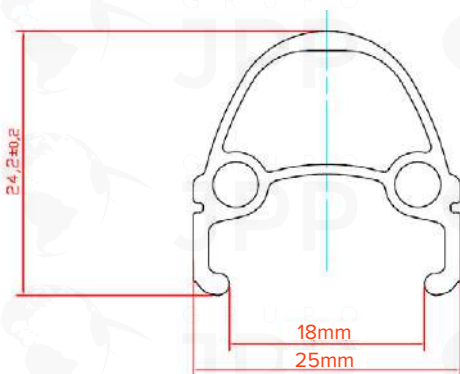

ARO 29 X 32F ALUM MTB PRETO F. XT 1000 IMP.

MATERIAL	Alumínio anodizado
CARACTERÍSTICA	<ul style="list-style-type: none"> • x-time xt1000 • alumínio 6061 • acabamento anodizado • largura externa 25mm • largura interna 18mm • perfil duplo • 32 furos • disc brake • largura do pneu 25mm – 55mm (1.0" – 2.2") • disponível com válvula americana
PESO	572g
EMBALAGEM	10 unidades
	22831

FOTOS MERAMENTE ILUSTRATIVAS. AS INFORMAÇÕES/CONFIGURAÇÕES DE PRODUTOS PODERÃO SOFRER ALTERAÇÕES SEM AVISO PRÉVIO.

ENTRE EM CONTATO COM O SEU CONSULTOR OU FALE COM O NOSSO TIME DE TELEVENDAS PELO (33) 3277-3030.

Alavanca CÂMBIO EZ-FIRE 21V. PRETA

CARACTERÍSTICA

- Conjunto de alavanca 21v ez-fire
- Material alumínio
- Alta qualidade
- Resistente
- Excelente acabamento
- Manetes de alumínio
- Sistema de transmissão 3x7v
- Acompanha cabos de marcha

PESO APROXIMADO +/- 342 g

EMBALAGEM 25 unidades

23221



Alavanca CÂMBIO EZ-FIRE 24V. PRETA

CARACTERÍSTICA

- Conjunto de alavanca 24v ez-fire
- Material alumínio
- Alta qualidade
- Resistente
- Excelente acabamento
- Manetes de alumínio
- Sistema de transmissão 3x8v
- Acompanha cabos de marcha

PESO APROXIMADO +/- 342 g

EMBALAGEM 25 unidades

23222



Conjunto De Câmbio 3X7 VEL. XTIME

CARACTERÍSTICA

- Conjunto de alavanca 21v ez-fire
- Material alumínio/aço
- Alta qualidade
- Resistente
- Excelente acabamento
- Manetes de alumínio
- Câmbio traseiro de 7 velocidades (fixação direta – parafuso na gancheira do quadro)
- Câmbio dianteiro de 3 velocidades (abraçadeira 31.8mm / down pull)
- Sistema de transmissão 3x7v
- Acompanha cabos de marcha

PESO APROXIMADO +/-728gr - peso referente ao kit

EMBALAGEM 25 unidades

23223



FOTOS MERAMENTE ILUSTRATIVAS. AS INFORMAÇÕES/CONFIGURAÇÕES DE PRODUTOS PODERÃO SOFRER ALTERAÇÕES SEM AVISO PRÉVIO.

ENTRE EM CONTATO COM O SEU CONSULTOR OU FALE COM O NOSSO TIME DE TELEVENDAS PELO (33) 3277-3030.

XTIME



Alavanca Câmbio EZ-FIRE 24v

CARACTERÍSTICA Com manetes de alumínio | Cabos e condutores

EMBALAGEM 25 peças

03613

Alavanca Câmbio EZ-FIRE 21v

CARACTERÍSTICA Com manetes de alumínio | Cabos e condutores

EMBALAGEM 25 peças

00150/20512



Roldana X-Time 12 dentes | Alumínio/Cerâmica

ROLAMENTO	Cerâmica
MATERIAL	Alumínio
NÚMERO DE DENTES	12
DIÂMETRO	46.7 mm
ESPESSURA DO DENTE	1.9 mm
COMPATIBILIDADE	Sram GX e SX
PESO	13 g
EMBALAGEM	25 peças
	15025



Roldana X-Time 14 dentes | Alumínio/Cerâmica

ROLAMENTO	Cerâmica
MATERIAL	Alumínio
NÚMERO DE DENTES	14
DIÂMETRO	55.5 mm
ESPESSURA DO DENTE	1.9 mm
COMPATIBILIDADE	Sram GX e SX
PESO	13 g
EMBALAGEM	25 peças
	15027



FOTO ILUSTRATIVA
DA EMBALAGEM



Roldana X-Time 12 dentes | Alumínio

ROLAMENTO	Comum
MATERIAL	Alumínio
NÚMERO DE DENTES	12
DIÂMETRO	46.7 mm
ESPESSURA DO DENTE	1.9 mm
COMPATIBILIDADE	Sram GX e SX
PESO	13 g
EMBALAGEM	25 peças
	15024



Roldana X-Time 13 dentes | Alumínio

ROLAMENTO	Comum
MATERIAL	Alumínio
NÚMERO DE DENTES	13
DIÂMETRO	49.4 mm
ESPESSURA DO DENTE	1.9 mm
COMPATIBILIDADE	Shimano XTR, XT, SLX, Deore 12 velocidades
PESO	13 g
EMBALAGEM	25 peças

15030



Roldana X-Time 14 dentes | Alumínio

ROLAMENTO	Comum
MATERIAL	Alumínio
NÚMERO DE DENTES	13
DIÂMETRO	55.5 MM
ESPESSURA DO DENTE	1.9 mm
COMPATIBILIDADE	Sram GX e SX
PESO	13 g
EMBALAGEM	25 peças

15026



FOTO ILUSTRATIVA DA EMBALAGEM



Roldana X-Time 11 dentes | Nylon

ROLAMENTO	Comum
MATERIAL	Nylon
NÚMERO DE DENTES	11
DIÂMETRO	42 mm
ESPESSURA DO DENTE	2.2 mm
COMPATIBILIDADE	Shimano ALTUS RD-M200, ALÍVIO RD-M4000, ALÍVIO RD-M3100, SLX RD-M7000, XT RD-M8000, CLARIS RD-R2000, SORA RD-R3000 e 105 RD-R7000
PESO	8 g
EMBALAGEM	25 peças

15031



Roldana X-Time 12 dentes | Nylon

ROLAMENTO	Comum
MATERIAL	Nylon
NÚMERO DE DENTES	12
DIÂMETRO	50.5 mm
ESPESSURA DO DENTE	2.5 e 3.7 mm
PESO	10g
EMBALAGEM	25 peças
	15029



Roldana X-Time 13 dentes | Nylon

ROLAMENTO	Comum
MATERIAL	Nylon
NÚMERO DE DENTES	13
DIÂMETRO	49.5 mm
ESPESSURA DO DENTE	2.45 mm
COMPATIBILIDADE	Altus RD-M310, Tourney RD-A070 e RD-TY 300
PESO	13g
EMBALAGEM	25 peças
	15028



Pedivela Single com Engrenagem 32T

CARACTERÍSTICA	Com braço Compatível com central ponta quadrada
MATERIAL PEDIVELA	Alumínio
MATERIAL ENGENHAGEM	Aço
ENGENHAGEM	32D
BCD	104 mm
COMPRIMENTO DO BRAÇO	170 mm
EMBALAGEM	5 peças
PESO	0.78 kg (com engrenagem 32D aço)
	18119



X-TIME

Engrenagem Tripla com Braço 42/34/24

CARACTERÍSTICA Com braço e protetor de coroa | Compatível com central ponta quadrada
Braço: Alumínio
Engrenagem: Aço

ENGENHAGENS 42/34/24D

COMPRIMENTO DO BRAÇO 170 mm

PESO 803 g

EMBALAGEM 5 peças

15470



Pedivela Direct Mount X-Time com engrenagem

CARACTERÍSTICA Direct mount | Com engrenagem | Material de alta resistência e rigidez | Eixo Ø 24 x 120 mm

MATERIAL Alumínio

COMPRIMENTO DO BRAÇO 170 mm

ENGENHAGENS COMPATÍVEIS Xtime e Sram®

ALINHAMENTO DA CORRENTE 49 mm | 52 mm (boost)

MOVIMENTO CENTRAL BSA Ø 24 mm

PESO 780 g (C/ engrenagem 32T)

EMBALAGEM 5 peças

170 MM 18120



Engrenagem alum. C/ braço Off set 3mm integ. Xt

CARACTERÍSTICA	Engrenagem com braço xtime coroa direct mount em alumínio braço em alumínio
MATERIAL	Alumínio / Aço
COMPRIMENTO DO BRAÇO	170 mm
EIXO DE AÇO	Ø24x120mm
ENGRENAGENS COMPATÍVEIS	Xtime e Sram®
ALINHAMENTO DA CORRENTE	49 mm 52 mm (boost)
MOVIMENTO CENTRAL	BSA Ø 24 mm
PESO	850gr - peso referente engrenagem completa e movimento central
EMBALAGEM	5 peças
CÓDIGO	22760 - 30D 22759 - 32D



X-TIME

Engrenagem Dupla 39/53D Speed

CARACTERÍSTICA	Com braço 170mm
BCD	130 mm
MATERIAL	Alumínio
COROA	Aço
EMBALAGEM	10 peças
130 MM	12660



FOTOS MERAMENTE ILUSTRATIVAS. AS INFORMAÇÕES/CONFIGURAÇÕES DE PRODUTOS PODERÃO SOFRER ALTERAÇÕES SEM AVISO PRÉVIO.

ENTRE EM CONTATO COM O SEU CONSULTOR OU FALE COM O NOSSO TIME DE TELEVENDAS PELO (33) 3277-3030.

Engrenagem Tripla C/ Braço 24/34/42d. Presta

CARACTERÍSTICA

- Engrenagem Tripla Com Braço
- Material Aço Revestido Com Nylon
- Coroas Fixas (42/34/24d.)
- Protetor De Coroa
- Sistema De Encaixe Compatível Com Eixo Central Ponta Quadrada
- Diâmetro Da Rosca Do Pedal 9/16 (Inglês)
- Comprimento Do Braço 170mm
- Indexada

MATERIAL

Aço Revestido De Nylon

ENGENHAGENS

42 | 34 | 24 D

PESO

1.086 gr

EMBALAGEM

12 Unidades

23205



Engrenagem Tripla 24/34/42D

CARACTERÍSTICA

Engrenagem tripla com braço | Coroa fixas | Possui protetor de coroa | Sistema de encaixe compatível com eixo central ponta quadrada | Diâmetro da rosca do pedal 9/16 (Inglês) | INDEX

ENGENHAGENS

42/34/24D

COMPRIMENTO DO BRAÇO

170 mm

MATERIAL

Aço/Nylon

PESO

1098 gr

EMBALAGEM

12 peças

18224



Engrenagem Tripla 24/34/42D

CARACTERÍSTICA

Engrenagem tripla com braço | Coroa fixa | Possui protetor de coroa | Sistema de encaixe compatível com eixo central ponta quadrada | Diâmetro da rosca do pedal 9/16 (Inglês) | INDEX

ENGENHAGENS

42/34/24D

COMPRIMENTO DO BRAÇO

170 mm

MATERIAL

Aço/Nylon

PESO

1106 gr

EMBALAGEM

12 peças

18225



Engrenagem Tripla 28/38/48D

CARACTERÍSTICA

Engrenagem tripla com braço | Coroa fixa | Possui protetor de coroa | Sistema de encaixe compatível com eixo central ponta quadrada | Diâmetro da rosca do pedal 9/16 (Inglês) | INDEX

ENGENHAGENS

48/38/28D

COMPRIMENTO DO BRAÇO

170 mm

MATERIAL

Aço/Nylon

PESO

1158 gr

EMBALAGEM

12 peças

18226



X-TIME

Engrenagem Tripla 28/38/48D

CARACTERÍSTICA

Engrenagem tripla com braço | Coroa fixa | Possui protetor de coroa | Sistema de encaixe compatível com eixo central ponta quadrada | Diâmetro da rosca do pedal 9/16 (Inglês) | INDEX

ENGENHAGENS

48/38/28D

COMPRIMENTO DO BRAÇO

170 mm

MATERIAL

Aço/Nylon

PESO

1160 gr

EMBALAGEM

12 peças

19686



Parafuso Eixo Centro

CARACTERÍSTICA

Allen | Com Retentor

FATOR

10

EMBALAGEM

100 peças

08MM

13107

12MM

13105

15MM

13106



8 MM



12 MM



15 MM

Parafuso Eixo Centro

CARACTERÍSTICA

Allen

COMPATÍVEL

Pedivela X-Time (15mm) 11S

EMBALAGEM

20 peças

FATOR

5

13091



Parafuso Fixação Engrenagem

CARACTERÍSTICA	Sextavado
MATERIAL	Inox/Aço carbono
MEDIDA	8 mm
EMBALAGEM	10 peças
	06123
OBSERVAÇÃO	Sem logo

DUPLA/TRIPLA



SUGESTÃO ENGRENAGEM PEDIVELA

X-TIME 08275 (Duplo)
08275 (Tripla)



Parafuso Eixo Centro Alum.

CARACTERÍSTICA	Parafuso eixo do braço do pedivela Diâmetro da bitola 27mm Bitola Allen Øm19 Torque recomendado 4-5n.M Possui bucha interna de segurança
MATERIAL	Alumínio
PESO	18gr
MEDIDA	17 mm
EMBALAGEM	100 peças



23848

X-TIME

Corrente 12S 128L X-Time

CARACTERÍSTICA	Corrente 12S 128L X-Time Missing link 12V. - SUMC (power link)
MATERIAL	Aço
PESO	270g
EMBALAGEM	50 peças

19154

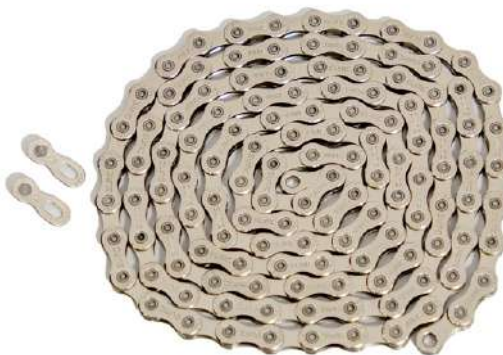

FOTOS MERAMENTE ILUSTRATIVAS. AS INFORMAÇÕES/CONFIGURAÇÕES DE PRODUTOS PODERÃO SOFRER ALTERAÇÕES SEM AVISO PRÉVIO.

ENTRE EM CONTATO COM O SEU CONSULTOR OU FALE COM O NOSSO TIME DE TELEVENDAS PELO (33) 3277-3030.

Parafuso Allen para Fixação Engrenagem

CARACTERÍSTICA	Allen
MATERIAL	Inox
MEDIDA	6 mm
EMBALAGEM	10 peças
	13166
OBSERVAÇÃO	Sem logo



Engrenagem 32d. Avulsa direct off set 3mm.

CARACTERÍSTICA	<ul style="list-style-type: none">• Padrão sram• Disponível em 32d. E 34d.• Sistema de fixação direct mount
MATERIAL	Alumínio
ENGENAGENS	32 34 D
PESO	88g referente a engrenagem 32D
EMBALAGEM	10 peças

32D 23845

34D 23846



Engrenagem Direct Single Avulsa *MTB* Off Set 0 mm

FOTO ILUSTRATIVA DA EMBALAGEM

CARACTERÍSTICA	Direct mount Compátivel com Sram®		
MATERIAL	Alumínio		
ENGENHAGENS	32 34 36 D		
PESO	32 - 0.08 kg	32D	18116
	34 - 0.09 kg	34D	18117
	36 - 0.11 kg	36D	18118
EMBALAGEM	10 peças		



FOTOS MERAMENTE ILUSTRATIVAS. AS INFORMAÇÕES/CONFIGURAÇÕES DE PRODUTOS PODERÃO SOFRER ALTERAÇÕES SEM AVISO PRÉVIO.

ENTRE EM CONTATO COM O SEU CONSULTOR OU FALE COM O NOSSO TIME DE TELEVENDAS PELO (33) 3277-3030.



Engrenagem Single Avulsa **BCD Mount** MTB

CARACTERÍSTICA	BCD 96 mm	
MATERIAL	Alumínio 7075	
ENGENHAGENS	32 34 36 38 D	
PESO	com parafuso	sem parafuso
	32 - 68 g	32 - 49 g
	34 - 80 g	34 - 60 g
	36 - 91 g	36 - 72 g
	38 - 102 g	38 - 83 g
EMBALAGEM	10 peças	
32D	15327	
34D	15328	
36D	15329	
38D	15330	

FOTO ILUSTRATIVA DA EMBALAGEM





Engrenagem 53D Speed

CARACTERÍSTICA 5 Furos avulsa

BCD 130 mm

MATERIAL Aço

EMBALAGEM 1 peça

130MM 12884

Obs.: sem logo



Engrenagem 39D Speed

CARACTERÍSTICA 5 Furos avulsa

BCD 110 mm /130 mm

MATERIAL Aço

EMBALAGEM 1 peça

130MM 12882

Obs.: sem logo

X-TIME

Movimento Central Integrado

CARACTERÍSTICA Alumínio

EMBALAGEM 1 peça

COMPATÍVEL Shimano Hollowtech
Caixa de Quadro 68 a 73mm

13110

13111

SUGESTÃO PEDIVELAS

SHIMANO Pedivela integrado 34.7 mm



FOTOS MERAMENTE ILUSTRATIVAS. AS INFORMAÇÕES/CONFIGURAÇÕES DE PRODUTOS PODERÃO SOFRER ALTERAÇÕES SEM AVISO PRÉVIO.

ENTRE EM CONTATO COM O SEU CONSULTOR OU FALE COM O NOSSO TIME DE TELEVENDAS PELO (33) 3277-3030.

Movimento Central MTB

CARACTERÍSTICA Movimento central integrado 34.7mm
estruturado em alumínio e aço
compatível com Shimano
Hollowtech® II para caixa
68/73 mm

MATERIAL Alumínio/Plástico

PESO 114 g (aproximado)

EMBALAGEM 1 peça

08277



Eixo Central Selado com Rolamento

CARACTERÍSTICA 34.7 mm | Selado

MODELO Rolamentado

EMBALAGEM 50 peças

110MM 13100/20467

113MM 13101

115MM 20487

119MM 13102

122MM 13103

126MM 13104

Eixo Centro C/ Rol Salva Quadro

CARACTERÍSTICA Movimento central salva quadro
estrutura em alumínio e aço
comprimento do eixo 122mm
compatível com movimento central
34.7 X 68mm | padrão bsa | eixo ponta
quadrada | acompanha parafusos
para instalação do braço do pedivela

MATERIAL Aço/Alumínio

PESO 284gr - incluindo parafusos

EMBALAGEM 20 peças

23819



FOTOS MERAMENTE ILUSTRATIVAS. AS INFORMAÇÕES/CONFIGURAÇÕES DE PRODUTOS PODERÃO SOFRER ALTERAÇÕES SEM AVISO PRÉVIO.

ENTRE EM CONTATO COM O SEU CONSULTOR OU FALE COM O NOSSO TIME DE TELEVENDAS PELO (33) 3277-3030.



Movimento Central **BSA/GXP MTB**

CARACTERÍSTICA BSA | Ø 24 mm com adaptador para GXP® Ø 22 mm | Caixa quadro: 68 / 73 mm

MATERIAL Alumínio/Plástico

EMBALAGEM 20 peças

14293



Adaptador Movimento Central

CARACTERÍSTICA PressFit 46 mm para GXP (34.7 mm)

MATERIAL Alumínio

EMBALAGEM 1 peças

13109



Guia de Corrente com Abraçadeira

CARACTERÍSTICA Guia para correntes 10, 11, ou 12v

EMBALAGEM 10 peças

11711



Guia de Corrente Direct Mount

CARACTERÍSTICA Guia para correntes 10, 11, ou 12v
Compatível com quadros de instalação direta

EMBALAGEM 10 peças

11712



Cubo D/T Boost XD Xtime

CARACTERÍSTICA	Par de cubo
CUBO DIANTEIRO	Material alumínio Eixo 15x110mm Eixo interno de alumínio Old 110mm 32 furos Esferado Compatível com disco 6 parafusos.
CUBO TRASEIRO	Material alumínio Eixo 12x148mm Eixo interno de alumínio 32 furos 02 rolamentos cubo (medida 6903-lu) 02 rolamentos freehub (medidas 6802-lu) Freehub padrão xd com 3 martelinhos Compatível com disco 6 parafusos.
MATERIAL	Alumínio/aço.
PESO	545gr - peso referente ao par
FATOR DE VENDA	1 unidade
EMBALAGEM	25 unidades

24374



Cubo Dianteiro X-Time 32 furos

CARACTERÍSTICA	Dianteiro Eixo com blocagem 32 furos
EIXO	9 mm
O.L.D	100 mm
MODELO	Esferado Freio a disco
MATERIAL	Alumínio
PESO	319 g
EMBALAGEM	1 peça

15592



Cubo Traseiro X-Time 32 furos

CARACTERÍSTICA	Traseiro Eixo com blocagem 32 furos
EIXO	9 mm
O.L.D	135 mm
MODELO	Rosca Esferado Freio a disco
MATERIAL	Alumínio
PESO	366 g
EMBALAGEM	1 peça

15593

Cubo Dianteiro X-Time 36 furos

CARACTERÍSTICA	Dianteiro Eixo com blocagem 36 furos
EIXO	9 mm
O.L.D	100 mm
MODELO	Esferado Freio a disco
MATERIAL	Alumínio
PESO	319 g
EMBALAGEM	1 peça

15590



X-TIME



Cubo Traseiro X-Time 36 furos

CARACTERÍSTICA	Traseiro Eixo com blocagem 36 furos
EIXO	9 mm
O.L.D	135 mm
MODELO	Rosca Esferado Freio a disco
MATERIAL	Alumínio
PESO	366 g
EMBALAGEM	1 peça

15591



Cubo Dianteiro X-Time 32 furos

CARACTERÍSTICA	Freio a disco 6 parafusos Eixo furado com blocagem Rolamento 6200rs
O.L.D	100 mm
MATERIAL	Alumínio Eixo de aço furado
PESO	330 g
EMBALAGEM	50 peças

19135



Cubo Traseiro X-Time 32 furos

CARACTERÍSTICA	Freio a disco 6 parafusos Eixo furado com blocagem Rolamento 6200rs Espaçador
O.L.D	135 mm
MATERIAL	Alumínio Eixo de aço furado
PESO	379 g
EMBALAGEM	50 peças

19136

FOTOS MERAMENTE ILUSTRATIVAS. AS INFORMAÇÕES/CONFIGURAÇÕES DE PRODUTOS PODERÃO SOFRER ALTERAÇÕES SEM AVISO PRÉVIO.

ENTRE EM CONTATO COM O SEU CONSULTOR OU FALE COM O NOSSO TIME DE TELEVENDAS PELO (33) 3277-3030.

Eixo Dianteiro 3/8 Furado para Blocação e com Rolamento

CARACTERÍSTICA 3/8 | Furado para blocação | Rolamentado | 100 mm

EMBALAGEM 20 peças

17024



Eixo Traseiro 3/8 Furado para Blocação e com Rolamento

CARACTERÍSTICA 3/8 | Furado para blocação | Rolamentado | 140 mm

EMBALAGEM 20 peças

15585

Eixo Dianteiro 3/8 Furado para Blocação

CARACTERÍSTICA 3/8 | Furado para blocação | 100 mm

EMBALAGEM 20 peças

17025



Eixo Traseiro 3/8 Furado para Blocação

CARACTERÍSTICA 3/8 | Furado para blocação | 134 mm

EMBALAGEM 20 peças

15586

Blocação de Eixo Traseiro

CARACTERÍSTICA Eixo de 135 x 9 mm | Alumínio

EMBALAGEM 50 peças

15588



Blocação de Eixo Dianteiro

CARACTERÍSTICA Eixo de 100 x 9 mm | Alumínio

EMBALAGEM 50 peças

15587

Conjunto para **FREIO A DISCO 36 Furos -mecânico** | Dianteiro

PINÇA	Dianteiro Para freio a disco mecânico Compatível com de discos de 160 mm Incluso pastilha
CUBO	Dianteiro 36 furos Suporte disco de freio parafuso Eixo de 9 mm Blocagem 308 g
ROTOR	160 mm parafuso (6) 2 mm de espessura 138 g
EMBALAGEM	10 peças

13203



Conjunto para **FREIO A DISCO 36 Furos mecânico** | Traseiro

PINÇA	Traseira Para freio a disco mecânico Compatível com de discos de 160 mm Incluso pastilha
CUBO	Traseiro 36 furos Suporte disco de freio parafuso Roda livre Eixo de 9 mm 349 g
ROTOR	160 mm parafuso (6) 2 mm de espessura 138 g
EMBALAGEM	10 peças

13204



Conjunto para **FREIO A DISCO 32 Furos mecânico** | Dianteiro

PINÇA	Dianteiro Para freio a disco mecânico Compatível com de discos de 160 mm Incluso pastilha
CUBO	Dianteiro 32 furos Suporte disco de freio parafuso Eixo de 9 mm Blocagem 308 g
ROTOR	160 mm parafuso (6) 2 mm de espessura 138 g
EMBALAGEM	10 peças

13205



Conjunto para **FREIO A DISCO** 32 Furos mecânico | Traseiro

PINÇA	Traseira Para freio a disco mecânico Compatível com de discos de 160 mm Incluso pastilha
CUBO	Traseiro 32 furos Suporte disco de freio parafuso Roda livre Eixo de 9 mm Blocação 349 g
ROTOR	160 mm parafuso (6) 2 mm de espessura 138 g
EMBALAGEM	10 peças

13206



Conjunto de **FREIO A DISCO** hidráulico

CARACTERÍSTICA	Material: Alumínio/Aço Peso: 709 gr (Apenas as manetes)
FREIO DIANTEIRO	Características: X-Time hidráulico Abraçadeira com dois parafusos Reservatório de alumínio Óleo mineral Caliper 2 pistões Mangueira com 800 mm Peso: 335 gr
FREIO TRASEIRO	Características: X-Time hidráulico Abraçadeira com dois parafusos Reservatório de alumínio Óleo mineral Caliper 2 pistões Mangueira com 1600 mm Peso: 374 gr
DISCOS	Características: X-Time 160 mm 06 parafusos Aço Peso: 242 gr (Apenas os discos) Observação: Acompanha jogo de parafusos para fixação.
EMBALAGEM	12 peças

08636



Conjunto de **FREIO A DISCO E CUBO** | Dianteiro/Traseiro

PINÇA	Dianteira/Traseira Freio a disco mecânico Incluso pastilhas Modelo Post mount com adaptador para International Standard
POST MOUNT	Discos de 160 mm
INTERNATIONAL STANDART	F:180/R160 F:160/R140
CUBOS	Dianteiro/Traseiro Cassete 8,9,10v. Free hub International Standard 32 ou 36 furos Suporte disco: parafuso Eixo de 9 mm Blocação
O.L.D.	Dianteiro 100 mm Traseiro 142 mm
ROTORES	Dianteiro/Traseiro 160 mm Parafuso (6) 2 mm de espessura
PESO	1.5kg (Aproximado)
EMBALAGEM	10 peças
32F	13207
36F	13208



FOTOS MERAMENTE ILUSTRATIVAS. AS INFORMAÇÕES/CONFIGURAÇÕES DE PRODUTOS PODERÃO SOFRER ALTERAÇÕES SEM AVISO PRÉVIO.

ENTRE EM CONTATO COM O SEU CONSULTOR OU FALE COM O NOSSO TIME DE TELEVENDAS PELO (33) 3277-3030.

Conjunto de FREIO A DISCO hidráulico | Mod01

CARACTERÍSTICA	Material: Alumínio/Aço Peso: 730 gr (Apenas freio Par)
FREIO DIANTEIRO	Características: X-Time hidráulico Abraçadeira com dois parafusos Reservatório de alumínio Óleo mineral Caliper 2 pistões Mangueira com 800 mm Peso: 355 gr
FREIO TRASEIRO	Características: X-Time hidráulico Abraçadeira com dois parafusos Reservatório de alumínio Óleo mineral Caliper 2 pistões Mangueira com 1550 mm Peso: 375 gr Observação: O freio traseiro vem desconectado no Manete (sistema j-kit) para instalação em bicicletas com cabearmentos internos. Acompanha olivas, pinos e terminal de acabamento.
EMBALAGEM	20 peças

20510



Pinça RM2 para FREIO A DISCO mecânico



CARACTERÍSTICA	Mecânico Dianteiro e traseiro compatível com de discos de 160 mm Incluso pastilha
-----------------------	---

MATERIAL alumínio

EMBALAGEM 50 peças

DIANTEIRO 13199

TRASEIRO 13200

PASTILHAS COMPATÍVEIS

CÓDIGO	3884 13216
---------------	---------------

FOTOS MERAMENTE ILUSTRATIVAS. AS INFORMAÇÕES/CONFIGURAÇÕES DE PRODUTOS PODERÃO SOFRER ALTERAÇÕES SEM AVISO PRÉVIO.

ENTRE EM CONTATO COM O SEU CONSULTOR OU FALE COM O NOSSO TIME DE TELEVENDAS PELO (33) 3277-3030.

Pinça Ride para **FREIO A DISCO** mecânico

CARACTERÍSTICA Mecânico | Dianteiro e traseiro | compatível com de discos de 160 mm | Incluso pastilha

MATERIAL alumínio

EMBALAGEM 50 peças

DIANTEIRO

13212



TRASEIRO

13213



PASTILHAS COMPATIVÉIS

CÓDIGO 8063
13222

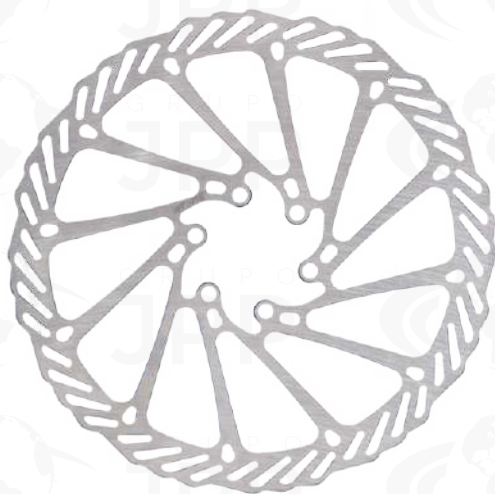

Rotor para **FREIO A DISCO** 180 mm

CARACTERÍSTICA Dianteiro ou traseiro | 180 mm | Fixação por 6 parafusos | 1.9 mm de espessura | conjunto com 6 parafusos allen

MATERIAL aço

PESO 130 g

EMBALAGEM 100 peças

13210

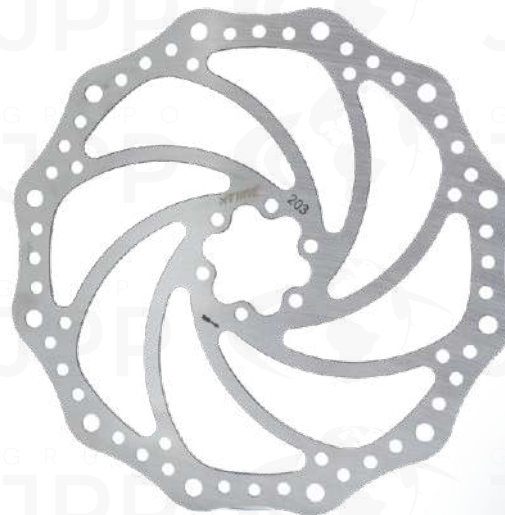

Rotor para **FREIO A DISCO** 203 mm

CARACTERÍSTICA Dianteiro ou traseiro | 203 mm | Fixação por 6 parafusos | 1.9 mm de espessura | conjunto com 6 parafusos allen

MATERIAL aço

PESO 193 g

EMBALAGEM 100 peças

13211



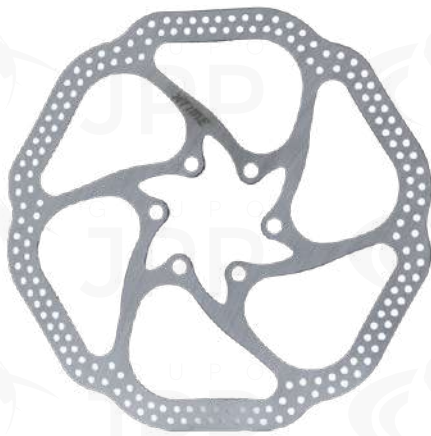

Rotor para **FREIO A DISCO** 160 mm

CARACTERÍSTICA Dianteiro ou traseiro | 160 mm | Fixação por 6 parafusos | 1.9 mm de espessura | conjunto com 6 parafusos allen

MATERIAL aço

PESO 103 g

EMBALAGEM 100 peças

13209

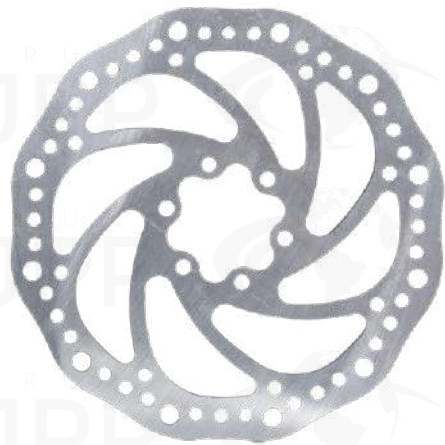

Rotor para **FREIO A DISCO** Standard 160 mm

CARACTERÍSTICA 160 mm | Fixação por 6 parafusos | 2 mm de espessura | conjunto com 6 parafusos allen

MATERIAL aço

PESO 142 g

EMBALAGEM 100 peças

13196 - 160MM. XT-01

23830 - 160MM. XT-02

Pastilha Mod.01 para **FREIO A DISCO**

CARACTERÍSTICA Com mola

COMPATIBILIDADE X-time mecânico código: 13197 e 13198

EMBALAGEM 20 peças

13267

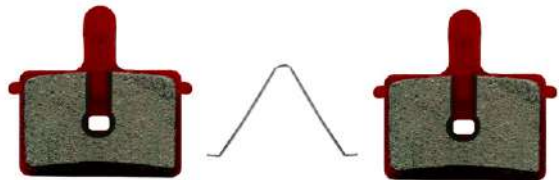

Pastilha RM 10 para **FREIO A DISCO**

CARACTERÍSTICA Semimetálico | Com mola

COMPATIBILIDADE X-Time RM2, SHIMANO HID/MEC (M395/M446) e Tektro

EMBALAGEM 10 peças

13216



Pastilha RD 1 para **FREIO A DISCO**

CARACTERÍSTICA	Dianteiro e traseiro
COMPATIBILIDADE	Para freio TSW Ride até 2016 e Zoom
EMBALAGEM	100 peças

13217



Pastilha RD 2 para **FREIO A DISCO**

CARACTERÍSTICA	Dianteiro e traseiro
COMPATIBILIDADE	Para pinça de freio Ride
EMBALAGEM	100 peças

13222



Pastilha RM 52 para **FREIO A DISCO**

CARACTERÍSTICA	Com mola Semimetálico
COMPATIBILIDADE	SHIMANO XTR (M985) e XT (M785)
EMBALAGEM	10 peças

13219



Pastilha RM 05 para **FREIO A DISCO**

CARACTERÍSTICA	Semimetálico
COMPATIBILIDADE	Tektro
EMBALAGEM	10 peças

13223



Pastilha RM 08F para **FREIO A DISCO**

CARACTERÍSTICA	Semimetálico
COMPATIBILIDADE	Zoom
EMBALAGEM	10 peças

13224



Pastilha RM 09 para **FREIO A DISCO**

CARACTERÍSTICA Com mola Semimetálico

COMPATIBILIDADE Avid

EMBALAGEM 10 peças

13225



Pastilha RM 14 para **FREIO A DISCO**

CARACTERÍSTICA Com mola Semimetálico

COMPATIBILIDADE Avid, Promax

EMBALAGEM 10 peças

13226



Pastilha RM 22 para **FREIO A DISCO**

CARACTERÍSTICA Com mola Semimetálico

COMPATIBILIDADE Formula

EMBALAGEM 10 peças

13227



Pastilha RM 29 para **FREIO A DISCO**

CARACTERÍSTICA Semimetálico

COMPATIBILIDADE Tektro

EMBALAGEM 10 peças

13228



Pastilha RM 25 para **FREIO A DISCO**

CARACTERÍSTICA Semimetálico

EMBALAGEM 10 peças

13229



Pastilha RM 60 para **FREIO A DISCO**

CARACTERÍSTICA Com mola | Semimetálico

COMPATIBILIDADE Avid Elixir

EMBALAGEM 10 peças

13220



Pastilha RM 17 para **FREIO A DISCO**

CARACTERÍSTICA Com mola | Semimetálico

COMPATIBILIDADE SHIMANO XTR (M965/966) XT (M765) e SAINT

EMBALAGEM 10 peças

13218



Pastilha RM 37 para **FREIO A DISCO**

CARACTERÍSTICA Semimetálico

COMPATIBILIDADE Hayes

EMBALAGEM 10 peças

13230



Pastilha RM 64 para **FREIO A DISCO**

CARACTERÍSTICA Dianteiro e traseiro

COMPATIBILIDADE Sram®

EMBALAGEM 10 peças

13232



XTR



PASTILHA DE FREIO disco X-Time | XTRM-70

CARACTERÍSTICA	Pastilha de freio X-Time para freio a disco orgânica Compatível com freios Formula modelos R1, Mega e The One
MATERIAL	Aço
COMPOSIÇÃO	Orgânica
PESO	19 gr
EMBALAGEM	50 peças
	13221



ROLAMENTO de Cubo X-Time | 6000

CARACTERÍSTICA	Rolamento de esferas 6000-2 rs Rolamento de esferas de sulco profundo 2 fechos selados Id (diâmetro interno): 10 mm Od (diâmetro externo): 26 mm Largura: 9 mm Quantidade: 10 rolamentos (pacote)
LUBRIFICAÇÃO	Graxa
DIMENSÕES	10 x 26 x 9 mm
MATERIAL	Aço
PESO	20 gr (unidade)
EMBALAGEM	50 peças
	17026



ROLAMENTO de Cubo X-Time | 6200

CARACTERÍSTICA	Rolamento de esferas 6200 rs Rolamento de esferas de sulco profundo 2 fechos selados Id (diâmetro interno): 10 mm Od (diâmetro externo): 30 mm Largura: 9 mm Quantidade: 10 rolamentos (pacote)
LUBRIFICAÇÃO	Graxa
DIMENSÕES	10 x 30 x 9 mm
MATERIAL	Aço
PESO	30 gr (unidade)
EMBALAGEM	50 peças
	17027

FOTOS MERAMENTE ILUSTRATIVAS. AS INFORMAÇÕES/CONFIGURAÇÕES DE PRODUTOS PODERÃO SOFRER ALTERAÇÕES SEM AVISO PRÉVIO.

ENTRE EM CONTATO COM O SEU CONSULTOR OU FALE COM O NOSSO TIME DE TELEVENDAS PELO (33) 3277-3030.

ROLAMENTO de Cubo X-Time | 6001

CARACTERÍSTICA Rolamento de esferas 6001 rs | Rolamento de esferas de sulco profundo | 2 fechos selados | Id (diâmetro interno): 12 mm | Od (diâmetro externo): 28 mm | Largura: 9 mm | Quantidade: 10 rolamentos (pacote)

LUBRIFICAÇÃO Graxa

DIMENSÕES 12 x 28 x 9 mm

MATERIAL Aço

PESO 22 gr (unidade)

EMBALAGEM 50 peças

17028



Regulador De Macaneta Alum. Fino

CARACTERÍSTICA

- Regulador De Maçaneta
- Material Alumínio
- Diâmetro Da Rosca 7mm (M7)
- Passo Da Rosca 1.0mm

MATERIAL Alumínio

PESO 58gr - Peso Referente Ao Pacote Com 20 Unidades

EMBALAGEM 500 Unidades

23202



X-TIME

Regulador De Macaneta Alum. Grosso

CARACTERÍSTICA

- Regulador De Maçaneta
- Material Alumínio
- Diâmetro Da Rosca 10mm (M10)
- Passo Da Rosca 1.0mm

MATERIAL Alumínio

PESO 94gr - Peso Referente Ao Pacote Com 20 Unidades

EMBALAGEM 500 Unidades

23201



Conduíte Preto C/Teflon 4mm P/ Câmbio (Rolo 20 Mts)

CARACTERÍSTICA	<ul style="list-style-type: none">• Conduíte para marcha• Material Aço Revestido De Nylon• Diâmetro 4mm• Fios Paralelo• Revestimento Interno De Teflon• Ideal Para Marchas
-----------------------	---

MATERIAL Aço Revestido De Nylon

PESO 664gr - Peso Referente Ao Rolo Com 20 Metros

EMBALAGEM 25 Unidades (Rolo)

23194



Conduíte Preto C/Teflon 5mm P/ Freio Esp. (Rol 20 Mts)

CARACTERÍSTICA	<ul style="list-style-type: none">• Conduíte De Freio• Material Aço Revestido De Nylon• Diâmetro 5mm• Fios Paralelo• Revestimento Interno De Teflon• Ideal Para Freio À Disco
-----------------------	--

MATERIAL Aço Revestido De Nylon

PESO 808gr - Peso Referente Ao Rolo Com 20 Metros

EMBALAGEM 25 Unidades (Rolo)

23203



CONECTOR E OLIVA MODELO 02 para freio hidráulico

CARACTERÍSTICA Freio a disco hidráulico

EMBALAGEM 50

FATOR. 25 conjuntos

12335





Manete V BRAKE

13201

CARACTERÍSTICA	Dianteiro e traseiro
MATERIAL	alumínio
PESO	150 g (par)
EMBALAGEM	100 peças

Cabo para freio traseiro extra light ceci

CARACTERÍSTICA	19 Fios ceci Extra light
COMPRIMENTO	180 cm
ESPESSURA	2.5 mm
CONTEÚDO	50 cabos
EMBALAGEM	500 peças

17845



Cabo câmbio tras 19 fios x 1900mm inox (cx 50 peças)

CARACTERÍSTICA	<ul style="list-style-type: none">• Cabo De Câmbio• Material Aço Inoxidável• 19 Fios• Comprimento 1900mm• Diâmetro 1.2mm
MATERIAL	Aço Inox
PESO	735gr - Peso Referente A Caixa Com 50 Unidades
CONTEÚDO	50 cabos
EMBALAGEM	20 Unidades (Caixa)

17843



FOTOS MERAMENTE ILUSTRATIVAS. AS INFORMAÇÕES/CONFIGURAÇÕES DE PRODUTOS PODERÃO SOFRER ALTERAÇÕES SEM AVISO PRÉVIO.

ENTRE EM CONTATO COM O SEU CONSULTOR OU FALE COM O NOSSO TIME DE TELEVENDAS PELO (33) 3277-3030.

X-TIME



Cabo para freio traseiro extra light

CARACTERÍSTICA	19 Fios Extra light Inox
COMPRIMENTO	190 cm
ESPESSURA	2.5 mm
CONTEÚDO	20 cabos
EMBALAGEM	500 peças

14160



Cabo para freio Dianteiro extra light

CARACTERÍSTICA	19 Fios Extra light Dianteiro
EMBALAGEM	500 peças

14141



Cabo para freio traseiro extra light

CARACTERÍSTICA	19 Fios Extra light Traseiro
EMBALAGEM	500 peças

14142



Terminal de conduíte

CARACTERÍSTICA	Aço cromado
ESPESSURA	5 mm
CONTEÚDO	100 terminais
EMBALAGEM	500 peças

14163



Terminal de conduíte

CARACTERÍSTICA	Nylon
ESPESSURA	4 mm
CONTEÚDO	100 terminais
EMBALAGEM	500 peças

14159



Cabo Câmbio Traseiro

CARACTERÍSTICA	19 Fios
COMPRIMENTO	190 cm
ESPESURA	2.2 mm
CONTEÚDO	50 cabos
EMBALAGEM	500 peças
	17844



Terminal de cabo

CARACTERÍSTICA	Alumínio
CONTEÚDO	100 terminais
EMBALAGEM	500 peças
	14162



Kit de Montagem XT-22

GUIDÃO	X-Time Rise bar 720 x 31.8 mm 9° backsweep Rise 20 mm Alumínio
SUPORTE DE GUIDÃO	X-Time Ahead set 90 x 31.8 mm / 7° Alumínio
CANOTE	X-Time 27.2 x 350 mm Parafuso único Alumínio
ABRACADEIRA	X-Time Blocação 31.8 mm Alumínio
EMBALAGEM	20 peças
	15458



Kit de Montagem XT-23

GUIDÃO	X-Time Rise bar 720 x 31.8 mm 9° backsweep Rise 20 mm Alumínio
SUPORTE DE GUIDÃO	X-Time Ahead set 90 x 31.8 mm / 7° Alumínio
CANOTE	X-Time 31.6 x 350 mm Parafuso único Alumínio
ABRACADEIRA	X-Time Blocação 34.9 mm Alumínio
EMBALAGEM	20 peças
	15459



XTIME

FOTOS MERAMENTE ILUSTRATIVAS. AS INFORMAÇÕES/CONFIGURAÇÕES DE PRODUTOS PODERÃO SOFRER ALTERAÇÕES SEM AVISO PRÉVIO.

ENTRE EM CONTATO COM O SEU CONSULTOR OU FALE COM O NOSSO TIME DE TELEVENDAS PELO (33) 3277-3030.



Kit de Montagem **XT-25**

GUIDÃO X-Time | Reto | 720 x 31.8 mm | 9° backsweep | Alumínio

SUORTE DE GUIDÃO X-Time | Ahead set | 90 x 31.8 mm / 7° | Alumínio

CANOTE X-Time | 31.6 x 350 mm | Parafuso único | Alumínio

ABRACADEIRA X-Time | Blocagem | 34.9 mm | Alumínio

EMBALAGEM 20 peças

15461



Kit de Montagem **XT-26**

GUIDÃO X-Time | Rise bar | 720 x 31.8 mm | 9° backsweep | Rise 20 mm | Alumínio

SUORTE DE GUIDÃO X-Time | Ahead set | 70 x 31.8 mm / 7° | Alumínio

CANOTE X-Time | 27.2 x 350 mm | Parafuso único | Alumínio

ABRACADEIRA X-Time | Blocagem | 31.8 mm | Alumínio

PESO 830gr

EMBALAGEM 20 peças

19532



Kit de Montagem **XT-28**

GUIDÃO X-Time | Reto | 720 x 31.8 mm | 9° backsweep | Alumínio

SUPORTE DE GUIDÃO X-Time | Ahead set | 70 x 31.8 mm / 7° | Alumínio

CANOTE X-Time | 27.2 x 350 mm | Parafuso único | Alumínio

ABRAÇADEIRA X-Time | Blocação | 31.8 mm | Alumínio

PESO 834gr

EMBALAGEM 20 peças

19537



Kit de Montagem **XT-24**

GUIDÃO X-Time | Reto | 720 x 31.8 mm | 9° backsweep | Alumínio

SUPORTE DE GUIDÃO X-Time | Ahead set | 90 x 31.8 mm / 7° | Alumínio

CANOTE X-Time | 27.2 x 350 mm | Parafuso único | Alumínio

ABRAÇADEIRA X-Time | Blocação | 31.8 mm | Alumínio

EMBALAGEM 20 peças

15460

FOTOS MERAMENTE ILUSTRATIVAS. AS INFORMAÇÕES/CONFIGURAÇÕES DE PRODUTOS PODERÃO SOFRER ALTERAÇÕES SEM AVISO PRÉVIO.

ENTRE EM CONTATO COM O SEU CONSULTOR OU FALE COM O NOSSO TIME DE TELEVENDAS PELO (33) 3277-3030.

X-TIME



Guidão Alum MTB 31.8mm **RETO** pt x-TIME

MATERIAL	Alumínio
TAMANHO	31.8mm x720 mm
RISE	0°
UPSWEEP	0
BACKSWEEP	9°
PESO APROXIMANDO	312 g
EMBALAGEM	15 unidades
	22702



Guidão X-Time **RETO**

MATERIAL	Alumínio
TAMANHO	720mmx31.8mm
EMBALAGEM	50 peças
	12901



Guidão X-Time **RETO**

MATERIAL	Alumínio
TAMANHO	730 x 31.8 mm
BACKSWEEP	9°
UPSWEEP	0
PESO APROXIMANDO	314 g
EMBALAGEM	50 peças
	15430

FOTOS MERAMENTE ILUSTRATIVAS. AS INFORMAÇÕES/CONFIGURAÇÕES DE PRODUTOS PODERÃO SOFRER ALTERAÇÕES SEM AVISO PRÉVIO.

ENTRE EM CONTATO COM O SEU CONSULTOR OU FALE COM O NOSSO TIME DE TELEVENDAS PELO (33) 3277-3030.



Guidão ALUMÍNIO MTB 31.8 MM X 740 MM RETO PT XT

- CARACTERÍSTICA**
- Guidão reto de alumínio
 - Rise 0°
 - Upsweep 0°
 - Backsweep 9°

MATERIAL Alumínio

TAMANHO 740 x 31.8mm

PESO APROXIMANDO 296g

EMBALAGEM 15 peças

23850



Guidão X-Time RISE BAR

MATERIAL Alumínio

TAMANHO 730 x 31.8 mm

BACKSWEEP 9°

UPSWEEP 9°

RISE 20 mm

PESO APROXIMANDO 319 g

EMBALAGEM 50 peças

15429



Guidão X-Time **RISE BAR - 680 MM**

MATERIAL	Aço
TAMANHO	680 x 25.4 mm
BACKSWEEP	9°
RISE	40 mm
PESO APROXIMANDO	445g
EMBALAGEM	50 peças

18054 OU 17869



Guidão **ALUM. SPEED 420/440 MM** **31.8MM PT XT**

CARACTERÍSTICA	<ul style="list-style-type: none">• Guidão de alumínio• Anatômico
MATERIAL	Alumínio
TAMANHO	420/440 mm x 31.8 mm
PESO APROXIMANDO	428g (guidão de 420mm)
EMBALAGEM	15 peças
420MM	23853
440MM	23854



FOTOS MERAMENTE ILUSTRATIVAS. AS INFORMAÇÕES/CONFIGURAÇÕES DE PRODUTOS PODERÃO SOFRER ALTERAÇÕES SEM AVISO PRÉVIO.

ENTRE EM CONTATO COM O SEU CONSULTOR OU FALE COM O NOSSO TIME DE TELEVENDAS PELO (33) 3277-3030.

Suporte de guidão alum. Mtb ahead 17° pt xt

CARACTERÍSTICA	<ul style="list-style-type: none">• Over Ahead Set• Compatível com 31.8 mm
MATERIAL	Alumínio
TAMANHO	70 mm / 80 mm
ÂNGULO	+/- 17°
PESO	130g
EMBALAGEM	20 peças
CÓDIGO:	22752 - 80MM/ 17º 22753 - 70MM/ 17º



Suporte de Guidão X-Time

CARACTERÍSTICA	Ahead Set
MATERIAL	Alumínio
TAMANHO	90 x 31.8 mm / 7°
PESO APROXIMADO	179 g
EMBALAGEM	50 peças
	15431



Suporte de Guidão X-Time

CARACTERÍSTICA	Ahead Set
MATERIAL	Alumínio
TAMANHO	60 x 31.8 mm / 7°
PESO APROXIMADO	155gr
EMBALAGEM	50 peças
	19524

FOTOS MERAMENTE ILUSTRATIVAS. AS INFORMAÇÕES/CONFIGURAÇÕES DE PRODUTOS PODERÃO SOFRER ALTERAÇÕES SEM AVISO PRÉVIO.

ENTRE EM CONTATO COM O SEU CONSULTOR OU FALE COM O NOSSO TIME DE TELEVENDAS PELO (33) 3277-3030.

X-TIME

Suporte de Guidão Alum. MTB AHEAD 80 MM 17° PT X-Time



CARACTERÍSTICA	<ul style="list-style-type: none">• Over Ahead Set• Compatível com 31.8 mm• Suporte de Alumínio
MATERIAL	Alumínio
TAMANHO	70 mm 80 mm 90 mm 100 mm / +- 17°
PESO APROXIMADO	127gr (referente ao suporte 80 mm)
EMBALAGEM	20 peças
CÓDIGO:	23860 - 80MM/ 17º 23861 - 70 MM/ 17º 23862 - 90 MM/ 17º 23863 - 100 MM/ 17º

X-TIME



Suporte de Guidão Alum. MTB AHEAD 80 MM 7° PT X-Time

CARACTERÍSTICA	<ul style="list-style-type: none">• SUPORTE DE GUIDÃO ALUMÍNIO• OVER AHEAD SET• TAMANHOS DISPONÍVEIS 60MM/ 80MM/ 90MM E 100MM• ÂNGULO +-7°• COMPATÍVEL COM GUIDÃO 31.8MM
-----------------------	--

MATERIAL	Alumínio
TAMANHO	60 mm 80 mm 90 mm 100 mm / +- 7°
PESO APROXIMADO	158gr (referente ao suporte 80 mm)
EMBALAGEM	20 peças

CÓDIGO:	23855 - 80MM/ 7º 23856 - 60 MM/ 7º 23858 - 90 MM/ 7º 23859 - 100 MM/ 7º
----------------	--





Suporte de Guidão X-Time

CARACTERÍSTICA	Ahead Set
MATERIAL	Alumínio
TAMANHO	80 x 31.8 mm / 7°
PESO APROXIMADO	174gr
EMBALAGEM	50 peças
	19520



Suporte de Guidão X-Time

CARACTERÍSTICA	Ahead Set
MATERIAL	Alumínio
TAMANHO	70 x 31.8 mm / 7°
PESO APROXIMADO	167gr
EMBALAGEM	50 peças
	19522



Canote SELIM ALUMÍNIO 31.6 X 400MM SLIM PT XT

CARACTERÍSTICA	<ul style="list-style-type: none">• Canote de alumínio• Micro ajuste• Limite inserção 130mm
MATERIAL	Alumínio
TAMANHO	400 x 31.6mm
PESO APROXIMANDO	300g
EMBALAGEM	25 peças

23867



Canote **SELIM ALUMÍNIO** **27.2 X 400MM SLIM PT XT**

CARACTERÍSTICA

- Canote de alumínio
- Micro ajuste
- Limite inserção 130mm

MATERIAL Alumínio

TAMANHO 400 x 27.2mm

PESO APROXIMANDO 300g

EMBALAGEM 25 peças

23869

XTIME

Canote de selim **X-Time**

CARACTERÍSTICA Parafuso único

MATERIAL Alumínio

TAMANHO 27.2 x 350 mm | 31.6 x 350 mm

PESO APROXIMANDO 281 g

EMBALAGEM 50 peças

27.2 MM 15432

31.6 MM 15433



FOTOS MERAMENTE ILUSTRATIVAS. AS INFORMAÇÕES/CONFIGURAÇÕES DE PRODUTOS PODERÃO SOFRER ALTERAÇÕES SEM AVISO PRÉVIO.

ENTRE EM CONTATO COM O SEU CONSULTOR OU FALE COM O NOSSO TIME DE TELEVENDAS PELO (33) 3277-3030.



Canote selim alum. 31.6 X 350mm **SLIM PT XT**

CARACTERÍSTICA	Micro ajuste Limite inserção 100mm
MATERIAL	Alumínio
TAMANHO	350 mm x 31.6 mm
PESO APROXIMANDO	270 g
EMBALAGEM	25 peças
CÓDIGO	22758



Abraçadeira **X-Time**

CARACTERÍSTICA	Com Blocação
MATERIAL	Alumínio
TAMANHO	31.8 mm 34.9 mm
PESO APROXIMANDO	51 g
EMBALAGEM	200 peças
31.8 MM	15434
34.9 MM	15435

X-TIME

Abraçadeira **SELIM ALUM. MTB 31.8 C/ BLOCAGEM PT XT**

CARACTERÍSTICA	<ul style="list-style-type: none"> • Abraçadeira de aperto do canote • Ajuste por blocação
MATERIAL	Alumínio
TAMANHO	31.8MM
PESO APROXIMANDO	43 g
EMBALAGEM	200 peças
31.8 MM	23872



FOTOS MERAMENTE ILUSTRATIVAS. AS INFORMAÇÕES/CONFIGURAÇÕES DE PRODUTOS PODERÃO SOFRER ALTERAÇÕES SEM AVISO PRÉVIO.

ENTRE EM CONTATO COM O SEU CONSULTOR OU FALE COM O NOSSO TIME DE TELEVENDAS PELO (33) 3277-3030.



Abraçadeira **SELIM ALUM. MTB 31.8 PT XT**

CARACTERÍSTICA	<ul style="list-style-type: none"> • Abraçadeira de aperto do canote • Ajuste por parafuso
MATERIAL	Alumínio
TAMANHO	31.8MM
PESO APROXIMANDO	22 g
EMBALAGEM	200 peças
31.8 MM	23874

Porta Ferramentas **X-Time Save Tools**

CARACTERÍSTICA	Ideal para transportar Camara de ar, ferramentas, chaves e suplementos
MATERIAL	Plástico
TAMANHO	ø 7,5 cm Altura: 13,5 cm
EMBALAGEM	01 peça

14706



Kit Conduíte e Cabo para Trava **Remote – IMPORTADO**



Característica	KIT conduíte Conduíte 4mm teflonado paralelo Terminais de alumínio na cor preta Regulador de tensão Cabo de marcha
Composição	1 conduíte 1 cabo de aço 4 terminais de conduíte 1 regulador
Dimensões	Cabo de aço 1900 mm X 1.2 mm Conduíte 1250 mm X 4 mm
Embalagem	10 pares

22701



Conduite para câmbio

CARACTERÍSTICA	Para câmbio Com teflon
COMPRIMENTO	30 m
ESPESSURA	4 mm
EMBALAGEM	25 peças
	14145



Sapata Freio Pino – IMPORTADO

Característica	Para freio V. Brake 70mm
Material	Nylon
Embalagem	250 pares
	◆ 07467



Sapata Freio Orbital Allen – IMPORTADO

Característica	Para freio V. Brake 70mm
Material	Nylon
Embalagem	250 pares
	◆ 07466



Espaçador de mov. de direção 5mm/ 8mm **Liso preto**

MATERIAL	Alumínio
CARACTERÍSTICA	Espaçador de direção liso Diâmetro interno 29mm Compatível com espiga ahead set 28.6mm

PESO 3g - 5mm | 5g - 8mm

EMBALAGEM 100 peças

5 MM 22776

8 MM 22777



Espaçador de mov. de direção 10 mm **Liso preto**

MATERIAL	Alumínio
CARACTERÍSTICA	Espaçador de direção liso Diâmetro interno 29mm Compatível com espiga ahead set 28.6mm

PESO 8 g

EMBALAGEM 100 peças

10 MM 22778



Espaçador de movimento de direção **Liso**

MATERIAL	Alumínio
EMBALAGEM	100 peças
8 MM	13097
10 MM	13098
15 MM	13099



Espaçador **Movimento de direção**

CARACTERÍSTICA	Ahead set 1-1/8"
TAMANHO	5 mm
MATERIAL	Carbono
PESO	1,5 g
EMB.	20 peças
FATOR	5
	13182



Espaçador Movimento de direção

CARACTERÍSTICA	Ahead set 1-1/8"
TAMANHO	8 mm
MATERIAL	Carbono
PESO	3 g
EMB.	20 peças
FATOR	5

13183



Tampa movimento de direção ahead

CARACTERÍSTICA	Com aranha e parafuso MTB
EMBALAGEM	50 peças
	13096
	13095



Extensor tubo do garfo

CARACTERÍSTICA	Headset 28.6 mm 4 espaçadores
MATERIAL	Alumínio
EMBALAGEM	1 peças

13119



Movimento de direção Tapered / Mega Over

CARACTERÍSTICA	Ahead Set Tapered Integrada/Semi integrada Mega Over Semi integrada/ Externa (com adaptador para 30 mm)
INTEGRADA	Tapered 1-1/8" (IS41/28.6) / 1.5" (IS52/40)
SEMI INTEGRADA	Tapered 1-1/8" (ZS44/28.6) / 1.5" (ZS56/40)
MEGA OVER	1-1/8" copo superior semi integrado (ZS44/28.6) e copo inferior externo (EC44/30*) usando o adaptador para 30 mm
EMBALAGEM	20 peças

13114



Movimento de direção **over ahead bmx**

CARACTERÍSTICA	Ahead Set Over p/ Rotor
EXTENSÃO	1.1/8
MATERIAL	Aço
EMBALAGEM	100 peças

13108



Movimento de direção **super over ahead**

CARACTERÍSTICA	Ahead Set Tapered Direção 1 1/8x44mm Integrado (com caixas)
MODELO	Com adaptador para garfo 30mm e 39.8mm
EXTENSÃO	1.5x1.1/8
EMBALAGEM	100 peças

13112



Movimento de direção **super over tapered**

CARACTERÍSTICA	Ahead Set Tapered Direção 1 1/8x1.5 Integrado (s/ caixas)
MODELO	Com adaptador para garfo 30mm e 39.8mm
ROLAMENTOS	Menor: diâmetro externo: 41 mm, diâmetro interno: 31 mm, Espessura: 6,5 mm Maior: diâmetro externo: 52 mm, diâmetro interno: 39,9 mm, Espessura: 8 mm
EMBALAGEM	100 peças

13113



Aranha para **garfo de carbono**

CARACTERÍSTICA	Para garfo com a espiga em carbono Tipo expander
MEDIDA DA ESPIGA	25.4mm (medida interna do Garfo)
MODALIDADE	Garfos MTB / Speed
MATERIAL	Aço/Alumínio
PESO APROXIMADO	42 g
EMBALAGEM	10 peças

22699

FOTOS MERAMENTE ILUSTRATIVAS. AS INFORMAÇÕES/CONFIGURAÇÕES DE PRODUTOS PODERÃO SOFRER ALTERAÇÕES SEM AVISO PRÉVIO.

ENTRE EM CONTATO COM O SEU CONSULTOR OU FALE COM O NOSSO TIME DE TELEVENDAS PELO (33) 3277-3030.

Movimento de direção mega over ahead

CARACTERÍSTICA Ahead mega over | Semi-selado | Esferado

EXTENSÃO 1.1/8

MATERIAL alumínio/aço

EMBALAGEM 100 peças

13115



Movimento de direção over

CARACTERÍSTICA Over | Com rosca

MODELO p/ Garfo 25.4mm

EXTENSÃO Rosca Colar 1 - 1/8

EMBALAGEM 100 peças

13116



Movimento de Direção SPACE

CARACTERÍSTICA Ahead set mega over

MODELO Rolamentado

EXTENSÃO 1.1/8

EMBALAGEM 100 peças

13117



FOTOS MERAMENTE ILUSTRATIVAS. AS INFORMAÇÕES/CONFIGURAÇÕES DE PRODUTOS PODERÃO SOFRER ALTERAÇÕES SEM AVISO PRÉVIO.

ENTRE EM CONTATO COM O SEU CONSULTOR OU FALE COM O NOSSO TIME DE TELEVENDAS PELO (33) 3277-3030.

XTRIME



FOTO ILUSTRATIVA DA EMBALAGEM



Válvula Tubeless

CARACTERÍSTICA	Padrão de rosca universal, seguindo as regras de produtos UCI Núcleo removível Porca recartilhada (alumínio) válvula Fina (Presta)
MATERIAL	Alumínio anodizado tipo 6351
TAMANHO	45 mm
PESO	12 g
EMBALAGEM	1 peça

CORES

	12902
	12903
	12904
	12905
	12906
	12907
	12908

FOTOS MERAMENTE ILUSTRATIVAS. AS INFORMAÇÕES/CONFIGURAÇÕES DE PRODUTOS PODERÃO SOFRER ALTERAÇÕES SEM AVISO PRÉVIO.

ENTRE EM CONTATO COM O SEU CONSULTOR OU FALE COM O NOSSO TIME DE TELEVENDAS PELO (33) 3277-3030.



Acionador Remoto para Suspensão | Modelo 01

CARACTERÍSTICA	Acionador remoto para trava da suspensão
MATERIAL	Alumínio
PESO	61 g
EMBALAGEM	1 peça
	14875



Acionador Remoto para Suspensão | Modelo 02

CARACTERÍSTICA	Acionador remoto para trava da suspensão Abraçadeira articulada Regulador de tensão do cabo Acompanha cabo
MATERIAL	Alumínio
PESO	59 g
EMBALAGEM	50 peças
	14876



1



2

Tampa para Válvula

CARACTERÍSTICA	Compatível com válvula americana Comprimento 32 mm Diâmetro 10 mm
MATERIAL	Alumínio
PESO	5 gr
EMBALAGEM	20 peças



3



4

CORES	
	14147
	14149
	14150
	14151









1 2 3 4 5

Tampa para Válvula

CARACTERÍSTICA	Pequena (18 mm)
VÁLVULA	Schader (americana)
MATERIAL	Alumínio
CONTEÚDO	20 tampas
EMBALAGEM	500 peças

CORES

	14154
	14155
	14156
	14157
	14158



Tampa De Válvula Alum. Vermelha

CARACTERÍSTICA

- Tampa Para Válvula
- Material Alumínio
- Compatível Com Válvula Americana
- Diâmetro 10mm
- Comprimento 32mm

PESO

88gr - Peso Referente Ao Pacote Com 20 Unidades

MATERIAL

Alumínio

CONTEÚDO

20 tampas

EMBALAGEM

500 peças

14148



Núcleo Válvulas Tubeless

CARACTERÍSTICA

Reparos de válvulas tubeless X-Time | Com tampa | Usinadas torno CNC em metal do tipo latão | Banho protetivo de níquel cromado | Vedações interna de borracha e silicone | Padrão de rosca universal e compatível com todos modelos já existentes no mercado | Seguindo as regras de produtos UCI



COMPOSIÇÃO

Latão banhado a níquel, vedação de borracha e silicone

FATOR

5

COMPATIBILIDADE

Válvulas Presta

EMBALAGEM

50 peças

12932



Adaptador para válvula

CARACTERÍSTICA

Adapta presta para Schader (americana)

CONTEÚDO

20 adaptadores

EMBALAGEM

500 peças

14164



Adaptador Válvula Presta P/ Válvula Americana

CARACTERÍSTICA

- Adaptador Para Válvula
- Material Bronze
- Adapta Válvula Presta Para Válvula Schader (Americana)
- Diâmetro 10x8mm
- Comprimento 15mm

PESO

62gr - Peso Referente Ao Pacote Com 20 Unidades

MATERIAL

Bronze

CONTEÚDO

20 unidades

EMBALAGEM

500 peças

23204

FOTOS MERAMENTE ILUSTRATIVAS. AS INFORMAÇÕES/CONFIGURAÇÕES DE PRODUTOS PODERÃO SOFRER ALTERAÇÕES SEM AVISO PRÉVIO.

ENTRE EM CONTATO COM O SEU CONSULTOR OU FALE COM O NOSSO TIME DE TELEVENIDAS PELO (33) 3277-3030.

Fita ARO TUBELESS 55mt



CARACTERÍSTICA	Fita polipropileno para vedação de aro tubeless
AROS	MTB, MTB Boost e Speed
MATERIAL	Polipropileno
EMBALAGEM	50 peças



TAMANHO 55mt x30mm

APLICAÇÃO. MTB Boost

PESO (APROXIMADO) 167g

12631

TAMANHO 55mt x24mm

APLICAÇÃO. MTB

PESO (APROXIMADO) 125g

12630

TAMANHO 55mt x18mm

APLICAÇÃO. Speed

PESO (APROXIMADO) 100g

12627

Fita ARO TUBELESS 10mt



CARACTERÍSTICA	Fita polipropileno para vedação de aro tubeless
AROS	MTB, MTB Boost e Speed
MATERIAL	Polipropileno
EMBALAGEM	50 peças



TAMANHO 10mt x18mm

APLICAÇÃO. Speed

12623

TAMANHO 10mt x24mm

APLICAÇÃO. MTB

08885

TAMANHO 10mt x30mm

APLICAÇÃO. MTB Boost

12624



Ferramenta de Reparo Tubeless

CARACTERÍSTICA Ferramenta de inserção 10 unidades de reparo

EMBALAGEM 50 peças

12632

FOTOS MERAMENTE ILUSTRATIVAS. AS INFORMAÇÕES/CONFIGURAÇÕES DE PRODUTOS PODERÃO SOFRER ALTERAÇÕES SEM AVISO PRÉVIO.

ENTRE EM CONTATO COM O SEU CONSULTOR OU FALE COM O NOSSO TIME DE TELEVENDAS PELO (33) 3277-3030.



Kit Macarrão Reparo Tubeless

CARACTERÍSTICA	Fabricado em borracha natural pré-vulcanizada e algodão Pacote com 20 unidades
APLICAÇÃO	Aplicação para vedação de furos maiores que 4 mm em pneus tubeless
FUNCIONAMENTO	O macarrão de reparo funciona juntamente com o selante, em uma reação química entre os dois, fazendo a vedação emergencial
COMPATIBILIDADE	Compatível com selantes à base de látex
EMBALAGEM	50 peças

12909



Bomba de AR Pequena | Oficina

CARACTERÍSTICA	Apoio para pé dobrável Cabo Nylon
COMPRIMENTO DA MANGUEIRA	38 cm
COMPATIBILIDADE DE VÁLVULAS	Presta / Schrader (Americana)
PESO APROXIMADO	198g
EMBALAGEM	1 peça

15581



Bomba de AR grande | Oficina

CARACTERÍSTICA	Apoio para pé dobrável Cabo Nylon
COMPRIMENTO DA MANGUEIRA	65 cm
COMPATIBILIDADE DE VÁLVULAS	Presta / Schrader (Americana)
PESO APROXIMADO	290g
EMBALAGEM	1 peça

15582



Bomba de AR | Oficina

CARACTERÍSTICA	Apoio para pé dobrável Cabo Nylon
COMPRIMENTO DA MANGUEIRA	60 cm
COMPATIBILIDADE DE VÁLVULAS	Schrader (Americana)
PESO APROXIMADO	462g
EMBALAGEM	1 peça

15583

FOTOS MERAMENTE ILUSTRATIVAS. AS INFORMAÇÕES/CONFIGURAÇÕES DE PRODUTOS PODERÃO SOFRER ALTERAÇÕES SEM AVISO PRÉVIO.

ENTRE EM CONTATO COM O SEU CONSULTOR OU FALE COM O NOSSO TIME DE TELEVENDAS PELO (33) 3277-3030.

X-TIME



Lubrificantes, higiene e limpeza

Soluções abrangentes em termos de manutenção de bicicletas e acessórios.

Com uma linha de lubrificantes e produtos de higiene e limpeza, desenvolvidos com as técnicas mais avançadas e com os insumos mais nobres, revolucionamos os parâmetros de cuidados para bikes, componentes, roupas e demais itens.



FOTOS MERAMENTE ILUSTRATIVAS

X-TIME LUBE

FOTOS MERAMENTE ILUSTRATIVAS. AS INFORMAÇÕES/CONFIGURAÇÕES DE PRODUTOS PODERÃO SOFRER ALTERAÇÕES SEM AVISO PRÉVIO.

ENTRE EM CONTATO COM O SEU CONSULTOR OU FALE COM O NOSSO TIME DE TELEVENDAS PELO (33) 3277-3030.

X-TIME



Selante para pneus **ULTRA**

CARACTERÍSTICA selante para vedação de pneus de bicicletas, agindo de forma eficaz em furos de até 4mm

CAPACIDADE 500ml

EMBALAGEM 6 peças

08884



Selante para pneus **ULTRA**

CARACTERÍSTICA selante para vedação de pneus de bicicletas, agindo de forma eficaz em furos de até 4mm

CAPACIDADE 250ml

EMBALAGEM 6 peças

08883

X-TIME



Cera Lubrificante 120 ml

CARACTERÍSTICA Biodegradável, prolonga a vida útil da corrente e diminui a sujeira acumulada

APLICAÇÃO Desenvolvida para bicicletas de todas as categorias

COMPOSIÇÃO Mistura de ceras naturais, aditivos em baixo percentual (oleígenos, hidrocarbonetos e polissiloxanos), conservante e essência

EMBALAGEM 140 peças (120 ml)

12783



Cera Lubrificante 300 ml

CARACTERÍSTICA Biodegradável, prolonga a vida útil da corrente e diminui a sujeira acumulada

APLICAÇÃO Desenvolvida para bicicletas de todas as categorias

COMPOSIÇÃO Mistura de ceras naturais, aditivos em baixo percentual (oleígenos, hidrocarbonetos e polissiloxanos), conservante e essência

EMBALAGEM 12 peças

16167

FOTOS MERAMENTE ILUSTRATIVAS. AS INFORMAÇÕES/CONFIGURAÇÕES DE PRODUTOS PODERÃO SOFRER ALTERAÇÕES SEM AVISO PRÉVIO.

ENTRE EM CONTATO COM O SEU CONSULTOR OU FALE COM O NOSSO TIME DE TELEVENDAS PELO (33) 3277-3030.

Suporte Caramanhola – SHUNFENG

Característica 2 Parafusos |
Alumínio

Embalagem 100 peças



00928



04480

ANODIZADO



04844



04845



Cesta Vime Retrô Com Tampa MITSU

Característica Cesta para bicicleta, com estilo vintage retrô com tampa;
-Acompanha suporte de nylon para fixação no guidão da bicicleta;
-Removível

Tamanho Topo: 33 x 26 x 23cm
Base: 25 x 20 cm (com suporte)

Embalagem 12 peças

11713



Cesta Vime Retrô MITSU

Característica Cesta para bicicleta, com estilo vintage retrô;
-Acompanha suporte de nylon para fixação no guidão da bicicleta;
-Removível

Tamanho Topo: 36 x 28 x 23/26cm
Base: 26 x 20.3 cm (com suporte)

Embalagem 8 peças

11714



FOTOS MERAMENTE ILUSTRATIVAS. AS INFORMAÇÕES/CONFIGURAÇÕES DE PRODUTOS PODERÃO SOFRER ALTERAÇÕES SEM AVISO PRÉVIO.

ENTRE EM CONTATO COM O SEU CONSULTOR OU FALE COM O NOSSO TIME DE TELEVENDAS PELO (33) 3277-3030.

C A T Á L O G O

ARISUN

P N E U S

ARISUN
T I R E S



PNEU ARISUN MOUNT BONA

MOUNTAIN BIKE

TAMANHO	TPI	TIPO	CODIGO
29X2.10	27	SKINWALL	08655
29X2.10	120	KEVLAR TUBELESS	-
29X2.35	27	SKINWALL	24099
29X2.35	60	KEVLAR	07796
29X2.35	120	KEVLAR TUBELESS	09327



PNEU ARISUN MOUNT GRAHAM

MOUNTAIN BIKE

TAMANHO	TPI	TIPO	CODIGO
29X2.20	27	SKINWALL	08654
29X2.20	60	KEVLAR	06742
29X2.20	120	KEVLAR TUBELESS	10180



MOUNT EMMONS - ARISUN

MOUNTAIN BIKE

TAMANHO	TPI	TIPO	CODIGO
29 X 2.10	30	BANDA LEVE	06748

FOTOS MERAMENTE ILUSTRATIVAS. AS INFORMAÇÕES/CONFIGURAÇÕES DE PRODUTOS PODERÃO SOFRER ALTERAÇÕES SEM AVISO PRÉVIO.

ENTRE EM CONTATO COM O SEU CONSULTOR OU FALE COM O NOSSO TIME DE TELEVENDAS PELO (33) 3277-3030.

ARISUN

PNEU ARISUN MOUNT GRAHAM TANWALL

CROSS COUNTRY

CARACTERÍSTICA Aro 29", Faixa Marrom / Logomarca Preta Small Block., Medida 29 x 2.20 (55 x 622) Skinwall e Kevlar

MATERIAL Borracha

PESO Skinwall 790 gr
Kevlar 740 gr

EMBALAGEM Skinwall 25 peças
Kevlar 10 peças

TAMANHO	TPI	TIPO	CODIGO
29 X 2.20	27	SKINWALL	21814

TAMANHO	TPI	TIPO	CODIGO
29 X 2.20	60	KEVLAR	24094
29 X 2.20	27	SKINWALL	24095



MOUNT COOK - ARISUN

MOUNTAIN BIKE

TAMANHO	TPI	TIPO	CODIGO
29X2.25	60	KEVLAR	07785

MOUNT COOK TANWALL - ARISUN

CROSS COUNTRY

CARACTERÍSTICA Tecnologia Nylon Defense (ND)

MATERIAL Borracha

PESO 818 gr

EMBALAGEM 25 peças

TAMANHO	TPI	TIPO	CODIGO
29 X 2.25	60	KEVLAR	24101



ARISUN



RAPIDE - ARISUN

ROAD BIKE

TAMANHO	TPI	TIPO	CODIGO
700X32C	60	KEVLAR	14266
700X28C	60	KEVLAR	14265
700X25C	60	KEVLAR	06757
700X23C	30	BANDA LEVE	-



VITESSE - ARISUN

ROAD BIKE

TAMANHO	TPI	TIPO	CODIGO
700X25C	27	SKINWALL	08656



CUTTING EDGE - ARISUN

BMX

TAMANHO	TPI	TIPO	CODIGO
20X2.10	27	SKINWALL	20518

CARACTERÍSTICA Pneu aro 20" | Reforçado e resistente, para um desempenho em alto nível e segurança

MATERIAL Borracha

PRESSÃO 85/110PSI - 5.8/7.5BAR - 580/755KPa

PESO 637 gr

EMBALAGEM 25 peças

FOTOS MERAMENTE ILUSTRATIVAS. AS INFORMAÇÕES/CONFIGURAÇÕES DE PRODUTOS PODERÃO SOFRER ALTERAÇÕES SEM AVISO PRÉVIO.

ENTRE EM CONTATO COM O SEU CONSULTOR OU FALE COM O NOSSO TIME DE TELEVENDAS PELO (33) 3277-3030.



PNEU ARISUN ALLURE

ROAD BIKE

TAMANHO	TPI	TIPO	CODIGO
700X23C	30	BANDA LEVE	06756
700X25C	30	BANDA LEVE	07789
700X25C	60	KEVLAR	07788
700X28C	120	KEVLAR	14263
700X32C	120	KEVLAR	14264
700X25C	27	SKINWALL	24102



METRO CRUISER - ARISUN

ROAD BIKE

TAMANHO	TPI	TIPO	CODIGO
700X32C	27	SKINWALL	08657



METRO TROOPER - ARISUN

ROAD BIKE

TAMANHO	TPI	TIPO	CODIGO
700X38C	30	BANDA LEVE	06759
700X23C	60	KEVLAR	-

FOTOS MERAMENTE ILUSTRATIVAS. AS INFORMAÇÕES/CONFIGURAÇÕES DE PRODUTOS PODERÃO SOFRER ALTERAÇÕES SEM AVISO PRÉVIO.

ENTRE EM CONTATO COM O SEU CONSULTOR OU FALE COM O NOSSO TIME DE TELEVENDAS PELO (33) 3277-3030.

ARISUN



PNEU SKINWALL MOUNT BONA TANWALL ARISUN

CROSS COUNTRY

MATERIAL Borracha

PESO 864 gr

EMBALAGEM 25 peças

TAMANHO	TPI	TIPO	CODIGO
29 X 2.10	27	SKINWALL	24098
29 X 2.35	27	SKINWALL	24100
29 X 2.35	60	KVELAR	24097

CÂMARA – ARISUN

TAMANHO	VÁLVULA	CODIGO
29X1.75/2.35	PRESTA 48MM	06761 / 17876
29X1.75/2.35 SCHRADER	AMERICANA	07805 / 17877
700X18/25C	PRESTA 48MM	06762
700X25/38C	PRESTA 48MM	24106
700X18/25C	PRESTA 48 MM SUPERLITE	24108
700X25/38C	PRESTA 60MM	24107
700X18/25C	PRESTA 60MM	07807
700X18/25C	PRESTA 60MM SUPERLITE	24109
700X35/50C	PRESTA 48MM	06763
700X35/50C	PRESTA 60MM	07808
700X18/25C	PRESTA 80 MM SUPERLITE	24110
700X18/25C	PRESTA 80MM	24105
29 X 1.75/2.35	PRESTA 48MM	24103





SRI68 - BEYOND

CARACTERÍSTICA	Pneu para MTB Aro 29" Com cravos Medida 2.10 (54-622) Pressão máxima 60 P.S.I / 4 bar Material borracha / Arame / Nylon
MARCA	Beyond
MATERIAL	Borracha
PESO	1000 gr
FATOR DE VENDA	1 unidade
EMBALAGEM	50 unidades

24378

FOTOS MERAMENTE ILUSTRATIVAS. AS INFORMAÇÕES/CONFIGURAÇÕES DE PRODUTOS PODERÃO SOFRER ALTERAÇÕES SEM AVISO PRÉVIO.

ENTRE EM CONTATO COM O SEU CONSULTOR OU FALE COM O NOSSO TIME DE TELEVENDAS PELO (33) 3277-3030.



ROCKBROS

Suporte para Caramanhola

MODELO	2009-14C
CARACTERÍSTICA	Leve e portátil Design avançado com apelo para performance
MATERIAL	Alumínio
COR	Preto
PESO APROXIMADO	45 g
EMBALAGEM	1 peça
	13341



Suporte para Caramanhola Nylon Modelo 07

CARACTERÍSTICAS	Design moderno Fixação por 2 parafusos Acompanha chave allen para instalação
MATERIAL	Nylon
COR	Preto
PESO APROXIMADO	47gr - peso referente kit (suporte, parafusos, chave allen)
EMBALAGEM	100 unidades
	22025



FOTOS MERAMENTE ILUSTRATIVAS. AS INFORMAÇÕES/CONFIGURAÇÕES DE PRODUTOS PODERÃO SOFRER ALTERAÇÕES SEM AVISO PRÉVIO.

ENTRE EM CONTATO COM O SEU CONSULTOR OU FALE COM O NOSSO TIME DE TELEVENDAS PELO (33) 3277-3030.

Suporte para Caramanhola Modelo 02

CARACTERÍSTICAS	Fixação por dois parafusos Allen 4 mm
MATERIAL	Alumínio
COR	Preto
PESO APROXIMADO	27 g
EMBALAGEM	1 peça

14764



Suporte para Caramanhola Modelo 03

CARACTERÍSTICAS	Fixação por dois parafusos Allen 4 mm
MATERIAL	Alumínio
COR	Preto
PESO APROXIMADO	34 g
EMBALAGEM	1 peça

14765



Suporte para Caramanhola Nylon Modelo 04

CARACTERÍSTICAS Pintura emborrachada |
Design moderno |
Cor preta | Acompanha
parafusos para fixação

MATERIAL Policarbonato - PC

COR Preto

PESO APROXIMADO 35gr - Peso referente
kit (suporte, parafusos)

EMBALAGEM 100 unidades

22022



Suporte para Caramanhola Alum. Modelo 06

CARACTERÍSTICAS Pintura anodizada
| Design moderno
| Cor preta
| Acompanha parafusos
para fixação

MATERIAL Alumínio

COR Preto

PESO APROXIMADO 41gr - Peso referente
kit (suporte, parafusos)

EMBALAGEM 100 unidades

22024



Suporte para Caramanhola Alum. Modelo 05

CARACTERÍSTICAS Pintura anodizada |
Design moderno |
Cor preta | Acompanha
parafusos para fixação

MATERIAL Alumínio

COR Preto

PESO APROXIMADO 37gr - Peso referente
kit (suporte, parafusos)

EMBALAGEM 100 unidades

22023



Selim Passeio Gel

CARACTERÍSTICAS Gel | Vazado | 2 molas em silicone | Trilho de aço | Suporte de apoio para as mãos | Design moderno e confortável | Acompanha castanha de aço

MATERIAL Polietileno e Poliéster

COR Preto

PESO APROXIMADO 720gr - Incluindo castanha

EMBALAGEM 20 unidades

22026



Selim MTB Vazado

CARACTERÍSTICAS Vazado | Estrutura de assento em polímero, espuma e couro sintético | Excelente acabamento | Não acompanha castanha

MATERIAL Polímero e aço

COR Preto

MEDIDAS 275x160mm

25002



Manguito | XT9002

MODELO XT9002

CARACTERÍSTICA Unisex | Tamanho único | Proteção UV | Rápida secagem

MATERIAL Lycra / Coolmax

EMBALAGEM 50 peças

 16523

 16524



Bomba De Ar Elétrica

PRESSÃO MÁXIMA	150 psi
TEMPO DE CARGA	Aproximadamente 2 horas
FUNÇÕES	Carro (0 a 2,5 BAR) Moto (0 a 50 psi) Mountain Bike (0 a 50 psi) Ciclismo (0 a 120 psi) e bola (0 a 9 psi)
VISOR	Com seleção de função Pressão desejada Pressão atual Nível de bateria
PESO	460 gramas
ESPECIFICAÇÕES	Recarregável via cabo USB-C Compatível com válvula presta, americana e bola Lanterna

24999



Kit Macarrão Reparo Tubeless

PESO	42 gramas
ESPECIFICAÇÕES	Textura anti deslizante Contém 10 refis de macarrão - 5 para furos de até 1,5mm e 5 para furos de até 3,5mm

25001



Mini Bomba de Ar Elétrica

PRESSÃO MÁXIMA	100 psi
NÍVEL DE BATERIA	Luz verde 80% a 100% Amarela 50% a 80% Vermelha abaixo de 50%
MATERIAL	Alumínio
PESO	97 gramas
ESPECIFICAÇÕES	Recarregável via cabo USB-C Compatível com válvula presta e americana

25000



FOTOS MERAMENTE ILUSTRATIVAS. AS INFORMAÇÕES/CONFIGURAÇÕES DE PRODUTOS PODERÃO SOFRER ALTERAÇÕES SEM AVISO PRÉVIO.

ENTRE EM CONTATO COM O SEU CONSULTOR OU FALE COM O NOSSO TIME DE TELEVENDAS PELO (33) 3277-3030.

Bolsa para Transporte de Bicicleta

MODELO	D33-1
CARACTERÍSTICA	Bolsa para transporte de bicicletas 26" 27.5" 29" 700C Bike Bolso interno para rodas Bolso externo com zíper Dobrável Alça regulável (Bolsa e mochila usam a mesma) Mochila com bolso lateral para guardar a bolsa de transporte
TAMANHO	120 x 75 x 34.5cm (Bolsa) 40 x 43,5 x 17 cm (mochila)
CAPACIDADE	310 L (Bolsa de transporte) 29 L (mochila)
EMBALAGEM	1 peça

16517



Ciclo Computador | Modelo 01

MARCA	Cat Eye Velo 5
MODELO	05 funções Com fio
FUNÇÕES	SPD (Velocidade atual) MX (Velocidade máxima) DST Trip distance ODO (Distância total) Relógio
FIXAÇÃO	Abraçadeira de nylon
EMBALAGEM	20 peças

16520



Protetor de Quadro

MARCA	Rockbros
CARACTERÍSTICA	Fechamento em velcro
EMBALAGEM	01 peça

16516



FOTOS MERAMENTE ILUSTRATIVAS. AS INFORMAÇÕES/CONFIGURAÇÕES DE PRODUTOS PODERÃO SOFRER ALTERAÇÕES SEM AVISO PRÉVIO.

ENTRE EM CONTATO COM O SEU CONSULTOR OU FALE COM O NOSSO TIME DE TELEVENDAS PELO (33) 3277-3030.

Bomba de Ar RB-380G com Pé e Manômetro

MODELO	RB-380G
CARACTERÍSTICA	Bomba de alta pressão Apoio para pé dobrável Três adaptadores de bico
COMPRIMENTO DA MANGUEIRA	71 cm
COMPATIBILIDADE DE VÁLVULAS	Presta / Schrader (Americana)
PRESSÃO MÁXIMA	160 PSI (11 BAR)
MATERIAL	Alumínio / Nylon
PESO APROXIMADO	770g
EMBALAGEM	1 peça
	16518



Bomba de Ar RB- GP6532B com Pé e Manômetro

MODELO	RB- GP6532B
CARACTERÍSTICA	Bomba de alta pressão Duplo apoio para pé Extenso alcance de aplicação Dois adaptadores de bico
COMPRIMENTO DA MANGUEIRA	99 cm
COMPATIBILIDADE DE VÁLVULAS	Presta / Schrader (Americana)
PRESSÃO MÁXIMA	160 PSI (11 BAR)
MATERIAL	Alumínio
PESO APROXIMADO	1.11kg
EMBALAGEM	1 peça
	16519



Bomba com Estojo para Remendo

ESPECIFICAÇÃO	Kit de ferramentas para reparos em câmaras de ar
CARACTERÍSTICA	Estojo de reparo de câmaras de ar
PESO APROXIMADO	135 g
KIT	1 mini bomba * 1 Par de Espátula * 6 remendo * 01 Bolsinha
EMBALAGEM	20 peças

19196



Manopla | BT1001

MODELO	BT 1001
CARACTERÍSTICA	Manopla de espuma com anel de trava e tampa
TRAVA	Parafuso Allen 3 mm
MATERIAL	Espuma / Alumínio
COMPRIMENTO	130 mm
PESO	63 g
EMBALAGEM	50 peça

16522



ROCKBROS

Remendo Estojó 6 Unidades

ESPECIFICAÇÃO	Remendo para Câmara de Ar
CARACTERÍSTICA	Autocolante Portátil
PESO	11 g (conjunto)
KIT	1 caixa / 1 Lixa de metal / 6 Remendo
EMBALAGEM	20 peças

19198

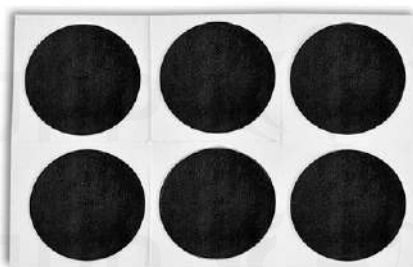

Remendo Patch Kit

ESPECIFICAÇÃO	Remendo para reparo de câmara de ar
CARACTERÍSTICA	Multifuncional Portátil Autocolante
PESO	87 g (conjunto)
EMBALAGEM DO PRODUTO	1 estojo / 1 lixa / 1 manual / 6 adesivos
EMBALAGEM	50 peças

19204



Fita Anti Furo 40 mm | Branca

ESPECIFICAÇÃO	Fita anti-furo
CARACTERÍSTICA	Proteger a câmara de ar
TAMANHO	29" MTB
LARGURA	40MM
COMPRIMENTO	2,30MT
ESPESSURA	0,5MM
PESO	121 g
KIT	1 PAR
EMBALAGEM	50 peças

19200



FOTOS MERAMENTE ILUSTRATIVAS. AS INFORMAÇÕES/CONFIGURAÇÕES DE PRODUTOS PODERÃO SOFRER ALTERAÇÕES SEM AVISO PRÉVIO.

ENTRE EM CONTATO COM O SEU CONSULTOR OU FALE COM O NOSSO TIME DE TELEVENDAS PELO (33) 3277-3030.

■ Espátula de Nylon para Retirar Pneu

ESPECIFICAÇÃO Para retirar pneu com trava de apoio que vai ao lado para facilitar a retirada do Pneu

MATERIAL Nylon Preto

PESO 0.27 Kg

KIT 2 espátulas

EMBALAGEM 50 peças

19202



■ Refletor/Retrovisor para Guidão Speed

ESPECIFICAÇÃO Refletor de guidão com 3 funções

CARACTERÍSTICA Fixação interna no guidão de speed com regulagem de ângulo (Retrovisor)

MATERIAL Nylon

PESO 0.42 Kg (embalagem)

EMBALAGEM 50 peças

19192



ROCKBROS

■ Extrator de Rolamento

ESPECIFICAÇÃO Instalador de rolamento

CARACTERÍSTICA Rolamentos de esferas modelo RC

MATERIAL Alumínio

DIÂMETRO DA FERRAMENTA: 2 mm / 3 mm / 4 mm / 5 mm / 6 mm / 8 mm / 10 mm / 12 mm / 14 mm

PESO 0.25 kg

EMBALAGEM 50 peças

19193



FOTOS MERAMENTE ILUSTRATIVAS. AS INFORMAÇÕES/CONFIGURAÇÕES DE PRODUTOS PODERÃO SOFRER ALTERAÇÕES SEM AVISO PRÉVIO.

ENTRE EM CONTATO COM O SEU CONSULTOR OU FALE COM O NOSSO TIME DE TELEVENDAS PELO (33) 3277-3030.

Cortador de Mangueira e Agulha Freio a Disco Hidráulico

ESPECIFICAÇÃO	Cortador de mangueira de freio hidráulico
CARACTERÍSTICA	Cortador de mangueira e instalador de pino da oliva de freio hidráulico
MATERIAL	Nylon/ Alumínio
TAMANHO	94x69x14 mm / 3,7x2,71x0,51"
PESO	79 g
EMBALAGEM	25 peças

19194



Chave Triângulo

ESPECIFICAÇÃO	Chave allen triângulo
CARACTERÍSTICA	Chave allen 4/5/6 mm
MATERIAL	Aço - meio emborrachado
TAMANHO	94x69x14 mm / 3,7x2,71x0,51"
PESO	82 g
EMBALAGEM	20 peças

19203



Chave Allen com Alavanca e Catraca

ESPECIFICAÇÃO	Chave allen com catraca
CARACTERÍSTICA	Ferramentas multifuncionais Dureza Antiferrugem Multifunção com 6 pontas
MATERIAL	Alumínio preto
KIT	Chaves allen 4/5/6 Chave Philips PH.2, T25/T30 estriada Plum 6 ângulos
COMPRIMENTO	10 cm
PESO	158 g
EMBALAGEM	20 peças

19201



FOTOS MERAMENTE ILUSTRATIVAS. AS INFORMAÇÕES/CONFIGURAÇÕES DE PRODUTOS PODERÃO SOFRER ALTERAÇÕES SEM AVISO PRÉVIO.

ENTRE EM CONTATO COM O SEU CONSULTOR OU FALE COM O NOSSO TIME DE TELEVENDAS PELO (33) 3277-3030.

Kit Ferramenta Allen com Remendo

ESPECIFICAÇÃO	Estojo de ferramentas
CARACTERÍSTICA	Multifuncional portátil 16 em 1 - Kit de ferramentas para reparo de bicicletas Stainles
TAMANHO	8,5 * 12 * 7,5 cm
COMPRIMENTO	Cerca de 10cm
PESO	281 g/ peças
CONTÉM	1 Bolsa de Ferramenta Azul 1 Ferramenta Allen 16 em 1 multifuncional 1 cola de remendo 1 Lixa de metal de borracha 5 Remendos de Câmara 1 Par de Espátula para retirada do Pneu
EMBALAGEM	20 peças
	19199



Chaveiro Allen 16 Funções

ESPECIFICAÇÃO	Chaveiro allen
CARACTERÍSTICA	Multifuncional portátil 16 em 1 - Kit de ferramentas para reparo de bicicletas Stainles
TAMANHO	4,4*9 CM
COR	Preta
PESO	205 g
KIT	<ul style="list-style-type: none">• Ferramentas metálicas Cr-Mo• 6 Hex 2. 2.5.3. 4. 5. 6 mm - Chave Allen• 3 Chaves planas: 8,10,15 mm• 3 Chaves de Caixa: 8,9,10 mm• 1 Chave Fenda• 1 Chave Phillips• Chave Raio (ajuste)
EMBALAGEM	50 peças
	19197



Maleta Ferramentas Bicicleta

ESPECIFICAÇÃO	Maleta de Ferramentas para Bicicleta
CARACTERÍSTICA	Kit Ferramentas Aço carbono
TAMANHO	Tamanho da caixa 32.5 x 25 x 7cm
PESO	3.195 Kg
KIT	<ul style="list-style-type: none">• 1 Kit Remendo com 6 Unidades Alto Colante, Lixa de Metal.• 2 Ponta Chave de Fenda (Média e Grande)• 2 Ponta Chave Phillips (Média e Grande)• 1 Chave Phillips (Para ajuste do cambio)• 1 Chave de Boca 8mm / 10mm• 1 Chicote de Corrente• 1 Chave de Movimento de Direção 30/32 + 36/40mm• 2 Chaves de Cone - 13-15mm e 14-16mm• 1 Extrator de Pedivela• 1 Chave de Raio• 6 Chave Allen 2 / 2,5 / 3 / 4 / 5 e 6mm• 1 Chave de Pino Ajustável para Movimento Central e Roda Lixe• 1 Chave de Pedal - 15/16 e 15/17• 1 Chave Inglesa - 0 a 21mm• 1 Extrator de Corrente• 1 Chave Allen - 8mm (Para remoção do braço da manivela)• 3 Unidades de Espátula de Pneu• 3 Chave Hexagonal - 8 / 9 / 10mm• 1 Extrator de Cassete• 1 Chave Extratora para Movimento Central• 1 Calibrador - Válvula Americana

EMBALAGEM 05 peças

19195



FOTOS MERAMENTE ILUSTRATIVAS. AS INFORMAÇÕES/CONFIGURAÇÕES DE PRODUTOS PODERÃO SOFRER ALTERAÇÕES SEM AVISO PRÉVIO.

ENTRE EM CONTATO COM O SEU CONSULTOR OU FALE COM O NOSSO TIME DE TELEVENDAS PELO (33) 3277-3030.

24983



24984



24985



— POR MAIS INFORMAÇÕES, LIGUE PARA O NÚMERO VERDE 0800 00 10 10. PARA MAIS INFORMAÇÕES, VISITE O SITE WWW.ROCKBROS.COM.BR

ENTRE EM CONTATO COM O SEU CONSULTOR OU FALE COM O NOSSO TIME DE TELEVENDAS PELO (33) 3277-3030.

Óculos Ciclismo

MODELO	10168
LENTE	Fotocromático
COR	Cinza
ACESSORIOS	Case, lenços e suporte para lentes de grau
QUANT. DE LENTES	Única
PESO	29 gramas
ESPECIFICAÇÕES	Suporte nasal ajustável

24983



Óculos Ciclismo

MODELO	10179
LENTE	Fotocromático espelhado
COR	Branco
ACESSORIOS	Case, lenços e suporte para lentes de grau
QUANT. DE LENTES	Única
PESO	29 gramas
ESPECIFICAÇÕES	Suporte nasal ajustável

24984



Óculos Ciclismo

MODELO	10179
LENTE	Fotocromático espelhado
COR	Preto
ACESSORIOS	Case, lenços e suporte para lentes de grau
QUANT. DE LENTES	Única
PESO	29 gramas
ESPECIFICAÇÕES	Suporte nasal ajustável

24985



24986



24987



24988



As imagens são meramente ilustrativas. A única maneira de garantir a qualidade de nossos produtos é comprando diretamente conosco sem intermediários.

ENTRE EM CONTATO COM O SEU CONSULTOR OU FALE COM O NOSSO TIME DE TELEVENDAS PELO (33) 3277-3030.

Óculos Ciclismo

MODELO	14110001001
LENTE	Espelhada
COR	Azul
ACESSORIOS	Case, lenços e suporte para lentes de grau
QUANT. DE LENTES	Única
PESO	29 gramas
ESPECIFICAÇÕES	Suporte nasal ajustável

24986



Óculos Ciclismo

MODELO	10136
LENTE	Fotocromático
COR	Azul
ACESSORIOS	Case, lenços e suporte para lentes de grau
QUANT. DE LENTES	Única
PESO	24 gramas
ESPECIFICAÇÕES	Proteção UV, suporte nasal ajustável

24987



Óculos Ciclismo

MODELO	10137
LENTE	Fotocromático
COR	Vermelho
ACESSORIOS	Case, lenços e suporte para lentes de grau
QUANT. DE LENTES	Única
PESO	24 gramas
ESPECIFICAÇÕES	Proteção UV, suporte nasal ajustável

24988



24989



24990



24991



FOTO: MARGARETE LUSILLI/MAZ. *IMAGEM: 100% CONFIGURAÇÕES DE PRODUTOS PODERÃO SOFRER ALTERAÇÕES SEM AVISO PRÉVIO.

ENTRE EM CONTATO COM O SEU CONSULTOR OU FALE COM O NOSSO TIME DE TELEVENDAS PELO (33) 3277-3030.

Óculos Ciclismo

MODELO	10173
LENTE	Fotocromático
COR	Preto/Vermelho
ACESSORIOS	Case, lenços e suporte para lentes de grau
QUANT. DE LENTES	Única
PESO	32 gramas
ESPECIFICAÇÕES	Proteção UV, suporte nasal ajustável

24989



Óculos Ciclismo

MODELO	10174
LENTE	Fotocromático
COR	Azul
ACESSORIOS	Case, lenços e suporte para lentes de grau
QUANT. DE LENTES	Única
PESO	32 gramas
ESPECIFICAÇÕES	UV400, Suporte nasal ajustável

24990



Óculos Ciclismo

MODELO	10175
LENTE	Fotocromático
COR	Preto
ACESSORIOS	Case, lenços e suporte para lentes de grau
QUANT. DE LENTES	Única
PESO	32 gramas
ESPECIFICAÇÕES	Suporte nasal ajustável

24991



24992



24993



24994



ENTRE EM CONTATO COM O SEU CONSULTOR OU FALE COM O NOSSO TIME DE TELEVENDAS PELO (33) 3277-3030.

Óculos Ciclismo

MODELO	10172
LENTE	Fotocromático
COR	Branco
ACESSÓRIOS	Case, lenços e suporte para lentes de grau
QUANT. DE LENTES	Única
PESO	32 gramas
ESPECIFICAÇÕES	Proteção UV, suporte nasal ajustável

24992



Óculos Ciclismo

MODELO	14110006002
LENTE	Fotocromático espelhado
COR	Branco
ACESSÓRIOS	Case, lenços e suporte para lentes de grau
QUANT. DE LENTES	Única
PESO	32 gramas
ESPECIFICAÇÕES	Proteção UV, suporte nasal ajustável

24993



Óculos Ciclismo

MODELO	14110006003
LENTE	Espelhada polarizada
COR	Verde
ACESSÓRIOS	Case, lenços e suporte para lentes de grau
QUANT. DE LENTES	Única
PESO	32 gramas
ESPECIFICAÇÕES	Proteção UV, suporte nasal ajustável

24994



FOTOS MERAMENTE ILUSTRATIVAS. AS INFORMAÇÕES/CONFIGURAÇÕES DE PRODUTOS PODERÃO SOFRER ALTERAÇÕES SEM AVISO PRÉVIO.

ENTRE EM CONTATO COM O SEU CONSULTOR OU FALE COM O NOSSO TIME DE TELEVENDAS PELO (33) 3277-3030.

24995



24996



FOTOS MERAMENTE ILLUSTRATIVAS. TODAS AS INFORMAÇÕES CONFIAMOS ÀS CONFIGURAÇÕES DE PRODUTOS MODERAS. SÓTILES ALTERNATIVAS SEMPRE ÀS SUAS NECESSIDADES.

ENTRE EM CONTATO COM O SEU CONSULTOR OU FALE COM O NOSSO TIME DE TELEVENDAS PELO (33) 3277-3030.

Óculos Ciclismo

MODELO	14110006004
LENTE	Fotocromático
COR	Preto
ACESSÓRIOS	Case, lenços e suporte para lentes de grau
QUANT. DE LENTES	Única
PESO	32 gramas
ESPECIFICAÇÕES	Proteção UV, suporte nasal ajustável

24995



Óculos Ciclismo

MODELO	14110006005
LENTE	Espelhada polarizada
COR	Preto/Vermelho
ACESSÓRIOS	Case, lenços e suporte para lentes de grau
QUANT. DE LENTES	Única
PESO	32 gramas
ESPECIFICAÇÕES	Proteção UV, suporte nasal ajustável

24996



24997



24998



FOTOS MERAMENTE ILUSTRATIVAS. AS INFORMAÇÕES E CARACTERÍSTICAS DE PRODUTOS PODERÃO SOFRER ALTERAÇÕES SEM AVISO PRÉVIO.

ENTRE EM CONTATO COM O SEU CONSULTOR OU FALE COM O NOSSO TIME DE TELEVENDAS PELO (33) 3277-3030.

Óculos Ciclismo

MODELO	SP225WR
LENTE	Espelhada polarizada
COR	Branco
ACESSÓRIOS	Case, lenços e suporte para lentes de grau
QUANT. DE LENTES	Única
PESO	25 gramas
ESPECIFICAÇÕES	Proteção UV, suporte nasal ajustável

24997



Óculos Ciclismo

MODELO	SP225GB
LENTE	Espelhada polarizada
COR	Cinza
ACESSÓRIOS	Case, lenços e suporte para lentes de grau
QUANT. DE LENTES	Única
PESO	25 gramas
ESPECIFICAÇÕES	Proteção UV, suporte nasal ajustável

24998





ZTT 



CASSETE 12S XD 9-50T

Característica	Cassete 12V. 9/50 Dentes - Arranha e Cog 50 de Alumínio - Padrão XD - Escalonamento 9/11/13/15/18/21/24/28/32/36/42/50 T
Material	Aço de alta resistência entre os corgs 9-42T e liga de alumínio 7075 no cog 50T
Peso	510 g
Embalagem	20 peças

19493



GUIA DE CORRENTE MODELO CG-02

Característica	Guia de Corrente
Material	Liga de alumínio 7075 ultraleve com usinagem CNC de alta qualidade. Peso leve, mas com alta resistência. Abraçadeira 35mm, acompanha calço redutor para Seat Tube 31.8mm. Montagem com braçadeira e montagem direta tipo E. Usinagem CNC de alta qualidade
Peso	52 g
kit	01 Guia de corrente, 04 Arruelas, 01 Protetor/Redutor de quadro, 01 Parafuso com porca
Embalagem	50 peças

19495



ARRUELA BASE GARFO TAPERAD

Característica	Cone inferior para Garfo Taperad
Material	Alumínio
Peso	6 g
Embalagem	50 peças

19496



HEADSET EXPANDER PLUG

Característica	Aranha/Expander para aperto da caixa de direção
	Aberta 22.2 ≤ 25.4 mm - Compatível com espigas Head Set de alumínio de 28,6 mm, carbono, aço, garfo de titânio. Fácil de instalar
Material	Alumínio
Peso	66 g
Embalagem	50 peças
	19497



ADAPTADOR CENTER LOCK PARA 6 PARAFUSOS

Característica	Adaptador Center Lock para 6 Parafuso
	Adaptador Center Lock para discos de 6 parafusos compatível com eixos de 9/12/15mm
Material	Alumínio
Peso	32 g
Embalagem	50 peças
	19498



ADAPTADOR CENTER LOCK PARA 6 PARAFUSOS 15X100 PARA 15X110

Característica	Adaptador Center Lock para 6 Parafuso
	Adaptador Center Lock para discos de 6 parafusos para converter cubos equipados com eixo 15x100 mm para serem usados em suspensões com o OLD de 15x110mm. Acompanha 02 arruelas calço de 0.5x15 mm
Material	Alumínio
Peso	46 g
Embalagem	50 peças
	19499





ADAPTADOR CENTER LOCK PARA 6 PARAFUSOS 12X142 PARA 12X148

Característica	Adaptador Center Lock para 6 Parafusos
	Adaptador Center Lock para discos de 6 parafusos para converter cubos equipados com eixo 12x142 mm para serem usados em quadros Boost (12x148mm). Acompanha 02 arruelas calço de 0.3x12 mm
Material	Alumínio
Peso	40 g
Embalagem	50 peças
	19500



ADAPTADOR DIANTEIRO 180MM PARA PINÇA FREIO POST MOUNT

Característica	Adaptador de pinça dianteiro para discos 180mm
	Adaptador dianteiro de freio a disco MTB para rotor 180mm, liga de alumínio 7075 leve de alta resistência com tratamento de endurecimento T6
Material	Alumínio
Peso	30 g
Embalagem	50 peças
	19501



ALICATE TRAVA E DESTRAVA CORRENTE

Característica	Alicate para extração da emenda de engate rápido da corrente (Tipo: Power Link, Missing Link)
	Alicate Multifunções 4 em 1 - Extrator de emenda, Instalador de emenda, Espátula e Estojo para guardar emenda de corrente
Material	Alumínio
Peso	33 g
Embalagem	50 peças
	19502

FOTOS MERAMENTE ILUSTRATIVAS. AS INFORMAÇÕES/CONFIGURAÇÕES DE PRODUTOS PODERÃO SOFRER ALTERAÇÕES SEM AVISO PRÉVIO.

ENTRE EM CONTATO COM O SEU CONSULTOR OU FALE COM O NOSSO TIME DE TELEVENDAS PELO (33) 3277-3030.



MEDIDOR CORRENTE

Característica	Ferramenta para verificar a vida útil da corrente.
	Verifica a variação de medida da corrente de 0mm à 1,00 mm (Régua 0/ 0.25/ 0.50/ 0.75/ 1.0 mm), de fácil manuseio
Material	Liga de alumínio CNC
Peso	42 g
Embalagem	50 peças
	19503



FERRAMENTA INSTALAR ARANHA GARFO AHEAD

Característica	Ferramenta para instalar aranha
	Adaptador para garfo de 28,6 mm em Alumínio com O'ring para dar estabilidade e diminuição de atritos na espiga. Ferramenta durável
Material	Alumínio/Aço
Tamanho	Comprimento 100 mm/ Diâmetro 34.5mm
Peso	232 g
Embalagem	50 peças
	19504

EXTRATOR PORCA MOV CENTRAL DUB



Característica	Extrator de Movimento central
	Extrator de movimento central Duplo (DUB e Hollowtech), Compatível com movimentos Sram DUB, Shimano Hollowtech II e X-TIME. Acompanha Ferramenta de aperto do parafuso do eixo central padrão Shimano Hollowtech II
Material	Alumínio
Material	Comprimento 230mm/ Largura ≤ 62mm/ Encaixes da Ferramenta de 44 mm
Peso	55 g
Embalagem	50 peças
	19505

FOTOS MERAMENTE ILUSTRATIVAS. AS INFORMAÇÕES/CONFIGURAÇÕES DE PRODUTOS PODERÃO SOFRER ALTERAÇÕES SEM AVISO PRÉVIO.

ENTRE EM CONTATO COM O SEU CONSULTOR OU FALE COM O NOSSO TIME DE TELEVENDAS PELO (33) 3277-3030.





FERRAMENTA PASSADOR CABEAMENTO INTERNO V1.0

Característica	Ferramenta para passar cabos internos
	Ferramenta para passar cabos, Ímã flexível, Tampa removível com ímã principal, Fio flexível com ímã e ponta rosqueada e Encaixe de mangueira hidráulica
Material	Alumínio/Aço
Peso	48 g
Embalagem	50 peças
	19506



FERRAMENTA PASSADOR CABEAMENTO INTERNO V0.8

Característica	Ferramenta para passar cabos internos
	Ferramenta para passar cabos, Ímã flexível, Tampa removível com ímã principal, Fio flexível com ímã e ponta rosqueada e Encaixe de mangueira hidráulica.
Material	Alumínio/Aço
Peso	49 g
Embalagem	50 peças
	19507



ALICATE CORTADOR CABO E CONDUÍTE

Característica	Alicate de corte
	Alicate para corte de cabos e conduítes de Bicicleta
Material	Aço - cabo emborrachado
Tamanho	200mm
Peso	326 g
Embalagem	50 peças
	19508

ALICATE TRAVA CORRENTE ZTTO

- Característica
- Alicate p/ instalação de emenda de corrente
 - Marca ztto
 - Acompanha ferramenta auxiliar para segurar os elos da corrente
 - Material aço
 - Compatível com emendas power link e missinglink

Material Aço

Peso +-45gr – peso ao par

Embalagem 50 unidades

23779



ALICATE DESTRAVA CORRENTE ZTTO

- Característica
- Alicate p/ extração de emenda de corrente
 - Marca ztto
 - Acompanha ferramenta auxiliar para segurar os elos da corrente
 - Material aço
 - Compatível com emendas power link e missinglink

Material Aço

Peso +-50gr – peso ao par

Embalagem 50 unidades

23780



EXTRATOR MOV CENTRAL INTEGRADO MOD. 01 PT ZTTO

- Característica
- Chave para extração mov. Central
 - Marca ztto
 - Material alumínio
 - Medidas 49mm/ 16 entalhes
 - Compatível com movimento press fit bb386evo

Material Alumínio

Peso • Peso +-48gr

Embalagem 50 unidades

23762



EXTRATOR MOV CENTRAL INTEGRADO MOD. 02 PT ZTTO

Característica	<ul style="list-style-type: none">• Chave para extração mov. Central• Marca ztto• Material alumínio• Medidas 48.5mm/ 12 entalhes• Compatível com movimento press fit bb386 (bsa30/ ita30)
Material	Alumínio
Peso	• Peso +-48gr
Embalagem	50 unidades 23763



EXTRATOR MOV CENTRAL INTEGRADO MOD. 03 PT ZTTO

Característica	<ul style="list-style-type: none">• Chave para extração mov. Central• Marca ztto• Material alumínio• Medidas 44mm/ 16 entalhes• Compatível com movimento bsa integrado (shimano / xtime)
Material	Alumínio
Peso	• Peso +-50gr
Embalagem	50 unidades 23764



EXTRATOR MOV CENTRAL INTEGRADO MOD. 04 PT ZTTO

Característica	<ul style="list-style-type: none">• Chave para extração mov. Central• Marca ztto• Material alumínio• Medidas 44mm/ 16 entalhes - 46mm/ 24 entalhes• Compatível com movimento bsa integrado (shimano / dub / xtime)
Material	Alumínio
Peso	+56gr - peso referente ao extrator de central e parafuso do eixo
Embalagem	50 unidades 23765



ADAPTADOR EXTRATOR MOV. CENTRAL BBT-1 PT ZTTO

- Característica
- Chave para extração mov. Central
 - Marca ztto
 - Funciona com chave auxiliar allen 10mm e/ou chave cachimbo 3/8 (não acompanham a ferramenta)
 - Material alumínio
 - Compatível com vários movimentos centrais

Material Aluminio

- Referência / compatibilidade:
- Sm-bb52 (hollowtech ii)
 - Sm-bbr60 (tl-fc25)
 - Sm-bb93 (tl-fc24)
 - Sr-dub
 - Mega bsa30 / bb386 evo

Peso +-94gr

Embalagem 50 unidades

23766



ADAPTADOR EXTRATOR MOV. CENTRAL BBT-2 PT ZTTO

- Característica
- Chave para extração mov. Central
 - Marca ztto
 - Funciona com chave auxiliar allen 10mm e/ou chave sextavada (não acompanham a ferramenta)
 - Material alumínio
 - Compatível com vários movimentos centrais

Material Aluminio

- Referência / compatibilidade:
- Sm-bb52 (hollowtech ii)
 - Sm-bbr60 (tl-fc25)
 - Sm-bb93 (tl-fc24)
 - Sr-dub
 - Mega bsa30 / bb386 evo

Peso +-96gr

Embalagem 50 unidades

23767



FERRAMENTA INSTALA E EXTRATO MOV CENTRAL ZTTO

- Característica
- Chave para extração mov. Central
 - Chave para extração coroa direct shimano (padrão center lock)
 - Marca ztto
 - Funciona com chave auxiliar ztto (código jpp 23764) e/ou chave sextavada (não acompanham a ferramenta)
 - Material alumínio
 - Compatível com movimentos centrais shimano m7100 / m8100 / m9100

Material Aluminio

Peso +-42gr

Embalagem 50 unidades

23773



CHAVE PRE-CARGA AJUSTE GARFO ALUM. MOD 01 ZTTO

Característica	<ul style="list-style-type: none">• Chave para reparo em suspensão ztto• Marca ztto• Material alumínio
Material	Alumínio
Referência / compatibilidade:	<ul style="list-style-type: none">• Instalação e extração do ajuste de preload• Ideal para manutenções em suspensões suntour e similares• Compatível com suspensões rst e suntour xct, xcm e xcr
Peso	+16gr
Embalagem	50 unidades
	23756



CHAVE PRE-CARGA AJUSTE GARFO ALUM. MOD 02 ZTTO

Característica	<ul style="list-style-type: none">• Chave para reparo em suspensão ztto• Marca ztto• Material alumínio
Material	Alumínio
Referência / compatibilidade:	<ul style="list-style-type: none">• Instalação e extração do ajuste de preload• Ideal para manutenções em suspensões suntour e similares• Compatível com suspensões rst e suntour xct, xcm e xcr
Peso	+20gr
Embalagem	50 unidades
	23757



FERRAMENTA DE INSTALAÇÃO DRIVER LIMPADOR ZTTO

Característica	<ul style="list-style-type: none">• Ferramenta para instalação de raspadores• Marca ztto• Material alumínio
Material	Alumínio
Referência / compatibilidade:	<ul style="list-style-type: none">• Ideal para manutenções em suspensões• Tamanhos disponíveis 32 à 34mm / 35 à 36mm / 38 à 40mm
Peso	+340gr - peso referente ao código 23758
Embalagem	20 unidades
Tamanho: 32 a 34	23758
Tamanho: 35 a 36	23759
Tamanho: 38 a 40	23760



FOTOS MERAMENTE ILUSTRATIVAS. AS INFORMAÇÕES/CONFIGURAÇÕES DE PRODUTOS PODERÃO SOFRER ALTERAÇÕES SEM AVISO PRÉVIO.

ENTRE EM CONTATO COM O SEU CONSULTOR OU FALE COM O NOSSO TIME DE TELEVENDAS PELO (33) 3277-3030.

FERRAMENTA DE INSTALAÇÃO DRIVER LIMPADOR PT ZTTO

Característica	<ul style="list-style-type: none">• Ferramenta para instalação de raspadores• Marca ztto• Material alumínio
Material	Alumínio
Referência / compatibilidade:	<ul style="list-style-type: none">• Ideal para manutenções em suspensões• Medidas 32, 34, 35 e 36mm
Peso	+/-72gr
Embalagem	50 unidades

23761



FERRAMENTA REMOVE ARANHA GARFO AHEAD ZTTO

Característica	<ul style="list-style-type: none">• Ferramenta remover aranha da espiga• Marca ztto• Material alumínio/aço
Material	Alumínio / Aço
Referência / compatibilidade:	<ul style="list-style-type: none">• Ideal para manutenções em suspensões• Comprimento 28.2mm• Diâmetro 18mm
Peso	+/-212gr
Embalagem	20 unidades

23774



CONJUNTO FERRAMENTAS EXTRATOR EIXO ROLAMENTO ZTTO

Característica	<ul style="list-style-type: none">• Ferramenta para instalação e remoção de rolamentos• Material em liga de Alumínio e aço• Compatível com Rolamentos 6000/ 6001/ 6900/ 6901/ 6902/ 6903 etc...• Kit 22 peças
Material	Alumínio / Aço
Box:	<ul style="list-style-type: none">• ADAPTADORES PARA INSTALAÇÃO DE ROLAMENTOS• ADAPTADORES PARA REMOÇÃO DE ROLAMENTOS• BARRA ROSQUEADA• CALÇOS
Peso	3.105 gr
Embalagem	5 unidades

23769



MALETA FERRAMENTAS MOV. CENTRAL PRESSFIT ZTTO

Característica	<ul style="list-style-type: none"> Ferramenta para instalação e remoção de movimento central padrão press fit Material em Liga de Alumínio e Aço Compatível com BB86/ BB30/ BB91/ BB92/ PF30, ETC... Kit com 14 peças
Material	Alumínio / Aço
Box	<ul style="list-style-type: none"> ALLEN 8MM ARRUELA Ø30 CILINDRO BB24/30 ENGATE 1 – 25X37 / 30X42MM ENGATE 2 – 22X37 / 30X42MM ENGATE 3 – 22X37 / 24X30MM PARAFUSO HEXAGONAL TAMPA DE REMOÇÃO HEXAGONAL TAMPA DE REMOÇÃO 52.5X59.3MM TAMPA DE REMOÇÃO 44.4X54.4MM 02 PUXADORES COM FENDA 01 PUXADOR INTEIRIÇO
Peso	968gr (peso referente a maleta completa)
Embalagem	5 unidades

23768



MOVIMENTO CENTRAL PRESS FIT BB86/92 ZTTO

Característica	<ul style="list-style-type: none"> Movimento central press fit BB86 Marca ztto Material alumínio Padrão Shimano Diâmetro Externo 41mm Diâmetro do Eixo 24mm Rolamentos de cerâmica Compatível BB 86/90/92 mm 41mm Ferramenta compatível 44mm/ 16 entalhes (referência catálogo JPP 23766/23767)
----------------	--

Material	Alumínio
Peso	92gr
Embalagem	20 unidades

23741



MOVIMENTO CENTRAL PRESS FIT BB386EVO ZTTO

Característica	<ul style="list-style-type: none"> Movimento central press fit BB386 Marca ztto Material alumínio Padrão DUB Diâmetro Externo 46mm Diâmetro do Eixo 28.9 mm Compatível 86 mm 46 mm Acompanha Arruelas calço Ferramenta compatível 49mm/ 16 entalhes (referência catálogo JPP 23766/23767)
----------------	--

Material	Alumínio
Peso	120gr (peso referênte ao movimento centrale aruelas calço)
Embalagem	20 unidades

23742



FOTOS MERAMENTE ILUSTRATIVAS. AS INFORMAÇÕES/CONFIGURAÇÕES DE PRODUTOS PODERÃO SOFRER ALTERAÇÕES SEM AVISO PRÉVIO.

ENTRE EM CONTATO COM O SEU CONSULTOR OU FALE COM O NOSSO TIME DE TELEVENDAS PELO (33) 3277-3030.

PAQUÍMENTO DIGITAL LCD 0 A 150MM ZTTO

Característica	<ul style="list-style-type: none"> • Paquímetro Digital • Marca ztto • Material nylon • Faixa de medição 0-150mm/0-6in • Resolução 0.1mm/ 0.01in • Precisão $\pm 0.2\text{mm}/ 0.01\text{in}$ • Display LCD • Bateria LR44 - Incluso no produto
Material	Nylon
Peso	+144gr (peso referênte ao paquímetro com case)
Embalagem	10 unidades
	23776



KIT ADAPTADOR BOOST DIANT/TRAS. C/ PARAFUSO ZTTO

Característica	<p>Kit Conversor BOOST (12x148 / 15x110)</p> <ul style="list-style-type: none"> • Kit adaptador ZTTO • Marca ztto • Material alumínio • Acompanha parafusos de fixação do disco
Kit	<ul style="list-style-type: none"> • 02 adaptadores de Eixo Traseiro (3x12mm) • 02 adaptadores de Eixo Dianteiro (5x15mm) • 01 espaçador de disco traseiro para 6 parafusos • 01 espaçador de disco dianteiro para 6 parafusos • 12 parafusos para fixação dos discos
Material	Alumínio
Peso	58gr (kit completo)
Embalagem	20 unidades
	23743



ADAPTADOR DE FREIO DISCO DIANT. 140/160MM ZTTO

Característica	<ul style="list-style-type: none"> • Kit adaptador para freio flat 160mm • Marca ztto • Material alumínio • Compatível com quadro com sistema de fixação flat • Conversor de 140mm para disco 160mm • Kit acompanha parafuso para fixação
Material	Alumínio
Peso	+34gr (peso referênte ao kit)
Embalagem	50 unidades
	23744



FOTOS MERAMENTE ILUSTRATIVAS. AS INFORMAÇÕES/CONFIGURAÇÕES DE PRODUTOS PODERÃO SOFRER ALTERAÇÕES SEM AVISO PRÉVIO.

ENTRE EM CONTATO COM O SEU CONSULTOR OU FALE COM O NOSSO TIME DE TELEVENDAS PELO (33) 3277-3030.

PASTILHA DE FREIO A DISCO SEMI-METALICA MDO. 01 ZTTO

Característica	<ul style="list-style-type: none">• Pastilha de freio a disco semi-metálica• Marca ztto• Material resina e aço• Compatível com freio SRAM e AVID (XO / XX / DB LEVEL/ TL LEVEL/ T LEVEL/ ELIXIR)
Material	Resina e Aço
Peso	+22gr (peso referênte ao PAR)
Embalagem	50 unidades
	23745



PASTILHA DE FREIO A DISCO FULL-METÁLICA MDO. 01 ZTTO

Característica	<ul style="list-style-type: none">• Pastilha de freio a disco metálica• Marca ztto• Material aço• Compatível com freio SRAM e AVID (XO / XX / DB LEVEL/ TL LEVEL/ T LEVEL/ ELIXIR)
Material	Aço
Peso	+24gr (peso referênte ao PAR)
Embalagem	50 unidades
	23746



PASTILHA DE FREIO A DISCO SEMI-METÁLICA MDO. 02 ZTTO

Característica	<ul style="list-style-type: none">• Pastilha de freio a disco semi-metálica• Marca ztto• Material resina e aço• Compatível com freio SHIMANO (M975 / M966 / M965 / M800 / M775 / M776 / M765 / M665 / M601 / M596 / M595 / M585 / M545 / M535 / R505 / S501 / S500 / T655 / T605)
Material	Resina e Aço
Peso	+22gr (peso referênte ao PAR)
Embalagem	50 unidades
	23747



PASTILHA DE FREIO A DISCO FULL-METALICA MDO. 02 ZTTO

Característica	<ul style="list-style-type: none">• Pastilha de freio a disco metálica• Marca ztto• Material aço• Compatível com freio SHIMANO (M975 / M966 / M965 / M800 / M775 / M776 / M765 / M665 / M601 / M596 / M595 / M585 / M545 / M535 / R505 / S501 / S500 / T655 / T605)
Material	Aço
Peso	+24gr (peso referênte ao PAR)
Embalagem	50 unidades
	23748



FOTOS MERAMENTE ILUSTRATIVAS. AS INFORMAÇÕES/CONFIGURAÇÕES DE PRODUTOS PODERÃO SOFRER ALTERAÇÕES SEM AVISO PRÉVIO.

ENTRE EM CONTATO COM O SEU CONSULTOR OU FALE COM O NOSSO TIME DE TELEVENDAS PELO (33) 3277-3030.

PASTILHA DE FREIO A DISCO SEMI-METÁLICA MDO. 03 ZTTO

Característica	<ul style="list-style-type: none">• Pastilha de freio a disco semi-metálica• Marca ztto• Material Resina e aço• Compatível com freio SHIMANO (M985 / M988 / M785 / M615 / M666 / M675 / XT / XTR / SLX)
Material	Resina e Aço
Peso	+24gr (peso referênte ao PAR)
Embalagem	50 unidades
	23749



PASTILHA DE FREIO A DISCO FULL-METÁLICA MDO. 03 ZTTO

Característica	<ul style="list-style-type: none">• Pastilha de freio a disco metálica• Marca ztto• Material aço• Compatível com freio SHIMANO (M985 / M988 / M785 / M615 / M666 / M675 / XT / XTR / SLX)
Material	Aço
Peso	+26gr (peso referênte ao PAR)
Embalagem	50 unidades
	23750



PASTILHA DE FREIO A DISCO SEMI-METÁLICA MDO. 04 ZTTO

Característica	<ul style="list-style-type: none">• Pastilha de freio a disco semi-metálica• Marca ztto• Material Resina e aço• Compatível com freio SHIMANO (M575 / M525 / M495 / M486 / M485 / M478 M465 / M447 / M446 / M445 / M416 / M415 / M4050 / M395 / M375 / M355 / M675 / M615)
Material	Resina e Aço
Peso	+26gr (peso referênte ao PAR)
Embalagem	50 unidades
	23751



PASTILHA DE FREIO A DISCO FULL-METÁLICA MDO. 04 ZTTO

Característica	<ul style="list-style-type: none">• Pastilha de freio a disco metálica• Marca ztto• Material aço• Compatível com freio SHIMANO (M575 / M525 / M495 / M486 / M485 / M478 M465 / M447 / M446 / M445 / M416 / M415 / M4050 / M395 / M375 / M355 / M675 / M615)
Material	Aço
Peso	+28gr (peso referênte ao PAR)
Embalagem	50 unidades
	23752



CONECTOR E OLIVA FREIO DISCO HID. MOD 01 ZTTO

Característica	<ul style="list-style-type: none"> • Kit Oliva e Pino ztto • Marca ztto • Material Cobre • Compatível com mangueira de disco SHIMANO BH90 • Pino +- 11.5mm de comprimento • Kit com 10 conjuntos de Oliva e Pino
Material	Cobre
Peso	+1gr (peso referente a um conjunto de Oliva e Pino)
Embalagem	50 unidades
	23753



CONECTOR E OLIVA FREIO DISCO HID. MOD 02 ZTTO

Característica	<ul style="list-style-type: none"> • Kit Oliva e Pino ztto • Marca ztto • Material Cobre • Compatível com mangueira de disco SHIMANO BH59 • Pino +- 13.5mm de comprimento • Kit com 10 conjuntos de Oliva e Pino
Material	Cobre
Peso	+1.2gr (peso referente a um conjunto de Oliva e Pino)
Embalagem	50 unidades
	23754



CHAVE TORQUE PRECISÃO 2NM A 24NM ZTTO

Característica	<ul style="list-style-type: none"> • Torquímetro de precisão • Marca ztto • Material Aço Cromo Vanádio • Comprimento 25.4mm • Especificação de torques 2-24nm • Precisão +-4%
Material	Aço Cromo Vanádio
Kit	<ul style="list-style-type: none"> • 1x1/4 chave de torque • 1 x adaptador de flor t25 • 1 x extensor adaptador haste (100mm) • 1 x adaptador t30 • 1x2.5mm adaptador sextavado • 1x3mm adaptador sextavado • 1x4mm adaptador sextavado • 1x5mm adaptador sextavado • 1x6mm adaptador sextavado • 1x8mm adaptador sextavado • 1x10mm adaptador sextavado • 1 x adaptador de cruz ph1 • 1 x adaptador de cruz ph2 • 1 x adaptador de cruz ph3 • 1 x adaptador t20
Peso	+ 792gr (Kit Completo Com Case)
Embalagem	10 unidades
	23775



FOTOS MERAMENTE ILUSTRATIVAS. AS INFORMAÇÕES/CONFIGURAÇÕES DE PRODUTOS PODERÃO SOFRER ALTERAÇÕES SEM AVISO PRÉVIO.

ENTRE EM CONTATO COM O SEU CONSULTOR OU FALE COM O NOSSO TIME DE TELEVENDAS PELO (33) 3277-3030.

FERRAMENTA UNIVERSAL EIXO P/TORNO TQJJ01 ZTTO

Característica	<ul style="list-style-type: none"> Mordente para morsa Marca ztto Material Alumínio Atração magnética para um melhor fixação na morsa Ideal para manutenção de cubos e eixos em geral Medidas (5 / 7.4 / 8 / 9 / 9.5 / 10 / 10.4 / 12 / 12.7 / 14 / 16MM)
Material	Alumínio
Peso	+138gr (peso referente ao conjunto com 2 peças)
Embalagem	25 unidades

23770



FERRAMENTA UNIVERSAL EIXO P/TORNO TQJJ02 ZTTO

Característica	<ul style="list-style-type: none"> Mordente para morsa Marca ztto Material Alumínio Atração magnética para um melhor fixação na morsa Ideal para manutenção de cubos, Shocks e eixos em geral Medidas(16.6 / 17 / 18 / 18.7 / 20 / 22.2 / 23.9MM)
Material	Alumínio
Peso	+172gr (peso referente ao conjunto com 2 peças)
Embalagem	25 unidades

23771



FERRAMENTA UNIVERSAL EIXO P/TORNO TQJJ03 ZTTO

Característica	<ul style="list-style-type: none"> Mordente para morsa Universal Marca ztto Material Alumínio Atração magnética para um melhor fixação na morsa Ideal para manutenção de cubos, Shocks e eixos em geral Medidas em mm (3 / 5 / 8 / 10 / 28.6) Medidas em polegadas (20-9 / 25-5 / 30-12 / 36-14)
Material	Alumínio
Peso	+212gr (peso referente ao conjunto com 2 peças)
Embalagem	25 unidades

23772



KIT FERRAMENTA DE REMOÇÃO DO GANCHO PISTÃO ZTTO

Característica	<ul style="list-style-type: none"> Pinça para remover o'rings Marca ztto Material Aço Ganchos com ângulos de 0° / 45° / 90° / 110° Comprimento +- 16cm Ideal para remover anéis o'rings e arruelas de pressão
Material	Aço
Peso	+90gr (peso referente ao kit com 4 peças)
Embalagem	25 unidades

23777



FOTOS MERAMENTE ILUSTRATIVAS. AS INFORMAÇÕES/CONFIGURAÇÕES DE PRODUTOS PODERÃO SOFRER ALTERAÇÕES SEM AVISO PRÉVIO.

ENTRE EM CONTATO COM O SEU CONSULTOR OU FALE COM O NOSSO TIME DE TELEVENDAS PELO (33) 3277-3030.





CORTADOR MANGUEIRA HIDRÁULICA

Característica	Kit Cortador de Mangueira e Instalador de Pino da Oliva
	Cortador de Mangueira de freio hidráulico de Nylon com Lâmina de aço e Instalador de Pino da Oliva durável de alta resistência, produzido em alumínio
Material	Cortador de Nylon/ Instalador de Pino da Oliva em Alumínio e aço
Tamanho	86x59x24mm - medidas extraídas com a ferramenta fechada
Peso	163 g
Embalagem	50 peças
	19509



CORTADOR DE TUBO AÇO

	Cortador de tubos
	Liga de aço de alta qualidade, usado para cortar espiga do garfo de bicicleta; guidão; canote; tanto em materiais de alumínio, quanto de aço ou produtos de titânio. compatível com tubo OD 6-42mm (AVISO: NÃO é indicado o uso em componentes de fibra de carbono)
Característica	
Material	Aço
Tamanho	150 x 60 mm
Peso	254 g
Embalagem	50 peças
	19510



ALINHADOR DE GANCHEIRA

Característica	Alinhador de Gancheira
	Corpo (barra) em aço ultraresistente com acabamento cromado; compatível com ajuste em quadros de bicicletas aro 20" a 29" (incl. 700c speed & híbridas); parafuso de inserção no quadro intercambiável; maior espaço entre a ferramenta e o quadro (parafuso de inserção mais comprido), o que a torna compatível com quadros mais modernos com eixos "passantes"
Material	Aço
Tamanho	400mm
Peso	775 g
Embalagem	50 peças
	19511

FOTOS MERAMENTE ILUSTRATIVAS. AS INFORMAÇÕES/CONFIGURAÇÕES DE PRODUTOS PODERÃO SOFRER ALTERAÇÕES SEM AVISO PRÉVIO.

ENTRE EM CONTATO COM O SEU CONSULTOR OU FALE COM O NOSSO TIME DE TELEVENDAS PELO (33) 3277-3030.



FERRAMENTA LIMPAR ROSCA PEDIVELA 9/16

Característica Macho limpador de rosca

Macho com rosca de 9/16 polegadas, Limpa e refaz rosca do braço do pedivela onde encaixa o pedal.
ATENÇÃO - Lado esquerdo (L): a ferramenta mais longa é para o lado esquerdo
ATENÇÃO - Lado direito (R): a ferramenta mais curta é para o lado direito

Material Aço

Tamanho 9/16-20hss / 9/16-20lhss

Peso 130 g

Embalagem 50 peças

19512



PROTETOR BRAÇO PEDIVELA PT

Característica Protetor de Pedivela

Protetor de braço do pedivela, excelente proteção contra impactos, incrívelmente leve, montagem rápida e fácil.

Material Borracha flexível (alta resistência)

Tamanho 43x33x18mm

Peso 15 g

Embalagem 50 peças

19513



GUIA CABO ADAPTADOR

Característica Guia para conduíte

Guia para conduítes e mangueira de freios

Material Alumínio/Plástico

Tamanho 20x20.6x0.3 mm

Peso 2 g

Embalagem 100 peças

19514





ABRAÇADEIRA PRENDEDOR CONDUITE PT

Característica	Abraçadeira rígida tipo "U" para prender conduíte
Material	Plástico
Tamanho	10.5X11.2X5.7mm
Peso	4 g
Embalagem	200 peças
	19515

PRENDEDOR CONDUITE DUPLO



Característica	Prendedor de Conduíte
	Prendedor de conduíte duplo compatível com cabos de 4 e 5mm, versátil, fácil instalação, gira 360°.
Material	Plástico rígido
Tamanho	20x7.65x5.4mm
Peso	0,05 g
Embalagem	200 peças
	19516

EIXO TRASEIRO BOOST 12X148MM



Característica	Eixo passante 12x148mm Boost
	Eixo traseiro Boost 12mm SEM bolcagem, eixo vazado, instalação com uso de chave allen 6mm, torque de aperto 9-13.5N-m
Material	Alumínio
Tamanho	comprimento total 171mm/ Diâmetro 12mm/ comprimento da rosca 19mm/ passo da Rosca 1.5 (M12 X P1.5)
Peso	39 g
Embalagem	50 peças
	19517

FOTOS MERAMENTE ILUSTRATIVAS. AS INFORMAÇÕES/CONFIGURAÇÕES DE PRODUTOS PODERÃO SOFRER ALTERAÇÕES SEM AVISO PRÉVIO.

ENTRE EM CONTATO COM O SEU CONSULTOR OU FALE COM O NOSSO TIME DE TELEVENDAS PELO (33) 3277-3030.



EIXO DIANTEIRO BOOST 15X110MM

Característica	Eixo passante 15x110mm Boost
	Eixo dianteiro Boost 15mm, OLD 110mm, SEM bolcagem, eixo vazado, instalação com uso de chave allen 6mm, torque de aperto 9-13.5N-m/ 80-120in-lbs
Material	Alumínio
Tamanho	Comprimento total 155mm/ Diâmetro 15mm/ comprimento da rosca 13mm/ passo da Rosca 1.5 (M14 X P1.5)
Peso	56 g
Embalagem	50 peças
	19518



EIXO BLOCAGEM TRASEIRO BOOST 12X148MM

Característica	Eixo passante 12x148mm Boost
	Eixo traseiro Boost 12mm COM bolcagem vazado, instalação por Blocagem/ Alavanca com regulagem de posição.
Material	Alumínio
Tamanho	comprimento total 171mm/ Diâmetro 12mm/ comprimento da rosca 19mm/ passo da Rosca 1.5 (M12 X P1.5)
Peso	58 g
Embalagem	50 peças
	19521



FITA ANTIFURO 29"

Característica	Fita antifuro 29"
	Fita antifuro de alta resistência compatível com aros 26" / 27.5" / 29" e 700c. Diâmetro de pneus 1.5" à 2.10"
Material	Compostos de polímero de poliuretano
Tamanho	0.5 x 40mm
Peso	110 g
Embalagem	50 peças
	19523





FITA POLIPROPILENO ARO TUBELESS 10 MTX23MM MTB

Característica	Fita de vedação para aro Tubeless Fita adesiva de Polipropileno de alta resistência para vedação de aros tubeless.
Material	Polipropileno
Tamanho	10 mt x 23 mm
Peso	45 g
Embalagem	50 peças
	19525



FITA POLIPROPILENO ARO TUBELESS 10 MTX29MM MTB

Característica	Fita de vedação para aro Tubeless Fita adesiva de Polipropileno de alta resistência para vedação de aros tubeless.
Material	Polipropileno
Tamanho	10 mt x 29 mm
Peso	54 g
Embalagem	50 peças
	19526



FITA POLIPROPILENO ARO TUBELESS 10 MTX33MM MTB

Característica	Fita de vedação para aro Tubeless Fita adesiva de Polipropileno de alta resistência para vedação de aros tubeless.
Material	Polipropileno
Tamanho	10 mt x 33 mm
Peso	60 g
Embalagem	50 peças
	19527

FOTOS MERAMENTE ILUSTRATIVAS. AS INFORMAÇÕES/CONFIGURAÇÕES DE PRODUTOS PODERÃO SOFRER ALTERAÇÕES SEM AVISO PRÉVIO.

ENTRE EM CONTATO COM O SEU CONSULTOR OU FALE COM O NOSSO TIME DE TELEVENDAS PELO (33) 3277-3030.





TAMPA VÁLVULA PRESTA PT

Característica	Tampa de válvula presta
Material	Alumínio
Tamanho	16x7mm
Peso	2 g
Embalagem	50 peças

19528



INJETOR SELANTE

Característica	Injetor de selante 60ml - Seringa
Material	Plástico/Borracha
Tamanho	151.5x31.3mm
Peso	35 g
Embalagem	50 peças

19529



ADESIVO PROTETOR QUADRO

Característica	Adesivo protetor de quadro
Material	PVC FLEXÍVEL de 500 microns
Peso	84 g
Embalagem	50 peças

19530

FOTOS MERAMENTE ILUSTRATIVAS. AS INFORMAÇÕES/CONFIGURAÇÕES DE PRODUTOS PODERÃO SOFRER ALTERAÇÕES SEM AVISO PRÉVIO.

ENTRE EM CONTATO COM O SEU CONSULTOR OU FALE COM O NOSSO TIME DE TELEVENDAS PELO (33) 3277-3030.





ABRAÇADEIRA CÂMBIO DIANTEIRO

Característica Abraçadeira de câmbio

Adaptador de câmbio dianteiro suspenso de 34,9mm. Abraçadeira feita exclusivamente para câmbios dianteiros braze-on, ou câmbios que não possuem abraçadeiras.

Material Alumínio

Tamanho 61x12mm

Peso 21 g

Embalagem 50 peças

19548



SUPORTE ADAPTADOR GPS MODELO 01

Característica Suporte adaptador para GPS, câmera ou lanterna.

Versátil e com várias possibilidades de regulagem. Pode ser instalado em guidões com diâmetro de 31,8 mm ou 25,4 mm.

Material Liga de alumínio CNC

Tamanho 115 mm x 54 mm

Peso 70 g

Embalagem 50 peças

19531



SUPORTE ADAPTADOR GPS MODELO 02

Característica Suporte adaptador para GPS, câmera ou lanterna.

Versátil e com várias possibilidades de regulagem. Pode ser instalado em guidões com diâmetro de 31,8 mm ou 25,4 mm.

Material Liga de alumínio CNC

Tamanho 128 mm x 55 mm

Peso 75 g

Embalagem 50 peças

19533



SUPORTE ADAPTADOR GPS MODELO 03

Característica	Suporte adaptador para GPS, câmera ou lanterna.
	Versátil e com várias possibilidades de regulagem.
Material	Liga de alumínio CNC
Tamanho	167 mm x 37 mm
Peso	85 g
Embalagem	50 peças
	19535



SUPORTE ADAPTADOR GPS MODELO 04

Característica	Suporte adaptador para GPS
	Adaptador Universal Para Montagem GARMIN - Fixado com fita dupla face 3M
Material	Plástico
Tamanho	40x40mm
Peso	10 g
Embalagem	50 peças
	19536



SUPORTE CO2 PT

Característica	Suporte para CO2
Material	Alumínio 6067 T6
Tamanho	83X72mm - Distância dos furos, aproximadamente 64mm
Peso	21 g
Embalagem	50 peças
	19543





ADAPTADOR SUPORTE CARAMANHOLA DUPLO PT

Característica	Suporte Duplo para caramanhola
Material	Alumínio
Tamanho	75.8X32.6X3.3mm - Distância dos furos, aproximadamente 64mm
Peso	18 g
Embalagem	50 peças

19544



TENSIONADOR DE CORRENTE PT

Característica	Tensionador de corrente
	Tensionador de corrente de bicicleta de velocidade única, equipado com roldana de alumínio com rolamento. Compatível com COG's de 13-23T
Material	Alumínio
Tamanho	110X24.5X10mm
Peso	62 g
Embalagem	50 peças

19545

FOTOS MERAMENTE ILUSTRATIVAS. AS INFORMAÇÕES/CONFIGURAÇÕES DE PRODUTOS PODERÃO SOFRER ALTERAÇÕES SEM AVISO PRÉVIO.

ENTRE EM CONTATO COM O SEU CONSULTOR OU FALE COM O NOSSO TIME DE TELEVENDAS PELO (33) 3277-3030.



ROLDANA DE CÂMBIO 12T

Característica	Roldana de câmbio 12T Liga de alumínio de alta resistência Rolamento de cerâmica Polia Jockey Wheel
Material	Liga de alumínio CNC 7075
Tamanho	50 mm x 3 mm - Suporte do rolamento 10mm
Peso	8 g
Embalagem	50 peças
	19546



ROLDANA DE CÂMBIO 13T

Característica	Roldana de câmbio 13T Liga de alumínio de alta resistência Rolamento de cerâmica Polia Jockey Wheel
Material	Liga de alumínio CNC 7075
Tamanho	51 mm x 1,7 mm - Suporte do rolamento 9,6 mm
Peso	9 g
Embalagem	50 peças
	19547



REPARO APERTO CASSETE 11V - ZTTO

Característica	Porca de aperto do cassete ztto Alumínio 7075 Cor grafite Compatível com cog de 11 dentes Padrão do free hub standard Aperto máximo de 40nm
Material	Alumínio
Peso	7 g
Embalagem	100 peças
	19494





A vida pede liberdade

PRÓBIKE



BOLSA DE SELIM VELO



BOLSA DE SELIM M2



BOLSA DE SELIM BIKE PRÓ

MARCA	Próbike
CARACTERÍSTICA	Expansível Confeccionada em Nylon de alta performance Estruturada com plástico rígido de 2 mm Zíperes invisíveis de qualidade A prova d'água Faixa e logo refletiva 3M Fixação central por fitas e fivelas de nylon Fixação por velcros no canote do selim Abertura de 180% Bolso telado interno para ferramentas Fita frontal para luz estroboscópica
TAMANHO	L: 0,110mm x A: 0,140mm x P: 0,170mm (Medidas após expandida: L: 0,110mm x A: 0,140mm x P: 0,210mm)
EMBALAGEM	30 peças
	20061

MARCA	Próbike
CARACTERÍSTICA	Confeccionada em exclusivo tecido emborrachado Resistente a água Zíperes invisíveis de qualidade Logo refletiva 3M Fixação central por fitas e fivelas de nylon Fixação por fitas de contato no canote do selim Abertura de 180%
CAPACIDADE	0,280 litros
PESO	102g (informado pelo fabricante)
TAMANHO	L: 120mm x A: 95mm x P: 150mm
EMBALAGEM	30 peças
	20063

MARCA	Próbike
CARACTERÍSTICA	Confeccionada em nylon ripstop de alta performance Revestimento inferior emborrachado (Resistente a água) Zíper invisível de alta qualidade Logo e fita refletiva 3M Fixação dupla por fitas de aderência e fivelas de nylon Fixação no canote do selim Fita frontal para luz estroboscópica
CAPACIDADE	0,220 litros
PESO	78g (informado pelo fabricante)
TAMANHO	L: 60mm x A: 70mm x P: 140mm
EMBALAGEM	30 peças
	20074

FOTOS MERAMENTE ILUSTRATIVAS. AS INFORMAÇÕES/CONFIGURAÇÕES DE PRODUTOS PODERÃO SOFRER ALTERAÇÕES SEM AVISO PRÉVIO.

ENTRE EM CONTATO COM O SEU CONSULTOR OU FALE COM O NOSSO TIME DE TELEVENDAS PELO (33) 3277-3030.



BOLSA DE SELIM MOUNTAIN

MARCA	Próbike
CARACTERÍSTICA	Expansível Confeccionada em nylon de alta performance Exclusivo zíper impermeável com cursor duplo invertido Estruturada com plástico rígido de 2 mm A prova d'água Faixa e logo refletiva 3M Fixação central por fitas e fivelas de nylon Fixação por fita de contato de alta aderência no canote do selim Abertura de 90% Bolso telado interno para ferramentas Fita frontal para luz estroboscópica.
TAMANHO	L: 90mm x A: 110mm x P: 150mm
EMBALAGEM	30 peças
	20090



BOLSA DE SELIM SQUEEZE

MARCA	Próbike
CARACTERÍSTICA	Confeccionada em nylon de alta performance Exclusivo zíper com cursor duplo invertido Estruturada com plástico rígido de 2 mm A prova d'água Desenho exclusivo com material em fibra de carbono Logo refletiva 3M frontal Fixação central por fitas de contato por alta aderência Fixação por fita de contato de alta aderência no canote do selim Bolso interno para ferramentas Fita frontal para luz estroboscópica
CAPACIDADE	1,200 litros
PESO	210g (informado pelo fabricante)
TAMANHO	L: 105mm x A: 240mm x P: 96mm
EMBALAGEM	30 peças
	20097



BOLSA DE GUIDÃO PARA CELULAR

MARCA	Próbike
CARACTERÍSTICA	Confeccionada em Nylon de alta performance Compartimento de grande capacidade Estruturada em espuma acrílica de 6 mm Toda forrada e acolchoada Sistema de fixação por fita de contato de alta aderência Tampa com exclusivo material touch-screen Fechamento por zíper invisível e duplo cursor
CAPACIDADE	0,900 litros
PESO	138g (informado pelo fabricante)
TAMANHO	L: 120 mm x P: 180 mm x A: 90 mm
EMBALAGEM	50 peças
	20065



BOLSA DE QUADRO PARA CELULAR UNIVERSAL

MARCA	Próbike
CARACTERÍSTICA	Confeccionada em Nylon de alta performance Compartimento principal de grande capacidade Estruturada em espuma acrílica de 6 mm Toda forrada e acolchoada Pequeno bolso interno telado Sistema de fixação com fitas A prova d'água Faixas laterais e logo refletivas 3M Tampa com exclusivo material touch-screen Fechamento por zíper invisível e duplo cursor
EMBALAGEM	50 peças
	20079



BRACELETE PARA CELULAR

MARCA	Próbike
CARACTERÍSTICA	Touch screen Fabricado em material super flexível Confortável e leve Pode ser usado em qualquer um dos braços
EMBALAGEM	50 peças
	20076



BOLSA DE CELULAR PARA STRAVA

MARCA	Próbike
CARACTERÍSTICA	Confeccionada em exclusivo material Plush Painel Touch Screen Compatível com todas as mesas Sistema de fixação por exclusivo fita de contato de alta aderência elástico Segura e de fácil instalação Moldada totalmente ao celular substituindo um suporte Proteção segura contra o pó e chuva fina Espuma traseira para proteger o celular dos choques
TAMANHO	L: 90mm x A: 170mm x P: 5mm
EMBALAGEM	50 peças
	20092

FOTOS MERAMENTE ILUSTRATIVAS. AS INFORMAÇÕES/CONFIGURAÇÕES DE PRODUTOS PODERÃO SOFRER ALTERAÇÕES SEM AVISO PRÉVIO.

ENTRE EM CONTATO COM O SEU CONSULTOR OU FALE COM O NOSSO TIME DE TELEVENDAS PELO (33) 3277-3030.



MALA BIKE ARO 29"

MARCA	Próbike
CARACTERÍSTICA	Possui 3 divisões internas para as rodas e quadro Confeccionada em nylon de alta resistência Fundo removível em E.V.A. de 4 mm para maior proteção A prova d'água Fechamento por zíperes de alta qualidade Reforço interno em velcro nas divisórias Acompanha bolsa/mochila para transporte Alças de mão e tiracolo
TAMANHO	L: 1.600mm x A: 900mm x 300mm
EMBALAGEM	1 peça

20077



FITA WRAP VELCRO PARA CAMARA DE AR

MARCA	Próbike
CARACTERÍSTICA	Confeccionada em Fita Nylon de alta performance Estruturada com plástico rígido de 2 mm Fita de contato de alta aderência de alta de qualidade Logo refletiva 3M Fixação central por fitas e fivelas de nylon Suporte extra em elásticos para maior segurança Não acompanha a camara e a bomba
TAMANHO	L: 50mm x A: 50mm x P: 430mm
EMBALAGEM	10 peças

20094



PROTECTOR DE QUADRO CONVENCIONAL

MARCA	Próbike
CARACTERÍSTICA	Confeccionado material emborrachado de alta densidade Desenho em alto relevo para maior durabilidade Fixado com exclusiva fita dupla face de alta aderência Acompanha o desenho do quadro Tamanho universal Não desgasta os quadros de carbono Lavável Fechamento por tirantes plásticos (acompanha o produto) O mais leve do mercado Sistema de instalação rápida
EMBALAGEM	50 peças

20072



PROTECTOR DE QUADRO ARO 29

MARCA	Próbike
CARACTERÍSTICA	Confeccionado em exclusivo material de alta densidade Estampa em silk de alta densidade lavável Fechamento por fita de contato de alta aderência Costura em zig-zag para maior durabilidade Sistema de instalação rápida Acompanha embalagem exclusiva
EMBALAGEM	50 peças

20073



PROTECTOR DE QUADRO ELITE



MARCA	Próbike
CARACTERÍSTICA	Confeccionado material emborrachado de alta densidade Desenho em alto relevo para maior durabilidade Fixado com exclusiva fita dupla face de alta aderência Acompanha o desenho do quadro Tamanho universal Não desgasta os quadros de carbono Lavável Fechamento por 3 tirantes plásticos (acompanha o produto) O mais leve do mercado Sistema de instalação rápida Pode ser re-utilizado várias vezes
EMBALAGEM	50 peças
	20091

Grupo pbk



COLETE REFLETIVO

MARCA	Próbike
CARACTERÍSTICA	Visibilidade de 1,5 km Bolso na parte traseira (1) Confeccionado em Tecido Mesh super ventilada Leve e prática Tamanho único
TAMAMHO	L: 340mm x A: 430mm
EMBALAGEM	10 peças

20067



COLETE CORTA VENTO REFLETIVO

MARCA	Próbike
CARACTERÍSTICA	Confeccionado em NY70 com hidropelente TelaMesh super ventilada na parte traseira 3 bolsos na parte traseira Refletivos com visibilidade de 1 km Zíper de alta qualidade Elástico no barrado
EMBALAGEM	10 peças

P 20068
M 20069
G 20070
GG 20071



Colete Refletivo Night Race

MARCA	Próbike
CARACTERÍSTICA	Confeccionado em elastano e refletivo 3M Visibilidade de 3 km leve e prático Tamanho único Elásticos de fixação lateral
EMBALAGEM	10 peças

20075

Grupo

p

blk[®]

A vida pede liberdade

MADE IN BRASIL



BOLSA DE SELIM AERO BIG

MARCA Made in Brasil

CARACTERÍSTICA Confeccionada em Nylon 600D | Fxação central por fitas e fivelas de nylon | Nova fixação por fita de contato no canote do selim | Fita para fixação de lanterna | Abertura por zíper

CAPACIDADE 0,980 litros

PESO 83g (informado pelo fabricante)

TAMANHO L: 110mm x A: 100mm x P: 170mm

EMBALAGEM 30 peças

20096



BOLSA DE SELIM M1

MARCA Made in Brasil

CARACTERÍSTICA Confeccionada em Nylon 600D | Detalhe refletivo na fita frontal e na logo | Nova fixação central por fitas e fivelas de nylon | Nova fixação por fita de fixação por contato no canote do selim | Estruturada com plástico rígido de 2 mm | Fita frontal para luz estroboscópica | Abertura por zíper

CAPACIDADE 0,280 litros

PESO 113g (informado pelo fabricante)

TAMANHO L: 85mm x A: 90mm x P: 120mm

EMBALAGEM 30 peças

20078



BOLSA DE QUADRO PARA CELULAR GRANDE

MARCA Made in Brasil

CARACTERÍSTICA Confeccionada em Poliéster 600D | Compartimento principal de grande capacidade | Sistema de fixação com fitas de contato de alta aderência | Resistente a água | Tampa com exclusivo material touch-screen | Fechamento por zíperes | Painel Toothscreen | Saída para fone de ouvido

CAPACIDADE 0,980 litros

EMBALAGEM 50 peças

20064

Grupo
pblk

FOTOS MERAMENTE ILUSTRATIVAS. AS INFORMAÇÕES/CONFIGURAÇÕES DE PRODUTOS PODERÃO SOFRER ALTERAÇÕES SEM AVISO PRÉVIO.

ENTRE EM CONTATO COM O SEU CONSULTOR OU FALE COM O NOSSO TIME DE TELEVENDAS PELO (33) 3277-3030.



BOLSA DE SELIM COMBAT

MARCA	Made in Brasil
CARACTERÍSTICA	Confeccionada em nylon de alta performance Revestimento inferior emborrachado Resistente a água Zíper invisível de alta qualidade Fixação central por fita de aderência e fivela de nylon Fixação no canote do selim Fita frontal para luz estroboscópica
CAPACIDADE	0,320 litros
TAMANHO	L: 65mm x A: 70mm x P: 150mm
EMBALAGEM	30 peças

20082

20083

20084

20085



BOLSA DE SELIM COMBAT PLUS

MARCA	Made in Brasil
CARACTERÍSTICA	Confeccionada em nylon ripstop de alta performance Revestimento inferior emborrachado Resistente a água Zíper invisível de alta qualidade Logo refletiva 3M Fixação central por fita e fivela de nylon Fixação no canote do selim Fita frontal para luz estroboscópica
CAPACIDADE	0,430 litros
TAMANHO	L: 80mm x A: 90mm x P: 160mm
EMBALAGEM	30 peças

20086

20087

20088

20089

Grupo
pblk[®]
 A vida pede liberdade

HIDRAT-PRÓ



**REFIL/RESERVATÓRIO
 BIPARTIDO 1,2 LITROS**



**REFIL/RESERVATÓRIO
 BIPARTIDO 2,5 LITROS**



**BICO DE SUÇÃO DE
 SILICONE**



MARCA Hydrat Pró

CARACTERÍSTICA Confeccionado em composto atóxico de extrema resistência | Muito mais qualidade pelo menor preço | É compatível com todas as mochilas de hidratação do mercado | Inodoro. Não altera o sabor dos líquidos | BPA Free - Material não tóxico | Bico dosador duplo anti-respingo siliconado | Mangueira dupla siliconada de 90cm atóxica de 9,3mm | Torneira dupla abre-fecha muito mais segura | Sistema deslizante que facilita a limpeza e abastecimento | Reservatório de 1 litro de um lado e 200ml do outro

TAMANHO 31 x 18 cm

EMBALAGEM 25 peças

20080

MARCA Hydrat Pró

CARACTERÍSTICA Confeccionado em material atóxico de extrema resistência | Muito mais qualidade pelo menor preço | É compatível com todas as mochilas de hidratação do mercado | Inodoro. Não altera o sabor dos líquidos | BPA Free | Material não tóxico | Novo Bico dosador anti-respingo em silicone | Mangueira dupla siliconada de 95cm atóxica de 9,3mm | Torneira dupla abre-fecha muito mais segura | Sistema deslizante que facilita a limpeza e abastecimento | Reservatório de 2,5 litros de capacidade total podendo ser bipartido em qualquer capacidade

TAMANHO 41 x 18 cm

EMBALAGEM 25 peças

20081

MARCA Hydrat Pró

CARACTERÍSTICA BPA free | Confeccionada em Silicone ultra macio, inodoro e atóxico | Embalada assepticamente | Encaixa em qualquer reservatório | Fácil de limpar | Rápida liberação de água | Processo de fabricação com sistema de gestão da qualidade de acordo com RDC-59

EMBALAGEM 100 peças

20095

FOTOS MERAMENTE ILUSTRATIVAS. AS INFORMAÇÕES/CONFIGURAÇÕES DE PRODUTOS PODERÃO SOFRER ALTERAÇÕES SEM AVISO PRÉVIO.

ENTRE EM CONTATO COM O SEU CONSULTOR OU FALE COM O NOSSO TIME DE TELEVENDAS PELO (33) 3277-3030.

SR

SELLE ROYAL



CYCLE THE WORLD IN COMFORT



DESCANSO LATERAL A20 ZINCADO

Material	Aço
Medida	0,019m ³
Tamanho	270mmx11mmx18mm
Peso	155g
Embalagem	120 peças

20705



DESCANSO LATERAL A20 ZINCADO PARA CAMBIO

Material	Aço
Medida	0,019m ³
Tamanho	270mmx11mmx18mm
Peso	149g
Embalagem	120 peças

20708



PEDAL BICOLOR EXPORT 9/16 S/ESF - CINZA

Característica	BICICLETAS A24 a A29, MTB E PASSEIO. Os pedais METALCICLO possuem a Base injetada em PP copolímero, refletores de poliestireno e eixo conformado com arame de aço.
Material	Copolímero
Medida	0,028m ³
Tamanho	96mmx30mmx70mm
Peso	161,60g
Embalagem	44 peças

20709

SR

SELLE ROYAL



PEDAL FREESTYLE PP 1/2 S/ESF - PRETO

Característica	BICICLETAS A24 a A29, MTB E PASSEIO. Os pedais METALCICLO possuem a Base injetada em PP copolímero, refletores de poliestireno e eixo conformado com arame de aço.
Material	Copolímero
Medida	0,028m³
Tamanho	98mmx25mmx89mm
Peso	149,50g
Embalagem	30 peças

20710



PEDAL FREESTYLE PP 9/16 S/ESF - PRETO

Característica	BICICLETAS A24 a A29, MTB E PASSEIO. Os pedais METALCICLO possuem a Base injetada em PP copolímero, refletores de poliestireno e eixo conformado com arame de aço.
Material	Copolímero
Medida	0,028m³
Tamanho	98mmx25mmx88,5mm
Peso	156,20g
Embalagem	30 peças

20711



PEDAL MTB 1/2 S/ESF - PRETO

Característica	BICICLETAS A24 a A29, MTB E PASSEIO. Os pedais METALCICLO possuem a Base injetada em PP copolímero, refletores de poliestireno e eixo conformado com arame de aço.
Material	Copolímero
Medida	0,028m³
Tamanho	98mmx25mmx75mm
Peso	130g
Embalagem	40 peças

20712

FOTOS MERAMENTE ILUSTRATIVAS. AS INFORMAÇÕES/CONFIGURAÇÕES DE PRODUTOS PODERÃO SOFRER ALTERAÇÕES SEM AVISO PRÉVIO.

ENTRE EM CONTATO COM O SEU CONSULTOR OU FALE COM O NOSSO TIME DE TELEVENDAS PELO (33) 3277-3030.



PEDAL BICOLOR EXPORT 9/16 S/ESF - VERMELHO

Característica	BICICLETAS A24 a A29, MTB E PASSEIO. Os pedais METALCICLO possuem a Base injetada em PP copolímero, refletores de poliestireno e eixo conformado com arame de aço.
Material	Copolímero
Medida	0,028m³
Tamanho	98mmx30mmx72mm
Peso	161,60g
Embalagem	44 peças

20713



PEDAL BICOLOR EXPORT 1/2 S/ESF - PRETO

Característica	BICICLETAS A24 a A29, MTB E PASSEIO. Os pedais METALCICLO possuem a Base injetada em PP copolímero, refletores de poliestireno e eixo conformado com arame de aço.
Material	Copolímero
Medida	0,028m³
Tamanho	98mmx30mmx72mm
Peso	158g
Embalagem	44 peças

20714



PEDAL FREE SPORT 9/16 S/ESF

Característica	BICICLETAS A24 a A29, MTB E PASSEIO. Design moderno, perfil fino e base larga. Super resistente. Com cravos maiores que ajudam na aderência. O pedal plataforma FREE SPORT é a resposta certa para seus desafios.
Material	Copolímero
Medida	0,028m³
Tamanho	95mmx21mmx101mm
Peso	290,66g
Embalagem	30 peças

20715

SR

SELLE ROYAL



PEDAL FREESTYLE PP 1/2 S/ESF - PRETO

Característica	Design moderno, perfil fino e base larga 93x102x27, super resistente! Com cravos maiores que ajudam na aderência, o novo pedal plataforma FREE SPORT é a resposta certa para seus desafios.
Material	Copolímero
Medida	0,028m³
Tamanho	95mmx21mmx101mm
Peso	290g
Embalagem	30 peças

20716



PEDAL MIRIM 1/2 S/ESF PRETO

Característica	BICICLETAS A16 a A20, INFANTO JUVENIL. Os pedais METALCICLO possuem a Base injetada em PP copolímero, refletores de poliestireno e eixo conformado com arame de aço.
Material	Copolímero
Medida	0,028m³
Tamanho	83mmx21mmx61,5mm
Peso	230g
Embalagem	60 peças

20722



PEDAL MOUNTAIN BARRA 1/2 S/ESF - PRETO

Característica	BICICLETAS A24 a A29, MTB E PASSEIO. Os pedais METALCICLO possuem a Base injetada em PP copolímero, refletores de poliestireno e eixo conformado com arame de aço.
Material	Copolímero
Medida	0,028m³
Tamanho	96mmx24mmx68mm
Peso	123,60g
Embalagem	48 peças

20724

FOTOS MERAMENTE ILUSTRATIVAS. AS INFORMAÇÕES/CONFIGURAÇÕES DE PRODUTOS PODERÃO SOFRER ALTERAÇÕES SEM AVISO PRÉVIO.

ENTRE EM CONTATO COM O SEU CONSULTOR OU FALE COM O NOSSO TIME DE TELEVENDAS PELO (33) 3277-3030.

SR

SELLE ROYAL



PEDAL MTB 9/16 S/ESF - PRETO

Característica	BICICLETAS A24 a A29, MTB E PASSEIO. Os pedais METALCICLO possuem a Base injetada em PP copolímero, refletores de poliestireno e eixo conformado com arame de aço.
Material	Copolímero
Medida	0,028m ³
Tamanho	98mmx25mmx75mm
Peso	132g
Embalagem	40 peças

20725



PEDAL MTB FASHION 9/16 S/ESF - PRETO

Característica	BICICLETAS A24 a A29, MTB E PASSEIO. Os pedais METALCICLO possuem a Base injetada em PP copolímero, refletores de poliestireno e eixo conformado com arame de aço.
Material	Copolímero
Medida	0,028m ³
Tamanho	98mmx26mmx75mm
Peso	129,82g
Embalagem	44 peças

20726



PEDAL TREKKING 9/16 S/ESF

Característica	BICICLETAS A24 a A29, MTB E PASSEIO. Os pedais METALCICLO possuem a Base injetada em PP copolímero, refletores de poliestireno e eixo conformado com arame de aço.
Material	Copolímero
Medida	0,028m ³
Tamanho	98mmx20mmx78mm
Peso	145,68g
Embalagem	44 peças

20728

FOTOS MERAMENTE ILUSTRATIVAS. AS INFORMAÇÕES/CONFIGURAÇÕES DE PRODUTOS PODERÃO SOFRER ALTERAÇÕES SEM AVISO PRÉVIO.

ENTRE EM CONTATO COM O SEU CONSULTOR OU FALE COM O NOSSO TIME DE TELEVENDAS PELO (33) 3277-3030.



SELLE ROYAL



PEDIVELA MONOBLOCO 115MM CROMADO

Característica	Com qualidade e tradição que você já conhece, a Pedivela Metalciclo possui um pino de arraste projetado para resistir a fadiga. Seu perfil plano faz com que o material fique simétrico e mais resistente, revestido com o mais moderno processo de cromo Trivalente, tornando todo o processo ecologicamente correto.
Material	Arame e Aço
Medida	0,009m ³
Tamanho	115mmx13mmx140mm
Peso	0,669g
Embalagem	20 peças

20729



PEDIVELA MONOBLOCO 140MM CROMADO

Característica	Com qualidade e tradição que você já conhece, a Pedivela Metalciclo possui um pino de arraste projetado para resistir a fadiga. Seu perfil plano faz com que o material fique simétrico e mais resistente, revestido com o mais moderno processo de cromo Trivalente, tornando todo o processo ecologicamente correto.
Material	Arame e Aço
Medida	0,011m ³
Tamanho	140mmx13mmx140mm
Peso	0,745g
Embalagem	20 peças

20730



PEDIVELA MONOBLOCO 165MM CROMADO

Característica	Com qualidade e tradição que você já conhece, o Pedivela Metalciclo possui um pino de arraste projetado para aguentar a fadiga. Seu perfil plano faz com que o material fique simétrico e mais resistente, revestido com o mais moderno processo de cromo Trivalente, tornando todo o processo ecologicamente correto.
Material	Arame e Aço
Medida	0,012m ³
Tamanho	165mmx13mmx140mm
Peso	0,85g
Embalagem	20 peças

20731

FOTOS MERAMENTE ILUSTRATIVAS. AS INFORMAÇÕES/CONFIGURAÇÕES DE PRODUTOS PODERÃO SOFRER ALTERAÇÕES SEM AVISO PRÉVIO.

ENTRE EM CONTATO COM O SEU CONSULTOR OU FALE COM O NOSSO TIME DE TELEVENDAS PELO (33) 3277-3030.

SR

SELLE ROYAL



SELIM SELLE ROYAL NEW CITY GEL

Característica	Trilhos em aço. Sistema de amortecimento: Elastômero Base em polipropileno extremamente resistente, espuma expandida, Royal Gel e cobertura de laminado de pvc. Bike de passeio e urbanas ciclistas que buscam conforto.
Material	Royalgel
Medida	0,081m³
Tamanho	252mmx114mmx195mm
Peso	771g
Embalagem	15 peças

20732



SELIM SELLE ROYAL NEW MOLISE PASSEIO GEL

Característica	Trilhos em aço. Base em polipropileno extremamente resistente, espuma expandida, Royal Gel e cobertura de laminado de pvc. Bike de passeio e urbanas ciclistas que buscam conforto.
Material	Royalgel
Medida	0,081m³
Tamanho	252mmx81mmx204mm
Peso	542g
Embalagem	15 peças

20734



SELIM SELLE ROYAL NEW VIALE GEL COM MOLA

Característica	Trilhos em aço. 2 molas acopladas ao trilho para absorção de impacto. Base em polipropileno extremamente resistente, espuma expandida, Royal Gel e cobertura de laminado de pvc. Bike de passeio e urbanas ciclistas que buscam conforto.
Material	Royalgel
Medida	0,081m³
Tamanho	274mmx108mmx175mm
Peso	633g
Embalagem	15 peças

20737

FOTOS MERAMENTE ILUSTRATIVAS. AS INFORMAÇÕES/CONFIGURAÇÕES DE PRODUTOS PODERÃO SOFRER ALTERAÇÕES SEM AVISO PRÉVIO.

ENTRE EM CONTATO COM O SEU CONSULTOR OU FALE COM O NOSSO TIME DE TELEVENDAS PELO (33) 3277-3030.

SR

SELLE ROYAL



SELIM CITY BIKE PRETO COM MOLHAS COM CARRINHO

Característica	Base em polipropileno extremamente resistente, espuma expandida e capa de laminado de PVC. Trilhos em aço. 2 molas acopladas ao trilho para absorção de impacto Carrinho em aço zincado. Bike de passeio e urbanas ciclistas que buscam conforto.
Material	RVS
Medida	0,081m³
Tamanho	260mmx105mmx215mm
Peso	650g
Embalagem	20 peças

20743



SELIM LOOKIN ATHLETIC GEL

Característica	3D SKINGEL: O Royalgel™ é colocado estrategicamente de acordo com as necessidades anatômicas do ciclista, resultando em um selim mais leve, enquanto mantém a redução da pressão na área perineal e isquiática em até 40%. DOUBLE-COVER: Um material de dupla camada aplicado nas laterais do selim para dobrar a resistência contra impactos e abrasões. FLEXITE SYSTEM: Através do Flexite System, a base do selim torna-se flexível e confortável. Esta construção garante uma flexibilidade superior e uma maior absorção de impactos durante a pedalada. Bike MTB Aro de 26 a 29.
Material	Royalgel
Medida	0,044m³
Tamanho	267mmx64mmx150mm
Peso	542,94g
Embalagem	12 peças

20746



SELIM LOOKIN MODERATE GEL

Característica	3D SKINGEL: O Royalgel™ é colocado estrategicamente de acordo com as necessidades anatômicas do ciclista, resultando em um selim mais leve, enquanto mantém a redução da pressão na área perineal e isquiática em até 40%. DOUBLE-COVER: Um material de dupla camada aplicado nas laterais do selim para dobrar a resistência contra impactos e abrasões. FLEXITE SYSTEM: Através do Flexite System, a base do selim torna-se flexível e confortável. Esta construção garante uma flexibilidade superior e uma maior absorção de impactos durante a pedalada. Bike de passeio e urbanas ciclistas que buscam conforto.
Material	Royalgel
Medida	0,044m³
Tamanho	280mmx65mmx180mm
Peso	598,83g
Embalagem	10 peças

20747

FOTOS MERAMENTE ILUSTRATIVAS. AS INFORMAÇÕES/CONFIGURAÇÕES DE PRODUTOS PODERÃO SOFRER ALTERAÇÕES SEM AVISO PRÉVIO.

ENTRE EM CONTATO COM O SEU CONSULTOR OU FALE COM O NOSSO TIME DE TELEVENDAS PELO (33) 3277-3030.



SELIM LOOKIN RELAXED GEL

Característica	Trilhos em aço. Sistema de amortecimento: Elastômero. 3D SKINGEL: O Royalgel™ é colocado estrategicamente de acordo com as necessidades anatômicas do ciclista, resultando em um selim mais leve, enquanto mantém a redução da pressão na área perineal e isquiática em até 40%. DOUBLE-COVER: Um material de dupla camada aplicado nas laterais do selim para dobrar a resistência contra impactos e abrasões. FLEXITE SYSTEM: Através do Flexite System, a base do selim torna-se flexível e confortável. Esta construção garante uma flexibilidade superior e uma maior absorção de impactos durante a pedalada. Bike de passeio e urbanas ciclistas que buscam conforto.
Material	Royalgel
Medida	0,044m³
Tamanho	260mmx76mmx255mm
Peso	0,7445g
Embalagem	6 peças

20748



SELIM MACH 2 RVS PRETO SEM CARRINHO

Característica	Base em polipropileno extremamente resistente, espuma expandida e capa de laminado de PVC. Trilhos em aço. Bike de passeio e urbanas ciclistas que buscam conforto. O novo Mach 2 traz um design revolucionário combinando conforto e performance em um selim altamente refinado.
Material	RVS
Medida	0,081m³
Tamanho	267mmx61mmx140mm
Peso	327,50g
Embalagem	32 peças

20749



SELIM MIRIM VERMELHO SILK "ARANHA BRANCO/ AZUL" COM CARRINHO

Característica	Base em polipropileno extremamente resistente, espuma expandida e capa de laminado de PVC. Trilhos em aço. Carrinho em aço zincado. Bicycletas aro 12, 14, 16.
Material	RVS
Medida	0,028m³
Tamanho	212mmx56mmx142mm
Peso	265,55g
Embalagem	20 peças

20752

SR

SELLE ROYAL



SELIM MIRIM AZUL SILK "VELOX PRETO/VERMELHO" + CANOTE 200MM

Característica	Base em polipropileno extremamente resistente, espuma expandida e capa de laminado de PVC. Bicicletas aro 12, 14, 16.
Material	RVS
Medida	0,028m ³
Tamanho	212mmx216mmx142mm
Peso	279g
Embalagem	12 peças

20753



SELIM PVC BARRA CIRCULAR COM MOLAS - PRETO

Característica	Trilhos em aço. 2 molas acopladas ao trilho para absorção de impacto. Base em polipropileno extremamente resistente, espuma expandida e capa de PVC. Bicicletas Aro 12, 14, 16.
Material	PVC
Medida	0,081m ³
Tamanho	258mmx118mmx221mm
Peso	748g
Embalagem	18 peças

20757



SELIM PVC MINI TOY CANOTE 7/8" 190MM - PRETO

Característica	Base em polipropileno extremamente resistente, espuma expandida e capa de PVC. Bicicletas Aro 12, 14, 16.
Material	PVC
Medida	0,081m ³
Tamanho	224mmx180mmx127mm
Peso	319g
Embalagem	24 peças

20759

FOTOS MERAMENTE ILUSTRATIVAS. AS INFORMAÇÕES/CONFIGURAÇÕES DE PRODUTOS PODERÃO SOFRER ALTERAÇÕES SEM AVISO PRÉVIO.

ENTRE EM CONTATO COM O SEU CONSULTOR OU FALE COM O NOSSO TIME DE TELEVENDAS PELO (33) 3277-3030.

SR

SELLE ROYAL



SELIM PVC TOY 20 COM CANOTE 7/8" 250MM - PRETO

Característica	Base em polipropileno extremamente resistente, espuma expandida e capa de PVC. Bicicletas Aro 12, 14, 16.
Material	PVC
Medida	0,081m ³
Tamanho	236mmx243mmx145mm
Peso	397g
Embalagem	18 peças

20765



SELIM SELLE ROYAL AMAZONAS PU COM MOLAS COM CARRINHO

Característica	Completamente fabricado em PU por injeção. Trilhos em aço. 2 molas acopladas ao trilho para absorção de impacto. Carrinho em aço zincado. Base em polipropileno extremamente resistente. Bike de passeio e urbanas ciclistas que buscam conforto.
Material	PU
Medida	0,081m ³
Tamanho	268mmx58mmx161mm
Peso	660g
Embalagem	22 peças

20767



SELIM SELLE ROYAL BARRA CIRCULAR PU COM MOLAS COM CARRINHO

Característica	Completamente fabricado em PU por injeção. Trilhos em aço. 2 molas acopladas ao trilho para absorção de impacto. Carrinho em aço zincado. Base em polipropileno extremamente resistente. Bike de passeio e urbanas ciclistas que buscam conforto.
Material	PU
Medida	0,081m ³
Tamanho	273mmx72mmx237mm
Peso	748g
Embalagem	15 peças

20769

FOTOS MERAMENTE ILUSTRATIVAS. AS INFORMAÇÕES/CONFIGURAÇÕES DE PRODUTOS PODERÃO SOFRER ALTERAÇÕES SEM AVISO PRÉVIO.

ENTRE EM CONTATO COM O SEU CONSULTOR OU FALE COM O NOSSO TIME DE TELEVENDAS PELO (33) 3277-3030.

SR

SELLE ROYAL



SELIM SELLE ROYAL BEACH BIKE PU COM MOLAS COM CARRINHO

Característica	Completamente fabricado em PU por injeção. Trilhos em aço. 2 molas acopladas ao trilho para absorção de impacto. Carrinho em aço zincado. Base em polipropileno extremamente resistente. Bike de passeio e urbanas ciclistas que buscam conforto.
Material	PU
Medida	0,081m³
Tamanho	260mmx37mmx261mm
Peso	677,75g
Embalagem	18 peças

20770



SELIM SELLE ROYAL BRISA/TROPICAL PU COM CARRINHO

Característica	Completamente fabricado em PU por injeção. Trilhos em aço. Carrinho em aço zincado. Base em polipropileno extremamente resistente. Bikes infantis.
Material	PU
Medida	0,081m³
Tamanho	250mmx63mmx195mm
Peso	347,7g
Embalagem	26 peças

20771



SELIM SELLE ROYAL CITY BIKE PU COM MOLAS COM CARRINHO

Característica	Completamente fabricado em PU por injeção. Trilhos em aço. 2 molas acopladas ao trilho para absorção de impacto. Carrinho em aço zincado. Base em polipropileno extremamente resistente. Bike de passeio e urbanas ciclistas que buscam conforto.
Material	PU
Medida	0,081m³
Tamanho	254mmx46mmx212mm
Peso	645,15g
Embalagem	20 peças

20772

FOTOS MERAMENTE ILUSTRATIVAS. AS INFORMAÇÕES/CONFIGURAÇÕES DE PRODUTOS PODERÃO SOFRER ALTERAÇÕES SEM AVISO PRÉVIO.

ENTRE EM CONTATO COM O SEU CONSULTOR OU FALE COM O NOSSO TIME DE TELEVENDAS PELO (33) 3277-3030.

SR

SELLE ROYAL



SELIM SELLE ROYAL HOLY RVS PRETO SEM CARRINHO

Característica Base em polipropileno extremamente resistente, espuma expandida e capa de laminado de PVC. Trilhos em aço. Canal ergonômico central que proporciona uma melhor ventilação e um melhor alívio de pressão nos tecidos sensíveis na área perineal e prostática. Versatilidade que permite adaptar-se facilmente de uma pedalada urbana até uma prática esportiva quer seja no Ciclismo de estrada ou Mountain Bike. Sistema patenteado chamado ICS-Integrated Clip System na parte de trás do selim para um fácil encaixe do pisca ou bolsinha de selim. Trilho com marcações milimetradas para ajudar no ajuste do bike fit. Espuma injetada através da tecnologia exclusiva de injeção Royal Vacuum System que faz com que o selim seja resistente a intempéries e tenha uma duração e qualidade por muito mais tempo.

Material RVS
Medida 0,081m³
Tamanho 260mmx56mmx157mm
Peso 361,27g
Embalagem 28 peças

20777



SELIM SELLE ROYAL JUNIOR PU COM CANOTE 190MM

Característica Completamente fabricado em PU por injeção. Base em polipropileno extremamente resistente. Bikes infantis.

Material PU
Medida 0,081m³
Tamanho 234mmx185mmx127mm
Peso 246g
Embalagem 24 peças

20778



SELIM SELLE COM CARRINHO

Característica Completamente fabricado em PU por injeção. Trilhos em aço. Carrinho em aço zincado. Base em polipropileno extremamente resistente. Bikes infantis.

Material PU
Medida 0,081m³
Tamanho 221mmx54mmx146mm
Peso 276g
Embalagem 54 peças

20779

FOTOS MERAMENTE ILUSTRATIVAS. AS INFORMAÇÕES/CONFIGURAÇÕES DE PRODUTOS PODERÃO SOFRER ALTERAÇÕES SEM AVISO PRÉVIO.

ENTRE EM CONTATO COM O SEU CONSULTOR OU FALE COM O NOSSO TIME DE TELEVENDAS PELO (33) 3277-3030.

SR

SELLE ROYAL



1.



2.



3.

SELIM SELLE ROYAL MOLISE RVS COM CARRINHO

Característica	Base em polipropileno extremamente resistente, espuma expandida e capa de laminado de PVC. Bike de passeio e urbanas ciclistas que buscam conforto. Sistema de encaixe para bolsas ou luz. Trilhos em aço. Carrinho em aço zincado.
Material	RVS
Medida	0,081m³
Tamanho	252mmx81mmx204mm
Peso	579g
Embalagem	20 peças

1. 20780

2. 20781

3. 20782

FOTOS MERAMENTE ILUSTRATIVAS. AS INFORMAÇÕES/CONFIGURAÇÕES DE PRODUTOS PODERÃO SOFRER ALTERAÇÕES SEM AVISO PRÉVIO.

ENTRE EM CONTATO COM O SEU CONSULTOR OU FALE COM O NOSSO TIME DE TELEVENDAS PELO (33) 3277-3030.

SR

SELLE ROYAL



SELIM SELLE ROYAL SOFT FIT PU COM MOLAS COM CARRINHO

Característica	Completamente fabricado em PU por injeção. Trilhos em aço. 2 molas acopladas ao trilho para absorção de impacto. Carrinho em aço zincado. Base em polipropileno extremamente resistente. Bike de passeio e urbanas ciclistas que buscam conforto.
Material	PU
Medida	0,081m ³
Tamanho	267mmx62mmx180mm
Peso	701g
Embalagem	22 peças

20785



SELIM SELLE ROYAL SOFT FIT PU SEM MOLAS COM CARRINHO

Característica	Completamente fabricado em PU por injeção. Trilhos em aço. Carrinho em aço zincado. Base em polipropileno extremamente resistente. Bikes infantis.
Material	PU
Medida	0,081m ³
Tamanho	267mmx62mmx180mm
Peso	546g
Embalagem	20 peças

20786



SELIM SELLE ROYAL VERSATILE RVS PRETO COM CARRINHO

Característica	Completamente fabricado em PU por injeção. Trilhos em aço. Carrinho em aço zincado. Base em polipropileno extremamente resistente. Bikes infantis.
Material	RVS
Medida	0,081m ³
Tamanho	278mmx60mmx159mm
Peso	497g
Embalagem	22 peças

20787

FOTOS MERAMENTE ILUSTRATIVAS. AS INFORMAÇÕES/CONFIGURAÇÕES DE PRODUTOS PODERÃO SOFRER ALTERAÇÕES SEM AVISO PRÉVIO.

ENTRE EM CONTATO COM O SEU CONSULTOR OU FALE COM O NOSSO TIME DE TELEVENDAS PELO (33) 3277-3030.

SR

SELLE ROYAL



SELIM SPYDER RVS PRETO COM CARRINHO

Característica Base em polipropileno extremamente resistente, espuma expandida e capa de laminado de PVC. Bicicletas aro 20 e 24. Trilhos em aço. Carrinho em aço zincado.

O PRIMEIRO SELIM INFANTIL DESENVOLVIDO COM TRILHO.

Material RVS
Medida 0,081m³
Tamanho 229mmx53mmx147mm
Peso 413,72g
Embalagem 32 peças

20788



SELIM TROPICAL/BRISA BASE PLÁSTICA COM CARRINHO - PRETO

Característica Base em polipropileno extremamente resistente, espuma expandida e capa de laminado de PVC. Bike de passeio e urbanas | ciclistas que buscam conforto. Trilhos em aço. Carrinho em aço zincado.

Material RVS
Medida 0,081m³
Tamanho 250mmx63mmx209mm
Peso 354g
Embalagem 26 peças

20790



SELIM VELOCE PU COM CARRINHO PRETO

Característica Completamente fabricado em PU por injeção. Trilhos em aço. Carrinho em aço zincado. Base em polipropileno extremamente resistente. Bikes A24 a A29.

Material PU
Medida 0,081m³
Tamanho 270mmx46mmx130mm
Peso 419,50g
Embalagem 32 peças

20792

FOTOS MERAMENTE ILUSTRATIVAS. AS INFORMAÇÕES/CONFIGURAÇÕES DE PRODUTOS PODERÃO SOFRER ALTERAÇÕES SEM AVISO PRÉVIO.

ENTRE EM CONTATO COM O SEU CONSULTOR OU FALE COM O NOSSO TIME DE TELEVENDAS PELO (33) 3277-3030.

SR

SELLE ROYAL



SELIM VELOCE RVS PRETO SEM CARRINHO VERNIZ PRETO

Característica	Base em polipropileno extremamente resistente, espuma expandida e capa de laminado de PVC. Bike de passeio e urbanas ciclistas que buscam conforto. Trilhos em aço.
Material	RVS
Medida	0,044m ³
Tamanho	267mmx46mmx140mm
Peso	327,50g
Embalagem	20 peças

20794



SELIM SELLE ROYAL MTB PREMIUM PU SEM MOLAS COM CARRINHO PT

Característica	Completamente fabricado em PU por injeção. Trilhos em aço. Carrinho em aço zincado. Base em polipropileno extremamente resistente. Bikes infantis.
Material	PU
Medida	0,081m ³
Tamanho	285mmx-mmx174mm
Peso	526g
Embalagem	24 peças

20783



SELIM SELLE ROYAL MTB SPORT PU COM CARRINHO

Característica	Completamente fabricado em PU por injeção. Trilhos em aço. Carrinho em aço zincado. Base em polipropileno extremamente resistente. Bikes infantis.
Material	PU
Medida	0,081m ³
Tamanho	255mmx65mmx170mm
Peso	347,85g
Embalagem	30 peças

20784

FOTOS MERAMENTE ILUSTRATIVAS. AS INFORMAÇÕES/CONFIGURAÇÕES DE PRODUTOS PODERÃO SOFRER ALTERAÇÕES SEM AVISO PRÉVIO.

ENTRE EM CONTATO COM O SEU CONSULTOR OU FALE COM O NOSSO TIME DE TELEVENDAS PELO (33) 3277-3030.

C A T Á L O G O

KMC

C O R R E N T E S



Corrente Z9 – KMC

Característica	1/2"x11/128" 116L
Conector	Missing Link 9R/ CL566R
Compatível	Todos os sistemas de transmissão de 9 velocidades
Peso	286g
Embalagem	25 peças

11074



SUGESTÃO MISSINGLINK

KMC 9 velocidades 11075



SUGESTÃO FERRAMENTA

RAVA Alicates para
corrente 13187



Corrente Z8.1 – KMC

Característica	1/2"x3/32" 116L
Conector	Missing Link 8R/ CL571R
Compatível	Todos os sistemas de transmissão de 8 velocidades
Peso	321 g
Embalagem	25 peças

11073



SUGESTÃO FERRAMENTA

RAVA Alicates para
corrente 13187



Corrente Z7 – KMC

Característica	1/2"x3/32" 116L
Compatível	Todos os sistemas de transmissão de 7 velocidades
Peso	331 g
Embalagem	25 peças

11072



SUGESTÃO FERRAMENTA

RAVA Alicates para
corrente 13187



FOTOS MERAMENTE ILUSTRATIVAS. AS INFORMAÇÕES/CONFIGURAÇÕES DE PRODUTOS PODERÃO SOFRER ALTERAÇÕES SEM AVISO PRÉVIO.

ENTRE EM CONTATO COM O SEU CONSULTOR OU FALE COM O NOSSO TIME DE TELEVENDAS PELO (33) 3277-3030.

Missing Link – KMC

Característica	Missing Link 12/CL552
Material	Aço
Compatível	Correntes 12 velocidades KMC Sram
Cor	Prateado
Embalagem	20 peças

11078 / 22706



Missing Link – KMC

Característica	Missing Link 11R/CL555R
Material	Aço
Compatível	Correntes 11 velocidades KMC Shimano Sram
Cor	Prateado
Embalagem	20 peças

11077



Missing Link – KMC

Característica	Missing Link 10R/CL559R
Material	Aço
Compatível	correntes 10 velocidades KMC Shimano
Cor	Prateado
Embalagem	20 peças

11076



KMC

Missing Link – KMC

Característica	MissingLink 9R/CL566R
Material	Aço
Compatível	Correntes 9 velocidades KMC Shimano Sram
Cor	Prateado
Embalagem	20 peças

11075



Corrente Corrida 116L 7v. INDEX HV500 GYBR KMC

Característica	1/2" x 3/32" 116L
Compatível	Todos os sistemas de transmissão 7 velocidades
Conector	Missing Link 7R/HV-500 GYBR
Peso	350 g
Embalagem	25 peças

17909



SUGESTÃO FERRAMENTA

RAVA

alicate para
corrente 13187





CORRENTE CORRIDA 116L 7/8V | C8

Característica	1/2"x3/32" 116 L
Velocidade	7/8 velocidades
Compatibilidade	Shimano Campagnolo Sram
Peso	306 g
Embalagem	40 peças
	15454



CORRENTE CORRIDA 116L 10V | C10

CARACTERÍSTICA	1/2"x11/128" 116 L
VELOCIDADE	10 velocidades
COMPATIBILIDADE	Shimano Campagnolo Sram de 10 velocidades
PESO	272 g
EMBALAGEM	40 peças
	15456/20505



CORRENTE CORRIDA 116L 9V | C9

CARACTERÍSTICA	1/2"x11/128" 116 L
VELOCIDADE	9 velocidades
COMPATIBILIDADE	Shimano Campagnolo Sram de 9 velocidades
PESO	289 g
EMBALAGEM	40 peças
	15455



FOTOS MERAMENTE ILUSTRATIVAS. AS INFORMAÇÕES/CONFIGURAÇÕES DE PRODUTOS PODERÃO SOFRER ALTERAÇÕES SEM AVISO PRÉVIO.

ENTRE EM CONTATO COM O SEU CONSULTOR OU FALE COM O NOSSO TIME DE TELEVENDAS PELO (33) 3277-3030.

CORRENTE CORRIDA 116L 6V | C30

CARACTERÍSTICA	1/2"x 3/32" 116 L
VELOCIDADE	6 velocidades
COMPATIBILIDADE	Shimano Campagnolo Sram de 6 velocidades (Estrada)
PESO	310 g
EMBALAGEM	50 peças
	15453



CORRENTE 114L | C410

CARACTERÍSTICA	1/2"x 1/8" 116 L
VELOCIDADE	Single Speed
COMPATIBILIDADE	Sistemas Single Speed
PESO	345 g
EMBALAGEM	50 peças
	15457



CORRENTE CORRIDA 116L 7/8V | C8

Característica	1/2"x3/32" 116 L
Velocidade	7/8 velocidades
Compatibilidade	Shimano Campagnolo Sram
Peso	306 g
Embalagem	40 peças
	22707



WTB

ARO ALUM PAREDE DUPLA 32F MOD 01 PT

CARACTERÍSTICAS

- WTB KOM i30
- ACABAMENTO ANODIZADO
- LARGURA INTERNA 30MM
- TUBELESS READY
- ETRTO RIM SIZE 30-622MM
- 32 FUROS
- DISC BRAKE
- LARGURA DO PNEU 42MM – 72MM
- ERD 606MM

MATERIAL

Alumínio

PESO

650g

EMBALAGEM

10 Unidades

24733



ARO ALUM PAREDE DUPLA 32F MOD 05 PT

CARACTERÍSTICAS

- WTB KOM i30
- ACABAMENTO FOSCO ANODIZADO
- LIGHT
- LARGURA INTERNA 30MM
- TUBELESS READY
- ETRTO RIM SIZE 30-622MM
- 32 FUROS
- DISC BRAKE
- LARGURA DO PNEU 42MM – 72MM
- ERD 606MM

MATERIAL

Alumínio

PESO

522g

EMBALAGEM

10 Unidades

24734



WTB

FOTOS MERAMENTE ILUSTRATIVAS. AS INFORMAÇÕES/CONFIGURAÇÕES DE PRODUTOS PODERÃO SOFRER ALTERAÇÕES SEM AVISO PRÉVIO.

ENTRE EM CONTATO COM O SEU CONSULTOR OU FALE COM O NOSSO TIME DE TELEVENDAS PELO (33) 3277-3030.

ARO ALUM PAREDE DUPLA 32F MOD 02 PT

CARACTERÍSTICAS

- WTB KOM TRAIL i35
- ACABAMENTO ANODIZADO
- LARGURA INTERNA 35MM
- TUBELESS READY
- ETRTO RIM SIZE 35-622MM
- 32 FUROS
- DISC BRAKE
- LARGURA DO PNEU 47MM – 72MM
- ERD 605MM

MATERIAL

Alumínio

PESO

618g

EMBALAGEM

10 Unidades

24735



ARO ALUM PAREDE DUPLA 28F MOD 03 PT

CARACTERÍSTICAS

- WTB KOM i30
- ACABAMENTO FOSCO ANODIZADO
- COM ILHÓS
- LARGURA INTERNA 30MM
- TUBELESS READY
- ETRTO RIM SIZE 30-622MM
- 28 FUROS
- DISC BRAKE
- LARGURA DO PNEU 42MM – 72MM
- ERD 606MM

MATERIAL

Alumínio

PESO

570g

EMBALAGEM

10 Unidades

24736



FOTOS MERAMENTE ILUSTRATIVAS. AS INFORMAÇÕES/CONFIGURAÇÕES DE PRODUTOS PODERÃO SOFRER ALTERAÇÕES SEM AVISO PRÉVIO.

ENTRE EM CONTATO COM O SEU CONSULTOR OU FALE COM O NOSSO TIME DE TELEVENDAS PELO (33) 3277-3030.

WTB

ARO ALUM PAREDE DUPLA 32F MOD 04 PT

CARACTERÍSTICAS

- WTB i23
- ACABAMENTO ANODIZADO
- LARGURA INTERNA 23MM
- TUBELESS READY
- ETRTO RIM SIZE 23-622MM
- 32 FUROS
- DISC BRAKE
- LARGURA DO PNEU 25MM – 65MM
- DIÂMETRO 29" / 700C
- ERD 606MM

MATERIAL

Alumínio

PESO

554g

EMBALAGEM

10 Unidades

24737



KIT RODA DIANTEIRA/TRASEIRA ARO 29" X 32F MODELO 01 BOOST PT

ARO

WTB Kom Trail i35 | 35 mm interno
Alumínio | ETRTO Rim Size 35 - 622 mm
Tubeless ready | 32 Furos
Largura recomendada da seção do pneu
47mm - 72mm (mínima x máxima) |
Acompanha Fita de proteção de câmara
WTB

RAIO

Sapin | Inox 2.0mm
Niple Sapin 14 mm x 2.0mm

CUBO DIANTEIRO

Shimano MT400B | Boost
Eixo de 15 mm | OLD 110 mm | 32 furos

CUBO TRASEIRO:

Shimano MT 410 | Boost
OLD 148 mm | Eixo de 12 mm
32 furos | Free Hub Micro-Spline

PESO

Dianteira 1070 gr / 1316 gr - 2386 (par)

EMBALAGEM

1 peça

17810



29"
WHEELS

FOTOS MERAMENTE ILUSTRATIVAS. AS INFORMAÇÕES/CONFIGURAÇÕES DE PRODUTOS PODERÃO SOFRER ALTERAÇÕES SEM AVISO PRÉVIO.

ENTRE EM CONTATO COM O SEU CONSULTOR OU FALE COM O NOSSO TIME DE TELEVENDAS PELO (33) 3277-3030.

KIT RODA DIANTEIRA/TRASEIRA ARO 700C X 32F PT

ARO WTB Kom i23 | 23 mm interno | Alumínio ETRTO Rim Size 23 - 622 mm | Tubeless ready | 32 Furos | Largura recomendada da seção do pneu 30 mm - 64mm (mínima x máxima) | 700C | Acompanha Fita de proteção de câmara WTB

RAIO Raio Comum | Preto 2.0mm | Niple 14 mm x 2.0mm

CUBO DIANTEIRO Shimano RM35 | Center-lock | 32 Furos Blocação | HB-RM35 | Corpo em Alumínio | Eixo e Blocação em Aço | Encaixe: Blocação Quick Release (tradicional) | Diâmetro do Eixo: 9mm Comprimento do Eixo (O.L.D): Dianteiro - 100mm | Rolamentos: Cone com Esferas | Ótima vedação contra impurezas, poeira e lama | Cor: Preto

CUBO TRASEIRO Shimano RM35 | Center-lock | 32 Furos Blocação | FH-RM35 | Corpo em Alumínio, Eixo e Blocação em Aço | Encaixe: Blocação Quick Release (tradicional) | Diâmetro do Eixo: 9mm | Comprimento do Eixo (O.L.D): Traseiro - 135mm | Rolamentos: Cone com Esferas | Cor: Preto

PESO 2362 gr (par) com a blocação

EMBALAGEM 1 peça

17809



29"
WHEELS

WTB

FITA PROTETORA DE ARO

TAMANHO	26"
LARGURA	11 mm
ESPECIFICAÇÃO	Fita de aro WTB de alta resistência com tecnologia SOLID STRIP, NÃO É FITA TUBELESS!
AVISO DO FABRICANTE	Leia o manual do usuário e compatibilidade: <ul style="list-style-type: none">• Confira as orientações em WTB.COM antes da instalação e uso.• Solid Strip (Tira Sólida) só é compatível com WTB TCS 2.0 e aro tipo tubo.
PESO	10 gr
EMBALAGEM	200 peças

24376



FITA PROTETORA DE ARO

TAMANHO	29"
LARGURA	11 mm
ESPECIFICAÇÃO	Fita de aro WTB de alta resistência com tecnologia SOLID STRIP, NÃO É FITA TUBELESS!
AVISO DO FABRICANTE	Leia o manual do usuário e compatibilidade: <ul style="list-style-type: none">• Confira as orientações em WTB.COM antes da instalação e uso.• Solid Strip (Tira Sólida) só é compatível com WTB TCS 2.0 e aro tipo tubo.
PESO	10 gr
EMBALAGEM	200 peças

25148



WTB

Athletica

NUTRITION



Go! Energy Now! | Gel

Ingredientes

FORMULA GO! ENERGY NOW GEL [Maltodextrina, Palatinose™ (Isomaltulose), Cafeína, Beta-Alanina, Cloreto de Sódio, Citrato de Sódio, Óxido de Magnésio, Cloreto de Potássio], Água Purificada, Água de Coco, Acidulante Ácido Cítrico, Regulador de Acidez Ácido Fosfórico, Aromatizantes, Conservadores Sorbato de Potássio, Benzoato de Sódio e EDTA Dissódico, Corante Artificial Vermelho 40 e Edulcorante Sucralose.

"NÃO CONTÉM GLÚTEN."

"ALÉRGICOS: PODE CONTER DERIVADOS DE SOJA."

Forma de Uso

1 sachê 15 minutos antes do treino
1 sachê durante, a cada 45 minutos de treino

Embalagem

10 sachês de 30 g cada



Athletica
NUTRITION



INFORMAÇÃO NUTRICIONAL

Porção de 30 g (1 sachê)

	Quantidade por porção	%VD
Valor Energético	76 kcal = 319 kJ	4%
Carboidratos	19 g	6%
Sódio	85 mg	4%
Cafeína	100 mg	
Beta-Alanina	100 mg	
Potássio	60 mg	**
Magnésio	80 mg	31%

*%VD - Valores diários com base em uma dieta de 2000 kcal ou 8.400 kJ. Seus valores diários podem ser maiores ou menores dependendo de suas necessidades energéticas. **VD não estabelecido.

INGREDIENTES: FORMULA GO! ENERGY NOW GEL [Maltodextrina, Palatinose™ (Isomaltulose), Cafeína, Beta-Alanina, Cloreto de Sódio, Citrato de Sódio, Óxido de Magnésio, Cloreto de Potássio], Água Purificada, Água de Coco, Acidulante Ácido Cítrico, Regulador de Acidez Ácido Fosfórico, Aromatizantes, Conservadores Sorbato de Potássio, Benzoato de Sódio e EDTA Dissódico, Corantes Artificiais Bordeaux S, Azul Brilhante FCF e Azul Indigotina, Edulcorante Sucralose. "NÃO CONTÉM GLÚTEN;" ALÉRGICOS: PODE CONTER DERIVADOS DE SOJA.

Suplemento alimentar líquido.

- FÓRMULA GO! ENERGY NOW GEL.
- Carboidratos, Sódio, Magnésio, Potássio e Água de Coco.
- Cafeína e Beta-Alanina.
- Pode auxiliar na diminuição da fadiga, no aumento do estado de alerta e na melhora da concentração, na capacidade de resistência e desempenho de exercícios físicos, no metabolismo energético e no equilíbrio de eletrólitos.

Ingerir 30 g (1 sachê) com água mineral, antes ou durante o exercício.

Não contém Glúten; Lactose e Gorduras.

Entre em contato com o seu consultor ou fale com o nosso time de televentas pelo (33) 3277-3030.

Fotos meramente ilustrativas. As informações/configurações de produtos poderão sofrer alterações sem aviso prévio.

Go! Recovery | Gel

Ingredientes FORMULA GO! RECOVERY GEL [Sacarose, Maltodextrina e Palatinose™ (Isomaltulose)], Água Purificada, Água de Coco, Cloreto de Sódio, Citrato de Sódio, Cloreto de Potássio, Óxido de Magnésio, Acidulante Ácido Cítrico, Regulador de Acidez Ácido Fosfórico, Aromatizantes, Conservadores Sorbato de Potássio, Benzoato de Sódio e EDTA Dissódico, Corante Artificial Vermelho 40.

“NÃO CONTÉM GLÚTEN.”
“ALÉRGICOS: PODE CONTER DERIVADOS DE SOJA.”

Forma de Uso 1 sachê 15 minutos antes do treino
1 sachê durante, a cada 45 minutos de treino

Embalagem 10 sachês de 30 g cada

Athletica
NUTRITION

■ 22574



■ 22573



INFORMAÇÃO NUTRICIONAL

Porção de 30 g (1 sachê)

	Quantidade por porção	%VD
Valor Energético	76 kcal = 319 kJ	4%
Carboidratos	19 g	6%
Sódio	85 mg	4%
Potássio	60 mg	**
Magnésio	80 mg	31%

*%VD - Valores diários com base em uma dieta de 2.000 kcal ou 8.400 kJ. Seus valores diários podem ser maiores ou menores dependendo de suas necessidades energéticas. **VD não estabelecido.

INGREDIENTES: FORMULA GO! RECOVERY GEL [Sacarose, Maltodextrina e Palatinose™ (Isomaltulose)], Água Purificada, Água de Coco, Cloreto de Sódio, Citrato de Sódio, Cloreto de Potássio, Óxido de Magnésio, Acidulante Ácido Cítrico, Regulador de Acidez Ácido Fosfórico, Aromatizantes, Conservadores Sorbato de Potássio, Benzoato de Sódio e EDTA Dissódico, Corante Artificial Vermelho 40. **“NÃO CONTÉM GLÚTEN.”**
ALERGICOS: PODE CONTER DERIVADOS DE SOJA.

Suplemento alimentar líquido.

FÓRMULA GO! RECOVERY GEL.

Carboidratos, Sódio, Magnésio, Potássio e Água de Coco.

Pode auxiliar na capacidade de resistência e desempenho de exercícios físicos, no funcionamento muscular e neuromuscular, no metabolismo energético, e no equilíbrio de eletrólitos.

Ingerir 30 g (1 sachê) com água mineral, antes ou durante o exercício.

Não contém Glúten; Lactose e Gorduras.

Entre em contato com o seu consultor ou fale com o nosso time de televentas pelo (33) 3277-3030.

Fotos meramente ilustrativas. As informações/configurações de produtos poderão sofrer alterações sem aviso prévio.

Go! Energy Now! | Cápsulas

Ingredientes Cafeína anidra (Teor de 99,5% de 1,3,7 trimetilxantina), Antiumectante Dióxido de Silício, Veículos Gelatina e Água Purificada e Corantes Artificiais Amarelo Crepúsculo, Amarelo Tartrazina, Azul Brilhante FCF, Ponceau, Azorubina e Dióxido de Titânio.

“NÃO CONTÉM GLÚTEN.”

Forma de Uso 1 cápsula (350 mg) antes do treino ou conforme orientação de Nutricionista ou Médico

Embalagem 60 cápsulas

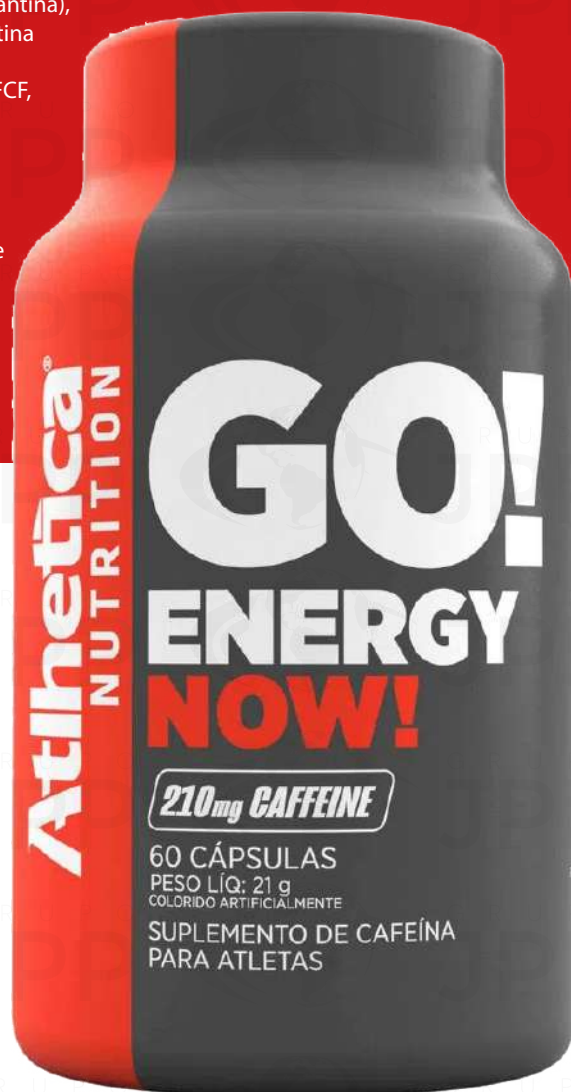

■ 22575

Suplemento de cafeína para atletas.

- Cafeína Anidra.
- Energia rápida.
- Pode auxiliar no aumento do estado de alerta, na melhora da concentração, na capacidade de resistência e desempenho de exercícios físicos de resistência e no metabolismo energético

Ingerir 1 cápsula antes do treino, uma vez ao dia.

Não contém Glúten; Lactose; Calorias; Gorduras e Sacarose.

INFORMAÇÃO NUTRICIONAL

Porção de 350 mg (1 cápsula)

	Quantidade por porção	%VD
Cafeína	210 mg	**

*Não contém quantidades significativas de Valor Energético, Carboidratos, Proteínas, Gorduras Totais, Gorduras Saturadas, Gorduras Trans, Fibra Alimentar e Sódio. **%VD-Valores Diários com base em uma dieta de 2.000 kcal ou 8.400 kJ. Seus valores diários podem ser maiores ou menores dependendo de suas necessidades energéticas. **VD não estabelecido.

INGREDIENTES: Cafeína anidra (Teor de 99,5% de 1,3,7 trimetilxantina), Antiumectante Dióxido de Silício, Veículos Gelatina e Água Purificada e Corantes Artificiais Amarelo Crepúsculo, Amarelo Tartrazina, Azul Brilhante FCF, Ponceau, Azorubina e Dióxido de Titânio. **“NÃO CONTÉM GLÚTEN.”**

Entre em contato com o seu consultor ou fale com o nosso time de televendas pelo (33) 3277-3030.

Fotos meramente ilustrativas. As informações/configurações de produtos poderão sofrer alterações sem aviso prévio.

Athletica
NUTRITION

Go! Isotonic Drink | Pó

Ingredientes FÓRMULA CARBO BLEND (Sacarose, Dextrose Desidratada, Maltodextrina e Frutose), Cloreto de Sódio, Citrato de Potássio, Aromatizante, Acidulante Ácido Cítrico, Edulcorante Artificial Acesulfame de Potássio, Corantes Artificiais Azul Brilhante FCF, Azul Indigotina, Bordeaux S e Corante Natural Caramelo.

"NÃO CONTÉM GLÚTEN."
"ALÉRGICOS: PODE CONTER DERIVADOS DE LEITE E SOJA."

Forma de Uso 30 g (2 colheres de sopa) durante o treino

Embalagem 900 g

■ 22576

■ 22577

■ 22578



Suplemento hidroeletrólítico para atletas.



INFORMAÇÃO NUTRICIONAL		
Porção de 30 g (2 colheres de sopa)		
	Quantidade por porção	%*VD
Valor Energético	112 kcal = 470 kJ	6%
Carboidratos	28 g	9%
Sódio	214 mg	9%
Cloro	328 mg	**
Potássio	61 mg	**

*Não contém quantidades significativas de Proteínas, Gorduras Totais, Gorduras Saturadas, Gorduras Trans e Fibra Alimentar. **VD-Valor diário com base em uma dieta de 2.000 kcal ou 8.400 kJ. Seus valores diários podem ser maiores ou menores dependendo de suas necessidades energéticas. **VD não estabelecido.

INGREDIENTES: FÓRMULA CARBO BLEND (Sacarose, Dextrose Desidratada, Maltodextrina e Frutose), Cloreto de Sódio, Citrato de Potássio, Vitamina C (Ácido Ascórbico), Aromatizante Idêntico ao Natural de Açaí e de Guaraná, Acidulante Ácido Cítrico, Edulcorante Artificial Acesulfame de Potássio e Corantes Artificiais Azul Brilhante FCF, Azul Indigotina, Bordeaux S e Caramelo. "ALÉRGICOS: PODE CONTER DERIVADO DO LEITE E DA SOJA." "NÃO CONTÉM GLÚTEN."

- Fórmula CARBO BLEND, Sódio, Cloro e Potássio.
- Energia.
- Pode auxiliar na reidratação, no equilíbrio hidroeletrólítico e ácido-base, no funcionamento muscular e neuromuscular, no metabolismo energético e na melhora do desempenho muscular durante exercícios físicos de alta resistência.

Misturar 30 g (2 colheres de sopa) em 400 mL de água mineral.

Preparo econômico para equipes: misturar 900 g (todo o conteúdo) em 12 L de água mineral.

Não contém Glúten; Lactose e Gorduras.

Entre em contato com o seu consultor ou fale com o nosso time de televentas pelo (33) 3277-3030.

Fotos meramente ilustrativas. As informações/configurações de produtos poderão sofrer alterações sem aviso prévio.

Go! Repor Salt | Cápsulas

Ingredientes Fórmula 4Tech Salts (Cloreto de Sódio, Fosfato de Sódio, Bicarbonato de Sódio e Citrato de Sódio), Cloreto de Potássio, Estearato de Magnésio, Antiumectantes Celulose Microcristalina e Dióxido de Silício, Cápsula Gelatinosa (Gelatina e Água Purificada).

“NÃO CONTÉM GLÚTEN.”

Forma de Uso Recomenda-se a ingestão da porção de 1,1 g (1 cápsula) com até 500 ml de água, a cada hora de treino. Não consumir mais de 2 cápsulas por hora de treino

Embalagem 30 cápsulas



Suplemento hidroeletrolítico para atletas.

- FÓRMULA 4TECH SALT.
- Fósforo, Magnésio, Potássio e Cloro.
- Pode auxiliar no equilíbrio hidroeletrolítico e ácido-base, no funcionamento muscular e neuromuscular, no metabolismo energético e na melhora do desempenho muscular durante exercícios físicos de alta resistência.

Ingerir 1 cápsula com 500 mL de água mineral a cada hora de treino. Não consumir mais de duas cápsulas por hora de treino.

Não contém Glúten; Lactose; Sacarose; Calorias e Gordura.

Athletica
NUTRITION

22579

INFORMAÇÃO NUTRICIONAL

Porção de 1,1 g (1 cápsula)

	Quantidade por porção	%VD
Sódio	314 mg	13%
Fósforo	22 mg	3%
Magnésio	1,4 mg	1%
Potássio	26 mg	**
Cloro	428 mg	**

*Não contém quantidades significativas de Valor Energético, Carboidratos, Proteínas, Gorduras Totais, Gorduras Saturadas, Gorduras Trans e Fibra Alimentar. **%VD Valores diários com base em uma dieta de 2.000 kcal ou 8.400 kJ. Seus valores diários podem ser maiores ou menores dependendo de suas necessidades energéticas. **VD não estabelecido.

INGREDIENTES: FÓRMULA 4TECH SALTS (Cloreto de Sódio, Fosfato de Sódio, Bicarbonato de Sódio e Citrato de Sódio), Cloreto de Potássio, Estearato de Magnésio, Antiumectante Dióxido de Silício e Cápsula Vegetal Vcaps® (Hidroxipropilmetilcelulose, Água e Corante Natural Clorofila). “NÃO CONTÉM GLÚTEN.”

GO!
REPOR
SALT CAPS

314mg SODIUM

30 CÁPSULAS
PESO LÍQ. 33 g
SUPLEMENTO HIDROELETROLÍTICO
PARA ATLETAS

Entre em contato com o seu consultor ou fale com o nosso time de televendas pelo (33) 3277-3030.

Fotos meramente ilustrativas. As informações/configurações de produtos poderão sofrer alterações sem aviso prévio.

Go! Cramp Block | Cápsulas

Ingredientes FÓRMULA CRAMP MINERALS: [Bicarbonato de Sódio, Fosfato de Cálcio Dibásico, Óxido de Magnésio e Citrato de Potássio], MIX DE VITAMINAS: [Vitamina C (Ácido Ascórbico), Vitamina E (Acetato), Vitamina B6 (Piridoxina HCl) e Niacina (Nicotinamida)], Antiemectantes Celulose Microcristalina e Estearato de Magnésio, Cápsula (Água Purificada, Gelatina, Corantes Artificiais Amarelo Crepúsculo, Amarelo de Quinoleína, Azul Brilhante FCF e Dióxido de Titânio).

“NÃO CONTÉM GLÚTEN.”

Forma de Uso 2 cápsulas pré-treino ou a cada hora de treino. Seguir a orientação de Nutricionista ou Médico. Não consumir mais de 2 cápsulas por hora de treino

Embalagem 60 cápsulas



Suplemento hidroeletrólítico para atletas.

- FÓRMULA CRAMP MINERALS e MIX VITAMINAS.
- Pode auxiliar na prevenção de câimbras.

Ingerir 2 cápsulas pré-treino ou a cada hora de treino. Não consumir mais de duas cápsulas por hora de treino.

Não contém Glúten; Lactose; Sacarose; Calorias e

INFORMAÇÃO NUTRICIONAL

Porção de 1,2 g (2 cápsulas)

	Quantidade por porção	%VD
Sódio	69 mg	3%
Cálcio	60 mg	6%
Magnésio	71 mg	27%
Potássio	100 mg	**
Vitamina C	45 mg	100%
Vitamina E	10 mg	100%
Niacina	16 mg	100%
Vitamina B6	1,3 mg	100%

*Não contém quantidades significativas de Valor Energético, Carboidratos, Proteínas, Gorduras Totais, Gorduras Saturadas, Gorduras Trans e Fibra Alimentar. **%VD Valores diários com base em uma dieta de 2.000 kcal ou 8.400 kJ. Seus valores diários podem ser maiores ou menores dependendo de suas necessidades energéticas. *VD não estabelecido.

INGREDIENTES: FÓRMULA CRAMP MINERALS: [Bicarbonato de Sódio, Fosfato de Cálcio Dibásico, Óxido de Magnésio e Citrato de Potássio], MIX DE VITAMINAS: [Vitamina C (Ácido Ascórbico), Vitamina E (Acetato), Vitamina B6 (Piridoxina HCl) e Niacina (Nicotinamida)], Antiemectantes Celulose Microcristalina e Estearato de Magnésio, Cápsula (Água Purificada, Gelatina, Corantes Artificiais Amarelo Crepúsculo, Amarelo de Quinoleína, Azul Brilhante FCF e Dióxido de Titânio). ***NÃO CONTÉM GLÚTEN***

Entre em contato com o seu consultor ou fale com o nosso time de televendas pelo (33) 3277-3030.

Fotos meramente ilustrativas. As informações/configurações de produtos poderão sofrer alterações sem aviso prévio.

Go! Hydrate Sport+ | Pó

Ingredientes Cloreto de Sódio, Água de Coco Desidratada, Cloreto de Potássio, Aromatizantes, Antiumectantes Fosfato Tricálcico e Dióxido de Silício, Acidulante Ácido Cítrico e Edulcorante Sucralose.

“NÃO CONTÉM GLÚTEN.”
ALÉRGICOS: PODE CONTER DERIVADOS DE SOJA.

Forma de Uso Misture 5,5g (1 stick) em 300 ml (1 copo) de água gelada, uma vez ao dia

Embalagem 20 sticks de 5,5g



Athletica
NUTRITION

22581



Suplemento alimentar de minerais em pó.

- Blend de Eletrólitos.
- Sódio, Potássio e Água de Coco.
- Pode auxiliar na hidratação, reposição de minerais perdidos na transpiração nos esporte, no equilíbrio hidroeletrólítico e ácido-base, no metabolismo energético e no funcionamento muscular e neuromuscular.

Misturar 5,5 g (1 stick) em 300 mL de água mineral, uma vez ao dia.

Não contém Glúten; Lactose; Sacarose e Gorduras.

INFORMAÇÃO NUTRICIONAL

Porção de 5,5 g (1 stick)

	Quantidade por porção	%VD
Valor Energético	16 kcal = 67 kJ	1%
Carboidratos	3,9 g	1%
Sódio	350 mg	15%
Potássio	80 mg	**

Não contém quantidades significativas de Proteínas, Gorduras Totais, Gorduras Saturadas, Gorduras Trans e Fibra Alimentar. *%VD Valores diários: com base em uma dieta de 2.000 kcal ou 8.400 kJ. Seus valores diários podem ser maiores ou menores dependendo de suas necessidades energéticas. **VD Não Estabelecido.

INGREDIENTES: Cloreto de Sódio, Água de Coco Desidratada, Cloreto de Potássio, Aromatizantes, Antiumectantes Fosfato Tricálcico e Dióxido de Silício, Acidulante Ácido Cítrico e Edulcorante Sucralose. “NÃO CONTÉM GLÚTEN.” ALÉRGICOS: PODE CONTER DERIVADOS DE SOJA.

Entre em contato com o seu consultor ou fale com o nosso time de tele vendas pelo (33) 3277-3030.

Fotos meramente ilustrativas. As informações/configurações de produtos poderão sofrer alterações sem aviso prévio.

Go! Pedal Pro + Electrolytes | Cápsulas

Ingredientes

Cloreto de Sódio, Cloreto de Potássio, Óxido de Magnésio, Bicarbonato de Sódio, Citrato de Sódio, L-Carnitina Tartarato, Bisglicinato de Magnésio, Cloridrato de Piridoxina, Coenzima Q10, Antieméticos Celulose Microcristalina, Estearato de Magnésio e Dióxido de Silício e Cápsula Gelatinosa (Gelatina e Água Purificada).

"NÃO CONTÉM GLÚTEN."

"ALÉRGICOS: PODE CONTER DERIVADOS DE SOJA."

Forma de Uso

Ingerir 2 cápsulas com 500 ml de água

Embalagem

90 cápsulas



Suplemento alimentar em cápsulas.

- Sódio, Potássio, Magnésio, Vitamina B6, Coenzima Q10 e Carnitina.
- Ciclismo.
- Pode auxiliar no equilíbrio hidroeletrólítico e ácido-básico no funcionamento muscular e neuromuscular, no metabolismo energético e na melhora do desempenho muscular durante exercícios físicos de alta resistência.

Ingerir 2 cápsulas ao dia com 500 mL de água mineral.

Não contém Glúten; Lactose; Sacarose; Calorias e Gorduras.

Athletica
NUTRITION

22582



INFORMAÇÃO NUTRICIONAL

Porção de 1,7 g (2 cápsulas)

	Quantidade por porção	%VD
Sódio	240 mg	10%
Potássio	100 mg	**
Magnésio	70 mg	27%
Vitamina B6	2,0 mg	154%
Coenzima Q10	0,50 mg	
L-Carnitina	10 mg	

Não contém quantidades significativas de Valor Energético, Carboidratos, Proteínas, Gorduras Totais, Gorduras Saturadas, Gorduras Trans e Fibra Alimentar. *%VD - Valores diários com base em uma dieta de 2.000 kcal ou 8.400 kJ. Seus valores diários podem ser maiores ou menores dependendo de suas necessidades energéticas. **VD não estabelecido.

INGREDIENTES: Cloreto de Sódio, Cloreto de Potássio, Óxido de Magnésio, Bicarbonato de Sódio, Citrato de Sódio, L-Carnitina Tartarato, Bisglicinato de Magnésio, Cloridrato de Piridoxina, Coenzima Q10, Antieméticos Celulose Microcristalina, Estearato de Magnésio e Dióxido de Silício e Cápsula Gelatinosa (Gelatina e Água Purificada). **"NÃO CONTÉM GLÚTEN."** **ALÉRGICOS: PODE CONTER DERIVADOS DE SOJA.**

Entre em contato com o seu consultor ou fale com o nosso time de televentas pelo (33) 3277-3030.

Fotos meramente ilustrativas. As informações/configurações de produtos poderão sofrer alterações sem aviso prévio.

Go! Pedal Pro | Pó

Ingredientes FORMULA CARBO BLEND [Maltodextrina (17% dextrose), Sacarose e Palatinose (Isolmaltulose)], FORMULA ELECTROLYTES [Citrato de Sódio Di-Hidratado, Cloreto de Sódio, Cloreto de Potássio, Óxido de Magnésio, Bicarbonato de Sódio, L-Carnitina, Coenzima Q10], FORMULA BETA-HD (Beta-Alanina, Cafeína e Taurina), FORMULA AMINO FUSION [L-Leucina, L-Lisina, L-Valina, L-Fenilalanina, L-Isoleucina, L-Treonina, L-Metionina, L-Histidina, L-Triptofano, L-Arginina], Acidulante Ácido Cítrico, Aromatizante, Antiumectantes Fosfato Tricálcico e Dióxido de Silício e Edulcorante Sucralose.

“NÃO CONTÉM GLÚTEN.”
 “ALÉRGICOS: PODE CONTER DERIVADOS DE SOJA.”

Forma de Uso 15 minutos antes do treino durante a cada 1 hora de treino

Embalagem 700 g



 22583

 22584

Athletica
NUTRITION

INFORMAÇÃO NUTRICIONAL

Porção de 35 g (1 dosador raso)

	Quantidade por porção	%VD
Valor Energético	120 kcal = 504 kJ	6%
Carboidratos	30 g	10%
Sódio	250 mg	10%
Potássio	83 mg	**
Magnésio	63 mg	24%
Coenzima Q10	0,50 mg	
Cafeína	75 mg	
Beta-Alanina	300 mg	
Taurina	100 mg	
Carnitina	10 mg	
Leucina	410 mg	
Isoleucina	230 mg	
Valina	275 mg	
Arginina	80 mg	
Fenilalanina	263 mg	
Treonina	158 mg	
Metionina	105 mg	
Triptofano	50 mg	
Histina	110 mg	
Lisina	315 mg	

*NÃO contém quantidades significativas de Proteínas, Gorduras Totais, Gorduras Saturadas, Gorduras Trans, Fibra Alimentar. **VD - Valores diários com base em uma dieta de 2.000 kcal ou 8.400 kJ. Seus valores diários podem ser maiores ou menores dependendo de suas necessidades energéticas. **VD não estabelecido.

INGREDIENTES: FORMULA CARBO BLEND [Maltodextrina (17% dextrose), Sacarose e Palatinose (Isolmaltulose)], FORMULA ELECTROLYTES [Citrato de Sódio Di-Hidratado, Cloreto de Sódio, Cloreto de Potássio, Óxido de Magnésio, Bicarbonato de Sódio, L-Carnitina, Coenzima Q10], FORMULA BETA-HD (Beta-Alanina, Cafeína e Taurina), FORMULA AMINO FUSION [L-Leucina, L-Lisina, L-Valina, L-Fenilalanina, L-Isoleucina, L-Treonina, L-Metionina, L-Histidina, L-Triptofano, L-Arginina], Acidulante Ácido Cítrico, Aromatizante, Antiumectantes Fosfato Tricálcico e Dióxido de Silício, Edulcorante Sucralose e Corante Artificial Amarelo Crepúsculo FCF. “NÃO CONTÉM GLÚTEN.” “ALÉRGICOS: PODE CONTER DERIVADOS DE SOJA.”

Suplemento alimentar em pó.

- Fórmulas CARBO BLEND, MIX ELECTROLYTES, BETA-HD e AMINO FUSION.
- Ciclismo.
- Pode auxiliar no metabolismo energético, na manutenção do equilíbrio hidroeletrólítico e ácido-base, no funcionamento muscular e neuromuscular, na diminuição da fadiga, no aumento do estado de alerta e melhora da concentração, além de beneficiar o desempenho muscular e aumentar a capacidade de resistência e desempenho antes do exercício físico de alta resistência.

Misturar 35 g (1 dosador) em 300 mL de água mineral, uma vez ao dia.

Não contém Glúten; Lactose e Gorduras.

Entre em contato com o seu consultor ou fale com o nosso time de televendas pelo (33) 3277-3030.

Fotos meramente ilustrativas. As informações/configurações de produtos poderão sofrer alterações sem aviso prévio.

COMBO

Athletica Nutrition

CÓD. 22688

Athletica
NUTRITION



CONTEÚDO DO COMBO

2	NOW GEL (GUARANÁ C/ AÇAÍ)
1	NOW GEL (LARANJA C/ ACEROLA)
1	NOW GEL (MORANGO C/ LIMÃO)
1	RECOVERY GEL (GUARANÁ C/ AÇAÍ)
1	RECOVERY GEL (MORANGO)

ACESSE NOSSO B2B E COMPRE PELO LINK ABAIXO:
<http://www.makeb2bjpp.avisnet.com.br/login>

Entre em contato com o seu consultor ou fale com o nosso time de teleendas pelo (33) 3277-3030.

Fotos meramente ilustrativas. As informações/configurações de produtos poderão sofrer alterações sem aviso prévio.



GRUPO
JPP

Avenida Industrial 312, Distrito Industrial
Governador Valadares - Minas Gerais/Brasil

bike@grujpp.com.br

(33) 3277-3030

www.grujpp.com.br





GIYO
Pro S444

GIYO



GIYO

BOMBA DE AR MANUAL ALUM. P/ SUSP

CARACTERÍSTICA

- Bomba para suspensão
- Marca giyo
- Pressão máxima 300 psi/ 20.7 Bar
- Alumínio

INFORMAÇÕES COMPLEMENTARES

- Válvula Schrader acoplada fácil com alavanca;
- Suspensão traseira 300-psi e suspensão dianteira;
- Sistema de borracha selado não-risco na cabeça da bomba;
- Base de calibre fundido;
- Mangueira giratória 360° projetada para fácil bombeamento;
- Punho macio de 2 tons.

MATERIAL

Alumínio

TAMANHO

Tamanho 25.5cm

PESO

224g

EMBALAGEM

10 unidades

CÓDIGO

23584

FOTOS MERAMENTE ILUSTRATIVAS. AS INFORMAÇÕES/CONFIGURAÇÕES DE PRODUTOS PODERÃO SOFRER ALTERAÇÕES SEM AVISO PRÉVIO.

ENTRE EM CONTATO COM O SEU CONSULTOR OU FALE COM O NOSSO TIME DE TELEVENDAS PELO (33) 3277-3030.



BOMBA DE AR MANUAL ALUM. MOD.01

CARACTERÍSTICA

- Bomba para suspensão
- Marca giyo
- Pressão máxima 120 psi
- Alumínio

INFORMAÇÕES COMPLEMENTARES

- Excelente acabamento
- Alça em t
- Compatível com válvula presta e americana
- Acompanha velcro e suporte de fixação para o quadro
- Modelo GP-92T

MATERIAL

Alumínio

PESO

186g

EMBALAGEM

10 unidades

CÓDIGO

23585

FOTOS MERAMENTE ILUSTRATIVAS. AS INFORMAÇÕES/CONFIGURAÇÕES DE PRODUTOS PODERÃO SOFRER ALTERAÇÕES SEM AVISO PRÉVIO.

ENTRE EM CONTATO COM O SEU CONSULTOR OU FALE COM O NOSSO TIME DE TELEVENDAS PELO (33) 3277-3030.

GIJO



BOMBA DE AR MANUAL ALUM. MOD.02

CARACTERÍSTICA

- Bomba para suspensão
- Marca giyo
- Pressão máxima 120 psi
- Alumínio

INFORMAÇÕES COMPLEMENTARES

- Excelente acabamento
- Alça em t
- Compatível com válvula presta e americana
- Acompanha velcro e suporte de fixação para o quadro
- Modelo GP-94C
- Manômetro

MATERIAL

Alumínio

PESO

178g

EMBALAGEM

10 unidades

CÓDIGO

23586



AVENIDA INDUSTRIAL 312, DISTRITO INDUSTRIAL
GOVERNADOR VALADARES - MINAS GERAIS/BRASIL

BIKE@GRUPOJPP.COM.BR

(33) 3277-3030

WWW.GRUPOJPP.COM.BR



GRUPO
JPP