



Synology FlashStation FS3017

Hardware Installation Guide

Table of Contents

Chapter 1: Before You Start

| | |
|--|---|
| Package Contents..... | 3 |
| Synology FlashStation at a Glance..... | 4 |
| Safety Instructions..... | 5 |

Chapter 2: Hardware Setup

| | |
|---|----|
| Tools and Parts for Drive Installation..... | 6 |
| Install Drives..... | 6 |
| Add a RAM Module on FlashStation..... | 8 |
| Attach PCIe Add-on Cards to the FlashStation..... | 12 |
| Replace System Fan..... | 14 |
| Replace Malfunctioning PSU..... | 15 |
| Start Up Your FlashStation..... | 16 |

Chapter 3: Install DSM on FlashStation

| | |
|-------------------------------------|----|
| Install DSM with Web Assistant..... | 17 |
| Learn More..... | 17 |

Appedix A: Specifications



Appedix B: LED Indicator Table

Before You Start

Thank you for purchasing this Synology product! Before setting up your new FlashStation, please check the package contents to verify that you have received the items below. Also, make sure to read the safety instructions carefully to avoid harming yourself or damaging your FlashStation.

Note: All images below are for illustrative purposes only, and may differ from the actual product.

Package Contents

| Main unit x 1 | AC power cord x 2 |
|--|--|
|  |  |
| | <p data-bbox="1043 882 1334 904">Screws for 2.5" drives x 100</p>  |



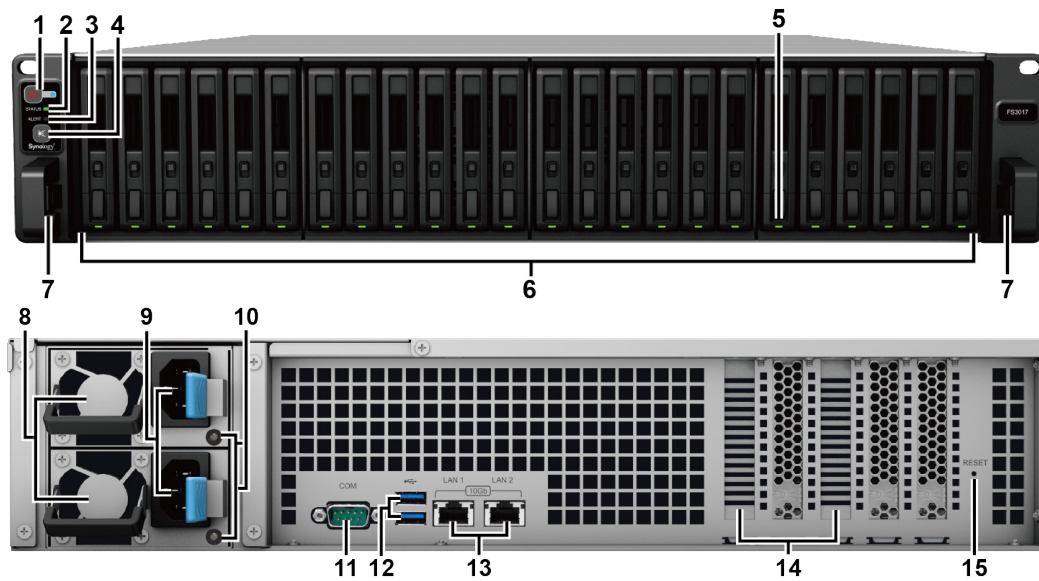



Synology FlashStation at a Glance



| No. | Article Name | Location | Description |
|-----|----------------------------|----------|---|
| 1 | Power Button and Indicator | Front | 1. Press to power on the FlashStation. 2. To power off the FlashStation, press and hold until you hear a beep sound and the Power LED starts blinking. |
| 2 | Status Indicator | | Displays the status of the system. For more information, see "Appendix B: LED Indicator Table". |
| 3 | Alert Indicator | | Displays warnings regarding fan or temperature. For more information, see "Appendix B: LED Indicator Table". |
| 4 | Beep Off Button | | Press to deactivate the beeping sound that is emitted when a malfunction occurs. |
| 5 | Drive Status Indicator | | Displays the status of drives. For more information, see "Appendix B: LED Indicator Table". |
| 6 | Drive Tray | | Install drives (hard disk drives or solid state drives) here. |
| 7 | Rail Kit Release Tab | | Push in and hold to release the FlashStation from the rail kit lock. ¹ |
| 8 | PSU Fan | Back | Disposes of excess heat and cools the PSU. |
| 9 | Power Port | | Connect power cords here. |
| 10 | PSU Indicator | | Displays the status of the power supply unit (PSU). For more information, see "Appendix B: LED Indicator Table". |
| 11 | Console Port | | This port is used for manufacturing use only. |
| 12 | USB 3.0 Port | | Connect external drives, USB printers, or other USB devices to the FlashStation here. |
| 13 | LAN Port | | Connect RJ-45 network cables here. |
| 14 | PCI Express Expansion Slot | | Supports two PCIe add-on cards. |
| 15 | RESET Button | | 1. Press and hold until you hear a beep sound to restore the default IP address, DNS server, and password for the admin account. 2. Press and hold until you hear a beep sound, then press and hold again until you hear three beep sounds to return the FlashStation to "Not Installed" status so that DiskStation Manager (DSM) can be reinstalled. |

¹ For more information about the rail kit installation, please refer to the Quick Installation Guide that comes with the rail kit.

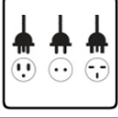
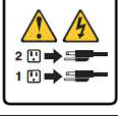
Safety Instructions

| | |
|---|---|
|  | <p>Keep away from direct sunlight and away from chemicals. Make sure the environment does not experience abrupt changes in temperature or humidity.</p> |
|  | <p>Place the product right side up at all times.</p> |
|  | <p>Do not place near any liquids.</p> |
|  | <p>Before cleaning, unplug the power cord. Wipe with damp paper towels. Do not use chemical or aerosol cleaners.</p> |
|  | <p>To prevent the unit from falling over, do not place on carts or any unstable surfaces.</p> |
|  | <p>The power cord must plug in to the correct supply voltage. Make sure that the supplied AC voltage is correct and stable.</p> |
|  | <p>To remove all electrical current from the device, ensure that all power cords are disconnected from the power source.</p> |
|  | <p>Risk of explosion if battery is replaced with an incorrect type. Dispose of used batteries appropriately.</p> |

Hardware Setup

Tools and Parts for Drive Installation

- A screwdriver
- At least one 2.5" SSD (SAS/SATA) or HDD (SAS only) (please visit www.synology.com for compatible drive models.)

Warning: If you install a drive that contains data, the system will format the drive and erase all existing data. Please back up any important data before installation.

Install Drives

- 1 Open the drive tray.

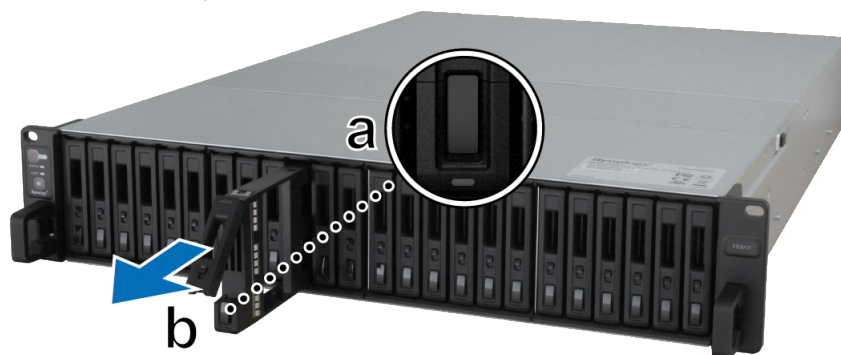

- a Find the small button located on the bottom side of the drive tray handle. Press the button down, and the drive tray handle will pop out.
- b Pull the drive tray handle out as illustrated above.

- 2 Place the drive in the drive tray. Tighten screws into the four spots indicated below to secure the drive.

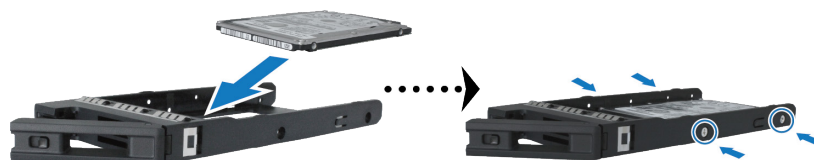

- 3 Insert the loaded drive tray into the empty drive bay.



Note: Make sure the tray is pushed in all the way. Otherwise, the drive might not be able to function properly.

- 4 Push the handle inward to secure the drive tray.
- 5 Push the switch on the drive tray handle to the bottom to lock the drive tray.

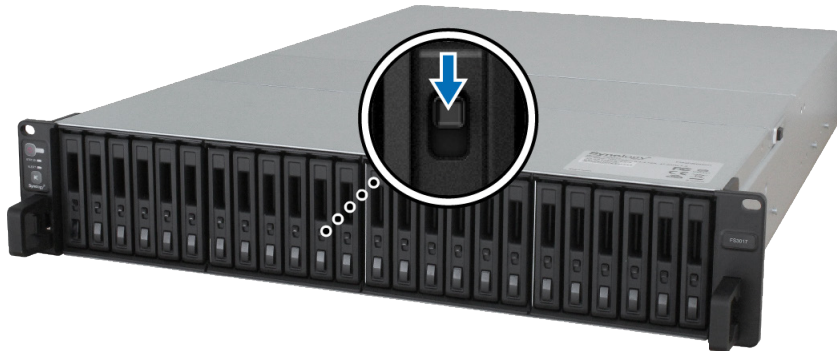

- 6 Repeat the steps above to assemble the other drives you have prepared.
- 7 Drives are numbered as shown below.



Note: If you want to create a RAID volume, we recommend all installed drives be the same size in order to optimize drive capacity usage.

Add a RAM Module on FlashStation

The optional Synology RAM module is designed for FlashStation memory expansion. Follow the steps below to install, check, or remove a RAM module on your FlashStation.

To install the RAM module:

- 1 Shut down your FlashStation. Disconnect all cables connected to your FlashStation to prevent any possible damage.
- 2 Remove the rear top cover:

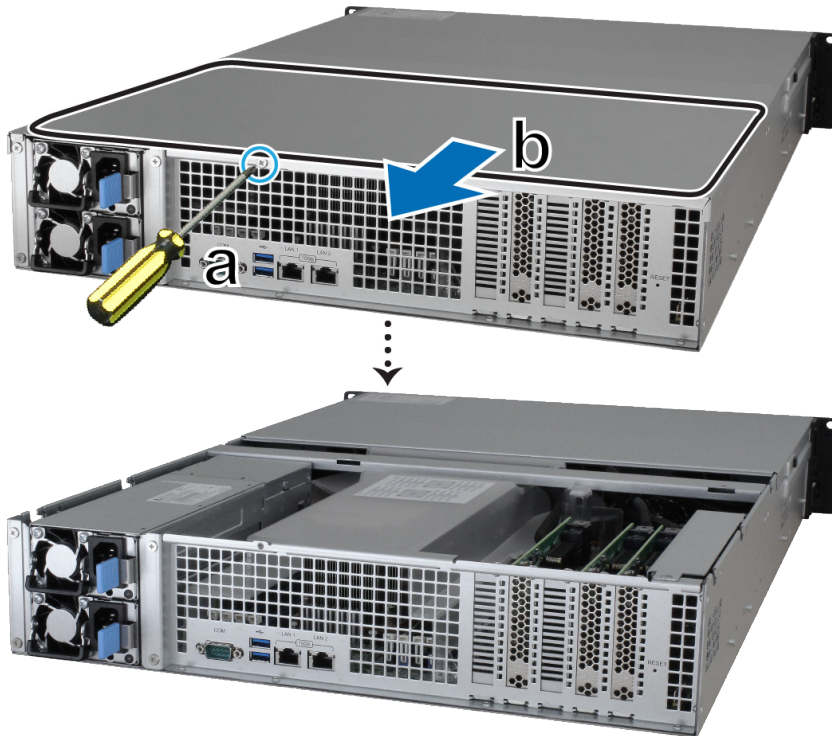

- a Remove the screw on the back of FlashStation.
- b Pull the rear top cover, and put it aside.

Note: When you remove the rear top cover, you expose sensitive internal components. Avoid touching anything other than the memory assembly when you remove or add memory.

- 3 Remove the beam:

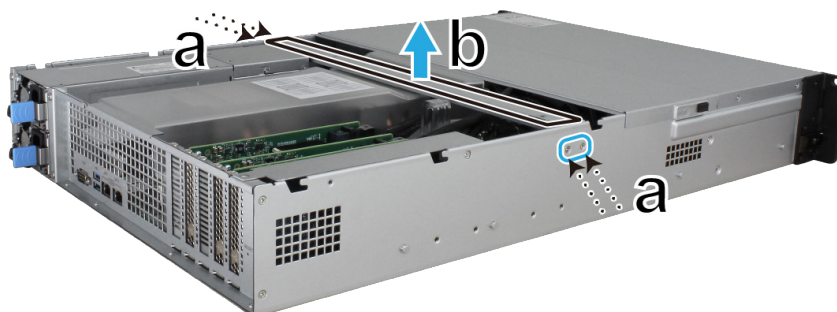

- a remove the 4 screws at both sides of the chassis.
- b Pull up the beam, and put it aside.

4 Unplug the cables numbered 5 and 6 to facilitate the removal of the ventilation duct cover.



5 Remove the 3 screws that secure the ventilation duct cover, pull up the ventilation duct cover, and put it aside.

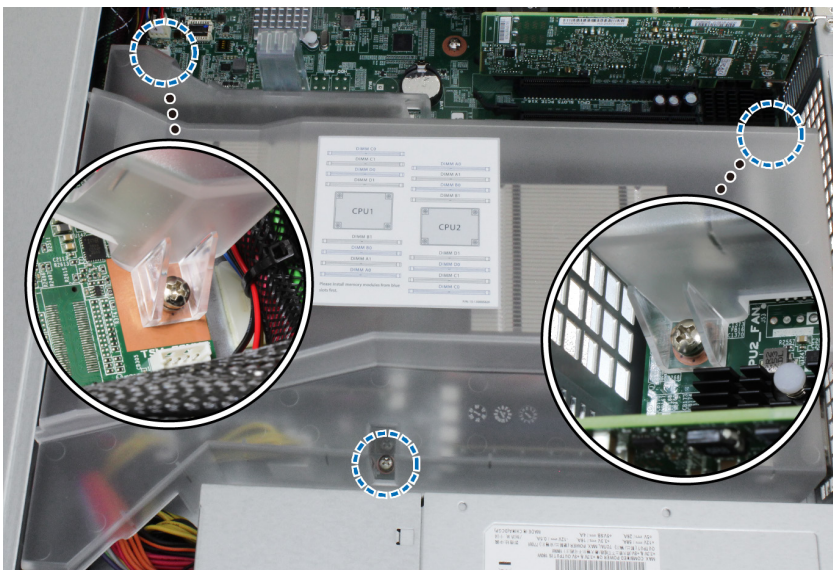

- 6 Insert the new memory module in the slot:
 - a Push the retaining clips on the slot out to the sides.
 - b Align the notch on the gold edge of the module with the notch in the memory slot.
 - c Push down on the memory module with firm and even pressure. The retaining clips will snap into position as the module is correctly inserted.

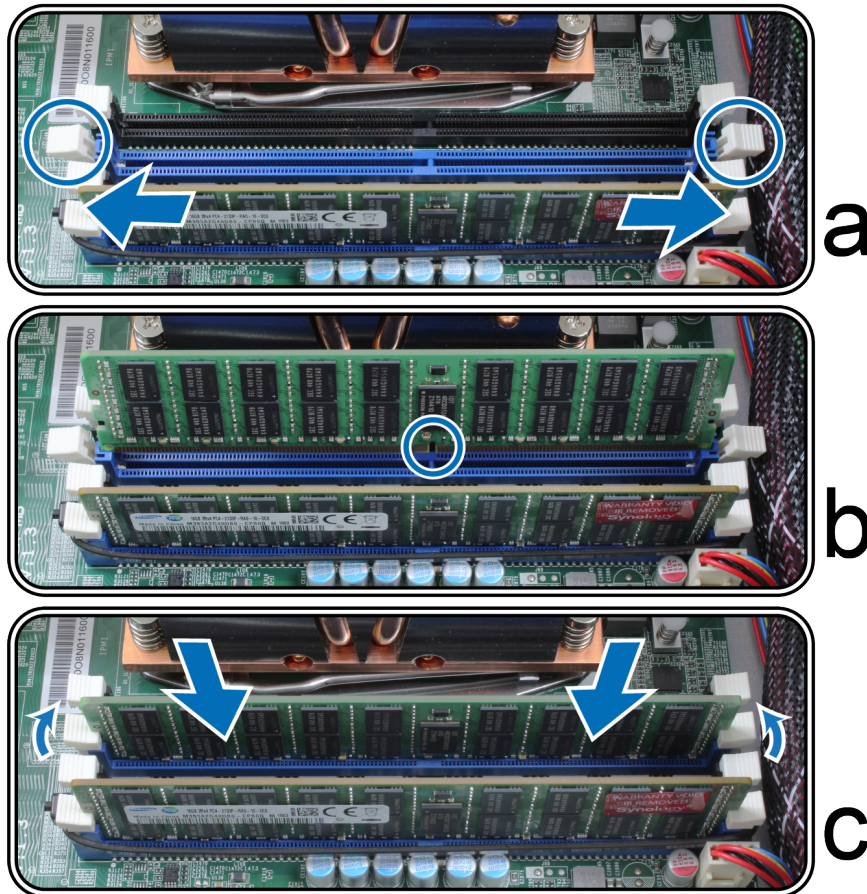

Note: Hold the memory module by its edges, and do not touch the gold connectors.

Important: You must install the memory module onto the blue slots first. Please refer to the sticker (as below) on the ventilation duct cover.

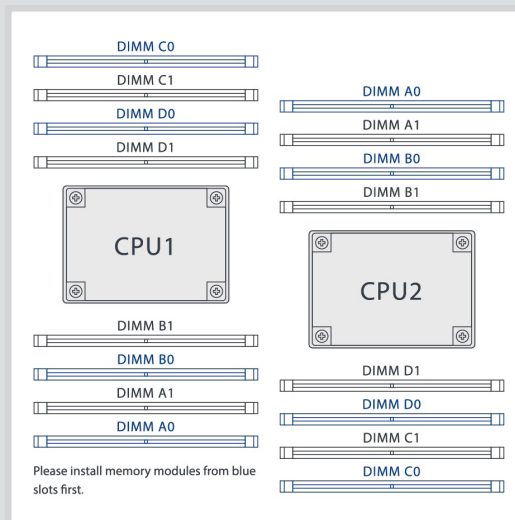

- 7 Put back the parts you removed in previous steps:
 - a Put back the ventilation duct cover, and fasten the 3 screws you removed in step 5.
 - b Connect the cables numbered 5 and 6 you unplugged in step 4.
 - c Put back the beam, and fasten the 4 screws you removed in step 3.
- 8 Put back the rear top cover you lifted in step 2.
 - a Align the round dots at the side of rear top cover with the slots on the chassis' edge, and push the rear top cover back in position.



- b Put back and fasten the screw you removed in step 2-a.

To make sure FlashStation recognizes the new memory capacity:

- 1 Log in to DSM as **admin** or a user belonging to the **administrators** group.
- 2 Check **Total Physical Memory** in **Control Panel > Info Center**.

If your FlashStation does not recognize the memory or does not start up successfully, confirm that the memory is installed correctly.

To remove the RAM Module:

- 1 Follow step 1 to 5 of the “To install the RAM module” section to shut down your FlashStation, disconnect the cables, lift the rear top cover, and then remove the covering parts.
- 2 Disengage the memory retaining clips by pushing them outwards, and the module will pop out of the slot.
- 3 Follow step 7 and 8 of the “To install the RAM module” section to put back the covering parts and top cover.

Attach PCIe Add-on Cards to the FlashStation

Your FlashStation comes with one PCIe x8 slot and one PCIe x16 slot. Follow the steps below to install optional add-on cards¹ to the slots. You may need to replace the long bracket (suited for PC) in your add-on card with the short bracket before installing the card on your FlashStation.

Important: FlashStation FS3017 requires the installation of one **Synology FS3017 Expansion Card** (optional) to connect up to two Synology Expansion Unit RX1217sas/RX2417sas (sold separately), and the expansion card must be installed in the PCIe **x16** slot only. In this case, you can install one network interface card in the other slot. Otherwise, you can install one or two network interface cards in either or both slots.

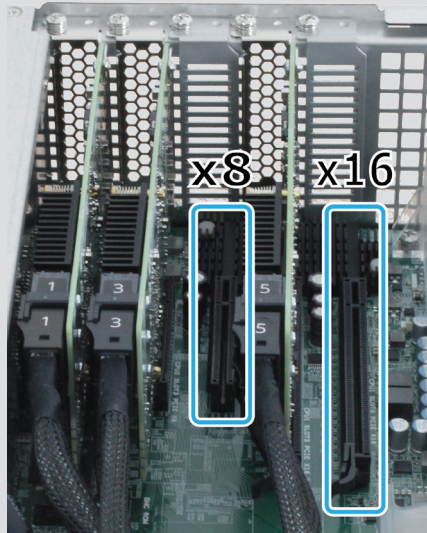

To install the PCIe add-on card:

- 1 Shut down your FlashStation. Disconnect all cables connected to your FlashStation to prevent any possible damages.
- 2 Open the FlashStation by following step 2 of **Add a RAM Module on FlashStation**.
- 3 Install the add-on card.
 - a Remove the screw that secures the expansion slot's cover.
 - b Lift the expansion slot's cover.

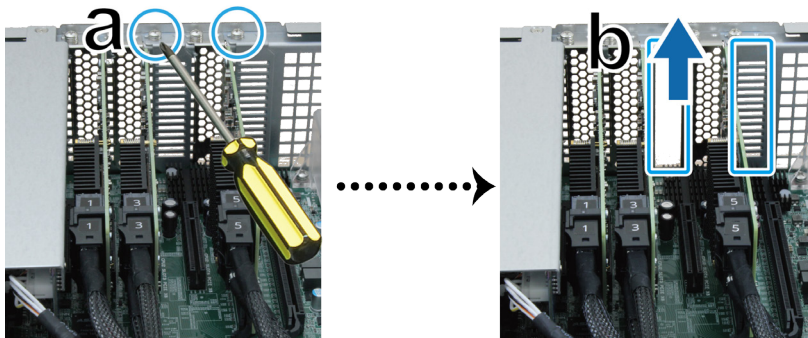

- c Align the card's connector with the expansion slot, and insert the card into the slot.

Note: Make sure the connector is fully inserted. Otherwise, the add-on card might not be able to function properly.

¹ For more information on supported add-on cards, please visit www.synology.com.

d Put back and fasten the screw that you removed in step 3-a so as to secure the newly inserted card.

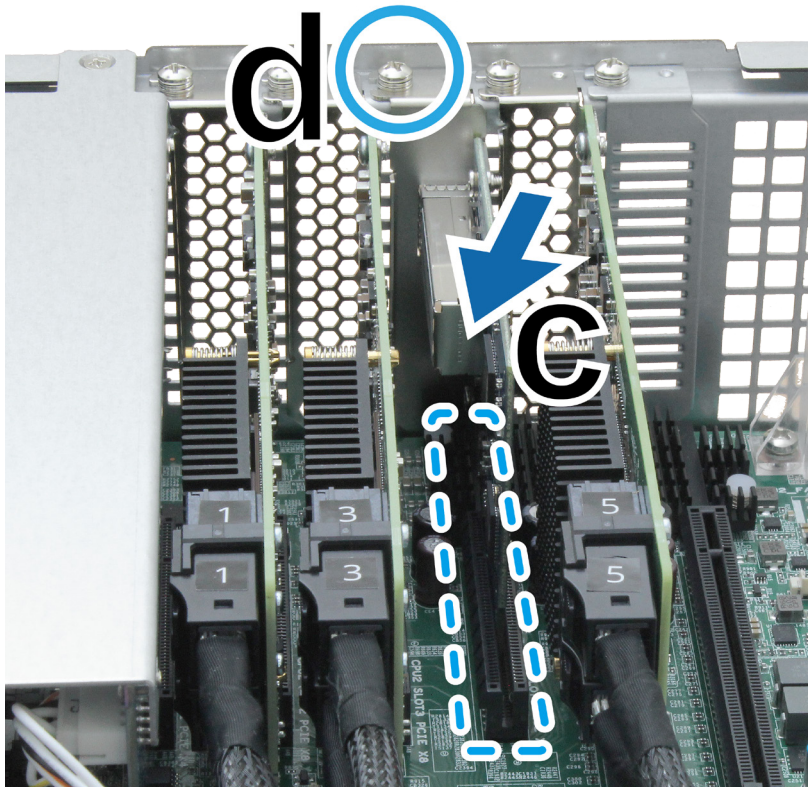

4 Repeat step 3 to install the other add-on card for your FlashStation.

5 Put back the rear top cover by following step 8 of **Add a RAM Module on FlashStation**.

Replace System Fan

If a system fan malfunctions, please see the instructions below to open the FlashStation and replace the malfunctioning fan.

- 1 Press the small buttons located on the sides of the FlashStation.



- 2 Lift to remove the fan cover.



- 3 Fans are numbered as indicated below:

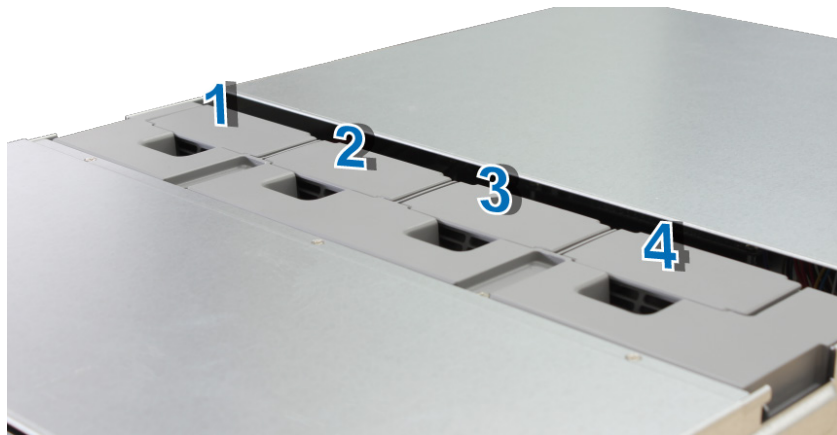

- 4 Find the malfunctioning fan. Lift the fan upward to remove it.

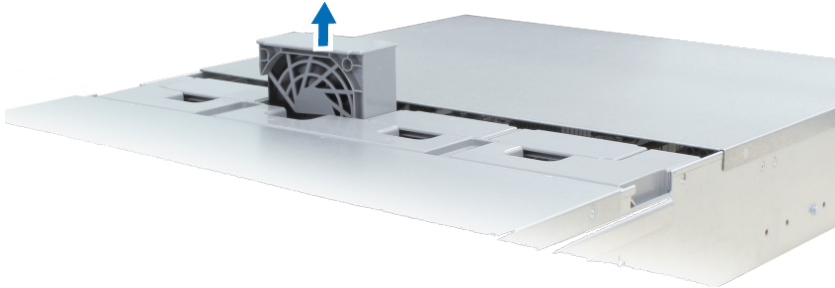

- 5 Prepare a new fan, and slide it into the FlashStation. Make sure the fan is aligned properly as illustrated below.

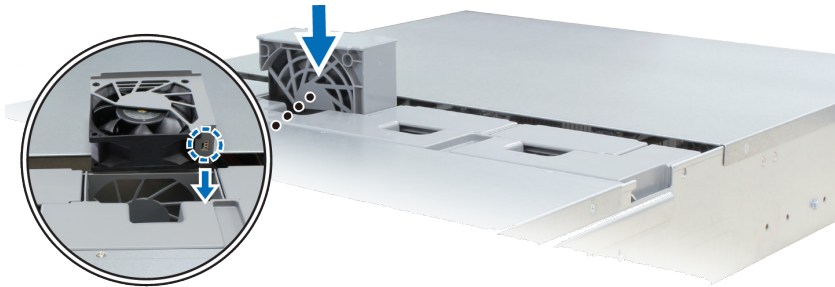

Replace Malfunctioning PSU

If a PSU or its fan malfunctions, please see the instructions below to replace the malfunctioning PSU.

- 1 Unplug the power cord from the PSU to be replaced.

Note: By pressing the **Beep Off** button, you can silence the long beeping sound when you hear it.

- 2 Push the lever of the PSU at the back panel in the indicated direction.
- 3 Pull out the PSU from the FlashStation.

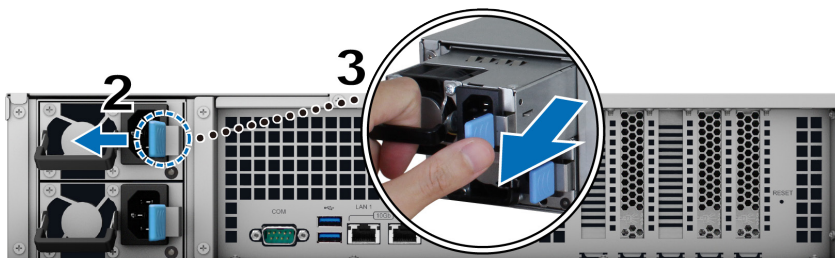

- 4 Prepare a new PSU, and push it back to the slot until you hear a click.

Start Up Your FlashStation

- 1 Connect one end of each power cord to the power ports located on the back of the FlashStation and the other end to a power outlet.
- 2 Connect at least one LAN cable to one of the LAN ports and the other end to your switch, router, or hub.

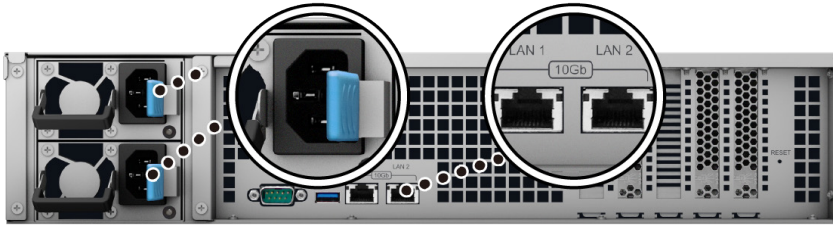

- 3 Press the power button to turn on the FlashStation.

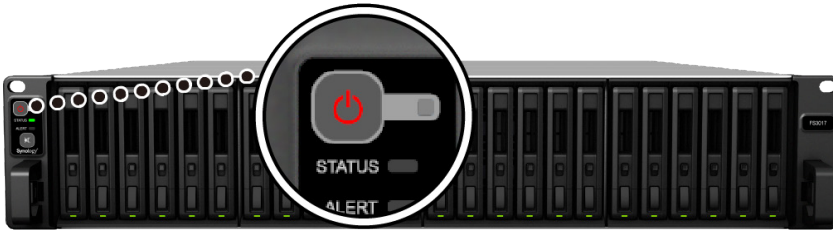

Congratulations! Your FlashStation is now online and detectable from a network computer.

Install DSM on FlashStation

After hardware setup is finished, please install DiskStation Manager (DSM) – Synology's browser-based operating system – on your FlashStation.

Install DSM with Web Assistant

Your FlashStation comes with a built-in tool called **Web Assistant** that helps you download the latest version of DSM from the Internet and install it on your FlashStation. To use Web Assistant, please follow the steps below.

- 1 Power on the FlashStation.
- 2 Open a web browser on a computer connected to the same network as the FlashStation.
- 3 Enter either of the following into the address bar of your browser:
 - a find.synology.com
 - b `flashstation:5000`
- 4 Web Assistant will be launched in your web browser. It will search for and find the FlashStation within the local network. The status of the FlashStation should be **Not Installed**.



- 5 Click **Connect** to start the setup process and follow the onscreen instructions.

Note:

1. The FlashStation must be connected to the Internet to install DSM with Web Assistant.
2. Suggested browsers: Chrome, Firefox.
3. Both the FlashStation and the computer must be in the same local network.

- 6 If you accidentally leave the installation process before it is finished, login to the DSM as **admin** (default administrative account name) with the password left blank.

Learn More

Congratulations! Your FlashStation is now ready for action. For more information or online resources about your FlashStation, please visit www.synology.com.

Specifications

| Item | FS3017 |
|-------------------------|---|
| Internal Drive | 2.5" 12Gb/s SAS drive (SSD and HDD) or 6Gb/s SATA SSD x 24 |
| External Device Port | USB 3.0 x 2 |
| LAN Port | 10GBase-T (RJ-45) x 2 |
| PCIe Slot | <ul style="list-style-type: none"> • PCIe x8 slot x 1, for add-on card (optional) • PCIe x16 slot x 1, for add-on card (optional)¹ |
| Size (H x W x D) (mm) | <ul style="list-style-type: none"> • 88 x 482 x 724 (Including rack mount kits) • 88 x 430.5 x 692 (Not including rack mount kits) |
| Weight (kg) | 17.13 |
| Supported Client | <ul style="list-style-type: none"> • Windows 7 onward • Mac OS X 10.10 onward |
| File System | <ul style="list-style-type: none"> • Internal: Btrfs, ext4 • External: Btrfs, ext4, ext3, FAT, NTFS, HFS+, exFAT² |
| Supported RAID Type | <ul style="list-style-type: none"> • Basic • JBOD • RAID 0 • RAID 1 • RAID 5 • RAID 6 • RAID 10 • RAID F1 |
| Agency Certification | <ul style="list-style-type: none"> • FCC Class A • CE Class A • BSMI Class A |
| HDD Hibernation | Yes |
| Scheduled Power On/Off | Yes |
| Language Localization | <ul style="list-style-type: none"> • English • Deutsch • Français • Italiano • Español • Dansk • Norsk • Svensk • Nederlands • Русский • Polski • Magyar • Português do Brasil • Português Europeu • Türkçe • Český • 日本語 • 한국어 • 繁體中文 • 简体中文 |
| Environment Requirement | <ul style="list-style-type: none"> • Line voltage: 100 to 240V AC • Frequency: 47 to 63Hz • Operating Temperature: 40 to 95°F (5 to 35°C) • Storage Temperature: -5 to 140°F (-20 to 60°C) • Relative Humidity: 5% to 95% RH |

Note: Model specifications are subject to change without notice. Please refer to www.synology.com for the latest information.

¹ FlashStation FS3017 supports only one optional Synology FS3017 Expansion Card, which must be installed in the PCIe x16 slot.

² exFAT Access is purchased separately in Package Center.

LED Indicator Table

| LED Indicator | Color | Status | Description |
|-------------------------------------|--------|-----------------|--|
| Power | Blue | Static | Powered on |
| | | Blinking | Booting up / Shutting down |
| | Off | | Powered off |
| STATUS | Green | Static | Volume normal |
| | Orange | Blinking | Volume degraded / Volume crashed |
| | | | Volume not created |
| | Off | | DSM not installed |
| Off | | HDD hibernation | |
| ALERT | Orange | Blinking | Fan failure / Over temperature |
| | Off | | System normal |
| Drive Status Indicator (on tray) | Green | Static | Drive ready and idle |
| | | Blinking | Accessing drive |
| | Red | Static | Drive error / Port disabled ¹ |
| | Off | | No internal drive |
| PSU Indicator | Green | Static | Power supply unit normal |
| | | Blinking | Power standby / AC present |
| | Red | Static | Power supply failure |
| | Off | | Power supply unit off |
| Rear LAN (on left side of jack) | Green | Static | 10 Gbps connection |
| | Orange | Static | 1 Gbps connection |
| | Off | | 100 Mbps connection / No network |
| Rear LAN (on right side of jack) | Green | Static | Network connected |
| | | Blinking | Network active |
| | Off | | No network |

Note: Model specifications are subject to change without notice. Please refer to www.synology.com for the latest information.

¹ Please try to restart your FlashStation or re-insert the drive(s), and then run the HDD/SSD manufacturer's diagnostic tool to check the health status of the drive(s). If you can log into DSM, please run the built-in S.M.A.R.T. test to scan the drive(s). If the problem remains unresolved, please contact Synology Technical Support for help.

SYNOLOGY, INC.
END USER LICENSE AGREEMENT

IMPORTANT—READ CAREFULLY: THIS END USER LICENSE AGREEMENT ("EULA") IS A LEGAL AGREEMENT BETWEEN YOU (EITHER AN INDIVIDUAL OR A LEGAL ENTITY) AND SYNOLOGY, INC. ("SYNOLOGY") FOR THE SYNOLOGY SOFTWARE INSTALLED ONTO THE SYNOLOGY PRODUCT PURCHASED BY YOU (THE "PRODUCT"), OR LEGALLY DOWNLOADED FROM WWW.SYNOLOGY.COM, OR ANY OTHER CHANNEL PROVIDED BY SYNOLOGY ("SOFTWARE").

YOU AGREE TO BE BOUND BY THE TERMS OF THIS EULA BY USING THE PRODUCTS CONTAINING THE SOFTWARE, INSTALLING THE SOFTWARE ONTO THE PRODUCTS OR DEVICE CONNECTED TO THE PRODUCTS. IF YOU DO NOT AGREE TO THE TERMS OF THIS EULA, DO NOT USE THE PRODUCTS CONTAINING THE SOFTWARE OR DOWNLOAD THE SOFTWARE FROM WWW.SYNOLOGY.COM, OR ANY OTHER CHANNEL PROVIDED BY SYNOLOGY. INSTEAD, YOU MAY RETURN THE PRODUCT TO THE RESELLER WHERE YOU PURCHASED IT FOR A REFUND IN ACCORDANCE WITH THE RESELLER'S APPLICABLE RETURN POLICY.

Section 1. Limited Software License. Subject to the terms and conditions of this EULA, Synology grants you a limited, non-exclusive, non-transferable, personal license to install, run and use one copy of the Software loaded on the Product or on your device connected to the Product solely relating to your authorized use of the Product.

Section 2. Documentation. You may make and use a reasonable number of copies of any documentation provided with the Software; provided that such copies will only be used for internal business purposes and are not to be republished or redistributed (either in hard copy or electronic form) to any third party.

Section 3. Backup. You may make a reasonable number of copies of the Software for backup and archival purposes only.

Section 4. Updates. Any software provided to you by Synology or made available on the Synology website at www.synology.com ("Website") or any other channel provided by Synology that updates or supplements the original Software is governed by this EULA unless separate license terms are provided with such updates or supplements, in which case, such separate terms will govern.

Section 5. License Limitations. The license set forth in Sections 1, 2 and 3 applies only to the extent that you have ordered and paid for the Product and states the entirety of your rights with respect to the Software. Synology reserves all rights not expressly granted to you in this EULA. Without limiting the foregoing, you shall not authorize or permit any third party to: (a) use the Software for any purpose other than that in connection with the Product; (b) license, distribute, lease, rent, lend, transfer, assign or otherwise dispose of the Software; (c) reverse engineer, decompile, disassemble or attempt to discover the source code of or any trade secrets related to the Software, except and only to the extent that such conduct is expressly permitted by applicable law notwithstanding this limitation; (d) adapt, modify, alter, translate or create any derivative works of the Software; (e) remove, alter or obscure any copyright notice or other proprietary rights notice on the Software or Product; or (f) circumvent or attempt to circumvent any methods employed by Synology to control access to the components, features or functions of the Product or Software. Subject to the limitations specified in this Section 5, you are not prohibited from providing any services hosted by Synology Product to any third party for commercial purpose.

Section 6. Open Source. The Software may contain components licensed to Synology under the GNU General Public License ("GPL Components"), currently available at <http://www.gnu.org/licenses/gpl.html>. The terms of the GPL will control solely with respect to the GPL Components to the extent that this EULA conflicts with the requirements of the GPL with respect to your use of the GPL Components, and, in such event, you agree to be bound by the GPL with respect to your use of such components.

Section 7. Audit. Synology will have the right to audit your compliance with the terms of this EULA. You agree to grant

Synology a right to access to your facilities, equipment, books, records and documents and to otherwise reasonably cooperate with Synology in order to facilitate any such audit by Synology or its agent authorized by Synology.

Section 8. Ownership. The Software is a valuable property of Synology and its licensors, protected by copyright and other intellectual property laws and treaties. Synology or its licensors own all rights, titles and interests in and to the Software, including but not limited to copyright and any other intellectual property rights.

Section 9. Limited Warranty. Synology provides a limited warrant that the Software will substantially conform to Synology's published specifications for the Software, if any, or otherwise set forth on the Website, for a period required by your local law. Synology will use commercially reasonable efforts to, in Synology's sole discretion, either correct any such nonconformity in the Software or replace any Software that fails to comply with the foregoing warranty, provided that you give Synology written notice of such noncompliance within the warranty period. The foregoing warranty does not apply to any noncompliance resulting from any: (w) use, reproduction, distribution or disclosure not in accordance with this EULA; (x) any customization, modification or other alteration of the Software by anyone other than Synology; (y) combination of the Software with any product, services or other items provided by anyone other than Synology; or (z) your failure to comply with this EULA.

Section 10. Support. During the period specified in the Section 9, Synology will make available to you the support services. Following the expiration of the applicable period, support for Software may be available from Synology upon written request.

Section 11. Disclaimer of Warranties. EXCEPT AS EXPRESSLY SET FORTH ABOVE, THE SOFTWARE IS PROVIDED "AS IS" AND WITH ALL FAULTS. SYNOLOGY AND ITS SUPPLIERS HEREBY DISCLAIM ALL OTHER WARRANTIES, EXPRESS, IMPLIED OR STATUTORY, ARISING BY LAW OR OTHERWISE, INCLUDING BUT NOT LIMITED TO ANY IMPLIED WARRANTIES OF MERCHANTABILITY, FITNESS FOR A PARTICULAR PURPOSE OR USE, TITLE AND NONINFRINGEMENT, WITH REGARD TO THE SOFTWARE. WITHOUT LIMITING THE FOREGOING, SYNOLOGY DOES NOT WARRANT THAT THE SOFTWARE WILL BE FREE OF BUGS, ERRORS, VIRUSES OR OTHER DEFECTS.

Section 12. Disclaimer of Certain Damages. IN NO EVENT WILL SYNOLOGY OR ITS LICENSORS BE LIABLE FOR ANY INCIDENTAL, INDIRECT, SPECIAL, PUNITIVE, CONSEQUENTIAL OR SIMILAR DAMAGES OR LIABILITIES WHATSOEVER (INCLUDING, BUT NOT LIMITED TO LOSS OF DATA, INFORMATION, REVENUE, PROFIT OR BUSINESS) ARISING OUT OF OR RELATING TO THE USE OF OR INABILITY TO USE THE SOFTWARE OR OTHERWISE UNDER OR IN CONNECTION WITH THIS EULA OR THE SOFTWARE, WHETHER BASED ON CONTRACT, TORT (INCLUDING NEGLIGENCE), STRICT

LIABILITY OR OTHER THEORY EVEN IF SYNOLOGY HAS BEEN ADVISED OF THE POSSIBILITY OF SUCH DAMAGES.

Section 13. Limitation of Liability. SYNOLOGY'S AND ITS SUPPLIERS' LIABILITY ARISING OUT OF OR RELATING TO THE USE OF OR INABILITY TO USE THE SOFTWARE OR OTHERWISE UNDER OR IN CONNECTION WITH THIS EULA OR THE SOFTWARE IS LIMITED TO THE AMOUNT ACTUALLY PAID BY YOU FOR THE PRODUCT REGARDLESS OF THE AMOUNT OF DAMAGES YOU MAY INCUR AND WHETHER BASED ON CONTRACT, TORT (INCLUDING NEGLIGENCE), STRICT LIABILITY OR OTHER THEORY. The foregoing disclaimer of warranties, disclaimer of certain damages and limitation of liability will apply to the maximum extent permitted by applicable law. The laws of some states/jurisdictions do not allow the exclusion of implied warranties or the exclusion or limitation of certain damages. To the extent that those laws apply to this EULA, the exclusions and limitations set forth above may not apply to you.

Section 14. Export Restrictions. You acknowledge that the Software is subject to U.S. export restrictions. You agree to comply with all applicable laws and regulations that apply to the Software, including without limitation the U.S. Export Administration Regulations.

Section 15. Termination. Without prejudice to any other rights, Synology may terminate this EULA if you do not abide by the terms and conditions contained herein. In such event, you must cease use of the Software and destroy all copies of the Software and all of its component parts.

Section 16. Assignment. You may not transfer or assign your rights under this EULA to any third party, except for that pre-installed in the Products. Any such transfer or assignment in violation of the foregoing restriction will be void.

Section 17. Applicable Law. Unless expressly prohibited by local law, this EULA is governed by and construed in accordance with the laws of the Republic of China (R.O.C. or Taiwan) without regard to any conflict of law principles to the contrary.

Section 18. Dispute Resolution. Any dispute, controversy or claim arising out of or relating to this EULA will be resolved exclusively and finally by arbitration conducted by three neutral arbitrators in accordance with the procedures of the R.O.C. Arbitration Law and related enforcement rules. In such cases, the arbitration will be limited solely to the dispute between you and Synology. The arbitration, or any portion of it, will not be consolidated with any other arbitration and will not be conducted on a class-wide or class action basis. The arbitration shall take place in Taipei, Taiwan, R.O.C., and the arbitration proceedings shall be conducted in English or, if both parties so agree, in Mandarin Chinese. The arbitration award shall be final and binding on the parties and may be enforced in any court having jurisdiction. You understand that, in the absence of this provision, you would have had a right to litigate any such dispute, controversy or claim in a court, including the right to litigate claims on a class-wide or class-action basis, and you expressly and knowingly waives those rights and agrees to resolve any disputes through binding arbitration in accordance with the provisions of this Section 18. Nothing in this Section shall be deemed to prohibit or restrict Synology from seeking injunctive relief or seeking such other rights and remedies as it may have at law or equity for any actual or threatened breach of any provision of this EULA relating to Synology's intellectual property rights.

Section 19. Attorneys' Fees. In any arbitration, mediation, or other legal action or proceeding to enforce rights or remedies under this EULA, the prevailing party will be entitled to recover, in addition to any other relief to which it may be entitled, costs and reasonable attorneys' fees.

Section 20. Severability. If any provision of this EULA is held by a court of competent jurisdiction to be invalid, illegal, or unenforceable, the remainder of this EULA will remain in full force and effect.

Section 21. Entire Agreement. This EULA sets forth the entire agreement of Synology and you with respect to the Software and the subject matter hereof and supersedes all prior and contemporaneous understandings and agreements whether written or oral. No amendment, modification or waiver of any of the provisions of this EULA will be valid unless set forth in a written instrument signed by the party to be bound thereby.

SYNOLOGY, INC.
LIMITED PRODUCT WARRANTY

THIS LIMITED WARRANTY ("WARRANTY") APPLIES TO THE PRODUCTS (AS DEFINED BELOW) OF SYNOLOGY, INC. AND ITS AFFILIATES, INCLUDING SYNOLOGY AMERICA CORP, (COLLECTIVELY, "SYNOLOGY"). YOU ACCEPT AND AGREE TO BE BOUND BY THE TERMS OF THIS WARRANTY BY OPENING THE PACKAGE CONTAINING AND/OR USING THE PRODUCT. IF YOU DO NOT AGREE TO THE TERMS OF THIS WARRANTY, DO NOT USE THE PRODUCT. INSTEAD, YOU MAY RETURN THE PRODUCT TO THE RESELLER WHERE YOU PURCHASED IT FOR A REFUND IN ACCORDANCE WITH THE RESELLER'S APPLICABLE RETURN POLICY.

Section 1. Definitions. (a) "New Product", including: (1) "Category I Product" means Synology product models RS810+, RS810RP+, RX410, all FS-series models, all DS/RS NAS models with the XS+/XS suffix (except RS3413xs+) in or after 13-series, all DX/RX/RXD expansion units with 12 or more drive bays in or after 13-series, 10GbE NIC, DDR4-2133 and DDR3-1600 memory modules. (2) "Category II Product" means Synology product models RS3413xs+, RS3412xs, RS3412RPxs, RS3411xs, RS3411RPxs, RS2211+, RS2211RP+, RS411, RS409RP+, RS409+, RS409, RS408-RP, RS408, RS407, DS3612xs, DS3611xs, DS2411+, DS1511+, DS1010+, DS509+, DS508, EDS14, RX1211, RX1211RP, RX4, DX1211, DX510, DX5, NVR216, VS360HD, VS240HD, and all other memory modules not included in Category I. (3) "Category III Product" means Synology product models that apply with the following requirements: all DS NAS models without the XS+/XS suffix and with 5 and more drive bays in or after 12-series, all RS NAS models without the XS+/XS suffix in or after 12-series, and all DX/RX expansion units with 4 or 5 drive bays in or after 12-series. (4) "Category IV Product" means all other Synology product models purchased by Customer after March 1, 2008. (5) "Category V Product" means all other Synology product models purchased by Customer before February 29, 2008. (b) "Refurbished Product" means all Synology products which have been refurbished and sold directly by Synology through Online Store, not including those sold by an authorized Synology distributor or reseller. (c) "Customer" means the original person or entity purchasing the Product from Synology or an authorized Synology distributor or reseller. (d) "Online Store" means an online shop operated by Synology or Synology's affiliate. (e) "Product" means a New Product or a Refurbished Product and any hardware incorporated into the Product by Synology and any accompanying documentation. (f) "Software" means the Synology proprietary software that accompanies the Product when purchased by Customer, is downloaded by Customer at the Web Site, or is pre-installed on the Product by Synology, and includes any firmware, associated media, images, animations, video, audio, text and applets incorporated into the software or Product and any updates or upgrades to such software. (g) "Warranty Period" means the period commencing on the date the Product is purchased by Customer and ending (1) five years after such date for Category I Products; (2) three years after such date for Category II & III Products; or (3) two years after such date for Category IV Products; or (4) one year after such date for Category V Products; or (5) 90 days after such date for Refurbished Products, except for those sold as "as is" or with "no warranty" on Online Store. (h) "Web Site" means the Synology web site located at www.synology.com.

Section 2. Limited Warranty and Remedies

2.1 Limited Warranty. Subject to Section 2.6, Synology warrants to Customer that each Product (a) will be free of material defects in workmanship and (b) under normal use will perform substantially in accordance with Synology's published specifications for the Product during the Warranty Period. Synology warrants the Software as set forth in the accompanying end user license agreement provided with the Product, if any. Synology provides no warranty to Refurbished Product sold as "as is" or with "no warranty" on Online Store.

2.2 Exclusive Remedy. If Customer gives notice of noncompliance with any of the warranties set forth in Section 2.1 within the applicable Warranty Period in the manner set forth below, then, upon verification of the noncompliance by Synology, Synology will, at Synology's option: (a) use commercially reasonable efforts to repair the Product, or (b) replace the noncomplying Product or part thereof upon return of the complete Product in accordance with Section 2.3. The foregoing sets forth Synology's entire liability and Customer's sole and exclusive remedy for any breach of warranty under Section 2.1 or any other defect or deficiency in the Product. Customer will reasonably assist Synology to diagnose and validate any nonconformity with the Product. The warranty set forth in Section 2.1 does not include: (1) any warranty relating to the Software; (2) physical installation or removal of the Product from Customer's site; (3) visits to Customer's site; (4) labor necessary to effect repairs or replace defective parts other than during Synology's or its contracted service providers' normal local business hours, exclusive of weekends and service providers' holidays; (5) any work with any third party equipment or software; (6) any warranty of the hard disk if installed by Customer or any other third party; or (7) any warranty of compatibility with the hard disk.

2.3 Return. Any Product returned by Customer under Section 2.2 must be assigned a Return Merchandise Authorization ("RMA") number by Synology before shipment and must be returned in accordance with Synology's then current RMA procedures. Customer may contact any authorized Synology distributor or reseller or Synology Support to obtain assistance in obtaining an RMA, and must provide proof of purchase and product serial number when asking for such assistance. For warranty claims, Customer must return the complete Product to Synology in accordance with this Section 2.3 to be eligible for coverage under this Warranty. Any Product returned without an RMA number, or any Product that has been disassembled (except under the direction of Synology) will be refused and returned to Customer at Customer's expense. Any Product that has been assigned a RMA number must be returned in the same condition as it was received from Synology to the address designated by Synology, freight pre-paid, in packaging sufficient to protect the contents thereof and with the RMA number prominently displayed on the outside of the box. Customer is responsible for insurance and risk of loss with respect to returned items until they are properly received by Synology. A Product issued a RMA number must be returned within fifteen (15) days after issuance of the applicable RMA number.

2.4 Replacement by Synology. If Synology elects to replace any Product under this Warranty set forth in Section 2.1, then Synology will ship a replacement Product at Synology's expense via the shipping method selected by Synology after receipt of the nonconforming Product returned in accordance with Section 2.3 and validation by Synology that the Product does not conform to the warranty. In some countries, Synology may at its own discretion apply the Synology Replacement Service to certain Products, through which Synology will ship a replacement Product to Customer before its receipt of the nonconforming Product returned by Customer ("Synology Replacement Service").

2.5 Support. During the Warranty Period, Synology will make available to Customer the support services. Following

the expiration of the applicable Warranty Period, support for Products may be available from Synology upon written request.

2.6 Exclusions. The foregoing warranties and warranty obligations do not apply to any Product that (a) has been installed or used in a manner not specified or described in the Product specifications; (b) has been repaired, modified or altered by anyone other than Synology or its agent or designee; (c) has been in any way misused, abused, or damaged; (d) has been used with items not provided by Synology other than the hardware or software for which the Product is designed; or (e) otherwise fails to conform to the Product specifications and such failure is attributable to causes not within or under Synology's control. Further, the foregoing warranties will be void if (1) Customer disassembles the Product except as authorized by Synology; (2) Customer fails to implement any correction, modification, enhancement, improvement or other update made available to Customer by Synology; or (3) Customer implements, installs or uses any correction, modification, enhancement, improvement or other update made available by any third party. The warranty set forth in Section 2.1 will terminate upon Customer's sale or transfer of the Product to a third party.

2.7 Disclaimer of Warranties. THE WARRANTIES, OBLIGATIONS, AND LIABILITIES OF SYNOLOGY AND THE REMEDIES OF CUSTOMER SET FORTH IN THIS WARRANTY ARE EXCLUSIVE AND IN SUBSTITUTION FOR, AND CUSTOMER HEREBY WAIVES, RELEASES AND DISCLAIMS, ALL OTHER WARRANTIES, OBLIGATIONS AND LIABILITIES OF SYNOLOGY AND ALL OTHER RIGHTS, CLAIMS AND REMEDIES OF CUSTOMER AGAINST SYNOLOGY, EXPRESS OR IMPLIED, ARISING BY LAW OR OTHERWISE, WITH RESPECT TO THE PRODUCT, ACCOMPANYING DOCUMENTATION OR SOFTWARE AND ANY OTHER GOODS OR SERVICES DELIVERED UNDER THIS WARRANTY, INCLUDING, BUT NOT LIMITED TO ANY: (A) IMPLIED WARRANTY OF MERCHANTABILITY OR FITNESS FOR A PARTICULAR PURPOSE OR USE; (B) IMPLIED WARRANTY ARISING FROM COURSE OF PERFORMANCE, COURSE OF DEALING, OR USAGE OF TRADE; (C) CLAIM OF INFRINGEMENT OR MISAPPROPRIATION; OR (D) CLAIM IN TORT (WHETHER BASED ON NEGLIGENCE, STRICT LIABILITY, PRODUCT LIABILITY OR OTHER THEORY). SYNOLOGY MAKES NO GUARANTEE AND SPECIFICALLY DISCLAIMS ANY WARRANTY THAT THE DATA OR INFORMATION STORED ON ANY SYNOLOGY PRODUCT WILL BE SECURE AND WITHOUT RISK OF DATA LOSS. SYNOLOGY RECOMMENDS THAT CUSTOMER TAKES APPROPRIATE MEASURES TO BACK UP THE DATA STORED ON THE PRODUCT. SOME STATES/JURISDICTIONS DO NOT ALLOW LIMITATIONS ON IMPLIED WARRANTIES, SO THE ABOVE LIMITATION MAY NOT APPLY TO CUSTOMER.

Section 3. Limitations of Liability

3.1 Force Majeure. Synology will not be liable for, or be considered to be in breach of or default under this Warranty on account of, any delay or failure to perform as required by this Warranty as a result of any cause or condition beyond its reasonable control (including, without limitation, any act or failure to act by Customer).

3.2 Disclaimer of Certain Damages. IN NO EVENT WILL SYNOLOGY OR ITS SUPPLIERS BE LIABLE FOR THE COST OF COVER OR FOR ANY INCIDENTAL, INDIRECT, SPECIAL, PUNITIVE, CONSEQUENTIAL OR SIMILAR DAMAGES OR LIABILITIES WHATSOEVER (INCLUDING, BUT NOT LIMITED TO LOSS OF DATA, INFORMATION, REVENUE, PROFIT OR BUSINESS) ARISING OUT OF OR RELATING TO THE USE OR INABILITY TO USE THE PRODUCT, ANY

ACCOMPANYING DOCUMENTATION OR SOFTWARE AND ANY OTHER GOODS OR SERVICES PROVIDED UNDER THIS WARRANTY, WHETHER BASED ON CONTRACT, TORT (INCLUDING NEGLIGENCE), STRICT LIABILITY OR OTHER THEORY EVEN IF SYNOLOGY HAS BEEN ADVISED OF THE POSSIBILITY OF SUCH DAMAGES.

3.3 Limitation of Liability. SYNOLOGY'S AND ITS SUPPLIERS' LIABILITY ARISING OUT OF OR RELATING TO THE USE OR INABILITY TO USE THE PRODUCT, ANY ACCOMPANYING DOCUMENTATION OR SOFTWARE AND ANY OTHER GOODS OR SERVICES PROVIDED UNDER THIS WARRANTY IS LIMITED TO THE AMOUNT ACTUALLY PAID BY CUSTOMER FOR THE PRODUCT REGARDLESS OF THE AMOUNT OF DAMAGES CUSTOMER MAY INCUR AND WHETHER BASED ON CONTRACT, TORT (INCLUDING NEGLIGENCE), STRICT LIABILITY OR OTHER THEORY. The foregoing disclaimer of certain damages and limitation of liability will apply to the maximum extent permitted by applicable law. The laws of some states/jurisdictions do not allow exclusion or limitation of certain damages. To the extent that those laws apply to the Product, the exclusions and limitations set forth above may not apply to Customer.

Section 4. Miscellaneous

4.1 Proprietary Rights. The Product and any accompanying Software and documentation provided with the Product include proprietary and intellectual property rights of Synology and its third party suppliers and licensors. Synology retains and reserves all right, title, and interest in the intellectual property rights of the Product, and no title to or ownership of any intellectual property rights in or to the Product, any accompanying Software or documentation and any other goods provided under this Warranty is transferred to Customer under this Warranty. Customer will (a) comply with the terms and conditions of the Synology end user license agreement accompanying any Software furnished by Synology or an authorized Synology distributor or reseller; and (b) not attempt to reverse engineer any Product or component thereof or accompanying Software or otherwise misappropriate, circumvent or violate any of Synology's intellectual property rights.

4.2 Assignment. Customer will not assign any of its rights under this Warranty directly, by operation of law or otherwise, without the prior written consent of Synology.

4.3 No Additional Terms. Except as expressly permitted by this Warranty, neither party will be bound by, and each party specifically objects to, any term, condition or other provision that conflicts with the provisions of this Warranty that is made by the other party in any purchase order, receipt, acceptance, confirmation, correspondence or otherwise, unless each party specifically agrees to such provision in writing. Further, if this Warranty conflicts with any terms or conditions of any other agreement entered into by the parties with respect to the Product, this Warranty will prevail unless the other agreement specifically references the sections of this Warranty that it supersedes.

4.4 Applicable Law. Unless expressly prohibited by local law, this Warranty is governed by the laws of the State of Washington, U.S.A. without regard to any conflict of law principles to the contrary. The 1980 U.N. Convention on Contracts for the International Sale of Goods or any successor thereto does not apply.

4.5 Dispute Resolution. Any dispute, controversy or claim arising out of or relating to this Warranty, the Product or services provided by Synology with respect to the Product or the relationship between Customers residing within the United States and Synology will be resolved exclusively and finally by arbitration under the current commercial rules of the American Arbitration Association, except as otherwise provided below. The arbitration will be conducted before a

single arbitrator, and will be limited solely to the dispute between Customer and Synology. The arbitration, or any portion of it, will not be consolidated with any other arbitration and will not be conducted on a class-wide or class action basis. The arbitration shall be held in King County, Washington, U.S.A. by submission of documents, by telephone, online or in person as determined by the arbitrator at the request of the parties. The prevailing party in any arbitration or legal action occurring within the United States or otherwise shall receive all costs and reasonable attorneys' fees, including any arbitration fee paid by the prevailing party. Any decision rendered in such arbitration proceedings will be final and binding on the parties, and judgment may be entered thereon in any court of competent jurisdiction. Customer understands that, in the absence of this provision, Customer would have had a right to litigate any such dispute, controversy or claim in a court, including the right to litigate claims on a class-wide or class-action basis, and Customer expressly and knowingly waives those rights and agrees to resolve any disputes through binding arbitration in accordance with the provisions of this Section 4.5. For Customers not residing within the United States, any dispute, controversy or claim described in this section shall be finally resolved by arbitration conducted by three neutral arbitrators in accordance with the procedures of the R.O.C. Arbitration Law and related enforcement rules. The arbitration shall take place in Taipei, Taiwan, R.O.C., and the arbitration proceedings shall be conducted in English or, if both parties so agree, in Mandarin Chinese.

The arbitration award shall be final and binding on the parties and may be enforced in any court having jurisdiction. Nothing in this Section shall be deemed to prohibit or restrict Synology from seeking injunctive relief or seeking such other rights and remedies as it may have at law or equity for any actual or threatened breach of any provision of this Warranty relating to Synology's intellectual property rights.

4.6 Attorneys' Fees. In any arbitration, mediation, or other legal action or proceeding to enforce rights or remedies under this Warranty, the prevailing party will be entitled to recover, in addition to any other relief to which it may be entitled, costs and reasonable attorneys' fees.

4.7 Export Restrictions. You acknowledge that the Product may be subject to U.S. export restrictions. You will comply with all applicable laws and regulations that apply to the Product, including without limitation the U.S. Export Administration Regulations.

4.8 Severability. If any provision of this Warranty is held by a court of competent jurisdiction to be invalid, illegal, or unenforceable, the remainder of this Warranty will remain in full force and effect.

4.9 Entire Agreement. This Warranty constitutes the entire agreement, and supersedes any and all prior agreements, between Synology and Customer related to the subject matter hereof. No amendment, modification or waiver of any of the provisions of this Warranty will be valid unless set forth in a written instrument signed by the party to be bound thereby.

FCC Declaration of Conformity

This device complies with Part 15 of the FCC Rules. Operation is subject to the following two conditions: (1) this device may not cause harmful interference, and (2) this device must accept any interference received, including interference that may cause undesired operation.