

Estancia Basin
New Mexico
Superconducting
Super Collider

Volume 1
Executive Summary



Taos

Los Alamos

SANTA FE

25

Las Vegas

ALBUQUERQUE

40

Santa Rosa

SSC PROJECT SITE

Estancia

Belen

Willard

Vaughn

NEW MEXICO SSC PROPOSAL JULY 31, 1987

Socorro

GARREY CARRUTHERS
Governor



OFFICE of the GOVERNOR
State of New Mexico
Santa Fe 87503

July 24, 1987

Honorable John S. Herrington
Secretary of Energy
Forrestal Building
Washington, DC 20585

Dear Mr. Secretary:

On behalf of the citizens of New Mexico I am honored to submit this proposal for the Estancia Basin as a site for the Superconducting Super Collider, in response to the Invitation for Site Proposals dated April, 1987.

I firmly believe the Estancia Basin is a geologically and geotechnically superior site, in an area where construction costs will be economical. The location is ideal -- only a short commute from Albuquerque, and near Santa Fe where an established and strong infrastructure already supports two national laboratories and numerous other federal, state and private sector facilities. It lies near the hub of the Rio Grande Research Corridor, an emerging center of high technology research and development. The Research Corridor is comprised of more than thirty institutions and three of the state's graduate-level universities, which support five centers of technical excellence and three technological innovation centers. A non-profit corporation, New Mexico Technet, Inc., offers a high quality fiber optic communication and data link system which ties all subscribers' facilities together throughout the Corridor.

New Mexico has a strong commitment to solid support for large federal research projects and institutions, backed by a forty-year tradition and an outstanding record. We also have varied and extensive choices of cultural, educational, recreational and lifestyle resources, offering in combination a superb quality of life. We would be proud to add the Superconducting Super Collider to our array of premier scientific research facilities.



Honorable John S. Herrington
July 24, 1987
Page 2

In accordance with the requirements of the Invitation for Site Proposals, I am enclosing herewith a Certificate of Accuracy and Completeness (Attachment #1); and a list of Authorized Representatives (Attachment #2) who may speak on my behalf with respect to this proposal.

Sincerely,

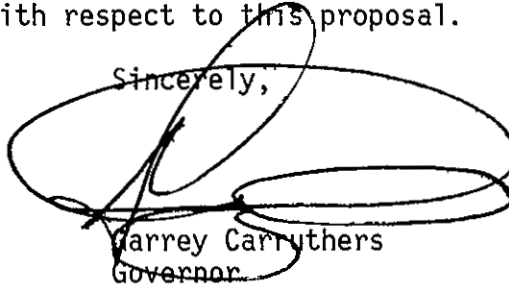
A large, stylized handwritten signature in black ink, consisting of several overlapping loops and a long horizontal stroke at the bottom.

Garrey Carruthers
Governor

GC:st
Attachments (2)

NEW MEXICO SSC PROPOSAL -- JULY 31, 1987

Certificate of Accuracy and Completeness

I hereby certify that the information contained in the New Mexico SSC Proposal, July 31, 1987, is accurate and complete to the best of my knowledge.

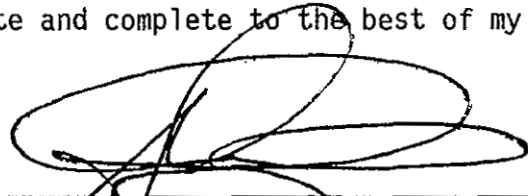

Garvey Carruthers
Governor

ATTEST:



Rebecca Vigil-Giron
Secretary of State

NEW MEXICO SSC PROPOSAL -- JULY 31, 1987

Authorized Representatives

Dr. Laurence M. Lattman, President
New Mexico Institute of Mining and Technology
Chairman, Site Evaluation Committee
Socorro, NM 87801
Phone: 505/835-5600

Mr. Herman E. Roser, President
Hernor Corporation
Proposal Coordinator
1004 Daskalos Drive NE
Albuquerque, NM 87123
Phone: 505/294-5003

Executive Summary

Volume 1

The State of New Mexico is pleased to offer to the Department of Energy a site in the northern Estancia Basin for the Superconducting Super Collider. This site has outstanding geotechnical conditions, is close to Albuquerque (40 miles) yet separated by a mountain range, has adequate water and electrical power, and would be welcomed within a state with a tradition of accomplishment and excellence in large federally funded research efforts.

GENERAL SITE REVIEW

The site which the State of New Mexico proposes for the Superconducting Super Collider is situated in the Estancia Basin, located in the north-central portion of the state. The setting, currently utilized principally for grazing, irrigated and dry-land farming, and rural housing, is sparsely populated. Natural features characterize the site as an intermontane basin with gently sloping terrain, gradually rising to flanking mountains and plateaus on three sides. The basin is internally drained, and there are neither permanently flowing streams nor natural bodies of water within the vicinity. The size and configuration of the area permit some variation in orientation and exact location of the collider ring; however, the general orientation and location selected provide a "best apparent fit" for ease of design and most economical construction.

Man-made features are sparse on the site itself and in the immediate site vicinity. These are composed principally of farm and ranch buildings with attendant structures (corrals, windmills, stock tanks, etc.), widely scattered residences and commercial buildings, an interstate highway (I-40) and other primary and secondary roads, and utility transmission and distribution facilities. The few small established communities in the general area are located completely inside or completely outside of the construction site and can remain physically undisturbed.

THE OFFER--VOLUME 2

The State of New Mexico will donate to the federal government the site described in Sec. 6.2.1 of this proposal, consistent with the required schedule, including approximately 16,338 acres of land within the various SSC areas. New Mexico will execute one or more Offers to Donate Real Property to the federal government in accordance with the general form specified in Appendix G of the Invitation for Site Proposals. It is understood that title must be acceptable to the Attorney General of the United States.

The title report and any title insurance or other acceptable evidence of title will be provided at no cost to the federal government.

The proposed site includes privately owned surface and mineral estates and state trust surface and mineral estates. Different acquisition programs apply to privately owned lands and to state trust lands. No federally owned land is involved.

Rights-of-entry upon the proposed site for survey by the U.S. Department of Energy and its contractors will be assured by the State of New Mexico.

All land acquisitions will comply with the Uniform Relocation Assistance and Real Property Acquisition Policies Act of 1970 (Public Law 91-646) and the Department of Energy Relocation Rules (10CFR1039, 51 FR7000).

Private land will be acquired by negotiation or, if required, by condemnation. The State Legislature has affirmed that the power of eminent domain may be properly exercised in connection with land acquisition for this site. State law also offers a "quick take statute" enabling New Mexico to secure possession within three weeks of filing a condemnation petition and depositing the offer of compensation in a court registry.

State trust land may be acquired by the Commissioner of Public Lands through exchange for lands of equal value. The State Land Office is experienced in this procedure and it is usually complete within six months. New Mexico will bear all costs in connection with acquiring exchange lands and completing the necessary exchanges.

Acquisition for the site will involve 8,057 acres for which fee simple title will be provided; and 8,281 acres for which stratified fee title will be provided, which will include rights-of-entry to land surface directly above this stratified fee estate.

New Mexico recognizes the DOE's right to accept title to any existing improvements on the site or to direct their demolition or relocation. All such demolition or relocation costs shall be borne by New Mexico until such time as title vests in the federal government.

Statements with respect to compliance with the qualification criteria and the technical evaluation criteria are included in the final two sections of this Executive Summary.

Access to approximately 100 acres within Area A of the proposed site will be provided by New Mexico at no cost to the federal government until title to that area is transferred to the federal government.

The schedule will be adhered to unless the Record of Decision is signed after December 31, 1988, in which event the schedule will be delayed by the number of days equal to

the days after December 31, 1988, in which the Record of Decision is signed.

GEOLOGY AND TUNNELING--VOLUME 3

Geotechnical evaluations of the proffered site have been performed over the past two years. The details of those evaluations, as reported in Volume 3, support the following conclusions with respect to geology and tunneling:

- A. No adverse geologic conditions exist.
- B. Tunnel is above water table for approximately 91% of its length.
- C. Foundations are stable and require no special treatment.
- D. Ground vibration is substantially below levels of concern.
- E. Seismicity is very low and earthquake potential is minimal.
- F. Subsidence potential is negligible.
- G. Tunneling is recommended; however, a two-mile reach is shallow enough for cut-and-cover.
- H. Excavation would be mainly in dry, competent alluvium and soft sedimentary rock.

The site is geotechnically excellent as well as being an economical construction area. It is admirably suited for the SSC.

REGIONAL RESOURCES--VOLUME 4

Regional resources are fully adequate in all particulars, and outstanding in certain respects, to support the construction and operation of the Superconducting Super Collider at the Estancia Basin site in New Mexico.

Topics specifically cited in the Invitation for Site Proposals are summarized briefly from Volume 4 as follows:

Airports

The campus area is 40 minutes driving time on an interstate highway from Albuquerque International Airport, now undergoing complete modernization at a cost of \$120,000,000, to be completed by 1990. Albuquerque International Airport is served by 16 scheduled carriers (including nine trunk and

feeder passenger lines, three commuter-type lines, and four freight lines) and three general aviation and charter facilities. Four additional general aviation facilities are located within 12 to 60 minutes driving time of the site.

Highways, Streets, Roads, and Railroads

Interstate Highway 40 crosses close to the southern end of the proposed site and the entire vicinity is served by several U.S. and state highways and county roads. Major routes are paved all-weather roads. New Mexico is committed to maintenance of the existing network, which is deemed to be adequate for the SSC, and to such improvements and upgrading as may be necessary or desirable.

Class 1 mainline rail service is available at seven sidings in three directions located 19, 25, and 34 miles from the site. Capabilities are in place to provide fully flexible and economical rail transportation services.

Highway and road improvements, which have been identified as desirable as the SSC progresses, are estimated to cost \$158,374,000. Specific projects totalling \$108,994,000 are already included in the New Mexico Highway Department's current annual and five-year plans.

Public Transportation

A variety of public transportation modes (scheduled and charter bus service, taxi, limousine, van-pools, automobile rental and leasing, and charter air service) currently serve the site vicinity or are available to serve it as the demand for such services develops. No deficiencies exist in present service availability.

Industrial and Construction Resources

New Mexico in general, and the Albuquerque area in particular, have very broad-based industrial support for research facilities. More than 30 federal- and state-funded facilities engaged in research and development programs are located within the state, including two National Laboratories, the Air Force Weapons Laboratory, and the White Sands Missile Range. Intra-state business volumes for industrial support of these institutions are several billion dollars annually. Areas of particular strength include industrial gases, electronic parts and equipment, ultra-precision machining, steel fabrication, computer maintenance, computer hardware and software, cryogenic systems, high-vacuum systems, and instrumentation.

Construction resources are also extensive, including an estimated work force of 19,000, many skilled in underground mine construction. Nine major concrete manufacturers and one

cement manufacturer producing 500,000 tons of cement per year operate in the Albuquerque area.

The total regional labor pool (Bernalillo, Santa Fe, and Torrance Counties) is estimated at 220,000. Educational levels are somewhat higher than levels of the general U.S. population. Wage rates are substantially lower than the rates used in the Conceptual Design Document for the SSC.

Human Resources

Population in the three-county area of the SSC site vicinity is estimated at 563,000, with approximately 62% living in the city of Albuquerque and an additional 21% in the metropolitan area of Albuquerque and Bernalillo County.

Albuquerque and all areas within Bernalillo County are less than one-hour driving time from the campus and most of the site area. There are many other communities and rural housing areas located within one-hour driving time of the campus or experimental areas. Santa Fe is 55 miles from the site.

Employment in the area has averaged 4.8% annual growth since 1970, while unemployment rates have been lower than national averages from 1980 through 1986 for Bernalillo and Santa Fe Counties and from 1980 through 1984 for Torrance County.

Definitive data are presented in the full report on fair employment practices, Equal Employment Opportunity statutes, and open housing practices. In summary, New Mexico has a progressive record in these areas and a very low incidence of assumed or determined probable cause with regard to formal complaints of discrimination in employment and housing.

Housing

Diverse housing opportunities, located in a variety of urban and rural environments, abound within a 40-mile radius of the proposed site. Wide choices are available in housing types, architectural styles, and cost.

The data assembled on purchase prices and rents for housing types in the site vicinity characterize Albuquerque area prices as less than U.S. and western region averages and Santa Fe prices as higher than those same averages.

Community Services

Excellent major medical centers and hospitals are located in Albuquerque, where a majority of the employees of the SSC are expected to reside. Rural housing areas are within a 20-45-minute driving time of these facilities, as is

the proposed campus location. Emergency services for stabilization and transport are available in several communities adjacent to the site.

Park and recreation facilities are both varied and extensive throughout New Mexico, with one of the state's fine ski areas within 20 minutes of the SSC campus and another within a 1-1/2 hour drive. Boating, sailing, and fishing are within less than two hours driving time.

Albuquerque has extensive public and private golf and tennis facilities, generally usable on a year-round basis.

Educational and Cultural Resources

Elementary and secondary public schools in the vicinity are organized as the Albuquerque Municipal School District, the Santa Fe Public School District, and the Moriarty Municipal School District. Per pupil expenditures and teacher-pupil ratios approximate the national averages in all three districts. Each district's composite scores on the ACT is better than the national average. Albuquerque Municipal Schools have more schools designated as Centers of Educational Excellence than any other district in the nation. Parochial (church-affiliated) schools enroll nearly 10,000 students in Albuquerque and Santa Fe in kindergarten through the twelfth grade. There are also three well respected non-sectarian private schools in the area, serving grades 6-12, which specialize in college preparatory work. These schools send 95% or more of their graduates to four-year colleges.

There are eleven degree-granting post-secondary institutions in Albuquerque and Santa Fe. Two are technical schools or community colleges, five are extension programs, three are liberal arts colleges, and one is the University of New Mexico.

The proposed SSC site is positioned near the mid-point of the Rio Grande Research Corridor. The Corridor is an informal consortium which includes three university research institutions and more than 30 federal- or state-funded research facilities. Employment at these facilities includes nearly 20,000 professionals engaged in high technology research in the fields of medicine, electronics, energy, materials, and environmental sciences. There are also a growing number of private-sector firms in the area. Key locations along the corridor are linked by a high-quality fiber optic communication system. Research expenditures for this year will be about 4.3 billion dollars.

Cultural resources abound in the area, encompassing artifacts and traditions of a multi-cultural heritage, internationally acclaimed opera and chamber music festivals, and art galleries that draw collectors from around the world.

Community Support

Each of the affected local-government entities in the site area have passed resolutions in support of the Superconducting Super Collider project. Existing community support is solid and widespread. Almost no negative comments have been made in any public forum or in the news media. There is no reason to believe that potential community support will be less positive.

Non-Federal Government Support

State support for the project has been expressed publicly by the Governor and the legislative leadership, as well as individual state legislators whose districts will be affected by the site. The entire State Legislature in special session on July 11 and 12, 1987, called by the Governor to consider the Superconducting Super Collider project, expressed unanimous support. The legislation enacted by that session is included as Appendices to the appropriate volumes of this proposal.

The State of New Mexico has also offered to upgrade the existing road network and snow removal priorities thereon, build access to and across the site from existing highways, and build a service road system for the SSC.

The Governor, by Executive Order, will establish a special staff within his own office to coordinate and expedite all required actions for state and local government permits, licenses, etc. if New Mexico is selected as the site for the SSC.

The State's tax policies have not been altered with respect to the SSC construction or operation. A complete exposition of existing tax policies and how they would affect construction and operation of the facility in New Mexico is contained in Volume 4. The tax information is stated as concisely as possible and cannot be further summarized. Please refer to Sec. 4.10.3.

ENVIRONMENT--VOLUME 5

The existing environment of the Estancia Basin is typical of a sparsely populated agricultural, grazing, and rural housing area in the southern Rocky Mountain region.

Details of the existing environment and the impact of construction and operation of the Superconducting Super Collider on that environment are summarized as follows:

Wetlands

No marshes or areas supporting riparian vegetation occur in the site vicinity.

Surface Water

There is no permanent flowing water, no major surface water body, and no surface water outlet in the Estancia Basin.

Surface water consists solely of natural or constructed catchments to accumulate surface run-off and water from underground pumping. Most such catchments are small, the largest approximating 20 to 30 surface acres and located 0.5 mile from the nearest site boundary.

No surface water quantity or quality data are available due to the ephemeral nature of surface water in the vicinity.

Any flooding on or near the site would be very short in duration; flash floods following heavy thunderstorms are limited in area.

Fish and Wildlife

There are no faunal concerns within the proposed site area and no federally protected, threatened, or endangered faunal species or critical habitats in the site vicinity.

Vegetation

No federally listed rare or endangered plant species occur within the proposed site area. State and federal priority and candidate species could occur in the vicinity but are highly unlikely along the recommended ring location.

Air Quality

The entire site area and its immediate vicinity is in attainment for national air quality standards covering all criteria pollutants, and there are no major emitting facilities in the vicinity.

Background Radiation

Background radiation for soils/rock and water in the region are in the low range.

Historical and Archaeological Resources

There is no potential for adverse effects to any major historical or cultural properties.

Preliminary Environmental Evaluation

There will be no adverse environmental impacts that would limit the use of the site, nor will any unusual mitigation or protective measures be required. The construction and operation of the Superconducting Super Collider at the Estancia Basin can be characterized as environmentally benign.

SETTING--VOLUME 6

The proposed location for the collider ring within the Estancia Basin site has the center line trending north-south along longitude $106^{\circ}00'$ and the east-west center line is along latitude $35^{\circ}08'$. A number of orientations and exact locations are possible within the study area; however, recommended placement provides the "best apparent fit" for ease of design and economy of construction. A reasonable degree of flexibility is available for final location.

Man-made features are minimal, composed principally of farm and ranch buildings, widely scattered residences, roads, and utility transmission, and distribution facilities. Natural features characterize the site as an intermontane basin with gently sloping terrain, gradually rising to flanking mountains and plateaus on three sides.

The total land acquisition encompasses 16,338 acres, 8,057 acres for which fee simple title will be required, and 8,281 acres for which stratified fee title and surface rights-of-entry will be required. There are 416 land parcels involved, ranging in size from 0.5 acres to 1,381 acres. The land held by 390 private owners comprises 15,200 acres, and state trust land comprises 1,138 acres.

Permanent improvements include 28 houses, 1 small business, and 23 water wells. In addition, 23 mobile homes will require relocation.

Privately owned land and improvements will be acquired by negotiation or, if required, by condemnation. State trust lands will be acquired by a process of exchange for lands of equal value.

Statutory authority exists for acquisition of privately owned land, including a "quick take statute," and \$11,000,000 has been authorized and appropriated for land acquisition. Statutory authority also exists for exchange of state trust lands.

A cadre of experienced personnel will be available to make the land acquisitions and consummate the exchanges. The schedule as set forth in the Invitation for Site Proposals can be met.

Current land uses, predominantly grazing and farming, are conducive to location of the SSC on this site; furthermore, there are no master planning or zoning requirements which are detrimental to its construction or operation.

REGIONAL CONDITIONS--VOLUME 7

No major source of noise or vibration is present on or near the proposed site. Traffic on Interstate 40, which crosses the ring at two locations, is the most significant source. Measured ambient vibrations are less than the specified criteria by at least an order of magnitude. This is a very quiet site.

The climate in the area is mild, with a mean average winter temperature of 40° F and mean average summer temperature of 66° F. Average annual precipitation is approximately 7.6 inches, most of which occurs as summer thundershowers. Predominant winds are from the west with an average velocity of 7.1 miles per hour.

Storm systems vary seasonally. Winter frontal systems (December through March) move through the area, generally on a weekly or bi-weekly basis. These carry little precipitation and produce average annual snowfalls of 20 inches in the Estancia area. Early spring frontal systems (March to May) have little precipitation but relatively high winds, resulting in some wind-blown dust, generally lasting for no more than two or three hours. Convective thunderstorms occur during July, August, and early September, accounting for as much as 50% of the annual precipitation.

UTILITIES--VOLUME 8

Available and unallocated power-generating capacity in the area is adequate to supply the power required for construction and operation of the SSC. Electric power generation is fueled by a mix of hydro, coal, gas, and nuclear energy. Additional electricity is available from the various power pools in which local utilities are active participants. These resources, coupled with the strong Extra High Voltage Transmission system in New Mexico, provide more than adequate capacity, reliability, and stability for the SSC load, plus significant load growth capacity to meet other requirements.

Water rights to sufficient industrial cooling water and potable water to meet SSC needs are available in the Estancia Basin. New Mexico will donate these rights to the federal government free of charge.

Abundant quantities of competitively priced natural gas are available near the proposed site.

Central sewage treatment facilities and solid waste disposal facilities are not now available in the immediate vicinity; however, permits for construction of such facilities on-site can be obtained routinely.

New Mexico is actively seeking an approved hazardous or mixed waste disposal site. Discussions are ongoing regarding a regional site for such wastes. Other DOE facilities in New Mexico currently store these materials on-site, pending a final disposition plan. With the progress being made, this issue will undoubtedly be resolved in accordance with existing policies before the operational readiness of the Superconducting Super Collider.

TECHNICAL EVALUATION CRITERIA

The foregoing summarizes information detailed in Volumes 2 through 8 inclusive of this Site Proposal. Each technical evaluation criterion is addressed in the detailed volumes and in this summary. All data indicate that New Mexico's proposed site meets or exceeds all technical evaluation criteria.

QUALIFICATION CRITERIA

The Estancia Basin site is located entirely within the State of New Mexico; it is adequate to accommodate the SSC facility; the land will be donated by the State, at no cost to the federal government; capability exists to deliver the requisite quantities of electrical power and water to the site; and there are no known unacceptable environmental impacts from the construction, operation, or decommissioning of the SSC at this site.

A certification attesting to this statement is included in Appendix 2-B.

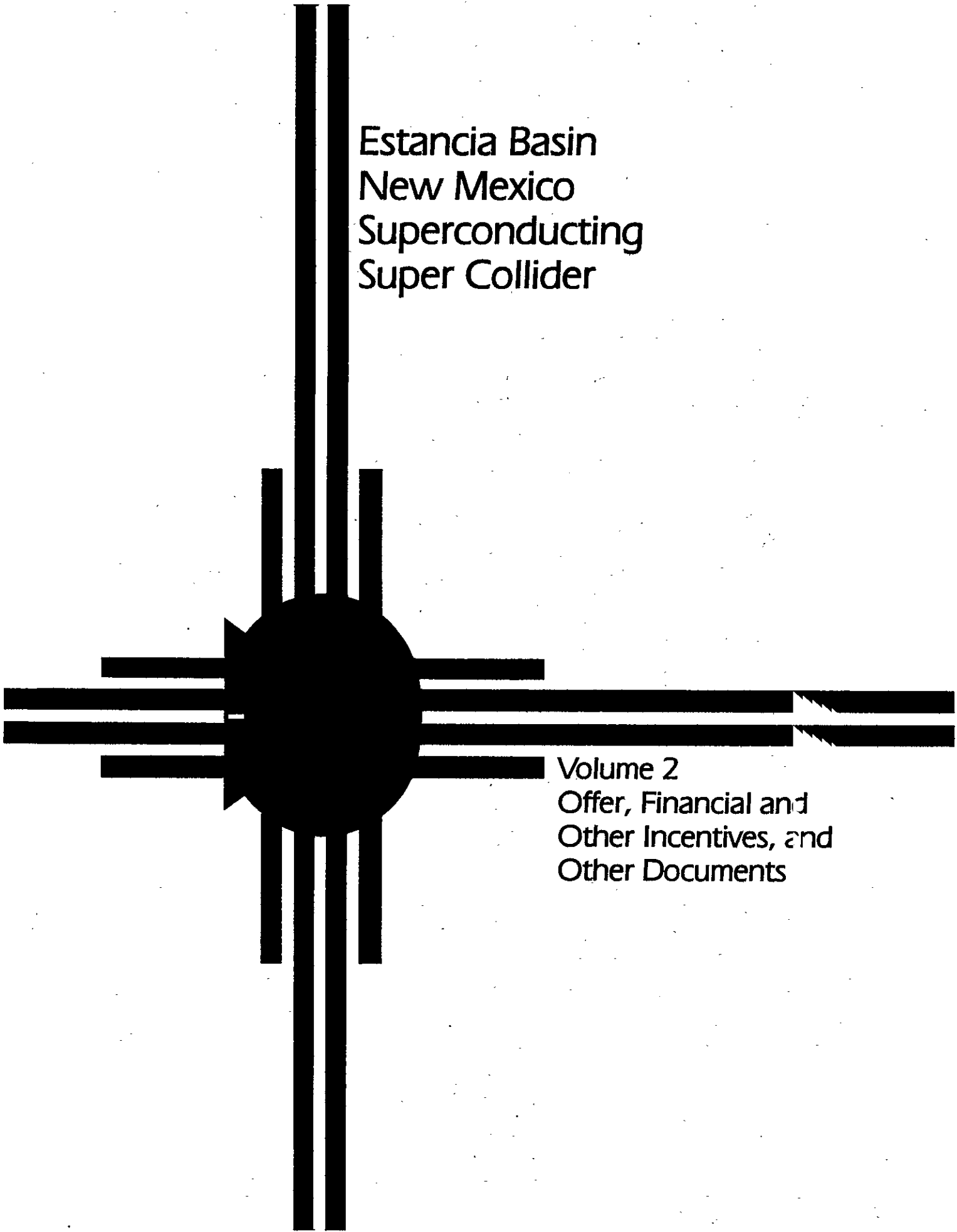

Estancia Basin
New Mexico
Superconducting
Super Collider

Volume 2
Offer, Financial and
Other Incentives, and
Other Documents



Taos

Los Alamos

SANTA FE

25

Las Vegas

ALBUQUERQUE

40

Santa Rosa

SSC PROJECT SITE

Estancia

Belen

Willard

Vaughn

Offer, Financial and Other Incentives, and Other Documents

Volume 2

TABLE OF CONTENTS

2.0	Summary	2-1
2.1	The Offer of Real Estate	2-2
2.1.1	Transfer of Title to the United States of America	2-2
2.1.2	Right-of-Entry	2-3
2.1.3	Compliance with Federal Real Property Acquisition Law	2-3
2.1.4	Land Acquisition Authority	2-4
2.1.5	Exemptions	2-5
2.1.6	Estates	2-5
2.1.7	Existing Improvements	2-6
2.2	The Offer of Financial and Other Incentives	2-6
2.3	Qualification Criteria	2-7
2.4	Schedule	2-7
	Appendices	2-9
2-A	Modifications to Offer to Donate Real Estate	2-9
2-B	Qualification Certification	2-10

2.0 SUMMARY

The Estancia Basin site, located in the State of New Mexico, meets the criteria of the Invitation for Site Proposals. The offer is summarized as follows:

- A. The proposed site will be donated to the Federal Government and title will be transferred to the United States of America without cost.
- B. Necessary right-of-entry will be provided during proposal evaluation and EIS preparation periods.
- C. Requisite authority exists to acquire the real property and improvements, in accordance with the mandated federal statutes and regulations.
- D. The amounts, types of ownerships, and estates to be acquired, of and in the land offered, are detailed.
- E. The DOE's options with regard to existing improvements are recognized and accepted.
- F. Compliance with all qualification criteria are demonstrated and certified.
- G. The schedule for delivery of title can be met and the requirements for use of 100 acres of Area A are acknowledged; both are subject to adjustments of the Record of Decision date and execution of the offer as proposed in Appendix 2-A.

2.1 THE OFFER OF REAL ESTATE

2.1.1 TRANSFER OF TITLE TO THE UNITED STATES OF AMERICA

The State of New Mexico will donate to the Federal Government consistent with the schedule outlined in Section 2.4 the site described in Section 6.2.1 of this proposal, including approximately 16,338 acres of land within the various SSC areas. New Mexico will execute one or more Offers to Donate Real Property to the Federal Government in accordance with the general form, Appendix G of the Invitation for Site Proposals. New Mexico recognizes that the form may be modified to reflect unusual requirements and acknowledges that any unusual requirements of the offer or any modifications must be approved by the Federal Government. Title must be acceptable to the Attorney General of the United States. Two proposed modifications to the offer to donate real property are listed in Appendix 2-A.

The title report and any title insurance or other acceptable evidence of title will be provided at no cost to the Federal Government. New Mexico will comply with the schedule specified in Section 2.4 for furnishing the title report and other evidence of title.

The proposed SSC site includes privately owned surface and mineral estates and state trust surface and mineral estates managed by the Commissioner of Public Lands as the constitutional agent of the State of New Mexico responsible for managing state trust lands. Different land acquisition programs have been designed for privately owned lands and for state trust lands.

A land exchange program between the State of New Mexico and the State Land Office, under the direction of the Commissioner of Public Lands has been developed to ensure that New Mexico will be able to secure title to state trust lands in compliance with the schedule specified in Section 2.4.

Title to privately owned surface and mineral estates shall be secured through a process of negotiation and, if necessary, condemnation. In the event of condemnation, title passes to New Mexico upon recording of final judgment; however, New Mexico obtains immediate and permanent possession within approximately three weeks of the filing of the action and New Mexico will transfer such permanent possession to the Federal Government, thereby allowing immediate construction. Condemnation authority is granted

to the State pursuant to Sections 42-2-1 through 42-2-16, N.M.S.A. 1978. Also, New Mexico has the authority to clear title defects by condemnation pursuant to Section 42A-1-28, N.M.S.A. 1978.

2.1.2 RIGHT-OF-ENTRY

Entry upon the proposed site for survey and exploration by the U.S. Department of Energy and its contractors will be assured and provided by New Mexico. No problems related to right-of-entry onto private or state trust lands within or near to the proposed SSC site arose during the preliminary evaluation of this proposed site. That evaluation lasted 18 months, ending in May 1987, and it included the drilling, sampling, and logging of more than 40 bore holes. Public access by way of state and county roads is available and, to date, owners of private land and the State Land Office have been receptive to the project.

Right-of-entry across private lands included in the proposed SSC site will be the subject of negotiations between New Mexico and the landowners consistent with the schedule specified in Section 2.4. In the event of unforeseen difficulty in the future, right-of-entry on private land may be obtained through court action pursuant to State law, Sections 42-2-3, 42A-1-8, and 42A-1-9, N.M.S.A. 1978. Any costs of obtaining right-of-entry will be borne by New Mexico.

Long-term right-of-entry across state trust lands will be authorized by the Commissioner of Public Lands as provided by State law, Section 19-7-57, N.M.S.A. 1978 consistent with the schedule specified in Section 2.4. By rule and regulation, the normal term for a right-of-entry is 35 years, although a longer term can be granted if necessary.

2.1.3 COMPLIANCE WITH FEDERAL REAL PROPERTY ACQUISITION LAW

New Mexico will comply with the Uniform Relocation Assistance and Real Property Acquisition Policies Act of 1970 (Public Law 91-646) and the Department of Energy Relocation Rules (10 CFR 1039, 51 FR 7000). Such compliance is not voluntary; it is mandated by state statute, Section 42-3-1, et seq. N.M.S.A. 1978.

2.1.4 LAND ACQUISITION AUTHORITY

Private Land

The State of New Mexico is authorized by State statute, Sections 42-2-1 through 42-2-16 N.M.S.A. 1978 to utilize a "special alternative condemnation procedure" to acquire privately owned land. Section 42-2-3C specifically provides that: "The State may use the special alternative procedure to acquire lands or any interest therein for any public purpose for which the power of eminent domain may be properly exercised." State law offers, in essence, a "quick take statute" providing a mechanism for New Mexico to secure possession of land within approximately three weeks of filing a condemnation petition and depositing the amount of the offer of compensation into a court registry.

New Mexico believes that condemnation of land, if necessary to comply with the provisions, fulfills a legitimate public purpose for which the power of eminent domain may be properly exercised. In support of this assertion, the Governor of New Mexico, the leadership of the State Legislature, and the state's Congressional delegation have all endorsed the siting of the SSC in New Mexico pursuant to the land acquisition procedures identified in this proposal. Moreover, the Legislature of the State of New Mexico has unanimously affirmed through authorizing legislation the power of eminent domain for the purpose of acquiring the proposed SSC site.

State Trust Lands

Land acquisition authority by the State of New Mexico for state trust lands within the proposed SSC site does not include condemnation by the State or donation to the State by the Commissioner of Public Lands. Section 10 of the New Mexico Enabling Act forbids the sale of state trust land except by competitive auction, which is an unacceptable land acquisition route in this instance. Moreover, Section 870 of the Jones Act (43 USC 870 - 1982) and Section 19-7-25, N.M.S.A. 1978, forbids the sale of state trust mineral rights under any circumstance.

The Commissioner of Public Lands may, however, exchange state trust surface lands and mineral rights for lands or mineral rights of equal value, as set forth in Section 19-2-12 N.M.S.A. 1978. An exchange process will be undertaken to obtain the fee simple and stratified fee ownership of state trust lands within the proposed SSC site. The State Land Office has extensive experience in land exchanges, and it

has completed a number of exchanges in recent years involving acreages much larger than the acreage of state trust lands included within the proposed SSC site. These exchanges have generally been completed within a six-month period. New Mexico will bear all costs of acquiring the lands to be exchanged for state trust lands.

2.1.5 EXEMPTIONS

No lands within the proposed SSC site are currently owned by the State of New Mexico or by any Federal agency. New Mexico acknowledges, therefore, that no requirements of Section 2.1.4 can be waived.

2.1.6 ESTATES

The total acreage encompassing the various areas of the SSC site is approximately 16,338 acres in Santa Fe and Torrance Counties. (See Sec. 6.2.1 for a discussion of the land acquisition plan.) No additional lands are required for new access roads or for utility or communication lines.

Fee Simple Title

Fee simple title will be provided by New Mexico to the Federal Government for 8,057 acres, or 49.3% of the total land area within the proposed SSC site. Fee simple title will be provided for SSC areas designated in Figure 6.2.1.4-1 (in map tube) as A, B, C, E, F, G (with minor exceptions), H, J, K, and the shaded portions of D.

The land for which fee simple title will be provided by New Mexico pursuant to this proposal is currently divided into 126 distinct land parcels owned by 116 individuals and corporations. Most of this area is farming and ranching land with some small-plot subdivision housing. Few structures exist on this land.

Stratified Fee Title

Stratified fee title will be provided by New Mexico to the Federal Government for 8,281 acres, or the 50.7% of the total proposed SSC site where fee simple title is not required by the Federal government. Right-of-entry will be provided by New Mexico to the Federal Government to all land surface directly above this stratified fee estate. Stratified fee title will be provided for the SSC areas designated in Figure 6.2.1.4-1 (in map tube) as I, the unshaded portions of D, and small strips of land at the

northern and southern edge of area G, which are traversed by highways. The tunnel depth at these two points in area G is 85 feet and 110 feet, respectively.

There is currently no existing or proposed mineral development activity in the area included in the proposed SSC site. The New Mexico Energy and Minerals Department reports that no significant mineral development potential exists in the area. The lack of past, present, or anticipated future mineral development activity should facilitate the acquisition of stratified fee title within the proposed SSC site.

A larger number of parcels and owners, 343 and 334 respectively, are affected by the lands for which stratified fee title will be provided by New Mexico pursuant to this proposal, compared to the scope of the fee simple title acquisition. The majority of these land parcels were acquired as a result of a nationwide real estate subdivision sales effort conducted in the 1960s and early 1970s. Little actual development has occurred, however. Nearly all the lots are vacant and the only infrastructure provided to some subdivided lands consists of dirt roads. These facts should simplify the task of acquiring right-of-entry to these areas.

2.1.7 EXISTING IMPROVEMENTS

New Mexico recognizes that the U.S. Department of Energy reserves the right to accept title to any existing improvements on the proposed SSC site or to direct their demolition or relocation. New Mexico agrees to perform such demolition or relocation as requested by the Department of Energy until such time as title to all lands in the proposed SSC site is transferred to the Federal Government consistent with the schedule specified in Section 2.4. All such demolition or relocation costs shall be borne by New Mexico.

Approximately 29 houses, 23 mobile homes, 26 water wells, three pipelines, several unpaved roadways, and 1 grass airstrip glider airport (currently closed) are located on lands within the proposed SSC site subject to fee simple title acquisition. A catalogue of existing improvements within the proposed SSC site appears in Section 6.2.1.5.

2.2 THE OFFER OF FINANCIAL AND OTHER INCENTIVES

Deleted per Amendment #2 to the Department of Energy's Invitation for Site Proposals.

2.3 QUALIFICATION CRITERIA

The following statements with respect to the New Mexico Superconducting Super Collider (SSC) Proposal of July 31, 1987, are true and correct:

1. The site offered is located entirely within the boundaries of the State of New Mexico (see Sec. 3.1, Fig. 3.1-1, and Sec. 6.1.1).
2. The size and configuration of the proffered site are adequate to accommodate the SSC facility, as specified in the Department of Energy's Invitation for Site Proposals for the Superconducting Super Collider (see Secs. 3.1.1 and 3.1.2, and Fig. 3.1-1).
3. The State of New Mexico will donate, at no cost to the Federal Government, the site described in the aforementioned proposal (see Secs. 2.1.1, 2.1.2, and 2.1.4, Appendix 2-B, and Appendix 6-A).
4. Capability exists to deliver at least 250 MW of electrical power with at least 500 gpm of industrial water to the SSC site (see Secs. 8.1, 8.2, and 8.3).
5. No known unacceptable environmental impacts will result from the construction, operation, or decommissioning of the SSC at this site (see Secs. 5.3, 5.4, 5.5, 5.7, and 5.8.1).

The statements above have been attested to in a letter of certification appearing in Appendix 2-B signed by Garrey M. Carruthers, Governor, and I.M. Smalley, President Pro-tempore of the State Senate, and Raymond Sanchez, Speaker of the State House of Representatives, duly elected Chief Executive and Presiding Officers of the Legislature, respectively, of the State of New Mexico.

2.4 SCHEDULE

New Mexico will adhere to the following schedule for the delivery of title to the proposed SSC site. New Mexico recognizes that the U.S. Department of Energy shall have the right to select the sequence of delivery of title to the four quarters of the collider ring.

AREA OF THE SITE	EXECUTION OF OFFER, SURVEY, AND PRELIMINARY TITLE EVIDENCE	TRANSFER DATE
Area A and first quarter of collider	April 1, 1989	July 1, 1989
Area B and second quarter of collider	July 1, 1989	Oct. 1, 1989
Third quarter of collider	October 1, 1989	Jan. 1, 1990
All remaining areas including I and J	January 1, 1990	April 1, 1990

New Mexico will, furthermore, provide access to the Department of Energy at no cost to the Federal Government to approximately 100 acres within Area A of the proposed site from January 1, 1989, until title to area A is transferred to the Federal Government.

New Mexico recognizes that the schedule cited above will be delayed if the Record of Decision is signed after December 31, 1988, by the number of days equal to the delay.

APPENDIX 2-A

Modifications of Offer to Donate Real Estate

- A. New Mexico does not have the statutory authority to issue a warranty deed (Sec. 13-6-2(D) N.M.S.A. 1973) as required by the "Offer to Donate." New Mexico may dispose of property by quit claim deed. Title insurance could be obtained with the United States of America as the name insured.

- B. Without beginning some of the functions of advance acquisition before the Record of Decision, New Mexico cannot transfer a "right of immediate occupancy and use of the land for any purpose" at the time of the acceptance by the United States of the Offer to Donate. If the Offer is to be executed on April 1, 1989, New Mexico can transfer title or permanent immediate possession as outlined in the schedule in Section 2.4.

APPENDIX 2-B

Qualification Certification



QUALIFICATION CRITERIA CERTIFICATION
FOR THE SUPERCONDUCTING SUPER COLLIDER PROJECT

We, the undersigned, Garrey M. Carruthers, Governor; I.M. Smalley, President Pro-tempore of the State Senate; and Raymond Sanchez, Speaker of the State House of Representatives; duly elected Chief Executive and Presiding Officers of the Legislature, respectively, of the State of New Mexico, by our signatures affixed hereto do hereby certify that the following statements with respect to the New Mexico Superconducting Super Collider (SSC) Proposal of July 31, 1987, are true and correct to the best of our knowledge and belief:

1. The site offered is located entirely within the boundaries of the State of New Mexico;
2. The size and configuration of the proffered site are adequate to accommodate the SSC facility, as specified in the Department of Energy Invitation for Site Proposals for the Superconducting Super Collider dated April, 1987;
3. The State of New Mexico will donate, at no cost to the Federal Government, the site described in the aforementioned proposal;
4. Capability exists to deliver at least 250 MW of electrical power with at least 500 gpm of industrial water to the SSC site;
5. No known unacceptable environmental impacts will result from the construction, operation or decommissioning of the SSC at this site.

This certificate executed in Santa Fe, New Mexico on July 24, 1987, and attested by the Secretary of State, State of New Mexico.

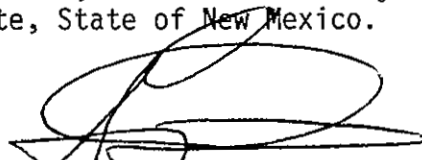

Garrey M. Carruthers
Governor of New Mexico



I.M. Smalley, President Pro-Tempore
New Mexico Senate



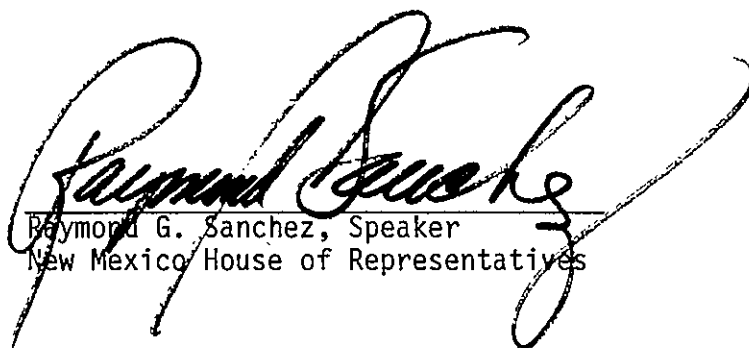

Raymond G. Sanchez, Speaker
New Mexico House of Representatives

Attested:

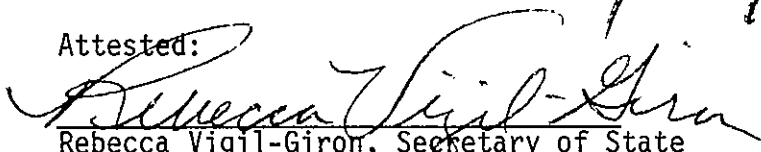

Rebecca Vigil-Giron, Secretary of State
State of New Mexico

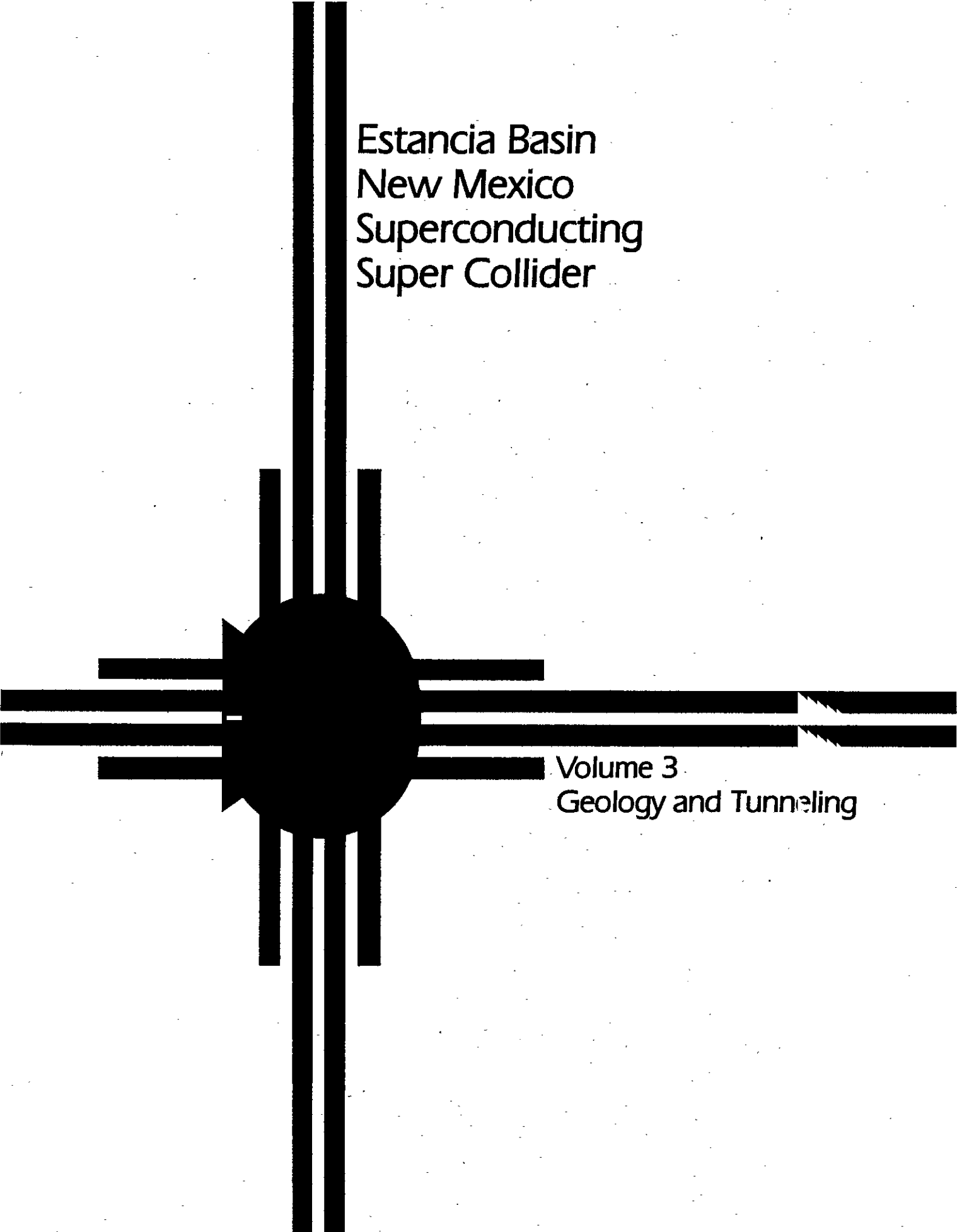

Estancia Basin
New Mexico
Superconducting
Super Collider

Volume 3
Geology and Tunneling



Taos

Los Alamos

SANTA FE

25

Las Vegas

ALBUQUERQUE

40

Santa Rosa

SSC PROJECT SITE

Estancia

Belen

Willard

Vaughn

Socorro

Geology and Tunneling

Volume 3

TABLE OF CONTENTS

3.0 Summary. 3-1

3.1 General. 3-2

 3.1.1 Proposed Location of SSC Facilities . . . 3-4

 3.1.2 Proposed Profile of the SSC 3-5

3.2 Geology. 3-7

 3.2.1 Regional Geology. 3-9

 3.2.2 Profile of the Tunnel 3-9

 3.2.3 Site Geology. 3-10

 3.2.4 Possible Construction Problems. 3-15

 3.2.5 Problem Soils 3-19

 3.2.6 Data Sources. 3-20

3.3 Geohydrology 3-20

 3.3.1 Characteristics of the Hydrological Regime 3-21

 3.3.2 Water Resources 3-23

 3.3.3 Underground Construction Concerns 3-26

3.4 Seismicity and Faulting. 3-27

 3.4.1 Characterization of Site Seismicity . . . 3-27

 3.4.2 Estimate of Site-Specific Maximum Ground
 Acceleration. 3-29

 3.4.3 Known and Suspected Active Faults in the
 Site Vicinity 3-31

 3.4.4 Estimate of Potential for Liquefaction. . 3-31

3.5 Tunneling and Underground Construction 3-33

 3.5.1 Relevant Soil and Rock Units. 3-34

 3.5.2 Physical and Mechanical Properties. . . . 3-34

 3.5.3 Difficulties or Advantages. 3-36

 3.5.4 Recommended Construction Techniques . . . 3-38

 3.5.5 Disposal of Muck and Spoils 3-40

References. 3-41

Appendices. 3-45

 3-A Boring Logs 3-45

 3-B Trench Logs 3-86

 3-C Downhole Geophysical Logs 3-87

 3-D Surface Geophysics. 3-88

 3-E Laboratory Test Data for Soil Units 3-97

Appendices (continued)

3-F	Estimated Unconfined Compressive Strength-- Cohesive Soils.	3-186
3-G	Laboratory Test Data for Rock Units	3-195
3-H	Method Used to Construct Tunnel Profile . .	3-199
3-I	Tunneling Conditions Data Sheets.	3-201
3-J	Chemical Analyses of Rock and Soil Units. .	3-211

Figures

3.1-1	(A-D) Location Maps of SSC Facilities	map tube
3.1-2	Single Plane Ring Profile. . . .	map pocket
3.1-3	(A-D) Cross Sections of SSC.	map tube
3.1-4	Abort Beam Line Profile.	map pocket
3.1-5	Injector Ring Profiles	3-6
3.1-6	Detailed Topography Profile. . . .	map tube
3.2-1	(A-D) Geology/Activity Location Maps . .	map tube
3.2-2	Subcrop Geology/Gravity Map. . . .	map tube
3.3-1	Water Table Map.	3-22
3.3-2	Hydrographs.	3-24
3.4-1	Seismicity Map	3-28
3.4-2	Fault Map.	3-30
3.5-1	Tunneling Conditions	map tube
3.5-2	Summary of Tunneling Conditions. . .	3-35
3.5-3	Summary of Costs for Tunneling Conditions	3-37

3.0 SUMMARY

The site proposed by New Mexico is located in the Estancia Basin in the central part of the state, having coordinates (at approximately the center of the ring) Longitude $106^{\circ}00'$, and Latitude $35^{\circ}08'$. The site assessments, as reflected in succeeding detailed sections of this volume, lead to the following conclusions:

- A. The site contains no adverse geologic conditions.
- B. The tunnel is above the regional water table for approximately 91 percent of its length.
- C. Foundations are stable and require only standard engineering design.
- D. Ground vibrations are well below the frequency and amplitude levels of concern.
- E. Seismicity is very low and the potential for any significant earthquake is negligible.
- F. Ground subsidence potential is minimal with the predicted maximum only a few inches over the next few centuries.
- G. The tunnel can and should, for most economical construction, be excavated along its entire length using conventional tunnel boring machines; however, a 2-mile reach in the northern portion of the site is shallow enough for cut-and-cover construction if this proves more economical.
- H. Tunnel excavation would be mainly in dry materials consisting of competent alluvium and soft sedimentary rock.

3.1 GENERAL

A 1985 technical report on the Estancia Basin site, produced by the New Mexico Bureau of Mines and Mineral Resources (NMBMMR) [3.1-1], concluded that the site appeared suitable for the SSC. A preliminary geotechnical characterization by NMBMMR, beginning in June, 1986, considered a number of possible ring and fold geometry configurations based on parameters provided in the SSC Siting Parameters Document [3.1-2]. This characterization concluded that no geotechnical "fatal flaws" precluded SSC siting in the study area. It also concluded that adequate utility capacity and regional infrastructure existed to support construction and operation of the SSC.

Further geotechnical studies with respect to ground subsidence potential, tunneling conditions, water quality, and water availability were performed by NMBMMR between January and May 1987. The data contained in the foregoing, plus ancillary data from other sources permitted full characterization of the New Mexico site as required by the Invitation for Site Proposals [3.1-3].

The scope of work used in characterization was interdisciplinary and featured the following techniques:

Aerial Photograph Analyses

Studying existing stereo aerial photographs including color and black-and-white photographs at a variety of scales and vintages, to delineate geologic units.

Engineering Geologic Mapping

Mapping of engineering geologic units.

Drilling

Drilling, sampling, and logging of 40 drill holes (Appendix 3-A) to identify and characterize engineering properties of subsurface soil and rock units.

Seismicity Review

Acquiring and analyzing available seismicity records.

Shallow Trench Logging

Excavating, shoring, and logging in detail the shallow soils (upper 12 ft) in ten backhoe trenches to

characterize typical foundation conditions for structures to be built at or near ground surface (Appendix 3-B).

Downhole Geophysical Logging

Geophysical logging (gamma, caliper, SP, and resistivity) in 13 drill holes and one previously drilled water well to further characterize subsurface units (Appendix 3-C).

Surface Geophysical Reflection and Refraction Surveys

Conducting 20,000 ft of reflection and 10,500 ft of refraction survey to characterize near-surface units (upper few hundred feet); delineating depths and attitudes of contacts between units in the subsurface; and determining the thickness and continuity of individual alluvial units (Appendix 3-D).

Soil and Rock Sample Collection

Collecting samples of soil and rock from natural exposures, hand-dug pits, quarries, road cuts, drill holes, and backhoe trenches. A total of 348 soil samples (325 disturbed and 23 undisturbed), 30 rock samples, and 400 ft of rock core was collected and tested.

Laboratory Testing

Geotechnical testing of soil and rock specimens. Emphasis was placed on tests that characterize tunneling conditions. Specific testing of soils included: moisture, density, gradation, consolidation, and Atterberg Limits; testing of rock included: rock point-load assessment, triaxial and uniaxial compression, shear, tensile strength, rock density, and thin section petrography (Appendices 3-E, 3-F, and 3-G).

Aerial Flyovers

Performing aerial flyovers (one helicopter and two fixed-wing planes) to obtain oblique and video photography of the site and to observe geologic conditions during low sun-angle periods. All photodocumentation is banked in the NMBMMR SSC files.

The position of the collider ring was given detailed consideration to achieve optimum site conditions (Sec. 6.1.1).

From a geotechnical standpoint, it is advantageous to position the ring as far north in the valley as possible to avoid shallow groundwater and soft clay deposits to the south. The western edge of the ring is east of the community of Edgewood to avoid known solution cavities. The eastern edge of the ring was placed west of a structural feature to minimize the potential for adverse tunneling conditions (Fig. 3.1-1; in map tube).

Originally, a planar ring approximately 53 miles in circumference was considered (Fig. 3.1-2; in map pocket); however, because of topography, excessively deep excavations would have been required. A terrain-following concept was later developed to examine the possible advantages of minimizing tunnel depth. The final configuration places the longer symmetry axis of the ring due north-south and is in full compliance with parameters asked for in the Invitation for Site Proposals [3.1-3] with a symmetrical fold of 0.40 degrees at the north and south points (in the outer arcs) that bends the near and far cluster regions toward the ground surface.

As shown on the facilities location map (Fig. 3.1-1; in map tube) and the final SSC cross section (Fig. 3.1-3; in map tube) the average depth to the tunnel is 99 ft. Its final position avoids, to the maximum extent possible, groundwater and numerous changes in rock type.

3.1.1 PROPOSED LOCATION OF SSC FACILITIES

The proposed locations of the collider ring, access shafts, and experimental facilities are shown on Figure 3.1-1 (in map tube). Because the proposed site for the collider is in a region where U.S. Geological Survey (USGS) topographic map coverage at 7-1/2-minute (1:24,000) scale is incomplete, the SSC facilities and all other required maps were plotted on existing USGS 15 minute (1:62,500) maps that were enlarged to 1:24,000 scale. The four 15-minute-scale maps used for enlargement are: Stanley, Edgewood, Estancia, and Lobo Hill quadrangles.

The long axis of the oval-shaped SSC ring is oriented north-south, parallel to the topographic axis of the basin. This allows the near cluster area (G on Fig. 3.1-1A; in map tube) with the main experimental areas (A) and injector area (B) to be located about 3 miles from Interstate 40 on the west. The main abort beam area (I) and main interaction points (K1 and K2) are also located on the west side of the

ring with easy access to I-40 at Edgewood. An alternate position for the abort beam area (I) is shown with a dashed line in the eastern far cluster area (Figure 3.1-1B; in map tube). Figure 3.1-1B also shows the positions of the access shafts (E and F) around the upper and lower arc regions (D) and the far cluster area (H). The 1,000-ft tunnel zone is indicated by the striped area around the circumference of the ring. The dashed line along the center of this zone is the profile line of Figure 3.1-3 (in map tube). A north-south profile along the abort beam line is presented in Figure 3.1-4 (in map pocket). Three other profiles are also shown on Figure 3.1-5. One is a profile around the high energy booster (HEB) ring. The second is a north-south profile through the injector area B and the third is an east-west profile through the injector area B. The method of constructing the ring profiles is presented in Appendix 3-H.

3.1.2 PROPOSED PROFILE OF THE SSC

Figure 3.1-3 (in map tube) is a profile of the SSC ring area showing the subsurface conditions and all major SSC facilities. As shown, the main ring can be tunneled its entire length. While there is one short reach where cut-and-cover construction may be feasible, we deem it highly advantageous to recommend that a tunnel boring machine (TBM) be used to excavate the collider ring and injector. This simplifies construction methods by reducing the changes in excavation techniques that would otherwise be required. The profile is located along the centerline shown on Figure 3.1-1 (in map tube). The approximately 53-mile circumference has been divided into four quadrants (Figs. 3.1-3A to 3.1-3D). The profile shows the geology, water table, and depths of cover along the ring. For ease of measurement and observations, the top of the 70-ft zone has been used as a base datum in another profile (Fig. 3.1-6; in map tube). In this profile, the surface to tunnel section has been enlarged for the near and far cluster areas. In areas where the centerline topography is not coincident with the topography of the experimental hall areas, the true topographic surface has been superimposed and identified. This provides an accurate portrayal of the tunnel depth at the large excavation areas. The 70-ft restricted zone is indicated on the profiles with the beam line projected as a dashed line. Borings and trenches are also shown.

The centerline of the tunnel is at an average depth of 99 ft. The deepest area is in the northwestern quadrant (Fig. 3.1-3A) where the tunnel is about 183 ft deep. There are several areas where the tunnel is 35 ft deep (Figs. 3.1-3A, C, and D). Along the near cluster region the tunnel

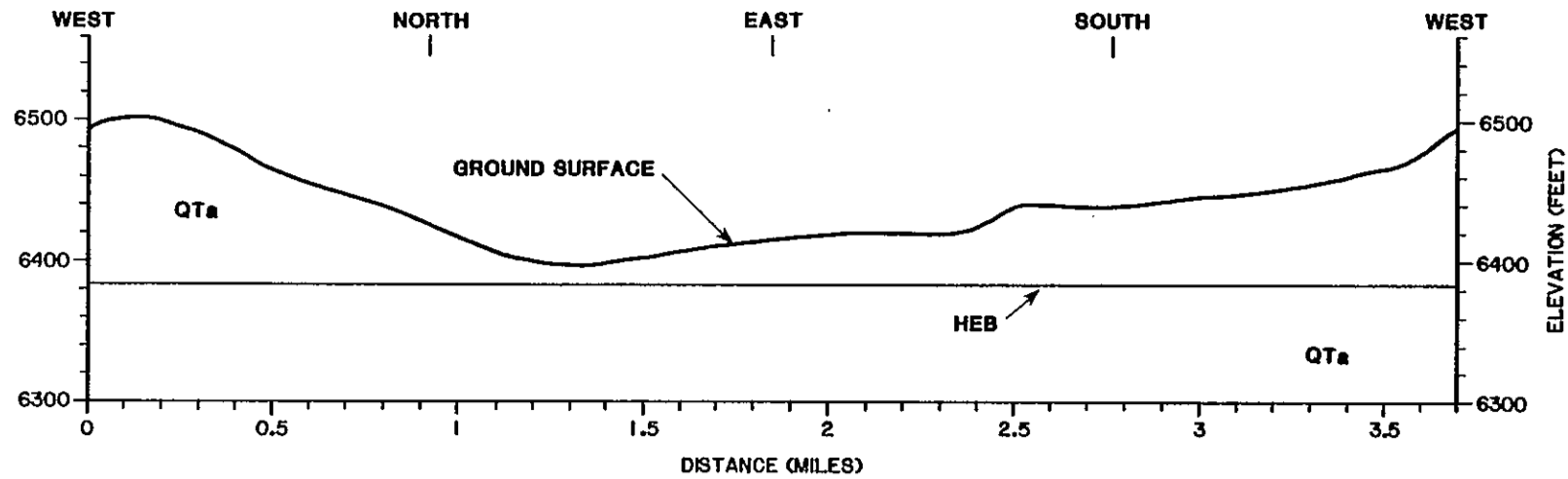

TYPICAL HEB TOPOGRAPHIC PROFILE (WITHIN LAND AREA B)
3.7 MILE CIRCUMFERENCE

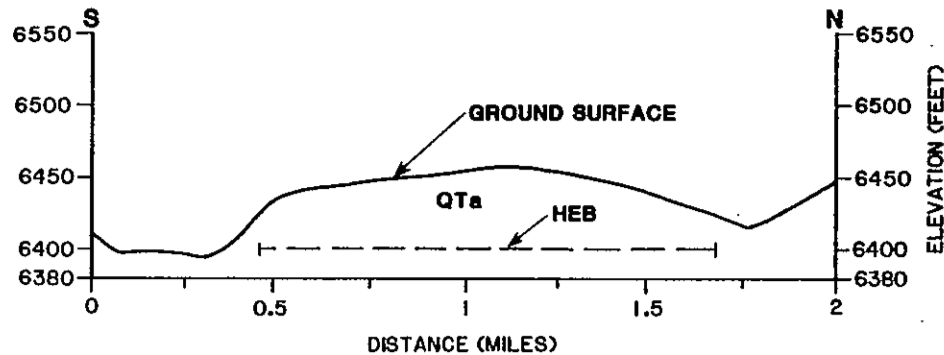

NORTH-SOUTH TOPOGRAPHIC CROSS SECTION
THROUGH INJECTOR AREA B

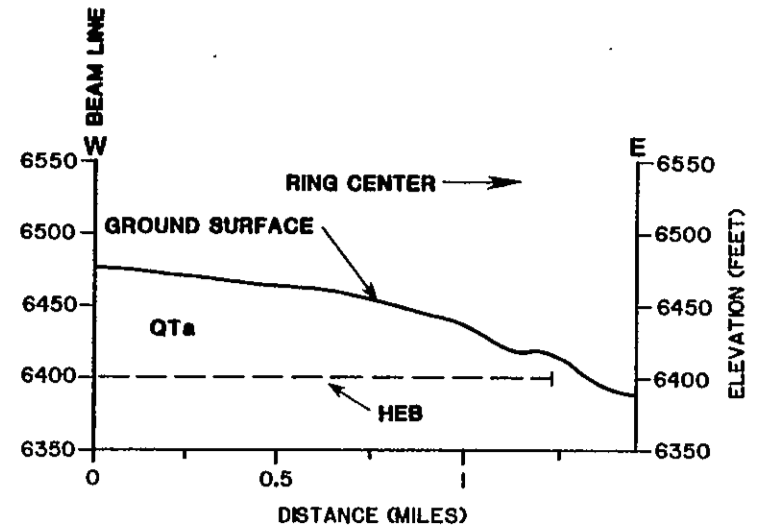

EAST-WEST TOPOGRAPHIC CROSS SECTION
THROUGH INJECTOR AREA B

Figure 3.1-5. Topographic profiles through Injector area B and the High Energy Booster (HEB).

ranges in depth from 48 to 110 ft deep. The profile along the abort beam line shows that the abort path is always greater than 35 ft below the ground surface (Fig. 3.1-4; in map pocket). The topography along injector region B is delineated and the projected trace of the high energy booster (HEB) is shown. The HEB has been placed in a horizontal plane at an elevation of 6,385 ft above sea level and everywhere is greater than 15 ft below the ground surface and 20 ft above the beam line of the SSC tunnel (Fig. 3.1-5). The north-south and east-west profiles of the injector ring complex (Fig. 3.1-5) show a "lobe" of old alluvium (Qta) dissected by arroyos in the north and south. The HEB has a "best fit" in the middle of the lobe as shown in Figure 3.1-1A (in map tube) but this position can be shifted if necessary.

3.2 GEOLOGY

In New Mexico, Precambrian rocks are exposed predominantly in the cores of mountain ranges along the east side of the Rio Grande and in a few isolated ranges to the west. Rocks approximately 1.8 billion years (b.y.) old occur in northern New Mexico. In the southern part of the state the Precambrian rocks are younger, about 1.6 b.y. old [3.2-1].

Through the Paleozoic Era, most of the state was covered by vast shallow seas in which thick sequences of limestones, sandstones, and shales accumulated. The sedimentary record for the early Paleozoic age rocks is limited mainly to mountain ranges in the south-central and southwestern parts of the state. Younger Paleozoic age rocks were deposited in many parts of New Mexico. The youngest Paleozoic rocks are mainly red (clastic) sediments shed from highlands when much of the state was being uplifted.

Mesozoic-age rocks are confined mainly to the northern part of the state. They were deposited as rivers spread sediment over vast continental plains. The colorful red, maroon, and purple rocks of the Chinle and Morrison Formations represent this period in many parts of northern New Mexico including part of the SSC site area. Late Mesozoic (Cretaceous) rocks were deposited on the land areas west of the great shallow sea that covered most of central North America. Most of New Mexico's coal deposits formed from the lush vegetation that existed during that time. At the end of the Mesozoic Era (66 m.y. ago) the mountain-building episode (Laramide Orogeny) was signified by intense regional volcanic activity and uplift. As a result, large volumes of

clastic sediments were deposited in structural depressions by rivers.

Local volcanic and igneous activity characterized parts of New Mexico during early Tertiary time. Early Cenozoic volcanism (beginning approximately 40 m.y. ago) built up great thicknesses of volcanic rocks. In the northwest corner of the state the eroded necks of isolated volcanoes, which formed in the middle Tertiary, still project above the modern landscapes.

Extensional crustal instability, initiated about 30 m.y. ago, produced the Rio Grande rift, a north-south-trending structural depression that bisects the state. Associated with this extension was renewed volcanism and formation of cauldrons. The youngest volcanism in the state is approximately 1,000-1,500 years old (basalt flows in west-central New Mexico; 100 miles west of the proposed site). During the late Tertiary and Quaternary periods, sediments continued to be deposited in all parts of the state. Notable areas of deposition include the High Plains of eastern New Mexico, the modern valley of the Rio Grande (and other river valleys in the state), and the Estancia Basin.

Central New Mexico has experienced major episodes of deformation during the Precambrian, Late Paleozoic, Laramide (Late Cretaceous-early Tertiary), Middle Tertiary, and late Cenozoic [3.2-2]. Throughout New Mexico, uplifted areas and basins formed in response to these deformations and the associated rock units record the geologic history. As deformation proceeded, deposits of contrasting lithologies responded differently. Precambrian igneous, metasedimentary, and metaigneous rocks, present at depth in the SSC site, fractured as they deformed. The Paleozoic rocks (sandstones and limestones) and Mesozoic rocks (sandstones) deformed by fracturing and folding, whereas the Mesozoic shales and mudstones deformed plastically. Upper Cenozoic sedimentary and volcanic rocks tend to fracture whereas upper Cenozoic unconsolidated sediments (alluvium) tend to deform by bending and sagging.

Central New Mexico includes parts of three major tectonic provinces, the Colorado Plateau, the Southern Rocky Mountains, and the Rio Grande rift. Both the Colorado Plateau and the Rocky Mountain provinces attained most of their present structural outlines during Late Cretaceous-early Tertiary time. The Rio Grande rift is a late Cenozoic structural feature superimposed on the older structures of New Mexico.

3.2.1 REGIONAL GEOLOGY

The proposed SSC site in central New Mexico is within the Sacramento and Mexican Highland Sections of the Basin and Range physiographic province. The Basin and Range Province includes much of central and southwestern New Mexico (Fig. 3.4-2), and extends into adjacent areas of Arizona, Texas, and Chihuahua (Mexico). The site is in the eastern, relatively stable portion of the Basin and Range Province. Other areas of the Basin and Range Province of the southwest U.S. extend into seismically active, tectonically unstable areas.

In the region of the proposed SSC site, the Sacramento and Mexican Highland sections are transitional. Most geologists therefore consider the axis of the Estancia Basin to be a boundary between the two sections. The Sacramento Section is characterized by high tablelands with broad, rolling summit plains; cuesta-form mountains with eastward dip slopes and west-facing escarpments; and widely separated structural basins. Many highlands are capped with gently dipping limestone and sandstone of Permian age. Gypsum is commonly interbedded with limestone and sandstone sequences.

The Estancia Basin marks the southern extent of structures related to the Rocky Mountains. It is a broad topographic and structural basin modified by erosion and by dissolution of gypsum. During much of the Pleistocene and early Holocene it contained fluctuating Lake Estancia, which extended to near Moriarty; perennial streams were present in the basin, but today only wind-deflated playas and windblown sand (interbedded in the near-surface soils with alluvium) occur on the valley floor. The broad syncline in the subsurface of the valley has an eastern limb defined by a Precambrian high (Pedernal Uplift) and a western limb, which is the dip-slope of the Sandia and Manzano Mountains (Sandia-Manzano Uplift). Basin fill is about 400 ft thick south of the site area but is generally less than 150 ft in the site area. It consists mainly of alluvial, lacustrine, and eolian deposits.

3.2.2 PROFILE OF THE TUNNEL

Descriptions of the tunnel profile conditions pertain mainly to depths of rock/soil contacts and groundwater conditions, as illustrated on Figures 3.1-3A to 3.1-3D (in map tube). The following discussion is by quadrant of the collider ring, keyed to Figure 3.1-3.

The northeast quadrant (E3 to F5, Fig. 3.1-3A) is above the water table and in the Quaternary-Tertiary alluvial unit (QTa). At E5 the tunnel has a short reach in the Triassic Dockum Group (mainly shales). About 0.75 miles north of K4 the tunnel enters Upper Permian units consisting of limestones and sandstones (Bernal, San Andres, and Glorieta). Here, the tunnel depth ranges from 35 ft to 182 ft deep. Access shafts F3, F4, and F5 range in depth from 64 ft to 153 ft. The interaction points K3 and K4 are 58 ft and 78 ft deep, respectively.

In the southeast quadrant (F5 to E8, Fig. 3.1-3B) the tunnel follows the topography to its lowest point at the south. The tunnel ranges in depth from 54 ft to 146 ft and is in rock to approximately E7. The rock units are Permian Glorieta and Yeso Formations, which are in fault contact. Near E7 the tunnel encounters older alluvium (Qao) and encounters the regional water table for about 5 miles. The access shafts F5 to E8 range in depth from 66 ft to 163 ft and the interaction points K5 and K6 are 130 ft and 141 ft deep, respectively.

In the southwest quadrant (E8 to F10, Fig. 3.1-3C) the tunnel rises above the water table and enters a reach of Madera Limestone for about 5.5 miles. Towards its westernmost point, it enters Quaternary-Tertiary alluvium (QTa). The tunnel ranges in depth from 35 ft to 179 ft and the access shafts F8 to F10 range in depth from 47 ft to 142 ft.

In the northwest quadrant (F10 to E3, Fig. 3.1-3D), the tunnel is entirely within Quaternary-Tertiary alluvium (QTa) above the water table and is at depths that range from 35 ft to 132 ft below the surface. Access shafts (E1, E2, E3, F1, and F2) range in depth from 42 ft to 142 ft. The depths to the tunnel at K1 and K2 are, 102 ft and 91 ft, respectively.

3.2.3 SITE GEOLOGY

The oldest rocks in the site area are Precambrian quartzites, gneisses, and schists which are exposed in the Lobo Hill and South Mountain areas [3.2-3, 3.2-4]. These will not be encountered along the proposed tunnel alignment.

Pennsylvanian-age rocks (Sandia and Madera Formations) occur mainly on the western side of the study area (Fig. 3.2-1; in map tube). The Sandia Formation underlies the Madera Formation. Because of the great thickness of the Madera Formation, the SSC tunnel will not encounter the Sandia Formation. In the site area, the Madera Formation

ranges from 1,000 to greater than 2,000 ft thick [3.2-5, 3.2-6]. The Madera can be subdivided into a lower and upper member. The lower member consists of massive, cliff-forming beds of cherty gray limestone with minor interbedded, nodular, gray and black shale and calcareous siltstone. The upper member contains more siltstone, sandstone, and shale. It consists of alternating light-gray cherty limestone, arkosic calcarenite, red to brown arkosic crossbedded sandstone, and calcareous gray shale [3.2-7]. Reddish siltstone and arkosic sandstone occur at the top, a gradational facies from the marine Pennsylvanian into the Abo red beds [3.2-8]. Fractures in the Madera crosscut at nearly right angles, imparting a blocky appearance to outcrops [3.2-9].

Overlying the Madera are Permian-age rocks consisting of interbedded shales, sandstones, and limestones. The Abo Formation, consisting of dark-red shale, sandstone, and conglomerate is the oldest and occurs beneath the valley fill in the west-central portion of the site area (Fig. 3.2-2; in map tube). It is probably less than 800 ft thick in the area with nearly one-half this thickness consisting of sandstones. In most places the top of the Abo is conformable with the overlying Yeso Formation and in places the highest sandstone of the Abo and the basal sandstone of the Yeso are nearly alike [3.2-10]; therefore, on the geologic map (Fig. 3.2-1; in map tube) they are mapped together. The overlying Yeso Formation crops out mainly on the eastern side of the study area and underlies basin fill in the eastern two-thirds (Fig. 3.2-1). The Yeso contains tan to reddish-brown and orange sandstones and siltstones with interbedded shales, limestones, and gypsum. In the study area, the Yeso is up to 600 ft thick. No gypsum anhydrite beds were encountered in any of the drill holes in the site area, but a thin anhydrite bed has been reported in a water well in the southern part of the site [3.2-9].

The overlying Glorieta Sandstone is a thick-bedded, well sorted, quartzose sandstone. The Glorieta strikes approximately east-west. One drill hole (SSC-DH-29, Appendix 3-A) penetrated 220 ft of Glorieta Sandstone in the east-central portion of the site area. This section of the Glorieta is a white to yellowish sandstone with gray and orange iron staining. Bedding is parallel, and bed thickness ranges from 0.5 ft to a few feet. The beds show laminations, without parting planes, and crossbedding is fairly common. Generally, the Glorieta is well cemented (with carbonate) and resistant to erosion.

The overlying San Andres Formation consists of a dense, fossiliferous, gray limestone with some gypsum and sand-

stone. In most places it is cherty and massive. It is less than 100 ft thick in the study area. Overlying the San Andres Formation are beds of the Permian-age Bernal Formation. These rocks occur as isolated erosional remnants of fine- to medium-grained, tan to brown sandstone and thin-bedded limestone up to 75 ft thick. These rocks occur east of the trace of the tunnel.

The contact between the Permian rocks and the overlying Triassic beds is unconformable with the hiatus spanning the last half of Permian and Early to Middle Triassic time. Triassic-age rocks of the Santa Rosa and Chinle Formations occur in the northern and eastern parts of the site. These two formations have been mapped as the Dockum Group. Generally, they are gray to reddish-brown sandstones and mudstones with the Chinle Formation being predominantly reddish-brown mudstone and claystone. The Dockum Group in the study area can be up to 1,000 ft thick.

In outcrop, the overlying Jurassic rocks (Jme; Fig. 3.2-1; in map tube) occur only in the northeastern portion of the site, although they are plotted as a band on the subcrop map (Fig. 3.2-2; in map tube) across the northern portion of the study area. They consist of the Entrada Sandstone, Todilto Limestone, and Morrison Formation. In the site area, the Entrada Sandstone disconformably overlies the Triassic Dockum Group and is predominantly a buff, tan, or bleached-white sandstone with massive bedding. It is fine to medium grained, consisting almost entirely of well sorted subangular to subrounded quartz, and is approximately 50 ft thick.

The overlying Todilto Limestone is approximately 20 ft thick. It is a fissile, laminated, gray limestone, which has a petroliferous odor on freshly broken surfaces.

The Morrison Formation is predominantly green, red, lavender, and light-gray claystones and siltstones interbedded with white, buff, and orange sandstones. Thin limestone and conglomerate beds occur locally. Much of the Morrison claystone is bentonitic. The sandstone is friable and consists of subangular to subrounded medium to coarse grains of quartz and lesser amounts of feldspar. In the subsurface of the study area, the Morrison may be a few hundred feet thick, thinning to approximately 50 ft thick in the northeast portion of the site.

The overlying Cretaceous rocks in the site consist of the Dakota Sandstone and Mancos Shale. The Dakota Sandstone subcrops follow closely those of the underlying Morrison

Formation. The Dakota intertongues with the overlying Mancos Shale and therefore has been mapped with the Mancos (Fig. 3.2-1; in map tube). The Dakota is approximately 50 ft thick in the site area and consists of white, grayish, or buff sandstone with thin black shale beds. Beds are well cemented and weather to angular ledges. The Mancos Shale overlies the Dakota Sandstone (Fig. 3.2-1). The Mancos is up to 1,500 ft thick, thinning to a few hundred feet thick in the northeast corner of the site. It consists of dark-gray to black fissile shale with interbedded gray and yellowish sandstone and siltstone beds, contains thin coal beds in the upper and lower parts, and ubiquitous pyrite crystals.

Tertiary-age (Oligocene-early Miocene; [3.2-11]) igneous rocks are present on South Mountain and as dikes, sills, and laccoliths north of the site. These rocks, which locally contain metallic ore deposits, will not be encountered by the SSC tunnel. Gray monzonite forms the main igneous mass of South Mountain (Fig. 3.2-1; in map tube). It is resistant to erosion, forms steep slopes, and breaks into angular blocks [3.2-12]. Microscopically, it contains mostly plagioclase, orthoclase, and amphibole. Emplacement of the monzonite resulted in metamorphism of the surrounding units; and metamorphosed sedimentary clasts of some of these units were encountered in a drill hole in the northwestern portion of the site (SSC-DH-34, Appendix 3-A). Other igneous rocks that occur to a lesser extent include: quartz monzonite, latite-andesite porphyry, diabase, and rhyolite.

Overlying the Paleozoic and Mesozoic bedrock is the Cenozoic basin-fill material (alluvial, lacustrine, and eolian deposits). Their maximum combined thickness is 300-400 ft in the center of the basin. The Quaternary-Tertiary alluvium (QTa; [3.2-6]) consists of: sand, clay, silt, and gravel beds, locally well cemented and containing interbeds of gravel and boulder conglomerate. These deposits are Pliocene and perhaps middle Pleistocene in age. These older piedmont deposits commonly have well-developed surfaces and buried soils with strong pedogenic horizons of carbonate and clay accumulation [3.2-13]. The gravel tends to be coarser at high levels on slopes and finer toward the center of the basin, where some ancient lake deposits may also be present. The alluvial deposits reflect the provenance of the local rocks.

The older alluvial unit (Qao; Fig. 3.2-1; in map tube) consists of interbedded sands, gravels, and silts. There is a weak to moderate calcium carbonate buildup throughout the

beds. Locally present are older lacustrine deposits that are tan, very pale orange, and gray clays. In many areas along the western edge of the site, the upper part of this unit is a thick, fine, red, eolian sand.

The lacustrine deposits (Qld; Dog Lake Formation; [3.2-6]) are mid-Pleistocene to Holocene in age, are less than 100 ft thick, and consist of silty lacustrine clays interbedded with clean sands. The lacustrine member was deposited over the irregular surface at the top of the older alluvial (Qao; Fig. 3.2-1; in map tube) deposits and is gray, green, or pale yellow to pale orange. It is a slightly silty clay commonly containing ostracod shells and gypsum crystals. The highest documented stand of the lacustrine unit is at the 6,225-foot contour line although geomorphic evidence exists for an ancient shoreline about the 6,330 ft contour line. Below the 6,225 ft elevation are shorelines, beach ridges, spits, and bars. As the lake dried, wind erosion cut into the lake sediments at places and redeposited them as dunes. The younger alluvial unit (Qay) covers the floors of arroyos that drain the basin margins. Lithologically, the younger alluvium is indistinguishable from the older material on which it rests, except that it lacks pedogenic carbonate development. Generally, the younger alluvium is not incised; its upper surface is everywhere one of deposition.

Geologic Structure

The Estancia Basin consists of two structurally low areas separated by a low, broad arch trending east-west just north of Moriarty [3.2-2]. The western margin of the basin is bounded by the structurally uplifted and eastward-tilted Manzano Mountains and Sandia Mountains. On the east, the bounding uplift is the Precambrian Pedernal Uplift with the east side of the basin probably faulted down against the west side of the Pedernal Mountains.

In the southeastern to east-central portions of the site (Figs. 3.1-3B, 3.2-1B, 3.2-2; all in map tube) the Permian rock units are in fault contact with Permian and Triassic units, whereas in the northeast corner Mesozoic units are in fault contact with the other Mesozoic units. None of these faults show indication of movement since early Tertiary time. A fault of younger age but still showing no recent movement (most recent offset is greater than 10,000 years ago) was investigated during the field work and is discussed in detail in Section 3.4.2.

3.2.4 POSSIBLE CONSTRUCTION PROBLEMS

The proposed site lacks any significant geologic features that would pose construction problems. The tunnel is within very competent rock or soil and it is above the water table for about 48 miles (Fig. 3.1-3; in map tube). The tunnel is oriented so that its best foundation conditions are beneath the injector and interaction areas, where ground stability is crucial. The area of shallowest ground water (southeast of Moriarty) is in the lower arc region.

Soils settle for a number of reasons, both natural and man-caused. In the southwestern U.S. the main causes include natural compaction of unconsolidated sediments, withdrawal of fluids (especially water), loading due to surcharge, and collapsible soils.

At the proposed site, as well as everywhere that unconsolidated soils occur, natural but imperceptible consolidation of soils is occurring. The rate of consolidation is rapid when soils are first deposited and slows as the soil becomes compacted. A measure of this is the characteristic increase in N-value with depth.

Typically, high N-values (obtained from standard penetration tests during drilling) of 50 are considered "refusal" and soils having such values have high bearing capacity. At the site, most surface development would be along the east and west sides of the ring in the Quaternary-Tertiary-age alluvium that typically has N-values of 40-50 or more. This unit contains interbeds of well-cemented (calcium carbonate) material, which further increases the bearing capacity and reduces the settlement potential.

Withdrawal of fluids is a well-documented cause of ground subsidence. In general, the phenomenon occurs in regions where fluid levels in thick, fine-grained, unconsolidated deposits are lowered significantly (about 100 ft or more). Differential settlement of the tunnel by land subsidence is considered a "fatal flaw." Therefore, the available data were studied for the site area to assess potential for ground subsidence. The National Geodetic Survey's level lines for the site area have not had repeat runs so the absence or presence of subsidence cannot be determined in that manner [3.2-14]. Experience from known subsidence areas indicates the following conditions must be present [3.2-14]:

- 1) Declining water levels or head decline

- 2) Either compressible soil in or below the dewatered zone or compressible soil forming a confining layer over the aquifer where the piezometric head is declining
- 3) Head decline must exceed the preconsolidation value of the compressible soil.

The New Mexico site does not meet these conditions. The water table is not being lowered significantly. The area has a drawdown rate of about 1 ft/yr [3.2-7, 3.2-9]. The soils are not, in general, thick fine-grained soils that are susceptible to settlement from this cause. In reaches of the tunnel where fine-grained soils do occur, the tunnel is in or near rock. Our analysis of the potential for ground subsidence in the lake deposits that contain fine-grained saturated soils (southern arc region) indicate a minimal potential for subsidence on the order of only a few inches over the next few centuries.

Subsidence from loading due to construction of SSC facilities was also assessed. Weight of massive structures (such as the experimental halls) has a tendency to consolidate the foundation soils, especially where clay is present. The amount of consolidation is predictable, and can be calculated in advance using soil properties that can be determined in the laboratory [3.2-15]. No areas with potential ground settlement, not treatable with standard designs, were identified during our investigations. Much effort was given to orienting the ring so that the experimental halls would be located in very stable materials. As shown on the profile (Fig. 3.1-3D; in map tube), the halls at K1 and K2 are in the Quaternary-Tertiary-age alluvium at depths of 102 ft and 91 feet, respectively. Both halls are about 100 ft above rock (limestone) and 50 ft above the water table. On the east side of the ring, halls K3 to K6 are all in rock at depths ranging from 58 ft to 141 ft (Fig. 3.1-3A; in map tube). The loading of the floors of the experimental halls is assumed to be 9 tons per square foot (TSF). Assuming a factor of safety of 2 to 3 the foundation material must support 18 to 27 TSF. This requirement can readily be met for the rock foundations of the eastern halls (K3 to K6) and the foundations in the Quaternary-Tertiary alluvium of the western halls (K-1 and K-2).

Another potential source of ground subsidence is collapsible soils (hydrocompaction). A study of collapsible soils [3.2-16] found that this phenomenon occurs throughout arid to semi-arid regions of the southwestern and central U.S. Collapsible soils are typically young (Holocene), silty sands, low in density, and low in seismic velocity.

They commonly occur in alluvial fans and are of mud and debris-flow origin. Settlements of up to 7 percent have been documented [3.2-16]. As can be shown from N-value data, these soils have much higher strength when dry than when wet. Potential sources of wetting include: disruption of natural runoff due to grading/leveling, roof runoff, leaky utilities, and lawn watering.

At the site, soils most likely to be collapsible are discontinuous zones in the older alluvium (Qao). The Quaternary-Tertiary-age (QTa) soils are more stable because of their great age and cementation by calcium carbonate, but some collapsible zones may occur within this unit also. The lake deposits (Qld) are not susceptible to soil collapse because they have been wetted many times since their deposition and this removes any collapse potential. Construction in suspected collapsible-soil areas should always be preceded by a thorough geotechnical study on a site-specific basis. Techniques such as the use of reinforced foundations developed by the Building Research Advisory Board [3.2-17] for use in expansive-soil areas work well in collapsible soil areas. Also, induced hydrocompaction has been shown to be a rapid, cost-effective technique to stabilize small construction sites. Other techniques that apply to larger structures include vibroflotation and dynamic compaction [3.2-18]. Adequate drainage and engineered provisions for control of runoff are routine measures that should be implemented where collapsible soils occur.

Slope instability is not a construction problem in the gently rolling areas along the SSC tunnel. A recent map of shallow and deep-seated landslides [3.2-19] does not delimit any landslides that cross the ring, and no landslide deposits were identified in the area during the field work.

Natural gas or oil occurrences have not been found in the basin although several deep exploration wells have been drilled. At depths much greater than tunnel depths, some wells had a "show" of petroleum only. The first carbon dioxide field to be commercially exploited was located south of the site near Estancia but it has been largely depleted. There are no shallow peat, coal, or other highly organic deposits in the site. There is some potential for gas seepage from the Mancos Shale but in the fractured near-surface rocks it cannot accumulate. Nevertheless, routine mining safety measures should be followed during tunnel excavation.

Subsidence due to faulting is not a concern in the site area. A single fault of possible Quaternary age east of the

ring was studied to determine its recency of movement and to detect any possible construction problems. A log of the trench excavated across the fault is presented in Appendix 3-B (trench SSC-BH-10), and a log of the drill hole near the fault is in Appendix 3-A (drill hole SSC-DH-38). The data for the seismic refraction line across the fault is in Appendix 3-D (seismic line SR-5). Soils above the fault are not disrupted. The soils contain well developed horizons of pedogenic calcium carbonate accumulation and are deemed well in excess of 10,000 years old. The tunnel would be excavated in the downdropped block in unsaturated, dense to moderately dense, silty sands and silts about one mile to the west of the fault.

Rock solution was not observed to any significant extent in any of the 40 borings. However, some of the Yeso Formation has small vugs (up to 1 inch in diameter) in the core indicating some solution has occurred. Throughout the basin, numerous surface depressions (in alluvium) on the order of tens to hundred of feet in diameter and a few feet deep occur. They are mainly in the central part of the valley and extend well to the south of the site. Near the ring about 2-1/2 miles northwest of Moriarty, one such depression exists, with vertical walls about 12 ft high and a diameter of about 30 feet. The origin is not known but they could, in part, be due to rock solution. Alternative causes would include wind deflation and collapsible soils. The surface trace of the ring does not intersect any of these features.

Expansive clays may be locally present in the Chinle Formation of the Triassic Dockum Group and in the Yeso Formation. Our X-ray diffraction analyses of samples from these two units show minor amounts of expansive clays (smectite-montmorillonite) to be present. The minor amount of expansive clay particles can be dealt with using standard engineering-construction procedures. The shrink-swell potential of soils is only high locally, suggesting expansive clays are present in the basin-fill material. Most soils have low to moderate shrink-swell potential [3.2-20, 3.2-21, 3.2-22].

A report of maze-type caverns in the Madera Formation north of Edgewood was investigated to determine its possible implication for the SSC. The caverns are reported to be small, room-size voids accessible only by rope through a cemented opening. Their areal extent (Fig. 3.2-1A; in map tube) is based on mapping done by local spelunking groups and analyses of water well logs from the State Engineer Office. The heights of the voids range from a few feet to about 6 feet. The roofs of the cavities are stable with no

spalling or stoping of material. No ground disturbance can be observed above the features, which further indicates that they are stable. The SSC ring, at its recommended location, is east of these cavities.

Parts of Arizona and California have subsided in excess of 15 feet due to withdrawal of water and oil. In New Mexico, only the Deming area (180 miles east of Tucson, Arizona, and 210 miles southwest of the site) has documented ground subsidence related to groundwater withdrawal.

3.2.5 PROBLEM SOILS

Studies to date have encountered no problem soils that will cause impediments to construction of the SSC. Some problem soils that are known to occur throughout the southwest and may occur in places at the site can only be delineated subsequent to detailed site-specific investigations. The orientation of the ring was selected, in large part, to avoid any soils such as soft clay, unconsolidated sand, or other soils that would cause tunneling, excavation, or foundation problems.

In its recommended north-south orientation within the basin, the lower arc passes beneath (but does not encounter) possible problem soils. The lake deposits (Qld on Fig. 3.2-1; in map tube) are interbedded layers of saturated clays, sands, and gravels that have an aggregate thickness of approximately 50 ft. In most of the site area the lake deposits are much thinner. The tunnel in the southern arc region averages about 75 ft deep and will encounter more competent soils of alluvial origin (QTa and Qao) with high bearing capacity, based upon the high N-values in drill holes into this unit (Appendix 3-F). The alluvium consists mainly of interbedded and saturated silty sands, gravelly sands, and thin beds of clean sands and clay. The alluvium is moderately well cemented to well cemented with calcium carbonate. Routine dewatering techniques can be implemented to temporarily dewater this unit so that the SSC tunnel can be excavated. The maximum hydraulic head is 30 ft. This condition exists for about 5 miles in the tunnel reach southeast of Moriarty.

Elsewhere in the basin, principally within the older alluvium (Qao) above the water table, collapsible soils may be encountered locally. These soils are described fully in Section 3.2.4. Such soils may require use of reinforced foundations, installation of high quality utility lines (water and sewer), and additional grading work to assure

good drainage. All these measures are routinely used in many parts of the southwestern U.S. where these soils occur.

3.2.6 DATA SOURCES

The geotechnical and geological investigations conducted draw upon existing published data as well as data from new field work and unpublished data from ancillary sources. Evaluation and synthesis of these data provided the framework within which siting conditions were assessed.

Existing published data reviewed include technical reports from professional journals and state and federal agencies, guidebooks of geological societies, university theses and dissertations, geologic maps, and Soil Conservation Service County reports [3.2-20, 3.2-21, 3.2-22]. Report reviews were supplemented by personal contacts with authors, where possible, and by contacts with individuals having technical knowledge of siting conditions (well drillers, backhoe operators, ranchers, etc.). Unpublished data reviews included water well logs, subdivision reports on file with the State Engineer, and climatic data from the State Climatologist.

Existing data were supplemented with new data generated during field work and laboratory testing. The field activities included review and interpretation of remote sensing data, drilling, topographic surveys, geophysical surveys, backhoe trenching, and downhole geophysical surveys. The laboratory work included numerous tests on both rock and soil samples. The specific tests conducted are presented in Appendices 3-E (soil) and 3-G (rock). A complete list of the works cited in this volume is contained in the reference list. Additional data sources are available upon request.

3.3 GEOHYDROLOGY

The principal aquifers within the proposed area are alluvium (QTa and Qao), Glorieta Sandstone, and Madera Formation. The principal aquifer depends upon location. In the central part of the basin, the older alluvium (QTa and Qao) is the principal aquifer. In the southern and eastern parts of the valley, the Yeso Formation is the principal aquifer [3.3-1]; however, in the site area it is not drawn upon heavily. Along the western edge of the basin, the Madera is the main aquifer. Locally, water is drawn from the Abo and San Andres Formations. In general, groundwater

flows from upland recharge areas on the Estancia Basin margins toward lower discharge points associated with playas 25 miles south of the site. Data from previous researchers [3.3-1, 3.3-2, 3.3-3, 3.3-4, 3.3-5] confirm that groundwater poses no significant underground construction problem in either rock or soil units. No unconsolidated granular soils with a head greater than 30 ft will be encountered in any excavations. Water is available in sufficient quantity and quality to meet the domestic and industrial needs of the SSC.

3.3.1 CHARACTERISTICS OF THE HYDROLOGICAL REGIME

The alluvium is the main aquifer in most of the Estancia Basin (Fig. 3.3-1). This unit ranges in thickness from 0 ft at the valley margins to as much as 115 ft near Moriarty and at least 340 ft 6 miles south of Moriarty. This important aquifer consists of sand, clay, and gravel lenses of varying extent and thickness with layers of sand generally separated by clay and silt. As a result the alluvium contains numerous water-bearing beds of local extent separated by relatively impermeable beds, causing local artesian and perched water conditions to exist. Recharge to this aquifer is from infrequent local precipitation and floods and by discharge from underlying rock units, especially the Glorieta Sandstone and the Madera Formation.

The Glorieta Sandstone is the aquifer in the central and east central parts of the site. This unit is well sorted and well cemented. Typically, the permeability of the Glorieta is low. Adequate supplies are available, however, because the unit is fractured in places. A well 3.5 miles north of Moriarty has a drawdown of only 6 ft when being pumped at more than 3,000 gpm [3.3-1]. Recharge to the Glorieta is from local precipitation and surface runoff. Recharge only occurs when precipitation persists long enough to permit infiltration beyond the root zone. Some recharge is probably by a combination of percolation through alluvium and inflow from the Yeso.

The San Andres Formation is not a principal aquifer in the site. Because of its stratigraphic position above the Glorieta and the generally deep groundwater in the area, water is only available locally in the San Andres. At the localities where the San Andres is tapped, water availability is good. Recharge to the San Andres is by precipitation and surface runoff.

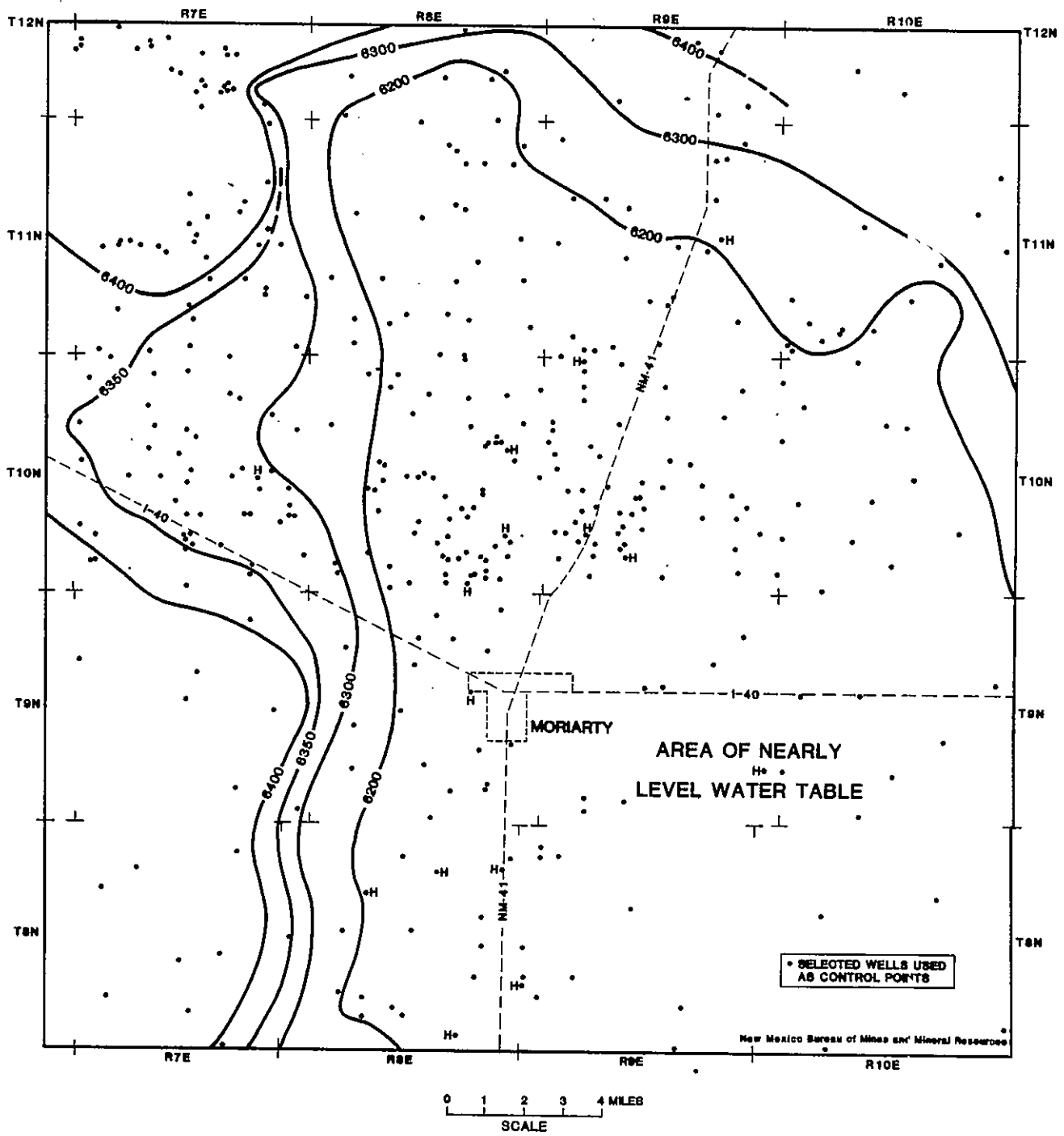

Figure 3.3-1. Elevation of the Water Table in the Estancia Basin [3.3-1 and 3.3-2]. H denotes location of well used in Figure 3.3-2.

NEW MEXICO SSC PROPOSAL JULY 31, 1987

In the eastern part of the site near Longhorn Ranch and in the Moriarty area, the Yeso Formation is locally tapped, mainly for stock and irrigation water but in places for domestic use. Where fractured, high yields can be obtained from the Yeso. For example, a well just south of Lobo Hill is reported to have been pumped at 3,000 gpm [3.3-4]. However, the typical yields of wells in the Yeso are much less [3.3-1] and only where the Yeso Formation is fractured or contains cavities would yields greater than 15 gpm generally be expected. A well just east of the site (T9N, R11E) was pumped at 90 gpm for 24 hours and the drawdown was 30 ft. Recharge is infrequent, mainly from local precipitation and surface runoff or recharge from an adjacent aquifer (especially the Glorieta).

The Madera Formation is the principal aquifer along the western margin of the site where it is under artesian conditions locally [3.3-4]. This aquifer consists mainly of gray cherty limestone and calcareous shale. It is tapped by many wells near Edgewood and is also tapped by wells drilled through the older alluvium north of Edgewood to Cedar Grove. Groundwater occurs in joints and solution channels. The recharge to the Madera is by snow melt and storm runoff. Yields greater than 1,000 gpm are common for wells in the Madera.

3.3.2 WATER RESOURCES

Water resources in the site area are adequate to support all SSC needs. The number of wells needed to produce the required amounts of water for the SSC would be minimal compared to the large capacity irrigation and domestic wells that already exist in the study area. The required volumes of both potable and industrial water are minimal compared to the pumpage rates of wells currently in use in the area. The rate of decline of the water table generally has not significantly increased since 1955. Based upon well hydrographs, the rate of decline is approximately 1 ft per year (Fig. 3.3-2). We have used a rate of decline of 1 ft per year in our assessments of the potential for ground subsidence.

Water quality varies from place to place. Generally, west of New Mexico Highway 41 (NM-41) water meets drinking and domestic water standards as published by the New Mexico Water Quality Control Commission [3.3-7]. East of NM-41 water quality is poorer. In T8N, R10E, the "upper or first" water must, by order of the State Engineer, be cased off and

**WATER LEVEL
(FEET BELOW
GROUND SURFACE)**

WELL DATA

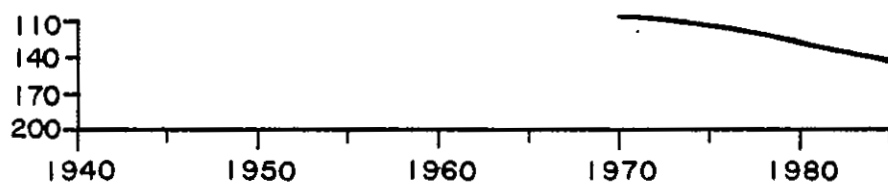

LOCATION
T8N, R9E, Sec. 11
TOTAL DEPTH
280 ft
AVG. DECLINE
0.48 ft/yr

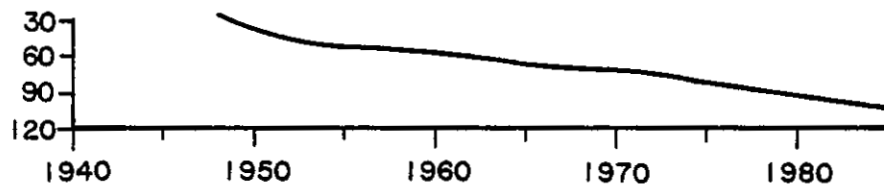

LOCATION
T8N, R9E, Sec. 12
TOTAL DEPTH
180 ft
AVG. DECLINE
1.57 ft/yr

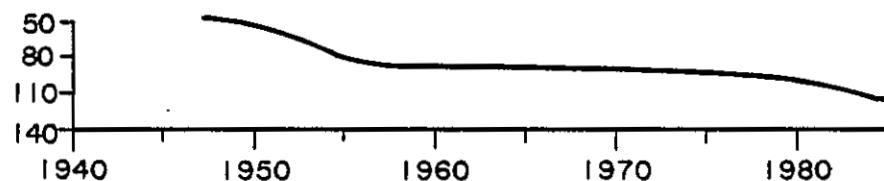

LOCATION
T8N, R9E, Sec. 35
TOTAL DEPTH
228 ft
AVG. DECLINE
1.44 ft/yr

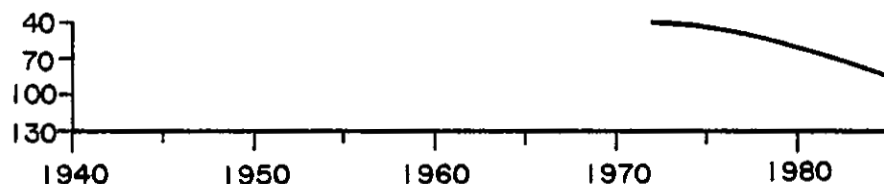

LOCATION
T8N, R9E, Sec. 30
TOTAL DEPTH
150 ft
AVG. DECLINE
3.38 ft/yr

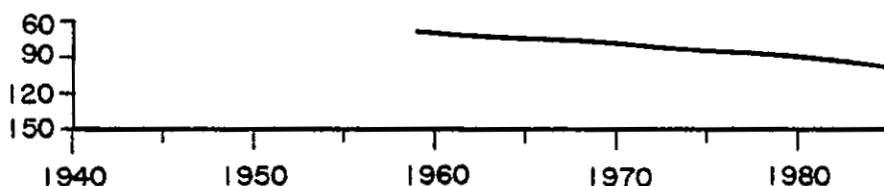

LOCATION
T9N, R8E, Sec. 14
TOTAL DEPTH
475 ft
AVG. DECLINE
1.07 ft/yr



LOCATION
T9N, R9E, Sec. 25
TOTAL DEPTH
180 ft
AVG. DECLINE
1.07 ft/yr

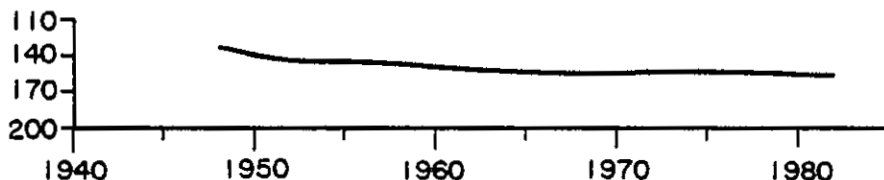

LOCATION
T10N, R7E, Sec. 23
TOTAL DEPTH
175 ft
AVG. DECLINE
0.49 ft/yr

continued next page

Figure 3.3-2. Hydrographs of water levels in 14 wells in the study area, Estancia Basin, New Mexico [3.3-6]. See Figure 3.3-1 for location of wells.

**WATER LEVEL
(FEET BELOW
GROUND SURFACE)**

WELL DATA

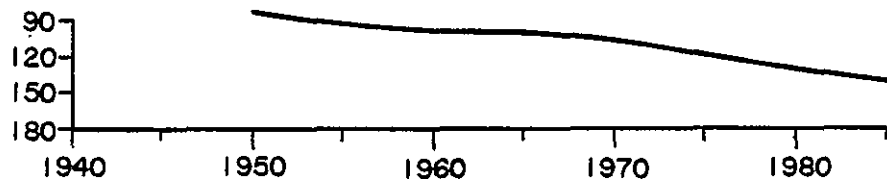

LOCATION
T10N, R8E, Sec. 13
TOTAL DEPTH
513 ft
AVG. DECLINE
1.31 ft/yr



LOCATION
T10N, R8E, Sec. 25
TOTAL DEPTH
238 ft
AVG. DECLINE
1.24 ft/yr

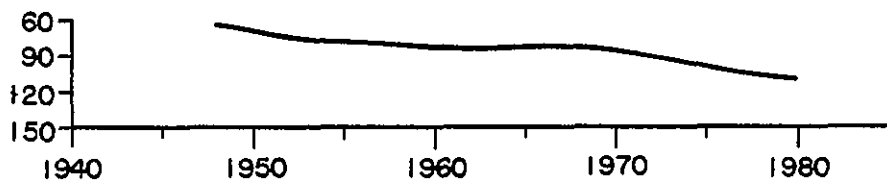

LOCATION
T10N, R9E, Sec. 35
TOTAL DEPTH
188 ft
AVG. DECLINE
1.36 ft/yr

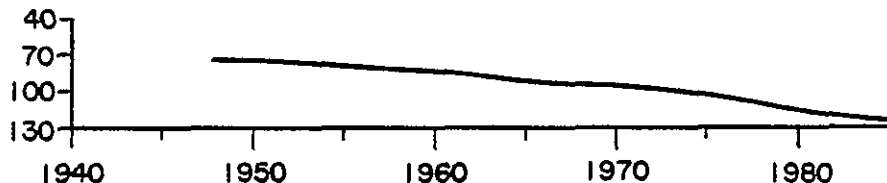

LOCATION
T10N, R9E, Sec. 5
TOTAL DEPTH
325 ft
AVG. DECLINE
1.62 ft/yr

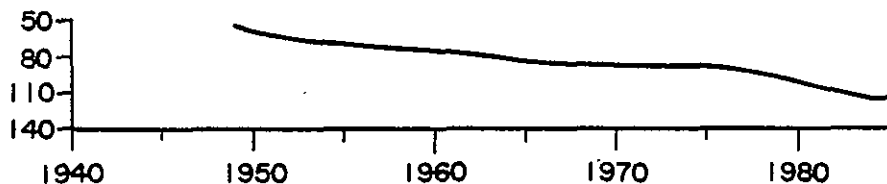

LOCATION
T10N, R9E, Sec. 29
TOTAL DEPTH
200 ft
AVG. DECLINE
1.35 ft/yr

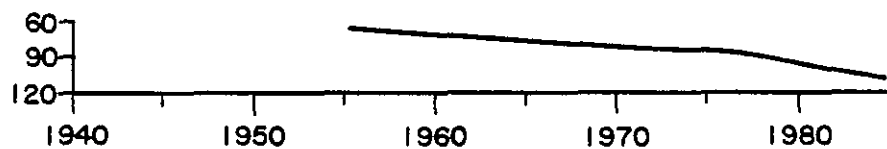

LOCATION
T10N, R9E, Sec. 33
TOTAL DEPTH
130 ft
AVG. DECLINE
1.33ft/yr

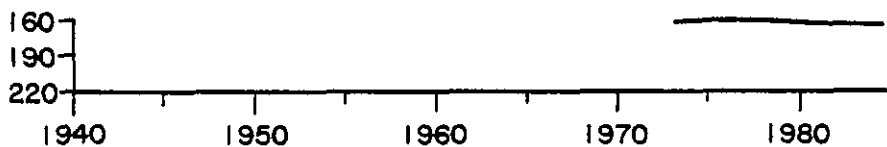

LOCATION
T11N, R9E, Sec. 14
TOTAL DEPTH
430 ft
AVG. DECLINE
0.20 ft/yr

Figure 3.3-2. Continued

NEW MEXICO BUREAU OF MINES & MINERAL RESOURCES

NEW MEXICO SSC PROPOSAL JULY 31, 1987

separated from the lower waters. The low quality water is probably derived from the Yeso Formation that contains gypsum. The SSC ring has been positioned 1.5 miles north of this area.

Specific conductance of water can be used in a general manner to characterize its quality. Although conductance does not indicate the chemical nature of the material in solution, it does indicate the concentration of dissolved solids. In general, the greater the concentration of dissolved solids, the greater its specific conductance. The total dissolved solids content is approximately the specific conductance (in micromhos) times 0.7.

The typical specific conductance for water from the Madera Formation is 430 to 860 micromhos [3.3-1, 3.3-8]. This water is suitable for domestic, stock, irrigation, and industrial use. It is locally hard and iron-bearing.

Specific conductance of water samples from the Yeso Formation ranges from 355 to 5,150 micromhos. Much of the water is not considered fit to drink or suitable for domestic use although it is used locally. In most places it is suitable for stock use and could be used for industrial purposes.

Conductance of water from the Glorieta Sandstone ranges from 890 to 6,040 micromhos. It is generally adequate for drinking and domestic use but locally has high conductance and does not meet drinking water standards. It is suitable for industrial use.

The water from the San Andres Formation, where available, is of good quality. While considered hard water, it can be used for drinking and domestic purposes.

The main aquifer in the northern Estancia Basin is the older alluvium (QTa and Qao). All wells drilled into this unit below the water table yield water. West of NM-41 the water from wells in the older alluvium is satisfactory for drinking and domestic use. However, east of the highway, the water becomes progressively more mineralized. Most would be suitable for industrial purposes but only locally is it suitable for drinking.

3.3.3 UNDERGROUND CONSTRUCTION CONCERNS

There are no major underground construction concerns at the site. The position and orientation of the ring avoids

potential construction problems to the fullest extent. There are two areas of the site that will require careful site-specific design, however. These areas are the experimental halls and the lower arc area.

The experimental halls (K1 to K6) will have a loading of approximately 9 TSF (distributed over the area of the foundation), which is about the natural bearing capacity of the soils where halls K1 and K2 (on the west side) would be constructed. The experimental halls on the east side of the ring (K3 to K6) are founded in Glorieta Sandstone and Triassic-age mudstones and claystones that have excellent bearing capacity. In Section 3.5.4 we recommend specific construction measures to assure a factor of safety of 3 for the experimental halls.

The lower arc region crosses an area of shallow groundwater for 5 miles (Figs. 3.1-3B, 3.1-3C; in map tube). As discussed in Section 3.2.5, the lower arc passes beneath (and does not encounter) unconsolidated lake deposits (Qld), which are relatively thin (generally less than about 25 ft; but locally up to 50 ft thick). Any construction in this unit will require site-specific foundation design using currently available techniques (see Sec. 3.5).

3.4 SEISMICITY AND FAULTING

Seismicity in New Mexico is low in comparison to some other western states such as California, Nevada, and Utah. According to one researcher [3.4-1], seismicity in New Mexico is controlled largely by local geologic conditions such as injection of magma into shallower regions of the earth's crust (Socorro area) or by man-caused hydrocarbon recovery (southeastern New Mexico). Some seismic activity can be correlated to major tectonic structures, none of which occur in the proposed SSC site. Statewide, New Mexico experiences approximately one magnitude 5.1 event per 100 years [3.4-2]. There are no active faults in the site area. Statewide, there has been little detailed work on assessment of active faulting but there are maps depicting earthquake hazards and locations of Pliocene and Quaternary faults. These maps support our findings of no active faults at the site.

3.4.1 CHARACTERIZATION OF SITE SEISMICITY

Near the proposed site, the largest historic earthquake was a modified Mercalli intensity VII earthquake near

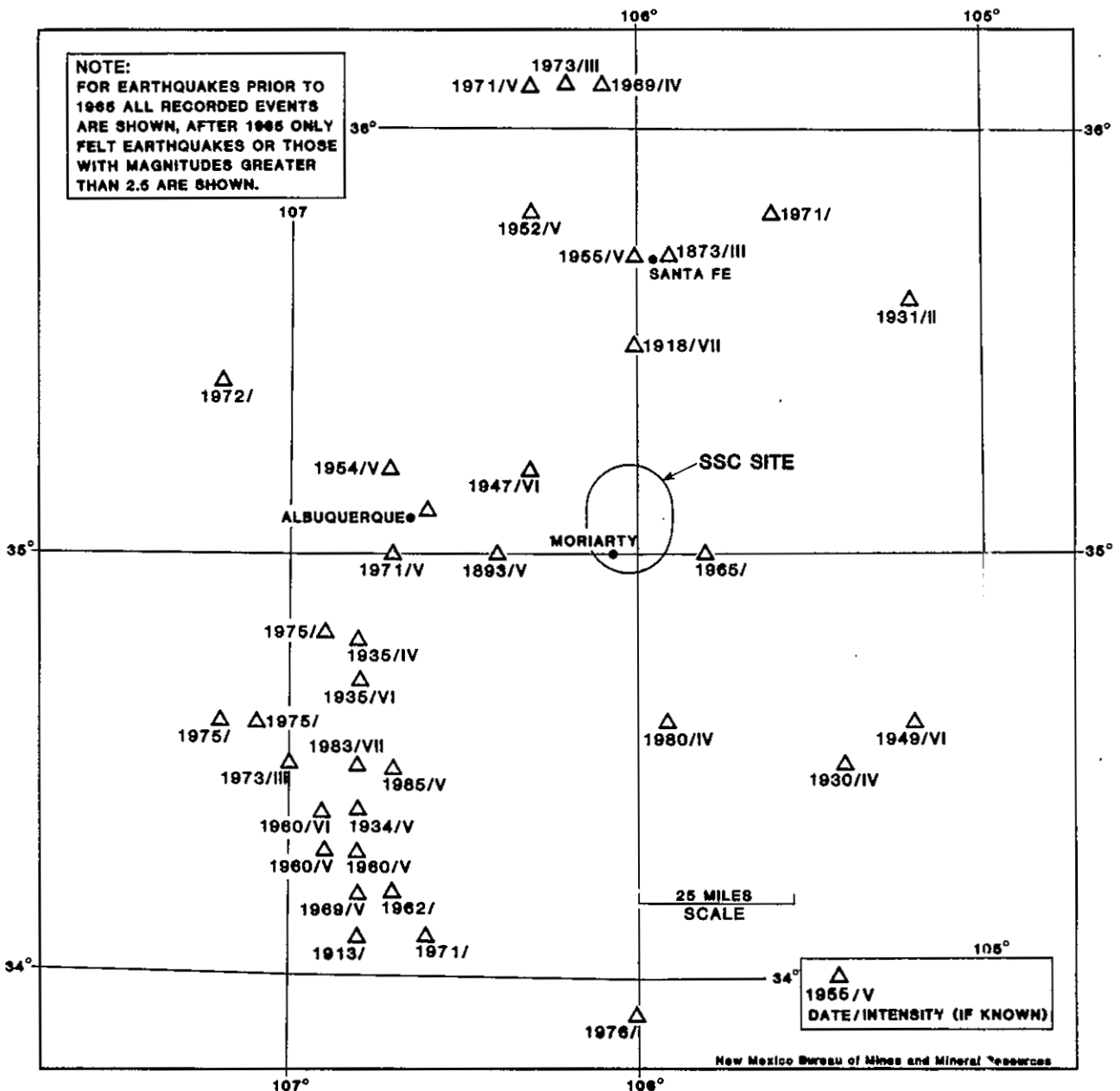

Figure 3.4-1. Seismicity map of north-central New Mexico showing earthquakes within 100 miles of Moriarty [from 3.2-4, after 3.4-7].

NEW MEXICO SSC PROPOSAL JULY 31, 1987

Cerrillos, 35 miles north of Moriarty, in 1918 (Fig. 3.4-1). Earthquakes of this magnitude are capable of damaging weakly constructed buildings or toppling chimneys. One researcher [3.4-3] estimated that the 1918 Cerrillos earthquake caused shaking in Moriarty at a level of about intensity III-V. Within the site, historic seismic activity has been very low. Only two events, which were both less than Richter magnitude 1.6 have been recorded instrumentally [3.2-4]. No evidence of stronger events were observed during current studies. No ground fracturing or liquefaction features were observed in any of the borings, trenches, seismic surveys, or in any of the literature or aerial photographs analyzed.

The proposed site falls within Zone 1 of the seismic risk map of the United States [3.4-4]. In this zone, minor damage could occur, especially from distant earthquakes with fundamental periods greater than 1.0 second. Earthquakes of intensity VII of the Modified Mercalli Intensity Scale of 1931 could occur.

A 1986 report [3.4-5] showed that the site falls within a moderate earthquake potential zone having very low to low hazard. The site is deemed capable of generating earthquakes of magnitude 5 to 6.5 over a time period of 1,000 to 10,000 years. Based on more recent assessments of the SSC area, this time period could be extended to perhaps 50,000 years.

We conclude that seismicity is very low in the proposed site and potential for generation of any significant event during operation of the SSC facility is nil.

3.4.2 ESTIMATE OF SITE-SPECIFIC MAXIMUM GROUND ACCELERATION

According to a USGS open-file report [3.4-6, plate 2] the maximum probable horizontal ground acceleration at the site (in rock, with 90 percent probability of not being exceeded in 50 years) is 4 percent of gravity or less. There is only a 10 percent probability that this value will be exceeded in 50 years. In this region of the nation, wind loading rather than earthquake acceleration governs the design of structures. The site is within seismic source zone 003 [3.4-6] and has potential for a maximum event of magnitude 6.1. Statistically, it has only 0.088 Modified Mercalli maximum intensity V events per year (see Sec. 3.4.1).

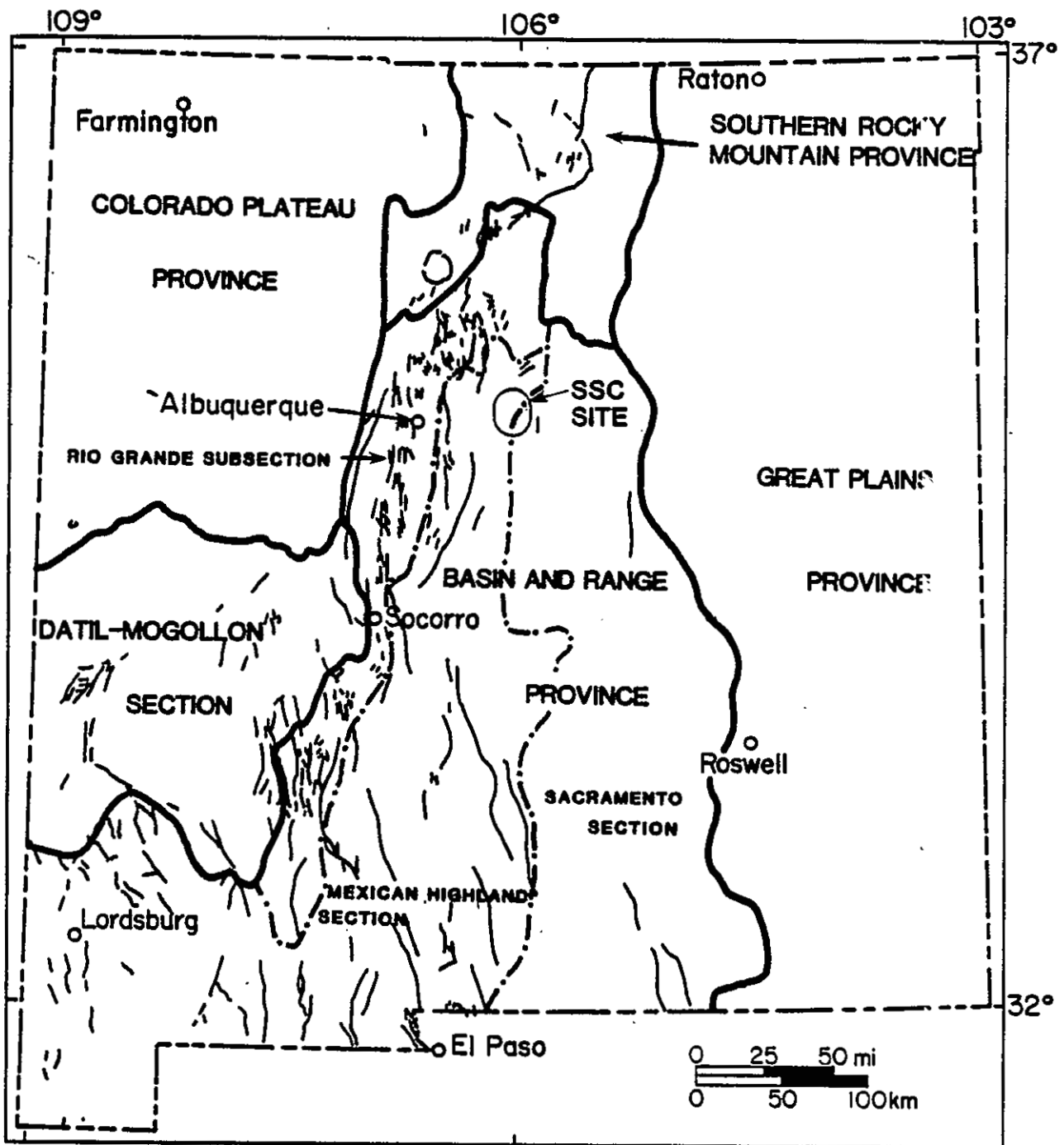

Figure 3.4-2. Distribution of Pliocene and Quaternary faults in New Mexico [from 3.4-5; after 3.4-8, 3.4-9].

From the geologic-geotechnical studies, a fault at the eastern side of the study area was found (Fig. 3.4-2; trench log SSC-BH-10 in Appendix 3-B). Aerial photo analyses indicate that it does not disrupt the older alluvium in the area. Drill hole data (SSC DH-38, Appendix 3-A) indicate that there are more than 108 ft of throw on the fault. There is no historic seismicity that can be associated with the feature. A trench excavated across the fault shows that approximately 6 ft of unbroken older alluvium covers the faulted alluvium below. The unbroken cover contains a moderately well-developed calcic horizon of pedogenic origin indicating that the fault below last moved well in excess of 10,000 years ago. The seismic reflection survey across the fault shows no disruption of the uppermost soils anywhere along the 0.75 mile length of the survey (seismic line SR-5 in Appendix 3-D). Therefore, we are certain that the fault is not active.

3.4.3 KNOWN AND SUSPECTED ACTIVE FAULTS IN THE SITE VICINITY

There are no known active faults in the site vicinity within 100 miles of the site. All faults shown on Figure 3.4-2 are Pliocene to Quaternary in age but are older than 10,000 years. Some faults along the Rio Grande valley may be as young as 20,000 years [3.4-8], but detailed mapping of the majority of them has not been done. A statewide compilation of Pliocene- to Quaternary-age faults [3.4-5] shows that the site is free of young faults. A structural feature northeast of Longhorn Ranch was investigated to assess its level of activity. We conclude, based on seismic, drilling, trenching, geotechnical and geologic data, that this fault last moved well in excess of 10,000 years ago (see Sec. 3.4.2).

3.4.4 ESTIMATE OF POTENTIAL FOR LIQUEFACTION

Liquefaction is not a concern in the site area, mainly due to the low level of seismicity and the stable soil conditions documented during field work. Generally, soils most susceptible to liquefaction are saturated, cohesionless, and and within about 30 feet of the surface. No such soils are present at the site.

At the site, only the lake deposits that occur below the 6,225-foot contour have soils that are saturated to near the surface (to within 25 ft). In general, however, these soils are cohesive. Nevertheless, the liquefaction poten-

tial in this limited area (southeast of Moriarty) is considered in this section.

The lake deposits consist of interbedded sands (thin and cohesionless), cohesive silts, and cohesive clays locally up to about 50 feet thick but averaging about 25 ft. One hole drilled southeast of Moriarty (SSC-DH-35; Fig. 3.2-1D) penetrated 63 ft of interbedded clean sands and clays (Appendix 3-A). There was a perched water table at 28 ft deep, and the regional water table is at 50.5 feet below the surface. Above the perched water table is a thin saturated zone (5 ft thick) of clean saturated sand. This zone is 23 to 28 feet below the ground surface. The N-values of the soils in this hole, obtained from standard penetration tests, average 18. The N-values of the saturated sand zone were not obtainable. The stratigraphic and hydrologic conditions in this hole are generally characteristic of the lake deposits throughout the site. With this general model, one can assess potential for liquefaction using simple geotechnical criteria.

Earthquakes on the order of Modified Mercalli (MM) intensity VII appear to be the threshold that can produce liquefaction [3.4-10]. The largest historic event in the region was an Intensity VII event near Cerrillos in 1918. It caused shaking in Moriarty at intensities estimated to be only III-IV (see Sec. 3.4.1). No reports of liquefaction are associated with the 1918 event, and no evidence of liquefaction was found during the field work.

To a certain degree, soil stratification influences the liquefaction potential at any site [3.4-10]. Thick, cohesionless, clean sand layers are more susceptible to liquefaction than thin ones. In the SSC area, where the water table is within 50 feet of the ground surface, cohesionless soil layers would, in general, have to be about 6 to 9 ft thick in order to be susceptible to liquefaction. This subsurface condition was not found at any of the 40 drill holes (Appendix 3-A).

A final assessment of the liquefaction potential can be gained by observing groundwater levels. Most commonly, liquefaction occurs where groundwater is shallow--less than 30 ft deep. None of the holes drilled encountered water at this depth. The depth to water at its shallowest point along the ring is 35 ft near Moriarty (Figs. 3.1-3B, 3.1-3C). On the average, for the entire ring, the depth to the water table is very deep (211 ft).

In summary, conditions favorable to liquefaction do not occur at the site because the earthquake potential is insignificant, the soil conditions are not susceptible to liquefaction, and the water table is too deep.

3.5 TUNNELING AND UNDERGROUND CONSTRUCTION

The proposed alignment is excellent for economical tunneling. There are five different tunneling conditions along the alignment, making design of tunneling machines and work organization direct. Most of the tunnel (about 37 miles) is in dry, soft sedimentary rock (Py/Pa and Trd) and cemented soils (QTa and Qao). About 12 miles of the tunnel will be in dry, competent, fairly massive sandstone (Pg) or limestone (PPg), which will probably not require lining except locally. Only about 5 miles will be below the groundwater but the water should be easily managed by conventional means. On the average, the tunnel will be at a depth of 99 ft with several locations at adequately shallow depth for cut-and-cover construction methods. The overall cost of completing and lining the tunnel is expected to be about 182 to 201 million 1987 dollars, which is an average unit cost of 615 to 840 dollars per foot. This low cost is due, in large part, to the dry, favorable conditions for underground work along most of the alignment.

This section presents the tunneling and underground excavation information asked for in the Invitation for Site Proposals [3.1-3]. The formation characteristics, tunneling conditions, expected rates of advance, and the expected costs for each designated tunneling condition have been shown for each geologic-geotechnical groundwater situation along the tunnel alignment (Fig. 3.5-1; in map tube). The information, data, and estimates of rates and costs apply only to the main collider ring and the experimental halls. The portals, access shafts, injector system, and surface structures have not been addressed separately because the conditions at the site are deemed typical of central New Mexico and are well understood. The soils are lightly cemented, and some can be locally subject to minor settlement if they are differentially wetted. Differential wetting is routinely dealt with in the American Southwest by adequate structural design and by controlling irrigation and leakage from piping. Most of the soils in the site have a low to moderate shrink-swell potential and only in small, isolated places do they have high shrink-swell potential [3.5-1, 3.5-2]. No soft soils are present which could adversely affect construction.

3.5.1 RELEVANT SOIL AND ROCK UNITS

The engineering descriptions of the soils, rocks, and groundwater conditions in this section are based on engineering and construction considerations. The geological descriptions of the soils and rocks are presented in Section 3.2.3. The tunneling conditions are shown on Figure 3.5-1 (in map tube). Figure 3.5-2 shows simplified descriptions of the tunneling conditions and the location of each condition along the alignment. The soil and rock units of concern are at the level of the tunnel and at the six experimental hall excavations. For the purposes of this engineering evaluation, a soil or rock type was analyzed differently depending on whether or not it was saturated or unsaturated.

We recommend that most of the collider ring be tunneled, but we recognize that several short segments, such as miles 50 to 52, may be suitable for cut-and-cover if it is more economical. Our engineering analysis shows that it may be economical to excavate the entire collider ring by tunneling due to the favorable soil and rock conditions and the probability that site-specific tunnel boring machines will be built for the project. As a result, no special construction methods will be required.

There is little evidence of geologic anomalies at the site; therefore, the potential construction methods associated with geological anomalies have not been assessed.

3.5.2 PHYSICAL AND MECHANICAL PROPERTIES

The physical and mechanical properties of the rocks and soils along the tunnel alignment are shown on Figure 3.5-1 (in map tube). The properties presented include the material type, strength range, abrasiveness, slake potential, gas-seepage potential, rock-quality designation (RQD), and shear characteristics. Also given are groundwater conditions and the estimated stand-up time. These data, which describe the conditions for tunneling, have been used to define the construction equipment needed (methods and shield), the estimated excavation rates for the condition described, and the support requirements (both temporary and permanent). The rates are for advancing the tunnel and lining only, and do not account for any ancillary equipment.

From an engineering and construction standpoint, there are five basic tunneling conditions. These five conditions

Bedrock Unit		
Condition	Simplified Description of Condition	Location, Mi
<hr/>		
PPm		
A	Madera Formation (PPm), above water table.	32-37
<hr/>		
Py/Pa		
C	Yeso/Abo Formation (Py/Pa), above water table.	19-22
C	Mixed face, soil over Yeso/Abo, above water table.	22-23 23-32 37-42
B	Mixed face, soil over Yeso/Abo, below water table.	23-28
<hr/>		
Pg/Psa		
D	Glorieta/San Andres Formation (Pg/Psa), above water table.	12-19
C	Mixed face, soil over Glorieta Sandstone, above water table.	42-45
<hr/>		
Trd		
C	Chinle Formation (Trd), above water table.	10-12
C	Mixed face, soil over Chinle Formation, above water table.	7-10 45-49
<hr/>		
Km		
C	Mixed face, soil over Mancos Shale (Km), above water table.	0-7 49-50 52-54
E	Cut-cover, soil over Mancos Shale, above water table.	50-52

Figure 3.5-2. A short summary of tunneling conditions (A, B, C, D, and E) grouped by bedrock geology.

are based on similar engineering and construction conditions. The conditions previously described (Sec. 3.2.3) are grouped according to bedrock units in Figures 3.5-2 and 3.5-3 and Appendix 3-I.

Conditions A, C, and E are in the dry zone above the water table, and are in either soft sedimentary rocks (PPm, Py/Pa, Trd) or in lightly cemented soils (QTa, Qao). These reaches, which represent very favorable tunneling conditions, total about 41 miles in length. Condition D is a 7-mile reach of the tunnel in massive sandstone (Pg) and condition B is a 5-mile reach in saturated soils (Qao) at shallow depth (Fig. 3.5-1; in map tube).

3.5.3 DIFFICULTIES OR ADVANTAGES

As shown in Figure 3.5-2, there are five distinct tunneling conditions along the alignment (A,B,C,D,E). The construction can easily be accomplished by using conventional tunneling techniques. Because of the magnitude of the project, worldwide attention will be focused on the tunneling effort, and special tunneling machines will likely be designed and built specifically for the SSC construction.

Figure 3.5-2 shows that conditions A, C, and E represent excavations in dry, soft sedimentary rocks and lightly cemented soils. These group conditions comprise about 42 miles of the alignment. Thus, about 80 percent of the alignment will be in essentially ideal tunneling conditions. These ideal tunneling conditions are described more fully in Section 3.5.2.

Condition B involves tunneling in soils beneath the groundwater for about 5 miles. The soil materials in this reach are of modest permeability (less than 2.0 inches per hour [3.5-1, 3.5-2]). Experience indicates that the water can be managed easily by conventional means such as pumping from sumps using medium-size pumps which are readily available. The permanent linings in this short reach will have to be waterproofed and dedicated sumps will have to be installed in case leakage should occur.

Condition D is dry tunneling in more massive sandstone that perhaps will not require lining for most of the reach. The tunneling should be easy, but will require many tooth changes on cutting heads. This reach is about 7 miles long.

There will be several opportunities to use cut-and-

Bedrock Unit	Formation	Above/Below Water Table	Location (in miles from North Point)	Total Footage (x1000 ft)	Total Reach *Unit Cost \$/ft	Cost Million \$
PPm						
A	Madera	Above	32-37	26	700 - 900	18-23
Py/Pa						
C	Yeso/Abo	Above	19-22	16	600 - 800	9-13
C	Soil (Qao)	Above	22-23			
	(Qao)		28-32			
	(QTa)		37-42	53	600 - 800	32-42
B	Soil (Qao)	Below	23-28	26	800 - 1000	21-26
Pg/Psa						
D	Glorieta	Above	12-19	37	750 - 1000	28-37
C	Soil (QTa)	Above	42-45	16	600 - 800	10-13
Trd						
C	Chinle	Above	10-12	11	600 - 800	7-9
C	Soil (QTa)	Above	7-10			
	(QTa)		45-49	37	600 - 800	22-30
Km						
C	Soil (QTa)	Above	0-7			
	(QTa)		49-50			
			52-54	53	600 - 800	32-42
E	Cut & Fill	Above	50-52	11	300 - 700	3-8
TOTALS.....				286.....	615 - 840...	182-201
				(x1000 ft)	(\$/ft)	(million \$)

Figure 3.5-3. Summary of costs for tunneling conditions grouped by bedrock geology. Cost estimates assume: 1987 dollars, on-site availability of power and water, and typical New Mexico labor costs. * Unit costs are discussed in Figure 3.5-1 (in map tube) and Appendix 3-I.

cover techniques (such as miles 50-52; condition E on Figure 3.5-1). The choice between tunneling and cut-and-cover should be made on the basis of construction cost and ease of tunneling. Tunneling for this project will be cost-competitive, especially if the cover backfill is required to be compacted. Tunneling greatly minimizes environmental disturbance and would therefore be advantageous. For these reasons, only one example of cut-and-cover (condition E) has been included. The topography within this zone is adequately flat and open so that cut-and-cover would be technically feasible.

3.5.4 RECOMMENDED CONSTRUCTION TECHNIQUES

The recommended construction techniques are shown for each tunneling condition on Figure 3.5-1 (in map tube), under the heading "Excavation" (methods and shield). The entire alignment can be excavated using tunnel boring machines (TBM's), but short segments such as miles 50-52 may be considered for cut-and-cover. Because the tunnel is rather small in diameter, it may be worthwhile not to specify the size to contractors but rather give them the opportunity to bid on a larger diameter tunnel if it represents a cost savings. If the tunnel is overcut, there would be more room for working and transport. If the outer tunnel is on the order of 12 ft diameter, contractors may want to install precast invert slabs immediately behind the TMB, which may result in substantial cost savings.

The recommended tunnel support systems are shown for each tunneling condition on Figure 3.5-1 (in map tube), under the heading "Support" (temporary and permanent). All of the recommended support systems are routine, and none involve special techniques or equipment. Support is not expected to be a problem anywhere along the alignment.

Because the alignment is in open, relatively flat terrain, the experimental halls can easily be constructed by cut-and-cover methods, using side slopes of about 1.5 to 1 (horizontal to vertical), with appropriate haul roads into and out of the hole. The upper parts of all the excavations will be in lightly cemented soils, and two of the excavations (K1 and K2) will be entirely in such soils. The remaining four (K3, K4, K5 and K6) will bottom in sandstone or shale. The shale will be rippable and may be amenable to excavation with scrapers. It may be necessary to blast the sandstone; however, that can easily be determined subsequent to the detailed investigations before the design phase. The

haul road grade should be about 12 percent for these conditions, so that the excavations can be carefully planned ahead of time. The excavations can be made using large scrapers, which would require about 30 to 40 total working days (to bottom grade at each experimental hall). Because of similarities of site conditions, at some of these excavations, it may be advisable to stage different-sized scrapers as the excavations proceed, scheduling the scrapers from excavation to excavation. Large scrapers would be used near the ground surface where adequate working room is available, and smaller scrapers would be used near the bottom of the excavation where working room becomes more restricted. With proper management, the excavation time for each site could easily be reduced to about 20 total working days. In either case, it will cost about \$1.50 per cubic yard to make the excavation, and about \$1.50 per cubic yard to compact the backfill over the halls. For the case where sandstone may have to be blasted, the excavation costs will be about \$5.00 per cubic yard, but the backfill will still be about \$1.50 per cubic yard. Therefore, the average costs for each hall will be about \$150,000, and the backfilling costs for each hall will be about \$100,000. The soils in the area generally have a bulking factor much less than unity (probably 0.7 to 0.8), so there will be little waste to dispose of after the compacted backfilling is completed.

The support of the locally high unit loadings (9 tsf) on the floors of the halls is trivial from a soil-bearing-capacity standpoint; the halls will be net buoyant because of the weights of the removed soils and rocks. A design that will reinforce the floors to distribute the locally high unit loadings is required. The design should provide that the bearing pressures on the supporting soils and rocks are not excessively differential. The floor will be a reinforced-concrete mat foundation 6 to 10 ft thick. The thickness will depend upon the configurations and locations of the high unit loadings.

The most important design situation in the halls is the design of the unsupported roofs to carry the weight of the compacted backfill above them. Those unsupported spans probably cannot be made with conventional flat reinforced-concrete techniques as sketched in the Invitation for Site Proposals [3.1-3] without resorting to excessive concrete thicknesses and/or steel densities. It will probably be more economical to design the roofs as thin-arch domes to support the backfill loads and carry the loads directly into the walls, which could then act as gravity members to

transfer these loads to the wall foundations. The foundations probably would be simple spread footings.

In summary, the construction techniques appropriate for both tunneling and the excavations for the halls are routine and conventional. Considering the pool of miners and mining experience (both tunnel and open-pit mines) available in New Mexico, these excavations can be handled routinely.

3.5.5 DISPOSAL OF MUCK AND SPOILS

New Mexico has the ability to dispose of all muck and spoils from the major excavations at convenient haul distances from the site. Disposal will be by a combination of on-site use during construction and disposal in nearby quarried-out portions of the Tijeras limestone quarry (a subdivision of Ideal Basic Industries) approximately 18 miles west of Edgewood and/or in Albuquerque.

The bulk of the muck and spoils will be generated from excavations for the collider ring, experimental halls, and the injector system (lineac, LEB, MEB, and HEB). A total of 2.06 million cubic yards of muck and spoils will be produced from these excavations (assuming a swell factor of 1.3). Analyses of soil and rock samples indicates that about 406,000 cubic yards could be used in cement manufacture (Appendix 3-J). Multiple batch plants could be set up on site for use of the high quality material. There does not appear to be any problem disposing of the remainder of the material in quarried-out portions of the Tijeras quarry (maximum storage capacity is 2.38 million cubic yards; Appendix 3-J). Other mined-out quarries exist in Albuquerque and operators there also express great interest in use of SSC generated muck and spoils for reclamation.

REFERENCES

- 3.1-1. New Mexico Bureau of Mines and Mineral Resources Staff, New Mexico Bureau of Mines and Mineral Resources, Open-file Report No. 234 (1985).
- 3.1-2. SSC Central Design Group, Report No. SSC-SR-2020 (1985).
- 3.1-3. U.S. Department of Energy, Invitation for Site Proposals for the Superconducting Super Collider (1987).
- 3.2-1. B.S. Kues, and J.F. Callender, in New Mexico in Maps (2nd edition), ed. J.L. Williams, p. 2-5 (1986).
- 3.2-2. L.A. Woodward, New Mexico Geological Society, Guidebook to 33rd Field Conference, p. 141-147 (1982).
- 3.2-3. V.C. Kelley, New Mexico Bureau of Mines and Mineral Resources, Geologic Map No. 18 (1963).
- 3.2-4. G.D. Johnpeer et al., New Mexico Bureau of Mines and Mineral Resources, Open-file Report No. 257 (1987).
- 3.2-5. D.A. Myers, and E.J. McKay, U.S. Geological Survey, Map No. I-968 (1976).
- 3.2-6. F.B. Titus, New Mexico Bureau of Mines and Mineral Resources, Open-file Report No. 69 (1973).
- 3.2-7. F.B. Titus, New Mexico Bureau of Mines and Mineral Resources, Hydrologic Report No. 5 (1980).
- 3.2-8. F.E. Kottlowski, New Mexico Geological Society, Guidebook to 12th Field Conference, p. 97-105 (1961).
- 3.2-9. R.E. Smith, New Mexico Bureau of Mines and Mineral Resources, Ground-Water Report No. 5 (1957).
- 3.2-10. V.C. Kelley, and S.A. Northrop, New Mexico Bureau of Mines and Mineral Resources, Memoir No. 29 (1975).
- 3.2-11. A.E. Disbrow and W.C. Stoll, New Mexico Bureau of Mines and Mineral Resources, Bulletin No. 48 (1957).

- 3.2-12. T.B. Thompson, M.S. thesis, Geology Department, University of New Mexico, 1963.
- 3.2-13. J.W. Hawley et al., New Mexico Geological Society, Guidebook to 33rd Field Conference, p. 8-24 (1982).
- 3.2-14. N. Strange, private communication (1987).
- 3.2-15. K. Terzaghi, and R.B. Peck, Soil Mechanics in Engineering Practice, 2nd edition, John Wiley and Sons Inc., New York (1967).
- 3.2-16. G.D. Johnpeer et al., New Mexico Bureau of Mines and Mineral Resources, Open-file Report No. 225 (1985).
- 3.2-17. Building Research Advisory Board, U.S. National Academy of Sciences Publication No. 1571 (1968).
- 3.2-18. A.D. Lovelace, W.T. Bennett, and R.D. Lueck, New Mexico State Highway Department, Project No. 1-025-4(58) 243 (1982).
- 3.2-19. F. Guzzetti, and E.E. Brabb, U.S. Geological Survey, Open-file Report No. 87-70 (1987).
- 3.2-20. Soil Conservation Service, Soil Survey of Torrance Area, New Mexico, U.S. Department of Agriculture (1970).
- 3.2-21. Soil Conservation Service, Soil Survey of Santa Fe Area, New Mexico, U.S. Department of Agriculture (1975).
- 3.2-22. Soil Conservation Service, Soil Survey of Bernalillo County and parts of Sandoval and Valencia Counties, New Mexico, U.S. Department of Agriculture (1977).
- 3.2-23. R.M. North, and V.T. McLemore, New Mexico Geological Society, Guidebook to 36th Field Conference, p. 301-305 (1985).
- 3.2-24. C.B. Read et al., U.S. Geological Survey, Oil and Gas Investigations Preliminary Map No. 21 (1944).
- 3.3-1. R.E. Smith, New Mexico Bureau of Mines and Mineral Resources, Ground-Water Report No. 5 (1957).
- 3.3-2. W.A. Mourant, New Mexico State Engineer, Basic Data Report (1980).

NEW MEXICO SSC PROPOSAL JULY 31, 1987

- 3.3-3. D.N. Jenkins, New Mexico Geological Society, Guidebook to 33rd Field Conference, p. 361-366 (1982).
- 3.3-4. F.B. Titus, Jr., New Mexico Bureau of Mines and Mineral Resources, Hydrologic Report No. 5 (1970).
- 3.3-5. G.D. Johnpeer et al., New Mexico Bureau of Mines and Mineral Resources, Open-file Report No. 257 (1987).
- 3.3-6. R.R. White, Estancia Valley Water-level Measurements, unpublished, (1986).
- 3.3-7. State of New Mexico Water Quality Control Commission Regulations (1986).
- 3.3-8. New Mexico State Engineer Office, private communication (1987).
- 3.4-1. A.R. Sanford, K.H. Olsen, and L.H. Jaksha, New Mexico Bureau of Mines and Mineral Resources, Circular No. 171 (1981).
- 3.4-2. A.R. Sanford, New Mexico Geological Society, Guidebook to 34th Field Conference, p. 123-125 (1983).
- 3.4-3. K.H. Olsen, New Mexico Geological Society, Guidebook to 30th Field Conference, p. 65-77 (1979).
- 3.4-4. International Conference of Building Officials, Uniform Building Code (1982).
- 3.4-5. G.D. Johnpeer, D.W. Love, and M. Hemingway, in Proceedings of the Third U.S. National Conference on Earthquake Engineering, p. 233-245 (1986).
- 3.4-6. S.T. Algermissen et al., U.S. Geological Survey, Open-file Report No. 82-1033 (1982).
- 3.4-7. C.W. Stover, B.G. Reagor, S.T. Algermissen, U.S. Geological Survey, Map No. MF-1660 (1983).
- 3.4-8. M.N. Machette, Map showing distribution of Quaternary and Pliocene faults and volcanic features in the Rio Grande Rift, New Mexico and West Texas, unpublished (1982).

- 3.4-9. J.W. Hawley, in New Mexico in Maps (2nd edition), ed. J.L. Williams, p. 28-32 (1986).
- 3.4-10. National Academy of Sciences, Committee on Earthquake Engineering, National Academy Press, Washington, D.C. (1986).
- 3.5-1. Soil Conservation Service, Soil Survey of Torrance Area, New Mexico, U.S. Department of Agriculture (1975).
- 3.5-2. Soil Conservation Service, Soil Survey of Santa Fe Area, New Mexico, U.S. Department of Agriculture (1975).
- 3-E-1. Unified Soil Classification System, American Society for Testing and Materials, ASTM-D 2487 (1983).
- 3-F-1. J. Lowe III, and P.F. Zaccheo, in Foundation Engineering Handbook, eds. H.F. Winterkorn and Hsai-Yang Fang, Van Nostrand Reinhold Co., New York (1975).
- 3-F-2. B.M. Das, Principles of Geotechnical Engineering, Prindle, Weber, Schmidt, Boston, Mass. (1985).
- 3-G-1. International Society for Rock Mechanics Commission on Testing Methods, International Journal of Rock Mechanics, Vol. 22, No. 2, p. 51-60 (1985).
- 3-G-2. Z.T. Bieniawski, Engineering Geology, Vol. 9, p. 1-11 (1975).

APPENDIX 3-A

Boring Logs

Following are logs of the 40 borings completed during the field investigation for this proposal. They show the geotechnical conditions of the soil and rock that the tunnel will encounter. The locations of these borings are shown on Figure 3.2-1 (in map tube), and the laboratory test data for both rock and soil samples are presented in Appendices 3-E, 3-F, and 3-G.

THE LOG OF SUBSURFACE CONDITIONS SHOWN HEREON APPLIES ONLY AT THE SPECIFIC BORING LOCATION AND AT THE DATE INDICATED. IT IS NOT WARRANTED TO BE REPRESENTATIVE OF SUBSURFACE CONDITIONS AT OTHER LOCATIONS AND TIMES.

ELEVATION (ft.)	DEPTH (ft.)	"N" VALUE	STD. PEN. TEST	LABORATORY DATA					SAMPLE TYPE <small>(U=Undisturbed D=Disturbed)</small>	USCS SYMBOL	GEOLOGIC SYMBOL	SOIL DESCRIPTION Gravel/Sand/Fines (%)
				MOISTURE (% of dry wt.)	DRY DENSITY (lb./cu. ft.)	LIQUID LIMIT	PLASTICITY LIMIT					
												BORING: SSC-DH-4 DATE DRILLED: 9/25/86 EQUIPMENT USED: SIMCO 2800 HS LOCATION: SE $\frac{1}{4}$ SE $\frac{1}{4}$ SEC27 T11N R8E ELEVATION: 6318 TOTAL DEPTH: 30 feet
6314	4-5	14	10	NA	26	17	D	SC			Clayey sand 1/69/30	
6309	9-10	9	11	NA	23	NP	D	SM			Silty sand 0/72/28	
6299	19-20	29	7	NA	25	21	D	SM/SC			Silty sand/clayey sand 0/69/31	
6289	29-30	39	13	NA	32	17	D	SC			Clayey sand 0/60/40	

NOTES: On Highway 471, 2½ miles west of Don King Ranch.
Drilled by G.J.

NV = no value
NP = non-plastic

BORING LOG
NEW MEXICO SSC PROPOSAL JULY 31, 1987

THE LOG OF SUBSURFACE CONDITIONS SHOWN HEREON APPLIES ONLY AT THE SPECIFIC BORING LOCATION AND AT THE DATE INDICATED. IT IS NOT WARRANTED TO BE REPRESENTATIVE OF SUBSURFACE CONDITIONS AT OTHER LOCATIONS AND TIMES.

ELEVATION (ft.)	DEPTH (ft.)	"N" VALUE	STD. PEN. TEST	LABORATORY DATA					USCS SYMBOL	GEOLOGIC SYMBOL	SOIL DESCRIPTION Gravel/Sand/Fines (%)
				MOISTURE (% of dry wt.)	DRY DENSITY (lb./cu. ft.)	LIQUID LIMIT	PLASTIC LIMIT	SAMPLE TYPE			
6386	4-5	30	10	NA	27	16	D	SC		Clayey sand 0/77/23	
6381	9-10	36	8	NA	36	18	D	SC		Clayey sand 0/60/40	

BORING: SSC-DH-5
 DATE DRILLED: 9/25/86
 EQUIPMENT USED: STMCO 2800 HS
 LOCATION: SW¹/₄, SW¹/₄, Sec 28, T11N, R8E
 ELEVATION: 6390
 TOTAL DEPTH: 15 feet

NOTES:

 NV = no value
 NP = non-plastic

BORING LOG
 NEW MEXICO SSC PROPOSAL JULY 31, 1987

THE LOG OF SUBSURFACE CONDITIONS SHOWN HEREON APPLIES ONLY AT THE SPECIFIC BORING LOCATION AND AT THE DATE INDICATED. IT IS NOT WARRANTED TO BE REPRESENTATIVE OF SUBSURFACE CONDITIONS AT OTHER LOCATIONS AND TIMES.

ELEVATION (ft.)	DEPTH (ft.)	'N' VALUE	STD. PEN. TEST	MOISTURE (% of dry wt.)	LABORATORY DATA				USCS SYMBOL	GEOLOGIC SYMBOL	SOIL DESCRIPTION Gravel/Sand/Fines (%)
					DRY DENSITY (lb./cu. ft.)	LIQUID LIMIT	PLASTIC LIMIT	SAMPLE TYPE			
<div style="text-align: right;"> BORING: SSC-DH-6 DATE DRILLED: 9/26/86 EQUIPMENT USED: SIACO 2800 HS LOCATION: SW¹/₄, SE¹/₄, Sec 26, T11N, R9E ELEVATION: 6345 TOTAL DEPTH: 24 feet </div>											
6341	4-5	27	7	NA	27	20	D	SM-SC		Silty sand-clayey sand 3/67/30	
6336	9-9½	REF	12	NA	42	23	D	CL		Lean clay with sand 0/20/80	
6326	19-19½	REF	16	NA	51	22	D	CH		Fat clay 0/13/87	

NOTES:

NV=no value
NP=non-plastic

BORING LOG

NEW MEXICO SSC PROPOSAL JULY 31, 1987

THE LOG OF SUBSURFACE CONDITIONS SHOWN HEREON APPLIES ONLY AT THE SPECIFIC BORING LOCATION AND AT THE DATE INDICATED. IT IS NOT WARRANTED TO BE REPRESENTATIVE OF SUBSURFACE CONDITIONS AT OTHER LOCATIONS AND TIMES.

ELEVATION (ft.)	DEPTH (ft.)	"N" VALUE	STD. PEN. TEST	LABORATORY DATA				SAMPLE TYPE U=Undisturbed D=Disturbed	USCS SYMBOL	GEOLOGIC SYMBOL	SOIL DESCRIPTION Gravel/Sand/Fines (%)
				MOISTURE (% of dry wt.)	DRY DENSITY (lb./cu. ft.)	LIQUID LIMIT	PLASTIC LIMIT				
6396	4-5	41	6	NA	23	19	D	SM-SC		Silty sand-clayey sand 0/57/43	
6391	9-10	13	5	NA	22	21	D	SM		Silty sand 0/73/27	
6381	19-20	REF	7	NA	29	23	D	SM		Silty sand 0/61/39	
6371	29-30	REF	7	NA	28	26	D	SM		Silty sand 0/79/21	

NOTES:

NV = no value
NP = non-plastic

BORING LOG
NEW MEXICO SSC PROPOSAL JULY 31, 1987

BORING: SSC-DH-7
 DATE DRILLED: 9/29/86
 EQUIPMENT USED: SIMCO 2800 HS
 LOCATION: NW $\frac{1}{4}$, NW $\frac{1}{4}$, Sec 32, T11N, R10E
 ELEVATION: 6400
 TOTAL DEPTH: 30 feet

THE LOG OF SUBSURFACE CONDITIONS SHOWN HEREON APPLIES ONLY AT THE SPECIFIC BORING LOCATION AND AT THE DATE INDICATED. IT IS NOT WARRANTED TO BE REPRESENTATIVE OF SUBSURFACE CONDITIONS AT OTHER LOCATIONS AND TIMES.

ELEVATION (ft.)	DEPTH (ft.)	"N" VALUE	STD. PEN. TEST	LABORATORY DATA				SAMPLE TYPE U=undisturbed; P=disturbed	USCS SYMBOL	GEOLOGIC SYMBOL	BORING: SSC-DH-8 DATE DRILLED: 9/30/86 EQUIPMENT USED: SIMCO 2800 HS LOCATION: SE 1/4, NE 1/4, Sec 32, T11N, R10E ELEVATION: 6410 TOTAL DEPTH: 30 feet	SOIL DESCRIPTION Gravel/Sand/Fines (%)
				MOISTURE (% of dry wt.)	DRY DENSITY (lb./cu. ft.)	LIQUID LIMIT	PLASTIC LIMIT					
6406	4-5 1/2	25	5	NA	21	16	D	SM-SC	▧		Silty sand-clayey sand 0/66/34	
6401	9-10	23	7	NA	27	22	D	CL	▧		Sandy lean clay 0/45/55	
6391	19-20	28	5	NA	20	18	D	SM	▧		Silty sand 0/54/46	
6381	29-30	34	2	NA	NP	NP	D	SP-SM	▧		Poorly graded sand with silt and gravel 23/69/8	

NOTES:
 NV = no value
 NP = non-plastic

BORING LOG
 NEW MEXICO SSC PROPOSAL JULY 31, 1987

THE LOG OF SUBSURFACE CONDITIONS SHOWN HEREON APPLIES ONLY AT THE SPECIFIC BORING LOCATION AND AT THE DATE INDICATED. IT IS NOT WARRANTED TO BE REPRESENTATIVE OF SUBSURFACE CONDITIONS AT OTHER LOCATIONS AND TIMES.

ELEVATION (ft.)	DEPTH (ft.)	"N" VALUE	STD. PEN. TEST	LABORATORY DATA					SAMPLE TYPE	USCS SYMBOL	GEOLOGIC SYMBOL	SOIL DESCRIPTION
				MOISTURE (% of dry wt.)	DRY DENSITY (lb./cu. ft.)	LIQUID LIMIT	PLASTICITY LIMIT	FLUIDITY				
6225	4-5	12	13	NA	24	20	D	CL/ML			Silty clay 0/43/57	
6220	9-10	15	10	NA	25	19	D	SM/SC			Silty sand/clayey sand 0/65/35	
6210	19-20	25	19	NA	42	24	D	SC			Clayey sand 0/53/47	
6200	29-30	45	14	NA	36	23	D	CL			Clay 0/25/75	

BORING: SSC-DH-9
 DATE DRILLED: 9/30/86
 EQUIPMENT USED: SIMCO 2800 HS
 LOCATION: NE 1/4 NW 1/4 SEC 29 T10N R9E
 ELEVATION: 6229
 TOTAL DEPTH: 30 feet

NOTES: On Highway 41 right of way, near King Brothers Feed Lot.
 Drilled by G.J.

NV - no value
 NP - non-plastic

BORING LOG
NEW MEXICO SSC PROPOSAL JULY 31, 1987

THE LOG OF SUBSURFACE CONDITIONS SHOWN HEREON APPLIES ONLY AT THE SPECIFIC BORING LOCATION AND AT THE DATE INDICATED. IT IS NOT WARRANTED TO BE REPRESENTATIVE OF SUBSURFACE CONDITIONS AT OTHER LOCATIONS AND TIMES.

ELEVATION (ft.)	DEPTH (ft.)	"N" VALUE	STD. PEN. TEST	LABORATORY DATA					SAMPLE TYPE <small>U=Undisturbed D=Disturbed</small>	USCS SYMBOL	GEOLOGIC SYMBOL	SOIL DESCRIPTION Gravel/Sand/Fines (%)
				MOISTURE (% of dry wt.)	DRY DENSITY (lb./cu. ft.)	LIQUID LIMIT	PLASTICITY LIMIT					
6216	4-5	21	13	NA	20	NP	D	SM			Silty sand 0/67/33	
6211	9-10	36	6	NA	NP	NP	D	SW/SM			Sand/silty sand 5/88/7	
6201	19-20	12	15	NA	20	16	D	CL/ML			Silty clay 0/42/58	
6191	29-30	32	13	NA	21	12	D	CL			Clay 0/37/63	

BORING: SSC-DH 10
 DATE DRILLED: 101 186
 EQUIPMENT USED: SIMCO 2800 HS
 LOCATION: Central SEC21 T10N R9E
 ELEVATION: 6220
 TOTAL DEPTH: 30 feet

NOTES: In potato field on King Brother's feed lot.
 Drilled by S.R.C.

NV=no value
 NP=non-plastic

BORING LOG
 NEW MEXICO SSC PROPOSAL JULY 31, 1987

THE LOG OF SUBSURFACE CONDITIONS SHOWN HEREON APPLIES ONLY AT THE SPECIFIC BORING LOCATION AND AT THE DATE INDICATED. IT IS NOT WARRANTED TO BE REPRESENTATIVE OF SUBSURFACE CONDITIONS AT OTHER LOCATIONS AND TIMES.

ELEVATION (ft.)	DEPTH (ft.)	"N" VALUE	STD. PEN. TEST	LABORATORY DATA							GEOLOGIC SYMBOL	SOIL DESCRIPTION Gravel/Sand/Fines (%)
				MOISTURE (% of dry wt.)	DRY DENSITY (lb./cu. ft.)	LIQUID LIMIT	PLASTIC LIMIT	SAMPLE TYPE	USCS SYMBOL	GEOLOGIC SYMBOL		
6496	4-5 1/2	22	7	NA	23	NP	D	SM	█	Silty sand 0/62/38		
6491	9-9 1/2	REF	7	NA	24	21	D	ML	█	Sandy silt 0/50/50		
6481	19-20 1/2	59	11	NA	26	22	D	CL-ML	█	Silty clay 0/17/83		
6471	29-29 1/2	REF	12	NA	35	23	D	CL	█	Sandy lean clay 0/30/70		

NOTES: REF = refusal

NV = no value
NP = non-plastic

BORING LOG
NEW MEXICO SSC PROPOSAL JULY 31, 1987

THE LOG OF SUBSURFACE CONDITIONS SHOWN HEREON APPLIES ONLY AT THE SPECIFIC BORING LOCATION AND AT THE DATE INDICATED. IT IS NOT WARRANTED TO BE REPRESENTATIVE OF SUBSURFACE CONDITIONS AT OTHER LOCATIONS AND TIMES.

ELEVATION (ft.)	DEPTH (ft.)	"N" VALUE	LABORATORY DATA						USCS SYMBOL	GEOLOGIC SYMBOL	SOIL DESCRIPTION	Gravel/Sand/Fines (%)
			STD. PEN. TEST	MOISTURE (% of dry wt.)	DRY DENSITY (lb./cu. ft.)	LIQUID LIMIT	PLASTICITY LIMIT	SAMPLE TYPE				
6656	4-5½	33	7	NA	25	20	D	SM/SC			Silty sand/clayey sand 0/64/36	
6651	9-10½	19	6	NA	24	18	D	SM/SC			Silty sand/clayey sand 0/61/39	
6641	19-20½	20	8	NA	29	19	D	SC			Clayey sand 0/60/40	

BORING: SSC-DH-12
 DATE DRILLED: 10/20/86
 EQUIPMENT USED: SIMCO 2800 HS
 LOCATION: SE¼ SE¼ SEC3 T12N R8E
 ELEVATION: 6660
 TOTAL DEPTH: 20.5 feet

NOTES: At Hyer near seismic line.
 Drilled by G.J.

NV = no value
 NP = non-plastic

BORING LOG
 NEW MEXICO SSC PROPOSAL JULY 31, 1987

THE LOG OF SUBSURFACE CONDITIONS SHOWN HEREON APPLIES ONLY AT THE SPECIFIC BORING LOCATION AND AT THE DATE INDICATED. IT IS NOT WARRANTED TO BE REPRESENTATIVE OF SUBSURFACE CONDITIONS AT OTHER LOCATIONS AND TIMES.

BORING: SSC-DH-13
 DATE DRILLED: 10/21/86
 EQUIPMENT USED: SIMCO 2800 HS
 LOCATION: Boundary of Sec 32 & 33, T11N, R7E
 ELEVATION: 6680
 TOTAL DEPTH: 23 feet

ELEVATION (ft.)	DEPTH (ft.)	SPT VALUE	MOISTURE (% of dry wt.)	LABORATORY DATA					SAMPLE TYPE	USCS SYMBOL	GEOLOGIC SYMBOL	SOIL DESCRIPTION Gravel/Sand/Fines (%)
				STD. PEN. TEST	DRY DENSITY (lbs./cu. ft.)	LIQUID LIMIT	PLASTIC LIMIT	USCS SYMBOL				
6676	4-5½	22	5	NA	23	19	D	SM-SC			Silty sand-clayey sand 0/70/30	
6671	9-10½	22	11	NA	39	23	D	CL			Lean clay 0/4/96	
6661	19-20½	17	7	NA	23	19	D	CL-ML			Sandy silty clay-sandy clayey silt 0/35/65	

NOTES:

NV = no value
 NP = non-plastic

BORING LOG
 NEW MEXICO SSC PROPOSAL JULY 31, 1987

THE LOG OF SUBSURFACE CONDITIONS SHOWN HEREON APPLIES ONLY AT THE SPECIFIC BORING LOCATION AND AT THE DATE INDICATED. IT IS NOT WARRANTED TO BE REPRESENTATIVE OF SUBSURFACE CONDITIONS AT OTHER LOCATIONS AND TIMES.

ELEVATION (ft.)	DEPTH (ft.)	"N" VALUE	STD. PEN. TEST	MOISTURE (% of dry wt.)	LABORATORY DATA			SAMPLE TYPE (U-Undersize, D-Disturbed)	USCS SYMBOL	GEOLOGIC SYMBOL	SOIL DESCRIPTION Gravel/Sand/Fines (%)
					DRY DENSITY (lb./cu. ft.)	LIQUID LIMIT	PLASTIC LIMIT				
6323	4-5½	23	11	NA	39	23	D	CL		Sandy lean clay 0/36/64	
6318	9-10½ 19-	33	10	NA	39	19	D	CL		Lean clay 0/21/79	
6308	19½	REF	9	NA	36	16	D	CL		Lean clay with sand 0/19/81	

NOTES:

NV = no value
NP = non-plastic

BORING LOG NEW MEXICO SSC PROPOSAL JULY 31, 1987

BORING: SSC-DH-14
DATE DRILLED: 10/22/86
EQUIPMENT USED: SIMCO 2800 HS
LOCATION: SW¼, SW¼, Sec 32, T8N, R8E
ELEVATION: 6327
TOTAL DEPTH: 29 feet

THE LOG OF SUBSURFACE CONDITIONS SHOWN HEREON APPLIES ONLY AT THE SPECIFIC BORING LOCATION AND AT THE DATE INDICATED. IT IS NOT WARRANTED TO BE REPRESENTATIVE OF SUBSURFACE CONDITIONS AT OTHER LOCATIONS AND TIMES.

ELEVATION (ft.)	DEPTH (ft.)	"N" VALUE	STD. PEN. TEST	MOISTURE (% of dry wt.)	LABORATORY DATA				SAMPLE TYPE <small>U=undisturbed D=disturbed</small>	USCS SYMBOL	GEOLOGIC SYMBOL	SOIL DESCRIPTION	Gravel/Sand/Fine (%)
					DRY DENSITY (lb./cu. ft.)	LIQUID LIMIT	PLASTIC LIMIT	PLASTICITY INDEX					
6133	4-4½	56	15	NA	NV	NV	D	CL-ML			silty clay	0/1/99	0/1/99
6132½	4½-5½	56	6	NA	24	21	D	ML			Silt with sand	0/19/81	
6128	9-10½	24	13	NA	38	20	D	CL			Lean clay	0/3/97	
6118	19-19½	22	13	NA	NP	NP	D	GP			Gravel*		
6117 ^{3/4}	19½-20½	22	40	NA	79	27	D	CH			Fat clay	0/9/91	
6108	29-30½	26	14	NA	27	15	D	CL			Sandy lean clay	0/49/51	

BORING: SSC-DH-17
 DATE DRILLED: 10/24/86
 EQUIPMENT USED: SIMCO 2800 HS
 LOCATION: NE¼, SE¼. Sec 31, T8N, R9E
 ELEVATION: 6137
 TOTAL DEPTH: 40 feet

NOTES:
 *Field description

NV=no value
 NP=non-plastic

BORING LOG
 NEW MEXICO SSC PROPOSAL JULY 31, 1987

THE LOG OF SUBSURFACE CONDITIONS SHOWN HEREON APPLIES ONLY AT THE SPECIFIC BORING LOCATION AND AT THE DATE INDICATED. IT IS NOT WARRANTED TO BE REPRESENTATIVE OF SUBSURFACE CONDITIONS AT OTHER LOCATIONS AND TIMES.

ELEVATION (ft.)	DEPTH (ft.)	"N" VALUE	STD. PEN. TEST	LABORATORY DATA				SAMPLE TYPE U-Undisturbed D-Disturbed	USCS SYMBOL	GEOLOGIC SYMBOL	BORING: SSC-DH-18	DATE DRILLED: 10/24/86	EQUIPMENT USED: SIMCO 2800 HS	LOCATION: NE ¹ / ₄ , SE ¹ / ₄ , Sec 32, T8N, R9E	ELEVATION: 6135	TOTAL DEPTH: 30 feet
				MOISTURE (% of dry wt.)	DRY DENSITY (lb./cu. ft.)	LIQUID LIMIT	PLASTIC LIMIT									
6131	4-5 ¹ / ₂	29	7	NA	25	21	D	SM-SC		Silty sand-clayey sand	0/53/47					
6122	9-9 ³ / ₄	21	11	NA	28	17	D	CL		Lean clay with sand	4/22/74					
6121 ¹ / ₂	9 ³ / ₄ - 10 ¹ / ₂	21	26	NA	30	16	D	CL		Lean clay	0/9/91					
6112	19-20	39	4	NA	NP	NP	D	SP-SM		Poorly graded sand with silt and gravel	21/70/9					
6111	20-20 ¹ / ₂	39	10	NA	32	19	D	CL		Sandy lean clay	0/35/65					
6102	29-30	REF	22	NA	63	23	D	CH		Fat clay	0/11/89					

NOTES:

NV=no value
NP=non-plastic

BORING LOG
NEW MEXICO SSC PROPOSAL JULY 31, 1987

THE LOG OF SUBSURFACE CONDITIONS SHOWN HEREON APPLIES ONLY AT THE SPECIFIC BORING LOCATION AND AT THE DATE INDICATED. IT IS NOT WARRANTED TO BE REPRESENTATIVE OF SUBSURFACE CONDITIONS AT OTHER LOCATIONS AND TIMES.

ELEVATION (ft.)	DEPTH (ft.)	"N" VALUE	STD. PEN. TEST	MOISTURE (% of dry wt.)	LABORATORY DATA				SAMPLE TYPE	USCS SYMBOL	GEOLOGIC SYMBOL	SOIL DESCRIPTION Gravel/Sand/Fines (%)
					DRY DENSITY (lb./cu. ft.)	LIQUID LIMIT	PLASTIC LIMIT	PLASTICITY INDEX				
6146	4-4½	REF	9	NA	22	16	D	CL-ML			Silty clay 0/13/87	
6141	9-9½	REF	11	NA	27	14	D	CL			Sandy lean clay 0/37/63	
6131	19½	REF	15	NA	22	15	D	CL-ML			Silty clay 0/42/58	

BORING: SSC-DH-19
DATE DRILLED: 10/27/86
EQUIPMENT USED: SIMCO 2800 HS
LOCATION: NE¼, NW¼, Sec 1, T7N, R8E
ELEVATION: 6150
TOTAL DEPTH: 19½ feet

NOTES:

NV = no value
NP = non-plastic

BORING LOG
NEW MEXICO SSC PROPOSAL JULY 31, 1987

THE LOG OF SUBSURFACE CONDITIONS SHOWN HEREON APPLIES ONLY AT THE SPECIFIC BORING LOCATION AND AT THE DATE INDICATED. IT IS NOT WARRANTED TO BE REPRESENTATIVE OF SUBSURFACE CONDITIONS AT OTHER LOCATIONS AND TIMES.

ELEVATION (ft.)	DEPTH (ft.)	"N" VALUE	STD. PEN. TEST	LABORATORY DATA				SAMPLE TYPE USCS	SYMBOL	GEOLOGIC SYMBOL	SOIL DESCRIPTION Gravel/Sand/Fines (%)
				MOISTURE (% of dry wt.)	DRY DENSITY (lb./cu. ft.)	LIQUID LIMIT	PLASTIC LIMIT				
6146	0-1½	9	16	NA	34	18	D	CL		Sandy lean clay 0/42/58	
6144½	1½-3	14	8	NA	32	17	D	CL		Lean clay with sand 0/37/63	
6143	3-4½	14	14	NA	32	25	D	ML		Silt 2/12/86	
6141½	4½-6	17	15	NA	35	21	D	CL		Lean clay with sand 2/19/79	
6140	6-7½	18	15	NA	34	15	D	CL		Lean clay with sand 2/23/75	
6138½	7½-9	15	17	NA	29	17	D	CL		Lean clay with sand 0/20/80	
6137	9-10½	18	18	NA	37	20	D	CL		Lean clay with sand 0/15/85	
6135½	10½-12	15	16	NA	29	17	D	CL		Sandy lean clay 1/44/55	
6134	12-13	13	11	NA	24	NP	D	ML		Silt 0/38/62	
6133	13-13½	--	--	NA	32	15	D	CL		Lean clay with sand 0/19/81	
6132½	13½-15	19	16	NA	41	15	D	CL		Lean clay with sand 0/15/85	
6131	15-16½	21	26	NA	37	17	D	CL		Lean clay with sand 0/26/74	
6129½	16-18	32	12	NA	31	14	D	CL		Lean clay with sand 3/18/79	
6128	18-19½	14	30	NA	57	22	D	CH		Fat clay 1/11/88	
6126½	19½-21	17	21	NA	43	16	D	CL		Lean clay 0/6/94	
6125	21-22½	14	29	NA	40	19	D	CL		Lean clay 0/9/91	
6117	29-30½	40	15	NA	34	20	D	CL		Lean clay 6/3/91	

NOTES:

NV=no value
NP=non-plastic

BORING LOG
NEW MEXICO SSC PROPOSAL JULY 31, 1987

THE LOG OF SUBSURFACE CONDITIONS SHOWN HEREON APPLIES ONLY AT THE SPECIFIC BORING LOCATION AND AT THE DATE INDICATED. IT IS NOT WARRANTED TO BE REPRESENTATIVE OF SUBSURFACE CONDITIONS AT OTHER LOCATIONS AND TIMES.

BORING: SSC-DH-21
 DATE DRILLED: 10/29/86
 EQUIPMENT USED: SIMCO 2800 HS
 LOCATION: NE $\frac{1}{4}$, NW $\frac{1}{4}$, Sec 31, T9N, R10E
 ELEVATION: 6300
 TOTAL DEPTH: 30 feet

ELEVATION (ft.)	DEPTH (ft.)	"N" VALUE	STD. PEN. TEST	LABORATORY DATA				SAMPLE TYPE <small>U=Undisturbed D=Disturbed</small>	USCS SYMBOL	GEOLOGIC SYMBOL	SOIL DESCRIPTION Gravel/Sand/Fines (%)
				MOISTURE (% of dry wt.)	DRY DENSITY (lb./cu. ft.)	LIQUID LIMIT	PLASTIC LIMIT				
6296	4-5 $\frac{1}{2}$	18	5	NA	19	16	D	SM		Silty sand 0/69/31	
6291	9-10 $\frac{1}{2}$	25	7	NA	29	17	D	SC		Clayey sand 0/53/47	
6281	19-20 $\frac{1}{2}$	26	5	NA	22	14	D	SM		Silty sand 0/74/26	
6276	24	—	0.5	NA	NP	NP	D	GP		Poorly-graded gravel	
6271	29-30 $\frac{1}{2}$	33	9	NA	35	20	D	CL		Sandy lean clay 0/45/55	

NOTES:

NV = no value
 NP = non-plastic

BORING LOG
 NEW MEXICO SSC PROPOSAL JULY 31, 1987

THE LOG OF SUBSURFACE CONDITIONS SHOWN HEREON APPLIES ONLY AT THE SPECIFIC BORING LOCATION AND AT THE DATE INDICATED. IT IS NOT WARRANTED TO BE REPRESENTATIVE OF SUBSURFACE CONDITIONS AT OTHER LOCATIONS AND TIMES.

ELEVATION (ft.)	DEPTH (ft.)	"N" VALUE	STD. PEN. TEST	LABORATORY DATA				SAMPLE TYPE	USCS SYMBOL	GEOLOGIC SYMBOL	BORING: SSC-DH-22 DATE DRILLED: 10/29/86 EQUIPMENT USED: SIMCO 2800 HS LOCATION: SW ¹ / ₄ , NE ¹ / ₄ , Sec 6, T8N, R10E ELEVATION: 6295 TOTAL DEPTH: 30.5 feet
				MOISTURE (% of dry wt.)	DRY DENSITY (lb./cu. ft.)	LIQUID LIMIT	PLASTIC LIMIT				
6291	4-5½	14	11	NA	25	21	D	CL-ML	█	Silty clay 0/22/78	
6286	9-10½	24	9	NA	24	17	D	CL-ML	█	Silty clay 0/32/68	
6276	19-20½	31	5	NA	25	19	D	SM-SC	█	Silty sand-clayey sand 0/65/35	
6266	29-30½	29	7	NA	22	19	D	SM	█	Silty sand 0/61/39	

NOTES:

NV = no value
NP = non-plastic

BORING LOG
NEW MEXICO SSC PROPOSAL JULY 31, 1987

THE LOG OF SUBSURFACE CONDITIONS SHOWN HEREON APPLIES ONLY AT THE SPECIFIC BORING LOCATION AND AT THE DATE INDICATED. IT IS NOT WARRANTED TO BE REPRESENTATIVE OF SUBSURFACE CONDITIONS AT OTHER LOCATIONS AND TIMES.

BORING: SSC-DH-23
 DATE DRILLED: 10/30/86
 EQUIPMENT USED: SIMCO 2800 HS
 LOCATION: NW¹/₄, NE¹/₄, Sec 13, T9N, R8E
 ELEVATION: 6225
 TOTAL DEPTH: 30.5 feet

ELEVATION (ft.)	DEPTH (ft.)	"N" VALUE	STD. PEN. TEST	LABORATORY DATA				SAMPLE TYPE <small>U-Undisturbed D-Disturbed</small>	USCS SYMBOL	GEOLOGIC SYMBOL	SOIL DESCRIPTION Gravel/Sand/Fines (%)
				MOISTURE (% of dry wt.)	DRY DENSITY (lb _e /cu. ft.)	LIQUID LIMIT	PLASTIC LIMIT				
6221	5-5½	25	12	NA	44	20	D	CL		Lean clay with sand 0/23/77	
6216	9-10½	23	7	NA	26	18	D	CL		Sandy lean clay 0/49/51	
6206	19-20½	32	22	NA	47	23	D	CL		Lean clay 0/14/86	
6196	29-30½	29	18	NA	38	19	D	CL		Lean clay with sand 0/15/85	

NOTES:

NV = no value
NP = non-plastic

BORING LOG NEW MEXICO SSC PROPOSAL JULY 31, 1987

THE LOG OF SUBSURFACE CONDITIONS SHOWN HEREON APPLIES ONLY AT THE SPECIFIC BORING LOCATION AND AT THE DATE INDICATED. IT IS NOT WARRANTED TO BE REPRESENTATIVE OF SUBSURFACE CONDITIONS AT OTHER LOCATIONS AND TIMES.

ELEVATION (ft.)	DEPTH (ft.)	STANDARD PEN. TEST VALUE	MOISTURE (% of dry wt.)	LABORATORY DATA				SAMPLE TYPE	USCS SYMBOL	GEOLOGIC SYMBOL	SOIL DESCRIPTION
				DRY DENSITY (lb./cu. ft.)	LIQUID LIMIT	PLASTIC LIMIT	GRAVEL/SAND/FINES (%)				

BORING: SSC-DH-24
 DATE DRILLED: 10/30/86
 EQUIPMENT USED: SIMCO 2800 HS
 LOCATION: SW¼, NW¼, Sec 35, T10N, R8E
 ELEVATION: 6255
 TOTAL DEPTH: 30.5 feet

ELEVATION (ft.)	DEPTH (ft.)	STANDARD PEN. TEST VALUE	MOISTURE (% of dry wt.)	DRY DENSITY (lb./cu. ft.)	LIQUID LIMIT	PLASTIC LIMIT	SAMPLE TYPE	USCS SYMBOL	GEOLOGIC SYMBOL	SOIL DESCRIPTION
6251	4-5½	23	9	NA	32	20	D	CL		Lean clay 0/14/86
6246	9-10½	20	7	NA	29	19	D	CL		Lean clay 0/12/88
6236	19-20½	23	13	NA	24	21	D	ML		Silt with sand 7/21/72
6226	29-30½	7	22	NA	29	12	D	CL		Sandy lean clay 0/34/66

NOTES:

NV = no value
 NP = non-plastic

BORING LOG
 NEW MEXICO SSC PROPOSAL JULY 31, 1987

THE LOG OF SUBSURFACE CONDITIONS SHOWN HEREON APPLIES ONLY AT THE SPECIFIC BORING LOCATION AND AT THE DATE INDICATED. IT IS NOT WARRANTED TO BE REPRESENTATIVE OF SUBSURFACE CONDITIONS AT OTHER LOCATIONS AND TIMES.

ELEVATION (ft.)	DEPTH (ft.)	"N" VALUE	STD. PEN. TEST MOISTURE (% of dry wt.)	LABORATORY DATA					SAMPLE TYPE <small>U=undisturbed D=disturbed</small>	USCS SYMBOL	GEOLOGIC SYMBOL	SOIL DESCRIPTION <small>Gravel/Sand/Fines (%)</small>
				DRY DENSITY (lb./cu. ft.)	LIQUID LIMIT	PLASTIC LIMIT						
6271	4-5½	7	4	NA	NP	NP	D	SP-SM			Poorly graded sand with silt and gravel 17/72/11	
6266	9-9½	29	4	NA	NP	NP	D	SP			Coarse sand * 18/47/35	
6265½	9½-10½	29	9	NA	31	18	D	CL			Sandy lean clay 1/37/62	
6256	19-19½	REF	8	NA	31	25	D	CL			Sandy lean clay 5/43/53	
6255	20-20½	REF	8	NA	28	19	D	CL			Sandy lean clay 0/43/57	
6246	29-30½	28	7	NA	28	16	D	SC			Clayey sand with gravel 49/20/31	

BORING: SSC-DH-25
 DATE DRILLED: 10/31/86
 EQUIPMENT USED: SIMCO 2800 HS
 LOCATION: NW¼, NW¼, Sec 23, T10N, R8E
 ELEVATION: 6275
 TOTAL DEPTH: 30.5 feet

NOTES: REF = refusal
 *Field description

NV = no value
 NP = non-plastic

BORING LOG
 NEW MEXICO SSC PROPOSAL JULY 31, 1987

THE LOG OF SUBSURFACE CONDITIONS SHOWN HEREON APPLIES ONLY AT THE SPECIFIC BORING LOCATION AND AT THE DATE INDICATED. IT IS NOT WARRANTED TO BE REPRESENTATIVE OF SUBSURFACE CONDITIONS AT OTHER LOCATIONS AND TIMES.

ELEVATION (ft.)	DEPTH (ft.)	"N" VALUE	STD. PEN. TEST	MOISTURE (% of dry wt.)	LABORATORY DATA			SAMPLE TYPE <small>U=Undisturbed D=Disturbed</small>	USCS SYMBOL	GEOLOGIC SYMBOL	SOIL DESCRIPTION Gravel/Sand/Fines (%)
					DRY DENSITY (lb./cu. ft.)	LIQUID LIMIT	PLASTIC LIMIT				
6301	4-5½	14	8	NA	30	19	D	CL		Sandy lean clay 0/38/62	
6296	9-9½	20	4	NA	23	19	D	CL-ML		Lean clay-silt 4/46/50	
6286	19-20½	39	16	NA	46	23	D	CL		Lean clay 0/12/88	
6276	29-30½	19	21	NA	31	19	D	CL		Lean clay with sand 1/27/72	

NOTES:

NV = no value
NP = non-plastic

BORING LOG
NEW MEXICO SSC PROPOSAL JULY 31, 1987

BORING: SSC-DH-26
DATE DRILLED: 10/31/86
EQUIPMENT USED: SIMCO 2800 HS
LOCATION: NW¼, NE¼, Sec 21, T10N, R8E
ELEVATION: 6305
TOTAL DEPTH: 30.5 feet

THE LOG OF SUBSURFACE CONDITIONS SHOWN HEREON APPLIES ONLY AT THE SPECIFIC BORING LOCATION AND AT THE DATE INDICATED. IT IS NOT WARRANTED TO BE REPRESENTATIVE OF SUBSURFACE CONDITIONS AT OTHER LOCATIONS AND TIMES.

ELEVATION (ft.)	DEPTH (ft.)	"N" VALUE	MOISTURE (% of dry wt.)	DRY DENSITY (lb./cu. ft.)	LABORATORY DATA				USCS, AGI SYMBOL	GEOLOGIC SYMBOL OR FORMATION	DESCRIPTION OF ROCK AND SOIL
					LIQUID LIMIT	PLASTIC LIMIT	SAMPLE TYPE U.O.C.P.				
6380	0-3	NA	NV	NV	NA	NA	NA	NA	NA	NA	not sampled
6377	3-9	NA	NV	150	NA	NA	C	SS	Pg	clean quartz sandstone	
6371	9-19	NA	NV	NV	NA	NA	C	SS	Pg	clean quartz sandstone with iron staining	
6361	19-29	NA	NV	NV	NA	NA	C	SS	Pg	at 26 feet hit brecciated zone	
6351	29-39	NA	NV	NV	NA	NA	C	SS	Pg	very fractured zone	
6341	39-49	NA	NV	NV	NA	NA	C	SS	Pg	brecciated zone	
6331	49-59	NA	NV	150	NA	NA	C	SS	Pg	minor limonitic seams	
6321	59-69	NA	NV	NV	NA	NA	C	SS	Pg	limonitic partings	
6311	69-79	NA	NV	NV	NA	NA	C	SS	Pg	very fractured	
6301	79-89	NA	NV	NV	NA	NA	C	SS	Pg	very weathered, soft	
6291	89-99	NA	NV	NV	NA	NA	C	SS	Pg	some minor heavy metals	
6281	99-109	NA	NV	162	NA	NA	C	SS	Pg	clean quartz sandstone	
6271	109-119	NA	NV	NV	NA	NA	C	SS	Pg	very fractured	
6261	119-129	NA	NV	NV	NA	NA	C	SS	Pg	copper and manganese staining	
6251	129-139	NA	NV	156	NA	NA	C	SS	Pg	cross-bedded sandstone	
6241	139-149	NA	NV	150	NA	NA	C	SS	Pg	iron-stained sandstone	

BORING: SSC-DE-27
 DATE DRILLED: 4/20/87
 EQUIPMENT USED: CME-55
 LOCATION: NW¼, SE¼, Sec. 31, T10N, R10E
 ELEVATION: 6380
 TOTAL DEPTH: 149 feet

NOTES: Located at Highway Department rock quarry approximately one and one-half mile south-east of Montoya Ranch.

NA= Not applicable
 NV= no value
 NP= non-plastic

SAMPLE TYPES
 U= undisturbed soil
 D= disturbed soil
 C= rock core
 P= plug (cuttings recovered)

BORING LOG
NEW MEXICO SSC PROPOSAL JULY 31, 1987

THE LOG OF SUBSURFACE CONDITIONS SHOWN HEREON APPLIES ONLY AT THE SPECIFIC BORING LOCATION AND AT THE DATE INDICATED. IT IS NOT WARRANTED TO BE REPRESENTATIVE OF SUBSURFACE CONDITIONS AT OTHER LOCATIONS AND TIMES.

BORING: SSC-DR-28
 DATE DRILLED: 4/20/87
 EQUIPMENT USED: Falling 1500W
 LOCATION: NW¼, NW¼, Sec. 4, T11N, R8E
 ELEVATION: 6576
 TOTAL DEPTH: 53 feet

ELEVATION (ft.)	DEPTH (ft.)	LABORATORY DATA						SAMPLE TYPE	USCS, AGI SYMBOL	GEOLOGIC SYMBOL OR FORMATION	DESCRIPTION OF ROCK AND SOIL
		WATER VALUE	MOISTURE (% of dry wt.)	DRY DENSITY (lb./cu. ft.)	LIQUID LIMIT	PLASTIC LIMIT	PLASTICITY INDEX				
6576	0-5	NA	NA	NV	NA	NA	P	ML-CL		sandy silt-silty clay	
6571	5-10	NA	NA	NV	NA	NA	P	ML		Sandy silt	
6566	10-15	NA	NA	NV	NA	NA	P	SM-ML		Silty sand-sandy silt	
6561	15-20	NA	NA	NV	NA	NA	P	SM-SP		Silty sand-gravelly sand	
6556	20-25	NA	NA	NV	NA	NA	P	SP		gravelly sand	
6551	25-30	NA	NA	NV	NA	NA	P	SP		coarse sand	
6546	30-35	NA	NA	NV	NA	NA	P	SP		medium sand	
6541	35-40	NA	NA	NV	NA	NA	P	SP		gravelly sand	
6536	40-45	NA	NA	NV	NA	NA	P	SP		gravelly sand	
6531	45-50	NA	NA	NV	NA	NA	P	SP		medium sand with gravel	
6526	50-53	NA	NA	NV	NA	NA	P	SP		medium sand with gravel	

NOTES: Drilling mud was used in hole after 20 feet. Drilled on King's land, 1 mile east of Hyer.

NA = Not applicable
 NV = no value
 NP = non-plastic

SAMPLE TYPES
 U = undisturbed soil
 D = disturbed soil
 C = rock core
 P = plug (cuttings recovered)

BORING LOG
 NEW MEXICO SSC PROPOSAL JULY 31, 1987

THE LOG OF SUBSURFACE CONDITIONS SHOWN HEREON APPLIES ONLY AT THE SPECIFIC BORING LOCATION AND AT THE DATE INDICATED. IT IS NOT WARRANTED TO BE REPRESENTATIVE OF SUBSURFACE CONDITIONS AT OTHER LOCATIONS AND TIMES.

ELEVATION (ft.)	DEPTH (ft.)	LABORATORY DATA							USCS, AGI SYMBOL	GEOLOGIC SYMBOL OR FORMATION	DESCRIPTION OF ROCK AND SOIL
		W VALUE	MOISTURE (% of dry wt.)	DRY DENSITY (lb./cu. ft.)	LIQUID LIMIT	PLASTIC LIMIT	SAMPLE TYPE U.S.C.P.				
											BORING: SSC-DH-29 DATE DRILLED: 4/21-22/87 EQUIPMENT USED: Failing 1500W LOCATION: NW $\frac{1}{4}$, NW $\frac{1}{4}$, Sec. 36, T10N, R9E ELEVATION: 6228 TOTAL DEPTH: 355 feet
6228	0-5	NA	NV	NA	NA	NA	P	SM		silty sand, 70/25/5	
6223	5-10	NA	NV	NA	NA	NA	P	SM		silty sand, 60/30/10	
6218	10-15	NA	NV	NA	NA	NA	P	ML-CL		sandy silt-silty clay, 30/50/20	
6213	15-20	NA	NV	NA	NA	NA	P	SM-ML		silty sand-sandy silt, 50/40/10	
6208	20-35	NA	NA	NA	NA	NA	C	SS	Pg	clean quartz sandstone	
6193	35-50	NA	NA	150	NA	NA	C	SS	Pg	clean quartz sandstone	
6178	50-100	NA	NA	NV	NA	NA	P	SS	Pg	clean quartz sandstone, water at 98 ft	
6128	100-120	NA	NA	NV	NA	NA	P	SS	Pg	iron staining	
6108	120-135	NA	NA	150	NA	NA	C	SS	Pg	well-cemented, some cross-bedding	
6093	135-160	NA	NA	NV	NA	NA	P	SS	Pg	iron staining	
6068	160-175	NA	NA	156	NA	NA	C	SS	Pg	some weathered zones	
6053	175-235	NA	NA	NV	NA	NA	P	SS	Pg	color change to orange-red at 235 ft	
5993	235-280	NA	NA	NV	NA	NA	P	SS	Py	orange and red fragments of siltstone and claystone	
5948	280-295	NA	NA	137	NA	NA	C	SS	Py	silty sandstone, easily scratched, some weathered clay zones, abundant bioturbation	
5928	300-340	NA	NA	NV	NA	NA	P	SS/Sh	Py	brick-red to gray sandstones and claystones	
5888	340-355	NA	NA	137	NA	NA	C	Sh	Py	4 feet of recovery, soft sandy claystone with drusy quartz growths	

NOTES: Permian Glorieta sandstone from 18 feet to 235 feet = 217 feet thick
Permian Yeso Formation from 235 feet

NA = Not applicable
NV = no value
NP = non-plastic

SAMPLE TYPES

U = undisturbed soil
D = disturbed soil
C = rock core
P = plug (cuttings recovered)

BORING LOG
NEW MEXICO SSC PROPOSAL JULY 31, 1987

THE LOG OF SUBSURFACE CONDITIONS SHOWN HEREON APPLIES ONLY AT THE SPECIFIC BORING LOCATION AND AT THE DATE INDICATED. IT IS NOT WARRANTED TO BE REPRESENTATIVE OF SUBSURFACE CONDITIONS AT OTHER LOCATIONS AND TIMES.

ELEVATION (ft.)	DEPTH (ft.)	LABORATORY DATA							USCG, AGI SYMBOL	GEOLOGIC SYMBOL OR FORMATION	DESCRIPTION OF ROCK AND SO'L
		W% VALUE	MOISTURE (% of dry wt.)	DRY DENSITY (lb./cu. ft.)	LIQUID LIMIT	PLASTIC LIMIT	SAMPLE TYPE U.D.C.P.				
											BORING: SSC-DH-30 DATE DRILLED: 4/21/87 EQUIPMENT USED: CME-55 LOCATION: NW¼, NE¼, Sec. 32, T11N, R10E ELEVATION: 6400 TOTAL DEPTH: 89 feet
6400	0-3	NA	NA	NA	NA	NA	NA	NA	NA	not sampled	
6397	3-5	NA	NV	NV	NV	NV	U	CL-ML		silty clay	
6395	5-8	15	14	NV	NV	NV	D	SC		clayey sand	
6392	8-10	NA	NV	NV	NV	NV	U	ML		sandy silt	
6390	10-13	14	14	NV	NV	NV	D	SM		silty sand	
6387	13-15	NA	NV	NV	NV	NV	U	SM		silty sand	
6385	15-18	22	7	NV	NV	NV	D	SM		silty sand	
6382	18-20	NV	NV	NV	NV	NV	U	SM		silty sand	
6380	20-23	17	18	NV	NV	NV	D	SM-SC		silty sand-clayey sand	
6377	23-25	NA	NV	NV	NV	NV	U	SM		silty sand with gravel	
6375	25-28	34	8	NV	NV	NV	D	SM		silty sand	
6372	28-33	>50	12	NV	NV	NV	D	SS/Sh	Rd	dark red-top of Chinle	
6367	33-38	>50	8	NV	NA	NA	D	SS/Sh	Rd	maroon sandstone and claystone	
6362	38-43	>50	7	NV	NA	NA	D	SS/Sh	Rd	fissile sandstone and claystone	
6357	43-48	>50	2	NV	NA	NA	D	SS/Sh	Rd	green reduction spots	
6352	48-53.5	>50	8	NV	NA	NA	D	SS/Sh	Rd	red fissile sandstone	
6342	58-59	NA	8	NV	NA	NA	C	SS/Sh	Rd	mottled green sandstone and claystone	
6341	59-69	NA	3	144	NA	NA	C	SS/Sh	Rd	red sandstone and claystone	
6331	69-79	NA	NV	NV	NA	NA	C	SS/Sh	Rd	red sandstone and claystone	
6321	79-89	NA	NV	147	NA	NA	C	SS/Sh	Rd	red sandstone and claystone	

NOTES: Located just northeast of Marshal Rowley Ranch
At 28 feet contact of Triassic Chinle Formation.
Rock from 33-61 feet very soft and weathered.

NA= Not applicable
NV= no value
NP= non-plastic

SAMPLE TYPES
U=undisturbed soil
D=disturbed soil
C=rock core
P=plug (cuttings recovered)

BORING LOG
NEW MEXICO SSC PROPOSAL JULY 31, 1987

THE LOG OF SUBSURFACE CONDITIONS SHOWN HEREON APPLIES ONLY AT THE SPECIFIC BORING LOCATION AND AT THE DATE INDICATED. IT IS NOT WARRANTED TO BE REPRESENTATIVE OF SUBSURFACE CONDITIONS AT OTHER LOCATIONS AND TIMES.

ELEVATION (ft.)	DEPTH (ft.)	W _N VALUE	LABORATORY DATA							USCS, AGI SYMBOL	GEOLOGIC SYMBOL OR FORMATION	DESCRIPTION OF ROCK AND SOIL
			MOISTURE (% of dry wt.)	DRY DENSITY (lb./cu. ft.)	LIQUID LIMIT	PLASTIC LIMIT	SAMPLE TYPE U.S.C.P.					
												BORING: SSC-DH-31 DATE DRILLED: 4/22/87 EQUIPMENT USED: CME-55 LOCATION: NE ₄ , NE ₄ , Sec. 6, T11N, R9E ELEVATION: 6421 TOTAL DEPTH: 61 1/2 feet
6421	0-2	>50	NA	NA	NA	NA	NA	NA	NA	NA		not sampled
6419	2-7	33	7.47	NV	NA	NA	D	SM				silty sand with gravel
6414	7-12	>50	11.37	NV	NA	NA	D	SM				silty sand
6409	12-17	>50	10.27	NV	NA	NA	D	SM-SC				silty-clayey sand
6404	17-22	>50	1.86	NV	NA	NA	D	SP				gravelly-fine sand
6399	22-28	>50	5.65	NV	NA	NA	D	SM				silty sand
6393	28-34	>50	NV	NV	NA	NA	D	SM				silty sand with caliche
6387	34-40	>50	NV	NV	NA	NA	D	SM-ML				silty sand-clayey silt
6381	40-45	>50	NV	NV	NA	NA	D	SM				silty sand
6376	45-51	>50	NV	NV	NA	NA	D	SM				silty sand
6370	51-55	>50	NV	NV	NA	NA	D	SP				sand with gravel
6366	55-61	>50	NV	NV	NA	NA	D	SM				silty sand with gravel

NOTES: On Hyer Road 3 miles west of NM-41.

- SAMPLE TYPES**
- U = undisturbed soil
 - D = disturbed soil
 - C = rock core
 - P = plug (cuttings recovered)

NA = Not applicable
 NV = no value
 NP = non-plastic

BORING LOG
 NEW MEXICO SSC PROPOSAL JULY 31, 1987

THE LOG OF SUBSURFACE CONDITIONS SHOWN HEREON APPLIES ONLY AT THE SPECIFIC BORING LOCATION AND AT THE DATE INDICATED. IT IS NOT WARRANTED TO BE REPRESENTATIVE OF SUBSURFACE CONDITIONS AT OTHER LOCATIONS AND TIMES.

ELEVATION (ft.)	DEPTH (ft.)	U _h VALUE	LABORATORY DATA					SAMPLE TYPE U.D.C.P.	USCS, AGI SYMBOL	GEOLOGIC SYMBOL OR FORMATION	DESCRIPTION OF ROCK AND SOIL
			MOISTURE (% of dry wt.)	DRY DENSITY (lb./cu. ft.)	LIQUID LIMIT	PLASTIC LIMIT					
6540	0-20	NA	NA	NA	NA	NA	P	ML-CL		sandy silt-silty clay	
6520	20-45	NA	NA	NA	NA	NA	P	CL-ML		silty clay-sandy silt (some cliche zones)	
6495	45-55	NA	NA	NA	NA	NA	F	SP-GP		coarse sand-fine gravel	
6485	55-75	NA	NA	NA	NA	NA	P	SP-GP		coarse sand-fine gravel (minor clay present)	
6465	75-95	NA	NA	NA	NA	NA	P	ML-CL		sandy silt-lean clay (minor gravel)	
6445	95-100	NA	NA	NA	NA	NA	P	SP-GP		coarse sand-fine gravel	
6440	100-120	NA	NA	NA	NA	NA	P	ML-CL		sandy silt-lean clay (about 10% gravel)	
6420	120-140	NA	NA	NV	NA	NA	P	Sh	Km	light-yellowish brown shale	
6400	140-155	NA	NA	134	NA	NA	C	Sh	Km	blue-black sandy mudstone, breaks easily along bedding planes, beds dipping at 25-45°	

NOTES: Located at intersection of Hyer Road and Highway 41. At 120 feet contact of Cretaceous Mancos Shale.

NA = Not applicable
 NV = no value
 NP = non-plastic

SAMPLE TYPES
 U = undisturbed soil
 D = disturbed soil
 C = rock core
 P = plug (cuttings recovered)

BORING LOG
 NEW MEXICO SSC PROPOSAL JULY 31, 1987

THE LOG OF SUBSURFACE CONDITIONS SHOWN HEREON APPLIES ONLY AT THE SPECIFIC BORING LOCATION AND AT THE DATE INDICATED. IT IS NOT WARRANTED TO BE REPRESENTATIVE OF SUBSURFACE CONDITIONS AT OTHER LOCATIONS AND TIMES.

ELEVATION (ft.)	DEPTH (ft.)	LABORATORY DATA								GEOLOGIC SYMBOL OR FORMATION	DESCRIPTION OF ROCK AND SOIL	
		W% VALUE	MOISTURE (% of dry wt.)	DRY DENSITY (lbs./cu. ft.)	LIQUID LIMIT	PLASTIC LIMIT	SAMPLE TYPE U.D.C.P.	USCS, AGI SYMBOL				
												BORING: SSC-DH-33
												DATE DRILLED: 4/23-24/87
												EQUIPMENT USED: CME-55
												LOCATION: NW¼, NW¼, Sec. 4, T11N, R8E
												ELEVATION: 6576
												TOTAL DEPTH: 38.5 feet
6576	0-3	NA	NA	NA	NA	NA	NA	NA	NA	NA	not sampled	
6573	3-5	NA	NV	NV	NV	NV	U	ML			sandy silt	
6571	5-8	23	8.38	NV	NV	NV	D	ML			sandy silt with gravel	
6568	8-13	48	8.71	NV	NV	NV	D	ML			sandy silt with 0.5 inch carbonate nodules	
6563	13-18	26	7.25	NV	NV	NV	D	SM			silty sand with interbedded sand	
6558	18-23	>50	4.31	NV	NV	NV	D	SM			silty sand with gravel	
6553	23-28	32	6.16	NV	NV	NV	D	SM-ML			silty sand-sandy silt with carbonate nodules	
6548	28-32	>50	NA	NA	NA	NA	NA	NA			no sample recovered	
6544	32-37	>50	9.36	NV	NV	NV	D	SM-ML			silty sand-sandy silt with gravel and carbonate	
6539	37-38.5	>50	6.82	NV	NV	NV	D	ML			sandy silt with gravel	

NOTES: Located on Hyer Road, same location as DH-28 and 34.
Hit hard caliche at approximately 10 feet.

NA= Not applicable
NV= no value
NP= non-plastic

SAMPLE TYPES

U = undisturbed soil
D = disturbed soil
C = rock core
P = plug (cuttings recovered)

BORING LOG

NEW MEXICO SSC PROPOSAL JULY 31, 1987

THE LOG OF SUBSURFACE CONDITIONS SHOWN HEREON APPLIES ONLY AT THE SPECIFIC BORING LOCATION AND AT THE DATE INDICATED. IT IS NOT WARRANTED TO BE REPRESENTATIVE OF SUBSURFACE CONDITIONS AT OTHER LOCATIONS AND TIMES.

ELEVATION (ft.)	DEPTH (ft.)	NW VALUE	MOISTURE (% of dry wt.)	LABORATORY DATA				SAMPLE TYPE U.S.C.P.	USCS, AGI SYMBOL	GEOLOGIC SYMBOL OR FORMATION	DESCRIPTION OF ROCK AND SOIL
				DRY DENSITY (lbs./cu. ft.)	LIQUID LIMIT	PLASTIC LIMIT					
											BORING: SSC-DH-34 DATE DRILLED: 4/24/87 EQUIPMENT USED: Failing 1500W LOCATION: NW¼, NW¼, Sec. 4, T11N, R8E ELEVATION: 6576 TOTAL DEPTH: 195 feet
6576	0-25	NV	NA	NA	NA	NA	P	ML-CL		Sandy silt-silty clay	
6551	25-65	NV	NA	NA	NA	NA	P	SP-SM		Coarse sand with silt	
6541	65-105	NV	NA	NA	NA	NA	P	SP		Coarse sand with fine gravel	
6471	105-135	NV	NA	NA	NA	NA	P	SM-GM		Medium sand-medium gravel with clay	
6441	135-160	NV	NA	NA	NA	NA	P	SM-GM		Medium sand-medium gravel with dark red clay	
6416	160-180	NV	NA	NV	NA	NA	P	sh	R d	dark-red sandy claystone	
6496	180-195	NV	NA	156	NA	NA	C	SS/Sh	R d	dark-red sandy siltstone with claystone, beds dip approximately 30°. Expansive claystone forced open sample barrel.	

NOTES: Located on Hyer Road, same location as DH-28 and 32.
At 160 feet, contact of Triassic Chinle claystone.
Some green claystone beds in Chinle.

SAMPLE TYPES
U = undisturbed soil
D = disturbed soil
C = rock core
P = plug (cuttings recovered)

NA = Not applicable
NV = no value
NP = non-plastic

BORING LOG
NEW MEXICO SSC PROPOSAL JULY 31, 1987

THE LOG OF SUBSURFACE CONDITIONS SHOWN HEREON APPLIES ONLY AT THE SPECIFIC BORING LOCATION AND AT THE DATE INDICATED. IT IS NOT WARRANTED TO BE REPRESENTATIVE OF SUBSURFACE CONDITIONS AT OTHER LOCATIONS AND TIMES.

ELEVATION (ft.)	DEPTH (ft.)	LABORATORY DATA								GEOLOGIC SYMBOL OR FORMATION	DESCRIPTION OF ROCK AND SOIL
		W VALUE	MOISTURE (% of dry wt.)	DRY DENSITY (lb./cu. ft.)	LIQUID LIMIT	PLASTIC LIMIT	SAMPLE TYPE U.D.C.P.	USCS, AGI SYMBOL			
											TOTAL DEPTH: 65 feet
6183	0-3	NA	NA	NA	NA	NA	NA	NA	NA	NA	not sampled
6180	3-4.75	NA	NV	NV	NV	NV	U	CL			green lean clay with gypsum
6178	4.75-8	12	18	NA	NV	NV	D	CL			green clay with gypsum
6175	8-9.75	NA	8	NV	NV	NV	U	ML			sandy silt
6173	9.75-13	15	13	NA	NV	NV	D	SM			fine clean sand with some silts and clays
6170	13-15	NA	NV	NV	NV	NV	U	SM			fine sand with mottled clay
6168	15-18.5	7	18	NA	NV	NV	D	ML-SP			clayey silt with fine sand at top
6164	18.5-20.25	NA	NV	NV	NV	NV	U	CL-CH			lean clay-plastic clay
6163	20.25-23.25	5	32	NA	NV	NV	D	CH			plastic clay with carbon filaments
6160	23.25-25	NA	16	NV	NV	NV	U	SP			fine clean sand
6158	25-28.25	30	NV	NA	NV	NV	D	SP			fine clean sand-poorly graded sand
6155	28.25-28.5	NA	14	NV	NV	NV	U	SP			saturated gravelly sand
6154	28.5-33	NA	NA	NA	NA	NA	NA	NA	NA	NA	no sample recovered
6150	33-35	NA	NV	NV	NV	NV	U	CL			yellowish-red hard clay
6148	35-38	15	30	NA	NV	NV	D	CH			very stiff clay with carbonate nodules
6144	38.5	NV	NA	NA	NA	NA	NA	NA	NA	NA	no sample recovered, running sand, saturated
6144	38.5-43.5	NV	NA	NA	NA	NA	NA	NA	NA	NA	no sample recovered, running sand, saturated
6139	43.5	NV	NA	NA	NA	NA	NA	NA	NA	NA	no sample recovered, running sand, saturated
6139	43.5-45	22	17	NA	NV	NV	D	SM			silty sand with clay at top
6138	45-51	23	28	NA	NV	NV	D	CL-SM			stiff clay with silty sand at top
6132	51-53	NA	NA	NA	NA	NA	NA	NA	NA	NA	no sample recovered
6130	53-54.75	NA	25	104	NV	NV	U	CH-SM			yellow clay with running sand at top
6128	54.75-58	NA	NA	NA	NA	NA	NA	NA	NA	NA	no sample recovered
6125	58-59.25	NA	NV	103	NV	NV	U	CL-ML			silty clay with carbonate nodules

NOTES: Located on Martinez Road just east of Salt Draw. Water at 50.5 ft depth after 2 days.

NA= Not applicable
 NV= no value
 NP= non-plastic

SAMPLE TYPES
 U=undisturbed soil
 D=disturbed soil
 C=rock core
 P=plug (cuttings recovered)

BORING LOG
 NEW MEXICO SSC PROPOSAL JULY 31, 1987

(Cont.)

THE LOG OF SUBSURFACE CONDITIONS SHOWN HEREON APPLIES ONLY AT THE SPECIFIC BORING LOCATION AND AT THE DATE INDICATED. IT IS NOT WARRANTED TO BE REPRESENTATIVE OF SUBSURFACE CONDITIONS AT OTHER LOCATIONS AND TIMES.

ELEVATION (ft.)	DEPTH (ft.)	PIV VALUE	MOISTURE (% of dry wt.)	LABORATORY DATA				SAMPLE TYPE U.S.C.P.	USCS, AGI SYMBOL	GEOLOGIC SYMBOL OR FORMATION	DESCRIPTION OF ROCK AND SOIL
				DRY DENSITY (lb./cu. ft.)	LIQUID LIMIT	PLASTIC LIMIT					
6124	59.25-63	30	22	NA	NV	NV	D	CL		sandy lean clay	
6120	63-65	NA	NV	NV	NV	NV	U	NA	NA	no sample	

BORING: SSC-DH-35
DATE DRILLED: 4/24/87
EQUIPMENT USED: CME-55
LOCATION: SE $\frac{1}{4}$, SE $\frac{1}{4}$, Sec. 17, T9N, R9E
ELEVATION: 6183
TOTAL DEPTH: 65 feet

NOTES: Located on Martinez Road just east of Salt Draw.
 Water at 50.5 ft depth after 2 days.

SAMPLE TYPES
 U = undisturbed soil
 D = disturbed soil
 C = rock core
 P = plug (cuttings recovered)

NA = Not applicable
 NV = no value
 NP = non-plastic

BORING LOG

NEW MEXICO SSC PROPOSAL JULY 31, 1987

THE LOG OF SUBSURFACE CONDITIONS SHOWN HEREON APPLIES ONLY AT THE SPECIFIC BORING LOCATION AND AT THE DATE INDICATED. IT IS NOT WARRANTED TO BE REPRESENTATIVE OF SUBSURFACE CONDITIONS AT OTHER LOCATIONS AND TIMES.

ELEVATION (ft.)	DEPTH (ft.)	LABORATORY DATA							USCS, AGI SYMBOL	GEOLOGIC SYMBOL OR FORMATION	DESCRIPTION OF ROCK AND SOIL
		W VALUE	MOISTURE (% of dry wt.)	DRY DENSITY (lbs./cu. ft.)	LIQUID LIMIT	PLASTIC LIMIT	SAMPLE TYPE U.D.C.P.				
6235	0-3	NA	NA	NA	NA	NA	NA	NA	NA	not sampled	
6232	3-5	NA	NV	NV	NV	NV	U	ML		sandy silt	
6230	5-8	15	NV	NA	NV	NV	D	SM/CL		silty sand-lean clay, carbonate nodules	
6227	8-9.5	14	NV	NA	NV	NV	D	SM		silty sand, caliche	
6225	9.5-16	NA	NA	NA	NA	NA	NA	NA	NA	no sample recovered	
6219	16-17.5	NA	NV	NV	NV	NV	U	CL-ML		lean clay-sandy silt, carbonate nodules	
6218	17.5-19	36	7	NA	NV	NV	D	CL/ML		lean clay-sandy silt, iron stained nodules	
6217	18-22.5	>50	6	NA	NV	NV	D	SM		silty sand, much more carbonate	
6212	22.5-28	31	9	NA	NV	NV	D	SM/ML		lean clay-sandy silt, rip-ups of lake clay	
6207	28-33	>50	11	NA	NV	NV	D	CL/ML		lean clay-sandy silt, gravel at top	
6202	33-38	>50	11	NA	NV	NV	D	SP-SM		poorly graded sand with silt	
6197	38-43	>50	5	NA	NV	NV	D	CL-ML		red silty clay with organics	
6192	43-48	39	30	NA	NV	NV	D	CL		lean clay with carbon stringers	
6187	48-53	NA	NA	NA	NA	NA	NA	NA	NA	no sample	
6182	53-55	>50	15	NA	NV	NV	D	D		reddish-yellow clay, very hard	

BORING: SSC-DH-36
 DATE DRILLED: 4/24/87
 EQUIPMENT USED: CME-55
 LOCATION: NE¼, NE¼, Sec. 22, T9N, R8E
 ELEVATION: 6235
 TOTAL DEPTH: 54.5 feet

NOTES: Located on Martinez Road West at George Stewart's place.

SAMPLE TYPES
 U = undisturbed soil
 D = disturbed soil
 C = rock core
 P = plug (cuttings recovered)

NA = Not applicable
 NV = no value
 NP = non-plastic

BORING LOG
 NEW MEXICO SSC PROPOSAL JULY 31, 1987

THE LOG OF SUBSURFACE CONDITIONS SHOWN HEREON APPLIES ONLY AT THE SPECIFIC BORING LOCATION AND AT THE DATE INDICATED. IT IS NOT WARRANTED TO BE REPRESENTATIVE OF SUBSURFACE CONDITIONS AT OTHER LOCATIONS AND TIMES.

ELEVATION (ft.)	DEPTH (ft.)	NP VALUE	LABORATORY DATA						SAMPLE TYPE U.S.G.S. P.	USCS, AGI SYMBOL	GEOLOGIC SYMBOL OR FORMATION	DESCRIPTION OF ROCK AND SOIL.
			MOISTURE (% of dry wt.)	DRY DENSITY (lb./cu. ft.)	LIQUID LIMIT	PLASTIC LIMIT						
											BORING: SSC-DH-37 DATE DRILLED: 4/25/87 EQUIPMENT USED: Falling 1500W LOCATION: SE$\frac{1}{4}$, SE$\frac{1}{4}$, Sec. 17, T9N, R9E ELEVATION: 6183 TOTAL DEPTH: 135 feet	
6113	70-75	NA	NA	NA	NA	NA	P	SM			silty sand with clay	
6108	75-80	NA	NA	NA	NA	NA	P	ML-CL			sandy silt-silty clay	
6103	80-85	NA	NA	NA	NA	NA	P	--			sample not described	
6098	85-90	NA	NA	NA	NA	NA	P	SM			silty sand with clay	
6093	90-95	NA	NA	NA	NA	NA	P	SM			silty sand with gravel	
6088	95-100	NA	NA	NA	NA	NA	P	SM-CL			silty sand-sandy clay	
6083	100-105	NA	NA	NA	NA	NA	P	GC			poorly graded gravel with chunk of red clay	
6078	105-110	NA	NA	NA	NA	NA	P	GC			gravel with chunks red clay	
6073	110-115	NA	NA	NA	NA	NA	P	GC			gravel with shaley siltstone	
6068	115-120	NA	NA	NA	NA	NA	P	SS	Py		shaley-fine sandstone	
6063	120-135	NA	NA	NA	NA	NA	C	SS	Py		shaley-fine sandstone in places vuggy	

NOTES: Located on Louis O'Neill property 1 mile east of Salt Draw on Martinez Road East.
 Depth to water 51 feet on 4/29/87
 Description of cuttings starts at 70 feet - See DH-35 for description of soil from 0-65 feet.

SAMPLE TYPES
 U=undisturbed soil
 D=disturbed soil
 C=rock core
 P=plug (cuttings recovered)

NA=Not applicable
 NV=no value
 NP=non-plastic

BORING LOG
NEW MEXICO SSC PROPOSAL JULY 31, 1987

THE LOG OF SUBSURFACE CONDITIONS SHOWN HEREON APPLIES ONLY AT THE SPECIFIC BORING LOCATION AND AT THE DATE INDICATED. IT IS NOT WARRANTED TO BE REPRESENTATIVE OF SUBSURFACE CONDITIONS AT OTHER LOCATIONS AND TIMES.

ELEVATION (ft.)	DEPTH (ft.)	NW VALUE	MOISTURE (% of dry wt.)	DRY DENSITY (lb./cu. ft.)	LABORATORY DATA				SAMPLE TYPE U.S.C.P.	USCS, ACI SYMBOL	GEOLOGIC SYMBOL OR FORMATION	BORING: SSC-DH-38 DATE DRILLED: 4/25/87 EQUIPMENT USED: CME-55 LOCATION: SE4, NE4, Sec. 4, T9N, R10E ELEVATION: 6410 TOTAL DEPTH: 109.5 feet
					LIQUID LIMIT	PLASTIC LIMIT	SHRINKAGE (%)	FLUIDITY				
6410	0-3	NA	NA	NA	NA	NA	NA	NA	NA	NA	not sampled	
6407	3-8	9	12	NA	NV	NV	D	SM			silty sand with carbonate	
6402	8-13	38	4	NA	NV	NV	D	ML			sandy silt with gravel	
6397	13-18	46	6	NA	NV	NV	D	SM			silty sand	
6392	18-23	>50	5	NA	NV	NV	D	SP			very gravelly sand	
6387	23-28	>50	7	NA	NV	NV	D	SM			very hard silty sand, stage I-III	
											caliche	
6382	28-33	>50	7	NA	NV	NV	D	SM-SP			silty sand-fine sand	
6377	33-38	>50	9	NA	NV	NV	D	ML/CL			sandy silt-silty clay	
6372	38-43	>50	NA	NA	NA	NA	NA	NA	NA	NA	no recovery	
6367	43-73	>50	9	NA	NV	NV	D	SP			sand with carbonate	
6337	73-98	>50	3	NA	NV	NV	D	SP			coarse sand with gravel	
6312	98-108	44	6	NA	NV	NV	D	SM			clean silty sand	
6302	108-109.5	>50	6	NA	NV	NV	D	SM/SP			silty sand to clean fine sand	

NOTES: Located at Valley of Estancia Ranchettes.

NA= Not applicable
 NV= no value
 NP= non-plastic

SAMPLE TYPES
 U=undisturbed soil
 D=disturbed soil
 C=rock core
 P=plug (cuttings recovered)

BORING LOG
 NEW MEXICO SSC PROPOSAL JULY 31, 1987

THE LOG OF SUBSURFACE CONDITIONS SHOWN HEREON APPLIES ONLY AT THE SPECIFIC BORING LOCATION AND AT THE DATE INDICATED. IT IS NOT WARRANTED TO BE REPRESENTATIVE OF SUBSURFACE CONDITIONS AT OTHER LOCATIONS AND TIMES.

ELEVATION (ft.)	DEPTH (ft.)	LABORATORY DATA										DESCRIPTION OF ROCK AND SOIL
		U _N VALUE	MOISTURE (% of dry wt.)	DRY DENSITY (lb./cu. ft.)	LIQUID LIMIT	PLASTIC LIMIT	SAMPLE TYPE U.D.C.P.	USCS' AGI SYMBOL	GEOLOGIC SYMBOL OR FORMATION			
6560	0-3	NA	NA	NA	NA	NA	NA	NA	NA	NA	NA	not sampled
6557	3-8	11	19	NA	NV	NV	D	ML/CL				sandy silt-silty clay with caliche
6552	8-13	>50	8	NA	NV	NV	D	CL/ML				silty clay, caliche coated Em boulder
6547	13-14.5	>50	2	NA	NA	NA	D	LS	Em			Em fragments in this soil
6545	14.5-37.5	NA	NA	168	NA	NA	C	LS	Em			very fractured, highly fossiliferous
6530	29.5-39.5	NA	NA	NV	NA	NA	C	LS	Em			more competent, few fossils
6520	39.5-49.5	NA	NA	NV	NA	NA	C	LS	Em			micritic, few fossils, very coherent
6510	49.5-69.5	NA	NA	175	NA	NA	C	LS	Em			some shale partings
6490	69.5-89.5	NA	NA	159	NA	NA	C	LS	Em			fractured, very fossiliferous, minor shale
6470	89.5-103	NA	NA	175	NA	NA	C	LS	Em			very fractured and fossiliferous, shaly limestone

BORING: SSC-DH-39
 DATE DRILLED: 4/26/87
 EQUIPMENT USED: CME-55
 LOCATION: NE 1/4, NE 1/4, Sec. 2, T9N, R7E
 ELEVATION: 6560
 TOTAL DEPTH: 103 feet

NOTES: Located at Nanneman's.
 At 14 feet contact of Pennsylvanian Madera Formation.

NA= Not applicable
 NV= no value
 NP= non-plastic

SAMPLE TYPES
 U= undisturbed soil
 D= disturbed soil
 C= rock core
 P= plug (cuttings recovered)

BORING LOG

NEW MEXICO SSC PROPOSAL JULY 31, 1987

THE LOG OF SUBSURFACE CONDITIONS SHOWN HEREON APPLIES ONLY AT THE SPECIFIC BORING LOCATION AND AT THE DATE INDICATED. IT IS NOT WARRANTED TO BE REPRESENTATIVE OF SUBSURFACE CONDITIONS AT OTHER LOCATIONS AND TIMES.

ELEVATION (ft.)	DEPTH (ft.)	LABORATORY DATA							USCS, AGI SYMBOL	GEOLOGIC SYMBOL OR FORMATION	DESCRIPTION OF ROCK AND SOIL
		W _p VALUE	MOISTURE (% of dry wt.)	DRY DENSITY (lb./cu. ft.)	LIQUID LIMIT	PLASTIC LIMIT	SAMPLE TYPE U.D.C.P.				
6198	0-3	NA	NA	NA	NA	NA	NA	NA	NA	not sampled	
6195	3.25-5	NA	NV	NV	NV	NV	U	ML		sandy silt	
6193	5-8	9	9	NV	NV	NV	D	ML		sandy silt with rock fragments	
6190	8-10	NA	NV	NV	NV	NV	U	SM		silty sand	
6188	10-13	28	11	NV	NV	NV	D	ML/SM		sandy silt-silty sand with caliche nodules	
6185	13-14.25	NA	NV	NV	NV	NV	U	CL-ML		sandy silty clay	
6184	14.25-18	18	16	NV	NV	NV	D	CL-ML		sandy, silty clay	
6180	18-18.5	NA	NV	NV	NV	NV	U	SM		silty sand with gravel	
6179	18.5-23	28	10	NV	NV	NV	D	ML/CL		sandy silt-silty clay, siltier at top	
6175	23-28	22	20	NV	NV	NV	D	CL		gravel at top, white lake clay bottom	
6170	28-33	41	14	NV	NV	NV	D	SP-SM		poorly graded sand with silt	
6165	33-38	41	11	NV	NV	NV	D	.SP		fine sand, iron staining	
6160	38-43	29	21	NV	NV	NV	D	CH		clay with some gravelly sand stringers	
6155	43-48	23	19	NV	NV	NV	D	CL-ML		silty clay-clayey silt with carbonate stringers	
6150	48-53	22	21	NV	NV	NV	D	SE-ML		fine sand-sandy silt	
6145	53-55	NA	NV	NV	NV	NV	U	SC		clayey sand	
6143	55-58	26	18	NV	NV	NV	D	SM-SC		silty, clayey sand with carbonate nodules	
6140	58-63	27	18	NV	NV	NV	D	SM/ML		silty sand-sandy silt with marl clasts	
6135	63-68	31	24	NV	NV	NV	D	ML/CL		sandy silt-stiff clay with gravel	
6130	68-69.5	>50	8	NV	NV	NV	D	GW		sandy gravel, mostly Fm clasts	

BORING: SSC DR-40
 DATE DRILLED: 4/27/87
 EQUIPMENT USED: CME-55
 LOCATION: SE $\frac{1}{4}$, SE $\frac{1}{4}$, Sec. 19, T9N, R9E
 ELEVATION: 6198
 TOTAL DEPTH: 69.5 feet

NOTES: Located on west end of airport.

SAMPLE TYPES
 U = undisturbed soil
 D = disturbed soil
 C = rock core
 P = plug (cuttings recovered)

NA = Not applicable
 NV = no value
 NP = non-plastic

BORING LOG
 NEW MEXICO SSC PROPOSAL JULY 31, 1987

APPENDIX 3-B

Trench Logs

Following are logs of the 10 trenches excavated during the field investigation for this proposal. They show the soil types and their stratigraphic relationships within the upper 12 feet of the surface. Trench locations are shown on Figure 3.2-1 (in map tube), and the laboratory test data are presented in Appendix 3-E.

VIEW NORTH

SEISMIC LINE SR-1
R-142

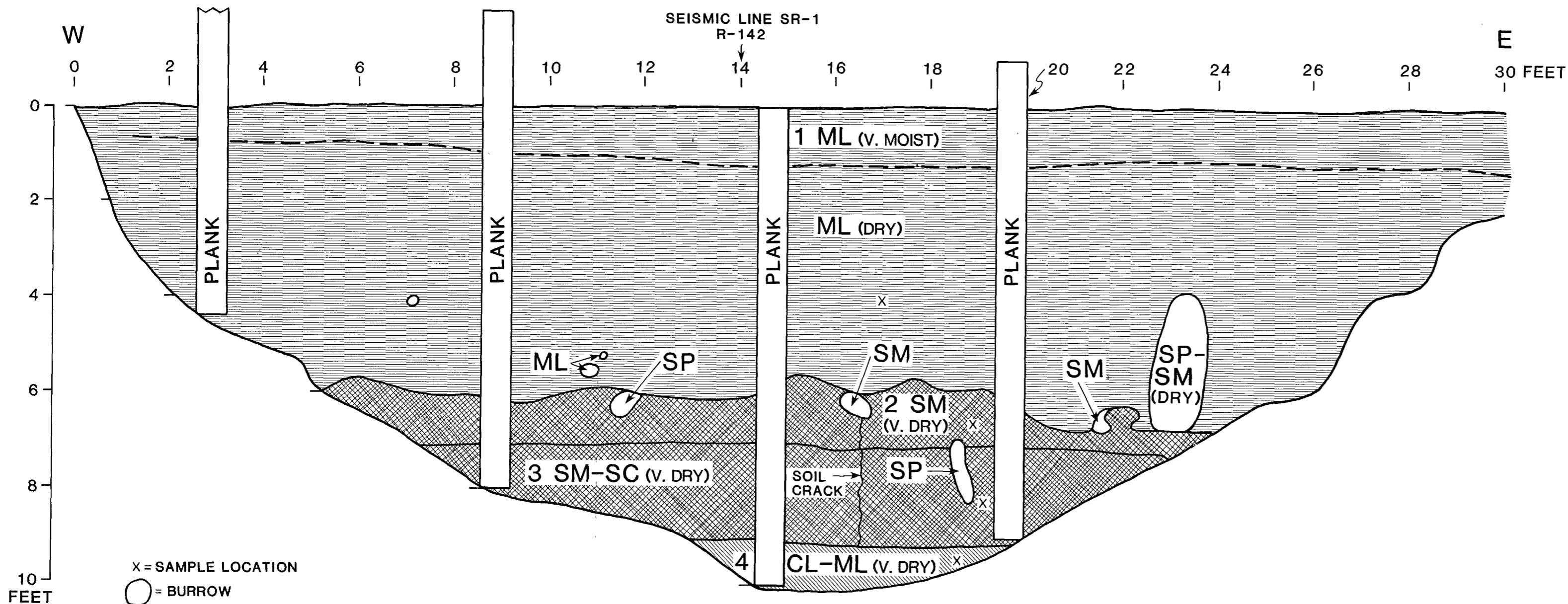

UNIT

- 1 ML, SANDY SILT, V. MOIST AT SURFACE, DRY BELOW 1 FOOT, SOFT AT SURFACE, STIFF BELOW 1 FOOT, CONTAINS GRAVEL SIZE CLASTS OF IGNEOUS AND LIMESTONE ROCK (SUBANGULAR), CaCO_3 NODULES AND FILAMENTS.
- 2 SM, SILTY SAND, V. DRY, HARD, CaCO_3 LAMINAR-SUBLAMINAR STAGE IV IN PLACES, BROKEN INTO GRAVEL SIZE PIECES THROUGHOUT. EXTENSIVELY BURROWED. BURROWS FILLED WITH FINE DARK COLORED SP-SM (GRAVELLY SAND-SILTY SAND), DRY, SOFT.
- 3 SM-SC, SILTY SAND-CLAYEY SAND, V. DRY, SOMEWHAT BURROWED.
- 4 CL-ML, SILTY CLAY, V. DRY, SCATTERED CARBON.

NOTES:

SOIL CRACK IS COATED WITH CaCO_3 , NO OFFSET NOTED.

SMALL ROOTS TO 6 FEET.

NO EVIDENCE FOR FAULTING IN TRENCH.

LOG OF TRENCH SSC-BH-1

JULY 31, 1987

VIEW NORTH

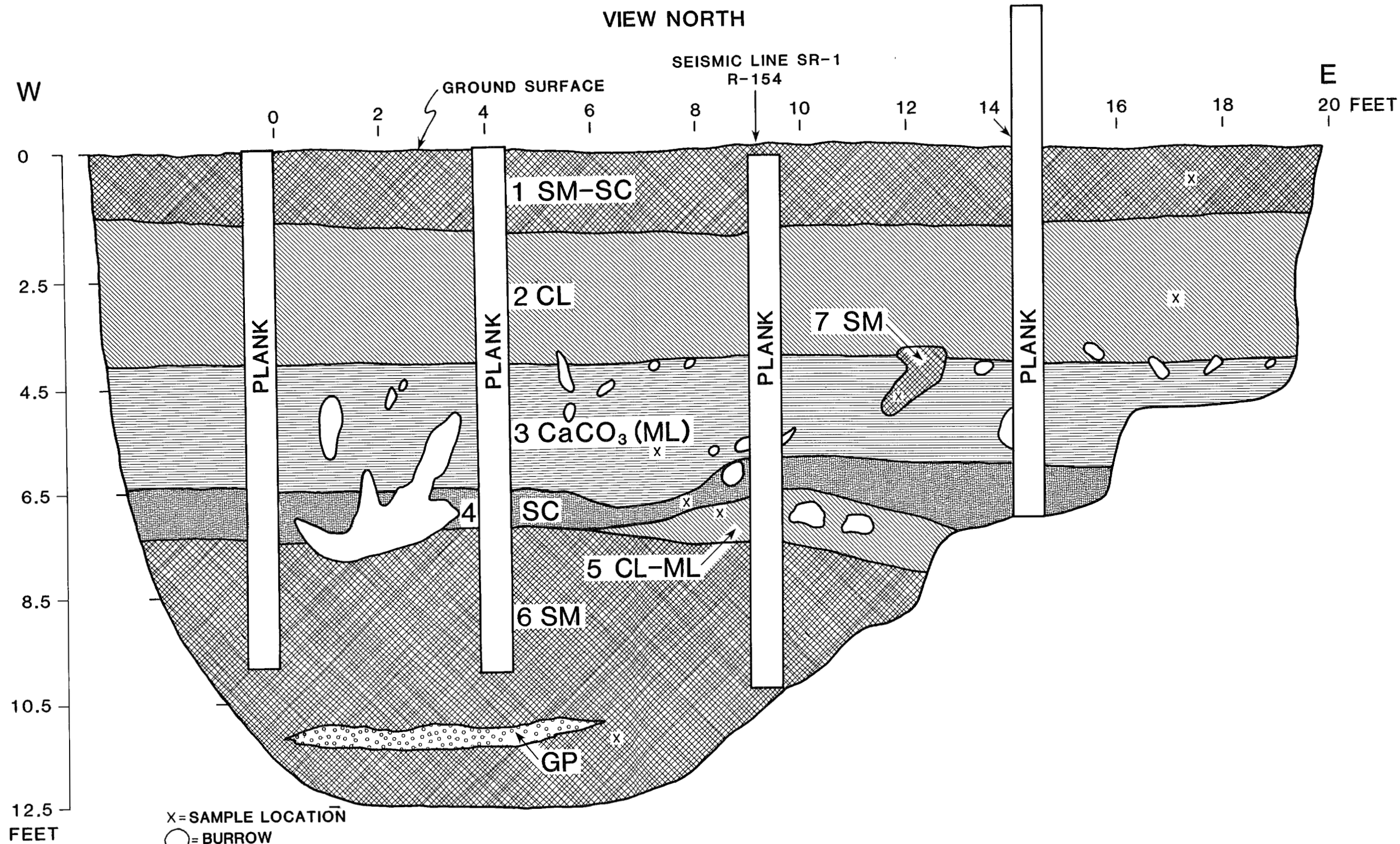

UNIT

- 1 SM-SC, SILTY SAND-CLAYEY SAND, MOIST, SOFT, PPV = 1.0 kg/cm², MANY ROOTS.
- 2 CL, LEAN CLAY, DRY, HARD, PPV > 4.5kg/cm², CONTAINS FILAMENTS AND NODULES, MANY ROOTS.
- 3 ML, CaCO₃, SILT WITH SAND, DRY, HARD-V. HARD, WHITE, STAGE III (NO LAMINAE), PPV > 4.5kg/cm².
- 4 SC, CLAYEY SAND, HARD, PPV > 4.5kg/cm².
- 5 CL-ML, SANDY SILTY CLAY, DRY, SOFT, FINELY LAMINATED FINE SAND, PPV < 0.5kg/cm², CONTAINS .25 INCH SIZE INTRACLASTS OF CLAY, RODENT BONES.
- 6 SM, SILTY SAND, DRY, MED. DENSE, PPV > 4.5kg/cm², DISCONTINUOUS GRAVEL LENSES.
- 7 SM, SILTY SAND, HARD-VERY HARD, FROM BURROW AT 5.5 FEET.

X = SAMPLE LOCATION
 ○ = BURROW
 PPV = POCKET PENETROMETER VALUE
 TSS = TORVANE SHEAR STRENGTH

LOG OF TRENCH SSC-BH-2
 JULY 31, 1987

NEW MEXICO SSC PROPOSAL

APPENDIX 3-B

VIEW WEST

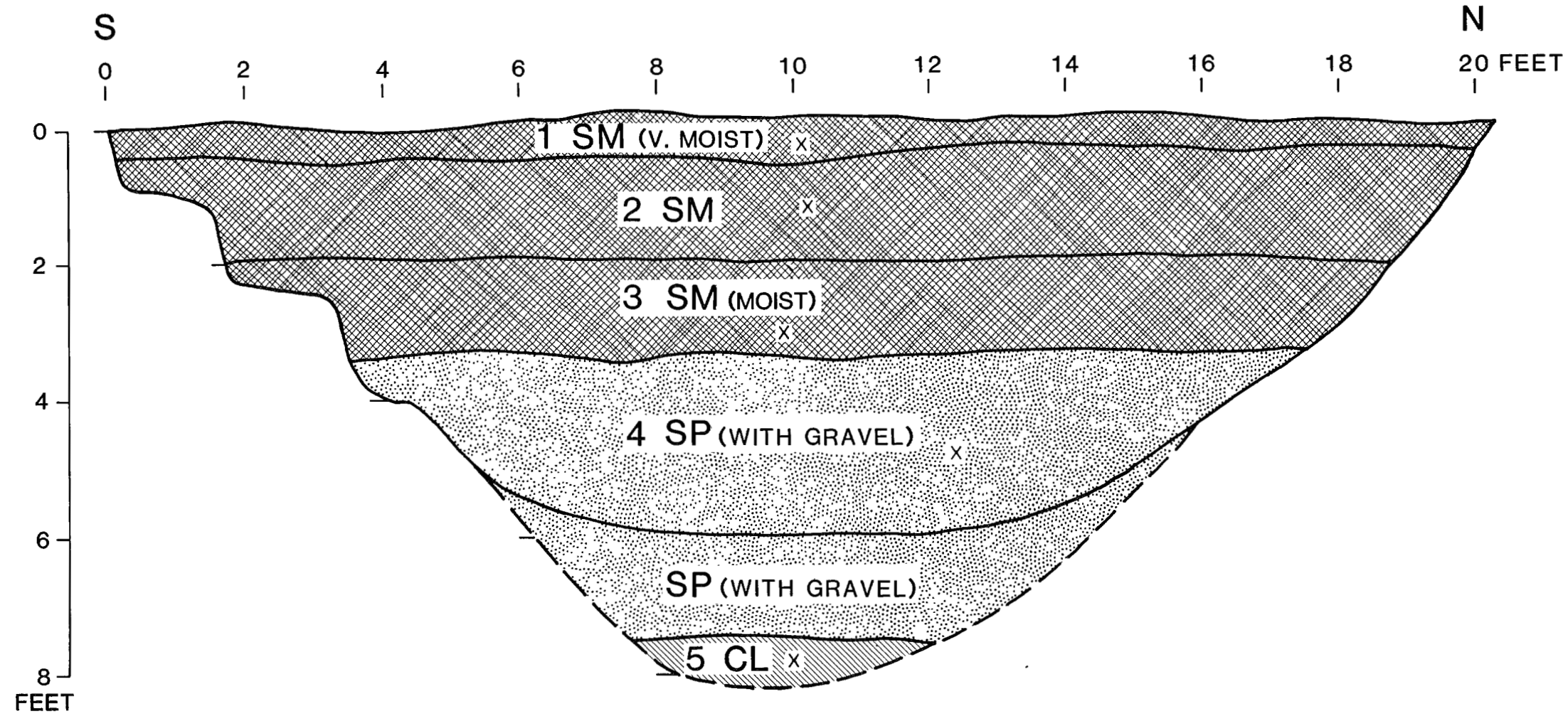

UNIT

- 1 SM, SILTY SAND, V. MOIST, LOOSE, CONTAINS ABUNDANT ROOTS AND ORGANIC MATTER.
- 2 SM, SILTY SAND, LOOSE, ABUNDANT ROOTS, FEW CaCO₃ NODULES.
- 3 SM, SILTY SAND, MOIST, LOOSE, ABUNDANT CaCO₃ NODULES, PEA-SIZED GRAVEL.
- 4 SP, POORLY GRADED SAND WITH GRAVEL LENSES, RUNNING SAND, GRAVEL CLASTS UP TO 0.5 INCH, LITHOLOGIES; IGNEOUS ROCKS, QUARTZ, FELDSPARS.
- 5 CL, LEAN CLAY WITH SAND, S. MOIST, STIFF, WHITE, BLOCKY TEXTURE (LAKE DEPOSIT).

X = SAMPLE LOCATION
 PPV = POCKET PENETROMETER VALUE
 TSS = TORVANE SHEAR STRENGTH
 S = SLIGHTLY

LOG OF TRENCH SSC-BH-3
 JULY 31, 1987

VIEW NORTH

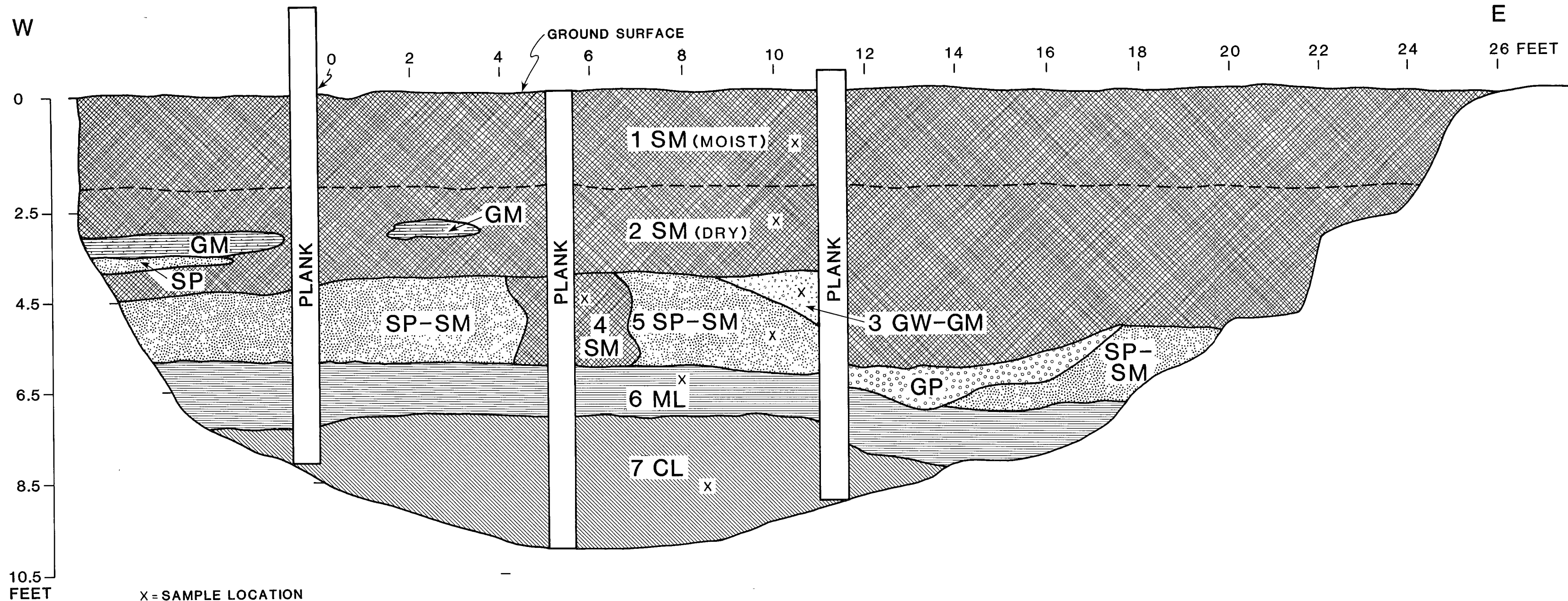

- UNIT
- 1 SM, SILTY SAND, S. MOIST, LOOSE.
 - 2 SM, SILTY SAND-GRAVELLY LENSES OF GM, (SILTY GRAVEL) AND SP, (CLEAN SAND). DRY, LOOSE, SNAIL SHELLS.
 - 3 GW-GM, WELL GRADED GRAVEL WITH SILT.
 - 4 SP, FINE SAND.
 - 5 SP-SM, FINE SAND-SILTY SAND, DRY, MED. DENSE TO LOOSE, LAMINATED.
 - 6 ML, SANDY SILT, DRY, STIFF, PPV > 4.5kg/cm².
 - 7 CL, LEAN CLAY WITH SAND, DRY-S. MOIST, STIFF-HARD, PPV > 4.5kg/cm², WHITE.

X = SAMPLE LOCATION
 PPV = POCKET PENETROMETER VALUE
 TSS = TORVANE SHEAR STRENGTH
 S = SLIGHTLY

LOG OF TRENCH SSC-BH-4
 JULY 31, 1987

VIEW WEST

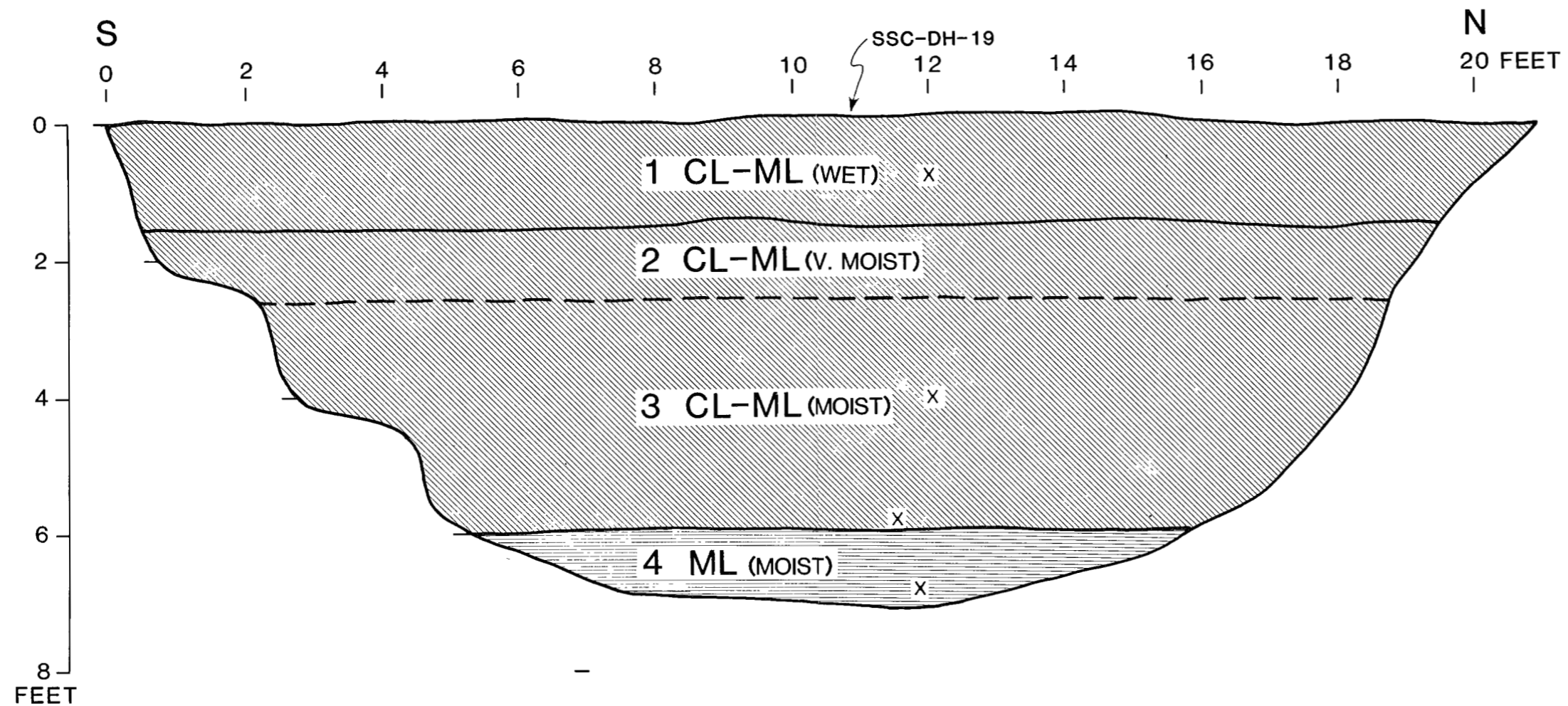

UNIT

- 1 CL-ML, SANDY-SILTY CLAY, WET, SOFT, PPV < 0.5kg/cm², GREEN/OLIVE (LAKE).
- 2 CL-ML, SANDY-SILTY CLAY, V. MOIST, SOFT-FIRM, PPV ≈ 2kg/cm², WHITE.
- 3 CL-ML, SILTY CLAY, WITH SAND, MOIST, STIFF-HARD, PPV > 4.5kg/cm², WHITE.
- 4 ML, SILT, S. MOIST, STIFF, PPV > 4.5kg/cm², ROCK-LIKE IN CHARACTER, VUGGY, CaCO₃ CRYSTALS ON VUG SURFACES, WHITE (LAKE MARE).

X = SAMPLE LOCATION
 PPV = POCKET PENETROMETER VALUE
 TSS = TORVANE SHEAR STRENGTH
 S = SLIGHTLY

LOG OF TRENCH SSC-BH-5
JULY 31, 1987

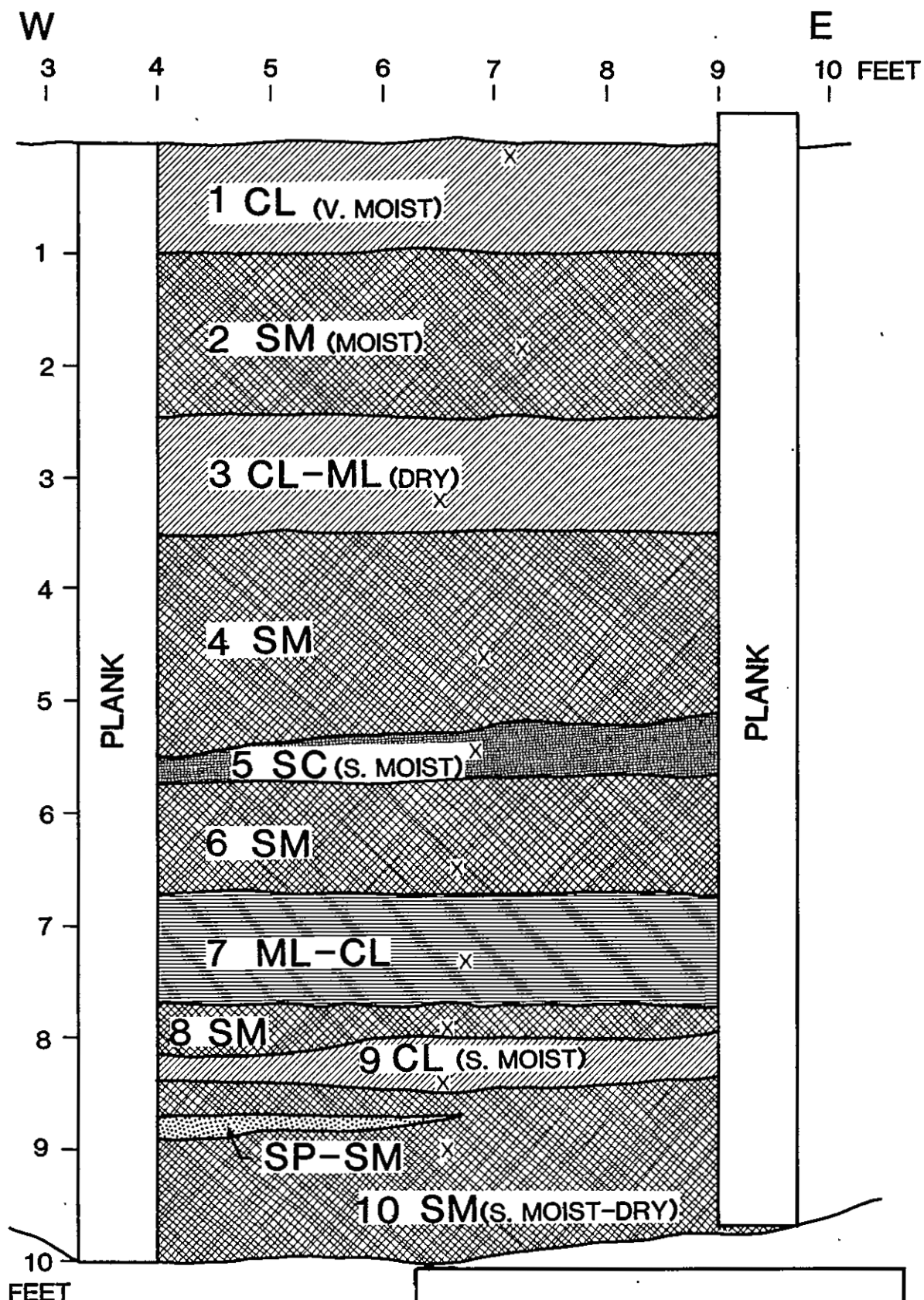

X = SAMPLE LOCATION
 PPV= POCKET PENETROMETER VALUE
 TSS= TORVANE SHEAR STRENGTH
 S= SLIGHTLY

LOG OF TRENCH SSC-BH-6
 JULY 31, 1987

NEW MEXICO SSC PROPOSAL
 APPENDIX 3-B

- 1 CL, SANDY, LEAN CLAY, V. MOIST, SOFT, PPV=1.5kg/cm², TSS=1.75kg/cm², VERY ORGANIC, WORM CASTINGS, ABUNDANT ROOTS, FEW CaCO₃ NODULES (LAKE), DARK BROWN.
- 2 SM, SILTY SAND, MOIST, SOFT, PPV=1.5kg/cm², TSS=2.5kg/cm², ABUNDANT BURROWS, GRUBS, SOFT CaCO₃ NODULES, PALE YELLOW.
- 3 CL-ML, SANDY SILTY CLAY, DRY, HARD, PPV>4.5kg/cm², TSS=2kg/cm², UPPER CONTACT GRADATIONAL, ABUNDANT ROOTS, FEW CLAY-FILLED BURROWS, ABUNDANT CaCO₃ NODULES, PALE YELLOW.
- 4 SM, SILTY SAND, HARD, PPV>4.5kg/cm², TSS=1kg/cm², MOTTLED AND STREAKED WITH RED/YELLOW IRON STAINING, YELLOW.
- 5 SC, CLAYEY SAND, S. MOIST, HARD, PPV>4.5kg/cm², TSS=3kg/cm², LOW PLASTICITY CLAY INTERBEDDED WITH SAND, FEW ROOTS, UPPER CONTACT WAVY, V. PALE BROWN.
- 6 SM, SILTY FINE SAND, SMALL CLAYEY SILT NODULES THROUGHOUT, SCATTERED CaCO₃ NODULES, MOTTLED AND STREAKED WITH YELLOWISH RED IRON STREAKS, PALE BROWN.
- 7 ML-CL, INTERBEDDED SILTY CLAYS AND CROSSBEDDED FINE SAND, STIFF, PPV>4.5kg/cm², TSS=2kg/cm², YELLOWISH BROWN.
- 8 SM, SILTY SAND, CROSSBEDDED, HARD, PPV>4.5kg/cm², TSS=1.0kg/cm², FEW ROOTS, UPPER MUCH MORE CLAYEY, UPPER CONTACT IS WAVY, LIGHT YELLOWISH BROWN.
- 9 CL, SANDY LEAN CLAY, S. MOIST, MASSIVE, STIFF, PPV>4.5kg/cm², TSS=3kg/cm², YELLOWISH BROWN.
- 10 SM, SILTY SAND, CROSSBEDDED, S. MOIST-DRY, HARD, PPV>4.5kg/cm², TSS=1.5kg/cm², FEW ROOTS, DISCONTINUOUS LAYERS OF SP-SM, LIGHT YELLOWISH BROWN.

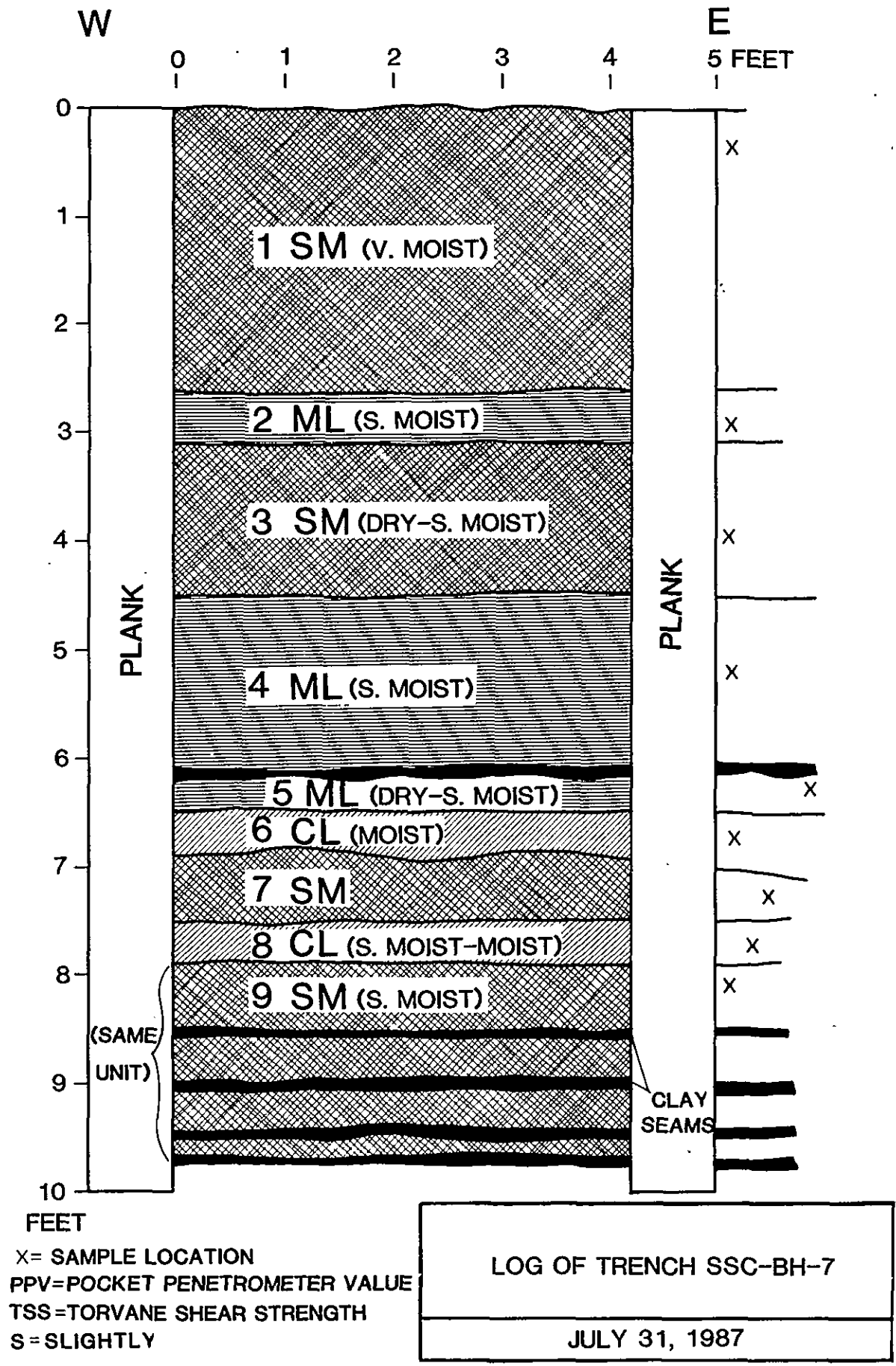

- 1 SM, SILTY SAND, V. MOIST, SOFT, PPV=0.5kg/cm², TSS=1.0kg/cm², ABUNDANT ROOTS, A FEW SOFT CaCO₃ NODULES BELOW 1.5 FEET, NO STRUCTURE, DARK YELLOWISH BROWN.
- 2 ML, SANDY SILT, S. MOIST, PPV=4.0kg/cm², TSS=2.5kg/cm², NEARLY PLUGGED WITH CaCO₃, NUMEROUS 0.5 INCH WORM BURROWS, GRADATIONAL CONTACT WITH UNIT 3 BELOW, WHITE.
- 3 SM, SILTY SAND, DRY TO SLIGHTLY MOIST, HARD, PPV=4.5kg/cm², TSS=3.0kg/cm², A FEW 0.5 INCH DIAMETER BURROWS, YELLOW MOTTLED WITH YELLOW IRON OXIDE STAINING.
- 4 ML, SANDY SILT, S. MOIST, HARD, PPV=4.5kg/cm², TSS=1.0kg/cm², POORLY CROSSBEDDED, SCATTERED CaCO₃ NODULES AND FEW ROOTS, UPPER CONTACT GRADATIONAL, V. PALE BROWN MOTTLED WITH ORANGE IRON OXIDE STAINING.
- 5 ML, SILT WITH SAND, DRY TO S. MOIST, FIRM, PPV=3.5kg/cm², TSS=1.0kg/cm², CROSSBEDDED, LIGHT BROWNISH GREY.
- 6 CL, LEAN CLAY, MOIST, HARD, PPV>5 4.5kg/cm², TSS=5.0kg/cm², SOME GYPSUM STRINGERS, ROOTS, V. PALE BROWN, IRON STAINED.
- 7 SM, SILTY SAND, SOFT, PPV=1.0kg/cm², TSS=1.0kg/cm², CROSSBEDDED, NUMEROUS CLAY CONCRETIONS UP TO .25 INCH DIAMETER, SHARP UPPER SURFACE, REWORKED CaCO₃ CONCRETIONS, YELLOW.
- 8 CL, LEAN CLAY, S. MOIST TO MOIST, STIFF, PPV=4.5kg/cm², TSS=5.5kg/cm², CONCRETIONS OF GYPSUM AT BASE, IRON OXIDE COLORATION ON PED SURFACES, UNIDENTIFIED RED ORGANIC FILAMENTS, LIGHT BROWNISH GREY.
- 9 SM, SILTY SAND, S. MOIST, HARD, PPV=4.5kg/cm², TSS=2kg/cm², STREAKED AND MOTTLED WITH ORANGE IRON OXIDE STAINING, FEW ROOTS, CaCO₃ LAMINAE AND CLAY SEAMS AT 9.0, 9.4, 8.5, AND 8.7 FEET, LIGHT BROWNISH GREY.

VIEW SOUTH

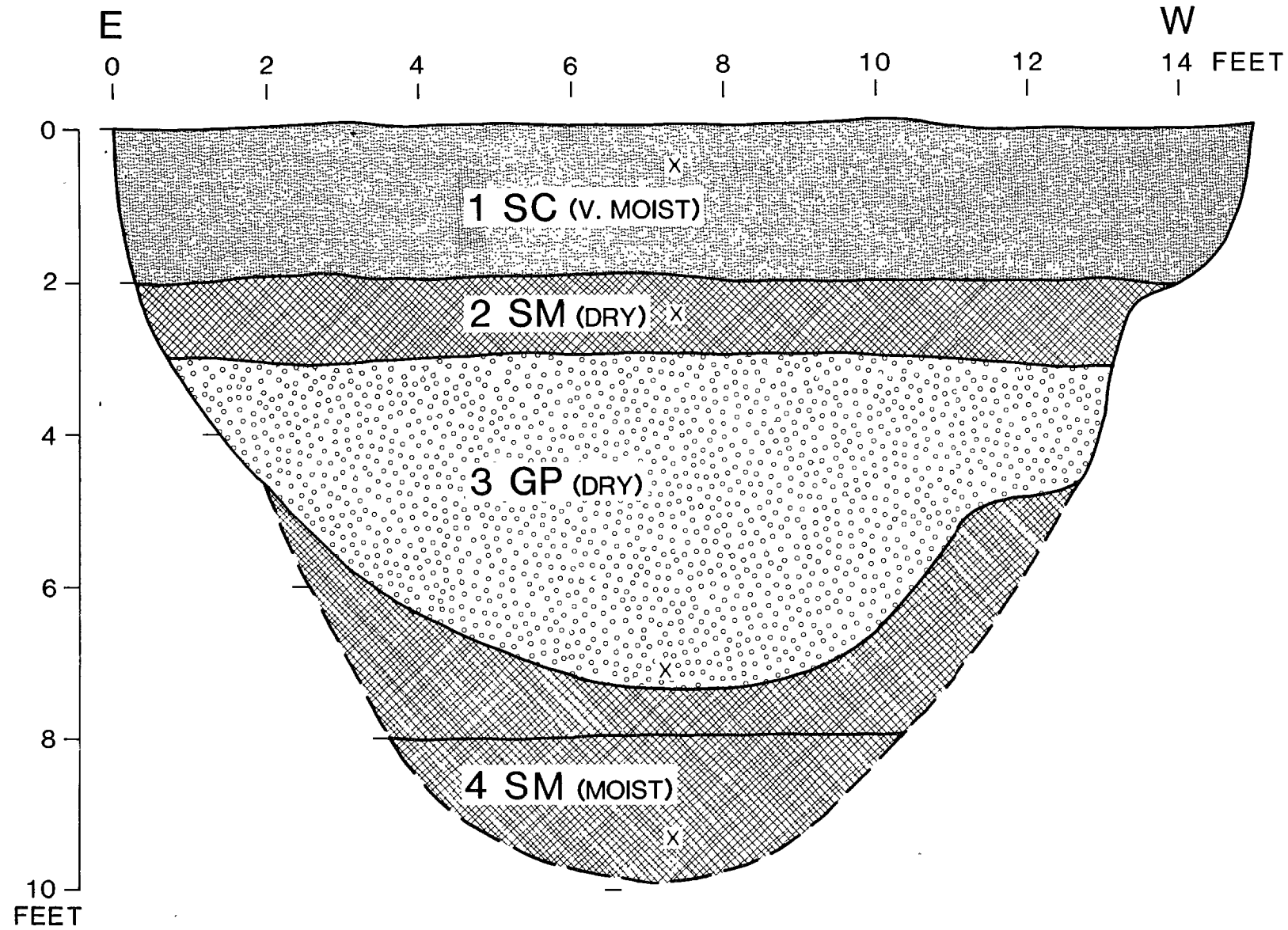

UNIT

- 1 SC, CLAYEY SAND WITH GRAVEL, V. MOIST, SOFT, VERY ORGANIC, ABUNDANT WORMS AND WORM BURROWS, SCATTERED GRAVEL (FINE TO MEDIUM).
- 2 SM, DRY, STAGE IV, CaCO₃.
- 3 GP, POORLY-GRADED GRAVEL WITH SAND, AND SCATTERED BOULDERS AND COBBLES, DRY, CLASTS ARE MADERA LIMESTONE, SUBANGULAR TO SUBROUNDED, MOST ARE WELL COATED WITH CaCO₃.
- 4 SM, SILTY SAND, MOIST, DENSE, CLASTS TO 0.5 INCH, SUBROUNDED, ALL MADERA LIMESTONE, BROWN TO DARK BROWN.

X = SAMPLE LOCATION
 PPV = POCKET PENETROMETER VALUE
 TSS = TORVANE SHEAR STRENGTH

LOG OF TRENCH SSC-BH-9
 JULY 31, 1987

VIEW NORTH

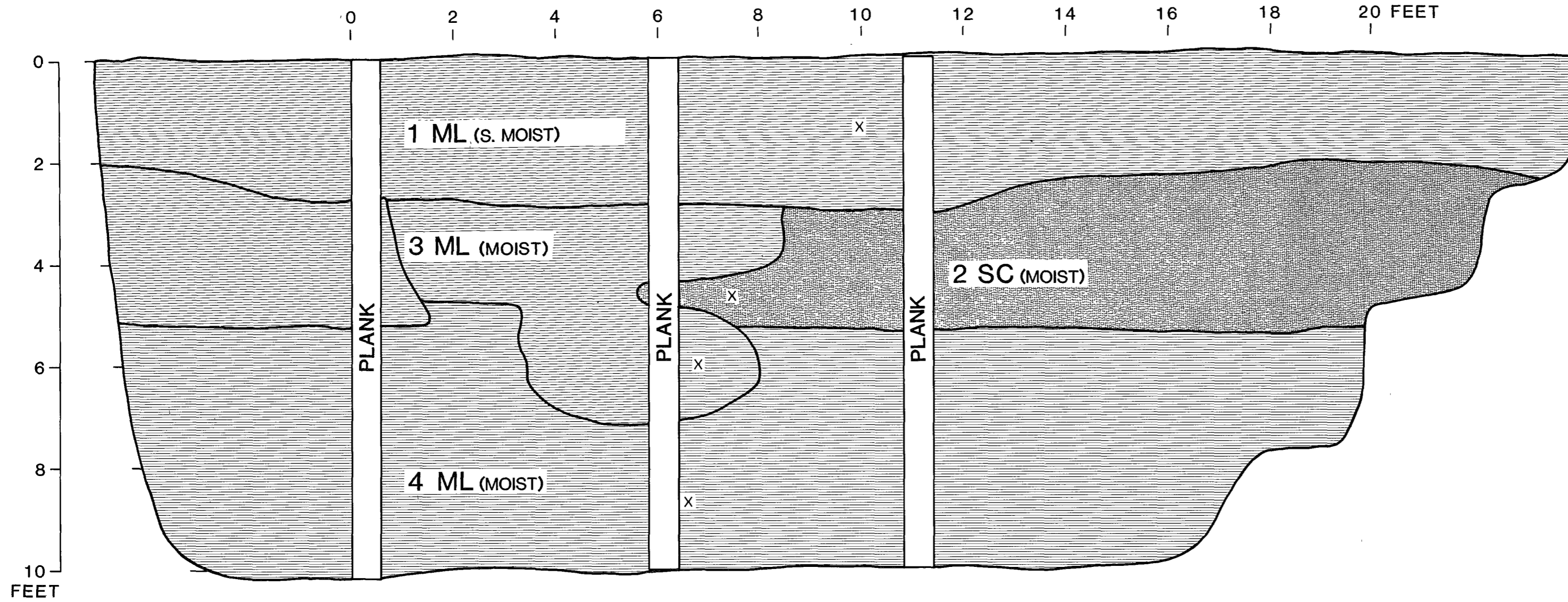

UNIT

- 1 ML, SANDY SILT, MOIST, PPV=2.0kv/cm², TSS=1.5kg/cm², ORGANIC RICH, HEAVILY BURROWED, MANY CaCO₃ NODULES, SOME REWORKED CLASTS FROM UNIT 2 BELOW, DARK YELLOWISH BROWN (POSSIBLY ALLUVIUM).
- 2 SC, CLAYEY SAND, MOIST, HARD, PPV > 4.5kg/cm², TSS=9.5kg/cm², FINE ROOTS, CONTACTS BETWEEN UNITS ABOVE AND BELOW ARE SHARP, V. PALE BROWN (LAKE).
- 3 ML, SILT TO SANDY SILT, MOIST, SOFT, PPV=1.5kg/cm², TSS=0.5kg/cm², MORE ORGANIC THAN OTHER UNITS, DISTINGUISHED FROM OTHER UNITS BY DARKER COLOR, STRONG REACTION TO HCl, FINE ROOTS, YELLOWISH BROWN.
- 4 ML, SANDY SILT, MOIST, HARD, PPV > 4.5kg/cm², TSS=3.0kg/cm², FEW ROOTS, STRONG REACTION TO HCl, GRADATIONAL CONTACT TO UNIT 3 ABOVE, STRONG BROWN.

X= SAMPLE LOCATION
 PPV=POCKET PENETROMETER VALUE
 TSS=TORVANE SHEAR STRENGTH

LOG OF TRENCH SSC-BH-8
 JULY 31, 1987

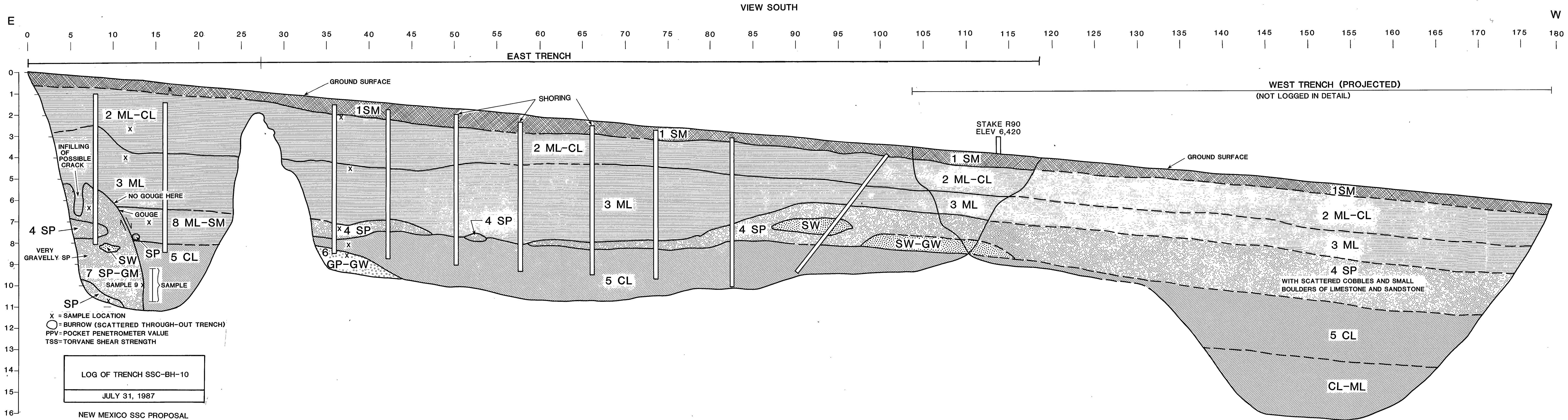

- UNIT
- 1 SM, FINE SAND, A. HORIZON, MANY ROOTS, SCATTERED FINE GRAVEL, VERY MOIST-MOIST, 5YR 4/4 TO 4/6, REDDISH BROWN TO YELLOWISH RED.
 - 2 ML-CL, SANDY SILT TO SILTY CLAY, PEDOGENIC ARGILLIC HORIZON, SOFT CARBONATE NODULES, SCATTERED FINE GRAVEL (SOME COARSE GRAVEL), SLIGHTLY MOIST-MOIST, MANY SMALL ROOTS, 5 YR 5/6 TO 5/8, YELLOWISH RED.
 - 3 ML, SANDY SILT, PEDOGENIC CALCIC HORIZON IN UPPER PART, SCATTERED COARSE GRAVEL INCLUDING LIMESTONE AND VERY SOFT YELLOWISH SANDSTONE CLASTS, FEW ROOTS, 5YR 7/4 TO 6/6, PINK TO REDDISH YELLOW.
 - 4 SP, COARSE GRAVELLY SAND, 35% GRAVEL, MANY GRAVELS HAVE THICK CALCIUM CARBONATE RINDS, CONTAINS LENSES OF CLEAN SAND (SW), UP TO 1 INCH CARBONATE NODULES, 5 YR 5/4 TO 6/6, REDDISH BROWN TO REDDISH YELLOW.
 - 5 CL, SILTY CLAY WITH GRAVEL, BURIED STRONG PEDOGENIC CALCIC HORIZON, VERY BLOCKY STRUCTURE; UP TO 2 INCH DIAMETER, HARD, WHITE, CARBONATE NODULES; BLACK STAINS ON PED SURFACES; CONTACTS WITH UNITS ABOVE AND BELOW ARE UNDULATORY; 7.5YR 8/2 TO 8/4; PINKISH WHITE TO PINK.
 - 6 GP-GW, POORLY TO WELL-GRADED GRAVEL, VERY HARD SANDY GRAVEL, 0.25 TO 0.5 INCH CLASTS, BACKHOE COULD NOT PENETRATE THIS BED.
 - 7 SP-GM, GRAVELLY SAND-SILTY GRAVEL, HARD, 7.5YR 7/6, REDDISH YELLOW.
 - 8 ML-SM, SANDY SILT-FINE SAND, CONTAINS RIP UP CLASTS OF UNIT 6, DRY, SCATTERED FINE GRAVEL, A FEW FINE ROOTS, GRADATIONAL CONTACT WITH UNIT 3, 5YR 4/6, YELLOWISH RED.

NOTE:
SAMPLE 9 - FROM FAULT GOUGE ZONE, LAMINATIONS IN GOUGE ARE PARALLEL TO FAULT PLANE.

APPENDIX 3-C

Downhole Geophysical Logs

Following are 14 geophysical logs completed for this proposal. They include electric (SP and resistivity), natural gamma, and caliper logs, which, when interpreted along with the boring logs in Appendix 3-A, allow better resolution of subsurface conditions such as lithology and stratigraphy. The locations of the borings logged are shown on Figure 3.2-1 (in map tube).

FRONTIER LOGGING CORP.

GAMMA-

FILING NO.		COMPANY <u>N.M.B.M.M.R.</u>					
		WELL <u>SSC - DH-27</u>					
		FIELD _____					
LOCATION: <u>SE 1/4</u>		OTHER SERVICES: _____					
SEC. <u>31</u> TWP. <u>10 N</u> RGE. <u>10 E</u>							
PERMANENT DATUM: <u>GROUND LEVEL</u> ELEV. _____		ELEV.: K.B. _____					
LOG MEASURED FROM <u>GROUND LEVEL</u> FT. ABOVE PERM. DATUM _____		D.F. _____					
DRILLING MEASURED FROM <u>GROUND LEVEL</u>		G.I. _____					
DATE	<u>APRIL 26, 1987</u>						
RUN NO.	<u>ONE</u>						
TYPE LOG	<u>GAMMA-RAY</u>						
DEPTH-DRILLER	<u>160'</u>						
DEPTH-LOGGER	<u>148'</u>						
BOTTOM LOGGED INTERVAL	<u>145'</u>						
TOP LOGGED INTERVAL	<u>SURFACE</u>						
TYPE FLUID IN HOLE	<u>AIR</u>						
SALINITY, PPM CL.							
DENSITY							
LEVEL							
MAX. REC. TEMP., DEG F.							
OPERATING RIG TIME							
RECORDED BY	<u>G.W. CLARKSON</u>						
WITNESSED BY							
RUN NO.		BORE-HOLE RECORD		CASING RECORD			
NO.	BIT	FROM	TO	SIZE	WGT.	FROM	TO
<u>ONE</u>	<u>6"</u>	<u>160'</u>	<u>- 0 -</u>				

NEW MEXICO SSC PROPOSAL JULY 31, 1987
APPENDIX 3-C

THIS HEADING AND LOG CONFORMS TO API RP 33

EQUIPMENT DATA		LOGGING DATA	
RUN NO.	<u>ONE</u>	RUN NO.	<u>ONE</u>
LOG TYPE	<u>G/G</u>	LOG TYPE	<u>G/G</u>
TOOL MODEL NO.	<u>104</u>	TOOL MODEL NO.	<u>104</u>
DIAMETER	<u>1 1/2"</u>	DIAMETER	<u>1 1/2"</u>
DETECTOR MODEL NO.	<u>1273</u>	DETECTOR MODEL NO.	<u>1273</u>
TYPE	<u>SCINT.</u>	TYPE	<u>SCINT.</u>
LENGTH	<u>3' X 2"</u>	LENGTH	<u>3' X 2"</u>
DISTANCE TO D SOURCE		DISTANCE TO D SOURCE	
HOIST TRUCK NO.	<u>111</u>	SOURCE MODEL NO.	<u>13.5</u>
INSTRUMENT TRUCK NO.	<u>111</u>	SPACING	<u>CS-137</u>
TOOL SERIAL NO.	<u>104-1273</u>	TYPE	
		STRENGTH	

GENERAL		GAMMA RAY	
DEPTHS	FROM <u>145'</u> TO <u>0 -</u>	T.C.	<u>3</u>
SPEED	<u>20</u> FT./MIN.	SENS. SETTINGS	<u>100 SCALE</u>
API G.R. UNITS PER LOG DIV.	<u>1</u>	ZERO DIV. I OR R	<u>L</u>
API N. UNITS PER LOG DIV.		T.C. SEC.	<u>DIAL @ 2.00 = 25 cps per inch</u>



FRONTIER LOGGING CORP.

GAMMA-

FILING NO.	COMPANY <u>N.M.B.M.M.R.</u>	
	WELL <u>SSC - DH - 28</u>	
	FIELD _____	
	COUNTY <u>SANTA FE</u>	STATE <u>NEW MEXICO</u>
LOCATION: <u>NW 1/4</u>	OTHER SERVICES:	
SEC. <u>4</u>	TWP. <u>11 N</u>	RGE. <u>8 E</u>

PERMANENT DATUM: <u>GROUND LEVEL</u>	ELEV. _____
LOG MEASURED FROM <u>GROUND LEVEL</u>	FT. ABOVE PERM. DATUM _____
DRILLING MEASURED FROM <u>GROUND LEVEL</u>	ELEV.: K.B. _____
	D.F. _____
	G.I. _____

DATE	<u>APRIL 26, 1987</u>
RUN NO.	<u>ONE</u>
TYPE LOG	<u>GAMMA-RAY</u>
DEPTH-DRILLER	<u>30'</u>
DEPTH-LOGGER	<u>29'</u>
BOTTOM LOGGED INTERVAL	<u>26'</u>
TOP LOGGED INTERVAL	<u>SURFACE</u>
TYPE FLUID IN HOLE	<u>AIR</u>
SALINITY, PPM CL.	
DENSITY	
LEVEL	
MAX. REC. TEMP., DEG F.	
OPERATING RIG TIME	
RECORDED BY	<u>G.W. CLARKSON</u>
WITNESSED BY	

RUN NO.	BORE-HOLE RECORD			CASING RECORD		
	BIT	FROM	TO	SIZE	WGT.	FROM TO
ONE	5"	50'	- 0 -			

THIS HEADING AND LOG CONFORMS TO API RP 33

EQUIPMENT DATA		LOGGING DATA	
RUN NO.	<u>ONE</u>	RUN NO.	<u>ONE</u>
TOOL MODEL NO.	<u>104</u>	LOG TYPE	<u>G/G</u>
DIAMETER	<u>1 1/4"</u>	TOOL MODEL NO.	
DETECTOR MODEL NO.	<u>1273</u>	DIAMETER	
TYPE	<u>SCINT.</u>	DETECTOR MODEL NO.	
LENGTH	<u>1 1/2" X 2"</u>	TYPE	<u>SCINT.</u>
DISTANCE TO D SOURCE	<u>72"</u>	LENGTH	
		SOURCE MODEL NO.	
		SERIAL NO.	<u>13.5</u>
		SPACING	<u>CS-137</u>
HOIST TRUCK NO.	<u>111</u>	TYPE	
INSTRUMENT TRUCK NO.	<u>111</u>	STRENGTH	
TOOL SERIAL NO.	<u>104-1273</u>		

GENERAL		GAMMA RAY		GAMMA RAY	
RUN NO.	<u>ONE</u>	T.C. SEC.	<u>3</u>	ZERO DIV. I OR R	<u>L</u>
DEPTHS FROM	<u>26'</u>	SENS. SETTINGS	<u>100 SCALE</u>	API G.R. UNITS PER LOG DIV.	
TO	<u>0 -</u>		<u>DIAL @ 2.00 =</u>	T.C. SEC.	
			<u>25 GSP PER INCH</u>	SENS. SETTINGS	
				ZERO DIV. I OR R	
				API N UNITS PER LOG DIV.	

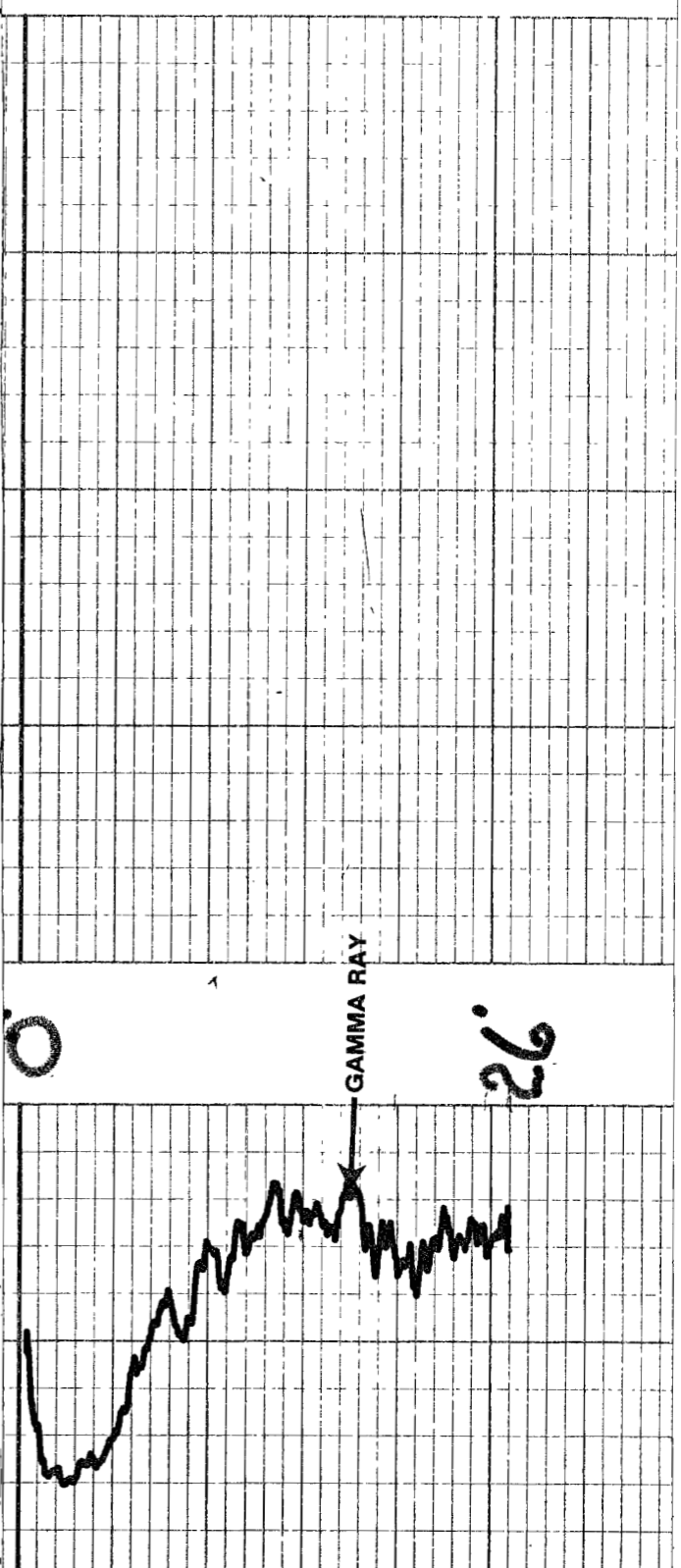

FRONTIER LOGGING CORP.

GAMMA -

FILING NO. _____

COMPANY N.M.B.M.R.

WELL SSC - DH - 29

FIELD _____

COUNTY SANTA FE **STATE** NEW MEXICO

LOCATION: NW 1/4 **OTHER SERVICES:** _____

SEC. 36 **TWP.** 10 N **RGE.** 9 E

PERMANENT DATUM: GROUND LEVEL **ELEV.** _____ **ELEV.: K.B.** _____

LOG MEASURED FROM: GROUND LEVEL **FT. ABOVE PERM. DATUM** _____ **D.F.** _____

DRILLING MEASURED FROM: GROUND LEVEL **G.I.** _____

DATE APRIL 25, 1987

RUN NO. ONE

TYPE LOG GAMMA-RAY, CALIPER, S.P. & RESISTANCE

DEPTH-DRILLER 360'

DEPTH-LOGGER 325'

BOTTOM LOGGED INTERVAL 322'

TOP LOGGED INTERVAL SURFACE

TYPE FLUID IN HOLE FRESH WATER MUD

SALINITY, PPM CL. _____

DENSITY LEVEL 94'

MAX. REC. TEMP., DEG F. _____

OPERATING RIG TIME _____

RECORDED BY G.W. CLARKSON

WITNESSED BY _____

BORE-HOLE RECORD				CASING RECORD			
RUN NO.	BIT	FROM	TO	SIZE	WGT.	FROM	TO
ONE	7 7/8"	20'	- 0 -	6"	PVC	20'	- 0 -
TWO	5 7/8"	360'	20'				

THIS HEADING AND LOG CONFORMS TO API RP 33

EQUIPMENT DATA		LOGGING DATA	
RUN NO.	ONE	API G.R. UNITS PER LOG DIV.	3
TOOL MODEL NO.	104	SENS. SETTINGS DIV. L OR R	1
DIAMETER	1 1/2"	SCALE	100
DETECTOR MODEL NO.	1273	DIAL @ 2.00 =	25 CPS PER INCH
TYPE	SCINT.		
LENGTH	1" X 2 1/2"		
DISTANCE TO D. SOURCE	72"		
GENERAL		GENERAL	
HOIST TRUCK NO.	111	HOIST TRUCK NO.	111
INSTRUMENT TRUCK NO.	111	INSTRUMENT TRUCK NO.	104-1273
TOOL SERIAL NO.		TOOL SERIAL NO.	

LOGGING DATA

GAMMA RAY

API UNITS

CALIPER

HOLE DIAM. IN INCHES

1" 2 1/8" 4 1/4" 6" 7 7/8" 9 1/4"

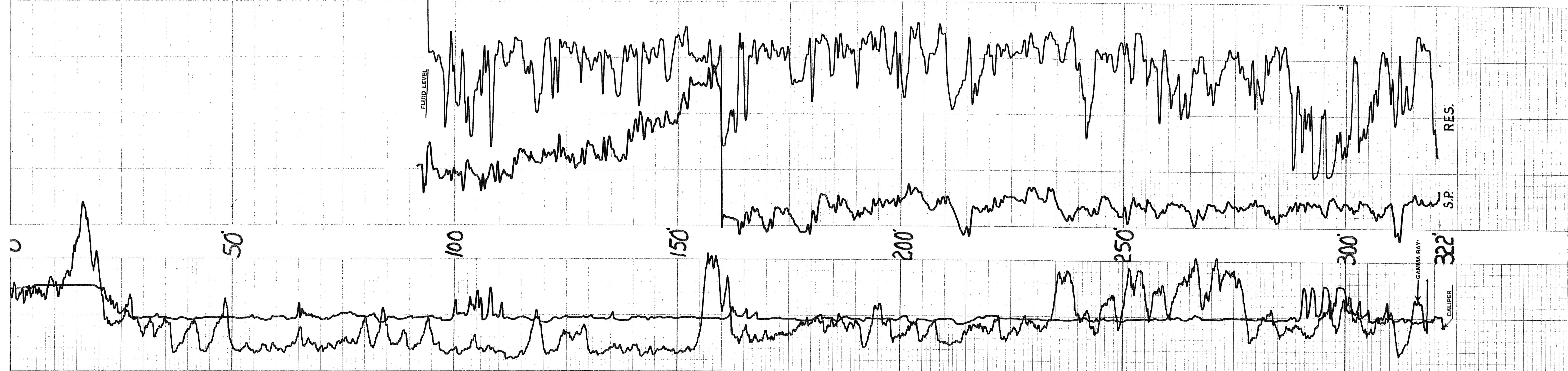

FRONTIER LOGGING CORP.

GAMMA-

FILING NO.		COMPANY <u>N.M.B.M.M.R.</u>					
		WELL <u>SSC - DH - 31</u>					
		FIELD _____					
		COUNTY <u>SANTA FE</u> STATE <u>NEW MEXICO</u>					
LOCATION: <u>NE 1/4</u>		OTHER SERVICES:					
SEC. <u>6</u> TWP. <u>11 N</u> RGE. <u>9 E</u>							
PERMANENT DATUM: <u>GROUND LEVEL</u> ELEV. _____		ELEV.: K.B. _____					
LOG MEASURED FROM <u>GROUND LEVEL</u> FT. ABOVE PERM. DATUM		D.F. _____					
DRILLING MEASURED FROM <u>GROUND LEVEL</u>		G.L. _____					
DATE	<u>APRIL 26, 1987</u>						
RUN NO.	<u>ONE</u>						
TYPE LOG	<u>GAMMA-RAY</u>						
DEPTH-DRILLER	<u>30'</u>						
DEPTH-LOGGER	<u>22'</u>						
BOTTOM LOGGED INTERVAL	<u>19'</u>						
TOP LOGGED INTERVAL	<u>SURFACE</u>						
TYPE FLUID IN HOLE	<u>AIR</u>						
SALINITY, PPM CL.							
DENSITY							
LEVEL							
MAX. REC. TEMP., DEG F.							
OPERATING RIG TIME							
RECORDED BY	<u>G.W. CLARKSON</u>						
WITNESSED BY							
RUN NO.		BORE-HOLE RECORD		CASING RECORD			
NO.	BIT	FROM	TO	SIZE	WGT.	FROM	TO
<u>ONE</u>	<u>6"</u>	<u>30'</u>	<u>- 0 -</u>				

THIS HEADING AND LOG CONFORMS TO API RP 33

FOLD HERE

EQUIPMENT DATA		GAMMA RAY		GAMMA RAY		GAMMA RAY	
RUN NO.	LOG TYPE	RUN NO.	LOG TYPE	RUN NO.	LOG TYPE	RUN NO.	LOG TYPE
<u>ONE</u>	<u>G/G</u>	<u>ONE</u>	<u>G/G</u>	<u>ONE</u>	<u>G/G</u>	<u>ONE</u>	<u>G/G</u>
TOOL MODEL NO.	TOOL MODEL NO.	TOOL MODEL NO.	TOOL MODEL NO.	TOOL MODEL NO.	TOOL MODEL NO.	TOOL MODEL NO.	TOOL MODEL NO.
<u>104</u>	<u>104</u>	<u>104</u>	<u>104</u>	<u>104</u>	<u>104</u>	<u>104</u>	<u>104</u>
DIAMETER	DIAMETER	DIAMETER	DIAMETER	DIAMETER	DIAMETER	DIAMETER	DIAMETER
<u>1 1/2"</u>	<u>1 1/2"</u>	<u>1 1/2"</u>	<u>1 1/2"</u>	<u>1 1/2"</u>	<u>1 1/2"</u>	<u>1 1/2"</u>	<u>1 1/2"</u>
DETECTOR MODEL NO.	DETECTOR MODEL NO.	DETECTOR MODEL NO.	DETECTOR MODEL NO.	DETECTOR MODEL NO.	DETECTOR MODEL NO.	DETECTOR MODEL NO.	DETECTOR MODEL NO.
<u>1273</u>	<u>1273</u>	<u>1273</u>	<u>1273</u>	<u>1273</u>	<u>1273</u>	<u>1273</u>	<u>1273</u>
TYPE	TYPE	TYPE	TYPE	TYPE	TYPE	TYPE	TYPE
<u>3" X 2"</u>	<u>3" X 2"</u>	<u>3" X 2"</u>	<u>3" X 2"</u>	<u>3" X 2"</u>	<u>3" X 2"</u>	<u>3" X 2"</u>	<u>3" X 2"</u>
LENGTH	LENGTH	LENGTH	LENGTH	LENGTH	LENGTH	LENGTH	LENGTH
<u>72"</u>	<u>72"</u>	<u>72"</u>	<u>72"</u>	<u>72"</u>	<u>72"</u>	<u>72"</u>	<u>72"</u>
DISTANCE TO D. SOURCE	DISTANCE TO D. SOURCE	DISTANCE TO D. SOURCE	DISTANCE TO D. SOURCE	DISTANCE TO D. SOURCE	DISTANCE TO D. SOURCE	DISTANCE TO D. SOURCE	DISTANCE TO D. SOURCE
HOIST TRUCK NO.	HOIST TRUCK NO.	HOIST TRUCK NO.	HOIST TRUCK NO.	HOIST TRUCK NO.	HOIST TRUCK NO.	HOIST TRUCK NO.	HOIST TRUCK NO.
<u>111</u>	<u>111</u>	<u>111</u>	<u>111</u>	<u>111</u>	<u>111</u>	<u>111</u>	<u>111</u>
INSTRUMENT TRUCK NO.	INSTRUMENT TRUCK NO.	INSTRUMENT TRUCK NO.	INSTRUMENT TRUCK NO.	INSTRUMENT TRUCK NO.	INSTRUMENT TRUCK NO.	INSTRUMENT TRUCK NO.	INSTRUMENT TRUCK NO.
<u>104-1273</u>	<u>104-1273</u>	<u>104-1273</u>	<u>104-1273</u>	<u>104-1273</u>	<u>104-1273</u>	<u>104-1273</u>	<u>104-1273</u>
TOOL SERIAL NO.	TOOL SERIAL NO.	TOOL SERIAL NO.	TOOL SERIAL NO.	TOOL SERIAL NO.	TOOL SERIAL NO.	TOOL SERIAL NO.	TOOL SERIAL NO.
SOURCE MODEL NO.	SOURCE MODEL NO.	SOURCE MODEL NO.	SOURCE MODEL NO.	SOURCE MODEL NO.	SOURCE MODEL NO.	SOURCE MODEL NO.	SOURCE MODEL NO.
<u>13.5</u>	<u>13.5</u>	<u>13.5</u>	<u>13.5</u>	<u>13.5</u>	<u>13.5</u>	<u>13.5</u>	<u>13.5</u>
SPACING	SPACING	SPACING	SPACING	SPACING	SPACING	SPACING	SPACING
<u>CS-137</u>	<u>CS-137</u>	<u>CS-137</u>	<u>CS-137</u>	<u>CS-137</u>	<u>CS-137</u>	<u>CS-137</u>	<u>CS-137</u>
TYPE	TYPE	TYPE	TYPE	TYPE	TYPE	TYPE	TYPE
STRENGTH	STRENGTH	STRENGTH	STRENGTH	STRENGTH	STRENGTH	STRENGTH	STRENGTH

LOGGING DATA		GAMMA RAY		GAMMA RAY		GAMMA RAY	
RUN NO.	API G.R. UNITS PER LOG DIV.	RUN NO.	API G.R. UNITS PER LOG DIV.	RUN NO.	API G.R. UNITS PER LOG DIV.	RUN NO.	API G.R. UNITS PER LOG DIV.
<u>ONE</u>	<u>3</u>	<u>ONE</u>	<u>3</u>	<u>ONE</u>	<u>3</u>	<u>ONE</u>	<u>3</u>
SPEED FT./MIN.	SPEED FT./MIN.	SPEED FT./MIN.	SPEED FT./MIN.	SPEED FT./MIN.	SPEED FT./MIN.	SPEED FT./MIN.	SPEED FT./MIN.
<u>20</u>	<u>20</u>	<u>20</u>	<u>20</u>	<u>20</u>	<u>20</u>	<u>20</u>	<u>20</u>
SENS. SETTINGS	SENS. SETTINGS	SENS. SETTINGS	SENS. SETTINGS	SENS. SETTINGS	SENS. SETTINGS	SENS. SETTINGS	SENS. SETTINGS
<u>100 SCALE</u>	<u>100 SCALE</u>	<u>100 SCALE</u>	<u>100 SCALE</u>	<u>100 SCALE</u>	<u>100 SCALE</u>	<u>100 SCALE</u>	<u>100 SCALE</u>
T.C. SEC.	T.C. SEC.	T.C. SEC.	T.C. SEC.	T.C. SEC.	T.C. SEC.	T.C. SEC.	T.C. SEC.
<u>3</u>	<u>3</u>	<u>3</u>	<u>3</u>	<u>3</u>	<u>3</u>	<u>3</u>	<u>3</u>
ZERO DIV. L OR R	ZERO DIV. L OR R	ZERO DIV. L OR R	ZERO DIV. L OR R	ZERO DIV. L OR R	ZERO DIV. L OR R	ZERO DIV. L OR R	ZERO DIV. L OR R
<u>L</u>	<u>L</u>	<u>L</u>	<u>L</u>	<u>L</u>	<u>L</u>	<u>L</u>	<u>L</u>
API N. UNITS PER LOG DIV.	API N. UNITS PER LOG DIV.	API N. UNITS PER LOG DIV.	API N. UNITS PER LOG DIV.	API N. UNITS PER LOG DIV.	API N. UNITS PER LOG DIV.	API N. UNITS PER LOG DIV.	API N. UNITS PER LOG DIV.
<u>25 CPS PER INCH</u>	<u>25 CPS PER INCH</u>	<u>25 CPS PER INCH</u>	<u>25 CPS PER INCH</u>	<u>25 CPS PER INCH</u>	<u>25 CPS PER INCH</u>	<u>25 CPS PER INCH</u>	<u>25 CPS PER INCH</u>

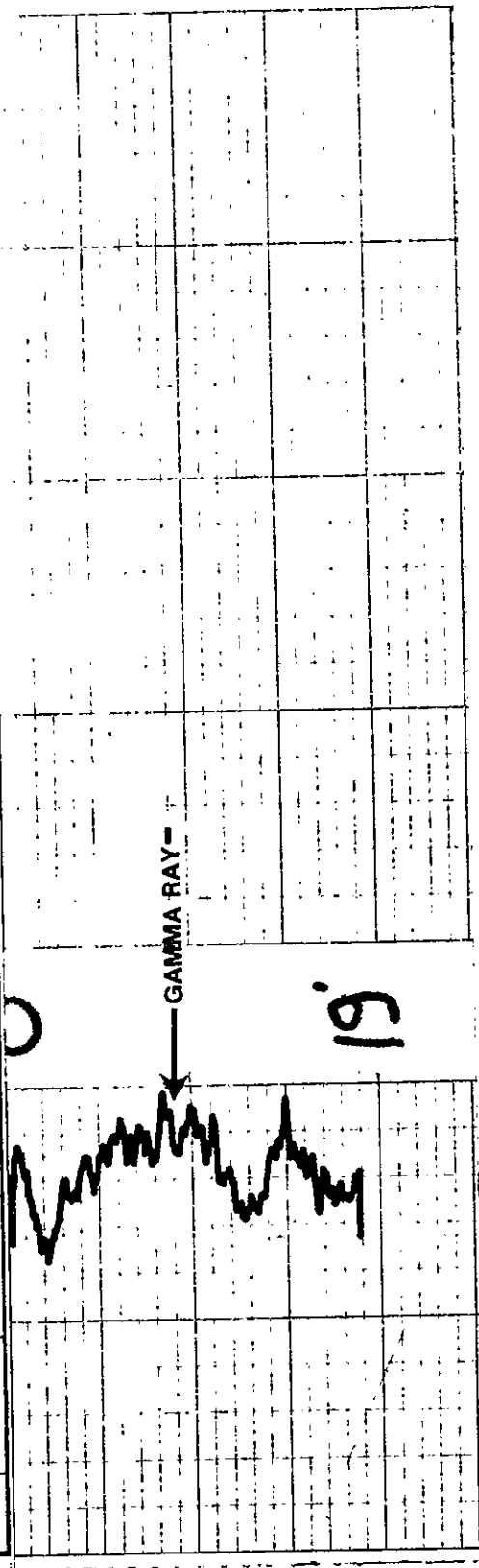

FRONTIER LOGGING CORP.

GAMMA-

FILING NO. _____

COMPANY N.M.B.M.M.R.

WELL SSC - DH - 32

FIELD _____

COUNTY SANTA FE STATE NEW MEXICO

LOCATION: SW 1/4 OTHER SERVICES: _____

SEC. 35 TWP. 12 N RGE. 9 E

PERMANENT DATUM: GROUND LEVEL ELEV. _____

LOG MEASURED FROM GROUND LEVEL FT. ABOVE PERM. DATUM _____

DRILLING MEASURED FROM GROUND LEVEL G.L. _____

DATE APRIL 25, 1987

RUN NO. ONE

TYPE LOG GAMMA-RAY, CALIPER, S.P. & RESISTANCE

DEPTH-DRILLER 160'

DEPTH-LOGGER 150'

BOTTOM LOGGED INTERVAL 147'

TOP LOGGED INTERVAL SURFACE

TYPE FLUID IN HOLE FRESH WATER MUD

SALINITY, PPM CL. _____

DENSITY _____

LEVEL 56'

MAX. REC. TEMP., DEG F. _____

OPERATING RIG TIME _____

RECORDED BY G.W. CLARKSON

WITNESSED BY _____

RUN NO.	BORE-HOLE RECORD				CASING RECORD			
	BIT	FROM	TO	SIZE	WGT.	FROM	TO	
ONE	7 7/8"	20'	- 0 -	6"	PVC	20'	- 0 -	
TWO	5 5/8"	150'	20'					

THIS HEADING AND LOG CONFORMS TO API RP 33

EQUIPMENT DATA

RUN NO. <u>ONE</u>	RUN NO. _____	G/G _____
TOOL MODEL NO. <u>104</u>	LOG TYPE _____	TOOL MODEL NO. _____
DIAMETER <u>1 3/4"</u>	DIAMETER _____	DIAMETER _____
DETECTOR MODEL NO. <u>1273</u>	DETECTOR MODEL NO. _____	SCINT. _____
TYPE <u>3" X 2"</u>	TYPE _____	LENGTH _____
LENGTH <u>72"</u>	SOURCE MODEL NO. _____	SERIAL NO. _____
DISTANCE TO D. SOURCE _____	SPACING _____	STRENGTH _____
HOIST TRUCK NO. <u>111</u>	TYPE _____	13.5
INSTRUMENT TRUCK NO. <u>111</u>	CS-137	
TOOL SERIAL NO. <u>104-1273</u>		

LOGGING DATA

GENERAL		GAMMA RAY		API N. UNITS PER LOG DIV.	
RUN NO. <u>ONE</u>	DEPTH FROM <u>147'</u>	T.C. <u>3</u>	SENS. SETTINGS <u>100 SCALE L</u>	ZERO DIV. L OR R _____	API N. UNITS PER LOG DIV. _____
DEPTHS TO <u>- 0 -</u>	SPEED FT./MIN. <u>20</u>	SEC. _____	DIAL @ <u>2.00 =</u>		
			<u>25 CPS PER INCH</u>		

REMARKS: S.P. DIAL @ 2.45 = 10 MV PER DIVISION
RES. DIAL @ 1.48 = 50 OHMS=5 INCH

REFERENCE LITERATURE: _____

REMARKS: _____

GAMMA RAY
API UNITS

CALIPER
HOLE DIAM. IN INCHES

1" 2" 3" 4" 5" 6" 7" 8" 9" 10"

CORRECTION GRAMS/CC.

GRAMS/CC.

0

-0.25

+0.25

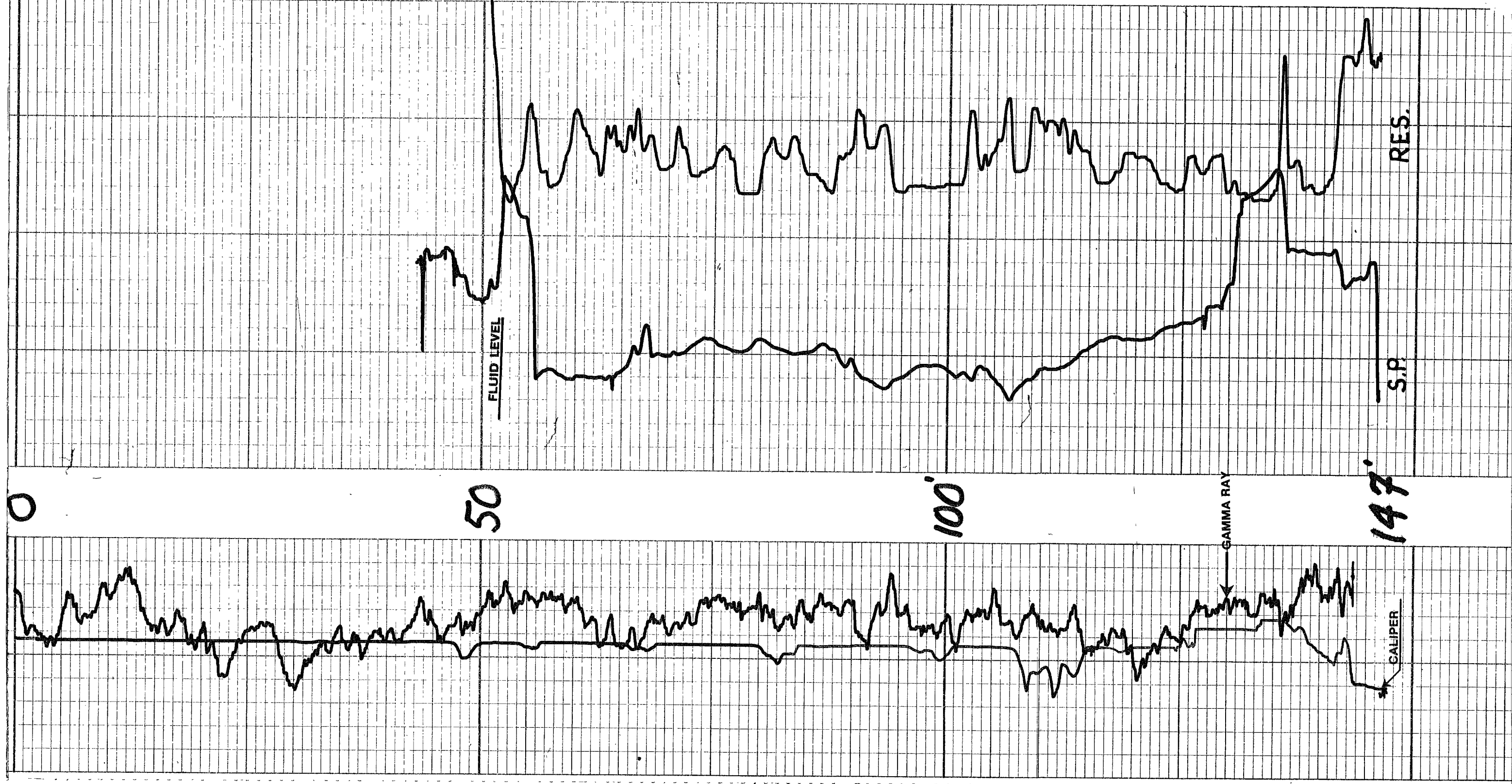

FRONTIER LOGGING CORP.

GAMMA-

FILING NO.	COMPANY <u>N.M.B.M.M.R.</u>	
	WELL <u>DH - 33</u>	
	FIELD _____	
	COUNTY <u>SANTA FE</u>	STATE <u>NEW MEXICO</u>
LOCATION: <u>NW 1/4</u>	OTHER SERVICES: _____	
SEC. <u>4</u>	TWP. <u>11 N</u>	RGE. <u>8 E</u>

PERMANENT DATUM: <u>GROUND LEVEL</u>	ELEV. _____
LOG MEASURED FROM <u>GROUND LEVEL</u>	FT. ABOVE PERM. DATUM _____
DRILLING MEASURED FROM <u>GROUND LEVEL</u>	ELEV.: K.B. _____
	D.F. _____
	G.L. _____

DATE	<u>APRIL 26, 1987</u>
RUN NO.	<u>ONE</u>
TYPE LOG	<u>GAMMA-RAY</u>
DEPTH-DRILLER	<u>50'</u>
DEPTH-LOGGER	<u>35'</u>
BOTTOM LOGGED INTERVAL	<u>32'</u>
TOP LOGGED INTERVAL	<u>SURFACE</u>
TYPE FLUID IN HOLE	<u>AIR</u>
SALINITY, PPM CL.	
DENSITY	
LEVEL	
MAX. REC. TEMP., DEG F.	
OPERATING RIG TIME	
RECORDED BY	<u>G.W. CLARKSON</u>
WITNESSED BY	

RUN NO.	BORE-HOLE RECORD			CASING RECORD			
	BIT	FROM	TO	SIZE	WGT.	FROM	TO
ONE	6"	50'	- 0 -				

THIS HEADING AND LOG CONFORMS TO API RP 33

EQUIPMENT DATA		LOGGING DATA	
RUN NO.	<u>ONE</u>	RUN NO.	<u>G/G</u>
TOOL MODEL NO.	<u>104</u>	LOG TYPE	<u>G/G</u>
DIAMETER	<u>1 1/2"</u>	TOOL MODEL NO.	
DETECTOR MODEL NO.	<u>1273</u>	DIAMETER	
TYPE	<u>SCINT.</u>	DETECTOR MODEL NO.	
LENGTH	<u>1 1/2" X 2"</u>	TYPE	<u>SCINT.</u>
DISTANCE TO D SOURCE	<u>72"</u>	LENGTH	
		SOURCE MODEL NO.	
		SERIAL NO.	<u>13.5</u>
		SPACING	<u>CS-137</u>
		TYPE	
		STRENGTH	
HOIST TRUCK NO.	<u>111</u>		
INSTRUMENT TRUCK NO.	<u>111</u>		
TOOL SERIAL NO.	<u>104-1273</u>		

GENERAL		GAMMA RAY	
DEPTHS		API G.R. UNITS	API N. UNITS
FROM		PER LOG DIV.	PER LOG DIV.
TO			
FROM	<u>32'</u>	T.C. SEC.	SENS. SETTINGS
TO	<u>0 - 0</u>		
		SPEED FT./MIN.	ZERO DIV. L OR R
		<u>20</u>	
		T.C. SEC.	
		<u>3</u>	
		SENS. SETTINGS	
		<u>100 SCALE L</u>	
		DIAL. @ <u>2.00 =</u>	
		<u>25 CPS PER INCH</u>	

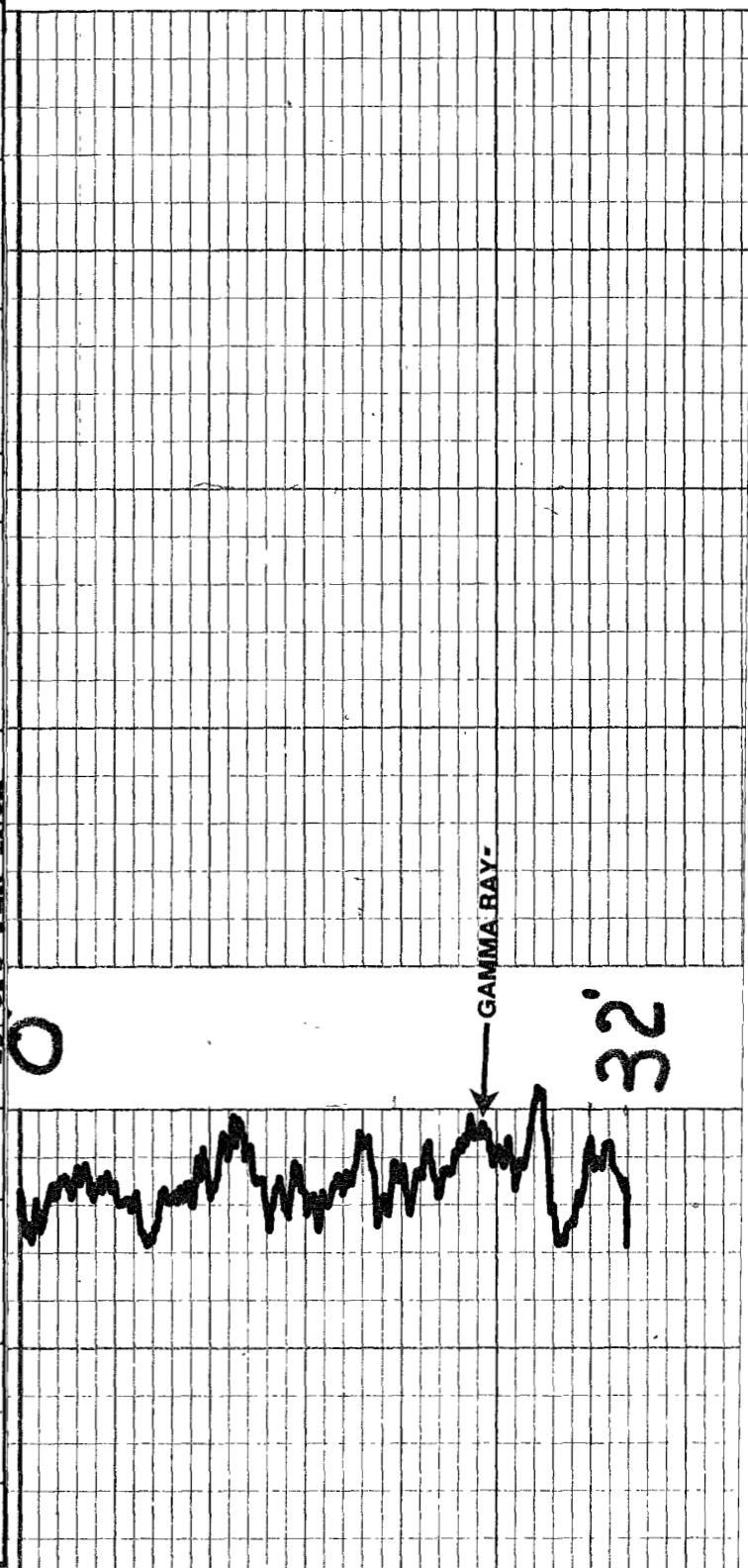

FRONTIER LOGGING CORP.

GAMMA-

FILING NO. _____

COMPANY N.M.B.M.M.R.

WELL HYER RANCH - DH - 34

FIELD _____

COUNTY SANTA FE STATE NEW MEXICO

LOCATION: NW 1/4 OTHER SERVICES: _____

SEC 4 TWP 11 N RGE 8 E

PERMANENT DATUM: GROUND LEVEL ELEV. _____

LOG MEASURED FROM GROUND LEVEL FT. ABOVE PERM. DATUM _____

DRILLING MEASURED FROM GROUND LEVEL G.L. _____

ELEV.: K.B. _____

D.F. _____

G.L. _____

DATE APRIL 26, 1987

RUN NO. ONE

TYPE LOG GAMMA-RAY, CALIPER, S.P. & RESISTANCE

DEPTH-DRILLER 200'

DEPTH-LOGGER 195'

BOTTOM LOGGED INTERVAL 192'

TOP LOGGED INTERVAL SURFACE

TYPE FLUID IN HOLE FRESH WATER MUD

SALINITY, PPM CL. _____

DENSITY _____

LEVEL 85'

MAX. REC. TEMP., DEG F. _____

OPERATING RIG TIME _____

RECORDED BY G.W. CLARKSON

WITNESSED BY _____

RUN NO.	BORE-HOLE RECORD				CASING RECORD			
	BIT	FROM	TO	SIZE	WGT.	FROM	TO	
ONE	7 7/8"	20'	- 0 -	6"	PVC	20'	- 0 -	
TWO	5 5/8"	200'	20'					

THIS HEADING AND LOG CONFORMS TO API RP 33

EQUIPMENT DATA		LOGGING DATA	
RUN NO.	LOG TYPE	RUN NO.	G/G
TOOL MODEL NO.	DIAMETER	TOOL MODEL NO.	SCINT.
DETECTOR MODEL NO.	TYPE	DETECTOR MODEL NO.	LENGTH
	LENGTH	SOURCE MODEL NO.	SERIAL NO.
	DISTANCE TO D SOURCE		SPACING
			TYPE
			STRENGTH
			13.5
			CS-137

LOGGING DATA		GAMMA RAY	
RUN NO.	API G.R. UNITS PER LOG DIV.	ZERO DIV. L OR R	API N. UNITS PER LOG DIV.
T.C.	SENS. SETTINGS	SEC.	ZERO DIV. L OR R
ONE	100 SCALE	3	
	DIAL @ 2.00 =		
	25 CPS PER INCH		

REMARKS: _____

S.P. DIAL @ 2.45 = 10 MV PER DIVISION

RES. DIAL @ 1.48 = 50 OHMS = 5 INCHS

API UNITS

GAMMA RAY

CALIPER

HOLE DIAM. IN INCHES

1" 2 1/3" 4 1/4" 6 1/8" 9 1/4"

GRAMS/CC.

CORRECTION GRAMS/CC.

0

-25

+25

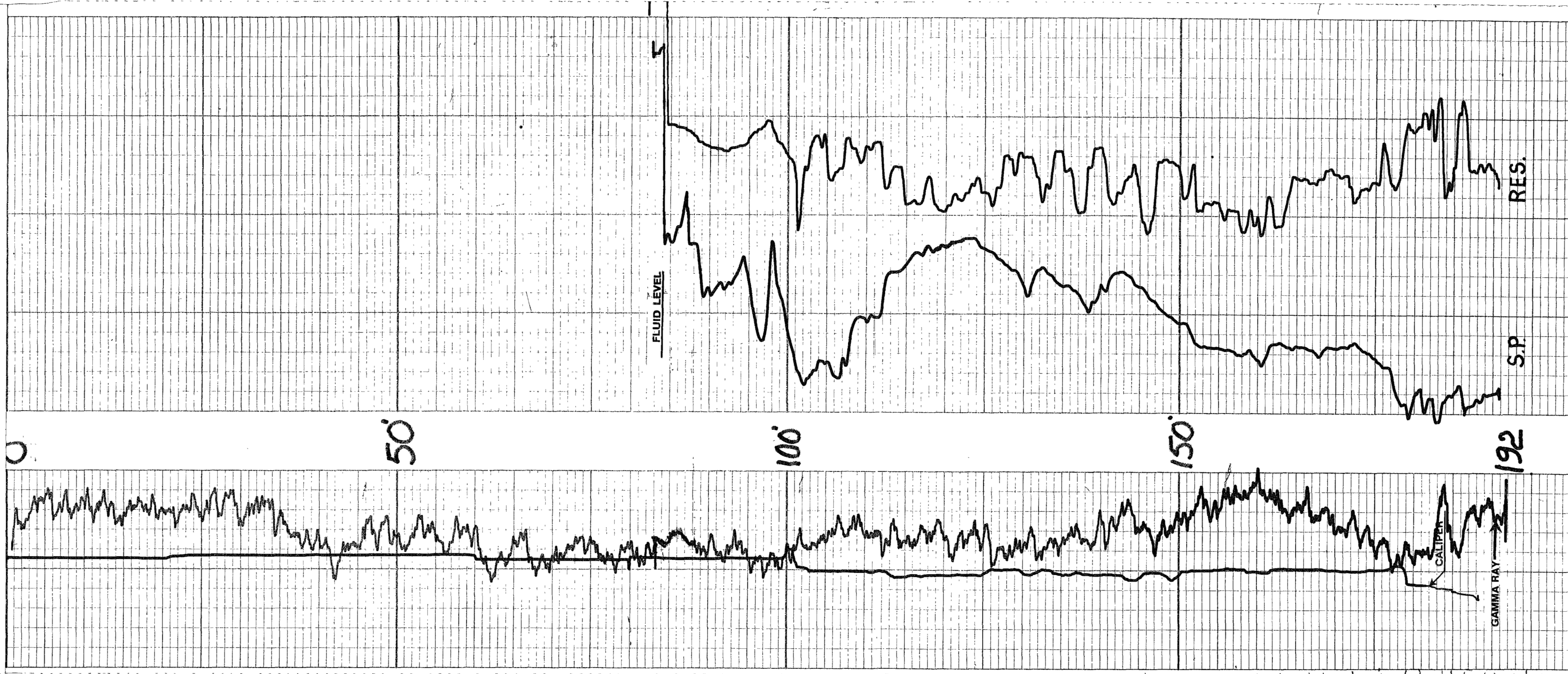

FRONTIER LOGGING CORP.

GAMMA-

FILING NO.	COMPANY <u>N.M.B.M.M.R.</u>	
	WELL <u>SSC - DH - 35</u>	
	FIELD _____	
	COUNTY <u>TORRANCE</u>	STATE <u>NEW MEXICO</u>
LOCATION: <u>SE 1/4</u>	OTHER SERVICES:	
SEC. <u>17</u>	TWP. <u>9 N</u>	RGE. <u>9 E</u>

PERMANENT DATUM: <u>GROUND LEVEL</u>	ELEV. _____
LOG MEASURED FROM <u>GROUND LEVEL</u>	FT. ABOVE PERM. DATUM _____
DRILLING MEASURED FROM <u>GROUND LEVEL</u>	ELEV.: K.B. _____
	D.F. _____
	G.I. _____

DATE	<u>APRIL 25, 1987</u>
RUN NO.	<u>ONE</u>
TYPE LOG	<u>GAMMA-RAY, CALIPER, S.P. & RESISTANCE</u>
DEPTH-DRILLER	<u>60'</u>
DEPTH-LOGGER	<u>59'</u>
BOTTOM LOGGED INTERVAL	<u>56'</u>
TOP LOGGED INTERVAL	<u>SURFACE</u>
TYPE FLUID IN HOLE	<u>FRESH WATER MUD</u>
SALINITY, PPM CL.	
DENSITY	
LEVEL	<u>20'</u>
MAX. REC. TEMP., DEG F.	
OPERATING RIG TIME	
RECORDED BY	<u>G.W. CLARKSON</u>
WITNESSED BY	

RUN NO.	BORE-HOLE RECORD			CASING RECORD			
	BIT	FROM	TO	SIZE	WGT.	FROM	TO
ONE	6"	60'	- 0 -				

FOLD HERE THIS HEADING AND LOG CONFORMS TO API RP 33

EQUIPMENT DATA	
RUN NO.	<u>ONE</u>
LOG TYPE	<u>G/G</u>
TOOL MODEL NO.	<u>104</u>
DIAMETER	<u>1 1/2"</u>
DETECTOR MODEL NO.	<u>1273</u>
TYPE	<u>SCINT.</u>
LENGTH	<u>2' X 2'</u>
DISTANCE TO D. SOURCE	<u>72"</u>
GENERAL	
HOIST TRUCK NO.	<u>111</u>
INSTRUMENT TRUCK NO.	<u>111</u>
TOOL SERIAL NO.	<u>104-1273</u>

LOGGING DATA	
GAMMA RAY	
GENERAL	
RUN NO.	<u>ONE</u>
DEPTHS	<u>56' - 0 - 20</u>
FROM	<u>56'</u>
TO	<u>0 - 20</u>
SPEED FT./MIN.	<u>3</u>
T.C. SEC.	<u>100 SCALE L</u>
ZERO DIV. 1 OR R	<u>DIAL @ 2.00 = 25 CPS PER INCH</u>
SENS. SETTINGS	<u>100 SCALE L</u>
API G.R. UNITS PER LOG DIV.	<u>100 SCALE L</u>
ZERO DIV. 1 OR R	<u>DIAL @ 2.45 = 10 MV/DIVISION</u>
T.C. SEC.	<u>RES. DIAL @ 1.48 = 50 OHMS = 5 INCH</u>
SENS. SETTINGS	
API N. UNITS PER LOG DIV.	

REFERENCE LITERATURE: _____

REMARKS: _____

GAMMA RAY	ZERO
API UNITS	<u>62 CPS</u>
CALIPER	
HOLE DIAM. IN INCHES	<u>3" 4" 6" 7" 8" 9" 10"</u>

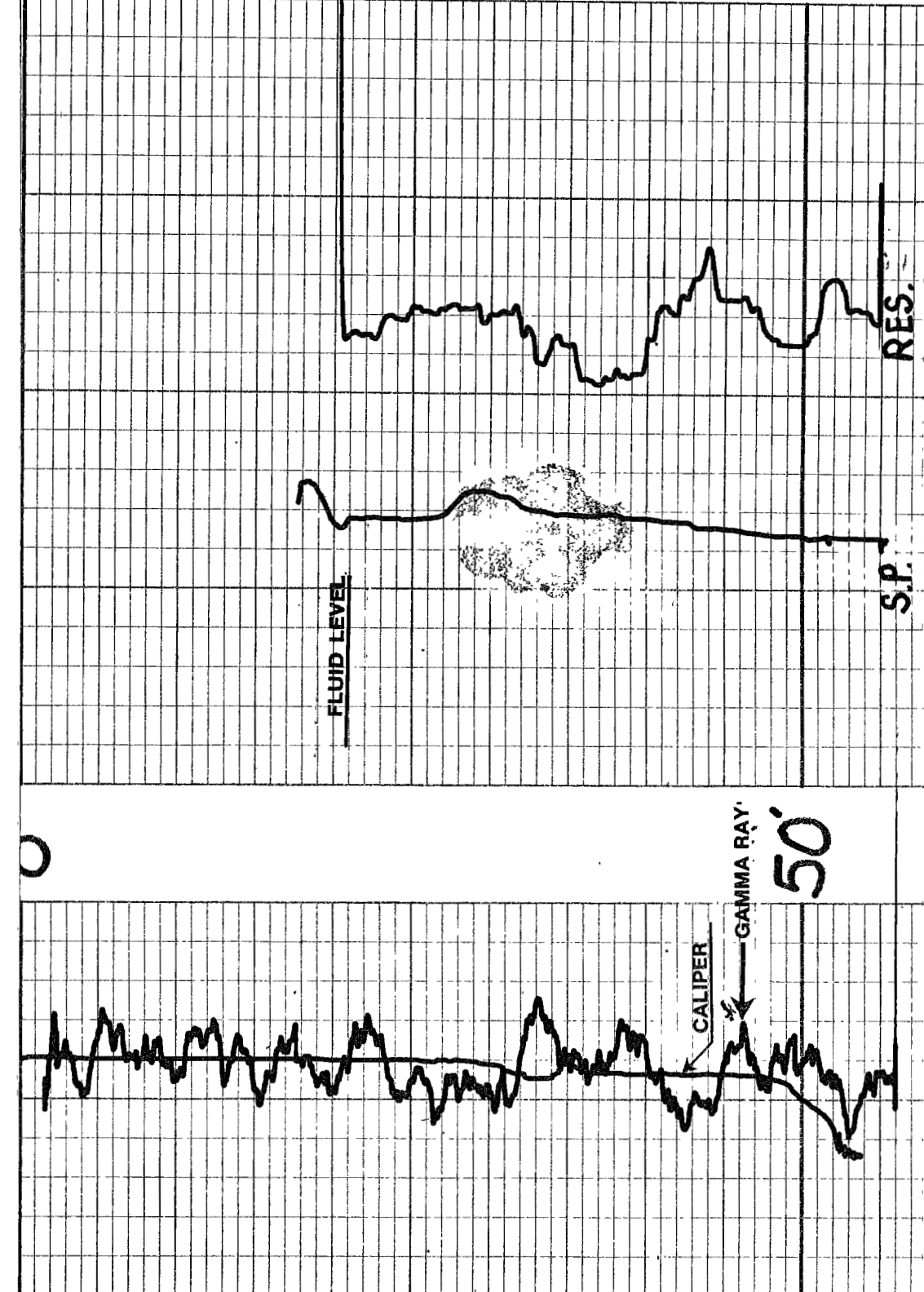

FRONTIER LOGGING CORP.

GAMMA-

FILING NO.		COMPANY <u>N.M.B.M.M.R.</u>					
		WELL <u>SSC - DH - 36</u>					
FIELD							
COUNTY <u>TORRANCE</u> STATE <u>NEW MEXICO</u>							
LOCATION: <u>NE 1/4</u>		OTHER SERVICES:					
SEC. <u>22</u> TWP. <u>9 N</u> RGE. <u>8 E</u>							
PERMANENT DATUM: <u>GROUND LEVEL</u> ELEV. _____		ELEV.: K.B. _____					
LOG MEASURED FROM <u>GROUND LEVEL</u> FT. ABOVE PERM. DATUM _____		D.F. _____					
DRILLING MEASURED FROM <u>GROUND LEVEL</u>		G.I. _____					
DATE	<u>APRIL 25, 1987</u>						
RUN NO.	<u>ONE</u>						
TYPE LOG	<u>GAMMA-RAY & CALIPER</u>						
DEPTH-DRILLER	<u>60'</u>						
DEPTH-LOGGER	<u>53'</u>						
BOTTOM LOGGED INTERVAL	<u>50'</u>						
TOP LOGGED INTERVAL	<u>SURFACE</u>						
TYPE FLUID IN HOLE	<u>AIR</u>						
SALINITY, PPM CL.							
DENSITY							
LEVEL							
MAX. REC. TEMP., DEG F.							
OPERATING RIG TIME							
RECORDED BY	<u>G.W. CLARKSON</u>						
WITNESSED BY							
RUN NO.		BORE-HOLE RECORD		CASING RECORD			
NO.	BIT	FROM	TO	SIZE	WGT.	FROM	TO
<u>ONE</u>	<u>6"</u>	<u>60'</u>	<u>- 0 -</u>				

FOLD HERE THIS HEADING AND LOG CONFORMS TO API RP 33

EQUIPMENT DATA	
GAMMA RAY	
RUN NO.	<u>ONE</u>
TOOL MODEL NO.	<u>104</u>
DIAMETER	<u>1 1/2"</u>
DETECTOR MODEL NO.	<u>1273</u>
TYPE	<u>SCINT.</u>
LENGTH	<u>3/2" X 2 1/2"</u>
DISTANCE TO D SOURCE	<u>72"</u>
GENERAL	
HOIST TRUCK NO.	<u>111</u>
INSTRUMENT TRUCK NO.	<u>111</u>
TOOL SERIAL NO.	<u>104-1273</u>
	<u>G/G</u>
	<u>SCINT.</u>
	<u>13.5</u>
	<u>CS-137</u>

LOGGING DATA	
GAMMA RAY	
GENERAL	
RUN NO.	<u>ONE</u>
DEPTHS FROM	<u>60'</u>
TO	<u>- 0 -</u>
SPEED FT./MIN.	<u>20</u>
T.C. SEC.	<u>3</u>
SENS. SETTINGS	<u>100 SCALE</u>
ZERO DIV. 1 OR R	<u>L</u>
API G.R. UNITS PER LOG DIV.	<u>DIAL @ 2,000 =</u>
API N. UNITS PER LOG DIV.	<u>25 CPS PER INCH</u>
T.C. SEC.	
SENS. SETTINGS	
ZERO DIV. 1 OR R	
API N. UNITS PER LOG DIV.	
REFERENCE LITERATURE:	
REMARKS	

GAMMA RAY	API UNITS
CALIPER	HOLE DIAM. IN INCHES
	<u>1" 2"3" 4"5" 6"7" 8"9"10"</u>
	CORRECTION GRAMS/CC.
	<u>GRAMS/CC.</u>
	0
	+ .25

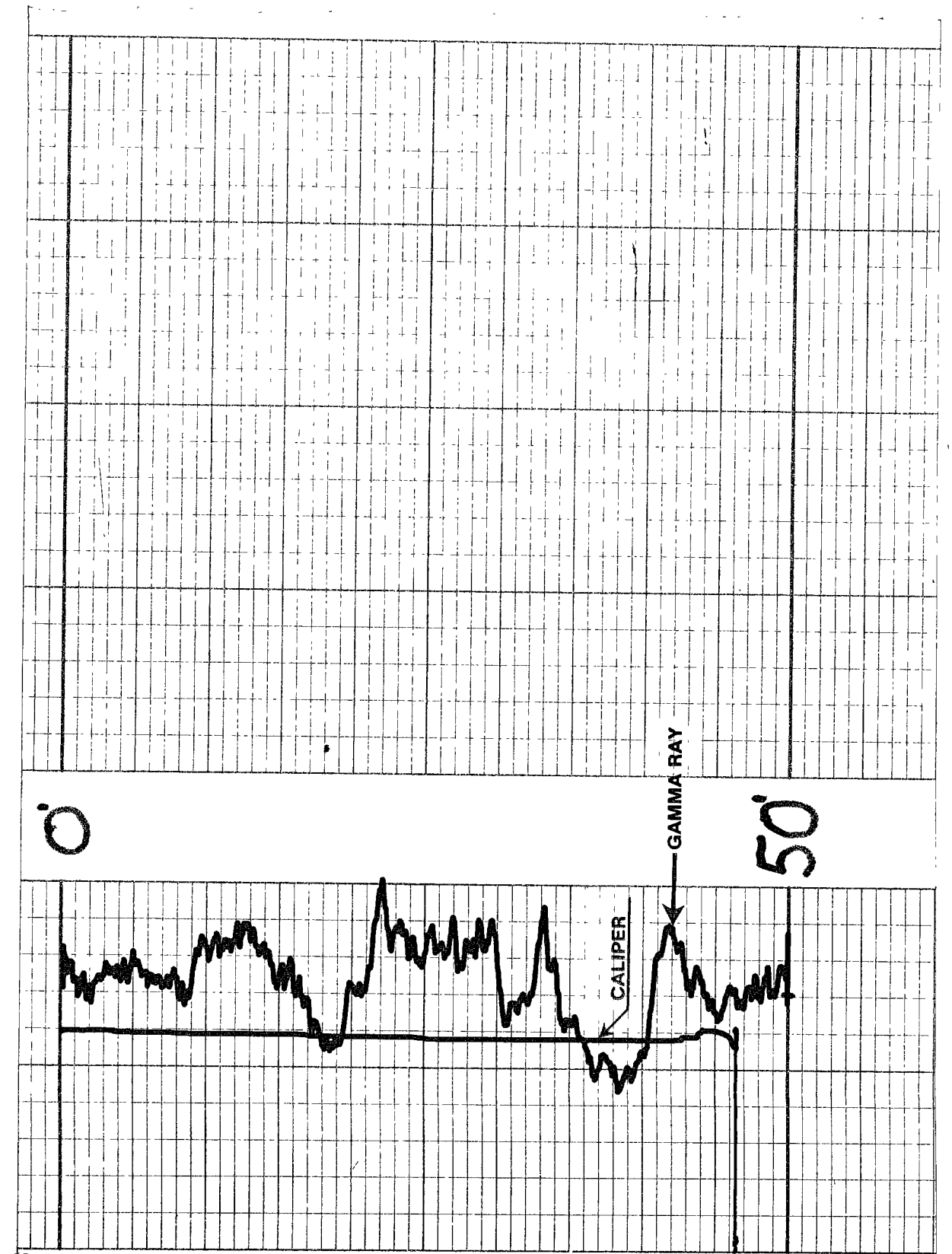

FRONTIER LOGGING CORP.

GAMMA-

FILING NO. _____

COMPANY N.M.B.M.M.R.

WELL SSC - DH - 37

FIELD _____

COUNTY TORRANCE STATE NEW MEXICO

LOCATION: SE 1/4 OTHER SERVICES: _____

SEC. 17 TWP. 9 N RGE. 9 E

PERMANENT DATUM: GROUND LEVEL ELEV. _____

LOG MEASURED FROM: GROUND LEVEL FT. ABOVE PERM. DATUM _____

DRILLING MEASURED FROM: GROUND LEVEL G.L. _____

ELEV.: K.B. _____

D.F. _____

G.L. _____

DATE APRIL 25, 1987

RUN NO. ONE

TYPE LOG GAMMA-RAY & CALIPER, S.P. & RESISTANCE

DEPTH-DRILLER 135'

DEPTH-LOGGER 133'

BOTTOM LOGGED INTERVAL 130'

TOP LOGGED INTERVAL SURFACE

TYPE FLUID IN HOLE FRESH WATER

SALINITY, PPM CL. _____

DENSITY _____

LEVEL 100'

MAX. REC. TEMP., DEG F. _____

OPERATING RIG TIME _____

RECORDED BY G.W. CLARKSON

WITNESSED BY _____

RUN NO.	BORE-HOLE RECORD				CASING RECORD			
	BIT	FROM	TO	SIZE	WGT.	FROM	TO	
ONE	7 7/8"	100'	- 0'	6"	PVC	100'	- 0'	
TWO	5 5/8"	120'	100'					
THREE	5 1/8"	135'	120'					

THIS HEADING AND LOG CONFORMS TO API RP 33

EQUIPMENT DATA		GAMMA RAY	
RUN NO.	LOG TYPE	RUN NO.	G/G
TOOL MODEL NO.	DIAMETER	TOOL MODEL NO.	
DETECTOR MODEL NO.	TYPE	DETECTOR MODEL NO.	SCINT.
LENGTH	LENGTH	SOURCE MODEL NO.	
DISTANCE TO D SOURCE	SCINT.	SERIAL NO.	13.5
		SPACING	CS-137
		TYPE	
		STRENGTH	

GENERAL		GAMMA RAY		LOGGING DATA	
RUN NO.	DEPTH	RUN NO.	ZERO	RUN NO.	API N. UNITS
ONE	130'	ONE	104	ONE	100 SCALE L
FROM	TO	TOOL MODEL NO.	DETECTOR MODEL NO.	T.C. SEC.	SENS. SETTINGS
- 0 -	20	1 1/2"	1273	3	100 SCALE L
		SCINT.	LENGTH	DIAL @ 2.00 =	DIAL @ 2.00 =
		2"	72"		25 CPS PER INCH
		GENERAL	HOIST TRUCK NO.		
			111		
			INSTRUMENT TRUCK NO.		
			111		
			TOOL SERIAL NO.		
			104-1273		

S.P. DIAL @ 2.45 = 10 MV PER DIVISION
RES. DIAL @ 1.48 = 50 OHMS=5 INCH

REFERENCE LITERATURE: _____

REMARKS: _____

GAMMA RAY
API UNITS

CALIPER
HOLE DIAM. IN INCHES

1 1/2" 3 1/4" 5 1/6" 7 1/8" 9 1/4"

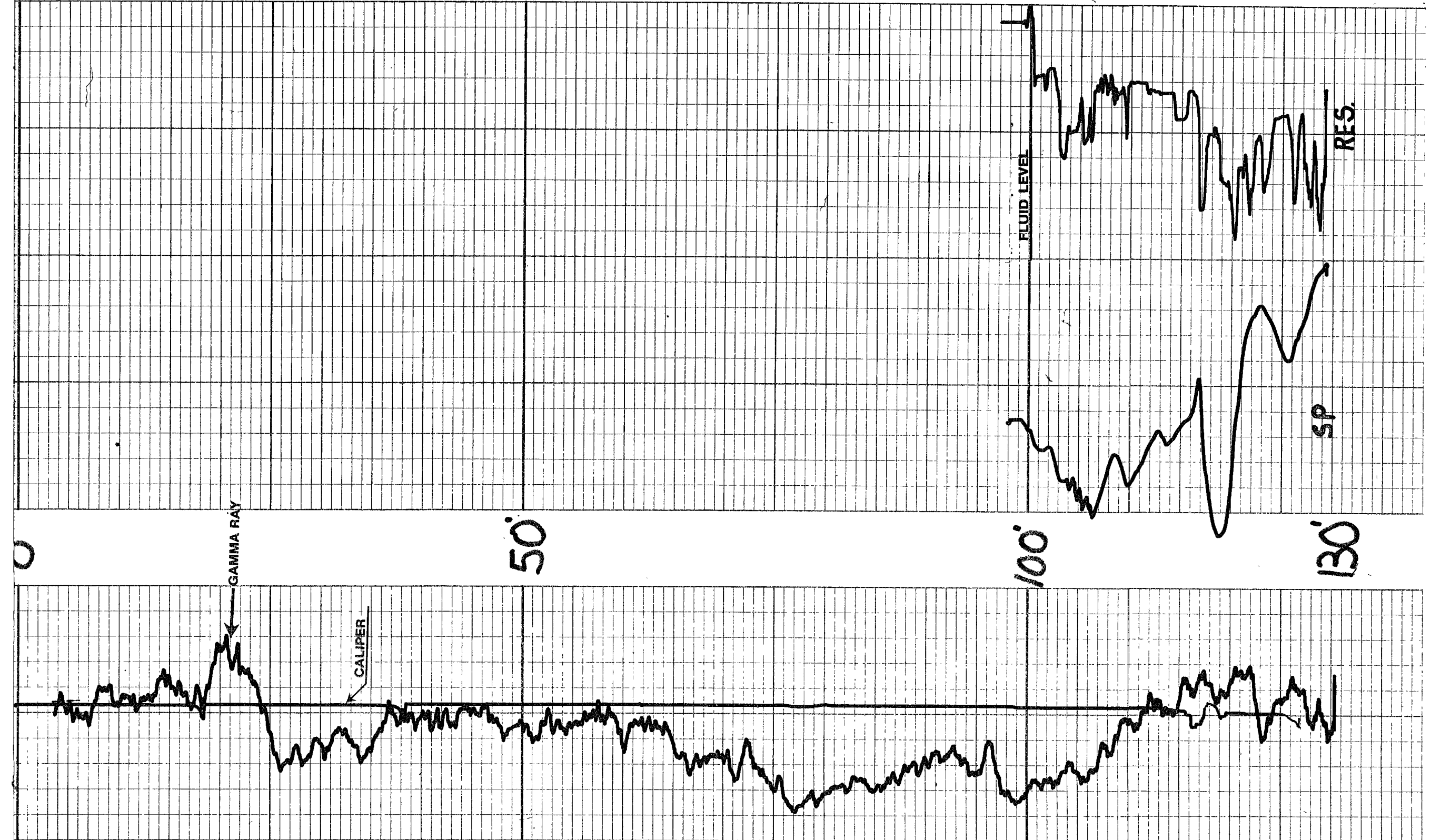
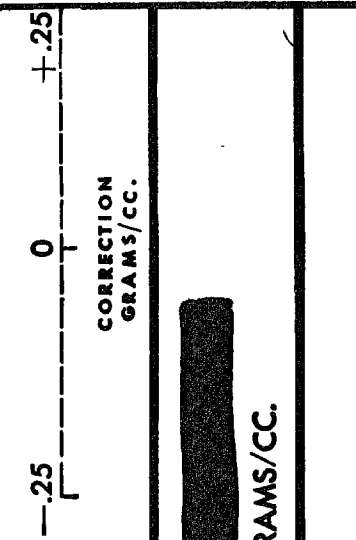

FRONTIER LOGGING CORP.

GAMMA-

FILING NO.		COMPANY <u>N.M.B.M.M.R.</u>	
		WELL <u>SSC - DH - 38</u>	
FIELD		COUNTY <u>TORRANCE</u> STATE <u>NEW MEXICO</u>	
LOCATION: <u>NE 1/4</u>		OTHER SERVICES:	
SEC. <u>4</u> TWP. <u>9 N</u> RGE. <u>10 E</u>			
PERMANENT DATUM: <u>GROUND LEVEL</u> ELEV. _____		ELEV.: K.B. _____	
LOG MEASURED FROM <u>GROUND LEVEL</u> FT. ABOVE PERM. DATUM		D.F. _____	
DRILLING MEASURED FROM <u>GROUND LEVEL</u>		G.L. _____	
DATE	<u>APRIL 26, 1987</u>		
RUN NO.	<u>ONE</u>		
TYPE LOG	<u>GAMMA-RAY & CALIPER</u>		
DEPTH-DRILLER	<u>100'</u>		
DEPTH-LOGGER	<u>96'</u>		
BOTTOM LOGGED INTERVAL	<u>93'</u>		
TOP LOGGED INTERVAL	<u>SURFACE</u>		
TYPE FLUID IN HOLE	<u>AIR</u>		
SALINITY, PPM CL.			
DENSITY			
LEVEL			
MAX. REC. TEMP., DEG F.			
OPERATING RIG TIME			
RECORDED BY	<u>G.W. CLARKSON</u>		
WITNESSED BY			
RUN NO.		BORE-HOLE RECORD	
NO.		FROM	TO
ONE	4 1/2"	100'	- 0 -
CASING RECORD		FROM	TO
NO.		FROM	TO

NEW MEXICO SSC PROPOSAL JULY 31, 1987
APPENDIX 3-C

FOLD HERE THIS HEADING AND LOG CONFORMS TO API RP 33

EQUIPMENT DATA		LOGGING DATA	
GAMMA RAY		GAMMA RAY	
RUN NO.	<u>ONE</u>	RUN NO.	<u>[REDACTED]</u>
TOOL MODEL NO.	<u>104</u>	LOG TYPE	<u>G/G</u>
DIAMETER	<u>1 1/2"</u>	TOOL MODEL NO.	
DETECTOR MODEL NO.	<u>1273</u>	DIAMETER	
TYPE	<u>SCINT.</u>	DETECTOR MODEL NO.	
LENGTH	<u>3 1/2" X 2 1/2"</u>	TYPE	<u>SCINT.</u>
DISTANCE TO D. SOURCE	<u>72"</u>	LENGTH	
GENERAL		SOURCE MODEL NO.	
HOIST TRUCK NO.	<u>111</u>	SERIAL NO.	<u>13.5</u>
INSTRUMENT TRUCK NO.	<u>111</u>	SPACING	<u>CS-137</u>
TOOL SERIAL NO.	<u>104-1273</u>	TYPE	
		STRENGTH	
GENERAL		LOGGING DATA	
RUN NO.	<u>ONE</u>	API G.R. UNITS PER LOG DIV.	<u>[REDACTED]</u>
DEPTHS FROM	<u>93'</u>	ZERO DIV. L OR R	<u>L</u>
TO	<u>0</u>	SENS. SETTINGS	<u>100 SCALE</u>
		T.C. SEC.	<u>2</u>
		SPEED FT./MIN.	<u>20</u>
		DIAL @ 2.00 =	<u>25 CPS PER INCH</u>
REFERENCE LITERATURE:		API N. UNITS PER LOG DIV.	
REMARKS		SENS. SETTINGS	
		T.C. SEC.	
		ZERO DIV. L OR R	

GAMMA RAY

API UNITS

CALIPER

HOLE DIAM. IN INCHES

0 1" 2 3" 4" 5" 6" 7" 8" 9" 10"

CORRECTION GRAMS/CC. [REDACTED] GRAMS/CC.

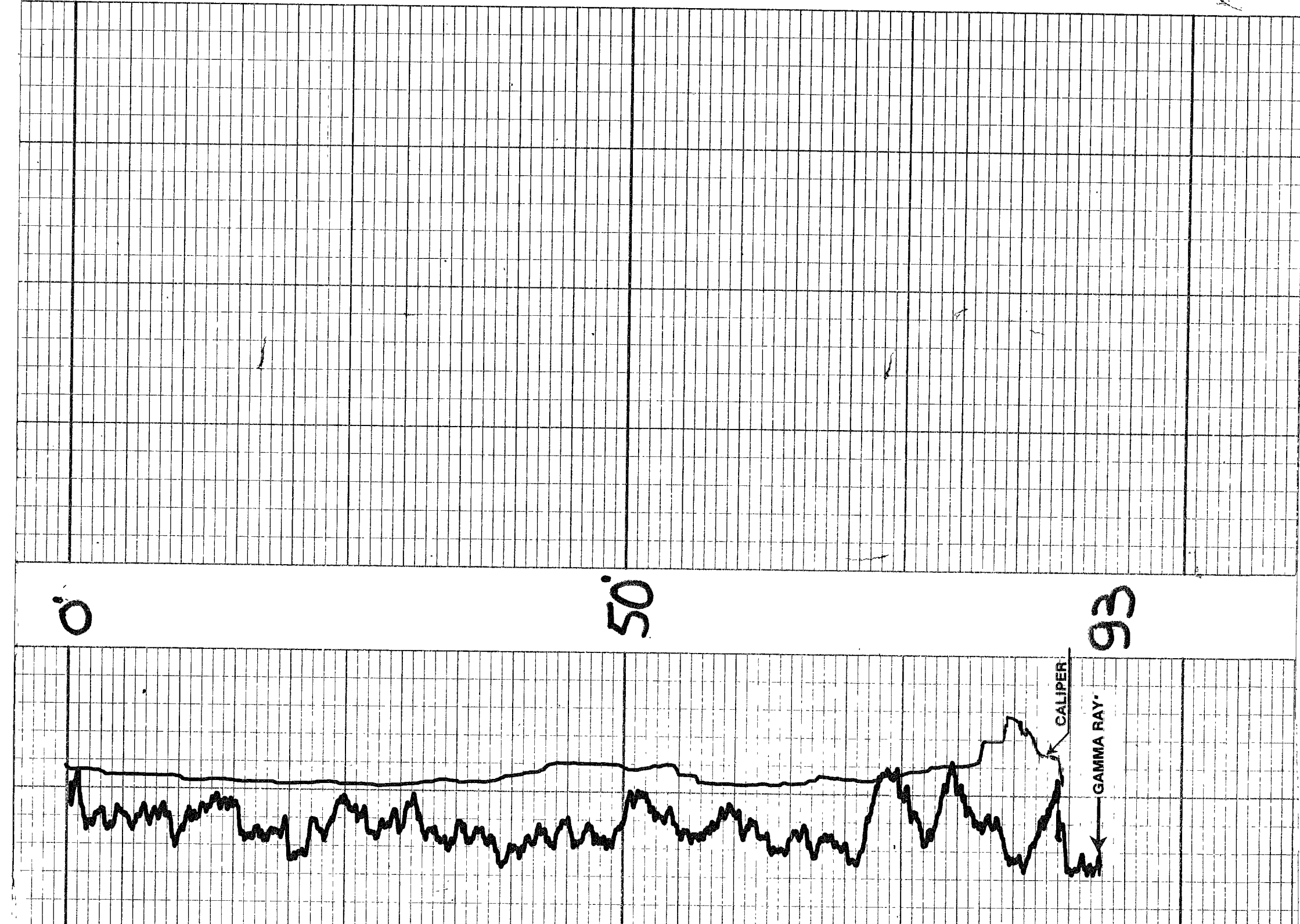

FRONTIER LOGGING CORP.

GAMMA-

FILING NO. _____

COMPANY N.M.B.M.M.R.

WELL SSC - DH - 39

FIELD _____

COUNTY TORRANCE STATE NEW MEXICO

LOCATION: NE 1/4

OTHER SERVICES: _____

SEC. 2 TWP. 9 N RGE. 7 E

PERMANENT DATUM: GROUND LEVEL, ELEV. _____

LOG MEASURED FROM GROUND LEVEL FT. ABOVE PERM. DATUM

DRILLING MEASURED FROM GROUND LEVEL

ELEV.: K.B. _____

D.F. _____

G.L. _____

DATE APRIL 26, 1987

RUN NO. ONE

TYPE LOG GAMMA-RAY, CALIPER, S.P. & RESISTANCE

DEPTH-DRILLER 103'

DEPTH-LOGGER 103'

BOTTOM LOGGED INTERVAL 100'

TOP LOGGED INTERVAL SURFACE

TYPE FLUID IN HOLE FRESH WATER MUD

SALINITY, PPM CL. _____

DENSITY _____

LEVEL 30'

MAX. REC. TEMP., DEG F. _____

OPERATING RIG TIME _____

RECORDED BY E.W. CLARKSON

WITNESSED BY _____

RUN NO.	BORE-HOLE RECORD				CASING RECORD			
	BIT	FROM	TO	SIZE	WGT.	FROM	TO	
ONE	5 5/8"	15'	- 0 -	4"	PVC	13'	- 0 -	
TWO	3 1/4"	103'	15'					

FOLD HERE THIS HEADING AND LOG CONFORMS TO API RP 33

EQUIPMENT DATA	
GAMMA RAY	LOG TYPE <u>G/G</u>
RUN NO. <u>ONE</u>	TOOL MODEL NO. _____
TOOL MODEL NO. <u>104</u>	DIAMETER <u>1 1/2"</u>
DIAMETER <u>1 1/2"</u>	DETECTOR MODEL NO. <u>1273</u>
DETECTOR MODEL NO. <u>1273</u>	SCINT. TYPE <u>1" X 2"</u>
SCINT. TYPE <u>1" X 2"</u>	LENGTH <u>72"</u>
LENGTH <u>72"</u>	DISTANCE TO D SOURCE _____
DISTANCE TO D SOURCE _____	SOURCE MODEL NO. _____
SOURCE MODEL NO. _____	SERIAL NO. _____
SERIAL NO. _____	SPACING TYPE _____
SPACING TYPE _____	STRENGTH _____
STRENGTH _____	13.5 CS-137

LOGGING DATA	
GENERAL	GAMMA RAY
RUN NO. <u>ONE</u>	ZERO DIV. I OR R _____
API G.R. UNITS PER LOG DIV. _____	T.C. SEC. _____
T.C. SEC. _____	SENS. SETTINGS _____
SENS. SETTINGS _____	DIAL @ 2.00 = _____
DIAL @ 2.00 = _____	25 CPS PER INCH
25 CPS PER INCH	

REFERENCE LITERATURE: _____

REMARKS: _____

GAMMA RAY

API UNITS _____

CALIPER

HOLE DIAM. IN INCHES _____

1" 2" 3" 4" 5" 6" 7" 8" 9" 10"

CORRECTION GRAMS/CC. _____

GRAMS/CC. _____

-25 0 +25

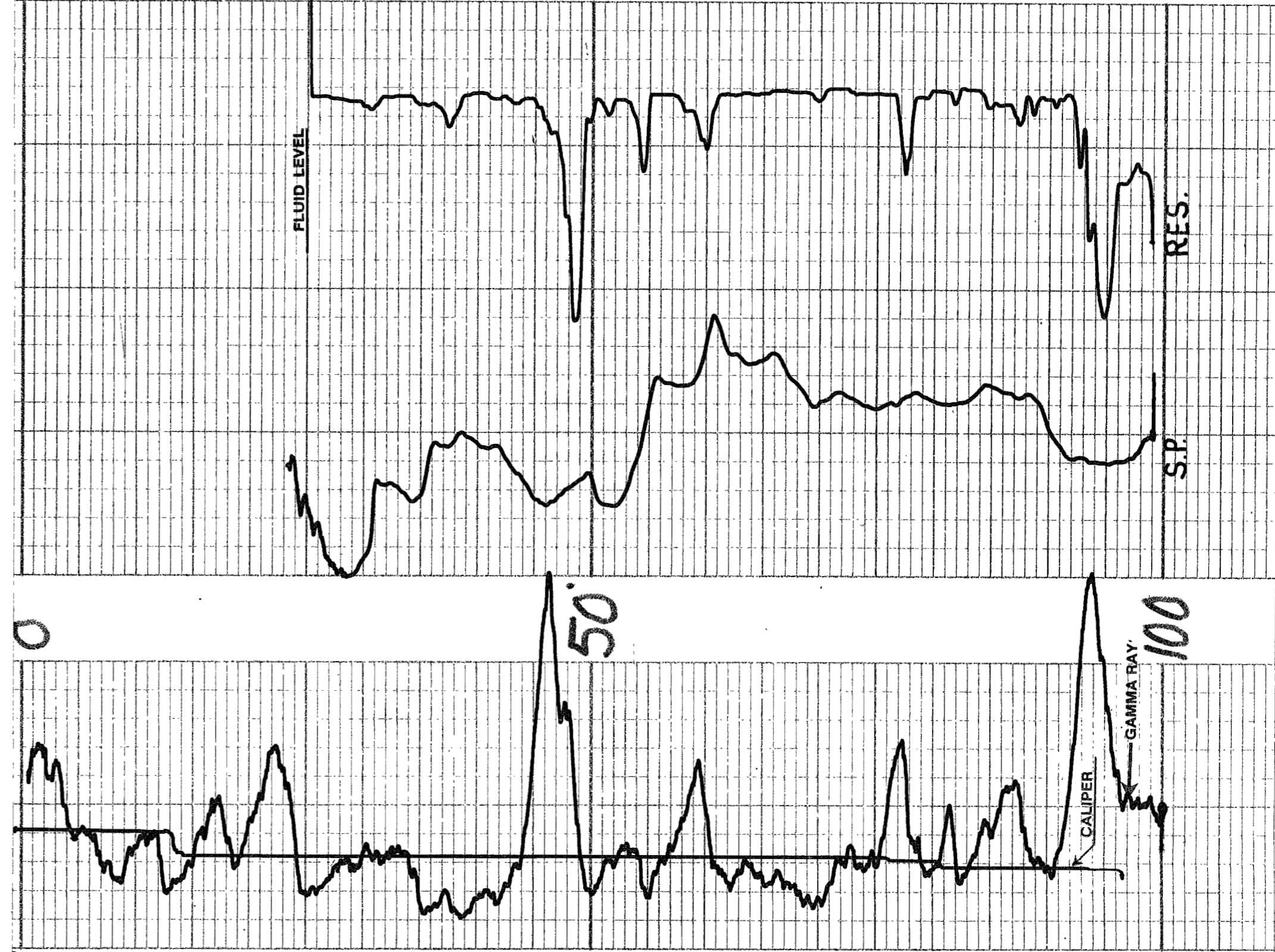

FRONTIER LOGGING CORP.

GAMMA-

FILING NO. _____

COMPANY N.M.B.M.M.R.

WELL WATER WELL - SSC - MASSEY

FIELD _____

COUNTY SANTA FE STATE NEW MEXICO

LOCATION: NE 1/4 OTHER SERVICES: _____

SEC. 2 TWP. 9 N RGE. 7 E

PERMANENT DATUM: GROUND LEVEL ELEV. _____

LOG MEASURED FROM: GROUND LEVEL .FT. ABOVE PERM. DATUM _____

DRILLING MEASURED FROM: GROUND LEVEL G.L. _____

DATE APRIL 26, 1987

RUN NO. ONE

TYPE LOG GAMMA-RAY, CALIPER, S.P. & RESISTANCE

DEPTH-DRILLER 460'

DEPTH-LOGGER 387'

BOTTOM LOGGED INTERVAL 384'

TOP LOGGED INTERVAL _____

TYPE FLUID IN HOLE FRESH WATER

SALINITY, PPM CL. _____

DENSITY _____

LEVEL 186'

MAX. REC. TEMP., DEG. F. _____

OPERATING RIG TIME _____

RECORDED BY C.W. CLARKSON

WITNESSED BY _____

BORE-HOLE RECORD				CASING RECORD			
RUN NO.	BIT	FROM	TO	SIZE	WGT.	FROM	TO
ONE	7 7/8"	15'	- 0	6"		15'	- 0 -
TWO	5 5/8"	460'	15'				

THIS HEADING AND LOG CONFORMS TO API RP 33

FOLD HERE

EQUIPMENT DATA		LOGGING DATA	
RUN NO.	LOG TYPE	RUN NO.	LOG TYPE
TOOL MODEL NO.	DIAMETER	TOOL MODEL NO.	DIAMETER
DETECTOR MODEL NO.	TYPE	DETECTOR MODEL NO.	TYPE
LENGTH	DISTANCE TO D. SOURCE	LENGTH	DISTANCE TO D. SOURCE
SOURCE MODEL NO.	HOIST TRUCK NO.	SOURCE MODEL NO.	HOIST TRUCK NO.
SERIAL NO.	INSTRUMENT TRUCK NO.	SERIAL NO.	INSTRUMENT TRUCK NO.
SPACING	TOOL SERIAL NO.	SPACING	TOOL SERIAL NO.
STRENGTH		STRENGTH	

GENERAL

APRIL 26, 1987

ONE

GAMMA-RAY, CALIPER, S.P. & RESISTANCE

460'

387'

384'

FRESH WATER

186'

C.W. CLARKSON

RESISTANCE

G/G

SCINT.

13.5

C5137

RES.

DIAL @ 2.45 = 10 MV PER DIVISION

DIAL @ 1.48 = 50 OHMS = 5 INCHES

RES.

GRAMS/CC.

API UNITS

CALIPER

HOLE DIAM. IN INCHES

0 1" 2 3/4" 4" 5 1/4" 6" 7 1/8" 8" 9" 10"

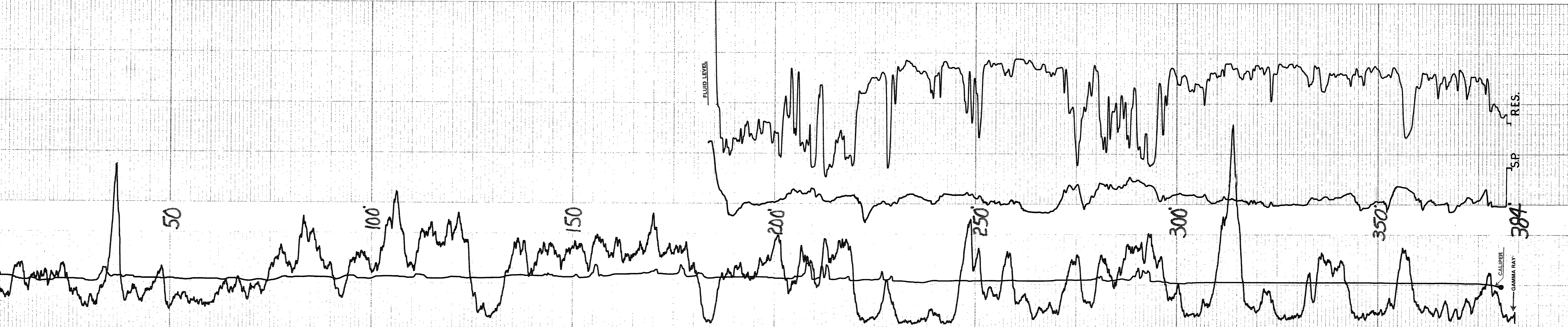

APPENDIX 3-D

Surface Geophysics

Following are the results of eight geophysical profiles completed in support of this proposal (see also Fig. 3.2-1, in map tube). The profiles shed light on subsurface conditions such as structure and stratigraphy at selected locations around the ring.

Charles B. Reynolds & Associates
Consulting Geophysicists and Geologists
4409 San Andres Avenue NE
Albuquerque, New Mexico 87110

APPENDIX 3-D

SHALLOW SEISMIC SURVEY
PROPOSED SSC AREA
Santa Fe and Torrance Counties, New Mexico

INTRODUCTION

During the period from September 25, 1986, to May 15, 1987, a shallow seismic survey was carried out for the New Mexico Bureau of Mines and Mineral Resources in the area of the proposed Superconductive Super Collider (SSC) site in the Estancia Valley, Santa Fe and Torrance Counties, New Mexico. The survey included six shallow seismic reflection lines (SR-1 through SR-6) totalling five miles in length and two shallow refraction lines (SR-7 and SR-8) totalling 1.5 miles in length.

The purposes of the different seismic lines were to investigate specific geological features which might influence the design and construction of the proposed SSC. Line SR-1 was intended to help determine whether a geomorphological lineation observed on aerial photographs represents a fault, and if so whether the fault shows evidence of recent movement. Lines SR-2, SR-5 and SR-6 were also designed to investigate possible faults for signs of recent movement. Each of these reflection lines is located near a test hole drilled as part of the SSC proposal project. Lines SR-3 and SR-4 were intended to investigate the nature and depth of origin of a sinkhole developed in recent years.

REFLECTION METHOD

The seismic system used is a single-vehicle operation specifically designed for shallow (generally, less than 3,000 ft of depth) reflection investigations. The seismic energy source is a patented "soft" weight of 550 lbs dropped 6-1/2 ft to the ground. The receiver array consists of six receivers attached to cables towed behind the seismic

truck, with geophones located at distances of 66, 131, 197, 262, 328 and 394 ft behind the impact point of the dropped weight. The receivers are Mark Products G-21 10 Hz gimbal-mounted self-orienting drag geophones spaced 66 ft apart inline. The output of each receiver is recorded separately.

The recording instruments are an E. G. & G. Geometrics Nimbus ES1210F system with frequency filters and a G724S digital recorder. Both analog and digital recordings are made at each drop point. The digital recordings are for one second with a sample rate of one millisecond and out-80 Hz filters during recording. Notch filters (60 Hz) are used at all times. Drop points are chained 33 ft apart along the line being recorded, producing 160 recordings per mile and 600% common depth point stacking. Two drops are usual at each position, though three or more drops may be summed in cases in which the instrument operator considers it desirable.

The seismic data processing is carried out on IBM PC computers using software written specifically for data recorded by this seismic system. Steps involved include transcription from field digital recordings to computer, reformatting to computer format, verification of data quality and editing, determination of the thickness of the surface low-velocity layer (weathering) and its velocity and that of the layer below by analysis of refraction returns, application of an F-K or velocity filter to remove refraction breaks as well as groundroll and airwave, 600% common depth point stacking, application of datum corrections (combined weathering and elevation corrections), use of a coherence filter which enhances seismic events dipping less than about 20 degrees in either direction, frequency filtering, trace normalization and variable area-wiggle trace plotting. A set of one-octave filter comparisons is made for selection of final frequency filters.

For those reflection lines with significant surface elevation variation the datum or reference plane used is a flat, horizontal plane. A datum plane above the ground surface is selected to avoid losing any of the shallow reflection data. The velocity of the surface layer is determined from refraction breaks, as is the subweathering velocity (means of many determinations). Because the reflection lines which were corrected for elevation and weathering (surface layer) variations are some distance apart, weathering and subweathering velocities vary, as do the elevations of the reference planes chosen. The lines which were datum-corrected are SR-2, SR-5 and SR-6. Lines SR-1, SR-3 and SR-4 were located in the flat inner part of the valley

and had very little elevation and weathering variations; they were consequently not corrected to a datum other than the surface.

Though sets of one-octave frequency comparison sections were made for two of the lines, the decision was made not to apply further frequency filtering (beyond the out-80Hz filters on recording) in order to preserve the high frequency very shallow reflections in the Quaternary and Tertiary beds above bedrock as well as the low-frequency reflection from the top of bedrock (top of older strata of Mesozoic and Paleozoic age). A lower frequency passband (e.g, 10-20Hz) would probably have enhanced reflections from within the older sediments at the expense of the shallower, higher frequency reflections. The exception is Line SR-1, which was filtered further (25-60Hz) because of low-frequency reverberations which obscured the data.

REFLECTION RESULTS

The final 600% (six-fold CDP stack) sections of Lines SR-1 through SR-6 are attachments to this report. Details of the recording, processing and plotting are given by the title blocks of the lines. For the primary purpose of the reflection survey, Lines SR-2, SR-3, SR-4 and SR-6 are considered to be of excellent quality, Line SR-1 is regarded as of good quality and Line SR-5 is considered to be of poor quality.

REFLECTION INTERPRETATION

The interpretation of each of the reflection lines will be discussed separately. The locations of Lines SR-1, SR-3 and SR-4 are shown on Fig. 3.2-1A elsewhere in the SSC proposal. The locations of Lines SR-2, SR-5 and SR-6 are shown by Fig. 3.2-1B.

Line SR-1 shows a strong base of Tertiary or top of bedrock reflection beginning from approximately 0.1 second at the east or right end of the section and remaining essentially horizontal westward to about Station 110, where it rises to the west, appears to be faulted up to the west at about Station 150, and thereafter continues fairly horizontally to the west with a shallow syncline centered at about 0.06 sec at Station 200. This apparent fault (at about Station 150) is the only evident break in the base of Tertiary event. A possible very small fault at about Station 67 does not appear to cut to the surface.

In general, recognition of the base of unconsolidated Tertiary or top of consolidated bedrock reflection in allu-

viated valleys of the West has proven to be fairly simple and fairly reliable. Because the top of bedrock is a reflector of large velocity and density contrast, and is a very thick (in fact, for practical purposes infinitely thick) reflector, it reflects all frequencies equally well and can therefor usually be recognized as the first strong reflector shown by a low frequency (i.e., 5-10Hz or 10-20Hz) record section. In the case of Line SR-1, this criterion suggested initially that the base of Tertiary was at about 150-250 feet of depth; waterwell drillers' reports, however, indicated that the top of bedrock should be at about 400 feet of depth on Line SR-1. This line was originally interpreted as if the depth of bedrock were at about 400 feet depth. The drilling of a test hole near Station 211 of Line SR-1 showed that the base of the Tertiary was in fact at about 160 feet depth, revealing that the usual criterion for recognition of the base of Tertiary reflection was correct here also.

Line SR-2 has a strong base of Tertiary event from about 0.04 at the east or right end of the section extending evidently without break to about 0.07 sec on the west or left end of the section. Deeper reflections show that the underlying Glorieta sandstone thins westward by pre-Tertiary erosion from east to west across the record section. A small pre-Tertiary graben centered at about Station 105 seems to produce only a shallow sag in the overlying Tertiary.

Line SR-3 was recorded from west to east past a surface sinkhole which has developed in the last few years. Line SR-4 was run from north to south past the same sinkhole; the two lines intersect northwest of the sinkhole. The base of Tertiary reflection, at about 0.08 sec on both sections, appears to be unbroken under and near the sinkhole, as does the next deeper reflection from within the underlying Paleozoic rocks. A small fault at about Station 11 on Line SR-3 may cut the base of Tertiary but does not appear to reach the surface. In contrast, Line SR-4 shows a concentration of high-frequency, lens-shaped reflections opposite the sinkhole and above the base of Tertiary event (above 0.08 sec). This seems to suggest strongly that the solution or other volume-reduction effect which produced the sinkhole is confined to the Tertiary beds and is not the result of deep-seated solution and collapse.

Line SR-5, as mentioned earlier, is the poorest of the reflection lines. The apparent base of Tertiary reflection begins at about 0.08 sec on the west (left hand) end of the section and rises to the east through a series of apparent drape steps over pre-Tertiary faults at about Stations 18,

34 and 49. At about Station 78 the base of Tertiary is evidently faulted up to the east to about 0.035 sec, from which point it descends eastward to about 0.06 sec at the right hand end of the line. A reflection at about 0.02 sec above the fault at Station 78 appears to cross the fault unbroken, though a short distance west it seems to be lost in the depositional thickness expansion of the Tertiary strata on the west or downthrown side of the fault. A possible fault at about Station 90 suggested by the refraction breaks does not seem to be particularly visible on the reflection record section.

Line SR-6 shows an apparently unbroken base of Tertiary reflection at about 0.09 sec on the east or right end, deepening to about 0.1 sec at Station 70, and then rising gently again to about 0.08 sec at the west or left end. Three interpreted faults of pre-Tertiary age, located at about Stations 30, 55 and 83, do not appear to cut the base of Tertiary, though they do seem to influence the character of the base of Tertiary reflection.

REFRACTION METHOD

The recording method used for Lines SR-7 and SR-8 utilizes the same truck, seismic energy source (550 lb. "soft" dropped weight) and seismic instruments as were described under the section on reflection. For refraction, however, hand-implanted geophones and special refraction cables are used. The geophones are Mark Products 8 Hz refraction seismometers, with a single geophone each 50 ft along the line. The cables are 300 ft long, with a geophone takeout each 50 ft (for a total of seven takeouts).

At the beginning of a refraction line, the cable is laid out along the line, with the seismic truck positioned to drop the weight at the starting end of the cable (first takeout position). Six geophones are then implanted at distances of 50, 100, 150, 200, 250 and 300 feet from the weight impact point, and connected to the cable. The weight is dropped and the resulting seismic record examined on the CRT screen of the seismograph. More than one drop can be summed if the operator judges it necessary to get a useable record. When the operator feels the best record which can be obtained at that point has been made, both analog and digital recordings are taken. In the case of Line SR-7, which was recorded from east to west, this first position is designated R1E (recording of profile 1 with the source at the east end of the cable). A geophone is next implanted at the center of the weight impact point at R1E and the truck moved to the other end of the cable and so positioned that the weight will fall exactly where the far

geophone had been (300 ft from position R1E). This new position is designated R1W (for recording of profile 1 with the source at the west end of the cable). The geophone at R1W is removed and the weight dropped one or more times and a new record taken. The reciprocal times - that is, the travel time from each of the two source positions, R1E and R1W, to the far geophone - are compared using the analog (paper) records. If the two match within less than 0.005 sec, the profile is completed. If not, one of the two records (usually the second one) must be repeated until the reciprocal times are acceptable.

After acceptable records and reciprocal times are obtained at positions R1E and R1W, the geophones are disconnected and the cable moved forward 150 ft. The geophones are next re-implanted and connected to the cable, and the process repeated to record profile 2 with the source at positions R2E and R2W. The reason the cable is moved forward only 150 ft is to obtain reasonably continuous subsurface refractor coverage. The recording continues in this way, advancing 150 ft between profiles until the end of the line is reached.

Because thunderstorms developed in the valley each afternoon during the refraction recording, it was usually necessary to bury the geophones to reduce wind noise. In a few cases, the wind was sufficiently strong that even with buried geophones wind noise obscured the data; in these cases frequency filtering of the digital data was required to remove the wind noise.

After completion of the field work, copies were made of the two records of each profile, so that the refraction breaks could be recognized and marked or "picked" by an experienced seismologist. Careful attention was paid to the reciprocal times, which are not only important as an indicator of data quality but make possible more accurate and sophisticated forms of interpretation of deeper refractors. The "picks" of the seismologist were next converted to travel times and inverse velocity lines fitted by the method of least squares, which also produces zero-distance time intercepts. The thicknesses of the shallower layers were next calculated by the zero-intercept method, and mean velocities determined. The depth and form of the deepest refractor detected was then calculated by a wavefront reconstruction method.

After completion of the record analysis, depth calculations and wavefront reconstructions, depth sections for the

two refraction lines were made. The depth sections form an attachment to this report. The location of Line SR-7 is shown on Fig. 3.2-1C and Fig. 3.2-1D, elsewhere in the proposal. The location of Line SR-8 is shown by Fig. 3.2-1C.

In most cases three layers are detected. These, in areas of deep unconsolidated sediments, commonly consist of a surface layer of 10-30 ft thickness and a velocity of 1,000-2,000 ft/sec, an intermediate layer 20-100 ft thick with a velocity of 3,000-4,000 ft/sec and a deep layer with a velocity of 4,000-6,000 ft/sec. In areas where consolidated rock is present at depths of less than a hundred feet, the deepest refraction is commonly from these consolidated rocks, with velocities in the range of 7,000-22,000 ft/sec, depending on lithology and degree of weathering.

REFRACTION INTERPRETATION

Line SR-7 shows three layers. The shallowest or surface layer is zero to 35 feet thick and has a mean velocity of about 1,100 ft/sec. The base of this surface layer is somewhat irregular and appears likely to be a stream-cut erosion surface. The indicated possible deep buried channel just east of R10E appears to be in approximate coincidence with a modern surface drainage (Salt Draw) and may be ancestral to it. The second layer seems to be at its thinnest (zero) at this indicated buried channel and at its thickest at the west end of the line. The second layer shows a striking change of velocity at a position just west of R21E; to the east its mean velocity is about 4,600 ft/sec, and to the west its mean velocity is about 2,400 ft/sec. The third or deepest layer also shows a velocity change at about the same position, except that the velocity increase is in the opposite direction. The higher mean velocity (9,400 ft/sec) is to the west, and the lower mean velocity (6,500 ft/sec) is to the east. The exact significance of this change is not obvious. Perhaps it is a pre-Tertiary fault which, while not cutting the Tertiary, has influenced Tertiary deposition. The rise of the third or deepest layer, centered just east of R10E, may be a buried hill of deeply weathered Paleozoic shale or it might represent a change in facies of the Tertiary. The third layer, west of the velocity change (west of R21E), seems likely to represent a Paleozoic unit of interbedded sandstone and shale, such as the Yeso fm.

Refraction line SR-8 also shows three layers. The surface layer, which varies from about 8 to about 26 feet in thickness as calculated, has a mean velocity of about 900 ft/sec and appears also to lie on a buried erosion

surface. The second layer has a fairly uniform velocity (mean of about 2,100 ft/sec). The deepest refractor detected in the eastern part of the line has a mean velocity of about 4,000 ft/sec. In the western part of the line, the deepest refractor detected has a mean velocity of about 4,500 ft/sec. Neither of these refractors appears to be present in the central part of the line, where the deepest refractor is much deeper (about 100 feet in depth) and has a mean velocity of about 5,100 ft/sec. This deepest refractor (the central one) may be present under the entire line but obscured by the shallower ones at the two ends of the line. In any case, the velocities suggest that Paleozoic strata, unless greatly weathered, were not detected by Line SR-8, but that the changes seen here are caused by facies variation within Tertiary strata.

CONCLUSIONS

The following conclusions seem merited by the results of the seismic survey:

A. Based on the seismic evidence alone, only one fault observed appears possibly to reach near the surface (i.e., likely to have been active in the recent past). This is the one near Station 150 on Line SR-1. Subsequent to the seismic survey of Line SR-1, the New Mexico Bureau of Mines and Mineral Resources trenched across this fault zone and found no evidence of recent (i.e., in the last 10,000 years) movement on the fault zone (see trench logs SSC-BH-1 and SSC-BH-2, in Appendix B-3).

B. The sinkhole investigated by Lines SR-3 and SR-4 does not seem to affect strata at or below the base of the Tertiary, and therefore appears likely to represent solution or other volume loss within the Tertiary.

C. Bedrock (i.e., consolidated pre-Tertiary rocks) appears to have been detected by refraction line SR-7 but not by refraction line SR-8.

Respectfully submitted,

Charles B. Reynolds
Charles B. Reynolds

Registered Geophysicist (Calif.)
Certified Professional Geologist

7 Attachments (in Pocket)

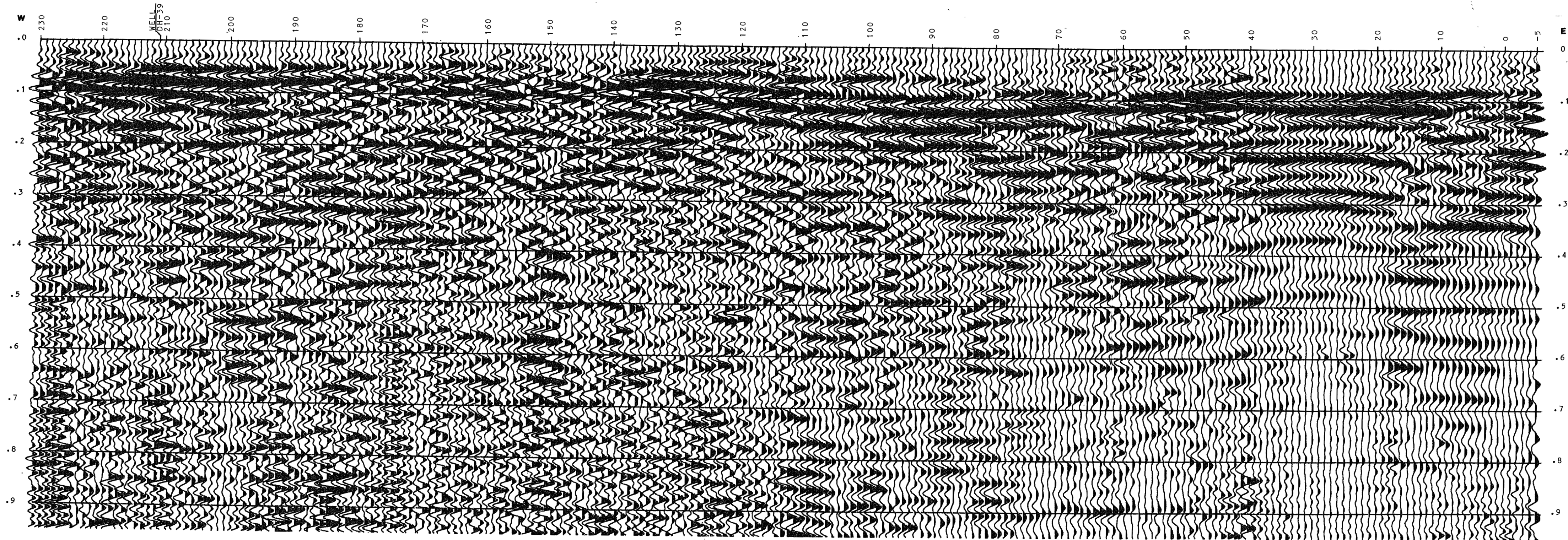

NMBMMR		
REFLECTION		
LINE SR-1 R1 - R230		
PROPOSED SSC AREA SANTA FE CO NM		
WIDE-BAND 600% CDP SECTION		
RECORDING		
RECORDED BY: CBR	DATE RECORDED: 9/26/86	INSTRUMENTS: EG&G ES1210F
GAIN MODE: FIXED	FIELD FILTER: OUT-60HZ	60HZ NOTCH FILTER: IN
RECORD LENGTH: 1 SEC	SAMPLE RATE: .001 SEC	
SPREAD		
TYPE: END OVER	CDP FOLD: 6	NO OF GROUPS: 6
LINE DIR: E-W	NEAR GRP CTR: 66 FT	FAR GRP CTR: 394 FT
SEIGES/GRP: 5 @ 13 FT INLINE	GROUP INTERVAL: 66FT	
ENERGY		
SOURCE: 550 LB WT DRP	SP ARRAY: POINT	SP INTERVAL: 33 FT
SP OFFSET: 0	DROPS/SP: 1	
PROCESSING SEQUENCE		
(1) TRANSCR	(2) DATA EDIT	(3) FANFIL
(4) STK 600%	(5) FIL 25-60	(6) TRC NORM
(7) PLOT VA/WT	(8)	(9)
(10)	(11)	(12)
PLOTTER DISPLAY		
HORIZ SCALE: 33 FT/TR	POLARITY: POS	VERT SCALE: 7.5 IN/SEC
WX VEL.: 1300 FT/SEC	DATUM: SURFACE	CORN VEL: 3800 FT/SEC
CHARLES B. REYNOLDS & ASSOC.		

NEW MEXICO SSC PROPOSAL JULY 31, 1987
APPENDIX 3-D

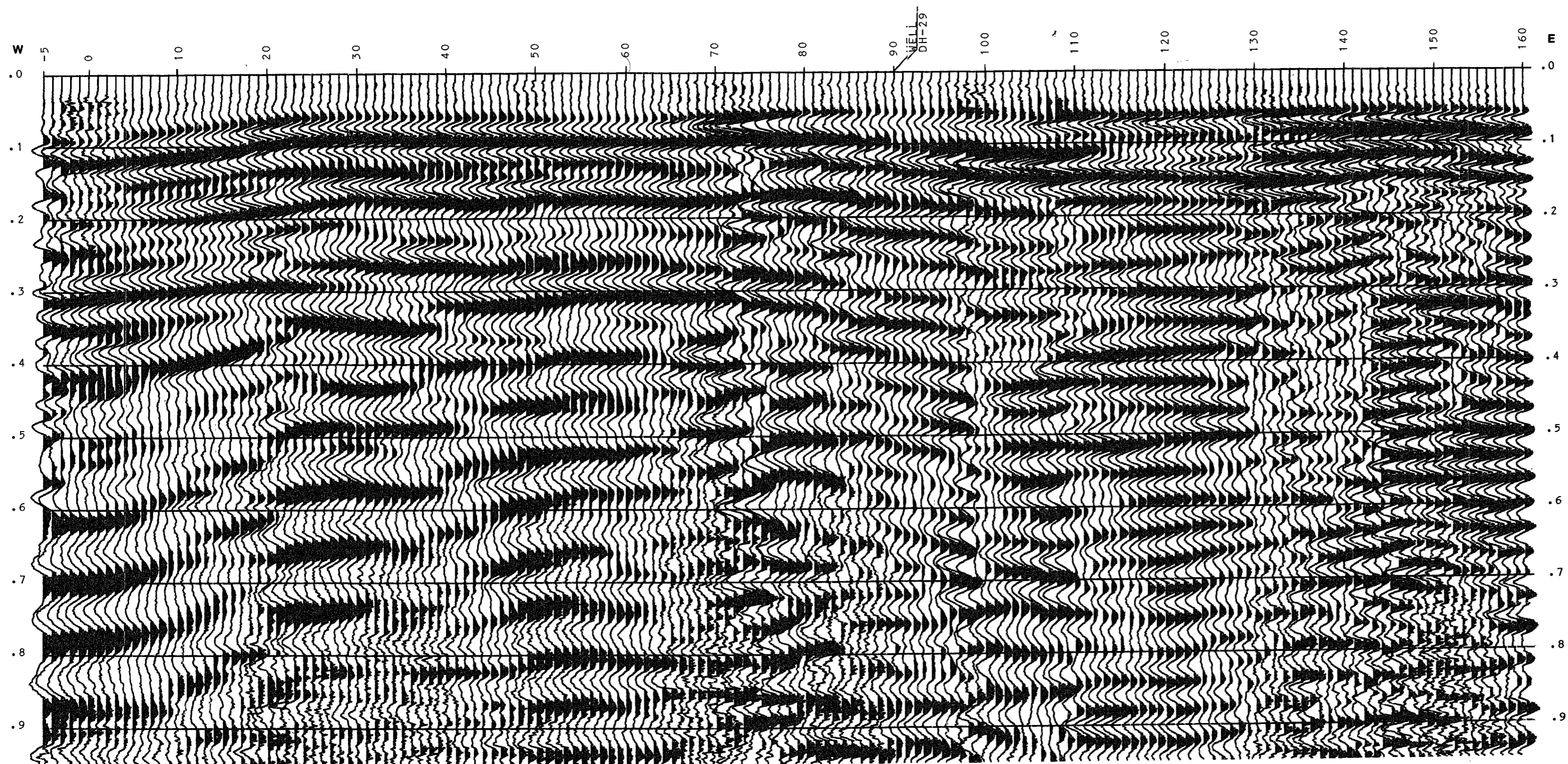

NMBMMR		
REFLECTION		
LINE SR-2 R1 - R160		
PROPOSED SSC AREA SANTA FE CO NM		
WIDE-BAND 600% CDP SECTION		
RECORDING		
RECORDED BY: CBR	DATE RECORDED: 4/28/87	INSTRUMENTS: EG&G ES1210F
GAIN MODE: FIXED	FIELD FILTER: OUT-80HZ	60HZ NOTCH FILTER: IN
RECORD LENGTH: 1.0 SEC	SAMPLE RATE: .001 SEC	
SPREAD		
TYPE: END OVER	CDP FOLD: 6	NO OF GROUPS: 6
LINE DIR: W-E	NEAR GRP CTR: 66 FT	FAR GRP CTR: 394 FT
SEISES/GRP: 1 @ 66 FT INLINE	GROUP INTERVAL: 66FT	
ENERGY		
SOURCE: 550 LB WT DRP	SP ARRAY: POINT	SP INTERVAL: 33 FT
SP OFFSET: 0	DROPS/SP: 2-4	
PROCESSING SEQUENCE		
(1) TRANSCR	(2) DATA EDIT	(3) WX DTRN
(4) FANFIL	(5) CDP STK	(6) DTM CRN
(7) DIPFIL	(8) TRC NORM	(9) PLT VA/WT
(10)	(11)	(12)
PLOTTER DISPLAY		
HORIZ SCALE: 33 FT/TR	POLARITY: POS	VERT SCALE: 7.5 IN/SEC
WX VEL.: 1300 FT/SEC	DATUM: +6300	CDRRN VEL: 4400 FT/SEC
CHARLES B. REYNOLDS & ASSOC.		

NEW MEXICO SSC PROPOSAL JULY 31, 1987
APPENDIX 3-D

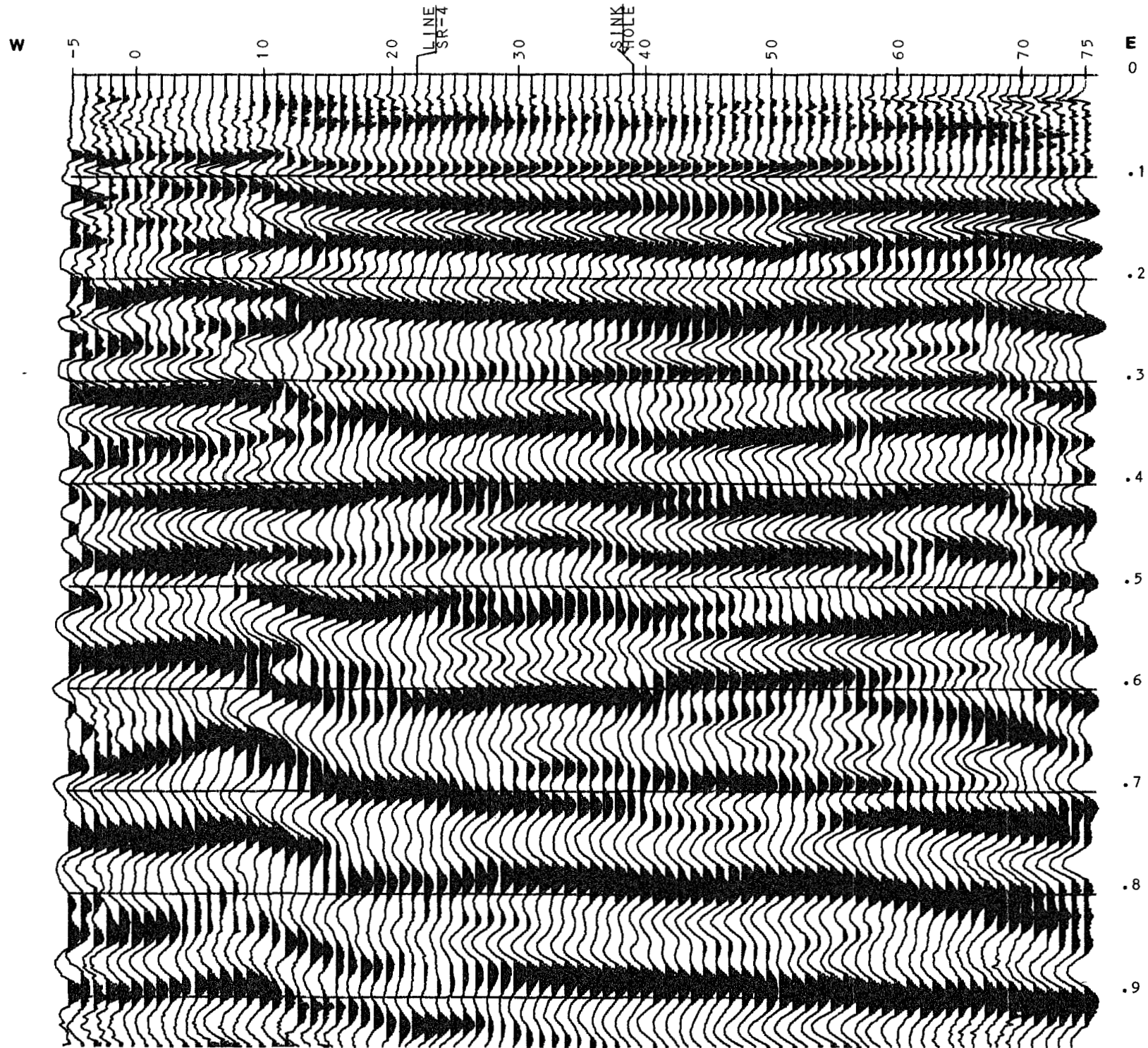

NMBMMR		
REFLECTION		
LINE SR-3 R1 - R75		
PROPOSED SSC AREA SANTA FE CO NM		
WIDE-BAND 600% CDP SECTION		
RECORDING		
RECORDED BY: CBR	DATE RECORDED: 4/30/87	INSTRUMENTS: EG&G ES1210F
GAIN MODE: FIXED	FIELD FILTER: OUT-80HZ	60HZ NOTCH FILTER: IN
RECORD LENGTH: 1.0 SEC	SAMPLE RATE: .001 SEC	
SPREAD		
TYPE: END OVER	CDP FOLD: 6	NO OF GROUPS: 6
LINE DIR: W-E	NEAR GRP CTR: 66 FT	FAR GRP CTR: 394 FT
SEISES/GRP: 1 @ 66 FT INLINE	GROUP INTERVAL: 66FT	
ENERGY		
SOURCE: 550 LB WT DRP	SP ARRAY: POINT	SP INTERVAL: 33 FT
SP OFFSET: 0	DROPS/SP: 2-4	
PROCESSING SEQUENCE		
(1) TRANSCR	(2) DATA EDIT	(3) WX DTRM
(4) FANFIL	(5) CDP STK	(6) DTM CRN
(7) DIPFIL	(8) TRC NORM	(9) PLT VA/WT
(10)	(11)	(12)
PLOTTER DISPLAY		
HORIZ SCALE: 33 FT/TR	POLARITY: POS	VERT SCALE: 7.5 IN/SEC
WX VEL.: 1600 FT/SEC	DATUM: SURFACE	CORRN VEL : 6500 FT/SEC
NO WEATHERING CORRECTIONS APPLIED		
CHARLES B. REYNOLDS & ASSOC.		

NEW MEXICO SSC PROPOSAL JULY 31, 1987
APPENDIX 3-D

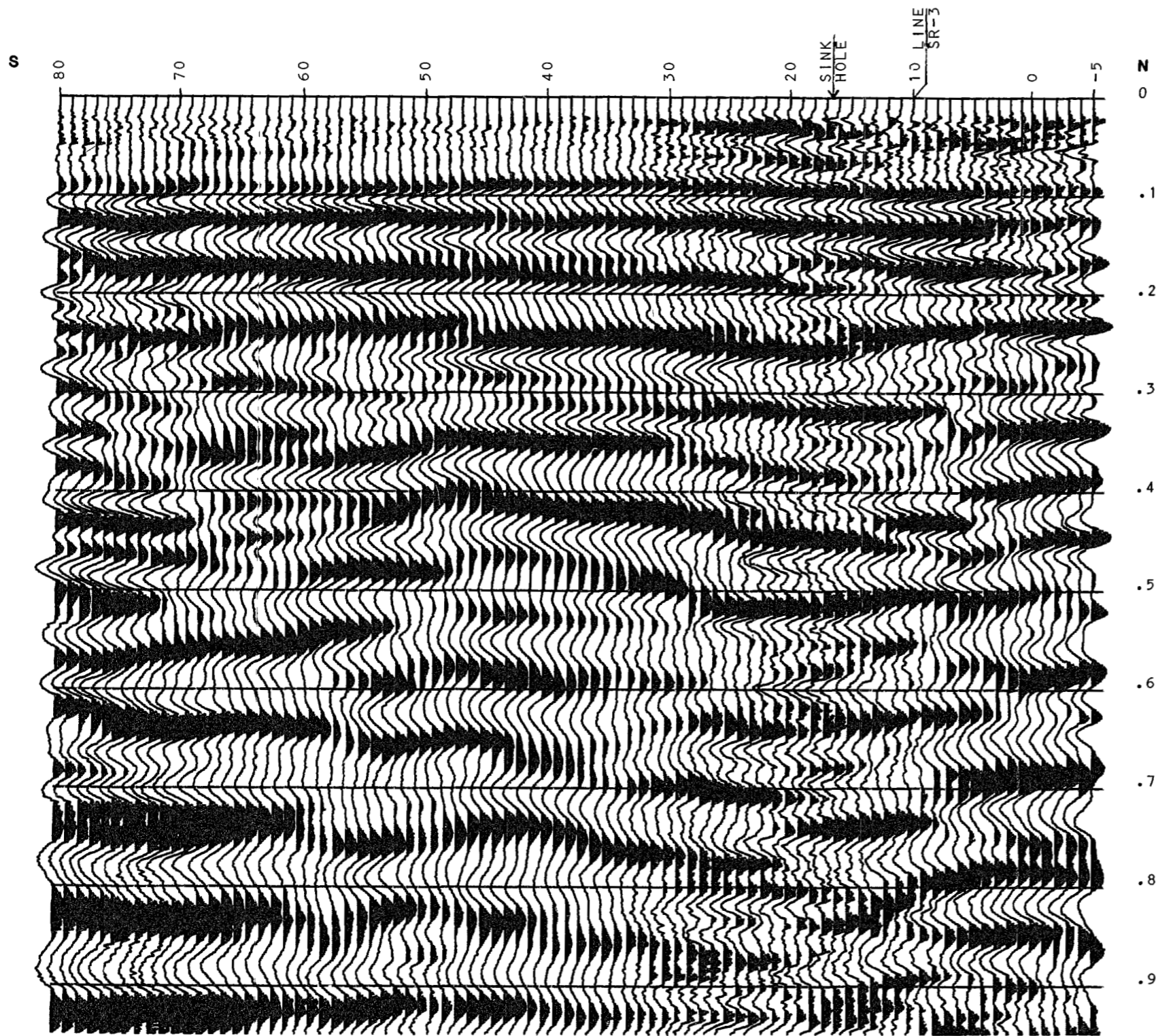

NMBMMR		
REFLECTION		
LINE SR-4 R1 - R80		
PROPOSED SSC AREA SANTA FE CO NM		
WIDE-BAND 600% CDP SECTION		
RECORDING		
RECORDED BY: CBR	DATE RECORDED: 5/4/87	INSTRUMENTS: EG&G ES1210F
GAIN MODE: FIXED	FIELD FILTER: CUT-80HZ	60HZ NOTCH FILTER: IN
RECORD LENGTH: 1.0 SEC	SAMPLE RATE: .001 SEC	
SPREAD		
TYPE: END OVER	CDP FOLD: 6	NO OF GROUPS: 6
LINE DIR: N-S	NEAR GRP CTR: 66 FT	FAR GRP CTR: 394 FT
SEISES/GRP: 1 @ 66 FT INLINE	GROUP INTERVAL: 66FT	
ENERGY		
SOURCE: 550 LB WT DRP	SP ARRAY: POINT	SP INTERVAL: 33 FT
SP OFFSET: 0	DROPS/SP: 2-4	
PROCESSING SEQUENCE		
(1) TRANSCR	(2) DATA EDIT	(3) WX DTRM
(4) FANFIL	(5) CDP STK	(6) DTM CRN
(7) DIPFIL	(8) TRC NORM	(9) PLT VA/WT
(10)	(11)	(12)
PLOTTER DISPLAY		
HORIZ SCALE: 33 FT/TR	POLARITY: POS	VERT SCALE: 7.5 IN/SEC
WX VEL.: 1600 FT/SEC	DATUM: SURFACE	CORRN VEL: 6500 FT/SEC
NO WEATHERING CORRECTIONS APPLIED		
CHARLES B. REYNOLDS & ASSOC.		

NEW MEXICO SSC PROPOSAL JULY 31, 1987

APPENDIX 3-D

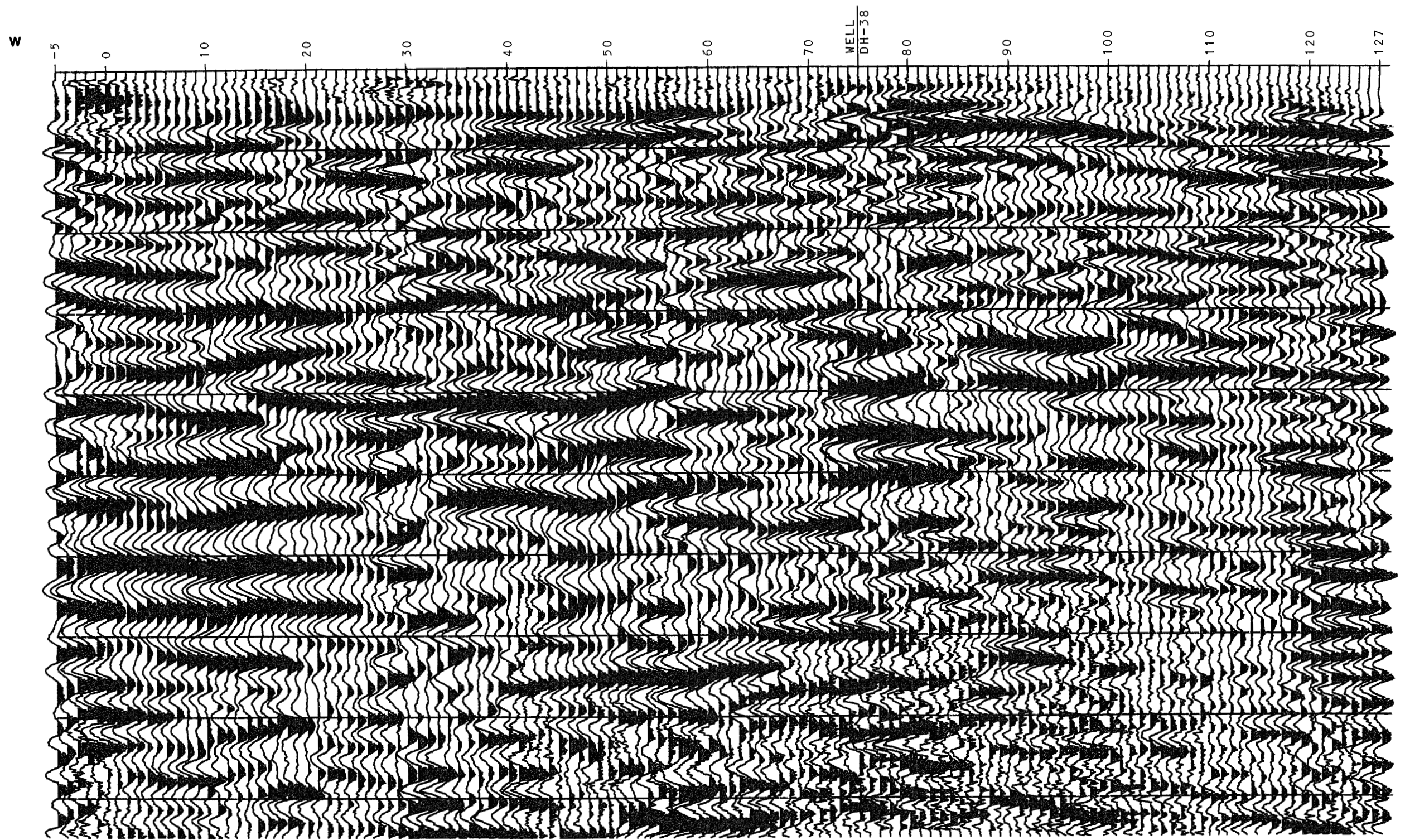

NMBMMR		
REFLECTION		
LINE SR-5 R1 - R127		
PROPOSED SSC AREA TORRANCE CO NM		
WIDE-BAND 600% CDP SECTION		
RECORDING		
RECORDED BY: CBR	DATE RECORDED: 5/5/87	INSTRUMENTS: EG&G ES1210F
GAIN MODE: FIXED	FIELD FILTER: OUT-80HZ	60HZ NOTCH FILTER: IN
RECORD LENGTH: 1.0 SEC	SAMPLE RATE: .001 SEC	
SPREAD		
TYPE: END OVER	CDP FOLD: 6	NO OF GROUPS: 6
LINE DIR: W-E	NEAR GRP CTR: 66 FT	FAR GRP CTR: 394 FT
SEISES/GRP: 1 @ 66 FT INLINE	GROUP INTERVAL: 66FT	
ENERGY		
SOURCE: 550 LB WT DRP	SP ARRAY: POINT	SP INTERVAL: 33 FT
SP OFFSET: 0	DROPS/SP: 2-4	
PROCESSING SEQUENCE		
(1) TRANSCR	(2) DATA EDIT	(3) WX DTRM
(4) FANFIL	(5) CDP STK	(6) DTM CRN
(7) DIPFIL	(8) TRC NORM	(9) PLT VA/WT
(10)	(11)	(12)
PLOTTER DISPLAY		
HORIZ SCALE: 33 FT/TR	POLARITY: POS	VERT SCALE: 7.5 IN/SEC
WX VEL.: 2300 FT/SEC	DATUM: +6500	CORRN VEL: 6300 FT/SEC
CHARLES B. REYNOLDS & ASSOC.		

NEW MEXICO SSC PROPOSAL JULY 31, 1987
APPENDIX 3-D

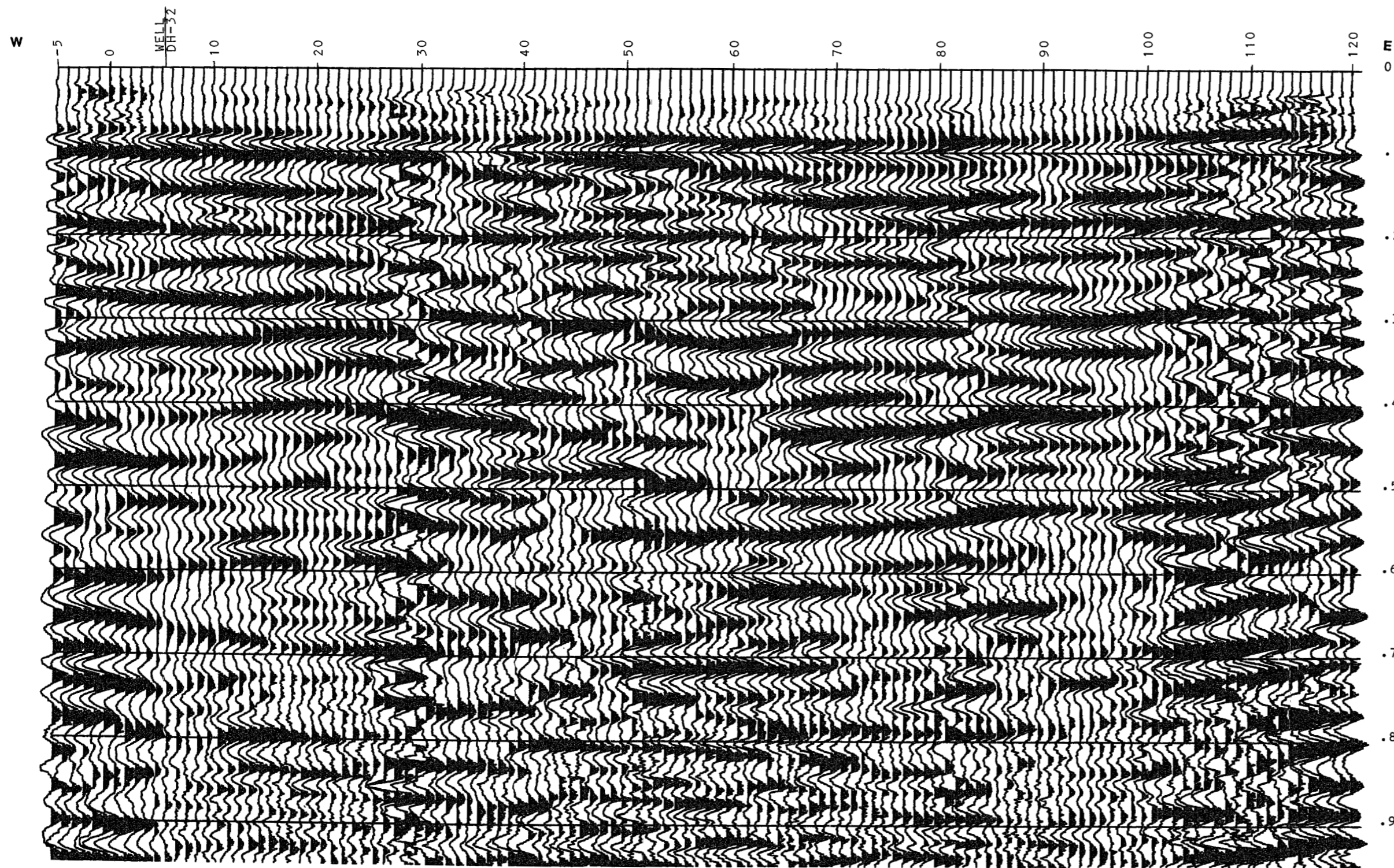

NMBMMR		
REFLECTION		
LINE SR-6 R1 - R120		
PROPOSED SSC AREA SANTA FE CO NM		
WIDE-BAND 600% CDP SECTION		
RECORDING		
RECORDED BY: CBR	DATE RECORDED: 5/6/87	INSTRUMENTS: EG&B ES1210F
GAIN MODE: FIXED	FIELD FILTER: OUT-80HZ	60HZ NOTCH FILTER: IN
RECORD LENGTH: 1.0 SEC	SAMPLE RATE: .001 SEC	
SPREAD		
TYPE: END OVER	CDP FOLD: 6	NO OF GROUPS: 6
LINE DIR: W-E	NEAR GRP CTR: 66 FT	FAR GRP CTR: 394 FT
SEISES/GRP: 1 @ 66 FT INLINE	GROUP INTERVAL: 66FT	
ENERGY		
SOURCE: 550 LB WT DRP	SP ARRAY: POINT	SP INTERVAL: 33 FT
SP OFFSET: 0	DROPS/SP: 2-4	
PROCESSING SEQUENCE		
(1) TRANSCR	(2) DATA EDIT	(3) WX DTRM
(4) FANFIL	(5) CDP STK	(6) DTM CRN
(7) DIPFIL	(8) TRC NORM	(9) PLT VA/WT
(10)	(11)	(12)
PLOTTER DISPLAY		
HORIZ SCALE: 33 FT/TR	POLARITY: POS	VERT SCALE: 7.5 IN/SEC
WX VEL.: 1900 FT/SEC	DATUM: +6700 FT	CORRN VEL: 6600 FT/SEC
CHARLES B. REYNOLDS & ASSOC.		

NEW MEXICO SSC PROPOSAL JULY 31, 1987

APPENDIX 3-D

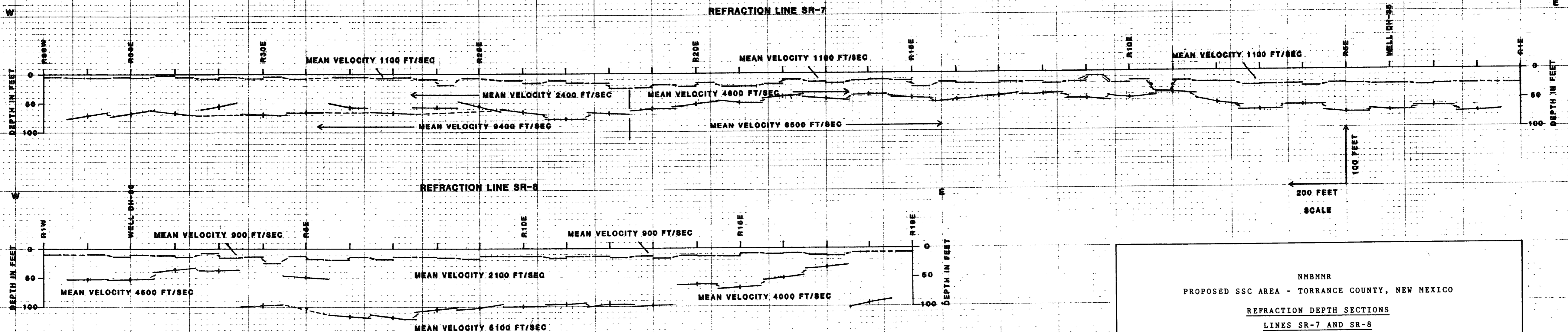

LEGEND

- ZERO DISTANCE TIME INTERCEPT DEPTH SOLUTIONS
- - - WAVEFRONT RECONSTRUCTION DEPTH SOLUTIONS

NMBMR
 PROPOSED SSC AREA - TORRANCE COUNTY, NEW MEXICO
REFRACTION DEPTH SECTIONS
LINES SR-7 AND SR-8
 Vertical Exaggeration: 2:1
 Horizontal and Vertical Scales as Shown.
 June 20, 1987 Charles B. Reynolds & Assoc.

APPENDIX 3-E

Laboratory Test Data for Soil Units

Following is a compilation of all the laboratory test data for soil samples acquired during field work for this proposal. The compilation includes samples acquired from drill holes, trenches, hand-dug pits, borrow pits, and natural exposures. The locations of all samples tested are shown on Figure 3.2-1 (in map tube).

Legend

NP	Not possible to test for this parameter
S	Hand-dug soil samples
S-1-mlsc to S-5-mlsc	Samples from outside the site area boundary
DH	Drill hole
BH	Backhoe trench
SL	Samples from topographic survey lines

Laboratory Test Data for Soil Units. D = disturbed; NP = nonplastic

Sample No.	Depth of Sample (ft)	Sample Type	Moisture Content (%)	Atterberg Limits		Sieve Analysis (% Passing)											USCS SOIL DESCRIPTION [3-E-1]	
				LL	PI	1/2"	3/8"	1/4"	No. 4	No. 20	No. 40	No. 60	No. 80	No. 100	No. 140	No. 200	GROUP SYMBOL	GROUP NAME
S-1	2	D		NP	NP	100	100	100	100	99	97	94	88	77	41	12	SP	sand
S1-misc.	2	D		26	6	100	100	100	100	93	83	77	72	66	46	28	SM-SC	clayey sand with silt
S-2	2	D		24	5	100	100	100	100	95	92	87	83	73	65	50	CL-ML	silty clay with sand
S2-misc.	2	D		44	15	100	100	100	100	97	95	90	86	82	77	65	ML	sandy silt
S-3	2	D		33	13	100	100	100	100	98	97	96	96	95	88	75	CL	clay
S3-misc.	2	D		30	10	100	100	100	100	99	98	97	96	96	94	77	CL	clay with sand
S-4	2	D		21	4	89	83	80	77	69	63	48	42	39	34	26	SM-SC	clayey sand with silt
S4-misc.	2	D		22	4	100	100	100	100	99	97	93	89	85	74	58	CL-ML	silty clay with sand
S-5	2	D		29	8	100	100	100	81	65	64	63	62	58	52	44	SM	silty sand with gravel
S5-misc.	2	D		23	4	100	100	100	100	97	95	91	87	83	75	56	CL-ML	silty clay with sand
S-6	2	D		NP	NP	90	81	71	63	25	14	9	8	7	6	5	SW	sand with gravel
S-7	2	D		27	10	100	100	100	100	100	100	99	99	95	88	68	CL	clay with sand
S-10	2	D		29	10	100	100	100	100	100	99	98	96	92	83	66	CL	sandy clay
S-11	2	D		25	6	100	100	100	99	99	98	97	94	89	75	56	CL-ML	silty clay
S-12	2	D		NP	NP	100	100	100	100	99	97	94	88	76	39	12	SP-SM	sand with silt
S-13	2	D		NP	NP	96	91	77	60	4	3	3	2	2	2	2	SP	sand with gravel
S-14	2	D		NP	NP	87	85	82	78	27	13	7	6	5	4	3	SW	sand with gravel
S-15	2	D		34	14	100	100	100	100	83	79	75	73	70	61	46	SC	clayey sand
S-16	2	D		28	11	100	100	100	97	97	96	95	94	92	87	74	CL	sandy clay
S-17	2	D		NP	NP	28	24	20	18	10	8	7	6	6	5	4	GP	gravel
S-18	2	D		30	13	100	100	100	100	98	98	98	97	96	94	88	CL	clay
S-19A	2	D		25	6	100	100	100	100	99	99	98	96	92	78	53	CL-ML	silty clay with sand
S-19B	2	D		NP	NP	53	42	35	31	16	13	11	10	9	7	4	GP	gravel with sand
S-20	2	D		43	18	100	100	100	100	99	99	98	97	96	87	59	CL	sandy clay
DH-1	2	D	6	26	7	100	100	100	100	96	88	79	75	71	63	54	CL-ML	silty clay
DH-1	5	D	6	19	3	100	100	100	99	97	93	88	85	82	76	72	ML	silt with sand
DH-1	8	D	2	NP	NP	100	100	100	100	58	36	24	20	17	13	10	SW-SM	sand with silt
DH-1	14	D	10	26	7	100	100	100	100	100	98	96	94	90	74	60	CL-ML	silty clay

3-97

Laboratory Test Data for Soil Units. D = disturbed; NP = nonplastic

Sample No.	Depth of Sample (ft)	Sample Type	Moisture Content (%)	Atterberg Limits		Sieve Analysis (% Passing)											USCS SOIL DESCRIPTION [3-E-1]	
				LL	PI	1/2"	3/8"	1/4"	No. 4	No. 20	No. 40	No. 60	No. 80	No. 100	No. 140	No. 200	GROUP SYMBOL	GROUP NAME
DH-2	4-5.5	D	7	21	NP	100	100	100	100	100	95	82	71	63	40	21	SM	silty sand
DH-2	9-10.5	D	16	53	31	100	100	100	100	100	100	100	100	100	99	97	CH	clay
DH-2	19-20.5	D	12	25	6	100	100	100	100	96	83	74	68	63	50	36	SM-SC	clayey sand with silt
DH-2	29-30.5	D	9	30	11	100	100	100	100	98	90	83	77	72	52	29	SC	clayey sand
DH-2	39-40.5	D	13	28	12	100	100	100	100	97	95	91	88	83	74	59	CL	clay
DH-3	9-10.5	D	12	38	NP	100	100	100	100	91	75	63	56	52	43	33	SM	silty sand
DH-3	19	D	4	NP	NP	100	99	86	76	38	22	12	9	4	1	0	SP	sand with gravel
DH-3	30	D	9	29	14	100	100	100	100	89	87	84	83	80	73	61	CL	sandy clay
DH-3	45	D	12	32	15	100	100	100	100	78	67	60	55	52	44	34	SC	clayey sand
DH-4	4-5	D	10	26	9	100	100	99	99	95	83	72	66	60	46	30	SC	clayey sand
DH-4	9-10	D	11	23	NP	100	100	100	100	99	93	83	76	70	53	28	SM	silty sand
DH-4	19-20	D	7	25	4	100	100	100	100	97	90	83	77	72	55	31	SM-SC	clayey sand with silt
DH-4	29-30	D	13	32	15	100	100	100	100	97	88	78	72	67	56	40	SC	clayey sand
DH-5	4-5	D	10	27	11	100	100	100	100	95	84	75	68	60	40	23	SC	clayey sand
DH-5	9-10	D	8	36	18	100	100	100	100	97	89	81	76	72	59	40	SC	clayey sand
DH-6	4-5	D	7	27	7	100	100	98	97	90	83	76	70	64	47	30	SM-SC	clayey sand with silt
DH-6	9-9.5	D	12	42	19	100	100	100	100	98	96	94	92	90	86	80	CL	clay with sand
DH-6	19-19.5	D	16	51	29	100	100	100	100	100	99	97	96	93	87		CH	clay
DH-7	4-5	D	6	23	4	100	100	100	96	92	90	84	81	76	60	43	SM-SC	clayey sand with silt
DH-7	9-10	D	5	22	1	100	100	100	100	97	91	84	78	72	51	27	SM	silty sand
DH-7	19-20	D	7	29	6	100	100	100	100	98	91	77	69	63	53	39	SM	silty sand
DH-7	29-30	D	7	28	2	100	100	100	99	88	76	65	56	49	34	21	SM	silty sand

3-98

Laboratory Test Data for Soil Units. D = disturbed; NP = nonplastic

3-99

Sample No.	Depth of Sample (ft)	Sample Type	Moisture Content (%)	Atterberg Limits		Sieve Analysis (% Passing)											USCS SOIL DESCRIPTION [3-E-1]	
				LL	PI	1/2"	3/8"	1/4"	No. 4	No. 20	No. 40	No. 60	No. 80	No. 100	No. 140	No. 200	GROUP SYMBOL	GROUP NAME
DH-8	4-5	D	5	21	5	100	100	100	100	99	92	82	76	71	55	34	SM-SC	clayey sand with silt
DH-8	9-10	D	7	27	9	100	100	100	100	100	96	90	86	83	75	55	CL	sandy clay
DH-8	19-20	D	5	20	2	100	100	100	100	100	98	91	84	78	65	46	SM	silty sand
DH-8	29-30	D	2	NP	NP	100	93	82	77	56	47	29	22	17	12	8	SP-SM	sand with silt
DH-9	4-5	D	13	24	4	100	100	100	100	100	99	96	94	91	78	57	CL-ML	silty clay
DH-9	9-10	D	10	25	6	100	100	100	100	99	93	87	82	77	59	35	SM-SC	clayey sand with silt
DH-9	19-20	D	19	42	18	100	100	100	100	99	92	83	76	72	62	47	SC	clayey sand
DH-9	29-30	D	14	36	13	100	100	100	100	100	99	95	90	86	83	75	CL	clay
DH-10	4-5	D	13	20	NP	100	100	100	100	99	95	88	81	75	57	33	SM	silty sand
DH-10	9-10	D	6	NP	NP	100	100	100	98	70	46	33	28	24	19	14	SM	silty sand
DH-10	19-20	D	15	20	4	100	100	100	100	99	99	92	83	78	71	58	CL-ML	silty clay
DH-10	29-30	D	13	21	9	100	100	100	100	100	100	100	97	95	83	63	CL	clay
DH-11	4.5-5	D	7	23	NP	100	100	100	100	100	99	95	89	74	52	38	SM	silty sand
DH-11	9-9.5	D	7	24	3	100	100	100	100	100	99	96	94	89	69	50	ML	sandy silt
DH-11	19-20.5	D	11	26	4	100	100	100	100	100	99	98	98	97	94	83	CL-ML	silty clay
DH-11	29-29.5	D	12	35	12	100	100	100	100	100	99	96	93	90	81	70	CL	sandy clay
DH-12	4-5.5	D	7	25	5	100	100	100	100	98	88	78	72	68	54	36	SM-SC	clayey sand with silt
DH-12	9-10.5	D	6	24	6	100	100	100	100	99	92	81	73	68	55	40	SM-SC	clayey sand with silt
DH-12	19-20.5	D	8	29	10	100	100	100	100	99	91	82	75	70	57	40	SC	clayey sand
DH-13	4-5.5	D	5	23	4	100	100	100	100	94	89	78	68	49	40	30	SM-SC	clayey sand with silt
DH-13	9-10.5	D	11	39	16	100	100	100	100	100	99	99	99	98	96		CL	clay
DH-13	19-20.5	D	7	23	4	100	100	100	100	100	99	98	96	89	65		CL-ML	silty clay with sand

Laboratory Test Data for Soil Units. D = disturbed; NP = nonplastic

Sample No.	Depth of Sample (ft)	Sample Type	Moisture Content (%)	Atterberg Limits		Sieve Analysis (% Passing)											USCS SOIL DESCRIPTION [3-E-1]	
				LL	PI	1/2"	3/8"	1/4"	No. 4	No. 20	No. 40	No. 60	No. 80	No. 100	No. 140	No. 200	GROUP SYMBOL	GROUP NAME
DH-14	4-5.5	D	11	39	16	100	100	100	100	97	94	91	88	85	76	64	CL	sandy clay
DH-14	9-10.5	D	10	39	20	100	100	100	100	99	99	98	97	96	89	79	CL	clay
DH-14	19-19.5	D	9	36	20	100	100	100	100	99	98	96	96	95	91	81	CL	clay with sand
DH-15	4-5.5	D	13	51	25	100	100	100	100	94	90	86	84	82	73	60	CH	sandy clay
DH-15	9-9.5	D	11	57	31	100	100	100	100	97	96	95	94	93	91	86	CH	clay
DH-15	19-20.25	D	13	60	39	100	100	100	100	98	97	96	96	95	94	89	CH	clay
DH-16	4-4.5	D	7	28	8	100	100	100	100	96	96	96	95	95	95	93	CL	clay
DH-16	9-9.83	D	12	42	22	100	100	100	100	96	96	96	95	95	95	92	CL	clay
DH-17	4-4.5	D	15			100	100	100	100	100	100	100	100	100	99	99	CL-ML	silty clay
DH-17	4.5-5.5	D	6	24	3	100	100	100	100	100	100	99	98	97	94	81	ML	silt with sand
DH-17	9-10.5	D	13	38	18	100	100	100	100	100	100	100	99	99	99	97	CL	clay
DH-17	19.25-20.5	D	40	79	52	100	100	100	100	100	100	100	99	99	98	91	CH	clay
DH-17	29-30.5	D	14	27	12	100	100	100	100	99	94	89	85	82	70	51	CL	sandy clay
DH-17	40	D	17	36	18	100	100	100	93	88	87	87	86	86	84	80	CL	clay
DH-18	4-5.5	D	7	25	4	100	100	100	100	100	99	98	96	92	71	47	SM-SC	clayey sand with silt
DH-18	9-9.75	D	11	28	11	100	100	100	96	91	89	88	88	88	87	74	CL	clay with sand
DH-18	9.75-10.5	D	26	30	14	100	100	100	100	99	99	99	98	98	94	91	CL	clay
DH-18	19-20	D	4	NP	NP	79	79	79	79	64	49	31	25	21	15	9	SP-SM	sand with silt and gravel
DH-18	20-20.5	D	10	32	13	100	100	100	100	98	97	96	94	92	81	65	CL	sandy clay
DH-18	29-30	D	22	63	40	100	100	100	100	96	95	94	93	93	91	89	CH	clay
DH-19	4-4.5	D	9	22	6	100	100	100	100	97	97	96	96	94	93	87	CL-ML	silty clay
DH-19	9-9.5	D	11	27	13	100	100	100	100	88	86	83	82	79	74	63	CL	sandy clay
DH-19	19.5	D	15	22	7	100	100	100	100	91	88	84	77	73	67	58	CL-ML	silty clay

3-100

Laboratory Test Data for Soil Units. D = disturbed; NP = nonplastic

Sample No.	Depth of Sample (ft)	Sample Type	Moisture Content (%)	Atterberg Limits		Sieve Analysis (% Passing)											USCS SOIL DESCRIPTION [3-E-1]	
				LL	PI	1/2"	3/8"	1/4"	No. 4	No. 20	No. 40	No. 60	No. 80	No. 100	No. 140	No. 200	GROUP SYMBOL	GROUP NAME
DH-20	0-1.5	D	16	34	16	100	100	100	100	100	99	96	95	92	83	58	CL	sandy clay
DH-20	1.5-3	D	8	32	15	100	100	100	100	100	100	100	99	99	95	85	CL	clay with sand
DH-20	3-4.5	D	14	32	7	100	100	100	100	97	94	92	91	89	89	86	ML	silt
DH-20	4.5-6	D	15	35	14	100	100	100	98	96	95	94	93	92	86	79	CL	clay with sand
DH-20	6-7.5	D	15	34	19	100	100	100	98	97	96	95	94	93	87	75	CL	clay with sand
DH-20	7.5-9	D	17	29	12	100	100	100	100	99	99	98	97	96	90	80	CL	clay with sand
DH-20	9-10.5	D	18	37	17	100	100	100	100	99	99	98	97	96	92	85	CL	clay with sand
DH-20	10.5-12	D	16	29	12	100	100	100	99	94	89	86	84	82	75	55	CL	sandy clay
DH-20	12-13	D	11	24	NP	100	100	100	100	98	95	89	87	84	74	62	ML	silt
DH-20	13-13.5	D		32	17	100	100	100	100	98	98	97	97	96	92	81	CL	clay with sand
DH-20	13.5-15	D	16	41	26	100	100	100	100	100	100	99	99	98	95	85	CL	clay with sand
DH-20	15-16.5	D	26	37	20	100	100	100	100	100	100	99	99	98	92	74	CL	clay with sand
DH-20	16.5-18	D	12	31	17	100	100	100	97	93	92	91	91	90	87	79	CL	clay with sand
DH-20	18-19.5	D	30	57	35	100	100	100	99	98	97	97	97	97	95	88	CH	clay
DH-20	19.5-21	D	21	43	27	100	100	100	100	99	99	99	99	98	98	94	CL	clay
DH-20	21-22.5	D	29	40	21	100	100	100	100	99	99	99	99	99	98	91	CL	clay
DH-20	29-30.5	D	15	34	14	100	100	100	94	93	93	93	93	93	93	91	CL	clay
DH-21	4-5.5	D	5	19	3	100	100	100	100	84	80	70	57	48	39	31	SM	silty sand
DH-21	9-10.5	D	7	29	12	100	100	100	100	91	88	81	78	75	57	47	SC	clayey sand
DH-21	19-20.5	D	5	22	8	100	100	100	100	83	78	67	61	54	40	26	SC	clayey sand
DH-21	29-30.5	D	9	35	15	100	100	100	100	97	95	87	81	77	70	55	CL	sandy clay
DH-22	4-5.5	D	11	25	4	100	100	100	100	99	99	97	94	92	86	78	CL-ML	silty clay
DH-22	9-10.5	D	9	24	7	100	100	100	100	100	100	97	92	87	79	68	CL-ML	silty clay
DH-22	19-20.5	D	5	25	6	100	100	100	100	98	97	86	73	65	50	35	SM-SC	clayey sand with silt
DH-22	29-30.5	D	7	22	3	100	100	100	100	97	95	88	83	77	65	39	SM	silty sand

3-101

Laboratory Test Data for Soil Units. D = disturbed; NP = nonplastic

Sample No.	Depth of Sample (ft)	Sample Type	Moisture Content (%)	Atterberg Limits		Sieve Analysis (% Passing)											USCS SOIL DESCRIPTION [3-E-1]	
				LL	PI	1/2"	3/8"	1/4"	No. 4	No. 20	No. 40	No. 60	No. 80	No. 100	No. 140	No. 200	GROUP SYMBOL	GROUP NAME
DH-23	4-5.5	D	12	44	24	100	100	100	100	99	98	97	95	92	85	77	CL	clay with sand
DH-23	9-10.5	D	7	26	8	100	100	100	100	96	95	94	94	90	78	51	CL	sandy clay
DH-23	19-20.5	D	22	47	24	100	100	100	100	100	100	99	99	98	95	86	CL	clay
DH-23	29-30.5	D	18	38	19	100	100	100	100	99	99	99	98	97	94	85	CL	clay with sand
DH-24	4-5.5	D	9	32	12	100	100	100	100	100	100	100	99	99	96	86	CL	clay
DH-24	9-10.5	D	7	29	10	100	100	100	100	100	100	100	100	99	98	88	CL	clay
DH-24	19-20.5	D	13	24	3	100	100	100	93	92	92	91	89	87	82	72	ML	silt with sand
DH-24	29-30.5	D	22	29	17	100	100	100	100	99	98	96	95	92	83	66	CL	sandy clay
DH-25	4-5.5	D	4	NP	NP	96	94	89	83	65	52	37	29	24	17	11	SP-SM	sand with silt and gravel
DH-25	9-9.5	D	4			100	100	85	82	66	58	54	53	51	47	35	SM-SC	clayey sand with silt
DH-25	9.5-10.5	D	9	31	13	100	100	100	99	93	90	88	86	84	77	62	CL	sandy clay
DH-25	19-19.5	D	8	31	8	100	100	100	95	85	80	75	72	69	61	52	CL	sandy clay
DH-25	20-20.5	D	8	28	9	100	100	100	100	98	95	92	89	85	74	57	CL	sandy clay
DH-25	29-30.5	D	7	28	12	51	51	51	51	51	50	50	49	47	39	31	SC	clayey sand with gravel
DH-26	4-5.5	D	8	30	11	100	100	100	100	100	100	99	98	96	84	62	CL	sandy clay
DH-26	9-9.5	D	4	23	4	100	100	100	96	85	81	78	77	75	65	50	CL-ML	silty clay with sand
DH-26	9.5-10.5	D	10	41	23	100	100	100	100	100	100	99	99	98	92	80	CL	clay with sand
DH-26	19-20.5	D	16	46	23	100	100	100	100	100	100	100	99	96	88		CL	clay
DH-26	29-30.5	D	21	31	12	100	100	100	99	98	97	97	96	95	87	72	CL	clay with sand
DH-30	5-6.5	D	14															
DH-30	10-11.5	D	14															
DH-30	15-16.5	D	7			100	100	95	92	72	63	56	51	48	42	34	SM	silty sand
DH-30	20-21.5	D	18															
DH-30	25-26.5	D	8			100	97	87	84	63	58	54	49	46	39	29	SM	silty sand
DH-30	28-29.5	D	12															

3-102

Laboratory Test Data for Soil Units. D = disturbed; NP = nonplastic

3-103

Sample No.	Depth of Sample (ft)	Sample Type	Moisture Content (%)	Atterberg Limits		Sieve Analysis (% Passing)											USCS SOIL DESCRIPTION [3-E-1]	
				LL	PI	1/2"	3/8"	1/4"	No. 4	No. 20	No. 40	No. 60	No. 80	No. 100	No. 140	No. 200	GROUP SYMBOL	GROUP NAME
DH-31	2-3.5	D	7			95	88	72	64	43	37	33	30	28	25	20	SM	silty sand
DH-31	7-8.5	D	11															
DH-31	12-13.5	D	10			100	100	100	99	95	90	76	69	63	45	34	SM-SC	clayey sand with silt
DH-31	18-19	D	2															
DH-31	22.5-24	D	6			100	79	73	70	37	32	27	24	21	15	6	SM	silty sand
DH-33	5-6.5	D	8			92	92	92	92	91	90	87	85	81	66	47	SM	silty sand
DH-33	8-9.5	D	9															
DH-33	13-14.5	D	7			100	100	100	100	100	99	98	96	91	71	46	SM	silty sand
DH-33	18-18.5	D	4															
DH-33	23-24.5	D	6			100	100	98	97	94	85	69	61	55	49	40	SM	silty sand
DH-33	32-33.5	D	9															
DH-33	37-38.5	D	7			100	100	100	99	93	86	75	67	63	55	43	SM	silty sand
DH-35	4.5-6	D	25			100	100	100	100	98	97	95	94	93	91	86	CL	clay
DH-35	5-6.5	D	10															
DH-35	8-9.5	D	8															
DH-35	9.5-11	D	13			100	97	97	96	95	95	94	94	91	79	57	ML	sandy silt
DH-35	15-16.5	D	18															
DH-35	20-21.5	D	32															
DH-35	25-26.5	D	16			100	100	100	100	100	100	100	99	94	69	27	SP	sand
DH-35	28-28.5	D	14															
DH-35	35-36.5	D	30			100	100	100	100	96	94	93	93	93	90	84	CL	clay with sand
DH-35	43.5-45	D	17															
DH-35	48.5-50	D	28			100	100	100	100	99	99	98	97	97	95	90	CL	clay
DH-35	53	D	25															
DH-35	59.5-61	D	22			100	100	100	100	99	99	97	95	93	86	69	CL	sandy clay

Laboratory Test Data for Soil Units. D = disturbed; NP = nonplastic

3-104

Sample No.	Depth of Sample (ft)	Sample Type	Moisture Content (%)	Atterberg Limits		Sieve Analysis (% Passing)										USCS SOIL DESCRIPTION [3-E-1]		
				LL	PI	1/2"	3/8"	1/4"	No. 4	No. 20	No. 40	No. 60	No. 80	No. 100	No. 140	No. 200	GROUP SYMBOL	GROUP NAME
DH-36	17.5-19	D	7			100	100	100	100	100	100	99	98	97	92	76	CL	clay with sand
DH-36	20-21.5	D	6			100	100	100	99	92	86	79	76	71	64	48	SM	silty sand
DH-36	25.5-27	D	9															
DH-36	30-31.5	D	11			89	83	83	83	83	83	82	81	81	75	62	CL	sandy clay
DH-36	33-34.5	D	11															
DH-36	38-38.5	D	5			100	100	95	91	52	32	22	21	19	16	12	SP-SM	sand with silt
DH-36	43-44.5	D	30															
DH-36	53-54.5	D	15			100	100	100	100	99	99	99	98	98	96	92	CL	clay
DH-38	3-4.5	D	12			100	100	92	90	82	77	64	54	49	43	35	SM	silty sand
DH-38	8-9.5	D	4															
DH-38	13-14.5	D	6			100	100	100	96	95	94	82	69	62	53	39	SM	silty sand
DH-38	18-19.5	D	5															
DH-38	23-24.5	D	7			100	98	88	82	64	59	50	43	39	34	26	SM	silty sand
DH-38	28-29.5	D	7															
DH-38	33-34.5	D	9			100	98	92	89	83	81	70	57	49	38	24	SM	silty sand
DH-38	43-44.5	D	9															
DH-38	73-74.5	D	3			100	87	81	78	66	64	47	35	30	23	18	SC	clayey sand
DH-38	98-99.5	D	6															
DH-38	108-109.5	D	6			100	100	100	99	98	98	92	85	78	62	42	SM	silty sand
DH-39	3-4.5	D	19			100	100	100	98	97	97	96	96	96	93	82	CL-ML	silty clay
DH-39	8-8.5	D	8															
DH-39	13-13.5	D	2															

Laboratory Test Data for Soil Units. D = disturbed; NP = nonplastic

3-105

Sample No.	Depth of Sample (ft)	Sample Type	Moisture Content (%)	Atterberg Limits		Sieve Analysis (% Passing)										USCS SOIL DESCRIPTION [3-E-1]		
				LL	PI	1/2"	3/8"	1/4"	4	20	40	60	80	100	140	200	GROUP SYMBOL	GROUP NAME
DH-40	5-6.5	D	9			100	100	100	100	99	99	97	96	94	87	70	ML	sandy silt
DH-40	10-11.5	D	11															
DH-40	14.5-15.5	D	16			100	100	100	100	100	99	97	96	95	89	78	CL-ML	silty clay
DH-40	18-18.5	D	13															
DH-40	18.5-20	D	10															
DH-40	23-24.5	D	20			94	89	80	79	75	74	74	74	74	74	72	CL	gravelly clay
DH-40	28-29.5	D	14															
DH-40	33-34.5	D	11			100	100	100	100	98	93	87	83	79	70	52	ML	sandy silt
DH-40	38.5	D	12															
DH-40	38-39.5	D	21															
DH-40	43-44.5	D	19			100	100	100	100	100	100	100	99	99	98	95	CL-ML	silty clay
DH-40	48-49.5	D	21															
DH-40	55-56.5	D	18			100	100	100	97	69	66	61	57	53	40	24	SC	clayey sand
DH-40	58-59.5	D	18															
DH-40	63-64.5	D	24			100	100	96	94	90	88	86	85	84	80	74	CL	clay with sand
BH-1	4	D	9	35	10	100	100	100	100	99	97	95	93	91	86	73	ML	silt with sand
BH-1	6.6	D	6	NP	NP	100	94	91	89	77	74	72	71	68	58	48	SM	silty sand
BH-1	8.2	D	10	27	5	100	100	100	100	100	99	97	96	92	69	47	SM	silty sand
BH-1	9.4	D	9	26	4	100	100	100	100	99	98	97	96	91	75	53	CL-ML	silty clay
BH-2	1.2	D	19	26	6	100	100	100	100	99	98	92	84	74	62	43	SM-SC	clayey sand with silt
BH-2	3	D	11	37	13	100	100	100	100	100	99	98	98	96	93	86	CL	clay
BH-2	5.5	D	7	36	9	100	100	100	100	99	99	98	96	92	87	80	ML	silt with sand
BH-2	6.9	D	10	30	8	100	100	100	100	100	100	89	79	70	53	28	SC	clayey sand
BH-2	7	D	10	26	6	100	100	100	100	99	98	96	94	91	85	70	CL-ML	silty clay
BH-2	11.5	D	7	21	NP	72	72	70	70	68	65	61	55	49	39	26	SM	silty sand with gravel

Laboratory Test Data for Soil Units. D = disturbed; NP = nonplastic

Sample No.	Depth of Sample (ft)	Sample Type	Moisture Content (%)	Atterberg Limits		Sieve Analysis (% Passing)											USCS SOIL DESCRIPTION [3-E-1]	
				LL	PI	1/2"	3/8"	1/4"	4	20	40	60	80	100	140	200	GROUP SYMBOL	GROUP NAME
BH-3	0.4	D	10	20	NP	100	100	100	100	98	88	73	62	52	34	19	SM	silty sand
BH-3	1	D	12	19	NP	100	100	100	100	99	96	85	78	70	55	37	SM	silty sand
BH-3	3	D	10	19	NP	100	100	100	100	92	83	71	58	41	32	23	SM	silty sand
BH-3	5	D	3	NP	NP	100	100	100	100	71	28	10	7	6	4	2	SP	sand
BH-3	7.8	D	13	34	19	100	100	100	100	100	99	99	98	97	91	81	CL	clay with sand
BH-4	1	D	12	NP	NP	100	100	100	100	97	94	84	78	71	59	44	SM	silty sand
BH-4	3	D	3	NP	NP	100	100	100	100	97	94	85	71	63	54	36	SM	silty sand
BH-4	4.4	D	5	NP	NP	61	60	49	42	24	19	14	13	11	9	8	GW-GM	gravel with silt
BH-4	4.6	D	6	NP	NP	100	100	100	100	100	100	96	86	77	53	18	SM	silty sand
BH-4	5	D	12	28	4	100	100	100	100	90	88	85	84	82	69	51	ML	sandy silt
BH-4	6.6	D	12	24	8	100	100	100	100	98	96	94	92	90	83	71	CL	clay with sand
BH-5	1	D	21	26	6	100	100	100	100	96	95	94	92	89	80	69	CL-ML	silty clay with sand
BH-5	4	D	11	21	4	100	100	100	100	98	98	95	94	93	89	75	CL-ML	silty clay with sand
BH-5	6.8	D	8	23	3	100	100	100	100	98	97	97	96	96	93	87	ML	silt
BH-6	0.2	D	21	NP	NP	100	100	100	100	99	98	96	94	87	43	19	SM	silty sand
BH-6	1.8	D	12	27	8	100	100	100	100	99	92	84	81	79	75	65	CL	sandy clay
BH-6	3.2	D	5	24	NP	100	100	100	100	95	90	87	84	82	74	48	SM	silty sand
BH-6	4.6	D	4	26	6	100	100	100	100	100	100	100	99	96	90	71	CL-ML	silty clay with sand
BH-6	5.4	D	10	NP	NP	100	100	100	100	100	99	98	97	94	72	30	SM	silty sand
BH-6	6	D				100	100	100	100	100	100	100	100	100	98	88	ML	silt
BH-6	6.5	D	4	29	11	100	100	100	100	100	99	98	98	93	59	28	SC	clayey sand
BH-6	7.3	D	11	NP	NP	100	100	100	100	100	100	100	99	96	75	32	SM	silty sand
BH-6	7.9	D	8	24	6	100	100	100	100	100	99	98	97	95	90	57	CL-ML	silty clay with sand
BH-6	8.4	D	15	22	NP	100	100	100	100	100	98	95	89	76	48	32	SM	silty sand
BH-6	9	D	5	30	12	100	100	100	100	100	99	97	95	75	71	54	CL	sandy clay

3-106

Laboratory Test Data for Soil Units. D = disturbed; NP = nonplastic

Sample No.	Depth of Sample (ft)	Sample Type	Moisture Content (%)	Atterberg Limits		Sieve Analysis (% Passing)										USCS SOIL DESCRIPTION [3-E-1]		
				LL	PI	1/2"	3/8"	1/4"	No. 4	No. 20	No. 40	No. 60	No. 80	No. 100	No. 140	No. 200	GROUP SYMBOL	GROUP NAME
BH-7	0.4	D	12	25	NP	100	100	100	100	100	100	96	93	91	86	44	SM	silty sand
BH-7	2.9	D	17	39	16	100	100	100	100	99	98	97	96	96	96	93	CL	clay
BH-7	3.9	D	6	26	NP	100	100	100	100	100	100	100	98	95	67	25	SM	silty sand
BH-7	5.2	D	8	35	16	100	100	100	100	100	100	100	99	99	97	86	CL	clay
BH-7	6.3	D	8	27	NP	100	100	100	100	100	100	98	95	92	86	85	ML	silt with sand
BH-7	6.7	D	14	24	NP	100	100	100	100	100	100	97	93	89	77	50	ML	sandy silt
BH-7	7.3	D	3	23	NP	100	100	100	100	100	100	98	94	80	62	45	SM	silty sand
BH-7	7.7	D	21	21	NP	100	100	100	100	100	100	98	94	84	72	50	ML	sandy silt
BH-7	8.1	D	8	22	NP	100	100	100	100	100	97	90	76	56	37	19	SM	silty sand
BH-8	1.2	D	20	27	5	100	100	100	100	100	100	97	91	85	66	65	ML	sandy silt
BH-8	4.6	D	16	33	8	100	100	100	100	100	100	91	82	74	55	54	ML	sandy silt
BH-8	6	D	16	38	18	100	100	100	100	100	100	89	78	68	48	33	SC	clayey sand
BH-8	8.6	D	12	31	8	100	100	100	100	100	100	90	80	72	56	51	ML	sandy silt
BH-9	0.6	D	60	29	9	67	67	67	67	51	49	48	47	45	41	34	SC	clayey sand with gravel
BH-9	2.4	D	6	33	4	74	72	66	62	39	35	32	30	28	26	22	SM	silty sand with gravel
BH-9	7.2	D	2	NP	NP	55	47	41	39	14	5	3	2	2	2	2	GP	gravel with sand
BH-9	9.2	D	9	30	4	100	98	96	95	87	73	60	53	49	46	39	SM	silty sand

3-107

Laboratory Test Data for Soil Units. D = disturbed; NP = nonplastic

Sample No.	Depth of Sample (ft)	Sample Type	Moisture Content (%)	Atterberg Limits		Sieve Analysis (% Passing)								USCS SOIL DESCRIPTION [3-E-1]			
				LL	PI	1/2"	3/8"	1/4"	No. 4	No. 20	No. 40	No. 60	No. 80	No. 100	No. 140	No. 200	GROUP SYMBOL
BH-10	0.5	D	12													SM	silty sand
BH-10	1.8	D	14													CL-ML	silty clay
BH-10	2.5	D	12													CL-ML	silty clay
BH-10	4a*	D	17													ML	silt
BH-10	4b*	D	13													ML	silt
BH-10	6.5	D	4													SP-SM	silty sand
BH-10	7	D	10													ML/SM	silt/silty sand
BH-10	7.25	D	4													SP	sand
BH-10	8.5	D	4													GP-GW	gravel
BH-10	8.5	D	7													CL	clay
BH-10	10	D	5													fault gouge	
BH-10	9.25-10.75	D	15													CL	clay
BH-10	10.75	D	4													SP	sand

3-108

*BH-10 4a located at station 12; BH-10 4b located at station 37

Laboratory Test Data for Soil Units. D = disturbed; NP = nonplastic

Sample No.	Depth of Sample (ft)	Sample Type	Atterberg Limits		Sieve Analysis (% Passing)											USCS SOIL DESCRIPTION [3-E-1]	
			LL	PI	1/2"	3/8"	1/4"	No. 4	No. 20	No. 40	No. 60	No. 80	No. 100	No. 140	No. 200	GROUP SYMBOL	GROUP NAME
SL1-3+00W	2	D	29	7	100	100	100	100	96	92	86	81	78	70	57	CL	sandy clay
SL1-9+00W	2	D	24	5	100	100	100	99	93	87	80	74	69	55	35	SM-SC	clayey sand with silt
SL1-15+00W	2	D	38	16	100	100	100	100	93	90	87	85	85	83	81	CL	clay with sand
SL1-21+00W	2	D	19	3	100	99	99	99	85	76	66	60	54	41	24	SM	silty sand
SL1-27+00W	2	D	25	5	100	100	99	99	98	96	94	92	91	86	74	CL-ML	silty clay with sand
SL1-33+00W	2	D	25	5	100	100	99	99	83	72	66	61	49	37	34	SM-SC	clayey sand with silt
SL1-39+00W	2	D	NP	NP	65	65	64	64	62	61	60	60	59	58	57	ML	gravelly silt
SL1-45+00W	2	D	NP	NP	80	80	79	79	77	76	75	74	73	70	68	ML	silt with gravel
SL1-51+00W	2	D	38	9	100	100	100	100	94	90	85	80	77	70	65	ML	sandy silt
SL1-57+00W	2	D	32	7	95	91	84	84	61	55	52	50	49	44	42	SM	silty sand
SL1-63+00W	2	D	27	5	100	100	100	100	69	51	41	37	36	34	30	SM	silty sand
SL1-69+00W	2	D	24	2	95	90	80	80	45	33	26	25	24	15	13	SM	silty sand
SL1-75+00W	2	D	24	5	98	97	92	92	73	56	42	38	36	33	28	SM-SC	clayey sand with silt
SL1-81+00W	2	D			100	100	100	100	100	100	99	98	92	58	39	SM	silty sand
SL1-87+00W	2	D	32	5	100	100	100	100	99	98	97	97	95	91	85	ML	silt
SL1-90+00W	2	D	35	12	100	100	100	100	99	98	97	97	96	91	77	CL	clay with sand
SL1-96+00W	2	D	32	11	100	100	100	100	97	84	74	69	65	54	41	SC	clayey sand
SL1-102+00W	2	D	39	17	100	100	100	100	67	53	44	39	36	29	21	SC	clayey sand
SL1-108+00W	2	D	32	12	100	100	100	100	97	96	94	90	89	81	64	CL	sandy clay
SL1-114+00W	2	D	32	10	100	99	97	97	84	75	68	63	59	48	34	SC	clayey sand

3-109

Laboratory Test Data for Soil Units. D = disturbed; NP = nonplastic

Sample No.	Depth of Sample (ft)	Sample Type	Atterberg Limits		Sieve Analysis (% Passing)								USCS SOIL DESCRIPTION [3-E-1]				
			LL	PI	1/2"	3/8"	1/4"	No. 4	No. 20	No. 40	No. 60	No. 80	No. 100	No. 140	No. 200	GROUP SYMBOL	GROUP NAME
SL2-9+00N	2	D	23	2													
SL2-18+00N	2	D	27	5													
SL2-27+00N	2	D	23	3													
SL2-36+00N	2	D	NP	NP													
SL2-42+00N	2	D	NP	NP													
SL2-0+00	2	D	32	8													
SL2-9+00S	2	D	28	5													
SL2-18+00S	2	D	NP	NP													
SL2-27+00S	2	D	NP	NP													
SL2-36+00S	2	D	NP	NP													
SL2-45+00S	2	D	NP	NP													
SL3-0+00	2	D	NP	NP													
SL3-9+00E	2	D	22	3													
SL3-15+00E	2	D	19	NP													
SL3-24+00E	2	D	23	4													
SL3-36+00E	2	D	21	3													
SL3-45+00E	2	D	26	7													
SL3-54+00E	2	D	NP	NP													
SL3-63+00E	2	D	NP	NP													
SL3-72+00E	2	D	28	8													
SL3-79+18E	2	D	23	5													

3-110

UNIFIED SOIL CLASSIFICATION

COBBLES	GRAVEL		SAND			SILT OR CLAY
	COARSE	FINE	COARSE	MEDIUM	FINE	
U.S. SIEVE SIZE IN INCHES			U.S. STANDARD SIEVE No.			HYDROMETER

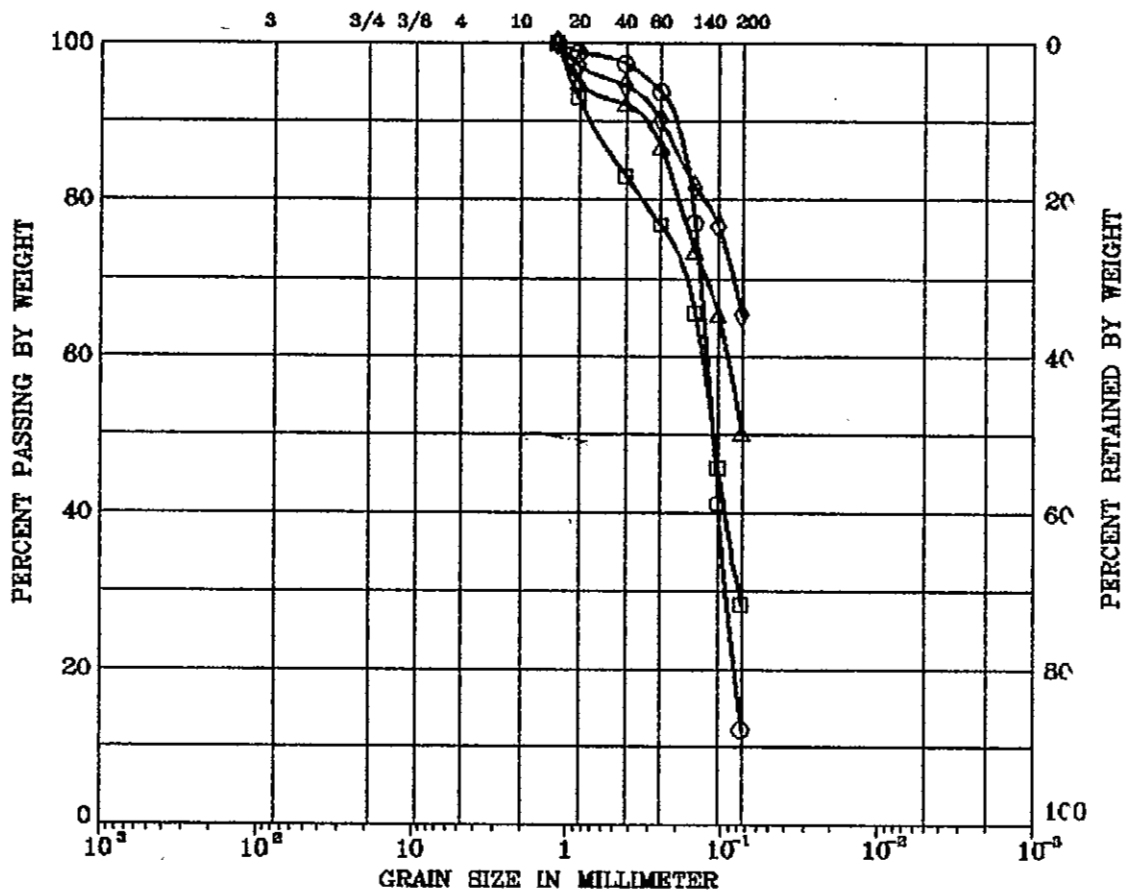

SYMBOL	BORING	DEPTH (ft)	LL (%)	PI (%)	DESCRIPTION
○	SSC S1	2.0			POORLY GRADED SAND (SP)
□	SSC S1M	2.0	26	6	SILTY, CLAYEY SAND (SM-SC)
△	SSC S2	2.0	24	5	SANDY SILTY CLAY (CL-ML)
◇	SSC S2M	2.0	44	15	SANDY SILT (ML)

Remark :

Project No. 9E-AB

NEW MEXICO SSC PROPOSAL JULY 31, 1987

New Mexico
Bureau of Mines

GRAIN SIZE DISTRIBUTION

UNIFIED SOIL CLASSIFICATION

COBBLES	GRAVEL		SAND			SILT OR CLAY
	COARSE	FINE	COARSE	MEDIUM	FINE	
U.S. SIEVE SIZE IN INCHES			U.S. STANDARD SIEVE No.			HYDROMETER

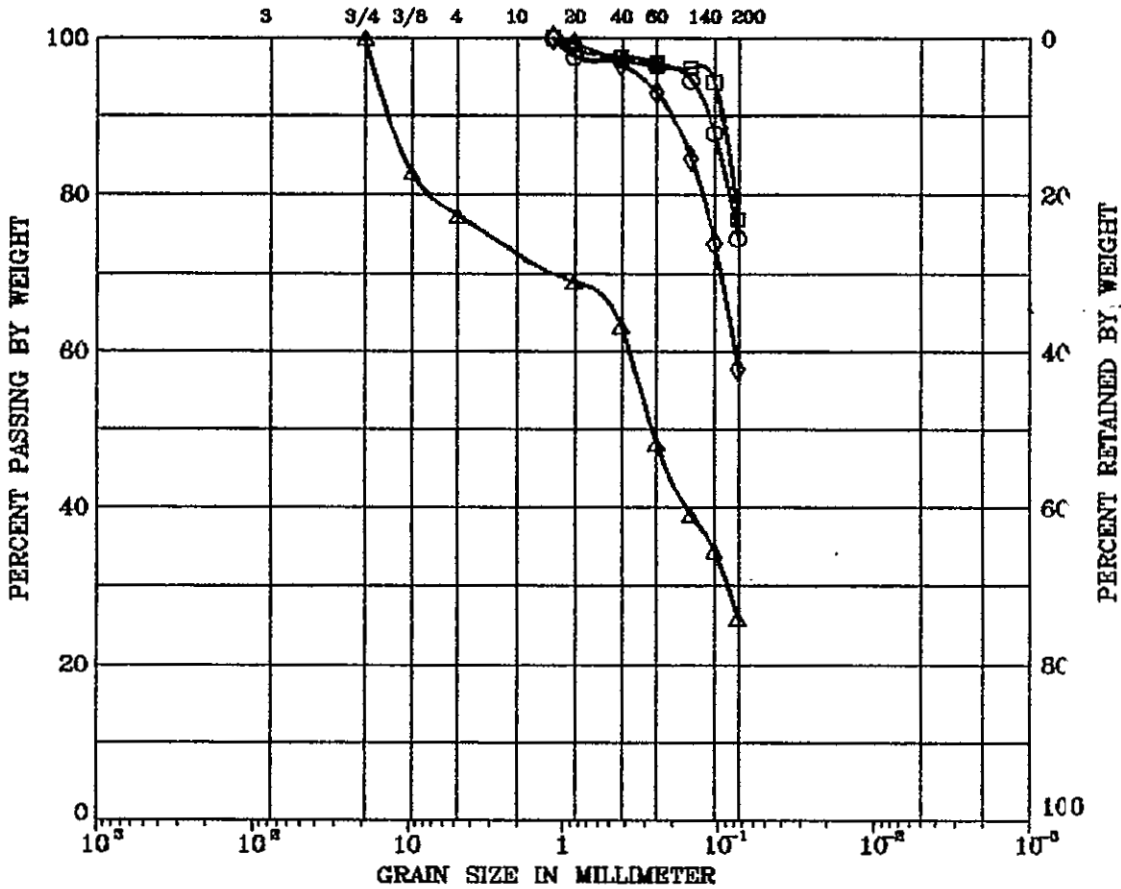

<u>SYMBOL</u>	<u>BORING</u>	<u>DEPTH (ft)</u>	<u>LL (%)</u>	<u>PI (%)</u>	<u>DESCRIPTION</u>
○	SSC S3	2.0	33	13	LEAN CLAY (CL)
□	SSC S3M	2.0	30	10	LEAN CLAY WITH SAND (CL)
△	SSC S4	2.0	21	4	SILTY, CLAYEY SAND (SM-SC)
◇	SSC S4M	2.0	22	4	SANDY SILTY CLAY (CL-ML)

Remark :

Project No. 9E-AB

NEW MEXICO SSC PROPOSAL JULY 31, 1967

New Mexico
Bureau of Mines

GRAIN SIZE DISTRIBUTION

UNIFIED SOIL CLASSIFICATION

COBBLES	GRAVEL		SAND			SILT OR CLAY
	COARSE	FINE	COARSE	MEDIUM	FINE	
U.S. SIEVE SIZE IN INCHES			U.S. STANDARD SIEVE No.			HYDROMETER

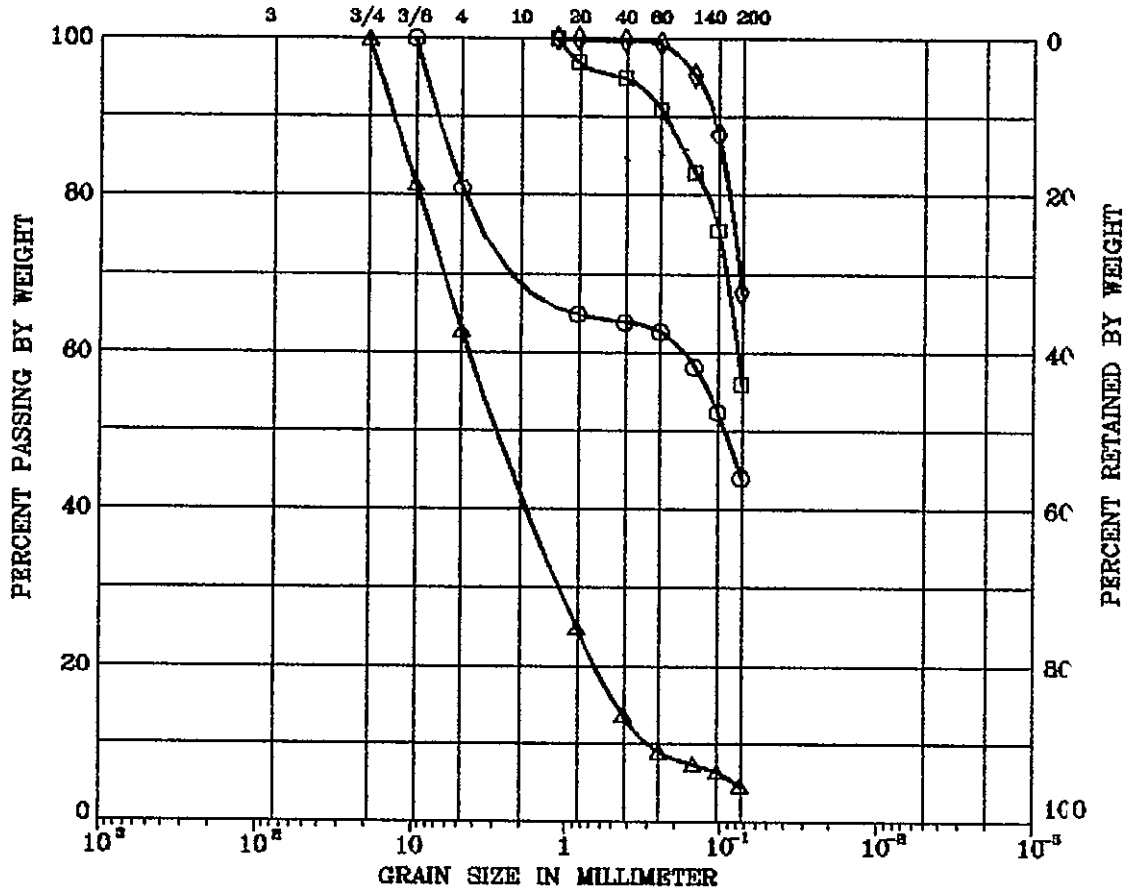

SYMBOL	BORING	DEPTH (ft)	LL (%)	PI (%)	DESCRIPTION
○	SSC S5	2.0	29	8	SILTY SAND WITH GRAVEL (SM)
□	SSC S5M	2.0	23	4	SANDY SILTY CLAY (CL-ML)
△	SSC S6	2.0			WELL-GRADED SAND WITH GRAVEL (SW)
◇	SSC S7	2.0	27	10	SANDY LEAN CLAY (CL)

Remark :

Project No. 9E-AB	NEW MEXICO SSC PROPOSAL JULY 31, 1987
New Mexico Bureau of Mines	GRAIN SIZE DISTRIBUTION

UNIFIED SOIL CLASSIFICATION

COBBLES	GRAVEL		SAND			SILT OR CLAY
	COARSE	FINE	COARSE	MEDIUM	FINE	
U.S. SIEVE SIZE IN INCHES			U.S. STANDARD SIEVE No.			HYDROMETER

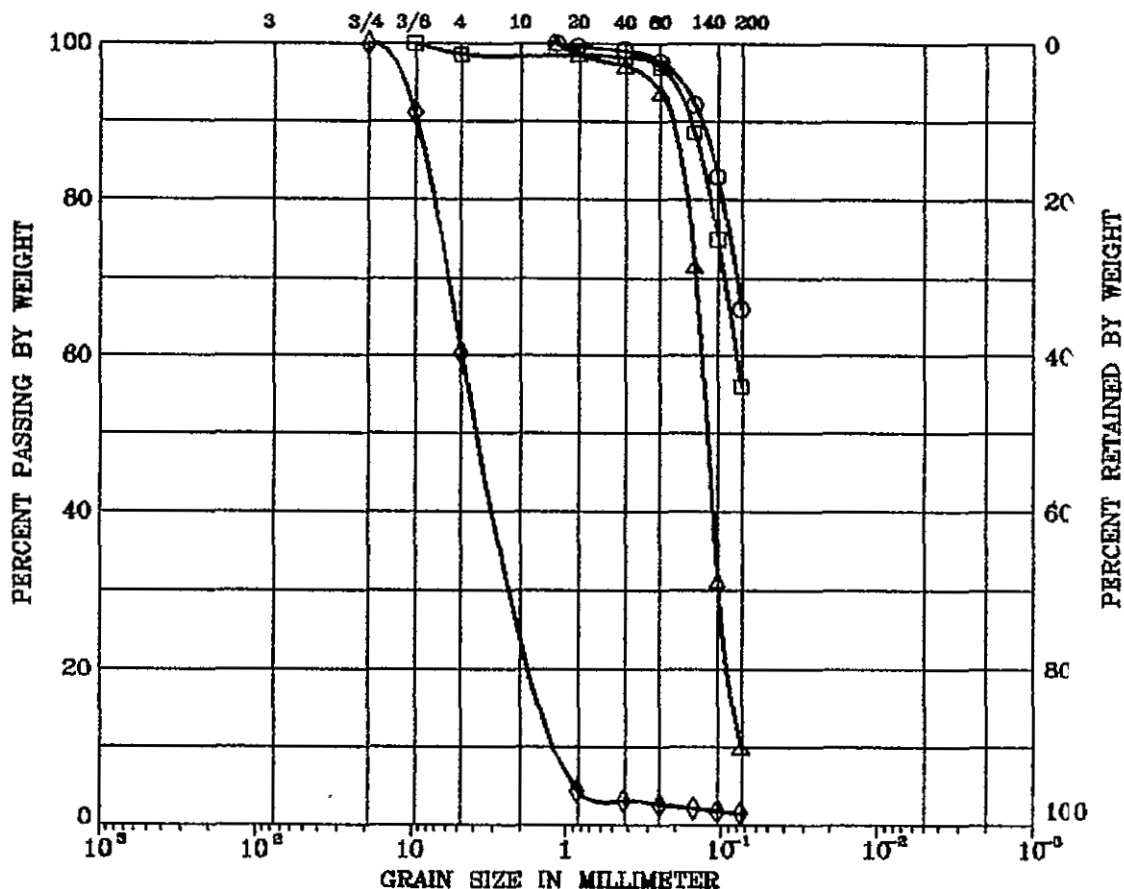

SYMBOL	BORING	DEPTH (ft)	LL (%)	PI (%)	DESCRIPTION
○	SSC S10	2.0	29	10	SANDY LEAN CLAY (CL)
□	SSC S11	2.0	25	6	SILTY CLAY (CL-ML)
△	SSC S12	2.0			POORLY GRADED SAND WITH SILT (SP-SM)
◇	SSC S13	2.0			POORLY GRADED SAND WITH GRAVEL (SP)

Remark :

Project No. 9E-AB

NEW MEXICO SSC PROPOSAL JULY 31, 1987

New Mexico
Bureau of Mines

GRAIN SIZE DISTRIBUTION

UNIFIED SOIL CLASSIFICATION

COBBLES	GRAVEL		SAND			SILT OR CLAY
	COARSE	FINE	COARSE	MEDIUM	FINE	
U.S. SIEVE SIZE IN INCHES			U.S. STANDARD SIEVE No.			HYDROMETER

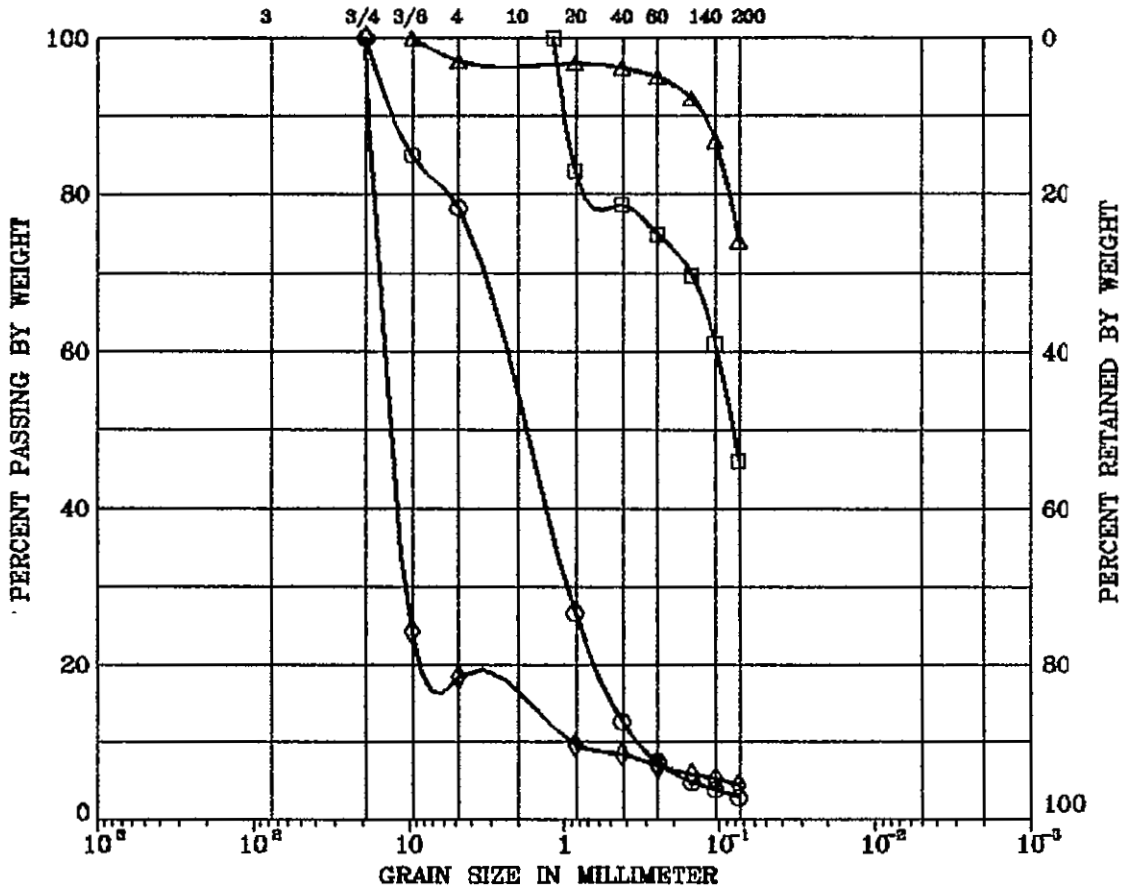

SYMBOL	BORING	DEPTH (ft)	LL (%)	PI (%)	DESCRIPTION
○	SSC S14	2.0			WELL-GRADED SAND WITH GRAVEL (SW)
□	SSC S15	2.0	34	14	CLAYEY SAND (SC)
△	SSC S16	2.0	28	11	SANDY LEAN CLAY (CL)
◇	SSC S17	2.0			POORLY GRADED GRAVEL (GP)

Remark :

Project No. 9E-AB	NEW MEXICO SSC PROPOSAL JULY 31, 1987
New Mexico Bureau of Mines	GRAIN SIZE DISTRIBUTION

UNIFIED SOIL CLASSIFICATION

COBBLES	GRAVEL		SAND			SILT OR CLAY
	COARSE	FINE	COARSE	MEDIUM	FINE	
U.S. SIEVE SIZE IN INCHES			U.S. STANDARD SIEVE No.			HYDROMETER

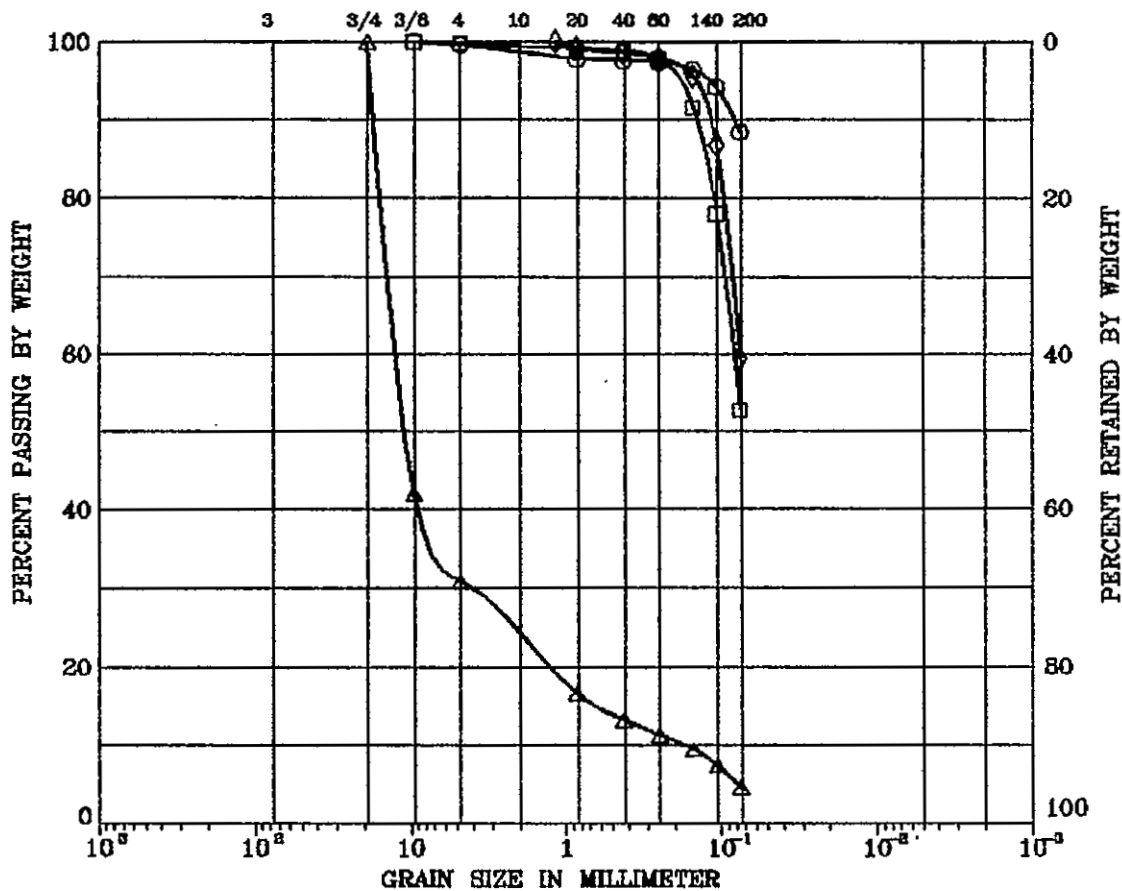

SYMBOL	BORING	DEPTH (ft)	LL (%)	PI (%)	DESCRIPTION
○	SSC S18	2.0	30	13	LEAN CLAY (CL)
□	SSC S19A	2.0	25	6	SANDY SILTY CLAY (CL-ML)
△	SSC S19B	2.0			POORLY GRADED GRAVEL WITH SAND (GP)
◇	SSC S20	2.0	43	18	SANDY LEAN CLAY (CL)

Remark :

Project No. 9E-AB

NEW MEXICO SSC PROPOSAL JULY 31, 1987

New Mexico
Bureau of Mines

GRAIN SIZE DISTRIBUTION

UNIFIED SOIL CLASSIFICATION

COBBLES	GRAVEL		SAND			SILT OR CLAY
	COARSE	FINE	COARSE	MEDIUM	FINE	
U.S. SIEVE SIZE IN INCHES			U.S. STANDARD SIEVE No.			HYDROMETER

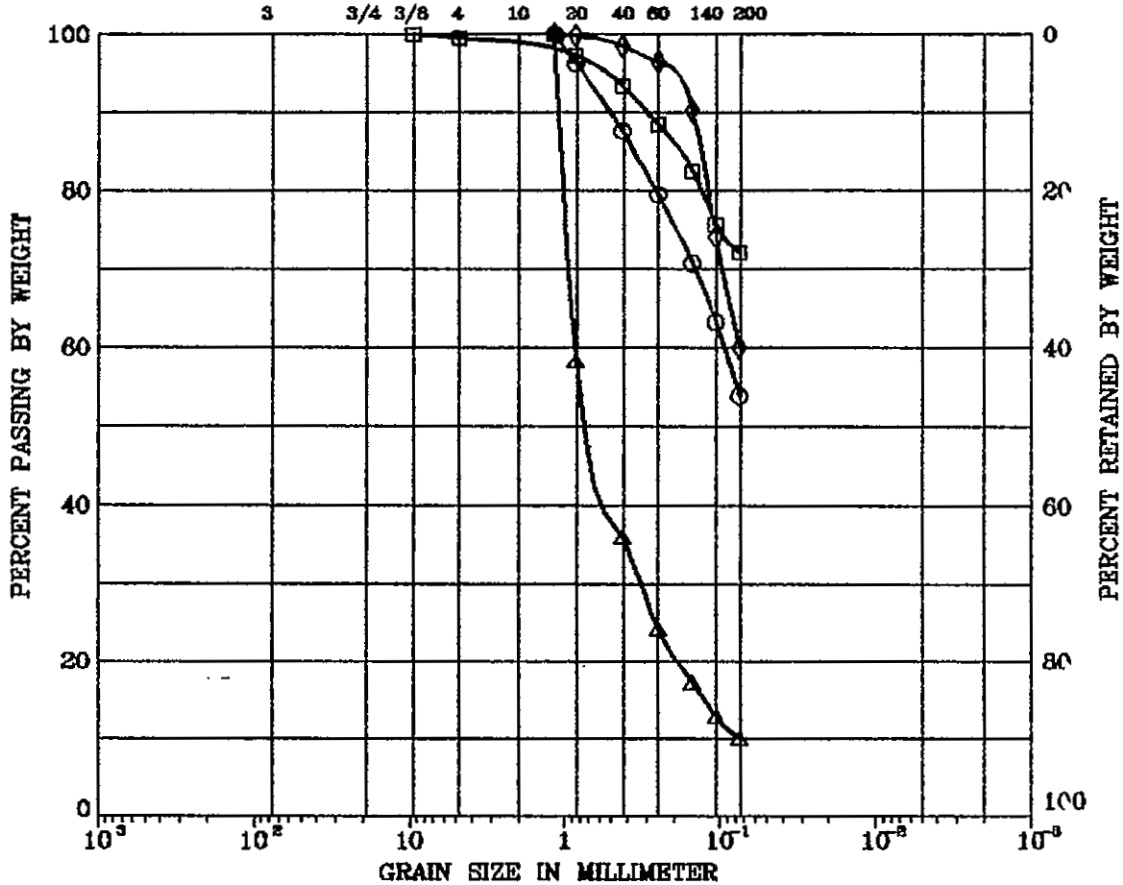

SYMBOL	BORING	DEPTH (ft)	LL (%)	PI (%)	DESCRIPTION
○	SSC DH 1	2.0	26	7	SILTY CLAY (CL-ML)
□	SSC DH 1	5.0	19	3	SILT WITH SAND (ML)
△	SSC DH 1	8.0			WELL-GRADED SAND WITH SILT (SW-SM)
◇	SSC DH 1	14.0	26	7	SILTY CLAY (CL-ML)

Remark :

Project No. 9E-AB	NEW MEXICO SSC PROPOSAL JULY 31, 1987
New Mexico Bureau of Mines	GRAIN SIZE DISTRIBUTION

UNIFIED SOIL CLASSIFICATION

COBBLES	GRAVEL		SAND			SILT OR CLAY
	COARSE	FINE	COARSE	MEDIUM	FINE	
U.S. SIEVE SIZE IN INCHES			U.S. STANDARD SIEVE No.			HYDROMETER

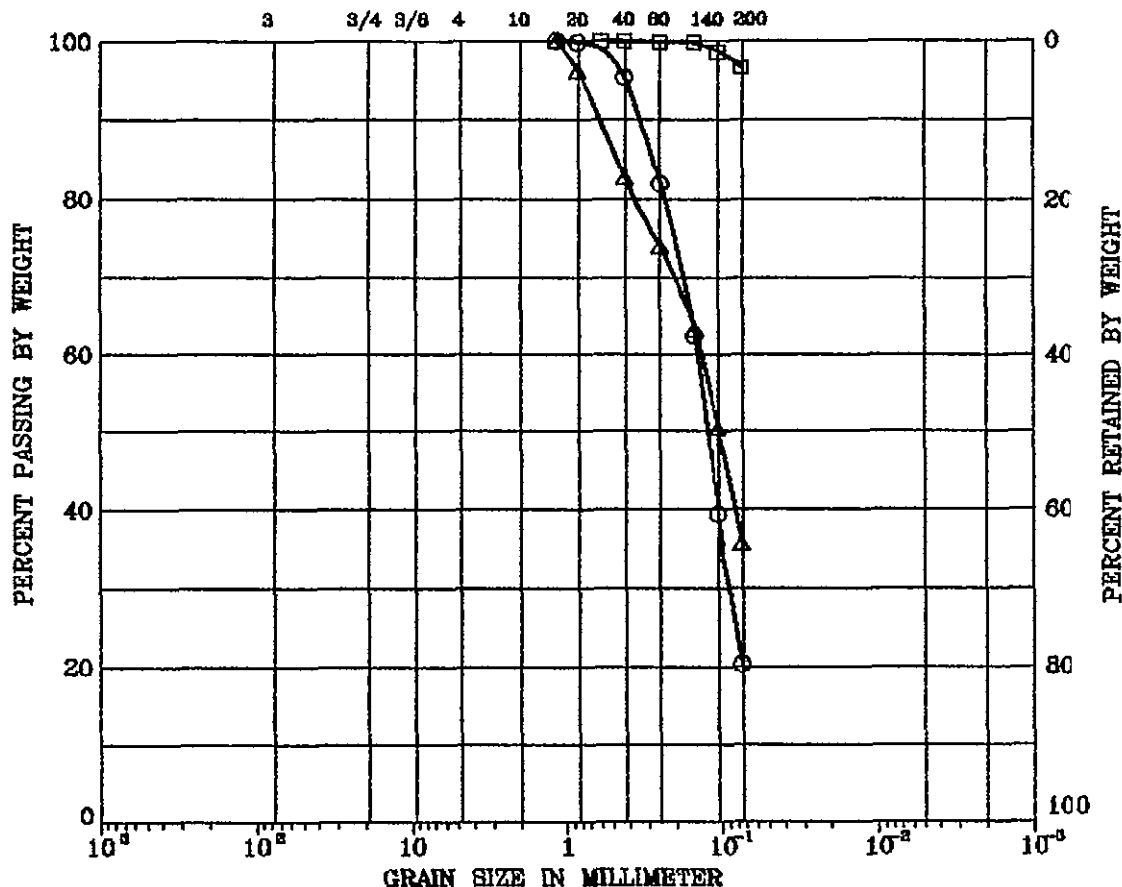

<u>SYMBOL</u>	<u>BORING</u>	<u>DEPTH (ft)</u>	<u>LL (%)</u>	<u>PI (%)</u>	<u>DESCRIPTION</u>
○	SSC DH 2	4.0	21		SILTY SAND (SM)
◻	SSC DH 2	9.0	83	31	FAT CLAY (CH)
△	SSC DH 2	19.0	30	11	SILTY SAND-CLAYEY SAND (SM-SC)

Remark :

Project No. 9E-AB	NEW MEXICO SSC PROPOSAL JULY 31, 1987
New Mexico Bureau of Mines	GRAIN SIZE DISTRIBUTION

UNIFIED SOIL CLASSIFICATION

COBBLES	GRAVEL		SAND			SILT OR CLAY
	COARSE	FINE	COARSE	MEDIUM	FINE	
U.S. SIEVE SIZE IN INCHES			U.S. STANDARD SIEVE No.			HYDROMETER

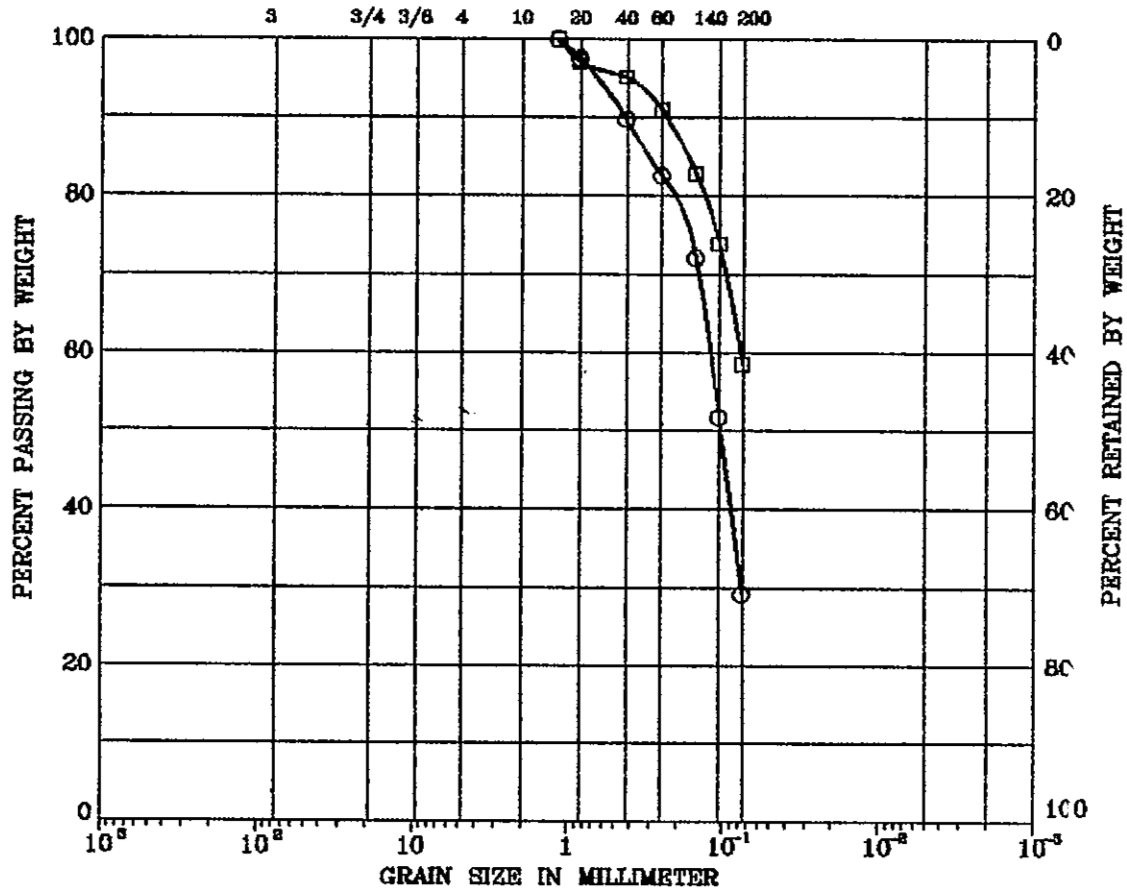

SYMBOL	BORING	DEPTH (ft)	LL (%)	PI (%)	DESCRIPTION
○	SSC DH 2	28.0	30	11	CLAYEY SAND (SC)
□	SSC DH 2	39.0	28	12	LEAN CLAY (CL)

Remark :

Project No. 9E-AB

NEW MEXICO SSC PROPOSAL JULY 31, 1967

New Mexico
Bureau of Mines

GRAIN SIZE DISTRIBUTION

UNIFIED SOIL CLASSIFICATION

COBBLES	GRAVEL		SAND			SILT OR CLAY
	COARSE	FINE	COARSE	MEDIUM	FINE	
U.S. SIEVE SIZE IN INCHES			U.S. STANDARD SIEVE No.			HYDROMETER

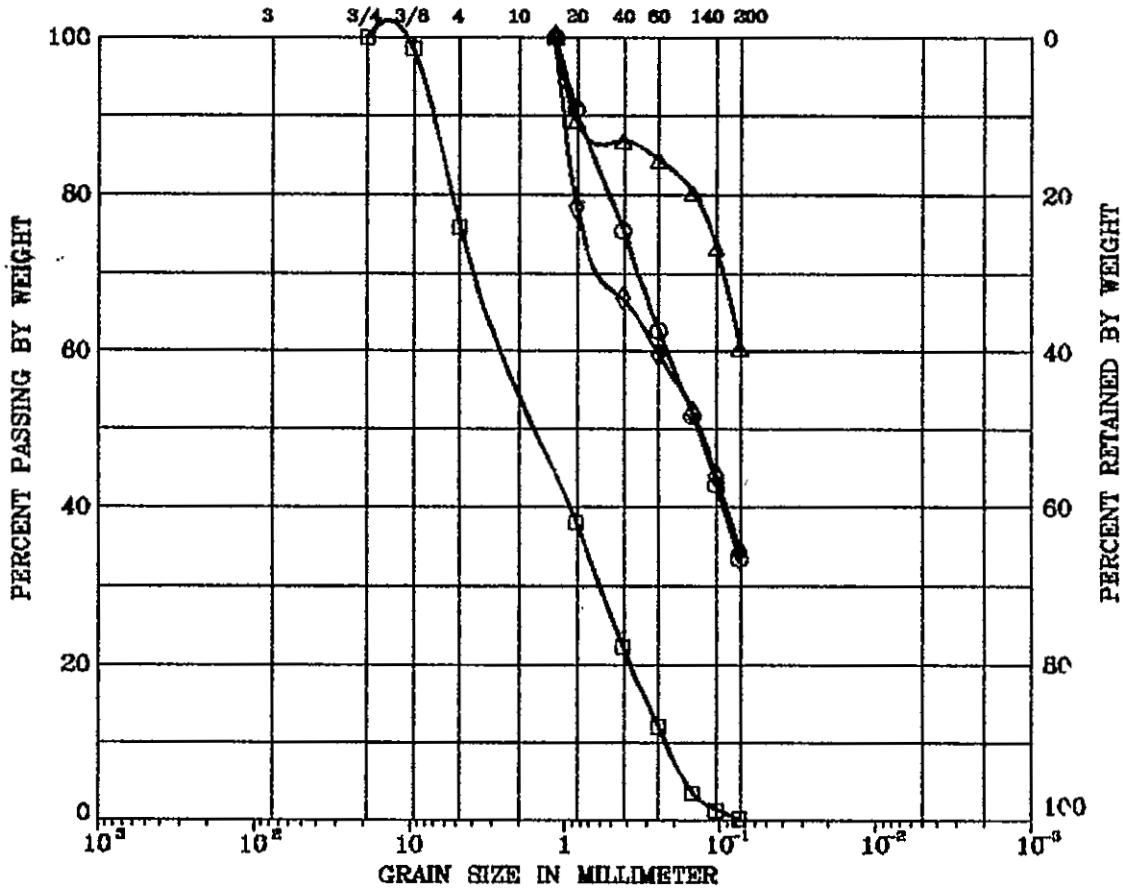

SYMBOL	BORING	DEPTH (ft)	LL (%)	PI (%)	DESCRIPTION
○	SSC DH 3	9.0	38		SILTY SAND (SM)
□	SSC DH 3	19.0			POORLY-GRADED SAND WITH GRAVEL (SP)
△	SSC DH 3	30.0	29	14	SANDY LEAN CLAY (CL)
◇	SSC DH 3	45.0	32	15	CLAYEY SAND (SC)

Remark :

Project No. 9E-AB

NEW MEXICO SSC PROPOSAL JULY 31, 1987

New Mexico
Bureau of Mines

GRAIN SIZE DISTRIBUTION

UNIFIED SOIL CLASSIFICATION

COBBLES	GRAVEL		SAND			SILT OR CLAY
	COARSE	FINE	COARSE	MEDIUM	FINE	
U.S. SIEVE SIZE IN INCHES			U.S. STANDARD SIEVE No.			HYDROMETER

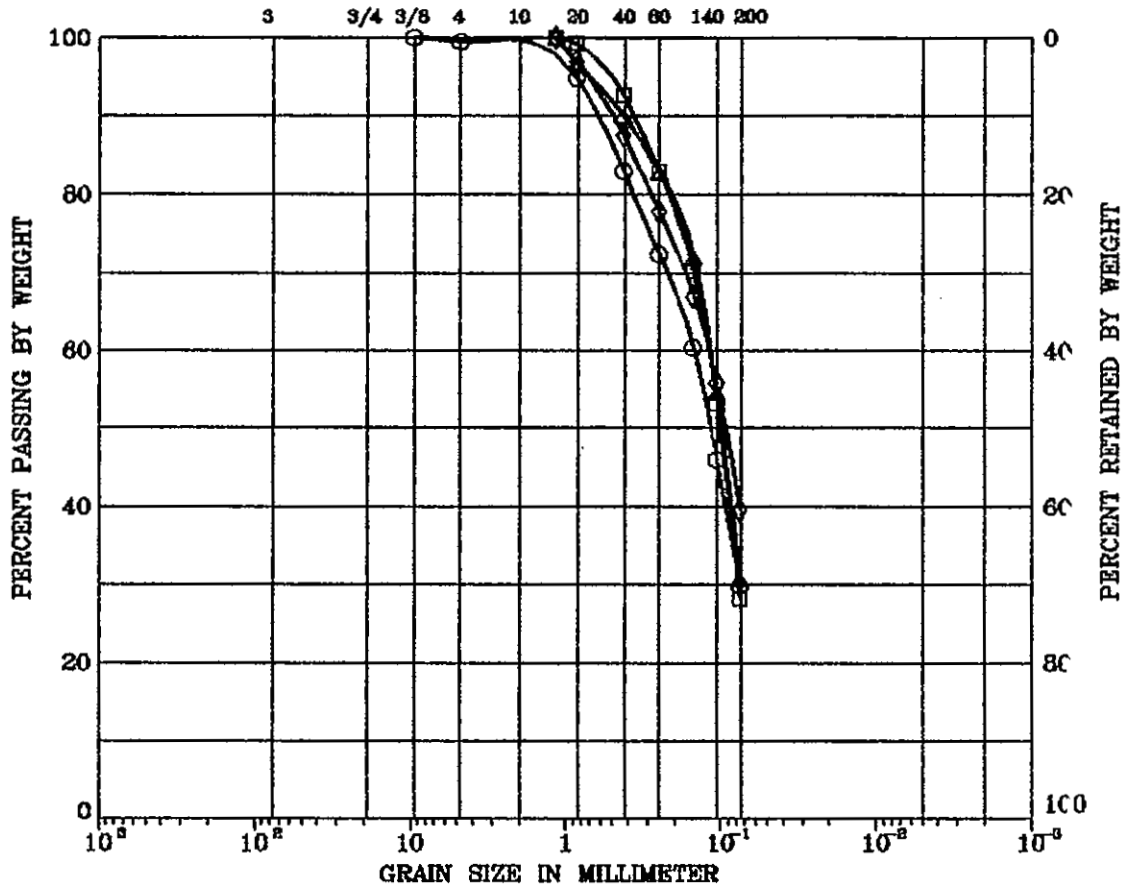

SYMBOL	BORING	DEPTH (ft)	LI (%)	PI (%)	DESCRIPTION
○	SSC DH 4	4.0	26	9	CLAYEY SAND (SC)
□	SSC DH 4	9.0	23		SILTY SAND (SM)
△	SSC DH 4	19.0	25	4	SILTY, CLAYEY SAND (SM-SC)
◇	SSC DH 4	28.0	32	15	CLAYEY SAND (SC)

Remark :

Project No. 9E-AB	NEW MEXICO SSC PROPOSAL JULY 31, 1987
New Mexico Bureau of Mines	GRAIN SIZE DISTRIBUTION

UNIFIED SOIL CLASSIFICATION

COBBLES	GRAVEL		SAND			SILT OR CLAY
	COARSE	FINE	COARSE	MEDIUM	FINE	
U.S. SIEVE SIZE IN INCHES			U.S. STANDARD SIEVE No.			HYDROMETER

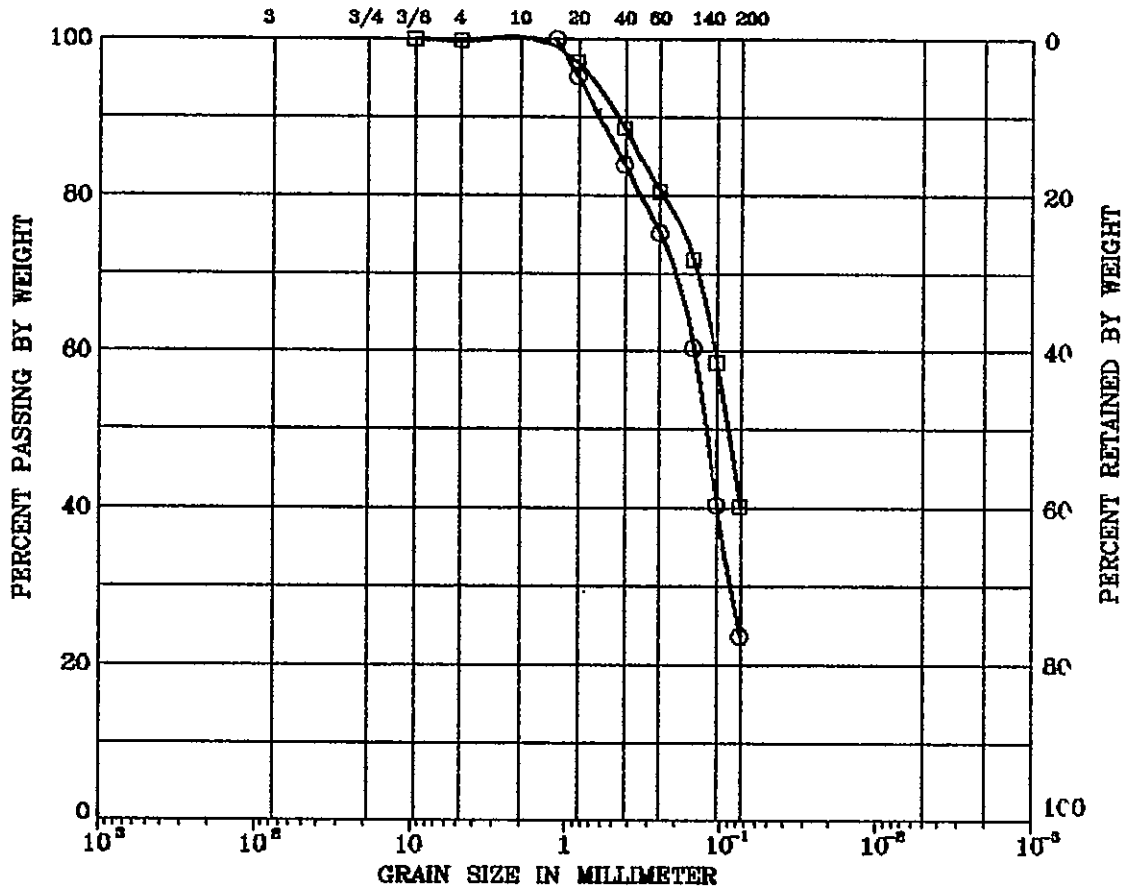

<u>SYMBOL</u>	<u>BORING</u>	<u>DEPTH (ft)</u>	<u>LL (%)</u>	<u>PI (%)</u>	<u>DESCRIPTION</u>
○	SSC DH 5	4.0	27	11	CLAYEY SAND (SC)
□	SSC DH 5	9.0	36	18	CLAYEY SAND (SC)

Remark :

Project No. 9E-AB	NEW MEXICO SSC PROPOSAL JULY 31, 1987
New Mexico Bureau of Mines	GRAIN SIZE DISTRIBUTION

UNIFIED SOIL CLASSIFICATION

COBBLES	GRAVEL		SAND			SILT OR CLAY
	COARSE	FINE	COARSE	MEDIUM	FINE	
U.S. SIEVE SIZE IN INCHES			U.S. STANDARD SIEVE No.			HYDROMETER

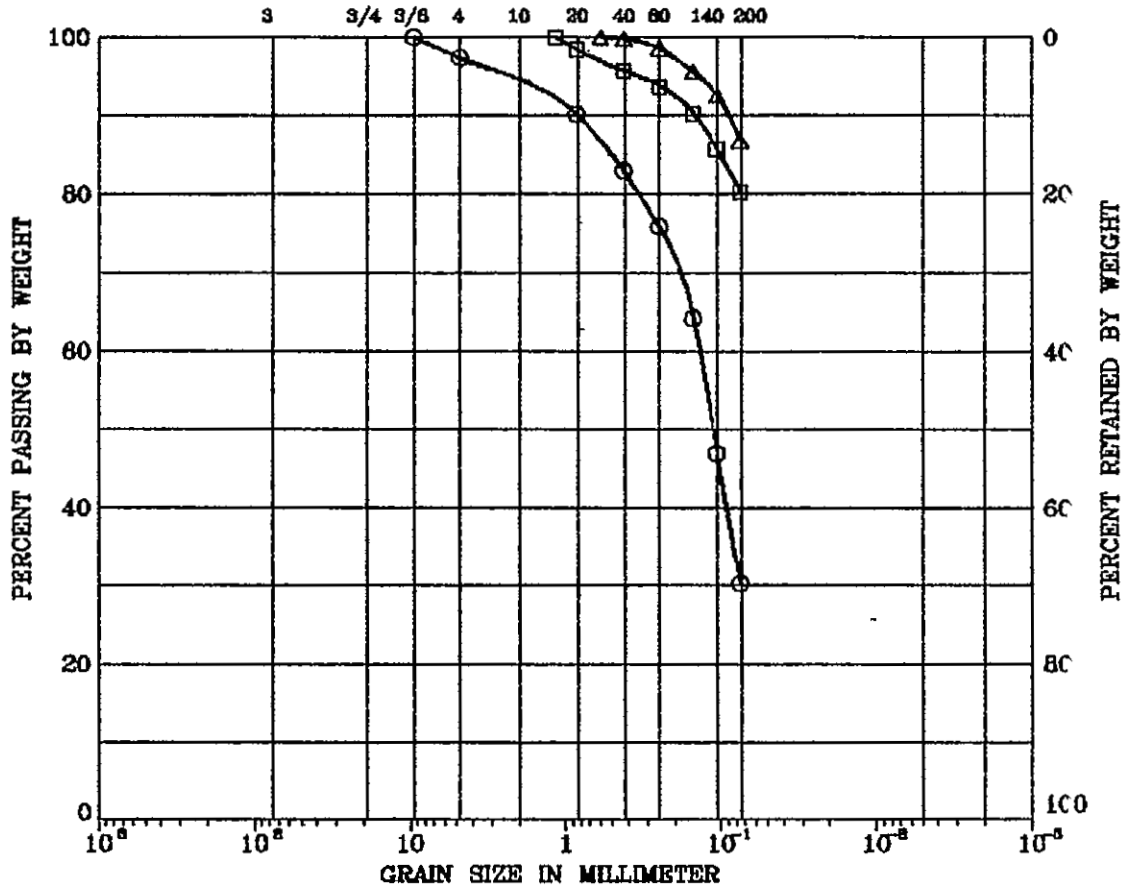

SYMBOL	BORING	DEPTH (ft)	LL (%)	PI (%)	DESCRIPTION
○	SSC DH 6	4.0	27	7	SILTY, CLAYEY SAND (SM-SC)
□	SSC DH 6	9.0	42	19	LEAN CLAY WITH SAND (CL)
△	SSC DH 6	19.0	51	29	FAT CLAY (CH)

Remark :

Project No. 9E-AB

NEW MEXICO SSC PROPOSAL JULY 31, 1987

New Mexico
Bureau of Mines

GRAIN SIZE DISTRIBUTION

UNIFIED SOIL CLASSIFICATION

COBBLES	GRAVEL		SAND			SILT OR CLAY
	COARSE	FINE	COARSE	MEDIUM	FINE	
U.S. SIEVE SIZE IN INCHES			U.S. STANDARD SIEVE No.			HYDROMETER

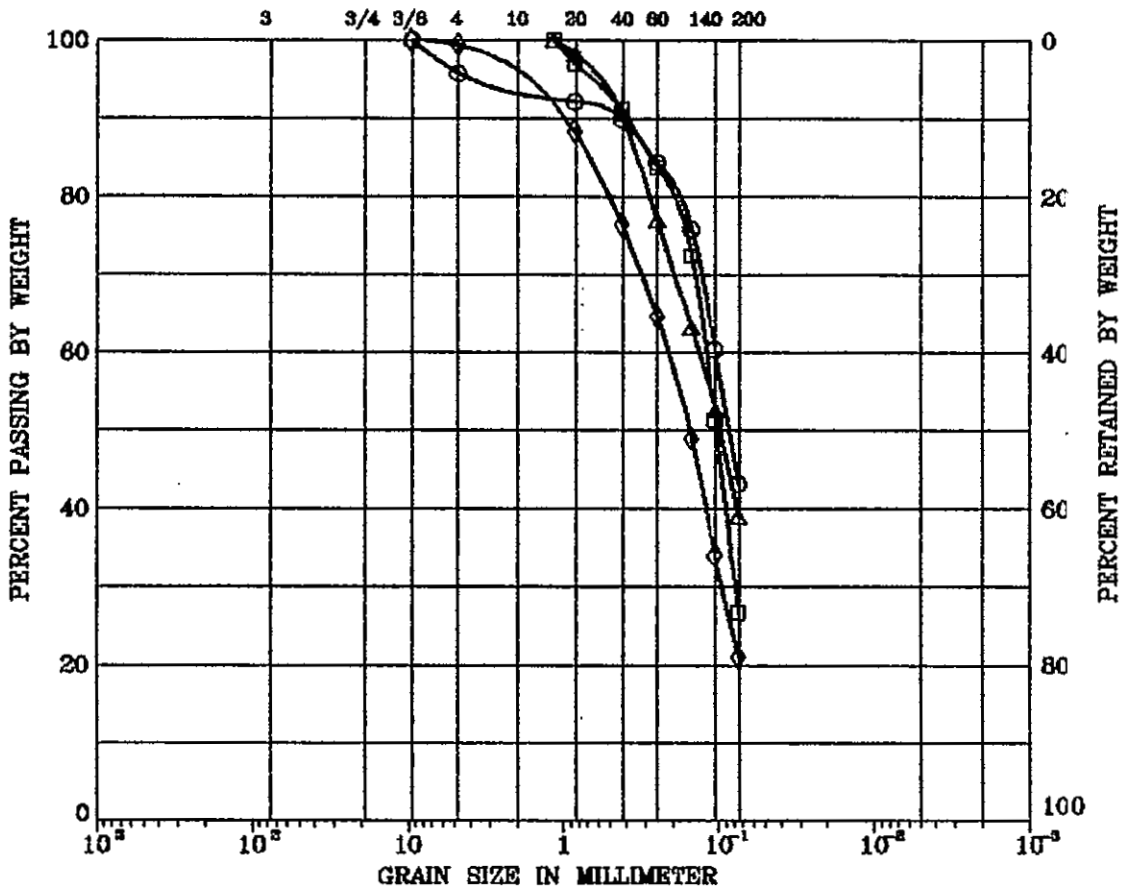

SYMBOL	BORING	DEPTH (ft)	LL (%)	PI (%)	DESCRIPTION
○	SSC DH 7	4.0	23	4	SILTY, CLAYEY SAND (SM-SC)
□	SSC DH 7	9.0	22	1	SILTY SAND (SM)
△	SSC DH 7	19.0	29	8	SILTY SAND (SM)
◇	SSC DH 7	29.0	28	2	SILTY SAND (SM)

Remark :

Project No. 9E-AB	NEW MEXICO SSC PROPOSAL JULY 31, 1987
New Mexico Bureau of Mines	GRAIN SIZE DISTRIBUTION

UNIFIED SOIL CLASSIFICATION

COBBLES	GRAVEL		SAND			SILT OR CLAY
	COARSE	FINE	COARSE	MEDIUM	FINE	
U.S. SIEVE SIZE IN INCHES			U.S. STANDARD SIEVE No.			HYDROMETER

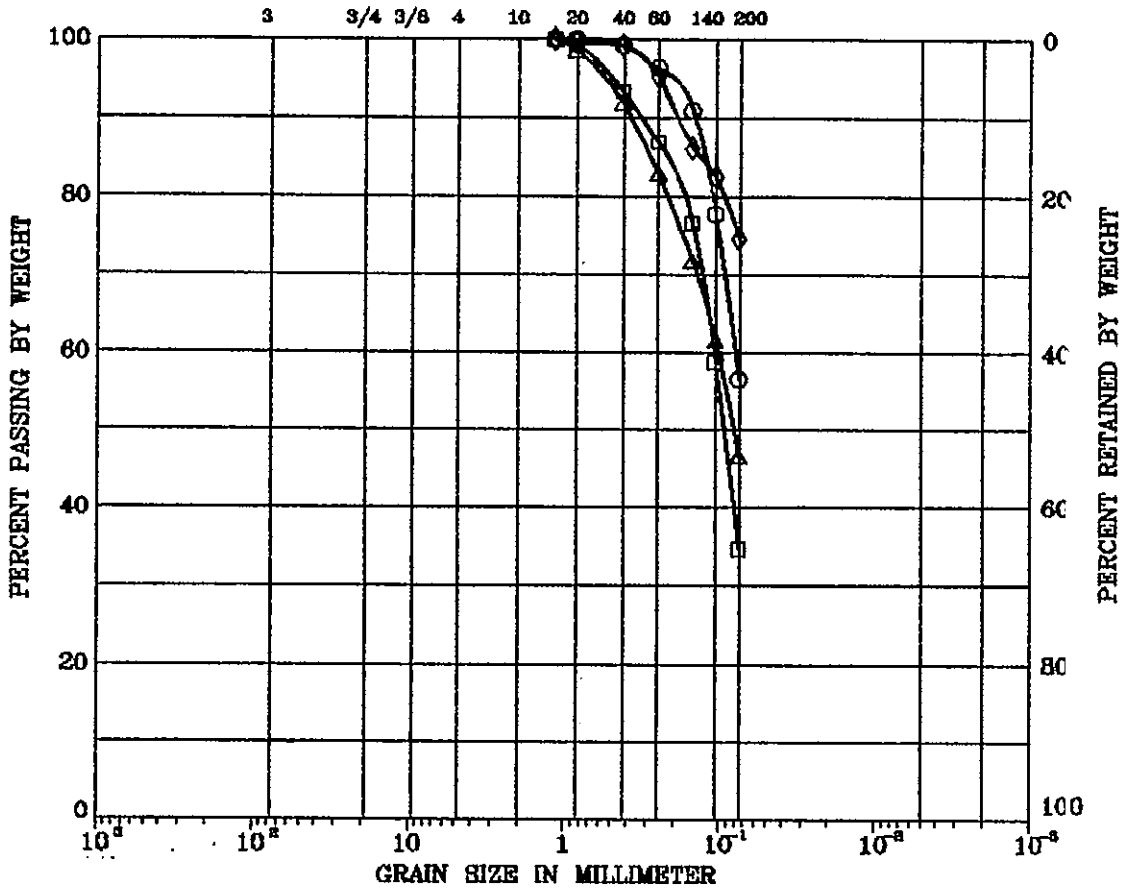

SYMBOL	BORING	DEPTH (ft)	LL (%)	PI (%)	DESCRIPTION
○	DH 9	4.0	24	4	SILTY CLAY (CL-ML)
□	DH 9	9.0	25	6	SILTY, CLAYEY SAND (SM-SC)
△	DH 9	19.0	42	18	CLAYEY SAND (SC)
◇	DH 9	29.0	38	13	LEAN CLAY (CL)

Remark :

Project No. 9E-AB	NEW MEXICO SSC PROPOSAL JULY 31, 1987
New Mexico Bureau of Mines	GRAIN SIZE DISTRIBUTION

UNIFIED SOIL CLASSIFICATION

COBBLES	GRAVEL		SAND			SILT OR CLAY
	COARSE	FINE	COARSE	MEDIUM	FINE	
U.S. SIEVE SIZE IN INCHES			U.S. STANDARD SIEVE No.			HYDROMETER

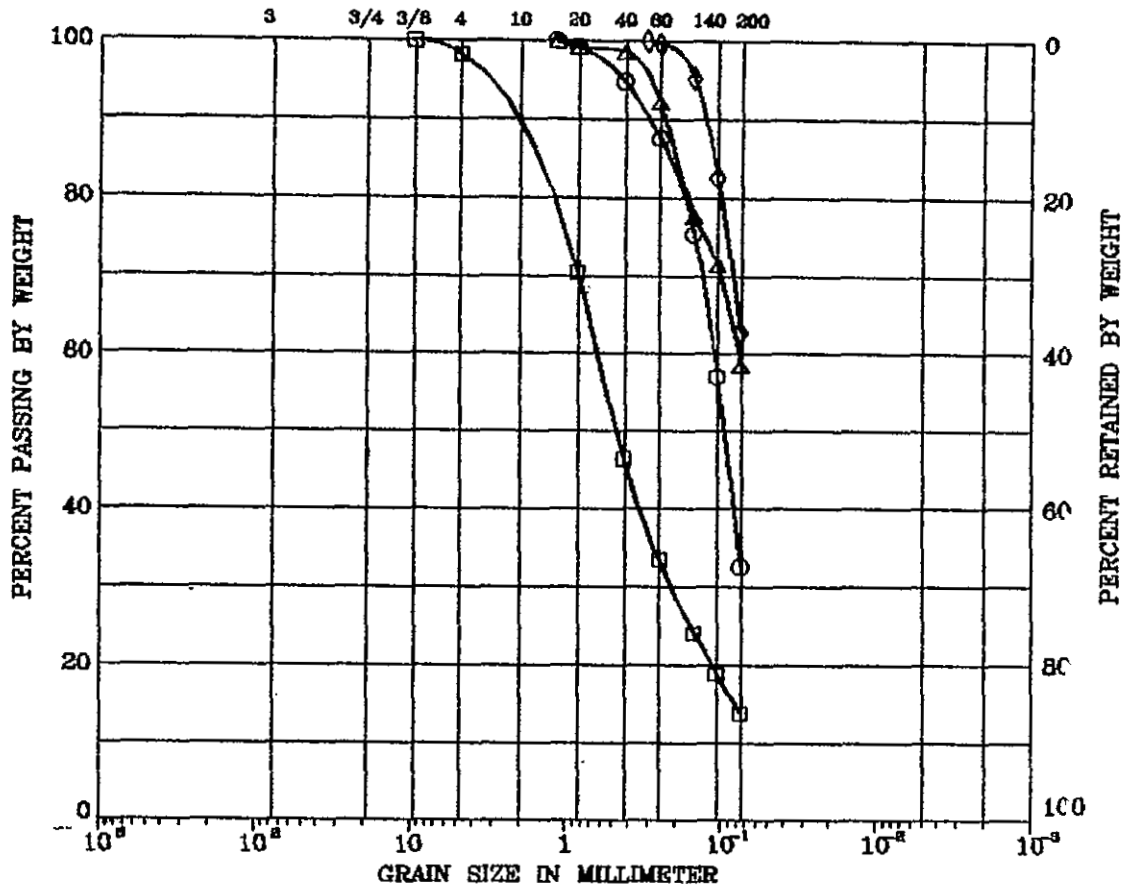

SYMBOL	BORING	DEPTH (ft)	LL (%)	PI (%)	DESCRIPTION
○	SSC DH10	4.0	20		SILTY SAND (SM)
□	SSC DH10	9.0			SILTY SAND (SM)
△	SSC DH10	19.0	20	4	SILTY CLAY (CL-MU)
◇	SSC DH10	29.0	21	9	LEAN CLAY (CL)

Remark :

Project No. 9E-AB	NEW MEXICO SSC PROPOSAL JULY 31, 1987
New Mexico Bureau of Mines	GRAIN SIZE DISTRIBUTION

UNIFIED SOIL CLASSIFICATION

COBBLES	GRAVEL		SAND			SILT OR CLAY
	COARSE	FINE	COARSE	MEDIUM	FINE	
U.S. SIEVE SIZE IN INCHES			U.S. STANDARD SIEVE No.			HYDROMETER

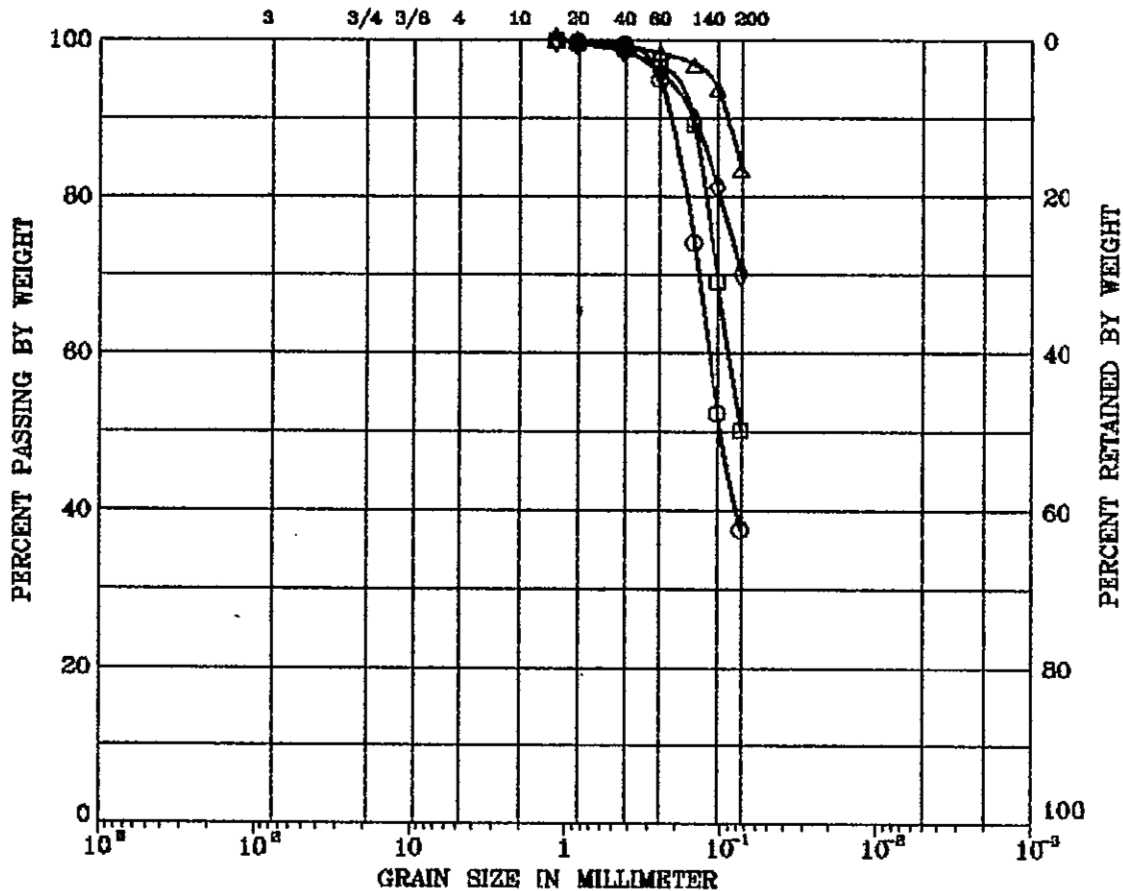

<u>SYMBOL</u>	<u>BORING</u>	<u>DEPTH (ft)</u>	<u>LL (%)</u>	<u>PI (%)</u>	<u>DESCRIPTION</u>
○	SSC DH11	4.00	23		SILTY SAND (SM)
□	SSC DH11	9.0	24	3	SANDY SILT (ML)
△	SSC DH11	19.0	26	4	SILTY CLAY (CL-ML)
◇	SSC DH11	29.0	35	12	SANDY LEAN CLAY (CL)

Remark :

Project No. 9E-AB

NEW MEXICO SSC PROPOSAL JULY 31, 1967

New Mexico
Bureau of Mines

GRAIN SIZE DISTRIBUTION

UNIFIED SOIL CLASSIFICATION

COBBLES	GRAVEL		SAND			SILT OR CLAY
	COARSE	FINE	COARSE	MEDIUM	FINE	
U.S. SEIVE SIZE IN INCHES			U.S. STANDARD SEIVE No.			HYDROMETER

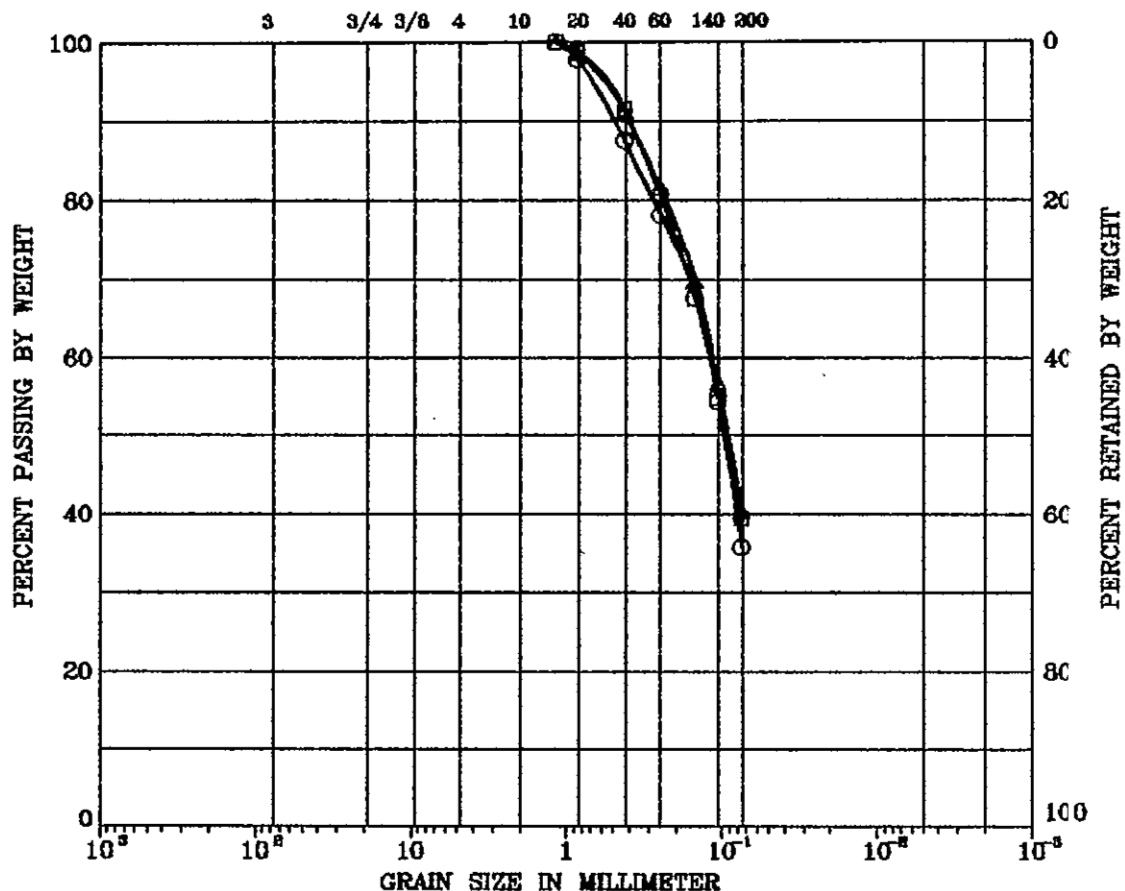

SYMBOL	BORING	DEPTH (ft.)	LL (%)	PI (%)	DESCRIPTION
○	SSC DH12	4.0	25	5	SILTY, CLAYEY SAND (SM-SC)
□	SSC DH12	9.0	24	6	SILTY, CLAYEY SAND (SM-SC)
△	SSC DH12	19.0	29	10	CLAYEY SAND (SC)

Remark :

Project No. 9E-AB

NEW MEXICO SSC PROPOSAL JULY 31, 1987

New Mexico
Bureau of Mines

GRAIN SIZE DISTRIBUTION

UNIFIED SOIL CLASSIFICATION

<i>COBBLES</i>	<i>GRAVEL</i>		<i>SAND</i>			<i>SILT OR CLAY</i>
	COARSE	FINE	COARSE	MEDIUM	FINE	
U.S. SIEVE SIZE IN INCHES			U.S. STANDARD SIEVE No.			HYDROMETER

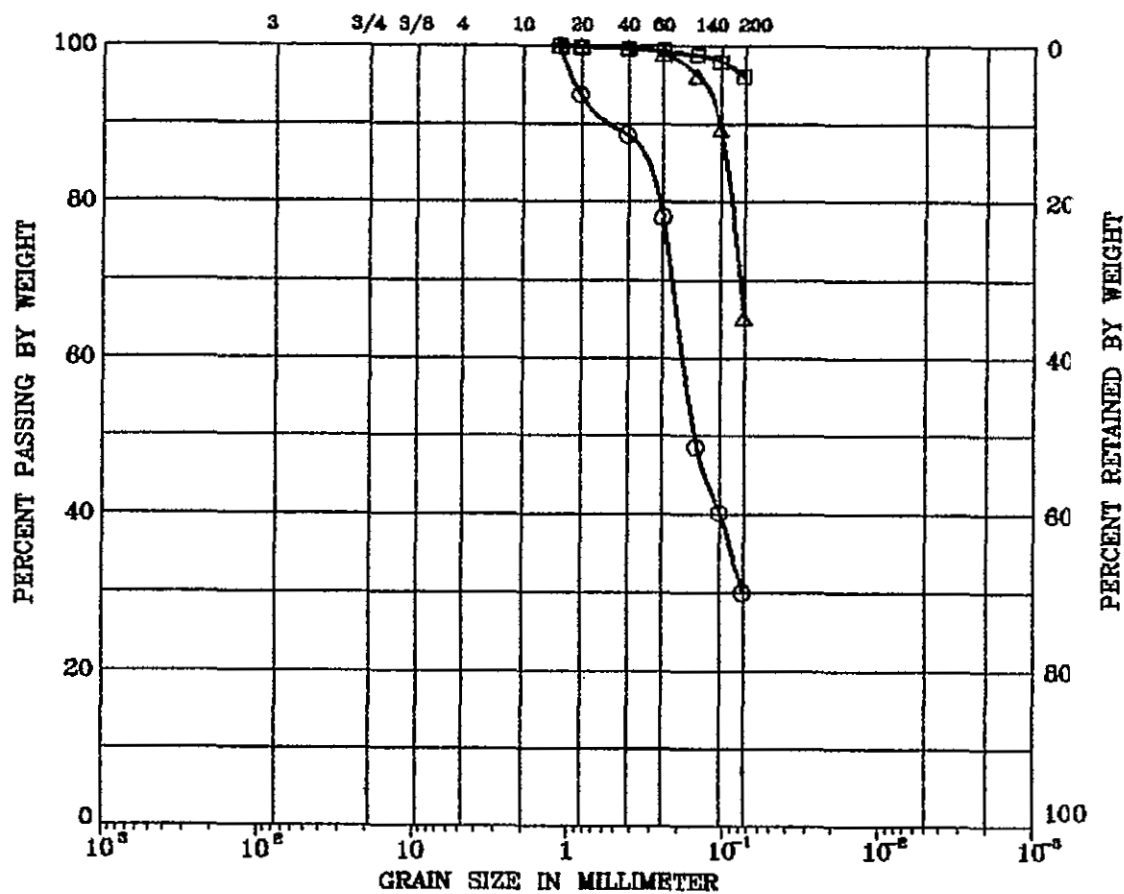

<u>SYMBOL</u>	<u>BORING</u>	<u>DEPTH (ft)</u>	<u>LL (%)</u>	<u>PI (%)</u>	<u>DESCRIPTION</u>
○	SSC DH13	4.0	23	4	SILTY, CLAYEY SAND (SM-SC)
□	SSC DH13	9.0	39	16	LEAN CLAY (CL)
△	SSC DH13	19.0	23	4	SANDY, SILTY CLAY (CL-ML)

Remark :

Project No. 9E-AB	NEW MEXICO SSC PROPOSAL JULY 31, 1967
New Mexico Bureau of Mines	GRAIN SIZE DISTRIBUTION

UNIFIED SOIL CLASSIFICATION

COBBLES	GRAVEL		SAND			SILT OR CLAY
	COARSE	FINE	COARSE	MEDIUM	FINE	
U.S. Sieve Size in Inches			U.S. Standard Sieve No.			Hydrometer

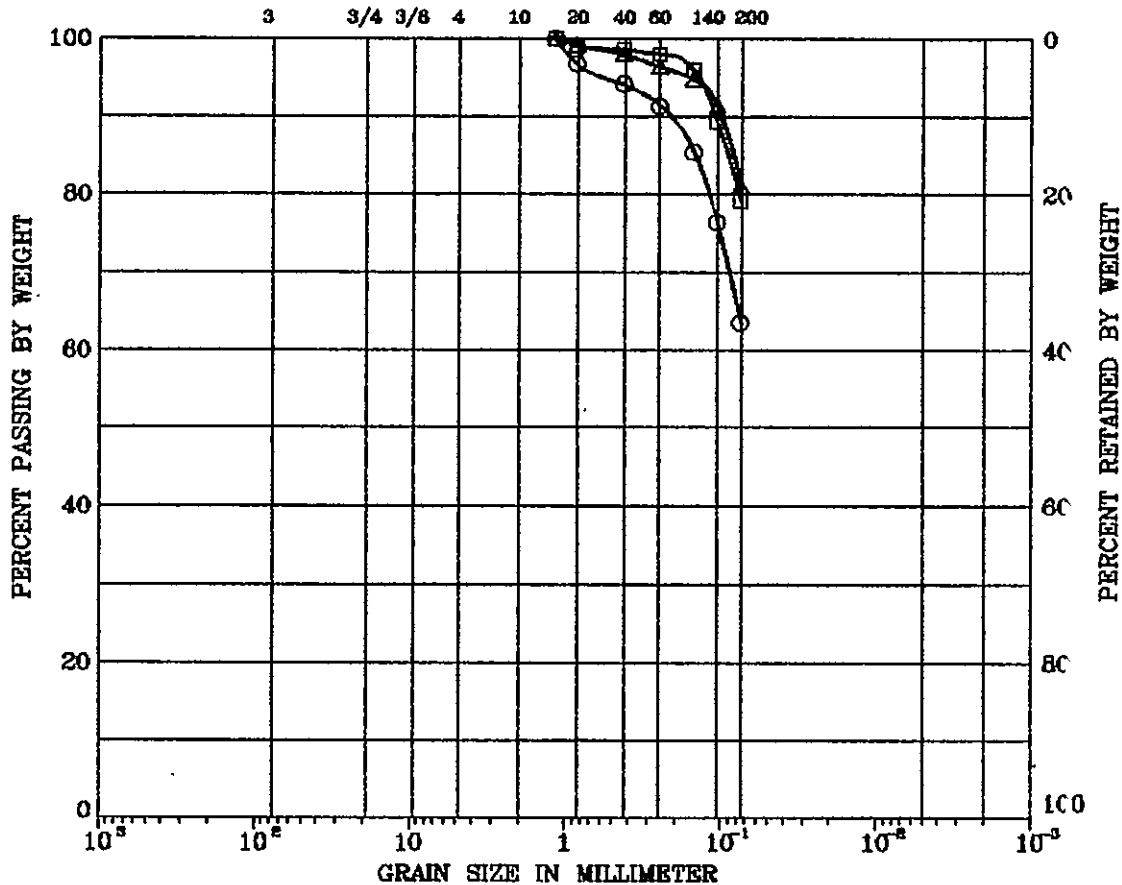

SYMBOL	BORING	DEPTH (ft)	LL (%)	PI (%)	DESCRIPTION
○	SSC DH14	4.0	39	16	SANDY LEAN CLAY (CL)
□	SSC DH14	9.0	39	20	LEAN CLAY (CL)
△	SSC DH14	19.0	36	20	LEAN CLAY WITH SAND (CL)

Remark :

Project No. 9E-AB	NEW MEXICO SSC PROPOSAL JULY 31, 1987
New Mexico Bureau of Mines	GRAIN SIZE DISTRIBUTION

UNIFIED SOIL CLASSIFICATION

COBBLES	GRAVEL		SAND			SILT OR CLAY
	COARSE	FINE	COARSE	MEDIUM	FINE	
U.S. Sieve Size in Inches			U.S. Standard Sieve No.			HYDROMETER

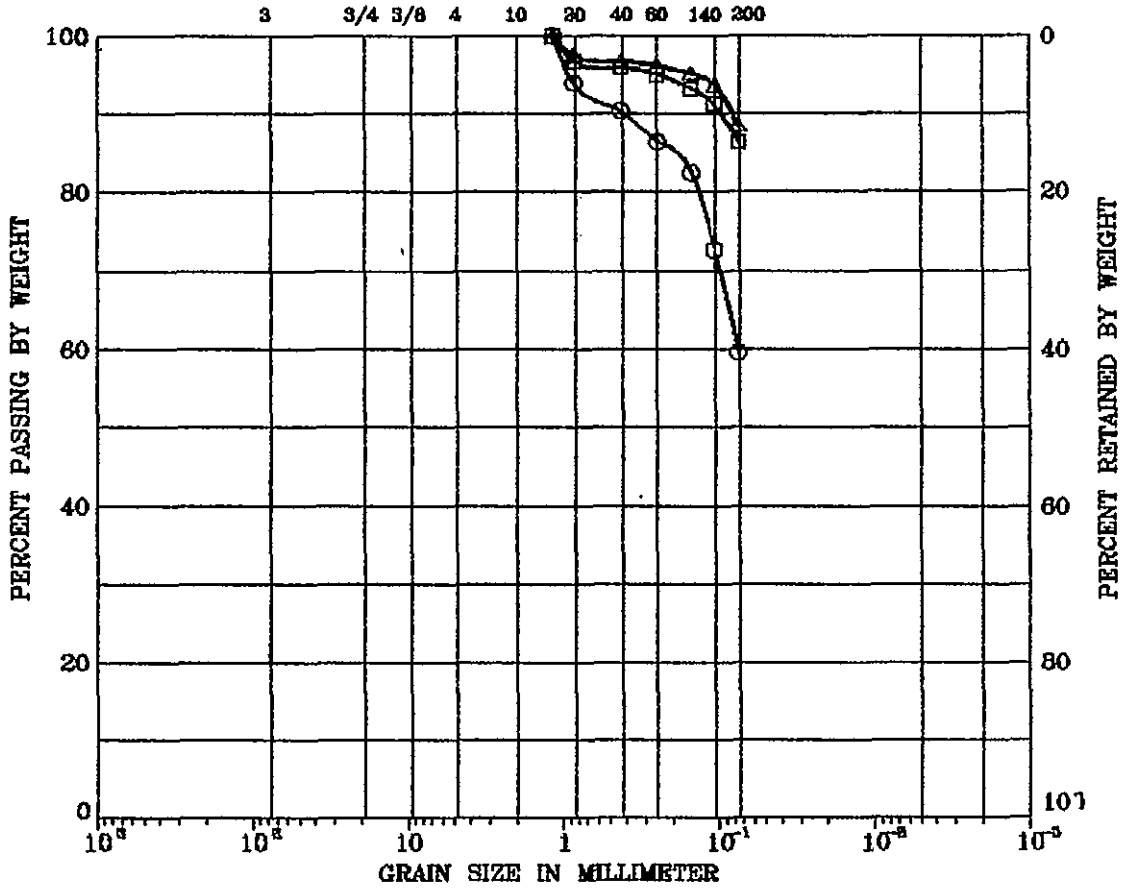

SYMBOL	BORING	DEPTH (ft)	LL (%)	PI (%)	DESCRIPTION
○	SSC DH15	4.0	51	25	SANDY FAT CLAY (CH)
□	SSC DH15	9.0	57	31	FAT CLAY (CH)
△	SSC DH15	19	60	39	FAT CLAY (CH)

Remark :

Project No. 9E-AB	NEW MEXICO SSC PROPOSAL JULY 31, 1987
New Mexico Bureau of Mines	GRAIN SIZE DISTRIBUTION

UNIFIED SOIL CLASSIFICATION

COBBLES	GRAVEL		SAND			SILT OR CLAY
	COARSE	FINE	COARSE	MEDIUM	FINE	
U.S. SIEVE SIZE IN INCHES			U.S. STANDARD SIEVE No.			HYDROMETER

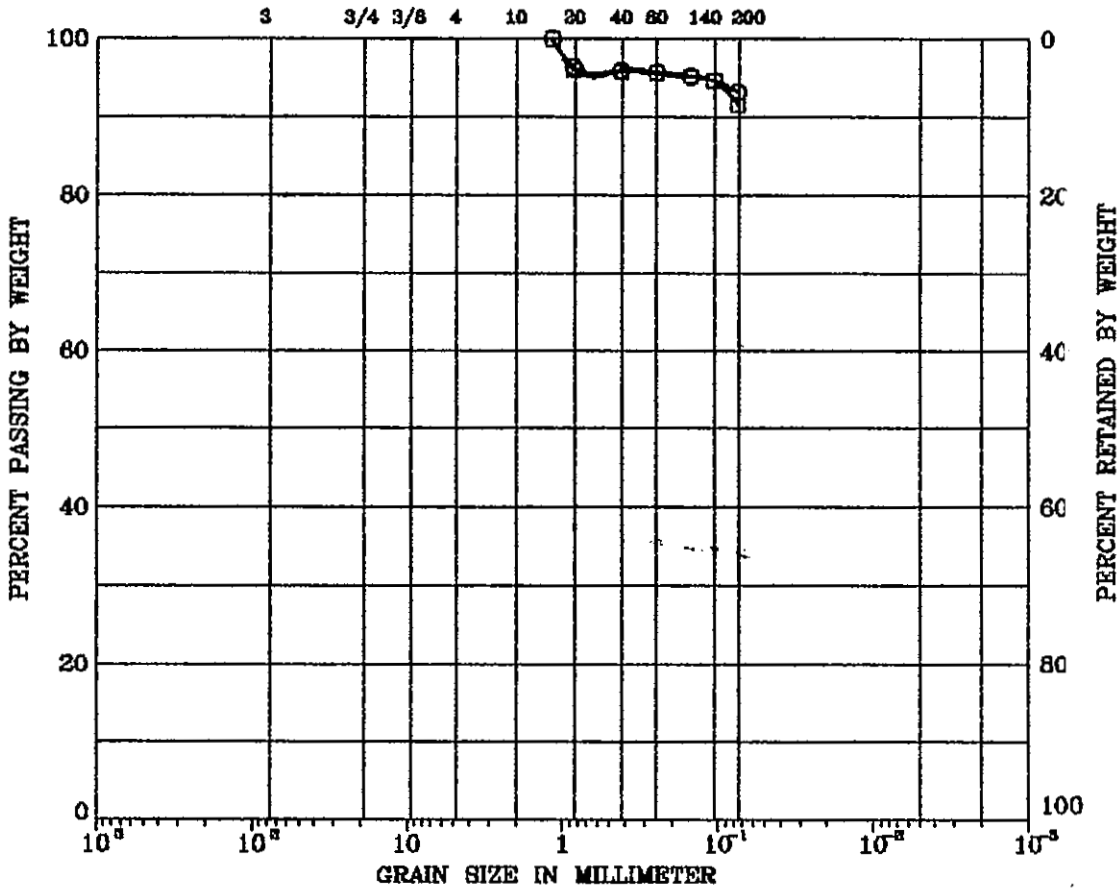

SYMBOL	BORING	DEPTH (ft)	LL (%)	PI (%)	DESCRIPTION
○	SSC DH16	4.0	28	9	LEAN CLAY (CL)
□	SSC DH16	9.0	42	22	LEAN CLAY (CL)

Remark :

Project No. 9E-AB NEW MEXICO SSC PROPOSAL JULY 31, 1987

New Mexico
Bureau of Mines

GRAIN SIZE DISTRIBUTION

UNIFIED SOIL CLASSIFICATION

COBBLES	GRAVEL		SAND			SILT OR CLAY
	COARSE	FINE	COARSE	MEDIUM	FINE	
U.S. SIEVE SIZE IN INCHES			U.S. STANDARD SIEVE No.			HYDROMETER

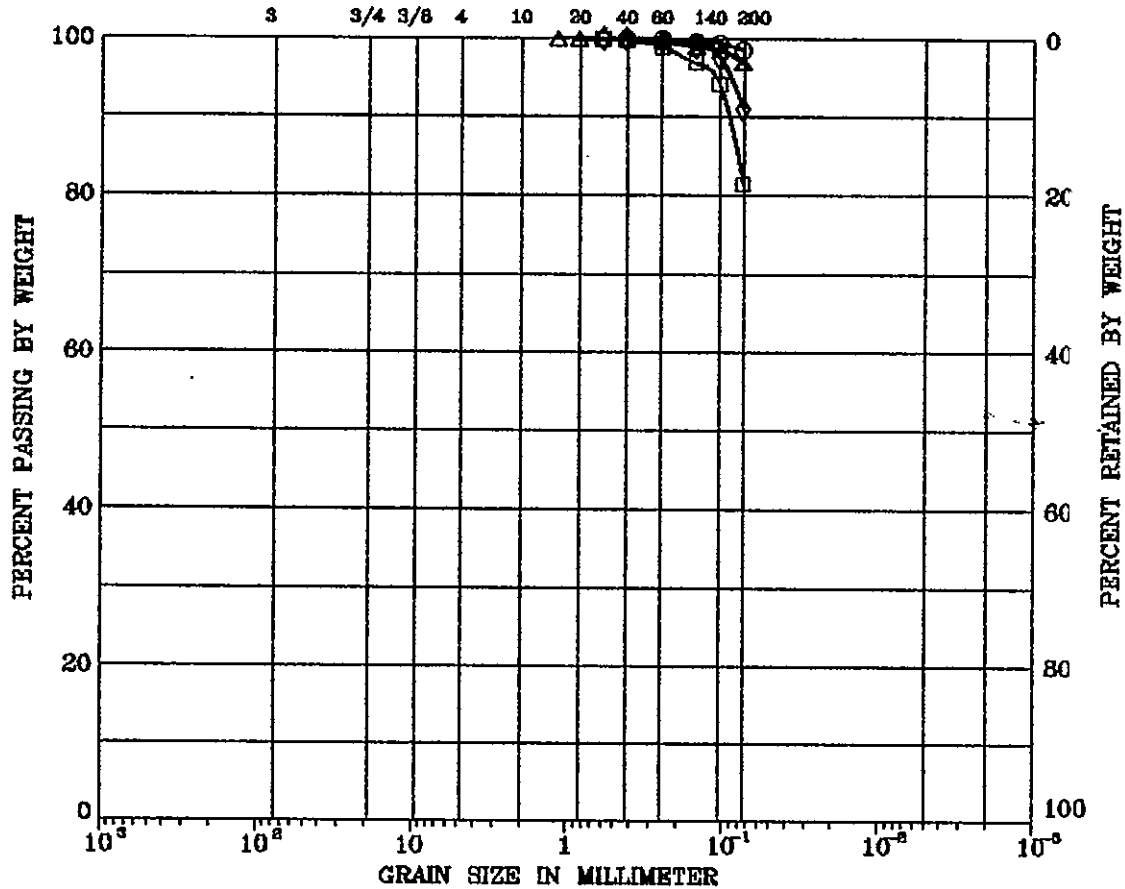

SYMBOL	BORING	DEPTH (ft)	LL (%)	PI (%)	DESCRIPTION
○	SSC DH17	4.00			SILTY CLAY (CL-ML)
□	SSC DH17	4.5	24	3	SILT WITH SAND (ML)
△	SSC DH17	9.0	38	18	LEAN CLAY (CL)
◇	SSC DH17	18.25	79	52	FAT CLAY (CH)

Remark :

Project No. 9E-AB

NEW MEXICO SSC PROPOSAL JULY 31, 1987

New Mexico
Bureau of Mines

GRAIN SIZE DISTRIBUTION

UNIFIED SOIL CLASSIFICATION

COBBLES	GRAVEL		SAND			SILT OR CLAY
	COARSE	FINE	COARSE	MEDIUM	FINE	
U.S. SIEVE SIZE IN INCHES			U.S. STANDARD SIEVE No.			HYDROMETER

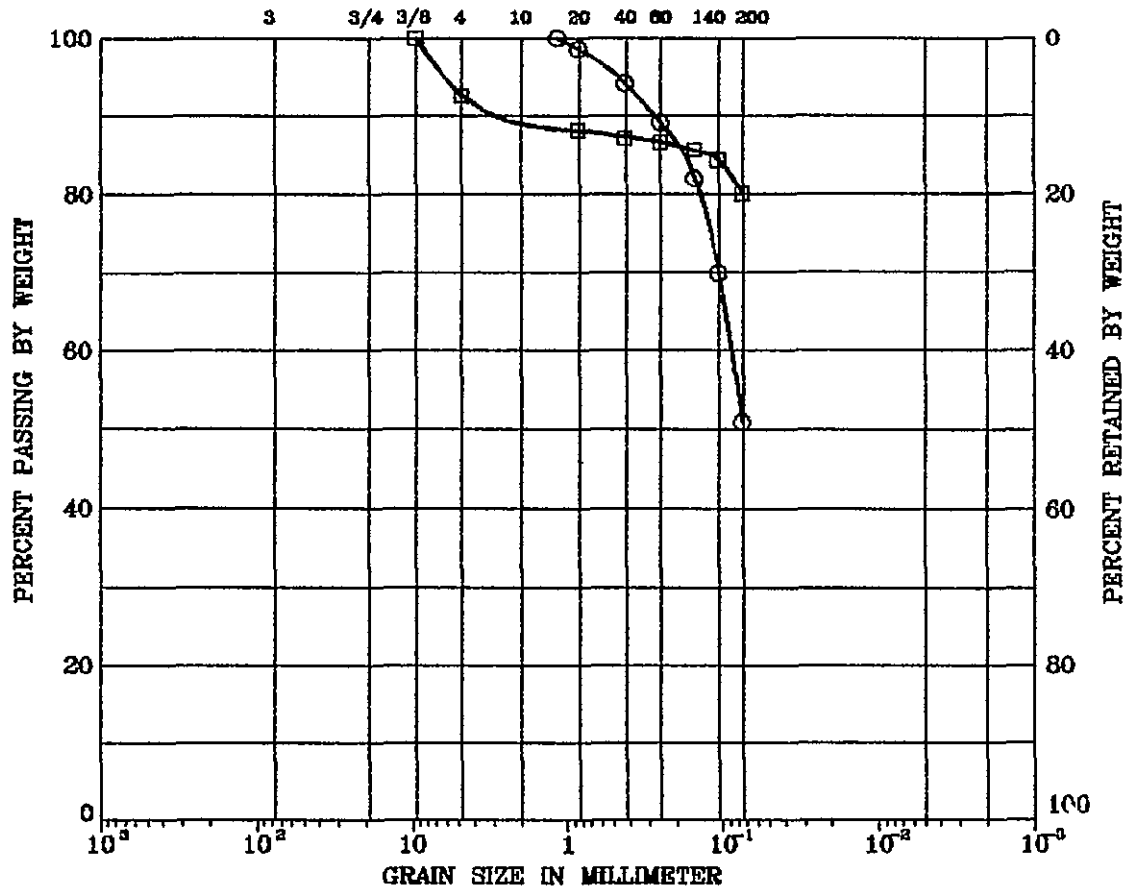

SYMBOL	BORING	DEPTH (ft)	LL (%)	PI (%)	DESCRIPTION
○	SSC DH17	29.0	27	12	SANDY LEAN CLAY (CL)
□	SSC DH17	40.0	36	18	LEAN CLAY (CL)

Remark :

Project No. 9E-AB	NEW MEXICO SSC PROPOSAL JULY 31, 1987
New Mexico Bureau of Mines	GRAIN SIZE DISTRIBUTION

UNIFIED SOIL CLASSIFICATION

COBBLES	GRAVEL		SAND			SILT OR CLAY
	COARSE	FINE	COARSE	MEDIUM	FINE	
U.S. SIEVE SIZE IN INCHES			U.S. STANDARD SIEVE No.			HYDROMETER

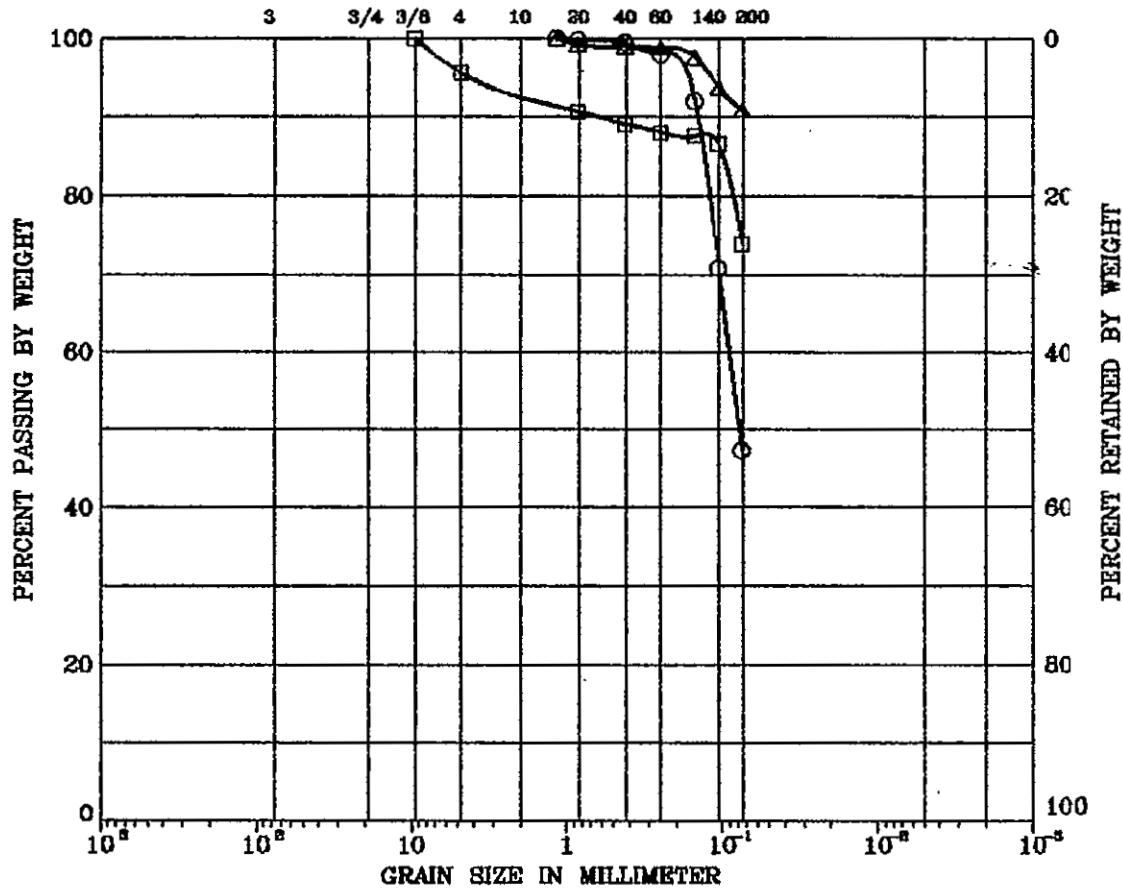

SYMBOL	BORING	DEPTH (ft)	LL (%)	PI (%)	DESCRIPTION
○	SSC DH18	4.0	25	4	SILTY, CLAYEY SAND (SM-SC)
□	SSC DH18	9.0	28	11	LEAN CLAY WITH SAND (CL)
△	SSC DH18	9.75	30	14	LEAN CLAY (CL)

Remark :

Project No. 9E-AB	NEW MEXICO SSC PROPOSAL JULY 31, 1987
New Mexico Bureau of Mines	GRAIN SIZE DISTRIBUTION

UNIFIED SOIL CLASSIFICATION

COBBLES	GRAVEL		SAND			SILT OR CLAY
	COARSE	FINE	COARSE	MEDIUM	FINE	
U.S. SIEVE SIZE IN INCHES			U.S. STANDARD SIEVE No.			HIDROMETER

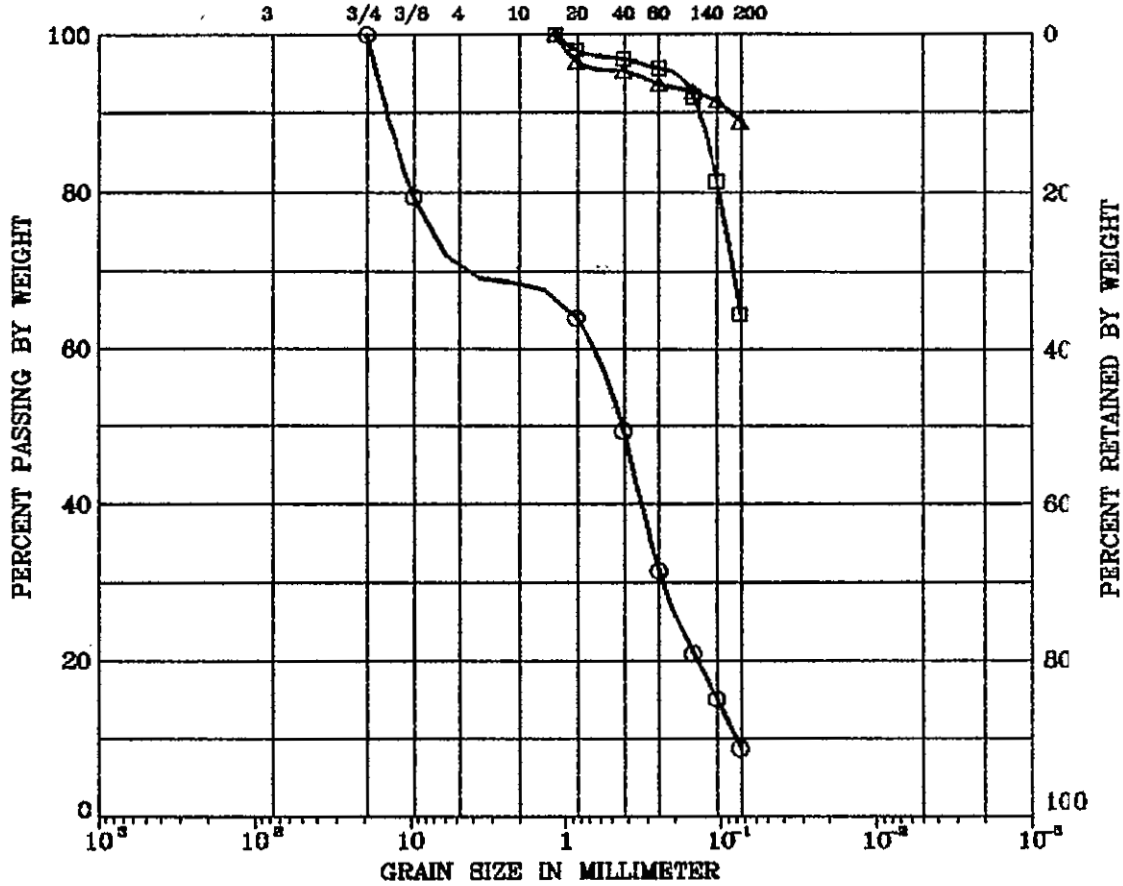

SYMBOL	BORING	DEPTH (ft)	LL (%)	PI (%)	DESCRIPTION
○	SSC DH18	19.0			POORLY GRADED SAND WITH SILT & GRAVEL (SP-SM)
□	SSC DH18	20.0	32	13	SANDY LEAN CLAY (CL)
△	SSC DH18	28.0	63	40	FAT CLAY (CH)

Remark :

Project No. 9E-AB

NEW MEXICO SSC PROPOSAL JULY 31, 1987

New Mexico
Bureau of Mines

GRAIN SIZE DISTRIBUTION

UNIFIED SOIL CLASSIFICATION

COBBLES	GRAVEL		SAND			SILT OR CLAY
	COARSE	FINE	COARSE	MEDIUM	FINE	
U.S. SIEVE SIZE IN INCHES			U.S. STANDARD SIEVE No.			HYDROMETER

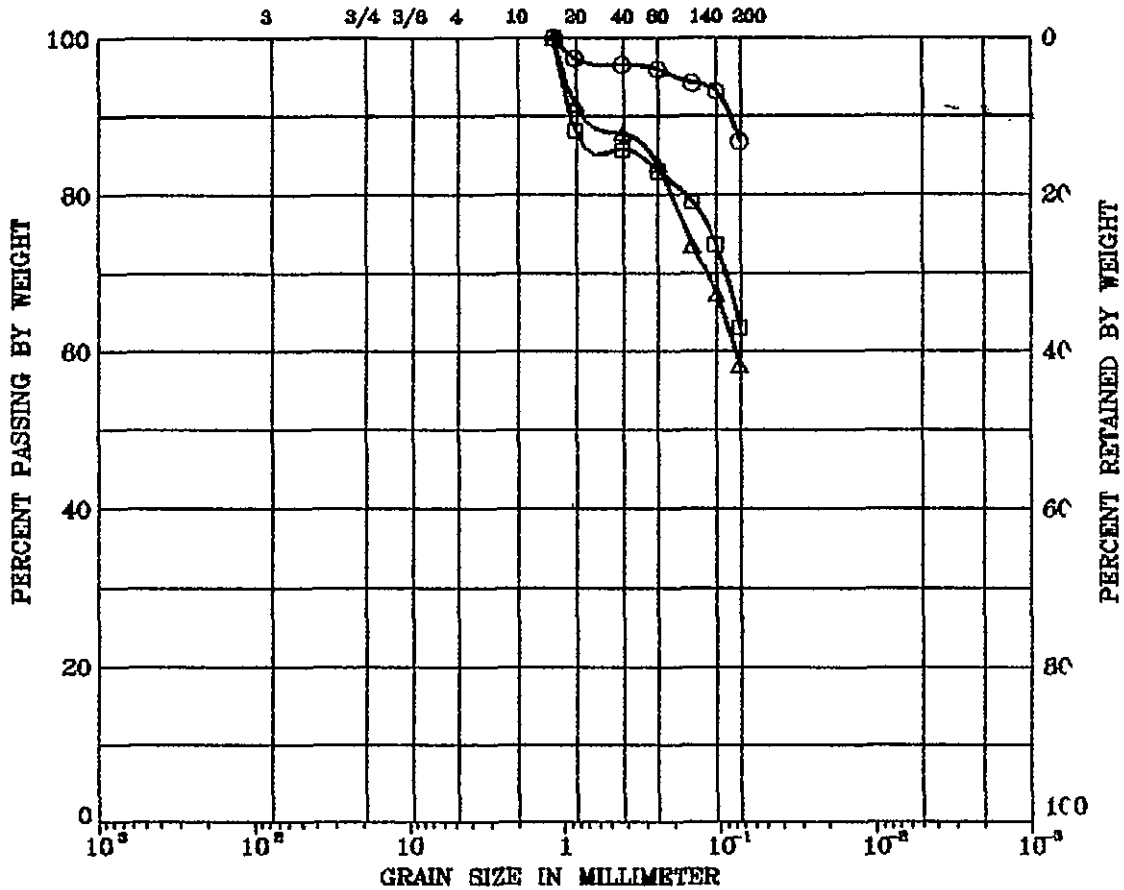

SYMBOL	BORING	DEPTH (ft)	LL (%)	PI (%)	DESCRIPTION
○	SSC 0H19	4.0	22	6	SILTY CLAY (CL-ML)
□	SSC 0H19	9.0	27	13	SANDY LEAN CLAY (CL)
△	SSC 0H19	19.5	22	7	SILTY CLAY (CL-ML)

Remark :

Project No. 9E-AB	NEW MEXICO SSC PROPOSAL JULY 31, 1987
New Mexico Bureau of Mines	GRAIN SIZE DISTRIBUTION

UNIFIED SOIL CLASSIFICATION

COBBLES	GRAVEL		SAND			SILT OR CLAY
	COARSE	FINE	COARSE	MEDIUM	FINE	
U.S. SIEVE SIZE IN INCHES			U.S. STANDARD SIEVE No.			HYDROMETER

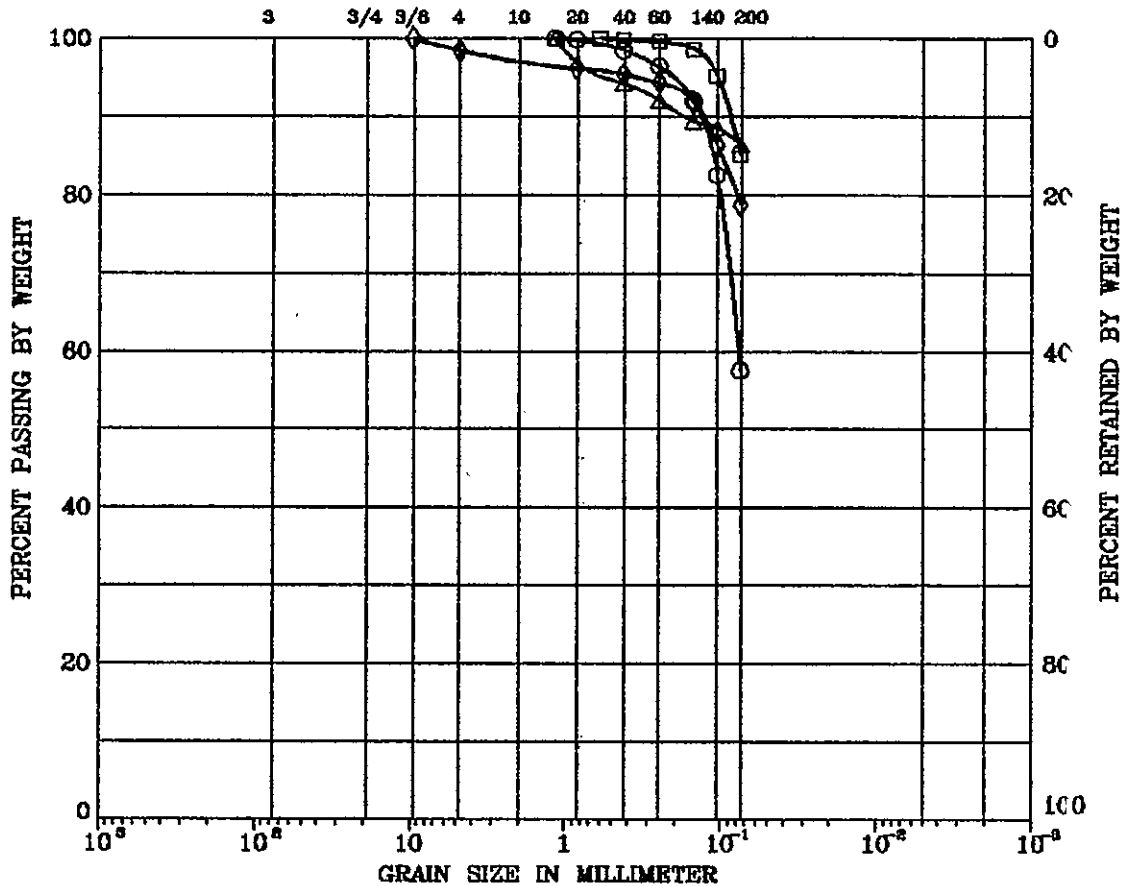

SYMBOL	BORING	DEPTH (ft)	LL (%)	PI (%)	DESCRIPTION
○	SSC DH20	0.0	34	16	SANDY LEAN CLAY (CL)
□	SSC DH20	1.5	32	15	LEAN CLAY WITH SAND (CL)
△	SSC DH20	3.0	32	7	SILT (ML)
◇	SSC DH20	4.5	35	14	LEAN CLAY WITH SAND (CL)

Remark :

Project No. 9E-AB

NEW MEXICO SSC PROPOSAL JULY 31, 1987

New Mexico
Bureau of Mines

GRAIN SIZE DISTRIBUTION

UNIFIED SOIL CLASSIFICATION

COBBLES	GRAVEL		SAND			SILT OR CLAY
	COARSE	FINE	COARSE	MEDIUM	FINE	
U.S. SIEVE SIZE IN INCHES			U.S. STANDARD SIEVE No.			HYDROMETER

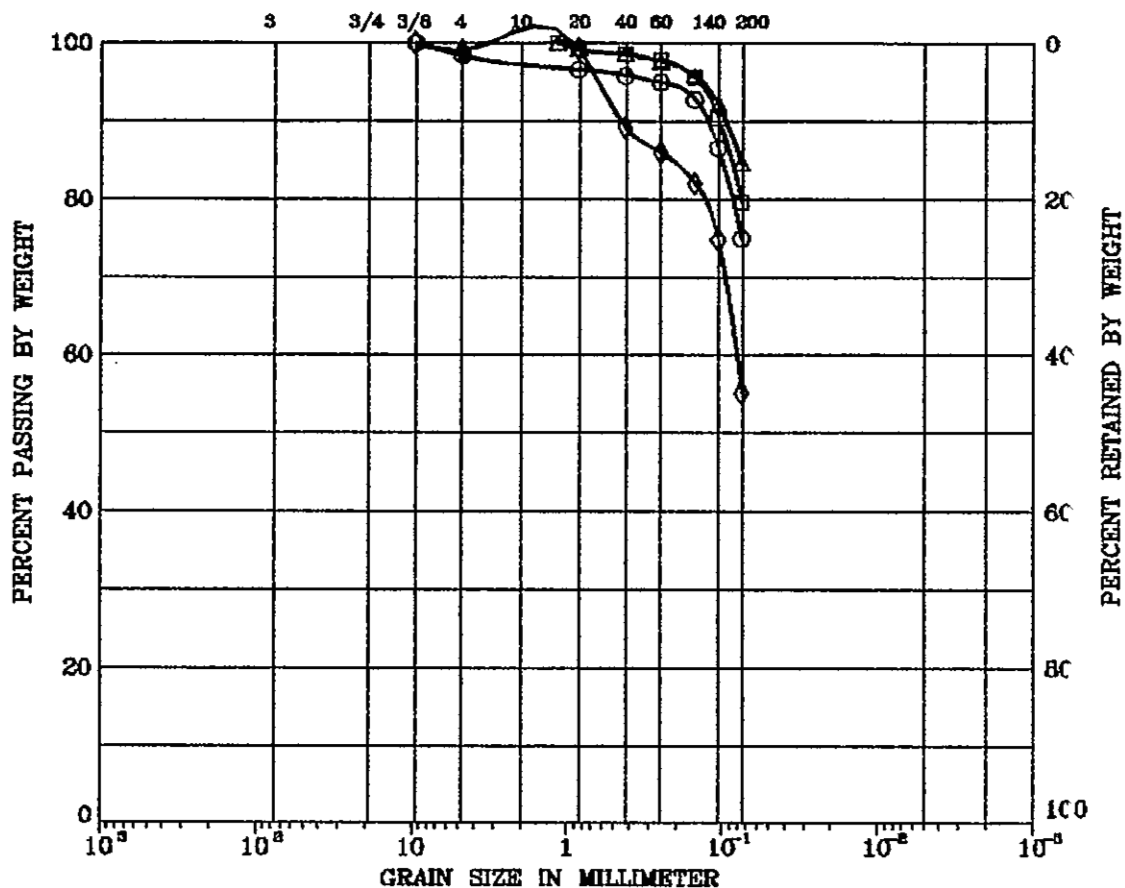

<u>SYMBOL</u>	<u>BORING</u>	<u>DEPTH (ft)</u>	<u>LL (%)</u>	<u>PI (%)</u>	<u>DESCRIPTION</u>
○	SSC DH20	6.0	34	19	LEAN CLAY WITH SAND (CL)
□	SSC DH20	7.5	29	12	LEAN CLAY WITH SAND (CL)
△	SSC DH20	9.0	37	17	LEAN CLAY WITH SAND (CL)
◇	SSC DH20	10.5	29	12	SANDY LEAN CLAY (CL)

Remark :

Project No. 9E-AB

NEW MEXICO SSC PROPOSAL JULY 31, 1987

New Mexico
Bureau of Mines

GRAIN SIZE DISTRIBUTION

UNIFIED SOIL CLASSIFICATION

COBBLES	GRAVEL		SAND			SILT OR CLAY
	COARSE	FINE	COARSE	MEDIUM	FINE	
U.S. SIEVE SIZE IN INCHES			U.S. STANDARD SIEVE No.			HYDROMETER

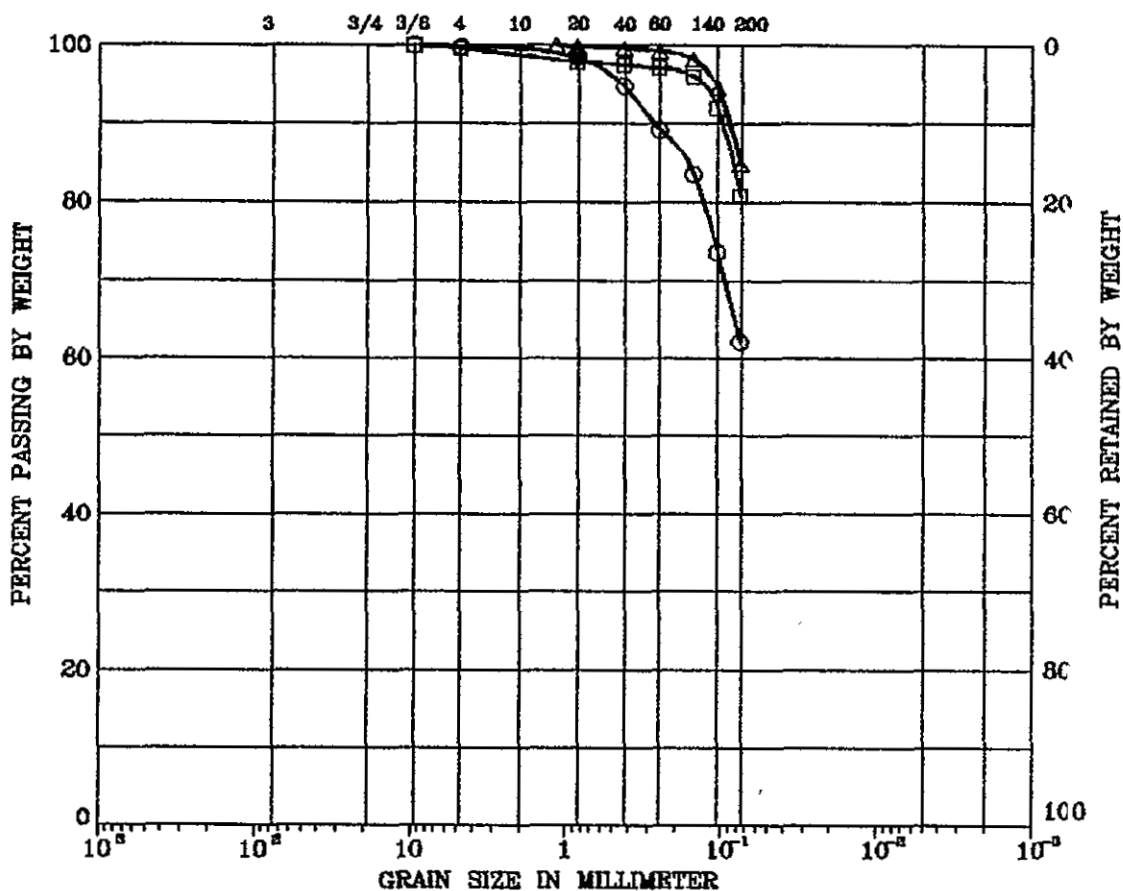

SYMBOL	BORING	DEPTH (ft)	LL (%)	PI (%)	DESCRIPTION
○	SSC DH20	12.0	24		SILT (ML)
□	SSC DH20	13.0	32	17	LEAN CLAY WITH SAND (CL)
Δ	SSC DH20	13.5	41	28	LEAN CLAY WITH SAND (CL)

Remark :

Project No. 9E-AB NEW MEXICO SSC PROPOSAL JULY 31, 1987

New Mexico Bureau of Mines **GRAIN SIZE DISTRIBUTION**

UNIFIED SOIL CLASSIFICATION

COBBLES	GRAVEL		SAND			SILT OR CLAY
	COARSE	FINE	COARSE	MEDIUM	FINE	
U.S. SIEVE SIZE IN INCHES			U.S. STANDARD SIEVE No.			HYDROMETER

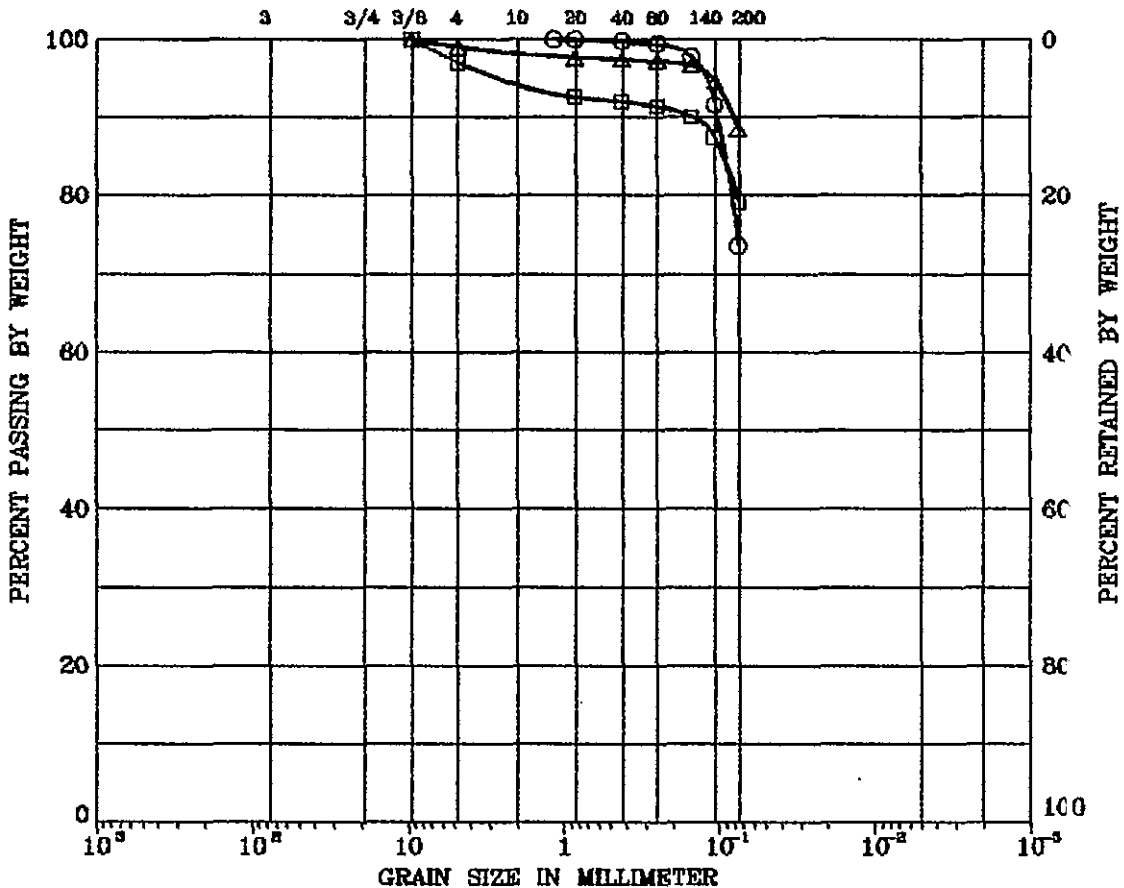

<u>SYMBOL</u>	<u>BORING</u>	<u>DEPTH (ft)</u>	<u>LL (%)</u>	<u>PI (%)</u>	<u>DESCRIPTION</u>
○	SSC DH20	15.0	37	20	LEAN CLAY WITH SAND (CL)
□	SSC DH20	16.5	31	17	LEAN CLAY WITH SAND (CL)
△	SSC DH20	18.0	57	35	FAT CLAY (CH)

Remark :

Project No. 9E-AB	NEW MEXICO SSC PROPOSAL JULY 31, 1967
New Mexico Bureau of Mines	GRAIN SIZE DISTRIBUTION

UNIFIED SOIL CLASSIFICATION

COBBLES	GRAVEL		SAND			SILT OR CLAY
	COARSE	FINE	COARSE	MEDIUM	FINE	
U.S. SIEVE SIZE IN INCHES			U.S. STANDARD SIEVE No.			HYDROMETER

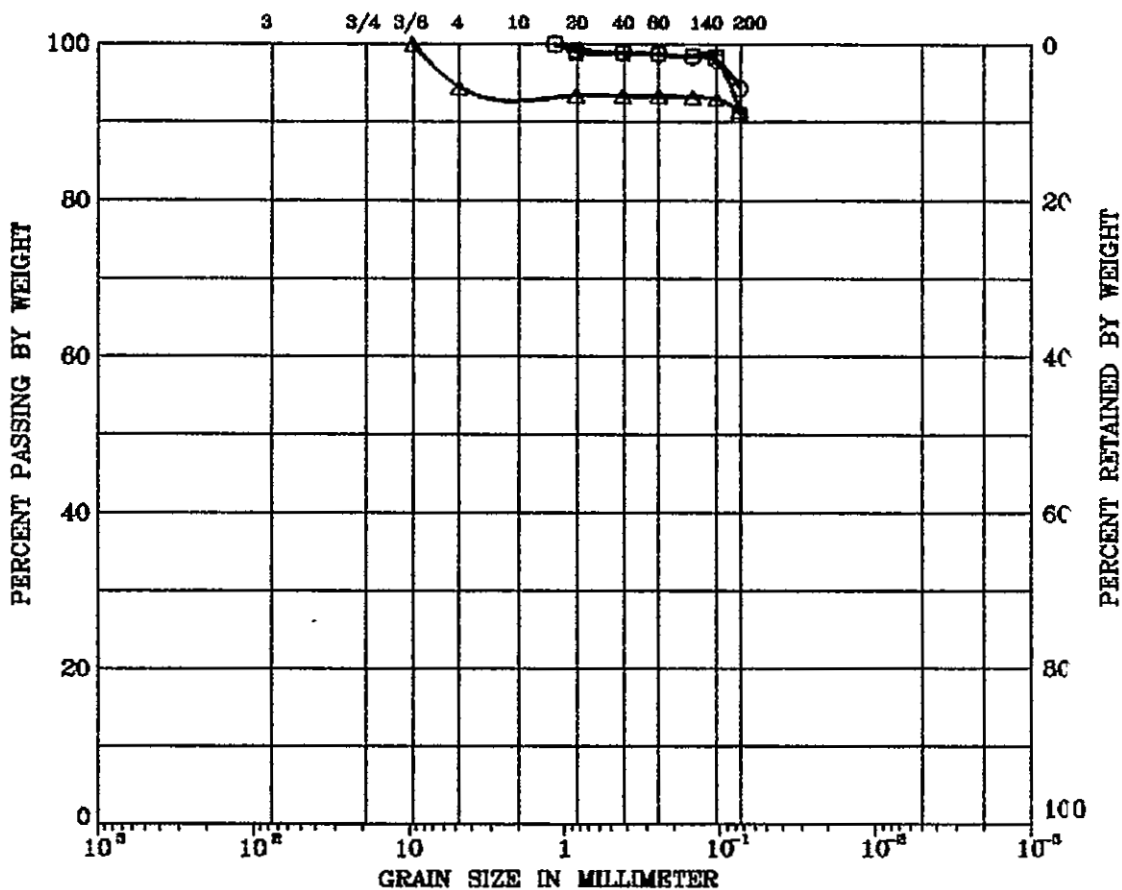

<u>SYMBOL</u>	<u>BORING</u>	<u>DEPTH (ft)</u>	<u>LL (%)</u>	<u>PI (%)</u>	<u>DESCRIPTION</u>
○	SSC DH20	19.5	43	27	LEAN CLAY (CL)
□	SSC DH20	21.0	40	21	LEAN CLAY (CL)
△	SSC DH20	29.0	34	14	LEAN CLAY (CL)

Remark :

Project No. 9E-AB	NEW MEXICO SSC PROPOSAL JULY 31, 1987
New Mexico Bureau of Mines	GRAIN SIZE DISTRIBUTION

UNIFIED SOIL CLASSIFICATION

COBBLES	GRAVEL		SAND			SILT OR CLAY
	COARSE	FINE	COARSE	MEDIUM	FINE	
U.S. STEVE SIZE IN INCHES			U.S. STANDARD SIEVE No.			HYDROMETER

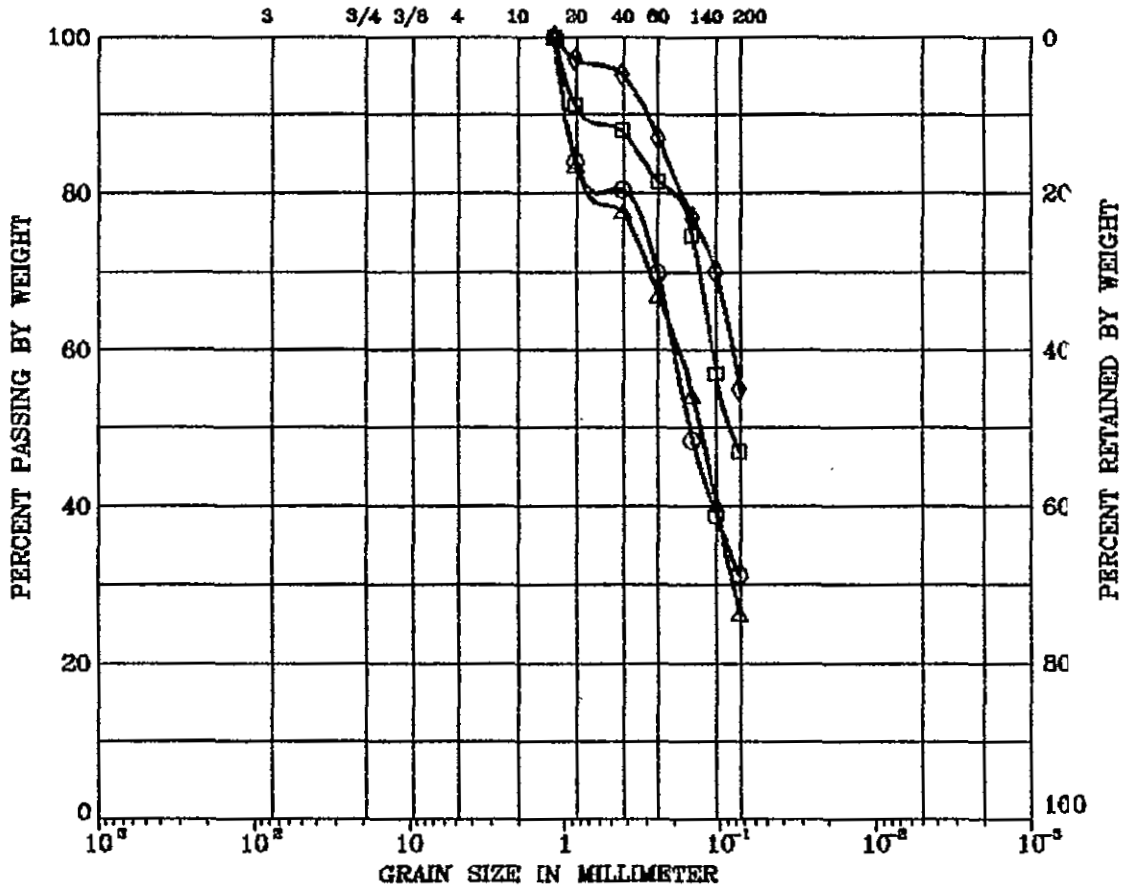

SYMBOL	BORING	DEPTH (ft)	LL (%)	PI (%)	DESCRIPTION
○	SSC DH21	4.0	19	3	SILTY SAND (SM)
□	SSC DH21	9.0	29	12	CLAYEY SAND (SC)
△	SSC DH21	19.0	22	8	CLAYEY SAND (SC)
◇	SSC DH21	29.0	35	15	SANDY LEAN CLAY (CL)

Remark :

Project No. 9E-AB	NEW MEXICO SSC PROPOSAL JULY 31, 1987
New Mexico Bureau of Mines	GRAIN SIZE DISTRIBUTION

UNIFIED SOIL CLASSIFICATION

COBBLES	GRAVEL		SAND			SILT OR CLAY
	COARSE	FINE	COARSE	MEDIUM	FINE	
U.S. SIEVE SIZE IN INCHES			U.S. STANDARD SIEVE No.			HYDROMETER

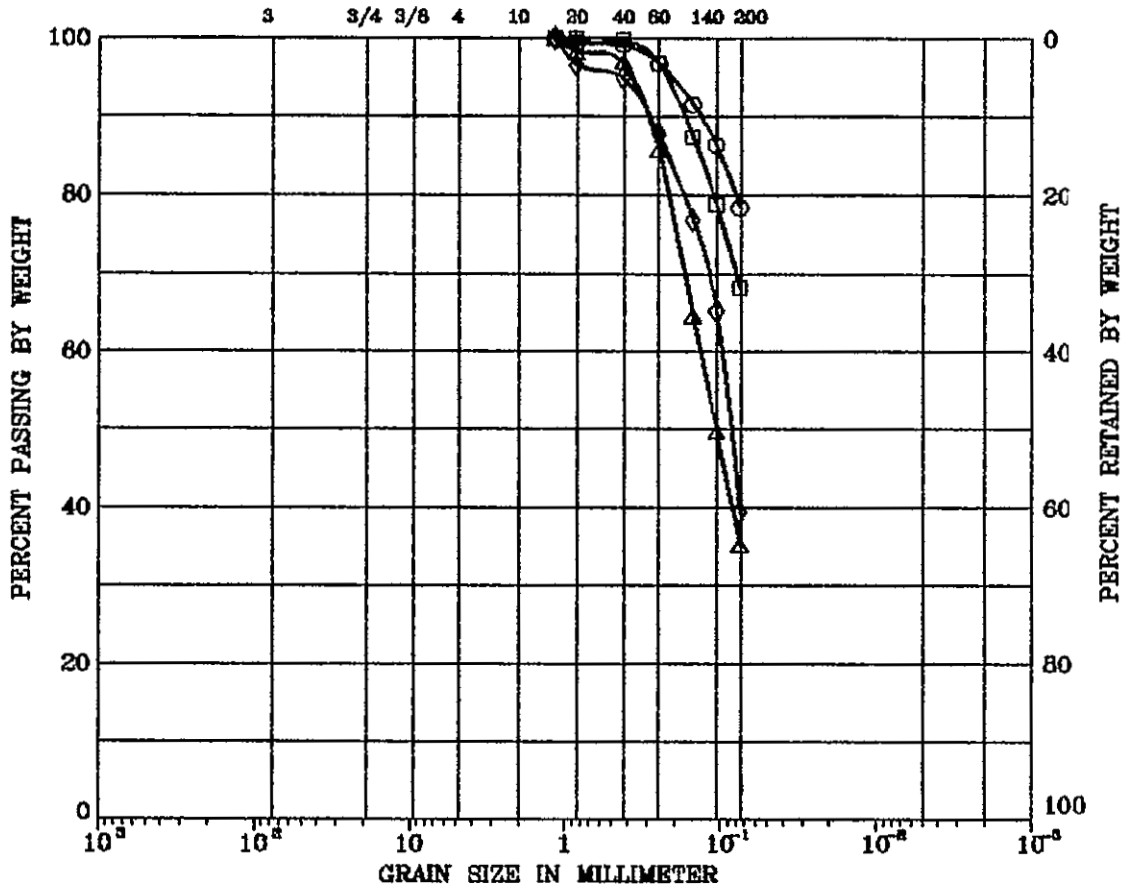

SYMBOL	BORING	DEPTH (ft)	LL (%)	PI (%)	DESCRIPTION
○	SSC DH22	4.0	25	4	SILTY CLAY (CL-ML)
□	SSC DH22	9.0	24	7	SILTY CLAY (CL-ML)
△	SSC DH22	19.0	25	6	SILTY, CLAYEY SAND (SM-SC)
◇	SSC DH22	29.0	22	3	SILTY SAND (SM)

Remark :

Project No. 9E-AB	NEW MEXICO SSC PROPOSAL JULY 31, 1987
New Mexico Bureau of Mines	GRAIN SIZE DISTRIBUTION

UNIFIED SOIL CLASSIFICATION

COBBLES	GRAVEL		SAND			SILT OR CLAY
	COARSE	FINE	COARSE	MEDIUM	FINE	
U.S. SIEVE SIZES IN INCHES			U.S. STANDARD SIEVE No.			HYDROMETER

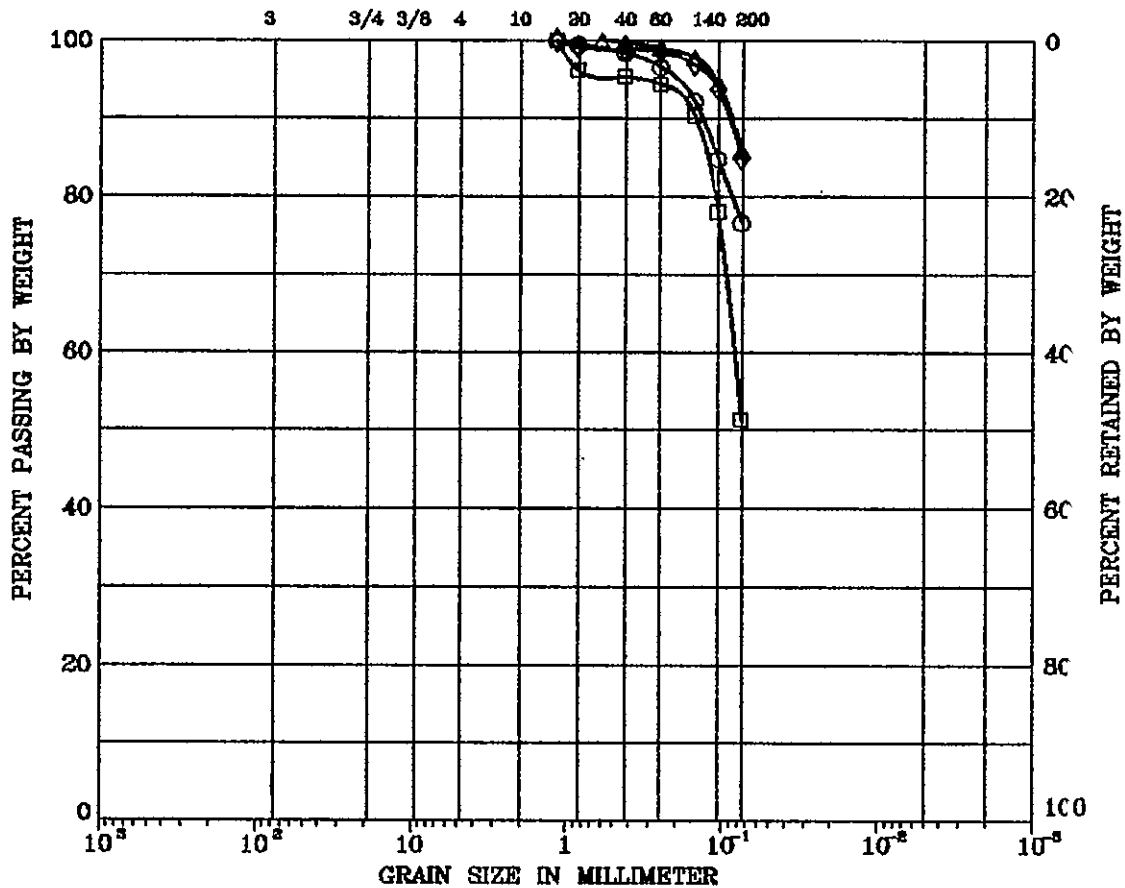

SYMBOL	BORING	DEPTH (ft)	LL (%)	PI (%)	DESCRIPTION
○	SSC DH23	4.0	44	24	LEAN CLAY WITH SAND (CL)
□	SSC DH23	9.0	26	8	SANDY LEAN CLAY (CL)
△	SSC DH23	19.0	47	24	LEAN CLAY (CL)
◇	SSC DH23	29.0	38	19	LEAN CLAY WITH SAND (CL)

Remark :

Project No. 9E-AB

NEW MEXICO SSC PROPOSAL JULY 31, 1987

New Mexico
Bureau of Mines

GRAIN SIZE DISTRIBUTION

UNIFIED SOIL CLASSIFICATION

COBBLES	GRAVEL		SAND			SILT OR CLAY
	COARSE	FINE	COARSE	MEDIUM	FINE	
U.S. SIEVE SIZE IN INCHES			U.S. STANDARD SIEVE No.			HYDROMETER

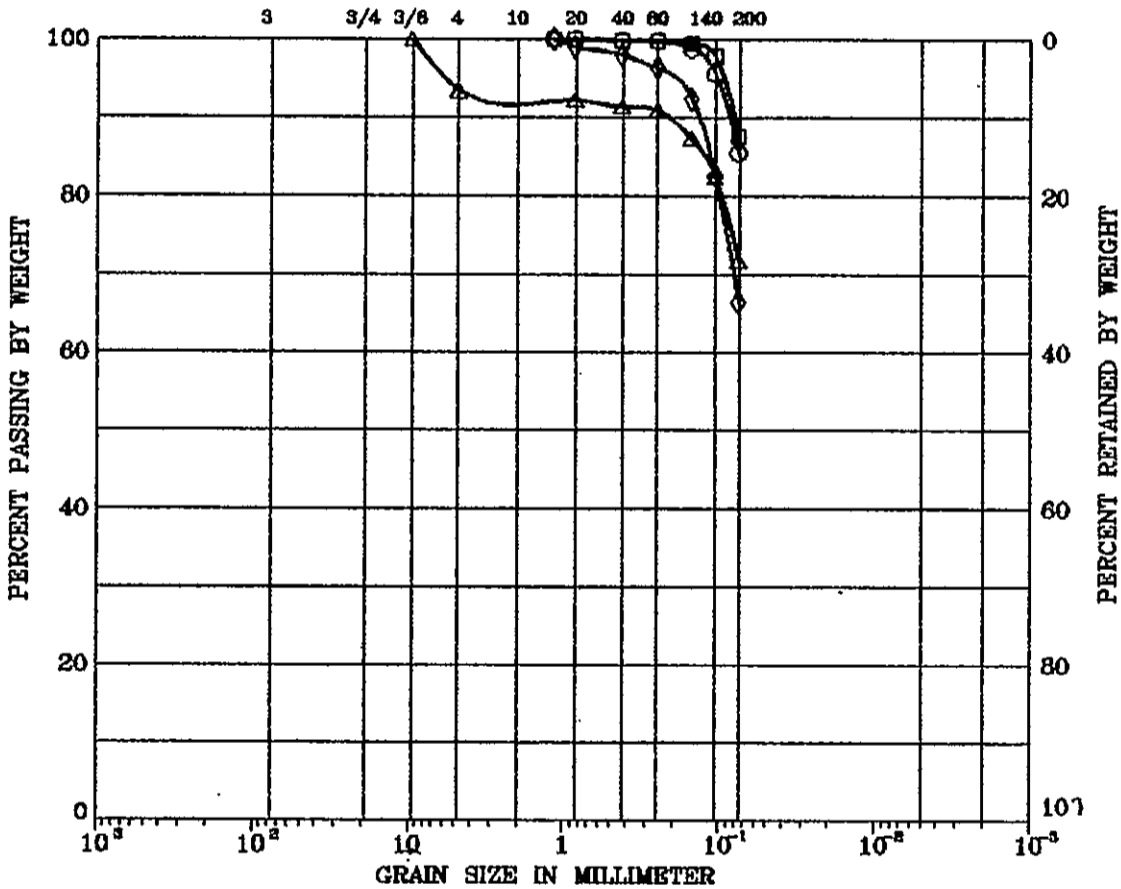

SYMBOL	BORING	DEPTH (ft)	LL (%)	PI (%)	DESCRIPTION
○	SSC DH24	4.0	32	12	LEAN CLAY (CL)
□	SSC DH24	9.0	29	10	LEAN CLAY (CL)
△	SSC DH24	19.0	24	3	SILT WITH SAND (ML)
◇	SSC DH24	29.0	29	17	SANDY LEAN CLAY (CL)

Remark :

Project No. 9E-AB

NEW MEXICO SSC PROPOSAL JULY 31, 1967

New Mexico
Bureau of Mines

GRAIN SIZE DISTRIBUTION

UNIFIED SOIL CLASSIFICATION

COBBLES	GRAVEL		SAND			SILT OR CLAY
	COARSE	FINE	COARSE	MEDIUM	FINE	
U.S. SIEVE SIZE IN INCHES			U.S. STANDARD SIEVE No.			HYDROMETER

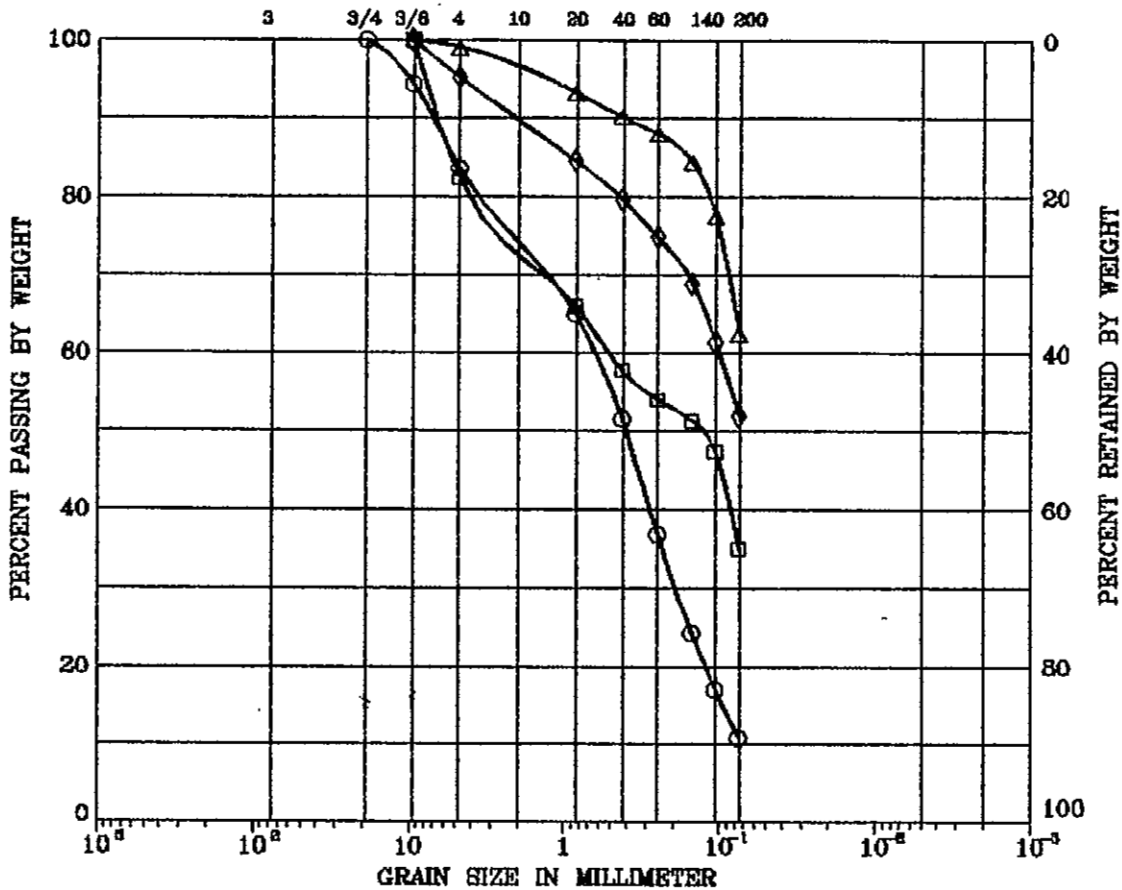

SYMBOL	BORING	DEPTH (ft)	LL (%)	PI (%)	DESCRIPTION
○	SSC DH25	4.0			POORLY-GRADED SAND WITH SILT AND GRAVEL (SP-SM)
□	SSC DH25	9.0			SILTY, CLAYEY SAND (SM-SC)
△	SSC DH25	9.5	31	13	SANDY LEAN CLAY (CL)
◇	SSC DH25	19.0	31	8	SANDY LEAN CLAY (CL)

Remark :

Project No. 9E-AB

NEW MEXICO SSC PROPOSAL JULY 31, 1987

New Mexico
Bureau of Mines

GRAIN SIZE DISTRIBUTION

UNIFIED SOIL CLASSIFICATION

COBBLES	GRAVEL		SAND			SILT OR CLAY
	COARSE	FINE	COARSE	MEDIUM	FINE	
U.S. SIEVE SIZE IN INCHES			U.S. STANDARD SIEVE No.			HYDROMETER

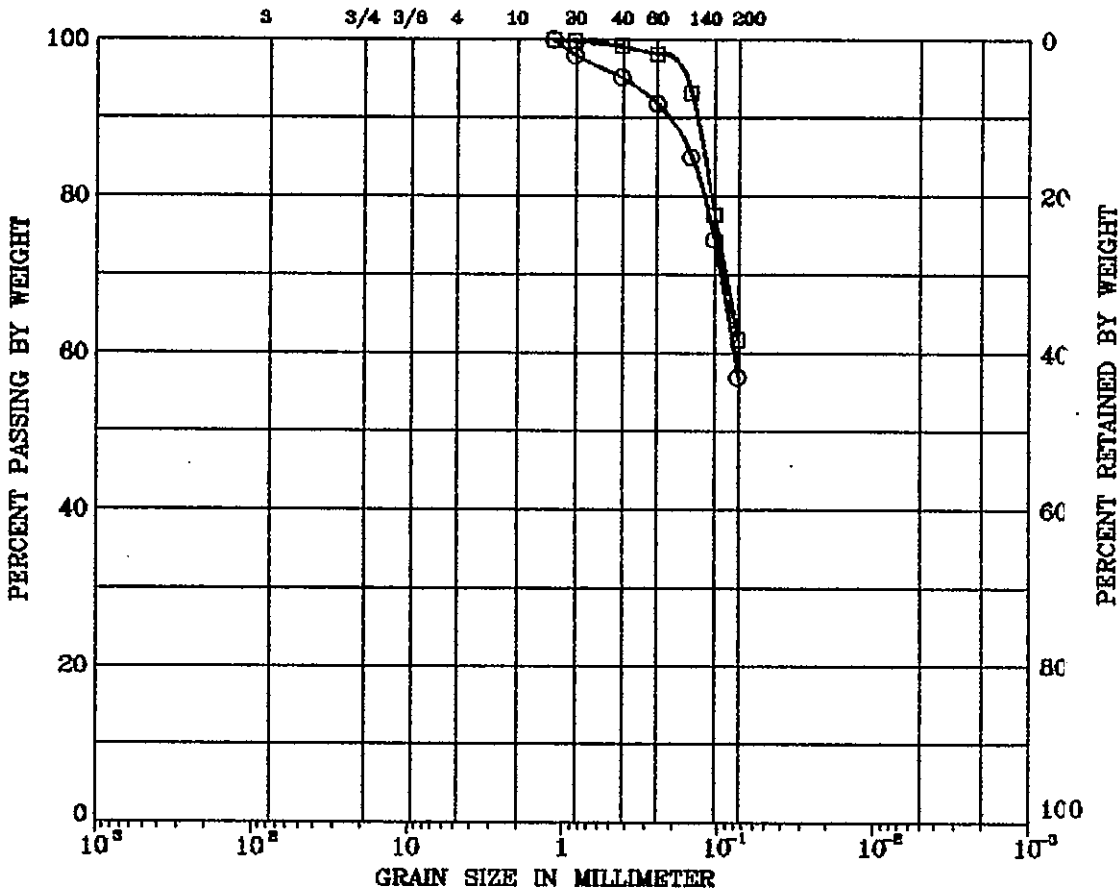

SYMBOL	BORING	DEPTH (ft)	LL (%)	PI (%)	DESCRIPTION
○	SSC DH25	20.0	28	9	SANDY LEAN CLAY (CL)
□	SSC DH25	29.0	28	12	CLAYEY SAND WITH GRAVEL (SC)

Remark :

Project No. 9E-AB

NEW MEXICO SSC PROPOSAL JULY 31, 1987

New Mexico
Bureau of Mines

GRAIN SIZE DISTRIBUTION

UNIFIED SOIL CLASSIFICATION

COBBLES	GRAVEL		SAND			SILT OR CLAY
	COARSE	FINE	COARSE	MEDIUM	FINE	
U.S. SIEVE SIZE IN INCHES			U.S. STANDARD SIEVE No.			HYDROMETER

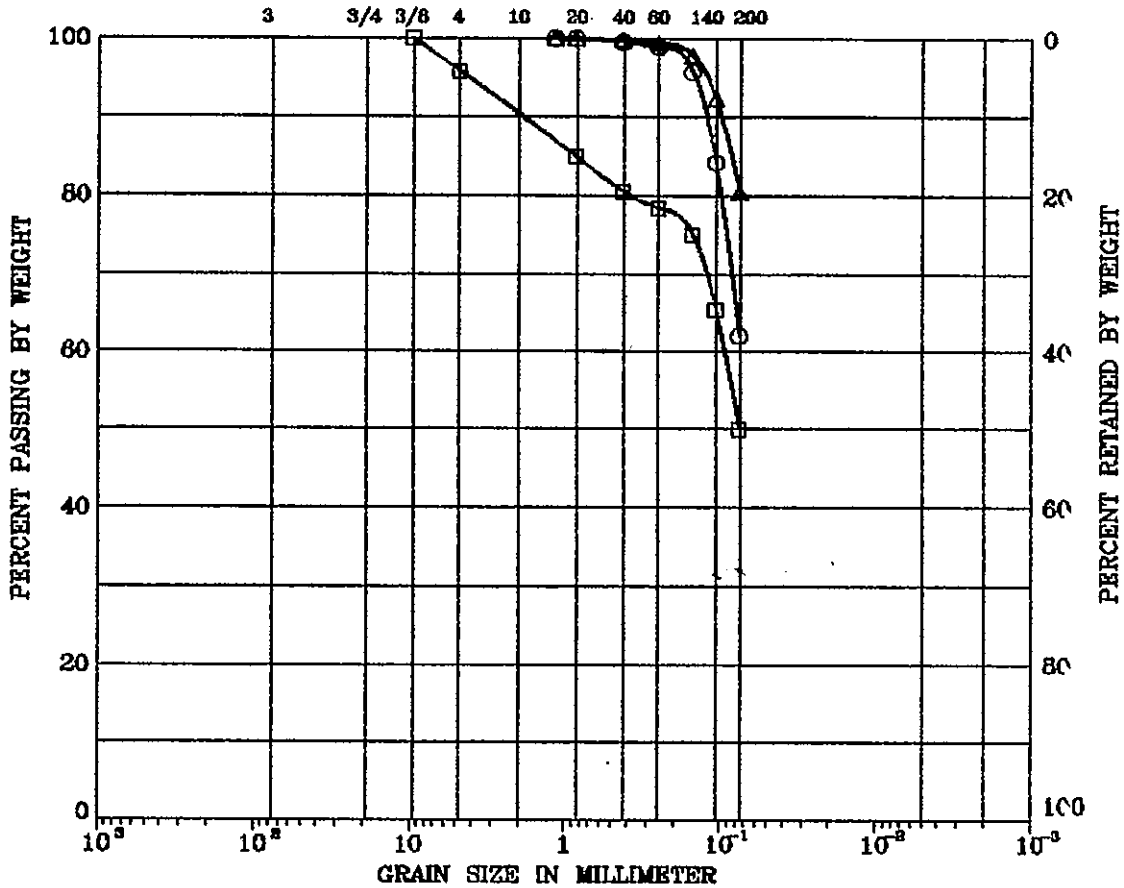

SYMBOL	BORING	DEPTH (ft)	LL (%)	PI (%)	DESCRIPTION
○	SSC DH26	4.0	30	11	SANDY LEAN CLAY (CL)
□	SSC DH26	9.0	23	4	SANDY SILTY CLAY (CL-ML)
△	SSC DH26	9.5	41	23	LEAN CLAY WITH SAND (CL)

Remark :

Project No. 9E-AB	NEW MEXICO SSC PROPOSAL JULY 31, 1967
New Mexico Bureau of Mines	GRAIN SIZE DISTRIBUTION

UNIFIED SOIL CLASSIFICATION

COBBLES	GRAVEL		SAND			SILT OR CLAY
	COARSE	FINE	COARSE	MEDIUM	FINE	
U.S. SIEVE SIZE IN INCHES			U.S. STANDARD SIEVE No.			HYDROMETER

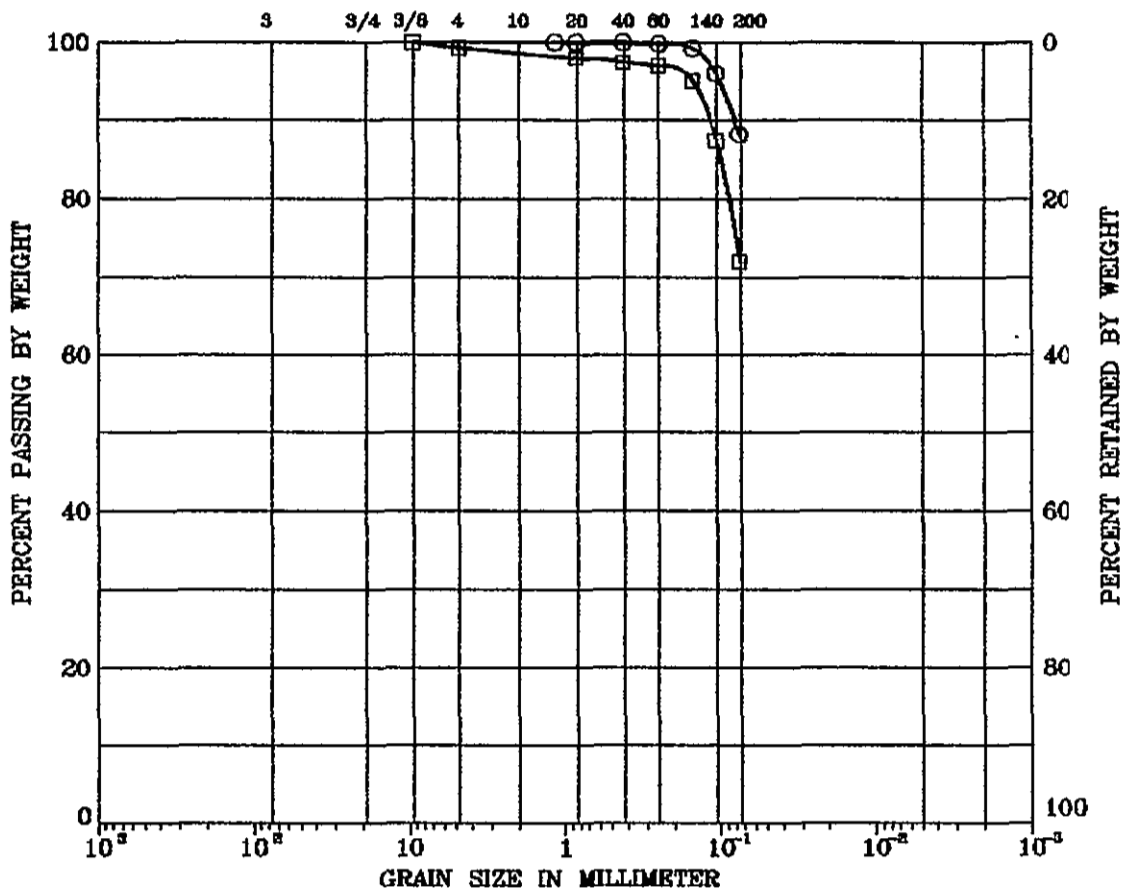

<u>SYMBOL</u>	<u>BORING</u>	<u>DEPTH (ft)</u>	<u>LL (%)</u>	<u>PI (%)</u>	<u>DESCRIPTION</u>
O	SSC DH26	19.0	46	23	LEAN CLAY (CL)
□	SSC DH26	29.0	31	12	LEAN CLAY WITH SAND (CL)

Remark :

Project No. 9E-AB

NEW MEXICO SSC PROPOSAL JULY 31, 1987

New Mexico
Bureau of Mines

GRAIN SIZE DISTRIBUTION

UNIFIED SOIL CLASSIFICATION

COBBLES	GRAVEL		SAND			SILT OR CLAY
	COARSE	FINE	COARSE	MEDIUM	FINE	
U.S. SIEVE SIZE IN INCHES			U.S. STANDARD SIEVE No.			HIDROMETER

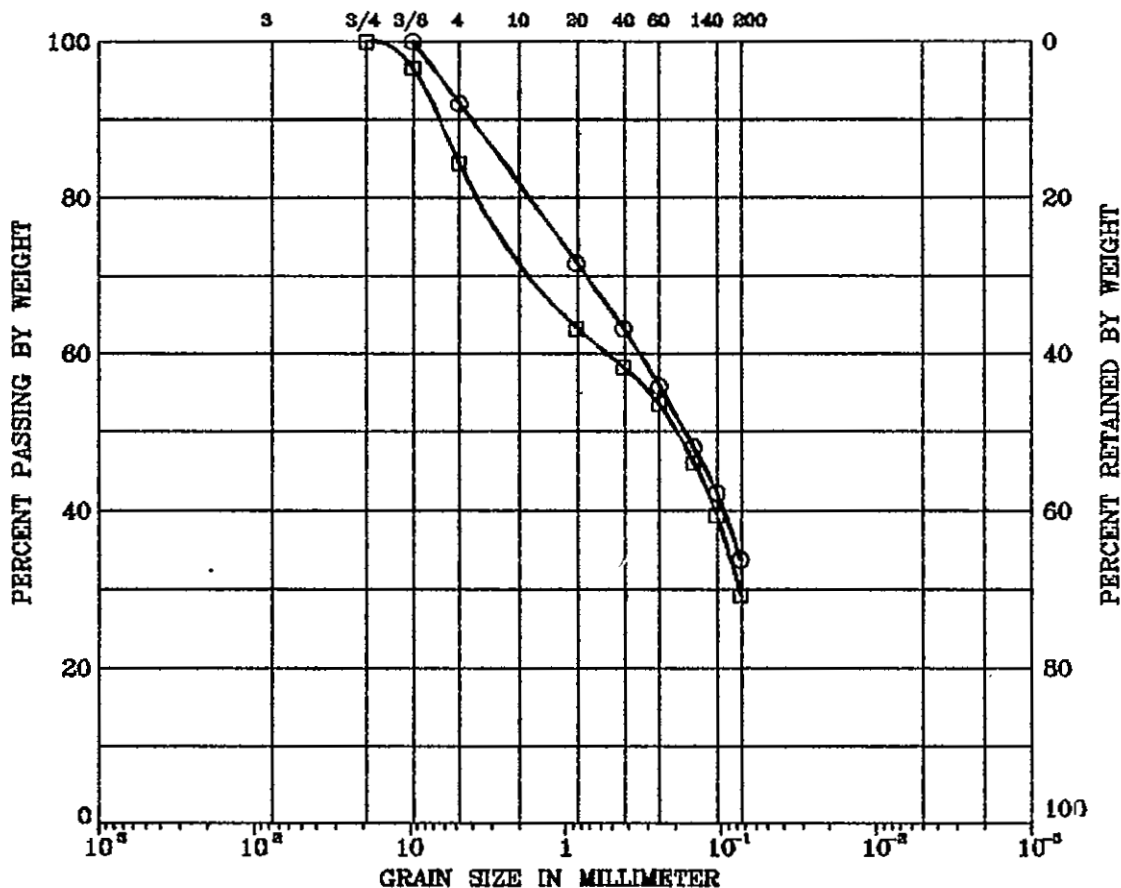

<u>SYMBOL</u>	<u>BORING</u>	<u>DEPTH (ft)</u>	<u>LL (%)</u>	<u>PI (%)</u>	<u>DESCRIPTION</u>
○	SSC DH30	15.0			SILTY SAND (SM)
□	SSC DH30	25.0			SILTY SAND (SM)

Remark :

Project No. 9E-AB

NEW MEXICO SSC PROPOSAL JULY 31, 1987

New Mexico
Bureau of Mines

GRAIN SIZE DISTRIBUTION

UNIFIED SOIL CLASSIFICATION

COBBLES	GRAVEL		SAND			SILT OR CLAY
	COARSE	FINE	COARSE	MEDIUM	FINE	
U.S. Sieve Size in Inches			U.S. Standard Sieve No.			Hydrometer

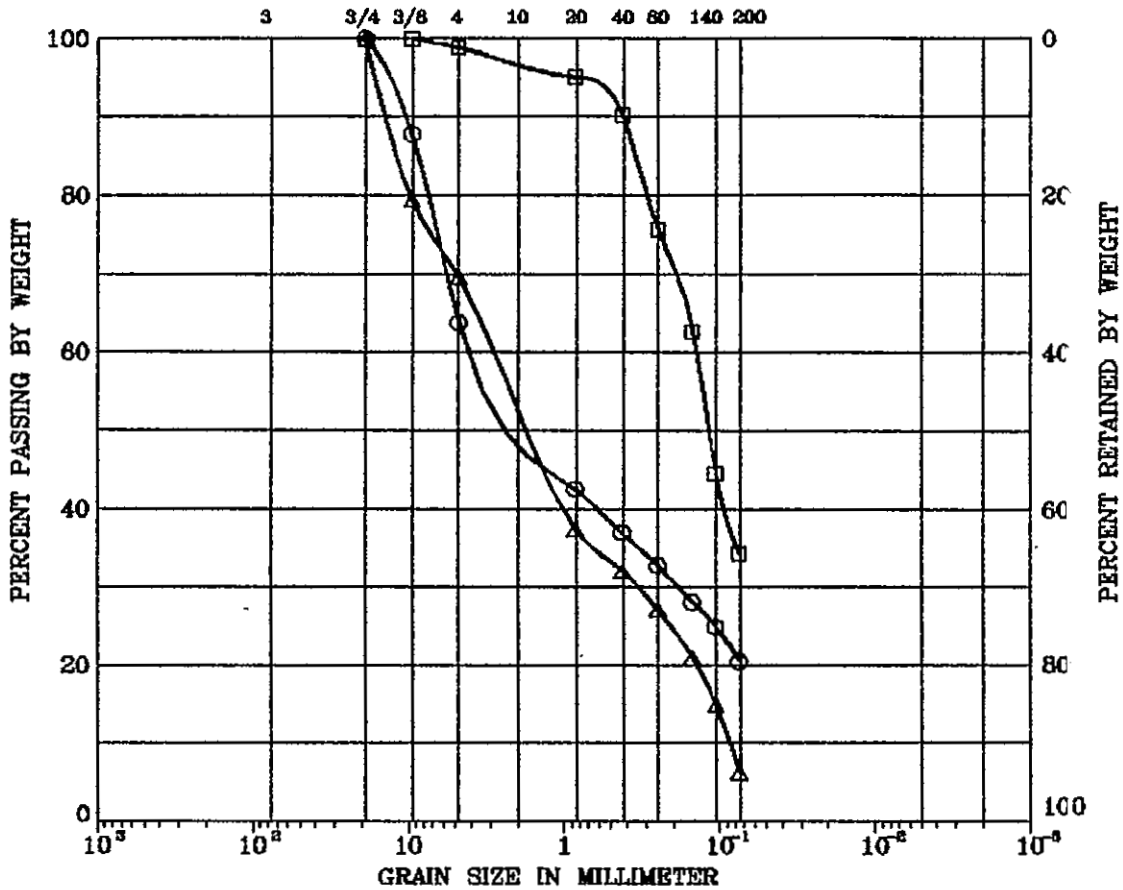

<u>SYMBOL</u>	<u>BORING</u>	<u>DEPTH (ft)</u>	<u>LL (%)</u>	<u>PI (%)</u>	<u>DESCRIPTION</u>
○	SSC DH31	2.0			SILTY SAND (SM)
□	SSC DH31	12.0			SILTY, CLAYEY SAND (SM-SC)
△	SSC DH31	22.25			SILTY SAND (SM)

Remark :

Project No. 9E-AB	NEW MEXICO SSC PROPOSAL JULY 31, 1987
New Mexico Bureau of Mines	GRAIN SIZE DISTRIBUTION

UNIFIED SOIL CLASSIFICATION

COBBLES	GRAVEL		SAND			SILT OR CLAY
	COARSE	FINE	COARSE	MEDIUM	FINE	
U.S. SIEVE SIZE IN INCHES			U.S. STANDARD SIEVE No.			HYDROMETER

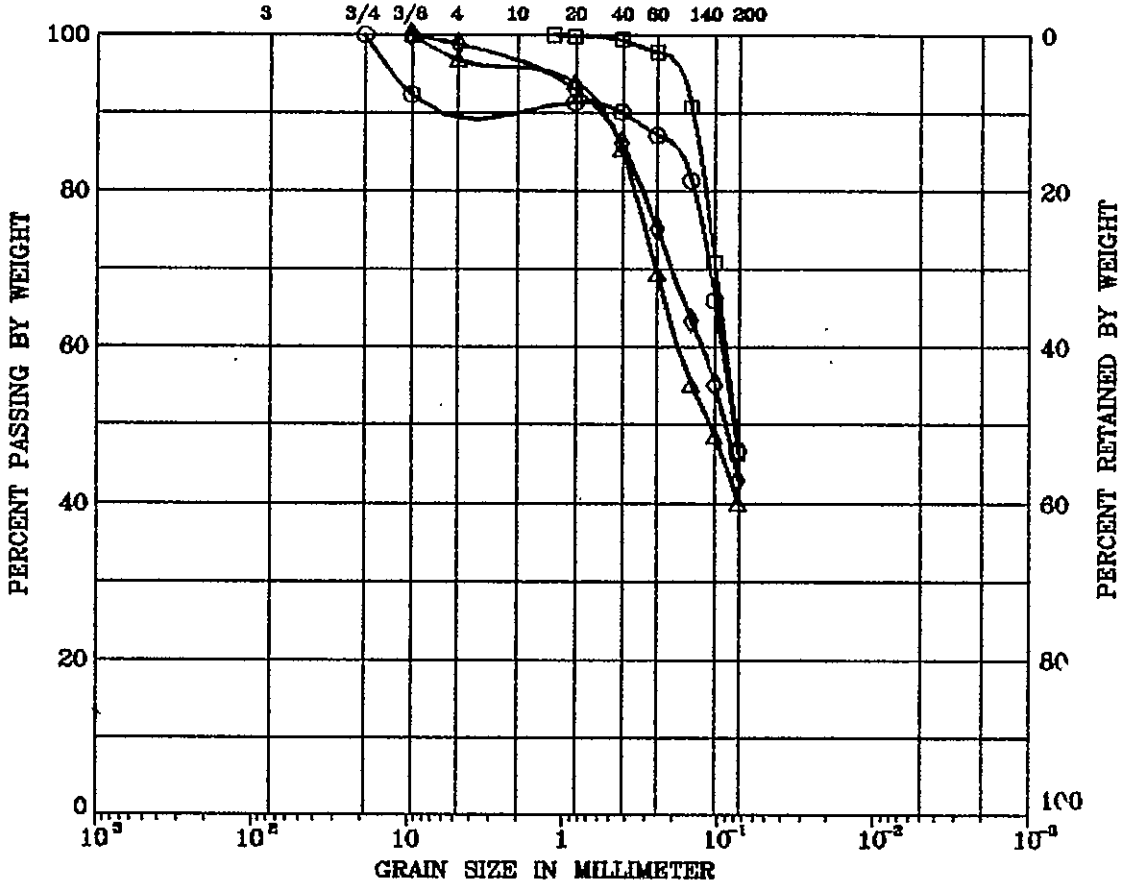

SYMBOL	BORING	DEPTH (ft)	LL (%)	PI (%)	DESCRIPTION
○	SSC DH33	5.0			SILTY SAND (SM)
□	SSC DH33	13.0			SILTY SAND (SM)
△	SSC DH33	23.0			SILTY SAND (SM)
◇	SSC DH33	37.083			SILTY SAND (SM)

Remark :

Project No. 9E-AB	NEW MEXICO SSC PROPOSAL JULY 31, 1987
New Mexico Bureau of Mines	GRAIN SIZE DISTRIBUTION

UNIFIED SOIL CLASSIFICATION

COBBLES	GRAVEL		SAND			SILT OR CLAY
	COARSE	FINE	COARSE	MEDIUM	FINE	
U.S. SIEVE SIZE IN INCHES			U.S. STANDARD SIEVE No.			HYDROMETER

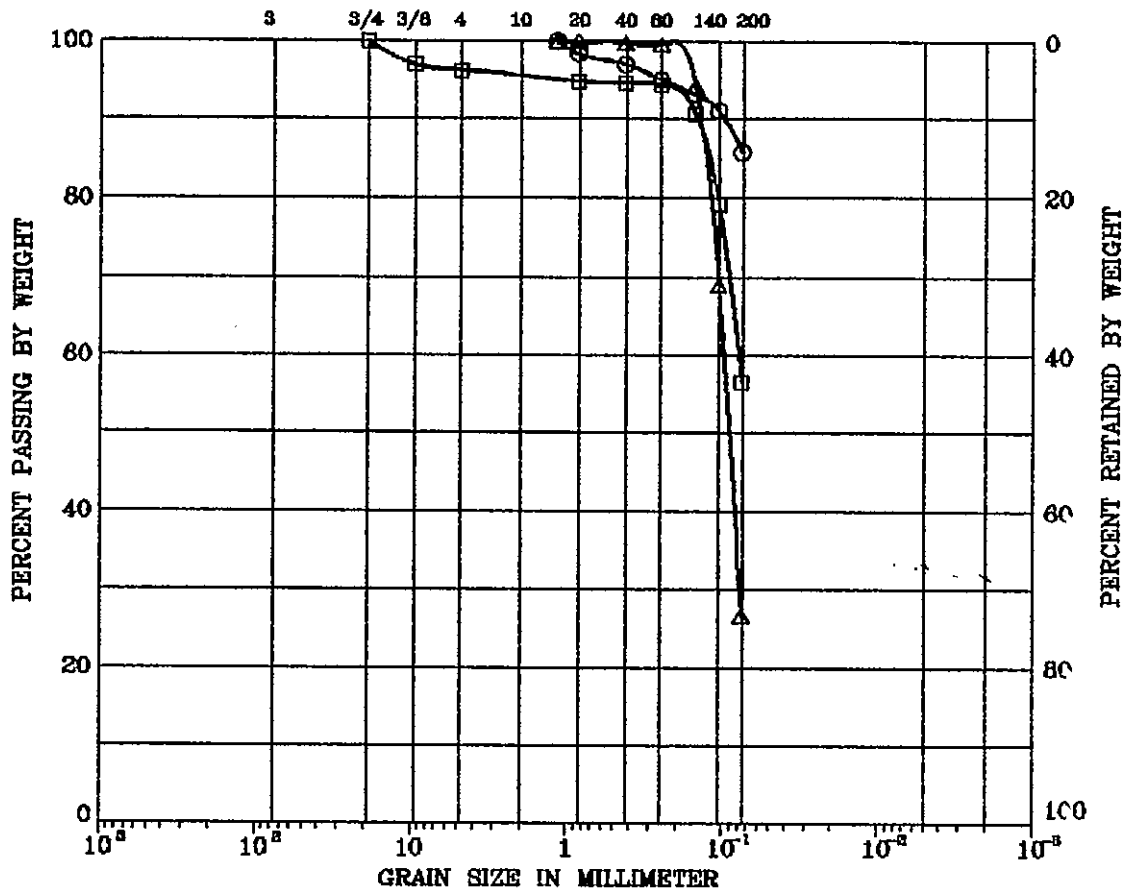

SYMBOL	BORING	DEPTH (ft)	LL (%)	PI (%)	DESCRIPTION
○	SSC DH35	4.75			LEAN CLAY (CL)
□	SSC DH35	9.66			SANDY SILT (ML)
△	SSC DH35	25.0			POORLY-GRADED SAND (SP)

Remark :

Project No. 9E-AB

NEW MEXICO SSC PROPOSAL JULY 31, 1987

New Mexico
Bureau of Mines

GRAIN SIZE DISTRIBUTION

UNIFIED SOIL CLASSIFICATION

COBBLES	GRAVEL		SAND			SILT OR CLAY
	COARSE	FINE	COARSE	MEDIUM	FINE	
U.S. SIEVE SIZE IN INCHES			U.S. STANDARD SIEVE No.			HYDROMETER

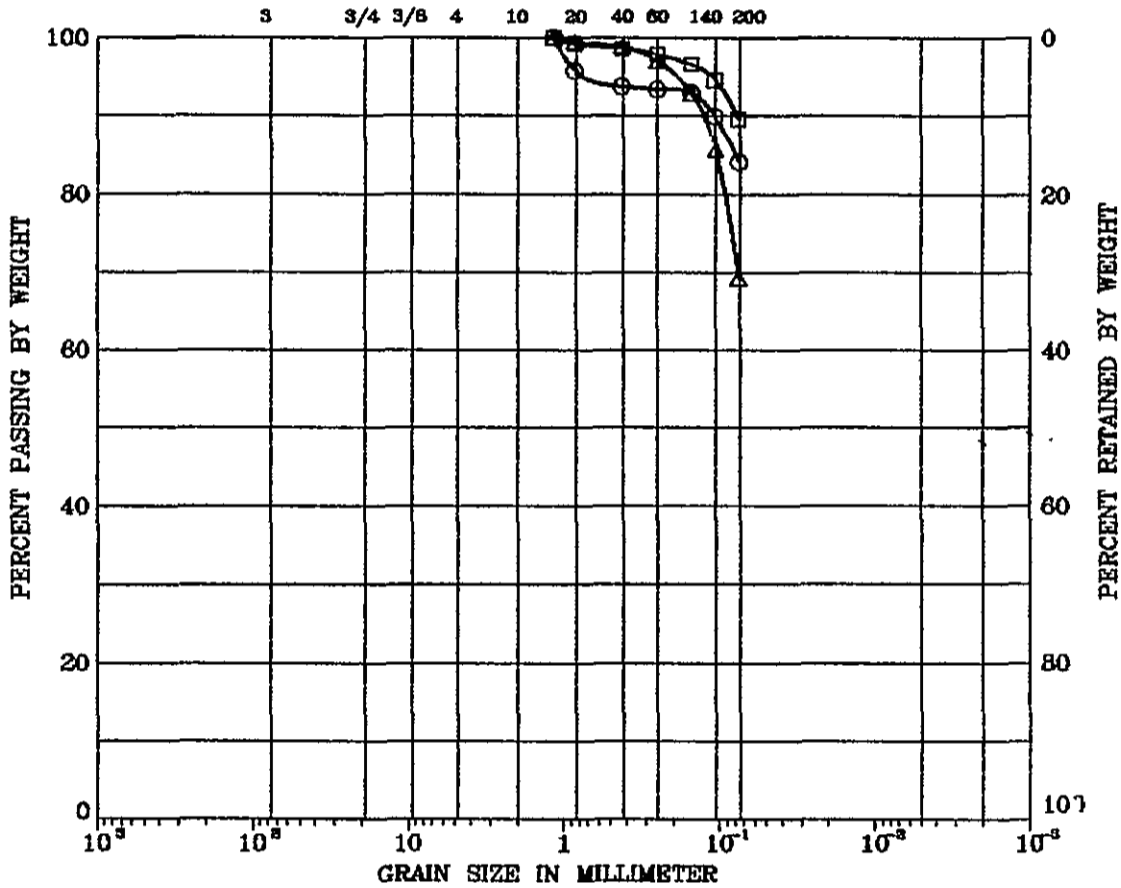

<u>SYMBOL</u>	<u>BORING</u>	<u>DEPTH (ft)</u>	<u>LL (%)</u>	<u>PI (%)</u>	<u>DESCRIPTION</u>
○	SSC DH35	34.833			LEAN CLAY WITH SAND (CL)
□	SSC DH35	48.5			LEAN CLAY (CL)
△	SSC DH35	59.25			SANDY LEAN CLAY (CL)

Remark :

Project No. 9E-AB

NEW MEXICO SSC PROPOSAL JULY 31, 1987

New Mexico
Bureau of Mines

GRAIN SIZE DISTRIBUTION

UNIFIED SOIL CLASSIFICATION

COBBLES	GRAVEL		SAND			SILT OR CLAY
	COARSE	FINE	COARSE	MEDIUM	FINE	
U.S. SIEVE SIZE IN INCHES			U.S. STANDARD SIEVE No.			HYDROMETER

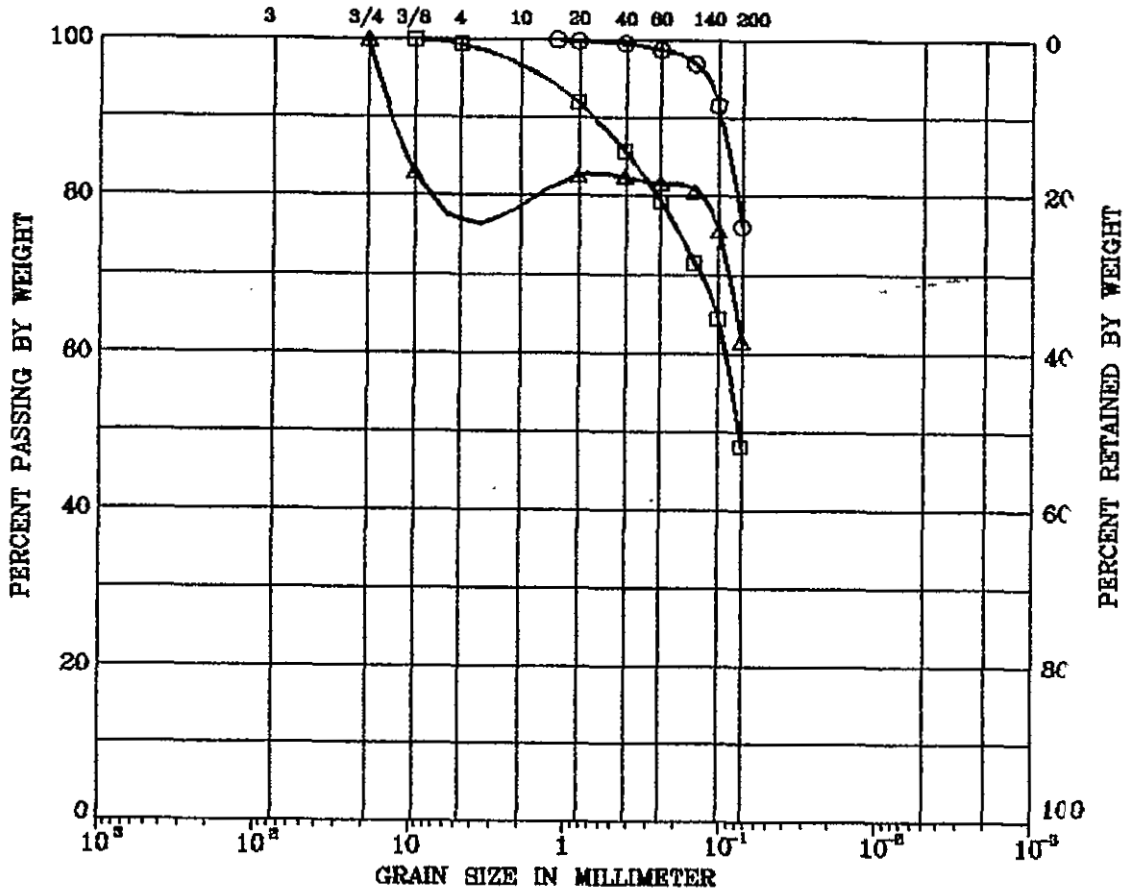

SYMBOL	BORING	DEPTH (ft)	LL (%)	PI (%)	DESCRIPTION
○	SSC DH36	17.5			LEAN CLAY WITH SAND (CL)
□	SSC DH36	20.0			SILTY SAND (SM)
Δ	SSC DH36	30.0			SANDY LEAN CLAY (CL)

Remark :

Project No. 9E-AB

NEW MEXICO SSC PROPOSAL JULY 31, 1987

New Mexico
Bureau of Mines

GRAIN SIZE DISTRIBUTION

UNIFIED SOIL CLASSIFICATION

COBBLES	GRAVEL		SAND			SILT OR CLAY
	COARSE	FINE	COARSE	MEDIUM	FINE	
U.S. SIEVE SIZE IN INCHES			U.S. STANDARD SIEVE No.			HYDROMETER

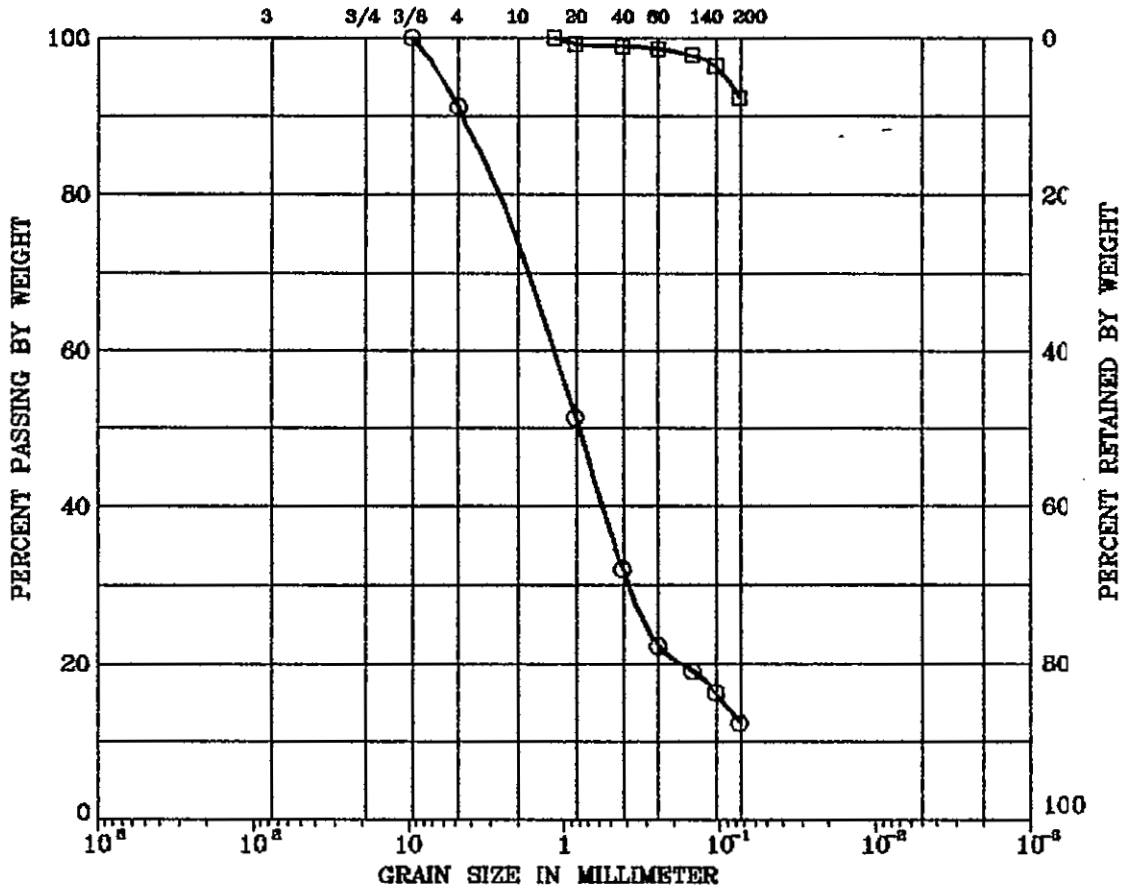

<u>SYMBOL</u>	<u>BORING</u>	<u>DEPTH (ft.)</u>	<u>LL (%)</u>	<u>PI (%)</u>	<u>DESCRIPTION</u>
○	SSC DH36	38.0			POORLY GRADED SAND WITH SILT (SP-SM)
□	SSC DH36	53.0			LEAN CLAY (CL)

Remark :

Project No. 9E-AB	NEW MEXICO SSC PROPOSAL JULY 31, 1987
New Mexico Bureau of Mines	GRAIN SIZE DISTRIBUTION

UNIFIED SOIL CLASSIFICATION

COBBLES	GRAVEL		SAND			SILT OR CLAY
	COARSE	FINE	COARSE	MEDIUM	FINE	
U.S. SIEVE SIZE IN INCHES			U.S. STANDARD SIEVE No.			HYDROMETER

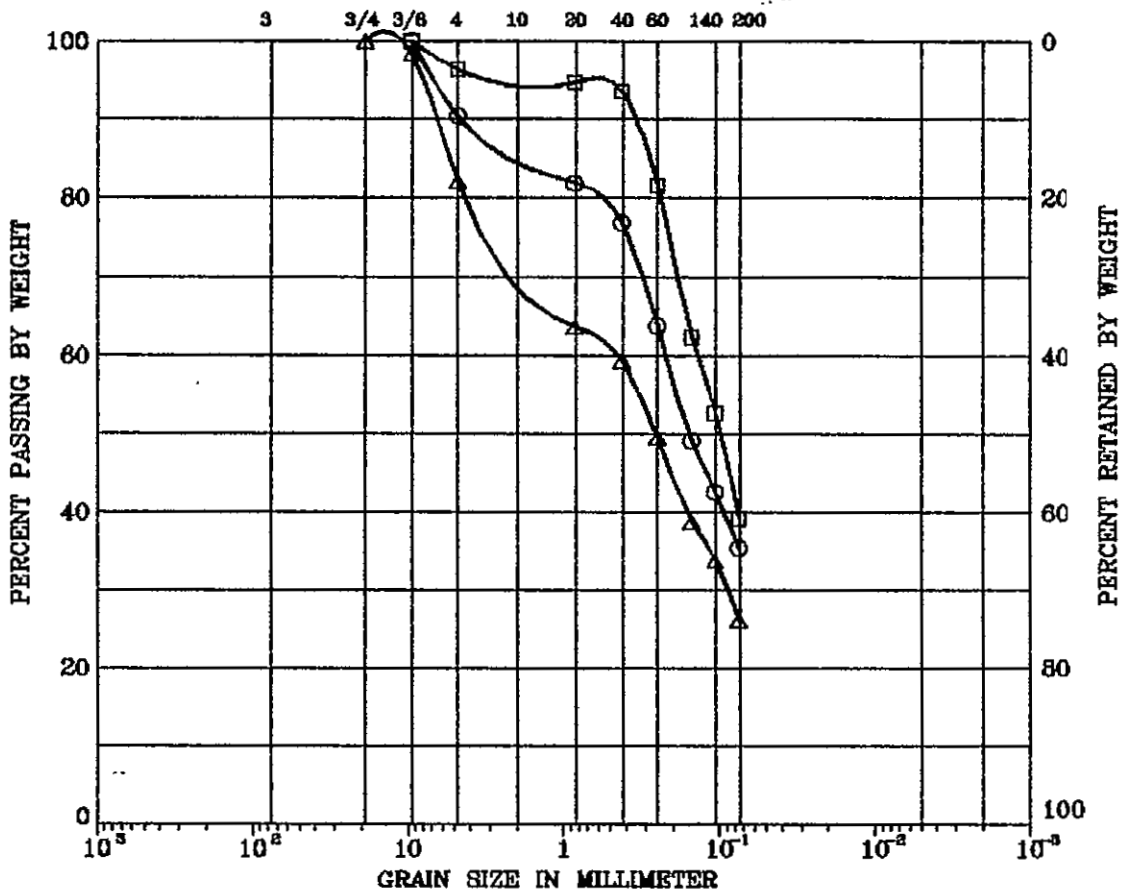

SYMBOL	BORING	DEPTH (ft)	LL (%)	PI (%)	DESCRIPTION
○	SSC DH38	3.0			SILTY SAND (SM)
□	SSC DH38	13.0			SILTY SAND (SM)
△	SSC DH38	23.0			SILTY SAND (SM)

Remark :

Project No. 9E-AB

NEW MEXICO SSC PROPOSAL JULY 31, 1967

New Mexico
Bureau of Mines

GRAIN SIZE DISTRIBUTION

UNIFIED SOIL CLASSIFICATION

COBBLES	GRAVEL		SAND			SILT OR CLAY
	COARSE	FINE	COARSE	MEDIUM	FINE	
U.S. SIEVE SIZE IN INCHES			U.S. STANDARD SIEVE No.			HYDROMETER

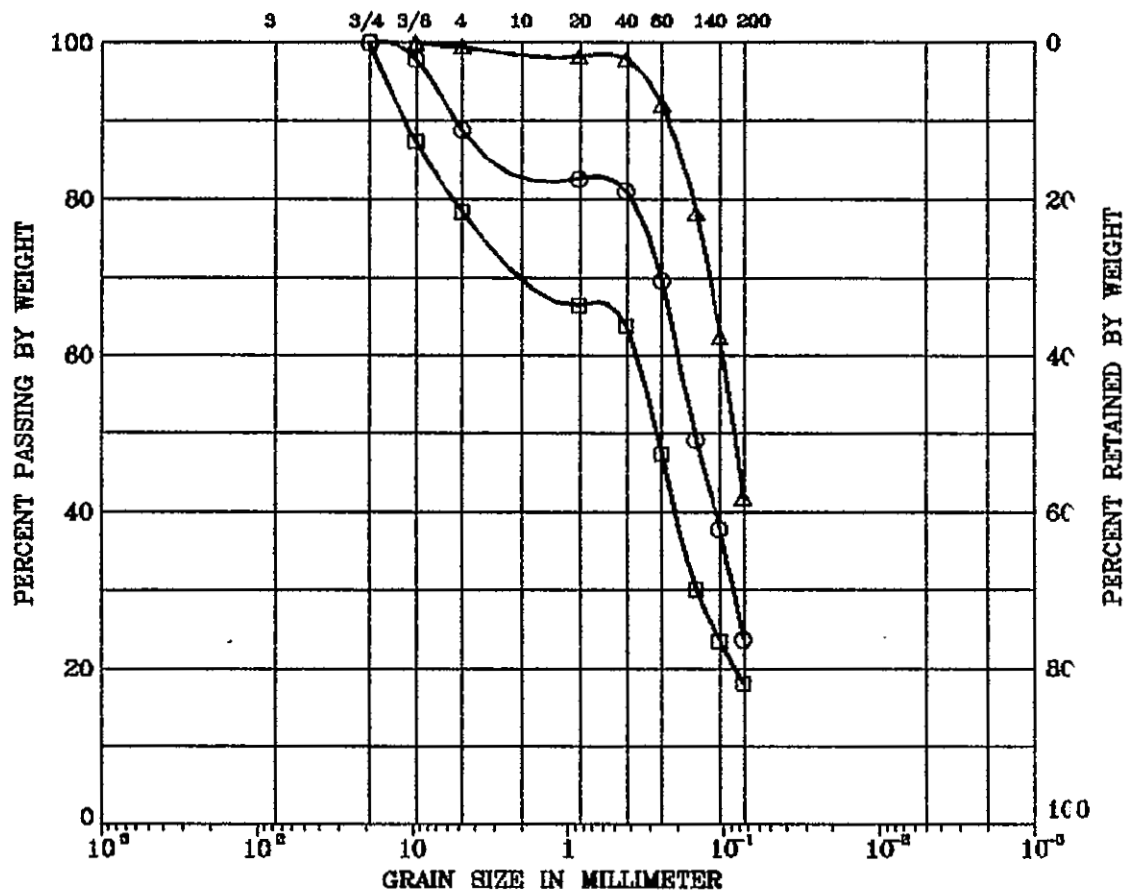

SYMBOL	BORING	DEPTH (ft)	LL (%)	PI (%)	DESCRIPTION
○	SSC DH38	33.0			SILTY SAND (SM)
□	SSC DH38	73.0			CLAYEY SAND (SC)
△	SSC DH38	108.0			SILTY SAND (SM)

Remark :

Project No. 9E-AB

NEW MEXICO SSC PROPOSAL JULY 31, 1987

New Mexico
Bureau of Mines

GRAIN SIZE DISTRIBUTION

UNIFIED SOIL CLASSIFICATION

COBBLES	GRAVEL		SAND			SILT OR CLAY
	COARSE	FINE	COARSE	MEDIUM	FINE	
U.S. SIEVE SIZE IN INCHES			U.S. STANDARD SIEVE No.			HYDROMETER

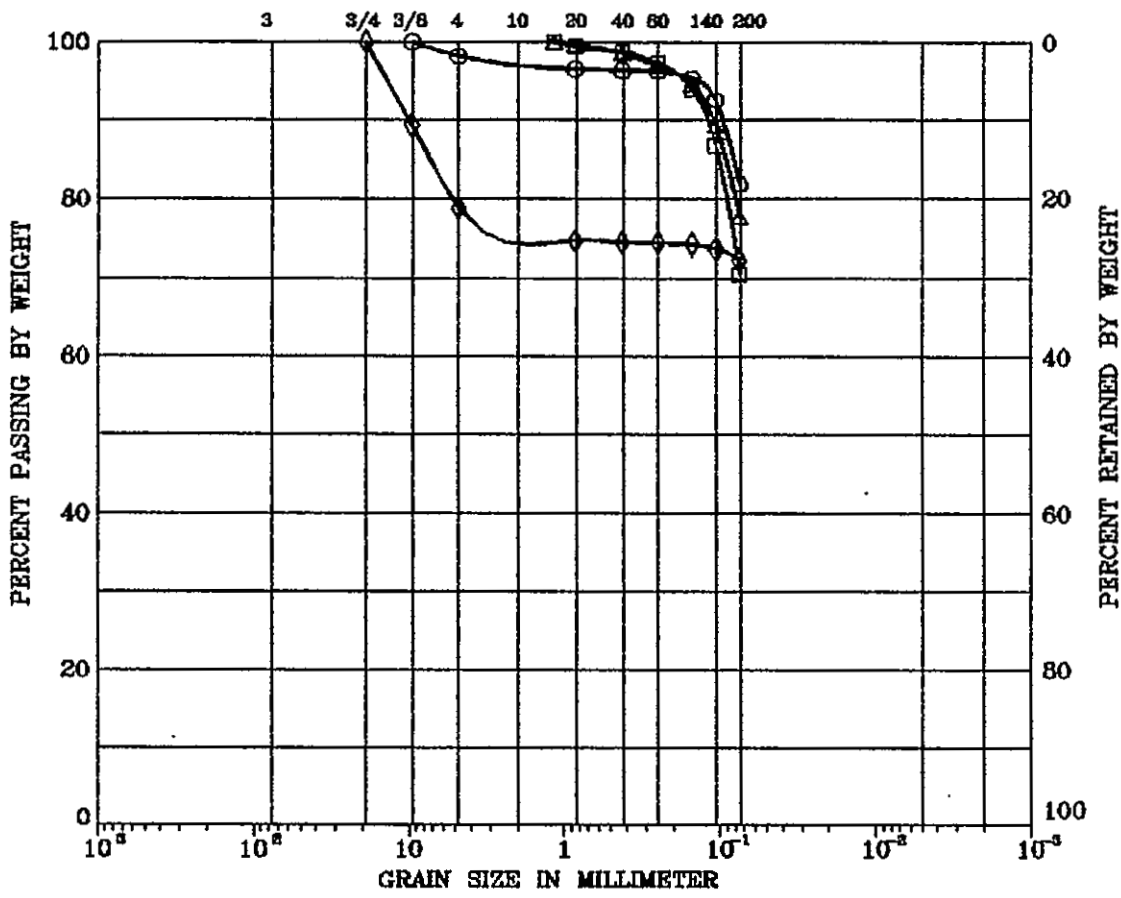

SYMBOL	BORING	DEPTH (ft)	LL (%)	PI (%)	DESCRIPTION
○	SSC DH39	3.0			SILTY CLAY (CL-ML)
□	SSC DH40	5.083			SANDY SILT (ML)
△	SSC DH40	14.33			SILTY CLAY (CL-ML)
◇	SSC DH40	23.0			GRAVELLY LEAN CLAY (CL)

Remark :

Project No. 9E-AB	NEW MEXICO SSC PROPOSAL JULY 31, 1987
-------------------	---------------------------------------

New Mexico Bureau of Mines	GRAIN SIZE DISTRIBUTION
----------------------------	-------------------------

UNIFIED SOIL CLASSIFICATION

COBBLES	GRAVEL		SAND			SILT OR CLAY
	COARSE	FINE	COARSE	MEDIUM	FINE	
U.S. SIEVE SIZE IN INCHES			U.S. STANDARD SIEVE No.			HYDROMETER

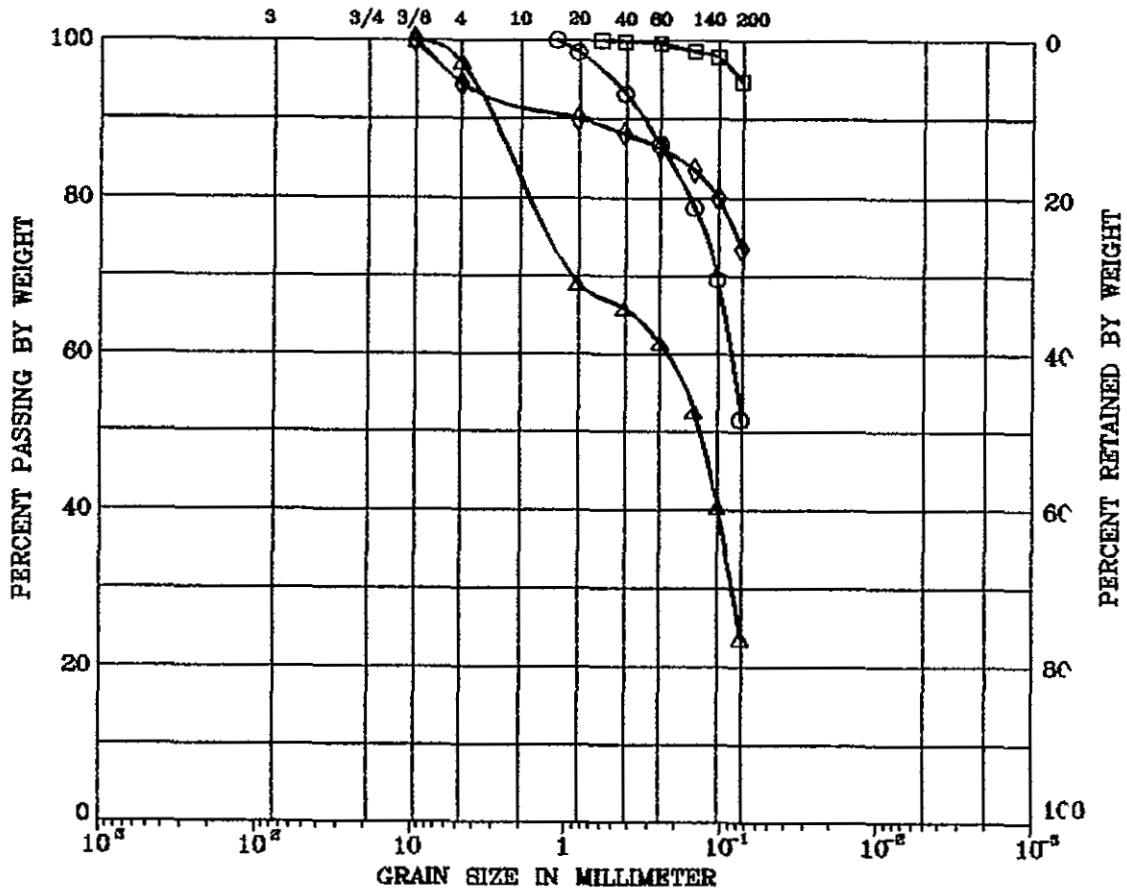

SYMBOL	BORING	DEPTH (ft)	LL (%)	FI (%)	DESCRIPTION
○	SSC DH40	33.0			SANDY SILT (ML)
□	SSC DH40	43.0			SILTY CLAY (CL-ML)
△	SSC DH40	54.83			CLAYEY SAND (SC)
◇	SSC DH40	63.0			LEAN CLAY WITH SAND (CL)

Remark :

Project No. 9E-AB NEW MEXICO SSC PROPOSAL JULY 31, 1987

New Mexico Bureau of Mines **GRAIN SIZE DISTRIBUTION**

UNIFIED SOIL CLASSIFICATION

<i>COBBLES</i>	<i>GRAVEL</i>		<i>SAND</i>			<i>SILT OR CLAY</i>
	COARSE	FINE	COARSE	MEDIUM	FINE	
U.S. SIEVE SIZE IN INCHES			U.S. STANDARD SIEVE No.			HYDROMETER

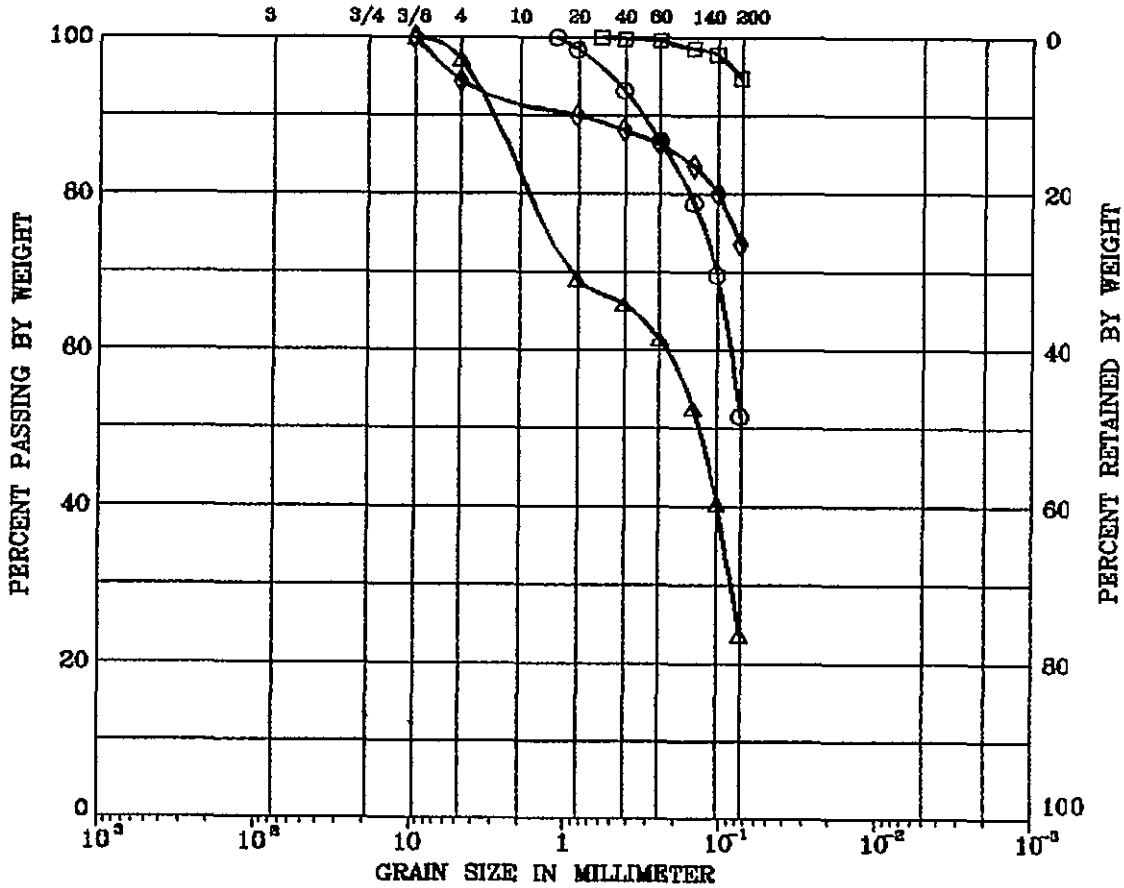

<u>SYMBOL</u>	<u>BORING</u>	<u>DEPTH (ft)</u>	<u>LL (%)</u>	<u>PI (%)</u>	<u>DESCRIPTION</u>
○	SSC DH40	33.0			SANDY SILT (ML)
□	SSC DH40	43.0			SILTY CLAY (CL-ML)
△	SSC DH40	54.83			CLAYEY SAND (SC)
◇	SSC DH40	63.0			LEAN CLAY WITH SAND (CL)

Remark :

Project No. 9E-AB	NEW MEXICO SSC PROPOSAL, JULY 31, 1987
-------------------	--

New Mexico Bureau of Mines	GRAIN SIZE DISTRIBUTION
----------------------------	--------------------------------

UNIFIED SOIL CLASSIFICATION

COBBLES	GRAVEL		SAND			SILT OR CLAY
	COARSE	FINE	COARSE	MEDIUM	FINE	
U.S. SIEVE SIZE IN INCHES		U.S. STANDARD SIEVE No.			HYDROMETER	

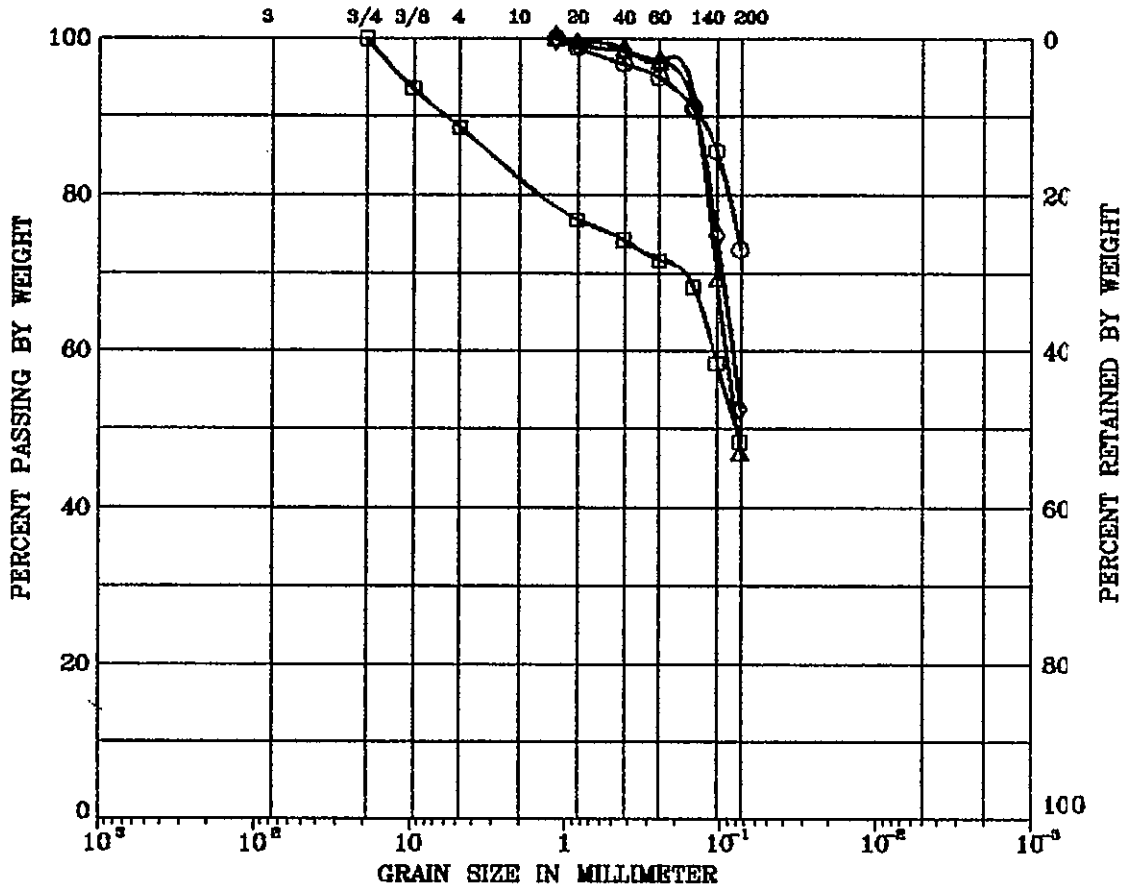

SYMBOL	BORING	DEPTH (ft)	LL (%)	PI (%)	DESCRIPTION
○	SSC BH1	4.0	35	10	SILT WITH SAND (ML)
□	SSC BH1	6.6			SILTY SAND (SM)
△	SSC BH1	8.2	27	5	SILTY SAND (SM)
◇	SSC BH1	9.4	25	4	SILTY CLAY (CL-ML)

Remark :

Project No. 9E-AB

NEW MEXICO SSC PROPOSAL JULY 31, 1987

New Mexico
Bureau of Mines

GRAIN SIZE DISTRIBUTION

UNIFIED SOIL CLASSIFICATION

COBBLES	GRAVEL		SAND			SILT OR CLAY
	COARSE	FINE	COARSE	MEDIUM	FINE	
U.S. SIEVE SIZE IN INCHES			U.S. STANDARD SIEVE No.			HYDROMETER

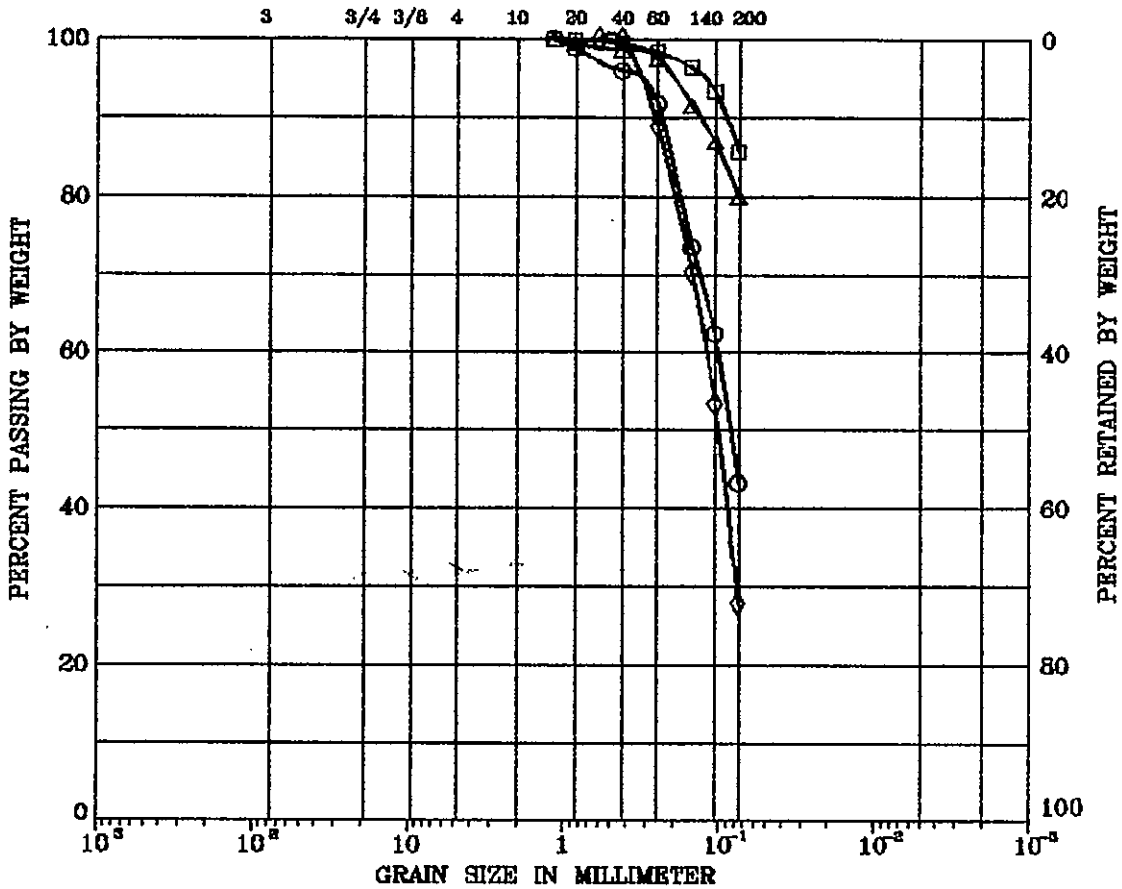

SYMBOL	BORING	DEPTH (ft)	LL (%)	PI (%)	DESCRIPTION
○	SSC BH2	1.2	26	6	SILTY, CLAYEY SAND (SM-SC)
□	SSC BH2	3.0	37	13	LEAN CLAY (CL)
△	SSC BH2	5.5	36	9	SILT WITH SAND (ML)
◇	SSC BH2	6.9	30	8	CLAYEY SAND (SC)

Remark :

Project No.9E-AB

NEW MEXICO SSC PROPOSAL JULY 31, 1987

New Mexico
Bureau of Mines

GRAIN SIZE DISTRIBUTION

UNIFIED SOIL CLASSIFICATION

COBBLES	GRAVEL		SAND			SILT OR CLAY
	COARSE	FINE	COARSE	MEDIUM	FINE	
U.S. SIEVE SIZE IN INCHES			U.S. STANDARD SIEVE No.			HYDROMETER

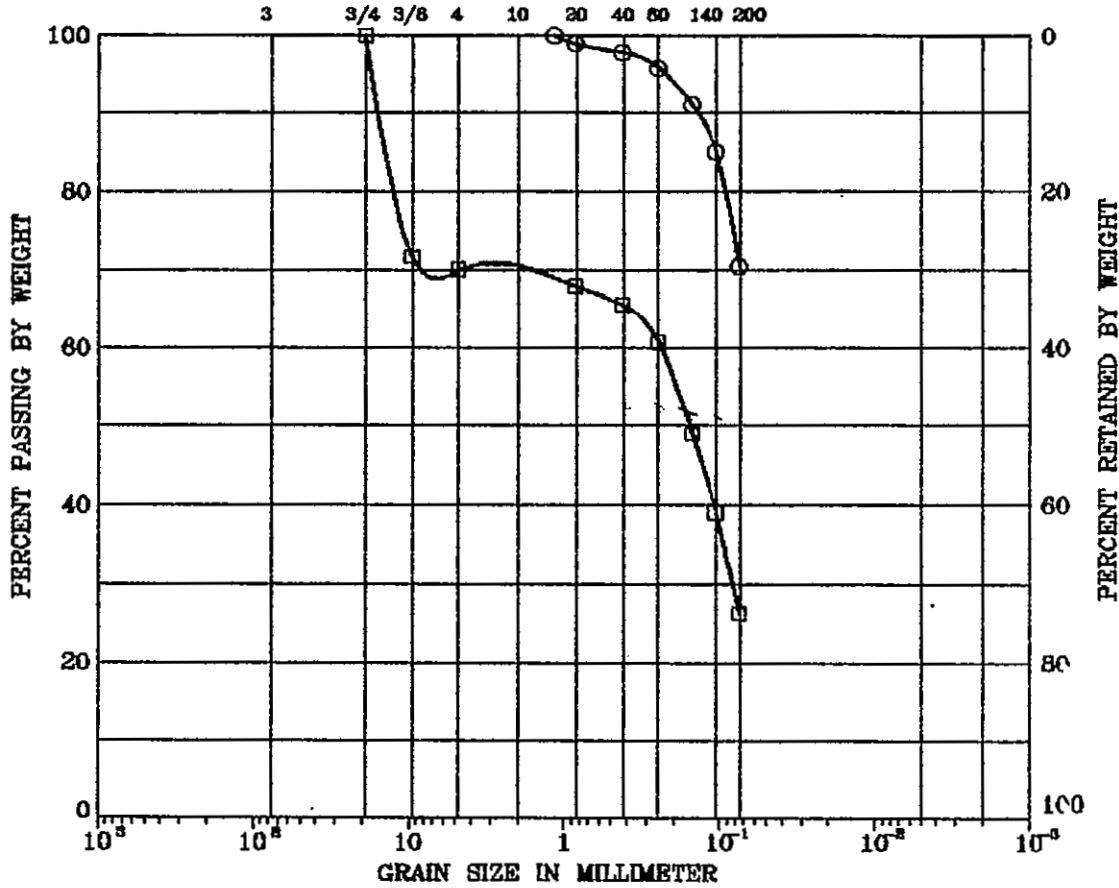

SYMBOL	BORING	DEPTH (ft)	LL (%)	PI (%)	DESCRIPTION
○	SSC BH2	7.0	26	6	SILTY CLAY (CL-ML)
□	SSC BH2	11.5	21		SILTY SAND WITH GRAVEL (SM)

Remark :

Project No. 9E-AB	NEW MEXICO SSC PROPOSAL JULY 31, 1967
New Mexico Bureau of Mines	GRAIN SIZE DISTRIBUTION

UNIFIED SOIL CLASSIFICATION

COBBLES	GRAVEL		SAND			SILT OR CLAY
	COARSE	FINE	COARSE	MEDIUM	FINE	
U.S. SIEVE SIZE IN INCHES			U.S. STANDARD SIEVE No.			HYDROMETER

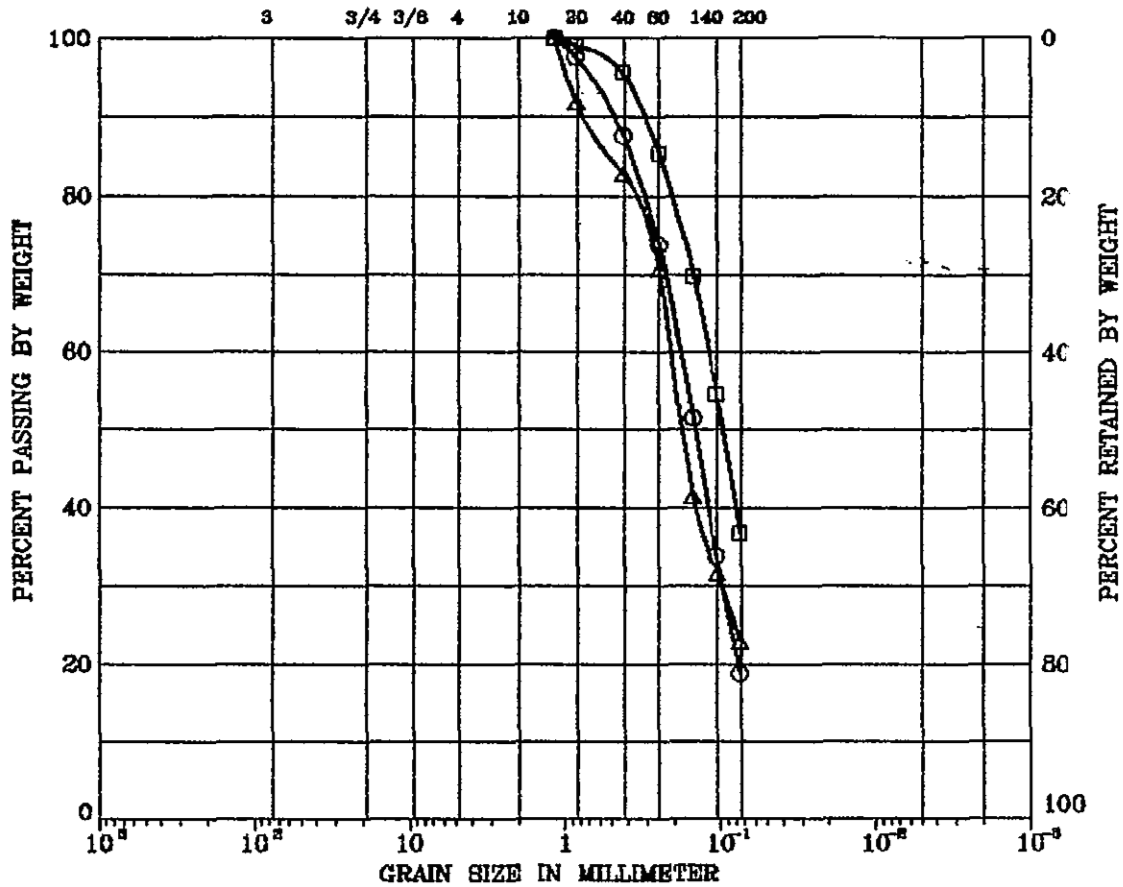

SYMBOL	BORING	DEPTH (ft)	LL (%)	PI (%)	DESCRIPTION
○	SSC BH3	0.4	20		SILTY SAND (SM)
□	SSC BH3	1.0	19		SILTY SAND (SM)
△	SSC BH3	3.0	19		SILTY SAND (SM)

Remark :

Project No. 9E-AB	NEW MEXICO SSC PROPOSAL JULY 31, 1987
New Mexico Bureau of Mines	GRAIN SIZE DISTRIBUTION

UNIFIED SOIL CLASSIFICATION

COBBLES	GRAVEL		SAND			SILT OR CLAY
	COARSE	FINE	COARSE	MEDIUM	FINE	
U.S. SIEVE SIZE IN INCHES			U.S. STANDARD SIEVE No.			HYDROMETER

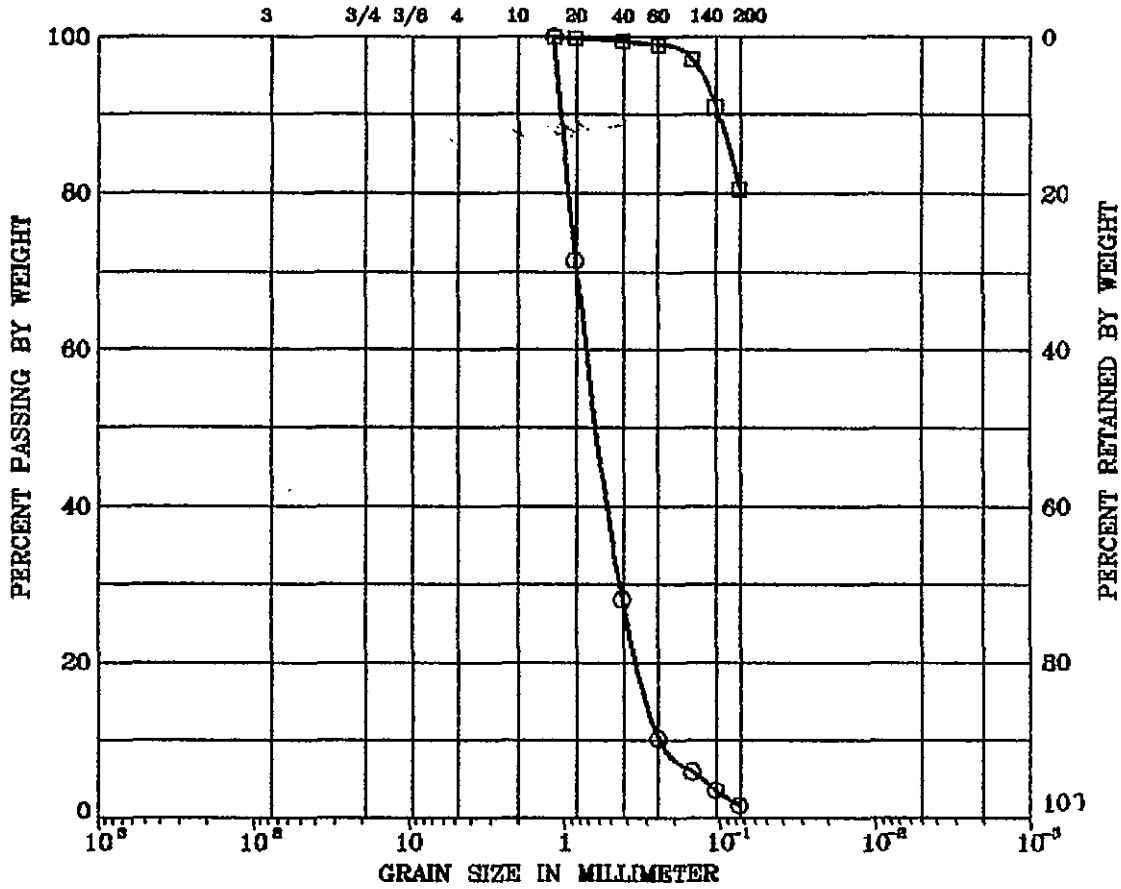

SYMBOL	BORING	DEPTH (ft)	LL (%)	PI (%)	DESCRIPTION
○	SSC BH3	5.0			POORLY-GRADED SAND (SP)
□	SSC BH3	7.6	34	19	LEAN CLAY WITH SAND (CL)

Remark :

Project No. 9E-AB	NEW MEXICO SSC PROPOSAL JULY 31, 1987
New Mexico Bureau of Mines	GRAIN SIZE DISTRIBUTION

UNIFIED SOIL CLASSIFICATION

COBBLES	GRAVEL		SAND			SILT OR CLAY
	COARSE	FINE	COARSE	MEDIUM	FINE	
U.S. SIEVE SIZE IN INCHES			U.S. STANDARD SIEVE No.			HYDROMETER

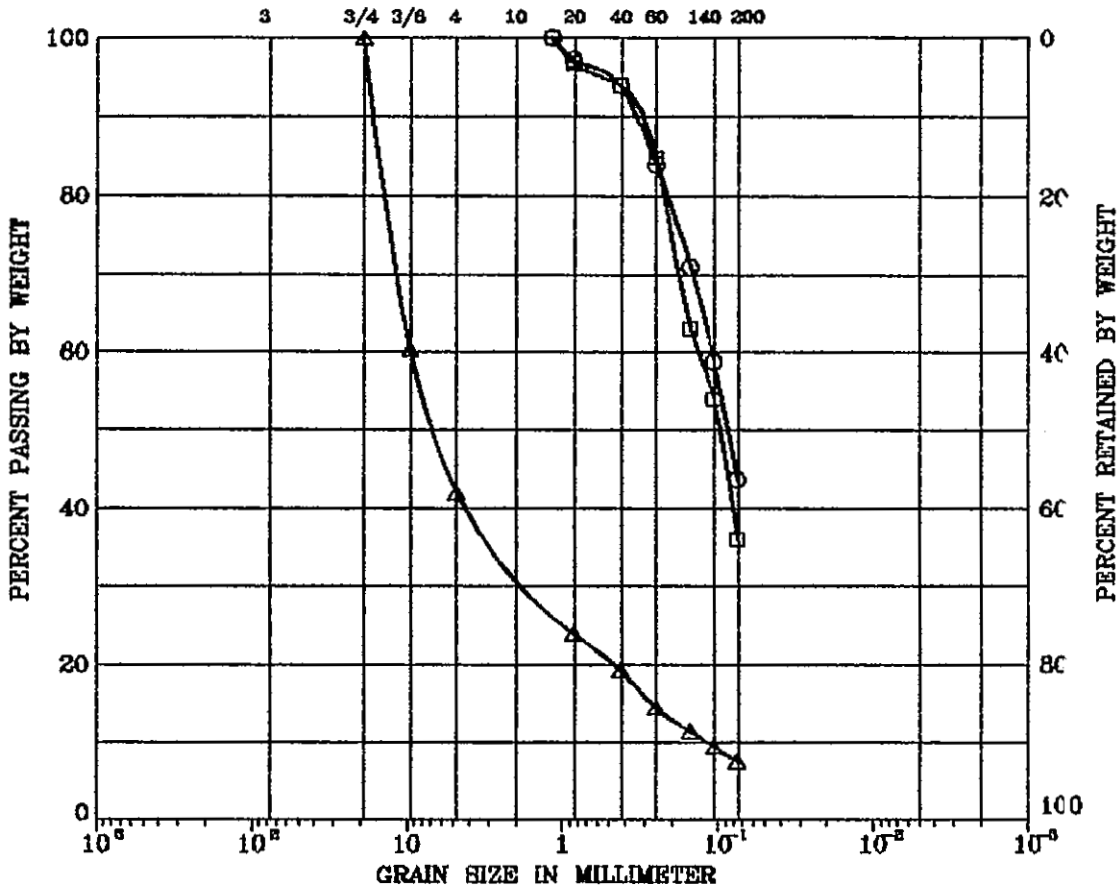

SYMBOL	BORING	DEPTH (ft)	LL (%)	PI (%)	DESCRIPTION
○	SSC BH4	1.0			SILTY SAND (SM)
□	SSC BH4	3.0			SILTY SAND (SM)
Δ	SSC BH4	4.4			WELL-GRADED GRAVEL WITH SILT (GW-GM)

Remark :

Project No. 9E-AB	NEW MEXICO SSC PROPOSAL JULY 31, 1987
New Mexico Bureau of Mines	GRAIN SIZE DISTRIBUTION

UNIFIED SOIL CLASSIFICATION

COBBLES	GRAVEL		SAND			SILT OR CLAY
	COARSE	FINE	COARSE	MEDIUM	FINE	
U.S. SIEVE SIZE IN INCHES			U.S. STANDARD SIEVE No.			HYDROMETER

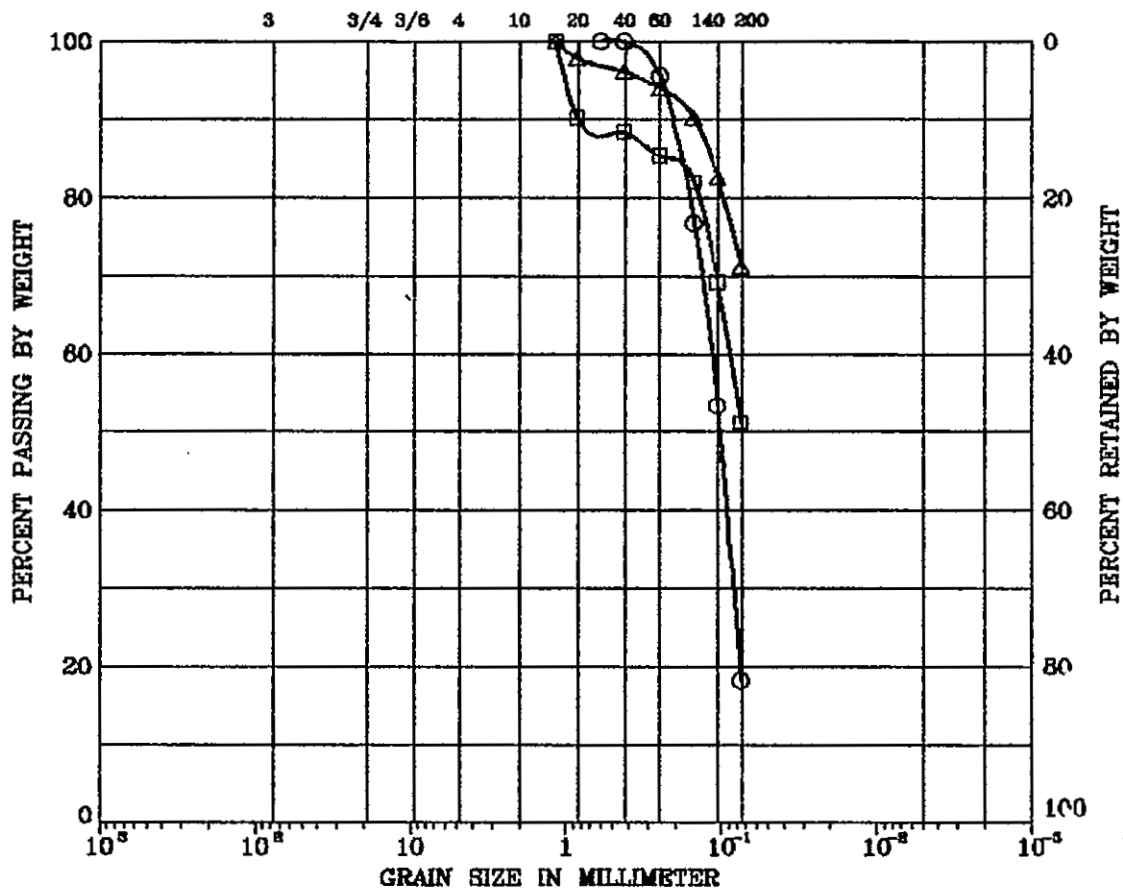

SYMBOL	BORING	DEPTH (ft)	LL (%)	PI (%)	DESCRIPTION
○	SSC BH4	4.6			SILTY SAND (SM)
□	SSC BH4	5.0	28	4	SANDY SILT (ML)
△	SSC BH4	6.6	24	8	LEAN CLAY WITH SAND (CL)

Remark :

Project No. 9E-AB	NEW MEXICO SSC PROPOSAL JULY 31, 1987
New Mexico Bureau of Mines	GRAIN SIZE DISTRIBUTION

UNIFIED SOIL CLASSIFICATION

COBBLES	GRAVEL		SAND			SILT OR CLAY
	COARSE	FINE	COARSE	MEDIUM	FINE	
U.S. SIEVE SIZE IN INCHES			U.S. STANDARD SIEVE No.			HYDROMETER

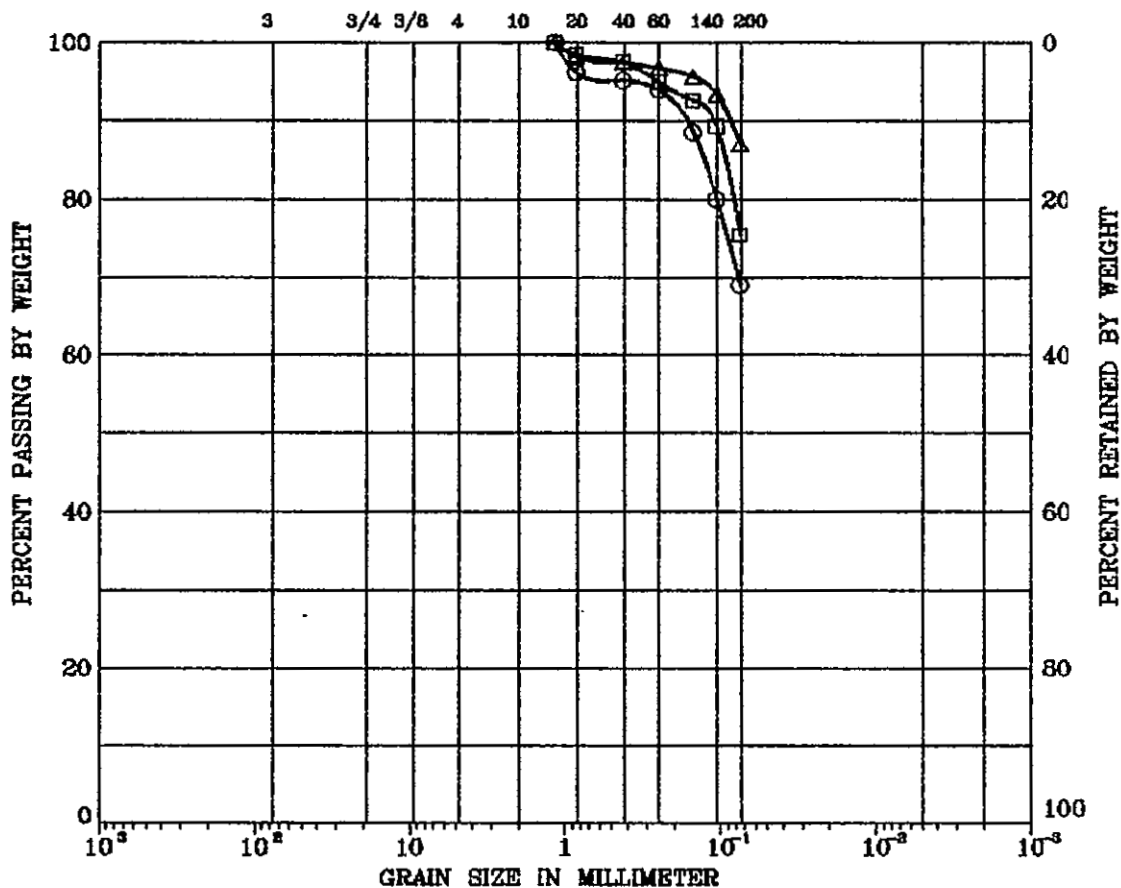

SYMBOL	BORING	DEPTH (ft)	LL (%)	PI (%)	DESCRIPTION
○	SSC BH5	1.0	26	6	SANDY SILTY CLAY (CL-ML)
□	SSC BH5	4.0	21	4	SILTY CLAY WITH SAND (CL-ML)
△	SSC BH5	6.8	23	3	SILT (ML)

Remark :

Project No. 9E-AB

NEW MEXICO SSC PROPOSAL JULY 31,1987

New Mexico
Bureau of Mines

GRAIN SIZE DISTRIBUTION

UNIFIED SOIL CLASSIFICATION

COBBLES	GRAVEL		SAND			SILT OR CLAY
	COARSE	FINE	COARSE	MEDIUM	FINE	
U.S. SIEVE SIZE IN INCHES			U.S. STANDARD SIEVE No.			HYDROMETER

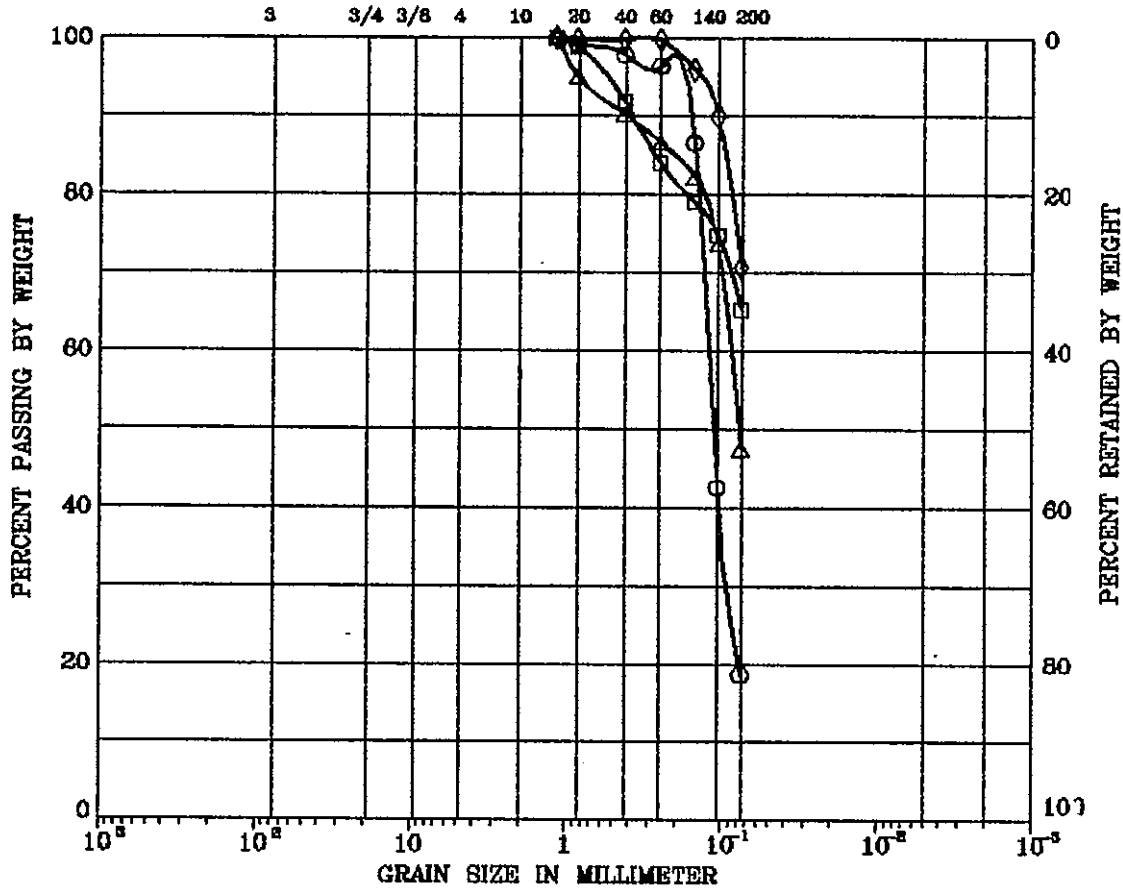

SYMBOL	BORING	DEPTH (ft)	LL (%)	PI (%)	DESCRIPTION
○	SSC BH6	0.2			SILTY SAND (SM)
□	SSC BH6	1.8	27	8	SANDY LEAN CLAY (CL)
△	SSC BH6	3.2	24		SILTY SAND (SM)
◇	SSC BH6	4.8	26	8	SILTY CLAY WITH SAND (CL-ML)

Remark :

Project No. 9E-AB NEW MEXICO SSC PROPOSAL JULY 31, 1987

New Mexico
Bureau of Mines

GRAIN SIZE DISTRIBUTION

UNIFIED SOIL CLASSIFICATION

COBBLES	GRAVEL		SAND			SILT OR CLAY
	COARSE	FINE	COARSE	MEDIUM	FINE	
U.S. SIEVE SIZE IN INCHES			U.S. STANDARD SIEVE No.			HYDROMETER

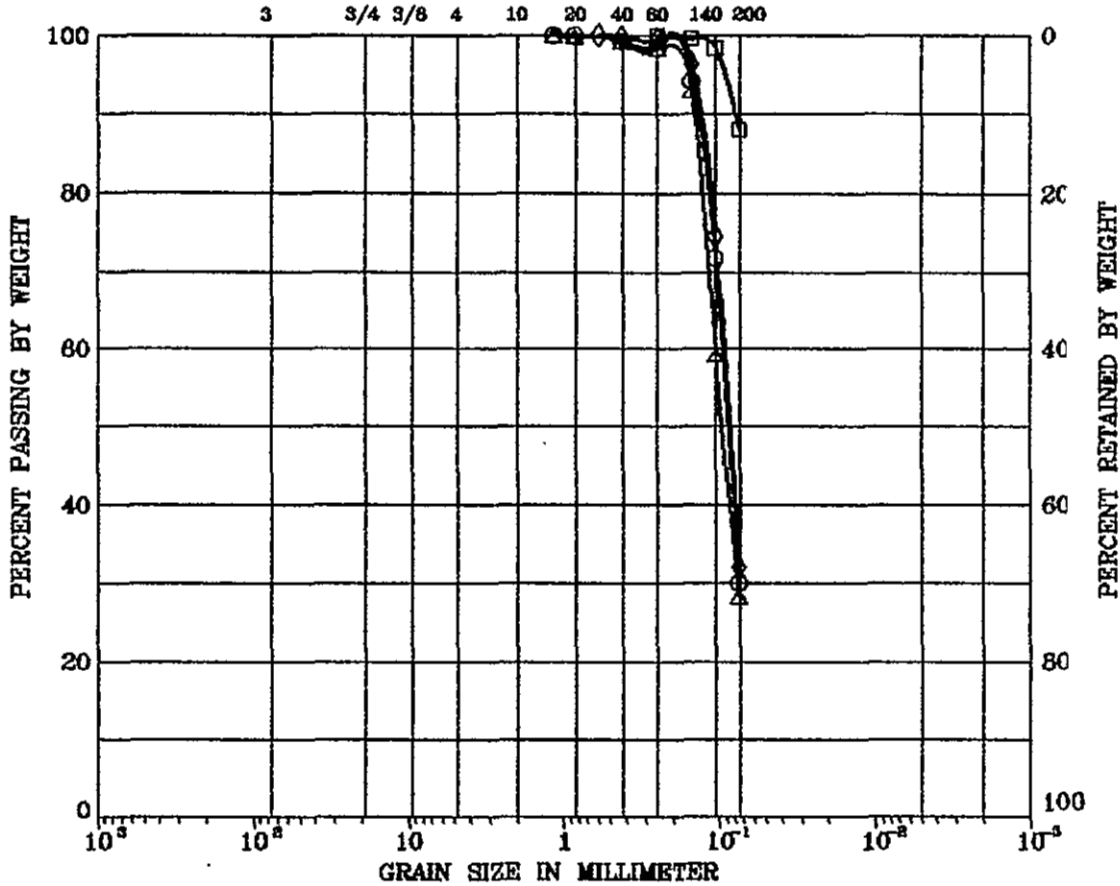

SYMBOL	BORING	DEPTH (ft)	LL (%)	PI (%)	DESCRIPTION
○	SSC BH6	5.4			SILTY SAND (SM)
□	SSC BH6	6.0			SILT (ML)
△	SSC BH6	6.5	29	11	CLAYEY SAND (SC)
◇	SSC BH6	7.3			SILTY SAND (SM)

Remark :

Project No. 9E-AB	NEW MEXICO SSC PROPOSAL JULY 31, 1987
New Mexico Bureau of Mines	GRAIN SIZE DISTRIBUTION

UNIFIED SOIL CLASSIFICATION

COBBLES	GRAVEL		SAND			SILT OR CLAY
	COARSE	FINE	COARSE	MEDIUM	FINE	
U.S. SIEVE SIZE IN INCHES			U.S. STANDARD SIEVE No.			HYDROMETER

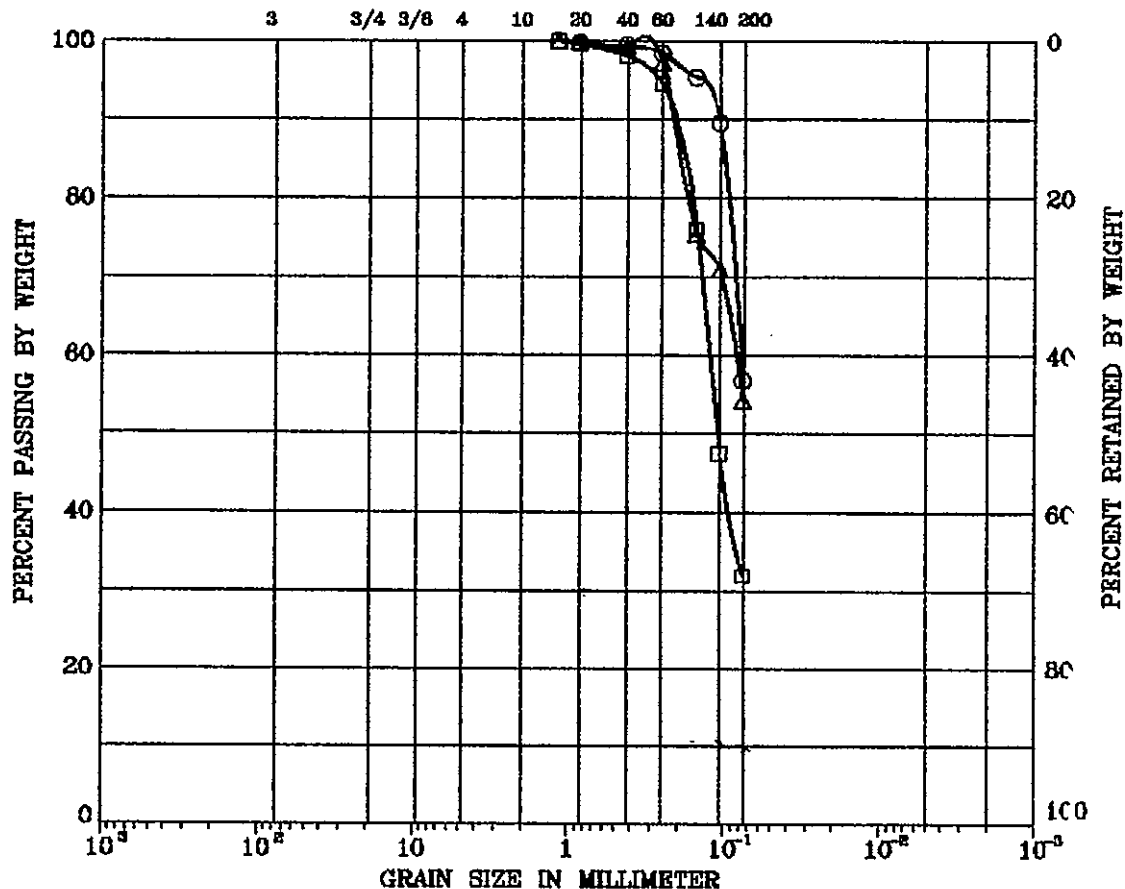

SYMBOL	BORING	DEPTH (ft)	LL (%)	PI (%)	DESCRIPTION
○	SSC BH8	7.9	24	6	SANDY SILTY CLAY (CL-ML)
□	SSC BH8	8.4	22		SILTY SAND (SM)
△	SSC BH8	9.0	30	12	SANDY LEAN CLAY (CL)

Remark :

Project No. 9E-AB	NEW MEXICO SSC PROPOSAL JULY 31, 1987
New Mexico Bureau of Mines	GRAIN SIZE DISTRIBUTION

UNIFIED SOIL CLASSIFICATION

COBBLES	GRAVEL		SAND			SILT OR CLAY
	COARSE	FINE	COARSE	MEDIUM	FINE	
U.S. SIEVE SIZE IN INCHES			U.S. STANDARD SIEVE No.			HYDROMETER

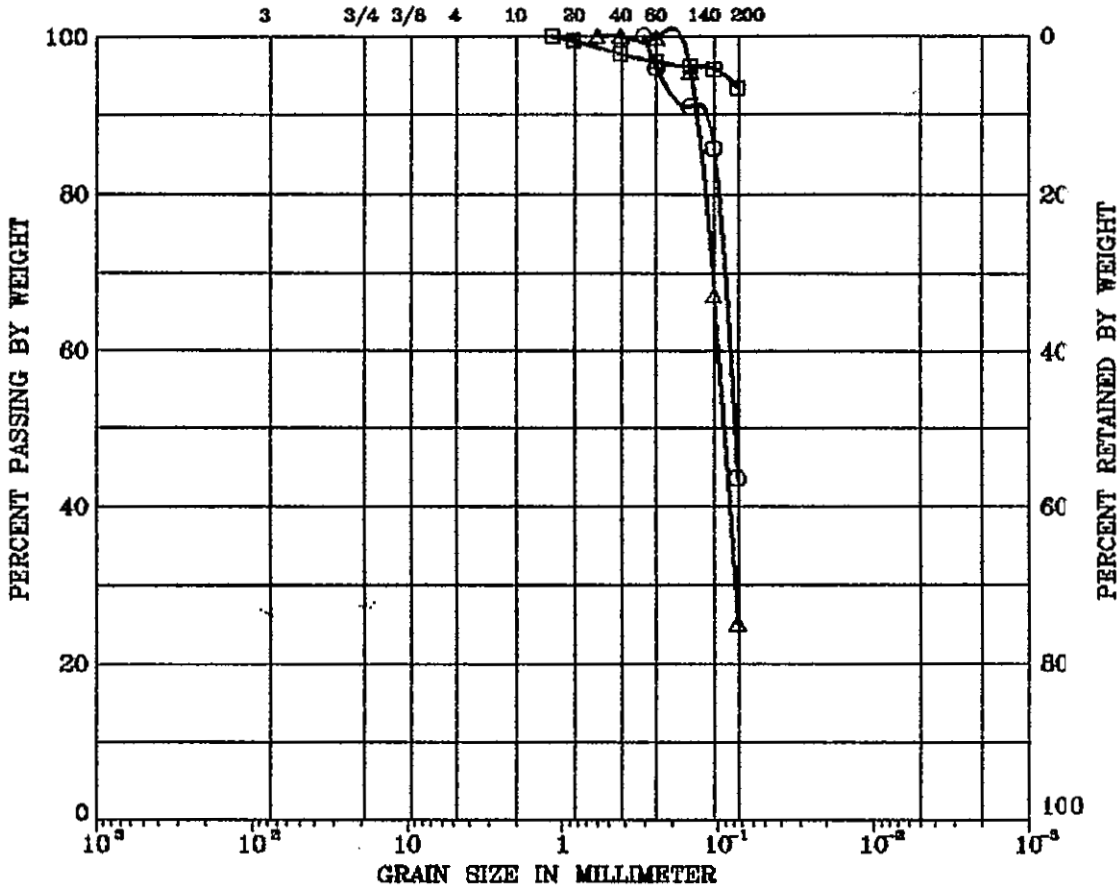

<u>SYMBOL</u>	<u>BORING</u>	<u>DEPTH (ft)</u>	<u>LL (%)</u>	<u>PI (%)</u>	<u>DESCRIPTION</u>
○	SSC BH7	0.4	25		SILTY SAND (SM)
□	SSC BH7	2.9	39	16	LEAN CLAY (CL)
△	SSC BH7	3.9	28		SILTY SAND (SM)

Remark :

Project No. 9E-AB

NEW MEXICO SSC PROPOSAL JULY 31, 1987

New Mexico
Bureau of Mines

GRAIN SIZE DISTRIBUTION

UNIFIED SOIL CLASSIFICATION

COBBLES	GRAVEL		SAND			SILT OR CLAY
	COARSE	FINE	COARSE	MEDIUM	FINE	
U.S. SIEVE SIZE IN INCHES			U.S. STANDARD SIEVE No.			HYDROMETER

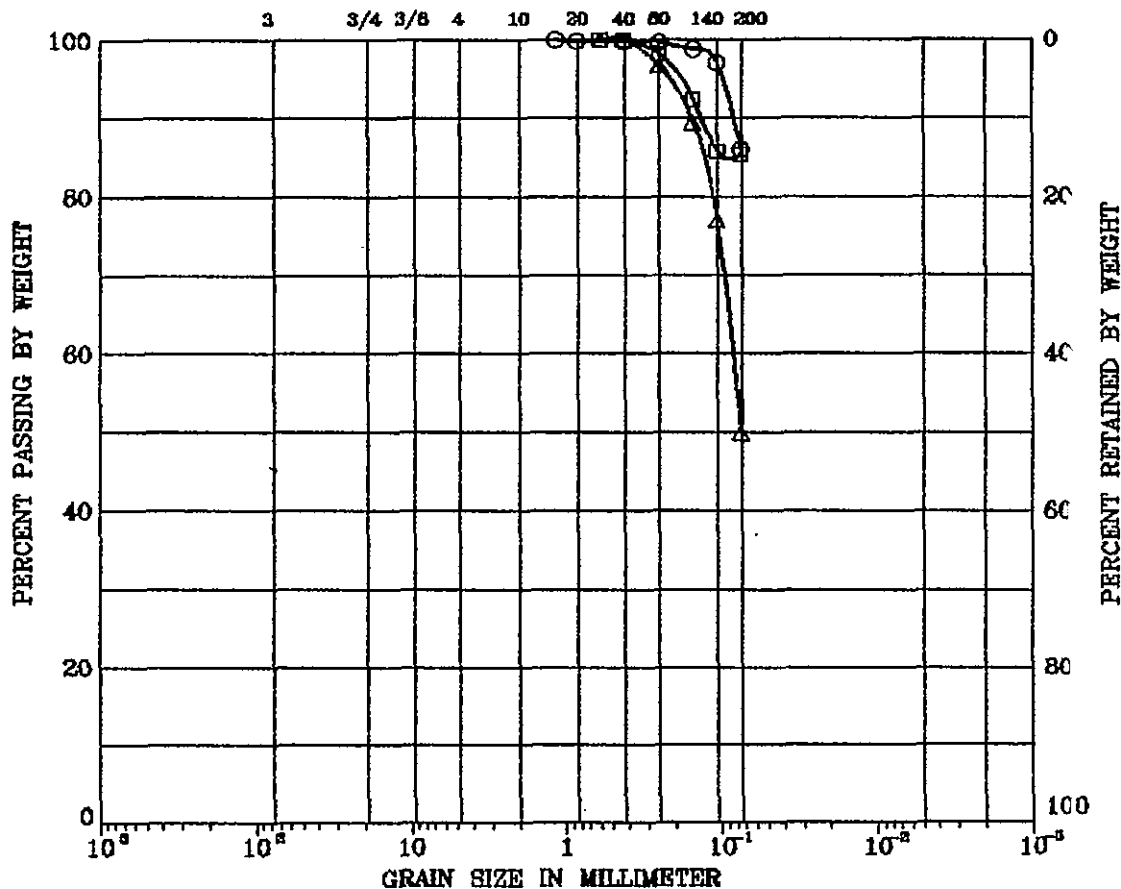

SYMBOL	BORING	DEPTH (ft)	LL (%)	PI (%)	DESCRIPTION
○	SSC BH7	5.2	35	16	LEAN CLAY (CL)
□	SSC BH7	6.3	27		SILT WITH SAND (ML)
△	SSC BH7	6.7	24		SANDY SILT (ML)

Remark :

Project No. 9E-AB	NEW MEXICO SSC PROPOSAL JULY 31, 1987
New Mexico Bureau of Mines	GRAIN SIZE DISTRIBUTION

UNIFIED SOIL CLASSIFICATION

COBBLES	GRAVEL		SAND			SILT OR CLAY
	COARSE	FINE	COARSE	MEDIUM	FINE	
U.S. SIEVE SIZE IN INCHES			U.S. STANDARD SIEVE No.			HYDROMETER

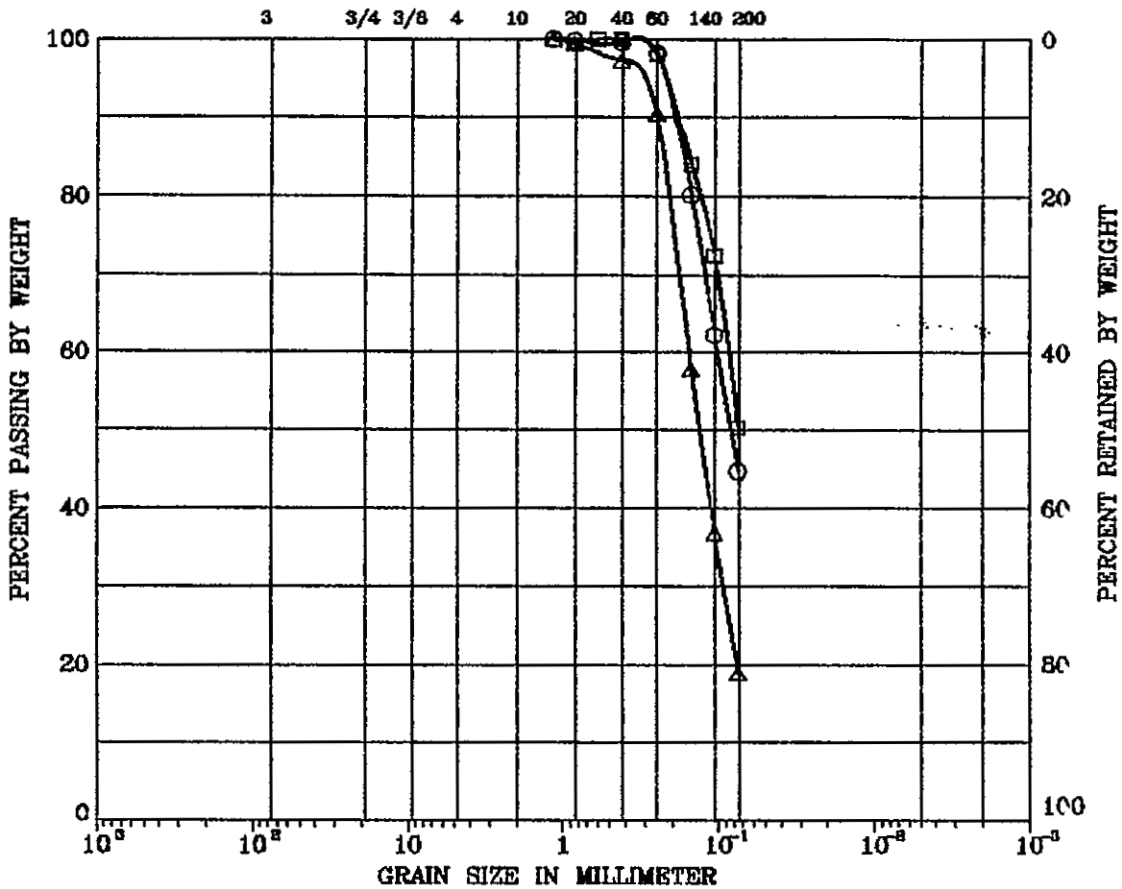

SYMBOL	BORING	DEPTH (ft)	LL (%)	PI (%)	DESCRIPTION
○	SSC BH7	7.3	23		SILTY SAND (SM)
□	SSC BH7	7.7	21		SANDY SILT (ML)
△	SSC BH7	8.1	22		SILTY SAND (SM)

Remark :

Project No. 9E-AB	NEW MEXICO SSC PROPOSAL JULY 31, 1987
New Mexico Bureau of Mines	GRAIN SIZE DISTRIBUTION

UNIFIED SOIL CLASSIFICATION

COBBLES	GRAVEL		SAND			SILT OR CLAY
	COARSE	FINE	COARSE	MEDIUM	FINE	
U.S. SIEVE SIZE IN INCHES			U.S. STANDARD SIEVE No.			HYDROMETER

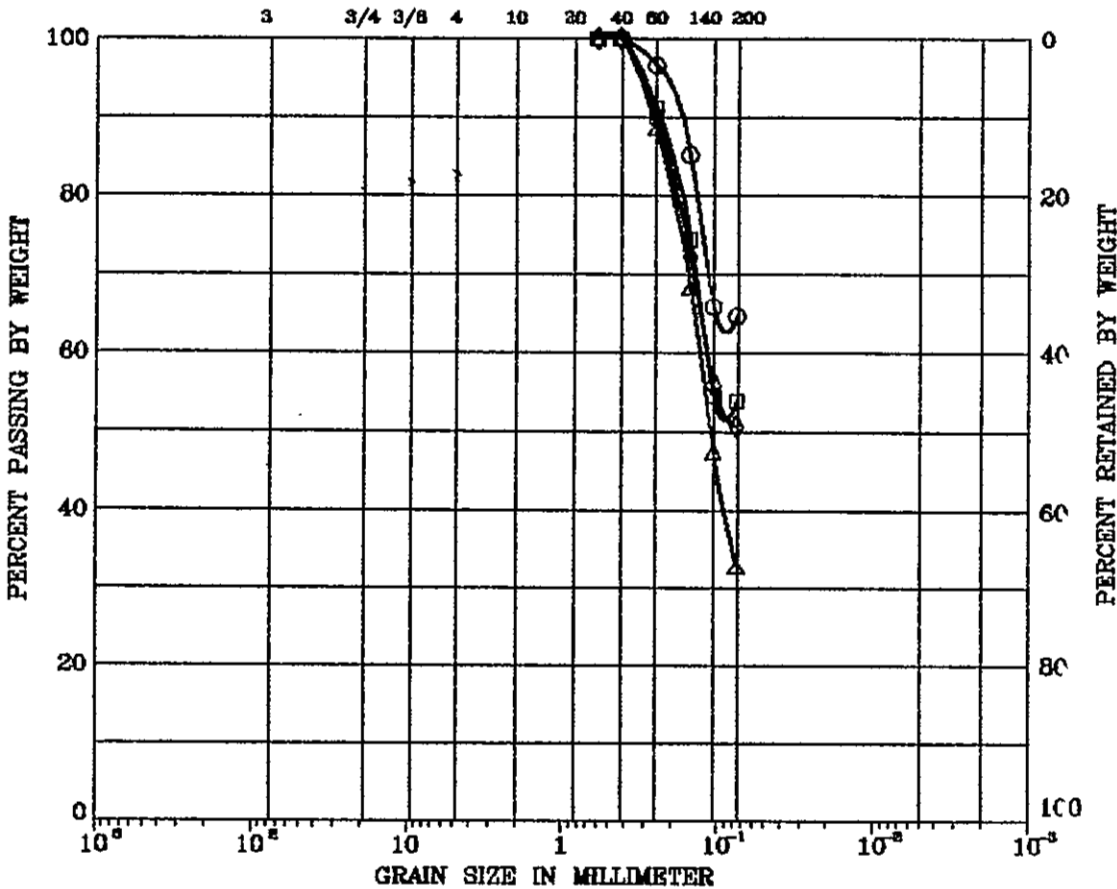

<u>SYMBOL</u>	<u>BORING</u>	<u>DEPTH (ft)</u>	<u>LL (%)</u>	<u>PI (%)</u>	<u>DESCRIPTION</u>
○	SSC BHB	1.2	27	5	SANDY SILT (ML)
□	SSC BHB	4.60	33	8	SANDY SILT (ML)
△	SSC BHB	6.0	38	16	CLAYEY SAND (SC)
◇	SSC BHB	8.6	31	8	SANDY SILT (ML)

Remark :

Project No. 9E-AB	NEW MEXICO SSC PROPOSAL JULY 31, 1987
New Mexico Bureau of Mines	GRAIN SIZE DISTRIBUTION

UNIFIED SOIL CLASSIFICATION

COBBLES	GRAVEL		SAND			SILT OR CLAY
	COARSE	FINE	COARSE	MEDIUM	FINE	
U.S. SIEVE SIZE IN INCHES			U.S. STANDARD SIEVE No.			HYDROMETER

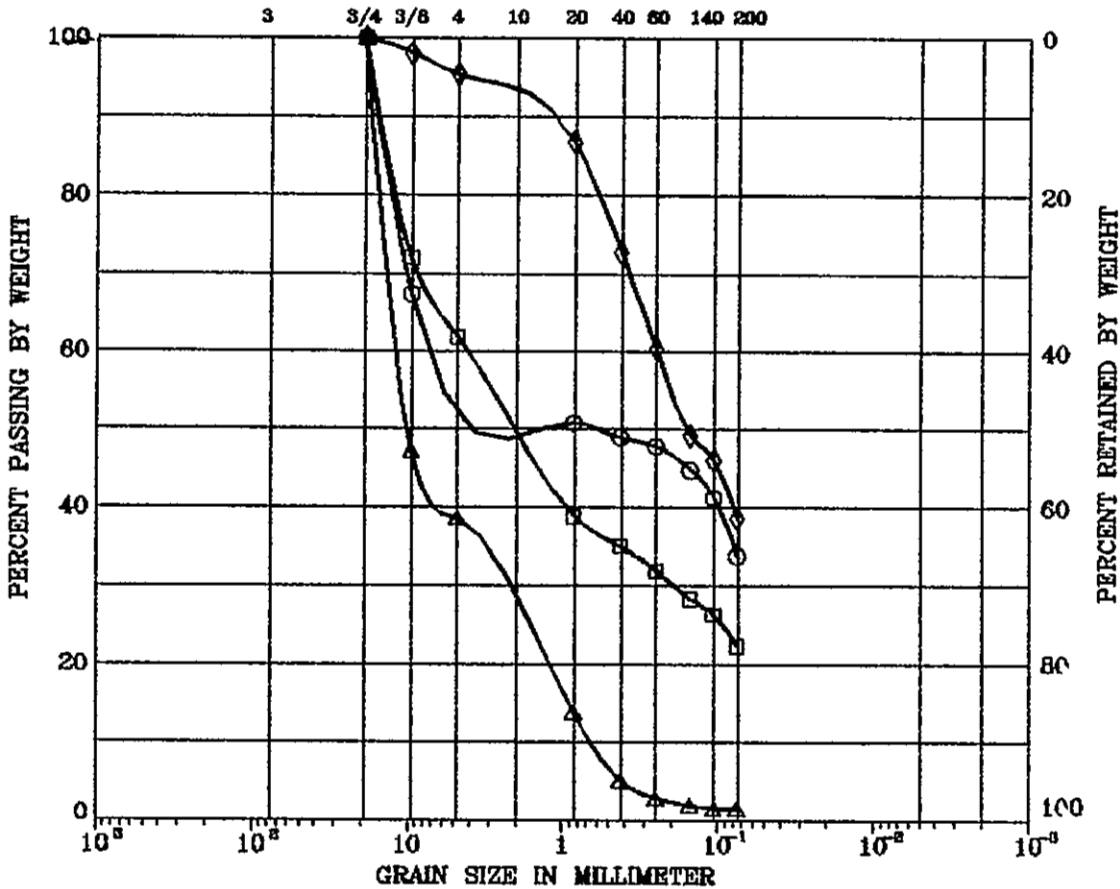

SYMBOL	BORING	DEPTH (ft)	LL (%)	PI (%)	DESCRIPTION
○	SSC BH9	0.6	29	8	CLAYEY SAND WITH GRAVEL (SC)
□	SSC BH9	2.4	33	4	SILTY SAND WITH GRAVEL (SM)
△	SSC BH9	7.2			GRAVEL WITH SAND (GP)
◇	SSC BH9	9.2	30	4	SILTY SAND (SM)

Remark :

Project No. 9E-AB	NEW MEXICO SSC PROPOSAL JULY 31, 1987
New Mexico Bureau of Mines	GRAIN SIZE DISTRIBUTION

UNIFIED SOIL CLASSIFICATION

COBBLES	GRAVEL		SAND			SILT OR CLAY
	COARSE	FINE	COARSE	MEDIUM	FINE	
U.S. SIEVE SIZE IN INCHES			U.S. STANDARD SIEVE No.			HYDROMETER

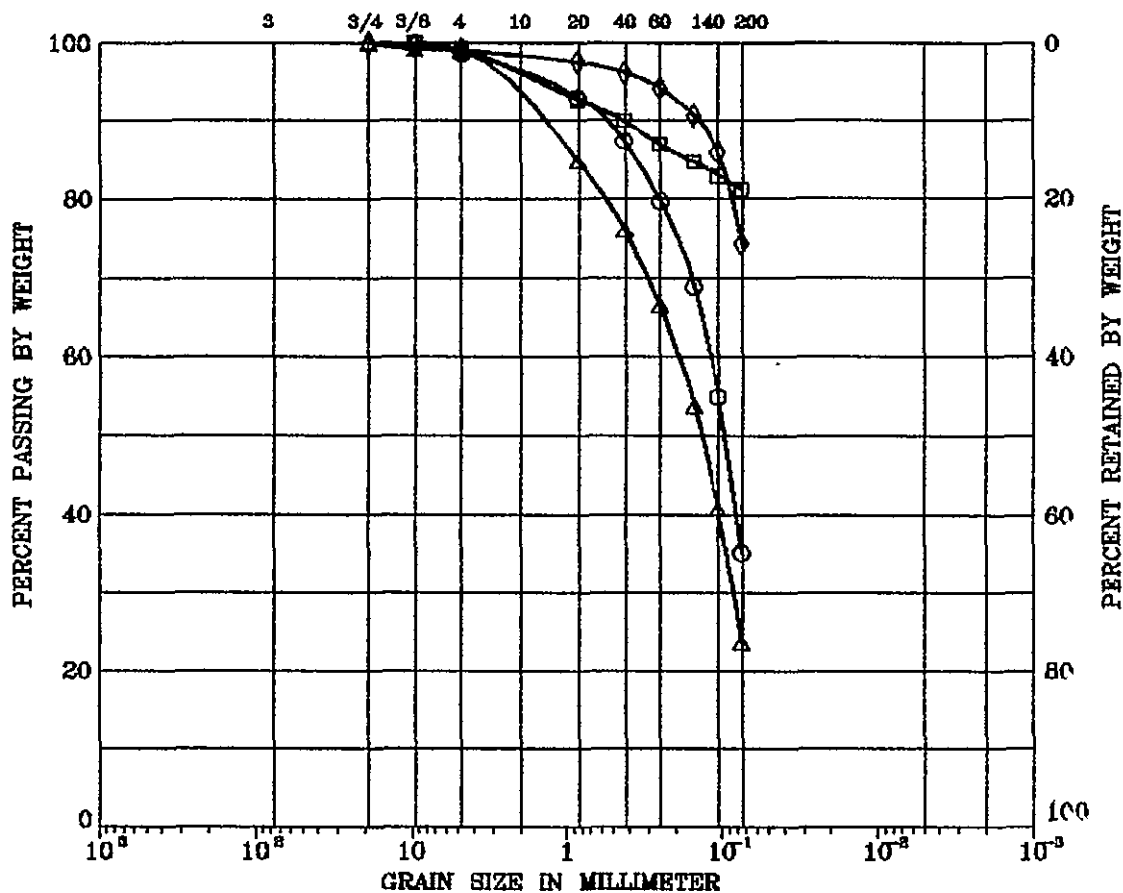

SYMBOL	BORING	DEPTH (ft)	LL (%)	PI (%)	DESCRIPTION
○	SL1 9 W	2.0	24	5	SILTY, CLAYEY SAND (SM-SC)
□	SL1 18 W	2.0	38	16	LEAN CLAY WITH SAND (CL)
△	SL1 21 W	2.0	19	3	SILTY SAND (SM)
◇	SL1 27 W	2.0	25	5	SILTY CLAY WITH SAND (CL-ML)

Remark :

Project No. 9E-AB	NEW MEXICO SSC PROPOSAL JULY 31, 1967
New Mexico Bureau of Mines	GRAIN SIZE DISTRIBUTION

UNIFIED SOIL CLASSIFICATION

COBBLES	GRAVEL		SAND			SILT OR CLAY
	COARSE	FINE	COARSE	MEDIUM	FINE	
U.S. SIEVE SIZE IN INCHES			U.S. STANDARD SIEVE No.			HYDROMETER

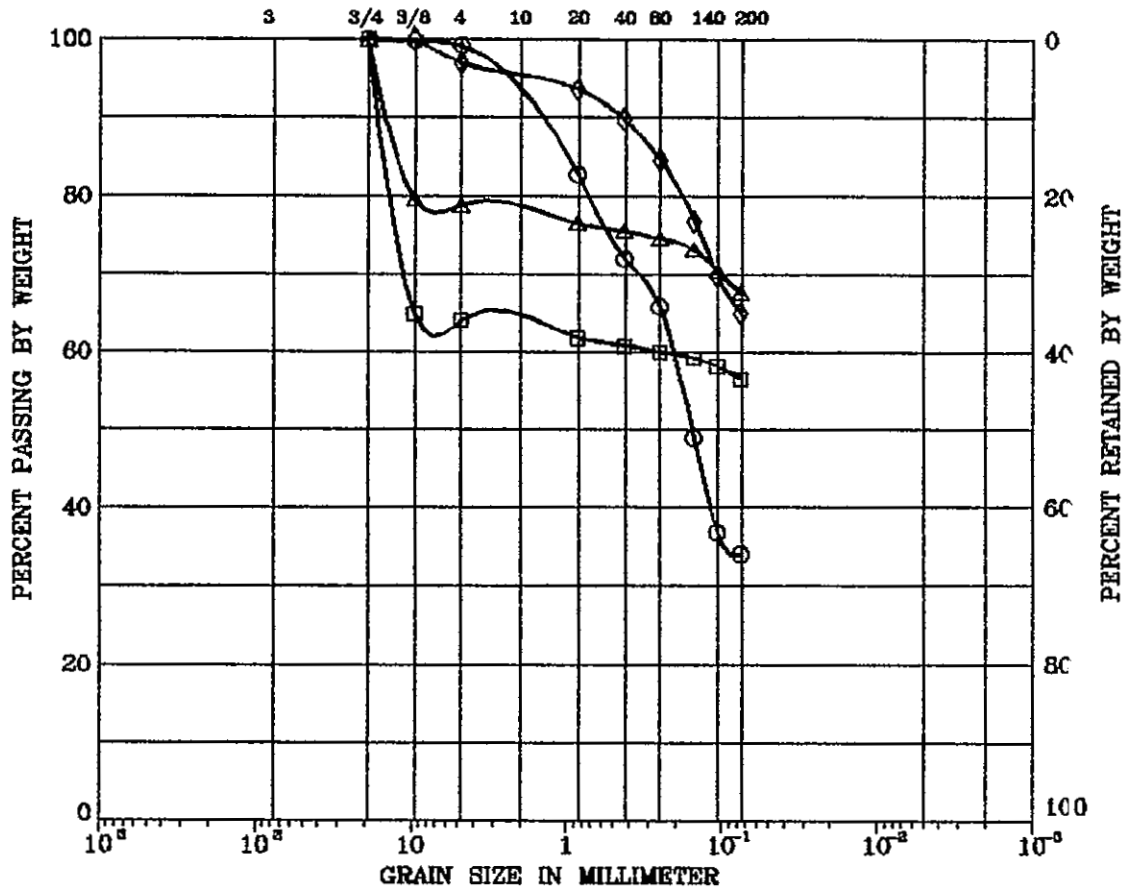

SYMBOL	BORING	DEPTH (ft)	LL (%)	PI (%)	DESCRIPTION
○	SL1 33 W	2.0	25	5	SILTY, CLAYEY SAND (SM-SC)
□	SL1 39 W	2.0			GRAVELLY SILT (ML)
△	SL1 45 W	2.0			SILT WITH GRAVEL (ML)
◇	SL1 51 W	2.0	38	9	SANDY SILT (ML)

Remark :

Project No. 9E-AB

NEW MEXICO SSC PROPOSAL JULY 31, 1987

New Mexico
Bureau of Mines

GRAIN SIZE DISTRIBUTION

UNIFIED SOIL CLASSIFICATION

COBBLES	GRAVEL		SAND			SILT OR CLAY
	COARSE	FINE	COARSE	MEDIUM	FINE	
U.S. SIEVE SIZE IN INCHES			U.S. STANDARD SIEVE No.			HYDROMETER

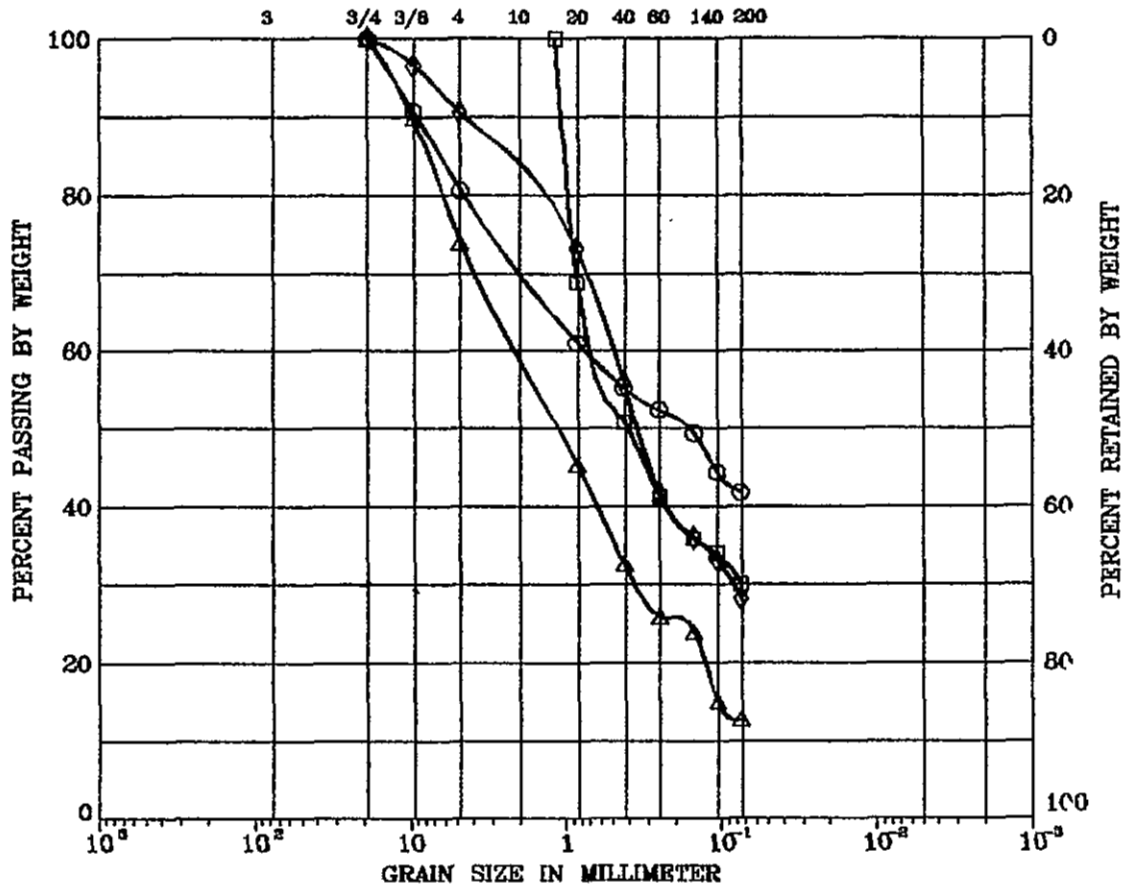

<u>SYMBOL</u>	<u>BORING</u>	<u>DEPTH (ft)</u>	<u>LL (%)</u>	<u>PI (%)</u>	<u>DESCRIPTION</u>
○	SL1 57 W	2.0	32	7	SILTY SAND (SM)
□	SL1 63 W	2.0	27	5	SILTY SAND (SM)
△	SL1 69 W	2.0	24	2	SILTY SAND (SM)
◇	SL1 75 W	2.0	24	5	SILTY, CLAYEY SAND (SM-SC)

Remark :

Project No. 9E-AB

NEW MEXICO SSC PROPOSAL JULY 31, 1987

New Mexico
Bureau of Mines

GRAIN SIZE DISTRIBUTION

UNIFIED SOIL CLASSIFICATION

<i>COBBLES</i>	<i>GRAVEL</i>		<i>SAND</i>			<i>SILT OR CLAY</i>
	COARSE	FINE	COARSE	MEDIUM	FINE	
U.S. SIEVE SIZE IN INCHES			U.S. STANDARD SIEVE No.			HYDROMETER

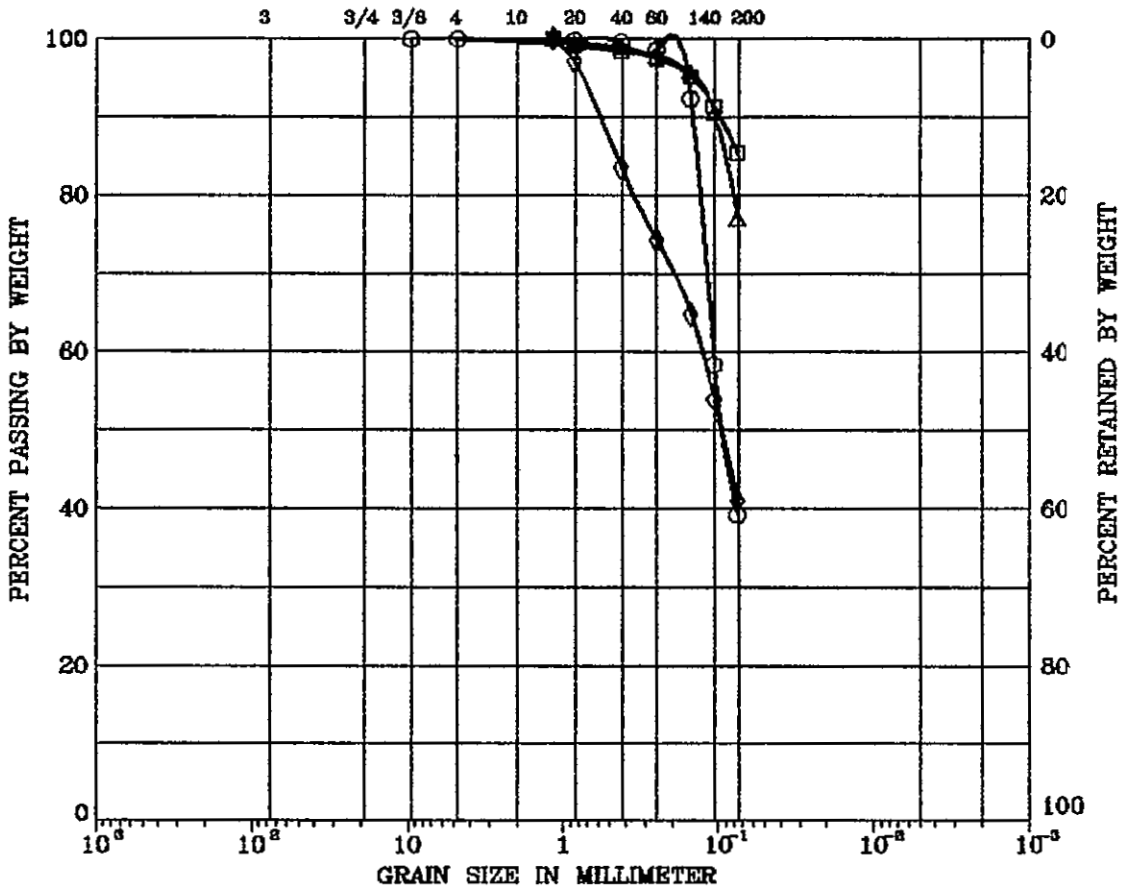

<u>SYMBOL</u>	<u>BORING</u>	<u>DEPTH (ft)</u>	<u>LL (%)</u>	<u>PI (%)</u>	<u>DESCRIPTION</u>
○	SL1 81 W	2.0			SILTY SAND (SN)
□	SL1 87 W	2.0	32	5	SILT (ML)
△	SL1 90 W	2.0	36	12	LEAN CLAY WITH SAND (CL)
◇	SL1 96 W	2.0	32	11	CLAYEY SAND (SC)

Remark :

Project No. 9E-AB

NEW MEXICO SSC PROPOSAL JULY 31, 1987

New Mexico
Bureau of Mines

GRAIN SIZE DISTRIBUTION

UNIFIED SOIL CLASSIFICATION

COBBLES	GRAVEL		SAND			SILT OR CLAY
	COARSE	FINE	COARSE	MEDIUM	FINE	
U.S. SIEVE SIZE IN INCHES			U.S. STANDARD SIEVE No.			HYDROMETER

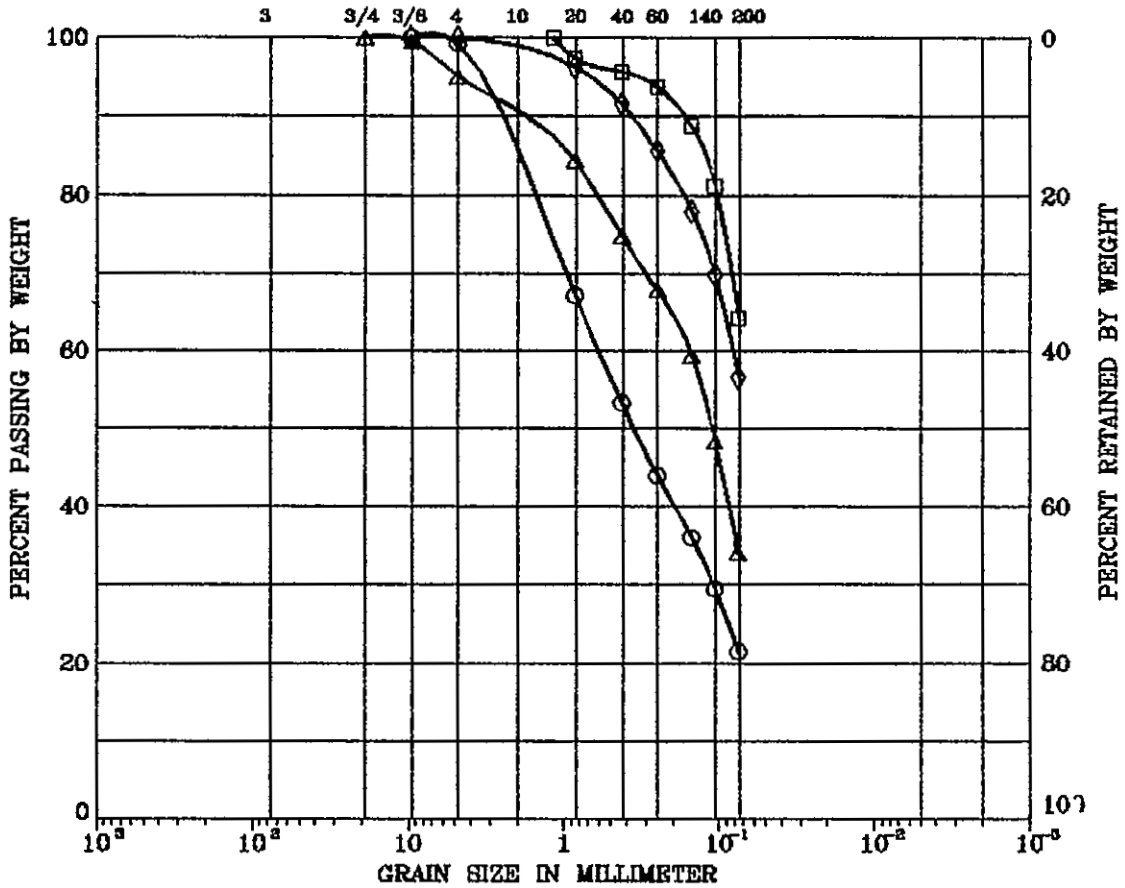

SYMBOL	BORING	DEPTH (ft)	LL (%)	PI (%)	DESCRIPTION
○	SL1 102W	2.0	39	17	CLAYEY SAND (SC)
□	SL1 108W	2.0	32	12	SANDY LEAN CLAY (CL)
△	SL1 114W	2.0	32	10	CLAYEY SAND (SC)
◇	SL1 003W	2.0	29	7	SANDY LEAN CLAY (CL)

Remark :

Project No. 9E-AB	NEW MEXICO SSC PROPOSAL
New Mexico Bureau of Mines	GRAIN SIZE DISTRIBUTION

UNIFIED SOIL CLASSIFICATION

COBBLES	GRAVEL		SAND			SILT OR CLAY
	COARSE	FINE	COARSE	MEDIUM	FINE	
U.S. Sieve Size in Inches			U.S. Standard Sieve No.			Hydrometer

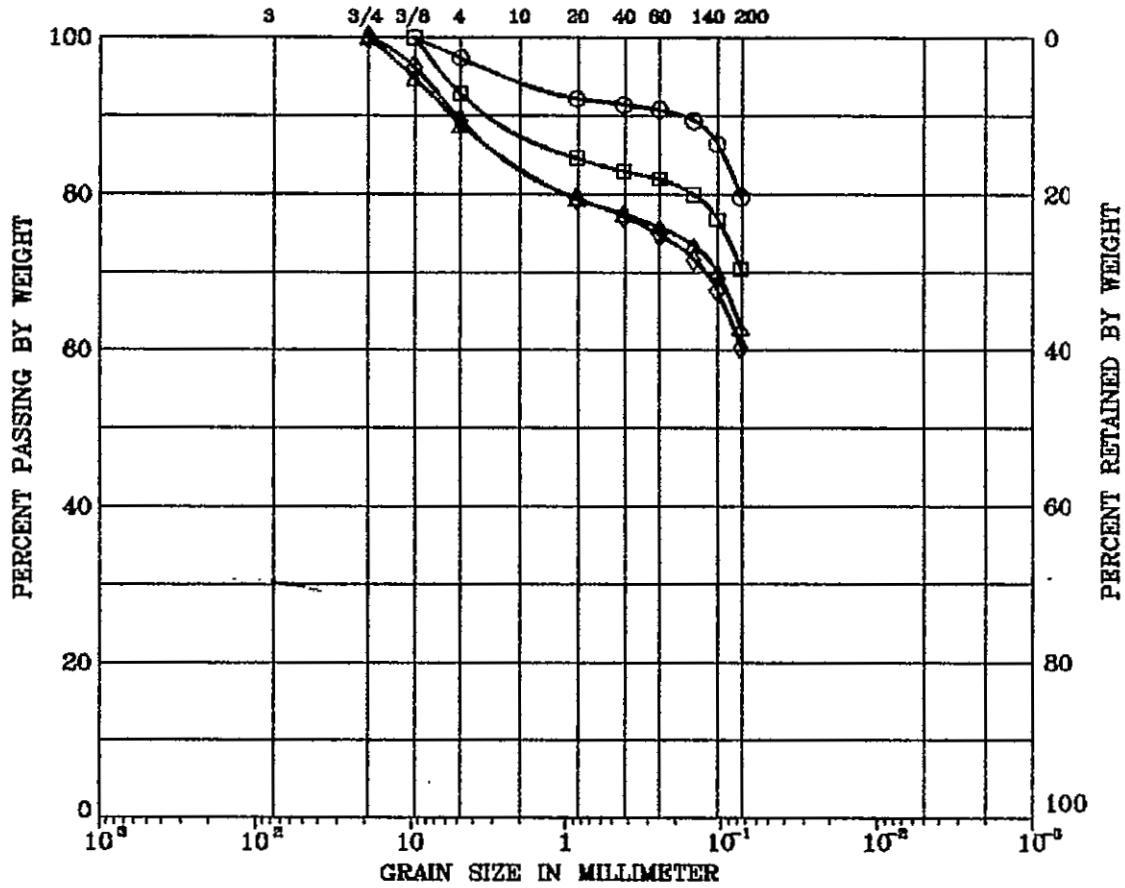

SYMBOL	BORING	DEPTH (ft)	LL (%)	PI (%)	DESCRIPTION
○	SSC MOR	90.0	36	17	LEAN CLAY WITH SAND (CL)
□	SSC MOR	95.0			LEAN CLAY WITH SAND (CL)
△	SSC MOR	183.0	29	12	LEAN CLAY WITH SAND (CL)
◇	SSC MOR	190.0	27	11	LEAN CLAY WITH SAND (CL)

Remark :

Project No. 9E-AB

NEW MEXICO SSC PROPOSAL JULY 31, 1987

New Mexico
Bureau of Mines

GRAIN SIZE DISTRIBUTION

APPENDIX 3-F

Estimated Unconfined Compressive Strength—Cohesive Soils Drill Holes SSC-DH-1 to SSC-DH-40

Estimated Unconfined Compressive Strength--Cohesive Soils. TSF = tons per square foot

Drill Hole Number	Depth of Sample (ft)	USCS GROUP SYMBOL	USCS GROUP NAME	Standard Penetration Test		Estimated Unconfined Compressive Strength (TSF) [3-F-2]
				N-Value (blows/ft)	Consistency (cohesive soils)/ Compactness (cohesionless soils) [3-F-1]	
DH-1	2	CL-ML	silty clay	15	Stiff/Very Stiff	1.9
DH-1	5	ML	silt with sand	8	Loose	--
DH-1	8	SW-SM	sand with silt	25	Medium Dense	--
DH-1	14	CL-ML	silty clay	20	Very Stiff	2.5
DH-2	4-5.5	SM	silty sand	6	Loose	--
DH-2	9-10.5	CH	clay	27	Very Stiff	3.4
DH-2	19-20.5	SM-SC	clayey sand with silt	26	Medium Dense	--
DH-2	29-30.5	SC	clayey sand	27	Medium Dense	--
DH-2	39-40.5	CL	clay	25	Very Stiff	3.1
DH-3	9-10.5	SM	silty sand	21	Medium Dense	--
DH-3	19-20.5	SP	sand with gravel	>50	Very Dense	--
DH-3	29-30.5	CL	sandy clay	30	Very Stiff/Hard	3.8
DH-3	44-45.5	SC	clayey sand	--	--	--
DH-4	4-5	SC	clayey sand	14	Medium Dense	--
DH-4	9-10	SM	silty sand	9	Loose	--
DH-4	19-20	SM-SC	clayey sand with silt	29	Medium Dense	--
DH-4	29-30	SC	clayey sand	39	Dense	--
DH-5	4-5	SC	clayey sand	30	Medium Dense/Dense	--
DH-5	9-10	SC	clayey sand	36	Dense	--
DH-6	4-5	SM-SC	clayey sand with silt	27	Medium Dense	--
DH-6	9-9.5	CL	clay with sand	>50	Hard	>6.3
DH-6	19-19.5	CH	clay	>50	Hard	>6.3

3-186

Estimated Unconfined Compressive Strength--Cohesive Soils. TSF = tons per square foot

Drill Hole Number	Depth of Sample (ft)	USCS GROUP SYMBOL	USCS GROUP NAME	Standard Penetration Test		Estimated Unconfined Compressive Strength	
				N-Value (blows/ft)	Consistency (cohesive soils)/ Compactness (cohesionless soils) [3-F-1]	(TSF) [3-F-2]	
DH-7	4-5	SM-SC	clayey sand with silt	41	Dense	--	
DH-7	9-10	SM	silty sand	13	Medium Dense	--	
DH-7	19-20	SM	silty sand	>50	Very Dense	--	
DH-7	29-30	SM	silty sand	>50	Very Dense	--	
DH-8	4-5	SM-SC	clayey sand with silt	25	Medium Dense	--	
DH-8	9-10	CL	sandy clay	23	Very Stiff	2.9	
DH-8	19-20	SM	silty sand	28	Medium Dense	--	
DH-8	29-30	SP-SM	sand with silt	34	Dense	--	
DH-9	4-5	CL-ML	silty clay	12	Stiff	1.5	
DH-9	9-10	SM-SC	clayey sand with silt	15	Medium Dense	--	
DH-9	19-20	SC	clayey sand	25	Medium Dense	--	
DH-9	29-30	CL	clay	45	Hard	5.6	
DH-10	4-5	SM	silty sand	21	Medium Dense	--	
DH-10	9-10	SM	silty sand	36	Dense	--	
DH-10	19-20	CL-ML	silty clay	12	Stiff	1.5	
DH-10	29-30	CL	clay	32	Hard	4.0	
DH-11	4.5-5	SM	silty sand	22	Medium Dense	--	
DH-11	9-9.5	ML	sandy silt	>50	Very Dense	--	
DH-11	19-20.5	CL-ML	silty clay	59	Hard	7.4	
DH-11	29-29.5	CL	sandy clay	>50	Hard	>6.3	
DH-12	4-5.5	SM-SC	clayey sand with silt	33	Dense	--	
DH-12	9-10.5	SM-SC	clayey sand with silt	19	Medium Dense	--	
DH-12	19-20.5	SC	clayey sand	20	Medium Dense	--	

3-187

Estimated Unconfined Compressive Strength--Cohesive Soils. TSF = tons per square foot

Drill Hole Number	Depth of Sample (ft)	USCS GROUP SYMBOL	USCS GROUP NAME	Standard Penetration Test		Estimated Unconfined Compressive Strength (TSF) [3-F-2]
				N-Value (blows/ft)	Consistency (cohesive soils)/ Compactness (cohesionless soils) [3-F-1]	
DH-13	4-5.5	SM-SC	clayey sand with silt	22	Medium Dense	--
DH-13	9-10.5	CL	clay	22	Very Stiff	2.8
DH-13	19-20.5	CL-ML	silty clay	17	Very Stiff	2.1
DH-14	4-5.5	CL	sandy clay	23	Very Stiff	2.9
DH-14	9-10.5	CL	clay	33	Hard	4.1
DH-14	19-19.5	CL	clay with sand	>50	Hard	>6.3
DH-15	4-5.5	CH	sandy clay	24	Very Stiff	3.0
DH-15	9-9.5	CH	clay	>50	Hard	>6.3
DH-15	19-20.25	CH	clay	48	Hard	6.0
DH-15	29-29.5	--	--	>50	Hard	>6.3
DH-16	4-4.5	CL	clay	>50	Hard	>6.3
DH-16	9-9.83	CL	clay	>50	Hard	>6.3
DH-17	4-4.5	CL-ML	silty clay	56		7.0
DH-17	4.5-5.5	ML	silt with sand	56	Very Dense	--
DH-17	9-10.5	CL	clay	24	Very Stiff	3.0
DH-17	19-19.25	--	--	22	--	--
DH-17	19.25-20.5	CH	clay	22	Very Stiff	2.8
DH-17	29-30.5	CL	sandy clay	26	Very Stiff	3.3
DH-17	40	CL	clay	--	--	--

3-188

Estimated Unconfined Compressive Strength--Cohesive Soils. TSF = tons per square foot

Drill Hole Number	Depth of Sample (ft)	USCS GROUP SYMBOL	USCS GROUP NAME	Standard Penetration Test		Estimated Unconfined Compressive Strength (TSF) [3-F-2]
				N-Value (blows/ft)	Consistency (cohesive soils)/ Compactness (cohesionless soils) [3-F-1]	
DH-18	4-5.5	SM-SC	clayey sand with silt	29	Medium Dense	--
DH-18	9-9.75	CL	clay with sand	21	Very Stiff	2.6
DH-18	9.75-10.5	CL	clay	21	Very Stiff	2.6
DH-18	19-20	SP-SM	sand with silt and gravel	31	Dense	--
DH-18	20-20.5	CL	sandy clay	31	Hard	3.9
DH-18	29-30	CH	clay	>50	Hard	>6.3
DH-19	4-4.5	CL-ML	silty clay	>50	Hard	>6.3
DH-19	9-9.5	CL	sandy clay	>50	Hard	>6.3
DH-19	19.0-19.5	CL-ML	silty clay	>50	Hard	>6.3
DH-20	0-1.5	CL	sandy clay	9	Stiff	1.1
DH-20	1.5-3	CL	clay with sand	14	Stiff	1.8
DH-20	3-4.5	ML	silt	14	Medium Dense	--
DH-20	4.5-6	CL	clay with sand	17	Very Stiff	2.1
DH-20	6-7.5	CL	clay with sand	18	Very Stiff	2.3
DH-20	7.5-9	CL	clay with sand	15	Stiff/Very Stiff	1.9
DH-20	9-10.5	CL	clay with sand	18	Very Stiff	2.3
DH-20	10.5-12	CL	sandy clay	15	Stiff/Very Stiff	1.9
DH-20	12-13	ML	silt	13	Medium Dense	--
DH-20	13-13.5	CL	clay with sand	13	Stiff	1.6
DH-20	13.5-15	CL	clay with sand	19	Very Stiff	2.4
DH-20	15-16.5	CL	clay with sand	21	Very Stiff	2.6
DH-20	16.5-18	CL	clay with sand	32	Hard	4.0
DH-20	18-19.5	CH	clay	14	Stiff	1.8
DH-20	19.5-21	CL	clay	17	Very Stiff	2.1
DH-20	21-22.5	CL	clay	14	Stiff	1.8
DH-20	29-30.5	CL	clay	40	Hard	5.0

3-189

Estimated Unconfined Compressive Strength--Cohesive Soils. TSF = tons per square foot

Drill Hole Number	Depth of Sample (ft)	USCS GROUP SYMBOL	USCS GROUP NAME	Standard Penetration Test		Estimated Unconfined Compressive Strength (TSF) [3-F-2]
				N-Value (blows/ft)	Consistency (cohesive soils)/ Compactness (cohesionless soils) [3-F-1]	
DH-21	4-5.5	SM	silty sand	18	Medium Dense	--
DH-21	9-10.5	SC	clayey sand	25	Medium Dense	--
DH-21	19-20.5	SC	clayey sand	26	Medium Dense	--
DH-21	29-30.5	CL	sandy clay	33	Hard	4.1
DH-22	4-5.5	CL-ML	silty clay	14	Stiff	1.8
DH-22	9-10.5	CL-ML	silty clay	24	Very Stiff	3.0
DH-22	19-20.5	SM-SC	clayey sand with silt	31	Dense	--
DH-22	29-30.5	SM	silty sand	29	Medium Dense	--
DH-23	4-5.5	CL	clay with sand	25	Very Stiff	3.1
DH-23	9-10.5	CL	sandy clay	23	Very Stiff	2.9
DH-23	19-20.5	CL	clay	32	Hard	4.0
DH-23	29-30.5	CL	clay with sand	29	Very Stiff	3.6
DH-24	4-5.5	CL	clay	23	Very Stiff	2.9
DH-24	9-10.5	CL	clay	20	Very Stiff	2.5
DH-24	19-20.5	ML	silt with sand	23	Medium Dense	--
DH-24	29-30.5	CL	sandy clay	7	Medium Stiff	0.9
DH-25	4-5.5	SP-SM	sand with silt and gravel	7	Loose	--
DH-25	9-9.5	SM-SC	clayey sand with silt	29	--	--
DH-25	9.5-10.5	CL	sandy clay	29	Very Stiff	3.6
DH-25	19-19.5	CL	sandy clay	>50	Hard	>6.3
DH-25	20-20.5	CL	sandy clay	>50	Hard	>6.3
DH-25	29-30.5	SC	clayey sand with gravel	28	Medium Dense	--

3-190

Estimated Unconfined Compressive Strength--Cohesive Soils. TSF = tons per square foot

Drill Hole Number	Depth of Sample (ft)	USCS GROUP SYMBOL	USCS GROUP NAME	Standard Penetration Test		Estimated Unconfined Compressive Strength	
				N-Value (blows/ft)	Consistency (cohesive soils)/ Compactness (cohesionless soils) [3-F-1]	(TSF) [3-F-2]	
DH-26	4-5.5	CL	sandy clay	14	Stiff	1.8	
DH-26	9-9.5	CL-ML	silty clay with sand	20	Very Stiff	2.5	
DH-26	9.5-10.5	CL	clay with sand	20			
DH-26	19-20.5	CL	clay	39	Hard	4.9	
DH-26	29-30.5	CL	clay with sand	19	Very Stiff	2.4	
DH-30	5-8	SC	clayey sand	15	Medium Dense	--	
DH-30	10-13	SM	silty sand	14	Medium Dense	--	
DH-30	15-18	SM	silty sand	22	Medium Dense	--	
DH-30	20-23	SM-SC	clayey sand with silt	17	Medium Dense	--	
DH-30	25-28	SM	silty sand	34	Dense	--	
DH-31	0-2			>50			
DH-31	2-7	SM	silty sand with gravel	33	Very Dense	--	
DH-31	7-12	SM	silty sand	>50	Very Dense	--	
DH-31	12-17	SM-SC	clayey sand with silt	>50	Very Dense	--	
DH-31	17-22	SP	sand with gravel	>50	Very Dense	--	
DH-31	22-28	SM	silty sand	>50	Very Dense	--	
DH-31	28-34	SM	silty sand	>50	Very Dense	--	
DH-31	34-40	SM/ML	silty sand/silt	>50	Very Dense	--	
DH-31	40-45	SM	silty sand	>50	Very Dense	--	
DH-31	45-51	SM	silty sand	>50	Very Dense	--	
DH-31	51-55	SP	sand with gravel	>50	Very Dense	--	
DH-31	55-61	SM	silty sand with gravel	>50	Very Dense	--	

3-191

Estimated Unconfined Compressive Strength--Cohesive Soils. TSF = tons per square foot

3-192

Drill Hole Number	Depth of Sample (ft)	USCS GROUP SYMBOL	USCS GROUP NAME	Standard Penetration Test		Estimated Unconfined Compressive Strength (TSF) [3-F-2]
				N-Value (blows/ft)	Consistency (cohesive soils)/ Compactness (cohesionless soils) [3-F-1]	
DH-33	5-8	ML	sandy silt with gravel	23	Medium Dense	--
DH-33	8-13	ML	sandy silt	48	Dense	--
DH-33	13-18	SM	silty sand	26	Medium Dense	--
DH-33	18-23	SM	silty sand with gravel	>50	Very Dense	--
DH-33	23-28	SM/ML	silty sand/silt	32	Dense	--
DH-33	28-32			>50		
DH-33	32-37	SM/ML	silty sand/silt	>50	Very Dense	--
DH-33	37-38.5	ML	sandy silt with gravel	>50	Very Dense	--
DH-35	4.75-8	CL	clay	12	stiff	1.5
DH-35	9.75-13	SM	silty sand	15	Medium Dense	--
DH-35	15-18.5	ML/SP	silt with sand at top	7	loose	--
DH-35	20.25-23.25	CH	clay	5	Medium Stiff	0.6
DH-35	25-28.25	SP	sand	30	Medium Dense/Dense	--
DH-35	35-38	CH	clay	15	Stiff/Very Stiff	1.9
DH-35	43.5-45	SM	silty sand	22	Medium Dense	--
DH-35	45-51	CL/SM	clay/silty sand	23	Very Stiff	2.9
DH-35	59.25-63	CL	sandy clay	30	Very Stiff/Hard	3.8
DH-36	5-8	SM/CL	silty sand/clay	15	Stiff/Very Stiff	--
DH-36	8-9.5	SM	silty sand	14	Medium Dense	--
DH-36	17.5-19	CL/ML	clay/sandy silt	36	Hard	4.5
DH-36	18-22.5	SM	silty sand	>50	Hard	--
DH-36	22.5-28	CL/ML	clay/sandy silt	31	Hard	3.9
DH-36	28-33	CL/ML	clay/sandy silt	>50	Hard	>6.3
DH-36	33-38	SP-SM	sand with silt	>50	Very Dense	--
DH-36	38-43	CL-ML	silty clay	>50	Hard	>6.3
DH-36	43-48	CL	clay	39	Hard	4.9
DH-36	53-55	CL	clay	>50	Hard	>6.3

Estimated Unconfined Compressive Strength--Cohesive Soils. TSF = tons per square foot

Drill Hole Number	Depth of Sample (ft)	USCS GROUP SYMBOL	USCS GROUP NAME	Standard Penetration Test		Estimated Unconfined Compressive Strength (TSF) [3-F-2]
				N-Value (blows/ft)	Consistency (cohesive soils)/ Compactness (cohesionless soils) [3-F-1]	
DH-38	3-8	SM	silty sand	9	Loose	--
DH-38	8-13	ML	sandy silt with gravel	38	Dense	--
DH-38	13-18	SM	silty sand	46	Dense	--
DH-38	18-23	SP	sand with gravel	>50	Very Dense	--
DH-38	23-28	SM	silty sand	>50	Very Dense	--
DH-38	28-33	SP-SM	sand with silt	>50	Very Dense	--
DH-38	33-38	ML/CL	sandy silt/silty clay	>50	Hard	>6.3
DH-38	38-43			>50		
DH-38	43-73	SP	sand	>50	Very Dense	--
DH-38	73-98	SP	sand with gravel	>50	Very Dense	--
DH-38	98-108	SM	silty sand	44	Dense	--
DH-38	108-109.5	SM/SP	silty sand to sand	>50	Very Dense	--
DH-39	3-8	ML/CL	sandy silt/silty clay	11	Stiff	1.3
DH-39	8-13	CL-ML	silty clay	>50	Hard	>6.3

3-193

Estimated Unconfined Compressive Strength--Cohesive Soils. TSF = tons per square foot

Drill Hole Number	Depth of Sample (ft)	USCS GROUP SYMBOL	USCS GROUP NAME	Standard Penetration Test		Estimated Unconfined Compressive Strength (TSF) [3-F-2]
				N-Value (blows/ft)	Consistency (cohesive soils)/ Compactness (cohesionless soils) [3-F-1]	
DH-40	5-8	ML	sandy silt	9	Loose	--
DH-40	10-13	ML/SM	sandy silt/silty sand	28	Medium Dense	--
DH-40	14.25-18	CL-ML	silty clay with sand	18	Very Stiff	2.3
DH-40	18.5-23	ML/CL	sandy silt/silty clay	28	Medium Dense/Very Stiff	3.5
DH-40	23-28	CL	clay	22	Very Stiff	2.8
DH-40	28-33	SP-SM	sand with silt	41	Dense	--
DH-40	33-38	SP	sand	41	Dense	--
DH-40	38-43	CH	clay	29	Very Stiff	3.6
DH-40	43-48	CL-ML	silty clay	23	Very Stiff	2.9
DH-40	48-53	SP/ML	sand	22	Medium Dense	--
DH-40	55-58	SM-SC	clayey sand with silt	26	Medium Dense	--
DH-40	58-63	SM/ML	silty sand/sandy silt	27	Medium Dense	--
DH-40	63-68	ML/CL	sandy silt/clay	31	Dense/Hard	--
DH-40	68-69.5	GW	gravel with sand	>50	Very Dense	--

3-194

APPENDIX 3-G

Laboratory Test Data for Rock Units

Following is a compilation of all the laboratory test data for rock samples acquired during field work for this proposal. The compilation includes samples acquired from drill holes, quarries, and natural exposures. The locations of all samples tested are shown on Figure 3.2-1 (in map tube).

Laboratory Test Data for Rock Units. PCF = pounds per cubic foot; TSF = tons per square foot

Sample Number	Geologic Unit	Geologic Period	Lithology	Dry Point Load		
				Density (PCF)	Strength Index (TSF) [3-G-1]	Strength Classification [3-G-2]
R-3	Psa/Pg	Permian	sandstone, moderately indurated	142	45.9	high strength
R3-misc.	Trd	Triassic	sandstone	150	62.7	high strength
R-6	Trd	Triassic	sandstone	132	34.5	medium strength
R-7	Pg	Permian	sandstone	150	89.8	very high strength
R-8	Pm	Pennsylvanian	limestone	168	75.2	high strength
R-14	Pg	Permian	quartzose sandstone	NP	60.6	high strength
R-16	Pm	Pennsylvanian	limestone with iron oxide solution bands	167	61.6	high strength
R-17	Tm	Tertiary	monzonite, very altered	149	71.0	high strength
R-18	Tm	Tertiary	monzonite	164	63.7	high strength
R-19	Pa	Permian	sandstone, very well indurated	154	111.7	very high strength
R-20	Tm	Tertiary	monzonite	153	181.7	very high strength
R-21	Pm	Pennsylvanian	limestone, highly fractured	168	62.7	high strength
R-22	Pm	Pennsylvanian	limestone	NP	50.1	high strength
R-23	Tm	Tertiary	monzonite with hematite stains	149	26.1	medium strength
R-24	Pm	Pennsylvanian	limestone, fossiliferous	164	75.2	high strength
R-26	Pb	Permian	limestone with solution veins	172	115.9	very high strength
R-27	Pg	Permian	sandstone	NP	54.3	high strength
R-28	Trd	Triassic	sandstone	156	56.4	high strength
R-29	Pb-Psa	Permian	quartz sandstone, poorly indurated	135	18.8	low strength
R-30	Pb	Permian	limestone	163	129.5	very high strength
R-32	pC	Precambrian	schist	161	61.6	high strength
R-33	pC	Precambrian	metaquartzite	165	128.4	very high strength
R-34	Pg	Permian	sandstone	140	40.7	medium strength
R-35	Pg	Permian	siltstone	148	66.8	high strength
R-36	Qao	Quaternary	pebble conglomerate	NP	27.2	medium strength
R-37	Trd	Triassic	quartzose sandstone	145	34.5	medium strength
R-38	Trd	Triassic	sandstone	157	74.1	high strength
R-39	Pm	Pennsylvanian	limestone	171	73.1	high strength
R-40	QTa	Quaternary	conglomerate, poorly sorted	NP	11.5	low strength

3-195

Laboratory Test Data for Rock Units. PCF = pounds per cubic foot; TSF = tons per square foot

Drill Hole Number	Depth of Sample (ft)	Geologic Unit	Geologic Period	Lithology	Dry Density (PCF)
DH-27	6	Pg	Permian	clean quartz sandstone	148
DH-27	55	Pg	Permian	sandstone with minor limonitic seams	149
DH-27	101	Pg	Permian	clean quartz sandstone	160
DH-27	133.5	Pg	Permian	sandstone, crossbedded, very fractured	157
DH-27	142	Pg	Permian	sandstone, iron stained, fractured	151
DH-29	45	Pg	Permian	clean quartz sandstone, fractured	153
DH-29	120	Pg	Permian	sandstone, iron stained	151
DH-29	169	Pg	Permian	sandstone, weathered	156
DH-29	282	Py	Permian	silty sandstone	137
DH-29	354	Py	Permian	sandy claystone	140
DH-30	62.3	Trd	Triassic	sandstone + claystone	142
DH-30	74.5	Trd	Triassic	sandstone + claystone	146
DH-30	88.5	Trd	Triassic	sandstone + claystone	153
DH-32	144	Km	Cretaceous	sandy claystone	131
DH-32	154	Km	Cretaceous	sandy claystone	136
DH-34	182	Trd	Triassic	sandy siltstone	154
DH-37	124	Py	Permian	shaly fine sandstone, vuggy	135
DH-37	127.5	Py	Permian	shaly fine sandstone, vuggy	144
DH-39	25.5	Pm	Pennsylvanian	limestone, very fractured	167
DH-39	54	Pm	Pennsylvanian	limestone with shale partings	173
DH-39	78	Pm	Pennsylvanian	limestone, fractured	158
DH-39	85.5	Pm	Pennsylvanian	limestone, fractured	165
DH-39	90	Pm	Pennsylvanian	shaly limestone, fractured	176

Explanation for following table

Shear Strength Equation: $Y = T + aS$

Y = shear stress

T = cohesion, defined as the y-intercept in the shear strength equation

a = slope of the line defined by the shear strength equation

S = normal stress

Uniaxial Compressive Strength--the stress at which a rock core ruptures when compressed parallel to its long axis.

Young's Modulus--a measure of how a material responds to applied stress.

Poisson's Ratio--a measure of the change in length divided by the change in width for a rock core subjected to uniaxial compression.

Tensile Strength--the stress at which failure occurs in rock material subject to tension.

Angle of Internal Friction--the arctangent of the slope of a shear stress versus normal stress plot.

Point Load Strength--the stress at which failure occurs when a rock material is compressed between two small-diameter spherical platens.

Laboratory Test Data for Rock Units*. PCF = pounds per cubic foot; TSF = tons per square foot;

*Data from K. Oravec, rock mechanics laboratory, NMIMT, Socorro, NM; **Km not encountered along tunnel alignment.

Drill Hole Number	Depth of Sample (ft)	Geologic Unit	Geologic Period	Lithology	Uniaxial Compressive Strength (TSF)	Modulus of Elasticity (TSF)	Poisson's Ratio
-------------------	----------------------	---------------	-----------------	-----------	-------------------------------------	-----------------------------	-----------------

Uniaxial Compressive Strength test results

DH-27	29.25	Pg	Permian	limestone, very fractured	966	164,880#	0.154#
DH-37	121	Py	Permian	shaly fine sandstone, vuggy	229	38,016	0.112
DH-37	122.5	Py	Permian	shaly fine sandstone, vuggy	236	52,128	0.077
DH-39	87	Pm	Pennsylvanian	limestone, fractured	1298	326,160	0.183
DH-39	92	Pm	Pennsylvanian	shaly limestone, fractured	509	563,760	0.143
DH-39	93.5	Pm	Pennsylvanian	shaly limestone, fractured	732	539,280	0.235

#Denotes tangent value

Tensile Strength test results

Drill Hole	Depth (ft)	Geologic Unit	Geologic Period	Lithology	Tensile Strength (TSF)
DH-27	29.25	Pg	Permian	sandstone, very fractured	44
DH-30	62	Trd	Triassic	sandstone + claystone	10
DH-37	122.5	Py	Permian	shaly fine sandstone, vuggy	14
DH-39	87	Pm	Pennsylvanian	limestone, fractured	68

Tensile Strength (TSF)

Shear Strength test results

Drill Hole	Depth (ft)	Geologic Unit	Geologic Period	Lithology	Equation (Y=T+aS) (TSF)	Angle of Internal Friction (degrees)
DH-27	29.25	Pg	Permian	sandstone, very fractured	Y=10.568+0.838S	40.0
DH-27	33	Pg	Permian	sandstone, very fractured	Y=6.798+0.787S	38.2
DH-32	150	Km**	Cretaceous	sandy claystone	Y=0.002+0.581S	30.2
DH-37	121	Py	Permian	shaly fine sandstone	Y=0.087+0.643S	32.7

Shear Strength Equation (Y=T+aS) (TSF) Angle of Internal Friction (degrees)

Point Load Strength results

Drill Hole	Depth (ft)	Geologic Unit	Geologic Period	Lithology	Point Load Strength (TSF)	Strength Classification [3-G-2]
DH-27	29.25	Pg	Permian	sandstone, very fractured	57	high strength
DH-32	150	Km**	Cretaceous	sandy claystone	1	very low strength

Point Load Strength (TSF) Strength Classification [3-G-2]

3-198

APPENDIX 3-H

Method Used to Construct Tunnel Profiles

Following is a description of the method that was used to construct the tunnel profiles shown on Figures 3.1-2 (in map pocket) and 3.1-3 and 3.1-6 (in map tube).

METHOD OF BEAM ELEVATION PROFILE ANALYSIS

The data for analyzing the beam path consist of elevations of the ground surface $z(t)$ read from 1:24,000 scale topographic maps of the site area and the surface location of the elevation measurement. The coordinates of this location are given by $x(t)$, the distance north from the center of the profile, and $y(t)$, the distance to the east. The parameter t measures the distance along the profile line (which is approximately the beam line). The coordinates $x(t)$ and $y(t)$ are set out on the topographic map. At each value t that the profile line crosses a contour line, the values of t and $z(t)$ are entered into a data block. The parameter t is rounded off to 1 mm on the map, or 78.74 ft on the surface. With the 20-ft contour interval of the USGS map, the beam profile crosses 250 contour lines. The total circumference is 3598 mm. A value of $z(t)$ for each mm on the map is then computed by linear interpolation between the contour crossings.

The values of $x(t)$ and $y(t)$ for $t=0$ to 3598 mm are computed using the radii of curvature as indicated in Appendix H of the Invitation for Site Proposals [3.1-3]. The four circular arcs are defined as follows. The two arcs describing the bends dominated by dipole magnets are centered at $x=0$ and $y=$ plus or minus 126.5 mm, with a radius of 491.7 mm, in map coordinates. The two arcs through the IR and injector regions are centered at $y=0$ and $x=$ plus or minus 658.4 mm and have a radius of 1161.6 mm. The arcs do cross, with essentially the same slopes, at the points PI, at $t=709$ mm, 1089 mm, 2508 mm, and 2889 mm. Thus, the orientation of the ring has the long axis of symmetry pointing due north-south, and the IR regions are on the east and west sides of the beam. The maps indicate the obvious advantages (due to infrastructure) for placing the injector and campus on the west side of the beam.

Calculation of the Profile

The analysis is based on single fold beam profile, with the intersection of the two planes lying along the north-south symmetry axis. The depth of the planes is calculated in terms of four parameters. Because the east and west planes are required to intersect at the north ($t=0$) and south ($t=1799$ mm) points of the ring, only the depths of the intersections are free parameters there. One depth at some t between 0 and 1798 mm, for the east plane, and another depth at some t between 1800 and 3597 mm, for the west plane, complete the parameterization of the planes. The 3 noncol-

linear points per plane $x(t_i)$, $y(t_i)$, $e(t_i)$ (where e is the elevation of the beam line) for 3 values of t define the values a , b , c of the plane $ax+by+e=c$. Thus, the three simultaneous linear equations for a , b , and c are solved, and $e(t)$ is then computed for all values of t from $e(t)=c-ax(t)-by(t)$ (of course, the x , y , and e coordinates are all converted to feet). There isn't very much fitting to be done, because the requirement $d_{min} > 0$ requested in the Invitation for Site Proposals [3.1-3] leaves little room for variation. Thus, at this stage of the analysis, there is little need for a fancy fitting routine to parameterize the planes.

We note that more optimal profiles could be obtained by allowing $d_{min} < 0$ and using the tunnel muck and spoils to increase the ground overburden on those regions where $d_{min} < 0$. Such options might be explored at a later time and depend on the selection of an optimal overburden at the IR's.

Parameters of the Planes

The angles of the normal to each plane measure the tilt and fold angle of the beam profile. For the east plane the tilt toward the west is 0.15 degrees, and toward the south it is 0.18 degrees. For the west plane the tilt toward the east is 0.24 degrees, and toward the south it is 0.18 degrees. Thus, the fold angle is 0.40 degrees.

Alternative Rings

We experimented with a number of alternative beam lines and with single plane fits to the beam line defined above. The result of the single plane fit is presented in Figure 3.1-2 (in map pocket). We tried two other beam lines with north-south orientation, similar to that in the proposal. The line selected is only marginally better, so there is some flexibility in the precise choice of beam line.

The second solution to the siting problem has the long axis in an east-west orientation, with the fold either in or between the IR's. This option has not been adequately investigated. Our proposal, including land acquisition, is based on a north-south orientation. However, we would argue the need to investigate east-west candidates, especially if it were shown that a 0.40° fold in the IR regions does not adversely affect the beam dynamics.

APPENDIX 3-I

Tunneling Conditions Data Sheets

Following are the detailed data sheets that document the five tunneling conditions shown on Figure 3.5-1 (in map tube).

Tunneling Condition A

Locations

Miles 32-37.

Formation Characteristics

Material Type:

Madera (PPm), interbedded limestones and shales, individual bed thicknesses <10 ft.

Strength, psi:

5,000 to 15,000.

Abrasiveness:

Low to moderate.

Slake potential:

Low to moderate.

Gas-seepage potential:

Low to none.

Discontinuities

RQD:

50 to 70.

Shears:

Slight to none.

Groundwater

Tunnel above/below:

Tunnel above.

Inflow potential:

Slight to none.

Excavation

Stand-up time:

Moderate to long.

Methods:

Full-face TBM or road header.

Shield:

Roof shield.

Rate, ft/day:

80 to 100.

Support

Temporary:

Rock bolts and wire mesh, precast invert slab.

Permanent:

Cast-in-place concrete.

Special Conditions

Possible local small vug fillings.

Possible local loose block wedges.

Cost

Unit cost, \$/ft: 700 to 900.

Total footage this condition, x1,000 ft: 26.

Total cost, this condition, millions \$: 18 to 23.

Tunneling Condition B

Locations	Miles 23-28.
Formation Characteristics	
Material type:	Mixed face; soils: slightly cemented silts, sands, and gravels over Yeso/Abo (Py/Pa).
Strength, psi:	15 to 30
Abrasive-ness:	Low.
Slake potential:	Low.
Gas-seepage potential:	Low.
Discontinuities	
RQD:	not applicable
Shears:	not applicable
Groundwater	
Tunnel above/below:	Tunnel below.
Inflow potential:	Probably moderate, controllable by sump pumps.
Excavation	
Stand-up time:	Low to moderate.
Methods:	Full-face TBM or digger.
Shield:	Full shield with roof tailshield.
Rate, ft/day:	100 to 120.
Support	
Temporary:	Ribs and boards, precast invert slab.
Permanent:	Cast-in-place concrete.
Special Conditions	None
Cost	
Unit cost, \$/ft:	800 to 1,000.
Total footage this condition, x1,000 ft:	37.
Total cost, this condition, millions \$:	30 to 37.

Tunneling Condition C

Locations	Miles 0-7; 49-50; 52-54.
Formation Characteristics	
Material Type:	Mixed face; soils: slightly cemented silts, sands, and gravels over Mancos (Km).
Strength, psi:	15 to 30.
Abrasive-ness:	Low.
Slake potential:	Low to moderate.
Gas-seepage potential:	Moderate to low.
Discontinuities	
RQD:	not applicable
Shears:	not applicable
Groundwater	
Tunnel above/below:	Tunnel above.
Inflow potential:	None.
Excavation	
Stand-up time:	Low to moderate.
Methods:	Full-face TBM or digger.
Shield:	Full shield with roof tailshield.
Rate, ft/day:	100 to 120.
Support	
Temporary:	Ribs and boards.
Permanent:	Cast-in-place concrete.
Special Conditions	
	Some of the soils may be collapsible, if wetted.
Cost	
Unit cost, \$/ft:	600 to 800.
Total footage this condition, x1,000 ft:	53.
Total cost, this condition, millions \$:	32 to 42.

Tunneling Condition C

Locations	Miles 7-10; 45-49.
Formation Characteristics	
Material Type:	Mixed face; soils: slightly cemented sands, silts, and gravels over Chinle (Trd).
Strength, psi:	15 to 30.
Abrasiveness:	Low.
Slake potential:	Low.
Gas-seepage potential:	Low.
Discontinuities	
RQD:	not applicable
Shears:	not applicable
Groundwater	
Tunnel above/below:	Tunnel above.
Inflow potential:	None.
Excavation	
Stand-up time:	Low to moderate.
Methods:	Full-face TBM or digger.
Shield:	Full shield with roof tailshield.
Rate, ft/day:	100 to 120.
Support	
Temporary:	Ribs and boards, precast invert slab.
Permanent:	Cast-in-place concrete.
Special Conditions	
	Soils may be collapsible, if wetted.
Cost	
	Unit cost, \$/ft: 600 to 800.
	Total footage this condition, x1,000 ft: 37.
	Total cost, this condition, millions \$: 23 to 30.

Tunneling Condition C

Locations	Miles 10-12.
Formation Characteristics	
Material Type:	Chinle (Trd) claystones and fine silty sandstones.
Strength, psi:	<2,000.
Abrasive ness:	Moderate to low.
Slake potential:	Moderate to high.
Gas-seepage potential:	Low.
Discontinuities	
RQD:	Locally low.
Shears:	Few to several.
Groundwater	
Tunnel above/below:	Tunnel above.
Inflow potential:	Low, could be some evanescent perched water.
Excavation	
Stand-up time:	Moderate to short.
Methods:	Full-face TBM or road header.
Shield:	Full shield with roof tailshield.
Rate, ft/day:	100 to 120.
Support	
Temporary:	Rock bolts and wire mesh, precast invert slab.
Permanent:	Cast-in-place concrete.
special Conditions	
	Possibly locally ravelling ground.
Cost	
	Unit cost, \$/ft: 600 to 800.
	Total footage this condition, x1,000 ft: 11.
	Total cost, this condition, millions \$: 7 to 9.

Tunneling Condition C

Locations	Miles 19-22.
Formation Characteristics	
Material type:	Yeso/Abo (Py/Pa), shales and silty sandstones.
Strength, psi:	<2,000.
Abrasiveness:	Low to moderate.
Slake potential:	Low to moderate.
Gas-seepage potential:	Low to none.
Discontinuities	
RQD:	75-85.
Shears:	Slight.
Groundwater	
Tunnel above/below:	Tunnel above.
Inflow potential:	Slight to none.
Excavation	
Stand-up time:	Short to moderate.
Methods:	Full-face TBM or road header.
Shield:	Roof shield.
Rate, ft/day:	100 to 120.
Support	
Temporary:	Rock bolts and wire mesh, precast invert slab.
Permanent:	Cast-in-place concrete.
Special Conditions	Possible local high slaking.
Cost	
Unit cost, \$/ft:	600 to 800.
Total footage this condition, x1,000 ft:	11.
Total cost, this condition, millions \$:	7 to 9.

Tunneling Condition C

Locations	Miles 22-23; 28-32; 37-42.
Formation Characteristics	
Material type:	Mixed face; soils: slightly cemented silts, sands, and gravels over Yeso/Abo (Py/Pa).
Strength, psi:	15 to 30
Abrasive-ness:	Low.
Slake potential:	Low.
Gas-seepage potential:	Low.
Discontinuities	
RQD:	not applicable
Shears:	not applicable
Groundwater	
Tunnel above/below:	Tunnel above.
Inflow potential:	None.
Excavation	
Stand-up time:	Low to moderate.
Methods:	Full-face TBM or digger.
Shield:	Full shield with roof tailshield.
Rate, ft/day:	100 to 120.
Support	
Temporary:	Ribs and boards, precast invert slab.
Permanent:	Cast-in-place concrete.
Special Conditions	
	Soils may be collapsible, if wetted.
Cost	
Unit cost, \$/ft:	600 to 800.
Total footage this condition, x1,000 ft:	48.
Total cost, this condition, millions \$:	30 to 39.

Tunneling Condition C

Locations	Miles 42-45.
Formation Characteristics	
Material type:	Mixed face; soils: slightly cemented silts, sands, and gravels over Glorieta (Pg).
Strength, psi:	15 to 30
Abrasiveness:	Low.
Slake potential:	Low.
Gas-seepage potential:	Low.
Discontinuities	
RQD:	not applicable
Shears:	not applicable
Groundwater	
Tunnel above/below:	Tunnel above.
Inflow potential:	None.
Excavation	
Stand-up time:	Low to moderate.
Methods:	Full-face TBM or digger.
Shield:	Full shield with roof tailshield.
Rate, ft/day:	100 to 120.
Support	
Temporary:	Ribs and boards, precast invert slab.
Permanent:	Cast-in-place concrete.
Special Conditions	
	Soils may be collapsible, if wetted.
Cost	
	Unit cost, \$/ft: 600 to 800.
	Total footage this condition, x1,000 ft: 16.
	Total cost, this condition, millions \$: 10 to 13.

Tunneling Condition D

Locations	Miles 12-19.
Formation Characteristics	
Material type:	Glorieta/San Andres (Pg/Fsa) sandstones and some limestones.
Strength, psi:	8,000 to 10,000.
Abrasive-ness:	Moderate to high.
Slake potential:	Low to none.
Gas-seepage potential:	None.
Discontinuities	
RQD:	30 to 70.
Shears:	Few to none, most healed by secondary mineralization.
Groundwater	
Tunnel above/below:	Tunnel above.
Inflow potential:	Slight to none.
Excavation	
Stand-up time:	Moderate to long.
Methods:	Full-face TBM.
Shield:	Full shield with roof tailshield.
Rate, ft/day:	75 to 90.
Support	
Temporary:	Rock bolts and wire mesh, precast invert slab.
Permanent:	Cast-in-place concrete or shotcrete.
Special Conditions	
	Possible local loose block wedges.
Cost	
	Unit cost, \$/ft: 750 to 1,000.
	Total footage this condition, x1,000 ft: 37.
	Total cost, this condition, millions \$: 28 to 37.

Tunneling Condition E

Locations

Miles 50-52.

Formation Characteristics

Material Type:

Soils: slightly cemented sands, silts, and gravels (cut-and-cover case).

Strength, psi:

15 to 30.

Abrasiveness:

Low.

Slake potential:

Low to moderate.

Gas-seepage potential:

Moderate to low.

Discontinuities

RQD:

not applicable

Shears:

not applicable

Groundwater

Tunnel above/below:

Tunnel above.

Inflow potential:

None.

Excavation

Stand-up time:

not applicable

Methods:

Cut and cover.

Shield:

not applicable

Rate, ft/day:

120 to 150.

Support

Temporary:

not applicable

Permanent:

not applicable

Special Conditions

Some of the soils may be collapsible, if wetted.

Cost

Unit cost, \$/ft: 300 to 700 (depends upon final depth).

Total footage this condition, x1,000 ft: 11.

Total cost, this condition, millions \$: 3 to 9.

APPENDIX 3-J

Chemical Analyses of Rock and Soil Units

Following are chemical analyses on representative samples of rock and soil from the SSC site. The data were used in Sec. 3.5.5 to confirm suitability of SSC muck for use in cement manufacture or as spoils that can be used for reclamation in mined-out quarries in the SSC vicinity. The locations of samples analyzed are shown in Figure 3.2-1 (in map tube).

MEMORANDUM

TO: Mr. Gary Johnpeer
FROM: F. M. Miller
DATE: June 15, 1987

NEW MEXICO DIVISION

The attached Table gives the chemical analytical results for the twelve geologic samples representing the materials that would be excavated for installation of the SSC Project tunnel. The materials represented by Drill Hole 39 would be completely usable in cement manufacture (245,000 yd³), about 20% of the sandstone material in Drill Hole 27 could be used (67,000 yd³) over about a four year period, and limited quantities (perhaps 10,000 yd³) of the TRD shale (Drill Hole 30) would be usable over a similar period; the limitation on its use is a high content of alkalis (Na₂O and K₂O), but its high Al₂O₃ content is attractive. Also, Sample R#38 is San Andreas limestone. To the extent that it could be separated from the Glorieta sandstone it too could be used (84,000 yd³).

There is thus a potential to use a total of about 322,000*406,000 yd³ in cement manufacture. There does not appear to be any problem with disposing of the remainder of the material (maximum 2.38 million yd³) in quarried*out portions of the Tijeras quarry. Among the available areas, two areas essentially totally quarried out have a total cross*sectional area of 222,000 yd². The maxi* mum average depth of the spoils material required would thus be about 32 ft. Our plant engineer and quarry supervisor have determined that this would not pose any insurmountable dif* ficulties.

FMM

FMM:rb

**CHEMICAL ANALYSIS
CORE SAMPLE
SSC PROJECT**

	%SiO ₂	%Al ₂ O ₃	%Fe ₂ O ₃	%CaO	%MgO	%SO ₃	%Na ₂ O	%K ₂ O	%Loss	Total
DH-3	65.24	7.72	2.48	10.95	1.16	0	0.94	1.60	8.81	98.9
DH-27	81.4	1.96	1.16	9.83	0	0	0.12	0.52	3.92	98.91
DH-30	53.06	20.68	7.24	4.27	3.80	0	0.78	2.20	7.97	100.00
DH-32	54.8	12.04	3.04	14.4	2.86	0	0.44	1.48	14.87	100.97
DH-33	53.4	9.12	2.96	15.59	2.72	0	1.20	1.54	13.89	100.42
DH-35	56.48	8.82	2.54	16.25	1.62	0.08	0.80	1.58	14.41	102.58
DH-37	71.0	5.96	2.04	9.03	1.32	0	1.14	1.50	5.97	97.96
DH-39	1.76	0.21	0.03	54.73	0.29	0	0.12	0.06	42.8	100.00
BH-10	66.2	5.6	2.04	11.91	0.64	0	0.74	1.22	8.93	97.28
R-38	10.94	0.63	0.57	49.50	0.71	0	0.14	0.94	39.46	102.89
R-40	18.61	1.38	0.69	43.38	0.48	0	0.48	0.16	33.54	98.72
ST-58	22.18	3.18	0.90	38.03	2.88	0.08	0.58	0.60	31.90	100.33

Ideal Basic Industries Number	SSC Sample Number (Fig. 3.2-1A-D; in map tube)	Depth Below Ground Surface (feet)	Geologic Unit (Fig 3.2-1A-D; in map tube)
DH-3	SSC-DH-23	9.0 - 10.5	Qao
DH-27	SSC-DH-27	101.0	Pg
DH-30	SSC-DH-30	78.0	R d
DH-32	SSC-DH-32	146.5	Km
DH-33	SSC-DH-33	32.0 - 33.3	QTa
DH-35	SSC-DH-35	58.4	Qld
DH-37	SSC-DH-37	124.0	Py
DH-39	SSC-DH-39	69.5	Pm
BH-10	SSC-BH-10	0.5	Qay
R-38	SSC-LH-R38	0	R d
R-40	SSC-ES-R40	0	QTa
ST-58	SSS-ST-S8	2.0	QTa

NEW MEXICO SSC PROPOSAL JULY 31, 1987

MAP POCKET

Figure 3.1–2. Single Plane Ring Profile
Figure 3.1–4. Abort Beam Line Profile

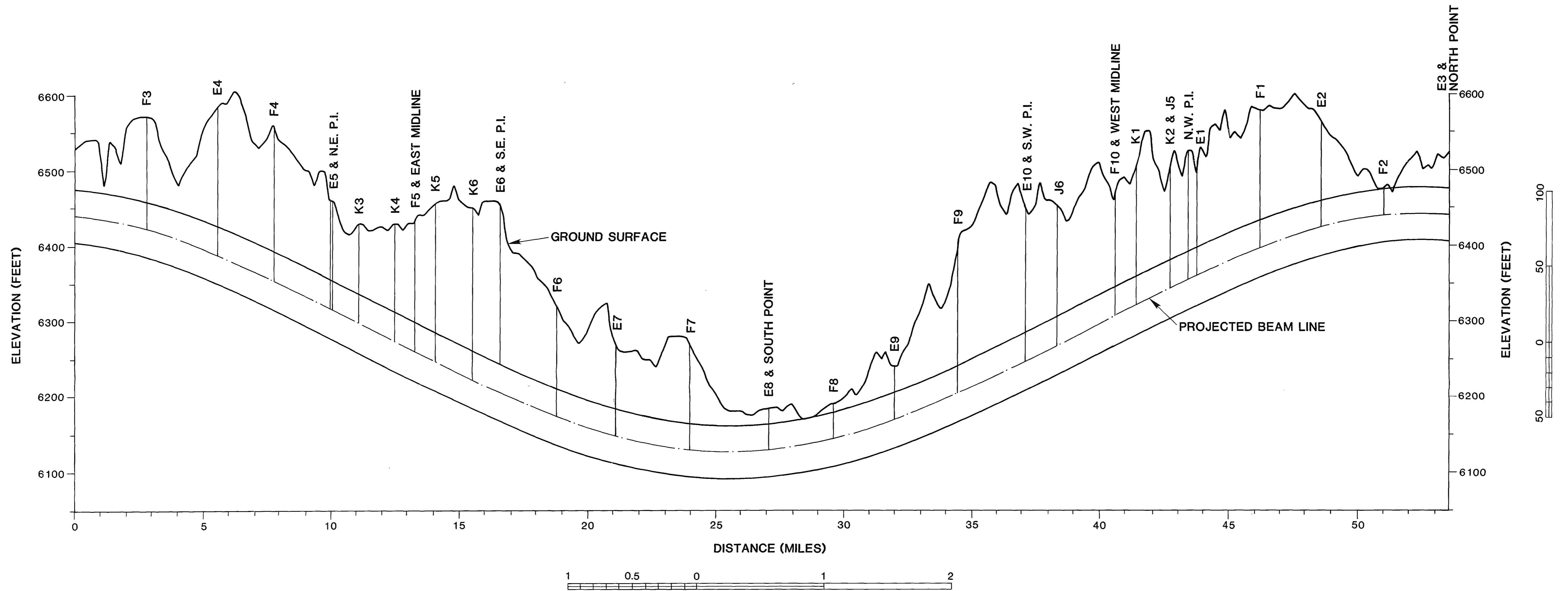

NOTES:

- E**= INTERMEDIATE ACCESS
- F**= SERVICE AREAS
- J**= ABORT/EXTERNAL BEAM ACCESS
- K**= INTERACTION POINTS

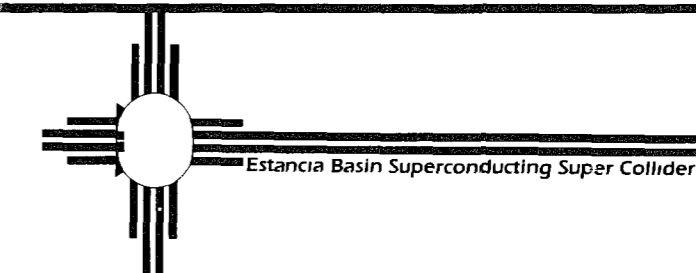

**SINGLE PLANE PROFILE OF SSC TUNNEL
ESTANCIA BASIN, NEW MEXICO**

JULY 31, 1987

FIGURE 3.1-2

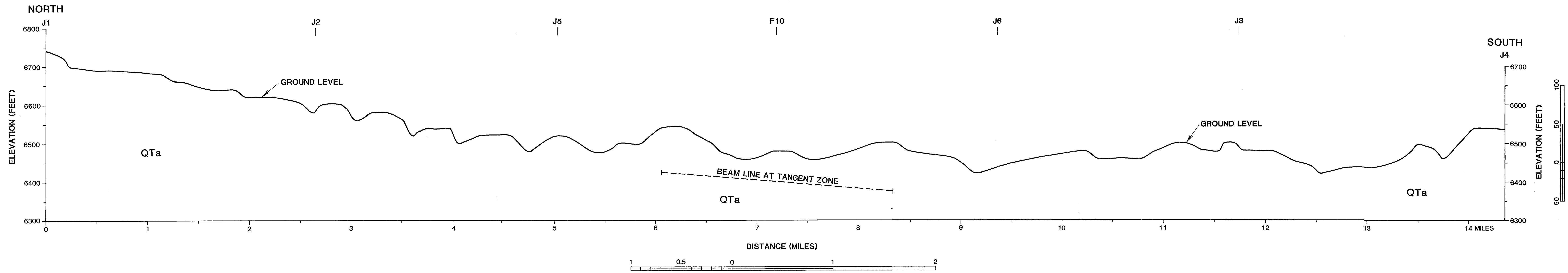

NOTES:

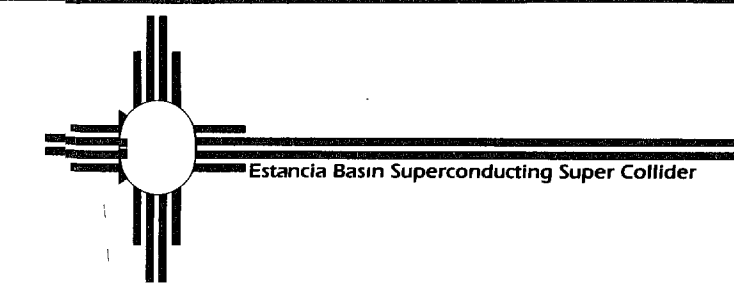

**NORTH-SOUTH PROFILE
ALONG ABORT BEAM LINE,
ESTANCIA BASIN, NEW MEXICO**

SEE FIGURE 3.2-1D FOR
EXPLANATION OF GEOLOGIC UNITS

JULY 31, 1987

FIGURE 3.1-4

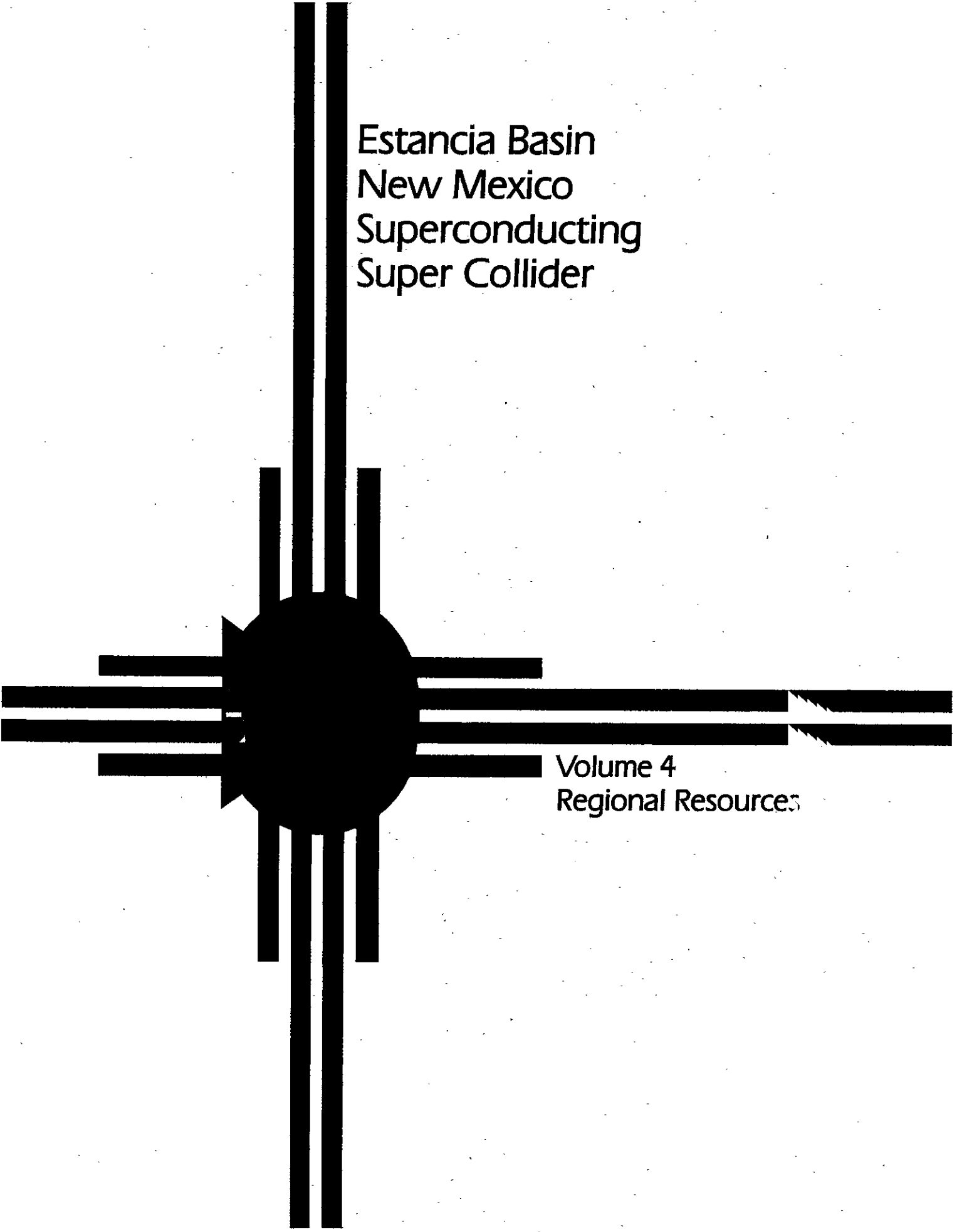

Estancia Basin
New Mexico
Superconducting
Super Collider

Volume 4
Regional Resources



Regional Resources

Volume 4

TABLE OF CONTENTS

4.0	Summary.....	4-1
4.1	Accessibility of Airports.....	4-2
4.1.1	Major Airports in Vicinity of Proposed Site.....	4-2
4.2	Highways, Streets, Roads, and Railroads.....	4-6
4.2.1	Major Road, Highway, and Rail Routes Serving the SSC Site.....	4-6
4.2.2	Necessary Improvements to the Existing Road, Highway, and Rail Network.....	4-12
4.3	Public Transportation.....	4-14
4.3.1	Public Transportation Systems.....	4-14
4.3.2	Necessary Improvements to the Public Transportation System.....	4-17
4.4	Industrial and Construction Resources.....	4-18
4.4.1	Accessibility of the Proposed Site to an Industrial Base.....	4-18
4.4.2	Regional Labor Pool and Prevailing Wage Rates.....	4-26
4.5	Human Resources.....	4-31
4.5.1	Geographic Distribution of the Population..	4-31
4.5.2	Driving Time from Surrounding Communities to the SSC Site.....	4-37
4.5.3	Local Employment Rates and Opportunities for Employment.....	4-37
4.5.4	Federal Fair Employment Practices, Equal Employment Opportunity Statutes, and Open Housing Practices.....	4-43
4.6	Housing.....	4-50
4.6.1	Characterization of Housing.....	4-50
4.6.2	Typical Purchase Prices and Rents.....	4-57
4.7	Community Services.....	4-59
4.7.1	Medical Centers, Hospitals, and Emergency Services.....	4-59
4.7.2	Description of Recreational and Open Space Facilities.....	4-68
4.8	Educational and Cultural Resources.....	4-76

4.8.1	Elementary and Secondary Educational Facilities.....	4-76
4.8.2	Higher Education and Research Institutions in the Vicinity of the Proposed Site.....	4-80
4.8.3	Description of Nearby Cultural Resources...	4-98
4.9	Community Support.....	4-108
4.9.1	Existing and Potential Community Support...	4-108
4.9.2	Existing or Anticipated Opposition to the Proposed Siting of the SSC.....	4-108
4.10	Non-Federal Government Support.....	4-109
4.10.1	Proposed State, Regional, and Local Government Support and Services Summarized.....	4-109
4.10.2	Existing Laws or Local Statutes and Jurisdictions that would be Affected by or Could Affect the SSC.....	4-109
4.10.3	Tax Policies.....	4-112
4.10.4	Procedural, Infrastructure, and Facility Needs Assistance.....	4-115
	References.....	4-116
	Appendices.....	4-126
4-A	Airports.....	4-126
4-B	Highways, Streets, Roads, and Railroads....	4-127
4-C	Public Transportation.....	4-143
4-D	Industrial and Construction Resources.....	4-145
4-E	Human Resources.....	4-161
4-F	Housing.....	4-177
4-G	Community Services.....	4-178
4-H	Educational and Cultural Resources.....	4-197
4-I	Community Support.....	4-224
4-J	Non-Federal Government Support.....	4-239

4.0 SUMMARY

New Mexico's SSC site is half an hour away from an economically healthy metropolitan area of 500,000 people. There is ample availability of labor and housing at reasonable costs. The recreational and cultural quality of life in the vicinity of the site is rich. Specific findings concerning these regional resources are the following:

- A. Albuquerque International Airport is 40 minutes from the SSC campus. The road network serving the site is more than adequate, and seven railroad sidings within 32 miles of the site meet or considerably exceed the SSC's requirements.
- B. The work force in the vicinity of the SSC site is a technologically skilled and educated one. 45,000 persons are currently employed in New Mexico's technology-based organizations. More than 40% of the adults in Albuquerque and Santa Fe have attended college. Overall, New Mexico has the highest per capita rate of Ph.D's in the nation.
- C. New Mexico's industrial-support businesses have been serving federal research facilities for over 35 years. The presence of the national laboratories has created in New Mexico an exceptional concentration and level of technical services.
- D. New Mexico's construction costs for the SSC should be extremely competitive. Our area construction wage rates are 59% to 66% of the Davis-Bacon rates assumed in the SSC Conceptual Design Document.
- E. The counties in the vicinity of the site produce new housing units at the rate of 7,700 a year, with current average sales price of \$126,700 in Santa Fe and \$92,000 in Albuquerque.
- F. The composite ACT scores of students in all three school districts in the vicinity of the site exceed the national average. Albuquerque Public Schools have won more Centers of Educational Excellence awards than any other school district in the nation.
- G. New Mexico's SSC site is positioned at the midpoint of the Rio Grande Research Corridor. Research expenditures in the Corridor this year will be \$4.3 billion. 20,000 professionals (scientists, engineers, other college-degreed individuals) staff the facilities located there.
- H. New Mexico's 16 million acres of public lands (and waters) provide a super abundance of recreational opportunities. Skiing is available within minutes of the site.
- I. New Mexico's alliance with the arts is legendary. It encompasses the artifacts and traditions of our cultural heritage, world class opera and music festivals, and art galleries that draw collectors from around the globe.

4.1 ACCESSIBILITY OF AIRPORTS

4.1.1 MAJOR AIRPORTS IN VICINITY OF PROPOSED SITE

The campus of New Mexico's SSC site is located 40 minutes by car from Albuquerque's International Airport and 12 minutes from a general aviation facility which can accommodate commuter service as well as private aircraft [4.4-1].

Four additional general aviation facilities are located in Albuquerque. Santa Fe's general aviation airport is one hour from the site.

The location and driving times for each of these facilities is indicated on Figure 4.1-1.

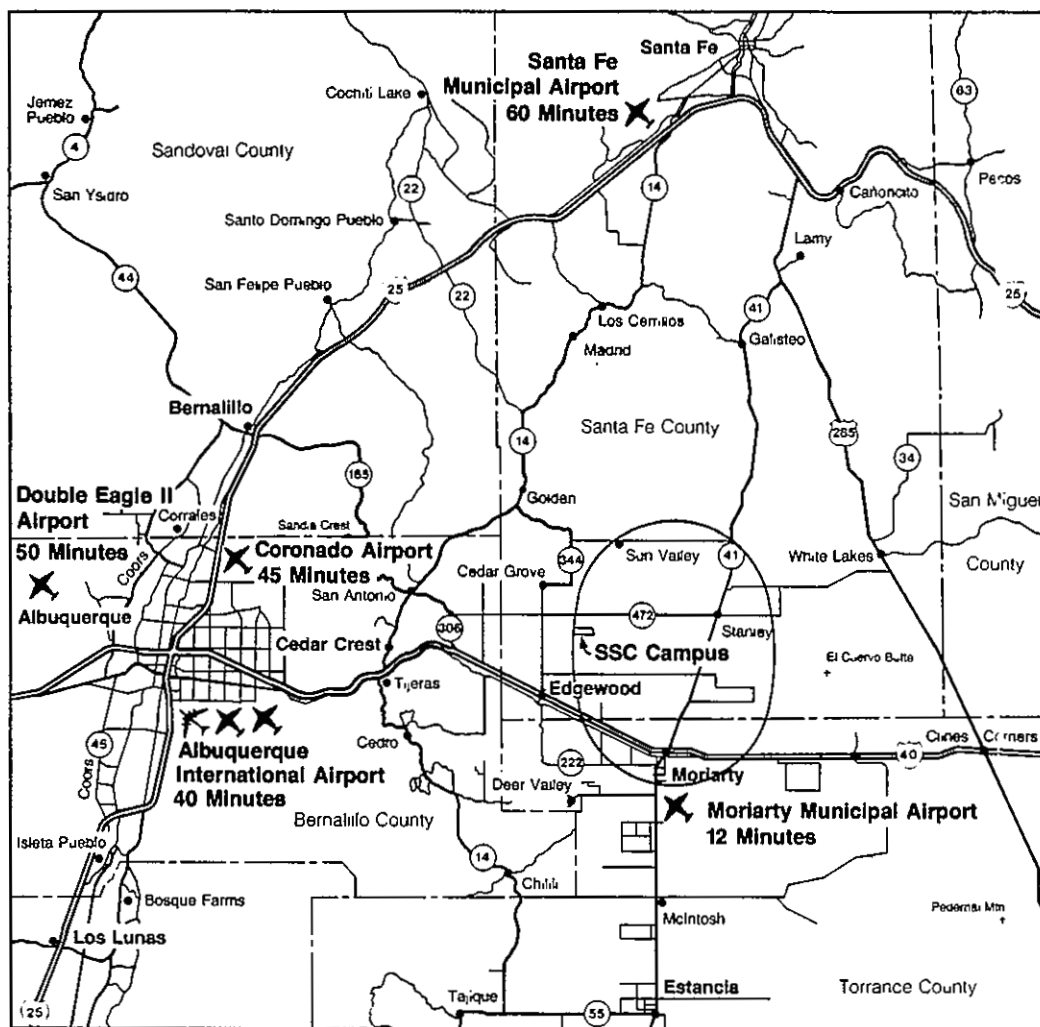

FIGURE 4.1-1. Location and Drive Times for all Airports in the Vicinity of the Superconducting Super Collider.

Data collected and map created by Southwest Land Research, Inc.

✈ Commercial Aviation Facility
✕ General Aviation Facility

0 10 20 Miles

Albuquerque International Airport

Albuquerque International Airport (AIA) houses a commercial and two general aviation facilities. Its excellent flying conditions have been instrumental in attracting major federal installations over the years, among them Kirtland Air Force Base. None one of the flight facilities at Albuquerque International Airport has ever been closed for a full day because of inclement weather. On the average, these facilities experience weather-related flight delays for a total of five hours per year [4.1-2].

AIA's commercial facility enplaned 4,135,011 passengers in 1986. Twelve passenger carriers (three of which are commuter lines) and four freight carriers operate on a scheduled basis (see Appendix 4-A). The commuter lines serve 14 cities in New Mexico and Colorado. Direct flights are available to 46 destinations outside the state. Figure 4.1-2 shows their location and the number of daily departures [4.1-3].

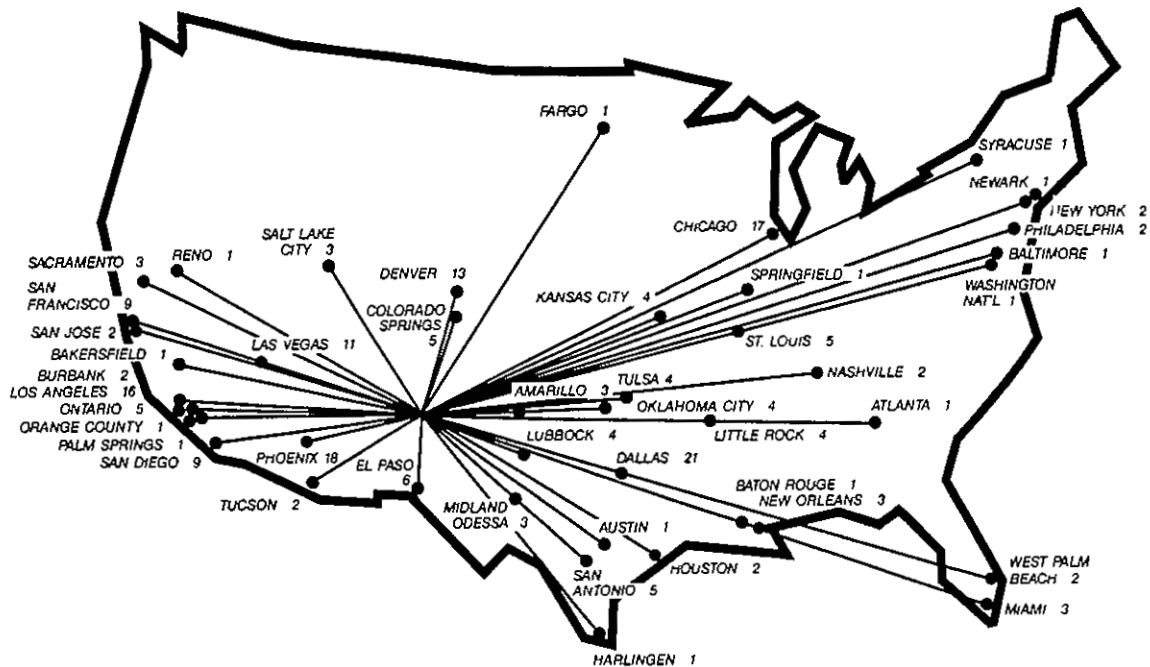

Data collected and map created by Southwest Land Research, Inc.

FIGURE 4.1-2. Destinations Served By Direct Flights from Albuquerque International Airport and Number of Daily Departures.

Charter service is provided by three operators at the commercial aviation facility. Also available here are the services of five rental car agencies.

Air charter, rental car services, and cargo transport are available at AIA's two general aviation facilities as well. Taken together, these two GAFs have the capacity to house 220 ground based aircraft [4.1-4]. Albuquerque International Airport's current character is summarized in Figure 4.1-3.

Figure 4.1-3. Character of Albuquerque International Airport in 1987 [4.1-2, 4.1-4].

Type of Facility (Name)	Commercial Aviation (Albuquerque International Airport)	General Aviation (Executive Aviation Center)	General Aviation (Cutter Flying Service)
Daily Operations (take off/landing)	125	40	60
Passenger Carriers	12	-	-
Freight Carriers	4	1	1
Charter Operators	1	1	1
Rental Car Agencies	5	1	1
Ground Based Aircraft	-	77	110
Capacity	-	85	135
Largest Craft Can Accommodate	747	>30 tons gross	737
Expansion Plans	Yes (see text)	No	Yes (Air ambulance)

AIA's commercial aviation facility is currently undergoing a \$120,000,000 expansion, which will double its capacity and upgrade its access and parking. By 1990, 32 gates will be in operation, a new roadway system will separate arrival and departure traffic and a 4,000 vehicle parking structure will be built and connected to the main concourse. The expansion will support an annual passenger volume of 8,000,000.

Moriarty Municipal Airport

The airport most immediately available to the campus of New Mexico's SSC site is Moriarty Municipal Airport. This small general aviation facility currently accommodates 10 based aircraft and could function as a commuter airline base (see Sec. 4.3.2). The airport expects to be equipped for instrument landings within a year.

4.2 HIGHWAYS, STREETS, ROADS, AND RAILROADS

4.2.1 MAJOR ROAD, HIGHWAY, AND RAIL ROUTES SERVING THE SSC SITE

New Mexico's SSC campus is located four miles north of Interstate Highway 40. Access to Class 1 railroad mainlines is available at points 25 miles south, 30 miles west, and 19 miles north of the collider ring. The road and rail network serving the site is shown on Figure 4.2-1.

Utilization of the Road Network

Trip origins for construction workers, materials, and equipment (and eventually, for the SSC's employees and visitors) are expected to be distributed around the site to the north, west, and south. The lion's share of these trips will originate west of the site, in Albuquerque, because it offers the greatest abundance of housing, services, and jobs for other family members, because it hosts an International Airport and plentiful accommodations for visitors, and because it offers a key intermodal transfer point on the Santa Fe Railway. This traffic from the west will be carried to the site on Interstate Highway 40.

Traffic originating to the north of the site is expected to have three components. A small proportion of the SSC's permanent work force is expected to reside in the Santa Fe area. (See Appendix 4-B-1 for the model, assumptions, and calculations for work force distributions.) Santa Fe is noted for its charm and attractiveness and it is likely that a substantial proportion of the SSC's visitors will choose to stay in this area. Finally, a railroad siding of adequate capacity to serve the SSC's construction requirements is located in Lamy; it is particularly well situated to support construction of the north arc and the structures on the east side of the ring. This traffic originating in the north will be carried to the site primarily on State Highways 41 and 472 and to a lesser degree on State Highways 14, 22, and 344.

Few of the facility's workers are expected to reside south of the site because housing opportunities are limited there. A rail siding with 10 times the capacity required for the SSC's equipment and material delivery is located in Willard, however, and is likely to generate a considerable amount of freight traffic. This traffic originating in the south will be carried to the site on State Highway 41.

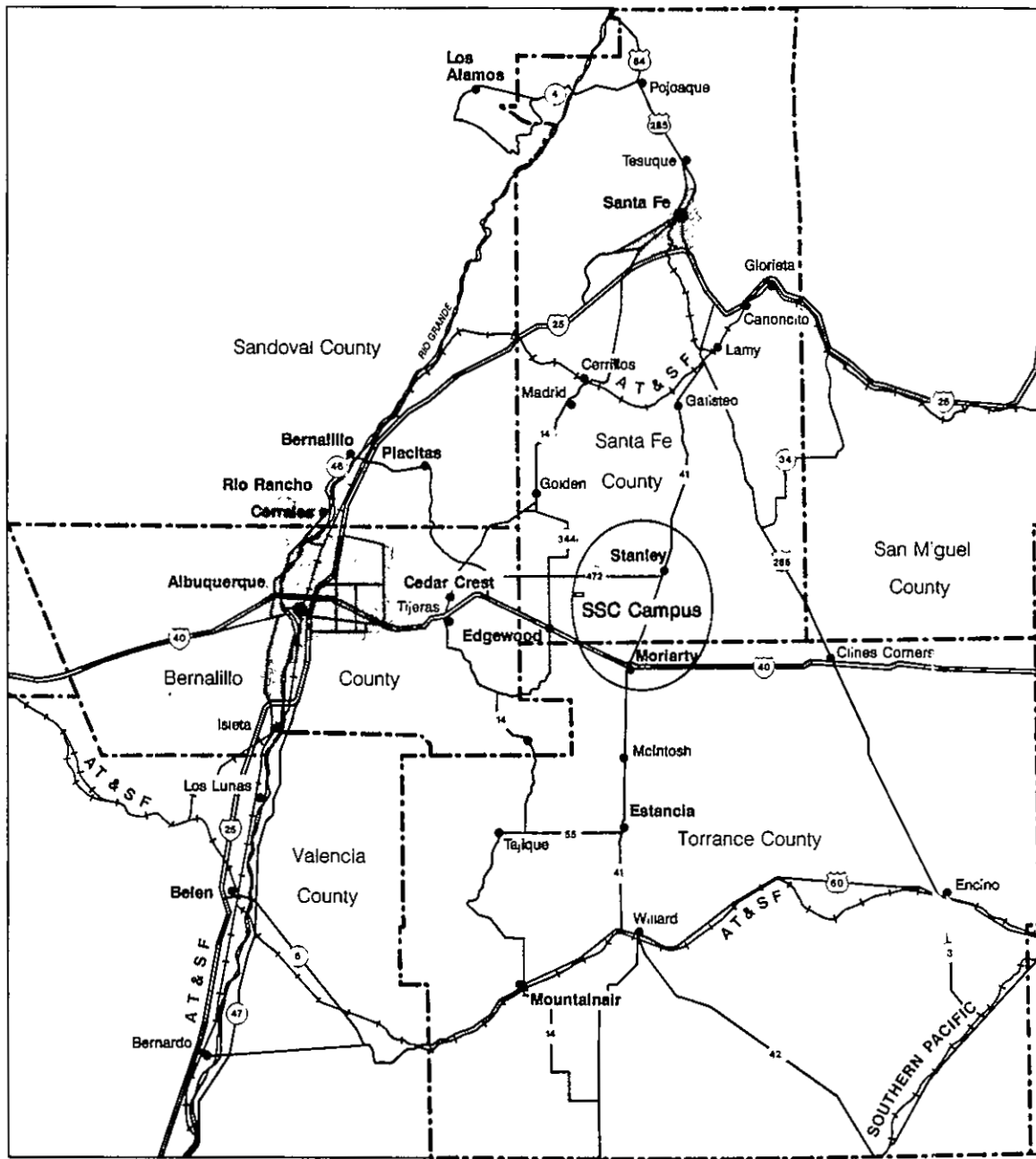

Data collected and map created by Southwest Land Research, Inc.



Figure 4.2-1. Road and rail network serving the SSC site.

Maintenance of the Road Networks

All of the highway routes providing access to the site are paved all-weather roads. A Pavement Management System and Priority Rating System are utilized by the New Mexico State Highway Department to insure timely attention to the roads' structural and surface adequacy.

Winter storms in the region of the site are typically brief and interspersed with several days of sunshine (see Sec. 7.3.4). Snow-removal equipment was in use by the Moriarty Patrol, in whose district the SSC site is located, for 68 eight-hour shifts in 1986. Each of the routes serving the site has been assigned a snow-removal priority. Priority ratings are based on the amount of traffic carried and whether the road serves as access to employment destinations. Currently Interstate Highway 40 has a snow-removal priority of One; the roads accessing the site from the north have Third priority; and the major road accessing the site from the south has priority Two. Third priority roads could remain unplowed for four to six hours if a storm is particularly severe. Roads would typically not be impassable during this time.

According to the State Highway Department's Maintenance Management Director, the stretch of I-40 linking the site to Albuquerque is never closed by snow. This stretch is very occasionally blocked during snowstorms by jackknifed trucks [4.2-1].

Adequacy of the Roads to Support Construction and Operation of the SSC

The Superconducting Super Collider is projected to become operational in 1995. By that year, traffic on the road network serving the SSC will have increased in response to New Mexico's normal economic and population expansion as well. Assuming the existing road network remained unchanged, 1995 traffic conditions were modeled by the New Mexico State Highway Department to determine the network's capacity to accommodate the SSC (see Appendix 4-B-2). The results are summarized in Figure 4.2-2 and presented graphically in Appendix 4-B-3.

The most efficient interpretation of the data generated by this modeling effort can be made by examining the "Level of Service" column (Fig. 4.2-2). Levels of Service A through F represent conditions of traffic flow ranging from "free-" (A), through "stable-" (C), through "unstable-" (E), to "no-" (F) flow. Level of Service D is considered acceptable functioning [4.2-2]. In general, the results suggest that the present road network can sustain 1995 traffic volumes at desirable levels of service and that the addition of traffic generated by the SSC will impact the system's functioning very little.

Figure 4.2-2. Impact of the SSC on existing road network, assuming 1995 traffic conditions (See Appendix 4-B-2).

Traffic Origin	Road	Segment	Number of Lanes	1985 Average Daily Traffic	1995 Estimated Average Daily Traffic		1995 Estimated Peak Vehicles Per Hour		1995 Estimated Volume/Capacity Ratio		1995 Estimated Level of Service	
					Without SSC	With SSC	Without SSC	With SSC	Without SSC	With SSC	Without SSC	With SSC
From the west	NM 541	I-40 immediately north	6	20,800	25,030	27,900	2,810	3,142	.52	.58	B	C
	I-40	NM 541 to Eubank	6	39,077	52,700	53,900	5,270	5,390	.75	.75	C	C
	I-40	NM 14 to NM 541	6/4	24,814	33,209	39,223	2,750	3,122	.46	.52	B	B
	I-40	NM 344 to NM 14	4	14,070	18,830	24,970	1,880	2,497	.41	.62	B	C
	NM 344	SSC to I-40	2	1,267	2,530	7,350	330	1,102	.13	.43	B	C
From the north	US 285	NM 41 to I-25	2	1,705	2,123	2,150	212	215	.09	.09	A	A
	NM 41	NM 472 to US 285	2	458	592	625	85	94	.07	.07	A	A
	NM 472	NM 344 to NM 41	2	191	220	1,800	31	250	.10	.26	C	C
	NM 344	SSC to NM 472	2	1,267	2,530	3,050	330	460	.19	.24	B	B
	NM 14	I-40 to NM 344	4	9,210	10,846	10,969	1,085	1,097	.27	.27	A	A
	NM 344	NM 472 to NM 14	2	203	2,530	2,600	330	340	.19	.19	B	B
From the east	I-40	US 285 to NM 41	4	9,966	18,870	18,990	1,890	1,895	.58	.58	C	C
From the south	NM 41	Estancia to I-40	2	1,877	3,335	3,355	364	366	.24	.24	B	B
	I-40	NM 41 to NM 344	4	12,587	18,850	21,130	1,880	2,113	.41	.46	B	B
	NM 41	I-40 to NM 472	2	625	925	3,325	93	333	.07	.15	A	A

The 1995 traffic conditions (with an SSC workforce of 3,000 included) represent the "worst case" scenario. It is a scenario that involves highly acceptable levels of transportation system functioning, however. Construction of the SSC during the six years prior to 1995 will involve far fewer worker trips and lower base levels of traffic. Although it will be characterized by a considerable number of materials and equipment transport trips, the construction period is not expected to impact the functioning of the transportation system beyond what will be experienced when the SSC becomes operational.

The conveyance of 100-ton loads to the site is not anticipated to be a problem by State Highway Department officials. Extremely large, overweight loads have been transported to Los Alamos National Laboratories and the Department is well experienced in accommodating them. Loads over 86,000 pounds and 16 feet wide are managed through the state's standard oversize/overweight permitting process [4.2-3].

Present Character of the Rail Network [4.2-4]

Class 1 mainline rail service is available at seven sidings in three directions from the site. The most distant of these sidings is 32 miles away. Rail service is provided by the Atchison, Topeka and Santa Fe Railway Company. On the Santa Fe's northern route, which has sidings at Albuquerque and at Lamy, two routine freight trains run in each direction every day. On the Santa Fe's southern route, which has a siding at Willard, 25 routine freight trains run in each direction every day. The rail lines serving the site and their links to the network that serves the United States are shown in Figure 4.2-3.

Lamy, located 19 miles north of the north arc of the collider ring, has a two-track siding that can accommodate 10 cars. Willard, located 25 miles south of the ring's south arc, has a two-track siding that can accommodate 60 to 65 cars. In Albuquerque, to the west, five sidings (four of which have specialized features) are available. Their distance from the site ranges from 30 to 32 miles.

- o Hahn Team Siding - 2 tracks, 46 cars
- o Heavy Implement Dock - 1 track, 5 cars, adjacent to an Interstate 40 Interchange
- o End or Side Dock Off-Loading Facility - 2 tracks, 15-20 cars
- o Centralized Work Equipment Facility - 1 track, 5 cars, 100-ton overhead crane, indoor
- o Piggyback Facility - 2 tracks, 20 cars, capacity for 2000+ loads/month

Albuquerque's piggyback facility is also an element in the Santa Fe's Quality Service Network, which offers shippers a high speed, low cost network of trains that are directly competitive with highway transport.

Adequacy of the Rail Network to Support Construction and Operation of the SSC

The SSC Conceptual Design Report [4.2-5] specifies a requirement for a five-car rail siding to serve the construction and operation of the SSC. New Mexico can meet or considerably exceed that requirement at seven locations near the site.

One hundred ton loads (253 ton gross weight) are routinely carried on the Santa Fe system. Loads of twice that weight can be readily accommodated by car adaptation procedures, as can extra-length cargo. In October, a giant generator will be shipped in pieces ranging from 232 to 500 tons to the Lamy siding for transport to Los Alamos. Santa Fe officials are confident they can arrange to meet the SSC's construction and operation needs with similar success [4.2-4].

4.2.2 NECESSARY IMPROVEMENTS TO THE EXISTING ROAD, HIGHWAY, AND RAIL NETWORK

No improvements to the rail system have been identified as necessary to support the construction and operation of the SSC.

The portions of the road network serving the SSC site that have a snow-removal priority of Three will be automatically upgraded by the changes in traffic levels and character of the destination served. That will occur when the SSC begins construction. District-stationed snow removal equipment is also upgraded on the basis of destination and traffic levels criteria.

Although the road network serving the SSC will not be impacted to the point of dysfunction, the increase in utilization of highway facilities that will be represented by the arrival of 1995 and the SSC warrant certain improvements the roadway system. These improvements can be generally described as bringing substandard facilities to adequate standards: for example, going from 11 foot lanes having no shoulder to 12 foot lanes with four- to six-foot shoulders. Roads of this type were built to old standards and have remained unchanged because traffic levels on them are low.

The segments of the road system that require such improvements have been identified by the New Mexico State Highway Department and are listed in Appendix 4-B-4. The total cost of these improvements is estimated at

\$158,374,000, not including right-of-way. Sixty-nine percent of these improvement costs already appear in the State Highway Department's Annual and Five Year Plans.

In addition to upgrading facilities in the road network that provides regional access to the site, the State of New Mexico proposes to develop a road system that connects the SSC campuses (both major and minor) to existing highways and allows internal circulation for SSC service and maintenance purposes to take place. The construction of a road network to serve the Super Collider facility would involve about 36 miles of new road and the improvement of about 34.3 miles or a total of some 70.3 miles. Approximately 18 miles of road would have to be paved at an estimated cost of \$600,000 per mile, for a total of 10.8 million. This \$600,000 cost per mile includes two 12-foot lanes and two eight-foot shoulders. Some 52.3 miles of dirt road would have to be provided at an estimated cost of \$210,000 per mile, or a total cost of approximately \$11 million. This would be for graded and drained roads with fencing. Right-of-way costs for the road network are estimated to be at least \$6 million. It is estimated that a right-of-way width of 150 feet would be needed for the road network. Total costs for constructing the road network and obtaining right-of-way is estimated at approximately \$27.8 million. The proposed road network is shown in Appendix 4-J-4.

4.3 PUBLIC TRANSPORTATION

The vicinity of the proposed site can be served by a variety of types of public transportation. Direct access to the site via public transportation can be provided by a number of local companies on a demand basis. Rental vehicles, leased vehicles, bus service, and van pools are all available in Albuquerque and Santa Fe both for transport from the airport and for commuter transport.

Figure 4.3-1 indicates public transportation routes throughout the vicinity of the site.

4.3.1 PUBLIC TRANSPORTATION SYSTEMS

Intra-City Bus Service

Bus service within Albuquerque is provided by SunTran, the city's public transit division. SunTran has a total of 107 35-40 foot buses which provide service primarily within the city of Albuquerque. SunTran has 28 routes throughout the city. Hours of operation are 5:30 a.m. to 7:00 p.m. SunTran also provides three park-and-ride lots which could be used by commuters [4.3-2].

Albuquerque Trolley Company provides three bus-trolleys with special routes for sightseeing or for intra-city transport between hotels, museums, and entertainment. A fourth trolley is available for charter. Hours of operation are 9:00 a.m. to 9:20 p.m. [4.3-3].

Inter-City Bus Service

Trailways, Greyhound, and Texas, New Mexico, and Oklahoma Transportation (TNM and O) provide intercity bus service in the vicinity of the proposed site. Bus service is provided several times per day east on I-40 through Moriarty, west on I-40 to Phoenix and Los Angeles, north on I-25 to Santa Fe and Denver, south on I-25 and NM-54 to Las Cruces and El Paso, northwest to Farmington, and southeast to Raton and Clovis [4.3-1, 4.3-4, 4.3-5, 4.3-6].

Charter Bus Service

Three companies, Shuttlejack, Sanchez Southwest Coaches, and TNM and O currently provide special transportation service on demand statewide. These services include regularly scheduled transportation as well as charter service. Specialized bus and van transportation service is currently being provided by private charter companies. Shuttle service from Albuquerque International Airport to Santa Fe includes 18 round trips daily, September-May; and 24 round trips daily June-August provided by Shuttlejack, and four round trips daily provided by TNM and O [4.3-6, 4.3-7, 4.3-8, 4.3-9].

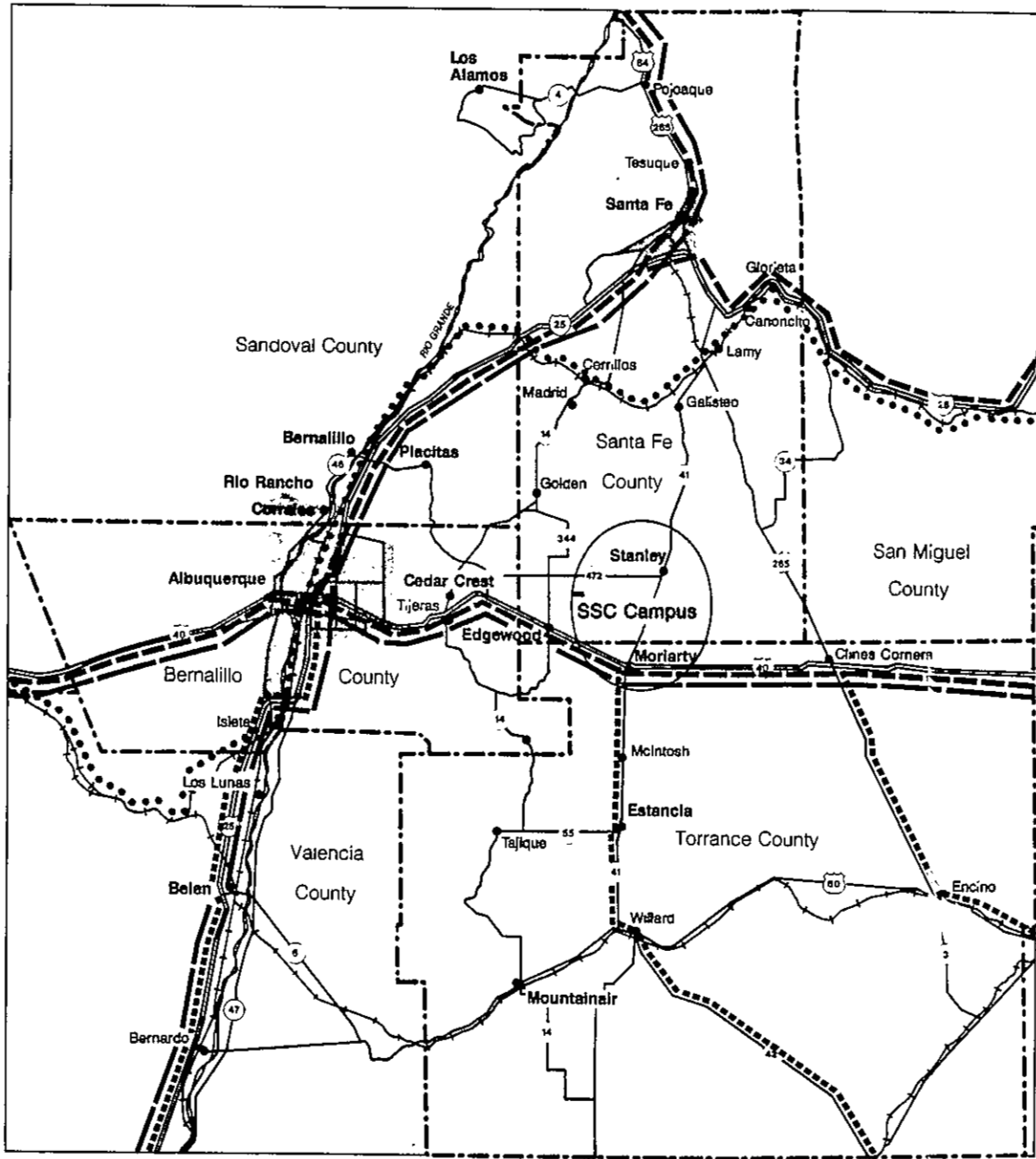

Data collected and map created by Southwest Land Research, Inc.

Scheduled Commercial Bus Lines

- TNM & O Coaches, Inc.
- Greyhound
- Trailways
- Amtrack Service

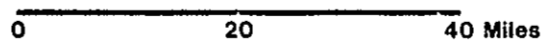

Figure 4.3-1. Public transportation routes in the vicinity of the site [4.3-1].

It is anticipated that a significant percentage of the SSC's employees will live in the large communities near the site. Commuter service can be provided from the major cities to the site by the charter bus companies. Ridership of 25 to 35 daily is sufficient to justify a commuter shuttle.

Van-pools

The State Employees Commuters Association (SECA) currently manages approximately 60 commuter van groups, primarily in the Albuquerque and Santa Fe areas. They also manage groups in the northwestern and northern parts of the state. Four groups operate vans which commute from the east mountain area near the site to Sandia National Laboratories. If there is need for vans in an area, SECA has been able to provide them. SECA owns 25 vans which were purchased through an interest-free loan from the State. The remainder of the vans are leased. The van-pools provide round-trip commuter service at a cost to the rider of about 4 cents per mile [4.3-10].

Individual groups of 10 to 15 people can incorporate as a non-profit organization and purchase a van through the State Section 146 interest-free loan program. These loans help with acquisition of the vehicle. Repayment of the loan and operating costs are typically paid out of rider fees.

Both Albuquerque and Santa Fe have ride sharing programs which match riders for car-pools and van-pools. These are additional resources which can be used by employees who commute to the site.

Taxi and Limousine Service

There are two companies in Albuquerque which provide taxi and limousine service - Yellow Cab Company/Checker Cab Company and Albuquerque Cab Company/Duke City Cab Company. Both companies provide 24-hour taxi and package delivery service. Taxi service from the Albuquerque International Airport is provided to hotels and motels and throughout the metropolitan area [4.3-11].

Automobile Rental and Leasing

It is likely that most transportation needs of visitors to the site will be met by rented vehicles. There are five national car rental firms based at Albuquerque International Airport, and three additional firms have offices nearby. An additional 12 firms in the Albuquerque area provide cars for short-term rental [4.3-11].

For longer term leasing, most automobile dealers provide leasing and fleet services. In total, there are 25 businesses in Albuquerque which make automobiles available on a lease basis.

In Santa Fe, there are two automobile rental agencies based at the municipal airport, and four other companies at locations elsewhere in the city. As in Albuquerque, dealers provide rental and leasing service [4.3-11].

Charter Air Service

Charter companies based in Albuquerque can provide passenger service to the proposed site commensurate with the capabilities of the runways available. Ross Aviation/Pierce Enterprises currently provides service for DOE installations within New Mexico and has expressed interest in serving the SSC site, as shown in their letter of support in Appendix 4-C. There are nine additional charter companies which provide air charter and leasing service from Albuquerque International Airport. Both fixed-wing and rotor-wing aircraft are available [4.3-11, 4.3-12].

At present, the Moriarty runway 11 miles southeast of the site is adequate for aircraft carrying up to 50 people. The unimproved strip located at the site could accommodate small aircraft allowing direct air travel to the site.

Charter air service is also available from Santa Fe Municipal Airport.

4.3.2 NECESSARY IMPROVEMENTS TO THE PUBLIC TRANSPORTATION SYSTEM

No deficiencies have been identified in the public transportation system. Service to the site does not currently exist because there is no demand for service. Bus, van, and air charter services available in the vicinity of the site have the ability to provide regularly scheduled service to Albuquerque International Airport and for employees who commute to the site. Automobile rental agencies and leasing companies are available at Albuquerque International Airport and Santa Fe Municipal Airport for maximum flexibility in scheduling.

4.4 INDUSTRIAL AND CONSTRUCTION RESOURCES

4.4.1 ACCESSIBILITY OF THE PROPOSED SITE TO AN INDUSTRIAL BASE

New Mexico hosts more than 30 federally- and state-funded research facilities employing approximately 20,000 professionals. These institutions require an extensive industrial support system with capabilities similar to those which will be required by the SSC. To serve these facilities, New Mexico, and Albuquerque in particular as the state's largest city, has developed an industrial support system capable of meeting their varied and complex needs. Many of these institutions have been in New Mexico over 20 years. New Mexico's support system thus has grown with the research-based facilities since the 1940s.

Proportion of Budgets Spent in New Mexico

One measure of New Mexico's ability to meet the needs of its existing federal facilities is the dollar value of goods and services purchased in the state. Sandia National Laboratories reported a 1985 annual procurement budget in excess of \$480 million. Almost \$227 million of this was spent in New Mexico, \$223 million in Albuquerque. Thus, almost half of all goods and services required by the Laboratory were available in New Mexico in the quantity and quality needed [4.4-1].

Kirtland Air Force Base spent almost \$1 billion of its 1986 research and development procurement budget within the Albuquerque area [4.4-2]. The White Sands Test Facility spent 50 percent of its \$8 million procurement budget in New Mexico in 1986 [4.4-3], as did the White Sands Satellite Station, whose 1986 procurement budget totalled \$25 million [4.4-4]. Los Alamos National Laboratories reported a 1986 procurement budget of \$377 million, 59 percent of which was spent in New Mexico [4.4-5]. These are quite impressive statistics for a state whose labor force totals only 672,000.

Statewide and Regional Suppliers of Industrial Resources

Figure 4.4-1 summarizes New Mexico and Bernalillo County suppliers by type of goods and services provided for those categories identified as "most important" in the Invitation for Site Proposals (ISP).

There are three major industrial gas suppliers in Albuquerque. A division of Big Three Industries maintains an air separation plant in Albuquerque for the manufacture of liquid nitrogen, with a production capacity of 198 tons per day. Plant capacity is currently 30 percent committed. The company also owns a second production plant in Odessa, Texas, which is capable of augmenting the local supply if needed. Its production capacity is approximately 250 tons per day.

Figure 4.4-1. Suppliers of industrial and construction resources within Bernalillo County [4.4-6].

Type of Service or Product	Number of Firms			Number of Bernalillo County Firms Reporting Employment	1985 Employment in Reporting Firms
	Bernalillo County	Rest of State	Total State		
<u>Industrial Resources</u>					
Manufacture of Industrial Gases	3	3	6	0	--
Electrical and Electronic Parts and Equipment					
Manufacturing	34	NA	NA	34	1090
Scientific Instrument and Control	10	NA	NA	8	328
Manufacture Distributors	86	14	100	66	471
Distributors with In-Plant Warehousing Capabilities	5	NA	NA	0	--
Industrial Materials	22	20	42	20	148
Machine Shops/Steel Fabrication Services	60	55	115	60	1243
Computer Equipment					
Manufacturing	3	2	5	3	995
Dealers	119	NA	NA	NA	NA
Programming/Software, Hardware Maintenance Services	120	96	216	89	922
Electrical Power Equipment					
Distributors	16	NA	NA	NA	NA
Maintenance	9	NA	NA	NA	NA
Mechanical Systems Equipment					
Distributors/Installation/Maintenance	100	NA	NA	NA	NA
<u>Construction Resources</u>					
Cement Manufacture	1	NA	NA	1	162
Aggregate Materials Mining	3	NA	NA	3	42
Concrete Manufacturers, Major	9	NA	NA	NA	NA
Construction and Other Heavy Equipment Rental/Repair/Maintenance	31	NA	NA	27	744

The cost of liquid nitrogen delivered to the site from either Big Three plant, including delivery charges, would approximate \$3,000.00 per 11,000 gallon delivery [4.4-7]. The Linde Division of Union Carbide maintains a local office and is capable of supplying liquid nitrogen from its plants in Big Spring, Texas, or Denver. Airco Industrial Gases out of Phoenix could also deliver liquid nitrogen to the site.

Liquid helium could be supplied by the Bureau of Mines in Amarillo, Texas, approximately 280 miles from Albuquerque. Costs of Bureau of Mines liquid helium, if delivered in 11,000 gallon loads, are approximately \$50,000 per truckload, plus \$.45 per round-trip mile in freight charges, if Bureau of Mines trailers are used [4.4-8]. Airco, the Linde Division of Union Carbide and Big Three (soon to be Tri-Gas) could also deliver liquid helium to the site in the quantities required.

Albuquerque is home to more than 40 electrical and electronic parts and equipment manufacturers, engineering and scientific instrument manufacturers and instrumentation and control device manufacturers (Fig. 4.4-1). Some of the larger manufacturers in the Albuquerque area include Digital Equipment Corporation (DEC), EG&G-Washington Analytical, Gulton Industries, Lasertechnics, Hewlett-Packard (HP), Sperry Corporation, Sparton Technology, Inc., Motorola Ceramic Products, and Honeywell Corporation. Eberline Industries is located in Santa Fe.

In addition to manufacturing firms, over 100 distributors of electrical and electronic parts are located in New Mexico, 86 in Albuquerque. A number of these are local warehousing operations, stocking parts for specific applications types such as electromechanics, instrumentation, RF and microwave components, etc. In addition, Albuquerque has several regional warehousing operations capable of acting as in-plant warehousing facilities.

Among the local branches of regional/national warehousing networks are Arrow, Bell Industries, Hamilton Avnet, Alliance, and Sterling. Each of these is tied in with 14 to 55 branches, the largest of which carries up to \$125 million worth of parts on any given day. Each represents from 27 to 50 manufacturers [4.4-9]. All distributors and warehousing operations offer 24-hour or earlier delivery on in-stock items. The regional warehousing operations offer same day shipping from affiliated branches. Turn-around time is then dependent on the shipping method chosen by the customer.

A number of the distributors offer value-added services such as assembly, system configuration or programming services. Many of the local manufacturers' representatives have been serving DOE for over 20 years and are particularly skilled in the areas of instrumentation, measurement and controls, and data acquisition [4.4-10].

More than 100 machine and steel fabrication shops are located in Albuquerque. A survey was recently completed of 115 machine and steel fabrication shops across the state. Figure 4.4-2 shows specialized services available in the shops surveyed. Because so many of these shops do prototype and precision work for Sandia, Los Alamos, Hughes Aircraft and others, many have quality assurance programs approved by federal facilities located in New Mexico and/or by private contractors such as Lockheed, Rockwell, or Martin Marietta. Several meet various military quality assurance standard qualifications. One-third of the surveyed shops in Albuquerque have CNC mills, lathes, chuckers, wire EDMs, shearing and/or turning machines. Of the Albuquerque shops surveyed, one-fourth are capable of ultra-precision work. Approximately 20 plastic fabrication shops are located in Albuquerque.

More than 120 computer dealers are located in the Albuquerque area representing virtually every manufacturer. DEC, HP, and Cray each have Albuquerque offices. Each firm has a large field service force devoted exclusively to DOE facilities in New Mexico. All of DEC's DOE accounts nationwide are administered out of its Albuquerque office, making Albuquerque the home base of some of its most experienced network specialists and field engineers. DEC also maintains one of its 14 national education centers in Los Alamos, primarily to serve the DOE community (Appendix 4-D-1). DEC maintains a staff of 145 professionals in New Mexico.

The data acquisition and monitoring systems used by Sandia and Los Alamos National Laboratories are HP equipment, making HP's contract with the Labs one of its largest contracts worldwide (Appendix 4-D-2). As a result, HP maintains some of its strongest instrumentation and radio-frequency people in Albuquerque [4.4-12]. Hewlett-Packard's local office is staffed with over 100 professionals.

The presence of these local offices gives DOE clients access to network, instrumentation, data acquisition, RF/microwave control, and product development specialists as well as immediate and sustained field support.

Cray Research's Albuquerque office has installed eight of the 11 Cray supercomputers located at Sandia National Laboratories, Los Alamos National Laboratories and the Air Force Weapons Laboratory, and provides maintenance and support for all 11 systems. A second installation at the Air Force Weapons Lab, to be completed in the Fall of 1987, will bring the total of local systems to 12, almost 10 percent of all Cray's installations worldwide. Given its extensive installation, maintenance, and support experience, Cray's Albuquerque office is considered one of the company's stronger district offices and includes one of its most knowledgeable and experienced site preparation specialists (Appendix 4-D-3).

Figure 4.4-2. Machine tooling, steel fabrication services in New Mexico as of first quarter 1985 [4.4-11]. 1, Federal agency/prime contractor quality control program approvals from such entities as Sandia National Labs, Los Alamos National Labs, Kirtland Air Force Base, Lockheed, Rockwell International, General Electric, Sperry, Hughes Aircraft, Martin Marietta, Department of Defense, and others. 2, CNC equipment includes lathes, mills, chuckers, wire EDMs, shearing and turning machines.

Shop Type	Number Shops		Additional Work Capabilities									
			Prototypa Design and Engineering		Sheet Metal Work		Non-Destructive Testing		Tool Design and Manufacture		Plating/Grinding or Stamping	
	Total	In Albuquerque	Total Shops	Albuquerque Shops	Total Shops	Albuquerque Shops	Total Shops	Albuquerque Shops	Total Shops	Albuquerque Shops	Total Shops	Albuquerque Shops
Machine Fabrication	35	22	11	8	4	3	4	3	12	8	15	8
Combination Machine and Fabrication	24	9	8	4	7	2	5	2	4	0	7	1
Total	56	29	14	8	14	9	7	5	17	12	15	11
Total	115	60	33	20	25	14	16	10	33	20	37	20

Shop Type	Employment		Size Which Can Be Worked						Tolerance			
			Miniature		Medium		Large		Standard and Precision		Ultra Precision	
	Total	In Albuquerque	Total Shops	Albuquerque Shops	Total Shops	Albuquerque Shops	Total Shops	Albuquerque Shops	Total Shops	Albuquerque Shops	Total Shops	Albuquerque Shops
Machine Fabrication	806	714	17	15	31	15	4	0	30	20	12	10
Combination Machine and Fabrication	657	100	5	2	21	6	8	2	22	7	2	2
Total	1233	429	8	6	54	28	21	14	53	28	4	4
Total	2696	1243	30	23	106	49	33	16	105	55	18	16

Shop Type	High Production		Production Type				Prototype		Quality Control Program Approved by Federal Agency, ¹ Prime Contractor	
			Production		Short Run					
	Total Shops	Albuquerque Shops	Total Shops	Albuquerque Shops	Total Shops	Albuquerque Shops	Total Shops	Albuquerque Shops	Total Shops	Albuquerque Shops
Machine Fabrication	6	5	25	17	32	20	22	18	13	12
Combination Machine and Fabrication	3	0	15	4	17	7	11	6	5	2
Total	10	8	37	20	48	26	36	22	23	21
Total	19	13	77	41	97	43	69	46	41	35

Shop Type	Military QA Standard Qualifications Met										Shops with CNC Equipment ²	
	MIL-STD-105		MIL-C-45662A		MIL-I-45208A		MIL-9858		Other		Total Shops	Albuquerque Shops
	Total Shops	Albuquerque Shops	Total Shops	Albuquerque Shops	Total Shops	Albuquerque Shops	Total Shops	Albuquerque Shops	Total Shops	Albuquerque Shops		
Machine Fabrication	2	2	4	3	7	7	3	2	1	1	11	10
Combination Machine and Fabrication	0	0	1	0	1	0	0	0	1	1	1	0
Total	2	2	11	10	22	18	8	1	0	0	13	10
Total	4	4	16	13	30	25	11	3	2	2	25	20

Given the number of new installations since 1980, as well as the site expansions needed, a number of Albuquerque electrical, mechanical, and general contractors have developed expertise in site preparation for/and installation of supercomputers (Appendix 4-D-3).

DEC, HP, and Cray provide maintenance services for their products, as do many other local dealers. In addition to the maintenance capabilities of suppliers, the Albuquerque area has over 120 independent programming and maintenance service suppliers employing almost 1,000 people in 1985.

Major manufacturers of electric power equipment are represented by 16 Albuquerque manufacturers' representatives. Several of these, including General Electric Supply Company (GESCO) and Westinghouse Electric Supply Company (WESCO) would be capable of providing a "turn-key" package for the on-site power system, including engineering design and consulting services, equipment installation and system maintenance. Both GESCO and WESCO are currently working with DOE to design the static controls, power system, and mechanical array for two mine hoist drives at the Waste Isolation Pilot Project (WIPP) site. GE installed and maintains the distribution equipment on the linear accelerator at Los Alamos and is currently working with Los Alamos to upgrade and change out a portion of the Laboratory's distribution system involving large amounts of vacuum switchgear [4.4-13].

Approximately 100 mechanical systems suppliers, installation and repair firms are located in Albuquerque. An estimated 80 percent of these supply/install/maintain commercial and/or industrial systems of the type which would be needed for the SSC's conventional facilities. Several local firms would be capable of supplying the cryogenic tanks needed to store the liquid gases used in the cryogenic system [4.4-14]. One local manufacturers' representative is expert in vacuum cryogenic equipment, representing approximately 16 manufacturers, with capabilities to supply all types of pumps, blower packages for all vacuum ranges, oils and fluids, valves, vacuum hardware, gauging and instrumentation for measuring vacuum pressure, and cryogenic vacuum insulated liquid gas transfer systems. The local representative and/or manufacturers it represents have experience in providing cryogenic systems for such entities as Lawrence Livermore National Laboratory, NASA, Martin Marietta-Vandenburg Operations, Sandia National Laboratories, and Airco [4.4-15] (Appendix 4-D-4).

Over 30 Albuquerque firms specialize in heavy equipment rental and repair. Virtually all types of construction equipment are available locally. A number of local electric and motor repair shops are capable of rewinding generators in excess of 1200 hp. There are no restrictions on the size of motors and turbines on which the Albuquerque General Electric

office can work. These shops are also capable of turning shafts [4.4-16].

The presence of the existing federal research facilities in New Mexico could be of benefit to the SSC, should it choose to locate here. These offices could, for instance, assist the SSC in identifying qualified contractors and suppliers for specific goods and services needed. The directors of the computing divisions at Sandia, Los Alamos, and the Air Force Weapons Lab have offered to provide consulting assistance to the SSC if requested in determining the type of supercomputer best suited to its needs, network configuration, and programming software (Appendix 4-D-5) [4.4-17, 4.4-18]. In addition, if it was necessary or desirable to the SSC, Los Alamos could actually provide computing services for the SSC [4.4-17].

The DOE's Albuquerque Operations Office currently handles the service contracts for Sandia and Los Alamos, and could possibly be of assistance in servicing the SSC contract.

Statewide and Regional Suppliers of Construction Resources

New Mexico has a construction labor force skilled in underground mine construction (uranium mines in western New Mexico), power plant construction (three major plants in northwestern New Mexico), and federal facilities construction including conventional facilities and experiments at Sandia and Los Alamos National Laboratories, Kirtland Air Force Weapons Lab and Space Technology Center, White Sands Missile Range and Test Facility, the National Radio Astronomy Observatory Very Large Array, the Waste Isolation Pilot Project in Carlsbad, the San Juan Chama Water Diversion Channel, and others.

Figure 4.4-3 shows New Mexico and Albuquerque-area union membership among the various crafts which would be called upon in constructing the SSC. In general, union membership is estimated to represent 17 percent of total skilled labor available in New Mexico. Total construction labor currently available in Albuquerque is estimated at almost 19,000.

Nine major concrete manufacturers and one cement producer are located in the Albuquerque area, with production capabilities more than sufficient to meet the needs of the SSC. Four of the nine concrete manufacturers are owned by national firms, allowing them to expand their local supply of computerized, on-site batch plants and other equipment quickly and cost effectively. Two concrete manufacturers operate their own laboratories, allowing them to perform quality control and quality assurance testing and to statistically monitor specialty control mixes, conduct cylinder and beam tests, sand gradations, etc. (Appendix 4-D-6). Four independent concrete test labs are also located in Albuquerque.

Figure 4.4-3. Construction labor wage rates. 1, Wage rates quoted are for work done on site in Torrance County; in some instances, work performed in Albuquerque is at a lesser rate per union contract. 2, Indicates data not available. 3, Indicates data category not applicable. 4, Membership reported includes only those members available for construction work. [4.4-19, 4.4-20, 4.4-21, 4.4-22].

Craft	Union Membership		Building and Heavy Construction		Street, Utility, and Light Engineering Construction		
	Albuquerque Santa Fe Membership	Statewide Union Membership	Hourly Wage Rate ¹	Hourly Fringe Benefits	Hourly Wage Rate ¹	Hourly Fringe Benefits	Hourly Maintenance Wages
Bricklayers	NA ²	NA	16.76	2.23	--- ³	--	12.35
Carpenters	1,600	2,100	13.15	3.45	8.11	0.44	11.71
Millwrights			15.80	3.45	--	--	12.35
Cement Masons	Included in plasterers		11.99	2.22	8.18	0.26	NA
Electricians/Linemen ⁴	1,080	1,350	18.53	2.89	17.00	2.35	12.35
Cable Splicers	NA	NA	20.23	2.96	--	--	--
Ironworkers	250-300	430-	14.10	3.28	7.96-	.50-	12.35
	800-	2,800-	9.25-		9.36	1.29	7.89-
Laborers	1,000	3,300	9.50	1.91	5.70-	0.35	12.35
			12.45-		6.40	0.91-	
Painters	160	160	12.95	2.10	8.64-	1.20	11.71
Plasterers	240	270	13.15	2.12	9.09	--	NA
Plumbers/Pipefitters	990	1,500	17.19	3.89	--	--	11.71
Power Equipment Operators	NA	2,000	--	--	8.06-	0.26	8.12-
			11.08-		10.51		11.71
Building Const.	--	--	13.95	1.90	--	--	--
			11.31-				
Heavy Const.	--	--	14.25	2.15	--	--	--
Roofers	NA	NA	9.00	1.30	--	--	--
Sheet Metal Workers	278	798	19.92	3.21	--	--	12.35
Teamsters	150	300	--	--	7.35	0.26	10.06
			11.68-				
Building Const.	--	--	12.69	1.79	--	--	--
			11.58-				
Heavy Const.	--	--	12.59	1.79	--	--	--

Because of their experience in working with defense and energy-related projects in New Mexico, several of these firms are capable of producing the high specification concretes which may be needed in various components of the SSC construction (Appendices 4-D-6, 4-D-7).

Albuquerque's local cement manufacturer is located approximately 18 miles from the site. This manufacturer is capable of producing approximately 500,000 tons of cement annually [4.4-23]. Standard cement types produced include Type I-II, Type I-modified, Type V, Type I-IIA, and masonry Type-S. The firm is also experienced in producing specialized cements for specific applications. Its quality control lab is certified by the National Bureau of Standards (NBS) and runs 24 hours a day, sampling batches every hour to ensure that quality standards are met. The lab is capable of physical testing as well as chemical analysis utilizing an X-ray analyzer.

The firm can accept approximately 2.8 million cubic yards of spoils from the project, to reclaim several of its quarries located only 18 miles from the proposed SSC site [4.4-24]. Its spoils disposition capabilities exceed the total amount of spoils expected to be generated during project construction (Sec. 3.5.5).

4.4.2 REGIONAL LABOR POOL AND PREVAILING WAGE RATES

Labor Pool

Figure 4.4-4 shows the estimated size of the labor force for counties within the SSC vicinity area (Figure 4.5-1), and its occupational characteristics. The three-county total is estimated at almost 220,000.

The local work force tends to have attained a higher level of education than has the general U.S. population. Sixteen percent of the U.S. population aged 25 years or older has completed four or more years of college. Within Bernalillo County, 23 percent of the population over age 25 has completed four or more years of college, as has 27 percent of the Santa Fe County population within this age group [4.4-25].

A survey conducted for the State's Economic Development and Tourism Department in 1987 identified 273 for-profit, technology-based companies in New Mexico [4.4-26]. These companies employ an estimated 12,600 people, about 46 percent of whom are classified as scientists or engineers [4.4-26]. Adding in the scientists and engineers employed by in-state federal and state research facilities results in an estimated supply of employed scientists and engineers of approximately 20,000 statewide.

Figure 4.4-4. Occupational characteristics of the labor force, SSC vicinity area, 1980. 1, Employment by residence. [4.4-25].

Occupation Group	Employment by Occupation, 1980 ¹									
	Bernalillo County		Santa Fe County		Torrance County		New Mexico		U.S.	
	Number	Percent of Total	Number	Percent of Total	Number	Percent of Total	Number	Percent of Total	Number	Percent of Total
Managerial and Professional Specialty	50,508	27	10,488	32	375	15	122,652	24	22,151,648	23
Technical Sales and Administrative Support	64,878	35	10,765	33	567	23	153,930	30	29,593,506	30
Service	22,918	12	4,488	13	329	14	68,648	14	12,629,425	13
Farming, Forestry and Fishing	1,744	1	643	2	259	11	16,757	3	2,811,258	3
Precision Production, Craft and Repair	22,826	12	3,832	12	428	18	75,935	15	12,594,175	13
Operators, Fabricators and Laborers	21,492	12	2,866	9	465	19	70,316	14	17,859,343	18
Total	184,366	99	33,082	101	2,423	100	508,238	100	97,639,355	100

Figure 4.8-5, Section 4.8.2, shows engineering, science, math, and computer science majors graduating annually from New Mexico's three research universities. The supply of scientists and engineers in New Mexico available for employment at facilities such as the SSC increases by more than 1,000 new graduates annually.

New Mexico firms do not appear to have problems attracting or retaining qualified technical personnel. Sandia National Laboratories received approximately 8,500 unsolicited applications in 1986 [4.4-27]. Los Alamos National Laboratories reported receiving more than 5,500 unsolicited applications from January 1987, through May 1987 [4.4-28]. Fifty-nine percent of the applications received by Los Alamos were from engineers, physicists, chemists, mathematicians, and computer science majors. Fifty-two percent of the applicants had masters and/or Ph.D. degrees. Appendix 4-D-8 provides a detailed listing of unsolicited applications received by Los Alamos by degree type.

Wage Rates

Figure 4.4-3 shows construction and maintenance wage rates for specific skilled/semi-skilled crafts. Wage rates shown are those which would apply to work done on the site in Torrance County. For some crafts, wage rates charged for work in Torrance County are somewhat higher than Albuquerque rates to recoup costs for the additional travel time to work.

The construction wage rates shown in Figure 4.4-3 are significantly lower than the Davis-Bacon rates assumed in the Conceptual Design Document (CDD), even with the 20 and 40 percent overhead and profit loadings assumed in the CDD backed out. For instance, drillers and mole and muck operators in New Mexico make \$13.95 an hour, with an hourly fringe benefit of \$1.90, for a total of \$15.85 per hour. The Davis-Bacon rates used in the CDD assumed wage rates of \$28.07 to \$29.21 per hour for these crafts. Construction labor rates which would apply at the site range from 59 to 66 percent of the Davis-Bacon rates assumed in the CDD with loadings for overhead and profit backed out.

Figures 4.4-5 and 4.4-6 show area average wage rates for selected groups of operations employees. Insufficient information is provided on wage rates in the CDD to determine the relationship between the local rates and the rates assumed by the SSC Central Design Group for these professions.

Figure 4.4-5. Area wage rates for and availability of specified crafts/professions [4.4-29, 4.4-30, 4.4-31, 4.4-32, 4.4-33]. 1, [4.4-33]. 2, [4.4-29]. 3, First number in series indicates average manufacturing wage; second number indicates average non-manufacturing wage. 4, Includes mechanical and electrical technicians. 5, Includes analyst programmers.

Job Title	Area Hourly Wage 11/86 ¹	Albuquerque Hourly Average 1/86 ^{2,3}	Federal Facility Hourly Average		Estimated Number in 1987 New Mexico Civilian Labor Force
			Sandia National Laboratories 1/87	Los Alamos National Laboratories 1/87	
Electrical Technician					5800
Level I	\$ 8.70 ⁴	\$ 8.72-9.97	\$11.17 ⁴	NA	NA
Level II	9.63 ⁴	9.31-9.03	12.40 ⁴	11.53	NA
Level III	11.97 ⁴	10.68-11.16	13.75 ⁴	15.61	NA
Mechanical Technician					1000
Level I	NA	NA	NA	7.34	NA
Level II	NA	NA	NA	10.97	NA
Level III	NA	NA	NA	15.22	NA
Computer Operator					1850
Level I	6.49	7.68-8.00	NA	6.95	NA
Level II	8.32	7.52-9.37	10.73	10.46	NA
Level III	11.84	10.52-10.85	12.60	13.86	NA
Computer Programmer					1450
Level I	8.42	8.22-11.46	NA	NA	NA
Level II	10.11	9.51-11.46	NA	11.92	NA
Level III	12.64	11.31-14.94	NA	14.26	NA
Computer Systems Analyst					1500
Level I	11.00	12.61-12.32	14.73 ⁵	NA	NA
Level II	12.78	12.38-14.56	17.11 ⁵	NA	NA
Level III	15.08	14.21-16.58	20.67 ⁵	18.31	NA
Machinist					1600
Production	12.35	10.93	NA	NA	NA
Tool Room	12.35	11.09	NA	NA	NA
Prototype, Level III	NA	NA	NA	16.16	NA
Tool and Die Maker	NA	12.56-14.19	NA	NA	150
Drafter					NA
Level I	5.33	7.32-8.75	NA	8.45	NA
Level II	7.00	9.54-9.04	NA	10.57	NA
Level III	7.79	9.99-11.13	NA	NA	NA
Level IV	9.52	NA	NA	NA	NA
Level V	11.93	NA	NA	NA	NA
Designer	NA	NA	NA	14.25	700
Senior Designer	NA	NA	NA	18.93	NA

Figure 4.4-6. Area wage rates for specified professions [4.4-34, 4.4-35, 4.4-32, 4.4-30].

Profession	Albuquerque Area Hourly Average Wage 1986	Hourly Average Wage, Los Alamos National Laboratories, Non-Supervisory Personnel, 1987									Average Hourly Wage, Sandia National Laboratories 1987
		BS			MS			Ph.D.			
		0-4 yrs.	5-9 yrs.	10+ yrs.	0-4 yrs.	5-9 yrs.	10+ yrs.	0-4 yrs.	5-9 yrs.	10+ yrs.	
Engineer											
Civil Engineer	NA	16.74	19.39	18.47	--	21.06	21.58	--	24.99	24.99	NA
Electrical Engineer	\$18.56	17.94	19.43	19.17	--	21.28	21.77	--	24.91	24.68	NA
Mechanical Engineer	20.98	16.99	19.66	18.75	19.56	20.80	20.21	NA	26.66	24.86	NA
Combined Electrical, Civil, Mechanical Engineers											
Level I	--	--	--	--	--	--	--	--	--	--	16.13
Level II	--	--	--	--	--	--	--	--	--	--	20.02
Level III	--	--	--	--	--	--	--	--	--	--	23.36
Physicist	22.95	15.01	18.82	17.15	18.25	20.28	19.99	23.33	24.50	24.46	NA

4.5 HUMAN RESOURCES

The following section deals with population totals and characteristics in the vicinity of the SSC site, communities within a one hour drive time from the SSC campus, the nature and growth of employment in the vicinity, and a review of state policies and history of compliance with fair employment and open housing practices.

In general, Best Qualified List (BQL) data have been included in Appendix 4-E and referred to in the following text when the information was important to the presentation.

4.5.1 GEOGRAPHIC DISTRIBUTION OF THE POPULATION

The New Mexico counties that are in the vicinity of the SSC site include the following: Bernalillo, Santa Fe, and Tarrant. These counties are shown on Figure 4.5-1.

The counties were selected because: (1) they form the geographical basis of the SSC site, (2) they probably will be the areas of residence of SSC labor force, and (3) they are the areas likely to contain the most intense professional, social, and recreational interaction of the SSC staff. While these three counties are the areas primarily referred to in the Human Resources section, the following communities also are described for the same reasons: Albuquerque (city), Santa Fe, Rio Rancho, Corrales, Cedar Crest, Placitas, Edgewood, Moriarty, and Stanley.

Population Totals and Projections

The estimated 1985 populations for the counties in the vicinity of the SSC site are contained in Figure 4.5-2. The total population in these counties is 563,500. Most of these individuals, 470,200 individuals or 83.4% of the total, reside in Bernalillo County. Santa Fe County is next most populous with 84,700 individuals, representing 15.0% of the total [4.5-1].

Population estimates for communities near the SSC site in 1984 are available primarily from the Bureau of the Census. These population totals are contained in Figure 4.5-2 [4.5-2, 4.5-3, 4.5-4].

The city of Albuquerque is the largest community in the vicinity of the SSC site, with a total population of 350,575. The Albuquerque metropolitan area is more populous and includes Rio Rancho, Corrales, and other smaller places. Rio Rancho contained 18,491 individuals in 1984 and is the fastest growing municipality in New Mexico. Corrales is a small, attractive village near the Rio Grande and has 2,616 residents.

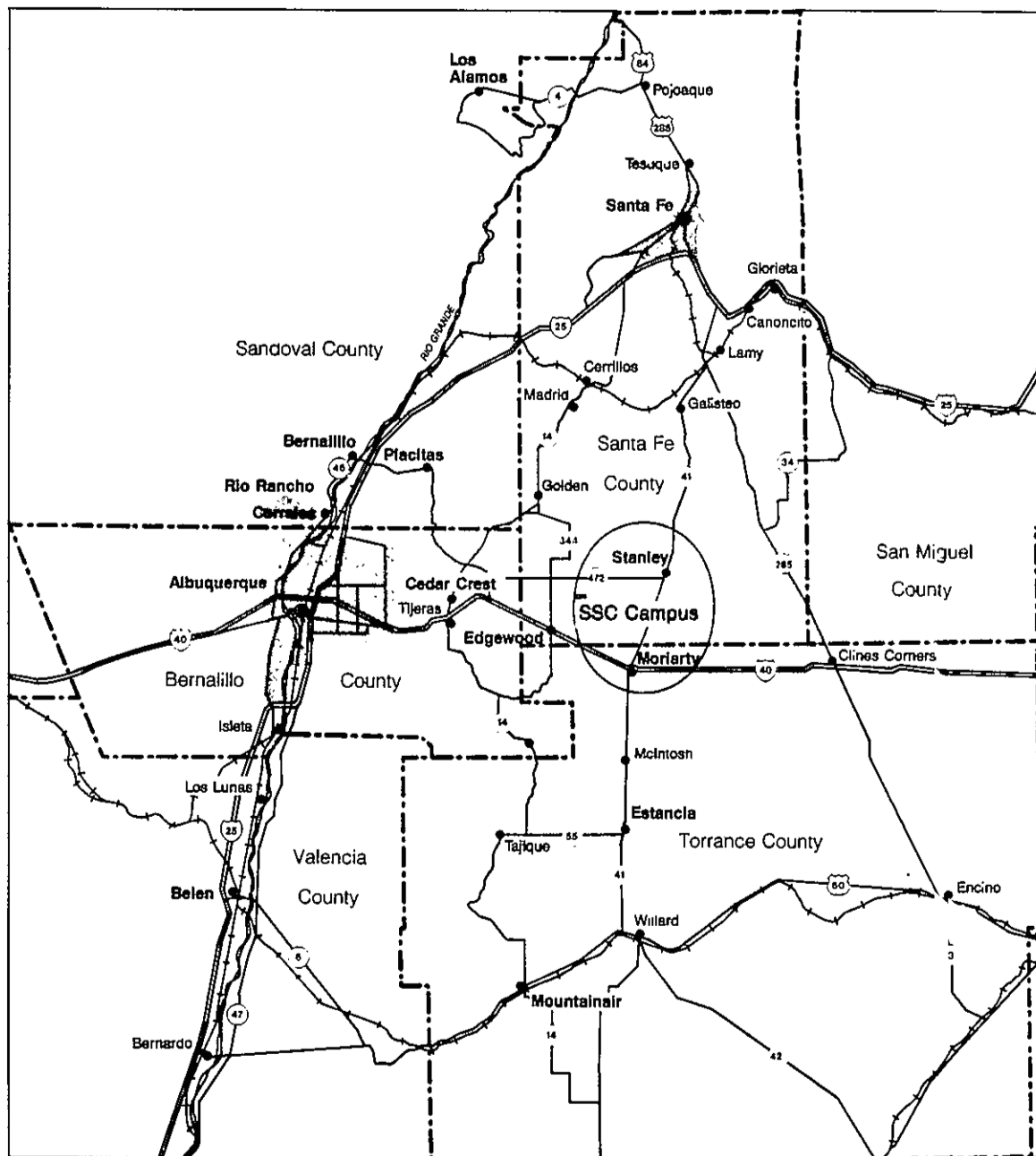

Data collected and map created by Southwest Land Research, Inc.

0 20 40 Miles

Figure 4.5-1. New Mexico counties and communities in the vicinity of the SSC site.

Figure 4.5-2. Population of New Mexico counties and communities in vicinity of the SSC site, 1984 and 1985 estimates. 1, U.S. Census Enumeration District data used: Placitas - ED 250A; Cedar Crest - EDs 327D, 328A; Edgewood - ED 101U. Placitas and Cedar Crest increased by Albuquerque metropolitan area 1980-1985 annual compounded growth rate of 2.3%; Edgewood increased by 1980-1984 growth rate of 3.26% per year. 2, Stanley 1980 total obtained from County of Santa Fe, Santa Fe County General Plan, October 28, 1980. 1980 population increased by 1980-1984 growth rate of Moriarty. [4.5-1, 4.5-2, 4.5-3, 4.5-4].

County	1985 Population	Percent of Total
Bernalillo	470,200	83.4
Santa Fe	84,700	15.0
Torrance	8,600	1.5
Total	563,500	99.9

Community	1984 Population	Distance from SSC Site
Albuquerque (City)	350,575	22
Santa Fe	52,274	55
Rio Rancho	18,491	36
Placitas ¹	3,310	50
Cedar Crest ¹	2,993	18
Corrales	2,616	41
Moriarty	1,451	15
Edgewood ¹	380	4
Stanley ²	68	18

The second largest community in the vicinity is Santa Fe, with a total 1984 population of 52,274. The remaining communities are small, all with less than 4,000 residents in 1984.

Cedar Crest and Placitas are very low density, middle and upper income residential areas on the east side of the Sandia Mountain crest and in the foothills of the Sandia Mountains to the west, respectively.

Figure 4.5-3 contains the 1980 population counts for each of the counties in the vicinity of the SSC site and forecasts for each five-year period until the year 2005 [4.5-1]. These projections do not include any effect of the development of the SSC. The population of each of the counties is expected to increase in a measured way from 1980 to 2005. The three-county area is predicted to grow steadily and substantially; increasing by 236,600 residents, from 504,800 in 1980 to 741,400 in 2005.

Characteristics of the Population

The populations in the counties in the vicinity of the SSC site are described in Appendix Figures 4-E-1 to 4-E-3 in terms of the following characteristics: (1) age and sex distributions, (2) educational levels, and (3) income levels. Appendix Figure 4-E-4 provides the United States population with regard to education and income. These data are presented for comparison purposes.

Age and Sex Characteristics

The populations of the three counties in the vicinity of the SSC site are provided according to five-year age categories and by sex. The data are 1985 population estimates [4.5-1].

These figures show normal distributions of the local county populations. A high percentage of Bernalillo County residents are 0 to 4 and 20 to 39 years of age. This is a reflection of the expanding local economy.

The population pattern found in Santa Fe County is similar to that in Bernalillo County, although not as pronounced. A higher percentage of Santa Fe County residents are 35 to 49 years of age than in Bernalillo County.

The age and sex distribution of Torrance County residents reflects the more rural character of this area; namely, that the population is pyramidal in shape resulting from higher birth rates during the past 20 years. Furthermore, a higher proportion of the individuals in Torrance County are 65 years of age or older than is found in the other counties.

Figure 4.5-3. Population projections of New Mexico counties in vicinity of the SSC site, 1980 to 2005 [4.5-1].

County	1980	1985	1990	1995	2000	2005	Annual Rate of Growth
Bernalillo	421,600	470,200	510,200	551,300	588,500	621,200	1.6
Santa Fe	75,700	84,700	90,300	96,600	102,600	107,900	1.4
Torrance	7,500	8,600	9,400	10,400	11,400	12,300	2.0
Total	504,800	563,500	609,900	658,300	702,500	741,400	1.5

Educational Characteristics

Primarily because of the presence of technology-based companies, New Mexico has the highest per capita rate of Ph.D.s of any state in the nation.

Appendix Figures 4-E-1 to 4-E-4 contain the educational attainment levels of residents of the three counties in the vicinity of the SSC site and comparable data for the United States. These data are from the 1980 U.S. Census and are for adults 25 years of age or older [4.5-5, 4.5-6].

Considering the population of the three-county area combined, the residents had a notably higher level of educational attainment than for the United States.

Bernalillo County residents had higher educational achievement levels than did residents of the United States. Forty-two point seven percent (42.7%) of Bernalillo County residents had one year of college education or more, compared to 31.9% for the U.S. Twelve point three percent (12.3%) of county residents had five or more years of college, compared to 7.6% for U.S. residents.

This situation was similar with regard to the Santa Fe County population. A higher percentage of Santa Fe County residents had gone to college one year or more than U.S. residents (45.4% compared to 31.9%). In addition, 14.2% of the county residents attended college five years or more.

This situation did not hold for residents of Torrance County. The modal educational level in this county was four years of high school education, representing 39.1% of the inhabitants. Nineteen point two percent (19.2%) of the residents attended college one year or more. Twenty-five point six percent (25.6%) had eight years of schooling or less, compared to 18.0% of U.S. residents.

Income Characteristics

In contrast to educational levels, household incomes in the three counties surrounding the SSC were somewhat lower than for U.S. households. These data are contained in Appendix Figures 4-E-1 to 4-E-4 and were obtained from the 1980 U.S. Census, representing 1979 incomes [4.5-5, 4.5-6].

Both the median and mean household income levels in Bernalillo County were slightly lower than for the United States (county median: \$16,239 compared to \$16,841 (U.S.); county mean: \$19,670 compared to \$20,306 (U.S.)). However, the percentage of Bernalillo County households with incomes of \$20,000 or more (39.4%) approximated that for U.S. households (40.8%). The percent of Bernalillo County households

with incomes of \$5,000 or less (12.4%) was lower than for U.S. households (13.1%).

Household income levels in Santa Fe County also were lower than for U.S. households. The county median household income was \$15,852 compared to \$16,841 for the United States. The county mean household income also was lower, \$19,393 compared to \$20,306 (U.S.). Thirty-eight point one percent (38.1%) of Santa Fe County households had incomes of \$20,000 or more. The same percentage of households in the U.S. and Santa Fe County had earnings of \$5,000 or less (13.1%).

Torrance County households had significantly lower incomes. The median household income was \$10,830 and the average household income, \$13,062. Nearly one-fourth of county households earned \$5,000 or less.

4.5.2 DRIVING TIME FROM SURROUNDING COMMUNITIES TO THE SSC SITE

The New Mexico communities within a one-hour drive time are shown in Figure 4.5-4. This map shows all New Mexico communities, large and small with a heterogeneity of social and physical environments, within this area.

The communities considered of relevance to the SSC are discussed in the preceding section, 4.5.1, and are referenced in 1984 population Figure 4.5-2. These communities include Albuquerque, Santa Fe, Rio Rancho, Corrales, Cedar Crest, Placitas, Edgewood, Moriarty, and Stanley.

4.5.3 LOCAL EMPLOYMENT RATES AND OPPORTUNITIES FOR EMPLOYMENT

In general, the three counties near the SSC site have had a consistent, healthy annual employment growth rate of 4.8% in the 16 years from 1970 through 1986. Since 1991, unemployment in these counties has been lower than national averages. Current civilian employment in public and private technology-based organizations in New Mexico totals approximately 49,800 jobs.

Total Employment and Unemployment Rates

Wage and salary employment (jobs) totals in the three counties in the vicinity of the SSC site from 1970 through 1986 are presented in Figure 4.5-5. Employment in the three counties combined has increased by nearly 140,000 jobs from 1970 through 1986, representing a 4.8% annual growth rate [4.5-7].

Employment in Bernalillo County, which represents about 83% of the total population in the three county area, grew

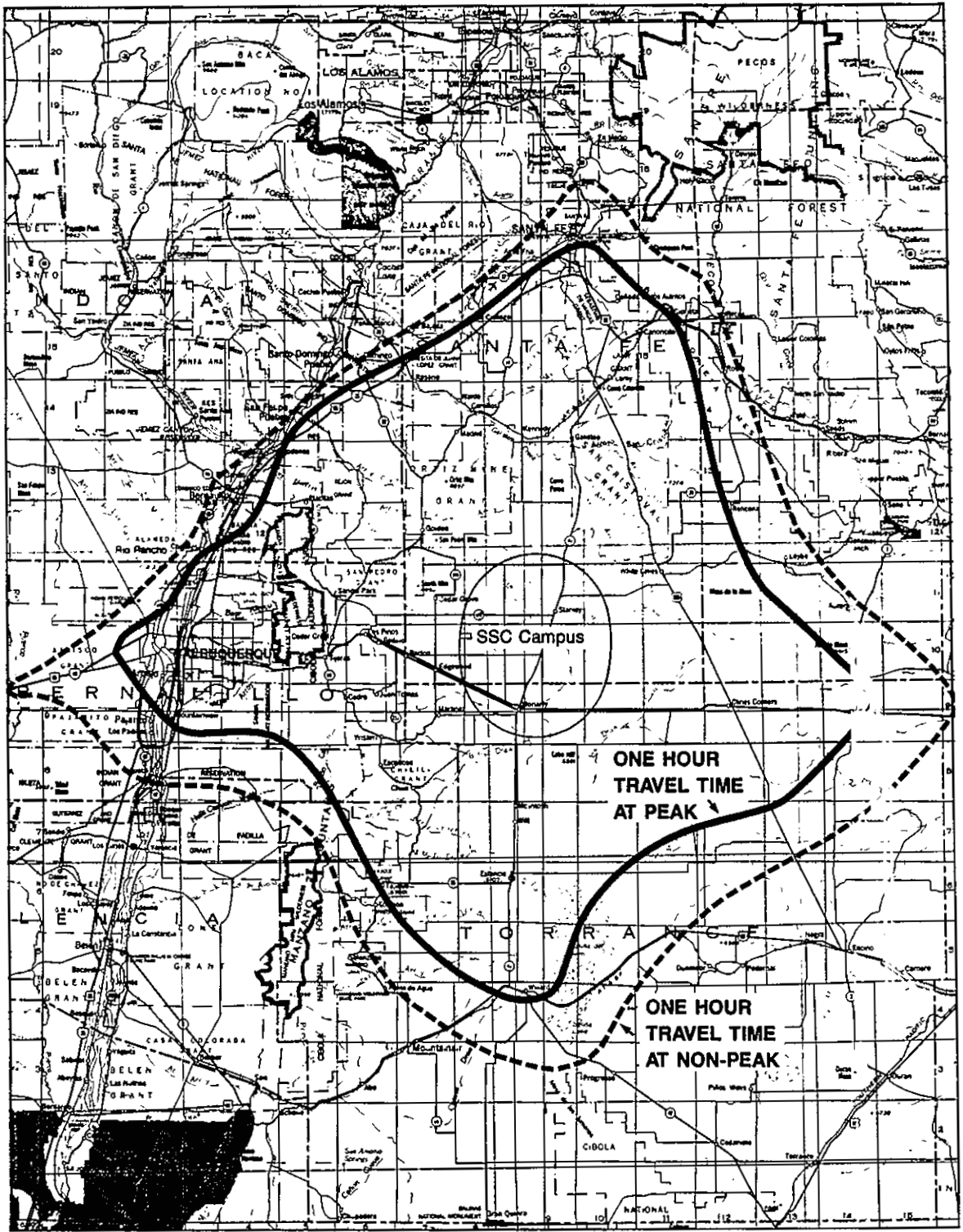

One inch equals approximately 15 miles

Base from USGS 1:500,000 State of New Mexico map.

Figure 4.5-4. New Mexico communities within a one hour drive time of the SSC site (peak and non-peak) [4.5-8].

4.7% annually from 1970 through 1986. Employment growth was higher in Santa Fe County during this period (5.2%).

The unemployment rates from 1980 through 1986 for each of these counties are provided in Figure 4.5-6. In general, the unemployment rates within each have been lower than national averages during the seven year period [4.5-9, 4-5-10].

The unemployment rate in Bernalillo County has been substantially lower than the U.S. figure during the past six years, from 1981 through 1986. This also was true for Santa Fe County during the period from 1980 through 1986.

The Torrance County unemployment levels were equal to or lower than national figures from 1980 through 1984. However, the constriction in the agricultural economy has driven Torrance County unemployment rates above U.S. levels in 1985 and 1986.

Employment forecasts for the Albuquerque SMSA (Bernalillo and Sandoval Counties combined) from 1985 to 2000 predict the creation of 90,820 new jobs. This represents an annual growth rate of 2.3%. These data are contained in Appendix Figure 4-E-5 [4.5-11].

Employment and Labor Force Characteristics

Wage and salary employment (jobs) totals for separate Standard Industrial Classification (SIC) divisions, including: mining; construction; manufacturing; transportation and utilities; wholesale and retail trade; finance, insurance, and real estate; services; and government, are provided in Appendix Figure 4-E-6. These data are supplied for 1970 through 1986, together with annual rates of growth, for each county in the vicinity of the SSC site [4.5-7].

With minor exceptions, there was employment growth within every SIC category for each county during the 1970 through 1986 period. The fastest growing sectors for all counties were services and wholesale and retail trade. The sectors which experienced declines were mining and transportation and utilities (in Torrance County). These declining sectors included only 554 jobs in 1970.

Most of the employment in 1986 in Bernalillo County was in the following industry groups: services, 26.8%; wholesale and retail trade, 25.7%; and government, 19.6%. The fastest growing sectors of the economy from 1970 through 1986 were manufacturing, 6.6% annually; services, 5.6%; wholesale and retail trade, 5.1%; and finance, insurance, and real estate, 5.0%. Employment in the other sectors increased at a slower pace and mining jobs declined from 300 to 200 during the 16 year period.

Figure 4.5-5. Total wage and salary employment (jobs), New Mexico counties in vicinity of the SSC, 1970-1986. 1, Average of January through September totals. [4.5-7].

County	1970	1975	1980	1985	1986	Annual Rate of Growth
Bernalillo	108,331	143,200	183,000	220,300	226,700	4.7
Santa Fe	16,414	21,601	28,689	35,089	36,709	5.2
Torrance	912	1,088	1,219	1,365	1,403 ¹	2.6
Total	125,657	165,889	212,908	256,754	264,812	4.8

Figure 4.5-6. Unemployment rates, New Mexico counties in vicinity of the SSC and U.S., 1980-1986 [4.5-9, 4.5-10].

	1980	1981	1982	1983	1984	1985	1986
Bernalillo County	7.9	7.3	7.9	8.6	6.2	6.7	6.5
Santa Fe County	6.2	5.8	7.5	6.6	5.0	6.2	6.4
Torrance County	7.1	3.1	5.4	5.5	6.6	11.3	12.1
U.S.	7.1	7.6	9.7	9.6	7.5	7.2	7.0

About 80% of total 1986 employment in Santa Fe County was in the following sectors: government, 29.6%; services, 26.5%; and wholesale and retail trade, 24.3%. The industries with the fastest rates of employment growth were construction, 7.3% annually; services, 6.5%; and wholesale and retail trade, 6.4%. Mining was the only sector which decreased in employment, from 135 to 120 jobs during 1970 through 1986.

The sectors containing significant percentages of total jobs in Torrance County in 1986 were government, 39.4%; wholesale and retail trade, 34.9%; and services, 10.5%. Of these sectors, employment in wholesale and retail trade grew most rapidly from 1970 through 1986 (4.1% annually). Employment in transportation and utilities declined from 119 to 89 jobs.

The civilian labor force participation rates, or the percentages of total residents within specific age categories who are in the civilian labor force, are presented in Appendix Figures 4-E-7 and 4-E-8. Appendix Figure 4-E-7 contains the rates by more detailed age categories for the Albuquerque SMSA (Bernalillo and Sandoval Counties) in 1980 [4.5-12]. Appendix Figure 4-E-8 includes the participation rates by broader age categories for the three counties in the vicinity of the SSC site and the United States. These data also are from 1980 [4.5-5, 4.5-6].

The labor force participation rates in the Albuquerque SMSA, Bernalillo County, and Santa Fe County conformed closely to national figures. The Torrance County rates were notably lower than U.S. percentages, due to the more rural character of this area.

New Mexico Civilian Employment in Technology-Based Organizations and Programs

Total New Mexico civilian employment in technology-based organizations and programs is approximately 49,800. This total includes employment in private sector corporations, non-profit organizations, universities, and civilian employees at military installations. These employment totals are included in Figure 4.5-7.

This substantial number indicates that there are many employment opportunities for scientists and engineers in New Mexico beyond those afforded by the SSC project.

Total employment in private sector technology-based corporations is 12,589. (See Appendix Figure 4-E-9 for the Standard Industrial Classifications of the corporations included in this count.) Sandia National Laboratories, Los Alamos National Laboratory, the Lovelace Medical Center research component, the Veterans Administration Hospital

Figure 4.5-7. Total employment in technology based organizations and programs, New Mexico [4.5-13, 4.5-14, 4.5-15, 4.5-16, 4.5-17].

	Number of Companies	Total Employment
Private Sector - for profit	273	12,589
Sandia National Laboratories	--	8,277
Los Alamos National Laboratory	--	9,600
Lovelace Medical Center-Research Component	--	850
Veteran's Administration Hospital- Research Component	--	85
Kirtland Air Force Base- Civilian Employees	--	6,100
Universities		
New Mexico State University	--	1,316
University of New Mexico	--	406
New Mexico Institute of Mining and Technology	--	325
National Radio Astronomy Observatory	--	270
Holloman Air Force Base- Civilian Employees	--	1,700
White Sands Missile Base- Civilian Employees	--	7,288
Sacramento Mountains- Civilian Employees	--	61
NASA facilities		950
Total		49,817

research component, NASA, the National Radio Astronomy Observatory, and the Sacramento Mountains research groups constitute the non-profit, technology-based organizations in the state. Total employment in these organizations is 20,093. The universities with substantial numbers of high technology professionals include: New Mexico State University, University of New Mexico, and New Mexico Institute of Mining and Technology. Total technology-based employment at these universities is 2,047. (This total excludes medical school faculties and social science, natural resources, and archeological researchers.) Military installations with a large number of civilians working in high technology positions include Kirtland Air Force Base, Holloman Air Force Base, and the White Sands Missile Base. The total number of civilian employees at these installations is 15,088 [4.5-13, 4.5-14, 4.5-15, 4.5-16, 4.5-17].

The total number of civilian scientists and engineers in these organizations is estimated as approximately 21,300.

This total is based on the reported number of scientists and engineers in the private sector technology-based corporations which responded to the New Mexico Research and Development Institute (NMRDI) survey and at Sandia National Laboratories [4.5-13, 4.5-15].

The percentages of the total number of civilian scientists and engineers trained in different specialties has been estimated in Figure 4.5-8. These percentages were based on employment among the private sector corporations responding to the NMRDI survey and at Sandia National Laboratories. These corporations represent approximately 44% of total employment in technology-based organizations, and it is expected that these figures would change somewhat if others had been included; for example, Los Alamos National Laboratory has a higher percentage of physicists than reported for the organizations above [4.5-18].

The principal scientific and engineering specialties found among these professionals were: electronics and electrical engineering (20.8%), physics (18.8%), mechanical engineering (15.2%), chemistry and chemical engineering (12.5%), and computer science (8.3%).

4.5.4 FEDERAL FAIR EMPLOYMENT PRACTICES, EQUAL EMPLOYMENT OPPORTUNITY STATUTES, AND OPEN HOUSING PRACTICES

Fair employment and open housing practices in New Mexico are regulated principally by three agencies: the U.S. Equal Employment Opportunity Commission, the U.S. Department of Housing and Urban Development, and the New Mexico Human Rights Commission. The Human Rights Commission enforces the New Mexico Human Rights Act which covers discriminatory practices in employment and housing.

Figure 4.5-8. Scientific and engineering specialties in technology-based organizations, New Mexico [4.5-13, 4.5-15].

	Percent of Total
Electronics/Electrical Engineering	20.8
Physics	18.8
Mechanical Engineering	15.2
Chemistry/Chemical Engineering	12.5
Computer Science	8.3
Mathematics	5.4
Biology/Earth Sciences	3.8
Nuclear Science	3.1
Materials Science	2.3
Aeronautical Engineering	2.0
Civil Engineering	1.6
Optics	0.4
Other	5.8
Total	100.0

Fair employment and open housing policies and practices in New Mexico were evaluated through objective measures, rather than by statements of intention. The New Mexico Human Rights Act has been compared to similar legislation in other states and federal law. This legislation is seen as the positive activity of the state government to secure equal employment and open housing opportunities for residents of New Mexico. Secondly, New Mexico equal employment and open housing complaints and their dispositions at state and federal levels have been quantified for the past three years [4.5-19, 4.5-20, 4.5-21, 4.5-22].

In general, New Mexico has a progressive record with regard to making available equal employment and open housing opportunities. New Mexico's human rights legislation goes beyond most other states' civil rights laws and has broader coverage than U.S. law. Furthermore, there is a very low incidence of assumed or determined probable cause with regard to formal complaints of discriminatory employment and housing practices.

The New Mexico Human Rights Commission was asked to provide an "introduction concerning the New Mexico Human Rights law and an evaluation of the quality of the New Mexico legislation" for inclusion in this proposal. The commission's response is included as Appendix Figure 4-E-10.

With regard to the extent of coverage, the commission stated [4-E-10]:

"Under New Mexico state law persons are protected from discrimination on the bases of race, color, national origin, sex, religion, ancestry and physical/mental handicap in all the basic categories. Additionally, they are protected from age discrimination in employment."

The commission went on to relate [4-E-10]:

"Compared to the coverage of other state civil rights laws in the nation New Mexico's Human Rights Act is one of the country's most inclusive in its categories and bases while allowing for due process in complaint resolution"

Furthermore, the Human Rights Act provides for the establishment of an educational program to promote human rights awareness by the commission. This program seeks to prevent unlawful discrimination by informing and assisting participants.

Measures of the history of compliance in New Mexico with equal employment and open housing laws and regulations can be found in the formal complaints filed and their dispositions.

Employment complaints can be made to the U.S. Equal Employment Opportunity Commission (EEOC). Housing complaints are made to the U.S. Department of Housing and Urban Development. Both employment and housing complaints are handled by the New Mexico Human Rights Commission.

A summary of the total number of employment-related complaints and of their outcomes for 1984 through 1986 are contained in Figure 4.5-9.

The total number of employment complaints filed in New Mexico in 1984 through 1986 ranged from .25% to .36% of the civilian labor force (1,582 to 2,313 total complaints). From 60% to 75% of these complaints were dismissed administratively or found to have no probable cause after formal investigation. Only about 10% of the complaints either were settled or determined to have probable cause (from 164 to 256 total complaints). Assuming there was some merit in the charges which were settled voluntarily, only about .03% to .04% of the civilian labor force were involved in formal complaints which are assumed to have merit.

Similar employment-related information was assembled for the three counties in the vicinity of the SSC site for 1986. These data are contained in Figure 4.5-10.

In 1986 about 1,070 employment complaints (.42% of the total civilian labor force) were filed in Bernalillo County and 120 in Santa Fe County (.24%). The total number of complaints in Tarrant County was estimated as 11 (.35%). In Bernalillo County, approximately 120 complaints were either settled voluntarily or found to have probable cause, representing about .04% of the local civilian labor force. In Santa Fe County five complaints were settled or found to have probable cause, about .01% of the total civilian labor force.

There were almost negligible numbers of housing discrimination complaints filed in New Mexico in 1984 through 1986. These data are summarized in Figure 4.5-11.

Of importance is the fact that 23 or fewer housing-related complaints have been filed in New Mexico each year from 1984 through 1986. Of this small number, at most three of the complaints were found to have probable cause.

Because of the low incidence of housing complaints, it was not believed relevant to provide county-level data.

Figure 4.5-9. Equal employment opportunity complaints and dispositions, New Mexico, 1984-1986 [4.5-19, 4.5-21].

	Percent of Civilian Labor Force		Percent of Civilian Labor Force		Percent of Civilian Labor Force	
	1984	1985	1985	1986	1986	1986
Total Civilian Labor Force	629,000	100.00	646,000	100.00	672,000	100.00
Total Charges Filed	1,582	0.25	2,313	0.36	2,226	0.33
Administrative Closures and Not Investigated	436	0.07	823	0.13	888	0.13
No Probable Cause Determination	748	0.12	606	0.09	547	0.08
Settlements	109	0.02	194	0.03	134	0.02
Probable Cause Determination	55	0.01	62	0.01	73	0.01
Administrative Carryover	234	0.04	628	0.10	584	0.09

Figure 4.5-10. Equal employment opportunity complaints and dispositions, counties in vicinity of the SSC, 1986 [4.5-19, 4.5-20, 4.5-21].

	Bernalillo		Santa Fe		Torrance	
	Number	Percent of Civilian Labor Force	Number	Percent of Civilian Labor Force	Number	Percent of Civilian Labor Force
Total Civilian Labor Force	253,641	100.00	51,295	100.00	3,143	100.00
Total Charges Filed	1,068	.42	122	.24	11	.35
Administrative Closures and Not Investigated	539	.21	45	.09	6	.19
No Probable Cause Determination	252	.10	22	.04	1	.03
Settlement	83	.03	2	.00	2	.06
Probable Cause Determination	34	.01	3	.01	0	.00
Administrative Carryover	160	.06	50	.10	2	.06

Figure 4.5-11. Equal housing opportunity, complaints and dispositions, New Mexico, 1984-1986. 1, Total charges and total probable cause determinations are actual counts. Other totals in table are based upon proportions of outcomes among overall dispositions by the New Mexico Human Rights Commission. [4.5-19, 4.5-20, 4.5-22].

	1984	1985	1986
Total Charges Filed ¹	23	15	14
Administrative Closures and Not Investigated	16	4	4
No Probable Cause Determination	3	4	6
Settlement	0	1	0
Probable Cause Determination	2	3	0
Administrative Carryover	2	3	4

4.6 HOUSING

4.6.1 CHARACTERIZATION OF HOUSING

The three-county SSC vicinity area offers a diversity of residential opportunities, ranging from urban to rural environments, mountains to high plains to river valleys. The three-county area, although extending no more than 40 miles out from the site, is rich in topographic and climatic variation.

The higher elevation areas in the Sandia and Sangre de Cristo Mountains, which offer rural and small-town living options, are heavily forested with spruce and fir, interspersed with aspens and open meadow lands, transitioning to ponderosa forests at slightly lower elevations. These areas receive from 15 to 20 inches of precipitation annually with the most moisture coming in the winter months. During the 1986/1987 winter ski season, Sandia Peak Ski Area, located proximate to Cedar Crest and Tijeras (Fig. 4.6-1), received 260 inches of snow, as did the Santa Fe Ski Area, located in the Sangre de Cristos [4.6-2].

The plains areas in which the city of Santa Fe is located consist of piñon/juniper on open grasslands and juniper grasslands. These areas receive from 11 to 14 inches of precipitation annually and tend to receive significantly less snowfall than the higher elevation areas.

The cool northern desert, consisting primarily of shrubs and grasses in which the site and most of Albuquerque are located, receives a maximum of 11 inches of precipitation annually, little of it in the form of snow.

The three-county area also contains riparian or bosque environments along the Rio Grande and smaller streams. These areas tend to be heavily forested with cottonwoods, Russian olive, tamarisk, and willows.

Living choices within these diverse ecosystems include two major cities, a variety of small towns and villages and rural, unincorporated areas. Housing opportunities available in each of these areas are described below.

Housing Characteristics in Albuquerque

Albuquerque was founded as a Spanish villa in 1706, consisting of an adobe church and a central plaza surrounded by several adobe houses. One hundred years later, the city consisted of only 2,200 people, still centered around the original settlement, known today as Old Town.

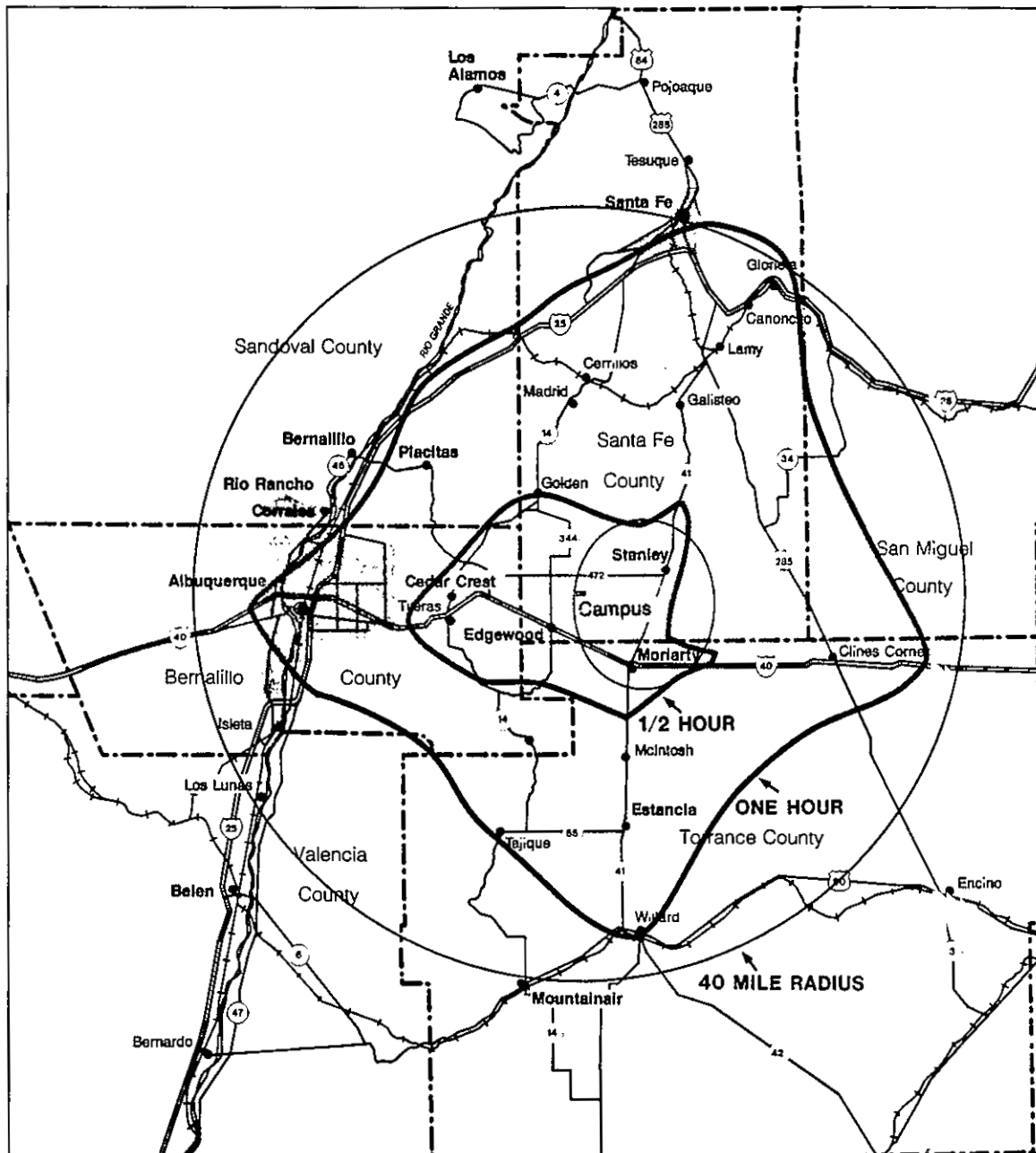

Data collected and map created by Southwest Land Research, Inc.

0 20 40 Miles

Figure 4.6-1. Residential areas within a one hour commuting distance at peak travel time from the SSC site [4.6-1].

Two major changes served as the impetus for Albuquerque's subsequent growth. The first was the coming of the railroads in 1880. The second was the decision to locate Kirtland Air Force Base and Sandia National Laboratories in Albuquerque in the 1940s. The city's population has increased tenfold since that time. Because of the rapid population growth experienced during the 1950 to 1980 period, approximately 80 percent of Albuquerque's housing stock is less than 30 years old [4.6-3].

The city offers a variety of housing types and a rich set of architectural styles. Living choices range from relatively urban environments in the Downtown and Uptown areas, to suburban densities in Albuquerque's Northeast Heights and West Mesa, to a quite rural environment in the city's North and South Valley areas adjacent to the Rio Grande.

While Albuquerque's appearance is generally similar to that of most growing Southwestern cities, several subareas offer unique housing environs. These include the city's North and South Valleys and the Foothills area, at the base of the Sandias.

The Valley areas lie adjacent to the Rio Grande Bosque which, due to its State Park status, has been preserved as open space, replete with native vegetation and wildlife. Although much of the Valley is within city limits, the area's character is rural. Much Valley land remains in agricultural use including alfalfa and chile fields, pasture land and Arabian horse farms. Bike, equestrian, and jogging trails are present along the river and the irrigation ditches interspersed throughout the Valley. Valley lot sizes range from 0.1 acres for townhouse/condominium lots to upwards of five acres for some single family units. Several older villages, established around the time of Albuquerque's Old Town, are located in the Valley, including Los Ranchos de Albuquerque and Los Duranes.

Albuquerque's Foothills area lies on the eastern edge of the city, at the base of the Sandia Mountains, adjacent to city open space and U.S. Forest Service lands. Restrictions imposed by the City of Albuquerque on development in the Foothills ensure preservation of native vegetation, including sage, saltbrush, and yucca in association with open grasslands. Housing here, whether townhouse, condominium, or single family units, tends to be contemporary adobe or adobe style construction, taking full advantage of the spectacular views and the sun by incorporating large areas of glazing with strategically placed overhangs and venting systems, coupling view windows with passive solar heating.

Figure 4.6-2 shows Albuquerque's current supply of housing by unit type. In 1980, approximately 57 percent of the city's housing units were owner occupied. Thirty-seven percent were renter occupied, with the remainder vacant (Appendix 4-F-1).

Albuquerque's ability to provide housing for SSC employees appears more than adequate. From 1970 to 1980, over 53,974 dwelling units were constructed city-wide (Fig. 4.6-2). An additional 27,000 single family dwellings, apartments and mobile homes were added to Albuquerque's housing base during the 1980 to 1985 period, an average annual increase of more than 5,000 units.

In 1986, over 5,300 single family units were sold through the Albuquerque Multiple Listings Service (MLS) [4.6-8]. New construction is generally not included in MLS listings. New single family housing construction, not including apartments and mobile homes, totalled 2,580 units during 1986 [4.6-6]. Total single family dwellings available for purchase in 1986, therefore, exceeded 7,800 units.

The city's ability to provide adequate rental housing as well as temporary housing for construction workers and visiting scientists is also apparent. Figure 4.6-3 shows the availability of temporary accommodations within the city, including apartments, mobile homes and motel/hotel rooms. Vacancies in overnight lodging facilities currently average 60 percent [4.6-11]. Almost 2,000 new hotel and motel rooms were constructed from 1983 to 1986, to meet the demand for additional overnight accommodations. Vacancies in multifamily housing were negligible in 1980. To respond to the need for additional rental housing, more than 14,000 multifamily units were constructed from 1980 to 1986 [4.6-6]. Almost 3,000 new mobile home spaces are currently under construction or in some phase of the development approval process [4.6-9].

Much developable vacant land exists within and adjacent to the city of Albuquerque. The largest parcel close to the SSC site is the 11,000-acre Mesa del Sol area adjacent to Kirtland Air Force Base. Under state ownership, Mesa del Sol has recently been master planned and will be sold to private developers, with construction projected to begin in the 1990s.

Characteristics of Santa Fe Housing

Santa Fe was founded in 1610 as the capital city of the Spanish "Kingdom of New Mexico". Given its long history, the city contains some of the nation's oldest buildings, including residences, mission churches, and public buildings.

Figure 4.6-2. Existing housing stock, SSC vicinity area, 1970-1986 [4.6-4, 4.6-5, 4.6-6, 4.6-7]. 1, Estimate based on actual city data.

County/ Municipality	Dwelling Units 1985							Annual Average Percent Change, Total Units, 1980-1985
	Total	Single Family	Percent of Total	Multi- Family	Percent of Total	Mobile Home	Percent of Total	
Bernalillo County	194,251	121,483	63	61,224	32	11,544	6	3.7
Albuquerque	160,320	97,653	61	56,664	35	6,003	4	3.9
Remainder of County	33,931 ¹	23,830	70	4,560	13	5,541	16	3.1
Santa Fe County	34,784 ¹	NA	NA	NA	NA	NA	NA	4.3
Santa Fe City	23,411 ¹	15,539	66	7,158	31	714	3	4.3
Remainder of County	11,373	NA	NA	NA	NA	NA	NA	4.3
Torrance County	3,908	NA	NA	NA	NA	NA	NA	3.9
Moriarty	956	499	52	54	6	403	42	12.4
Remainder of County	2,952	NA	NA	NA	NA	NA	NA	1.9
Total Region	232,943	NA	NA	NA	NA	NA	NA	3.8

County/ Municipality	Dwelling Units 1980							Annual Average Percent Change, Total Units 1980-1985
	Total	Single Family	Percent of Total	Multi- Family	Percent of Total	Mobile Home	Percent of Total	
Bernalillo County	161,843	105,740	65	46,766	29	9,337	6	5.1
Albuquerque	132,757	84,849	64	43,075	32	4,833	4	5.4
Remainder of County	29,086	20,891	72	3,691	13	4,504	15	4.0
Santa Fe County	28,174	18,446	66	6,863	24	2,865	10	5.7
Santa Fe City	18,962	12,735	67	5,679	30	548	3	4.2
Remainder of County	9,212	5,711	62	1,184	13	2,317	25	10.0
Torrance County	3,222	2,237	69	208	7	777	24	5.3
Moriarty	534	370	69	37	7	127	24	7.2
Remainder of County	2,688	1,867	69	171	7	650	24	5.0
Total Region	193,239	126,423	65	53,837	28	12,979	7	10.6

County/ Municipality	Dwelling Units 1970							Annual Average Percent Change, Total Units 1980-1985
	Total	Single Family	Percent of Total	Multi- Family	Percent of Total	Mobile Home	Percent of Total	
Bernalillo County	98,491	76,903	78	17,882	18	3,706	4	
Albuquerque	78,783	60,221	76	16,533	21	2,029	3	
Remainder of County	19,708	16,682	85	1,349	7	1,677	8	
Santa Fe County	16,117	12,996	81	2,470	15	651	4	
Santa Fe City	12,558	9,996	80	2,183	17	379	3	
Remainder of County	3,559	3,000	84	287	8	272	8	
Torrance County	1,919	1,730	90	80	4	109	6	
Moriarty	266	214	80	21	8	31	12	
Remainder of County	1,653	1,516	92	59	3	78	5	
Total Region	116,527	91,629	79	20,432	18	4,466	4	

Figure 4.6-3. Temporary housing availability, SSC vicinity area, 1987. [4.6-9, 4.6-10, 4.6-11, 4.6-12]. 1, Average monthly rent for an efficiency apartment. 2, Average monthly rent for a three-bedroom apartment.

Municipality	Hotel/Motel Rooms				Apartment Units			Mobile Home Spaces		
	Total	Average Price (Nightly)		Current Vacancy	Total	Current Vacancy Rate	Average Monthly Rent	Total	Current Vacancy Rate	Average Monthly Rent
		Full Service	Budget							
Albuquerque	11,000	\$69.00	\$28.00	40	59,500	13	\$277.00 ¹ 475.00 ²	7,900	1.3	\$190.00
Santa Fe	5,132	\$49.00- \$190.00	\$25.00- \$79.00	39	7,519	12	450.00	714	NA	NA

In the late 1950s Santa Fe's first historic district was established and a Historic Zoning Ordinance was adopted, mandating the use of either Spanish Pueblo or Territorial-style architecture for new construction within the historic district (see Sec. 4.8.3 for explanation of architectural styles). Since that time, Santa Fe's historic district boundaries have been expanded, covering the entire central city area and the southeast quadrant.

As a result of this preservation effort, the city looks unlike any other in the United States. Much of the city's new housing, even in areas outside of the designated historic districts, is constructed in the traditional Spanish Pueblo or Territorial styles, repeating the overall massing, form, and proportion of these indigenous regional styles, while incorporating passive solar technology for heating and cooling.

Santa Fe's central core area, located within its original historic district, offers a dense urban housing environment at a pedestrian scale. The northern and eastern portions of the city provide suburban to semi-rural densities in areas of varied topographic relief. Housing is constructed along ridgebacks and in valley areas with spectacular views of the Sangre de Cristo Mountains to the north and east. Because of the construction difficulties posed by the rough terrain and steep slopes in much of northern and eastern Santa Fe, new housing construction here tends to be relatively high-priced. The southwestern portion of the city offers suburban densities and moderately priced units. Santa Fe was recently voted America's most livable small city by the U.S. Conference of Mayors.

Figure 4.6-2 shows the current supply of housing within Santa Fe. Appendix 4-F-1 shows that approximately 36 percent of its housing stock is renter occupied.

Provision of housing for SSC employees does not appear problematic. Santa Fe experienced rapid population growth from 1970 to 1980, resulting in the construction of more than 6,000 housing units, increasing its housing supply by more than 50 percent during the 10-year period. An additional 4,400 units were constructed from 1980 to 1985 (Fig. 4.6-2).

Santa Fe's supply of hotel rooms exceeds 5,000, with average vacancies estimated at 39 percent [4.6-12]. Almost 900 motel/hotel rooms have been constructed since 1983 [4.6-6]. While mobile home spaces within the city are fairly limited, more than 2,800 spaces were available county-wide in 1980. Almost 1,500 multifamily units were constructed city-wide from 1980 to 1985, a 22 percent increase. Current apartment vacancies are estimated at 12 percent.

Santa Fe, like Albuquerque, has abundant vacant, developable land remaining within and proximate to city boundaries. Over 2,800 acres in the city's northwest quadrant is under city ownership and is being held for future development. Thousands of acres south of the city are in private ownership and will be developed as needed [4.6-13].

Small Town, Village, and Rural Housing Characteristics

Small towns and villages within a 15 to 40 minute commuting distance of the site include Moriarty and Edgewood, located in the cool northern desert region south of the campus area; Tijeras, Cedar Crest, and Sandia Park, located in the higher elevation areas on the east side of the Sandias; Placitas, on the west side of the Sandias; La Cienega, just south of Santa Fe; and Lamy and Galisteo, located north of the site.

Rural living choices are also available in portions of each of the three counties, on the east side of the Sandia Mountain Range or in the Sangre de Cristo Mountains north of Lamy, and in the plains in Torrance and Santa Fe Counties.

Placitas, La Cienega, and Galisteo are older Spanish villages established in the 1700's and 1800's which have expanded only relatively recently to include large lot residential development outside the original village boundaries. The housing stock includes traditional adobe construction as well as more contemporary styles, incorporating passive solar design with traditional pueblo forms. A limited number of mobile homes are also present.

Tijeras, Cedar Crest, and Sandia Park on the east side of the Sandias are at relatively high elevations and therefore receive more snowfall than do the other smaller communities. Tijeras, like Galisteo and La Cienega, is an older Spanish community which has expanded over the years. Cedar Crest and Sandia Park are relatively new areas, with large lot developments of contemporary homes.

Moriarty is a farming and ranching community of about 1,400 people, established in the early 1800s. Edgewood, set in the eastern foothills of the Sandias, serves as a bedroom community for both Santa Fe and Albuquerque. Both Moriarty and Edgewood provide a variety of sites for single family and mobile home development, at considerably lower cost than Albuquerque or Santa Fe [4.6-7].

4.6.2 TYPICAL PURCHASE PRICES AND RENTS

Figure 4.6-4 shows purchase prices and rents for Albuquerque and Santa Fe area housing. Albuquerque's prices for single family and townhouse/condominium units are considerably less than the national average, while Santa Fe's prices are somewhat above the national/regional averages.

Figure 4.6-4. Average housing sale prices and monthly rents in SSC vicinity area, 1987 [4.6-8, 4.6-9, 4.6-10, 4.6-11, 4.6-12, 4.6-14, 4.6-15]. 1, Average monthly rent for efficiency unit. 2, Average monthly rent for three-bedroom unit. 3, Includes price of land. 4, Average monthly rent for all unit types. 5, 1987 data. 6, Includes states of New Mexico, Montana, Wyoming, Colorado, and all states west of these.

Municipality	Average Price Motel/Hotel, 1987		Average Monthly Rent, 1987		Average Sales Price ³ , 1986		
	Full Service	Budget	Apartment	Mobile Home	Single Family	Townhouse Condominium	Mobile Home
Albuquerque	\$69	\$28	\$277 ¹ \$475 ²	\$190	\$ 90,824	\$ 80,840	\$43,900 ⁵
Santa Fe	\$49-190	\$25-79	\$475 ⁴	NA	\$126,000	\$110,000	NA
Western Region ⁶	NA	NA	NA	NA	\$122,200	NA	NA
United States	NA	NA	NA	NA	\$ 98,500	NA	NA

4.7 COMMUNITY SERVICES

4.7.1 MEDICAL CENTERS, HOSPITALS, AND EMERGENCY SERVICES

The campus of the SSC site is located less than 30 miles from major regional medical facilities located in Albuquerque. General facilities and a wide array of specialized services are available in Albuquerque and Santa Fe. Medical clinics are available in rural communities outside the major cities, and emergency services throughout the area provide immediate care and transport to hospitals.

Medical Centers and Hospitals

It is anticipated that many of the SSC's employees will live in the metropolitan areas near the site. Albuquerque and Santa Fe have regional medical facilities which provide health care statewide. Families of employees who live within the urban areas will have an extensive array of health care services immediately available. Families who choose to live in more rural areas will have these facilities available within a 30-45 minute drive-time. Medical centers and hospitals are shown in Figure 4.7-1 and in Appendix 4-G-1.

The Albuquerque metropolitan area has four major medical centers and hospitals which serve the entire state.

The University of New Mexico Medical Center includes the UNM School of Medicine, UNM Hospital, Cancer Center, Mental Health Center, Children's Psychiatric Hospital, Center for Non-Invasive Diagnosis, and related programs [4.7-1].

UNM's School of Medicine, which opened in 1964, has graduated 1,165 physicians in 19 classes. Another 1,529 have completed residency training programs in 16 medical specialties. In addition to the traditional curriculum, UNM offers a Primary Care Curriculum which focuses on community medicine. This program has received attention from schools both nationally and internationally. The school trains medical technologists, physical therapists, nuclear medicine and radiology technicians, respiratory therapists, and human service workers.

Biomedical research at UNM is active in immunobiology, cell biology, arthritis and rheumatology, aging, metabolism, and the treatment of diabetes. Through joint endeavors with Los Alamos and Sandia National Laboratories, UNM medical faculty have explored the use of high technology to resolve problems in human biology.

The Center for Non-Invasive Diagnosis, a UNM-Los Alamos collaboration, is the state's most extensive and sophisticated resource for studies of magnetic resonance imaging, which can produce images and chemical analyses of the patient without radiation exposure, biopsies, or surgery.

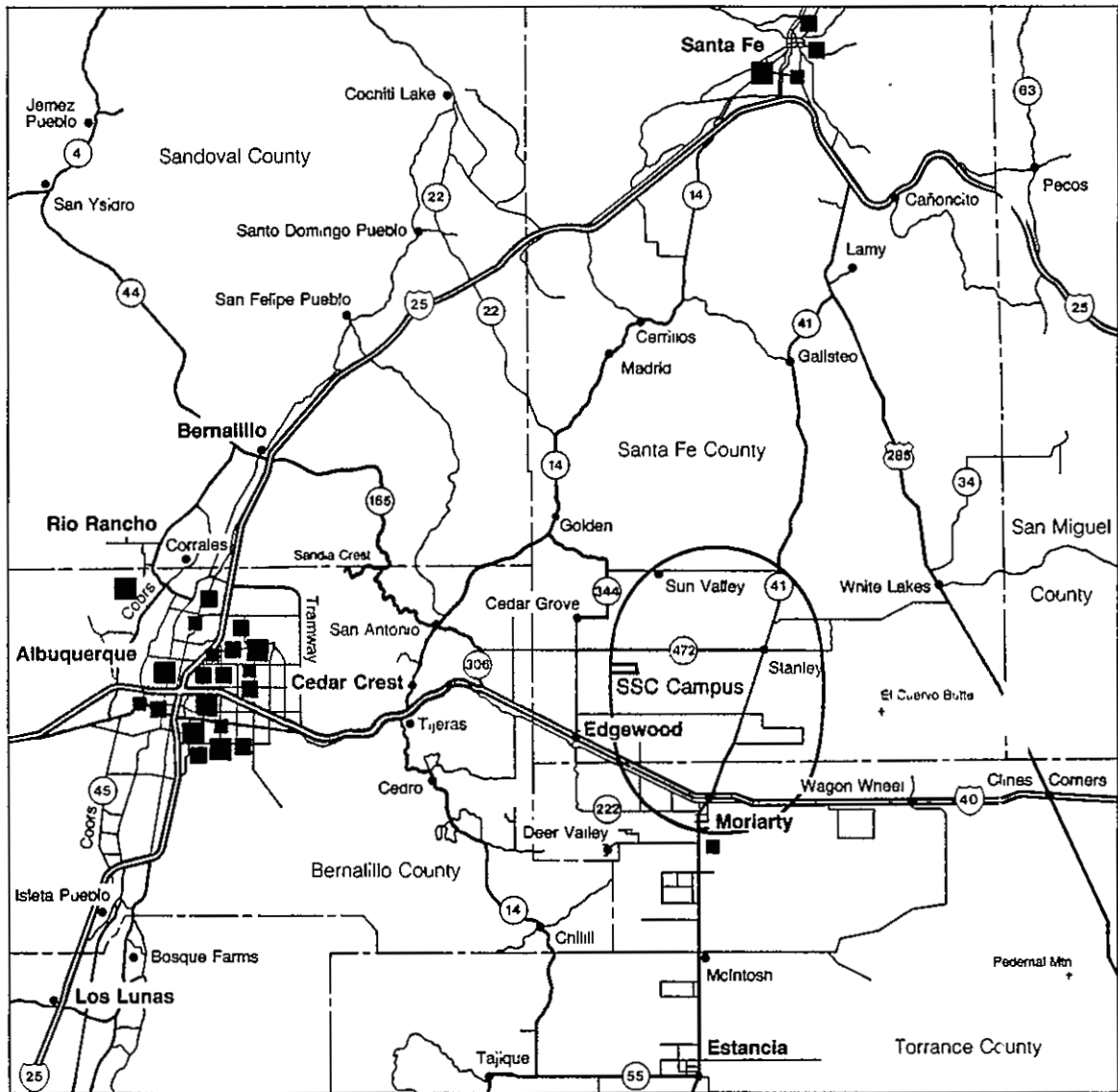

Data collected and map created by Southwest Land Research, Inc.

- Medical Center/General Hospital
- Special Service Hospital
- Medical Clinic

0 10 20 Miles

Figure 4.7-1. Medical centers and hospitals in the vicinity of the SSC site.

Special programs at UNM Hospital include the Level I Trauma Center and Lifeguard Emergency Helicopter Service, kidney transplantation service, reimplantation service, clinical research center, and high-risk pregnancy care. Pediatric programs include newborn intensive care, newborn transport, pediatric intensive care, pediatric specialties, and the Child Life Program. The UNM Hospital is licensed for 340 beds and has a staff of 1,940.

The UNM Mental Health Center, Cancer Center, and Children's Psychiatric Hospital provide medical and patient/family support services in their specialty.

Lovelace, one of the largest health care facilities in the Southwest, includes four operating divisions. Lovelace Medical Foundation is responsible for medical research and education. Lovelace is one of 11 institutions in the U.S. and Canada chosen for the planning phase of a nine-year study of the effectiveness of using community organizations to help heavy smokers stop smoking. The Foundation is also involved in the Veteran's Health Study to assess the health effects of wartime service in Vietnam in general, and of exposure to the herbicide Agent Orange in particular. The Lovelace Biomedical and Environmental Research Institute, a subsidiary of the Lovelace Medical Foundation, is known for its research in inhalation toxicology, airborne pollutants, and biodynamics [4.7-2].

The Lovelace Medical Center, Inc., maintains health services, including inpatient and outpatient care. Lovelace operates a general acute care hospital with a licensed bed capacity of 230, providing a full range of hospital services, including Ob/Gyn, pediatrics, medical and surgical care, renal dialysis, ICU/CCU and emergency center services. The center operates seven satellite urgent care clinics in Albuquerque and a clinic in Santa Fe. Lovelace has an annual operating budget of more than \$100 million and over 1,900 employees.

Lovelace Clinic Professional Corporation includes the nearly 175 Lovelace physicians.

The Lovelace Health Plan, with more than 70,000 members, was the state's first health maintenance organization and remains the state's largest HMO. The Lovelace Health Plan serves Albuquerque and Santa Fe, and has arranged with family doctors in some rural areas to care for a limited number of Health Plan Members in those communities.

Presbyterian includes three hospitals and a convalescent unit. Presbyterian Hospital is a 500-bed general acute care hospital which provides a full range of hospital services. With a staff of 1,800, it is known for its cardiology program and is the only hospital in New Mexico to conduct heart transplants. Presbyterian is a Level 2 trauma center,

providing 24-hour emergency services. Other services include a diabetes center, pediatrics center, and women's center. Presbyterian operates two satellite urgent care clinics in Albuquerque and one in Los Lunas, a rural community south of the city [4.7-3].

Kaseman Hospital, with 252 beds and a staff of 600, specializes in treatment of psychiatric disorders. In addition, Kaseman provides general acute care, emergency care, day surgery, and outpatient services.

The 119-bed Northside Presbyterian Hospital provides treatment for chemical dependency. Its staff size is 135. Pickard Presbyterian Convalescent Center provides long-term care for the elderly. Pickard has 120 beds and a staff of 90.

St. Joseph Hospital, now part of the St. Joseph Healthcare Corporation (SJHC), was the first hospital in Albuquerque. Today the corporation includes the downtown St. Joseph Hospital, a 313-bed general acute-care facility at the original location, which specializes in orthopedics, ophthalmology, neuroscience, oncology, and rehabilitation services for those recovering from head and spinal cord injuries. The hospital operates a 24-hour emergency room. Construction will begin in fall 1987 on the new \$9.2 million, 64-bed St. Joseph Rehabilitation Center adjacent to the downtown facility [4.7-4].

St. Joseph West Mesa Hospital, on Albuquerque's west side, is a 128-bed primary care facility which provides general medical and surgical services, pediatric care, rehabilitation services, a skilled nursing unit, a brain injury unit, Family Birthing Center, and 24-hour emergency room service.

SJHC is actively involved in health care for older adults and research through its Center for Senior Care and Research. Services available at both hospitals include wellness and exercise programs, reduced priced meals, and a pharmacy hotline. SJHC recently received a three-year grant to provide a coordinated care program for the frail elderly, and several research projects aimed at finding a cure for Alzheimer's Disease are underway.

The range of general, emergency, and specialized services provided by each hospital is shown in Appendix 4-G-1. In addition to hospital care, these institutions provide outpatient clinics for a variety of special needs.

The Albuquerque metropolitan area also has a number of smaller hospitals which provide specialized services, including psychiatric care, special pediatric services, and long-term care for the elderly.

Federal hospitals in Albuquerque include the 417-bed Veteran's Administration Medical Center, a 54-bed Public Health Service Indian Hospital, and a 58-bed U.S. Air Force Hospital at Kirtland Air Force Base (housed in the VA Hospital).

Three hospitals are located in Santa Fe. St. Vincent Hospital, a private general hospital, provides general acute care and emergency care and specialized services for much of northern New Mexico. St. Vincent is a Level 2 trauma center serving the northern part of the state. Additional services include a cancer treatment center, cardiac rehabilitation program, pediatric intensive care, a family recovery center for families with adolescents having drug or alcohol dependencies, and a psychiatric unit.

A 55-bed PHS Indian Hospital is located in Santa Fe. Piñon Hills, a private psychiatric facility, provides hospital care in Santa Fe and an outpatient clinic in Los Alamos.

Primary Care Clinics

The primary care clinic closest to the proposed SSC site is Central New Mexico Medical Clinic, which has a full-time doctor and certified family nurse practitioner. Part-time services are provided by a chiropractor and ophthalmologist. There are five primary care clinics in Bernalillo County and one in Santa Fe [4.7-5], as shown on Figure 4.7-1.

Physicians

Within the area surrounding the site are over 1,500 doctors who provide primary care and non-primary care in 40 different specialities as shown in Appendix 4-G-2 [4.7-5].

Emergency Services

Emergency services are available to transport patients in the event of an emergency to hospitals in Albuquerque or Santa Fe. Both local ambulance service and air ambulance service are available in communities where employees are expected to live. Emergency service is also available for emergencies at the site [4.7-6]. The locations of emergency services are shown on Figure 4.7-2.

The University of New Mexico Hospital Lifeguard Air Emergency Service provides air emergency services with both fixed-wing and rotor-wing air craft. Response time to the vicinity of the SSC site is less than 20 minutes. Response times to nearby communities is 15 to 30 minutes depending upon distance from the hospital [4.7-7].

The University of New Mexico Hospital is the state's Level 1 trauma center. A doctor or crew can be dispatched to the site of an emergency if necessary.

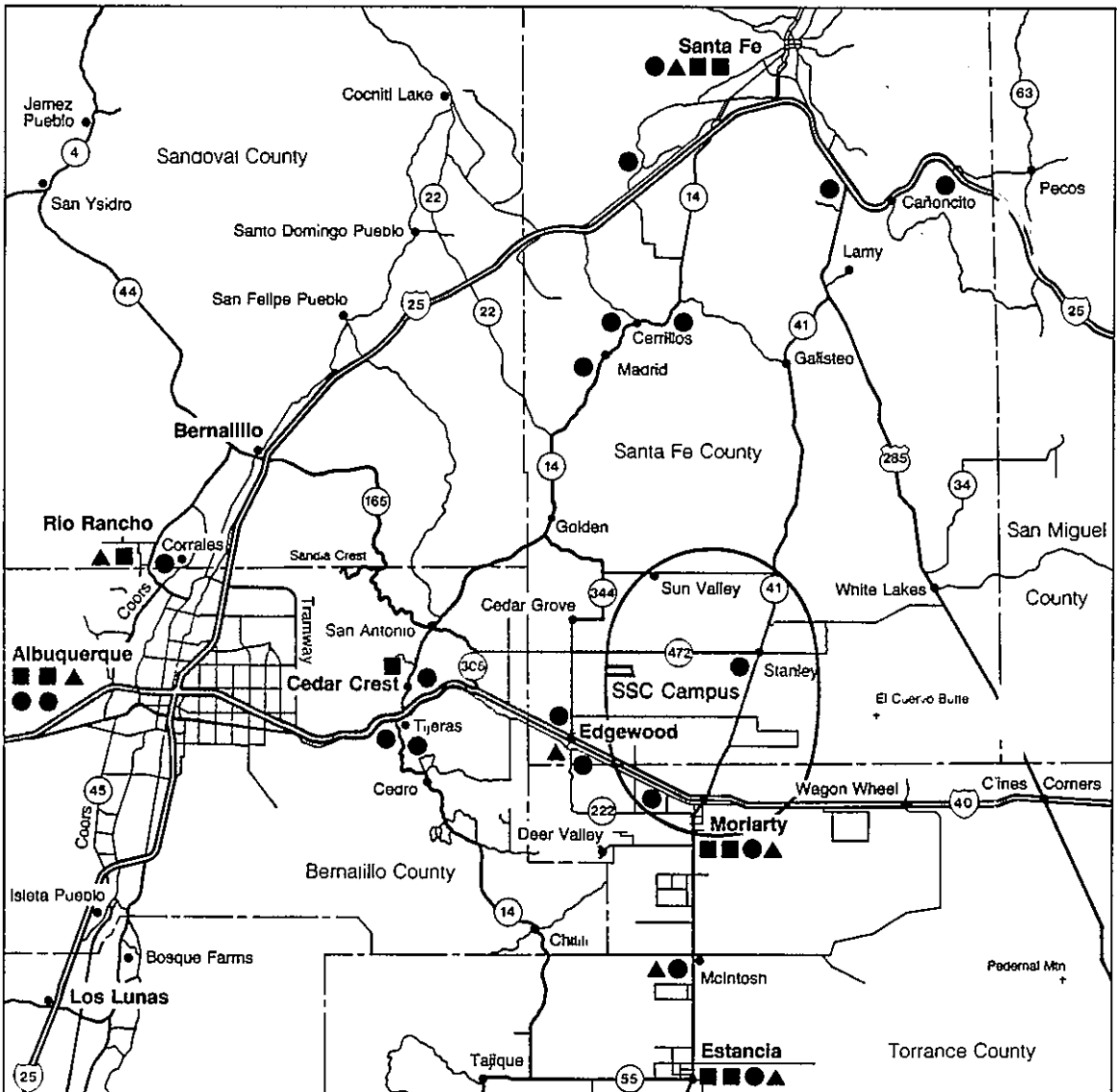

Data collected and map created by Southwest Land Research, Inc.

Figure 4.7-2. Emergency services in the vicinity of the SSC site.

The Lifeguard Air Emergency Service has worked with other DOE and military installations in the state to establish disaster plans, and the University of New Mexico Hospital is prepared to handle the emergency needs of the project.

Presbyterian Hospital provides fixed-wing air ambulance service. For emergencies which occur as close to Albuquerque as the proposed site, Lifeguard's helicopter is generally used. However, Presbyterian Hospital's fixed-wing service can be used to supplement the helicopter service if necessary [4.7-8].

Both hospital services have medical crews available and response ready 24 hours per day. The services work cooperatively to provide optimum service.

In addition to hospital air ambulance services, there is a private company based at Albuquerque International Airport which provides air ambulance services to outlying communities.

Emergency medical service in Torrance County is provided by A-1 Ambulance Service in Estancia. A-1 Ambulance Service has one full-time EMT and provides service 24 hours per day, seven days per week.

Four certified EMTs (basic) are located in Stanley, and five certified EMTs are located in Moriarty. Back-up emergency service is provided by volunteer fire departments and law enforcement agencies, which are located throughout Torrance and southern Santa Fe Counties, as shown in Appendix 4-G-3.

Law Enforcement

The vicinity of the SSC site is served by eight agencies. The Albuquerque, Rio Rancho, Santa Fe, and Moriarty police departments provide service within the incorporated municipalities. The Bernalillo, Santa Fe, and Torrance County Sheriff's Offices and New Mexico State Police serve unincorporated areas. The locations of law enforcement offices are shown in Figure 4.7-2.

Appendix 4-G-4 shows the staffing levels of the various agencies, number of stations, and equipment available.

The New Mexico State Police have concurrent jurisdiction with city, county, and tribal authorities. They also have jurisdiction within federal lands. The vicinity of the site is covered by two districts headquartered in Santa Fe and Albuquerque. A subdistrict office out of Albuquerque is located in Moriarty. The Moriarty subdistrict has seven officers based in Edgewood, Clines Corners, and Moriarty. These officers patrol all of Torrance County and the southwest portion of Santa Fe County. The Moriarty office is

manned from 8 to 16 hours per day. Headquarters are manned 24 hours per day [4.7-9].

The Bernalillo County Sheriff has jurisdiction over Bernalillo County, excluding incorporated areas of Albuquerque, Indian Reservations, and federal lands. A substation in Tijeras serves the east mountain area. The Sheriff's office has an emergency response team trained by the Department of Energy which can be at the scene in 15 minutes [4.7-10].

The Albuquerque Police Department, with 688 sworn officers, is the largest and most sophisticated in the state. The department has three area commands in addition to the main office and is in the planning stages for a fourth area command. The officer-to-population ratio is now 1.83 per 1,000 population, and the goal is a ratio of two officers per 1,000 population [4.7-11].

Rio Rancho's Department of Public Safety has 37 paid officers who are cross-trained as firefighters and EMTs. The department, which is located in the fastest growing community in the Albuquerque area, is planning two new substations to serve new subdivisions [4.7-12].

In Santa Fe County, the Santa Fe County Sheriff's office serves all unincorporated areas, excluding Indian and federal lands. In addition to a paid force of 31, there are 15 reserve deputies available if needed. Two new officers will be hired this summer [4.7-13].

The Santa Fe Police Department provides police protection within the city limits. The department has an officer-to-population ratio of 2 officers per 1,000 residents. A new substation in the downtown area is planned within two years [4.7-14].

The Torrance County Sheriff's office, based in Estancia, serves unincorporated areas in Torrance County. The Moriarty Police Department provides police protection within the city limits of Moriarty. According to local law enforcement officials, the incidence of crime in Torrance County is extremely low [4.7-15].

Fire Protection

The vicinity of the SSC site is served by 16 fire departments. Albuquerque and Santa Fe have paid firefighters. Rural fire stations are staffed by volunteers. All stations are manned on a 24-hour basis. Figure 4.7-2 shows the locations of fire stations, and Appendix 4-G-3 shows staffing levels and equipment.

Bernalillo County has 14 fire districts, three of which provide fire and emergency service east of the Sandia Mountains. East mountain districts are located in Cedar Crest,

Tijeras, and on south NM-14 near Tijeras. These are all volunteer stations [4.7-16].

The City of Albuquerque Fire Department has 500 paid firefighters and 18 stations. Average response time within the City of Albuquerque is 4 minutes.

The Albuquerque Fire Department has three hazardous materials squads which serve the entire state. These squads are on call full time to handle spills or other emergencies involving hazardous materials [4.7-17].

The Rio Rancho Department of Public Safety has 37 paid firefighters and 30 volunteers which serve the City of Rio Rancho, northwest of Albuquerque [4.7-12].

The City of Santa Fe Fire Department serves the city and portions of Santa Fe County adjacent to the city limits. The Santa Fe Fire Department is in the process of forming a hazardous materials team. Santa Fe area volunteer firefighters and EMTs are trained in Santa Fe. Expansion plans include construction of a new fire station in south Santa Fe [4.7-18].

Moriarty and Estancia each have a volunteer fire district which provides fire protection within their municipal limits. These units serve the county areas if needed [4.7-19].

Unincorporated portions of Santa Fe and Torrance Counties are served by volunteer districts in rural areas surrounding the site [4.7-20], as shown in Figure 4.7-2.

4.7.2 DESCRIPTION OF RECREATIONAL AND OPEN SPACE FACILITIES

New Mexico has a wealth of recreational opportunities from wilderness experiences to organized sports. New Mexico's climate and spectacular setting provide the backdrop for year-round recreational activities. This section first addresses recreation in the general environs of the SSC site, then moves to specific consideration of recreational opportunities in the immediate vicinity of the site.

General Environs: Outdoor Recreation

There are more than 16 million acres of federal- and state-owned land that are open in New Mexico for recreational use. These vast public holdings include high mountain timberland, huge underground caverns, ancient volcanos, wild and scenic rivers, 22 square miles of white gypsum sand dunes, and 178 square miles of lakes and reservoirs. An accounting of New Mexico's public lands, their designations, locations, allowable uses, and driving distances from the SSC site is contained in Appendix 4-G, 5 through 11.

The recreational activities undertaken in New Mexico's great outdoors are myriad. Among them are the following:

- o Downhill Skiing - New Mexico's mountains offer some of the finest skiing in the country at 11 areas throughout the state. One of these ski areas--Sandia Peak--is a twenty-minute drive from the main campus of the SSC site. Another--Taos--has world famous intermediate and advanced slopes. New Mexico's ski season generally lasts from early December until April. In our sunny climate, it is not unusual to be able to ski in the morning and play tennis in the afternoon [4.7-27].
- o Cross-country Skiing - There are over 70 groomed trails in northern New Mexico for cross-country skiing and many more miles of Forest Service roads and trails. The state hosts five ski touring centers. Snowshoers enjoy these facilities as well [4.7-27].
- o Boating/Sailing - New Mexico has 19 lakes and reservoirs in State Parks and there are several more on Indian lands. Eight of the State Parks have marinas. In addition to motorized craft, New Mexico's waters attract a large number of sailors, ranging from yachtsmen to wind surfers. Some lakes invite sailing by limiting allowable motor sizes [4.7-28].
- o White Water Rafting and Kayaking - The northern stretches of the Rio Grande and the Rio Chama are exciting enough to support 13 local commercial outfitters and several more who are headquartered out of

state. Private trips are not rationed. A variety of access points allow runs to range from a few to 62 miles [4.7-27].

- o Camping, Hiking and Backpacking - New Mexico has seven National Forests encompassing 10 million acres, and 1.3 million acres of designated wilderness and primitive areas. The Forest Service has developed 2,269 miles of trails that can be used for hiking and backpacking; camping is permitted throughout the National Forest lands [4.7-24]. Within these public lands are seven peaks whose summits are above 13,000 feet, and 85 more that are over two miles high [4.7-29].
- o Wildlife Observation - The Rio Grande and the Pecos River are major flyways. Six National Wildlife Refuges and 25 State Wildlife Areas preserve habitat for waterfowl and other beasts. Some of these areas are major wintering grounds and present extraordinary observational opportunities (see Appendix 4-G-9).
- o Fishing - Trout fishing is a prime activity in the snow-fed waters of our mountain streams and lakes. New Mexico has seven major water sheds and 400 individual trout waters that hold four introduced and two native species.

Warm water fishing opportunities abound in New Mexico's lakes and reservoirs, and the San Juan, the Gila, and the Rio Grande offer river fishing for bass and cat species. The larger reservoirs host trophy competitions. There are dozens of smaller reservoirs that contain big fish as well [4.7-30].

- o Hunting - The six Life Zones present in New Mexico create a widely varied set of plant communities and animal habitats. Accordingly, its game population varies extensively. New Mexico lists a dozen big game animals--among them, deer, antelope, elk, wild turkey, bear, mountain lion, and ibex--four varieties of quail, two of dove, a host of duck species, shore birds, geese, and upland game birds [4.7-30].

General Environs: Special Events

New Mexico's calendar is rich with scheduled celebrations and sporting events. Ranging from ceremonial dances at the state's 19 pueblos to the Deming Duck Race to the Triple Crown for quarter horse racing to the Santa Fe Opera to the celebration of every town's patron saint day with a Fiesta, these events draw 22.6 million tourists a year--more than 20 times the state's population. The wealth of New Mexico's special event offerings are detailed in Appendix 4-G-12 and 4-G-13.

General Environs: Scenic Resources

There is much to see that is beautiful in our state. Although New Mexico has 1,562 miles of designated scenic highway routes, there is more than the view from the roadway to be had. New Mexico shares with Colorado the ownership and operation of the Cumbres and Toltec Scenic Railway which winds for a day-long trip through the Southern Rockies. And, within 20 minutes of the SSC campus, is the world's longest aerial tramway.

Recreational Resources in the Vicinity of the SSC Site

A regimen of clear weather couples with the local geography to produce, at the SSC site itself, some of the best conditions in the state for soaring. A glider port is adjacent to the main campus. Twenty minutes away, these conditions create a world class hang gliding locale at Sandia Crest, where pilots leap out from the mountain top to catch thermal currents that may take them to elevations of 18,000 feet. Albuquerque's reputation as the Balloon Capital of the World rests on its share of these natural earth and air resources. Albuquerque claims as its sons the first men to cross the Atlantic in a balloon and is home to the famed International Balloon Fiesta, held each October.

Sandia Crest, which launches hang gliders in spring, summer and fall, welcomes skiers in the winter. With annual snowfall of 130 inches, this neighbor to the site offers 23 trails and three chairs and is near enough to provide a lunch-break skiing opportunity. Almost twice as large and just over an hour away is Santa Fe Ski Basin. Within a 1.5-hour drive is Pajarito Ski Area at Los Alamos, and within 2.5 hours are Taos, Red River, and Angel Fire. All of these areas have excellent cross-country skiing as well.

In the off-season from skiing, the mountains around the site are used by hikers and backpackers. In the three counties in which these nearby ranges are located, there are 229 miles of Forest Service trails. These public land resources in the vicinity of the site are shown in Figure 4.7-3.

There are extensive urban recreational facilities available in the communities located in the vicinity of the SSC site. Albuquerque and Santa Fe and outlying areas provide neighborhood parks. In Albuquerque, neighborhood parks are located within 0.5 mile of every resident. Both Santa Fe and Albuquerque require dedication of land or development fees to assist in constructing parks in developing areas. County governments construct and maintain park and recreational facilities outside these incorporated areas.

County and municipal park and recreation facilities in each county in the vicinity of the SSC site are shown in Figure 4.7-4.

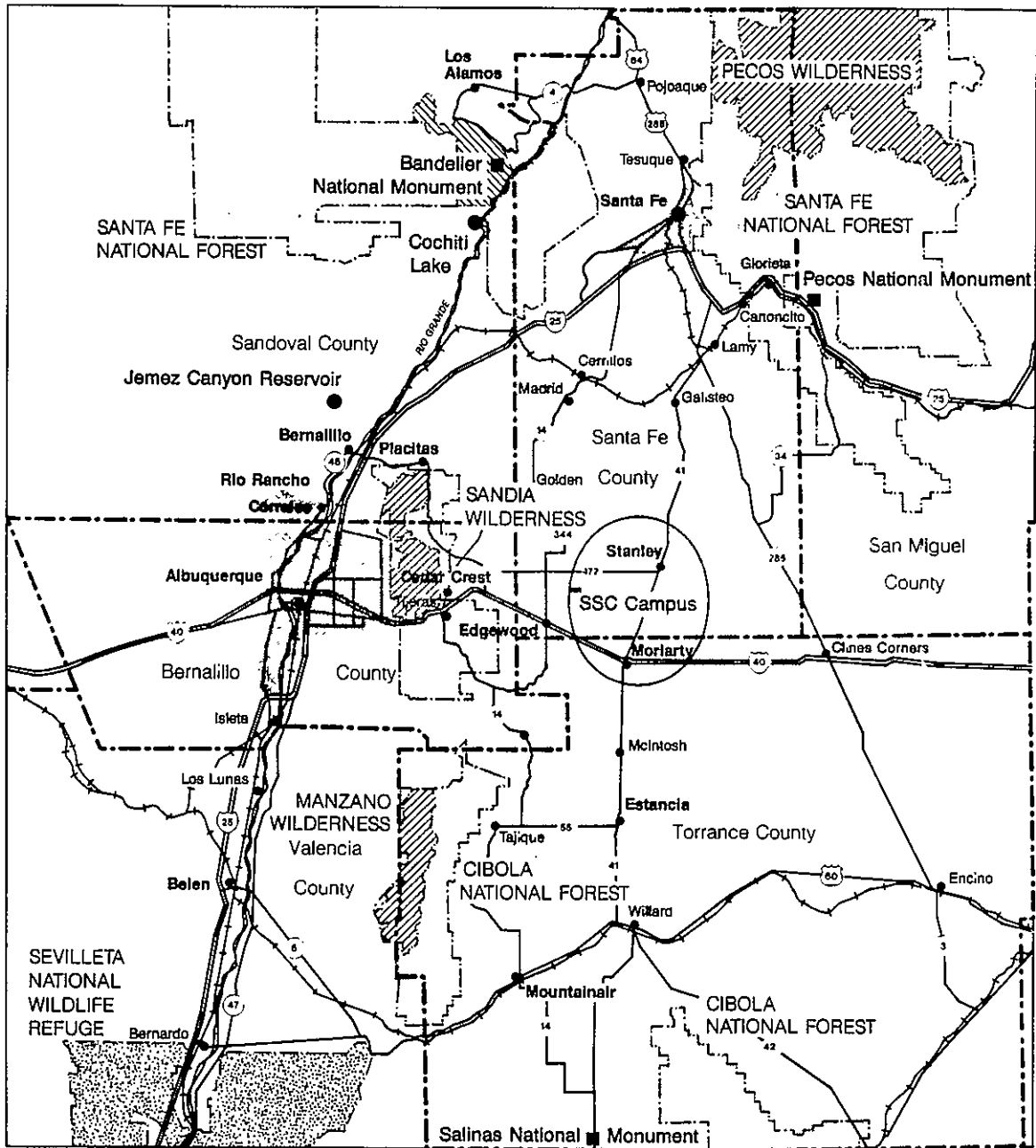

Data collected and map created by Southwest Land Research, Inc.

0 20 40 Miles

Figure 4.7-3. Public land recreation resources in the vicinity of the SSC site.

Figure 4.7-4. County and municipal park and recreation facilities within the SSC vicinity area [4.7-1].

County	Acres of Park Lands	Acres of Park Lands Per 1,000 Population	Tennis Courts	Handball Racquet Courts	Other Courts	Football Soccer Fields	Softball Baseball Fields	Tracks	Golf Courses
Bernalillo	13,928	29.62	209	10	283	74	312	30	4
Santa Fe	426	5.02	41	5	27	9	29	4	1
Torrance	178	20.75	7	0	8	8	5	6	0

County	Pools	Play Areas	Rodeo Arenas	Ranges	Picnic Tables	Camp Sites	Rinks	Open Play Area
Bernalillo	19	183	1	2	190	4	2	58
Santa Fe	3	35	1	1	213	19	2	9
Torrance	0	11	2	1	35	10	1	3

In addition to facilities for active recreation, the City of Albuquerque and Bernalillo County own and maintain 22,000 acres of public open space in the foothills, along the Rio Grande, and surrounding the five volcanoes which form Albuquerque's western skyline. Public open space presents opportunities for nature study, hiking, and picnicking in a natural setting. In some areas, the open space system is linked to the urban parks system by Albuquerque's extensive bikeway network.

Private recreational facilities, located primarily in the Albuquerque and Santa Fe areas, augment public facilities. Private facilities include tennis courts, swimming pools, two ski resorts, shooting ranges, rodeo arenas, auto and horse racing tracks, ice skating rinks, miniature golf courses, archery ranges, and campgrounds, as shown on Figure 4.7-5.

Albuquerque is home to the Albuquerque Dukes AAA Baseball Team, the chief farm team for the Los Angeles Dodgers. As members of the Pacific Coast League, the Dukes have won three PCL titles and four southern division championships. Games are played in the 30,000-seat Duke Stadium from mid-April through September.

The University of New Mexico's Lobos have fanatical support among Albuquerqueans in both football and basketball. Lobo basketball, played in a below-grade arena called The Pit, regularly draws 15,000 fans. In 1984, UNM hosted the final four rounds of the NCAA Championship games here. The Pit is also the location of other sporting events, including the International Gymnastics Invitational held in Albuquerque every year.

Men's sports at UNM are played in the Western Athletic Conference. Lobo women compete in the High Country Athletic Conference. Lobo women's golf, tennis, ski, and volleyball teams have been nationally ranked in recent years.

Other spectator sporting events held in Albuquerque include golf tournaments, boxing, professional rodeos, and the National Arabian Horse Show, which is held bi-annually. Both Albuquerque and Santa Fe have excellent horse racing facilities. Albuquerque's season totals 86 days; Santa Fe's season is 61 days long. In addition, by 1990 Albuquerque expects to have a \$20,000,000 motor racing facility, built by the Indianapolis 500 Champion Unser family, who are long-time residents. The Unser Racing Complex will include a 2 mile super speedway and a 2 1/2 mile road course, each of which are slated to accommodate world class competitions.

Figure 4.7-5. Private recreation facilities within the SSC vicinity area open to the public.

County	Tennis Courts	Swimming Pools	Ski Resort	Shooting Range	Rodeo Arena	Racing, Horse & Auto	Ice Skating	Golf Mini	Dude Ranch	Youth Camps	Developed Camp-ground	Archery
Bernalillo	53	9	1	10	6	2	1	5	-	3	6	1
Santa Fe	20	2	1	3	2	1	-	-	2	2	5	3
Torrance	-	-	-	2	-	-	-	-	-	1	4	-

Because of New Mexico's strong orientation to the outdoors, there are opportunities for participation by both youth and adults in sports of all kinds. Municipal and private leagues for baseball, softball, football, soccer, basketball, track, volleyball, racquetball, and bowling are located in communities near the site. Participation in these sports is high. In soccer, for example, Albuquerque fields 7,990 youth and 900 adult players. In addition, there are instruction and competitive teams and events at all levels in swimming, gymnastics, boxing, horseback riding, skiing, tennis, and running. There are numerous dance academies, three affiliated with professional ballet companies.

Five private country clubs and six public golf courses provide extensive facilities for golf in Albuquerque and Santa Fe. Albuquerque's golf season is year round; Santa Fe's season lasts from March through November.

Numerous health clubs provide facilities for racquetball, aerobics, and weight-lifting.

Special summer programs are offered through county and municipal parks departments, the YMCA, the YWCA, Camp Fire, the Boy Scouts and Girl Scouts, and Hummingbird Music Camp.

To meet special needs, therapeutic recreation programs through public agencies as well as the Special Olympics are available.

Consistent with the diversity of lifestyles available in the vicinity of the site, a number of more rural activities are popular in the small communities. These include 4-H and horse-related activities, such as trail rides and rodeos.

Finally, a wide variety of special events and local festivals occur in the vicinity of the site during the year. In Albuquerque, these events include the Duke City Marathon, the New Mexico State Fair, the Great Rio Grande Raft Race, the New Mexico Arts and Crafts Fair, the Greek Festival, and the International Balloon Fiesta. In Santa Fe, in addition to the Opera, summer brings the Santa Fe Chamber Music Festival, Indian Market, and the Burning of Zozobra, which heralds Fiesta. Within 50 miles of these two cities are 17 pueblos where visitors may join the Native American inhabitants in Feast Day celebrations and special ceremonies that are many hundreds of years old.

4.8 EDUCATIONAL AND CULTURAL RESOURCES

4.8.1 ELEMENTARY AND SECONDARY EDUCATIONAL FACILITIES

Public Schools

Based on the likely residential location choices by the SSC staff and visitors, which we assume will be shaped by commuting distances and city sizes, "vicinity" is defined in this section as the following school districts: Albuquerque Municipal Schools, Santa Fe Public Schools, and Moriarty Municipal Schools. The boundaries of these districts, and some information on their facilities and enrollments, are indicated on Figure 4.8-1.

Funding for the schools in these districts is based on a formula that relies on state resources for 70.6% of their revenues, federal resources for 11.7% and local resources for 17.7%. A flow chart which details the components of public school funding in New Mexico is presented in Appendix 4-H-1. State appropriations to the public schools have increased, on the average, 19% each year, for the past 10 years. (See Appendix 4-H-2.) Per pupil expenditures in each district are influenced by the size of the district; overall, they very nearly approximate the national average. Albuquerque, which is the largest of the districts, is slightly under the national average; Santa Fe and Moriarty are above it.

Figure 4.8-2 summarizes the characteristics of the three school districts in the vicinity of the site and compares them to national averages, where possible. Public schools in Albuquerque and Santa Fe are nearly identical in teacher/student ratios to the national average (1:18.0); the Moriarty schools exceed that ratio slightly (1:19.1). Teachers in the Albuquerque and Moriarty public schools have somewhat less tenure in their profession than do the nation's teachers; the proportion of teachers with Master's Degrees in each district, however, is substantial.

Four of Albuquerque's public schools were recognized this year by the U.S. Department of Education as Centers of Educational Excellence. Eleven other schools in the district have been so recognized since 1983. Albuquerque Municipal Schools has had more schools designated as Centers of Educational Excellence than any other district in the nation.

More than half of the graduating seniors in the Albuquerque Municipal Schools go on to college. In Santa Fe and Moriarty, college-bound students represent 35% and 44% of the graduates, respectively. In each of these districts, performance on the ACT (composite score) is better than the national average.

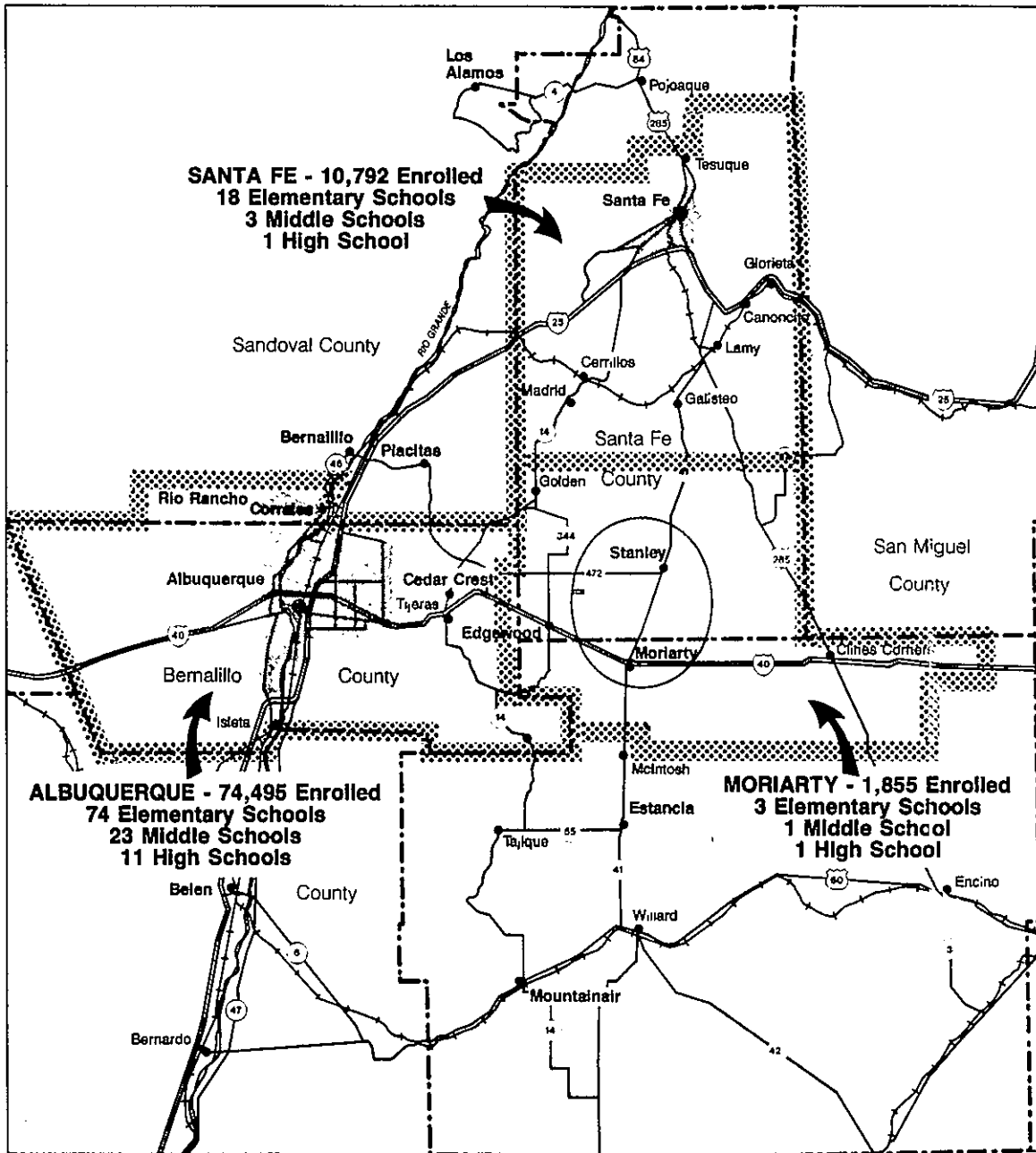

Data collected and map created by Southwest Land Research, Inc.

Figure 4.8-1. School districts and schools in the vicinity of the SSC site [4.8-1].

Figure 4.8-2. Characteristics of the school districts in the vicinity of the SSC site, 1985-1986 school year [4.8-2, 4.8-3, 4.8-4, 4.8-5].

	Albuquerque Municipal Schools	Santa Fe Public Schools	Moriarty Municipal Schools	National Average
Number of Pupils	74,495	10,792	1,855	--
Number of Teachers	4,255	597	97	--
Teacher/Pupil Ratio	1:17.5	1:18.0	1:19.1	1:18.0
Average Years Experience of Teachers	11.5	13.0	9.0	13.0
Percent of Teachers with Master's Degree or Higher	49.1%	51.0%	35.2%	Not available
District Revenues	\$260,258,995	\$40,811,030	\$7,361,534	--
Expenditure per Pupil	\$3,759	\$3,497	\$3,782	\$3,968
Net Operational Expenditure per Pupil	\$2,621	\$2,447	\$2,333	Not available
Number of Graduating Seniors	4,652	496	91	--
Number (%) of Graduates that attend a 4-Year College	2,414 (51.9%)	174 (35.1%)	40 (44.0%)	61
<u>ACT Scores</u>				
English	19.0	18.8	18.1	18.5
Math	17.9	17.7	17.0	17.3
Social Studies	18.0	17.7	19.0	17.6
Science	22.2	21.8	22.8	21.4
Composite	19.4	19.1	19.4	18.8
<u>SAT Scores</u>				
Verbal	494	471	425	431
Math	538	490	585	475

Private Schools

The Archdiocese of Santa Fe administers schools in Santa Fe and Albuquerque which serve over 5,000 students. The characteristics of these schools are summarized in Figure 4.8-3. In Albuquerque, in addition to the Catholic schools, there are 49 private, church-affiliated schools, with a total enrollment of 4,700 students [4.8-6].

Albuquerque and Santa Fe also host non-sectarian private schools whose emphasis is preparation of its graduates for college. These schools are typified by excellent student/teacher ratios and nearly complete matriculation by their graduates. The characteristics of these schools are briefly summarized in Figure 4.8-3.

Figure 4.8-3. Private schools in the vicinity of the SSC site [4.8-5, 4.8-7].

	Albuquerque Catholic	Santa Fe Catholic	Albuquerque Academy	Sandia Prep.	Santa Fe Prep.
Grades	K-12	K-12	6-12	6-12	7-12
Number of Pupils	4,092	1,398	805	285	206
Number of Teachers	222	81	102	30	20
Teacher/Pupil Ratio	1:18	1:17	1:8	1:9	1:10
Operational Budget	-- \$9,313,348 --		-----	Not Available	-----
Expenditure per Pupil	---- \$1,125 ----		-----	Not Available	-----
Graduating Seniors	199	182	106	22	41
Graduates Attending Four-Year College	82%	49%	99%	100%	95%
Annual Tuition	El: \$ 841 HS: \$1,862	El: \$1,016 HS: \$1,850	\$4,075	\$4,440	\$4,950

4.8.2 HIGHER EDUCATION AND RESEARCH INSTITUTIONS IN THE VICINITY OF THE PROPOSED SITE

New Mexico's SSC site is located near two cities which, in combination, host 11 degree-granting post-secondary institutions. Two of these are technical schools or community colleges, five are extension programs, three are liberal arts colleges, and one is the University of New Mexico (UNM).

New Mexico's SSC site is also positioned at the midpoint of the Rio Grande Research Corridor. This 300-mile corridor stretches from Los Alamos to Las Cruces. It includes, along with UNM, the major research institutions of New Mexico Tech and New Mexico State University. It encompasses, in addition, more than 30 federal- or state-funded research facilities where nearly 20,000 professionals are engaged in the study of the high technology aspects of medicine, energy, and environmental sciences. These institutions, and a growing number of private sector firms, are linked by a fiber optic communication system--New Mexico Technet, Inc.

Local Post-Secondary Institutions

The post-secondary institutions in the immediate vicinity of the site are summarized in Figure 4.8-4. In general, these institutions offer an abundance of opportunities for the training of local employment resources, for the education of the families of the SSC staff and its visitors, and for SSC staff to acquire additional skills and degrees.

Albuquerque's Technical-Vocational Institute (T-VI) and Santa Fe's Community College both emphasize training for employment. T-VI is specifically geared to be employment demand responsive in its program. For each of the past two years, \$1.5 million has been set aside to develop programs for new industry. Employers are invited to bring their training needs to T-VI, which can respond with pre-employment or on-the-job supplementary programs [4.8-10].

Several schools offer a limited number of degree programs locally on an extension basis. These programs are, for the most part, available at Kirtland Air Force Base and are utilized by adults seeking to upgrade their educational qualifications.

Of the three small liberal arts colleges in the cities near the site, perhaps the most prestigious is St. John's College in Santa Fe. The originator of the Great Books Program, St. John's was established in Annapolis, Maryland, in 1784 and developed its Santa Fe campus in 1964.

Figure 4.8-4. Characteristics of post-secondary institutions in immediate vicinity of SSC site [4.8-8, 4.8-9].

Institution	Location	Type	Emphases	Enrollment	Number of Areas in which Degrees are Offered			
					Graduate	Bachelor	Associate	Certificate
Albuquerque Technical-Vocational Institute	Albuquerque	Voc-Tech	Technical Trade Medical Business	13,000	--	--	4	33
Santa Fe Community College	Santa Fe	Community College	Business	2,000	--	--	19	13
Chapman College	Albuquerque	Extension	Technical Business	250	1	7	1	--
Embry-Riddle	Albuquerque	Extension	Aviation	100	1	2	2	--
University of Idaho	Albuquerque	Extension	Computer Science Engineering	2	3	--	--	--
University of Phoenix	Albuquerque	Extension	Business Medical	300	2	2	--	--
Webster University	Albuquerque	Extension	Business	300	7	--	--	--
College of Santa Fe	Santa Fe	Liberal Arts	Business Education Medical Visual & Performing Arts	739	1	33	7	--
College of Santa Fe at Albuquerque	Albuquerque	Liberal Arts	Business Education Humanities Social Science	500	1	8	2	--
St. John's College	Santa Fe	Liberal Arts	Liberal Arts	366	1	1	--	--
University of New Mexico	Albuquerque	University	Management Architecture & Planning Arts & Sciences Education Engineering Fine Arts Law Medicine Nursing Pharmacy University College	27,853	58 Masters 26 Doctoral	101	18	5

The University of New Mexico is by far the largest and richest of the educational resources in the immediate vicinity of the site. UNM hosts 11 schools and grants baccalaureate degrees in 101 disciplines, master's degrees in 58, and doctoral degrees in 26.

Research Universities

The work force of the Superconducting Super Collider will function most productively if there are opportunities for individuals who staff the facility to acquire academic training that will allow them to advance in responsibility. It will be further advantageous to the SSC project to have access to a pool of graduate students who can assist in the operation of the facility and its experiments. New Mexico is home to three research universities which can provide these advantages to the Superconducting Super Collider. Taken together these institutions, the University of New Mexico, New Mexico Institute of Mining and Technology, and New Mexico State University, offer degrees in 22 areas pertinent to the operations of the SSC. Their science and engineering specialties are staffed by a combined full-time faculty of 405. The specific offerings of these institutions, along with their respective productions of graduates, are presented in Figure 4.8-5.

UNM as a Resource to the SSC

The University of New Mexico, closest to the SSC site, is committed to excellence in a broad range of research programs in both new and existing technologies, as well as in the arts and humanities. Its enrollment is steady, and students are taking larger credit hour loads. Retention rates are the highest in 13 years, despite stiffer entrance requirements. UNM's faculty continues to receive national and international awards, including the MacArthur, Fulbright, Searle and Sloan Fellowships, the Royal Society of Chemistry Honorary Fellowship, the American College of Radiology Gold Medal, and the Huxley Medal of the Royal Anthropological Society of Great Britain and Ireland. Sponsored research reached \$51.3 million in FY 1986, up 14% in one year. Following the legislative creation in 1984 of endowments for excellent faculty, UNM has matched with private funds 93% of the state's contribution, creating 3 endowed chairs, 9 professorships, 12 lectureships, and 23 fellowships. Undergraduate and graduate students at UNM are selected for highly competitive awards and scholarships, including National Science Foundation Fellowships, Fulbright Awards, and Mellon Fellowships in the Humanities. Several of the University's programs have been recognized for superior achievement:

- o KNME-TV is the most-watched public television station nationwide in prime time.

Figure 4.8-5. Science and engineering capabilities of New Mexico's three research universities. 1, 1984-85 graduating information. 2, Computer and electrical engineering share faculty. 3, Geological and materials engineering share faculty. 4, There are 12 geology science professors. [4.8-11].

School	Department	Number of Full-time Faculty	1985-86 Degrees Awarded			
			AA/AS	BS	MS	PhD
University of New Mexico ¹	Chemistry	21	--	15	10	7
	Mathematics	43	--	16	9	--
	Physics	26	--	8	4	--
	Chemical Engineering	9	--	25	8	--
	Civil Engineering	18	--	37	11	2
	Computer Engineering ²	27	--	19	--	--
	Electrical Engineering	--	--	122	34	9
	General Engineering	0	--	12	--	--
	Mechanical Engineering	18	--	87	11	1
	Nuclear Engineering	3	--	5	4	6
Computer Science	19	--	52	21	--	
New Mexico State University	Chemistry	24	--	24	3	5
	Mathematics	45	--	11	6	2
	Physics	20	--	7	3	2
	Civil Engineering	13	7	46	11	1
	Electrical & Computer Engineering	26	25	122	9	3
	Mechanical Engineering	17	12	61	4	1
	Chemical Engineering	7	--	29	6	--
	Geological Engineering	--	--	7	--	--
	Industrial Engineering	5	--	18	13	--
	Engineering Technology	14	--	83	--	--
New Mexico Institute of Mining and Technology	Petroleum Engineering	5	--	38	3	--
	Mining Engineering	--	--	5	1	--
	Geological Engineering ³	5	--	1	--	--
	Materials Engineering	--	--	4	--	--
	Engineering Science/Chemistry	--	--	1	--	--
	Structural Mechanics	--	--	1	--	--
	Metallurgy Engineering	8	--	10	--	--
	Geology with Mining Emphasis ⁴	12	--	5	--	--
	Geology with Petroleum Emphasis	--	--	4	--	--
	Physics	8	--	1	2	2
	Chemistry	7	--	5	2	--
	Computer Science	5	--	5	2	--

- o UNM Medical School's innovative Primary Care Medical Curriculum was recognized as exemplary by the World Health Organization.
- o UNM's Technology Innovation Program has helped form 49 new companies and attracted millions of dollars in venture capital.
- o U.S. Department of Energy has recognized UNM's energy conservation program's innovative electrical cogenerator.
- o UNM's 1986 production of Mozart's "The Marriage of Figaro" won the National Opera Association's first place award for opera production.
- o The University's Tamarind Institute is the nation's premier center for lithography, credited with reviving the art.
- o The University of New Mexico Press, not only a successful enterprise, won 10 awards in national book competitions in FY 86-87.
- o The Institute of Meteoritics of the UNM Department of Geology has brought nearly \$8 million in federal grants since its 1968 inception. Its director, Klaus Reil, was one of 75 scientists involved with the Viking Mission to Mars.
- o UNM's Latin American Programs in Education has the only master's program in Educational Administration conducted entirely in Spanish.
- o UNM's Anthropology Department is ranked 10th nationally out of 70 doctoral programs by "Current Anthropology" review.
- o The University Medical Center is the only level-one trauma center in the state and has the state's only burn and trauma unit and first kidney-transplant program.

The University of New Mexico's commitment to excellent science and engineering research is strong and growing. Its College of Engineering includes computer science and computer engineering, graduate studies in signal processing and communications, and nuclear engineering. The Mechanical Engineering Department includes a new instructional robotics laboratory which is the first of its kind in the country, offering a wide assortment of robots for instruction and research. Research in lasers, modern optics, and microelectronics at UNM's Center for High Technology Materials has resulted in more than \$3 million in three years in outside funding. Collaborations with Los Alamos National Laboratory,

the Air Force Weapons Laboratory, and Sandia National Laboratories provide a constant infusion of scientific creativity into UNM's research programs, bringing some of the best scientific talent in the country into contact with UNM's faculty and students [4.8-12]. Similar interaction with the Superconducting Super Collider staff would be encouraged by the University.

The University of New Mexico offers a critical component of the intellectual environment necessary for the SSC and its staff. The wide array of learning opportunities range from technical doctoral degrees for members of the scientific staff to general interest courses for members of the SSC community. An immensely varied academic and cultural program, including hundreds of short-courses, concerts, recitals, theatre productions, lectures, and symposia are offered through the University. When the SSC is located in New Mexico, its staff will also find the following specific responses [4.8-13].

Science and Technology Programs and Courses. Senior scientists associated with the SSC will have completed the terminal degree in their disciplines, but may wish high level courses in specific areas, degree programs in other technical disciplines, and professional course or degree requirements in business or management. The greatest demand may be for educational opportunities for the support staff and dependents of those associated with the SSC. The University is prepared to meet these demands.

The scientific programs of the University are crucial to allow SSC scientists access to scientists in an academic institution. The University will offer joint appointments to SSC senior scientists wherever mutually beneficial. In the Department of Electrical and Computing Engineering, there are strong programs in computer engineering of software and hardware development, pulsed power, electro-optics, signal processing and systems and networks. In the Department of Physics, a recognized program in experimental theoretical physics offers an appropriate access to academic collaborators. In addition, the University can provide bachelor through doctoral degrees for support staff who wish to increase their academic credentials.

The University has anticipated some of the needs of the SSC staff, and would offer the following enhancements of its science and technology programs:

- o Electrical and computing engineering: two new faculty members.
- o Particle physics: three new faculty members.

- o Creation of a distinguished professorship in one of these areas, according to the needs of the SSC staff and mission.
- o Creation of joint appointments with Los Alamos and Sandia National Laboratories to enhance the academic talent offered to the SSC.
- o Graduate student stipends for students (10 initially) who will be guided by faculty from the SSC with joint appointments at the university.

Business and Management Programs. The management schools at the University have been active collaborators with a number of scientific research institutions, including Los Alamos National Laboratory and Sandia National Laboratories. The University offers a part-time MBA and a Masters of Management degree which have both served personnel from the federal laboratories in New Mexico. At the undergraduate degree level, the University offers service courses in many basic fields of management on a non-degree basis with few or no prerequisites. Because many research organizations prefer advanced degrees, the University is planning to reinstitute the Ph.D. degree in management.

The Anderson School of Management and the College of Engineering have planned a Masters of Science and Technology Management. All the necessary planning and approvals have been achieved and the University would activate and vigorously support this degree program in order to better serve the SSC community.

Through its Technological Innovation Program, the University is able to provide technical assistance on patents and licensing, financing, marketing, and management to any scientist wishing to patent and develop technology.

General Education. The University has a broad curriculum, including programs in the following colleges: Law, Medicine, Architecture, Pharmacy, Nursing, Fine Arts, Education, Engineering, Management, and Arts and Sciences. SSC personnel and dependents will have access to these programs, along with a large College of Continuing Education with about 30,000 students enrolled in both degree and non-degree programs. The University is just beginning a vigorous Evening and Weekend Degree Program, which can be expanded or revised to accommodate the needs of SSC staff.

Televised Instruction. Since 1985, the University of New Mexico has been aggressively developing its multichannel ITFS Educational Delivery System. This student-classroom interactive program has grown from one course to the 50 courses which will be offered in the Fall of 1987. These include engineering, education, public administration, business, math, psychology, biology, and health education. The

entire program can be made readily available to the SSC site, and because of the short distance between the site and UNM, TV professors can make frequent visits. Several channels could be made available to serve the region, allowing a rich balance of televised offerings.

State Commitment to Education

In a specially convened session of the legislature to consider New Mexico's support for the SSC, a Joint Resolution was passed by both houses expressing the state's continuing commitment to the enhancement of educational quality. Specifically, this Senate Joint Resolution directs all state educational institutions to respond to the SSC's educational needs, all education planning bodies to incorporate the SSC's requirements into their programming efforts, and the legislature to attend to the funding of these programs. Apperdx 4-H-10 contains the full text of the Resolution.

Research Institutions

New Mexico's site for the Superconducting Super Collider is bracketed for 150 miles to the north and south by the Rio Grande Research Corridor. In this corridor, expenditures for research activity exceed \$4.3 billion annually [4.8-14]. Such a matrix of activity engenders resources for the SSC that range from human to theoretical to mechanical. They include scientific colleagues, communication networks for interacting with them, libraries, data bases, experimental facilities, experiment observation opportunities, ideas, one-of-a-kind specialized equipment, technical materials, electronic hardware, computer software, and the myriad suppliers of expertise, services, tools, and technologies that have sprung up in the Rio Grande Research Corridor to support this giant industry. The component elements in New Mexico's Rio Grande Research Corridor are shown on the map in Figure 4.8-6.

New Mexico's Rio Grande Research Corridor encompasses an extraordinary array of technological research and development facilities. Following the establishment of its two national laboratories and the White Sands Missile Range in the 1940s, New Mexico has gradually acquired research institutions whose specialties range from astronomy to explosives effects to primate studies. Two of its largest institutions are the Los Alamos and Sandia National Laboratories which conduct research across a wide spectrum, ranging from basic research on the nature of matter to biological and energy systems engineering and computer research. The Air Force Weapons Laboratory conducts not only nuclear weapons but laser development and applications research, and the White Sands Missile Range and Test Facility have been in the forefront of world research in missile development and testing and space-related studies [4.8-15].

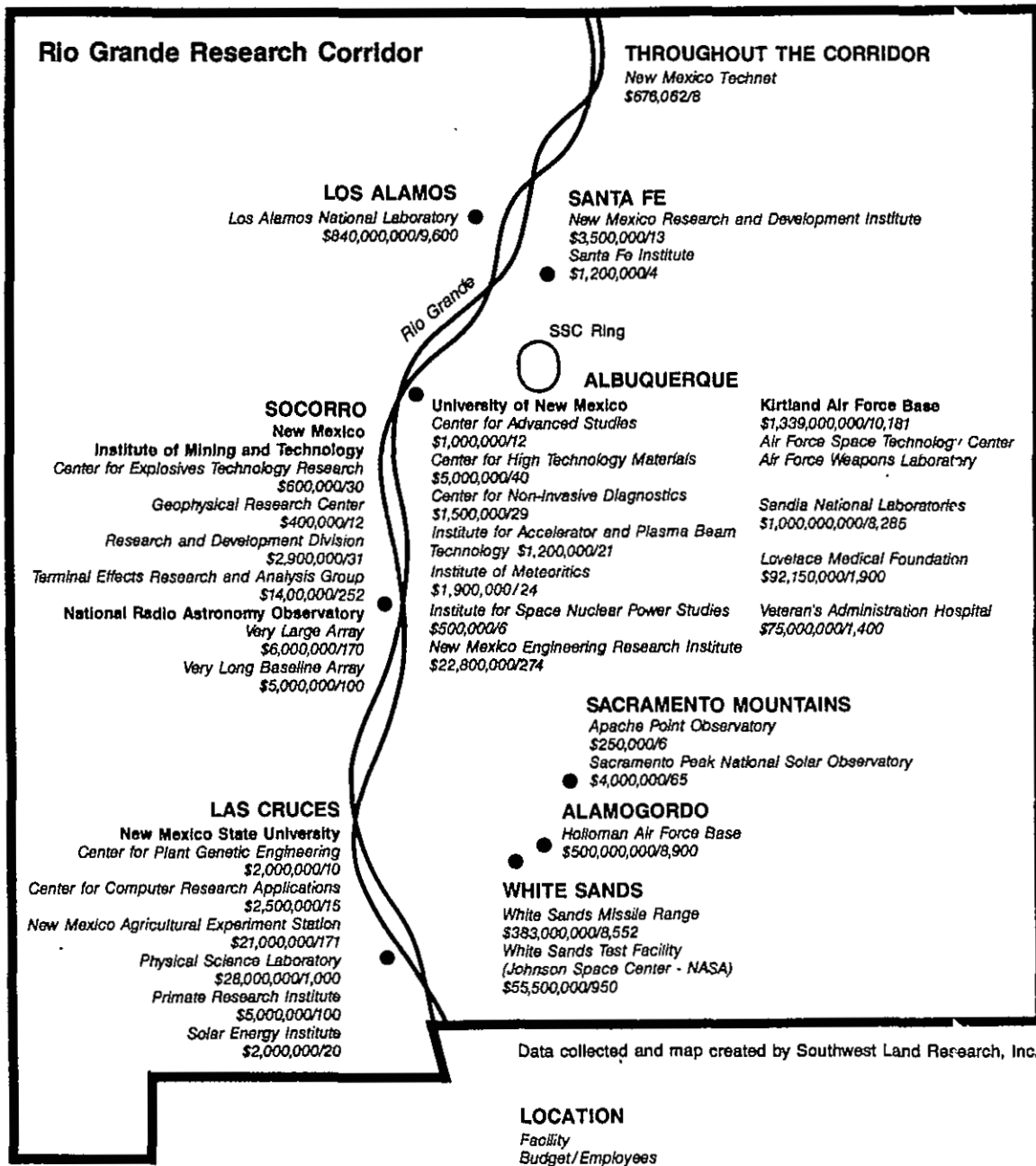

Figure 4.8-6. Institutions in the Rio Grande Research Corridor, their budgets and employment [4.5-14, 4.8-15, 4.8-16].

In 1981 the state recognized and expanded the importance of its scientific base by creating Centers of Technical Excellence in the universities which would directly relate to its national research institutions. A Science and Technology Commission was formed to coordinate research activities throughout the Rio Grande Research Corridor and translate these efforts into commercially viable products and processes. The Commission is served by the New Mexico Research and Development Institute (NMRDI), a state agency which administers the Centers of Excellence, carries out mandated economic development research related to the Rio Grande Research Corridor, and provides seed money for commercialization. Technological Innovation Centers (TICs) were created at the universities to provide technical, financial, and management expertise to companies forming around technology created through this interaction between labs and universities. The state of New Mexico has invested \$29.7 million over a five-year period in these technology efforts [4.8-16].

In 1983, New Mexico Technet, a nonprofit corporation, was formed to establish a communications network linking the federal research installations, the universities, state government, and private industry to encourage interactive research, video classes, and data exchange. That network is now complete, providing broad band fiber optics service from Los Alamos to Las Cruces and microwave service throughout the state. Its \$3 million start-up cost has been financed jointly by the State of New Mexico and the U.S. Department of Energy [4.8-17].

In 1984, the Santa Fe Institute was formed by a distinguished group of scientists, scholars, corporate, and financial leaders to focus the tools of traditional disciplines and emerging new scientific techniques on the problems and opportunities involved in the study of complex systems--those fundamental processes that shape human life. It offers research and graduate education, workshops, and research networks to apply interdisciplinary research to complex systems which have traditionally been studied separately. Its private funding may soon be augmented by a multi-year National Science Foundation grant [4.8-18].

In 1985, another private organization, the Rio Grande Technology Foundation (Riotech) was formed to foster joint research projects, using laboratory and university scientists to address industry problems. Privately financed, Riotech has created a Manufacturing Engineering Research program involving three universities, two national laboratories, and numerous industry sponsors, which will offer a master's degree in Manufacturing Engineering and study critical manufacturing technology and systems [4.8-19].

In cooperative efforts between public and private agencies, New Mexico has developed incubation centers to encourage formation of small industries. These centers, at Los

Alamos, Albuquerque, Las Cruces, Socorro, and Hobbs, offer office space, management and technical assistance and support services to new businesses. The state, through its universities, has developed research parks to offer locations adjacent to the universities where research-based industry can develop and grow [4.8-20].

All of these efforts have built on the state's enormous research base, using talent in its federal installations to strengthen the capabilities of its university system. The following paragraphs inventory these scientific resources by traveling across the state from north to south and describing each entity briefly. A more detailed accounting of the accomplishments and character of some of these facilities is presented in the Appendix 4-H-3.

<u>Facility</u>	<u>Focus</u>
Los Alamos National Laboratory	Multi-disciplinary, multi-program: nuclear weapon development, energy supply and conservation, basic and applied scientific and engineering research.
The Santa Fe Institute	Interdisciplinary research on a variety of non-adaptive and adaptive complex systems. Workshops, extended research programs, and ongoing research networks in physical and biological sciences, mathematics, social sciences, behavioral sciences, the humanities, industry, and public affairs.
New Mexico Research and Development Institute	Initiates state-funded research, development and demonstration projects to encourage the location of new industries in the state, encourage expansion of existing industries, and stimulate economic growth.
At the University of New Mexico:	
Center for Non-Invasive Diagnosis	Advanced applications of nuclear magnetic resonance, a non-invasive technique for creating detailed anatomical images of soft tissue by analysis of the magnetic properties of atomic nuclei, and NMR spectroscopy

	properties of tissue. Working with Los Alamos National Laboratory, the Center seeks to develop the next generation of NMR diagnostic tools and processes.
Center for High Technology Materials	Laser systems, modern optics, microelectronics, and thin film applications. Strong liaisons have been formed with the Air Force Weapons Laboratory, Los Alamos National Laboratory, and Sandia National Laboratories. The Center has been instrumental in providing clean room facilities to Krysalis, a company formed to develop advanced computer chip technology.
School of Medicine	One of 78 General Clinic Research Centers funded by the National Institute of Health. Cooperative research with Los Alamos and Sandia National Laboratories in a wide area of bio-medical and biotechnical developments.
New Mexico Engineering Research Institute	Research for Air Force Weapons Lab on environmental engineering, structural systems and contents, advanced simulation techniques, field instrumentation, theoretical and mathematical computer technology.
Center for Advanced Studies	Physics and Astronomy: laser physics, optics, theoretical quantum optics, solid-state physics, and optical measurement techniques.
Institute for Accelerator and Plasma Beam Technology	Plasma beam, accelerator technology, and materials modification.
Institute for Space Nuclear Power Studies	MS and Ph.D. degrees in nuclear engineering with space power option; short courses on relevant topics.
Institute of Meteoritics	Planetary geosciences.

Sandia National
Laboratories

Development of nuclear weapons based on nuclear explosives. Technology to improve safety, control, deliverability, survivability, and security. Support technologies in materials, instrumentation, systems analysis, quality assurance, and testing. Major energy programs in basic energy science, solar energy, and fossil fuels.

At Kirtland Air Force Base:

Air Force Weapons
Laboratory

Research and development in high energy laser technology, advanced weapons concepts, and non-conventional weapons technology, including nuclear survivability.

Air Force Space
Technology Center

Plans and executes Air Force research and development of space systems technology. Coordinates technology development and forecasts technology needs.

Rio Grande Technology
Foundation (Rio Tech)

Privately financed. Manufacturing Engineering Research program involving three universities, two national laboratories, and numerous industry sponsors, which will offer a Master's Degree in Manufacturing Engineering and study critical manufacturing technology and systems.

At New Mexico Institute of Mining and Technology:

Center for Explosives
Technology Research

Research and development of energetic materials and high-strain-rate technology for materials and explosives processes with important industrial applications. Assists industry to develop new explosives technology and transfers that technology from national laboratories to industry.

Terminal Effects
Research and Analysis

Design, development, testing, and research analysis evaluation of weapons-system components and

	<p>items related to transportation and storage of hazardous materials. Performs research and testing for the Department of Defense and industrial users, including Honeywell, Aerojet Ordnance, and General Defense Corp.</p>
<p>Research and Development Division</p>	<p>Engineering techniques, processes, devices and testing procedures. Studies natural resources.</p>
<p>New Mexico Bureau of Mines and Mineral Resources</p>	<p>Investigates, evaluates, and disseminates information on geology and mineral resources, energy resources, and metallurgy. Takes lead in applied research to insure industry growth.</p>
<p>Petroleum Recovery Research Center</p>	<p>Basic and applied research to improve the recovery of petroleum and gas. Studies displacement techniques, gas and liquid chromatography, and computer simulation of displacements. Disseminates information to its industry sponsors.</p>
<p>Geophysical Research Center</p>	<p>Atmosphere and water resources, including air quality and industrial emissions control. The Center operates Langmuir Laboratory for Atmospheric Research, one of the leading centers for thunderstorm research in the world.</p>
<p>Very Large Array</p>	<p>Radio telescope located on the Plains of San Agustin west of Socorro. Its 27 parabolic antennas, each 25 meters in diameter, constitute the world's most powerful imaging radio telescope. Combining the signals of the antennae and using sophisticated image processing, astronomers use the VLA to make "radio pictures" of astronomical objects.</p>
<p>Very Long Baseline Array</p>	<p>Ten radio telescopes located across the nation from Hawaii to the Caribbean. VBLA will have</p>

	headquarters in Socorro when it begins full operation in 1991.
Sacramento Peak Solar Observatory	High resolution studies of the solar surface and a broad range of solar physics studies.
Apache Point	USAF Electro-Optical observation site.
Holloman Air Force Base	Research on radar backscatter, high speed rocket sled technology and inertial guidance and navigation technologies.
White Sands Missile Range	Development and testing of defensive missiles. Will house Ground Based Free Electron Laser, research designed to demonstrate efficient propagation of high level laser energy through the atmosphere, and validation of a scalable technology base.
White Sands Test Facility	Spacecraft propulsion systems research and testing.

At New Mexico State University:

Physical Science Laboratory	Antennae design, telemetry, satellite tracking, antennae pattern measurements, large-scale electronic and computer systems, and data reduction.
Center for Plant Genetic Engineering Laboratory	Molecular biology cellular genetics, stress physiology, plant biochemistry, and desert plant resource acquisition and evaluation. Programs stress new, high technology approaches to research made possible by recombinant DNA techniques. Works with Los Alamos National Laboratory scientists and sophisticated equipment.
Center for Computer Research Applications	Artificial intelligence, computer language, investigations on mechanical senses--vision, hearing, and touch--for computer applications. The center has broad industrial support.

Primate Research Institute	World's largest chimpanzee re- search colony; basic and applied research in toxicology and bio- medicine; assists government and industry in developing beneficial pharmaceutical and other chemical products.
Solar Energy Institute	Testing and evaluation of solar energy systems; collects, devel- ops, and disseminates information on solar energy applications and technologies to industry, state agencies, and citizens.
Water Resources Research Institute	Preservation, development, and management of water resources. Stimulate and promote excellence in water-related research and education and foster the applica- tion of technology to water prob- lems.
Educational Research Center	Encourages research and training within NMSU's College of Educa- tion, provides research and eval- uation services for schools and educational agencies; coordinates off-campus courses.
New Mexico Agricul- tural Experiment Station	Agricultural research designed to maintain a constant food and fiber supply, modify production practices as equipment, plant material, water, and land dic- tates; provide innovative crop alternatives.
Cultural Resources Management Division	Cultural resources management services; archaeological surveys and mitigation programs for com- panies and government agencies.
Arts and Sciences Research Center	Hard and theoretical scientific inquiry in the biological and physical sciences and mathematics through applied studies; scholar- ly activity in the humanities, social sciences, and fine arts.

An exciting diversity of interaction is occurring among the myriad of New Mexico institutions focused on research, spurred by the state's desire to stimulate technology devel- opment and create new economic growth. Basic research and education projects are conducted interactively among the

universities, Los Alamos and Sandia National Laboratories, and the Air Force Weapons Laboratory. Applied research is supported within the university Centers of Excellence, by the Technological Innovation Centers (TICs), by the New Mexico Research and Development Institute, and by the Rio Grande Technology Foundation (Riotech). Business development takes place through the TICs and the incubator centers at Los Alamos and Albuquerque. All of these activities are enhanced by the communications capabilities of New Mexico Technet.

Both national laboratories support joint faculty appointments at the universities and are involved in colloquia and seminars, assistance in curriculum design, and development and cooperative work-study programs for science and engineering students. The Air Force Weapons Laboratory has been actively involved in developing the Center for High Technology Materials at UNM. All of the major institutions are either offering or scheduling video classing between laboratory, university, and private industry.

The outcomes of these interactions include the spinoff of several new companies from joint laboratory-university technology and the development of new technologies for existing companies. Companies can receive assistance in financing, marketing, and management from the nearby TIC and can locate in an incubator center, where they occupy inexpensive space, receive technical assistance, and share services. The New Mexico Business Development Corporation will provide financing to companies in development, expansion or growth stages, filling the gap between venture capital companies, and financial institution lending. Several private venture capital companies have been established within the state, and the legislature has recently authorized the investment of up to \$24 million of state funds in various venture capital funds to encourage their participation in New Mexico projects.

The burgeoning activity throughout the scientific and technological community makes New Mexico an attractive state for the scientists of the SSC. Not only will the laboratories and universities provide the opportunities for staff exchange, joint appointments, and multidisciplined professionals for consulting, but the laboratories offer an established infrastructure of DOE legal, procurement and other activities, health and environmental testing and consulting, computing power, systems, and network experience. The synergistic potential for the national laboratories and the SSC was seen by New Mexico's Siting Committee and communicated to the labs by the SSC proposal coordinator. An exchange of letters concerning these areas of mutual and direct benefit is presented in Appendix 4-H-4.

Los Alamos can offer use of its Meson Physics Facility and Van de Graff accelerator for detector calibration, use of its structures lab for cavity tuning and accelerators for calibration, access to its materials fabrication specialists

and equipment, hydrogen brazing furnaces, and remote handling expertise and equipment.

Sandia is experienced in the development and operation of large-scale particle beam fusion accelerators, has extensive capabilities in solid state and device physics, including the fabrication of radiation-hardened micro circuits, and has an extensive background in large-scale systems engineering. The Air Force Weapons Lab can offer assistance in geology, accelerator technology instrumentation and diagnostics, and on materials and controls.

The Santa Fe Institute, using its network of Nobel Laureates and internationally recognized scientists and scholars, will offer the SSC intellectual interaction in multidisciplinary workshops, courses, and lectures. Its Visiting Fellows Program will offer SSC scientists the opportunity to pursue research in complex systems. Through video classing, many of these programs can be brought to the SSC site.

4.8.3 DESCRIPTION OF NEARBY CULTURAL RESOURCES

New Mexico's intellectual life is not only technical. The state's alliance with the arts is a long and pervasive one. It encompasses the artifacts and traditions of our cultural heritage; an architecture that is a unique amalgamation of the state's three main cultures--Indian, Hispanic, and Anglo; the arts community which began gravitating to northern New Mexico in the Twenties, beginning with D. H. Lawrence, Edward Weston, and Georgia O'Keefe; a local literature whose acclaim is national; a world class opera and chamber music festival; and Southwestern art galleries that draw tourists from around the globe.

New Mexico's Architecture and History

New Mexico's history differs greatly from that of the rest of the nation. Technology, on one hand, has given birth to the post-1940 New Mexico. On the other hand, many of New Mexico's finest gifts to the world are created out of traditions established hundreds of years ago--silver, hand-tooled by Navajo craftsmen; woven rugs auctioned around the world as art; pottery constructed and decorated as it was hundreds of years ago by Puebloan forebears. Yet nowhere is New Mexico's history more apparent than in its architecture.

New Mexico's architecture is unique in the United States in that its style derives from aboriginal urban roots. From these roots, New Mexico's indigenous architecture has evolved to reflect elements from the state's three dominant cultures--Indian, Spanish, and Anglo.

The beginnings of New Mexico's regional architecture can be traced to the period from 950 to 1100 A.D., when more than 10,000 multistoried masonry complexes, or pueblos, were constructed, some with over 300 ground-floor rooms and large separate plazas [4.8-21]. These structures were built entirely without mortar, and were roofed as many New Mexico homes still are--using exposed wooden beams or vigas as structural support, covered with a "ceiling" of saplings, or latillas, before applying the roofing material. The most renowned of these pueblos in New Mexico is Pueblo Bonito in San Juan County, at the Chaco Canyon National Historic Park.

Archaeologists believe that extended droughts forced the Chacoan inhabitants out of their settlements in the western basins of New Mexico to higher elevations where rain was more plentiful, producing such impressive settlements as the Gila Cliff dwellings, Tyuoni at Bandelier, and the Cliff House at Mesa Verde [4.8-21]. By the late thirteenth century, droughts again forced the population to move, this time to areas of permanent water supply along the Rio Grande, Rio San Jose, Rio Chama, Zuni, and Gila Rivers. Some of these

villages were ancestors of the Pueblo communities surviving today, often within a few miles of the original fourteenth century settlements [4.8-21].

The Spanish began their explorations of New Mexico in the 1530s, and established Santa Fe as the capital of their new territory in 1610. The Spanish adopted the Pueblo style of building, using adobe bricks rather than masonry and constructing their residences around a central courtyard, their towns around a central plaza, developing what is referred to as the Spanish Pueblo style, with its thick adobe walls, low flat roofs with parapets, small window and door openings, and a rectangular form softened by virtue of irregular hand-hewn materials [4.8-22].

The opening of the Santa Fe Trail in the 1790s eventually brought Anglo-American traders to the area, and, in 1848, New Mexico was made a U.S. territory, opening the way for Anglo settlers and a new architectural influence. Anglo settlers further modified the Spanish Pueblo style, developing what is known as the Territorial style in which Greek revival trim around windows and entryways, pedimented lintels, brick coping, and long covered porches or portales were combined with traditional Spanish Pueblo forms.

Much of the residential and commercial building in New Mexico today continues to draw inspiration from the indigenous architecture developed by the state's inhabitants over 900 years ago. The University of New Mexico campus, the new City-County Government office building, UNM's Center for Non-Invasive Diagnostics, and many of the state's residences, reflect the region's sense of place.

A selected listing of New Mexico's historic places is shown in graphic and summary form in Appendix 4-H-5.

Museums/Art Community

A thriving arts community has long been a fixture in New Mexico. Indigenous art forms which have gained national and international acclaim include silver work, produced primarily by the Navajos in northwestern New Mexico and Arizona; weaving--again a skill especially well developed by the Navajos; the carving of Santos, kachinas, and fetishes--stones carved in the shape of animals; fine baskets fashioned from yucca and other native plants; and pottery--the polished red and black of Santa Clara Pueblo, the black on black ware of the San Ildefonso Pueblo, and the intricately decorated works of the Zia.

New Mexico has been a mecca for artists and writers since the early 1900s, when writers like D. H. Lawrence and Willa Cather, painters like Georgia O'Keefe and John Marin, and photographers like Ansel Adams and Elliot Porter first came to the state to practice their craft. Since that time,

the state, Santa Fe and Taos in particular, has provided a strong base from which the arts communities can reach a national audience. Major museums in the SSC vicinity area are shown in Figure 4.8-7.

More than one million visitors a year view the prestigious collections of Santa Fe's five major museums which include collections of regional art from early 20th century Santa Fe and Taos artists at the Museum of Fine Arts, and the world's largest collection of miniature ethnic crafts at the Museum of International Folk Art [4.8-23]. The Wheelwright Museum of the American Indian includes silverwork, tapestries, pottery, and baskets from tribes throughout the U.S. The Museum of Indian Arts and Culture, opened in 1987, houses the collections of the Laboratory of Anthropology, including interpretive exhibitions on the prehistory and ethnology of Southwestern Indians. Exhibits illustrating New Mexico's history are housed at the Palace of the Governors. Santa Fe houses 150 commercial galleries, making it one of the larger art markets in the country [4.8-24].

Albuquerque museums include the Geology and Meteoric Museum at the University of New Mexico campus and the Albuquerque Museum of Art, History and Science, featuring the largest collection of Spanish colonial artifacts in the United States. The Albuquerque Museum recently hosted the Armand Hammer collection and was responsible for mounting the acclaimed Maya exhibit which toured New York, Los Angeles, Dallas, Toronto, Kansas City, and Albuquerque [4.8-25].

The Maxwell Museum of Anthropology hosts outstanding examples of Southwestern anthropologic finds and Southwestern crafts. The National Atomic Museum at Kirtland Air Force Base traces the history of the Manhattan Project. The New Mexico Museum of Natural History, opened in 1986, contains permanent and changing exhibits on zoology, botany, geology, and paleontology. This is the first natural history museum to be built in the U.S. in 50 years [4.8-26]. The University of New Mexico's Johnson Gallery features permanent and traveling displays of contemporary American and regional art.

Albuquerque's Indian Pueblo Cultural Center presents exhibits depicting the development of Pueblo culture from prehistoric times to the present. It also displays works of contemporary Pueblo artists.

Appendix 4-H-6 provides additional information on New Mexico museums. A summary of arts and ethnic events statewide is presented in Appendix 4-H-7.

Figure 4.8-7. Museums within the SSC vicinity area [4.8-21].

County	City	Museum	Controlling Agency	Type Collection
Bernalillo				
	Albuquerque	Albuquerque Museum	Local Government	History/General
	Albuquerque	Ernie Pyle Memorial Library	Local Government	Personal collection
	Albuquerque	National Atomic Museum	Federal Government	Science/History
	Albuquerque	New Mexico Museum of Natural History	State Government	Natural/History
	Albuquerque	Pueblo Indian Cultural Center	Indian Government	Art/History
	Albuquerque	Rio Grande Zoological Park	Local Government	Wildlife
	Albuquerque	Sandia Labs Exhibit Center	Nonprofit	Science/Technology
	Albuquerque	State Fair Fine Arts Gallery	State Government	Art
	Albuquerque	Telephone Pioneer Museum	Private/Nonprofit	Science/Technology
	Albuquerque	University of New Mexico		
		Geology Museum	University	Geology/Natural History
		Jonson Gallery	University	Art
		Maxwell Museum of Anthropology	University	Anthropology/Art
		Meteoritics Museum	University	Geology
		Museum of Southwestern Biology	University	Plants/Animals
		Fine Arts Museum	University	Art
Santa Fe				
	Santa Fe	Chapel of San Miguel	Private/Nonprofit	History/Building
	Santa Fe	Institute of American Indian Arts Museum	Federal Government	Arts/Crafts
	Santa Fe	Museum of New Mexico		
		International Folk Art Museum	State Government	Arts/Crafts
		Fine Arts Museum	State Government	Art
		Palace of the Governors	State Government	History
		Laboratory of Anthropology	State Government	Archaeology/Anthropology
	Santa Fe	Governor's Gallery	State Government	Art
	Santa Fe	Santuario de Guadalupe	Nonprofit	Art/History
	Santa Fe	School of American Research	Nonprofit	Arts/Crafts/Archaeology
	Santa Fe	Wheelwright Museum of the American Indian	Private/Nonprofit	Anthropology/Crafts
	La Cienega	Old Cienega Village Museum	Nonprofit	History/Crafts
	San Ildefonso	Pueblo Museum	Indian Government	Arts/Crafts
	Galisteo	Galisteo Museum	Private	Archaeology/History
	Madrid	Old Coal Mine Museum	Private	Technology/History
Torrance				
	Moriarty	Historical Society Museum	Nonprofit	History
	Mountainair	Salinas National Monument Center	Federal Government	Archaeology/History

Music and the Performing Arts

The multicultural lifestyle which has attracted visual artists to the region has also drawn musicians, singers, actors, and dancers. As a result, spectacular stage events are offered throughout the year. Local performing arts groups and major theatres sponsoring performances are shown in Figure 4.8-8.

The Santa Fe Opera, an internationally acclaimed forum for world-class performers, ranks among the six finest companies in the United States today [4.8-23]. Its open-air theater overlooks mountains, plains, and mesas. Each season, the company presents both classics and innovative works by contemporary composers. The Santa Fe Chamber Music Festival, currently broadcast on National Public Radio, features classics by Mozart and Beethoven as well as more recent works. The 1987 calendar includes works by cellist Carter Brey and violinist Ani Kavafian. Santa Fe hosts two professional symphonies. The Orchestra of Santa Fe and the Santa Fe Symphony present baroque, classical, and contemporary programs from late September through May.

Theatre companies based in Santa Fe are shown in Figure 4.8-8. The city features two choral groups, a resident ballet company, and the Maria Benitez Dance Company, led by the nation's most acclaimed Flamenco dancer [4.8-23]. Several art centers, including the Greer Garson Theatre and the Center for Contemporary Arts, present a number of dance and performance series throughout the year.

Albuquerque's performing arts groups, also summarized in Figure 4.8-8, include resident theatre groups which put on almost 50 productions annually, with over 240 performances per year. An opera and light opera company provide 55 performances annually. The New Mexico Symphony and the Chamber Orchestra of Albuquerque provide both classical and contemporary performances. Several ballet companies are also based in Albuquerque.

Albuquerque's Kimo Theatre, Keller Hall, and Popejoy Hall sponsor music and dance performances throughout the year, including in 1986, the National Symphony, the Royal Ballet of Flanders, and the Guarneri Quartet.

Libraries

Appendix 4-H-8 provides information on regional public library resources, as well as academic and specialized libraries statewide. Specialized libraries include those at major Albuquerque medical centers, historic and law libraries as well as the collections at Los Alamos and Sandia.

Figure 4.8-8. Theaters, symphonies, and operas in the SSC vicinity area [4.8-27, 4.8-28, 4.8-29].

Performing Arts Centers/Groups	Seating Capacity	Productions Per Year	Performances Per Year	Examples of Recent or Coming Productions/Performers
Albuquerque				
Adobe Theater, Corrales	99	3	18	"Of Mice and Men" "Spoon River" "The Good Doctor"
Albuquerque Children's Theater	2,094	3	12	"The Clown Prince" "The Round-eyed Rumpelstiltskin" "The Magic Menace"
Albuquerque Civic Light Opera	2,094	5	40	"Hello Dolly" "Music Man" "Pirates of Penzance"
Albuquerque Little Theater	626	9	90	"Spoken Dreams Before the Mourning" "Arsenic and Old Lace" "Crimes of the Heart"
Albuquerque Opera Theater	752 (Kimo)	5	15	"Regina" "I Pagliacci" "Barber of Seville"
Kimo Theater	752	150	200	"Carmen", Jazz Workshop-Stan Getz Ballet Hispanico
New Mexico Symphony Orchestra	2,094	--	60	Issac Stern, Rostopovich "Nutcracker Ballet"
University of New Mexico Music Department (Keller Hall)	336	--	200	Student Recitals, Bachathon The Guarneri String Quartet
University of New Mexico Popejoy Hall	2,094	70	160	"Evita" The National Symphony Orchestra The Royal Ballet of Flanders
University of New Mexico Theater Arts Department Rodey Theater	436	6	36	"The Visit" "The Tempest" "Playboy of the Western World"
Experimental Theater	125	15	45	"Getting Out" "Talking With . . ." "Who's Afraid of Virginia Woolf"

Continued on next page

NEW MEXICO SSC PROPOSAL JULY 31, 1987

4-103

Figure 4.8-8. (Continued)

Performing Arts Centers/Groups	Seating Capacity	Productions Per Year	Performances Per Year	Examples of Recent or Coming Productions/Performers
Vortex Theater	100	5	20	"A Thousand Clowns" "Last of the Red Hot Lovers" "American Buffalo"
Wool Warehouse Dinner Theater	350	8	150	"Little Shop of Horrors" "Guys and Dolls" "Brighton Beach Memoirs"
Albuquerque Youth Symphony	752	3	3	"Reinzi Overture" "Pictures at an Exhibition" "Lincoln Portrait"
Chamber Orchestra of Albuquerque	600	NA	18	Classical Subscription Concerts POPS Children's Concert June Music Festival
Contemporary Dance Alliance	NA	NA	NA	
La Compania	700	5	60	"Who Killed Don Jose?"
Loren Kahn's Old Town Puppet Theatre	50	6	375	"The Chuang Brocade" Shadow Puppetry "Wishes Don't Wash Dishes"
New Mexico Ballet	2,094	5	13	"Fire Bird" "The Snow Queen" "The Gift of Dance" Mikhail Baryshnikov Royal Danish Ballet
New Mexico Jazz Workshop	NA	--	12	Sonny Rollins Cecil Taylor Stan Getz Stephan Grappelli
Southwest Ballet	2,094	4	13	"Billy the Kid" "Romeo and Juliet" "Nutcracker"

Continued on next page

Figure 4.8-8. (Continued)

Performing Arts Centers/Groups	Seating Capacity	Productions Per Year	Performances Per Year	Examples of Recent or Coming Productions/Performers
Santa Fe				
Santa Fe Opera	1,773	5	37	"Intermezzo" "La Traviata" "The Magic Flute" Handel's "Ariodante"
Santa Fe Chamber Music Festival (St. Francis Auditorium)	432	NA	50	Stephen Paul's "Letters from Collette"
The Orchestra of Santa Fe (Lentic Theater)	850	NA	11	Bach Festival
The Santa Fe Symphony (Sweeney Center)	1,200	NA	12	86-87 Season Finale featuring Jaime Laredo. Benefit fundraiser with Dinah Shore.
New Mexico Repertory Theatre	228	7	96	"Who's Afraid of Virginia Woolf" "Fool for Love"
British American Theatre Institute	NA	NA	NA	
The Armory for the Arts	340	50	110	"Oliver" Twyla Tharp Dance Company Woody Herman
Santa Fe Desert Chorale	NA	4	20	Monteverdi's Madrigals "The Hour Glass" "Miriam's Song of Triumph"
Greer Garson Theatre	514	9	40	"Noises Off" "The Crucible" "She Loves Me" "Loot"
Santa Fe Community Theatre	136	7	87	"Enter Laughing" "HMS Pinafore" "The Lady's Not for Burning" Fiesta Melodrama

Continued on next page

Figure 4.8-8. (Continued)

Performing Arts Centers/Groups	Seating Capacity	Productions Per Year	Performances Per Year	Examples of Recent or Coming Productions/Performers
The Chorus of Santa Fe	400	3	6	"The Creation" "C Minor Mass" "Brahm's Requiem" "Gabriel Faure"
The Maria Benitez Dance Company	NA	NA	90	International Estampa Flamenco Dance Company
Pajarito Ballet Theatre	514	12	24	"Proud Heritage" "Winter War" "Nutcracker"
The Center for Contemporary Arts	140	NA	NA	Multi-dimensional art center presenting films, video, poetry and literature reading, visual arts, dance, and theatre.

Churches

Appendix 4-H-9 provides information on churches and synagogues in Albuquerque and Santa Fe. Virtually every major denomination is represented by several institutions.

4.9 COMMUNITY SUPPORT

4.9.1 EXISTING AND POTENTIAL COMMUNITY SUPPORT

Each of the governmental entities with jurisdiction over the site or likely to be affected by the development of the SSC has prepared and passed a Resolution endorsing the project. These Resolutions acknowledge the public purpose of the SSC, the contributions the project is likely to make to the quality of life in each of these neighboring communities, and, most important, what the communities themselves can contribute to the SSC's successful development. The Resolutions are presented in Appendix I.

In addition, the State Representatives and State Senator in whose districts the SSC lies as well as the Mayor of the City of Albuquerque have each written letters of endorsement. These letters follow the Resolutions in Appendix I.

4.9.2 EXISTING OR ANTICIPATED OPPOSITION TO THE PROPOSED SITING OF THE SSC

Although numerous news articles and editorials have appeared in local newspapers concerning the SSC and its proposed location, a survey of these newspapers reveals no letters to the editor or negative responses of any kind to the project. Neither have any protests been made at the public forums in which Resolutions were adopted. The State Representatives in whose districts the SSC lies have received no complaints from constituents. No members of the Siting Team have been contacted with negative concerns. The only issue that has been raised to a member of the Proposal Team is a desire to see the SSC built with domestically purchased materials. Specifically, concern was expressed that Mexican cement not be used.

4.10 NON-FEDERAL GOVERNMENT SUPPORT

4.10.1 PROPOSED STATE, REGIONAL, AND LOCAL GOVERNMENT SUPPORT AND SERVICES SUMMARIZED

Each of the local governmental entities having jurisdiction over or likely to be affected by the SSC has officially welcomed its prospective development. (See Sec. 4.9.1.) All of these local governments, in their Resolutions of endorsement for the project, have stated their interest in providing employees, goods, and services to the SSC. Albuquerque, the largest community in the vicinity of the SSC, has further identified its housing, highways, airport, schools, and community facilities as resources it will place in the service of the project.

The State of New Mexico has offered to upgrade the existing road network serving the SSC site, upgrade the snow-removal priority on those roads, build access to and across the site from existing highways, and build a service road system for the SSC. This offer is detailed in Section 4.2.2.

The University of New Mexico has offered to upgrade its program of courses in science, technology, the management of scientific and technological efforts, and its televised institution capability. The University's offer is detailed in Section 4.8.2. The State has agreed to fund these upgrades.

The Governor of the State of New Mexico has offered to establish, by Executive Order, a Task Force to handle all permits required for construction and operation of the SSC. The establishment of this single application agency is detailed in Section 4.10.4.

Finally, in a specially convened session to consider New Mexico's support for the SSC, both houses of the state legislature passed resolutions and memorials offering the state's commitment to address the needs and requirements associated with construction and operation of the Superconducting Super Collider in New Mexico. Senate Joint Resolution 1 expresses this commitment with respect to education (see Sec. 4.8.2); Senate Joint Memorial 1 focuses on the provision of infrastructure (see Sec. 4.10.4).

4.10.2 EXISTING LAWS OR LOCAL STATUTES AND JURISDICTIONS THAT WOULD BE AFFECTED BY OR COULD AFFECT THE SSC

Existing Laws and Regulations

The SSC will involve numerous environmental impacts regulated by state law and regulations in New Mexico including matters of air pollution, water quality, and liquid and solid waste (including hazardous waste) disposal. In addition, the SSC will involve other non-tax regulatory matters

including water rights and use, land planning, subdivision, and land use, building codes and permits, construction industry licensing, bonding of contractors for state taxes, condemnation, and state lands.

The following statutes and regulations issued thereunder comprise the state environmental law administered by the Environmental Improvement Division of the Health and Environment Department which might affect or be affected by the SSC:

- o Environmental Improvement Act - Sections 74-1-1 to 74-1-10 NMSA 1978
- o Air Quality Control Act - Sections 74-2-1 to 74-2-17
- o Radiation Protection Act - Sections 74-3-1 to 74-3-16
- o Hazardous Waste Act - Sections 74-4-1 to 74-4-13
- o Radioactive and Hazardous Materials Act - Sections 74-4A-2 to 74-4A-14
- o Site Identification Act - Sections 74-4A-15 to Sections 74-4A-19
- o Emergency Management Act - Sections 74-4B-1 to 74-4B-11
- o Water Quality Act - Sections 74-6-1 to 74-6-13
- o Environmental Compliance Act - Sections 74-7-1 to 74-7-8
- o For specifics relating to environmental permits, see Appendix 4-J-1.

The following statutes and regulations issued thereunder plus related cases comprise the state water law administered by the State Engineer which might affect or be affected by the SSC:

- o Water Rights in General - Sections 72-1-1 to 72-1-9 NMSA 1978
- o State Engineer - Sections 72-2-1 to 72-2-17
- o Underground Waters - Sections 72-12-1 to 72-12-28

Counties have the power to establish planning commissions by ordinance (Sections 4-57-1 to 4-57-3 NMSA 1978). Planning and development districts have been created by statute (Sections 4-58-1 to 4-58-6 NMSA 1978). The statute gives recognition to councils of government and economic development districts. District 2 includes Santa Fe County; District 3 includes Torrance County. County subdivision is

regulated pursuant to Sections 47-5-1 to 47-5-9 and 47-6-1 to 47-6-27.1 NMSA 1978.

Building standards and permits as well as construction industry licensing are covered by Sections 60-13-1 through 60-14-20 and regulations issued thereunder administered by the Construction Industries Division. A requirement that construction contractors without a principal place of business in New Mexico provide bond for New Mexico taxes is contained in Section 7-1-55 NMSA 1978.

Condemnation is covered by a substantial body of New Mexico law. For references to this law, please refer to the response in Section 2.1.4.

Matters involving state lands are under the control of the State Land Commissioner and are governed by law, insofar as relevant to the SSC, set out at Sections 19-1-1 to 19-1-24 and 19-7-1 to 19-7-69 together with regulations thereunder.

Local Statutes and Jurisdiction

About three-quarters of New Mexico's SSC site lies in Santa Fe County, one-quarter in Torrance County. In Santa Fe County, a General Plan and Land Development Code govern the county's development. Torrance County has no General Plan or zoning requirements, although work on documents of this type is soon to be undertaken. The City of Moriarty, which is situated just inside the SSC's south arc, has a Comprehensive Plan, a City Zoning Ordinance, and an Extra-Territorial Zoning Ordinance which grants jurisdiction over a three-mile area surrounding the city of Moriarty in Torrance County.

Mitigation and Satisfaction of Requirements

Santa Fe County's Land Development Code specifically exempts activities on lands owned by the federal government from its zoning regulations [4.10-2]. Because no major above-ground facilities are planned for the portion of the SSC that lies in Torrance County, the existence of the City of Moriarty's Extra-Territorial Zoning jurisdiction has no direct implications for the SSC's development. Discussions with the City Attorney in Moriarty indicate a willingness to add language to the Extra-Territorial Planning and Platting Ordinance that mirrors Santa Fe County's position with respect to lands owned by the federal government. A letter to this effect is included in Appendix 4-J-2.

The State of New Mexico Construction Industries Division would ordinarily regulate construction projects in Santa Fe and Torrance Counties. A 1975 State Attorney General's Opinion found that the Construction Industries Division has no jurisdiction over federal government projects. A letter conveying this Opinion is included in Appendix 4-J-3.

To further assist the United States in its efforts to construct the SSC, the Governor of New Mexico proposes to, immediately upon selection of the New Mexico site and continuing through the remainder of his term, provide staff (in his office) to coordinate, expedite, and otherwise deal with state (and local government, if any) actions needed to minimize problems and bureaucratic and other delay in the construction and operation of the SSC. As proof of this commitment, please refer to Executive Order 87-33 in Appendix 4-J-4. The matters of funding staff for this purpose and of recognition in the budget of the workload increase the SSC will place upon some elements of state and local government have been fully discussed with and agreed to by legislators and legislative staff having budgetary responsibility. Because New Mexico has a small population and a tradition of prompt governmental response to changing conditions, the United States should be assured that the problems to be anticipated in the larger governments of the more populous states will be avoided in New Mexico.

4.10.3 TAX POLICIES

State, Regional and Local Taxes Applicable to Transactions and Properties Involved in Construction and Operation of the SSC

New Mexico state government relies very heavily on a gross receipts tax which is imposed on the seller and applies to receipts from the sale of property in New Mexico, from the performance of services in New Mexico, and from the lease of property employed in New Mexico. The present rate of the state gross receipts tax is 4.75%. Municipalities and counties have limited power to impose local gross receipts taxes which are collected by the state Taxation and Revenue Department (TRD). Receipts from the sale of tangible personal property to the United States may be deducted in computing gross receipts tax liability, but receipts from the sale of services, including receipts from construction services and the value of materials incorporated into a construction project, may not be deducted even if the United States is buying the services. No tax is imposed upon the receipts of construction subcontractors and material suppliers where the services and materials are incorporated into a project and the receipts of the prime contractor are subject to tax on the full contract amount, as is almost always the case. Recent legislatures have been reluctant to protect contractors where tax rates are increased and the contractor is not entitled to an adjustment in the contract amount in case of a tax increase. A 4.75% compensating (use) tax applies to property imported into New Mexico if the gross receipts tax would have applied to the transaction in which the property was acquired had that transaction occurred in New Mexico.

New Mexico state government has increased reliance upon the personal and corporate income tax in recent years but the aggregate burden remains somewhat modest. The personal income tax is based, with certain adjustments, upon adjusted gross income as computed for federal income tax purposes. The corporate income tax is based, with certain adjustments, upon federal taxable income as computed for federal tax purposes. The Uniform Division of Income for Tax Purposes Act applies. Personal income tax rates now run from 2.4% to 8.5%. Corporate income tax rates presently run from 4.8% to 7.6% plus a franchise tax of \$50 per year. New Mexico uses a withholding tax system for income tax purposes.

New Mexico state government places no reliance on the property tax for operating purposes but counties, municipalities, and some school districts depend, in part, on property tax operating levies the aggregate of which levies may not constitutionally exceed \$20 per \$1,000 of assessed valuation unless authorized by a vote of the people in the taxing jurisdiction imposing the tax. In addition, all levels of government rely, to some extent, on general obligation bonds funded by property tax voted by the public for that purpose. The state government has not, in recent years, used general obligation bonds to any great extent; however, the problems in the oil and gas industry may cause severance tax bonding to be less suitable and force increased reliance by the state on general obligation bonds in future years. Property is required by the constitution to be assessed at no more than one-third of value for property tax purposes. Tangible personal property, excluding inventories but including contractor's equipment, is subject to property tax. Property of the United States is, of course, free from property tax. The total tax rates in the counties in which the proposed site is located were less than \$20 per \$1,000 of assessed valuation in the 1986 tax year.

New Mexico imposes the usual assortment of special sales taxes and license fees which, aside from motor fuel, motor vehicle excise (sales) taxes, and motor vehicle fees, are not substantial revenue producers. Earlier reliance upon special taxes (sometimes called severance taxes) on the extractive industries has been materially reduced due to the economic distress in those industries.

New Mexico receives considerable non-tax revenue from interest and from mineral royalty shared with the state by the United States.

New Mexico has no regional governments with taxing jurisdiction that would be expected to impact the proposed site.

It is considered unlikely that the basic tax and revenue structure of New Mexico and its political subdivisions will change materially in the foreseeable future although rate

changes may shift the relative contributions of certain taxes. It is also considered unlikely that significant tax concessions could be made to benefit those engaged in the construction and operation of the SSC because of the recent severe adverse impact on state revenues resulting from reduced oil prices, restricted gas markets, and distress in the agriculture and solid minerals sectors of the state economy.

Tax Costs Likely to be Borne by the SSC

Based upon assumed tax rates of 5.375 for both Santa Fe and Tarrant Counties (present rates 5.375, Santa Fe; 5.00, Tarrant) and the present structure and assuming that (1) SSC construction will be accomplished by independent contractors, (2) some equipment for the SSC will be purchased directly by the United States and installed by the operator of the facility or by other contractors, and (3) the operator of the facility will be an entity which contracted with the United States for cost plus no fee or a nominal fee and that title to property acquired for the operation of the project by the contractor will immediately vest in the United States, the following summary gives a general idea of the tax costs which will be borne by the project:

Construction cost \$3.21 billion	X 5.375%	= \$172.54 million
Assumed \$719 million direct detector and computer equipment purchase by the United States	X 0	= - 0 -
Assumed \$274 million construction research	X 5.375%	= \$14.73 million
Assumed \$172 million pre-operating cost	X 5.375%	= \$9.25 million
Assumed annual operating cost \$270 million of which \$180 million is personnel and other costs not involving the acquisition of tangible personal property (including electric power) title to which rests in the U.S. under a title vesting clause in the contract.		
\$180 million per year	X 5.375%	= \$9.68 million per year
Acquisition of \$90 million tangibles per year		= - 0 -

Impact of the SSC on Local Tax Revenues

The introduction of the SSC in the site proposed and the resultant withdrawal of land from the tax base would have a

very minor impact (estimated to be less than 0.3%) on property tax revenues in either county involved since the land involved is presently devoted to agricultural purposes, contains few valuable improvements and is not a substantial portion of the property tax base in either of the counties involved. There are no special assessment tax districts in the area involved. In New Mexico, school operations are almost wholly financed by state appropriations distributed to school districts on the basis of a formula. Cooperation between the federal, state, and local areas will be particularly important in timing additions to facilities and services made necessary by the location of SSC at the proposed site, but the problems involve future needs, not present situations.

4.10.4 PROCEDURAL, INFRASTRUCTURE, AND FACILITY NEEDS ASSISTANCE

Procedural Assistance

The Governor of New Mexico has issued Executive Order 87-33, which establishes a Task Force among the various state agencies so that contractors seeking permits or licenses may submit their applications to the office of the Governor and expect prompt review and action by the respective state agencies, in accordance with law. The full text of the Executive Order is presented in Appendix 4-J-4.

Infrastructure Assistance

As described in Section 4.2.2, the state proposes to build access to and across the site from existing highways and build a service road system for the SSC. This road network is shown in Appendix 4-J-5.

New Mexico has further indicated its intent to assist with infrastructure requirements in Senate Joint Memorial 1, passed in a specially convened session of the state legislature. The Memorial expresses a commitment to the provision of the infrastructure necessary for the successful construction and operation of the SSC and directs all state agencies and instrumentalities of the state to recognize and respond to the specific infrastructure needs of the SSC. Appendix 4-J-12 contains the full text of Senate Joint Memorial 1.

Facility Needs

The requirements of the SSC for water and electricity can be easily met in New Mexico. The letters contained in Appendices 4-J-6 through 4-J-11 discuss the manner in which these requirements will be fulfilled. The letters convey, as well, the desire of the regulators and providers of these resources to assist, support, and expedite the development and successful operation of the SSC.

REFERENCES

- 4.1-1. New Mexico State Highway Department, Planning Bureau, private communication (1987).
- 4.1-2. Albuquerque International Airport, Administration Office, private communication (1987).
- 4.1-3. Commercial and commuter airlines, private communication (1987).
- 4.1-4. General aviation facility executive offices, private communication (1987).
- 4.2-1. New Mexico State Highway Department, Maintenance Management Division, private communication (1987).
- 4.2-2. L.J. Pignataro, Traffic Engineering: Theory and Practice (1973).
- 4.2-3. New Mexico State Highway Department, Planning Bureau, private communication (1987).
- 4.2-4. Atchison Topeka and Santa Fe Railway Company, District Manager, private communication (1987).
- 4.2-5. Superconducting Super Collider Conceptual Design Non-Site Specific Report (1986).
- 4.3-1. J. Williams, ed., New Mexico in Maps, UNM Press (1987).
- 4.3-2. L. Yeager, City of Albuquerque Transit Department, private communication (1987).
- 4.3-3. Albuquerque Trolley Company, private communication (1987).
- 4.3-4. Trailways Bus System, Albuquerque, New Mexico, private communication (1987).
- 4.3-5. Greyhound Bus Lines, Albuquerque, New Mexico, private communication (1987).
- 4.3-6. TNM and O Coaches, Inc., Albuquerque, New Mexico, private communication (1987).
- 4.3-7. Shuttlejack, Inc., Santa Fe, New Mexico, private communication (1987).
- 4.3-8. Sanchez Southwest Coaches, Ltd., Albuquerque, New Mexico, private communication (1987).
- 4.3-9. Santa Fe Information Brochure, Santa Fe City Planning Department (1986).

- 4.3-10. J. Roybal, State Highway Department, Santa Fe, New Mexico, private communication (1987).
- 4.3-11. Mountain Bell Yellow Pages, Albuquerque and Santa Fe, New Mexico (1986).
- 4.3-12. C. Finkenbine, Jr., Vice President and General Manager, Ross Aviation, Albuquerque, New Mexico, private communication (1987).
- 4.4-1. Sandia National Laboratories Brochure, Public Information Division 3161, Sandia National Laboratories (1987).
- 4.4-2. 1986 Economic Resource Impact Statement, Kirtland Air Force Base, Albuquerque, New Mexico (1987).
- 4.4-3. A. Duran, White Sands Test Facility, Alamogordo, New Mexico, private communication (1987).
- 4.4-4. V. Rue, White Sands Satellite Station, Alamogordo, New Mexico, private communication (1987).
- 4.4-5. R. Upton, Los Alamos National Laboratory, Los Alamos, New Mexico, private communication (1987).
- 4.4-6. New Mexico Employment Security Department, unpublished computer file (1987).
- 4.4-7. M. Erdhal, Big Three Industries, Inc., Albuquerque, New Mexico, private communication (1987).
- 4.4-8. L.D. Bippus, U.S. Department of the Interior, Bureau of Mines, Amarillo, Texas, private communication (1987).
- 4.4-9. Local representatives of Alliance, Arrow, Bell Industries, Hamilton Avnet Electronics, Sterling Electronics, Albuquerque, New Mexico, private communication (1987).
- 4.4-10. E. Westfahl, Westfahl and Associates, Albuquerque, New Mexico, private communication (1987).
- 4.4-11. New Mexico Industrial Manufacturing Guide, New Mexico Industrial Assistance Project, Albuquerque, New Mexico (1985).
- 4.4-12. W. Rozum, Hewlett-Packard, Albuquerque, New Mexico, private communication (1987).
- 4.4-13. J. Neidig, General Electric Supply Company, Denver, Colorado, private communication (1987).

- 4.4-14. Local representatives of Linde, Union Carbide, and Big Three Industries, Albuquerque, New Mexico, private communication (1987).
- 4.4-15. P. Brubaker, Scientific Sales, Albuquerque, New Mexico, private communication (1987).
- 4.4-16. Representatives of General Electric, Childers Machine, Telco Electric, and Electric Motor Company, Inc., Albuquerque, New Mexico, private communication (1987).
- 4.4-17. N. Morse, Los Alamos National Laboratories, Los Alamos, New Mexico, private communication (1987).
- 4.4-18. L. Bertholf, Sandia National Laboratories, Albuquerque, New Mexico, private communication (1987).
- 4.4-19. M.S. Gutierrez, AFL-CIO, Albuquerque, New Mexico, private communication (1987).
- 4.4-20. Business Managers of local labor unions, Albuquerque and Farmington, New Mexico, private communication (1987).
- 4.4-21. General Wage Decision No. NM87-1, U.S. Department of Labor, Dallas, Texas (1987).
- 4.4-22. General Wage Decision No. NM87-3, U.S. Department of Labor, Dallas, Texas (1987).
- 4.4-23. R. Dyke, Cement Division, Ideal Basic Industries, Albuquerque, New Mexico, private communication (1987).
- 4.4-24. F.M. Miller, Cement Division, Ideal Basic Industries, Albuquerque, New Mexico, private communication (1987).
- 4.4-25. U.S. Department of Commerce, Bureau of the Census, 1980 Census of Population, U.S. Government Printing Office, Washington, DC (1981).
- 4.4-26. An Inventory of Technology Based Companies in New Mexico, NMRDI-2-75-5106, New Mexico Research and Development Institute, Santa Fe, New Mexico (1987).
- 4.4-27. M. Torneby, Sandia National Laboratories, Albuquerque, New Mexico, private communication (1987).
- 4.4-28. W. Law, Los Alamos National Laboratories, Los Alamos, New Mexico, private communication (1937).

- 4.4-29. Manufacturing and Selected Nonmanufacturing Firms Wage Surveys, Albuquerque Economic Development, Albuquerque, New Mexico (1986).
- 4.4-30. M. Vigil, Los Alamos National Laboratories, Los Alamos, New Mexico, private communication (1987).
- 4.4-31. New Mexico Employment Security Department, unpublished computer file B (1987).
- 4.4-32. A. Goodman, Sandia National Laboratories, Albuquerque, New Mexico, private communication (1987).
- 4.4-33. Register of Wage Determinations Under the Service Contract Act, No. 86-105 (Rev. 1), U.S. Department of Labor, Washington, DC (1986).
- 4.4-34. Albuquerque "High Tech" Wage Survey, New Mexico Employment Security Department, Albuquerque, New Mexico (1984).
- 4.4-35. The New Mexico Compensation Report, New Mexico Personnel Association, Santa Fe, New Mexico (1987).
- 4.5-1. Bureau of Business and Economic Research, Population Projections for New Mexico Counties: 1980-2005, University of New Mexico (1986).
- 4.5-2. U.S. Department of Commerce, Bureau of the Census, Local Population Estimates, No. 84-W-SC, U.S. Government Printing Office, Washington, DC (1986).
- 4.5-3. U.S. Department of Commerce, Bureau of the Census, 1980 Census of Population and Housing, STF-3, U.S. Government Printing Office, Washington, DC (1983).
- 4.5-4. Santa Fe County General Plan, County of Santa Fe, (1980).
- 4.5-5. U.S. Department of Commerce, Bureau of the Census, 1980 Census of Population, General Social, and Economic Characteristics, New Mexico, U.S. Government Printing Office, Washington, DC (1983).
- 4.5-6. U.S. Department of Commerce, Bureau of the Census, 1980 Census of Population, General Social, and Economic Characteristics, United States Summary, U.S. Government Printing Office, Washington, DC (1983).
- 4.5-7. Table B--Non-Agricultural Wage and Salary Employment (Jobs), New Mexico Employment Security Department (1987).
- 4.5-8. Planning Bureau, New Mexico State Highway Department, private communication (1987).

- 4.5-9. Table A--Civilian Labor Force, Employment, Unemployment and Unemployment Rate, New Mexico Employment Security Department (1987).
- 4.5-10. New Mexico Employment Security Department, Bureau of Economic Research and Analysis, private communication (1987).
- 4.5-11. Demographic Projections for the Albuquerque Area, 1987-1997, Southwest Land Research (1987).
- 4.5-12. U.S. Department of Commerce, Bureau of the Census, 1980 Census of Population, Detailed Population Characteristics, New Mexico, U.S. Government Printing Office, Washington, DC (1983).
- 4.5-13. An Inventory of Technology-Based Companies in New Mexico, New Mexico Research and Development Institute (1987).
- 4.5-14. Bureau of Economic Research and Analysis, New Mexico Employment Security Department, private communication (1987).
- 4.5-15. Sandia National Laboratories, Public Information Division, Sandia National Laboratories (1987).
- 4.5-16. Albuquerque's Top Employers, Albuquerque Economic Development, Inc. (1987).
- 4.5-17. Kirtland Air Force Base, New Mexico State University, University of New Mexico, New Mexico Institute of Mining and Technology, Lovelace Medical Center, Veterans Administration Hospital, National Radio Astronomy Observatory, Holloman Air Force Base, White Sands Missile Base, NASA, and Sacramento Peak Solar Observatory, private communications (1987).
- 4.5-18. Information Services Division, Welcome to Los Alamos, Los Alamos National Laboratory (1985).
- 4.5-19. Fourteenth, Fifteenth, Sixteenth, and Seventeenth Annual Reports, New Mexico Human Rights Commission, undated.
- 4.5-20. New Mexico Human Rights Commission, private communication (1987).
- 4.5-21. T.E. Robles, EEOC Area Director, Albuquerque Area Office, Equal Employment Opportunity Commission, private communication (1987).

- 4.5-22. J.E. Wright, Director, Fort Worth Regional Office, Office of Fair Housing and Equal Opportunity, U.S. Department of Housing and Urban Development, private communication (1987).
- 4.6-1. New Mexico State Highway Department, Planning Bureau, Santa Fe, New Mexico, private communication (1987).
- 4.6-2. Ski New Mexico Association, Santa Fe, private communication (1987).
- 4.6-3. U.S. Department of Commerce, Bureau of the Census, 1950 Census of Housing, Detailed Housing Characteristics: New Mexico, U.S. Government Printing Office, Washington, DC (1952).
- 4.6-4. U.S. Department of Commerce, Bureau of the Census, 1970 Census of Housing, Detailed Housing Characteristics: New Mexico, U.S. Government Printing Office, Washington, DC (1981).
- 4.6-5. U.S. Department of Commerce, Bureau of the Census, 1980 Census of Housing, Detailed Housing Characteristics: New Mexico, U.S. Government Printing Office, Washington, DC (1983).
- 4.6-6. Unpublished computer files, Southwest Land Research, (1987).
- 4.6-7. Property Analysis for a 305-acre Tract in Moriarty, New Mexico, Southwest Land Research, Albuquerque, New Mexico (1986).
- 4.6-8. Albuquerque Board of Realtors, Albuquerque, New Mexico, private communication (1987).
- 4.6-9. Mobile Home Market Update: Albuquerque, Southwest Land Research, Albuquerque, New Mexico (1986).
- 4.6-10. Marketscope Apartments: Spring 1987, Southwest Land Research Albuquerque, New Mexico (1987).
- 4.6-11. Albuquerque Convention and Visitors Bureau, Albuquerque, New Mexico, private communication (1987).
- 4.6-12. Santa Fe Convention and Visitors Bureau, Santa Fe, New Mexico, private communication (1987).
- 4.6-13. Santa Fe City Planning Department, Santa Fe, New Mexico, private communication (1987).
- 4.6-14. Santa Fe Board of Realtors, Santa Fe, New Mexico, private communication (1987).

- 4.6-15. National Association of Realtors, Washington, DC, private communication (1987).
- 4.7-1. C. Tinker, Public Affairs Department, University of New Mexico Medical Center, Albuquerque, New Mexico, private communication (1987).
- 4.7-2. Community Relations Department, Lovelace Medical Center, Albuquerque, New Mexico, private communication (1987).
- 4.7-3. Community Relations Department, Presbyterian Hospital, Albuquerque, New Mexico, private communication (1987).
- 4.7-4. C. Bobo, Director of Communications, St. Joseph Health Care Corporation, Albuquerque, New Mexico, private communication (1987).
- 4.7-5. New Mexico Health Resources Registry, Statistical Summary-1984/1985, University of New Mexico Medical Center (1985).
- 4.7-6. J. Lopez, Director EMS Region I, Health and Environment Department, State of New Mexico, Santa Fe, New Mexico, private communication (1987).
- 4.7-7. K.D. Gonzales, Chief Flight Coordinator, Lifeguard Air Emergency Services, Albuquerque, New Mexico, private communication (1987).
- 4.7-8. Presbyterian Air Ambulance, Albuquerque, New Mexico, private communication (1987).
- 4.7-9. New Mexico State Police, District 5, Albuquerque, New Mexico, private communication (1987).
- 4.7-10. Capt. Jones, Bernalillo County Sheriff's Department, Albuquerque, New Mexico, private communication (1987).
- 4.7-11. R. Turpin, Planner, City of Albuquerque Police Department, private communication (1987).
- 4.7-12. Rio Rancho Department of Public Safety, private communication (1987).
- 4.7-13. M. McGarity, Santa Fe County Sheriff's Office, Santa Fe, New Mexico, private communication (1987).
- 4.7-14. R. Lucero, City of Santa Fe Police Department, Police Community Relations, private communication (1987).

- 4.7-15. Torrance County Sheriff, Estancia, New Mexico, private communication (1987).
- 4.7-16. C. Standifer, State Fire Marshall, State of New Mexico Fire Marshall's Office, Santa Fe, New Mexico, private communication (1987).
- 4.7-17. E. Waide, City of Albuquerque Fire Department, private communication (1987).
- 4.7-18. P. Duran, Chief, City of Santa Fe Fire Department, private communication (1987).
- 4.7-19. City of Moriarty and City of Estancia Fire Departments, private communications (1987).
- 4.7-20. C. Standifer, State Fire Marshall, State of New Mexico Fire Marshall's Office, Santa Fe, New Mexico, private communication (1987).
- 4.7-21. Local hospitals, administrative offices, private communication (1987).
- 4.7-22. Local law enforcement agencies, private communication (1987).
- 4.7-23. Local fire departments, private communication (1987).
- 4.7-24. New Mexico Natural Resources Department, State Comprehensive Outdoor Recreation Plan (1987).
- 4.7-25. U.S. Department of Interior, U.S. Fish and Wildlife Service, Visitor's Guide for National Wildlife Refuges (1986).
- 4.7-26. J. Williams, ed., New Mexico in Maps, UNM Press (1986).
- 4.7-27. New Mexico Tourism and Travel Division, New Mexico USA: Where to Go; What to Do (1986).
- 4.7-28. J.V. Young, A Park by Any Other Name. . . , New Mexico Magazine (June 1984).
- 4.7-29. C. Pirtle, New Mexico: A Land of Stark Beauty Lies in Waiting, New Mexico Magazine, Spring/Summer (1984).
- 4.7-30. New Mexico Hunting and Fishing Guide (1987).
- 4.8-1. Individual school district offices, private communication (1987).

- 4.8-2. Office of Education, Department of Finance and Administration, State of New Mexico, Statistics (1987).
- 4.8-3. National Education Association, private communication (1987).
- 4.8-4. New Mexico State Department of Education, Evaluation, Testing, and Data Management Unit, New Mexico School District Profile, 1985-86.
- 4.8-5. Archdiocese of Santa Fe, private communication (1987).
- 4.8-6. New Mexico State Department of Education, Private School 40-Day Average Daily Membership, 1986-87.
- 4.8-7. Individual school counseling offices, private communication (1987).
- 4.8-8. Greater Albuquerque Community Educational Alliance, A Guide to Postsecondary Education in the Albuquerque Area, 1986-87.
- 4.8-9. Individual postsecondary institution's registrars, private communication (1987).
- 4.8-10. Albuquerque Technical-Vocational Institute, Vice President for Instruction, private communication (1987).
- 4.8-11. Individual institutions' Personnel Offices and Science and Engineering Departments, private communication (1987).
- 4.8-12. University of New Mexico Public Affairs Department, Highlights from UNM, 1985-87.
- 4.8-13. University of New Mexico, Vice President for Research, private communication (1987).
- 4.8-14. Individual institutions' Public Relations Offices, private communication (1987).
- 4.8-15. D. Hsi and J. Panitz, eds., From Sundaggers to Space Exploration--Significant Contributions to Science and Technology in New Mexico, New Mexico Journal of Science, Vol. 26, No. 1 (February 1986).
- 4.8-16. New Mexico and Technology Advisory Committee, Report to the New Mexico Economic Development and Tourism Department and the New Mexico State Legislature (1986).

- 4.8-17. New Mexico TechNet, Executive Vice President, private communication (1987).
- 4.8-18. Santa Fe Institute, Brochure (1987).
- 4.8-19. RioTech, Office of the President, private communication (1987).
- 4.8-20. New Mexico Economic Development and Tourism Department, NMRDI, private communication (1987).
- 4.8-21. J. Williams, ed., New Mexico in Maps, UNM Press (1987).
- 4.8-22. Historical District Handbook, City of Santa Fe, Santa Fe, New Mexico (1986).
- 4.8-23. Santa Fe Convention and Visitors Bureau, Santa Fe, New Mexico, private communication (1987).
- 4.8-24. Santa Fe Community Profile, New Mexico Business Journal, September (1986).
- 4.8-25. The Albuquerque Museum, Albuquerque, New Mexico, private communication (1987).
- 4.8-26. New Mexico Museum of Natural History, Albuquerque, New Mexico, private communication (1987).
- 4.8-27. Albuquerque Fact Book, Albuquerque Economic Development, Albuquerque, New Mexico (1986).
- 4.8-28. Official Visitors Guide to Santa Fe, Laino-Ludwig Publishing, Santa Fe, New Mexico (1987).
- 4.8-29. Various performing arts groups, Santa Fe, New Mexico, private communication (1987).
- 4.8-30. 1986 Santa Fe Church Directory, Diamond Publishing Company, Albuquerque, New Mexico (1986).
- 4.10-1. Public Service Company of New Mexico, private communication (1987).
- 4.10-2. Article I, Section 8.1, Santa Fe Land Development Code (1980).

APPENDIX 4-A

Airports

Appendix 4-A. Airlines serving the Albuquerque International Airport.

Commercial Airlines:	American America West Continental Delta Eastern PSA Southwest TWA United
Commuter Airlines:	Mesa Air Shuttle Ross Aviation Trans-Colorado
Freight Carriers:	Airbourne Express Emery Air Freight Federal Express Parcel Delivery of Albuquerque

APPENDIX 4-B

Highways, Streets, Roads, and Railroads

Appendix 4-B-1
INITIAL DESIGN FOR IMMIGRANT WORKER
DISTRIBUTION AMONG RESIDENTIAL ZONES
FOR A SITE-SPECIFIC DEVELOPMENT:
SUPERCONDUCTING SUPERCOLLIDER

PLANNING RESEARCH UNIT

MAY 17, 1987

This design for estimating residential distribution of immigrant workers is prepared for site specific developments. The specific initial application is the proposed Superconducting Supercollider.

The model is based on same-sized residential zones. Zones are established on the basis of possible residence for immigrant workers. All zones must have the same total acreage.

Once the residential zones have been established, the primary roadway route to the workplace is determined. The critical intersection within each residential zone is designated the centroid. A rule-of-thumb is to place the centroid as close as possible to the center of the zone, unless the critical intersection dictates otherwise. The travel time from each centroid to the workplace is calculated.

The following information is gathered for each residential zone:

- average cost of housing, rounded to 1000's of dollars
- number of available houses, rounded to 10's of houses
- developable acres
- population, rounded to 100's of persons

The total acreage of the zone is divided into the developable acres for the percent developable acres in the zone.

The following equation is used to establish the residential base for each zone:

$$RB = (AH/HC) \times DA \times (P/TT)$$

where,

RB = Residential Base for a Zone

AH = Available Houses

HC = Average Housing Cost

DA = Percent Developable Land

P = Population

TT = Travel Time

This equation provides the Residential Base by Zone. The total of all zone bases is summed. This figure is divided into each zone's RB. The result is the relative residential attractiveness of the zones for the specific development being considered. These percentages are applied to the total number

of employees for the development, to give the estimated additional residential distribution among the zones provided by the development.

The equation first calculates the available housing per housing cost, then adjusts this figure for potential development in the zone. This provides a indication of both present and potential residential attractiveness of a zone. These three housing estimators are then adjusted by service and convenience. Population in the model is used not as an attraction to residence in itself. Rather, it is used as a measure of relative services (education, fire, shopping, etc.). The attractiveness of relative services is expressed in terms of relative travel time to work. The convenience and cost of work trips, in other words, is used to qualify the convenience and costs of travel to services in the residential zone.

Other methods were examined. A 1975 study for distribution of immigrant workers based on population was rejected for low explanation of variation around the mean by the proposed model, and because population is the singular variable is contra-intuitive. Regression analysis was rejected as a method because of error in estimating historical immigration patterns in time-series relationship to independent variables.

The proposed model has limitations. First, it is an intuitive rather than a derivative model. As such the residential distribution should the project be built should be monitored to adjust the model for future applications. This would indicate if the data should be normalized, whether coefficients should be assigned the variables (although specific coefficients will be limited to the specific development studied...more work would be required for model coefficients), and perhaps if other variables should be included.

Second, not all possible factors in residential distribution are incorporated in the model. The factors included are considered most critical in the application being examined.

Third, the arithmetic operation of the equation is open for consideration and refinement. For example, travel time is assigned a relatively minor role in qualifying relative services, rather than as essentially an economic factor. One reason for this is the level of income of the employees will allow relative freedom in transportation costs in the study area. Another reason for reducing the role of travel time is the number of employees. The size of the operation suggests vanpooling or other private or corporate-sponsored transportation opportunities will be provided. In this regard

the traditional method of estimating travel costs may be inaccurate.

In summary, the initial design for employment distribution is the best available tool given the project at hand and the brief turn-around time for delivery. It is an interesting idea, and should be developed more fully in the future.

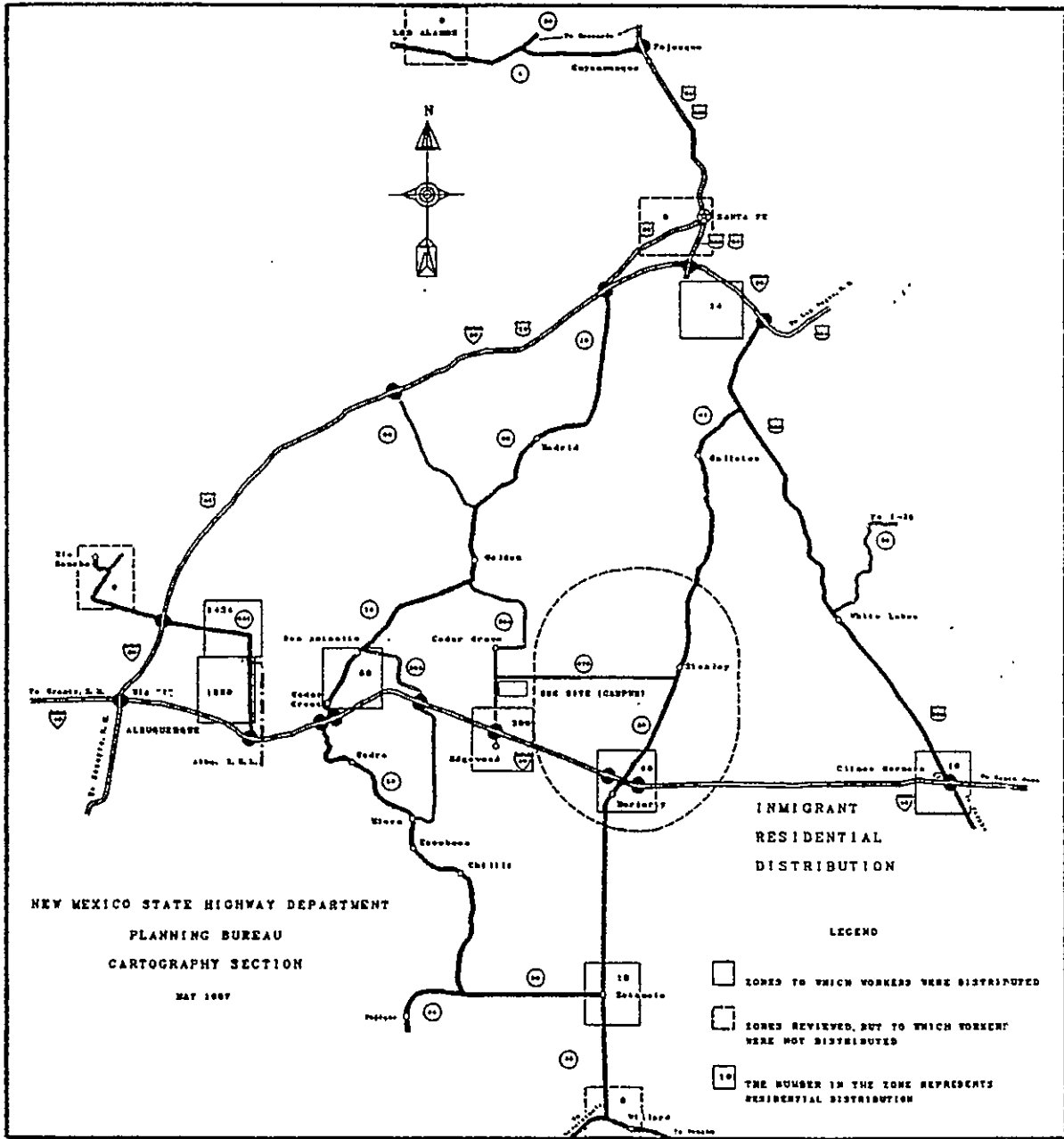

NEW MEXICO SSC PROPOSAL JULY 31, 1987

Appendix 4-B-2
SUPERCONDUCTING SUPER COLLIDER
ROADWAY NETWORK IMPACT
PLANNING BUREAU, NMSHD
JUNE 1, 1987

INTRODUCTION

This paper addresses the roadway network impact of the Superconducting Super Collider (SSC). In the request from Southwest Land Research, Inc., dated May 27, 1987, five areas of roadway information were requested.

The first area of information requested was traffic impact of the SSC. This information is provided in the present paper. All information is estimated for 1995. Where roadway traffic is impacted by the proposed facility, the 1995 estimate is presented with and without the SSC. Information presented is in terms of Average Daily Traffic (ADT); Peak Vehicles Per Hour (Peak VPH); Volume-to-Capacity Ratio (V/C Ratio); and Level Of Service (LOS).

The second area of request was to extend the Interstate System impact analysis throughout the Albuquerque urban area. While the network may be extended for a variety of other purposes, there is no traffic impact in the Albuquerque urban area beyond the segments noted in this paper. Other segments which may be defined may be noted as having no traffic impact through SSC development. While there may be intermittent SSC-related traffic on any given route in Albuquerque, Santa Fe, or Los Alamos, these volumes are not significant for modelling as either ADT or Peak VPH. The minimal volumes will not affect the operating characteristics of extended network roadways.

The third request for information was for travel times. An isopleth has been prepared showing geographic distribution of common travel times around the SSC proposed site. This is presented separately. Airport travel times are presented in this paper following roadway travel characteristics.

Requests four and five are concerned with improvements to existing roadways, and improvement and ROW costs. These are the subject of separate analysis.

TRAFFIC CHARACTERISTICS FOR ROADWAY SEGMENTS IMPACTED BY SSC

ROAD: NM 344
SEGMENT: SSC TO I/40
LANES: 2
1995 EST ADT: 2,530
1995 EST ADT WITH SSC: 7,350
1995 EST PEAK VPH: 330
1995 EST PEAK VPH WITH SSC: 1,102

NEW MEXICO SSC PROPOSAL JULY 31, 1987

1995 EST V/C RATIO: .13
1995 EST V/C RATIO WITH SSC: .43
1995 EST LOS: B
1995 EST LOS WITH SSC: C

ROAD: NM 344
SEGMENT: SSC TO NM 472
LANES: 2
1995 EST ADT: 2,530
1995 EST ADT WITH SSC: 3,050
1995 EST PEAK VPH: 330
1995 EST PEAK VPH WITH SSC: 460
1995 EST V/C RATIO: .19
1995 EST V/C RATIO WITH SSC: .24
1995 EST LOS: B
1995 EST LOS WITH SSC: B

ROAD: NM 344
SEGMENT: NM 472 TO NM 14
LANES: 2
1995 EST ADT: 2,530
1995 EST ADT WITH SSC: 2,600
1995 EST PEAK VPH: 330
1995 EST PEAK VPH WITH SSC: 340
1995 EST V/C RATIO: .19
1995 EST V/C RATIO WITH SSC: .19
1995 EST LOS: B
1995 EST LOS WITH SSC: B

ROAD: NM 472
SEGMENT: NM 344 TO NM 41
LANES: 2
1995 EST ADT: 220
1995 EST ADT WITH SSC: 1,800
1995 EST PEAK VPH: 31
1995 EST PEAK VPH WITH SSC: 250
1995 EST V/C RATIO: .1
1995 EST V/C RATIO WITH SSC: .26
1995 EST LOS: C
1995 EST LOS WITH SSC: C

ROAD: I/40
SEGMENT: US 285 TO NM 41
LANES: 4
1995 EST ADT: 18,870
1995 EST ADT WITH SSC: 27,500
1995 EST PEAK VPH: 1,890
1995 EST PEAK VPH WITH SSC: 2,750
1995 EST V/C RATIO: .58
1995 EST V/C RATIO WITH SSC: .58
1995 EST LOS: C
1995 EST LOS WITH SSC: C

NOTE: This segment LOS without the SSC is impacted primarily by 1995 estimated 31.5% heavy commercial vehicles, of which 80% are 5-axles.

ROAD: I/40
SEGMENT: NM 41 TO NM 344
LANES: 4
1995 EST ADT: 18,850
1995 EST ADT WITH SSC: 21,130
1995 EST PEAK VPH: 1,880
1995 EST PEAK VPH WITH SSC: 2,113
1995 EST V/C RATIO: .41
1995 EST V/C RATIO WITH SSC: .46
1995 EST LOS: B
1995 EST LOS WITH SSC: B

ROAD: I/40
SEGMENT: NM 344 TO NM 14
LANES: 4
1995 EST ADT: 18,830
1995 EST ADT WITH SSC: 24,970
1995 EST PEAK VPH: 1,880
1995 EST PEAK VPH WITH SSC: 2,497
1995 EST V/C RATIO: .41
1995 EST V/C RATIO WITH SSC: .62
1995 EST LOS: B
1995 EST LOS WITH SSC: C

ROAD: I/40
SEGMENT: NM 14 TO NM 541
LANES: 6 FOR APPROXIMATELY 5.8 MILES EUB, THEN 4
1995 EST ADT: 33,209
1995 EST ADT WITH SSC: 39,223
1995 EST PEAK VPH: 2,750
1995 EST PEAK VPH WITH SSC: 3,122
1995 EST V/C RATIO: .46
1995 EST V/C RATIO WITH SSC: .52
1995 EST LOS: B
1995 EST LOS WITH SSC: B

ROAD: I/40
SEGMENT: NM 541 TO EUBANK
LANES: 6
1995 EST ADT: 52,700
1995 EST ADT WITH SSC: 53,900
1995 EST PEAK VPH: 5,270
1995 EST PEAK VPH WITH SSC: 5,390
1995 EST V/C RATIO: .75
1995 EST V/C RATIO WITH SSC: .75
1995 EST LOS: C
1995 EST LOS WITH SSC: C

ROAD: NM 14
SEGMENT: I/40 TO NM 344

LANES: 4
1995 EST ADT: 10,846
1995 EST ADT WITH SSC: 10,969
1995 EST PEAK VPH: 1,085
1995 EST PEAK VPH WITH SSC: 1,097
1995 EST V/C RATIO: .27
1995 EST V/C RATIO WITH SSC: .27
1995 EST LOS: A
1995 EST LOS WITH SSC: A

ROAD: NM 41
SEGMENT: ESTANCIA TO I/40
LANES: 2
1995 EST ADT: 3,335
1995 EST ADT WITH SSC: 3,355
1995 EST PEAK VPH: 364
1995 EST PEAK VPH WITH SSC: 366
1995 EST V/C RATIO: .24
1995 EST V/C RATIO WITH SSC: .24
1995 EST LOS: B
1995 EST LOS WITH SSC: B

ROAD: NM 41
SEGMENT: I/40 TO NM 472
LANES: 2
1995 EST ADT: 925
1995 EST ADT WITH SSC: 3,325
1995 EST PEAK VPH: 93
1995 EST PEAK VPH WITH SSC: 333
1995 EST V/C RATIO: .07
1995 EST V/C RATIO WITH SSC: .15
1995 EST LOS: A
1995 EST LOS WITH SSC: A

ROAD: NM 41
SEGMENT: NM 472 TO US 285
LANES: 2
1995 EST ADT: 592
1995 EST ADT WITH SSC: 625
1995 EST PEAK VPH: 85
1995 EST PEAK VPH WITH SSC: 94
1995 EST V/C RATIO: .07
1995 EST V/C RATIO WITH SSC: .07
1995 EST LOS: A
1995 EST LOS WITH SSC: A

ROAD: US 285
SEGMENT: NM 41 TO I/25
LANES: 2
1995 EST ADT: 2,123
1995 EST ADT WITH SSC: 2,150
1995 EST PEAK VPH: 212
1995 EST PEAK VPH WITH SSC: 215
1995 EST V/C RATIO: .09

1995 EST V/C RATIO WITH SSC: .09
1995 EST LOS: A
1995 EST LOS WITH SSC: A

ROAD: NM 541
SEGMENT: I/40 IMMEDIATELY NORTH
LANES: 6
1995 EST ADT: 25,030
1995 EST ADT WITH SSC: 27,900
1995 EST PEAK VPH: 2,810
1995 EST PEAK VPH WITH SSC: 3,142
1995 EST V/C RATIO: .52
1995 EST V/C RATIO WITH SSC: .58
1995 EST LOS: B
1995 EST LOS WITH SSC: C

TRAVEL TIMES

OFF-PEAK TRAVEL TIME TO ALBUQUERQUE INTERNATIONAL AIRPORT: 40
MINUTES

PEAK TRAVEL TIME TO ALBUQUERQUE INTERNATIONAL AIRPORT: 60
MINUTES

OFF-PEAK TRAVEL TIME TO MORIARITY AIRPORT: 12 MINUTES

PEAK TRAVEL TIME TO MORIARITY AIRPORT: 17 MINUTES

SOURCES

Average Daily Traffic: regression analysis techniques used to forecast future traffic for NMSHD construction projects under development.

Distribution of SSC employees to residential zones: model developed by David Albright of the Planning Research Unit, Advanced Planning Section, Planning Bureau, Engineering/Design Division, New Mexico State Highway Department.

Average Daily Traffic Increase due to SSC: percentage of employees distributed to residential zone times traffic generated by 3000 employees added to ADT of route from SSC to residential zone.

Peak VPH, V/C Ratio, LOS: HCM computer software, McTrans Centers, Florida; Professional Solutions, Inc.

Appendix 4-B-3

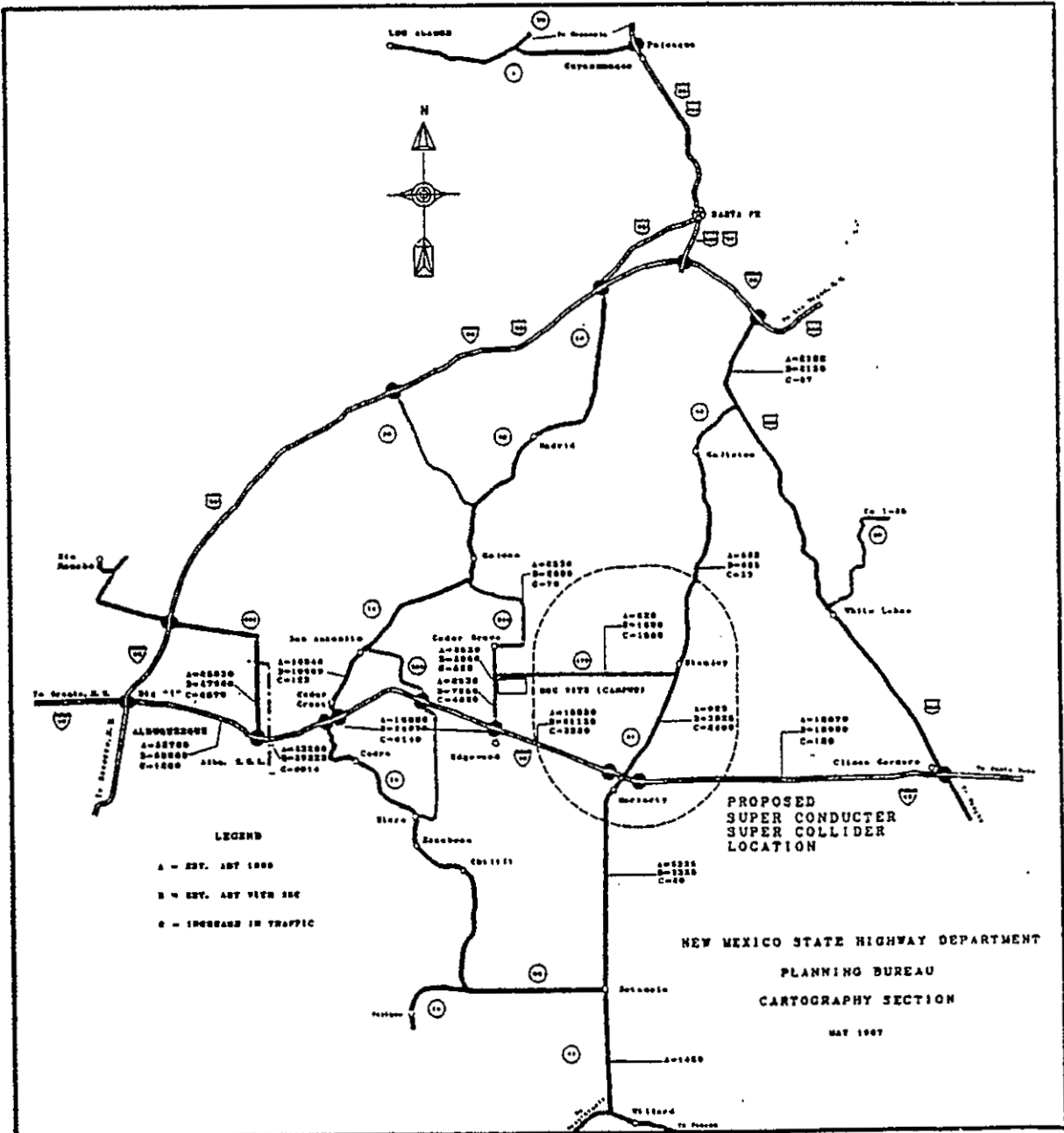

NEW MEXICO SSC PROPOSAL JULY 31, 1987

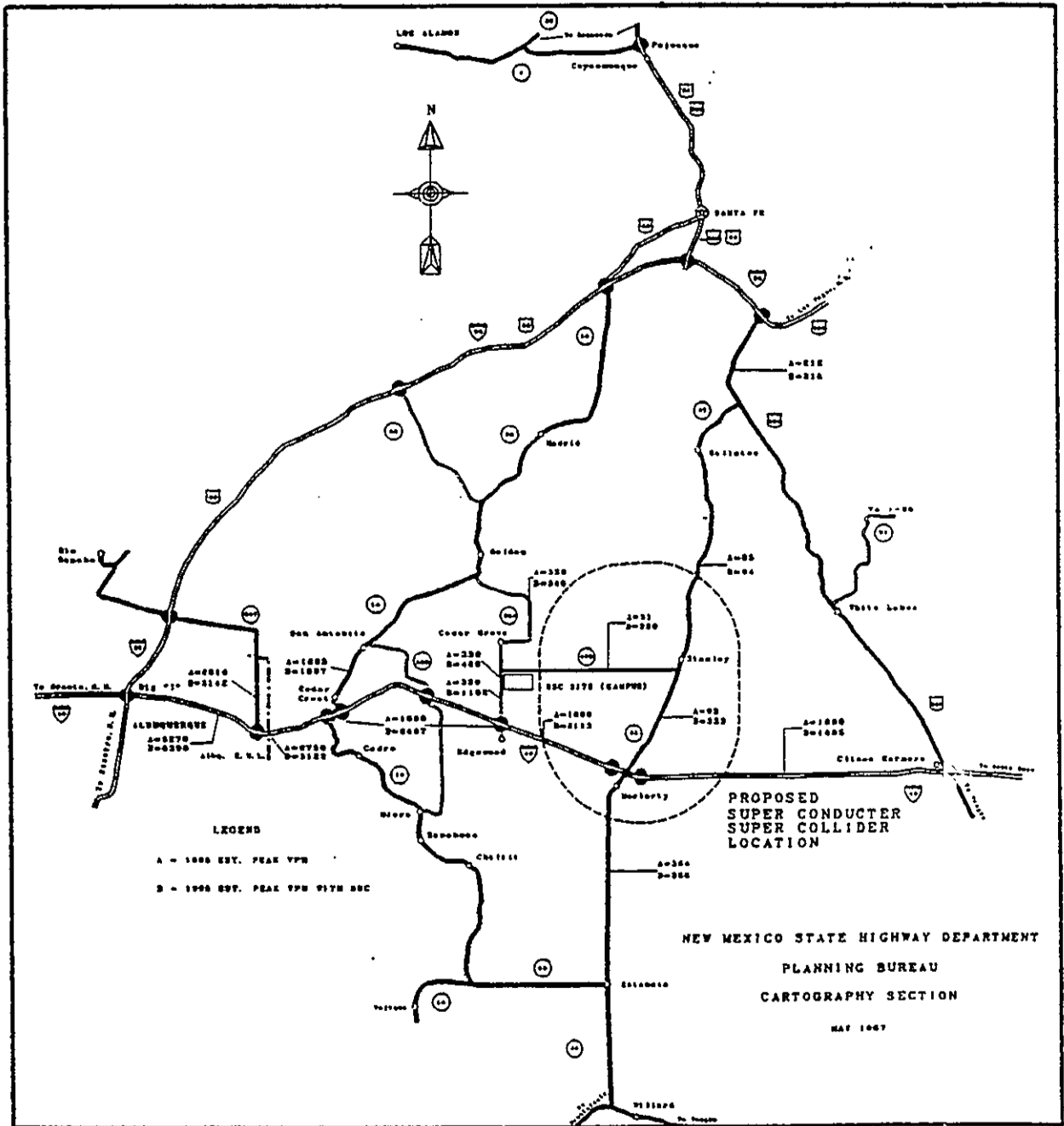

NEW MEXICO SSC PROPOSAL JULY 31, 1987

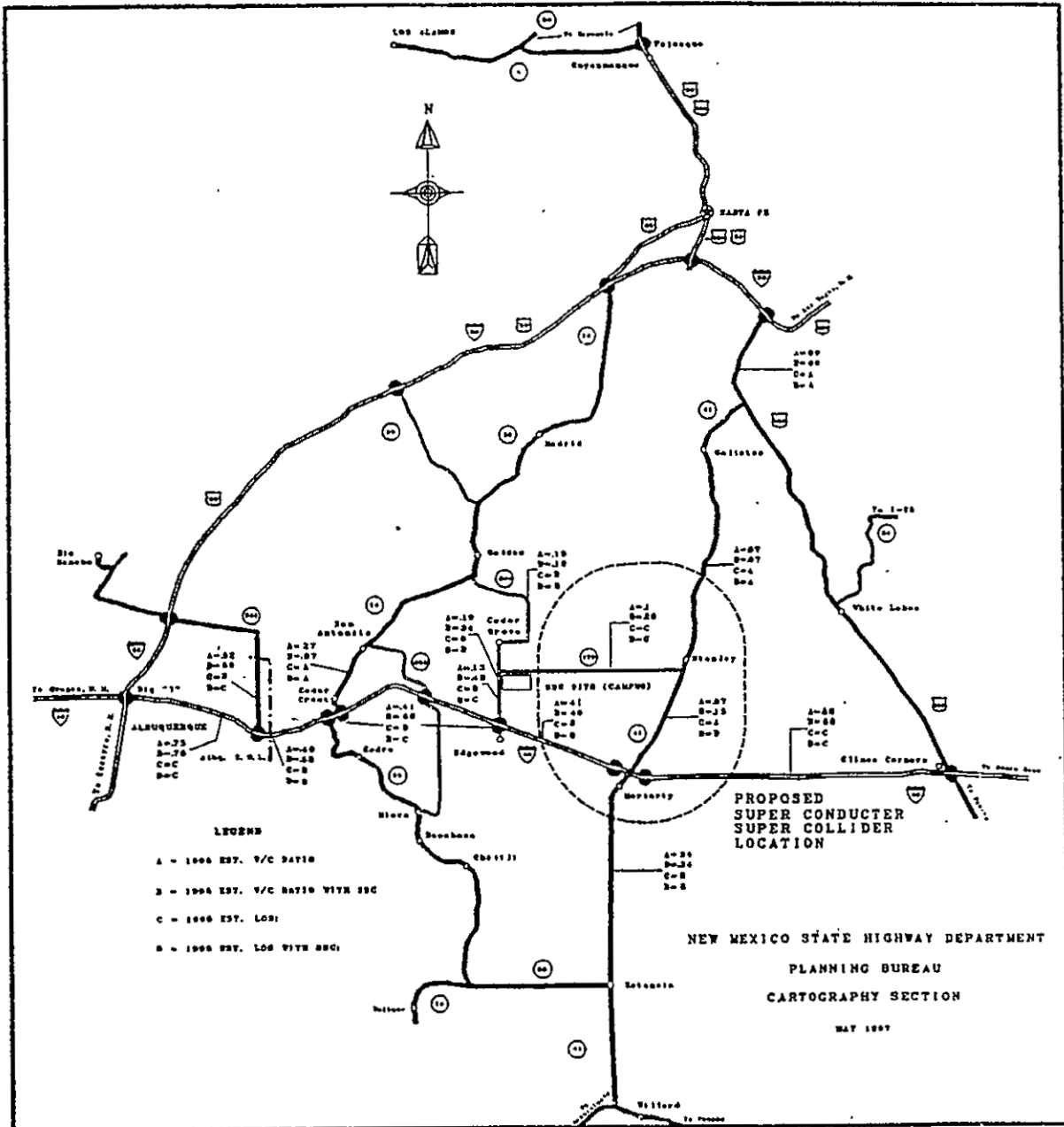

NEW MEXICO SSC PROPOSAL JULY 31, 1987

Appendix 4-B-4

Form No. 4-110
Rev. 8-29-79

**NEW MEXICO STATE
HIGHWAY DEPARTMENT**

INTRA-DEPARTMENTAL CORRESPONDENCE

SUBJECT SUPERCONDUCTING SUPER COLLIDER (SCC)

DATE May 29, 1987

FILE REFERENCE:

TO Anthony Garcia, T.S.E.

ATTENTION OF

FROM Pauline Orosco, Supervisor *PO*
Estimating Unit

The estimated construction bid cost including 10% E.&C. on subject project in "1988 Dollars" is as follows:

<u>ROUTE</u>	<u>TERMINI</u>	<u>MILES</u>	<u>TYPE</u>	<u>COST</u>
SR 344	I-40 to SR 14	17.53	Reconstruction	\$10,420,000
SR 472	SR 41 to SR 344	12.0	Reconstruction	\$ 7,220,000
SR 44	I-40 to SR 14	7.7	Reconstruction	\$ 4,930,000
SR 41	Willard to 8 mi. N. of Stanley	47.0	Reconst. 13.2 mi.) Overlay 16.4 mi.) 3-R 17.4 mi.)	\$26,810,000
				<u>\$49,380,000</u>

Note: Above costs do not include R/W and Utilities.

cc: Luis Duffy
Paul C. Roybal

Road Improvements Planned for SSC Area

FY 87/88 Annual Plan -	\$34,800,000
FY 87/88-91/92 Five Year Plan	74,194,000
SCC	49,380,000
Total	\$158,374,000

APPENDIX 4-C

Public Transportation

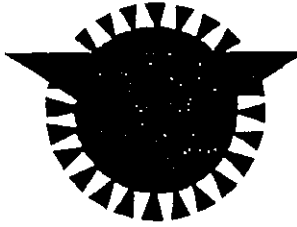

Ross Aviation, Inc.

June 11, 1987

Mr. John S. Herrington
Secretary of Energy
1000 Independence Avenue S.W.
Forestal Building
Washington, D.C. 20003

SUPERCONDUCTIVITY COLLIDER PROJECT

As members of the New Mexico business community deeply involved in the Department of Energy Programs, we at Ross Aviation, Inc. have a sincere interest in the Super Collider Project. The potential benefits of superconductivity to our society are undeniable and we would welcome the opportunity to provide any information or assistance which may be of value in the evaluation and selection of the site for this important project. We pledge our full support to Mr. Herman E. Roser in his efforts in assembling New Mexico's bid for the Superconducting Super Collider.

We believe that Ross Aviation, Inc. is in a unique position to provide a vital function in this worthy project through an expansion of our existing Air Transportation Service Contract (Contract No. DE-AC04-76DPO3276) with the U.S. Department of Energy (D.O.E.). Ross has provided the Albuquerque Office of the D.O.E. and the National Laboratories with Air Transportation Service since 1970. Ross provides this service under both FAR 121 air carrier operation as well as FAR 135 operation. Our operations range from busy commercial airports to military fields, to isolated test sites, to remote expeditionary landing sites. The company currently operates a diversified fleet of aircraft which includes the following:

- . DC-9 - (3);
- . DHC-7 - (3);
- . King Air Model B-200 - (2);
- . DHC-6 - (2); and
- . L-19 - (1)

These aircraft could be utilized and/or augmented as necessary to support the Super Collider Project at minimal cost and optimum efficiency.

P.O. BOX 9124 ALBUQUERQUE, NEW MEXICO 87119 TELEPHONE (505) 242-2811

NEW MEXICO SSC PROPOSAL JULY 31, 1987

Mr. John S. Herrington
June 11, 1987
Page Two

Throughout our service to the D.O.E., the company has achieved a record of both outstanding safety and exemplary accomplishment in service, responsiveness, and operational efficiency. These vital achievements on behalf of the D.O.E. have been compiled during a period of ever-growing, ever-changing requirements with a complex variety of passenger and cargo missions. Operations encompassing a mixture of scheduled, on-demand and special projects involving critical national security missions have posed great challenges and have been met.

Over the years, Ross has flown more than 115,000 hours without an accident. This is a remarkable accomplishment since the aircraft fleet, which is designed for mission effectiveness, has been composed of five or six different types of airplanes at any given time.

As Vice President and General Manager of Ross Aviation, Inc., I can pledge our complete cooperation with the DOE in whatever effort is required in support of the Super Collider Project. Please feel free to call upon us to provide any additional information which may be helpful in furtherance of this national project.



CHARLES FINKENBINE, JR.
VICE PRESIDENT AND GENERAL MANAGER

dr

APPENDIX 4-D

Industrial and Construction Resources

Appendix 4-D-1

Digital Equipment Corporation
P. O. Box 499
Albuquerque, New Mexico 87103
(505) 345-4471

digital

6/19/88

Ms. Valinda Parker
Southwest Land Research
P.O. Box 36120
Albuquerque, NM 87176

Dear Ms. Parker:

I appreciate the opportunity to provide information on Digital Equipment Corporation's technical capability in the State of New Mexico. We believe our presence here dramatically enhances the technology base in the State and its ability to support a project such as the Superconducting Super Collider. There are four areas that have led to our leadership position as a supplier of computing solutions in New Mexico.

1. Understanding Laboratory and Scientific Applications

Digital's roots are in the laboratory environment. Our first products were designed to acquire and process data by individual scientific experimentors in their laboratories. We designed products that were inexpensive and flexible-two characteristics essential to a changing laboratory environment.

These early products led to Digital's presence in New Mexico more than 20 years ago, supporting Sandia Labs and Los Alamos Labs. Since that time, Digital products have become the standard for Scientific Distributed Processing at the labs and are used extensively in virtually every other laboratory environment in the state. More than 2000 of Digital's PDP-11 and MicroVAX products are used in data acquisition and control in the state. In addition, every institution of higher learning in New Mexico uses Digital products for instruction in such areas as Computer Science, Physics, Chemistry and other scientific disciplines.

Digital's premier networking capability has led to its use in such projects as New Mexico's Technet, the National Magnetic Fusion Energy Network, and DOE's Wide Band Communication Network as well as the Distributed Processing Networks mentioned earlier.

2. Understanding the Government Environment

Digital is organized to understand and support the unique requirements of the Federal government. Besides our extensive government marketing, engineering and support resources located in New Hampshire (near Corporate Headquarters) and Washington, Digital's South Central Area Government Solutions District, headquartered in Albuquerque, concentrates on supporting Government requirements in Colorado, Texas, Oklahoma and New Mexico.

Digital supports the government's product requirements through specially engineered secure systems, and Tempest certified products among others. Digital's involvement in standards organizations insures our ability to coexist in the multi-vendor environment common to most government facilities.

3. Capability of Products

Digital has invested more than \$4 billion during the past 10 years in research and engineering. The result of these expenditures is a set of products based upon an architecture that ensures top to bottom compatibility, the ability to add capability only as needed and the assurance of compatibility as new technologies emerge and are exploited in products. Each computer, from the desk top MicroVAX to the Computer Data Center VAXcluster, is based on the same instruction set, data structures and operating software.

4. Capability of the New Mexico Field Service Organization

Digital services the state from three office locations: Los Alamos, servicing northern New Mexico; Albuquerque, servicing central New Mexico; and El Paso, servicing southern New Mexico, primarily White Sands Missile Range, Holloman AFB, and the Colleges and Universities in that area.

Digital has a staff of 145 professionals who provide hardware and software service, professional consulting and sales support for our products as well as selected products from other related manufacturers. One of 14 U.S. wide training centers is located in Los Alamos, teaching more than 300 different courses. The courses range from instruction on the use of Digital products like operating systems and languages, to generic courses on Artificial Intelligence and Data Base Technology.

Digital Equipment Corporation

Of the 145 personnel in New Mexico, 83 are virtually dedicated to the DOE. Also located in Albuquerque is the DOE National Account Manager, responsible for all-business that Digital does with the DOE. Among the technical staff, we can provide assistance in such areas as network design, special engineering, and software design.

Because of the quality of life in New Mexico, the staff has proven to be significantly more stable than in other areas of the country, with most of our local management having been here more than 10 years. This has fostered an environment of greater understanding with customers and an involvement in and commitment to the community.

The presence of a Digital manufacturing facility in Albuquerque adds to our ability to service customers. The plant produces a variety of state of the art workstations and houses a customer returns/repair facility, thus providing a level of support by Digital not found in most localities outside New England. The 250 engineers and technicians and almost 300 electronics workers add to technological base of the community and serve as a resource to the customers.

I think you will find that Digital provides a significant contribution to New Mexico's ability to host a complex program like the SSC. If you need more information or if I might be of further assistance, please don't hesitate to call.

Sincerely,

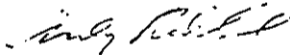

Andy Reddish
National Account Manager
D.O.E. Defense Programs

NEW MEXICO SSC PROPOSAL JULY 31, 1987



NEELY SALES REGION • P O. Box 10000, Albuquerque, New Mexico 87184 • Telephone (505) 823-6100
7801 Jefferson Street, N.E., Albuquerque, New Mexico 87109

June 30, 1987

Ms. Valinda Parker
Southwest Land Research
P. O. Box 36120
Albuquerque, NM 87176

Dear Valinda:

Because the State of New Mexico is a potential site for the Energy Department's Superconducting Supercollider project, you may be interested in Hewlett-Packard Company's facilities and capabilities in the state.

As a major designer and manufacturer of electronic products and systems for measurement and computation, Hewlett-Packard is capable of providing a broad range of products and services to a project of Superconducting Supercollider's magnitude. Hewlett-Packard's ability to combine its high quality precision instruments and computers makes the company uniquely capable of providing total solutions to the information needs of large, technical customers.

More than half the company's business in the State of New Mexico is currently from prime contractors or subcontractors of the Department of Energy. Our two New Mexico sales and support offices -- located in Albuquerque and Los Alamos -- also serve many other federal agencies, including both the Sandia and Los Alamos National Laboratories and Kirtland Air Force Base.

Our 40,000-square-foot Albuquerque office has 70 employees, half of them engineers with technical degrees, serving the hardware and software needs of customers. Our smaller Los Alamos office has a staff of six, five of whom are engineers.

The company is noted for its low turnover rate, and in the New Mexico offices turnover in the last two years has been nearly zero.

June 30, 1987

In addition to providing direct service and support to local customers, our Albuquerque office has product demonstration rooms and a fully equipped customer training center. The site also handles service and repairs and maintains \$500,000 in parts inventory for repair and replacement for all Hewlett-Packard product lines.

Hewlett-Packard Company is a Fortune 100 company, recognized internationally for the quality of its products and its dedication to customer satisfaction. Each Hewlett-Packard customer has its own support team of hardware and software experts. In addition, a company wide system called "Escalation Management" provides for assigning additional company resources to resolve difficult or unusual customer problems.

Should New Mexico be selected as the site for the Superconductor Supercollider, we at Hewlett-Packard have the resources -- including service and support, as well as products -- to contribute to its success.

Sincerely,

HEWLETT-PACKARD COMPANY
NEELY SALES REGION



Lynn Waide
Branch Business Manager

LW/yp



Appendix 4-D-3

NEW MEXICO DISTRICT OFFICE
8500 Menaul Blvd. N.E., Suite A-225, Albuquerque, New Mexico, 87112 • (505) 299-1300

June 11, 1987

Southwest Land Research, Inc.
P. O. Box 36120
Albuquerque, New Mexico 87176
Valinda Parker, Vice President

Dear Ms. Parker:

The Albuquerque Office of Cray Research, Inc. is one of the stronger district offices in Cray Research, Inc. This is primarily because of customers like Los Alamos National Laboratory, Sandia National Laboratories, and the Air Force Weapons Lab that need the latest and greatest in supercomputers. This office was opened in February of 1980. At that time there were three computers installed in what comprises the district territory. The district currently includes New Mexico, Colorado, Wyoming, Montana, Kansas, Nebraska and Missouri. The highest concentration of district people are in Albuquerque and at the sites that we service here in New Mexico.

We have about 40 people and of that 40 we have over ten which have been with us five years or longer. We have relatively low turnover in this office. We have people who have been promoted to other places in the company, but we have very few people leaving Cray. Cray has been growing tremendously over the last eight years and we've been fortunate in that we have lost very few and hired some extremely capable people.

A typical Cray analyst or salesman will have an advanced degree in science, engineering, physics, or computer science. A typical customer engineer will have either a bachelor's degree or an associate degree in electronics, electrical maintenance or liberal arts with a smattering of mathematicians and pre-science students.

Of the 40 people in New Mexico some are located in the district office but most of them are located at the sites. It is Cray policy to locate customer engineering at the site that uses the computer and usually we have some analysts at the site.

We have eleven machines in New Mexico and most of these have been installed by the Cray team that is now located here in New Mexico. These machines do a variety of things and we've had to learn how to work with them in a variety of situations. There are networks of various kinds. We use a variety of other machines as front-end inputs. We have extensive experience in using graphic devices with them and our customers use a variety of work stations. This office usually gets the experience first and indeed we've sent people to many other areas of the country

to help with installations, even to the extent of sending some to international accounts. Not connected with this office, but a resource nevertheless, will be two entities in Santa Fe. One will be a very senior analyst working for a special account in the eastern region and the other will be a software development activity to develop an ADA compiler. This office has sold all the various types of machines that Cray manufactures.

Because many of the sites needed to be expanded and in some cases prepared for the first time, we have developed a certain expertise in the electrical, mechanical and general contractors in this area concerning the installation and site preparation for supercomputers. We have located in this office a specialist in site preparation who is used throughout the entire Cray organization.

The region office for this district is in Boulder, CO and to back up the district analysts there is a staff of very senior analysts at the region who normally have a particular specialty. We also have some very senior customer engineers at the region level to help with the very difficult problems and to help install and maintain new products.

Cray has four regions in the United States. Our products are built in Chippewa Falls, WI. Our headquarters is located in Minneapolis, MN and we have software, product marketing and product support in Mendota Heights which is a suburb of Minneapolis.

We have a staff of specialists in Mendota who not only write software, but write applications software and produce demonstrations, do benchmarking, handling publications and consult with the districts whenever needed.

Cray Research has about 140 machines installed world-wide and about 70 percent of the market share of the supercomputer business. That's all Cray Research does. We put our entire energy into producing supercomputers and we have been the leader in that area now for the past eight years. We put 15 percent of our profit into research so that we may maintain that leadership and the 4,000 people at Cray Research are dedicated to doing just that.

If there is any additional information I can give you please let me know.

Very truly yours,

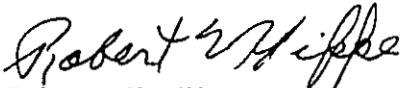

Robert W. Hippe

RWH:njr



SCIENTIFIC SALES ASSOCIATES

200 Altez S.E. Station E. P.O. Box 13201 Albuquerque, New Mexico 87192
(505) 266-7861 (505) 266-7862

June 16, 1987

Ms. Valinda Parker
Southwest Land Research Inc.
P.O. Box 36120
Albuquerque, NM 87176

Dear Ms. Parker,

Scientific Sales Associates, Inc. is a representative company for approximately sixteen (16) manufacturers of equipment for high vacuum cryogenic technologies. The major products available, along with all the necessary technical support are:

All types of mechanical pumps, cryopumps, diffusion pumps, turbomolecular pumps, and roots type blower packages for all vacuum ranges;

The oils and fluids used in vacuum pumping;

Valves of various types, sizes, and materials;

Vacuum hardware such as flanges, manifolding, and seals;

Any necessary gauging/instrumentation for measuring the vacuum pressure;

Cryogenic vacuum insulated liquid helium and liquid nitrogen transfer systems.

Cryolab, a major national manufacturing firm represented by Scientific Sales, produces cryogenic valves and vacuum insulated cryogenic piping transfer systems. They are located in San Luis Obispo, CA, and have participated/provided systems for the following:

Lawrence Livermore National Lab. Hardware and technical support for liquid helium and liquid nitrogen supply lines.

NASA Johnson/White Sands Rocket Test Facility. Hardware and technical support. 4" diameter liquid hydrogen and liquid oxygen supply lines for test stand 401.

Martin Marietta, Vandenberg Operations. Hardware and technical support 10" diameter liquid hydrogen and 4" diameter liquid oxygen loading systems, Vandenberg Space Shuttle Project.

Sandia National Labs. Hardware and technical support. Scheduled to install liquid nitrogen supply piping in Bldgs. 893, RHIC, and 6594.

Airco. Vacuum jacketed piping for air reduction manufacturing plants and several helium liquefaction plants.

Scientific Sales has a combined vacuum/cryogenic experience level in excess of forty-five (45) years. One sales manager while employed at Sandia National Labs had a super conducting magnet project cooled by liquid helium. The liquid helium was produced from gaseous helium in an on-site refrigeration liquefaction unit. A "layered" technique of liquid helium, vacuum, liquid nitrogen, and vacuum again was used to minimize the heat losses.

We have recently been privileged to provide technical support to Lovelace Hospital on their "Magnetic Resonance Imaging" (MRI) machine which uses a liquid helium cooled super conducting magnet.

In closing, we would simply say that the hardware as well as the technical support for the technology involved in the SSC is available in New Mexico.

Sincerely,



Phil Brubaker
Sales Representative

Appendix 4-D-5



DEPARTMENT OF THE AIR FORCE
AIR FORCE WEAPONS LABORATORY (AFSC)
KIRTLAND AIR FORCE BASE, NM 87117-6008

25 JUN 1987

Department of Energy
Office of Energy Research
Washington DC 20585

Dear Sirs

The Air Force Weapons Laboratory (AFWL), located at Kirtland Air Force Base, has operated a computer center since 1965. We have had a CRAY-1S computer since 1979, and in August of this year will receive a CRAY-2. We have 135 people working in the computer center to support this supercomputer effort.

If the superconductor supercollider is located in New Mexico, we would be more than willing to lend expertise to help them establish a supercomputer center of their own. We have helped the Navy and Army establish supercomputer centers in the past and have a very strong working relationship with Sandia National Laboratory and Los Alamos National Laboratory.

I feel we could offer a tremendous amount of knowledge to this effort. If you need additional information, I will be happy to supply it.

Sincerely

DR NAZARENO L. RAPAGNANI
Chief, Communications-Computer
Systems Technology Office

NEW MEXICO SSC PROPOSAL JULY 31, 1987



TELEPHONE (505) 243-8851
2851 PAN AMERICAN FREEWAY, NE, SUITE D
POST OFFICE DRAWER "S" ALBUQUERQUE, NEW MEXICO 87103

January 16, 1987

Southwest Land Research, Inc.
2400 Louisiana Blvd. N. E.
Building Five, Suite 260
Albuquerque, New Mexico 87176

Attention: Valinda Parker

Re: State of New Mexico Proposal on the Super Collider

Dear Valinda,

As mentioned in our previous discussions regarding the above referenced project, Springer Building Materials Corporation would be extremely capable of serving the concrete, sand, and gravel needs for a project of this magnitude.

Originally established in 1902, Springer Building Materials Corporation has been serving the commercial construction requirements in the community, especially in the high technological field, for over seventy five years. With a marketing and sales approach that has targeted projects demanding unique concrete requirements, Springer has successfully supplied the concrete on the following recent projects located at Kirtland Air Force Base:

1.) 1/6 Scale Model Nuclear Containment Vessel- Constructed by United Engineers of Philadelphia, this state of the art project was the first constructed in the world. Designed to test the load bearing capacity of a containment vessel similar to those used throughout the United States, this project demanded a special concrete mix using a scaled down aggregate and extended life superplasticizer.

2.) Extension of the Rocket Sled Track- Constructed by K. L. House Construction of Albuquerque, New Mexico, this project extended the existing sled track by one mile. With rocket speeds exceeding 2,000 mph, the utmost accuracy in grade construction was a stringent requirement. Once again, a high strength flowable mix design was created through the use of superplasticizer.

3.) 16' Diameter Shock Tube-Constructed by Ed Logan Contracting out of Arizona, this project was designed to recreate the shock waves that would be experienced during a nuclear explosion and determine how it would effect the capabilities of the new medium range mobile missile launch system being employed by the United States Army. Both a high strength concrete mix design and superplasticizer ensured success of this project.

4.) Solar Tower-Constructed by R. E. McKee Construction of El Paso, Texas, this multi-story facility was designed to advance the research in solar energy. High strength concrete designed for use in slip form construction highlighted this project.

5.) Other miscellaneous projects located on Kirtland Air Force Base that Springer Building Materials Corporation has supplied concrete on are listed below:

- a. Electron Beam Fusion Facility
- b. Trestle Site
- c. New Mexico Engineering Research Facility Projects
- d. MX Missile Silo Research Project

Furthermore, Springer Building Materials Corporations ability to produce high specification concrete is highlighted by it's ability to perform in house quality control and quality assurance testing. With two registered professional engineers employed, Springer has the knowledge and ability to design and statistically monitor specialty concrete mixes, conduct cylinder and beam tests, sand gradations, and other miscellaneous testing. Current editions of ASTM and ACI specifications are kept in an updated library that is available to our customers.

Operationally, Springer Building Materials Corporation has, within it's corporate structure, the ability to draw upon a vast resource of equipment. Both concrete and sand and gravel equipment is available to satisfy the requirements of most types of projects.

Valinda, we appreciate your inquisition into Springer Building
Materials Corporation and appreciate the opportunity to become
part of the state of New Mexico's proposal on the Super Collider.

Good Luck in your continuing research!

Sincerely,
Springer Building Materials Corp.

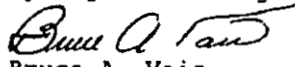
Bruce A. Vaio
Marketing Director

Appendix 4-D-7

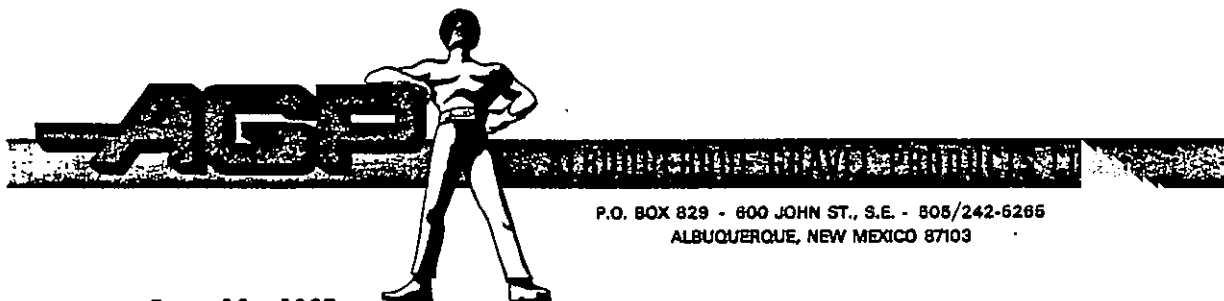

June 10, 1987

Dear Sirs:

Albuquerque Gravel Products Co., Inc., a division of Sundt Corporation, is a major producer of concrete, sand and gravel products in the state of New Mexico. A.G.P., as we are known across the state, has throughout its history provided concrete and sand and gravel products for many and various state and federal agencies including the Energy and Defense Departments. Our technical expertise and reliability have been proven time and again in projects such as the Particle Beam Fusion Accelerator Complex and the pulse reactor for Sandia Laboratories at Kirtland Air Force Base in Albuquerque, New Mexico. These two projects in particular showcased our ability to produce and deliver tight specification materials in a timely and professional manner.

A.G.P. is currently operating two stationary transit mix plants and one portable batch plant. All three plants are completely automated as is our central dispatching system. This state of the art equipment makes it possible for us to batch a variety (over 250 currently in our product file) of concrete mixes, with a precision and consistency that compares favorably with any concrete producer in the country.

A.G.P.'s fleet of transit mix trucks numbers seventy-five at present. Most of these mixers have a ten cubic yard capacity.

Our in-house testing laboratory keeps us, we feel, at the leading edge of concrete technology through research and testing of new products. The laboratory is fully equipped to perform most of the ASTM and ACI tests on concrete and sand and gravel.

Our sand and gravel mining and classifying operations are also completely automated and located on approximately 600 acres of land in the Albuquerque metropolitan area. We also have access to an additional 600 plus acres of mining reserves located on the Sandia Indian Reservation just north of the city. When combined with other reserves further north of the city, these give us a mining reserve that should last upwards of twenty years.

● MEMBERS NATIONAL READY-MIXED CONCRETE ASSOCIATION AND AMERICAN CONCRETE INSTITUTE ●

NEW MEXICO SSC PROPOSAL JULY 31, 1987

The sand and gravel fleet consists of twelve dump trucks, five tandem and pup rigs and five semi tractor trailers. These work out of the main pit and supply our concrete batch plants as well as our sand and gravel customers. Specification sands and gravels are manufactured by two crushing and screening plants located at the main pit. We also wash and classify materials at this location.

We at A.G.P. are very proud of our land reclamation activities. We have just recently completed the reclamation and sale of several acres to the south of our present mining operations. This land is being developed under the name of Renaissance Center and will contain a variety of hotels, restaurants, and even a soon to open water recreation park.

As one can see from our record of over forty years in the business of producing specification concrete and sand and gravel products, we at A.G.P. would welcome the opportunity and challenge of involvement in the proposed S.S.C. project. Our people, machinery and land holdings, we feel, make us confident in our ability to meet the requirements of a project of this magnitude. Our various operations and equipment could contribute to the project in many ways. In addition to supplying ready mixed concrete and sand and gravel products, we feel that we can also be of assistance in transporting materials and also disposing of excavated materials. We are anxious to continue our tradition of supplying quality materials and technical expertise to the construction industry and point to our excellent track record and many years of involvement in defense and energy related projects in the state of New Mexico.

Sincerely,

ALBUQUERQUE GRAVEL PRODUCTS CO.



Michael La Manna
Sales Representative

MPLM/cb

Appendix 4-D-8. Unsolicited applicants by degree type, January 1987 - May 1987, Los Alamos National Laboratories [4.4-30].

Applicant's Degree Type	Unsolicited Applications Received
General Administration	1938
Technical Services	
Electrical Engineering	419
Mechanical Engineering/Applied Mechanics	390
Environmental Life Sciences Engineering	522
Earth Science Engineering	199
Chemical Engineering	73
Civil/Architectural Engineering	140
Industrial Engineering	78
Nuclear and Accelerator Engineering	77
Materials Science Engineering	50
Space Science Engineering	35
Physics	497
Chemistry	221
Mathematics/Computer Science	579
Fabrication/Crafts	26
Double Majors	84
No Degree Type Stated	192
Total	5520

Applicant's Degree Level	Unsolicited Applications Received
Ph.D.	1627
MS, MA	492
BS, BA	2363
AA or TIG	906
No degree	132
Total	5520

APPENDIX 4-E

Human Resources

Appendix 4-E-1. Social and economic characteristics of the population in the vicinity of the SSC, Bernalillo County [4.5-1, 4.5-5].

1. Population Totals by Age and Sex, 1985.

Age	Total	Male	Percent	Female	Percent
0-4	39,800	20,200	4.3	19,600	4.2
5-9	33,700	17,000	3.6	16,700	3.6
10-14	33,000	16,800	3.6	16,200	3.4
15-19	34,900	17,600	3.7	17,300	3.7
20-24	44,100	21,500	4.6	22,600	4.8
25-29	48,100	23,400	5.0	24,700	5.3
30-34	44,500	21,900	4.7	22,600	4.8
35-39	38,200	19,000	4.0	19,200	4.1
40-44	28,100	13,800	2.9	14,300	3.0
45-49	22,300	10,800	2.3	11,500	2.4
50-54	20,600	9,800	2.1	10,800	2.3
55-59	19,900	9,200	2.0	10,700	2.3
60-64	19,700	9,000	2.0	10,700	2.3
65-69	15,100	7,000	1.5	8,100	1.7
70-74	12,100	5,100	1.1	7,000	1.5
75 or more	16,100	5,600	1.2	10,500	2.2
Total	470,200	227,700	48.4	242,500	51.6

2. Years of School Completed, 25 Years of Age or Older, 1980

		Male	Percent	Female	Percent
Elementary:	0-4 years	2,965	2.6	3,549	2.9
	5-7 years	4,660	4.1	5,140	4.2
	8 years	5,153	4.6	6,465	5.2
High School:	1-3 years	12,219	10.8	15,403	12.4
	4 years	32,931	29.2	47,017	38.0
College:	1-3 years	22,999	20.4	24,220	19.6
	4 years	13,395	11.9	11,439	9.2
	5 years	18,581	16.5	10,545	8.5
	or more				
Total		112,903	100.1	123,778	100.0

Continued on next page

Appendix 4-E-1. (Continued)

3. Household Income, 1979

	Total	Percent
Less than \$5,000	18,815	12.4
\$5,000 - 7,499	12,130	8.0
\$7,500 - 9,999	12,775	8.4
\$10,000 - 14,999	26,090	17.2
\$15,000 - 19,999	21,711	14.3
\$20,000 - 24,999	18,357	12.1
\$25,000 - 34,999	22,702	15.0
\$35,000 - 49,999	12,311	8.1
\$50,000 or more	6,428	4.2
Median	\$16,239	
Mean	\$19,670	
Total Households	151,319	

Appendix 4-E-2. Social and economic characteristics of the population in the vicinity of the SSC, Santa Fe County [4.5-1, 4.5-5]

1. Population Totals by Age and Sex, 1985.

Age	Total	Male	Percent	Female	Percent
0-4	7,100	3,500	4.1	3,600	4.3
5-9	6,300	3,200	3.8	3,100	3.7
10-14	6,300	3,200	3.8	3,100	3.7
15-19	6,600	3,400	4.0	3,200	3.8
20-24	7,200	3,600	4.3	3,600	4.3
25-29	6,700	3,300	3.9	3,400	4.0
30-34	7,900	3,900	4.6	4,000	4.7
35-39	7,900	4,000	4.7	3,900	4.6
40-44	5,700	2,900	3.4	2,800	3.3
45-49	4,400	2,200	2.6	2,200	2.6
50-54	3,600	1,800	2.1	1,800	2.1
55-59	3,500	1,600	1.9	1,900	2.2
60-64	3,200	1,500	1.8	1,700	2.0
65-69	2,700	1,200	1.4	1,500	1.8
70-74	2,300	1,000	1.2	1,300	1.5
75 or more	3,500	1,300	1.5	2,200	2.6
Total	84,700	41,500	49.0	43,200	51.0

2. Years of School Completed, 25 Years of Age or Older, 1980

		Male	Percent	Female	Percent
Elementary:	0-4 years	771	3.7	809	3.5
	5-7 years	1,072	5.1	1,139	5.0
	8 years	985	4.7	1,112	4.9
High School:	1-3 years	2,229	10.7	2,476	10.8
	4 years	5,635	27.0	7,676	33.5
College:	1-3 years	3,599	17.2	4,382	19.1
	4 years	2,709	13.0	2,968	13.0
	5 years	3,905	18.7	2,334	10.2
	or more				
Total		20,905	100.1	22,896	100.0

Continued on next page

Appendix 4-E-2. (Continued)

3. Household Income, 1979

	Total	Percent
Less than \$5,000	3,442	13.1
\$5,000 - 7,499	2,152	8.2
\$7,500 - 9,999	2,411	9.2
\$10,000 - 14,999	4,397	16.7
\$15,000 - 19,999	3,881	14.7
\$20,000 - 24,999	3,130	11.9
\$25,000 - 34,999	3,811	14.5
\$35,000 - 49,999	2,025	7.7
\$50,000 or more	1,064	4.0
Median	\$15,852	
Mean	\$19,363	
Total Households	26,313	

Appendix 4-E-3. Social and economic characteristics of the population in the vicinity of the SSC, Torrance County [4.5-1, 4.5-5].

1. Population Totals by Age and Sex, 1985.

Age	Total	Male	Percent	Female	Percent
0-4	752	345	4.0	407	4.7
5-9	774	409	4.8	365	4.3
10-14	765	403	4.7	362	4.5
15-19	726	353	4.1	373	4.3
20-24	562	299	3.5	263	3.1
25-29	463	195	2.3	268	3.1
30-34	682	349	4.1	333	3.9
35-39	630	331	3.9	299	3.5
40-44	451	224	2.6	227	2.6
45-49	430	215	2.5	215	2.5
50-54	376	197	2.3	179	2.1
55-59	403	193	2.2	210	2.4
60-64	417	191	2.2	226	2.6
65-69	408	186	2.2	222	2.6
70-74	344	161	1.9	183	2.1
75 or more	415	198	2.3	217	2.5
Total	8,579	4,249	49.5	4,348	50.5

2. Years of School Completed, 25 Years of Age or Older, 1980

		Male	Percent	Female	Percent
Elementary:	0-4 years	147	7.0	98	4.4
	5-7 years	217	10.4	194	8.7
	8 years	224	10.7	224	10.1
High School:	1-3 years	284	13.6	407	18.3
	4 years	783	37.4	904	40.7
College:	1-3 years	221	10.6	200	9.0
	4 years	90	4.3	100	4.5
	5 years	125	6.0	94	4.2
	or more				
Total		2,091	100.0	2,221	99.9

Continued on next page

Appendix 4-E-3. (Continued)

3. Household Income, 1979

	Total	Percent
Less than \$5,000	629	23.3
\$5,000 - 7,499	347	12.8
\$7,500 - 9,999	258	9.5
\$10,000 - 14,999	641	23.7
\$15,000 - 19,999	305	11.3
\$20,000 - 24,999	192	7.1
\$25,000 - 34,999	203	7.5
\$35,000 - 49,999	84	3.1
\$50,000 or more	44	1.6
Median	\$10,830	
Mean	\$13,062	
Total Households	2,703	

Appendix 4-E-4. Social and economic characteristics of the United States population, 1980 [4.5-6].

1. Years of School Completed, 25 Years of Age or Older, 1980

	Male Percent	Female Percent
Elementary: 0-4 years	3.9	3.3
5-7 years	6.8	6.5
8 years	7.8	8.2
High School: 1-3 years	14.2	16.2
4 years	31.1	37.7
College: 1-3 years	16.1	15.3
4 years	9.8	7.5
5 years	10.3	5.3
or more		
Total	100.0	100.0

3. Household Income, 1979

	Percent
Less than \$5,000	13.1
\$5,000 - 7,499	7.9
\$7,500 - 9,999	7.8
\$10,000 - 14,999	15.2
\$15,000 - 19,999	15.2
\$20,000 - 24,999	12.3
\$25,000 - 34,999	15.5
\$35,000 - 49,999	8.5
\$50,000 or more	4.5
Median	\$16,841
Mean	\$20,306

Appendix 4-E-5. Wage and salary employment (jobs) projections, Albuquerque SMSA (Bernalillo and Sandoval Counties) 1985-2000 [4.5-10].

	1985	1990	1995	2000
Total jobs	227,682	255,240	287,067	318,502
Annual increase		2.3	2.4	2.1

Appendix 4-E-6. Wage and salary employment (jobs), by Standard Industrial Classification (SIC) industry division, New Mexico counties in vicinity of the SSC, 1970-1986. 1, January-September average in 1986. 2, Not available for industry category, included in services employment total. [4.5-7].

	1970	Per- cent	1980	Per- cent	1986	Per- cent	Annual Percent Increase
<u>Bernalillo</u>							
Mining	300	0.3	300	0.2	200	0.1	-2.5
Construction	9,300	8.6	12,600	6.9	17,000	7.5	3.8
Manufacturing	7,000	6.5	17,200	9.4	19,600	8.6	6.6
Transportation & Utilities	6,900	6.4	11,500	6.3	12,300	5.4	3.7
Wholesale & Retail Trade	26,400	24.4	46,300	25.3	58,200	25.7	5.1
Finance, Insurance & Real Estate	6,500	6.0	10,600	5.8	14,200	6.3	5.0
Services	25,400	23.4	42,500	23.2	60,700	26.8	5.6
Government	26,600	24.5	42,000	23.0	44,500	19.6	3.3
Total	108,400		183,000		226,700		4.7

<u>Santa Fe¹</u>							
Mining	135	0.8	370	1.3	120	0.3	-0.7
Construction	880	5.4	1,871	6.5	2,729	7.4	7.3
Manufacturing	697	4.2	1,321	4.6	1,505	4.1	4.9
Transportation & Utilities	660	4.0	909	3.2	1,165	3.2	3.6
Wholesale & Retail Trade	3,332	20.3	5,983	20.9	8,937	24.3	6.4

Continued on next page

Appendix 4-E-6. (Continued)

Finance, Insurance & Real Estate	781	4.8	1,284	4.5	1,679	4.6	4.9
Services	3,532	21.5	7,226	25.2	9,713	26.5	6.5
Government	6,397	39.0	9,725	33.9	10,861	29.6	3.4
Total	16,414		28,689		36,709		5.2

Torrance¹

Mining	0	0.0	NA ²	—	NA ²	—	—
Construction	NA ²	—	32	2.6	49	3.5	7.4
Manufacturing	NA ²	—	43	3.5	49	3.5	2.2
Transportation & Utilities	119	13.0	108	8.9	89	6.3	-1.8
Wholesale & Retail Trade	257	28.2	381	31.3	490	34.9	4.1
Finance, Insurance & Real Estate	10	1.1	14	1.1	26	1.9	6.2
Services	120	13.2	74	6.1	148	10.5	1.3
Government	406	44.5	568	46.6	553	39.4	2.0
Total	912		1,220		1,404		2.7

Appendix 4-E-7. Detailed civilian labor force participation rates, Albuquerque SMSA (Bernalillo and Sandoval Counties), 1980 [4.5-11].

Age	Males in Labor Force	Percent of Total	Females in Labor Force	Percent of Total
16 years or older	125,319	76.6	90,720	51.6
16-19	10,195	54.8	8,558	46.7
20-24	18,760	82.2	16,380	68.8
25-29	20,175	91.0	15,499	68.5
30-34	18,509	94.1	12,409	62.6
35-39	13,256	94.2	9,218	62.4
40-44	10,750	93.1	7,562	62.5
45-49	9,899	92.8	6,184	56.7
50-54	8,738	85.3	5,762	51.3
55-59	7,403	74.5	4,948	42.4
60-64	4,665	56.3	2,411	27.0
65-69	1,828	27.8	1,021	13.0
70-74	781	18.3	458	7.6
75 or older	360	7.7	310	4.0

Appendix 4-E-8. Civilian labor force participation rates,
New Mexico counties in vicinity of the SSC and U.S., 1980
[4.5-5, 4.5-6].

Age	Males in Labor Force	Percent of Total	Females in Labor Force	Percent of Total
<u>Bernalillo County</u>				
16 years or older	112,848	74.4	84,798	52.0
16-19	9,226	53.6	7,942	46.9
20-24	16,603	76.8	15,427	68.6
25-54	73,167	88.9	52,829	62.1
55-64	11,142	66.6	6,931	36.9
65 or older	2,710	19.6	1,669	8.4
<u>Santa Fe County</u>				
16 years or older	19,616	73.2	15,734	54.6
16-19	1,544	53.0	1,314	45.2
20-24	2,173	72.5	2,197	73.0
25-54	13,248	86.9	10,776	68.4
55-64	2,091	70.9	1,151	37.7
65 or older	560	20.6	296	7.3
<u>Torrance County</u>				
16 years or older	1,717	66.1	948	34.8
16-19	115	47.7	90	35.0
20-24	246	92.5	140	57.6
25-54	1,133	85.3	594	44.2
55-64	180	53.3	118	29.2
65 or older	43	10.1	6	1.3

Continued on next page

Appendix 4-E-8. (Continued)

Age	Male Percent of Total	Female Percent of Total
<u>United States</u>		
16 years or older	73.3	49.8
16-19	49.9	45.4
20-24	77.7	67.2
25-54	90.8	63.0
55-64	71.2	41.6
65 or older	19.3	8.2

Appendix 4-E-9. Standard Industrial Classifications (SIC) of private sector technology-based corporations, New Mexico, 1986 [4.5-13].

Code	Short Title
2831	Biological products
2833	Medicinals and botanicals
2834	Pharmaceutical preparations
3573	Electronic computing equipment
3576	Scales and balances, except laboratory
3579	Office machines, not elsewhere classified
3599	Machinery, except electrical, not elsewhere classified
3661	Telephone and telegraph apparatus
3662	Radio and TV communication equipment
3674	Semiconductors and related devices
3676	Electronic resistors
3679	Electronic components, not elsewhere classified
3721	Aircraft
3724	Aircraft engines and engine parts
3728	Aircraft equipment, not elsewhere classified
3761	Guided missiles and space vehicles
3811	Engineering and scientific instruments
3822	Environmental controls
3823	Process control instruments
3825	Instruments to measure electricity
3829	Measuring and controlling devices, not elsewhere classified
3832	Optical instruments and lenses
3841	Surgical and medical instruments
3842	Surgical appliances and supplies
3851	Ophthalmic goods
7372	Computer programming and software
7374	Data processing services
7379	Computer related services, not elsewhere classified

Appendix 4-E-10

David F. Montoya
Executive Director



OFFICE:
930 BACA STREET, SUITE A
SANTA FE, NEW MEXICO 87501
PHONE: (505) 827-6420

HUMAN RIGHTS COMMISSION
OF NEW MEXICO
GARREY CARRUTHERS
Governor

COMMISSIONERS
ELAINE R. TRUJILLO
Chairperson
Santa Fe, NM
DAVID BUSSE
Vice Chairperson
Las Cruces, NM
JIM ATCITY
Shiprock, NM
GILBERT FERRAN
Española, NM
TYRONE L. HARDY
Albuquerque, NM
ERNESTINE A. FLOREZ
Carlsbad, NM

May 26, 1987

United States Department of Energy
Office of Energy Research
Washington, D.C. 20585

Dear Sir/Madam:

In conjunction with the state of New Mexico's proposal to the U.S. Department of Energy for the national Superconducting Super Collider project, I have been asked to offer a brief overview of the human rights regulatory status involving the law and regulations for the state of New Mexico.

The state of New Mexico has one comprehensive statute and set of regulations covering categories and issues within which unlawful discrimination is charged. Under New Mexico state law persons are protected from discrimination in the categories of employment, housing, credit and public accommodations. They are protected from discrimination on the bases of race, color, national origin, sex, religion, ancestry and physical/mental handicap in all the basic categories. Additionally, they are protected from age discrimination in employment. Age protection does not have a coverage limitation such as the recently amended federal Age Discrimination in Employment Act which protects persons from ages forty years and above. Every employer in the state not including an entity of the federal government or tribal government with four or more employees is subject to the Human Rights Act unless otherwise exempt by law.

The New Mexico Human Rights Act provides for awards of unlimited actual damages and reasonable attorney's fees after a determination of unlawful discrimination. Determinations are made by three members of the seven members Commission and are subject to appeal into the state's district court system. Compared to the coverage of other state civil rights laws in the nation New Mexico's Human Rights Act is one of the country's most inclusive in its categories and bases while allowing for due process in complaint resolution by providing for a formal administrative hearing on the facts.

NEW MEXICO SSC PROPOSAL JULY 31, 1987

United States Department
of Energy
Page 2

The New Mexico Human Rights Act also directs the Human Rights Commission to promote civil rights awareness through educational programs developed in cooperation with the state department of education and local school districts throughout the state. At the present time, the education section of the Commission is offering a "no charge" series of briefing sessions and workshops to employers, community organizations, real estate agents and brokers on a variety of current civil rights issues. All of the educational offerings are designed to inform and assist participants in the direction of preventing unlawful discrimination.

If the Commission can be of further assistance or explain any additional aspect of its program please feel free to contact us at (505) 827-6420.

Sincerely,

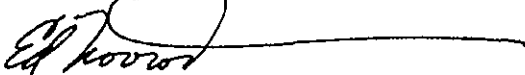
A handwritten signature in cursive script, appearing to read "Ed. Navrot", is written over a horizontal line.

Ed. Navrot
Director, Education Section

EN/mr

APPENDIX 4-F

Housing

Appendix 4-F-1. Occupancy status of SSC vicinity area housing stock, 1980. [4.6-5]

County/ Municipality	Total Housing Units	Owner Occupied	Percent of Total	Renter Occupied	Percent of Total	Vacant Units	Percent of Total
Bernalillo County	161,843	95,529	59	55,508	34	10,806	7
Albuquerque	132,757	75,389	57	48,643	37	8,725	6
Remainder of County	29,086	20,140	69	6,865	24	2,081	7
Santa Fe County	28,174	17,460	62	8,827	31	1,887	7
Santa Fe City	18,962	10,932	58	6,919	36	1,111	6
Remainder of County	9,212	6,528	71	1,908	21	776	8
Torrance County	3,222	2,167	67	478	15	577	18
Moriarty	534	380	71	82	16	72	13
Remainder of County	2,688	1,787	66	396	15	505	19

APPENDIX 4-G

Community Services

Appendix 4-G-1. Medical centers and hospitals [4.7-21].

Facility	Location	Number of Beds	Staff	General Hospital Care	Emergency Care	Specialized Surgery	Special Cancer Treatment Facilities	Psychiatric Services/ Substance Abuse	Burn/Trauma Center
University of New Mexico Medical Center	Albuquerque	340	1949	X	X	X	X	X	Level 1
Presbyterian Hospital- Main Campus	Albuquerque	499	1800	X	X	X			Level 2
Kaseman Pres.	Albuquerque	252	600	X	X			X	
Northside Proo.	Albuquerque	119	135						
Pickard Convalescent Center	Albuquerque	120	90						
Lovelace Medical Center	Albuquerque	230	1900	X	X	X	X	X	
St. Joseph Hospital	Albuquerque	313		X	X	X	X		
St. Joseph West Mesa Hospital	Albuquerque	128		X					
Heights General Hospital	Albuquerque	120	275	X				X	
Memorial Hospital	Albuquerque	58	120					X	
Carrie Tingley Hospital	Albuquerque	38	112-120						
Vista Sandia Hospital	Albuquerque	92	100					X	
Heights Psychiatric Hospital	Albuquerque	80	120					X	
Charter Sunrise Hospital	Albuquerque	80	100					X	
St. Vincent Hospital	Santa Fe	268	1000	X	X		X	X	Level 2
Pinon Hills	Santa Fe Los Alamos (outpatient)	32	50					X	
Veteran's Administration Medical Center/ Kirtland AFB Hospital	Albuquerque	475	1400	X		X			
PHS Indian Hospital	Albuquerque	54		X					
	Santa Fe	55		X					

Continued on next page

NEW MEXICO SSC PROPOSAL JULY 31, 1987
4-178

Facility	Location	Special Pediatric Services	Organ Transplants (including heart)	Diabetes Center	Air Ambulance	Other	Teaching	Research	Satellite Clinics/ Urgent Care
University of New Mexico Medical Center	Albuquerque	X			X		X	X	
Presbyterian Hospital- Main Campus	Albuquerque	X	X	X	X				2 Albuquerque 1 Los Lunas
Kaseman Pres. Northside Pres. Pickard Convalescent Center	Albuquerque Albuquerque Albuquerque					X			
Lovelace Medical Center	Albuquerque			X				X	6 Albuquerque 1 Santa Fe
St. Joseph Hospital	Albuquerque					X		X	
St. Joseph West Mesa Hospital	Albuquerque								
Heights General Hospital	Albuquerque								
Memorial Hospital	Albuquerque								
Carrie Tingley Hospital	Albuquerque	X							
Vista Sandia Hospital	Albuquerque								
Heights Psychiatric Hospital	Albuquerque								
Charter Sunrise Hospital	Albuquerque								
St. Vincent Hospital	Santa Fe	X							
Pinon Hills	Santa Fe Los Alamos (outpatient)								
Veteran's Administration Medical Center/ Kirtland AFB Hospital	Albuquerque								
PHS Indian Hospital	Albuquerque Santa Fe								

Appendix 4-G-2. Doctors in the vicinity of the SSC site by specialty [4.7.5].

	County		
	Bernalillo	Santa Fe	Torrance
<u>Total MDs</u>	1293	174	2
<u>Total DOs</u>	60	3	--
<u>Non-Federal Primary Care Physicians by Specialty</u>			
Family Practice and General Practice	121	23	1
Internal Medicine	115	18	0
Ob-Gyn	81	13	0
Pediatrics	73	5	0
<u>Non-Federal Physicians in non-primary care by Specialty</u>			
Allergy	9	1	--
Anesthesiology	55	7	--
Cardiovascular	33	2	--
Dermatology	20	4	--
Emergency Medicine	36	8	--
Endocrinology	9	2	--
Gastroenterology	17	--	--
General Preventive Medicine	1	2	--
Geriatrics	4	1	--
Infectious Disease	4	1	--
Nephrology	7	1	--
Neurology	21	3	--
Nuclear Medicine	1	--	--
Occupational Medicine	7	--	--
Oncology	14	3	--
Ophthalmology	30	6	--
Otorhinolaryngology	15	1	--
Pathology	35	3	--
Clinical Pathology	9	1	--
Forensic Pathology	6	--	--
Pediatric Allergy	2	--	--
Pediatric Cardiology	6	--	--
Physical Medicine and Rehabilitation	1	12	--
Psychiatry	82	12	--
Child Psychiatry	7	1	--
Psychoanalysis	--	2	--
Pulmonary Disease	13	1	--

Continued on next page

Appendix 4-G-2. (Continued)

	County		
	Bernalillo	Santa Fe	Torrance
Radiology	8	2	--
Diagnostic Radiology	43	2	--
Therapeutic Radiology	5	1	--
Rheumatology	8	1	--
Diagnostic Rhoentgenology	1	1	--
Cardiovascular Surgery	12	--	--
General Surgery	56	7	--
Hand Surgery	6	--	--
Neurological Surgery	10	1	--
Orthopedic Surgery	63	8	--
Pediatric Surgery	3	--	--
Plastic Surgery	15	2	--
Thoracic Surgery	7	1	--
Urology/Urologic Surgery	22	3	--

Appendix 4-G-3. Fire and rescue services in communities near the proposed SSC site. 1, EMT levels are as follows: B = basic, IV = IV technician, P = paramedic. 2, Includes three hazardous materials vans. 3, Paid firefighters are cross-trained as police officers and EMTs. 4, Includes two ambulance units and an excavating unit. 5, Includes five ambulance units, one snorkle unit, and one airport crash truck. 6, Includes four wheel drive vehicles. 7, Includes one mini-pumper. 8, Includes two ambulance units. [4.7-23]

Agency	Number of Paid Firefighters	Number of Volunteer Firefighters	Number of Stations	Number of Vehicles					EMTs ¹	Average Response Time in Service Area
				Pumper Truck	Ladder Truck	Rescue Vehicle	Tanker	Other		
Bernalillo County Fire Department	49	38	11	26	0	17	9	0	NA	NA
Albuquerque Fire Department	500	0	18	18	5	9	0	3 ²	406-B 94-P	4 minutes
Rio Rancho Fire Department ³	37	30	2	6	0	1	2	4 ⁴	15-20-B 2-IV 5-P	3-4 minutes
Santa Fe Fire Department	76	23	7	10	1	2	1	7 ⁵	40-B 13-IV 11-P	5-7 minutes
Moriarty Fire Department	1	22	1	2	0	2	1	0	5-B	5 minutes
Estancia Fire Department	0	13	1	2	0	1	1	2 ⁶	8-B	5 minutes
Edgewood Volunteer Fire Department	0	42	2	2	0	1	2	1 ⁷	4-B 1-IV 2-P	NA
Village of Tijeras Fire Department	0	12	1	1	0	0	1	0	5-B	10 minutes
Indian Hills Fire Department	0	12	1	1	0	0	2	0	0	NA
Stanley Fire Department	0	17	1	1	0	1	1	0	4-B	5 minutes
McIntosh Fire Department	0	16	1	2	0	0	0	0	0	NA
El Dorado Fire Department	0	14	1	2	0	0	0	0	2-B	5-15 minutes
Glorieta Pass Fire Department	0	18	1	2	0	1	1	0	3-B 3-1st responders	15 minutes
La Cienega Fire Department	0	17	1	2	0	1	1	0	4-B	9-15 minutes
Madrid Fire Department	0	15	1	1	0	1	0	0	3-B	5-10 minutes
Turquoise Trail Fire Department	0	16	2	2	0	1	2	2	6-B 1-IV	12 minutes

Appendix 4-G-4. Police services in communities near the proposed SSC site. 1, Officers are cross-trained as firefighters and EMTs [4.7-22].

Agency	Headquarters Location	Jurisdiction	Number of Officers	Number of Stations	Number of Vehicles	Average Response Time in Service Area
New Mexico State Police	Santa Fe	Santa Fe,	12	1	12	30 minutes maximum
	Albuquerque	Bernalillo and	15	1	15	
	Moriarty	Torrance Counties	7	1	7	15-20 minutes maximum
Bernalillo County Sheriff's Office	Albuquerque	Bernalillo County, excluding Indian Reservations	175	3	191	5-6 minutes
Albuquerque Police Department	Albuquerque	City of Albuquerque	688	4		4 minutes
Rio Rancho Department of Public Safety	Rio Rancho ¹	City of Rio Rancho	37	2	40	3-4 minutes
Santa Fe County Sheriff's Office	Santa Fe	Santa Fe County, excluding Indian Reservations	31	2	45	20 minutes maximum
Santa Fe Police Department	Santa Fe	City of Santa Fe	107	1	125	5 minutes
Torrance County Sheriff's Office	Estancia	Torrance County	8	1	12	30 minutes
Moriarty Police Department	Moriarty	City of Moriarty	5	1	2	5-7 minutes

Appendix 4-G-5. National forest lands in New Mexico [4.7-24].

Forest	County or Counties	Acreage	Activities Available					Miles from Site
			Camping	Boating	Fishing	Hiking	Cross Country Skiing	
Carson	Colfax, Rio Arriba, Taos	1,323,000	X	X	X	X	X	95
Cibola	Bernalillo, Cibola, Catron, Lincoln, McKinley, Sandoval, Socorro, Torraine	1,727,000	X	X	X	X	X	25-110
Coronado	Hidalgo	68,000	X			X		325
Gila	Catron, Grant, Sierra	3,328,000	X	X	X	X		220
Lincoln	Chaves, Eddy, Lincoln, Otero	1,093,000	X	X	X	X	X	212-252
Santa Fe	Mora, Rio Arriba, Sandoval, San Miguel, Santa Fe	1,568,000	X	X	X	X	X	65
Total	—	9,106,000	—	—	—	—	—	

Appendix 4-G-6. Lands available for public recreation use under BLM control. 1, Represents only those BLM-managed land areas which have been inventoried; totals will not equal total BLM-managed lands. [4.7-24].

Resource Area	County or Counties	Total Acreage	Primitive	Semi-Primitive Non-Motorized	Semi-Primitive Motorized	Roaded Natural	Rural	Urban	Miles from Site
Rio Puerco	Cibola, Bernalillo, Sandoval, Valencia	896,490	43,034	149,142	577,702	124,774	1,838	0	52
White Sands	Sierra, Otero	2,470,500	0	319,700	1,553,200	519,600	61,200	16,800	188
Las Cruces/ Lordsburg	Dona Ana	27,167	0	6,470	14,820	5,860	17	0	260
Carlsbad	Eddy, Lea, Southwest Chavez	2,171,000	0	55,100	1,038,320	1,071,520	5,780	280	250
Farmington	San Juan, part of Rio Arriba	1,130,400	0	19,000	180,000	901,400	30,000	0	206
Total		6,695,557	43,034	549,412	3,364,042	2,623,154	98,835	17,080	

Appendix 4-G-7. Designated wilderness areas within the National Forests, Park Service, Fish and Wildlife and BLM lands in New Mexico [4.7-24].

Name	Land Manager	Miles from Site	Acres
Gila Wilderness	Gila National Forest	225	558,065
Aldo Leopold	Gila National Forest	225	202,016
Blue Range	Gila National Forest	225	29,304
White Mountain	Lincoln National Forest	205	48,873
Capitan Mountain	Lincoln National Forest	220	34,822
Manzano Mountain	Cibola National Forest	40	36,970
Withington	Cibola National Forest	170	18,870
Apache Kid	Cibola National Forest	168	44,650
Sandia Mountain	Cibola National Forest	20	37,482
Chama River	Carson National Forest	186	2,900
Cruces Basin	Carson National Forest	164	18,000
Latir Peak	Carson National Forest	190	20,000
Pecos	Carson National Forest	82	24,736
Wheeler Peak	Carson National Forest	174	19,663
Pecos	Santa Fe National Forest	60	197,597
Chama	Santa Fe National Forest	114	47,400
San Pedro Park	Santa Fe National Forest	120	41,132
Dome	Santa Fe National Forest	92	5,200
Bisti	BLM	208	3,946
De Na Zin	BLM	215	23,872
Bandelier	National Park Service	145	23,267
Bosque del Apache	U.S. Fish and Wildlife	125	30,287
Salt Creek	U.S. Fish and Wildlife	288	9,671
Total			1,478,723

Appendix 4-G-8. National parks and national monuments in New Mexico
[4.7-25, 4.7-26].

Park/Monument	County	Description	Miles from Site
<u>Parks</u>			
Carlsbad Caverns	Eddy	Limestone caverns 750 feet underground	250
Chaco Culture National Historic Park	San Juan	13 major Anasazi ruins	200
<u>Monuments</u>			
Aztec Ruins	San Juan	Fully restored twelfth century Pueblo ruins	165
Bandelier	Sandoval	Twelfth century Pueblo and cliff dwellings	125
Capulin Mountain	Union	One thousand foot tall volcanic cinder cone	235
El Morro	Cibola	Rocks inscribed by Spanish explorers and westbound pioneers	160
Fort Union	Mora	Fort built in the 1800s to guard the Santa Fe Trail	145
Gila Cliff Dwellings	Catron	Thirteenth century cliff dwellings	275
Pecos	San Miguel	Fourteenth century Pueblo ruins; seventeenth century Spanish mission ruins	60
Salinas	Torrance	Ninth to twelfth century Pueblo ruins; seventeenth century Spanish mission ruins	64
White Sands	Otero	World's largest deposit of gypsum sand	188

Appendix 4-G-9. Wildlife refuges, wildlife areas, and major flyways [4.8-21]. (Table below keyed to map on next page.)

Fish and Wildlife

State-Operated Fish, Wildlife, and Waterfowl Areas—1984

Map Key		Date Established	Size*
State Fish Hatcheries			
A	Seven Springs	1933	
B	Glenwood	1938	
C	Parkview	1932	
D	Lisboa Springs	1921	
E	Red River	1941	
F	Rock Lake	1984	
State Wildlife and Waterfowl Areas			
G	Jackson Lake Waterfowl	1948	840
H	Navajo Dam Wildlife	—	3,785
I	Miller Mesa Waterfowl	1963	3,060
J	Humphries Wildlife	1966	10,868
K	Rio de los Pinos Wildlife and Fishing	1953	850
L	Rio Chama Wildlife and Fishing	1953	13,000
M	Marquez Wildlife	1968	15,000
N	Water Canyon Wildlife	1953	2,340
O	Rio Costilla Wildlife	1965	89,000**
P	Uracca Wildlife	1966	13,870
Q	Tres Piedras Wildlife	1940	3,260
R	Cimarron Canyon Wildlife	1950	33,116
S	Elliott Barker Wildlife	1966	5,415
T	Bert Clancey Wildlife and Fishing	—	2,166
U1	Wagon Mound Lake Waterfowl	1930	735
U2	McAllister Lake Fish and Waterfowl	1944	623
V1	Belen Waterfowl	1959	230
V2	Bernardo Waterfowl	1961	1,573
W	La Joya Waterfowl	1928	3,550
X	Heart Bar Wildlife	1951	797
Y	Red Rock Wildlife	1960	20,000
Z	Prairie Chicken Wildlife	1940	21,000
AA	Artesia Waterfowl	1962	640
BB	Sargent Wildlife	1980	20,400
CC	Eagle Nest Waterfowl	1980	1,200
State Fishing Areas			
1	San Juan Easement	1966	6 miles
2	Chama Easement	1970	4.3 miles
3	Hopewell Lake	1951	19
4	San Gregorio Reservoir	—	75
5	Fenton Lake Fish and Waterfowl	1952	256
6	McGaffey Lake	1954	14
7	Springer Lake	1960	400
8	Charrette Lakes Fish and Wildlife	1949	410
9	Morphy Lake	1965	50
10	Monastery Lake	1965	12
11	Ute Lake	1962	4,100
12	Quemado Lake	1972	130
13	Snow Lake	1967	75
14	Wail Lake	1948	15
15	Bill Evans Lake	1972	62
16	Lake Roberts	1962	71
17	Bear Canyon Reservoir	1949	25
18	Sacramento Lake	1965	5
19	Green Meadow Lake	1967	12
20	Clayton Lake Fish and Waterfowl	1954	150

*size given in acres unless specified

**leased land

Continued on next page

Appendix 4-G-9. (Continued) Wildlife refuges, wildlife areas, and major flyways [4.8-21].

Fish and Wildlife

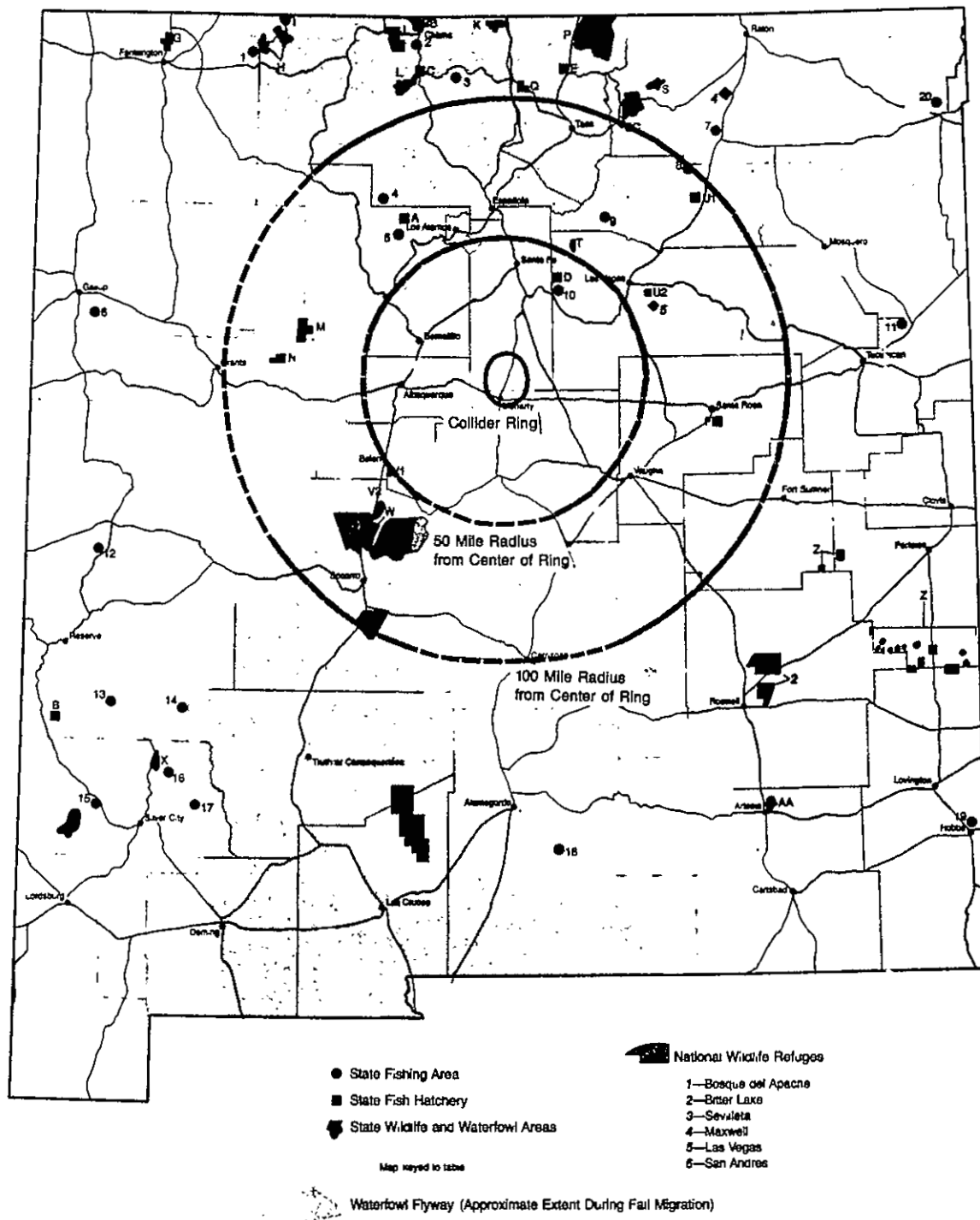

Source: N.M. Dept. of Game and Fish 1961

After Jerry Williams, ed., New Mexico in maps, UNM Press (1987).

Appendix 4-G-9. National wildlife refuges in New Mexico [4.7-25].

Refuge	Acreage	Limited Access	Activities								Number Waterfowl Species Present	Miles from Site	
			Hunting	Boating	Fishing	Camping	Trails	Auto Tour	Hiking	Picnicing			
Bitter Lake	23,000		X		X				X	X	X	283	152
Bosque del Apache	57,000		X		X			X	X	X		293	125
Sevilleta	228,134		X									NA	100
Las Vegas	8,750		X			X		X	X			244	96
Maxwell				X	X	X					X	NA	174
San Andres	57,215	X										Big Horn Sheep	180
Grulla	3,236	X										87	216

Appendix 4-G-10. New Mexico state park and recreation areas [4.7-24].

Area	Park	Land Acres	Water Acres	Lake	Ramp	Marina	Picnic Sites	Camp Sites	Trails	Fishing	Swimming	Water Skiing	Boating	Play Areas	Fields	Courts	Miles From Site	
Northwest	Bluewater	2,105	500	X	X	X	200	200	X	X	X	X	X	X	X	X	130	
	Red Rock	640					140	140	X								164	
	Navajo Lake	14,479	15,600	X	X	X	198	137	X	X	X	X	X	X	X	X	200	
	San Juan River Area	4,500					24	48	X	X							190	
Northeast	Cimarron Canyon	33,000					74	80	X	X							144	
	Sugarite Canyon	10,000		X	X		20	20	X	X			X	X			204	
	Santa Rosa Lake & Dam	518	15,618	X	X		30	30	X	X			X	X	X	X	90	
	Chicosa Lake	407	233	X			46	46		X				X			170	
	Coyote Creek	80					30	30		X							136	
	Morphy Lake	65	31	X			20	20		X			X				124	
	Ute Lake	1,307	4,078	X	X	X	150	150	X	X	X	X	X	X	X	X	164	
	Clayton Lake	417	170	X	X		78	78		X	X		X	X	X		256	
North Central	Petroglyph	85					10		X								44	
	Rio Bravo	26					1		X								38	
	Rio Grande Nature Center	160							X					X	X	X	35	
	San Gabriel	42					10		X					X	X	X	35	
	El Vado Lake	1,728	3,220	X	X	X	67	67	X	X	X	X	X	X	X	X	150	
	Heron Lake	4,107	5,905	X	X	X	75	60	X	X	X		X	X	X	X	150	
	Sims Mesa	500		X	X		75	65	X	X	X	X	X	X	X		196	
	Coronado	218					10	10									40	
	Fenton Lake	256		X	X		50	50	X	X			X	X			114	
	Hyde Memorial	350					127	127	X	X							60	
	Santa Fe River	5					21			X	X		X				54	
	Storrie Lake	82	1,100	X	X		64	64		X		X	X	X	X	X	84	
	Villanueva	1,679					77	77	X	X				X			65	
	Conchas Lake	1,742	3,220	X	X	X	154	154	X	X	X	X	X	X	X	X	X	116
	Kit Carson	19					1		X					X	X	X	120	
	Rio Grande Gorge	1,344	5				46	46	X	X		X			X		108	
	Monzano	160					29	24									50	
Sen Willie Chavez	107					20		X					X	X		68		
Southwest	Leasburg	140					37	37	X	X			X	X	X		228	
	City of Rocks	770					56	56	X							X	258	
	Smokey Bear	3.5					2		X					X		X	208	
	Valley of Fires	459					50	50	X								184	
	Pancho Villa	49					25	25	X					X			294	
	Rock Hound	255					30	30	X					X			275	
	Oliver Lee	180					54	44	X								256	
	Caballo Lake	11,160	6,700	X	X	X	149	35	X	X	X	X	X	X	X	X	196	
	Elephant Butte	20,512	36,558	X	X	X	155	200	X	X	X	X	X	X	X	X	X	176
	Percha Dam	10					22	22		X			X		X		212	
	Sumner Lake	6,667	4,560	X	X		42	42	X	X	X	X	X	X	X	X	X	226
	Living Desert	1,107					2		X								240	
	Harry McAdams	44					35	15						X		X	270	
	Oasis	198		X			34	34	X	X				X			200	

Appendix 4-G-11. State monuments administered by the Department of Cultural Affairs [4.7-24].

Monument	Description	Geographic Location	Miles from Site
Salmon Ruins	Eleventh Century Pueblo Ruins	San Juan County	192
Cumbres and Toltec Scenic Railroad	Narrow Gauge Steam Locomotive	Extends from Chama, NM to Antonito, CO	160
Palace of the Governors	Oldest Continuously Used Building in the U.S., Built in 1610	Santa Fe	65
Jemez Monument	Thirteenth Century Pueblo Ruins Seventeenth Century Spanish Mission Ruins	Sandoval County	90
Coronado Monument	Fifteenth Century Pueblo Ruins; Kiva, Mural	Sandoval County	43
Fort Sumner	U.S. Fort, Constructed 1862	DeBaca County	130
Lincoln Monument	Preserved Frontier Town	Lincoln County	220
Fort Selden	U.S. Fort, Constructed 1865	Dona County	242

Appendix 4-G-12. Festivals, fairs, and horse events [4.8-21]. (Table below keyed to map on next page.)

Town Festivals and Reunions

1	Las Vegas	Kiwanis Ice Carnival	January or February	34	Esperanza	Fiesta de Ofitas	Last week in July
2	Farmington	Lions Club Carnival	February	35	Magdalena	Montosa Camp Meeting	Last week in July
3	Santa Fe	St. Catherine Indian School Fiesta	April	36	Puerto de Luna	24th of July holiday	July 24
4	Deming	Old Timers Celebrations	3rd Saturday in April	37	Cambon	Old Timers Reunion	July
5	Farmington	San Juan Coseage Apple Blossom Festival	April	38	Lincoln	Old Lincoln Days and Baly the Kid Pageant	1st week in August
6	Tularosa	Rose Festival	1st week in May	39	Chama	Chama Days	August
7	T or C	Ralph Edwards Fiesta	May	40	Checo	Reunion	August 10
8	Las Vegas	Cinco de Mayo Fiesta	May	41	Meroso	Old Timers Day and Rodeo	August
9	Tularosa	St. Francis de Paula Fiesta	May	42	Cimarron	Cimarron Days	August
10	Cloudcroft	Old Timers Reunion	May	43	La Bajada	Yaagea Fiesta	August
11	Santa Rosa	Santa Rosa Day	May	44	Hobbs	Fraternl Order of Poeco Street Dance and Barbecue	August
12	La Joya	Yvra La Joya Day	May				
13	Santa Fe	End of the Trail Jubilee	May	45	Oak Rats Picnic Area, South NM 14	Union County Old Timers Picnic	August
14	Hessboro	Fiesta and Sideshow Sale	May	46	Bosque Farms	Bosque Farms Fair	August
15	Madrid	Old Fashioned Fair	1st week in June	47	Prewitt	Prewitt Fair	Labor Day week
16	Clavis	Pioneer Days	1st week in June	48	Las Vegas	Peopes Fare (sic)	September
17	Cerrillos	Fiesta de la Primavera	2nd Sat. in June	49	Lordsburg	Old Timers Banquet	September
18	Isleta Pueblo	Governor's Day	June 20	50	Hobbs	St. Helena Family Fair	2nd week in Sept
19	Fort Sumner	Old Fort Days and Great Tombstone Race	2nd week in June	51	Red River	Aspenade Festival	1st week in Oct
20	Socorro	San Marcano Old Timers Day	June	52	Socorro	49ers' Celebration	1st week in Oct
21	Capitan	Lincoln County Ranch Tour and Barbecue	Sat. before Father's Day	53	Ruidoso	Aspenade Festival	1st two weeks in Oct
22	Aztec	Aztec Fiesta Days	June	54	Cloudcroft	Octoberfest and Aspenade Festival	1st week in Oct
23	Cloudcroft	July Jamboree	July 4				
24	Deming	Butterhead Trail Days	Week of July 4	55	Springer	Ungraded Aspenade and Tursey Shoot	2nd Sun. in Oct
25	Mountainair	Firecracker Jubilee	July 4	56	Alamogordo	Probler Festival	October
26	Hobbs	Rough and Ready Days	Week of July 4	57	Los Alamos	Opera Guild Octoberfest	October
27	Las Vegas	Old Town Fiesta	July 4	58	Eunice	Hotswoven Carnival	October 31
28	Silver City	Frontier Days	Week of July 4	59	Socorro	Candy Cane Parade	November
29	Tucuman	Piñata Festival	2nd week in July	60	Albuquerque	Christmas Parade	November (Saturday after Thanksgiving)
30	Magdalena	Old Timers Day, including town of Kely	Week after July 4th				
31	Portales	Fiesta de Portales	July	61	Cloudcroft	Christmas Lights and Snow Queen Pageant	December
32	Eunice	Old Timers Reunion	July	62	Farmington	Jaycees Christmas Parade	December
33	Hogas Mesa, Lincoln County	Ranchman's Camp Meeting	Last week in July	63	Albuquerque	Luminaria Tour	December 2 ^d

Rodeos

5	Window Rock, Az.	Navajo Nation Spring Roundup	April
6	Farmington	PRCA Pro Rodeo Roundup	May
7	T or C	Sheriff's Posse Saddle Race	May
11	Mountainair	Amateur Rodeo	June
12	Farmington	Sheriff's Posse Rodeo	June
13	Taos	Sheriff's Posse Rodeo	June
14	Garup	Rodeo	June
15	Bloomfield	Angel Peak Stampede	June
16	Raton	Rodeo	June
17	Lovington	High Plains Junior Rodeo	June
20	Tucuman	Quay County Rodeo	July
21	Dulce	Little Beaver Roundup Rodeo and Powwow	2nd week in July
22	Grants	Rodeo and Art Show	July 4
23	Capitan	Smokee the Bear Rodeo	July 4
24	Cimarron	Maverick Club Rodeo	July 4
25	Tucuman	Lion's Club Rodeo	July 4
26	Santa Fe	Rodeo de Santa Fe	2nd week in July
27	Galisteo	Rodeo de Galisteo	July
28	Taos	Sheriff's Posse Rodeo	July
32	Albuquerque	4-H Rodeo and Fair	August
33	Data	Rodeo	August
34	Garup	North American Rodeo Championships	August
36	Escabosa	Rodeo and Dance	September
39	Albuquerque	State Fair Rodeo	September
40	Albuquerque	Late Branches Rodeo	October
45	Albuquerque	Indian National Finals Rodeo	November

Horse Events (Except rodeos)

1	Roswell	Vasey Dressage Spring Show	March
2	Clavis	Spring Registered Horse Show	April
3	Albuquerque	Guadalupe Pony Club Horse Show	April
4	Albuquerque	Quarter Horse Show	April
5	Albuquerque	New Mexico Dressage Society Spring Show	May or June
9	Roswell	Vasey Dressage Spring Show	May or June
10	Estancia	Couplers Horseback Ride through Manzanao Mountains	June
18	Ruidoso	Kansas Futurity Quarter Horse Race	June
19	Ruidoso	Rainbow Futurity Quarter Horse Race	July
29	Pea Town	Peo Tournament, Barbecue and Dance	1st week in August
30	Santa Fe	Tribune-Downs at Santa Fe Handicapping Challenge	August
31	Roswell	Tractor Pull and Quarter Horse Sales	August
35	Roswell	John Chisum Trail Ride	August or September
36	Jemez Mountains	Shrine Mounted Patrol Trail Ride	Labor Day week
37	Ruidoso	All-American Futurity Quarter Horse Race	Labor Day week
41	Ruidoso	Araban Horse Show	October
42	Ruidoso	Hunter Jumper Show	October
43	Ruidoso	Lincoln County Muse-o-rama	October
44	Albuquerque	National Arabian Horse Show	October, alternating years
46	Clavis	Winter Catalogue Registered Horse Sale	December
47	Silver City	Gymkhana	every month

County, State, and Regional Fairs

1	Las Vegas	Sengre de Cristo Fair	August
2	Lovington	Lea County Fair and Rodeo	August
3	Tucuman	Quay County Fair	August
4	Esperanza	Rio Arriba County Fair	August
5	Capitan	Lincoln County Fair	August
6	Portales	Roosevelt County Fair	3rd week in Aug
7	Artesa	Eddy County Fair	August
8	Cayton	Union County Fair	August
9	Taos	Taos County Fair	August
10	Socorro	Socorro County Fair and Rodeo	August
11	Reserve	Canon County Fair and Rodeo	August
12	Los Alamos	Los Alamos County Fair and Rodeo	August
13	Zuni	Tinai Fair	August
14	Fort Sumner	De Baca County Fair	August
15	Williamsburg	Sierra County Fair	September
16	Springer	Coffey County Fair	September
17	Clavis	Curry County Fair	September
18	Window Rock, Az	Navajo Nation Fair	September
19	Roswell	Eastern New Mexico State Fair	September
20	Cul	Cliff/Gala/Grant County Fair	September or October
21	Farmington	San Juan County Fair	September
22	Grants	Cibola County Fair	September
23	Alamogordo	Otero County Fair	September
24	Belen	Valencia County Fair	September
25	Albuquerque	State Fair	September
26	Shiprock	Northern Navajo Fair	October
27	Deming	Southwest New Mexico State Fair and Rodeo	1st week in Octo-ber
28	Las Cruces	Southern New Mexico State Fair	October

Science





1	Garup	Four Corners Science Exposition	March
2	Deming	Roundup Roundup	March
3	Albuquerque	Gem and Mineral Show	March or April
4	Las Cruces	S.W. Regional Science & Engineering Fair	March
5	Roswell	S.E. Regional Science & Engineering Fair	March
6	Albuquerque	N.W. Regional Science & Engineering Fair	March
7	Farmington	Oil and Gas Show	April
8	Roswell	Chaparral Roundup Gem and Mineral Show	September
9	Carrsbad	Roadrunner Rock Club Gem and Mineral Show	October

Continued on next page

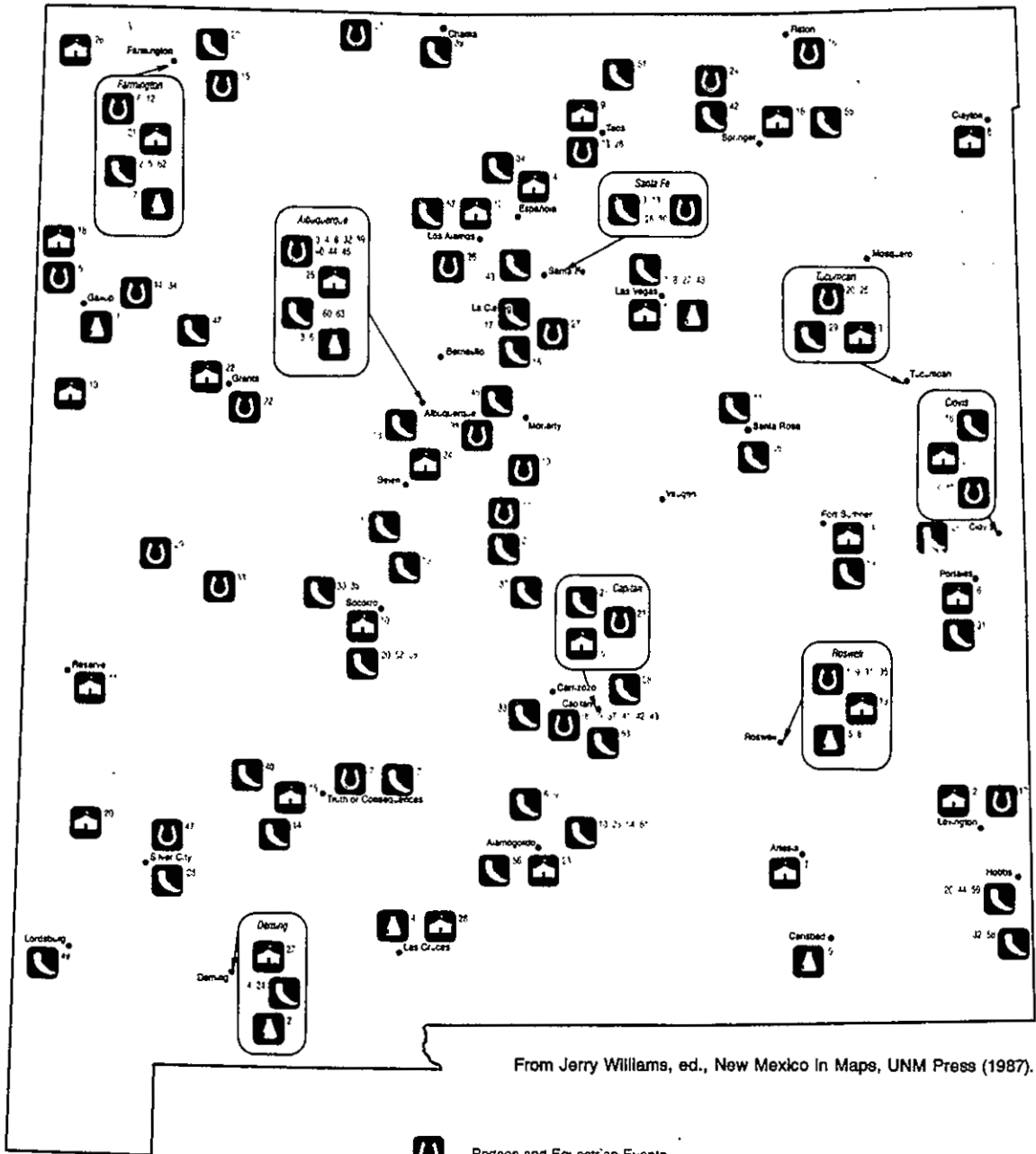
Appendix 4-G-12. (Continued) Festivals, fairs, and horse events [4.8-21].

Festivals, Fairs, and Horse Events



-  Rodeos and Equestrian Events
-  County, State and Regional Fairs
-  Local Festivals and Reunions
-  Science Fairs and Shows

0 10 20 30 40 50 60 Miles

Appendix 4-G-13. Sporting and other special events [4.8-21]. (Table below keyed to map on next page.)

Sports and Miscellaneous Events

Balloon (Hot Air) Events			TEAM SPORTS		
1	Angel Fire	Winter Balloon Rally and Snowmobile Races	January		
2	Albuquerque	Friends & Lovers Valentine Balloon Rally	February		
3	Chama	Balloon Fiesta and Snowmobile Races	February		
4	Farmington	Four Corners Hot Air Balloon Rally	May		
5	Galup	Greene Faire and Balloon Festival	June		
6	Angel Fire	Jack Davore Mem. Hot Air Balloon Rally	August		
7	Artesia	Hot Air Balloon Fiesta	August		
8	Albuquerque	International Hot Air Balloon Fiesta	October		
Winter Sports			Basketball		
1	Angel Fire	Winter Balloon Rally and Snowmobile Races	January		
2	Chama	Balloon Fiesta and Snowmobile Races	February		
3	Chama	Chia Classic Cross-Country Ski Race	February		
4	Chama	High-County Winter Carnival and Chama Rendezvous Ski Day Race	1st week in March		
5	Chama	State Championship Snowmobile Races	March		
6	Albuquerque	UHM/Miller Lite Cross-Country Spring Fling Ski Festival	March		
7	Taos	Taos Cup Ski Run	March		
8	Angel Fire	Southwest Pro Ski Tour Gran Prix and Volkssport Cross-Country Skiing	March		
9	Angel Fire	World Cup Freestyle Finals	March		
10	Sierra Blanca	Sierra Blanca Handicapped Ski Championship	March		
11	Taos	Barbusena Giant Slalom Ski Race	March or April		
Water-Related Sports			Baseball		
1	Albuquerque	Concrete Canoe Competition	April		
2	Elephant Butte	Alamogordo Bassmasters Open Fishing Tournament	April		
3	Pinar	Rio Grande White Water Race	May		
4	Albuquerque	Great Race down the Rio Grande	May or June		
5	Cochiti Lake	Arthritis Foundation Fishing Jubilee	May		
6	Elephant Butte	Apache Open Marina Sloop Race	May		
7	Marion Lake	Jay Benson Memorial Catamaran Regatta	May		
8	Elephant Butte	Big Brothers/Big Sisters of Santa County Fishing Tournament	July		
9	Deming	Great American Overland Canoe Race	August		
Racing Races			Bowling		
1	Albuquerque	UHM Couples Race	February		
2	Albuquerque	Love Run	February		
3	Albuquerque	Mujeres de LULAC Run	March		
4	Albuquerque	Sun Sports Spring Classic Run	March		
7	Laguna Pueblo	Spring Run	April		
8	T or C	10,000 Meter Gran Prix Run	April		
9	Albuquerque	Corporate Track Meet	May		
10	Fort Bayard	Open Trail Run	May		
12	Santa Fe	Santa Fe Run-Around	June		
13	Pecos Wilderness	100 Kilometer Trail for Life and Breath	July		
14	Raton	Summer Run	July		
17	Albuquerque	"Shining Season" Road Run	August		
18	Albuquerque	La Luz Trail Run	August		
19	Santa Fe	Old Santa Fe Trail Run	September		
22	Clovis	Clovis Marathon	October		
23	Socorro	"M" Mountain Race	October		
24	Taos	Comida de Taos	October		
25	Raton	Old Raton Pass Run	October		
28	T or C	Mod Mountain Run	November		
Bicycle Races and Tours			Miscellaneous Sports		
5	Albuquerque	American Diabetes Association Bike-a-thon	March		
6	Albuquerque	Rio Grande Vasey Bicycle Tour	April		
11	Albuquerque	Double Eagle Bicycle Race	June		
15	Los Alamos	Tour de Los Alamos Bicycle Race	July		
16	Silver City	Inner Loop Bicycle Tour	August		
20	Red River	Enchanted Circle/Wheeler Peak Century Bicycle Tour	September		
21	Albuquerque	Around the Mountain Bicycle Tour	October		
Golf			Special Olympics		
1	Socorro	"M" Mountain Pro/Lady Golf Tournament	March		
2	Albuquerque	St. Pius Golf Invitational	April		
3	Hobbs	American Petroleum Institute Members Golf Tournament	May		
4	Carrizozo	Bay the Kid Open Golf Tournament	May		
5	Albuquerque	McDonald Golf Matches	May		
6	Las Vegas	Arctic Circle Golf Tournament	May		
7	Albuquerque	Charley Pride Golf Tournament	June		
8	Socorro	Conrad Hilton Golf Tournament and Eliego Back Shoot	June		
9	Albuquerque	Longest Day of Golf	June		
10	Farmington	San Juan Open Golf Championship	July		
11	Albuquerque	Joyce's Men's City Golf Tournament	July		
12	Las Vegas	Rough Riders Invitational Golf Tournament	August		
13	Albuquerque	City Match Play Championship	Labor Day week		
14	Socorro	Chili Chase Golf Tournament	September		
15	Carrizozo	Four Winds Open Golf Tournament	September		
16	Socorro	Gold Rush Golf Tournament	October		
1	Shiprock	Lions Basketball Tournament	March		
2	Albuquerque	New Mexico State Basketball Tournament	March		
6	Santo Domingo Pueblo	Six-Foot and Under Men's Basketball Tournament	April		
3	Albuquerque	New Mexico Exes Association John Hickey Memorial Bowling Tournament	March		
7	Albuquerque	Albuquerque Trophies and Awards Bowling Tournament	May		
Bowling			Baseball		
4	Albuquerque	Cordova Glass Women's Fast Pitch Softball Tournament	April		
5	Albuquerque	Easter Seal-Rio Grande Kiwanis Softball Tournament	April		
6	Farmington	Contra Mex World Series Baseball Tournament	August		
Miscellaneous Sports			Baseball		
1	Angel Fire	No. N.M. Special Olympics Winter Games	January		
2	Ruidoso	So. N.M. Special Olympics Winter Games	January		
19	Albuquerque	N.M. Special Olympics Summer Games	1st week in June		
Baseball			Baseball		
3	Albuquerque	Regional Golden Gloves Boxing Tournament	February		
3	Farmington	Regional Golden Gloves Boxing Tournament	February		
10	Roswell	Regional Golden Gloves Boxing Tournament	February		
11	Clovis	Regional Golden Gloves Boxing Tournament	February		
12	Albuquerque	Golden Gloves State Championship	March		
Muzzleloaders and other Gun Events			Baseball		
4	Galup	Mid-winter Roo-d-voe of Red Rock Muzzleloaders	February		
20	Raton	Santa Fe Trail Primitive Black Powder Rendezvous	June		
23	Roswell	State Hunter Pistol Small Bore Championship	July		
28	Silver City	Whiskey Creek Muzzleloading Shoot	December		
29	Albuquerque	Petroglyph Park Muzzleloading Matches	December		
Darts			Baseball		
13	Albuquerque	N.M. Dart Association Dart Shoot Out	March		
14	Albuquerque	New Mexico Open V Dart Tournament	April		
Motorcycle Races			Baseball		
7	Alamogordo	Half-Mile High Enduro Motorcycle Race	February		
26	Carlsbad	Caverns Run	September		
Other			Baseball		
3	Albuquerque	International Gymnastic Invitational	January		
5	Angel Fire	New Mexico Shovel Race Championship	February		
6	Albuquerque	Sports Show	February		
15	Bosque de Apache	Albuquerque Retiree Club Field Trips	April		
16	Albuquerque	Kite Festival	May		
17	Cedar Crest	Arroyo Games	May		
18	Yafo	Three-Wheeler Mudbog Competition	June		
21	Fort Sumner	Great Tomestone Race (with Old Fort Days)	June		
22	Farmington	Air Affair	June		
24	Hobbs	Standard Soaring Championship	July		
25	Deming	Great American Duck Race	August		
27	Roswell	Wool Bow—National Junior College Football Championships	November		

Continued on next page

Appendix 4-G-13. (Continued) Sporting and other special events [4.8-21].

Sporting and Other Events

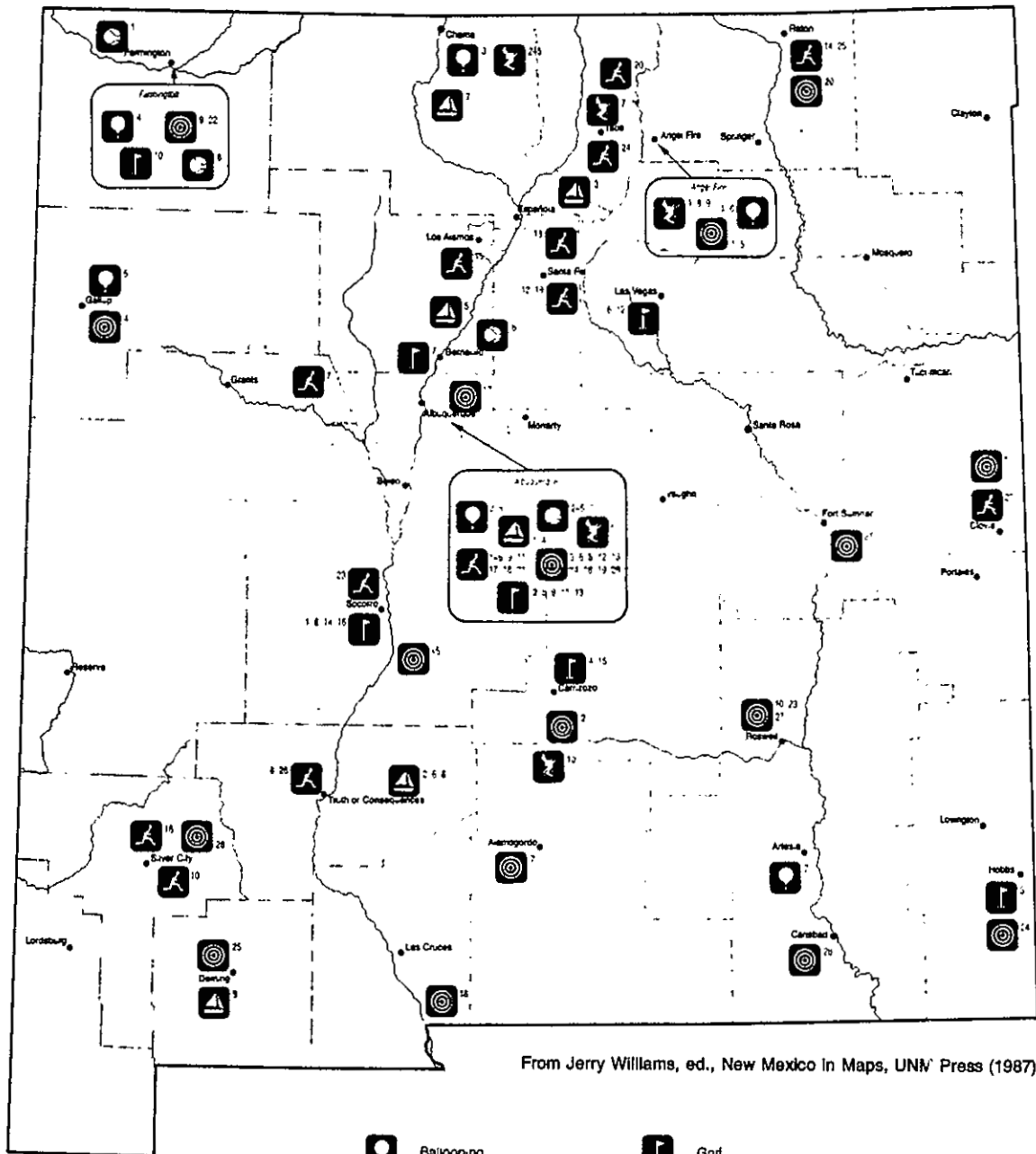

- | | | | |
|--|-----------------------|--|-------------------------------|
| | Ballooning | | God |
| | Water Sports | | Team Sports |
| | Water Sports | | Miscellaneous Sporting Events |
| | Running and Bicycling | | |

0 10 20 30 40 50 Miles

APPENDIX 4-H

Educational and Cultural Resources

Appendix 4-H-1

FLOW CHART OF NEW MEXICO PUBLIC SCHOOL RESOURCES 1985 - 1986 STATE

GENERAL FUND REVENUE			
Gen. & Selective (Sales) Taxes	305	Rent & Royalties	115
Income Taxes	135	Interest Earnings	265
License Fees	15	Misc. Receipts	15
Severance Taxes	105		
			\$1,371,549

GENERAL FUND DISTRIBUTIONS	
State Equalization Guarantee	627,013,683
Plus: 1/2 Mill. Redistribution	4,471,600
	631,485,283
Less: Fed. Mineral Lease Current	118,260,674
Net	295,936,711
Supplemental Transportation	1,290,142
P.L. 874 Emergency	45,274,606
P.L. 874 Sp. Ed. Payback	1,727,106
	2,600,000
TOTAL	346,928,565

CURRENT SCHOOL FUND	
Earnings on Invested Perm. School Fund	194,375,106
Land Income	17,629,033
Less Hobbs Leases	8,400
Court Fines, Escheats, Misc.	5,392,159
TOTAL	217,287,898

Federal Mineral Lease	127,739,546
Free Textbooks	9,478,872
Motor Vehicle Registration Fees	3,851

PUBLIC SCHOOL FUND	
State Equalization Guarantee	631,485,283
Transportation	45,274,606
Supplemental Distributions:	
Out-of-State Tuition	567,927
Emergency	750,000
Emergency Capital Outlay	72,215
TOTAL	1,390,142
P.L. 874 Emergency	1,727,106
P.L. 874 Sp. Ed. Payback	2,600,000
TOTAL	682,477,137

Cultural Affairs Arts Division	1,879
Dept. of Human Services	18
State Highway	530,135
State Natural Resources	163,039
State Civil Emrg. Preparedness	96,914
Adult Basic Education	58,811
Gadsden Capital Outlay	
Special Appropriation	6,750,000
TOTAL	7,697,197

FEDERAL	
P.L. 874	34,536,275
Indirect Costs	1,397,097
Forest Reserve	788,284
BIA Title I	16,155
Title III, DOE Conservation	5,329,111
Johnson O'Malley	2,156,362
P.L. 815	2,870,205
ICIA, Chapter I Regular	26,678,885
ICIA, Chapter I Migrant	1,974,430
P.L. 874 Sp. Ed.	1,181,027
ICIA, Chapter II Block Grant	2,685,126
ESPA, Title VII Bilingual	2,796,037
Adult Basic Education	45,624
Title IV Indian Education	3,175,279
Headstart	1,987,038
P.L. 94-142	7,464,814
JIPA	652,620
Misc. Federal	24,410,880
TOTAL	120,014,149

Critical Capital Outlay G.O. Bonds	13,220,475
Cap. Imprvts. SB 9 Severance Bonds	12,724,619
Computer Hardware/Software Sev. Bonds	1,048,675
Vocational Equipment Sev. Bonds	971,274

OPERATIONAL FUND	
	753,233,239

OTHER FUNDS	
Teacherage	810,902
Debt Service	46,759,254
Bond Building	63,967,200
Critical Capital Outlay	13,220,475
Fed./State/Local Bldg.	20,05,953
Cap. Proj. Investment Earnings	6,421,004
Capital Improvements SB 9	32,155,993
Federal Projects	54,421,921
Cafeteria	36,045,406
Non-Instructional (Athletics)	2,148,335
Deferred Sick Leave	112,357
TOTAL	276,968,800

LOCAL	
AD VALOREM TAXES	
District Tax Levy	4,940,089
Earnings on Investments	10,273,561
Local Miscellaneous	24,769,194
TAX LEVIES	
Interest and Principal	45,058,847
Capital Improvements (SB 9)	17,661,283
Public School Buildings (MB 33)	7,780,037
TOTAL	70,500,167
Sale of G.O. Bonds	63,967,200
Accrued Interest on G.O. Bonds	215,579
TOTAL	182,665,790

TOTAL RESOURCES		
STATE	\$ 727,822,100	78.0%
LOCAL	182,665,790	17.7%
FEDERAL	120,014,149	11.7%
TOTAL	\$ 1,030,492,039	100.0%

NEW MEXICO SSC PROPOSAL JULY 31, 1987

4-197

Appendix 4-H-2. State funds distributed to public schools in New Mexico 1976-1986 [4.8-2].

1976-77	\$268,602,873
1977-78	310,798,021
1978-79	356,699,612
1979-80	394,600,702
1980-81	438,581,819
1981-82	556,380,497
1982-83	624,763,373
1983-84	638,230,947
1984-85	694,496,947
1985-86	727,522,100

Average Annual Increase = \$50,991,025

Average Percentage Increase = 19%

Appendix 4-H-3

Brochures from Research Institutions:

Los Alamos National Laboratory

Sandia National Laboratories

Computing Research Laboratory

Center for Non-Invasive Diagnosis

Center for Explosives Technology Research

The brochures listed below are contained in a pocket.

Santa Fe Institute

The Center for High Technology Materials

Plant Genetic Engineering Laboratory

Appendix 4-H-4

SSC Site Evaluation Committee
for New Mexico
Office of the Proposal Coordinator
June 23, 1987

Dr. Siegfried S. Hecker, Director
Los Alamos National Laboratory
Mail Stop A100
Los Alamos, NM. 87545

Dear Sig:

Our Committee is preparing the Superconducting Super Collider (SSC) site proposal for the State of New Mexico. Our recommended site is located in the northern part of the Estancia Basin east of Albuquerque and south of Santa Fe, encircling, but mostly north of Moriarty. This area has excellent geologic and topographic features that are ideal for the SSC. We intend to identify and discuss all of the assets that make our site attractive. An obvious asset is the talent and equipment that comprise the Los Alamos National Laboratory.

Please be assured that we understand, support, and have scrupulously adhered to the instructions from the Department of Energy concerning participation of DOE-funded organizations and their employees in the preparation of proposals for the SSC site; however, the presence of National Laboratories in New Mexico is factual, and we do not believe this request violates either the letter or the spirit of the DOE instructions.

The Committee has identified several areas that it believes are synergistic between Los Alamos and a New Mexico-sited SSC. We list these areas below and would appreciate your opinion of our assessment.

Areas of mutual benefit

- * Staff exchanges
- * Joint appointments
- * Joint colloquia speakers
- * Joint use of specialized equipment

Of benefit to the SSC by being near LANL

- * Established infrastructure accustomed to interacting with the DOE that can provide guidance: legal, procurement, accounting, property control, etc.
- Health and environment: specialized safety experts, backup radiation protection specialists, radiation detector calibration, respirator fitting and testing facilities, etc.
- * LAMPF and Van de Graaff for detector calibration.
- AT-Division structures laboratory for cavity tuning and accelerator component test stands.
- * MP-Division for hydrogen brazing furnaces, remote handling expertise and equipment, and accelerator facility operating experience.
- * Powerful computing facilities, and software, systems, and network experience.

NEW MEXICO SSC PROPOSAL JULY 31, 1987

- * Multidisciplined professionals available for consulting.
- * Materials fabrication specialists and equipment.

Of benefit to Los Alamos by being near the SSC

- * Employment pool from graduate students associated with SSC experiments.
- * Employment pool of technical people that were attracted to build the SSC.
- * Strengthened regional universities.
- * Strengthened regional distribution centers, contractors with improved techniques and modernized equipment, and increased number of local technical vendors.

This short list represents an impressive array of areas of possible mutual benefit. We will appreciate your comments.

Sincerely,

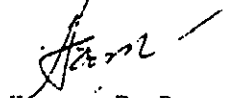

Herman E. Roser
NM SSC Proposal Coordinator
1004 Daskalos Dr. N.E.
Albuquerque, NM. 87123

Phone (505) 294-5003



Los Alamos Los Alamos National Laboratory
of the University of California

Los Alamos, New Mexico 87545

June 30, 1987

Mr. Herman E. Roser
NM SSC Proposal Coordinator
1004 Daskalos Dr., N.E.
Albuquerque, NM 87123

Dear Herm:

I have reviewed your letter of June 23, 1987, discussing the synergism that would prevail should a location in the vicinity of Los Alamos be chosen as the site for the Superconducting Super Collider (SSC).

The many tasks and activities necessary to construct and operate the SSC will require expertise from a broad spectrum of technical disciplines, many of which are represented at Los Alamos. The excitement that will prevail among participants in this new project cannot help but raise an already high level of enthusiasm among scientists and engineers along the Rio Grande Corridor. This is probably the largest benefit to us of the SSC being close to Los Alamos. In addition, I concur with the areas of mutual benefit as well as the areas of specific benefit to Los Alamos listed in your letter.

As further indicated in your letter, there is a set of clear potential benefits to the SSC by being close to Los Alamos. Some of these require specific agreements being negotiated and require DOE concurrence. However, all are, in principle, possible and would be pursued should your site be selected.

Clearly, it would be good for Los Alamos should the SSC be in close proximity. We wish you good luck!

Sincerely,

S. S. Hecker
Director

SSH/WFM:k

cy: CRM-4 (2)

NEW MEXICO SSC PROPOSAL JULY 31, 1987

SSC Site Evaluation Committee
for New Mexico
Office of the Proposal Coordinator
June 23, 1987

Mr. I. Welber, President
Sandia National Laboratories
Albuquerque, New Mexico 87185-5800

Dear Irwin:

Our Committee is preparing the Superconducting Super Collider (SSC) site proposal for the State of New Mexico. Our recommended site is located in the northern part of the Estancia Basin east of Albuquerque and south of Santa Fe, encircling, but mostly north of Moriarty. This area has excellent geologic and topographic features that are ideal for the SSC. We intend to identify and discuss all of the assets that make our site attractive. An obvious asset is the talent and equipment that comprise the Sandia National Laboratories, particularly in Albuquerque.

Please be assured that we understand, support, and have scrupulously adhered to the instructions from the Department of Energy concerning participation of DOE-funded organizations and their employees in the preparation of proposals for the SSC site; however, the presence of National Laboratories in New Mexico is factual, and we do not believe this request violates either the letter or the spirit of the DOE instructions.

The Committee has identified several areas that it believes are synergistic between Sandia and a New Mexico-sited SSC. We list these areas below and would appreciate your opinion of our assessment.

Areas of Mutual Benefit

- * Staff Exchanges
- * Joint Appointments
- * Joint Colloquia Speakers
- * Joint Use of Specialized Equipment

Of Benefit to the SSC by Being Near Sandia

- * Established infrastructure accustomed to interacting with the DOE that can provide guidance: legal, procurement, accounting, property control, etc.
- * Health and environment: specialized safety experts, backup radiation protection specialists, radiation detector calibration, respirator fitting and testing facilities, etc.
- * Development and operational experience with Particle Beam Fusion Accelerator (PBFA) research.
- * Extensive capabilities in solid state and device physics, including radiation hardened micro-circuit fabrication.
- * Metallurgical, ceramic and organic materials design, fabrication, and systems integration.
- * Powerful computing facilities, and software, systems, and network experience.

NEW MEXICO SSC PROPOSAL JULY 31, 1987

- * Multidisciplined professionals available for consulting.
- * Large-scale systems engineering and integration experience.

Of Benefit to Sandia by Being Near the SSC

- * Employment pool from graduate students associated with SSC experiments.
- * Employment pool of technical people that were attracted to build the SSC.
- * Strengthened regional universities.
- * Strengthened regional distribution centers, contractors with improved techniques and modernized equipment, and increased number of local technical vendors.

This short list represents an impressive array of areas of possible mutual benefit. We would appreciate any comments you man have.

Sincerely,

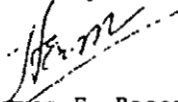

Herman E. Roser
NM SSC Proposal Coordinator
1004 Daskalos Dr. N.E.
Albuquerque, NM. 87123

Phone (505) 294-5003

Irwin Welber
President

Sandia National Laboratories
Albuquerque, New Mexico 87185

July 8, 1987

Mr. Herman E. Roser
NM SSC Proposal Coordinator
1004 Daskalos Dr., N.E.
Albuquerque, NM 87123

Dear Herm,

Thanks very much for your letter of June 23, 1987 regarding the proposal to DOE for siting the Superconducting Super Collider (SSC) in the Estancia Basin near Albuquerque.

As you have pointed out in your letter, there would be many mutual benefits to Sandia and the SSC if this proposal were to be accepted. It seems to me that the greatest benefit for Sandia would be the general increase of the scientific and technical personnel pool in the Rio Grande Corridor and the interactions taking place on a personal and professional basis. The level of scientific excitement and enthusiasm in the area, already high, would necessarily increase.

You identified a set of potential benefits to the SSC from being close to Sandia, and I agree with you. Most of these are possible, at least in principle, though detailed discussions and DOE concurrence would probably be required.

If the SSC is to be constructed, it would certainly be good for Sandia and our personnel to have it at the site you have proposed.

Sincerely,



NEW MEXICO SSC PROPOSAL JULY 31, 1987

4-205

Appendix 4-H-5. Prehistoric and historic sites in New Mexico [4.8-21]. (Table below keyed to following map.)

Map Key	Vicinity	Historic Place	Map Key	Vicinity	Historic Place	Map Key	Vicinity	Historic Place
BERNALILLO			88	North Valley	Los Gnegos historic District: Rio Grande NW	HERALDO		
1	Abuquerque	Armo (Salvador) House: Old Town	89	North Valley	Dietz Farmhouse: Rio Grande NW	134	Lordsburg	Shakespeare Ghost Town: 2 mi S
2	Abuquerque	Bares-Bredsoe (Dietz) House: Edith NE	70	North Valley	Shatt House: 4th St. NW	LINDSLEY		
3	Abuquerque	Botmer House: Old Town	71	North Valley	Los Duranes Chapel: Duranes NW	135	Jcarua	Schoolhouse: 10 mi NE of White Oaks
4	Abuquerque	Davis House: Parkland Circle SE	72	Tijeras	Holy Child Church: Frontage Rd. Isleta Pueblo	138	White Oaks	Historic District: 12 mi. NE of Camarizo
5	Abuquerque	First National Bank Building: Downtown	73	Isleta		137	Lincoln	Historic District: Viraga Center
6	Abuquerque	Fourth Ward Historic District: Downtown	CATRON			138	Lincoln	Feather Cave: 4 mi. W
7	Abuquerque	Garca (Teppan) House: Edith NE	74	Dati	Aka Site: SE of Dati	139	Logan	Bonito Pipeline: 4 mi. S
8	Abuquerque	Gladding House: Cedar NE	75	Horse Springs	Bat Cave: South of Horse Springs	140	Ruidoso	Wizard's Roost site
9	Abuquerque	Hacienda del Lago: Griega Rd NE	76	Red Hill	Cox Ranch Pueblo	141	Ruidoso	NMMA Summer Camp Building
10	Abuquerque	Hoggin Hall: URM Campus	77	Gila Mountains	Gaa Cliff Overhangs	LOS ALAMOS		
11	Abuquerque	Huning Highland Historic District: NE/SE	CHAVEZ			142	White Rock	Pajarito Springs site
12	Abuquerque	KilMo Theatre: Downtown	78	Roosevelt	White House: N. Lea Ave.	143	Los Alamos	Guaje site
13	Abuquerque	Lombrie House: Laguna SW	CIBOLA			144	Los Alamos	Scientific Laboratory
14	Abuquerque	Lewis Building: 2nd St. SW	79	Grants	Candelaria Pueblo: Malpais Area	145	Los Alamos	Bandelier Monument: 12 mi. S
15	Abuquerque	Manzano Day School: Old Town	80	Grants	District site: South of Grants	LUNA		
16	Abuquerque	Manual School: Manual NE	81	Acoma	Acoma Pueblo	146	Columbus	Village Center and Camp Furlong
17	Abuquerque	Occidental Insurance Building: Downtown	82	Acoma	San Estevan Mission Church: El Morro Monument	147	Deming	Armory: Silver and Hemlock Sts.
18	Abuquerque	O'Reilly House: 9th St. NW	83	El Morro	Laguna Pueblo	148	Deming	Courthouse and Courthouse Park
19	Abuquerque	Our Lady of Mt. Carmel Church: Edith NE	84	Laguna	San Jose Mission and Convento	149	Deming	Mahoney Building: Gold and Service Sts.
20	Abuquerque	Pacific Desk Building: Downtown	85	Laguna	San Mateo Archaeological site (Anasazi)	150	Floydwood	Upton site
21	Abuquerque	Old Post Office Building: Downtown	86	San Mateo	Hawkhill Ruin: 12 mi. SW of Zuni	MCKINLEY		
22	Abuquerque	Forrester Historic District: Downtown	87	Zuni		151	Crownpoint	Casa de Estrella site
23	Abuquerque	1930 Federal Building: Downtown	COLFAX			152	Fort Wingate	Fort Wingate Historic District
24	Abuquerque	First Methodist Episcopal Church: Downtown	88	Cimarron	Cimarron Historic District	153	Gaspar	Cotton House: W. Aztec
25	Abuquerque	Rancho de Camue site: La Cañada SE	89	Folsom	Forsom Man site: 10 mi NW	154	Haystack	Archaeological District
26	Abuquerque	Rosemead Building: Downtown	90	Raton	Catskill Overst: 30 mi W	155	Manuelito	Manuelito Complex
27	Abuquerque	San Felipe de Neri Church: Old Town	91	Raton	Downtown Historic District	156	Prewitt	Andrews archaeological site
28	Abuquerque	San Ignacio Church: Water NE	92	Raton	Raton Pass: 8 mi. N	157	Seven Lakes	Greenlee archaeological site
29	Abuquerque	Southwestern Brewery & Ice Co.: Downtown	93	Johnson Mesa	St. John's Church: 17 mi. E of Raton	158	Seven Lakes	Upper Kin Klizhin site
30	Abuquerque	Spitz (Berthold) House: 10th St. NW	94	Springer	Cowan Livery Stable: Macwell Ave.	159	Zuni	Zuni-Cibola Composite: sites
31	Abuquerque	Superintendent's House, A&P RR: 2nd St. SW	95	Springer	Miss House: 1st St.	160	Zuni	Zuni Pueblo
32	Abuquerque	Vahl House: Old Town	96	Abbot	Dorsey Mansion: 12 mi. NE	MORA		
33	Abuquerque	Washington Apartments: Central SW	CURY			161	Cleveland	Cassidy & Sons General Merchandise
34	Abuquerque	Kramer House: El Pueblo NW	97	Clovis	Clovis Baptist Hospital: Prince St.	162	Cleveland	Cassidy Mill
35	Abuquerque	Pearce House: Downtown	DE BACA			163	Mora	La Cueva Historic District: 6 mi SE
36	Abuquerque	Sommer Building: Downtown	98	Fort Sumner	Pecos Railroad Bldg: 2 mi. NW	164	Mora	St. Vran's Mill
37	Abuquerque	Springer Building: Downtown	99	Fort Sumner	Fort Sumner Monument: 5 mi SE	165	Ocala	Strong Store
38	Abuquerque	Tafuya House: Edith NE	DOÑA ANA			166	Ocala	Vaioz House
39	Abuquerque	New Mexico—Arizona Wood Warehouse: Downtown	100	Las Cruces	Arroyo/Hector House: Christ St.	167	Wagon Mound	Wagon Mound Butte
40	Abuquerque	Shoup Boarding House: 1st St. SW	101	Las Cruces	Fort Finmore site: 8 mi S	168	Wadsworth	Fort Union Monument: 9 mi. N
41	Abuquerque	Spring Park Historic District: NE	102	Radium Springs	Fort Selden site: 1 mi. E	169	Wadsworth	Wadsworth Town Historic District
42	Abuquerque	McCanna Hubbel Building: Downtown	103	Mescal	Mesaue Historic District	OTERO		
43	Abuquerque	Monte Vista School: Monte Vista NE	104	Mescal	Mescal Plaza	170	Cloudercroft	Railroad Trestle—Newman Canyon
44	Abuquerque	Indian School—Dorm & Club: Manual NW	105	Mescal	Barnes Reynolds House: on plaza	171	La Luz	Townsite District
45	Abuquerque	Indian School—Gym: Manual NW	EDDY			172	La Luz	Pottery Factory
46	Abuquerque	Indian School—Lodge: Manual NW	106	Artesia	Ludms House: Richardson Ave.	173	Tularosa	Original Townsite District
47	Abuquerque	Hudson House: God SW	107	Artesia	Rutyan-Brandard House: W. Quay Ave.	174	Sacramento	Circle Cross Ranch House
48	Abuquerque	Old Armo School: Isleta SE	108	Artesia	Baskin House: W. Quay Ave.	QUAY		
49	Abuquerque	1930 St. Joseph's Hospital: Grande NE	109	Artesia	Gester House: Mission Ave.	175	Montoya	Richardson's Store
50	Abuquerque	Galchist House: Comer SE	110	Artesia	Acord House: Main St.	176	Nara Visa	Nara Visa School
51	Abuquerque	VA Hospital Historic District: SE	111	Artesia	Hodges-Soppe House: Missouri Ave.	RIO ARriba		
52	Abuquerque	Eber Apartments: 8th St. SW	112	Artesia	Atkinson House: Grande Ave.	177	Abiquiu	Santa Rosa de Lima: 2 mi. E
53	Abuquerque	Allen House: Manual NW	113	Artesia	Ross House: Rosestawn Ave.	178	Abiquiu	Tsiping Run: 7 mi. W
54	Abuquerque	Foraker Farmhouse: Manual NW	114	Artesia	Mauldin-Hall House: Rosestawn Ave.	179	Alamosa	Los Luceros House
55	Abuquerque	Los Candelarias Chapel: Candelaria NW	GRANT			180	Banco	Francis Canyon Rd: 17 mi. NE
56	North Valley	Araya House: Duranes NW	120	Cliff	Woodrow Ruin: 5 mi NE	181	Chama	Cumbres and Toft: Railroad
57	North Valley	Los Pobosmas Historic District: Los Ranchos	121	Gila	Burro Springs Site #2	182	Cordova	San Antonio de Piedra
58	North Valley	Romero House: Edith NE	122	Gila	L.C. Ranch headquarters	183	Duaca	La Jara site
59	North Valley	Chavez House: 4th NW	123	Mimbres	Janas site	184	Duaca	Juanita Apache Historic District
60	North Valley	Lucero y Montoya House: 4th St.	124	Mimbres	Mattocks site	185	Embudo	Embudo Historic District
61	North Valley	Grande House: Grande NW	125	San Juan	Whetstn-Smith site	186	Espanola	Bond House: Bond St.
62	North Valley	Chavez House: Gregos NE	126	Silver City	Silver City Historic District: Downtown	187	Espanola	Puye Ruins: 14 mi. W
63	North Valley	Bares House: Guadalupe Tr. NW	127	Silver City	Treasure Hill site: Lone Mountain Rd.	188	San Juan	San Gabriel de Yutue-Yungre
64	North Valley	Gomez House: Guadalupe Tr. NW	128	Silver City	Alman House: W. Broadway	189	San Juan	San Juan Pueblo
65	North Valley	Nordhaus House: Los Tomases NW	129	Silver City	St. Mary's Academy Historic District	190	Espanola	Santa Clara Pueblo
66	North Valley	Samms House: Rio Grande NW	130	Silver City	N. Addition Historic District	191	Ojo Calientes	Santa Cruz Chapel
67	North Valley	Los Tomases Chapel: Los Tomases NW	131	Silver City	Chihuahua Hill Historic District	192	Medanazes	Leaf Water Run
			132	Silver City	Water Works Building	193	Medanazes	Tsama Pueblo Run
			GUADALUPE			ROOSEVELT		
			133	Santa Rosa	Casas House: 3rd St.	194	Portales	Anderson Basin (Backwater Draw)

Continued on next page

Appendix 4-H-5. (Continued) Prehistoric and historic sites in New Mexico [4.8-21].

Map Key	Locality	Historic Place	Map Key	Locality	Historic Place	Map Key	Locality	Historic Place
SANDOVAL			SANTA FE			SANTA FE		
195	Piaconas	Sandia Cave	243	Madrdo	Townsite Historic District	292	Magdalena	Gotierrez House
196	Bernalillo	Kasha Ruins: 1 mi. W	244	Espanola	Santa Cruz Plaza and Church	293	Magdalena	McTavish House
197	Bernalillo	Our Lady of Sorrows Church	245	Chernayo	Oratorio de San Buenaventura	294	Magdalena	Hixon House
198	Bernalillo	Abencio Saezar Historic District	246	Chernayo	Plaza de Cerro	295	Magdalena	Magdalena Bank Building
199	Santo Domingo	Santo Domingo Pueblo	247	Chernayo	El Sarmatorio de Chernayo	296	Magdalena	AT&SF Railroad Depot
200	Cochiti	Cochiti Pueblo	248	Galisteo	Yutupa Historic District	297	Magdalena	Itted Co. Warehouse
201	Casa Saezar	Big Bend Mesa	249	Galisteo	Pueblo Colorado	298	Kerry	Clements Ranch House
202	Cornudas	San Ysidro Church	250	Glorieta	Glorieta Pass Battlefield	299	Cibola Forest	Gaunas Springs Run: 25 mi. S of Magdalena
203	Jemez Springs	Glusawa Ruin State Monument	251	Lamy	Apache Canyon Railroad Bridge	300	Gran Quivira	National Monument Historic District
204	Jemez Springs	San Juan Mesa Ruin: 4 mi. E	252	Lamy	Pueblo of San Cristobal Ruin	301	Socorro	AT&SF Railroad Depot: Manzanaras Ave.
205	Jemez	Jemez Pueblo	253	Pojoaque	Nambe Pueblo	302	Socorro	Bursum House: Church St.
206	Bernalillo	Santa Ana Pueblo: 10 mi. NW	254	Pojoaque	San Ildefonso Pueblo	303	Socorro	Garca Opera House: Terry Ave.
207	San Ysidro	Zia Pueblo: 6 mi. SE	255	Pojoaque	Gran Embudo Historic District	304	Socorro	Luna's Brewery: Mesa Ave.
208	Santo Domingo	Tonque Pueblo Ruin: 7 mi. E	256	Cerrillos	San Marcos Pueblo Ruin	305	Socorro	Via Verde Hotel: Manzanaras St
SAN JUAN			257	La Cienega	Barron de Anasco Historic District: Old Santa Fe Trail	306	San Marcial	Fort Craig Site: 37 mi. S of Socorro
209	Aztec	Aztec Ruins	258	Santa Fe	Bergere House: Grant Ave.	TAOS		
210	Blanco	Halfway House Ruin	259	Santa Fe	Crespan House: E. DeVargas	307	Taos	Downtown Historic District
211	Chaco Canyon	National Monument	260	Santa Fe	Davey House: Upper Canyon Rd.	308	Taos	La Loma Plaza Historic District
		Archaeological District	261	Santa Fe	Dugmo-Vidales House: Paseo de Perana	309	Taos	Taos Inn: Pueblo del Rio
212	Farmington	Crow Canyon Archaeological District: E	262	Santa Fe	Fort Marcey Officers' Residence: Lincoln Ave.	310	Taos	Governor Bent House: Bent St
213	Farmington	Gallegos Wash Archaeological District: SE	263	Santa Fe	Fort Marcey site: NE heights	311	Taos	Bumenschen House: La Doux St
214	Bloomfield	Salmon Run: 3 mi. W	264	Santa Fe	Hayt-Whitney Mansion: Paseo de la Curra	312	Taos	Fechin House: Paseo Del Pueblo Norte
215	Fruitedale	CGP Archaeological District: 13 mi. SE	265	Santa Fe	Palace of the Governors: plaza	313	Taos	Lyon Gaspard House: Raton Rd.
216	Bloomfield	Kutz Canyon—Twin Angles Ruin	266	Santa Fe	Raredos of Our Lady of Light: Canyon Rd.	314	Taos	Harwood Foundation: La Doux St
217	La Plata	Morro site: 4 mi. N	267	Santa Fe	Town Center Historic District	315	Taos	Kel Carson House: Kel Carson St
SAN MIGUEL			268	Santa Fe	Santa Fe Plaza	316	Taos	Lujan House: Lujan Lane
218	Conchas	Bel Ranch Headquarters: 10 mi. N	269	Santa Fe	Second Ward School: Sandoval St.	317	Taos	Micraza de Nuestra Señora de Guadalupe
219	Las Vegas	Douglas—8th St. Historic District	270	Santa Fe	Seton Castle: 6 mi. S	319	Taos	San Francisco de Assisi Mission Church
220	Las Vegas	North New Town Historic District	271	Santa Fe	Shonard House: Paseo de Perana	320	Taos	Taos Pueblo: 3 mi. N
221	Las Vegas	Old Town Residential District	272	Santa Fe	Sorensberg-Spitz House: Palace St.	321	Taos	Turkey Mill Distillery Site: 11 mi. N
222	Las Vegas	Douglas Ave. School	273	Santa Fe	Tudy House: Grant Ave.	322	Red River	Schoolhouse
223	Las Vegas	Railroad Ave. Historic District	274	Santa Fe	Vierra House: Old Pecos Trail	323	Red River	Orin Mallett Cabin: 1 mi. W
224	Las Vegas	St. Paul's Church and Gold Hair National Ave.	275	Santa Fe	Vign House: Alro St.	324	Red River	Sylvester Mallett Cabin: River St.
225	Las Vegas	Presbyterian Mission Church: Chaves St.	276	Santa Fe	Old Federal Building	325	Red River	Mason-O'Graham Cabin: Tall Pine Resort
226	Las Vegas	Our Lady of Sorrows Church: National Ave.	277	Santa Fe	Laboratory of Anthropology	326	Red River	Brigham Young House: Main St.
227	Las Vegas	Lincoln Park Historic District	278	Santa Fe	Don Gaspar Historic District	327	Red River	Perce-Funer House: High St
228	Las Vegas	Library Park Historic District	279	Santa Fe	Tesuque Pueblo	328	Las Trampas	Valaje Caezar Historic District
229	Las Vegas	Las Vegas Plaza: Old Town	280	Tesuque	Jean Bouquet Historic District	329	Las Trampas	San Jose de Gracia Church
230	Las Vegas	Infed Auditorium: NMHU	281	Pojoaque	Bagada Mesa Agricultural site	330	Peñasco	Picous Pueblo
231	Las Vegas	Gross, Baconwell & Co. Building: Railroad Ave.	282	La Bajada	Percha Diversion Dam: 2 mi. NE Elephant Butte Dam	331	Peñasco	Corona Mill/Vault: 2 mi. N
232	Las Vegas	Elk's Lodge Building: Douglas Ave.	SIERRA			332	Ranchos de Taos	Ranchos de Taos Plaza
233	Las Vegas	El Distrito de las Escuelas: Old Town	283	Arroyo		333	Tres Piedras	Railroad Water Tower
234	Las Vegas	Bridge Street Historic District	284	Elephant Butte		TORRANCE		
235	Las Vegas	Armory: Douglas Ave.	285	Bingham	Trinity Site: 18 mi. S	334	Montzuma	Eckose Windmill: 2 mi. W
236	Montezuma	Montezuma Hotel Complex	286	Magdalena	Main Street Commercial Building	335	Scholes	Abso Monument: 3 mi. E
237	Pecos	Pecos Ruins Monument	287	Magdalena	Salome Store	336	Mountzuma	Rancho Bonito: 3 mi. S
238	Pecos	San Antonio del Padua Church	288	Magdalena	Argon House	337	Mountzuma	Shaffer Hotel: Broadway
239	Roadada	Pendales Grist Mill	289	Magdalena	Hall Hotel	338	Puerta de Agua	Osaura Monument: 1 mi. S
240	San Miguel	San Miguel del Vado Historic District	290	Magdalena	Lewisden House	URDON		
241	Mineral Hill	San Geronimo Historic District	291	Magdalena	Magdalene House	339	Clayton	Rabbit Ear Complex: 9 mi. N
242	Pecos	Valencia Ranch Historic District	SOCORRO			VALENCIA		
			295	Bingham	Trinity Site: 18 mi. S	340	Beien	Chaves House: Lara Rd.
			296	Magdalena	Main Street Commercial Building	341	Beien	Beien Hotel: Becker Ave
			297	Magdalena	Salome Store	342	Beien	Beien Harvey House: Trackside
			298	Magdalena	Argon House	343	Los Lunas	Luna-Otero House
			299	Magdalena	Hall Hotel	344	Los Lunas	AT&SF Railroad Depot
			300	Magdalena	Lewisden House	345	Tome	Baca House: 2 mi. S
			301	Magdalena	Magdalene House	346	Tome	Tome Jail: Tome Plaza

Continued on next page

Appendix 4-H-5. (Continued) Prehistoric and historic sites in New Mexico [4.8-21].

Historic Sites

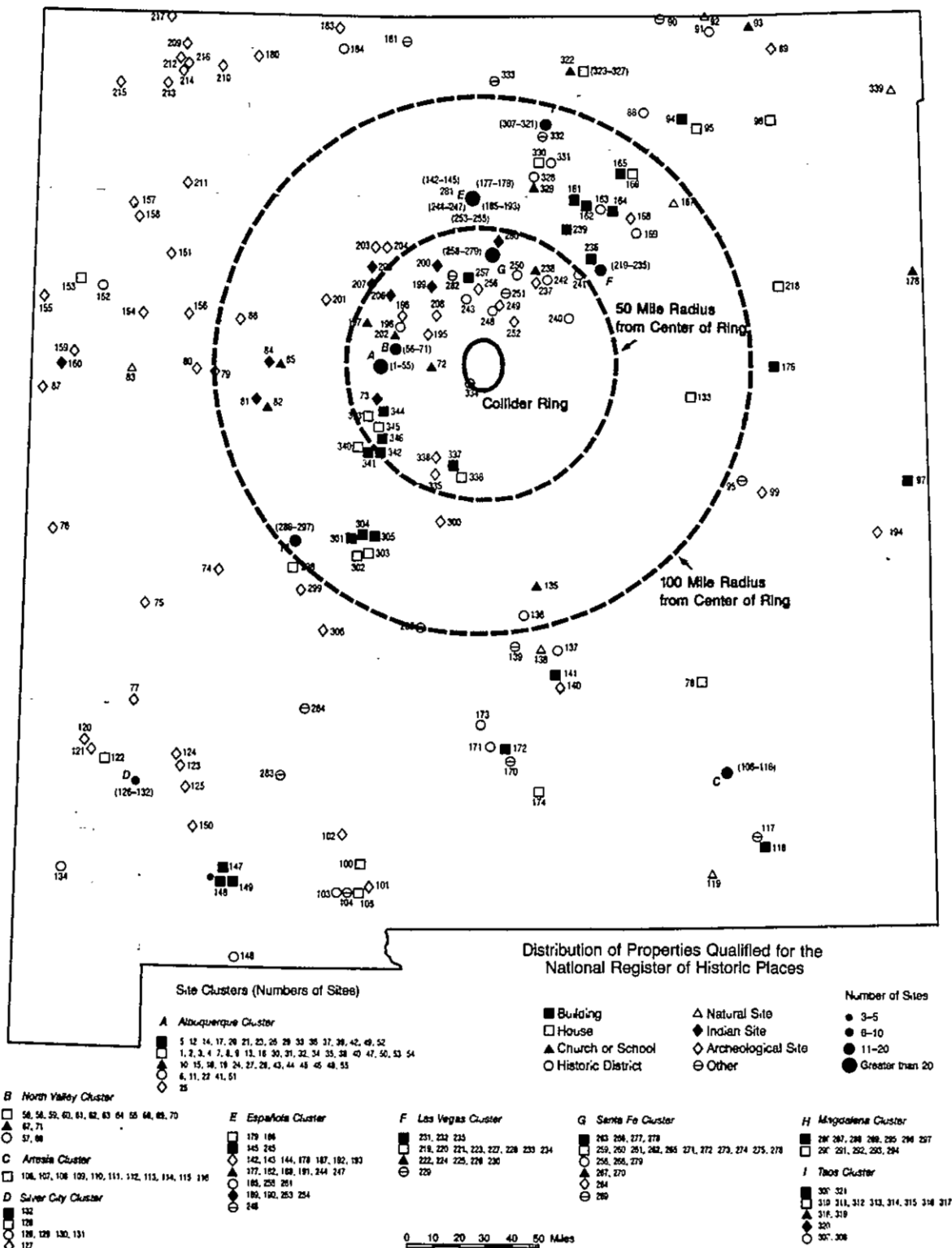

After Jerry Williams, ed., *New Mexico in Maps*, UNM Press (1987).

Appendix 4-H-6. New Mexico museums [4.8-21].
(Table below keyed to following map.)

Map Number	Location	Name	Control	Type	Map Number	Location	Name	Control	Type
BERNALILLO					McKINLEY				
1	Albuquerque	Albuquerque Museum	LG	History-General	63	Church Rock	Red Rock Museum	NP	Arts-Crafts
2	Albuquerque	Ernie Pyne Memorial Library	LG	Personal collection	OTERO				
3	Albuquerque	National Atomic Museum	FG	Science-History	84	Alamogordo	Alameda Park Zoo	LG	Wildlife
4	Albuquerque	New Mexico Museum of Natural History	SG	Natural history	85	Alamogordo	International Space Hall of Fame	SG	Technology-History
5	Albuquerque	Pueblo Indian Cultural Center	IG	Archistory	86	Alamogordo	Tularosa Basin Historical Museum	NP	History
6	Albuquerque	Rio Grande Zoological Park	LG	Wildlife	87	Cloudcroft	Sacramento Mountains Museum and Pioneer Village	NP	History
7	Albuquerque	Sandia Labs Exhibit Center	NP	Science-Technology	88	Tularosa	Village Historical Museum	NP	History
8	Albuquerque	State Fair Fine Arts Gallery	SG	Art	89	White Sands	National Monument Center	FG	History-Geology-Nature
9	Albuquerque	Telephone Pioneer Museum	P/NP	Science-Technology	DUNN				
10	Albuquerque, University of New Mexico	Geology Museum	U	Geology-Natural History	70	Tucuman	Historical Research Institute	LG	History-Art
11		Jordan Gallery	U	Art	71	Mosley	Rickardson General Store	P	History
12		Museum of Anthropology	U	Anthropology-Art	RIO ARriba				
13		Mesquits Museum	U	Geology	72	Abiqui	Ghost Ranch Living Museum	FG	Wildlife-Nature
14		Museum of Southwestern Biology	U	Plants-Animals	73	Abiqui	Florence Hawley Ellis Museum	P/NP	Anthropology
15		Fine Arts Museum	U	Art	74	Chaco	Cumbres and Tropic Railroad	SG	Technology-History
CATRON					75	Delia	Jacinto Museum	IG	Arts-Crafts
16	Gila National Forest	Gila Cliff Dwellings Visitor Center	FG	Archaeology-Ethnology	ROOSEVELT				
17	Mogadon	Mogadon Ghost Town Museum	P	History	76	Portales—Eastern	New Mexico University	U	Archaeology-Geology
CHAVES					77		Suzewater Drive Museum	U	Archaeology
18	Roswell	Chaves County Historical Museum	NP	History	78		Mees Museum	U	Anthropology
19	Roswell	Roswell Museum and Art Center	LG	Art-Archaeology-Science	79		Natural History Museum	U	Natural History
20	Roswell	Spring River Zoo	LG	Wildlife			Pueblo-Indian Institute	U	Archaeology
CIBOLA					80		Roosevelt County Museum	U	History-General
21	Acoma	Acoma Pueblo Museum	IG	Art-Archaeology	SANDOVAL				
22	Raton	El Morro National Monument Center	FG	History-Archaeology	81	Bernalillo	Coronado Monument Museum	SG	Archaeology
23	Grants	Chamber of Commerce Museum	LG	History	82	Jemez Springs	Jemez Monument Visitor Center	SG	Archaeology
COLFAX					SAN JUAN				
24	Carrizosa	Old Mill Museum	NP	History	83	Aztec	Aztec Museum	NP	History
25	Carrizosa	E.T. Seton Memorial Library	NP	Personal collection	84	Aztec	National Monument Center	FG	Archaeology
26	Carrizosa	Kit Carson Museum	NP	History	85	Chaco Canyon	Historical Park Center	FG	Archaeology
27	Raton	Raton Museum	LG	History-Art	86	Farmington	Historical Museum	LG	History
28	Springer	Santa Fe Trail Museum	LG	History	87	Farmington	San Juan County Archaeological Research Center and Library	LG-P	Archaeology
CURRY					SAN MIGUEL				
29	Curry County Zoo	Curry County Zoo	P/NP	Wildlife	88	Las Vegas	Rough Rider and City Museum	LG	History
DE SACA					89	Pecos	National Monument Center	FG	Archaeology-Ethnology
30	Fort Sumner	Billy the Kid Museum	P	History	SANTA FE				
31	Fort Sumner	Old Fort Sumner Monument	SG	History	90	Santa Fe	Chapel of San Miguel	P/NP	History-Building
DONA ANA					91	Santa Fe	Institute of American Indian Arts Museum	FG	Arts-Crafts
32	Mesita	American Cowboy Museum	NP	History	92	Santa Fe—Museum of New Mexico	Interpretive Folk Art Museum	SG	Arts-Crafts
33	Mesita	Gadsden Museum—A. J. Fountain	P	Personal collection			Fine Arts Museum	SG	Art
34	Radium Springs	Fort Selden State Monument	SG	History-General	94		Palace of the Governors	SG	History
35	Las Cruces	Playhouse Museum of Old Dolls and Toys	P	General	95		Laboratory of Anthropology	SG	Archaeology-Anthropology
36	Las Cruces—New Mexico State University	Mexico State University Museum	U	History-Archaeology	96	Santa Fe	Governor's Gallery	SG	Art
37		Art Gallery	U	Art	97	Santa Fe	Santismo de Guadalupe	NP	Art-History
EDDY					98	Santa Fe	School of American Research	NP	Arts-Crafts
38	Artesia	Historical Museum and Art Center	LG	History-Art	99	Santa Fe	Wheelwright Museum of the American Indian	P/NP	Anthropology-Crafts
39	Carrizosa	Caverna National Park	FG	Geology-Nature	100	La Cienega	Old Cienega Village Museum	NP	History-Crafts
40	Carrizosa	Fine Arts and Museum	LG	General	101	San Idelfonso	Pueblo Museum	IG	Arts-Crafts
41	Carrizosa	Living Desert State Park	SG	Wildlife-Botany	102	Gallup	Galestro Museum	P	Archaeology-History
42	White City	Nelson Oscar Museum	P	General	103	Madrid	Old Casa Mare Museum	P	Technology-History
GRANT					SIEBORA				
43	Silver City	Silver City Museum	LG	History	104	Truth or Consequences	Geronimo Songs Museum	NP	History-Geology
44	Silver City—Western New Mexico	Francis McCoy Gallery	U	Art	105	Hobbs	Back Range Museum	P	History
45		University Museum	U	History-General	106	Kingston	Percha Valley Museum	P	History
46	Pecos Altos	Historical Museum	P	History	SOCORRO				
HIDALGO					107	Socorro	Mineral Museum of the Bureau of Mines	U	Geology-Nature-History
47	Lordsburg	Shakespeare Ghost Town	P	History	108	San Augustin	Very Large Array Center	FG	Technology-Science
LEA					TAOS				
48	Lovington	Lee County Museum	P/NP	History	108	Taos	Governor Bent Museum	P	History-Art
49	Hobbs	Cowboy Hall of Fame and Western Heritage	NP	History	110	Taos	Stables Art Center	NP	Art
50	Hobbs	Confederate Air Force Museum	P	Technology-History	111	Taos	Montezuma Rogers Museum	NP	Anthropology-Art
LINCOLN					112	Taos	Hamwood Foundation	NP	Art
51	Ancho	My House of Old Things	P	History-General	113	Taos	Kit Carson Memorial Foundation	NP	History-Buildings
52	Capitan	Strobel Bear Historical Park	SG	Nature	114	Taos	Leon Gaspard Museum	NP	History-Buildings
53	Lincoln	La Piedad Museum	P	History	115	Ranchos de Taos	Pt. Burghen Research Center	NP	History-Buildings
54	Lincoln	Lincoln County Heritage Trust	NP	History-Buildings	116	Padasco	Picosa Pueblo Museum	IG	History-Archaeology
55	Lincoln	Old Lincoln County Courthouse Museum	SG	History-Buildings	117	Vadito	Lazarino Cordova Memorial Museum	P	History-Technology
LOS ALAMOS					TORRANCE				
56	Bandelier	National Monument Center	FG	Archaeology-Ethnology	118	Montevito	Historical Society Museum	NP	History
57	Los Alamos	Bradbury Science Museum	FG	Science-Technology	119	Mountainair	Salinas National Monument Center	FG	Archaeology-History
58	Los Alamos	Fueller Lodge Art Center	P-NP	Art	UNION				
59	Los Alamos	County Historical Museum	P/NP	History-Art	120	Capitan	National Monument Center	FG	Geology-Nature-History
LUNA					121	Folsom	Folsom Museum	P/NP	History-Archaeology
60	Deming	Memorial Museum	NP	History-General	VALENCIA				
61	Carmouss	Historical Museum	P	History	222	Tome	Parson Museum	P-NP	History
MORA					Key: LG—Local Government; SG—State Government; NP—National Park; FG—Federal Government; IG—Indian Government; U—University; Source: Directory of New Mexico Museums, 1982-1983				
62	Watrous	Fort Union Monument Museum	FG	History					

Museums

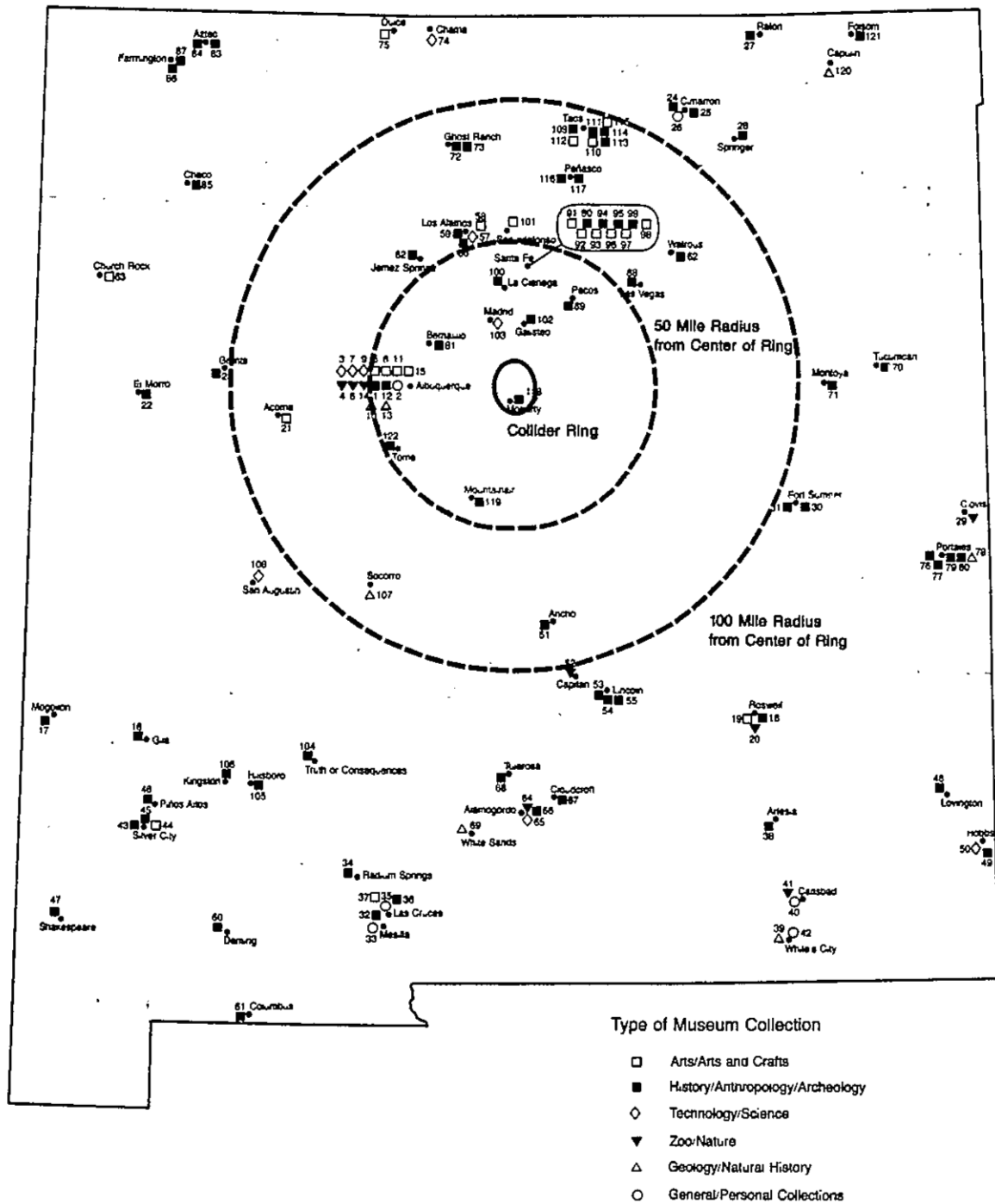

After Jerry Williams, ed., *New Mexico in Maps*, UNM Press (1987).

Source: N.M. Association of Museums, National Register, American Association of Museums
 0 10 20 30 40 50 Miles

Appendix 4-H-7. Arts and ethnic events in New Mexico [4.8-21]. (Table below keyed to map on next page.)

Arts & Crafts Shows and Auctions			Music and Dancing				
1	Albuquerque	Amigos de las Americas Art Auction	March	2	Santa Fe	OSF Bach Festival	February
2	Santa Fe	Pueblo Spring Invitational Arts & Crafts Show	April	3	Albuquerque	Gilbert & Sullivan Presentation	March
3	Socorro	Arts & Crafts Show	April	5	Roswell	Pop's Concert	April
4	Bellevue	Spring Art Show	April	6	Carlsbad	Choral Music Festival	April
5	Albuquerque	Bienal Spring Embroidery Fiesta	April	7	Carlsbad	Band Festival	April
6	Albuquerque	Craftwork Exhibition	May	9	T or C	Fiddlers Contest	May
7	Roswell	Arts & Crafts Fair of the Southwest	May	10	Deming	Fiddlers Contest	May
8	Bellevue	Art League Benefit Auction	May	11	Reserve	Fiddlers Contest	May
9	Los Alamos	No. New Mexico Arts & Crafts Fair	May	12	Albuquerque	Mother's Day Symphony Concert at Rio Grande Zoo	May
10	Clowdcroft	May Fair Arts & Crafts Festival	May (Memorial Day week)	15	Ruidoso	Summer Music Festival	June
11	Hesboro	Fiesta and Sidewalk Sale	Memorial Day week	16	Corrales	Library Concert	June
12	Tesuque	Shodini Outdoor Show	June-August	17	Madrid	Jazz Workshops and Concerts	weeks, June-Aug.
13	Albuquerque	New Mexico Arts & Crafts Fair	June	18	Madrid	Southwest Pickers Concerts	weeks, June-Aug.
14	Farmington	Earthwoks Guild Arts & Crafts Fair	June	19	Albuquerque	June Music Festival	June
15	Tucuman	C.R.A.F.T. Exhibition	June	20	Taos	Summer Chamber Music Festival	June
16	Santa Fe (or at one of the pueblos)	Eight Northern Pueblos Arts & Crafts Show	3rd week in July	21	Animas	Old Time Fiddlers Contest	June
17	Ruidoso	Ruidoso Art Festival	July	24	Roswell	"Rasin' A Rucos" Country & Western Concert	July 4
18	Carlsbad	Tri-State Arts & Crafts Show	August	26	Santa Fe	Santa Fe Opera Season	July-August
19	Los Alamos	Arts Festival	August	28	Magdalena	Fiddlers Contest	Week after July 4
20	Albuquerque	Inter-Tribal Arts & Crafts Show	August	29	Santa Fe	Chamber Music Festival	July
21	Santa Fe	Indian Market	August	30	Albuquerque	Chamber Orchestra of Albuquerque Annual Concert and Auction	August
22	Carlsbad	Peoples' Market Place	August	31	Bosque Farms	Old Time Fiddlers Contest	August
23	Hesboro	Black Range Art Exhibit	August	34	Santa Fe	Old Time Banjo and Fiddle Contest	August or September
24	Raton	Street Arts & Crafts Fair	August	35	Hatch	Old Time Fiddlers Contest	Labor Day week
25	Albuquerque	Feria Artesana	August	36	Prewit	Old Time Fiddlers Contest	Labor Day week
26	Santa Fe	Fiesta Arts & Crafts Show	Labor Day week	37	Socorro	Old Time Fiddlers Contest	September
27	Santa Fe	Once a Tree (Woodworkers' Show)	September	38	Carlsbad	Fiddlers Contest and Bluegrass Festival	September
28	Red Rancho	Arts & Crafts Show	September	42	T or C	State Old Time Fiddlers Championship	October
29	Silver City	Arts in the Park and Flea Market	September	43	Las Cruces	Concert of Sacred Choral Classics	October
30	Grants	October Festival of the Arts	October	44	Farmington	Four Corners Opera Assn. Prodn	November
31	Taos	Festival of the Arts	October	45	Albuquerque	New Mexico Symphony Orchestra Beethoven Festival	December
32	Santa Fe	Festival of the Arts	October				
33	Clayton	Arts & Crafts Festival	October				
34	Roswell	Fair Invitational Art Show	October				
35	Socorro	Arts & Crafts Day	October				
36	Albuquerque	Southwest Arts & Crafts Fair	October				
37	Mesita	Renaissance Arts & Crafts Fair	November				
38	Lovington	Festival of the Arts	November				
39	White Sands	Officers' Wives Club of White Sands Miscra Range Invitational Christmas Bazaar	November				
40	La Cienega	Arts Association Open House	November				
41	La Luz	Folk Art and Christmas Show	November				
42	Silver City	Grant Co. Art Guild Christmas Show	November				
43	Albuquerque	Arts & Crafts Committee Show	Sat. before Thanksgiving				
44	Los Alamos	No. New Mexico Arts & Crafts Fair	November				
45	Farmington	San Juan Archaeological Association Arts & Crafts Show	November				
46	Tucuman	December Arts & Crafts Fair	December				
47	Las Vegas	Arts & Crafts Fair	December				
48	Alamogordo	Christmas Fair	December				
49	Crowpoint	Nazajo Rug Auction	Spring to fall, every 6 weeks				

Dancing (Besides Religious Holidays)			
1	Pueblos	Installation of governors	January
4	Santa Fe	Bane de Cascares	Saturday after Lent
8	Albuquerque	Nahoni Days (UNM)	April
13	—	New Mexico Square Dance Festival (every 5th year in Santa Fe, Portales, Farmington, Albuquerque, Las Cruces)	May
14	Red River	Memorial Day Square Dance Festival	May
22	Red River	Trail-in Round and Square Dance	June
23	Albuquerque	Inter-Tribal Powwow	June
25	Nambe Pueblo	Waterfall Ceremony	July 4
27	Dulce	Little Beaver Roundup Rodeo and Powwow	July
32	Gallup	Inter-Tribal Ceremonial	August
33	Hobbs	Fraternity Order of Powce Street Dance and Barbecue	August
39	Escabosa	Rodeo and Dance	September
40	Gallup	Regional Square Dance Festival	September
41	Roswell	New Mexico Round Dance Festival	September

Continued on next page

Appendix 4-H-7. (Continued) Arts and ethnic events in New Mexico [4.8-21].

Primary Food Celebrations			Miscellaneous Events				
1	Albuquerque	Spring Wine & Beer Judging Festival	May	1	Albuquerque	Zoo Photo Contest	January
2	Albuquerque	Strawberry Festival	May	2	Albuquerque	Scout-o-Rama	March
3	Red River	Chia Cookoff	May (Memorial Day week)	3	Albuquerque or a so. N.M. town	New Mexico Weavers Conference	March
4	Albuquerque	Cowbeef Cookoff	June	4	Silver City	Bear Mountain Guest Ranch Nature and Spring Bird Migration Tour	April to December
5	Waldo	Waldo Picnic	June	5	Hobbs	Academic Games Clinic	April
6	High Ross	High Ross Cherry Festival	End of June	6	Santa Fe	Film Festival	April
7	Carlsbad Cavern	Bat Flight Breakfast	August	7	La Cienega	El Rancho de las Golondrinas Open House	1st Sun. June-Sept
8	Hatch	Hatch Chik Festival	September	8	Chama	Cumbres & Toiyac Scenic Railroad	2nd wkd in June-2nd wkd in Oct
9	Halaboro	Apple Festival	September	9	Santa Fe	Rose Society Show	June
10	Las Cruces	N.M. State Chia Championship Cookoff	October	10	Santa Fe	Santa Fe Trail Museum	June-August
11	Las Cruces	Whole Enchilada Classic	September or October	10	Springer	Bear Mountain Guest Ranch Edible Plant Workshop and Wildflower Tours	June-August
12	Albuquerque	Gourmet Day Tours	October	11	Gran Qshira	Gran Qshira Conference	July, every 4th year
13	Valencia	Harvest Festival	October	11	Silver City	Bear Mountain Guest Ranch Wildflower Tour	August
14	Socorro	Free State of Socorro Chui Cookoff	October	11	Silver City	Bear Mountain Guest Ranch Fall Wildflower, Bird Migration, and Raming Fall Fowage Tours	September
15	High Ross	Apple Festival	October	12	Albuquerque	PI Beta Phi Interior Design Show	September, art years
16	Albuquerque	Red's Winery Bacchanalia and Harvest Festival	October	13	Alamogordo	Trinity Site Tour	1st Sat. in Oct
17	Albuquerque	All Fash's Apple Festival	October	14	Alamogordo	International Space Hall of Fame Induction Ceremonies	1st Sat. in Oct
18	Portales	Peanut Valley Festival	October	15	Albuquerque	Colonial Infantry of Albuquerque's Columbus Day Celebration	October 12

Ethnic Days (But not feast days)			
1	Pueblas	Installation of Governors	January
2	Albuquerque	Chinese New Year	January
3	Albuquerque	German Fasching Fiesta	Week before Lent
4	Dodge	Jicamla Winter Fun Festival	February
5	Santa Fe	Baile de Cascarones	Saturday after Lent
6	Albuquerque	St. David's Day (Welsh)	March
7	Socorro	St. Patrick's Day	March 17
8	Albuquerque	St. Patrick's Day	March 17
9	Albuquerque	Hommage to Shakespeare and Cervantes	April 23
10	La Cienega	El Rancho de las Golondrinas	May
11	Las Vegas	Cinco de Mayo Fiesta	May
12	Albuquerque	Flores de Mayo—St. Helen's Day (Philippines)	May
13	Albuquerque	Omatsuri Japanese Festival	June
14	Espanola	Fiesta de Ofata	July
15	Santa Fe	Spanish Market	July
16	Luna	24th of July holiday (Mormon)	July 24
17	Rio Rancho	Festa Italiana	August
18	Angel Fire	Paul Bunyan Days and Oktoberfest	September
19	Santa Fe	Fiesta de Santa Fe	September
20	Mesa	Pan American Fiesta	September
21	Mesa	16 de Septiembre Celebration (Mexican Independence)	September 16
22	Lovington	Fiesta Internacional	September
23	Albuquerque	Chinese Moon Festival	October
24	La Cienega	El Rancho de las Golondrinas Harvest Festival	October
25	Las Cruces	Vaquero Days	October
26	Eagle Nest	Oktoberfest	October
27	Albuquerque	Grecian Festival	October
28	Deming	Kobase Festival (Bohemian)	October
29	Farmington	Four Corners Cultural Heritage Festival	October
30	Albuquerque	St. Andrew's Day (Scottish)	November



11	Silver City	Bear Mountain Guest Ranch Wildflower Tour	September
11	Silver City	Bear Mountain Guest Ranch Fall Wildflower, Bird Migration, and Raming Fall Fowage Tours	September, art years
13	Alamogordo	Trinity Site Tour	1st Sat. in Oct
14	Alamogordo	International Space Hall of Fame Induction Ceremonies	1st Sat. in Oct
15	Albuquerque	Colonial Infantry of Albuquerque's Columbus Day Celebration	October 12
16	Albuquerque	Don and Miniature Fair and Sale	October
17	Silver City	Bear Mountain Guest Ranch Artss in Residence Paintouts	October
16	Carlsbad	Fall Color Tour of McKittrick Canyon, Guadalupe Mountains	October
17	Silver City	Bear Mountain Guest Ranch Wild Plant and Thanksgiving Weekend Bird Tours	November
19	Albuquerque	Hanging of the Greens (UNM)	November
20	Albuquerque	Civil War Living History Encampment	December
21	Albuquerque	Zoo Holiday	December
21	Silver City	Bear Mountain Guest Ranch Christmas and New Years Weekend Plant Tours	December

Continued on next page

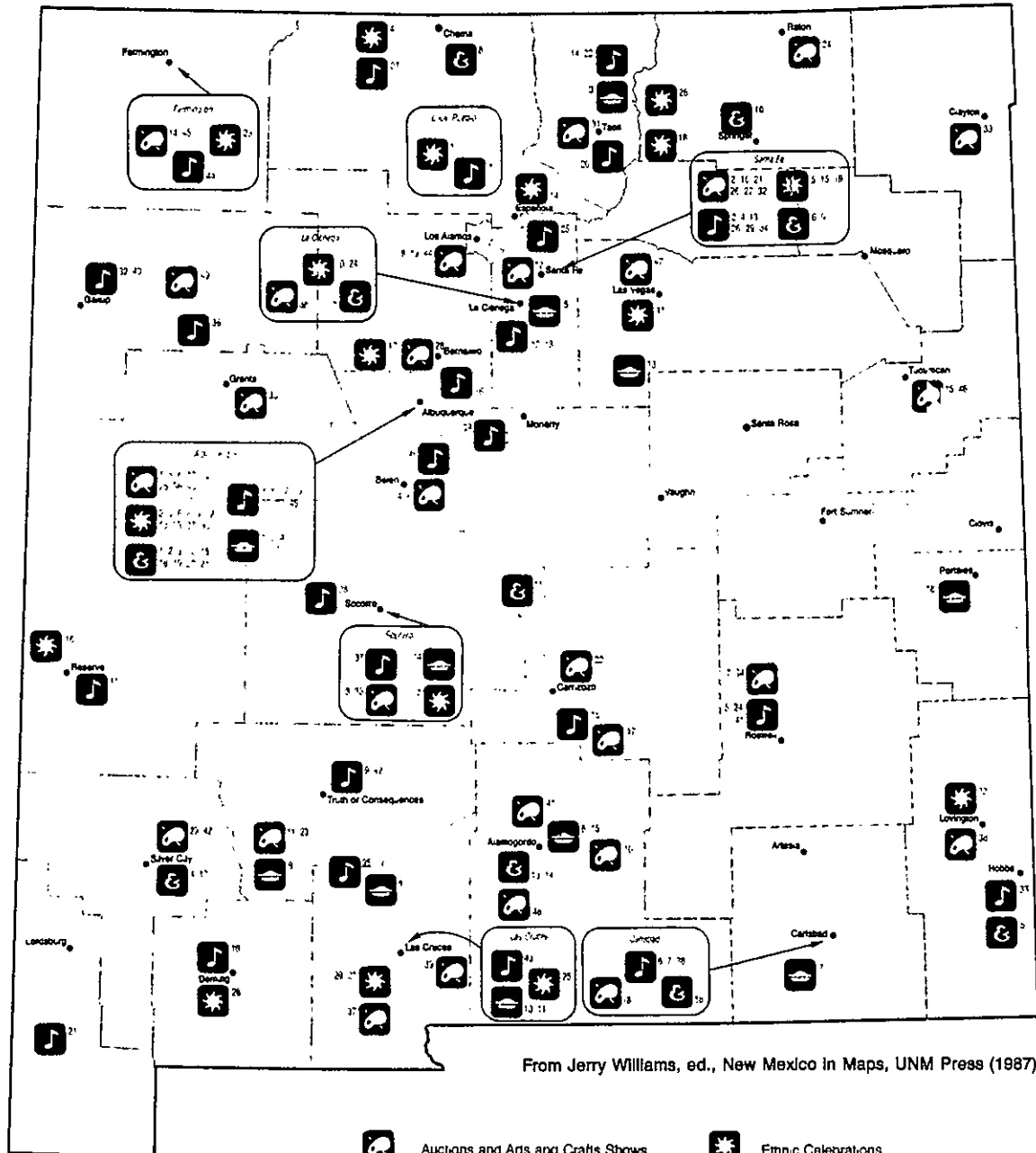
Arts and Ethnic Events



From Jerry Williams, ed., *New Mexico in Maps*, UNM Press (1987).

-  Auctions and Arts and Crafts Shows
-  Music and Dance Events
-  Food Festivals
-  Ethnic Celebrations
-  Miscellaneous Cultural Events

0 10 20 30 40 50 Miles

Appendix 4-H-8. Public and community libraries within the SSC vicinity area; academic and specialized libraries statewide [4.8-21].

Place	Volumes/ Reports	Microfilms	Subscriptions
PUBLIC LIBRARIES			
Albuquerque	404,782	44,985	1,079
Bernalillo County	14,319	0	35
Santa Fe	183,143	6,400	268
Statewide Total, Public Libraries	1,855,987	67,383	5,228
COMMUNITY LIBRARIES			
Estancia	8,010	0	8
Moriarty	5,867	0	0
ACADEMIC LIBRARIES			
Eastern New Mexico University			
Portales	214,172	326,759	1,274
Clovis	21,840	6,577	186
Roswell	27,471	6,866	228
Highlands University	152,079	60,909	1,192
New Mexico Junior College	94,775	65,498	567
New Mexico State University			
Las Cruces	701,960	530,924	6,563
Alamogordo	33,572	2,688	264
Carlsbad	18,927	1,431	108
Grants	25,000	NA	39
New Mexico Institute of Mining and Technology	116,123	33,940	872
Northern New Mexico Community College	16,700	NA	200
San Juan College	26,188	3,234	182
University of New Mexico			
Albuquerque	1,086,529	1,836,899	8,425
Gallup	17,259	NA	89
Western New Mexico University	122,267	279,609	761

Continued on next page

Appendix 4-H-8. (Continued)

Place	Volumes/ Reports	Microfilms	Subscriptions
College of the Southwest	36,717	10,500	409
St. John's College	47,860	NA	192
University of Albuquerque	83,000	32,396	467
Statewide Total, Academic Libraries	2,825,739	3,225,230	22,018
SCIENTIFIC LIBRARIES			
Sandia Laboratories	162,710	670,000	1,500
Los Alamos National Laboratory	680,000	400,000	8,235
White Sands Missile Range	8,567	2,500,000	404
Total Scientific Libraries	851,277	3,570,000	10,139
MEDICAL, LAW, AND OTHER SPECIAL LIBRARIES			
Albuquerque			
Lovelace Center	17,099	NA	206
Presbyterian Hospital	2,287	50	97
St. Joseph Hospital	1,300	NA	105
UNM-Bureau of Business	11,000	200	NA
UNM Medical Center	104,730	1,706	2,161
UNM Law School	166,844	395,000	950
Alamogordo			
Holloman AFB Center	10,700	NA	120
Cimarron			
Seton Memorial	8,000	NA	8
Clovis			
Cannon AFB	34,449	20,519	371
San Juan County			
Archaeological Center	4,000	0	41
Santa Fe			
Institute of American Indian Arts	14,000	50	80
Sunspot	12,000	NA	112
Museum of New Mexico	43,488	2,183	856
Supreme Court	104,300	NA	400

Continued on next page

Appendix 4-H-8. (Continued)

Place	Volumes/ Reports	Microfilms	Subscriptions
Taos			
Kit Carson Memorial	10,018	NA	23
Statewide Total, Medical, Law, and Other Special Libraries	665,952	419,753	5,215

Appendix 4-H-9. Churches and synagogues in the SSC vicinity area [4.8-27, 4.8-30].

Denomination	Number in Albuquerque	Number in Santa Fe
Baptist	71	8
Catholic	42	10
Christian Science	3	1
Church of Christ	14	2
Church of Jesus Christ of Latter Day Saints	6	3
Greek Orthodox	2	0
Episcopal	8	2
Jehovah's Witness	9	1
Lutheran	33	3
Methodist	30	1
Presbyterian	18	2
Jewish	4	1
Interdenominational	22	1
Non-Denominational	24	4
Other	143	26
Total	430	65



The Legislature
of the
State of New Mexico

38th Legislature, 1st SPECIAL Session

LAWS 1987

CHAPTER _____

SENATE JOINT RESOLUTION 1, as amended

Introduced by

SENATOR MICHAEL ALARID AND SENATOR WILLIAM R. VALENTINE
SENATOR W. S. EOFF
SENATOR TOM RUTHERFORD
SENATOR I. M. SMALLEY



1 A JOINT RESOLUTION

2 CONFIRMING NEW MEXICO'S LONG-STANDING AND CONTINUING COMMITMENT TO
3 THE ENHANCEMENT OF EDUCATIONAL QUALITY IN THE STATE.
4

5 WHEREAS, the state of New Mexico has established an extensive
6 network of public education facilities, guaranteeing access to public
7 schooling and higher education for all residents of the state; and

8 WHEREAS, the state has an outstanding record of stable support
9 for education, in particular, nationally recognized formula funding
10 of public schools that guarantees equalized support based on student
11 needs, regardless of a student's location in the state, and state
12 formula funding of colleges and universities based upon their funding
13 needs; and

14 WHEREAS, New Mexico's commitment to funding education is demon-
15 strated by the fact that New Mexico ranks second in the nation in the
16 percentage of its state budget appropriated to public education; and

17 WHEREAS, the New Mexico legislature, the state board of educa-
18 tion, the commission on higher education and the boards of regents
19 have demonstrated their dedication to continued improvement of educa-
20 tion in the state, as exemplified by:

21 A. recent statutory and regulatory public school improve-
22 ments, including increased salaries for instructional personnel; re-
23 duced class sizes; and increased instructional time in mathematics,
24 science and other essential subject matters;

25 B. a long-term program of statutory and regulatory improve-

SJR 1
Page 1

1 ment in the preparation, licensing and professional development of
2 teachers and administrators; and

3 C. the establishment of new cooperative relationships among
4 post-secondary educational institutions, between public school dis-
5 tricts and post-secondary educational institutions and between public
6 schools and post-secondary institutions and the technical and business
7 communities throughout the state; and

8 WHEREAS, as a result of New Mexico's educational environment,
9 New Mexico school districts have accomplished the following:

10 A. student success above national averages in all subject
11 areas on standardized achievement tests;

12 B. many centers of educational excellence awards by the
13 United States department of education and other national awards;

14 C. operation of nationally recognized programs and services
15 for children with special educational needs; and

16 D. alternative and enrichment programs for students with
17 superior potential, including advanced instruction in science and
18 mathematics and arrangements with colleges and universities for dual
19 enrollment programming; and

20 WHEREAS, the legislature and the institutions of higher education
21 have shown their commitment to meet new educational challenges and
22 are ready to provide full support to the superconducting super col-
23 lider program, its personnel and their dependents, as demonstrated by
24 the following:

25 A. extensive, long-standing relationships with federal re-

SJR 1
Page 2

1 search facilities in the state;

2 B. establishment of New Mexico TECHNET, providing state-
3 of-the-art telecommunication and data transmission linkages between
4 universities, national research laboratories and other technical in-
5 stallations and the private sector;

6 C. establishment of centers of technical excellence at New
7 Mexico's three research universities within the Rio Grande research
8 corridor to stimulate world-class research programs and the transfer
9 of technological knowledge to business and industry;

10 D. establishment of an extensive system of two-year col-
11 leges and vocational institutions that are able to respond rapidly to
12 prepare technicians and support personnel for emerging technologies
13 and industries;

14 E. rapidly developing materials science programs at the
15 research universities, which will generate complementary fields of
16 expertise of particular relevance to superconductivity; and

17 F. expanding programs that provide engineering and other
18 technically related instruction by the use of interactive video tele-
19 communication linking universities and laboratories in locations
20 throughout the state;

21 NOW, THEREFORE, BE IT RESOLVED BY THE LEGISLATURE OF THE STATE
22 OF NEW MEXICO that New Mexico's long-standing and continuing commit-
23 ment to the enhancement of educational quality is confirmed and that
24 the educational resources of the state of New Mexico are committed to
25 the support and development of the proposed superconducting super

SJR 1
Page 3

1 collider; and

2 BE IT FURTHER RESOLVED that New Mexico's public schools and
3 higher education institutions are directed to make every effort to
4 respond to the educational needs of the proposed superconducting
5 super collider facility; and

6 BE IT FURTHER RESOLVED that the legislature directs the legisla-
7 tive education study committee, the interim legislative universities
8 study committee, the commission on higher education, the state board
9 of education and the boards of regents of the state's universities to
10 recognize the educational needs of this project in their planning for
11 the state's educational system and advise the legislature of programs
12 that may be necessary to respond to educational needs; and

13 BE IT FURTHER RESOLVED that copies of this joint resolution be
14 transmitted to the director and chairman of the legislative education
15 study committee, the chairman of the universities study committee,
16 the executive director and chairman of the commission on higher
17 education, the president of the state board of education, the state
18 superintendent of public instruction and the presidents of the boards
19 of regents. _____

SJR 1
Page 4

S/Jack Stahl

Jack Stahl, President
Senate

S/Juanita Pino

Juanita Pino, Chief Clerk
Senate

S/Raymond G. Sanchez

Raymond G. Sanchez, Speaker
House of Representatives

S/Stephen R. Arias

Stephen R. Arias, Chief Clerk
House of Representatives

APPENDIX 4-I

Community Support

CITY of ALBUQUERQUE
SEVENTH COUNCIL

COUNCIL BILL NO. R-255 ENACTMENT NO. 53-1987

SPONSORED BY: *Patrick J. Baca*

*Underscored Material - New
Bracketed Material - Deletion*

RESOLUTION

1
2 SUPPORTING THE LOCATION OF THE SUPERCONDUCTING SUPER COLLIDER IN THE
3 ALBUQUERQUE, NEW MEXICO, AREA.

4 WHEREAS, the City of Albuquerque, along with informed people
5 throughout the nation, applauds the federal government's intention
6 to build a Superconducting Super Collider (SSC) 53 miles in
7 circumference so as to better understand the nature of physical
8 matter and energy, with a view towards improving the quality of life
9 for mankind; and

10 WHEREAS, the proposed location in the Estancia Valley being only
11 20 miles from the City of Albuquerque, the City's transportation
12 facilities, which include a fine urban street network, service by
13 two Interstate Highways, a major international airport, a major
14 rail-to-truck transfer facility, and extensive bus service, can
15 materially assist those working at and visiting the SSC; and

16 WHEREAS, Albuquerque is a large enough City to provide a labor
17 pool with diverse technical and professional skills which will allow
18 easy recruitment of qualified personnel for construction and
19 operation of the SSC; and

20 WHEREAS, Albuquerque has an extensive supply of housing of all
21 kinds, as well as community facilities and cultural resources which
22 will make it a convenient and attractive place for people working at
23 or visiting the SSC; and

24 WHEREAS, Albuquerque's beautiful site, containing mountains,
25 mesas, and a famous river, combined with its dry climate and its
26 friendly and diverse population, will make this an enjoyable place

Underscored Material - New
Bracketed Material - Deletion

1 for people from other cities who may be recruited to work at the
2 SSC; and

3 WHEREAS, Albuquerque is the home of a major research university
4 and diverse other educational opportunities including a fine public
5 school system and Technical-Vocational Institute which can provide
6 quality education to the staff and families of the SSC; and

7 WHEREAS, Albuquerque is the home of Sandia National Laboratory
8 and other federal research institutions, specialized research
9 institutes connected to the University of New Mexico, and is at the
10 center of the Rio Grande Research Corridor which contains many other
11 reasearch institutions.

12 BE IT RESOLVED BY THE COUNCIL, THE GOVERNING BODY OF THE CITY OF
13 ALBUQUERQUE:

14 Section 1. That the City of Albuquerque supports the proposal
15 to locate the Super Conducting Super Collider in the Estancia Valley
16 28 miles from Albuquerque and will work with those constructing and
17 operating the facility to make it a successful venture in every way.

18 Section 2. The City of Albuquerque will welcome and serve
19 visitors and residents associated with the Super Conducting Super
20 Collider.

21
22
23
24
25
26
27
28
29
30
31
32
33

5822C

- 2 -

1 PASSED AND ADOPTED THIS 15th DAY OF June, 1987.

2 BY A VOTE OF 9 FOR AND 0 AGAINST.

3

4

5

6

7

8

9

10

11

12

13

14

15

16

17

18

19

20

21

22

23

24

25

26

27

28

29

30

31

32

33

Patrick J. Baca
Patrick J. Baca, President
City Council

APPROVED THIS 22nd DAY OF June, 1987.

Ken Schultz
Ken Schultz, Mayor
City of Albuquerque

ATTEST:

Thomas J. Smith
City Clerk

Underscored Material - New
Bracketed Material - Deletion

RESOLUTION #3-87

WHEREAS the Superconducting Super Collider (SSC) is intended to push forward the frontiers of science by providing a way to study the nature of matter and energy in ways that have never been possible.

WHEREAS the SSC ring is an underground facility and is designed to disrupt the landscape very little.

WHEREAS technical investigations have confirmed that the Northern Estancia Basin offers an excellent geological setting for the SSC and that water resources will not be adversely impacted.

WHEREAS approximately 750 workers will be employed each year for six years in the construction of the SSC.

WHEREAS the SSC will require a staff of 2500, half of whom will be support staff, assisting the scientists and engineers and maintaining the operation of the facility itself.

WHEREAS Moriarty can help meet the need for supplies, repair work, equipment and a variety of other services that will be required in the construction and operation of the SSC.

WHEREAS Moriarty has residents who can provide valuable assistance in both the construction and operation of the SSC as members of its workforce.

NOW BE IT RESOLVED

1. That the City of Moriarty strongly supports the development of the Superconducting Super Collider on New Mexico's proposed site.
2. That the City of Moriarty will do whatever it can to facilitate the construction and operation of the Superconducting Super Collider.

DONE at Moriarty, New Mexico on this 23rd day of June, 1987.

CITY OF MORIARTY

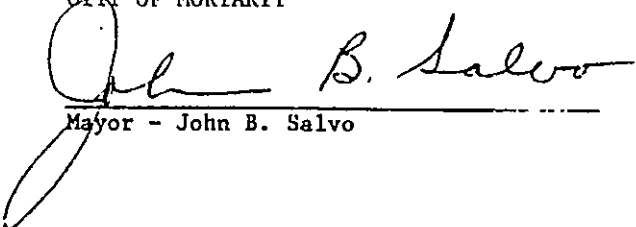

Mayor - John B. Salvo

ATTEST:



City Clerk - Karen Armijo

NEW MEXICO SSC PROPOSAL JULY 31, 1987

SANTA FE COUNTY
BOARD OF COUNTY COMMISSIONERS

580000

RESOLUTION NO. 1987- 54

ENDORSEMENT FOR LOCATING THE PROPOSED NEW MEXICO SUPERCONDUCTING SUPER COLLIDER (SSC) IN THE COUNTY OF SANTA FE.

- WHEREAS, the Board of County Commissioners recognizes that the Superconducting Super Collider (SSC) is a prestigious project for scientific research, and
- WHEREAS, Santa Fe County possesses a site suitable for the SSC which will not seriously disrupt existing communities, and
- WHEREAS, New Mexico has an established scientific research community and nearby support facilities for the installation of the project, and
- WHEREAS, the SSC represents potential benefits to the economy of Santa Fe County, and
- WHEREAS, the environment of Santa Fe County and the health of its residents will be protected by those who will be managing the project, and
- THEREFORE, be it resolved by the Board of County Commissioners that the County of Santa Fe would benefit from the proposed New Mexico Superconducting Super Collider project.

PASSED, APPROVED AND ADOPTED THIS 8th DAY OF JUNE, 1987.

BOARD OF COUNTY COMMISSIONERS

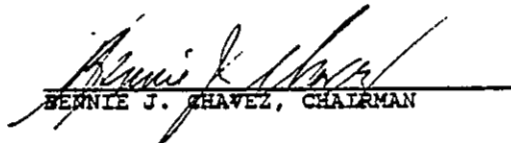
BENNIE J. CHAVEZ, CHAIRMAN

ATTEST:

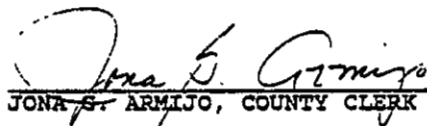
JONA G. ARMIJO, COUNTY CLERK



624367
COUNTY OF SANTA FE
STATE OF NEW MEXICO
With my Hand and Seal of Office
Jona G. Armijo
County Clerk Santa Fe County, N.M.

I hereby certify that this instrument was filed for record on the 11 day of June A.D. 1987 at 7:09 o'clock PM and was duly recorded in Book 583 page 123

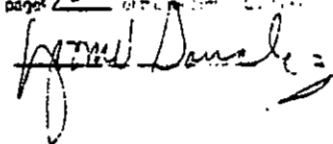

RESOLUTION

#87-11

- WHEREAS, the Superconducting Super Collider (SSC) is intended to push forward the frontiers of science by providing a way to study the nature of matter and energy in ways that have never been possible.
- WHEREAS, the SSC ring is an underground facility and is designed to disrupt the landscape very little.
- WHEREAS, technical investigations have confirmed that the Northern Estancia Basin offers an excellent geological setting for the SSC and that water resources will not be adversely impacted.
- WHEREAS, approximately 750 workers will be employed each year for six years in the construction of the SSC.
- WHEREAS, the SSC will require a staff of 2,500, half of whom will be support staff, assisting the scientists and engineers and maintaining the operation of the facility itself.
- WHEREAS, Torrance County can help meet the need for supplies, repair work, equipment and a variety of other services that will be required in the construction and operation of the SSC.
- WHEREAS, Torrance County has residents who can provide valuable assistance in both the construction and operation of the SSC as members of its workforce.

NOW THEREFORE, be it resolved that the County of Torrance does strongly support the development of the Superconducting Super Collider on New Mexico's proposed site, and that the County of Torrance will do whatever it can to facilitate the construction and operation of the Superconducting Super Collider.

DONE THIS third day of June, 1987, at Estancia, Torrance County, New Mexico.

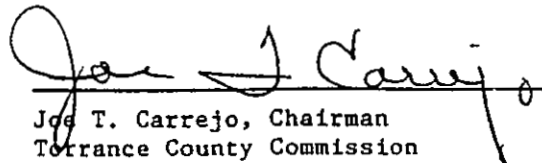
Joe T. Carrejo, Chairman
Torrance County Commission

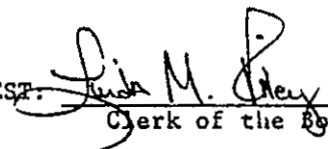
ATTEST: 
Clerk of the Board

NEW MEXICO SSC PROPOSAL JULY 31, 1987

RESOLUTION NO. 39-87

SUPPORTING THE SITE SELECTION OF THE SUPERCONDUCTING
SUPER COLLIDER IN THE ALBUQUERQUE, NEW MEXICO, AREA

WHEREAS, the State of New Mexico is currently preparing a proposal to the Federal government to locate the Superconducting Super Collider in New Mexico; and

WHEREAS, New Mexico is amongst thirty states bidding for the location of the project; and

WHEREAS, the site selection would involve 16,000 acres in the Estancia Valley in the vicinity of Edgewood, Moriarty, and Stanley; and

WHEREAS, operation of the proposed facility would require a workforce of 3,000; and

WHEREAS, Bernalillo County and the City of Albuquerque are large enough to provide a labor force with diverse technical and professional skills that will allow easy recruitment of qualified personnel for the construction and operation of such a facility.

NOW, THEREFORE, BE IT RESOLVED, that the Board of County Commissioners of Bernalillo County, New Mexico, does hereby support the proposal to locate the Superconducting Super Collider in the Estancia Valley.

DONE, this 16th day of June, 1987, in Albuquerque, New Mexico.

BOARD OF COUNTY COMMISSIONERS

Lenton Malry, Chairman

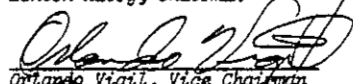
Orlando Vigil, Vice Chairman

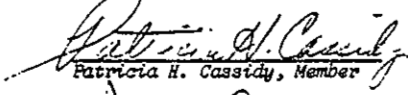
Patricia H. Cassidy, Member

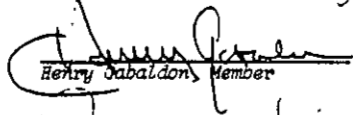
Henry Jabaldon, Member

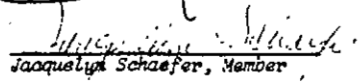
Jacquelyn Schaefer, Member

ATTEST:

Gladys Davis, County Clerk

NEW MEXICO SSC PROPOSAL JULY 31, 1987

JAMES A. (JIM) CAUDELL
R-BERNALILLO & TORRANCE-22
Home Address:
1704 TOMASITA, NE
ALBUQUERQUE, NEW MEXICO 87112
Home Telephones:
299-0646
Business Telephone:
883-9353



COMMITTEES:
Chairman:
RUIES
Member:
PUBLIC AFFAIRS

New Mexico State Senate

Santa Fe

July 9, 1987

The Honorable John Herrington
Secretary of Energy
U.S. Department of Energy
1000 Independence Ave. SW
Washington, DC 20585

Dear Mr. Secretary:

New Mexico is not a newcomer to the field of advanced science and technology. All we need to do is recall our state's commitment to our country during World War II and the MANHATTAN PROJECT. I did not live in New Mexico until later; however, many of my constituents who live in and around the Superconducting Super Collider proposed site in the Estancia Basin have told me that if the Superconducting Super Collider is built in New Mexico, New Mexico again will have made a commitment, which will not only benefit New Mexico, but also our country and the world with unequalled advances in science and technology. I think the Senate Memorial 73, which I introduced this past session in the New Mexico legislature and is supported by my constituents (see the Congressional Record, Vol. 133, No. 98, June 1987), is a prime example of the commitment by not only the people of the site location, but also the people living in other areas of the state.

During my almost twenty years in the New Mexico legislature I have seen an unequalled commitment of dedication from the constituency of the state, our congressional delegation and our citizen legislature to bring New Mexico into the twentieth century as a highly technical state. Our commitment to a multi-cultural people in education, transportation, employment, housing, farming, industrial development, science and technology has not been equaled by any other state in this same twenty year time span. New Mexico is a committed state . . . we can fulfill the needs of the Department of Energy and the needs of our country by building the Superconducting Super Collider.

Sincerely,

A handwritten signature in cursive script that reads "Jim Caudell".

James A. (Jim) Caudell



GARY K. KING
TORRANCE, VALENCIA &
BERNALILLO COUNTIES
District 50
P.O. BOX 117
Home Telephone: 832-4461
MORIARTY, NEW MEXICO 87033

State of New Mexico
House of Representatives

OFFICE OF THE HOUSE PARLIAMENTARIAN
THIRTY-EIGHTH LEGISLATURE
Sesión II

COMMITTEES:
Member:
CONSUMER & PUBLIC AFFAIRS
PRINTING & SUPPLIES
ENROLLING & ENROSSING B
JUDICIARY

June 11, 1987

John S. Herrington
Secretary of Energy
11100 Independence, S.W.
Washington, D.C. 20003

Dear Mr. Secretary:

I am the New Mexico State Representative for the district which comprises the major portion of the Estancia Valley, the proposed New Mexico site for the SSC. I am a lifelong resident of the Valley and am confident that I understand the feelings of my constituents. My law firm also represents the communities of Moriarty and Estancia which are the two largest municipalities in the Valley.

The people of the area are very excited about the prospect of having the SSC located here and are willing to cooperate in every way possible to facilitate the project. Moriarty, which would be at the southern end of the project is a growing community. Most of the businesspeople and other community leaders are already actively involved in planning for the future growth and development of the area. We are presently working on proposals to bring other research and technology oriented business to the community.

We have an excellent local school system and the school administration is already planning for projected growth of the system because our district is one of the fastest growing districts in the state. We know that a project of this size would have a large impact on the schools and other community services and are prepared to deal with this type of growth problem. The city of Moriarty is adding new water lines, sewer systems and residential living space to accommodate projected future growth and it would be relatively easy to include plans for the additional population which would result from the SSC.

NEW MEXICO SSC PROPOSAL JULY 31, 1987

John S. Herrington
Secretary of Energy
June 11, 1987
Page 2

Our local economic development organization would be helpful in assisting with land and water rights acquisition, infrastructure development and information provision and dissemination. Local government entities have also expressed to me their desire to help in the development of the SSC and they can be counted on to cooperate with the Department of Energy in minimizing local government impact on the project.

I have also found my colleagues in the State Legislature to be very interested in supporting the growth and development of technologically advanced industries in the state. I am sure that our state government and the Department of Energy can continue to cooperate in this matter to the mutual benefit of all. I look forward to working with the Department and will be happy to assist in any way I can to help with the SSC project. If you need further information, please feel free to contact me.

Very truly yours,

Gary King

GK/djf

ANGIE VIGIL PÉREZ
SANTA FE COUNTY
District 45
3002 CALLE CABALLERO
Home Telephone: 471-5848
SANTA FE, NEW MEXICO 87505



COMMITTEES:
Member:
EDUCATION
VOTERS & ELECTIONS
ENROLLING & ENROSSING B

State of New Mexico
House of Representatives

THIRTY-EIGHTH LEGISLATURE

Santa Fe

June 05, 1987

Mr. John S. Herrington
Secretary of Energy
1000 Independence Ave., S. W.
Forrestal Bldg.
Washington, D. C. 20003

Dear Mr. Herrington:

It is with great enthusiasm that I write this letter in support of the SSC, which will partially be housed in my district. I would venture to say that not only will this proposal benefit my constituency, but it will most certainly benefit the citizens of the entire County of Santa Fe, as well as the State of New Mexico by creating jobs and further enhancing the economy that only an industry of this multitude can provide.

In addition, I have discussed this matter with some of my colleagues in Santa Fe as well as other local elected officials, and support for this particular project is tremendous.

We look forward to working with you and your representatives in an effort to make this proposal a reality for the County of Santa Fe and the State of New Mexico.

NEW MEXICO SSC PROPOSAL JULY 31, 1987

Page 2

If you should have any questions regarding this matter,
please do not hesitate to contact me.

Sincerely yours,

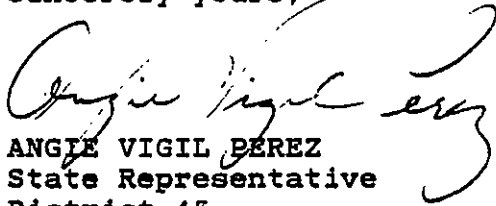
A handwritten signature in cursive script, appearing to read "Angie Vigil Perez".

ANGIE VIGIL PEREZ
State Representative
District 45

xc: Susan Johnson
SW Land Research, Inc.



City of Albuquerque

P.O. BOX 1293 ALBUQUERQUE, NEW MEXICO 87103

MAYOR
KEN SCHULTZ

CHIEF
ADMINISTRATIVE OFFICER
GENE ROMO

DEPUTY CAO
PUBLIC SERVICES
FRANK MARTINEZ

DEPUTY CAO
PLANNING DEVELOPMENT
BILL MUELLER

June 8, 1987

Ronald Reagan, President
United States of America
The White House
1600 Pennsylvania Avenue
Washington, DC 20500

Dear Mr. President:

As Mayor of the City of Albuquerque, I would like to support the location of the Superconducting Super Collider (SSC) in the Albuquerque, New Mexico area. The Comprehensive Plan, which reflects the long range goals of the citizens of Albuquerque, commits community support to quality growth. Although the site is outside the jurisdiction of the city and Bernalillo County, clearly Albuquerque will be the economic, educational, cultural and residential center for the SSC facility.

As a medium-size city with a metro area population of about 500,000, Albuquerque has the best of both urban amenities and rural qualities. We are a rapidly growing community (2 percent annually) and are endowed with enormous quantities of vacant land for future growth. Our city has accommodated, in an orderly, planned manner, a population growth of 9,000 annually for the last five years and 8,000 jobs annually for the same period. Let me stress the ease of living and working in this well-planned medium size-city.

This community has given priority to developing and maintaining an efficient transportation system. Albuquerque International Airport, a 40 minute drive from our proposed SSC site, has accommodated a 14 percent average annual increase in air passenger traffic over the past five years. Currently, a major airport expansion is underway to meet the needs of this anticipated growth. Two major interstate highways, intersecting in the heart of Albuquerque (28 minutes from the SSC site), are complemented by road networks and public transportation systems which facilitate inter-city travel. Key to Albuquerque since its founding have been rail passenger and commercial transport, with extensive rail spurs which could facilitate construction and ongoing work in the proposed SSC area.

AN EQUAL OPPORTUNITY EMPLOYER

NEW MEXICO SSC PROPOSAL JULY 31, 1987

President Ronald Reagan
Superconducting Super Collider
June 8, 1987
Page Two

Our growing labor force offers a wide variety of technical training, educational attainment as well as experience but reflects a relatively low cost of labor. Albuquerque has a locally based economy and enabling it to minimize the effects of national and international market fluctuations. Historically, Albuquerque has boasted a comparatively low unemployment rate and continues growth in all economic sectors, especially the service sector.

Tourism and business travel contribute tremendously to this growth. Local tourism and recreation is stimulated by an area rich in cultural and natural resources. Often visualized as a desert community, Albuquerque is endowed with a fascinating terrain. Her Rio Grande River, 12,000 foot mountains, inert volcanos, forest lands, mesas, canyons, arroyos, and gorges provide magnificent settings for skiing, hiking, boating, fishing, camping and other recreational pleasures. These physical amenities compliment our rich historical and cultural heritage, a treasure which Albuquerque's citizens and government have worked together to protect and nurture.

Because our concerned citizens place a high priority on preserving Albuquerque's cultural heritage as well as on maintaining their present quality of life, we have been proactive with legislation addressing not only our natural environment but also our environmental health. We are proud to have one of the most progressive programs of protecting open space in the nation, enveloping more than 21,000 acres of protected wilderness which is open for public enjoyment and recreation. This reflects the urban form which we strive to protect through an intermingling of open space with our urban centers.

The housing facilities in Albuquerque are diverse in style, setting and price, ranging from very modest to exclusive, urban to rural. The average selling price of a residential home in 1986 was \$91,000. Local residents indicate in surveys that travel time to work has not been a major concern in their selection of a home. Driving from the east to the west edge or the north to the southern limits of Greater Albuquerque takes less than 30 minutes. The demand for housing has been sensitive to the needs of our population, with the authorization of 7,000 new residential housing units in 1986.

One of our finest assets is our educational base, consisting of a nationally recognized, exemplary public education system, complimented by excellent private and parochial schools. Education attainment levels at both high school and college are among the highest in the nation. Through the University of New Mexico, New Mexico Technical University and the Technical Vocational Institute, Albuquerque supports a comprehensive educational network. Because the long established link between our educational institutions and the national scientific labs of Sandia, Los Alamos, and Livermore, is well established and respected, it can readily support the educational needs of SSC employees. Kirtland Air Force Base houses over twenty extensive technical and research facilities including Sandia Laboratories,

President Ronald Reagan
Superconducting Super Collider
June 8, 1987
Page 3

Department of Energy, Lovelace, Department of Defense, and E.G.& G. Tech Net links, with a fiber optic cable, our five defense related institutions, three universities and associated business firms along the corridor from Los Alamos to Las Cruces, New Mexico.

Finally, and most importantly, I wish to emphasize the strong community support you can expect in Albuquerque, from our citizens, our businesses and from our City government. We would be proud to have New Mexico chosen for the SSC site, and to include the Superconducting Super Collider project as part of the quality growth which we demand and support.

Respectfully yours,

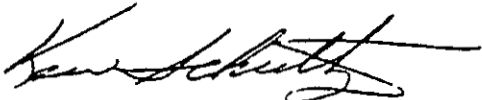

Ken Schultz,
Mayor

KS:GR:KK:SW/pp

APPENDIX 4-J

Non-Federal Government Support

Appendix 4-J-1. Estancia Basin SSC Environmental Permit Survey [4.10-1].

Air

The only sources of air contaminants associated with this project that appear to require permitting are the diesel generators which will supply emergency power. If these generators are expected to produce more than 10 lb/hr of any regulated pollutant, then an Environmental Improvement Division (EID) Construction Permit must be obtained. EID Construction Permits are relatively routine and uncomplicated permitting actions. It is not anticipated that generator emissions would be of sufficient magnitude to trigger Prevention of Significant Deterioration (PSD) review.

Water

Impoundments of waste water, sewage lagoons, and septic systems require EID Discharge Plans. Discharge plans specifically address the potential impact on groundwater of impoundments, etc. If wastewater will be discharged to waters of the United States, then a National Pollution Discharge Elimination System (NPDES) permit will be required. Discharge plan preparation and approval is a straightforward process and less complicated than the NPDES process.

Hazardous Wastes

SSC is expected to be a small quantity generator of hazardous wastes and should register as such. Registration as a small quantity generator only requires a letter to EID requesting such status. This is a routine matter. There are no approved hazardous waste storage facilities in New Mexico. Long term storage of accumulated hazardous wastes would require permitting under Resource Conservation and Recovery Act (RCRA) as a "Treatment, Storage, or Disposal" facility.

Solid Waste

Should SSC locate a solid waste landfill on its property, notification to EID would be required.

Appendix 4-J-2

King & Stanley

Attorneys at Law

P.O. Box 117
Moriarty, New Mexico 87035
(505) 832-4461

June 29, 1987

Susan Johnson
Southwest Land Research, Inc.
P.O. Box 36120
Albuquerque, NM 87176

Dear Susan:

I am writing you this letter in my capacity as city attorney for the City of Moriarty to bring you up-to-date on the status of the City's consideration of the subject of their potential zoning authority over the supercollider site. At this point we have presented the idea for an ordinance similar to that of the Santa Fe County Land Development Code which would make it clear that the extraterritorial zoning authority of the City will not apply to lands owned by the Federal Government. I don't anticipate that there will be a problem with having this kind of language adopted. I know the City is willing to cooperate in any way possible.

Very truly yours,

KING & STANLEY

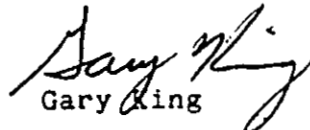
Gary King

GK/djf

cc: Karen Armijo, Clerk
City of Moriarty

NEW MEXICO SSC PROPOSAL JULY 31, 1987



STATE OF NEW MEXICO
Construction Industries Division
REGULATION AND LICENSING DEPARTMENT

Bataan Memorial Building, Santa Fe, New Mexico 87503 (505) 827-6251

GARREY CARRUTHERS
Governor

ROBERT D. GORDON
Director

TOM BACA
Superintendent

June 3, 1987

Susan Strand Johnson, President
Southwest Land Research, Inc.
P.O. Box 36120
Albuquerque, New Mexico 87176

RE: SUPERCONDUCTING SUPER COLLIDER

Dear Ms. Johnson:

Please be advised that the Construction Industries Division has no jurisdiction on federal government projects, whether on owned, or leased land.

I am attaching an Attorney General's Opinion on the matter dated October 1, 1975 for your review.

Should you require further information or any assistance, please feel free to call on this office.

Sincerely,

A handwritten signature in cursive script that reads "Robert D. Gordon".

ROBERT D. GORDON
Director

RDG/th

Encl: As Stated

STATE OF NEW MEXICO
Office of the Attorney General
DEPARTMENT OF JUSTICE
P. O. BOX 2246
Santa Fe, N. M. 87501

TONY ANAYA
Attorney General

October 1, 1975

M E M O R A N D U M

To: John Block, Jr.
Executive Director
Construction Industries Commission

From: Thomas Patrick Whelan, Jr.
Assistant Attorney General

Re: Applicability of the Construction Industries Act
to contractors on federal projects.

The Construction Industries Commission has for many years held the position that a contractor bidding or working on a federal project need not obtain a license or permits when the following three conditions exist:

1. the project is totally owned by the federal government;
2. the project is on federal land; and
3. the project is totally financed by the federal government.

I have researched the legality of this position and have reached the following conclusions:

1. The Construction Industries Licensing Act is inapplicable to any contractor who has, by bid or negotiation, contracted with any agency of the U.S. government or with any branch of the U.S. military when that agency has procured the contractor's services pursuant to federal laws and regulations on procurement.
2. The ownership of the project, its location, and the matter of the financing are irrelevant. There are only two questions the commission should ask: (a) Is the purchaser of the contractor's services an entity of the federal government? and (b) Is the purchase being made pursuant to federal law and regulations?

NEW MEXICO SSC PROPOSAL JULY 31, 1987

John Block, Jr.
October 1, 1975
Page 2

If you receive any inquiries about this interpretation, you may give the following cases as authority for it:

1. Leslie Miller, Inc. v. Arkansas, 352 U.S. 187, 1 L.Ed.2d 231, 77 S.Ct. 257 (1956).
2. Public Utilities Comm'n of California v. U.S., 355 U.S. 534, 2 L.Ed.2d 470, 78 S.Ct. 446 (1958).
3. Sperry v. Florida, 373 U.S. 379, 10 L.Ed.2d 428, 83 S.Ct. 1322 (1963).
4. Annotation, 1 L.Ed.2d 1729.

Robert W. Allen

Appendix 4-J-4

GARREY CARRUTHERS
Governor



OFFICE of the GOVERNOR
State of New Mexico
Santa Fe 87503

EXECUTIVE ORDER NO. 87-33

WHEREAS, the State of New Mexico is competing nationally for a multi-billion dollar project to be sponsored by the Federal Department of Energy called the Superconducting Super Collider; and

WHEREAS, the public benefit to the citizens of the State of New Mexico if New Mexico were selected as the site for the Superconducting Super Collider would be tremendous and would bolster the economy of New Mexico because of the employment of 4,500 people during construction and the potential creation of 10,000 full-time jobs; and

WHEREAS, the potential spin-off of other industries locating in New Mexico as a result of the location of the Superconducting Super Collider in New Mexico would be extremely beneficial to the citizens of New Mexico; and

WHEREAS, the construction and operation of the Superconducting Super Collider will entail the application for and granting of permits and licenses from various state agencies in a prompt manner in accordance with the law;

NOW, THEREFORE, I, GARREY CARRUTHERS, Governor of the State of New Mexico, by the authority vested in me by the Constitution and laws of this State do hereby establish a Superconducting Super Collider Task Force comprised of the Secretaries of the following agencies for the purposes of receiving applications for the granting of permits and licenses and processing said applications in an expeditious manner in accordance with the law; Health and Environment Department, Energy, Minerals and Natural Department, Regulation and Licensing Department, Taxation and Revenue Department, and the Chief Highway Administrator of the State Highway Department and the State Engineer.

ATTEST

Rebecca Vigil-Guin
SECRETARY OF STATE

DONE AT THE EXECUTIVE OFFICE
THIS EIGHTH DAY OF JUNE, 1987.

WITNESS MY HAND AND THE GREAT SEAL
OF THE STATE OF NEW MEXICO.



[Signature]
GARREY CARRUTHERS
GOVERNOR

NEW MEXICO SSC PROPOSAL JULY 31, 1987

Appendix 4-J-5

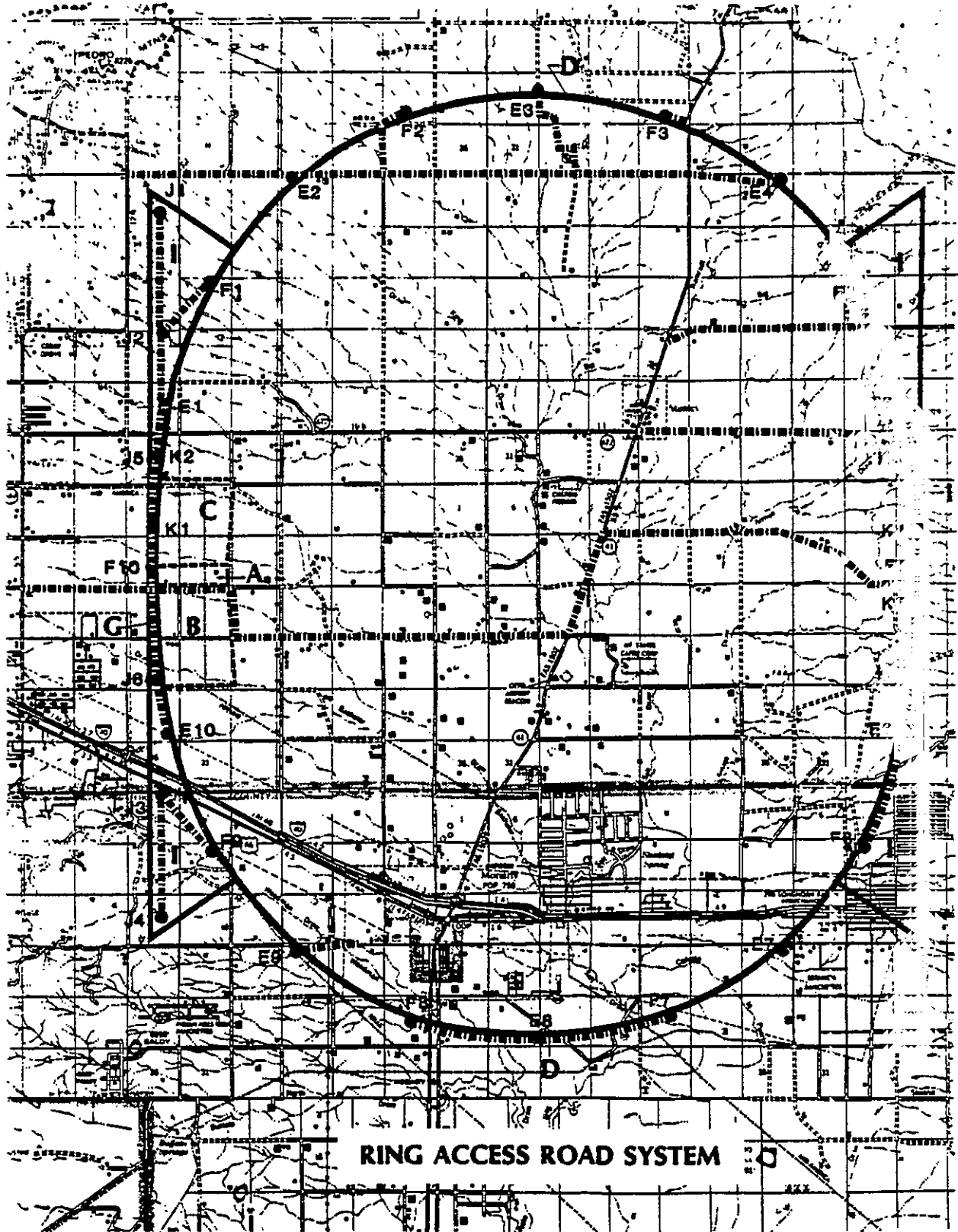

NEW MEXICO SSC PROPOSAL JULY 31, 1987

Appendix 4-J-6

STATE OF NEW MEXICO

STATE ENGINEER OFFICE

SANTA FE

S. E. REYNOLDS
STATE ENGINEER

June 26, 1987

BATAAN MEMORIAL BUILDING
STATE CAPITOL
SANTA FE, NEW MEXICO 87503

Mr. Herman E. Roser
Coordinator, New Mexico SSC
Site Evaluation Committee
2808 Central Avenue, N.E.
Albuquerque, N.M. 87110

Dear Mr. Roser:

I have reviewed information pertaining to the location of the Superconducting Super Collider (SSC) selected by your committee in the North Estancia Basin. The files of the State Engineer Office indicate that there are a number of irrigation wells located within one mile of the proposed alignment of the collider ring which have a reported water producing capacity of 450 to 1,000 gallons per minute.

A partial list of these wells, their location, and their reported capacity is:

Well	Location	Reported Capacity (gpm)
E-280	NW $\frac{1}{4}$ NW $\frac{1}{4}$ SW $\frac{1}{4}$ Sec. 8, T9N, R8E	750
E-1257 & E-1257-S	S $\frac{1}{4}$ NW $\frac{1}{4}$ Sec. 15, T9N, R8E	1,000 total
E-288	SW $\frac{1}{4}$ NW $\frac{1}{4}$ NE $\frac{1}{4}$ Sec. 24, T9N, R8E	440
E-288-S	SW $\frac{1}{4}$ NW $\frac{1}{4}$ NE $\frac{1}{4}$ Sec. 24, T9N, R8E	450
E-288-S-2	NE $\frac{1}{4}$ NW $\frac{1}{4}$ NE $\frac{1}{4}$ Sec. 24, T9N, R8E	450
E-193	SW $\frac{1}{4}$ SE $\frac{1}{4}$ Sec. 26, T9N, R8E	1,000
E-47	SE $\frac{1}{4}$ NW $\frac{1}{4}$ NE $\frac{1}{4}$ Sec. 35, T9N, R8E	500

It is my understanding that the SSC project will require a pumping capacity of 2200 gallons per minute (peak) from one or more wells for industrial purposes and 250 gallons per minute (average) for potable water purposes. The foregoing supports a conclusion that these capacities can be obtained for the proposed SSC site.

Information made available indicates as much as 3700 acre feet per year, may be required for the SSC. The inventory of the State Engineer indicates that that amount of unappropriated water is available within the vicinity of the ring; however, a permit for that amount may require acquisition and retirement of existing irrigation rights. The amount of such acquisition would depend on the well sites selected.

The administrative procedures required by the statutes and the rules and regulations of the State Engineer for relocation of wells or permits to appropriate groundwater will be expedited.

Sincerely,

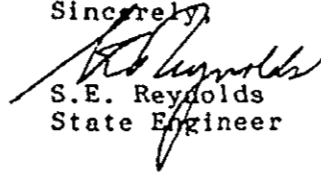

S.E. Reynolds
State Engineer

11g



NEW MEXICO PUBLIC SERVICE COMMISSION

POST OFFICE BOX 2205
SANTA FE, NEW MEXICO
87504-2205
(505) 827-6940

GARREY CARRUTHERS
GOVERNOR

MARIAN HALL, 224 EAST PALACE AVE. SANTA FE, NM 87501

JOSEPH E. SAMORA, JR.
CHAIRMAN
MARTIN J. BLAKE
COMMISSIONER
S. PETER BICKLEY
COMMISSIONER

June 26, 1987

Mr. Herman Roser
SSC Proposal Coordinator
1004 Daskalos, N.E.
Albuquerque, New Mexico 87123

Dear Mr. Roser:

The New Mexico Public Service Commission understands that the Department of Energy, in April 1987, issued its Invitation for Site Proposals for the Superconducting Super Collider Project (SSC).

The Commission fully supports the SSC Project and the potential benefits this project would have on the economic development of our State. We encourage and are fully committed toward achieving such development.

Based on our analysis, and the written analyses of the utilities under Commission jurisdiction, the Commission concludes that the utilities under our jurisdiction have the ability to serve the 250 MW SSC load requirement addressed in Section 3.2.4 of the Qualifications Criteria, now and into the next century with the existing state reserve margins. We have already received commitments from some of our jurisdictional utilities to serve the entire SSC load requirements at prices ranging from 5.0 to 6.5 cents per kwh (in 1990s dollars) in the 1990s beginning with full operation of the project.

If I may ever be of any assistance to you, please do not hesitate to call me.

Very truly yours,

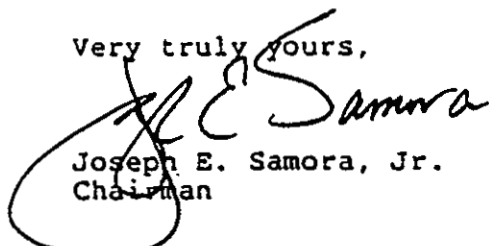
Joseph E. Samora, Jr.
Chairman

JES/ts



El Paso Electric Company
Mesilla Valley Division
P.O. Box 910
Las Cruces, New Mexico 88004
(505) 526-5551

June 22, 1987

Mr. Domingo Sanchez, III
Public Utility Engineer
New Mexico Public Service Commission
Marian Hall
224 E. Palace Avenue
Santa Fe, New Mexico 87501-2013

RECEIVED
JUN 23 10 53 AM '87
COMMUNICATIONS SECTION

Dear Mr. Sanchez:

**SUPERCONDUCTING SUPER COLLIDER
ESTANCIA BASIN SITE, NEW MEXICO**

The El Paso Electric Company fully supports the Superconducting Super Collider (SSC) Project and its potential for a new revolution in science, education, technology and commerce.

Our Company has the generation and transmission resources fully capable of providing reliable electric service to support the power requirements of the SSC at the Estancia Basin site. Because we have ample capacity, and the prospect of a continuing decline in fuel costs, we can be flexible in the design of a competitive pricing proposal to keep operating costs to a minimum. We can also provide two 345 KV transmission lines to this site for increased reliability.

El Paso Electric Company has provided firm, reliable electric service to White Sands Missile Range and Holloman Air Force Base in New Mexico for many years. Our commitment to provide this electric service at the lowest cost possible is of utmost importance to our Company.

We stand ready to assist SSC Project Officials wherever possible and if you have any questions, please call me at (505) 526-5551.

Sincerely,

L.M. Downum
Vice President

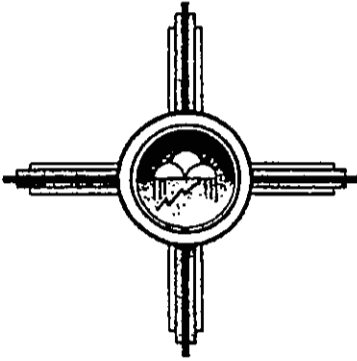

PLAINS ELECTRIC GENERATION AND TRANSMISSION COOPERATIVE, INC.

Albuquerque Headquarters
2401 Aztec Road, NE, P.O. Box 6551
Albuquerque, New Mexico 87197
Phone (505) 884-1881

Escalante Generating Station
P.O. Box 577
Prewitt, New Mexico 87045
Phone (505) 876-2271

June 22, 1987

Mr. John Herrington
Secretary of Energy
U. S. Department of Energy
1000 Independence Avenue SW
Washington, D. C. 20585

RECEIVED
JUN 22 10 17 AM '87
U.S. PUBLIC
SERVICE
COMMISSION

Dear Mr. Herrington:

We believe that the Superconducting Super Collider is a research project of critical importance to the United States.

The proposed New Mexico SSC site is aligned in an area served by Plains' member, Central New Mexico Electric Cooperative, Inc. Plains and Central New Mexico would like to assure the DOE that, should the New Mexico SSC site be selected, we are willing and able to provide electric service to the facility.

Sincerely,

PLAINS ELECTRIC GENERATION AND
TRANSMISSION COOPERATIVE, INC.

S. K. Basant
Executive Vice President/General Manager

SKB:tar/15

Appendix 4-J-10

PNM

PUBLIC SERVICE COMPANY OF NEW MEXICO

ALVARADO SQUARE ALBUQUERQUE, NEW MEXICO 87158 _ _ _ _

June 24, 1987

Mr. John Herrington
Secretary of Energy
U. S. Department of Energy
1000 Independence Avenue, SW
Washington, DC 20585

Dear Sir:

Subject: Superconducting Super
Collider (SSC)

This letter is to inform you, for purposes of New Mexico's SSC proposal, that the Public Service Company of New Mexico (PNM) has the capability and would be very pleased to provide 200 to 250 MW of firm electrical power to the SSC project.

PNM is a New Mexico corporation which, among other business activities, provides electric, gas, and water service within various portions of the State of New Mexico. As a public utility, PNM's retail services are subject to the jurisdiction of the New Mexico Public Service Commission, and certain wholesale transactions are subject to regulation by the Federal Energy Regulatory Commission.

PNM currently has uncommitted, installed generating capacity sufficient to serve the additional 250 MW SSC load to beyond the turn of the century. PNM's transmission system, which currently is within four miles of the proposed SSC site, includes a 345 kV line which would link that site to both the eastern (Southwest Power Pool) and western (Western States Coordinating Council) United States grids. This is one of very few lines in the United States with this reliability enhancing characteristic. New Mexico's proposal to serve the SSC site provides for an "integration plan" which would provide two separate 345 kV sources to the SSC site. This linkage would provide an extremely reliable and cost-effective source to the SSC.

In summary, PNM has generating capacity available which we are willing to commit to the SSC at a competitive price, and we have an existing high voltage delivery system at the proposed SSC site. We would be very pleased to secure firm service to the SSC should the Estancia

NEW MEXICO SSC PROPOSAL . JULY 31, 1987

Mr. John Herrington

- 2 -

June 24, 1987

Valley site be selected. If you need additional information, please feel free to call my office anytime at (505) 848-2891.

Sincerely yours,

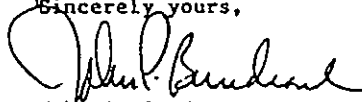

John P. Bundrant
President and Chief Operating
Officer, Electric Operations

BAK:slm

cc: Mr. Joseph E. Samora, Jr., Chairman
New Mexico Public Service Commission

Appendix 4-J-11

PNM

PUBLIC SERVICE COMPANY OF NEW MEXICO

ALVARADO SQUARE ALBUQUERQUE, NEW MEXICO 87168 - - - -

June 24, 1987

Mr. Herman Roser
1004 Daskalos, NE
Albuquerque, NM 87123

Dear Mr. Roser:

Subject: Superconducting Super
Collider (SSC) Project

The prospects of having the proposed SSC Project site located in New Mexico is a very challenging and exciting endeavor which Public Service Company of New Mexico (PNM) is fully committed to support. In addition to our participation in the development of the New Mexico proposal for the SSC Project, we have a high degree of interest in utilizing our electrical resources to serve the Project, should New Mexico be successful. This letter is to inform you that PNM is very interested in and has the capability to provide firm electric service to the proposed Project which we understand to have a load requirement of 200 to 250 MW.

We would welcome this Project as a means to efficiently use our current oversupply of electric power to the benefit of all of our New Mexico customers and we see the many benefits the Project would bring to the state as a whole. For these reasons, PNM is willing to make available a 250 MW supply of power at what we believe will be a very competitive price of 5 to 5.5 cents per kWh (assuming an 84 percent load factor) beginning in 1994 (this is equivalent to 3.6 to 3.9 cents per kWh in current dollars at 5 percent inflation). This rate is based on a special economic development rate which PNM is proposing as part of a reorganization plan to be filed with the New Mexico Public Service Commission (NMPSC) shortly. The plan will result in fixed wholesale prices of power from a generation company to a distribution company, each created as a result of our proposed reorganization. Under the wholesale economic development rate proposal, a 10-year commitment could be made on rates for the power supply to the SSC Project. We firmly believe that over this 10 year term the initial rate will decline in real terms. (We expect this rate will increase at 3 to 4 percent per year assuming inflation averages 4 to 5 percent.)

NEW MEXICO SSC PROPOSAL JULY 31, 1987

Mr. Herman Roser

- 2 -

June 24, 1987

Please note that these rate projections do not include the costs of new transmission facilities that would be required in order to provide reliable service to the site. However, as discussed in the utility section of the New Mexico SSC proposal, there is a PNM-owned 345 kV line within four miles of the proposed SSC site. We also propose a second 345 kV source, to provide dual feed capability, from only 38 miles away. The cost of these fairly nominal system improvements to the transmission system could either be added to the rates discussed above or other innovative financing arrangements could be employed.

In summary, we are appreciative of the opportunity to participate in the preparation of New Mexico's SSC proposal and we stand ready to help do whatever may be necessary in order to improve New Mexico's probability of success. PNM stands ready, willing, and able to meet the firm electric requirements of the SSC at competitive rates, as discussed in this letter. If there is anything that we can do to further support this very important effort, please feel free to contact me at 848-4568.

Sincerely yours,

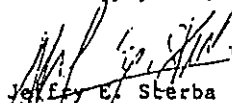

Jeffrey E. Sterba
Vice President, Revenue Management

BAK:sim

cc: Mr. John P. Bundrant
Mr. Joseph E. Samora, Chairman, NMPSC

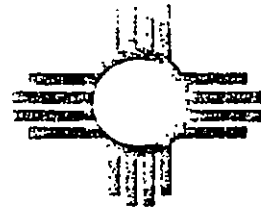

The Legislature
of the
State of New Mexico

38th Legislature, 1st SPECIAL Session

LAWS 1987

CHAPTER _____

SENATE JOINT MEMORIAL 1

Introduced by

SENATOR I. M. SMALLEY
SENATOR MICHAEL ALARID
SENATOR W. S. EOFF
SENATOR TOM RUTHERFORD
SENATOR WILLIAM R. VALENTINE

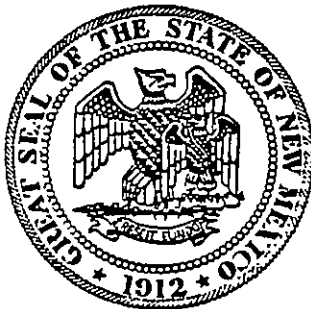

1 A JOINT MEMORIAL

2 RECOGNIZING THE STATE OF NEW MEXICO'S EXTENSIVE INFRASTRUCTURE AND
3 DIRECTING ALL APPROPRIATE STATE AGENCIES AND INSTRUMENTALITIES OF THE
4 STATE TO RECOGNIZE AND RESPOND TO THE INFRASTRUCTURE REQUIREMENTS
5 ARISING DURING THE CONSTRUCTION AND OPERATION OF THE SUPERCONDUCTING
6 SUPER COLLIDER.

7
8 WHEREAS, the state of New Mexico has established an extensive
9 11,748 mile urban and rural highway system that the state highway de-
10 partment will expend \$922,500,000 to improve and expand during the
11 current five-year planning period 1986-1991; and

12 WHEREAS, many improvements and much of the new construction and
13 road maintenance necessary for the superconducting super collider
14 project are already included in the highway department's five-year
15 plan; and

16 WHEREAS, the state engineer has declared that the state has ample
17 water resources, and the legislature and the state engineer will en-
18 sure that adequate water resources are available and will expedite
19 the acquisition of water rights necessary to serve the superconduct-
20 ing super collider project; and

21 WHEREAS, the lieutenant governor will facilitate and coordinate
22 the state's effort to simplify the regulatory process, eliminate un-
23 necessary paperwork and assist in the acquisition of all necessary
24 local, state and federal regulatory permits and licenses required by
25 the superconducting super collider project; and

SJM 1
Page 1

1 WHEREAS, state and local governments statewide have provided for
2 and will continue to upgrade and expand refuse and waste facilities
3 necessary during the construction phase and for the operational life
4 of the proposed facility; and

5 WHEREAS, state and local governments statewide have provided a
6 safe and sanitary environment through the construction of water, sewer
7 and other essential services including law enforcement and fire con-
8 trol agencies; and

9 WHEREAS, the state, in cooperation with financial institutions
10 and local housing authorities, continues to improve and expand the
11 state's stock of affordable housing; and

12 WHEREAS, the state possesses a vital construction industry with
13 a well trained workforce estimated at 19,000 that provides residen-
14 tial, commercial and industrial construction; and

15 WHEREAS, the state's transportation facilities include an inter-
16 national airport, air service to rural communities, interstate high-
17 ways that serve all major common carriers, an extensive railroad sys-
18 tem and access to over 10,000 miles of rural highways open year-round;
19 and

20 WHEREAS, state and local governments in New Mexico have demon-
21 strated a strong commitment to the protection and promotion of their
22 health care systems and to the protection of the outstanding natural
23 environment including clean air and water; and

24 WHEREAS, the state provides a wide range of social services de-
25 signed to achieve and maintain a self-sufficient population including

1 special services for children and the aged; and

2 WHEREAS, New Mexico is abundant in urban and rural recreational
3 and cultural opportunities including forty-three state parks, seven
4 national forests, ten ski areas and other year-round outdoor recrea-
5 tional activities; and

6 WHEREAS, the state is nationally known for its tricultural heri-
7 tage and also has a wide variety of fine art galleries, museums and
8 cultural programs;

9 NOW, THEREFORE, BE IT RESOLVED BY THE LEGISLATURE OF THE STATE
10 OF NEW MEXICO that New Mexico's extensive infrastructure is recognized
11 and that the state is committed to the provision of the infrastructure
12 necessary for the successful construction and operation of the super-
13 conducting super collider; and

14 BE IT FURTHER RESOLVED that all appropriate state agencies and
15 instrumentalities of the state are directed to recognize and respond
16 to the specific infrastructure needs of the superconducting super
17 collider; and

18 BE IT FURTHER RESOLVED that copies of this memorial be transmit-
19 ted to all appropriate state and local government agencies, the secre-
20 tary of finance and administration and the director of the legislative
21 finance committee. _____

SJM 1
Page 3

S/Jack Stahl

Jack Stahl, President
Senate

S/Juanita Pino

Juanita Pino, Chief Clerk
Senate

S/Raymond G. Sanchez

Raymond G. Sanchez, Speaker
House of Representatives

S/Stephen R. Arias

Stephen R. Arias, Chief Clerk
House of Representatives

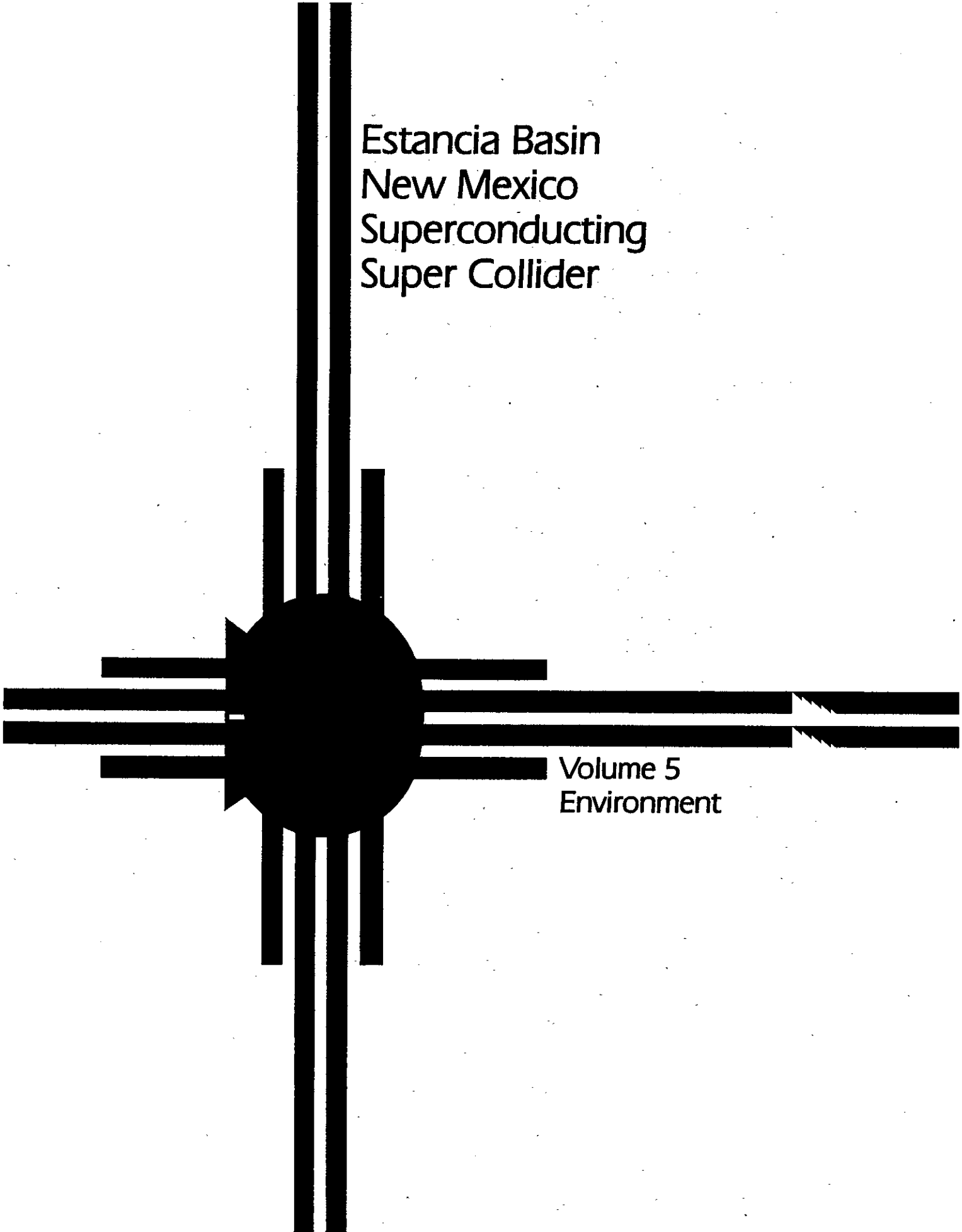
A stylized Zia sun symbol, a common symbol for New Mexico, is centered on the page. It consists of a central circle with four thick arms extending horizontally and vertically. Each arm has a double-line structure, with the inner line being slightly shorter than the outer line. The symbol is rendered in solid black.

Estancia Basin
New Mexico
Superconducting
Super Collider

Volume 5
Environment



Taos

Los Alamos

SANTA FE

25

Las Vegas

ALBUQUERQUE

40

Santa Rosa

SSC PROJECT SITE

Estanda

Belen

Willard

Vaughn

Environment

Volume 5

TABLE OF CONTENTS

5.0	Summary	5-1
5.1	Wetlands	5-3
5.1.1	Wetlands in Project Vicinity	5-3
5.2	Surface Water	5-3
5.2.1	Major Drainage Basins and Surface Water Features	5-3
5.2.2	Baseline and Seasonal Variations in Water Quantity	5-3
5.2.3	Baseline and Seasonal Variations in Water Quality	5-3
5.2.4	Flood Areas and Frequency	5-5
5.3	Fish and Wildlife	5-5
5.3.1	Significant Fish and Wildlife Resources	5-5
5.3.2	State or Federally Protected, Threatened, or Endangered Species and Their Critical Habitat	5-9
5.4	Vegetation	5-9
5.4.1	Botanical Resources	5-9
5.4.2	Threatened or Endangered Plant Species	5-13
5.5	Air Quality	5-15
5.5.1	Existing Air Quality	5-15
5.6	Background Radiation	5-15
5.6.1	Soil, Rock, and Groundwater Background Radioactivity Levels	5-15
5.7	Historical and Archaeological Resources	5-15
5.7.1	Historical, Paleontological, and Archaeological Resources	5-20
5.8	Preliminary Environmental Evaluation	5-23
5.8.1	Impacts on the Environment	5-23

5.0 SUMMARY

The existing environment of the Estancia Basin SSC site is typical of a sparsely populated agricultural, grazing, and rural housing area in the southern Rocky Mountain region.

The Estancia Basin Superconducting Super Collider (SSC) site is located at the southern end of the Rocky Mountains in north-central New Mexico. The western half of the site falls in the Basin and Range physiographic province and the eastern half of the site falls in the Great Plains physiographic province. The main physical feature is the Estancia Basin, a relatively flat basin oriented in a north-south direction with drainage toward the south. The entire basin is surrounded by higher land. (The Sandia and Manzano Mountains to the west, Chupadera Mesa to the south, the Pedernal Hills to the east, and the Sangre de Cristo and Ortiz Mountains to the north.) Annual precipitation varies from an average of 11 inches in the central to approximately 15 inches on the edge of the basin site.

The information contained in this volume is summarized as follows:

- A. No marshes or areas supporting riparian vegetation occur in the site vicinity.
- B. There is no permanent flowing water, no major surface water body, and no surface water outlet in the Estancia Basin.
- C. Surface water consists solely of natural or constructed catchments to accumulate surface run-off and underground pumping. The largest catchment comprises approximately 20 to 30 surface acres, located 0.5 mile from the nearest site boundary.
- D. There are no surface water quantity or quality data available due to the ephemeral nature of surface water in the site area.
- E. Any flooding on or near the site would be very short duration, limited-area flashfloods following heavy thunderstorms.
- F. There are no faunal concerns within the proposed site area; and no state or federally protected, threatened, or endangered faunal species or critical habitats in the site vicinity.
- G. No federally listed rare or endangered plant species occur within the proposed site area. State and federal priority and candidate species could occur in the vicinity but are highly unlikely along the recommended ring siting.
- H. The entire site area is in attainment for national air quality standards covering all criteria pollutants, and there are no major emitting facilities in the vicinity.

- I. Background radiation for soils, rock, and water in the region are in the low range.
- J. There is no potential for adverse effects to any major historical or cultural properties.
- K. There will be no adverse environmental impacts which would limit the use of the site, nor will any unusual mitigation or protective measures be required.

5.1 WETLANDS

5.1.1 WETLANDS IN PROJECT VICINITY

The areas designated as wetlands by the United States Fish and Wildlife Service (USFWS) include low areas catching precipitation, stock tanks, and arroyos dammed to catch runoff. No marshes or areas supporting riparian vegetation occur within the SSC site vicinity. Please refer to Section 5.2.1, discussion of surface waters, for more information. The wetland type data from the USFWS wetland maps for the SSC site area are presented in Figure 5.1-1 (in map pocket).

5.2 SURFACE WATER

5.2.1 MAJOR DRAINAGE BASINS AND SURFACE WATER FEATURES

The project site is on the northern flank of the Estancia Closed Basin. Drainage within the basin is to the south. This basin has no surface water outlet. All surface waters are contained within the basin. In general, evaporation greatly exceeds precipitation, so there is no accumulation of water in the basin. Dry salt lakes which may have water on a seasonal basis are present in the southern end of the basin 20 miles south of the project area. Figure 5.2-1 shows the boundary of the Estancia Basin and surface drainage features.

There are no major surface water bodies in the project area. There is no permanent flowing water. Surface water does exist in the form of runoff collected behind small berms constructed in arroyos. These are generally less than an acre, and the largest of these catchments is called K&R Reservoir. It is approximately 20 to 30 acres and is located 0.5 mile from the proposed SSC location directly east of Stanley, New Mexico. Runoff may also collect in small natural, shallow surface depressions for short time periods. The area also has numerous cattle water tanks supplied by wells. These tanks may be above-ground structures or small, excavated pits.

5.2.2 BASELINE AND SEASONAL VARIATIONS IN WATER QUANTITY

There are no permanent flowing surface waters. All drainages (arroyos) on the site are ephemeral. They contain water only immediately after large precipitation events or rapid snowmelts. There are no flow records for these arroyos.

5.2.3 BASELINE AND SEASONAL VARIATIONS IN WATER QUALITY

Because of the ephemeral nature of surface water in the area, there are no data on surface water quality.

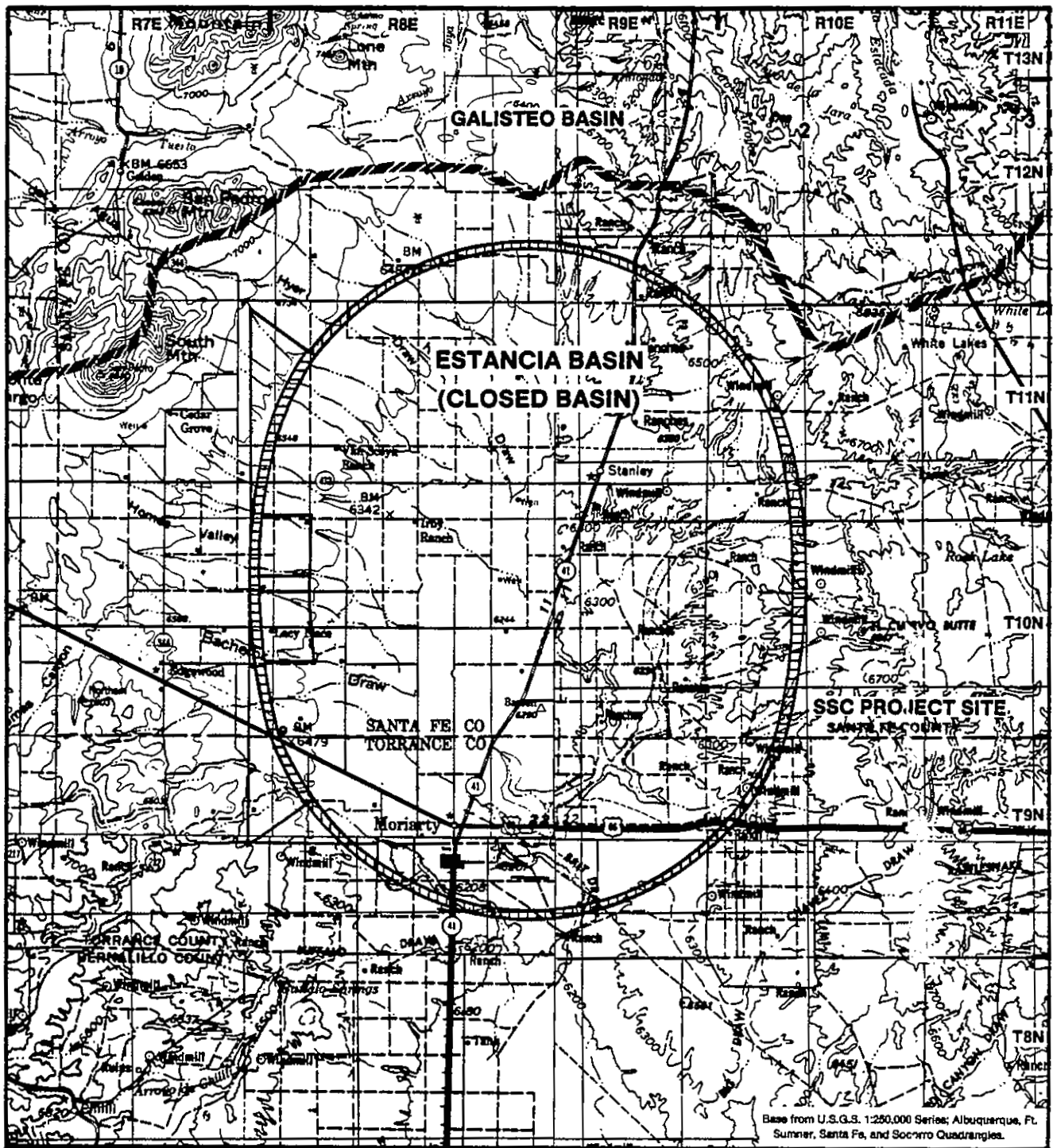

Figure 5.2-1. Drainage Basins and Surface Water Features.

There are two major water quality regulations that apply to this area. Any discharge into or below the surface of the ground requires a State of New Mexico Discharge Permit under Water Quality Control Commission regulations. These regulations prohibit discharge of any materials listed in Figure 5.2-2. In addition, discharges should not degrade groundwater beyond the standards listed in Figure 5.2-3. The limitations on concentration and quantity of materials in the discharge required to prevent degradation beyond these limits is determined in conjunction with the State Environmental Improvement Division on a case-by-case basis.

The second requirement is the National Pollution Discharge Elimination System (NPDES) permit. This is a federal permit requirement. There is no specific discharge category for facilities like the superconducting super collider. It is reasonable to assume that the standards for best available technology effluent standards will apply. These standards are listed in Figure 5.2-4.

5.2.4 FLOOD AREAS AND FREQUENCY

General floods are seldom widespread in New Mexico. Very short duration, limited-area flashfloods can occur immediately following heavy thunderstorms. Data are available on a county-by-county basis for the years 1959-1979. The data for Santa Fe County are not generally applicable because they are heavily influenced by the mountainous areas and the Rio Grande in the northern portion of the county. Torrance County is much more representative of the project area.

5.3 FISH AND WILDLIFE

5.3.1 SIGNIFICANT FISH AND WILDLIFE RESOURCES

There are no known faunal concerns within the study area that would delay or preclude the construction of the SSC project.

It must be noted that the Estancia Valley has been used for grazing and limited agriculture for almost 100 years. Native fauna are limited to those areas restricted for grazing and large ranches.

The dominant fauna in the SSC study area were identified through observation and information obtained from landowners. Figure 5.3-1 is a list of dominant native fauna to be found in the SSC site vicinity. Only the larger, dominant mammals and birds reported in the SSC study are discussed in this section; small mammals (such as rodents), reptiles, and amphibians are not included. Little or no research has been conducted on small mammals, reptiles, or amphibians in the Estancia Basin due to the large tracts of privately owned property and modified natural environment. There are no known occurrences of threatened or endangered mammals, reptiles, or amphibians within the Estancia Basin.

acrolein	heptachlor
acrylonitrile	hexachlorobutadine
aldrin	hexachlorocyclohexane (HCH)
benzene	alpha-HCH
benzidine	beta-HCH
carbon tetrachloride	gamma-HCH
chlorodane	technical HCH
chlorinated benzenes	hexachlorocyclopentadine
monochlorobenzene	isophorone
hexachlorobenzene	nitrobenzene
pentachlorobenzene	nitrophenols
1,2,4,5-tetrachlorobenzene	2,2-dinitro-o-cresol
chlorinated ethanes	nitrosamines
1,2-dichloroethane	N-nitrosodiethylamine
hexachloroethane	N-nitrosodimethylamine
1,1,2,2-tetrachloroethane	N-nitrosodibutylamine
1,1,1-trichloroethane	N-nitrosodiphenylamine
1,1,2-trichloroethane	N-nitrosopyrrolidine
chlorinated phenols	pentachlorophenol
2,4-dichlorophenol	phenol
2,4,5-trichlorophenol	phthalate esters
2,4,6-trichlorophenol	dibutyl phthalate
chloroalkyl ethers	di-2-ethylhexyl phthalate
bis (2-chloroethyl) ether	dimethyl phthalate
bis (2-chloroisopropyl) ether	polychlorinated biphenyls (PCBs)
bix (chloromethyl) ether	polychlorinated aromatic hydrocarbons (PAH)
chloroform	anthracene
DDT	3,4-benzofluoranthene
dichlorobenzene	benzo (k) fluoranthene
dichlorobenzidine	fluoranthene
dichlorobenzidine	fluorene
1,1-dichloroethylene	phenanthrene
dichloropropenes	pyrene
dieldrin	tetrachloroethylene
2,4-dinitrotoluene	toluene
diphenylhydrazine	toxaphene
endosulfan	trichloroethylene
endrin	vinyl chloride
ethylbenzene	
halomethanes	
bromodichloromethane	
bromomethane	
chloromethane	
dichlorodifluoromethane	
dichloromethane	
tribromomethane	
trichlorofluoromethane	

Figure 5.2-2. Water quality control commission list of prohibited materials.

Arsenic (As)	0.1 mg/l
Barium (Ba)	1.0 mg/l
Cadmium (Cd)	0.01 mg/l
Chromium (Cr)	0.05 mg/l
Cyanide (CN)	0.2 mg/l
Fluoride (F)	1.6 mg/l
Lead (Pb)	0.05 mg/l
Total Mercury (Hg)	0.002 mg/l
Nitrate (NO ₃ as N)	10.0 mg/l
Selenium (Se)	0.05 mg/l
Silver (Ag)	0.05 mg/l
Uranium (U)	5.0 mg/l
Radioactivity: Combined	
Radium-226 and Radium-228	30.0 pCi/l
Benzene	0.01 mg/l
Polychlorinated biphenyls (PCBs)	0.001 mg/l
Toluene	15.0 mg/l
Carbon Tetrachloride	0.01 mg/l
1,2-dichloroethane (EDC)	0.02 mg/l
1,1-dichloroethylene (1,1-DCE)	0.005 mg/l
1,1,2,2-tetrachloroethylene (PCE)	0.02 mg/l
1,1,2-trichloroethylene (TCE)	01. mg/l
Chloride (Cl)	250. mg/l
Copper (Cu)	1.0 mg/l
Iron (Fe)	1.0 mg/l
Maganese (Mn)	0.2 mg/l
Phenols	0.005 mg/l
Sulfate (SO ₄)	600. mg/l
Total Dissolved Solids (TDS)	1000. mg/l
Zinc (Zn)	10.0 mg/l
pH	between 6 and 9

Figure 5.2-3. New Mexico Human health standards for groundwater.

Arsenic	0.1 mg/l
Barium	1.0 mg/l
Cadmium	0.01 mg/l
Chromium	0.05 mg/l
Cyanide	0.2 mg/l
Fluoride	1.6 mg/l
Lead	0.05 mg/l
Mercury	0.002 mg/l
Nitrate	10.0 mg/l
Selenium	0.05 mg/l
Silver	0.05 mg/l
Uranium	5.0 mg/l
Radioactivity (Ra 26 and Ra 228)	30.0 pCi/l
Benzene	0.01 mg/l
Polychlorinated biphenyls	0.001 mg/l
Toluene	15.0 mg/l
Carbon Tetrachloride	0.01 mg/l
1,2-dichloroethane	0.02 mg/l
1,1-dichloroethylene	0.005 mg/l
1,1,2,2-tetrachloroethylene	0.02 mg/l
1,1,2-trichloroethylene	0.1 mg/l

Figure 5.2-4. Federal groundwater quality human health standards.

antelope (Antilocapra americana)
 badger (Taxidea taxus)
 prairie dog (Cynomys ludovicianus and C. gunnisoni)
 coyote (Canis latrans)
 mule deer (Odocoileus hemionus)
 bobcat (Lynx rufus)
 cougar (Felis concolor)
 porcupine (Erethizon dorsatum)
 black bear (Ursus americanus)
 raccoon (Procyon lotor)
 Mourning dove (Zenaidura macroura)
 horned lark (Eremophila alpestris)
 scaled quail (Callipepla squamata)
 ring-necked pheasant (Phasianus colchicus torquatus)
 golden eagle (Aquila chrysaetos)
 Swainson's hawk (Buteo swainsoni)
 redtail hawk (Buteo jamaicensis)
 prairie falcon (Falco mexicanus)
 kestrel (Falco sparverius)
 piñon jay (Gymnorhinus cyanocephalus)
 Stellar's jay (Cyanocitta stelleri)
 common flicker (Colaptes cafer)

Figure 5.3-1. Common and scientific names of dominant fauna within the SSC study area.

The larger mammals, antelope, mule deer, badger, and black bear, are restricted to the northern half of the study area where open rangeland and woodland habitats are prevalent. The rest of the fauna listed are found to be ubiquitous in the study area in low population numbers.

5.3.2 STATE OR FEDERALLY PROTECTED, THREATENED, OR ENDANGERED SPECIES AND THEIR CRITICAL HABITAT

There are no state or federally protected, threatened, or endangered faunal species or critical habitats in the Estancia Basin SSC site vicinity. The nearest occurrence of such species is the nesting of peregrine falcons on the west face of the Sandia Mountains (25 miles west of the Estancia Basin SSC site). The proposed project would have no impact on threatened or endangered species.

5.4 VEGETATION

5.4.1 BOTANICAL RESOURCES

The SSC site area is divided into five basic vegetative zones or associations. Figure 5.4-1 illustrates the location and extent of

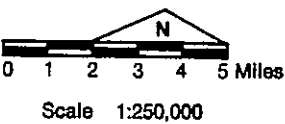
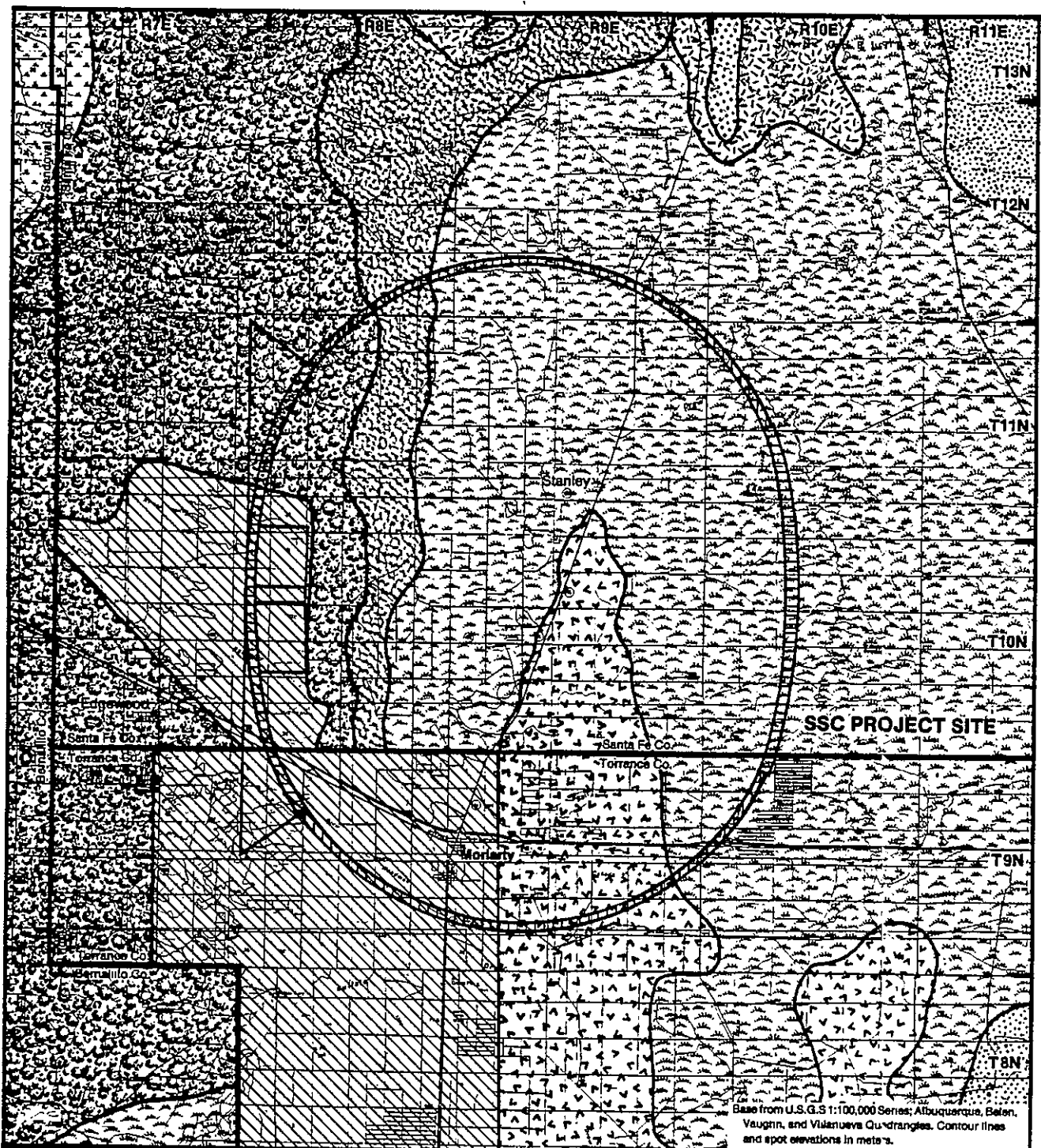









- | | |
|---|--|
| <ul style="list-style-type: none">  <i>Atriplex canescens</i>: dominated almost entirely by fourwing saltbush with a sparse grass understory.  <i>Atriplex canescens</i>, <i>Hilaria jamesii</i>, and <i>Bouteloua gracilis</i>: dominated by fourwing saltbush, galleta grass, and blue grama grass.  <i>Bouteloua gracilis</i> and <i>Agropyron smithii</i>, blue grama grass with western wheatgrass; associated with species include bottlebrush squirreltail, threeawn, ring muhly, winterfat, and fringed sage.  <i>Bouteloua gracilis</i> and <i>Stipa neomexicana</i>: blue grama with New Mexico feathergrass, needle and threadgrass, sideoats grama grass and sand dropsed. Western wheatgrass, winterfat, and scattered piñon and juniper are also found. | <ul style="list-style-type: none">  <i>Hilaria jamesii</i>, <i>Oryzopsis hymenoides</i>, and <i>Juniperus monosperma</i>: galleta grass and Indian ricegrass occur with blue grama, sideoats grama, threeawn, and sand dropsed.  <i>Juniperus monosperma</i> and <i>Bouteloua</i> spp.: one-seed juniper with a mixture of sideoats, black, blue, and hairy grama grasses, interspersed with western wheatgrass, threeawn, ring muhly and vine mesquite.  <i>Pinus edulis</i> and <i>Juniperus monosperma</i>: piñon pine and one-seed juniper with little appreciable woody understory; may include ponderosa pine at higher elevations.  Special area, gypsum outcrop: dominated by <i>Muhlenbergia</i>, <i>Bouteloua</i>, <i>Calylophus</i>, <i>Corderia</i> and <i>Mentzelia</i>. Often the preferred habitat of rare plants.  Agriculture - Human Impact. |
|---|--|

Figure 5.4-1. Estancia Basin SSC Site Vegetation Map.

vegetative associations in the SSC area. These vegetative associations are as follows:

Agriculture

The western and southern portions of the SSC pass through an area of agricultural fields with little or no native vegetation present. Agricultural products vary from wheat grass hay, alfalfa, potatoes, beets, to pumpkins. Most farming in the valley is irrigated with some dry land farming. Irrigation is from groundwater wells associated with an agricultural field.

Pinon-Juniper Association

Areas usually above 6,500 feet in elevation on the northern and western portions of the study area contain very thick stands of pinon pine, Pinus edulis, and one seeded juniper, Juniperus monosperma. These areas sustain very little shrubby understory and a few bunch grasses and forbes. Although wooded, this area provides marginal habitat for large mammals or herbivores.

Juniper-Bouteloua Association

At slightly lower elevations (6,500-6,400 feet), the vegetative dominance shifts to one seeded juniper and various grama grasses. The grama species prevalent are blue grama, Bouteloua gracilis, and sideoats grama, Bouteloua curtipendula. In addition, several species of three awn grasses, Aristida spp., western wheat, Agropyron smithii, and ring muhly Muhlenbergia torreyii. This area, due to its greater vegetative diversity, is a better habitat for herbivores and other large mammals.

Bouteloua-Agropyron Association

Moving farther east along the northern study area boundary and at a slightly lower elevation, we find the most abundant vegetative association in the SSC site study area. This area is the blue grama grass and western wheat grass association. These two species dominate the perennial flora present but are associated also with bottlebrush squirreltail Sitanion hystrix, threeawn, ring muhly, winterfat Eurotia lanata, and fringed sage, Artemisa filifolia. This area, although an open grassland habitat, supports a large number of herbivores both domestic and native.

Atriplex Association

Traveling to the southeastern portion of the study area in slightly heavier soils the vegetation is dominated by four wing salt bush, Atriplex canescens, with a sparse understory of various perennial grass species and annual forbes during the rainy season. This area provides excellent habitat for many small mammals and native herbivores.

All of these associations added together create the typical environment found throughout north-central and central New Mexico at elevations from 5,000 feet to 7,500 feet. No unique or scientifically significant habitats would be disturbed by construction of the proposed Estancia Basin SSC facility.

Major types of flora present in the SSC site area are summarized primarily from existing data and are based on the major soil associations present. Figure 5.4-2 lists the common and scientific names of plants common to the study area.

sideoats grama (Bouteloua curtipendula)
blue grama (Bouteloua gracilis)
black grama (Bouteloua eriopoda)
hairy grama (Bouteloua hirsuta)
six weeks grama (Bouteloua barbatus)
little bluestem (Andropogon scoparius)
big bluestem (Andropogon gerardi)
sand dropseed (Sporobolus cryptandrus)
alkali sacaton (Sporobolus airoides)
mesa dropseed (Sporobolus flexuosus)
New Mexico feathergrass (Stipa neomexicana)
three-awn (Artistida spp.)
Indiangrass (Sorghastrum nutans)
buffalograss (Buchloe dactyloides)
galleta (Hilaria jamesii)
spike muhly (Muhlenbergia pungens)
ring muhly (Muhlenbergia torreyi)
western wheatgrass (Agropyron smithii)
needle-and-thread (Stipa comata)
Indian ricegrass (Oryzopsis hymenoides)
plains bristlegass (Setaria macrostachya)
prairie sandreed (Calimouilfa longifolia)
yucca (Yucca spp.)
broom snakeweed (Gutierrezia sarothrae)
snakeweed (Gutierrezia microcephla)
fringed sagebrush (Artemisia filifolia)
big sagebrush (Artemisia tridentata)
bottlebrush squirrel tail (Sitanion histrix)
Mormon tea (Ephedra sp.)
skunkbrush sumac (Rhus trilobata)
Apache plume (Falugia paradoxa)
rubber rabbitbrush (Chrysothamnus nauseosus)
cholla (Opuntia spp.)
pincushion cactus (Coryphantha vivipara)
prickly pear (Opuntia spp.)
flat cream pincushion (Mammillaria gummifera)
Texas rainbow hedgehog (Echinocereus dasyacanthus)
one-seed juniper (Juniperus monosperma)
piñon pine (Pinus edulis)
ponderosa pine (Pinus ponderosa)
oak (Quercus spp.)

Figure 5.4-2. Common and scientific names of common plants in the SSC site area.

5.4.2 THREATENED OR ENDANGERED PLANT SPECIES

No federally listed rare or endangered plant species occur within the SSC study area. However, there are five species of plants that the state of New Mexico has placed on their priority 1 list and one federal candidate species that could occur within the study area. A state priority 1 species may be common in New Mexico but wholly endemic to the state, or of restricted distribution in New Mexico, commercially exploited, and usually being eradicated in much of its historic range. Figure 5.4-3 is a summary of the various species, common names, general habitat location, threat to taxon, if any, and legal status.

It should be noted that the species listed in Figure 5.4-3 could occur within the SSC regional vicinity but are highly unlikely along the SSC ring itself. An on-the-ground survey of lands to be disturbed should be conducted before construction and coordinated with the New Mexico Heritage section of the New Mexico Department of Natural Resources and the United States Fish and Wildlife Service. This is a routine procedure within New Mexico and is conducted to ensure no protected or listed species are inadvertently harmed.

<u>Family</u>	<u>Common Name</u>	<u>Scientific Name</u>	<u>Legal Status</u>	<u>General Habitat</u>	<u>Threat to Taxon</u>
<u>Apiaceae</u>					
	Threadleaf False Carrot	<u>Aletes filifolius</u>	State Priority 1	Canyons and open slopes at the pinon-juniper level at 5,500-7,500 feet.	None known.
<u>Cactaceae</u>					
	Wright's Pincushion Cactus	<u>Mammillaria wrightii</u> var. <u>wrightii</u>	Biologically Threatened	Gravelly hills or plains, desert grassland to pinon-juniper at 3,000-7,000 feet.	Over collection and habitat alteration.
	Dagger-Thorn Cholla	<u>Opuntia clavata</u>	State Priority 1 NM Endemic	Sandy soils of valleys and grasslands at 6,000-8,000 feet.	None known.
	Grama Grass Cactus	<u>Toumeyia papyracantha</u>	Federal Candidate	Grama-Galleta grasslands usually sandy soil at 5,000-7,300 feet.	Over collection, over grazing urbanization, and habitat destruction.
<u>Fabaceae</u>					
	Santa Fe Milk-Vetch	<u>Astragalus feensis</u>	State Priority 1	Dry slopes usually with pinon-juniper at 5,000-6,500 feet.	None known.
	Flint Mountains Milk Vetch	<u>Astragalus siliceus</u>	State Priority 1	Rocky knolls, banks, and flats on high rolling plains at about 6,000 feet.	None known.

5-14

Figure 5.4-3. Rare, endemic, or candidate plant species with possible occurrence in the SSC site area, Estancia, New Mexico.

5.5 AIR QUALITY

5.5.1 EXISTING AIR QUALITY

The site area is in Environmental Protection Agency (EPA) Region VI. Within New Mexico, the area is under jurisdiction of the State Environmental Improvement Division (EID). The EID is the primary permitting authority. Applicable New Mexico and Federal Ambient Air Quality Standards are given in Figure 5.5-1. The area is in attainment for national ambient air quality standards for all criteria pollutants. There are no major emitting facilities in the vicinity. The major local emissions are particulates from unpaved roads, disturbed soils, and agricultural operations. Vehicle emissions and emissions from wood burning stoves are present, but are very minor. Although baseline NO_x and SO₂ data are not available, the lack of sources makes typical rural western background values applicable.

Data on particulate concentrations in Total Suspended Particulates (TSP) are available from an EID station operating in Moriarty. These data are summarized in Figures 5.5-2 and 5.5-3. Occasionally, TSP concentrations exceed the ambient standards. This is not considered a violation of standards nor does it result in nonattainment designation, since the source is natural wind-blown dust and sand.

Additional air quality data have been collected under an Electric Power Research Institute (EPRI) project called Western Regional Air Quality Studies (WRAQS) at Encino, New Mexico. Sixteen months of data were collected during 1981-82. The data were primarily focused on visibility and aerosol parameters. The visibility data are available in an EPRI summary report and are reproduced in Figure 5.5-4. The detailed data base for this site has been requested from EPRI and will be available to the project.

5.6 BACKGROUND RADIATION

5.6.1 SOIL, ROCK, AND GROUNDWATER BACKGROUND RADIOACTIVITY LEVELS

No site specific surveys of background radiation have been performed at the Estancia site. According to the New Mexico Environmental Improvement Division Radiation Protection Bureau the level of background radiation at the Estancia Site would fall in the following ranges:

Soil - 0.5-1.0 pCi/g (picoCuries per gram)
Rock - 0.5-5.0 pCi/g
Groundwater - 3.5 pCi/l (picoCuries per liter)
Surface water - 0.75 pCi/l

5.7 HISTORICAL AND ARCHAEOLOGICAL RESOURCES

There is no potential for the project to adversely affect any major historical or cultural properties.

NEW MEXICO AIR QUALITY STANDARDS

	<u>Sulphur Dioxide</u>	<u>Oxides of Nitrogen</u>	<u>Total Suspended Particulates</u>	<u>Carbon Monoxide</u>
Annual	0.02 ppm	0.05 ppm	60 ug/m ³	
30 day			90 ug/m ³	
7 day			110 ug/m ³	
24 hour	0.10 ppm	0.10 ppm	150 ug/m ³	
8 hour				(8.7 ppm) 8,500 ug/m ³
1 hour				(13.1 ppm) 15,600 ug/m ³

FEDERAL AIR QUALITY STANDARDS

Annual	80 ug/m ³ (.03ppm)	100 ug/m ³ (.05ppm)	75 ug/m ³	
24 hour	365 ug/m ³ (.14ppm)		150 ug/m ³ (secondary)	
3 hour	1300 ug/m ³ (.5ppm)		260 ug/m ³ (primary)	
8 hour				10,000 ug/m ³
24 hour				40,000 ug/m ³

Figure 5.5-1. Federal and state ambient air quality standards.

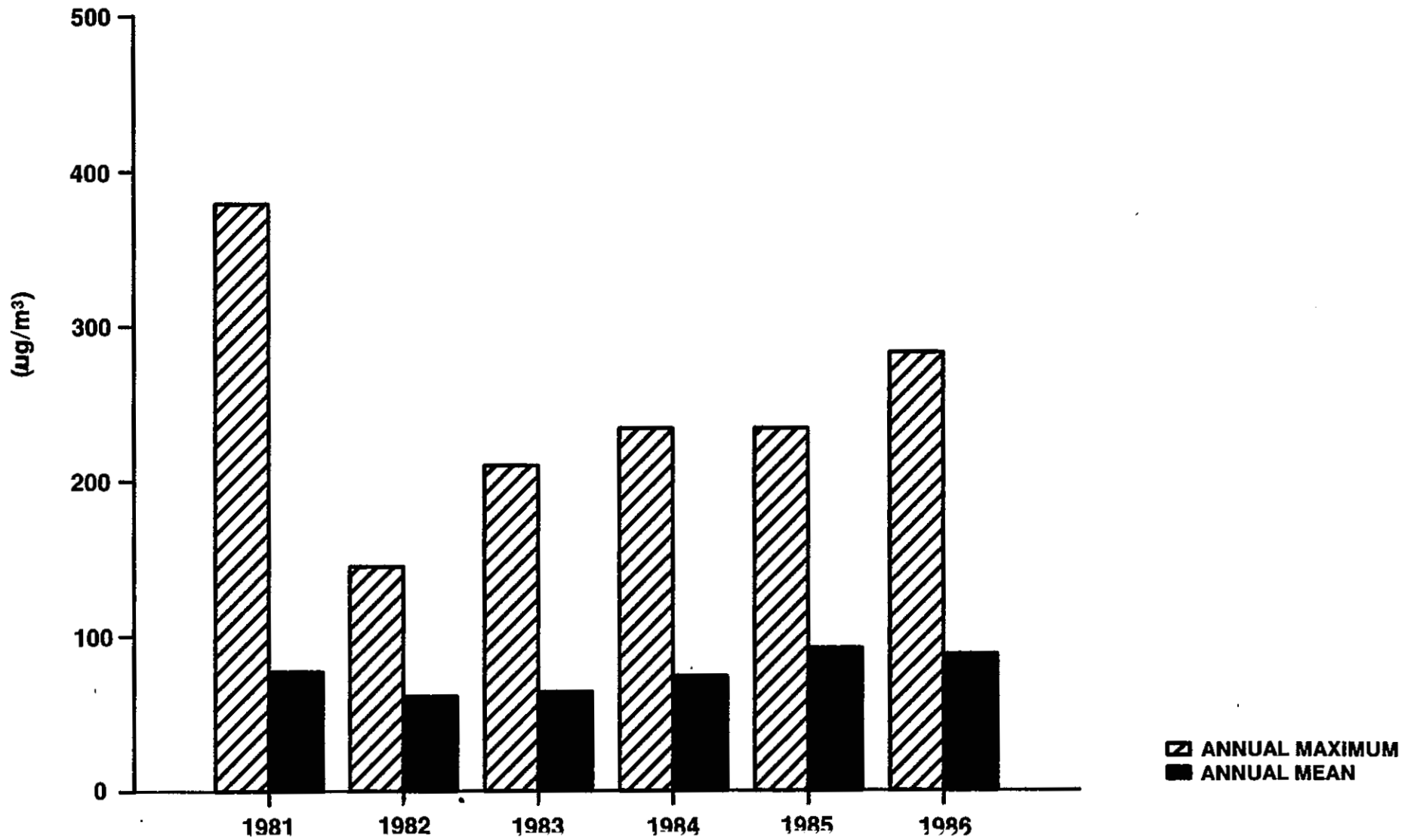

Figure 5.5-2. Suspended Particulate Matter, Moriarty, New Mexico (µg/m³).

5-18

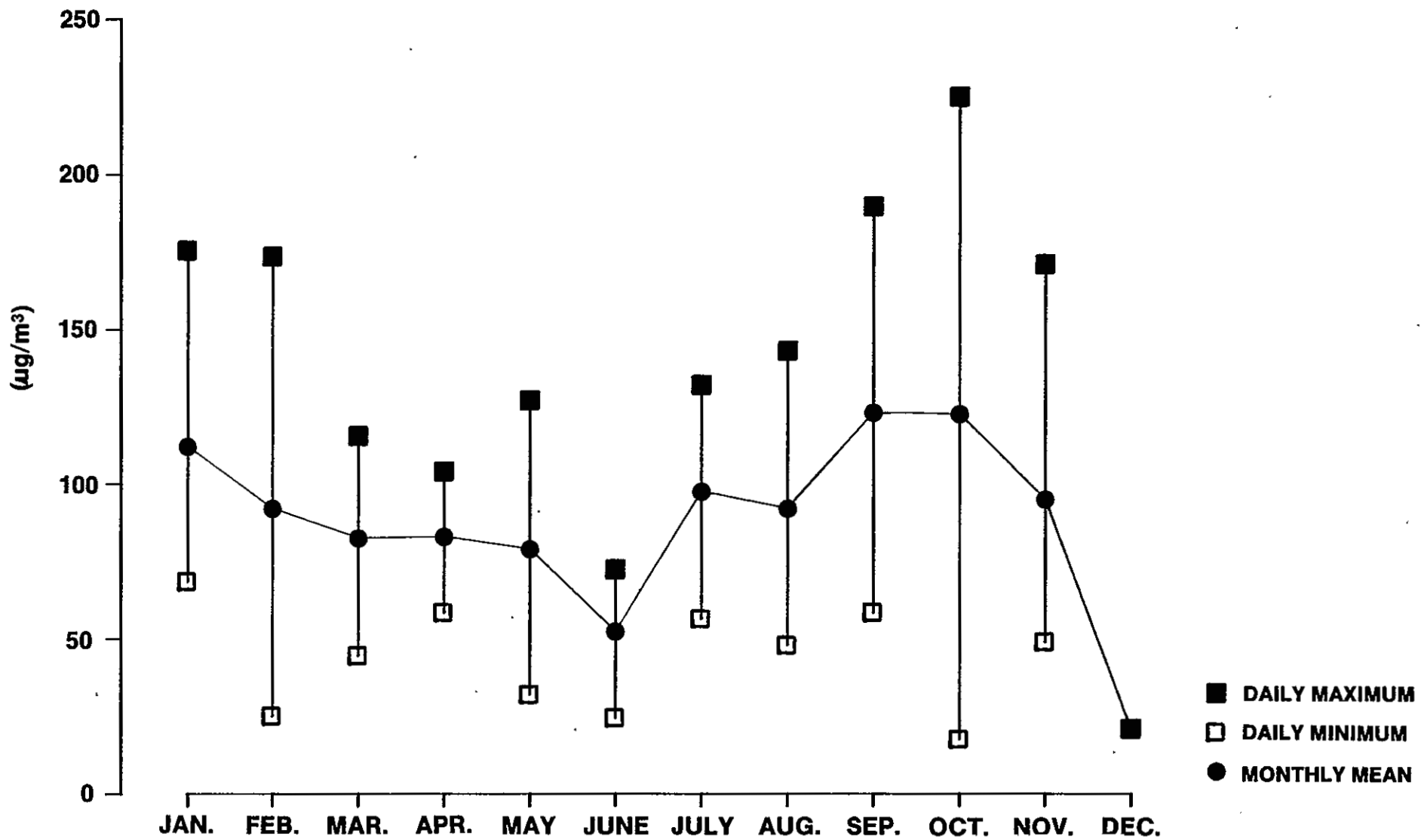

Figure 5.5-3. Suspended Particulate Matter, Moriarty, New Mexico ($\mu\text{g}/\text{m}^3$).

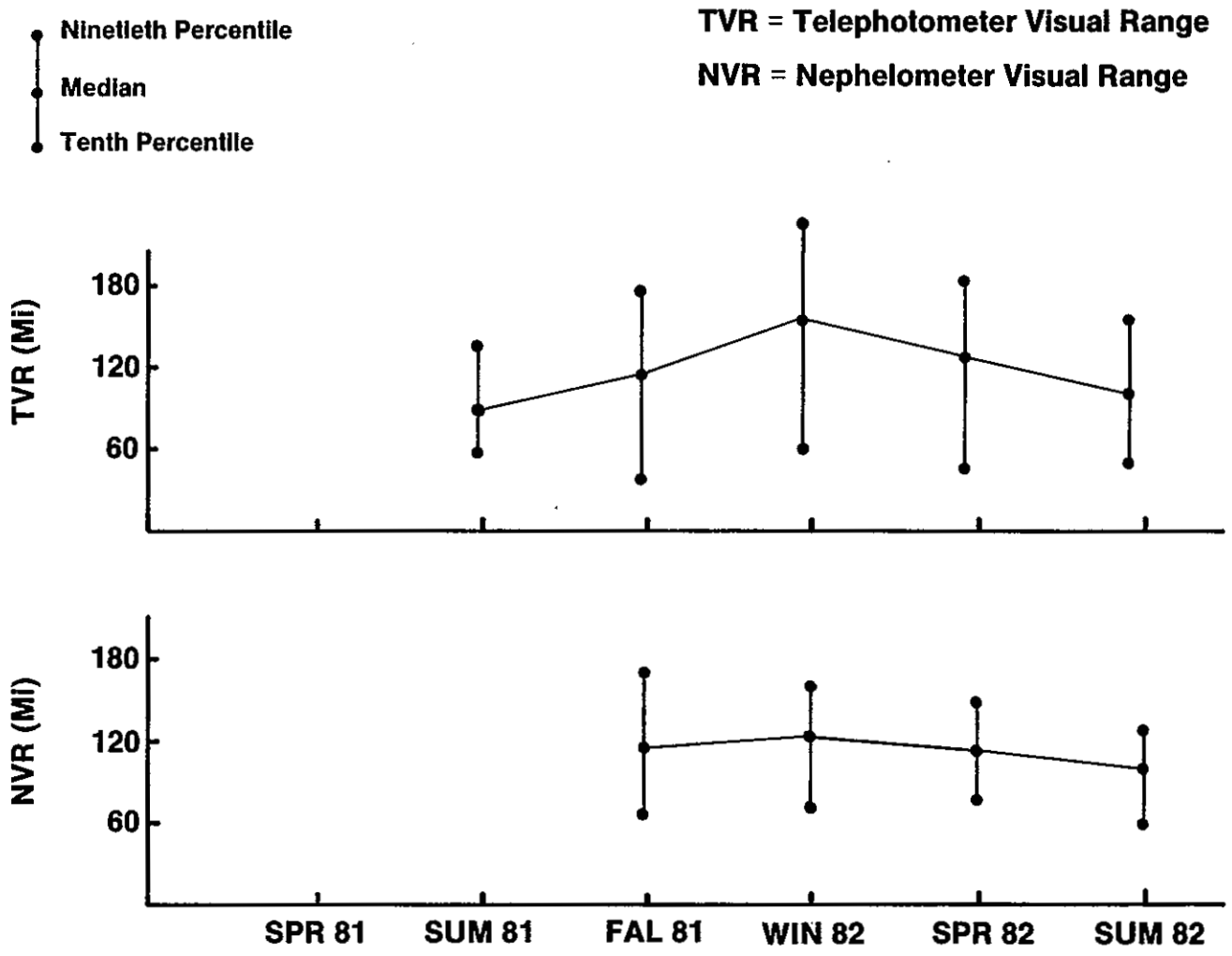

Figure 5.5-4. Visibility Data, Encino, New Mexico.

The Estancia Basin contains sites spanning all time periods from Early Man to the Spanish Conquest, as well as historic sites of the Colonial, Territorial, and Statehood periods. These sites range in significance from completely surficial lithic scatters to substantial pueblos and abandoned towns. The majority of the sites, including all sites of exceptional size and importance, occur outside the area proposed for the SSC. Figure 5.7-1 shows the general location of site concentrations near the proposed SSC location.

The major historic sites are the two towns of Golden and Old Chilili. Golden is on the opposite side of San Pedro Mountain and South Mountain from the proposed SSC location, outside the area of proposed effect. Old Chilili is a little more than 10 miles south-southwest of the southern boundary of the SSC site.

The most significant prehistoric pueblo sites in the general region are the Salinas culture sites preserved as the Salinas National Monument. These lie completely outside the area being considered for SSC placement. Additional substantial prehistoric pueblos lie 8 miles and more northwest of the northern boundary of the ring.

The Estancia Basin is known to contain Early Man Occupations of the Clovis and Folsom periods. The most important of these sites lie in the lake region of the valley, 26 miles south of the proposed SSC location.

5.7.1 HISTORICAL, PALEONTOLOGICAL, AND ARCHAEOLOGICAL RESOURCES

In addition to the general characterization just given, which was taken from the published literature on Southwestern Archaeology, this assessment of archeological resources is based on three sources of information:

- A. The site files maintained by the Museum of New Mexico, Laboratory of Anthropology, were consulted. This computerized file was queried for a list and plot of all sites within the proposed SSC area and for an additional six miles outside. This search revealed 26 sites.
- B. Eight additional sites are known for the area from the archeological survey the Public Service Company of New Mexico performed before constructing its 345 kV electric transmission line Eastern Interconnection Project. That project also provides valuable information on excavated sites, some of which are in the proposed SSC project area and others, nearby, which provide a clear indication of the kinds of archaeological remains likely to be affected by the project.

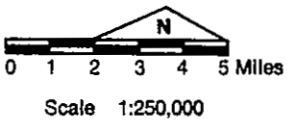
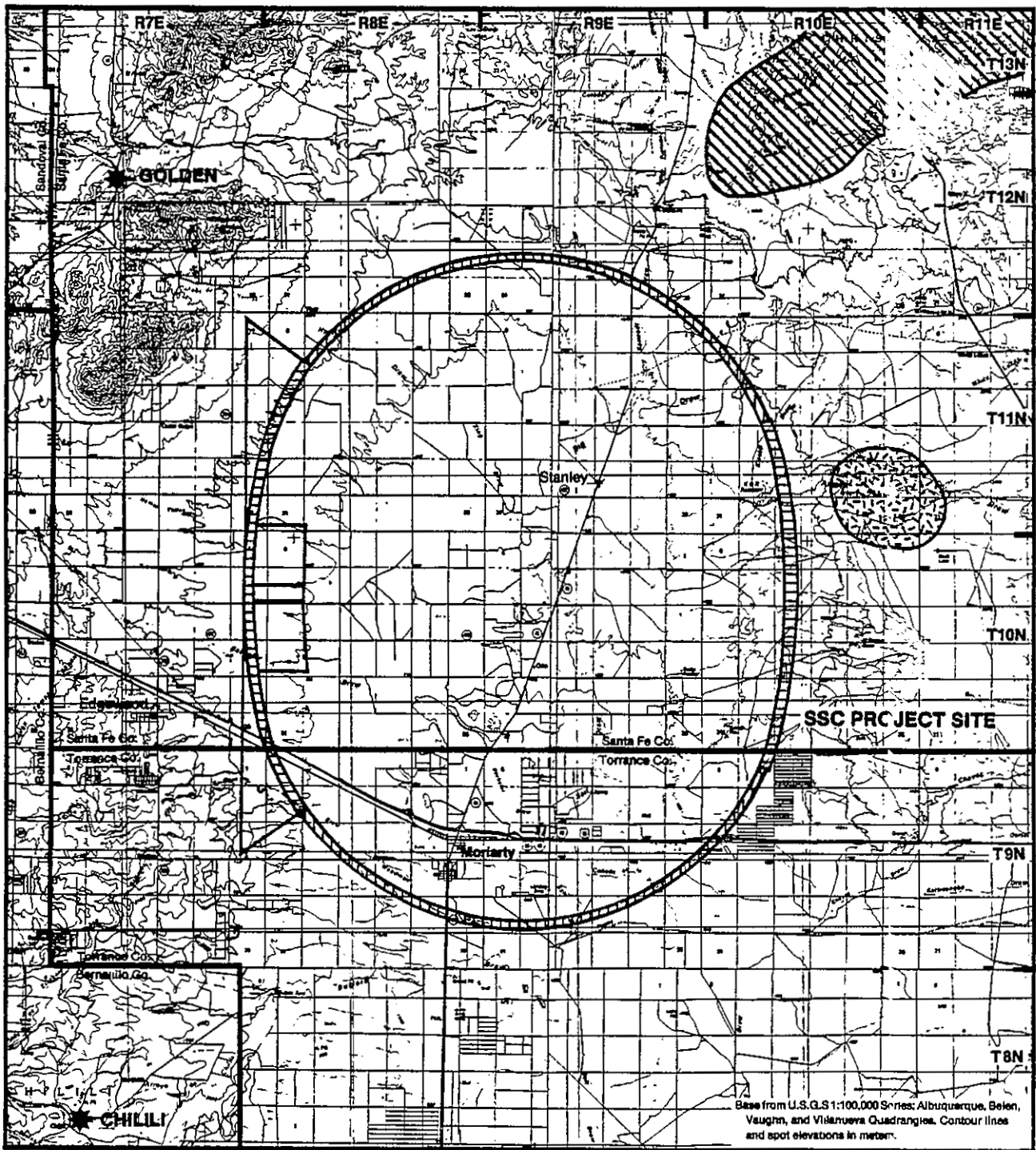



-  **Area Containing Pueblo Sites**
-  **Known Concentration of Lithic/Ceramic Scatter**
-  **Major Historic Site**

Figure 5.7-1. Estancia Basin SSC Site Historical and Archeological Resources.

- C. A brief on-the-ground reconnaissance encountered two early 20th Century dug-outs within 0.5 mile of the eastern portion of the ring. The general lack of archeological materials predicted from the literature search was confirmed.

Figure 5.7-2 summarizes the archaeological sites known to occur within the SSC project area. These sites are not located on property proposed for siting the SSC.

<hr/>	
Historic	
Towns	2
Small structural sites	6
Camps	1
Trash scatters	3
	<hr/>
	12
Prehistoric structural sites	
Roomblocks	4
Other	2
	<hr/>
	6
Prehistoric possible structural sites	5
	<hr/>
	5
Prehistoric artifact scatters	
Ceramic	3
Lithic	3
Lithic and ceramic	7
	<hr/>
	13
 Total	 36
<hr/>	

Figure 5.7-2. Known Archaeological Sites in the SSC Project Area.

The small number of sites reported for this large area results from two factors: (1) a limited amount of survey and (2) a low actual density. The inference of low actual site density is based on the results of the EIP archeological survey and the limited ground reconnaissance. The EIP survey encountered sites at higher elevations on both the east and west sides of the SSC project area, primarily within the juniper grasslands and mixed piñon-juniper woodland. Very few sites were encountered in a natural setting similar to that proposed for the SSC.

5.8 PRELIMINARY ENVIRONMENTAL EVALUATION

5.8.1 IMPACTS ON THE ENVIRONMENT

Topographical

There are no topographical impacts from construction and operation of the Estancia Basin SSC. The Estancia Basin SSC site as proposed is predominantly a tunnel site. Areas which could be cut and filled are of sufficient depth to preclude berming of the surface and altering current topographical features. The campus, main laboratory, and test facilities are located on flat to relatively flat terrain.

Geological

There are no known geologic impacts from construction and operation of the Estancia Basin SSC. There are no known fault features or unique exploitable geologic resources within the immediate area of the proposed tunnel and facilities locations. Materials removed from the SSC tunnel and experimental halls will be removed from the area permanently.

Soil

There are no known major soil impacts from construction and operation of the Estancia Basin SSC. Local short-term impacts may occur from surface erosion in areas where surface disturbance occurs during construction. In areas of surface disturbance, the use of water retention berms and post-construction restoration will mitigate soil impacts.

Land Resources

There are no major land resources impacts from construction and operation of the Estancia Basin SSC site. As stated previously in this volume, the majority of the Estancia Basin SSC site is utilized for grazing of domestic livestock. The western and southern portions of the site cross areas of rural to small community housing. Approximately 20 individual homeowners would be impacted by surface use requirements. There are no unique, limited, or special land resources which would be impacted or precluded from future use by the proposed SSC site.

Water

There are no known major impacts to water resources from construction and operation of the Estancia Basin SSC. The allocation of water rights and use are issued by township within the basin. Drawdown of groundwater levels is carefully monitored to ensure domestic and agricultural use and interests are protected within New Mexico. The State Engineer's office states that there is more than sufficient water resources to supply approximately 3,600 acre-feet/year of potable and industrial cooling water to the SSC site without impacting domestic

and agricultural interests within the basin. Normal construction practices which minimize erosion should be utilized to minimize short-term impacts to surface waters.

Ecological

There are no known major or long-term impacts to the ecological balance of the Estancia Basin from the construction of operation of the SSC. The natural environment of the basin has been one of limited rural housing and predominantly limited agriculture and extensive grazing for nearly 100 years. As with all construction projects, limited short-term impacts will occur predominantly during the construction phase of the project. Such impacts will be displacement of small pronghorn antelope herds, possible destruction of small mammal burrows, possible destruction of some ground nesting birds, disturbance or removal of approximately 10-20,000 acres of vegetation for up to 20 years and permanent removal of approximately 4,440 acres of vegetation for the life of the project and beyond.

When considering impacts of the SSC facility, the cumulative effects of such a facility must also be considered. The SSC facility will draw additional housing, industry, and general land development within the vicinity of the project. The basin has been on a general trend of development for nearly 100 years. There are no unique or limited habitats or ecosystems found within the site area which will be adversely impacted or lost due to the siting, construction, or operation of the SSC facility.

Siting of a facility such as the SSC within the Estancia Basin is more ecologically sound than many other types of development. In general, ecological impacts are limited to the campus lab, compressor, and test facility areas. This leaves the rest of the area to continue to support native vegetation and coincident faunal species.

Health and Safety

There are no known or identifiable health or safety impacts associated with the Estancia Basin SSC site. The proposed site is a rural low population area without any other major facilities present. Existing highway and road access is adequate for a much greater traffic flow than the level anticipated once the SSC facility is constructed.

Air Quality

There are no significant air quality impacts. Only two potential sources of air quality impacts were identified. During construction, disturbed areas may result in some windblown dust. However, this will be of short duration and all excess soil and rock will be removed from the site. The other source is secondary emissions from vehicles and residences. Due to the rural nature of the site and sparse population, these secondary emissions should not cause any adverse impacts. Neither the

construction phase nor the secondary vehicle emissions require special permitting nor will they result in permitting problems.

Noise Levels

There are no known sensitive facilities or natural areas that could be adversely impacted long-term by noise levels such as those emitted by or caused by the location, construction, and operation of the SSC, as stated in Volume 7, Section 7.2.1. Major current noise sources are from a major interstate highway (I-40), aircraft landing in Albuquerque, and thunderstorms. The Estancia Basin SSC facility is a tunneled facility with limited areas where sound emissions will occur. The current character of sound emissions within the basin is the same. Unless there are major noise sources from the SSC facility which were not identified within the conceptual design, no major impacts are anticipated.

Historical and Archaeological

There are no known major or long-term impacts to historical, archaeological, or paleontological resources from construction and operation of the Estancia Basin SSC. In areas where surface disturbance will occur, it is anticipated that a very limited number of cultural or scientifically interesting properties will be encountered. Section 5.7 discusses the limited amount of these resources within the basin. New Mexico is a very diverse state, rich in cultural and paleontologic resources and colorful history. The Estancia Basin, however, is a border area to many of these resources and contains a very low density of sites.

Socioeconomic

Few adverse socioeconomic impacts are expected from the SSC project. It is estimated that the bulk of the construction labor force, expected to average 750 workers over the six-year construction period, will be local to the Albuquerque, Santa Fe, Tarrant County region. No significant in-migration, therefore is expected in response to the addition of 750 jobs to the construction labor force.

Based on the skills available and size of the regional labor force, it is assumed that New Mexico's SSC vicinity area will be capable of providing most of the administrative staff needed--accountants, personnel, purchasing, etc., as well as a high proportion of the technical staff including engineers, chemists, electrical and mechanical technicians, and others. Although New Mexico has a large number of physicists, estimated at approximately 3,000 (Sec. 4.5), most of these are not high energy physicists, indicating that a significant number of physicists working at the site will be new in-migrants to the area. In-migration in response to new permanent jobs created by the SSC, therefore, could reasonably be expected to be approximately 500 employees and their families, totalling perhaps 1,500 people.

The population of the three-county SSC region as a whole increased by almost 120,000 people during the 1970 to 1980 period. The 1980 to 1985 population increase within the area is estimated at 58,000, an average annual increase of almost 12,000 people per year over the 15-year period. An increase of 1,500 people as a result of in-migration related to SSC employment opportunities, even an increase of the possible 10,000 as cited in the CDR, is expected to be well within the region's capacity to accommodate. Temporary accommodations for visiting scientists and their families are believed adequate (Sec. 4.6).

A variety of positive economic benefits are expected. Taxes which will accrue to the state during construction are estimated at \$196.5 million (Sec. 4.10). Taxes expected to accrue to the state as a result of project operation approach \$10 million annually (Sec. 4.10). Land withdrawals are expected to reduce Santa Fe and Torrance County property tax bases by less than 0.3 percent (Sec. 4.10).

Kirtland Air Force Base has estimated its economic multiplier at 2.73. Assuming an annual after-tax payroll approximating \$60,000,000 and acquisition of approximately 50 percent of tangibles purchased by the project as New Mexico-based purchases, the economic non-tax impact to the state can be approximated at \$287 million per year.

MAP POCKET

Figure 5.1-1. Wetlands

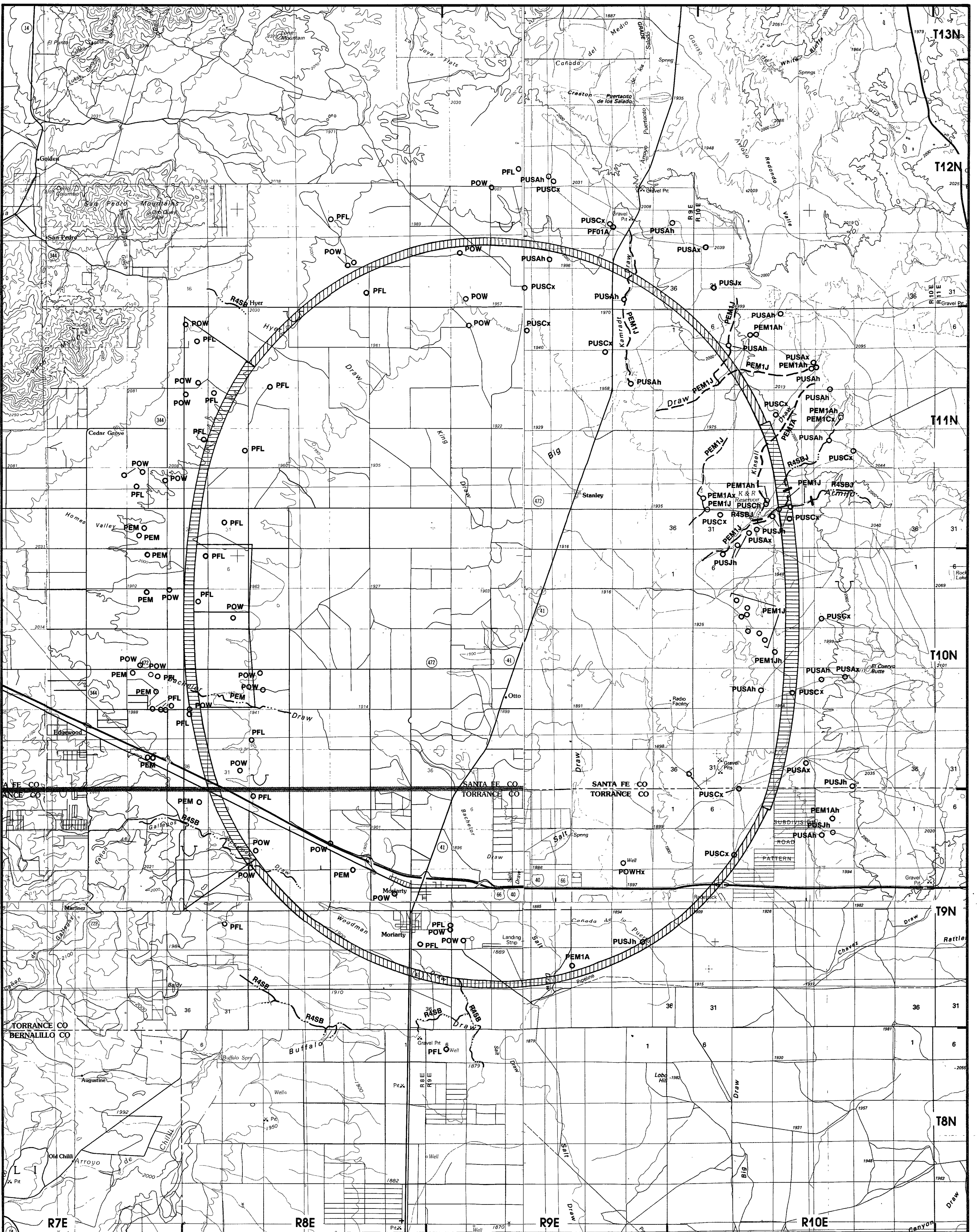

ECOLOGICAL SYSTEM

P - PALUSTRINE

CLASS	RB ROCK BOTTOM	UB UNCONSOLIDATED BOTTOM	AB AQUATIC BED	FL FLAT	ML MOSS LICHEN	EM EMERGENT	SS SCRUB SHRUB	FD FORESTED	OW OPEN WATER
Subclass	1 Bedrock 2 Boulder	1 Cobble Gravel 2 Sand 3 Mud 4 Organic	1 Submerged Aquatic 2 Submerged Vascular 3 Submerged Moss 4 Floating 5 Unknown Submerged 6 Unknown Surface	1 Cobble Gravel 2 Sand 3 Mud 4 Organic 5 Vegetated 6 Vegetated Non-growing	1 Moss 2 Lichen	1 Persistent 2 Nonpersistent 3 Narrow-leaved Nonpersistent 4 Broad-leaved Nonpersistent 5 Narrow-leaved Persistent 6 Broad-leaved Persistent	1 Broad-leaved Deciduous 2 Needle-leaved Deciduous 3 Broad-leaved Evergreen 4 Needle-leaved Evergreen 5 Dead 6 Deciduous 7 Evergreen	1 Broad-leaved Deciduous 2 Needle-leaved Deciduous 3 Broad-leaved Evergreen 4 Needle-leaved Evergreen 5 Dead 6 Deciduous 7 Evergreen	Unknown Bottom

R - RIVERINE

CLASS	RB ROCK	UB UNCONSOLIDATED BOTTOM	SB STREAMBED	AB AQUATIC BED	RS ROCKY SHORE	US UNCONSOLIDATED SHORE	EM EMERGENT	OW OPEN WATER
Subclass	1 Bedrock 2 Rubble	1 Cobble Gravel 2 Sand 3 Mud 4 Organic	1 Bedrock 2 Rubble 3 Cobble Gravel 4 Floating Vascular 5 Submerged 6 Unknown Surface 7 Vegetated	1 Algal 2 Aquatic Moss 3 Rooted Vascular 4 Floating Vascular 5 Submerged 6 Unknown Surface 7 Vegetated	1 Bedrock 2 Rubble	1 Cobble Gravel 2 Sand 3 Mud 4 Organic 5 Vegetated	2 Nonpersistent	Unknown Bottom

Modifying Terms

- A Temporary
- C Seasonal
- H Permanent
- J Intermittently Flooded
- h Diked/Impounded
- x Excavated

Symbology Example

System Subsystem
Wetland L2EM2F
Class Subclass, Water Regime

Upland (Non-wetlands)
Primarily represents upland areas, but may include unclassified wetlands such as man-modified areas, non-photo-identifiable areas and/or unintentional omissions

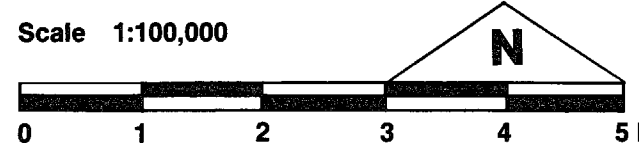

Wetlands data are depicted only for a 4 mile wide corridor surrounding the SSC project site (2 miles on either side of ring centerline).

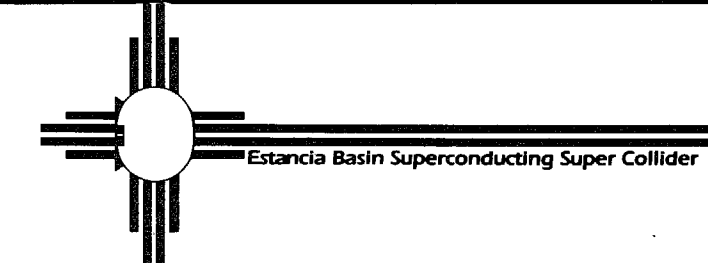

1:100,000 U.S.G.S. Topographic Base Map (Metric Series): Albuquerque, Belen, Vaughn and Villanueva Quadrangles.

Data from U.S. Dept. of the Interior, Fish and Wildlife Service, National Wetlands Inventory Map Series: Edgewood, N.M., Estancia, N.M. Quads (1:62,500); Villanueva, N.M. Quad (1:100,000); Lobo Hill NW, N.M. Quad (1:24,000).

Estancia Basin SSC Site Wetlands Map

July 31, 1987 Figure 5.1-1

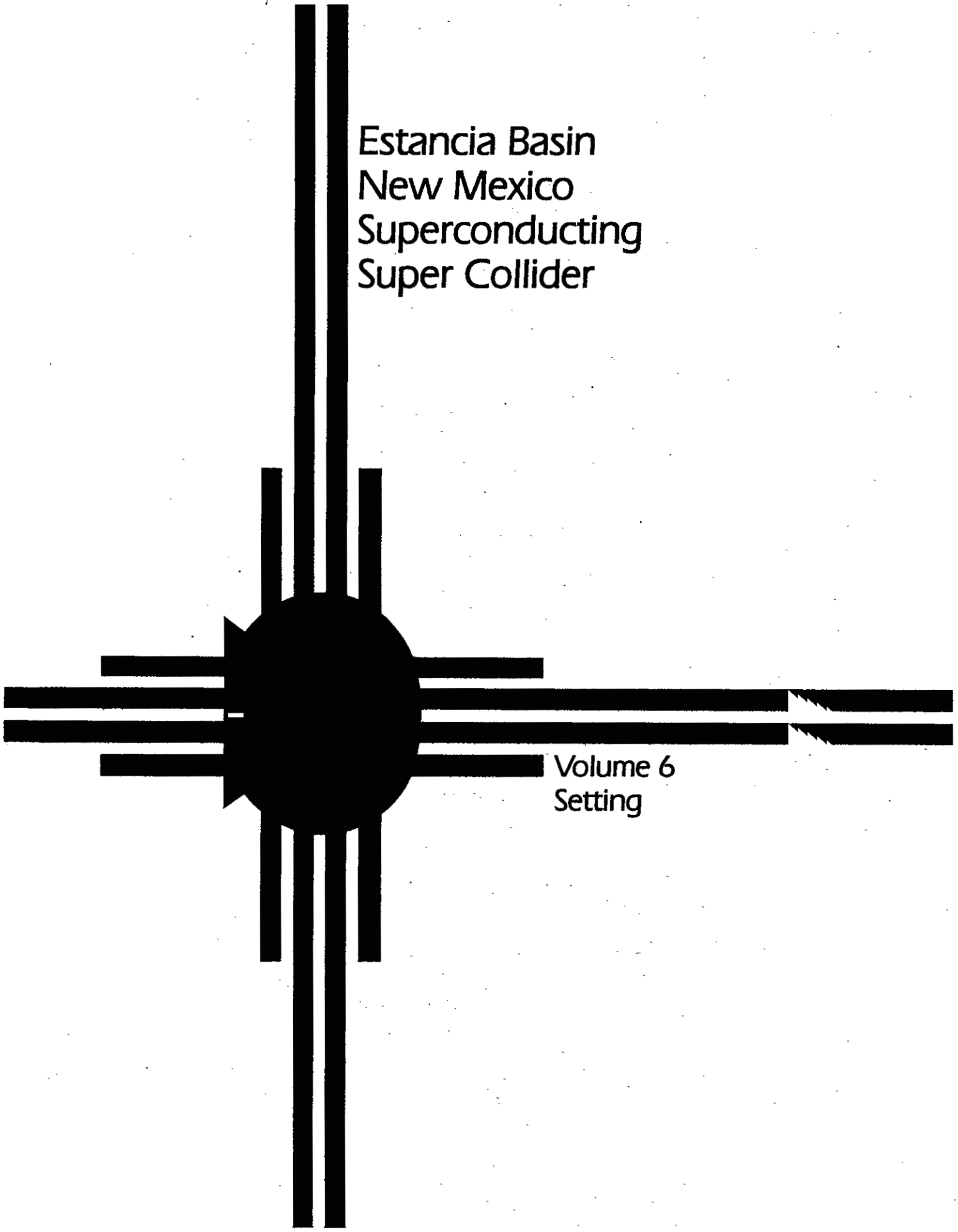

Estancia Basin
New Mexico
Superconducting
Super Collider

Volume 6
Setting



Setting

Volume 6

TABLE OF CONTENTS

6.0	Summary	6-1
6.1	General	6-3
6.1.1	Description of Placement of SSC Facilities.	6-3
6.1.2	Narrative of Man-made and Natural Features of the Area	6-4
6.2	Real Estate Acquisition Plan	6-5
6.2.1	Scope of Acquisition	6-5
6.2.1.1	Acreage	6-5
6.2.1.2	Number of Parcels and Ownerships .	6-7
6.2.1.3	Identification of Political Subdivisions	6-9
6.2.1.4	Location Maps of SSC Facilities Showing Land Use	6-10
6.2.1.5	Residences and Businesses	6-11
6.2.2	Method of Acquisition	6-12
6.2.2.1	Description of Proposed Method of Acquisition	6-12
6.2.2.2	Summary of Land Acquisition Legislation	6-14
6.2.2.3	Instances Where Inadequate Condemnation Authority Exists ...	6-15
6.2.2.4	Federal Government-owned Land ...	6-15
6.2.2.5	Situations Requiring Assistance of DOE	6-15
6.2.2.6	Qualifications and Number of Personnel	6-16
6.2.3	Schedule of Acquisition	6-17
6.2.3.1	Appraisal	6-17
6.2.3.2	Survey	6-17
6.2.3.3	Preliminary Title Evidence	6-17
6.2.3.4	Commencement of Negotiations	6-18
6.2.3.5	Filing of Condemnation Proceedings	6-18
6.2.3.6	Completion of Acquisition	6-18
6.2.3.7	Completion of Relocation of Residences and Businesses	6-18
6.2.3.8	Completion of Relocation or Miti-	

	gation of Roads, Cemeteries, etc.	6-19
6.2.3.9	Identification of Delays and Areas of Concern	6-19
6.2.4	Additional Available Land	6-19
6.3	Other Information	6-20
Appendices	6-21
6-A	Authorizing Legislation	6-21
6-B	Resumes of Key Land Acquisition Personnel ..	6-26

6.0 SUMMARY

The setting of the Estancia Basin SSC site is located within Santa Fe and Torrance Counties, State of New Mexico. The "best apparent fit" orientation and location presented herein were developed after intensive study of several alternatives; however, a fair degree of flexibility exists in the site area for alternative orientations and locations. The suggested placement locates the north-south centerline at longitude $106^{\circ} 00'$ and the east-west centerline at latitude $35^{\circ} 08'$.

Man-made features are minimal and widely scattered, consisting principally of farm and ranch buildings and residences. Natural features, including gently sloping terrain and absence of surface water, contribute positively to construction and operation of the SSC at this location. There is no apparent potential for a negative impact from either man-made or natural features.

The Real Estate Acquisition Plan is summarized as follows:

A. Scope

The total acquisition is approximately 16,338 acres, of which 8,057 acres will be fee simple title and 8,281 acres will be stratified fee estate with surface right-of-entry.

There are 416 parcels involved, some of which contain both fee simple and stratified fee requirements. Ownership of 15,200 acres is held by 390 individuals and corporations. State trust land composes the remaining 1,138 acres. A detailed map of ownerships, types of estates required, and existing permanent improvements has been furnished.

Permanent improvements include 28 houses, 1 business, and 23 water wells. About 23 mobile homes will require relocation.

B. Method

Privately owned land and improvements will be acquired by negotiation or, if necessary, by condemnation. Right-of-entry across private land will follow the same procedure.

State trust land will be acquired by a process of exchange for lands of equal value. Right-of-entry over state trust land will be granted directly by the State Commissioner of Public Lands.

C. Acquisition Legislation

Statutory authority exists for acquisition of privately owned lands, including a "quick take" statute, and the New Mexico legislature has appropriated \$11,000,000 for land acquisition for the SSC. Statutory authority also exists for the exchange of state trust land.

Adequate condemnation authority currently exists, no Federal Government-owned land is included, and no situations requiring DOE assistance are foreseen.

A cadre of experienced personnel will be available to acquire the land to be donated, and their qualifications are detailed.

D. Schedule

The appraisal, survey, and preliminary title evidence for privately owned land will be completed during a six-month period beginning July 1, 1988. The appraisal, survey, and preliminary title evidence for state trust land will be completed during a three-month period beginning January 1, 1989.

All private land acquisition will be completed by April 30, 1989. Final acquisition of state trust land will be completed by July 1, 1989.

Condemnation delays can be mitigated by the "quick take" statute and no delays or areas of concern are evident.

E. Additional Available Land

The land use and ownership patterns for areas lying within several miles of the site in all directions are typical of the patterns in the selected site area. This provides flexibility for design refinements and future upgrades.

Current land use, predominantly grazing and farming, are conducive to location of the SSC; furthermore, there are no master planning and zoning requirements in the area that are detrimental to its construction or operation.

6.1 GENERAL

6.1.1 DESCRIPTION OF PLACEMENT OF SSC FACILITIES

The SSC study area is in the northern Estancia Valley, approximately 40 miles east of Albuquerque. The area is in a north-south-trending basin with highlands to the west and to the east. The land surface slopes gently to the south (see Fig. 6.1-1; in map tube). Surrounding the valley floor are remnants of lacustrine shorelines of ancient Lake Estancia. The shorelines generally follow the 6,225-ft contour line. To the west the slopes initially rise at about 45 ft per mile then steepen to about 77 ft per mile until the mountains are encountered. To the east the slopes above the 6,225-foot contour line initially rise at 45 ft per mile, but then steepen to about 80 ft per mile.

Drainages on the floor and slopes of the basin are generally in wide draws (up to 1 mile across). Most of these draws are former stream tributaries of ancient Lake Estancia. The modern arroyo channels occupy the central portions of these draws. Drainage is generally from highlands on the west and east toward the central part of the basin then to the south toward modern playas about 30 miles southeast of Moriarty.

Several alternative ring locations were considered before the final selection was made (Fig. 6.1-1; in map tube). Each location was examined in detail, and topographic and geologic cross sections were drawn to assess tunneling conditions.

The north-south trend of the Estancia Valley was a factor in the initial placement (N-S #1, Fig. 6.1-1) along an axis parallel to but 2 miles west of the present position. Two east-west orientations were also examined. In these orientations the tunnel would be asymmetrically folded along the cluster regions and bent upwards to the highlands in the arc regions. Position E-W #1 oriented along the northern study area boundary was excluded because the topography was not suitable. Position E-W #2 farther south was studied in more detail. These positions were excluded from consideration in favor of the present ring location, which is superior from geologic and geotechnical standpoints. The present location has flexibility and can be repositioned, if need be, by up to 0.5 miles in any direction.

The final placement of the SSC within the northern Estancia Basin is as far north in the valley as possible to

avoid areas of shallow and heavily mineralized groundwater and possible problem soils associated with Pleistocene lake deposits southeast of Moriarty. It is oriented north-south to fit between the solution features north of Edgewood and structural features northeast of the Longhorn Ranch area (Fig. 6.1-1; in map tube). The slope of the tunnel is only 0.2 to the south with a symmetrical fold at the northernmost and southernmost points. The symmetrical fold is 0.40, which brings the near and far cluster areas (G and H) close to the surface. The north-south orientation places the campus area (A) and injector rings (B) at convenient distances from Albuquerque with easy access to Interstate 40 at Edgewood (Fig. 6.2.1.4-1A; in map tube).

The north-south centerline of the SSC is aligned along longitude $106^{\circ} 00'$ and the east-west is aligned along latitude $35^{\circ} 08'$. The Quaternary-Tertiary alluvium, with excellent foundation and tunneling characteristics, is the surficial unit along three-fourths of the tunnel. The southern one-fourth of the SSC has younger alluvium and lacustrine units at ground surface, but the tunnel at depth is in Quaternary alluvium that has favorable construction conditions. The slope of the ground from the northernmost point on the ring to the southernmost point is only 19 ft per mile. Although the ring is placed in its most favorable position at this time, our study indicates that there is a fair degree of flexibility.

6.1.2 NARRATIVE OF MAN-MADE AND NATURAL FEATURES OF THE AREA

Man-made features are minimal and sparse on the site itself and in the immediate site vicinity. These are composed principally of farm and ranch buildings with attendant structures (corrals, windmills, stock tanks, etc.), widely scattered residences and commercial buildings, Interstate Highway I-40 and other primary and secondary roads, and utility transmission and distribution facilities. The few small established communities in the general area are located completely inside or completely outside of the construction ring, and can remain physically undisturbed. No other relevant man-made features exist.

Natural features characterize the site as an intermontane basin with gently sloping terrain, gradually rising to flanking mountains and high plateaus on all sides. The setting is sparsely populated, currently utilized principally for grazing, irrigated and dry-land farming, and rural housing. The basin is internally drained, and there

are neither permanently flowing streams nor natural bodies of water within the vicinity.

The combination of minimal man-made features and advantageous natural features permit a fair degree of flexibility in the orientation and exact location of the collider ring within the proposed site area. The general orientation and location of the ring, selected as the basis for this proposal, provide a "best apparent fit" for ease of design and most economical construction.

Overall, existing man-made and natural features of the Estancia Basin contribute positively to the construction and operation of the SSC in this location. There is no apparent potential for a negative impact of either man-made or natural features.

6.2 REAL ESTATE ACQUISITION PLAN

6.2.1 SCOPE OF ACQUISITION

6.2.1.1 ACREAGE

The total acreage encompassing the various areas of the SSC site is approximately 16,338 acres in Santa Fe and Torrance Counties, divided as follows.

Santa Fe County	12,045 acres	73.7%
Torrance County	4,293 acres	26.3%
TOTAL SSC SITE	16,338 acres	

The acreage includes all areas A-K within the SSC site as designated in Figure 6.2.1.4-1 (in map tube). The SSC site is currently served by access roads and utility and communication lines. Additional off-site roadways as may be desirable will be provided as part of the State of New Mexico's offer of incentive.

Fee Simple Title

Fee simple title will be provided by New Mexico to the Federal Government for 8,057 acres, or 49.3% of the total land area within the proposed SSC site. Fee simple title will be provided for SSC areas designated in Figure

6.2.1.4-1 (in map tube) as A, B, C, E, F, G (with two minor exceptions explained below), H, J, K and the shaded portions of D.

New Mexico will provide stratified fee title to two small strips of land that cross the northern and southern edges of the SSC area designated G, although the Invitation for Site Proposals calls for delivery of fee simple title in this area. These corridors house the crossing of Interstate I-40 near the south edge of area G and State Highway 472, a two-lane road crossing the northern edge of area G. The SSC tunnel depth at these two road crossings is 155 feet in the case of I-40 and 85 feet in the case of State Highway 472. Given the distance of these crossings from the main campus area, the small acreage involved, and the tunnel depth at these points, substitution of stratified fee title for fee simple title in these instances will not interfere with the construction or use of SSC surface buildings or the operation of the SSC.

As shown below, more than 90% of the land for which fee simple title will be provided to the Federal Government is located in Santa Fe County.

Santa Fe County	7,344 acres	91.1%
Torrance County	713 acres	8.9%
TOTAL SSC		
FEE SIMPLE LAND		
REQUIREMENTS	8,057 acres	

Lands in Santa Fe County for which fee simple title will be obtained compose 61.0% of the total SSC site located in that county. Only 16.6% of the SSC site located in Torrance County involves land for which fee simple title will be provided to the Federal Government.

Stratified Fee Title

Stratified fee title will be provided by New Mexico to the Federal Government for the 8,281 acres beneath the 50.7% of the total proposed SSC site where fee simple title is not required by the Federal Government. Right-of-entry will be provided by New Mexico to the Federal Government on the land surface directly above this stratified fee estate. Stratified fee title will be provided for the SSC areas designated in Fig. 6.2.1.4-1 (in map tube) as I and the unshaded portions of D, plus the small roadway corridors

within section G discussed above. These lands are divided between Santa Fe and Torrance Counties as follows.

Santa Fe County	4,701 acres	56.7%
Torrance County	3,580 acres	43.3%
TOTAL SSC STRATIFIED		
FEE LAND REQUIREMENTS	8,281 acres	

Lands in Santa Fe County for which stratified fee title will be obtained compose 39.0% of the total SSC site located in that county. About 83.4% of the SSC site located in Torrance County involves land for which stratified fee title will be provided to the Federal Government.

6.2.1.2 NUMBER OF PARCELS AND OWNERSHIPS

Parcels

Part or all of 416 individual parcels of land fall within the 16,338-acre proposed SSC site. The smallest parcel is 0.5 acres and the largest is 1,381 acres. As shown below, 76.4% of the total number of parcels are located in Torrance County, where considerable subdivision development was proposed in the 1960s and 1970s.

Santa Fe County	98 parcels	23.6%
Torrance County	318 parcels	76.4%
TOTAL SSC SITE		416 parcels

It is important to note that although sizable areas within the Torrance County portion of the SSC site were divided into small 0.5 and 1.0 acre plots over a decade ago, very little residential development has actually taken place. As discussed in Section 6.2.1.5 of this proposal, less than 25 homes have been built on the subdivision land parcels in Torrance County falling within the boundaries of the proposed SSC site.

Another characteristic of the land parcel pattern within the proposed SSC site is that nearly three-quarters of the parcels are located in areas where New Mexico needs to acquire only stratified fee title to fulfill the land acquisition requirements of the SSC. As shown below, only 126 parcels of land, 26.9% of the total number of land parcels, are located in areas where New Mexico must donate

to the Federal Government fee simple title. The average size of these land parcels is 64 acres, compared to an average of 24 acres for land parcels for which stratified fee title must be obtained.

Santa Fe County	77 parcels	61.1%
Torrance County	49 parcels	38.9%
TOTAL SSC FEE SIMPLE LAND REQUIREMENTS		
	126 parcels	

Most of the parcels, 87.8%, for which stratified fee title will be obtained pursuant to this proposal are located in Torrance County, as shown below.

Santa Fe County	42 parcels	12.2%
Torrance County	301 parcels	87.8%
TOTAL SSC STRATIFIED FEE LAND REQUIREMENTS		
	343 parcels	

In the last two tables above, the sum of the parcels falling in each of the two categories of estates, fee simple and stratified fee, exceeds the total number of parcels because some parcels contain acreage falling into both estate categories.

Ownerships

Land ownership patterns within the proposed SSC site closely parallel the scope and distribution of land parcels. In total, the land within the proposed SSC site is currently controlled by 390 private primary landowners, including both individuals and corporations. The distribution of land owners by county is summarized below.

Santa Fe County	87 owners	22.3%
Torrance County	303 owners	77.7%
TOTAL SSC SITE		
	390 private owners	

In addition to privately owned land, New Mexico State trust lands are also located in Santa Fe and Torrance Counties within the proposed site.

Privately owned land	15,200 acres	93.0%
State trust land	1,138 acres	7.0%
TOTAL SSC SITE	16,338 acres	

Lands for which New Mexico must acquire fee simple title pursuant to this proposal are currently held by 116 primary owners, as shown below.

Santa Fe County	71 owners	61.2%
Torrance County	45 owners	38.8%
TOTAL SSC FEE SIMPLE LAND REQUIREMENTS	116 primary owners	

Lands for which New Mexico must acquire stratified fee title pursuant to this proposal are currently held by 334 primary owners, as shown below.

Santa Fe County	39 owners	11.7%
Torrance County	295 owners	88.3%
TOTAL SSC STRATIFIED FEE LAND REQUIREMENTS	334 primary owners	

As in the case of the land parcels, the sum of the number of owners in each category of land estate exceeds the total number of owners because some owners' land lies in both estate categories.

6.2.1.3 IDENTIFICATION OF POLITICAL SUBDIVISIONS

State trust lands located within the proposed SSC site include nearly all of the lands owned by a political subdivision for which New Mexico must obtain fee simple or stratified fee title pursuant to this proposal. State trust lands comprise 1,138 acres or 7.0% of the proposed SSC site. State trust lands are managed by the New Mexico State Land Office, which is directed by the Commissioner of Public Lands. Section 6.2.2.1 of this proposal discusses the real

estate acquisition plan for state trust lands within the proposed SSC site.

In addition to the state trust lands, small acreages of land occupied by local-use roadways are included within areas for which fee simple title will be provided to the Federal Government pursuant to this proposal. These roads are unpaved, generally single lane, and unequipped with infrastructure such as lighting and sewers. Relocation or abandonment of these roads will be undertaken by New Mexico if their continued existence interferes with the construction or operation of the SSC.

A final category of lands owned by political subdivisions involves minimal acreage covered by roadways above areas for which New Mexico must provide stratified fee title pursuant to this proposal. Existence of these roadways is not expected to interfere with the construction or operation of the SSC.

6.2.1.4 LOCATION MAPS OF SSC FACILITIES SHOWING LAND USE

The configuration and acreage of the proposed SSC site are identified in Fig. 6.2.1.4-1 (in map tube). Lands belonging to each of the two estate categories--fee simple title and stratified fee title--are indicated by the shading explained in the map legend.

The existing improvements within the SSC site, as discussed in Section 6.2.1.5 of this proposal, are also indicated on the maps, with one exception. Not shown on the map are the locations of approximately 23 mobile homes that are estimated to be situated within the proposed SSC site. Due to the impermanent nature of mobile homes, it is pointless to map their precise location at this time.

Acquisition of fee simple title to the lands included in the proposed SSC site will require relocation, demolition, or use by the SSC project of the houses and business identified on the map. Relocation of some of the pipelines and roadways would be necessary if their presence interferes with the construction or operation of the SSC. Due to the depth of the SSC tunnel at the point of crossing of many of these facilities and considering the small amount of land involved, such interference is not anticipated.

6.2.1.5 RESIDENCES AND BUSINESSES

A review of land records maintained by the County Assessors of Santa Fe and Torrance Counties, supplemented by analyses of aerial photographs of the proposed SSC site, resulted in the identification of approximately 52 homes and businesses within the proposed SSC site that might require demolition or relocation if they cannot be used by the SSC and if their presence interferes with the construction and operation of the SSC. The existing improvements include approximately 28 houses, 23 mobile homes, and one building associated with a glider grass airstrip, which is currently closed. All of these structures are located in areas where fee simple title will be provided to the Federal Government pursuant to this proposal.

In addition, approximately 26 water wells are located within the SSC site for which fee simple title must be obtained pursuant to this proposal. Another 13 water wells are situated in areas where stratified fee title will be acquired. Because these wells could potentially penetrate the restricted zone of SSC tunnel or otherwise interfere with the SSC project, some of them might require relocation.

The location of the existing improvements by county is shown below.

	SANTA FE COUNTY	TORRANCE COUNTY	TOTAL
HOUSES	16	12	28
MOBILE HOMES	15	8	23
BUSINESS	1	0	1
WATER WELLS (fee simple title)	16	10	26
WATER WELLS (stratified title)	4	9	13

In addition to the existing improvements cited above, several unpaved county roads traverse areas A, B, C, G, and H of the proposed SSC site as do three long-distance pipelines (Fig. 6.1.2.4-1; in map tube). The pipelines are the Mid-American liquid petroleum gas pipeline, the Cortez

carbon dioxide pipeline, and the Texas-New Mexico crude oil pipeline. The roadways will be relocated or abandoned if they interfere with the construction or operation of the SSC. The pipelines will be relocated as necessary to avoid conflicts with the construction or operation of the SSC, although none are anticipated at this time.

New Mexico recognizes that the U.S. Department of Energy reserves the right to accept title to any existing improvements on the proposed SSC site for which fee simple title is provided pursuant to this proposal or to direct their demolition or relocation. New Mexico agrees to perform such demolition or relocation as requested by the Department of Energy until such time as title to all lands in the proposed SSC site is transferred to the Federal Government consistent with the schedule specified in Section 2.4 of this proposal. All such demolition or relocation costs shall be borne by New Mexico.

The existing buildings currently located within the SSC site could serve a number of purposes, either temporarily during the construction of the SSC or throughout the lifetime of the project. They could, for example, be used as housing for construction workers or permanent SSC personnel, office space for construction contractors or SSC staff, or storage areas for parts and supplies. The existing water wells could provide a portion of the water supply required by the SSC.

6.2.2 METHOD OF ACQUISITION

6.2.2.1 DESCRIPTION OF PROPOSED METHOD OF ACQUISITION

The proposed SSC site includes privately owned surface and mineral estates and state trust surface and mineral estates. Different land acquisition procedures will be pursued by New Mexico for privately owned lands and for state trust lands.

Privately Owned Lands

Title to privately owned surface and mineral estates will be secured through a process of negotiation and, if necessary, condemnation. The site acquisition process will begin with a survey of the land and property interests to be acquired. After the survey is complete, a definitive title search of the property will be performed in order to determine the ownership. Next, the property interests to be acquired will be appraised by qualified professional appraisers.

After appraisal, negotiators representing New Mexico will present to the landowners the value determined by the appraiser as an offer to purchase the property interests involved. If purchase of the property interests can be negotiated with the landowners, the landowners would transfer the property interests to New Mexico by warranty deeds. If a purchase cannot be negotiated or if title defects are so severe that they cannot be corrected, New Mexico will then proceed to acquire the property interests needed through its powers of eminent domain. (See Sec. 6.2.2.2 for more information about condemnation authority.)

Right-of-entry across private lands included in the proposed SSC site will be subject to a similar process of negotiation and, if necessary, legal action. Right-of-entry on private land may be obtained through court action pursuant to state law.

The site acquisition practices and procedures outlined above for privately owned lands will be the same as those generally used in the acquisition of rights of way for Interstate Highways and for Federal Primary Highways. The procedures will comply with the Uniform Relocation Assistance and Real Property Acquisition Policies Act of 1970 (Public Law 91-646) and all applicable federal and state civil rights acts, executive orders, rules, regulations, and directives.

State Trust Lands

Land acquisition authority by the State of New Mexico for state trust lands within the proposed SSC site does not include condemnation by the State or donation to the State by the Commissioner of Public Lands. Section 10 of the New Mexico Enabling Act forbids the sale of state trust land except by competitive auction, which is an unacceptable land acquisition route in this instance. Moreover, Section 870 of the Jones Act (43 USC 870, 1982) and Section 19-7-25, N.M.S.A. 1978, forbids the sale of state trust mineral rights under any circumstance.

The Commissioner of Public Lands may, however, exchange state trust surface lands and mineral rights for federal lands or mineral rights of equal value, as set forth in Section 19-2-12 N.M.S.A. 1978. State trust land located within the proposed SSC site will be acquired by the State of New Mexico through a three-way land exchange process and then donated to the Federal Government. The land exchange process will involve the State Land Office, the New Mexico State Office of the U.S. Bureau of Land Management (BLM),

and the New Mexico State General Services Department. The State Land Office will first exchange the land it controls within the proposed SSC site for BLM lands of equal value elsewhere in New Mexico. The BLM will then exchange the newly acquired land within the SSC site for state lands of equal value managed by the General Services Department.

The initial process of the exchange will be the precise identification through surveys, appraisals, and title searches of the state trust lands within the proposed SSC site. Next, similar processes will be undertaken to identify BLM lands and state lands of approximate equal value to the state trust lands that might be suitable for exchange. Once these processes are complete, draft deeds will be prepared for review by the parties to the exchanges.

The second phase of the exchange procedure will involve the final review of the lands to be acquired, including analysis of the appraised value, reservations, and encumbrances as well as a review of the conveying documents. After the review process is completed, and each party has agreed to the proposed conveying documents, the exchange is finalized by the execution of deeds by the appropriate officials. Any cost incurred in this process would be primarily administrative costs which would be paid by the State of New Mexico.

The State Land Office has extensive experience in land exchanges, and it has completed a number of exchanges in recent years involving acreages much larger than the acreage of state trust lands included within the proposed SSC site. These exchanges have generally been completed within a six-month period.

Long-term right-of-entry on state trust lands for which stratified fee title will be provided to the Federal Government pursuant to this proposal will be authorized by the Commissioner of Public Lands as provided by state law, Section 19-7-57, N.M.S.A. 1978. By rule and regulation, the normal term for a right-of-entry is 35 years, although a longer term can be granted, if necessary.

6.2.2.2 SUMMARY OF LAND ACQUISITION LEGISLATION

The State of New Mexico is authorized by State statute, Sections 42-2-1 through 42-2-16 N.M.S.A. 1978 to utilize a "special alternative condemnation procedure," which serves as a "quick take statute" providing a mechanism for securing possession of privately owned land within approximately three weeks of filing a condemnation petition and depositing

the amount of the offer into a court registry. Also, New Mexico has the authority to clear title defects on privately owned land by condemnation pursuant to Section 42A-1-28 N.M.S.A. 1978.

Statutory authority set forth in Section 19-2-12 N.M.S.A. 1978 permits the Commissioner of Public Lands to exchange state trust surface lands and mineral rights for federal lands or mineral rights of equal value.

The Legislature of the State of New Mexico, 38th Legislature, 1st Special Session, Laws 1987, Chapter 2, authorized the sale of Severance Tax Bonds in an amount not to exceed \$11,000,000, appropriated the proceeds from the sale of such bonds to fund activities necessary for the acquisition of approximately 16,000 acres of land for the Superconducting Super Collider, and affirmed the power of eminent domain for the purposes of acquiring such land. The provisions of this Act are effective upon the selection of New Mexico as the preferred site for the SSC and the authorization and appropriation of funds by Congress to begin construction on that project. A copy of this legislation is attached as Appendix 6-A.

6.2.2.3 INSTANCES WHERE INADEQUATE CONDEMNATION AUTHORITY EXISTS

Adequate condemnation authority currently is provided by state statute to permit New Mexico to accomplish the land acquisition plan explained in Section 6.2.2.1.

6.2.2.4 FEDERAL GOVERNMENT-OWNED LAND

No surface lands or mineral estates included within the proposed SSC site are currently owned by any agency of the Federal Government. Involvement by agencies of the Federal Government in the acquisition of land pursuant to this proposal is limited to the participation of the New Mexico State Office of the U.S. Bureau of Land Management in the land exchange process affecting state trust lands within the proposed SSC site. (See Sec. 6.2.2.1 for a discussion of the land exchange process.)

6.2.2.5 SITUATIONS REQUIRING ASSISTANCE OF DOE

New Mexico has not identified any situations that would require the assistance of DOE in any regard. In the event that unforeseen occurrences cause the need for assistance,

New Mexico would reimburse DOE for such necessary costs pursuant to a Joint Powers or Intergovernmental Agreement.

6.2.2.6 QUALIFICATIONS AND NUMBER OF PERSONNEL

The New Mexico State Highway Department, which will provide the core of personnel necessary to accomplish the acquisition of privately owned land pursuant to this proposal, has considerable expertise and experience in acquiring real property. Although New Mexico is one of the largest states in the Union, it was one of the first to complete its portion of the Interstate Highway System involving approximately 1,000 miles.

Since 1970, all state and federal roadway land acquisitions have been performed in compliance with the Uniform Relocation Assistance and Real Property Acquisition Policies Act of 1970 (Public Law 91-646) by the same core group of people who will undertake the SSC site land acquisition. In addition, New Mexico may solicit and obtain contracts for professional services as needed to assure compliance with the requisite time frames for the SSC project.

The present staff of land appraisers and review appraisers within the State Highway Department includes eight professionals with a total of 101 years of appraisal experience. Four negotiators, with a collective professional experience of 40 years, are also on staff as are three relocation specialists with 43 years of combined professional experience.

The following three persons will be available through the New Mexico State Highway Department to direct the SSC site land acquisition process. Resumes for these individuals appear in Appendix 6-B.

Wayne Kennedy, Right-of-Way Manager
C.O. Rominger III, Right-of-Way Supervisor
Hugh Parry, General Counsel for Litigation
Richard Russell, Attorney V

The land exchange program for acquisition of the state trust lands within the proposed SSC site will be coordinated by the State Land Office. The four Land Office personnel that will direct this land acquisition program are listed below. Resumes for these individuals appear in Appendix 6-B.

Belarmino Giron, Assistant Commissioner
Carlos Anaya, Public Lands Resource Director
Philip Larragoite, Bureau Chief, Mapping and Title
Bill Garcia, Legal Counsel

6.2.3 SCHEDULE OF ACQUISITION

The following schedule details a land acquisition procedure for the first quarter of the SSC site, the title to which must be transferred to the Federal Government on July 1, 1989. Schedules for the acquisition of the remaining three-quarters of the land can be constructed by adding three, six, and nine months, respectively, to the deadlines contained in the schedule below. The activities described below will be conducted concurrently to the extent possible.

6.2.3.1 APPRAISAL

The appraisal, survey, and preliminary title evidence for privately owned land will be completed during a six-month period beginning on July 1, 1988, and ending December 31, 1988.

The appraisal, survey, and preliminary title evidence for state trust lands and for the lands to be included in the exchange program, outlined in Section 6.2.2.1, will be completed during a three-month period beginning on January 1, 1989, and ending March 31, 1989.

6.2.3.2 SURVEY

The appraisal, survey, and preliminary title evidence for privately owned land will be completed during a six-month period beginning on July 1, 1988, and ending December 31, 1988.

The appraisal, survey, and preliminary title evidence for state trust lands and for the lands to be included in the exchange program, outlined in Section 6.2.2.1, will be completed during a three-month period beginning on January 1, 1989, and ending March 31, 1989.

6.2.3.3 PRELIMINARY TITLE EVIDENCE

The appraisal, survey, and preliminary title evidence for privately owned land will be completed during a six-

month period beginning on July 1, 1988, and ending December 31, 1988.

The appraisal, survey, and preliminary title evidence for state trust lands and for the lands to be included in the exchange program, outlined in Section 6.2.2.1, will be completed during a three-month period beginning on January 1, 1989, and ending March 31, 1989.

6.2.3.4 COMMENCEMENT OF NEGOTIATIONS

Land acquisition for privately owned land is scheduled to take place over a four-month period beginning January 1, 1989. Commencement of negotiations would begin immediately upon the filing of the Record of Decision by the Department of Energy.

Commencement of review and negotiation of the land exchanges involving the state trust lands will begin on April 1, 1989, and final land acquisition will be completed during a three-month period ending July 1, 1989.

6.2.3.5 FILING OF CONDEMNATION PROCEEDINGS

Land acquisition for privately owned land is scheduled to take place over a four-month period beginning January 1, 1989. Condemnation, if necessary, could entail a three-month effort within this time frame.

6.2.3.6 COMPLETION OF ACQUISITION

Land acquisition for privately owned land is scheduled to take place over a four-month period beginning January 1, 1989. All private land acquisition will be completed by April 30, 1989.

Commencement of review and negotiation of the land exchanges will begin on April 1, 1989, and final land acquisition will be completed during a three-month period ending July 1, 1989.

6.2.3.7 COMPLETION OF RELOCATION OF RESIDENCES AND BUSINESSES

Relocation of all residences and businesses in accordance with Public Law 91-646 is estimated to take four

months. In order to be completed by July 1, 1989, the process must begin in March.

6.2.3.8 COMPLETION OF RELOCATION OR MITIGATION OF ROADS, CEMETERIES, ETC.

No relocation or mitigation of this type is anticipated to be necessary. If instances arise, the required actions will be undertaken and completed during May and June, 1989.

6.2.3.9 IDENTIFICATION OF DELAYS AND AREAS OF CONCERN

In the event that condemnation of any portion of the the property within the proposed SSC site is necessary, transfer of title can not occur until a final judgment is obtained and filed with the County Clerk. However, New Mexico can obtain an order of entry providing for permanent physical possession. This order may be obtained within approximately three weeks of the filing of the condemnation action assuming the court finds compliance with the statutory procedure. In the event that a property owner files an objection to the taking, some delay may be experienced due to scheduling of hearings by the court. The permanent order of entry will allow construction of the project without being delayed by the final resolution of the issue of compensation, which can ultimately be decided by the court or jury.

6.2.4 ADDITIONAL AVAILABLE LAND

The land use and ownership patterns for areas lying within several miles of the proposed SSC site in all directions have been examined to assess the degree of flexibility in accommodating potential future expansion of the SSC facility. This process indicates that the general land use and ownership patterns in the vicinity of the SSC site are typical of those discussed in this proposal for lands located within the proposed SSC site. Surrounding lands tend to be sparsely populated and are typically used for grazing, dry or wet land farming, and rural residences. The only exceptions to this general pattern are encountered within the more densely populated centers of Edgewood, which lies about 1.5 miles to the west of SSC area G, and Moriarty, which lies about 1.5 miles north of the southernmost point in SSC area D.

In a more extensive investigation, a complete land parcel and ownership survey has been performed to assess the

practicality of locating SSC area I on the east side of the ring, as opposed to its position on the west side in the proposed SSC site. That study indicates that relocation of section I will not create any unusual or insurmountable land acquisition problems.

6.3 OTHER INFORMATION

About three-quarters of the proposed SSC site is located in Santa Fe County, with the remainder in Torrance County. In Santa Fe County, a General Plan and Land Development Code guide the county's development. Torrance County has no General Plan or zoning requirements, although work on documents of this type is scheduled to begin soon. The City of Moriarty, which is situated inside the SSC's south arc, has a Comprehensive Plan, a City Zoning Ordinance and an Extra-Territorial Zoning Ordinance which grants jurisdiction over a 3-mile area surrounding the city in Torrance County.

Santa Fe County's Land Development Code specifically exempts activities on lands owned by the federal government from its zoning regulations. The Land Development Code and General Plan influence the character of the proposed SSC site by their ability to direct and control the quality of growth in the vicinity of the site. The guiding philosophy of the Santa Fe County General Plan is to concentrate growth in preferred settlement locations, thereby preserving the dominant agricultural use of the southern portion of the county.

One such preferred settlement location includes Edgewood, which is situated in close proximity to the main campus area in the proposed SSC site. The General Plan indicates that Edgewood has the potential for development of 23,347 dwelling units, although the current population is just 380. A 1985 county report entitled Preliminary Report on the Edgewood Area of Santa Fe County indicates that considerable expansion of Edgewood's water supply system is possible. Overall, Edgewood has attained only 5% of its development potential, as defined by the General Plan.

There are no above-ground facilities in the portion of the proposed SSC site located in Torrance County. Therefore, the City of Moriarty's Extra-territorial or City Zoning Ordinances have little or no direct implications for the SSC project. Moriarty's Comprehensive Plan supports economic growth. It predicts a population growth rate of 8.3% per year within the planning horizon. The population of Moriarty in 1984 was 1,451.

APPENDIX 6-A

Authorizing Legislation



The Legislature
of the
State of New Mexico

38th Legislature, 1st SPECIAL Session

LAWS 1987

CHAPTER 2

HOUSE BILL 2, as amended

with emergency clause

Introduced by

REPRESENTATIVE RAYMOND G. SANCHEZ AND REPRESENTATIVE RICHARD T. FLOWLES

REPRESENTATIVE RICHARD P. CHENEY

REPRESENTATIVE BEN LUJAN

REPRESENTATIVE TOBY MICHAEL



EMERGENCY CLAUSE

NEW MEXICO SSC PROPOSAL JULY 31, 1987

AN ACT

RELATING TO THE SUPERCONDUCTING SUPER COLLIDER; AUTHORIZING THE ISSU-
ANCE OF SEVERANCE TAX BONDS FOR THE ACQUISITION OF LAND FOR THE
SUPERCONDUCTING SUPER COLLIDER; MAKING AN APPROPRIATION; AUTHORIZING
THE USE OF EMINENT DOMAIN PROCEDURES; DECLARING AN EMERGENCY.

BE IT ENACTED BY THE LEGISLATURE OF THE STATE OF NEW MEXICO:

Section 1. LEGISLATIVE FINDINGS AND PURPOSE.--The legislature finds that the superconducting super collider, a pure research project to determine the ultimate nature of matter, will be extremely beneficial to the citizens of the state of New Mexico in providing jobs and encouraging economic development. The legislature also finds that the superconducting super collider will contribute to New Mexico's educational system and will not interfere with but will enhance New Mexico's high quality of life. The legislature further finds that it is in the best interest of the state that the real property to be acquired for the superconducting super collider be appraised and that all such appraisals be done by independent fee appraisers. Therefore, it is the purpose of this act to authorize the issuance of severance tax bonds for the state to acquire land for the superconducting super collider in order to meet the federal requirement that states seeking the superconducting super collider provide the land for that project.

Section 2. SEVERANCE TAX BONDS--PURPOSE FOR WHICH ISSUED--APPROPRIATION OF PROCEEDS.--

HB 2
Page 1

1 A. The state board of finance may issue and sell severance
2 tax bonds in compliance with the Severance Tax Bonding Act in an
3 amount not to exceed eleven million dollars (\$11,000,000) for all
4 activities necessary for the acquisition of land to provide approxi-
5 mately sixteen thousand acres for the superconducting super collider
6 when the state highway and transportation department certifies the
7 need for the issuance of the bonds and the need for the land. The
8 state board of finance is authorized to issue and sell severance tax
9 bonds in such lesser amounts and at such times as it deems necessary,
10 upon appropriate certification, to fund activities necessary for the
11 acquisition of the land. The proceeds from the sale of the bonds are
12 appropriated to the state highway and transportation department for
13 the purposes stated in this subsection. The state highway and trans-
14 portation department shall not finally acquire the land until such
15 time as New Mexico is designated as the final site for the super-
16 conducting super collider.

17 B. This authorization and appropriation is contingent upon
18 the selection of New Mexico by the federal department of energy as
19 the preferred site for the superconducting super collider and the
20 authorization and appropriation of funds by congress to begin con-
21 struction on that project.

22 C. The state board of finance shall schedule the sale and
23 issuance of the bonds in the most expeditious manner possible after
24 the contingencies of Subsection B of this section have been met. The
25 state board of finance shall take the appropriate steps necessary to

comply with the Internal Revenue Code of 1986, as amended.

2 Section 3. REVERSION.--Unless otherwise specified, any unex-
3 pended or unencumbered balance remaining from the proceeds of sever-
4 ance tax bonds issued pursuant to Section 2 of this act shall revert
5 to the severance tax bonding fund six months after completion of the
6 project.

7 Section 4. EMINENT DOMAIN PROCEDURES AUTHORIZED.--

8 A. There is a compelling need for the acquisition of the
9 property for the superconducting super collider, and acquisition of
10 the land for the superconducting super collider is a valid public
11 purpose for which the power of eminent domain may be exercised by the
12 state through any of its agencies.

13 B. The state through its appropriate agencies is autho-
14 rized to utilize any statutory condemnation procedure under New
15 Mexico law to acquire land necessary for the superconducting super
16 collider.

17 C. The provisions of this section shall be effective upon
18 the selection of New Mexico as the preferred site for the supercon-
19 ducting super collider and the authorization and appropriation of
20 funds by congress to begin construction on that project.

21 Section 5. EMERGENCY.--It is necessary for the public peace,
22 health and safety that this act take effect immediately.

23
24
25
HB 2
Page 3

S/RAYMOND G. SANCHEZ
RAYMOND G. SANCHEZ, SPEAKER
HOUSE OF REPRESENTATIVES

S/STEPHEN R. ARIAS
STEPHEN R. ARIAS, CHIEF CLERK
HOUSE OF REPRESENTATIVES

S/JACK STAHL
JACK STAHL, PRESIDENT
SENATE

S/JUANITA PINO
JUANITA PINO, CHIEF CLERK
SENATE

Approved by me this 12th day of July, 1987

S/GARREY CARRUTHERS
GARREY CARRUTHERS, GOVERNOR
STATE OF NEW MEXICO

NEW MEXICO SSC PROPOSAL JULY 31, 1987

APPENDIX 6-B

Resumes of Key Land Acquisition Personnel

QUALIFICATIONS OF THE RIGHT OF WAY MANAGER

Wayne F. Kennedy

A graduate of San Jose State College:

BA degree - Major in Business Administration
MS degree - Major in Real Estate

Holds Certificates in Real Estate and Public Administration from the University of California Extension

His work experience includes:

a pilot in the U.S. Air Force

a staff appraiser for the U.S. Army Corps of Engineers

a Multi-family Projects Appraiser for FHA

a Right-of-Way Officer - California Division, FHWA

a "Procedures Review Team Member", Procedures Division, Office of Right-of-Way, Washington, D.C., FHWA

a Division Right-of-Way Officer, Michigan Division, FHWA

Director, Office of Right-of-Way, Region 3, FHWA

Chief, Procedures Branch, Land Acquisition Division, Office of Right-of-Way, Washington, D.C., FHWA

Chief, Appraisal Branch, Real Property Acquisition Division, Washington, D.C., FHWA

Director, Office of Right-of-Way, Region 9, FHWA

(In this capacity, he received his agency's highest award, the Administrator's Award for superior Achievement for Outstanding Professional and Managerial Contributions to the Federal-Aid Transportation Program.)

Director, Office of Right-of-Way, FHWA, Washington, D.C.

Presently, Right of Way Manager, State Highway Department
Santa Fe, New Mexico

He is: a Past President of the Maryland Chapter and Past National President of the Association of Federal Appraisers (AFA)

a Master Member of the former Association of Governmental Appraisers (MGA)

a Senior Member of the American Society of Appraisers (ASA) and Past President of both the San Francisco Bay Area and Washington, D.C. Chapters of the ASA.

a Senior Member of the American Right-of-Way Association (SR/WA); Past President and Director of the Potomac Chapter #14; Regional Chairman and Regional Vice-Chairman of Region 4 and Regional Vice-Chairman of Region 1; and has been Chairman of the National Transportation Committee; Chairman and member of the International Nominations and Elections Committee; Member of the International Highways Committee; Member of a Special Task Force on Ethical Standards; and Member of the Merger Committee (IRWA and AGA).

He was also the Potomac Chapter's:

Right-of-Way Man of the Year, for 1973

Right-of-Way Professional of the Year, for 1984

QUALIFICATIONS OF THE APPRAISER

C. O. ROMINGER, III

C.R.A., C.A.S., N.M.C.A., G.R.I.

EDUCATION

Major - Business Administration
Minor - History
Rangeland Management, T.C.U.

Attended Texas Christian University, Ft. Worth, Texas
Attended Texas Wesleyan College, Ft. Worth, Texas

PRESENT EMPLOYMENT

Presently employed by the New Mexico State Highway Department as Right of Way Agent IV, Appraisal Unit.

PAST EMPLOYMENT

Past owner of Rominger and Associates, Real Estate Sales and Real Estate Fee Appraisals.

Past employee of the State of New Mexico Property Tax Department as Appraisal Specialist.

Past employee of the Lincoln County Assessor's Office as Supervising Appraiser.

Past owner of Rominger Enterprises, Property Appraisal, Property Investment and Consultant Company.

Past manager and part owner of Aero Enterprises, Inc., Aerial Photography used in tax mapping, feasibility studies, and appraisal work.

Past employee of the General Dynamics Corporation, as design engineer assigned to flight test.

OTHER INFORMATION

Graduate of the Realtors Institute, (G.R.I.)
Senior Member, National Association of Review Appraisers, (C.R.A.)
Charter Designate, American Association of Certified Appraisers, (C.A.S.)
New Mexico Certified Appraiser, by State Statute, (N.M.C.A.)
Member of the Veterans Administration Panel of Appraisers
Member of the F.H.A. Panel of Appraisers
New Mexico Real Estate Broker
Commercial Pilots Certificate, Instrument Rating, Multi-Engine Rating,
Instructors Rating, No. 1644157
Attended Courses and/or Seminars Conducted by the Society of Real Estate Appraisers, International Association of Assessing Officers, American Right of Way Association, Association of Farm Managers and Rural

NEW MEXICO SSC PROPOSAL JULY 31, 1987

PAGE TWO

Appraisers, and the New Mexico Bureau of Taxation and Revenue.

(Courses I, II, III, 206, etc.)

Received Appraiser I, II, III, and IV Certificates from the State of New Mexico Property Tax Department.

Qualified as expert witness in the field of property appraisal in Lincoln, Otero, Rio Arriba and Santa Fe Counties, New Mexico.

HUGH W. PARRY

2 Sandia lane
Santa Fe, NM 87505
988-5238 (home)
827-5100 (work)

PERSONAL DATA

Date of Birth: June 4, 1948
Marital Status: Married
Health: Excellent

EDUCATION

Bachelor of University Studies (engineering and business)
University of New Mexico, 1970

Juris Doctor
University of New Mexico, 1973

BAR ADMISSIONS

Supreme Court, State of New Mexico, 1974

U. S. District Court, District of New Mexico, 1974

PROFESSIONAL EMPLOYMENT

1973 - present New Mexico State Highway Department,
Legal Division

During this employment, I have advanced from Law Clerk through Staff Attorney and Trial Preparation Supervisor to Deputy Director of the Legal Division.

My responsibilities have given me extensive experience in various areas of civil litigation, Indian law, real property law, contracts, administrative law and eminent domain; more specifically:

- Negotiations with numerous Indian pueblos and tribes in New Mexico concerning right of way acquisition, labor, tax and trespass matters;

- For the last five years, I have handled all Indian law problems with the Department;
- In the administrative law area, I have had considerable dealing with state and federal agencies - Federal Highway Administration, Bureau of Indian Affairs, State Land Office, Taxation and Revenue Department, and Attorney General's Office;
- 15 to 20 jury trials and numerous non-jury matters in several judicial districts in New Mexico;
- Briefs for the New Mexico Supreme Court;
- Supervised and coordinated trial preparation and strategy of eight staff attorneys.

CONTINUED LEGAL EDUCATION

Attended seminars across the United States in contractor claims, transportation law, highway tort litigation, construction contract litigation, American Indian law, eminent domain, inverse condemnation, and trial advocacy (Hastings College of Advocacy).

Further details, references, and writing samples are available upon request.

R E S U M E

NAME: Richard L. Russell

Date: November 12, 1986

ADDRESS: 1396 Hyde Park Road
Santa Fe, New Mexico
87501

Tel: 982-5080

Personal Data

Social Security : #525-60-9571
Date of Birth: December 15, 1930
Place of Birth: Albuquerque, New Mexico
Height: 5'8" - Weight: 175 lbs.
Health: Excellent
Marital Status: Married
Military Status: Honorable Discharge - U.S. Army

Education: John Marshall Law School
Chicago, Illinois

LLB: June 1961
Juris Doctor: May 1970

University of New Mexico
1949-50, 1953-58
Majors in Philosophy and Political Science
Minor in Psychology

Professional Societies

Illinois State Bar Association;
New Mexico State Bar Association;
American Judicature Society.

Admitted to Practice

Illinois Supreme Court and all inferior courts of the State;
United States Federal District Court - Northern District of Illinois;
New Mexico Supreme Court and all inferior courts of the State;
United States Federal District Court - District of New Mexico;
United States Circuit Court of Appeals;
United States Supreme Court;
United States Court of Claims.

RESUME OF RICHARD L. RUSSELL
Page 2

Experience

January 1968 to Present

Assistant Attorney General, State of New Mexico--assigned to New Mexico State Highway Department

September 1966 to January 1968

Attorney for Bigbee & Byrd, Santa Fe, New Mexico--general practice of law.

December 1963 to August 1966

Poulakidas & Wood, Wacker Drive, Chicago, Illinois; Defense Attorney, Workers Compensation and Tort cases.

June 1961 to December 1963

Continental Casualty Company, 175 W. Jackson Blvd., Chicago, Illinois.

September 1958 to June 1961

Law student at John Marshall Law School, Chicago, Illinois.

September 1953 to June 1958

Student, University of New Mexico at Albuquerque. Worked at various jobs with Southern Union Gas Company in Albuquerque while attending U.N.M.

August 1951 to July 1953

U.S. Army--13 months in Korea during hostilities; served as machine gun section leader artillery battalion (68th A.A.A. Gun Battalion)

June 1949 to July 1951

Southern Union Gas Company, Albuquerque, New Mexico--pipe fitter's helper.

September 1946 to ~~July 1951~~ June 1949

Albuquerque High School, Albuquerque, New Mexico--general academic courses.

SUMMARY RESUME OF
BELARMINO GIRON
ROUTE 5, BOX 216 AA
SANTA FE, NEW MEXICO 87501

Born: October 10, 1930

Graduated: St. Michael's High School, Santa Fe, New Mexico, 1948

BS in Business Administration, St Michael's College,
Santa Fe, New Mexico, 1959

Work History

1948 - 1952 Served United States Army

1953 - 1957 Security Inspector, Atomic Energy Commission, Los Alamos,
New Mexico

1957 - 1965 State of New Mexico, Deputy Director, Department of
Finance and Administration

1965 -1967 Business Manager, Albuquerque Public School System

1967 - 1969 Consultant, U.S. Department of State, Dominican Republic

1969 - 1971 Executive Assistant, State Land Office, Santa Fe, New Mexico

1971 - 1975 Secretary of Hospitals and Institutions, State of New Mexico

1975 - 1978 Personnel Director, City of Albuquerque

1978 - 1983 Aide to Governor Bruce King, State of New Mexico

1983 - Present Assistant Commissioner, New Mexico State Land Office

Married - 6 children

New Mexico Distinguished Public Service Award, 1973

Coordinator - Recovery of 1980 Prison Riot - 1980 - 1982

Acting Secretary - New Mexico Department of Corrections, 1981

Acting State Highway Administrator, 1980

NEW MEXICO SSC PROPOSAL JULY 31, 1987

RESUME

ANAYA, CHARLES A. (CARLOS)

HOME ADDRESS: P.O. Box 87
Moriarty, New Mexico 87035

OFFICE ADDRESS: New Mexico State Land Office
P.O. Box 1148
Santa Fe, New Mexico 87504-1148

TELEPHONE: (505) 827-5734 (Work)
(505) 832-4924 (Home)

EMPLOYMENT

4-1-84 to Present:

Public Lands Resources Director
New Mexico State Land Office
P.O. Box 1148
Santa Fe, New Mexico 87504-1148

Land Exchange Coordinator; Manage the land exchange program to ensure an equal value return to the trust by ensuring accurate evaluation and title procedures. Provide advice and consultation to the Assistant Commissioner of Public Lands on all division programs and serve as a representative of the Commissioner with the general public and other state and federal agencies. Negotiate final settlement on land exchanges with the federal government and ensure that all documents are prepared for land title transfer and acquisition.

3-26-83 to 4-1-84

Public Land Resources Director
New Mexico State Land Office
P.O. Box 1148
Santa Fe, New Mexico 87504-1148

Field Division Director- Establish criteria for use of Land Use Specialist in gathering data for the purpose of determining future State Land Potential. Assigned and supervised the work of

NEW MEXICO SSC PROPOSAL JULY 31, 1987

17 Land Use Specialist conducting investigations, making appraisals, and executing final sales for the Land Office; coordinated requests for field investigations by Land Office departments, reviewed and transmitted reports of investigations and appraisals. Supervised 2 secretaries assigned to the main office in Santa Fe.

12-18-82 to 3-26-83

Public Land Resources Assistant Director
New Mexico State Land Office
P.O. Box 1148
Santa Fe, New Mexico 87504-1148

Assist the Public Land Resources Director in providing information pertaining to policy and procedures for the effective administration of public lands. Duties include appraisals of improvements and lands for sale or lease fee setting, check mineral, grazing, oil and gas and business leases for production, current use, highest and best use and trespassing. Conduct sales of public lands and collect money on same. Meet with State, Federal and local officials in matters affecting public lands. Supervise 16 personnel.

11-10--79 to 12-18-82

Land Use Specialist
New Mexico State Land office
P.O. Box 1148
Santa Fe, New Mexico 87504-1148

Provide field data information, appraisals and land investigations on state business leases, commercial and industrial leases, economic conditions, environmental matters, state grazing, agricultural, water easements, rights-of-way easements and range conditions to the Commissioner and Division Directors which they use in managing the public lands.

2-1-71 to 11-10-79

Fieldman II
New Mexico State Land Office
P.O. Box 1148
Santa Fe, New Mexico 87504-1148

NEW MEXICO SSC PROPOSAL JULY 31, 1987

EMPLOYMENT HISTORY

July 1, 1987

PHILIP P. LARRAGOITE

116 W. Houghton (P.O.Box 1657)
Santa Fe, New Mexico 87501

TELEPHONE: 505/982-5158 (HOME)
505/827-5711 (OFFICE)

SS Number: 525-46-7499

March 24, 1980 to Present	NEW MEXICO STATE LAND OFFICE 1987 - Public Lands Resources Assistant Director - Bureau Chief, Mapping & Title Bureau 1980 - 1987-Head Land Inventory Mapping Bureau Chief
July 1968 to March 1980	NEW MEXICO ASSOCIATION OF COUNTIES Executive Director
August 1966 to July 1968	NEW MEXICO STATE HIGHWAY COMMISSION Supervisor of Title (Land) Examiners
July thru August 1968	JACOBS COMPANY (30-day contract) Land Title and Mapping Consultant Panama City, Panama
November 1, 1963 to July 8, 1968	NEW MEXICO STATE HIGHWAY COMMISSION TITLE EXAMINER
March 1954 thru September 1963	GALLUP TITLE COMPANY Abstracter and Manager Title Insurance Agent ROCKY MOUNTAIN ABSTRACT COMPANY President, Abstracter and Manager RIMAC INC. Mineral Reporting Publication Manager and Publisher
July 1949 thru March 1954	FEDERAL ABSTRACT COMPANY Abstracter and Manager
October 5, 1946 thru March 25, 1948	U. S. Army - RA-18252524
April 1948 thru June 1949	MELITON P. SANDOVAL, R.P.A. Jr. Accountant
Prior to Military Service	SANTA FE BOYS' CLUB Assistant Director

NEW MEXICO SSC PROPOSAL JULY 31, 1987

BILL R. GARCIA
2838 Paseo del Los Pueblos, No. 23
Santa Fe, New Mexico 87505
(505) 473-2743

DATE OF BIRTH: August 26, 1955
PLACE OF BIRTH: Artesia, New Mexico
MARITAL STATUS: Married to Gina M. Garcia;
Three children, Sarah, 7, Michael, 2
Erin, 4 months

EDUCATIONAL/PROFESSIONAL

Member: New Mexico Bar Association; Federal District
Court, New Mexico; Tenth Circuit Court of
Appeals; United States Claims Court
Juris Doctor: University of Colorado, 1980
B.A. Degree: In Political Science/History from the
University of New Mexico, 1977
High School Graduate: Roswell High School, Roswell, New Mexico,
1973

LEGAL EXPERIENCE

Since 1982 I have been legal counsel to the Commissioner of public lands and the New Mexico State Land Office. As counsel to the Commissioner and the Land Office, which administers 13 million acres of state land, my legal work has consisted primarily of natural resource and real property law, including oil and gas law, mining and mineral law, public land law, environmental law, and landlord-tenant law. I also work in the areas of administrative law, contract law, and Indian law. In addition, I advise staff on matters dealing with the day-to-day administration of the Land Office. Since November 1985, I have served as the Assistant Director of the Land Office Legal Division which consists of five attorneys, two legal secretaries and one paralegal.

During my employment as legal counsel, I have attended numerous Continuing Legal Education courses, including Fundamentals of Oil and Gas Law, Dallas, Texas, May 1982; Rights of Access and Surface Use, Denver, Colorado, November 1984; Environmental Law--Hazardous and Toxic Wastes, Washington, D. C., February 1985; Western Water Law and Mineral Leasing on Public

Lands, Boulder, Colorado, June 1985; and Governmental Liability: Section 1983, Albuquerque, New Mexico, January 1986.

Prior to my employment as legal counsel, I worked as the law clerk for the Land Office Legal Division. My duties included legal research, the drafting of pleadings and legislation, as well as the promulgation of rules and regulations.

In 1978, I was employed as law clerk with the Mexican American Legal Defense and Educational Fund (MALDEF) in Denver, Colorado. Here, my duties consisted primarily of legal and statistical research.

In 1978 I was also enrolled for two semesters in the Law School's Legal Aid Program where, as a student attorney, I represented clients in court on matters pertaining to divorce, child custody and collections.

OTHER WORK EXPERIENCE

From January 1976 to May 1977, I was employed by the New Mexico State Medical Investigator in Albuquerque, New Mexico. My duties consisted primarily of assisting in the filing of reports of death and assisting in the examination of evidence. I was also certified as a deputy medical investigator.

ACTIVITIES AND INTERESTS

Member: New Mexico Bar Association - Natural Resources Section.

Interests include golfing and city league softball.

- References and writing samples available upon request.

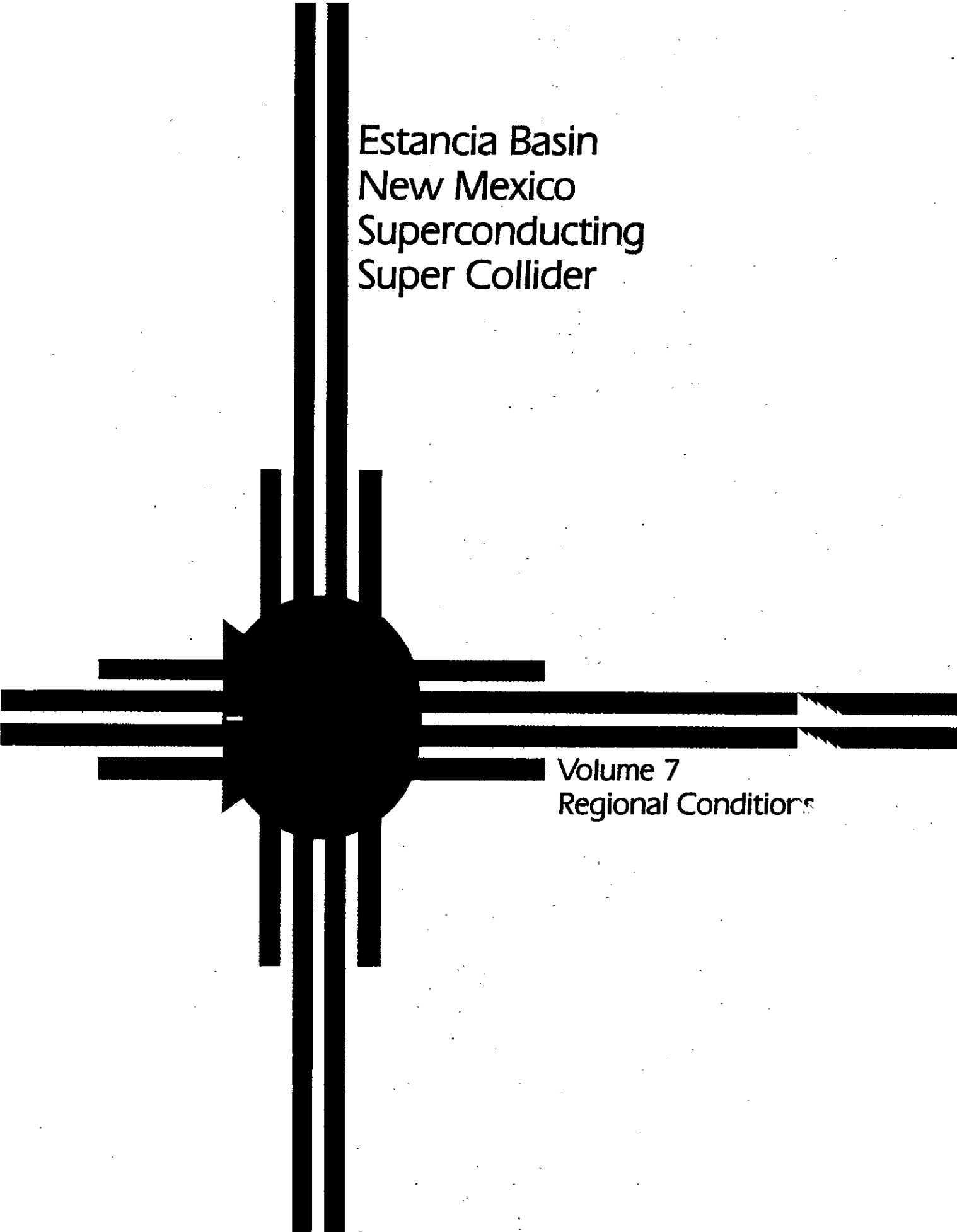

Estancia Basin
New Mexico
Superconducting
Super Collider

Volume 7
Regional Conditions



Regional Conditions

Volume 7

TABLE OF CONTENTS

7.0	Summary	7-1
7.1	Vibrations.	7-2
7.1.1	Present and Potential Sources.	7-4
7.1.2	Proximity of Vibration Sources to the Collider Ring.	7-5
7.2	Noise	7-5
7.2.1	Principal Noise Sources and Sensitive Receptors.	7-5
7.3	Climatic Conditions	7-7
7.3.1	Average Temperature, Precipitation, and Humidity	7-7
7.3.2	Degree Days, Snowfall, and Frost	7-7
7.3.3	Winds.	7-11
7.3.4	Storm Characteristics.	7-11
	References	7-16
	Appendices	7-17
7-A	Ambient Vibration Measurements	7-17
7-B	Harmonic Plots of the Ambient Vibration Measurements	7-21

7.0 SUMMARY

The site has no major sources of vibration or noise such as railroads, quarries, mining operations, or heavy machinery operations. The most significant source of noise is traffic on Interstate 40 (I-40), which crosses the collider ring at two locations.

The measured ambient vibrations are greatest near I-40 and least at the north end of the tunnel. In all cases, however, the vibrations are less than the specified criteria [7.1-1] by at least an order of magnitude. Thus, ambient vibrations at this site will not be a problem. This is a very quiet site.

The climate at the site is ideal with a mean average winter temperature of 40°F and a mean average summer temperature of 66°F. The annual precipitation is 7.6 inches at Otto, which is about 6 miles north of Moriarty. Most precipitation occurs as summer thundershowers. The average wind velocity is 7.1 miles per hour blowing predominantly from the west.

7.1 VIBRATIONS

Significant sources of ground vibration such as major highways, railroads, quarries, mining operations, or heavy machinery operations were considered during site selection. The following describes the vibration amplitudes and frequencies from these sources and their positions with respect to the tunnel.

Random ambient-vibration measurements were made each hour for 24-hour periods at four locations. The locations are: the western crossing of I-40 and the tunnel, the southern crossing of NM-41 and the tunnel, the northern crossing of NM-41 and the tunnel, and the northwest corner of the site (Fig. 7.1-1, Appendix 7-A). The measurements were made with buried Sprengnether S-6000 three-component velocity seismometers, using a Honeywell 117 6-channel amplifier and a Honeywell 1858 strip-chart recorder. The readings were made for a nominal random 2-minute period each hour of the day. The results are presented in Appendix 7-A.

The tunnel depth averages about 99 ft. At this depth, the higher frequency (5 to 30 cps) surface-generated vibrations are principally Rayleigh waves. Rayleigh waves attenuate relatively rapidly with depth. At the average tunnel depth of 99 ft, both the horizontal and vertical components of the Rayleigh waves are 10 to 20 percent of their surface amplitudes. In soil materials at the site a typical Rayleigh wave will have a surface amplitude of 70 to 150 ft. Therefore, at average tunnel depth the amplitude will be between 7 and 30 ft.

Measured vibrations are attenuated by three factors: geometry (spatial attenuation in all directions), hysteresis (in all directions), and depth (due to Rayleigh wave effects). For the reported measurements, only the first two, spatial and hysteretic, were assessed. For this assessment, we placed the transducer about 100 ft from the source of identifiable vibrations.

The strongest source of vibrations was the heavy truck traffic on I-40 (Appendix 7-A). The measurements were taken about 120 ft from I-40. The pavement at that location is badly broken and uneven and vibrations measured are higher than they will be when the road is repaired.

The results of the vibration measurements are presented on harmonic plots in Appendix 7-B. The interpreted criteria from the Invitation for Site Proposals [7.1-1] are plotted

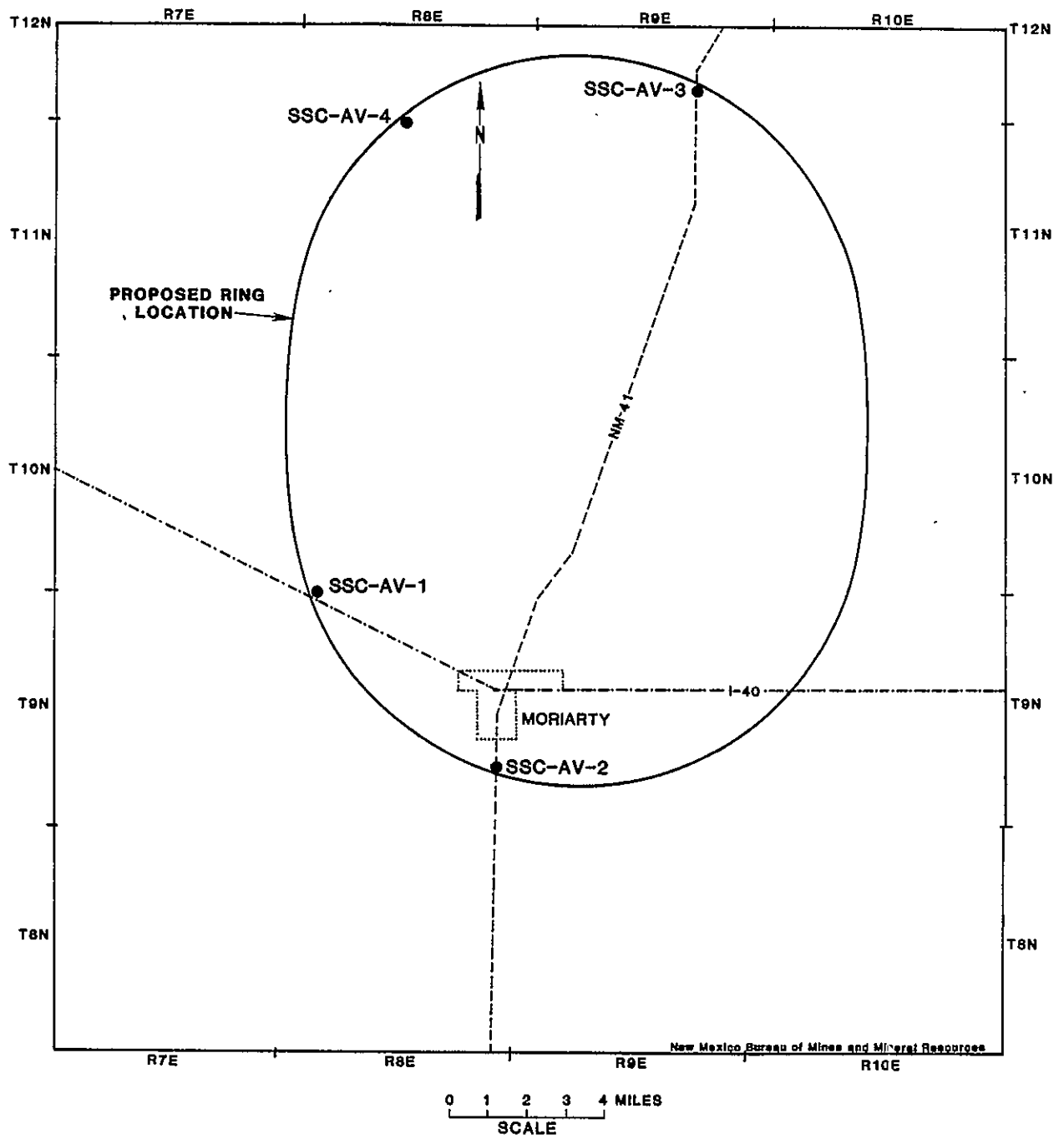

Figure 7.1-1. Locations of vibration monitoring stations.

NEW MEXICO SSC PROPOSAL JULY 31, 1987

above the long dashed line in the upper-right portion of the figures in Appendix 7-B. Any vibration that falls below this line would be acceptable to the facility.

The measured vibrations are shown in two forms in Appendix 7-B. The first is a solid line that shows the background vibrations (neglecting the transient vibrations), and the second is as a short dashed line enveloping the transient vibrations. The actual measured values of the transient vibrations are shown as squares, triangles, or circles, depending on the day they were acquired.

7.1.1 PRESENT AND POTENTIAL SOURCES

Interstate 40 (I-40) intersects the ring at two locations (Fig. 7.1-1). The tunnel at the western intersection point is in Madera Limestone 125 ft below I-40, and at the eastern intersection point it is in the Yeso Formation, 125 ft below I-40. NM-41 also crosses the ring at two points (Fig 7.1-1). At the southern intersection point the tunnel is in older alluvium 60 ft below NM-41 and at the northern intersection point it is in older alluvium, 110 ft below the highway. At all four intersection points the tunnel is above the water table. I-40 and NM-41 are the only major highways in the site area.

The capacity of I-40 is approximately 1,200 vehicles per hour per lane (I-40 is two lanes each way). The current Average Daily Traffic (ADT) near Moriarty is 10,000 vehicles, indicating that highway use is well below capacity. The peak-hour traffic is approximately 11 percent of the ADT. At present approximately 32 percent of all traffic is composed of heavy vehicles. The capacity of NM-41 is approximately 900 vehicles per hour. On NM-41 to the north of Moriarty the ADT is approximately 1,167 and to the south it is 1,759. The percent of commercial traffic is not known, but is well below that of I-40. Most commercial vehicle usage on NM-41 is for support of the farming and ranching industry in the area.

Ground vibration from railroads is not a concern, although it was assessed. Amtrack rail passenger service stops at Lamy, which is about 20 miles northeast of the ring, but it does not service the site area. Daily rail freight service runs from Santa Fe to Albuquerque approximately 50 miles west of the ring.

There are no operating underground mines in the site vicinity. Surface quarries and surface mines operate outside

the ring. Only two such operations are significant enough to warrant assessment, although all were considered. One is the San Pedro surface mine in the San Pedro Mountains approximately 5 miles northwest of the ring. The other is the Tijeras cement plant and quarry (Ideal Basic Industries) about 18 miles west of Edgewood. This plant produces about 1,600 tons per day of Portland cement and is the largest surface mine in the vicinity. Other mines in the vicinity are either abandoned or operate intermittently during times of higher ore prices than the present. Only two mining districts in Torrance County and 10 in Santa Fe County have been identified [7.1-2]. Only the Placers mining district in the San Pedro Mountains (Santa Fe County) is close to the ring.

Except for the Tijeras cement plant and San Pedro mine there are no heavy machinery operators in the site vicinity. Occasionally, heavy equipment is used for road repair, especially on I-40. Typical machinery in use include small- to medium-size loaders, bulldozers, and backhoes used to support the local housing industry.

7.1.2 PROXIMITY OF VIBRATION SOURCES TO THE COLLIDER RING

As discussed above and documented by on-site vibration measurements, the only significant source of vibrator is vehicular traffic on I-40 that crosses the collider ring between Edgewood and Moriarty and near Longhorn Ranch, east of Moriarty (Fig. 7.1-1). On the west side of the site, the point of intersection of arcs (PI) near intermediate access area E10 is 1 mile north of the Interstate. The PI near E1 is about 7 miles north of the Interstate. On the east side of the site, the PI near E6 is about 3 miles north of the Interstate, and the PI near E5 is about 9.5 miles north of the Interstate.

7.2 NOISE

7.2.1 PRINCIPAL NOISE SOURCES AND SENSITIVE RECEPTORS

Principal sources of noise for the SSC site area are Interstate Highway 40 (I-40) at the southern edge of the site, westbound aircraft landing at Albuquerque International Airport, and thunderstorms. The most significant noise source is traffic on I-40.

Figure 7.2-1 is a summary of sound level modeling for the southern portion of the SSC site.

Distance from edge of row	LEQ at current traffic volumes	LEQ at capacity traffic volumes
100 feet	71 dBA	78 dB
200 feet	68 dBA	74 dB
300 feet	66 dBA	72 dB
400 feet	64 dBA	71 dB
500 feet	63 dBA	69 dB
1,000 feet	59 dBA	65 dB

Figure 7.2-1. Existing sound level conditions.

In Figure 7.2-1 LEQ represents the mean-squared energy level over a specified period of time, or more loosely defined as "average" sound level. The term dBA refers to the A-weighted decibel level.

The sound levels provided were generated using STAMINA 2.0 and Federal Highway Administration (FHWA) Noise Prediction Models, which are accepted by the Department of Transportation for predicting noise levels associated with roadways.

An average daily traffic (ADT) level of 10,000 vehicles consisting of 28 percent heavy trucks, 4 percent medium trucks, and an 11 percent peak-hour traffic level was used to estimate the existing conditions sound levels. The same criteria were used to generate sound levels at roadway capacity with the exception of peak-hour volume. A peak-hour volume of 4,800 vehicles was used to estimate sound levels for the roadway at capacity levels. ADT, traffic composition, and peak-hour percentages were based on data supplied by the New Mexico State Highway Department.

There are no hospitals, parks, or natural areas within close proximity to the site that would be susceptible to noise pollution. The western and southern portions of the site do have private residences in close proximity to the ring.

7.3 CLIMATIC CONDITIONS

There are a variety of sources of regional and local climatic data applicable to the project area. These include sites run by governmental agencies and private monitoring programs. The closest Class 1 weather station is in Albuquerque. Because of differences in elevation and terrain, however, local data are preferable. Local climatic sites are located at Otto, Stanley, and Estancia. These data are available from the National Climatic Center (NCC). The data described below are taken from summaries of this NCC data. In general, temperature and precipitation data are available from 1905 through 1985. Wind data are available from Otto for 1950 through 1954. Wind, temperature, precipitation, and humidity data are also available from a site at Encino for mid-1981 through mid-1982. This site was a part of the Electric Power Research Institute's (EPRI) Western Regional Air Quality Study (WRAQS). The complete EPRI data are not available at present, but they are being obtained. The following sections summarize selected local climatic data.

7.3.1 AVERAGE TEMPERATURE, PRECIPITATION, AND HUMIDITY

Local temperature data are summarized in Figures 7.3-1 and 7.3-2 for Otto and Estancia, respectively. These figures show the mean, mean maximum, and mean minimum temperatures by month.

Monthly precipitation data are summarized in Figure 7.3-3 for Otto and Estancia. The yearly means are also given. No local humidity data are currently available. Approximately 16 months of humidity data will be available from the EPRI data. The National Weather Bureau summary for Estancia states: "Relative humidity probably averages near 50 percent for the year, with humidities below 20 percent during the warmer part of the day in late winter and spring. Hot, humid weather is practically unknown."

7.3.2 DEGREE DAYS, SNOWFALL, AND FROST

Annual heating degree days and cooling degree days are summarized in Figure 7.3-4. These data, which are taken from New Mexico in Maps [7.3-1], are based on interpolation of local and regional data. Heating degree days are much greater than cooling degree days. Local data on a monthly basis are available for Estancia. Data for numerous regional sites are available [7.3-2].

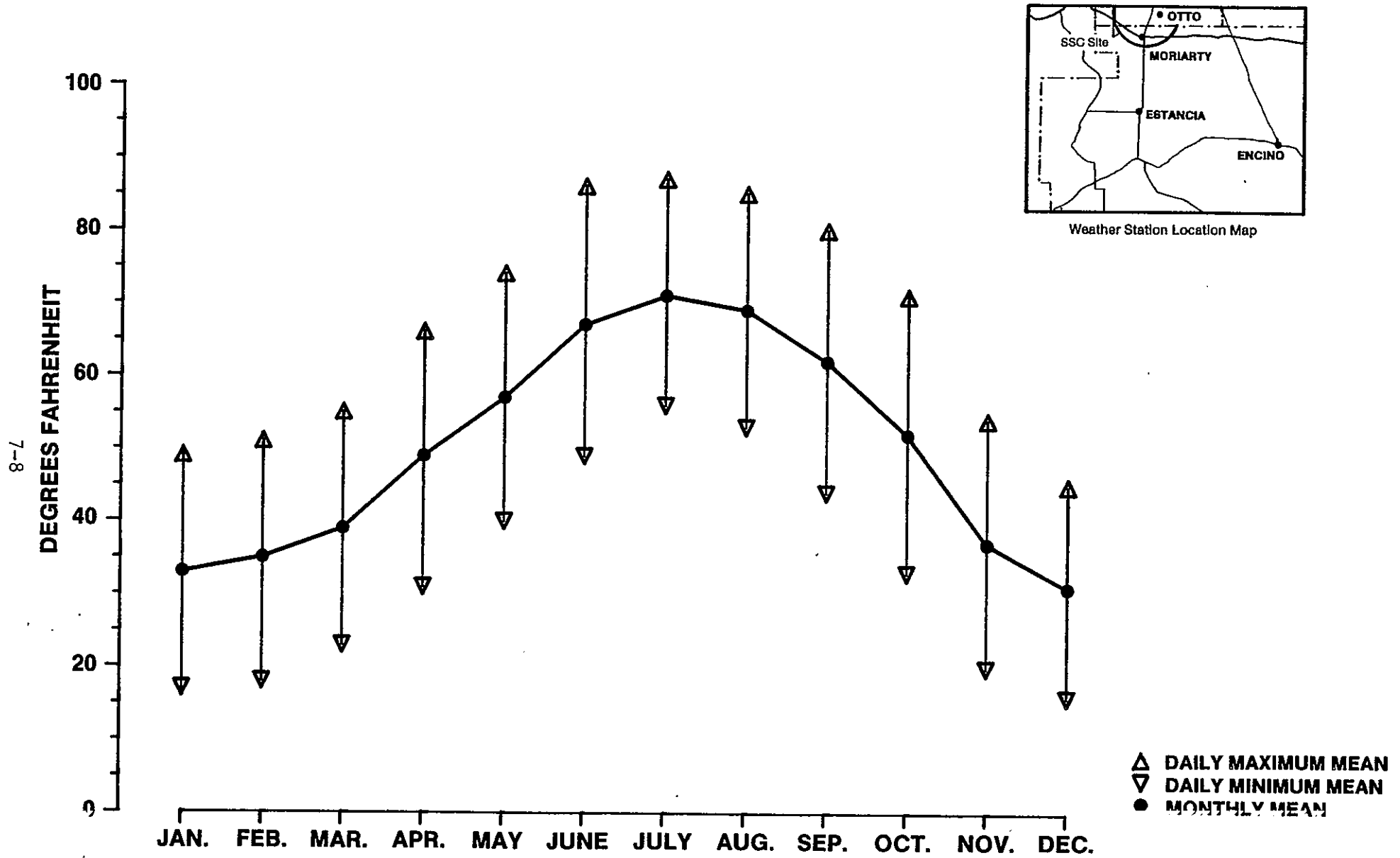

Figure 7.3-1. Temperature Summary, Otto, New Mexico, (1950-1954).

6-7

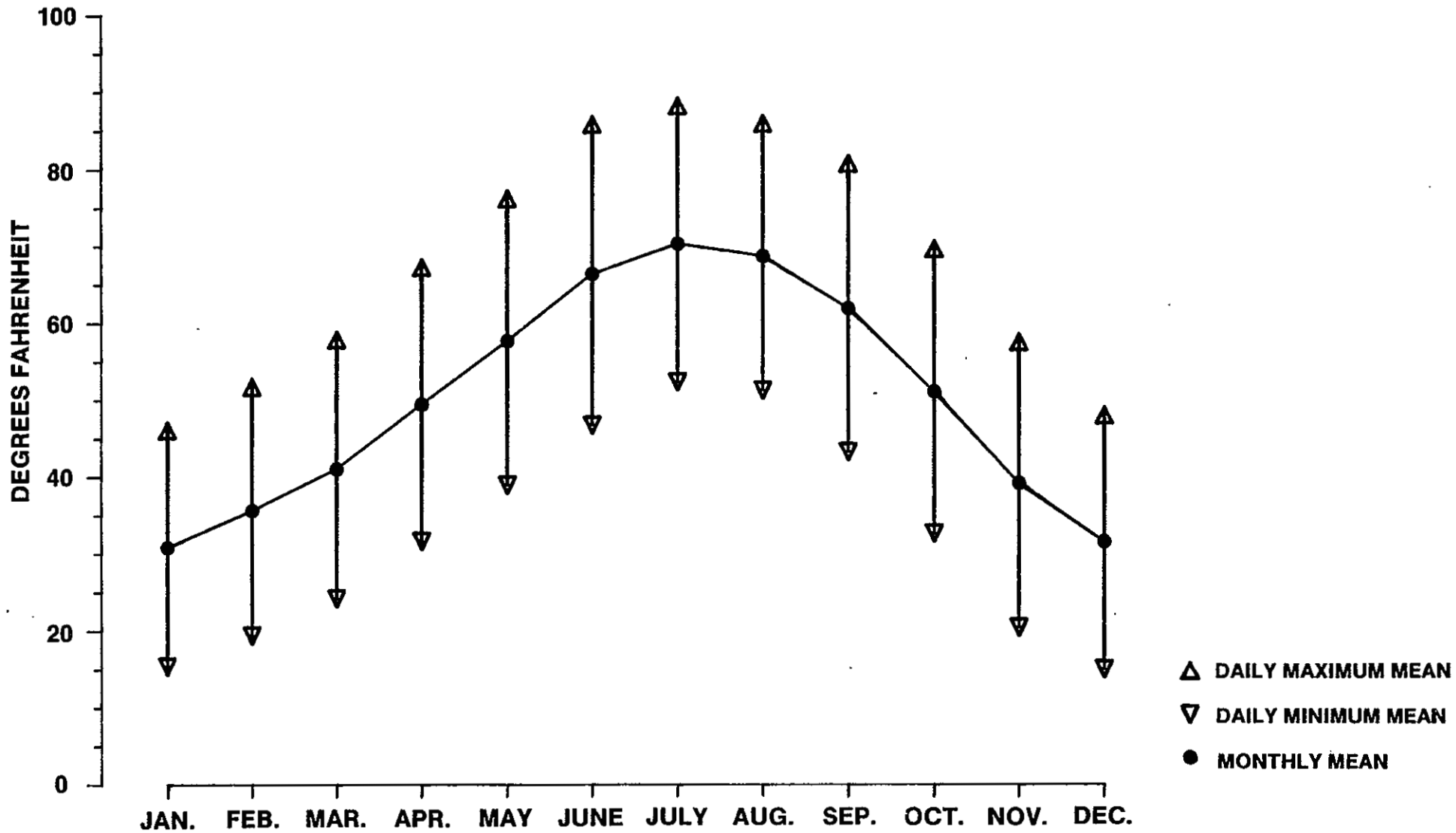

Figure 7.3-2. Temperature Summary, Estancia, New Mexico, (1916-1950).

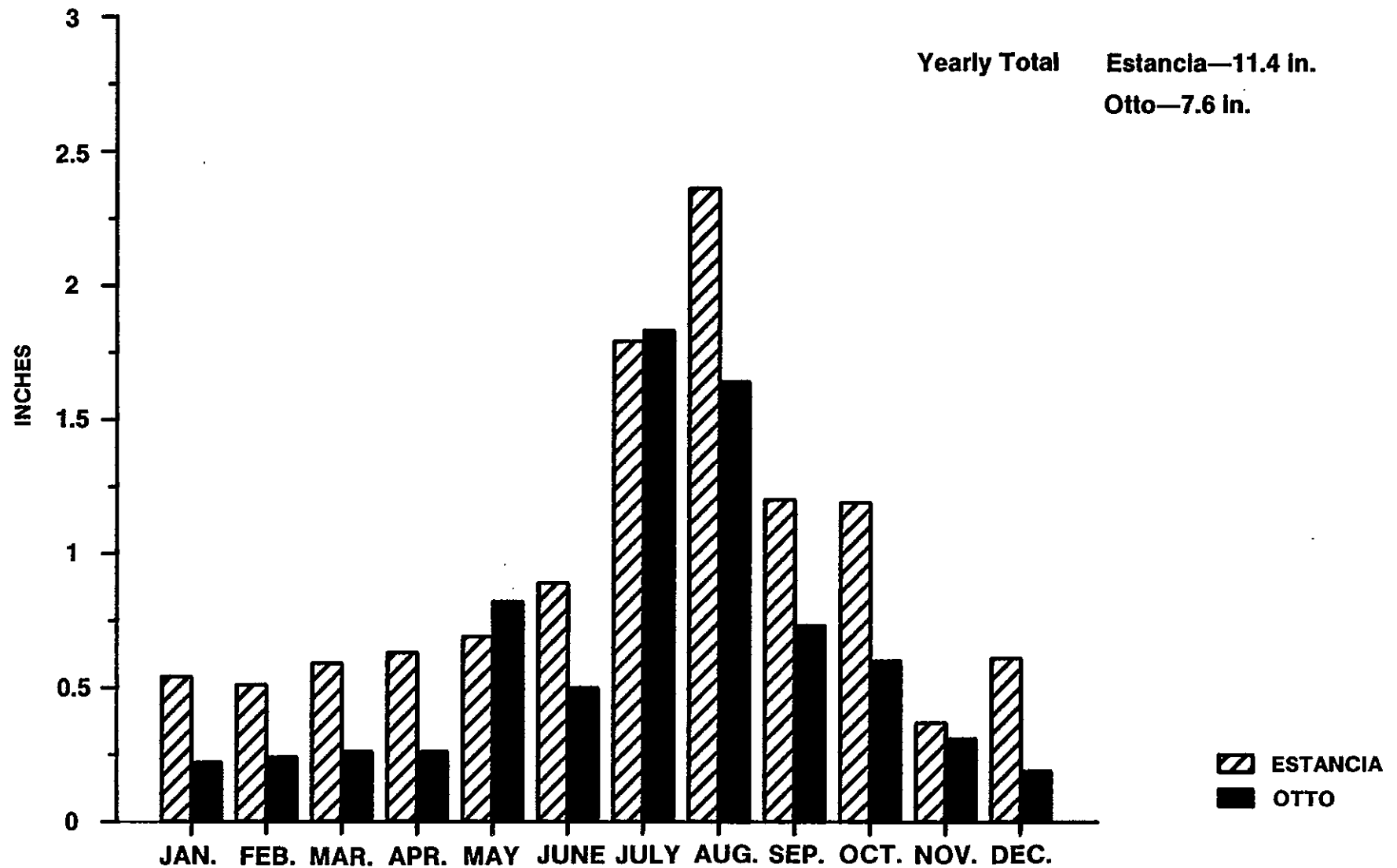

Figure 7.3-3. Precipitation Summary For Estancia (1916-1960), Otto (1950-1954), New Mexico.

Average snowfall for Estancia is given in Figure 7.3-5.

At this time, no local data on frost penetration have been located. Discussion with area builders and contractors indicates a value of 36 inches is generally used in the area.

7.3.3 WINDS

Local wind data are available from two sites. At Otto, winds have been summarized for the 1950-1954 period. These data are summarized as a wind direction rose and a monthly wind speed distribution in Figure 7.3-6. Winds are predominately from the west and northwest. Average wind speeds range from approximately 12 mph in March to 5 mph in August. Wind data were also collected for 16 months at Encino under the EPRI WRAQS program in 1981-82. These data are currently being obtained.

7.3.4 STORM CHARACTERISTICS

Storms in the project area are generally of three types: winter-time frontal systems, spring-time wind-blown dust storms, and summer-time isolated convective thunderstorms. On very rare occasions, easterly flow winds carry moisture into the area from the Gulf Coast.

From December through March, winter frontal systems move through the area every one to two weeks. Most of these have little precipitation. At Estancia (20 miles to the south), total annual snowfall averages 20 inches. Snowfalls greater than six inches are uncommon. On the average, only five days per year remain below freezing all day. These conditions prevent significant snow accumulation.

During March and April, frontal systems may have very little moisture, but relatively high winds. Under these conditions, wind-blown dust is produced. Under the most severe conditions near areas of disturbed ground cover, local visibility may be reduced. These periods of peak winds and associated dust generally last no more than two or three hours at a time.

During July, August, and early September, isolated convective thunderstorms occur. These storms develop as a result of strong ground heating due to insolation. Also, thunderstorms occur in the surrounding areas due to mountain terrain effects. These thunderstorms are generally small,

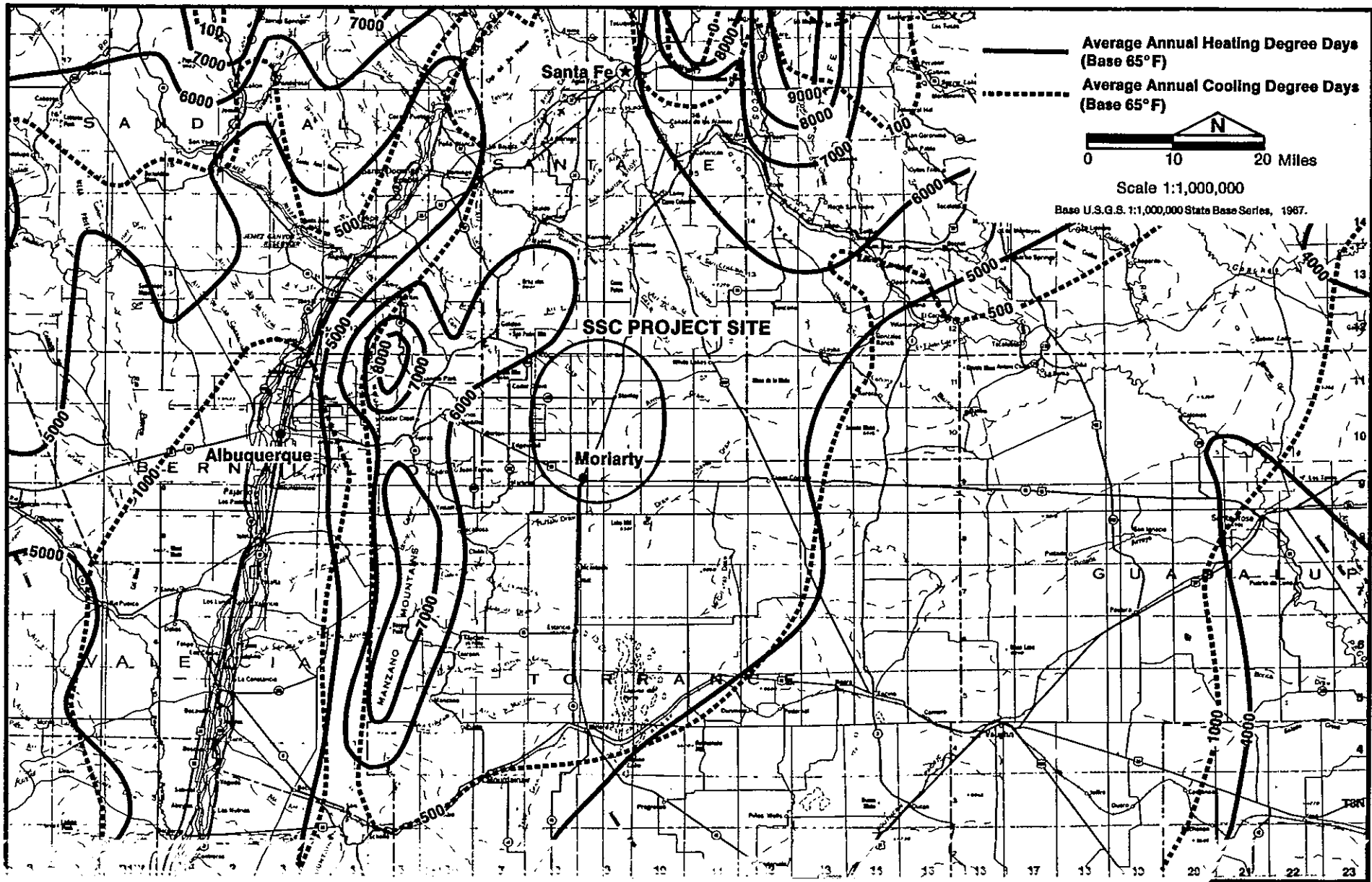

Figure 7.3-4. Heating and Cooling Degree Days (1951-1980).

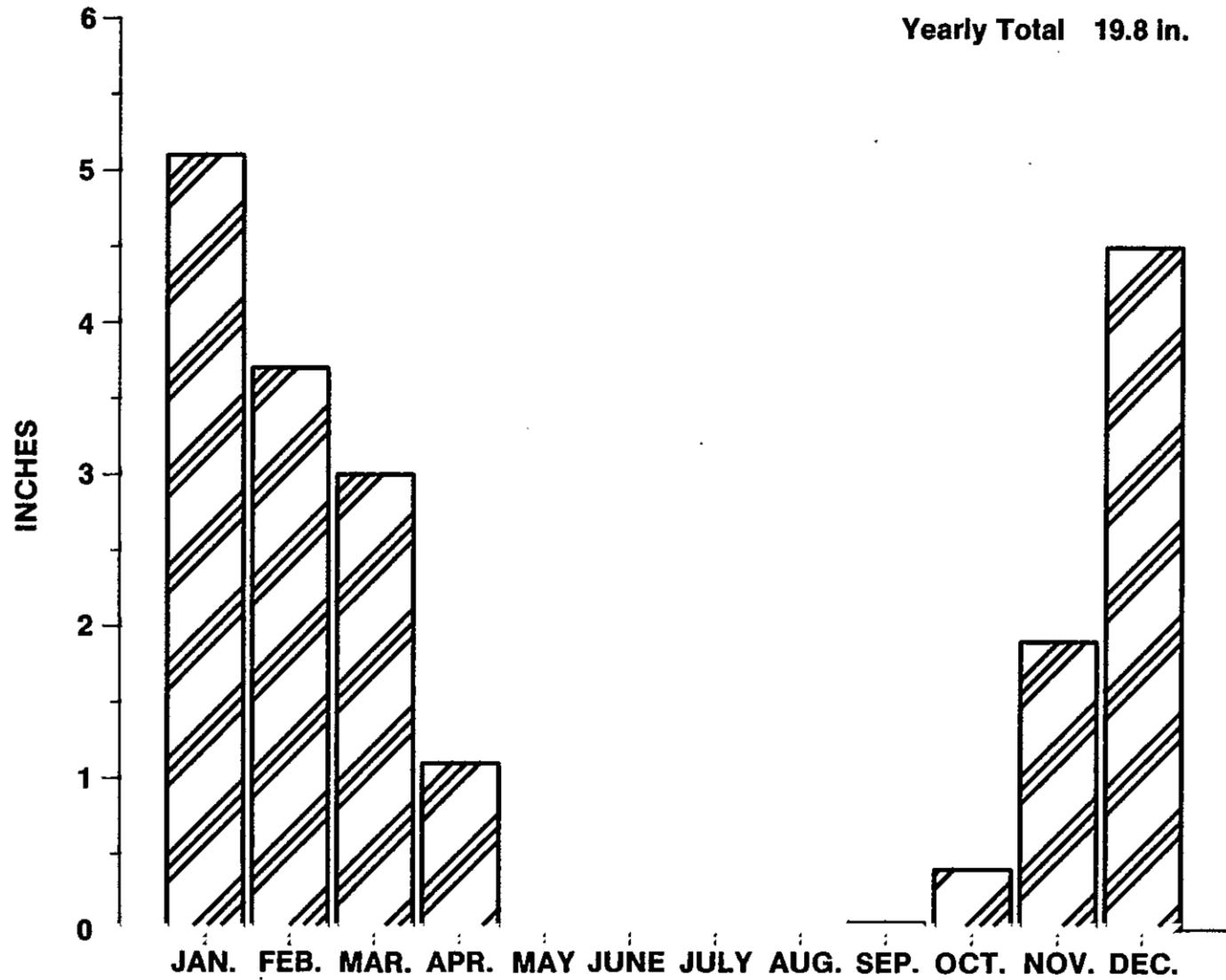

Figure 7.3-5. Average Snowfall, Estancia, N.M. (1916-1960).

Average Monthly Wind Speed 1949-1954 (miles per hour)

Otto, New Mexico

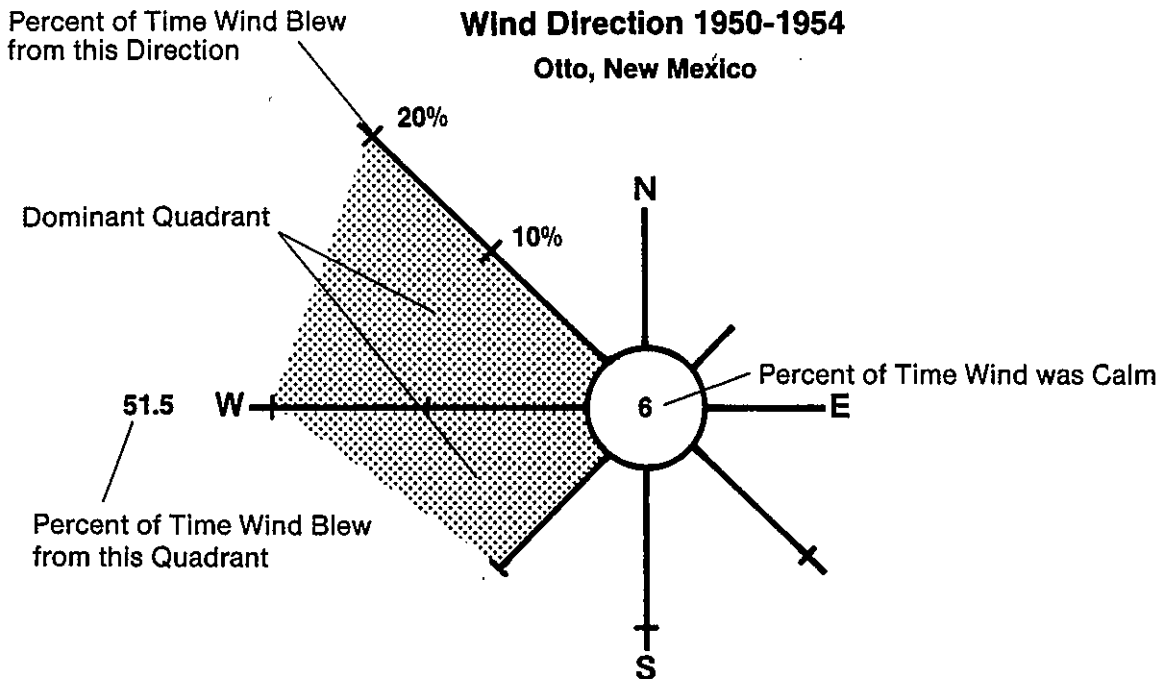
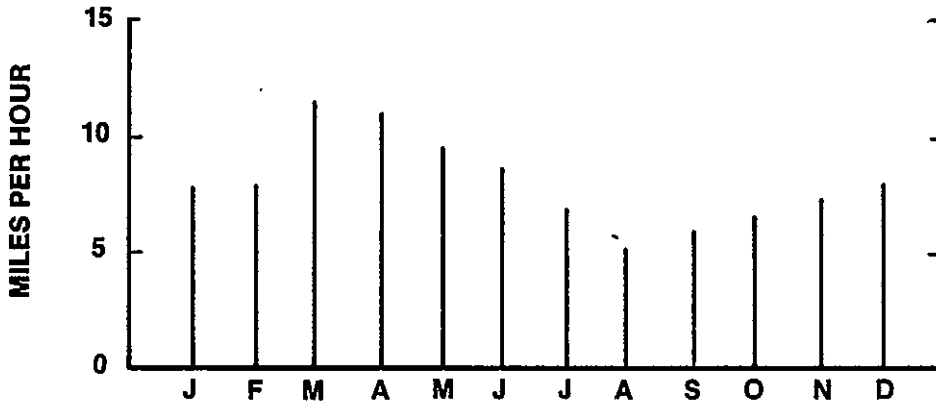

Figure 7.3-6. Wind Speed and Direction, Otto, New Mexico.

isolated and last for a few minutes to several hours. Many produce no precipitation which reaches the ground. However, as much as 50 percent of the area's annual rainfall is from thunderstorms. At Estancia, average precipitation is maximum in August at 2.64 inches and slightly over one inch for both July and September. For short periods, winds may become very gusty near the thunderstorms.

Periods of destructive winds or damaging hail are rare. Tornadoes have been reported, but are very rare, small, and short lived.

REFERENCES

- 7.1-1 U.S. Department of Energy, Invitation for Site Proposals for the Superconducting Super Collider (1987).
- 7.1-2. L. File and S.A. Northrop, New Mexico Bureau of Mines and Mineral Resources, Circular 84 (1966).
- 7.3-1. J. L. Williams, New Mexico in Maps, University of New Mexico, Albuquerque (1986).
- 7.3-2. New Mexico Energy Research and Development Institute, New Mexico Climate Manual, Solar and Weather Data (1985).

APPENDIX 7-A

Ambient Vibration Measurements

STATION: AV-1

LOCATION: 120 ft south of I-40, at Santa Fe-Torrance County line. Very frequent heavy-truck traffic. Pavement very rough and broken adjacent to station.

<u>DATE</u>	<u>TIME</u>	<u>FREQUENCY RANGE</u> cps	<u>PERIOD RANGE</u> seconds	<u>PEAK PARTICLE VELOCITY</u> in./sec.
June 5, 1987	1100	9 - 20	0.05 -0.11	0.001
		9 - 20	0.05 -0.11	0.007
	1200	15 - 20	0.05 -0.07	0.005
	1300	10 - 20	0.05 -0.10	0.009
	1400	9 - 20	0.05 -0.11	0.011
	1500	12 - 20	0.05 -0.08	0.014
	1600	12 - 14	0.07 -0.08	0.002
	1700	9 - 18	0.06 -0.11	0.013
	1800	9 - 18	0.06 -0.11	0.007
	1900	9 - 20	0.05 -0.11	0.013
	2000	9 - 20	0.05 -0.11	0.009
	2100	10 - 22	0.04 -0.10	0.014
	2200	10 - 20	0.05 -0.10	0.009
	2300	9 - 20	0.05 -0.11	0.009
2400	10 - 16	0.06 -0.10	0.002	
June 6, 1987	0100	9 - 20	0.05 -0.11	0.011
	0200	9 - 16	0.06 -0.11	0.002
	0300	9 - 20	0.05 -0.11	0.009
	0400	9 - 22	0.04 -0.11	0.006
	0500	10 - 22	0.04 -0.10	0.007
	0600	10 - 20	0.05 -0.10	0.010
	0700	10 - 22	0.04 -0.10	0.010
	0800	10 - 22	0.04 -0.10	0.012
	0900	10 - 20	0.05 -0.10	0.012
	1035	8 - 20	0.05 -0.13	0.013

STATION: AV-2

LOCATION: 1.5 miles south of Moriarty on NM-41; in Woodman Draw 50 ft west of highway.

DATE	TIME	FREQUENCY	PERIOD	PEAK
		RANGE	RANGE	PARTICLE
		cps	seconds	VELOCITY
				in./sec.
June 5, 1987	1033	9 - 20	0.05 - 0.11	0.0004*
		15 - 20	0.05 - 0.07	0.0021
	1120	12 - 12	0.08 - 0.08	0.0018
	1230	14 - 18	0.06 - 0.07	0.0014
	1335	12 - 18	0.06 - 0.08	0.0028
	1430	12 - 15	0.07 - 0.08	0.0035
	1530	12 - 20	0.05 - 0.08	0.0080
	1630	10 - 20	0.05 - 0.10	0.0042
	1730	12 - 16	0.06 - 0.08	0.0025
	1830	12 - 16	0.06 - 0.08	0.0028
	1930	12 - 20	0.05 - 0.08	0.0022
	2020	14 - 16	0.06 - 0.07	0.0025
	2120	12 - 20	0.05 - 0.08	0.0028
	2220	10 - 14	0.07 - 0.10	0.0010
2320	12 - 18	0.06 - 0.08	0.0009	
June 6, 1987	0020	10 - 14	0.07 - 0.10	0.0014
	0120	14 - 18	0.06 - 0.07	0.0060
	0220	12 - 12	0.08 - 0.08	0.0010
	0330	2 - 60	0.02 - 0.50	0.0004*
	0430	2 - 60	0.02 - 0.50	0.0004*
	0530	10 - 20	0.05 - 0.10	0.0030
	0630	12 - 15	0.07 - 0.08	0.0021
	0730	12 - 12	0.08 - 0.08	0.0023
	0830	12 - 20	0.05 - 0.08	0.0025
	0930	10 - 18	0.06 - 0.10	0.0035

* Lower limit of readings for instrument at this gain setting.

STATION: AV-3

LOCATION: 1 mi south of Kamradt Ranch, on NM-41, 20 ft east of east edge of pavement. Station is at point of tangency with highway's curve to the northeast.

<u>DATE</u>	<u>TIME</u>	<u>FREQUENCY RANGE</u> cps	<u>PERIOD RANGE</u> seconds	<u>PEAK PARTICLE VELOCITY</u> in./sec.
June 6, 1987	1215	20 - 20	0.05 - 0.05	0.0014
	1315	20 - 50	0.02 - 0.05	0.0028
	1415	20 - 50	0.02 - 0.05	0.0018
	1730	20 - 50	0.02 - 0.05	0.0026
	1830	20 - 50	0.02 - 0.05	0.0014
	1930	20 - 50	0.02 - 0.05	0.0030
	2030	30 - 50	0.02 - 0.03	0.0014
	2225			background*
	2345			"
June 7, 1987	0100			"
	0200			"
	0300			"
	0400			"
	0500			"
	0600			"
	0700			"
	0800	20 - 50	0.02 - 0.05	0.0038
	0915			background
	1010	20 - 50	0.02 - 0.05	0.0028
	1110	20 - 50	0.02 - 0.05	0.0034

*background is the lower sensitivity of the instrument about 0.0004 inches per second, at all frequencies detectable: about 1 cps to several hundred cps.

STATION: AV-4

LOCATION: Near section-line dirt road 1.5 miles east of Hyer and 1.5 miles southwest of J. Yates Ranch; about 30 ft south of edge of dirt road.

<u>DATE</u>	<u>TIME</u>	<u>FREQUENCY RANGE</u> cps	<u>PERIOD RANGE</u> seconds	<u>PEAK PARTICLE VELOCITY</u> in./sec.
June 6, 1987	1245			background*
	1345			"
	1445			"
	1800	20 - 30	0.03 - 0.05	0.005
	1900			background
	2000			"
	2145			"
	2300			"
June 7, 1987	0030			background
	0130			"
	0230			"
	0330			"
	0430			"
	0530			"
	0630			"
	0730			"
	0830			"
	0945			"
	1040			"
	1145			"

*background is the lower sensitivity of the instrument about 0.004 inches per second, at all frequencies detectable: about 1 cps to several hundred cps.

APPENDIX 7-B

Harmonic Plots of the Ambient Vibration Measurements

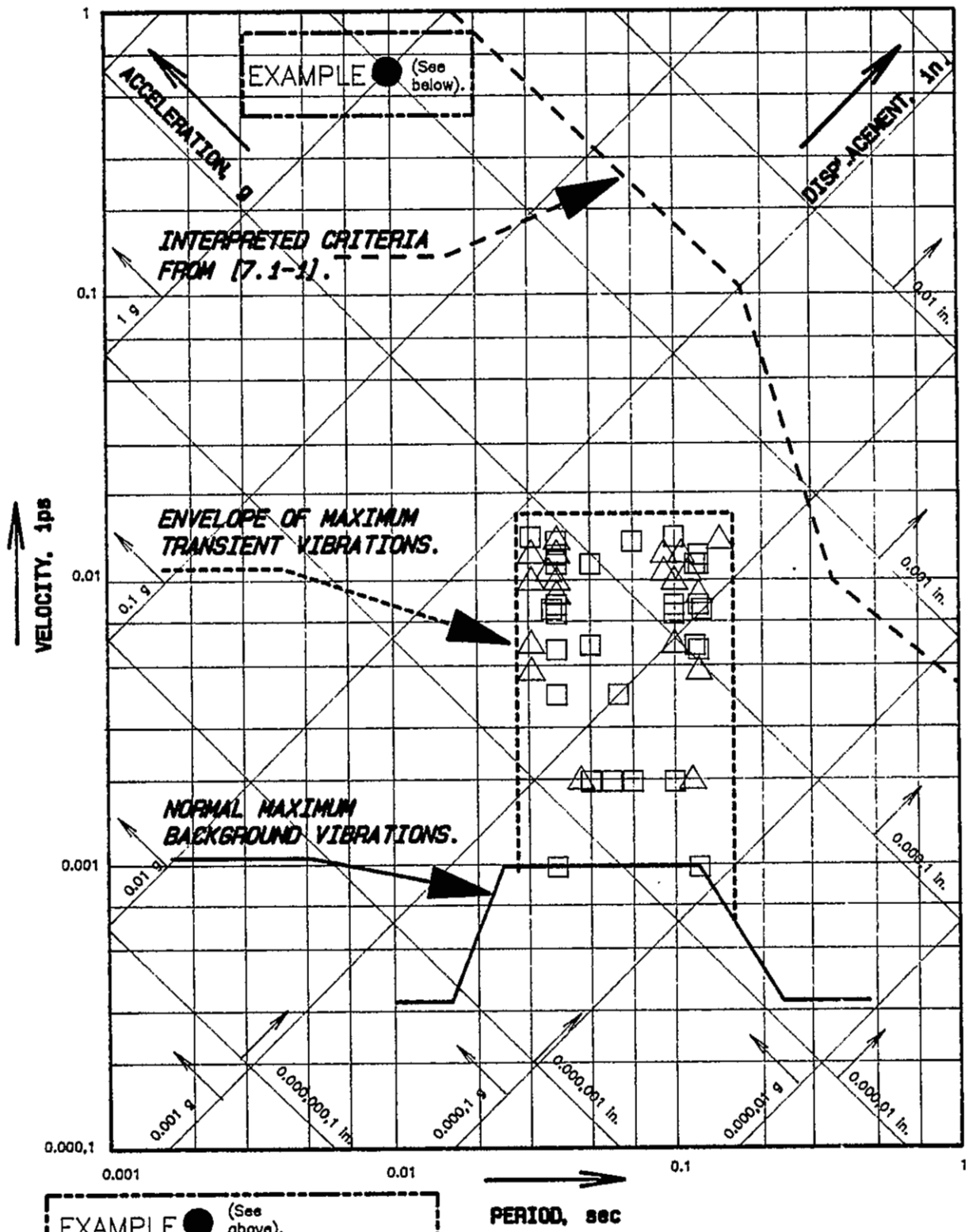

EXAMPLE (See above).

- Period = 0.01 second.
- ↗ Displacement = 0.001 inch.
- ↑ Velocity = 0.6 inches per second.
- ↖ Acceleration, 1 g.

PERIOD, sec

Vibrations at Station AV-1

- Reading of June 5, 1987.
- △ Reading of June 8, 1987.

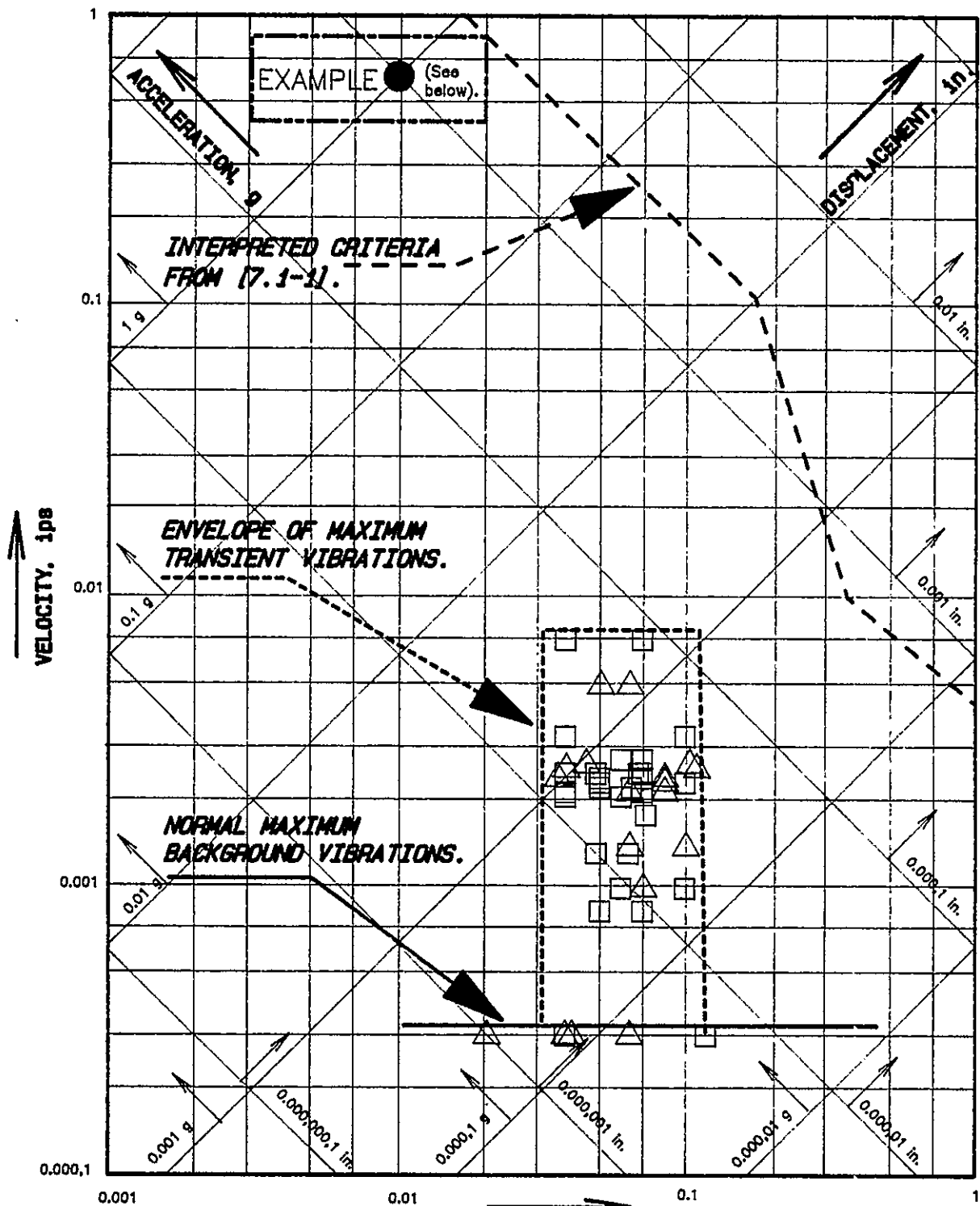

EXAMPLE ● (See above).
 → Period = 0.01 second.
 ↗ Displacement = 0.001 inch.
 ↑ Velocity = 0.6 inches per second.
 ↘ Acceleration, 1 g.

PERIOD, sec

Vibrations at Station AV-2

□ Readings of June 5, 1987.
 △ Readings of June 6, 1987.

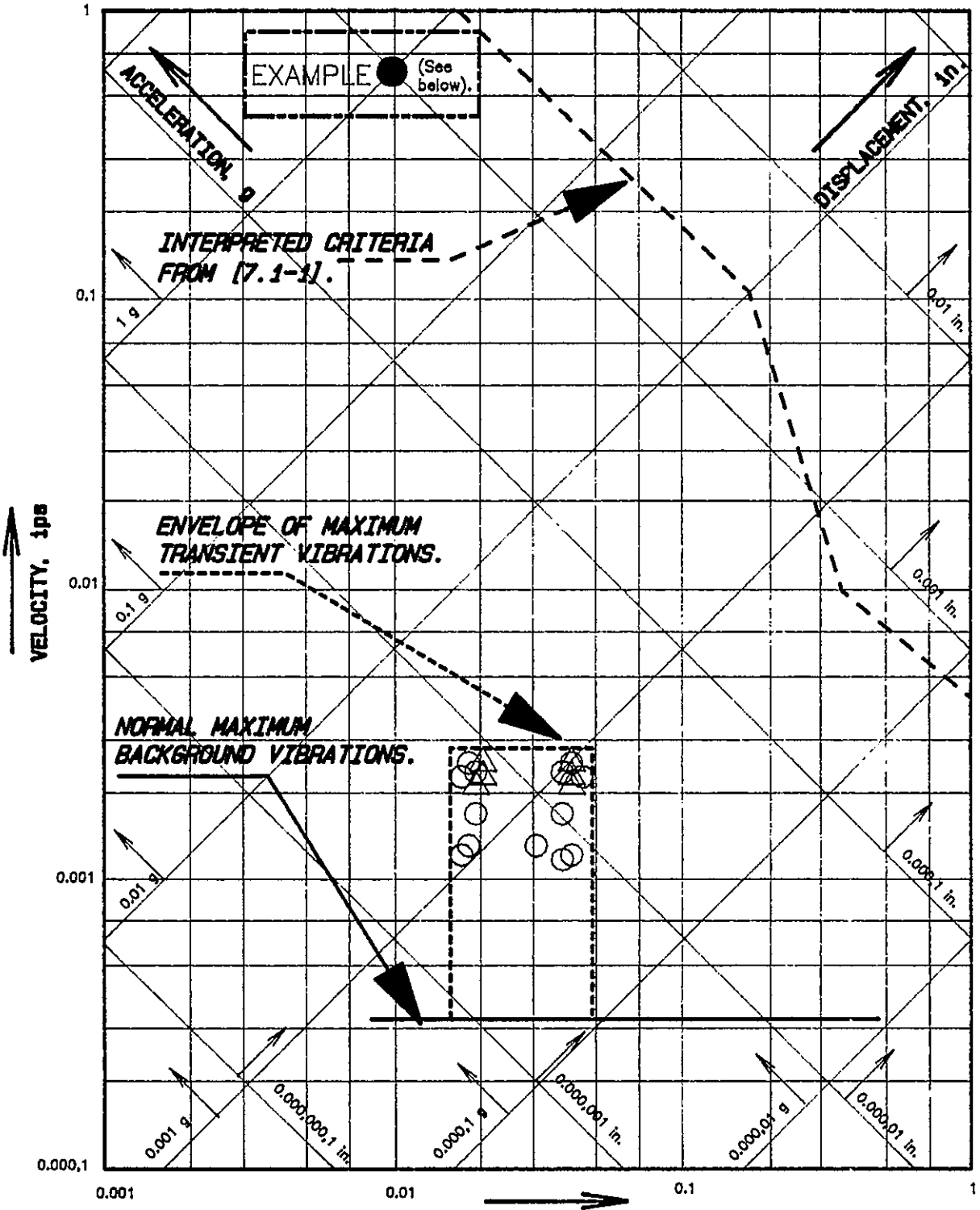

EXAMPLE ● (See above).

- Period = 0.01 second.
- ↗ Displacement = 0.001 inch.
- ↑ Velocity = 0.6 inches per second.
- ↖ Acceleration, 1 g.

PERIOD, sec

Vibrations at Station AV-3

- △ Readings of June 6, 1987.
- Readings of June 7, 1987.

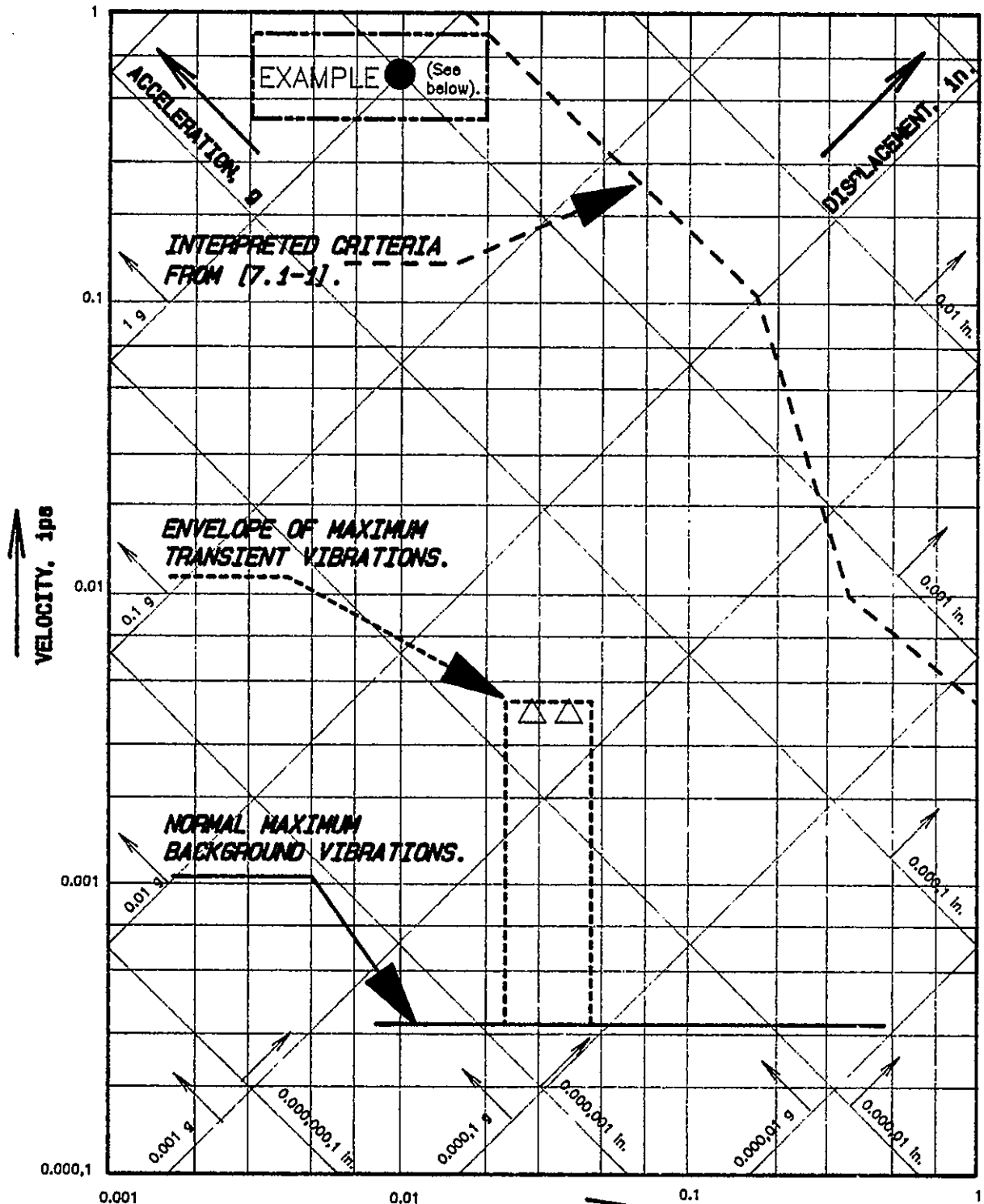

EXAMPLE (See above).

- Period = 0.01 second.
- ↗ Displacement = 0.001 inch.
- ↑ Velocity = 0.6 inches per second.
- ↖ Acceleration, 1 g.

PERIOD, sec

Vibrations at Station AV-4

- △ Readings of June 6, 1987.
- Readings of June 7, 1987.
Values below sensitivity of instrument.

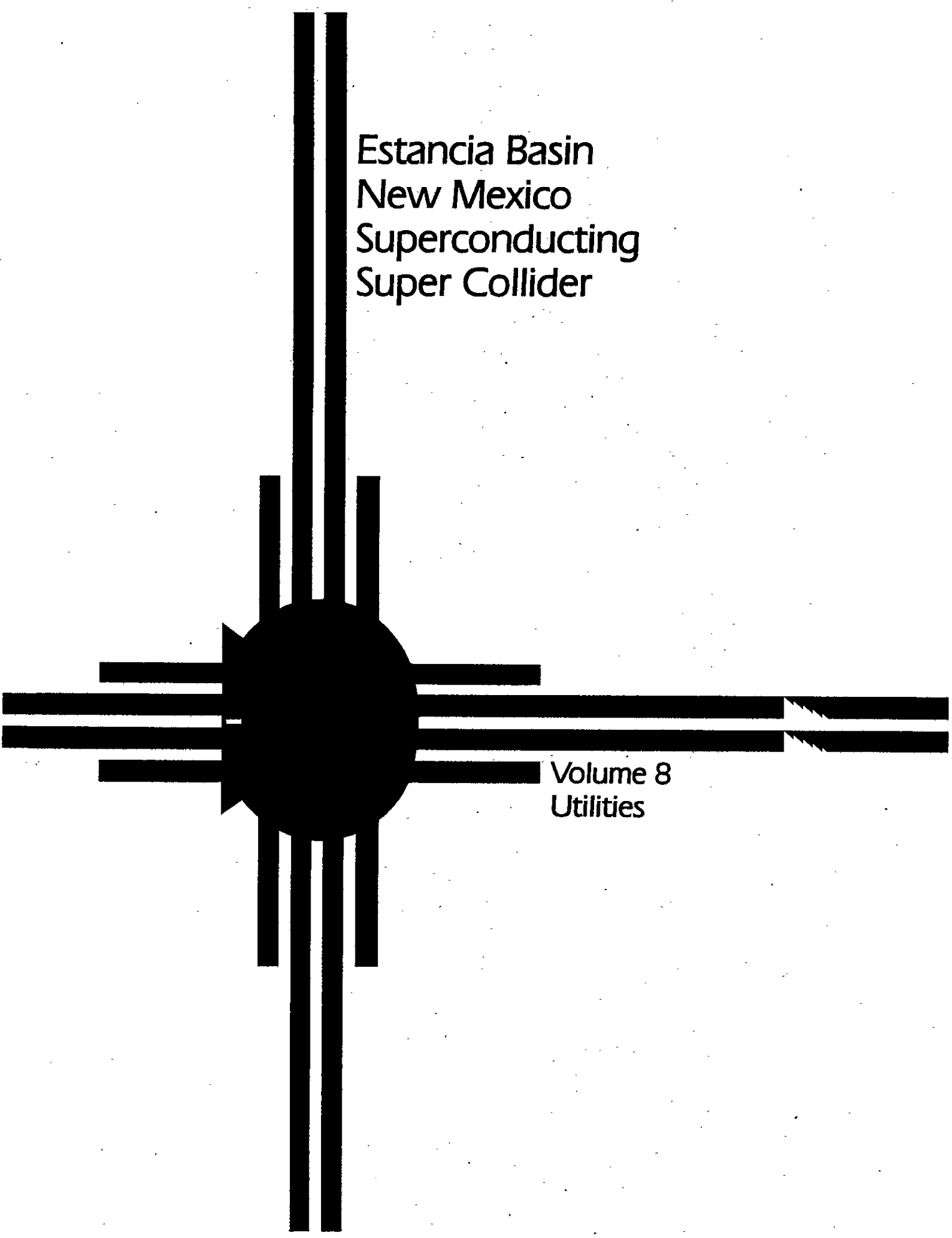

Estancia Basin
New Mexico
Superconducting
Super Collider

Volume 8
Utilities

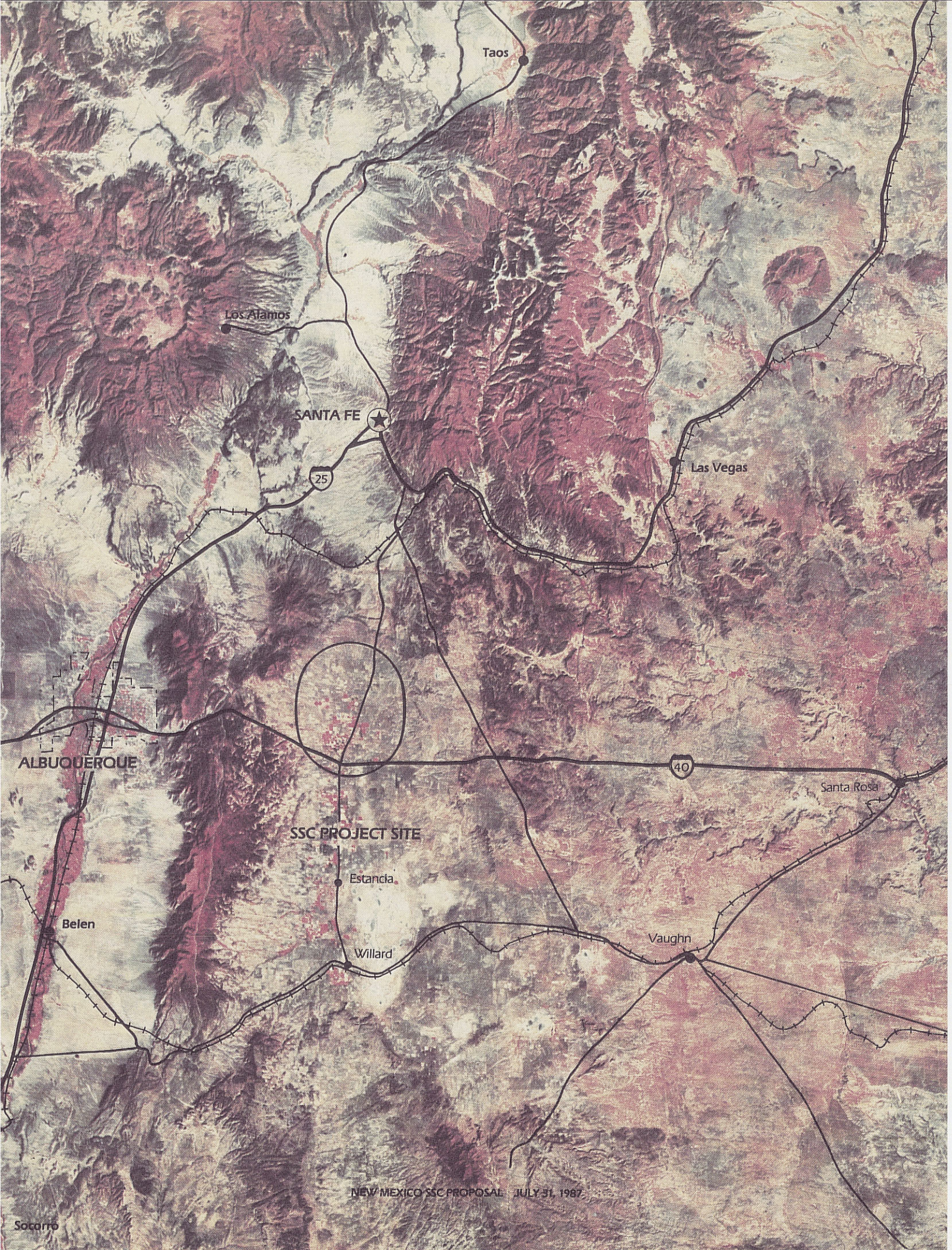

Taos

Los Alamos

SANTA FE

25

Las Vegas

ALBUQUERQUE

40

Santa Rosa

SSC PROJECT SITE

Estancia

Belen

Willard

Vaughn

NEW MEXICO SSC PROPOSAL JULY 31, 1987

Socorro

Utilities

Volume 8

TABLE OF CONTENTS

8.0	Summary	8-1
8.1	Power	8-2
8.1.1	Electric Power Generating and Transmission Grid System(s)	8-2
8.1.2	Maps of Regional Transmission Network	8-12
8.1.3	Power System Capability and Stability	8-17
8.1.4	Utility Rate Schedules	8-17
8.1.5	Projection of Future Power Demands	8-18
8.2	Industrial Cooling Water	8-19
8.2.1	Available Sources and Seasonal Variations	8-19
8.2.2	Water Cost	8-20
8.2.3	Water Quality	8-20
8.3	Potable Water	8-20
8.3.1	Available Sources	8-20
8.3.2	Water Cost	8-20
8.4	Fuel	8-22
8.4.1	Fuel Supply Description	8-22
8.4.2	Natural Gas Price Forecast	8-22
8.5	Waste and Sewage Disposal	8-24
8.5.1	Available Treatment Facilities	8-24
8.5.2	Types and Capacities of Solid Waste Disposal Resources	8-25
	Appendices	8-26
8-A	Commitments to Supply Electric Power	8-26
8-B	Letter From State Engineer	8-31

8.0 SUMMARY

Detailed information on the location and capacity of existing and planned generating plants, transmission grid systems, and the available and planned multiple feeder lines to the proposed SSC site in the Estancia Basin is contained in this volume. Data on industrial cooling water, potable water, and waste and sewage disposal are also included. Conclusions based on these data may be summarized as follows:

- A. Fully adequate generating capacity, fueled by a mix of hydro, coal, gas, and nuclear energy exists in the area to provide reliable power to the SSC site.
- B. Additional resources and excellent reliability are provided by participation of local utility suppliers in several power pools.
- C. New Mexico has a strong Extra High Voltage Transmission System with more than adequate capacity, reliability, and stability to provide the predicted power requirements for the SSC, as well as to accommodate significant load growth.
- D. Industrial cooling water and potable water of high quality and in adequate quantities are available in the Estancia Basin.
- E. Abundant quantities of competitively priced natural gas are readily available near the proposed site.
- F. No sewage treatment facilities exist on the proposed site or in the vicinity. On-site facilities would be required.
- G. Solid waste disposal facilities of a size adequate to serve the SSC are not currently available in the vicinity of the proposed site. Establishment of an on-site or vicinity landfill area should receive a permit routinely under existing regulations.
- H. New Mexico has no approved hazardous or mixed-waste disposal site. Discussions are ongoing regarding establishing a regional site for such wastes. Other DOE facilities in New Mexico currently store these materials on-site, pending a final disposition plan.

8.1 POWER

8.1.1 ELECTRIC POWER GENERATING AND TRANSMISSION GRID SYSTEM(S)

Location of Generating Plants

Approximately 1,438 MW of New Mexico owned (Public Service Company of New Mexico (PNM)-1027 MW, City of Farmington (COF)-42 MW, Los Alamos County (LAC)-36 MW, El Paso Electric Company (EPE)-103 MW, Plains Generation and Transmission Cooperative (PGT)-230 MW) installed coal generation capacity is located in the Four Corners and western New Mexico areas, and approximately 990 MW of New Mexico owned (PNM-390 MW, EPE-600 MW) nuclear generation is located at Palo Verde, west of Phoenix. In addition, significant gas-fired generation is installed near both the Albuquerque (259 MW) and El Paso (893 MW) load centers.

Installed Generating Capacity

The generating resources of the major utilities operating the contiguous, synchronized system in New Mexico are illustrated in Figure 8.1-1.

Present and Future Reserve Margins

Figure 8.1-2 illustrates the New Mexico resource reserve margins for summer peak loads from 1987 through 1996. The resources include generation plus net firm imports.

The substantial reserve margins shown in Fig. 8.1-2 indicate that New Mexico resources are more than adequate to accommodate the proposed SSC loads. Refer to Section 8.1.5 for further reserve margin discussions.

Power Pool Participation

The New Mexico utilities belong to various power pools for sharing generating reserve responsibilities, to provide mutual emergency assistance through their interconnections described earlier, and to facilitate economy energy interchange. Those pools are: the New Mexico Power Pool (NMPP), the Inland Power Pool (IPP), the Southwest Power Pool (SPP), and the Western Systems Power Pool (WSPP).

<u>Utility</u>	<u>Installed Capacity</u>	<u>Fuel Type (Transport Method)</u>
City of Farmington (COF)	42 MW	Coal (mine-mouth)
	32 MW	Natural Gas (pipe)
El Paso Electric Company (EPE)	600 MW	Nuclear (railroad)
	103 MW	Coal (mine-mouth)
	893 MW	Natural Gas (pipe)
Los Alamos County (LAC)	36 MW	Coal (mine-mouth)
	20 MW	Natural Gas (pipe)
Plains Electric Generation and Transmission Cooperative (PGT)	230 MW	Coal (railroad)
	45 MW	Natural Gas (pipe)
Public Service Company of New Mexico (PNM)	390 MW	Nuclear (railroad)
	1,027 MW	Coal (mine-mouth)
	279 MW	Natural Gas (pipe)
Texas-New Mexico Power Company (TNP)	11 MW	#2 Oil (railroad)
	42 MW	Natural Gas (pipe)
Western Area Power Administration, Upper Colorado River (WAPA-UC)	24 MW	Hydro
	<u>3,774 MW</u>	
New Mexico Total		

Figure 8.1-1. New Mexico installed capacity. Note: Additionally, Southwest Public Service Company (SPS), which is part of the Southwest Power Pool (SPP), operates in eastern New Mexico, connected to the major New Mexico transmission system by two 200 MW asynchronous ties. Up to 334 MW of emergency capacity is currently available to New Mexico from SPS over those ties.

	<u>1987</u>	<u>1988</u>	<u>1989</u>	<u>1990</u>	<u>1991</u>	<u>1992</u>	<u>1993</u>	<u>1994</u>	<u>1995</u>	<u>1996</u>
Resources	3405	3611	3635	3840	3951	3961	3987	3974	4049	4024
Firm Load	2263	2291	2350	2411	2490	2572	2679	2767	2808	2882
Reserve Margin										
Megawatts	1142	1320	1285	1429	1461	1389	1308	1207	1241	1142
% of Load	50	58	55	59	59	54	49	44	44	40

Figure 8.1-2. Total New Mexico summer reserve margins (MW). Note: Additional resources (not included above) varying from 25 MW to 75 MW are available, but not yet committed, from 1994 through 1996.

Transmission Grid Systems

New Mexico currently has a strong Extra High Voltage (EHV) transmission system. The planned transmission system additions described below will further strengthen the EHV system, ensuring adequate system capacity to serve the proposed SSC loads and significant load growth. New Mexico's SSC Transmission Integration Plan, also described below, will not only accommodate the proposed Estancia Basin SSC loads, but will also increase the EHV system's stability and reliability.

Figure 8.1-3 is a map of the existing regional transmission system including New Mexico, and the transmission system additions planned for the next 10 years. Please refer to it for the following discussion.

Transmission Grid Description

The New Mexico EHV transmission grid is composed of seven 345 kV lines and one 230 kV line. The EHV system has been designed to transport remotely located base-load coal and nuclear resources to the large load centers in the central and south-central portion of the state, and to the west Texas area. This strong "backbone" EHV system, shown in Figure 8.1-3, is solidly interconnected to the neighboring transmission systems for stability, economy energy interchange, and mutual assistance for system emergencies. It also ties the large New Mexico load centers together.

The EHV system overlays the subtransmission networks located at the load centers. Large auto-transformers located near the load centers are used to step the EHV system voltage down to subtransmission levels, primarily 115 kV, but also 69 kV and 46 kV at various system locations.

NERC Control Areas

The New Mexico system is operationally composed of three major North American Electric Reliability Council (NERC) control areas. EPE operates the NERC control area for most of the southern New Mexico system south of Albuquerque and east of Deming; PNM operates the NERC control area for most of the northern and western system; and SPS operates the NERC control area in eastern New Mexico. The SPS control area is asynchronous to the other two areas, but is connected by back-to-back DC ties described later. PNM's control area includes within it PGT, TNP, LAC, and WAPA as sub-areas. Arizona Public Service Company (APS), WAPA-Upper Colorado Area (WAPA-UC), Tucson Electric Power Company (TEP), and Utah Power and Light (UPL) operate the adjacent NERC control areas.

Normal Powerflow Directions

Economic dispatch of the resource mix necessitates backing down gas generation at the load centers to the extent possible and maximizing imports across the transmission system from the remote coal and nuclear plants. This operating philosophy leads to a transmission system which is normally loaded in the north to southeast direction in northern New Mexico and west to east across southern New Mexico.

Interconnections to the Western System Coordinating Council (WSCC)

The New Mexico Transmission System is strongly tied to the WSCC transmission system in the Four Corners region by: 1-500 kV line, 6-345 kV lines, 1-230 kV line, and 1-115 kV line. Additionally, there is a single 345 kV interconnection to the southwest New Mexico area and a single 345/115 kV 200 MVA transformer interconnection in the west-central area.

Interconnections to the Southwest Power Pool (SPP)

Two 200 MW asynchronous interconnections exist from the New Mexico system to the Southwest Power Pool (SPP), accomplished through back-to-back DC converters at Clovis (Blackwater) and Artesia (Eddy County), New Mexico. Both are bidirectional 200 MW DC converter stations connected to the New Mexico grid by radial 345 kV AC lines and to the SPP 230 kV system. Current interutility transactions result in normal schedules of 200 MW from the New Mexico system to the SPP at Blackwater, and schedules of 66-200 MW from the SPP to New Mexico at Eddy County.

New Mexico Load Description

The New Mexico systems are summer peaking, as a whole, with the winter peak load reaching approximately 90-95 percent of the summer peak. The New Mexico loads are distributed slightly heavier to the northern system in the winter months, and to the southern system in summer months.

Planned Transmission Grid System Additions

Transmission system additions are planned for New Mexico, with environmental and licensing processes already underway, to enhance the capabilities of EHV transmission system. They will further ensure the capability of the New Mexico transmission system to serve the proposed SSC load. The projects listed below are slated for construction over the next 10 years. Figure 8.1-3 is a regional transmission system map which includes the planned system additions.

Ojo Line Extension 345 kV Project (OLE)

The OLE Project will connect two existing 345 kV radially fed substations in northern New Mexico, and complete the third 345 kV path from the Four Corners region to the Albuquerque load center. The planned in-service date is November 1988. This project will provide about 170 MW of additional import capability to the northern New Mexico system. This will have a positive effect on ability to import economical coal and nuclear resources from remote generating sources to the proposed SSC site.

Arizona Interconnection 345 kV Project (AIP)

The AIP will provide a new 345 kV interconnection from the coal-fired Springerville Generating Station in east-central Arizona to the El Paso area. The planned in-service date is currently February 1990.

This new interconnection to the WSCC system will provide 300-350 MW of additional import capability to the southern New Mexico area.

Dineh Power Project (DPP)

The Dineh Project is an entrepreneurial venture which is currently in the conceptual planning phase. DPP consists of a four-unit, mine-mouth, base-load, 2,000 MW coal-fired power plant in the Bisti region, about 40 miles south of Farmington, New Mexico. The proposed related transmission facilities for the first two units (1,000 MW) consist of a 500 kV line from DPP to the Four Corners Power Plant and a 500 kV line from DPP to north-central Arizona, tying into the Arizona 500 kV system. Commensurate with the in-service date of the first DPP unit, PNM may build the Dineh-Ambrosia-Pajarito (DAP) 500 kV Project, described below, which will emanate from the DPP site.

DPP represents New Mexico's ability to develop future generation resources. Also, the related 500 kV transmission facilities will tremendously strengthen New Mexico's ties to the WSCC system, ensuring adequate emergency assistance from other utilities for local generation problems. The planned in-service date for the DPP transmission system is tentatively set for November 1992, with the first unit (500 MW) scheduled to be in-service in May 1995.

Dineh-Ambrosia-Pajarito 500 kV Project (DAP)

This 500 kV transmission line will emanate from the Dineh Power Project, reinforcing the 230 kV system at Ambrosia, and terminating about 10 miles south of Albuquerque, tying into the 345 kV system. This project will serve to reinforce the New Mexico EHV transmission system, providing a direct 500 kV tie into the Albuquerque area from the Arizona 500 kV system (in conjunction with the DPP transmission system). The planned in-service date for the DAP project is May 1995, but construction could be accelerated if required to support the proposed SSC or other loads.

Existing Transmission System Near Estancia SSC Site

Two transmission lines presently exist in the vicinity of the proposed SSC site near Estancia, New Mexico. Figure 8.1-4 is a map showing geographic orientation of these lines to the proposed SSC site.

B-A-Blackwater 345 kV Line (BB)

The BB 345 kV line is constructed on guyed delta and self-supporting lattice steel structures with 2-795 MCM ACSR (double-bundle) conductor per phase. This 223-mile-long 345 kV circuit is fed from B-A Substation, which is a very strong, firm source north of the Albuquerque area, tied directly to the 345 kV lines from the Four Corners region. Blackwater is a back-to-back DC converter station interconnecting New Mexico with the Southwest Power Pool.

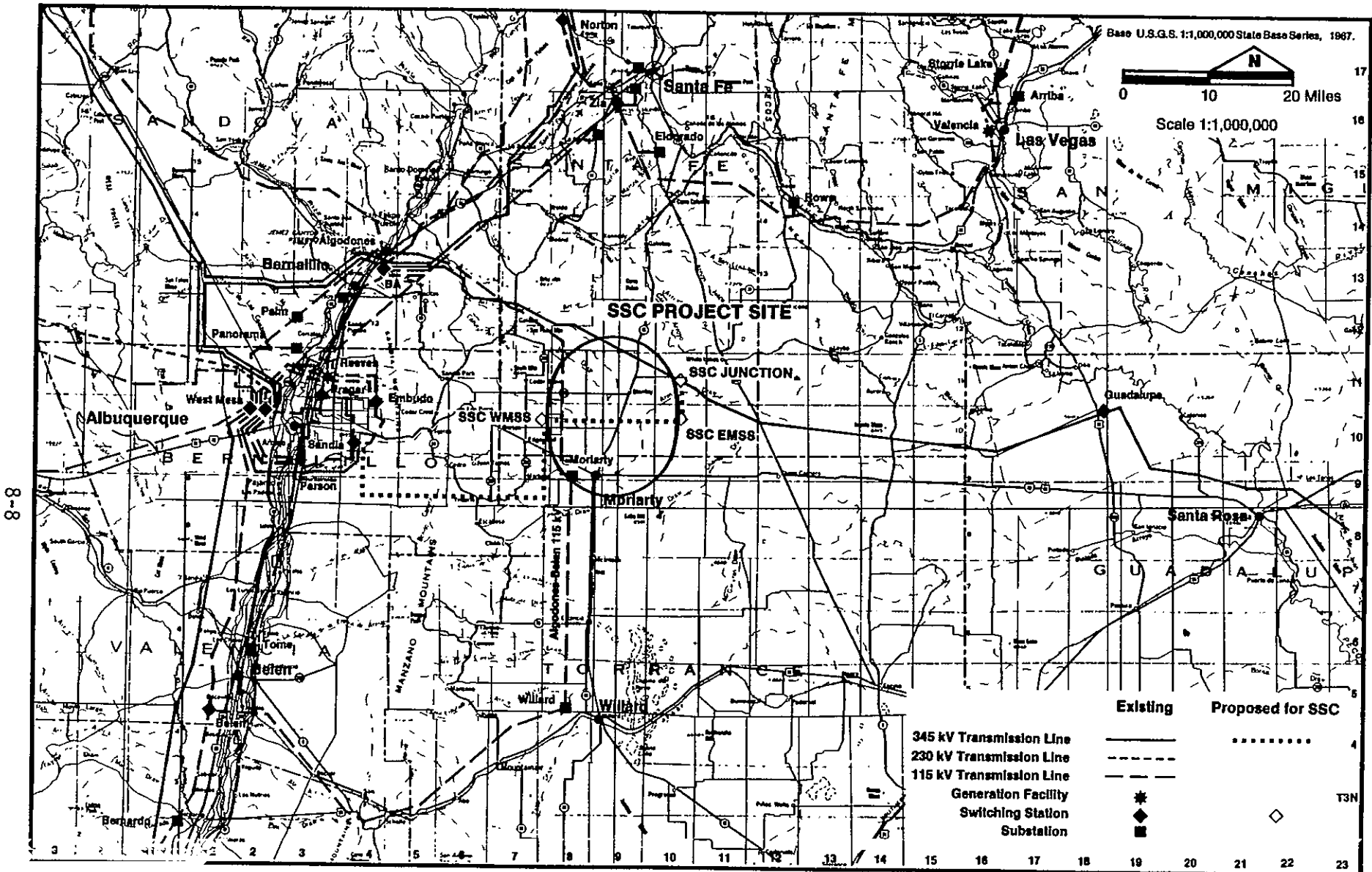

Figure 8.1-4. Central New Mexico Electrical Transmission System.

NEW MEXICO SSC PROPOSAL JULY 31, 1987

Algodones-Belen 115 kV Line

The Algodones-Belen 115 kV line is a 119 mile loop, normally operated open between Willard substation and Belen substation. Half of the loop (about 68 miles) is 397.5 MCM ACSR conductor, with the remainder being 4/0 ACSR conductor. About 28 miles of the loop is on steel poles; the other portion is wood H-frame construction. The Belen end of the loop is fed by a 36-mile 115 kV circuit (397.5 MCM ACSR) from the West Mesa 115 kV bus, which is strongly supported by 2-230/115 kV 200 MVA transformers and 1-345/115 kV 400 MVA transformer. The Algodones end of the loop is also connected to the West Mesa 115 kV bus by a 22-mile 115 kV line (397.5 MCM ACSR), and to Norton substation by a 37-mile 115 kV line (397.5 MCM ACSR). The Norton 115 kV bus is supported by a 400 MVA 345/115 kV transformer, making it a strong source as well. In addition to the two 115 kV tie lines, Algodones also is a generating station with 3-15 MW gas-fired steam generators. The Algodones units are normally not run for economic reasons.

New Mexico's SSC Transmission Integration Plan

The New Mexico utilities are committed to working with the SSC contractor to design and build the most cost-effective, reliable power supply for the Estancia SSC, incorporating it into New Mexico's existing transmission system. The Transmission Integration Plan proposed by New Mexico is conceptual. Additional refinements would be added through cooperative efforts with the SSC contractor as the SSC design itself evolves.

There are a multitude of transmission system configurations technically capable of serving the proposed Estancia SSC loads. For simplicity, New Mexico is only proposing a single alternative at this time. As design specifications for the SSC evolve, New Mexico utilities would work jointly with the SSC contractor to develop the most cost-effective, reliable system possible. Figure 8.1-4 is a map depicting the proposed SSC transmission integration plan.

The New Mexico SSC Transmission Integration Plan calls for providing double-ended 345 kV feeds to both the Western Master Substation (WMSS) and the Eastern Master Substation (EMSS). The BB 345 kV line would be tapped at a new 345 kV substation, called SSC Junction, at a point approximately 39 miles east of B-A substation. SSC Junction substation would consist of a 3-breaker 345 kV ring bus, expandable to a breaker-and-one-half scheme. Figure 8.1-5 is a station one-line diagram of the proposed SSC Junction 345 kV substation.

A 345 kV line would be built from SSC Junction to EMSS (approximately 12 miles), from EMSS to WMSS traversing the SSC site (approximately 15.5 miles), and from WMSS to the existing Sandia 345 kV substation in Albuquerque (approximately 38 miles). Figure 8.1-6 is a station one-line diagram of the existing Sandia 345 kV substation, as modified for the SSC transmission integration plan.

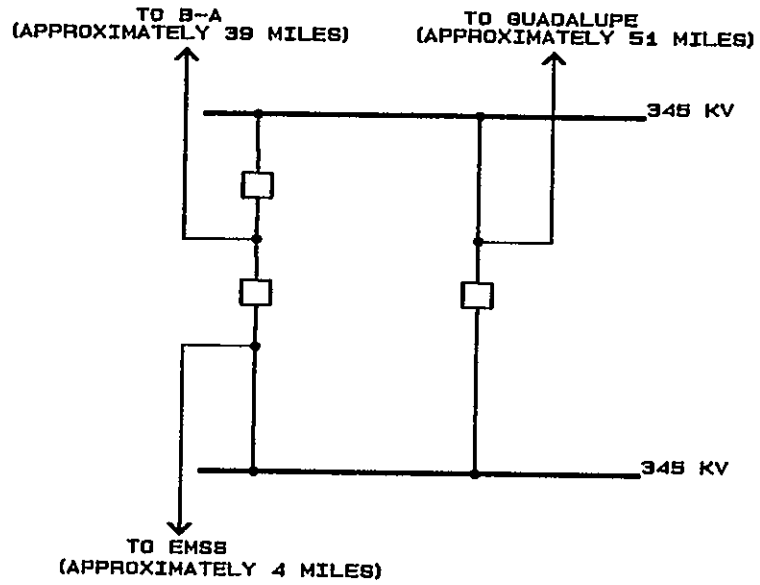

NEW MEXICO ESTANCIA BASIN		
SSC PROPOSAL		
Title		
SSC JUNCTION 345KV		
Size	Document Number	REV
A	GW - 18B	5
Date:	June 24, 1987	Sheet 1 of 1

Figure 8.1-5.

8-11

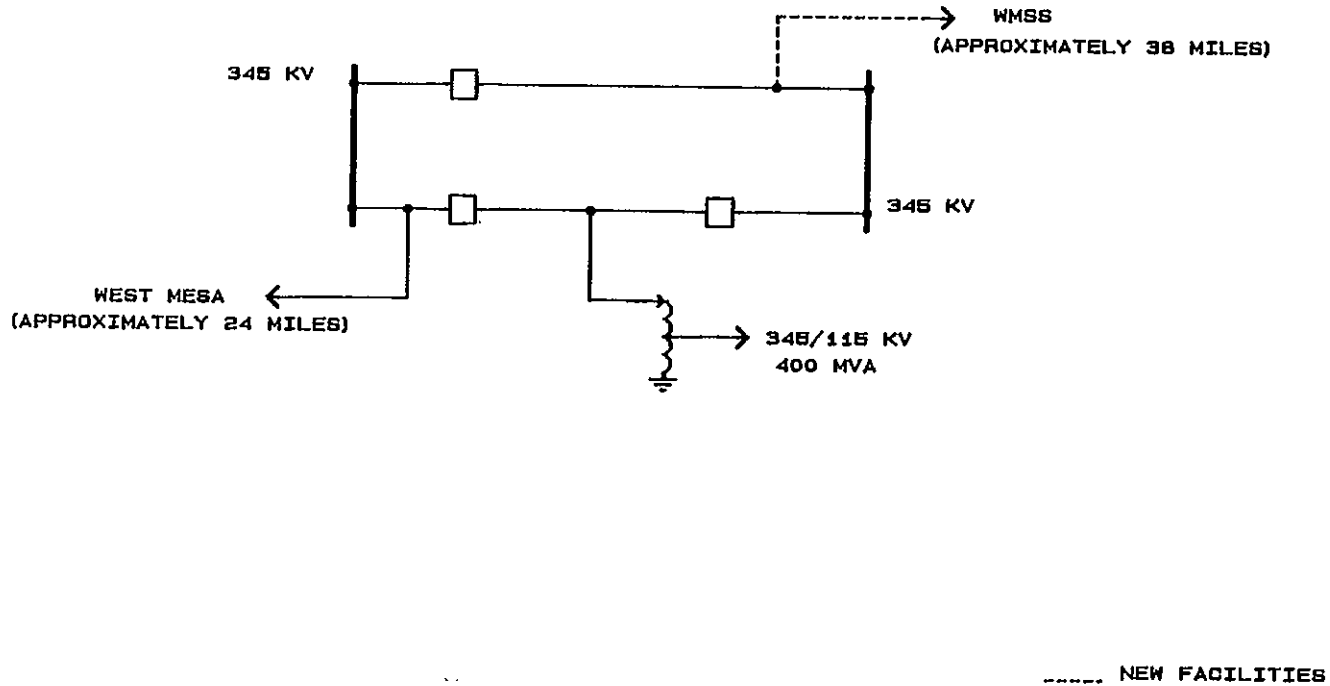

NEW MEXICO ESTANCIA BASIN SSC PROPOSAL		
Title		
SANDIA 345 KV		
Size	Document Number	REV
A	GW - 17	3
Date:	June 28, 1987	Sheet 1 of 1

Figure 8.1-6.

All 345 kV line construction would consist of 2-795 MCM ACSR double-bundle conductor per phase, on guyed and/or self-supporting lattice steel structures. Larger conductor could be used if electrical noise problems are of concern. New Mexico's climate and abundant land should allow all transmission and distribution lines for the proposed Estancia SSC site to be overhead construction.

Elements at EMSS can be reliably served by a four-element 345 kV ring bus arrangement. Figure 8.1-7 is a station one-line diagram of the proposed EMSS.

An intermediate transmission substation voltage of 115 kV is recommended at WMSS to reduce the cost of the breaker-and-one-half scheme needed for the line terminations plus the five proposed transformers. No specific 345/115 kV transformer rating is yet specified. However, use of two 345/115 kV transformer with interlocked load tap changing (LTC) capabilities may be desirable. Figure 8.1-8 is a station one-line diagram of the proposed WMSS. Additional reliability might also be added by looping the Algodones-Belen 115 kV circuit into and out of the WMSS 115 kV switchyard.

Figure 8.1-9 is a one-line system diagram of the overall SSC Transmission Integration Plan.

This proposed transmission system provides a very strong and reliable double-ended feed to both SSC load centers. It strengthens the New Mexico transmission grid by creating a 345 kV loop around the Albuquerque load center. The Sandia National Laboratory and Kirtland Air Force Base, which are fed from the Sandia 345 kV substation, would also be provided with a new double-ended 345 kV source. The plan ensures the ability to serve any future load growth at the Estancia SSC site by providing a direct 345 kV tie line, through Sandia substation, to the proposed southern 500/345 kV terminus (Pajarito) of the planned DAP 500 kV Project. If the Algodones-Belen 115 kV circuit is looped into and out of the SSC WMSS, the 345/115 kV transformation at WMSS will also strengthen the Algodones-Belen 115 kV loop.

8.1.2 MAPS OF REGIONAL TRANSMISSION NETWORK

Figure 8.1-3 is a map of the existing regional transmission system including New Mexico, and the transmission system additions planned for the next 10 years.

Figure 8.1-10 is a regional transmission map showing voltage levels and line capacities, including the locations of switching stations and substations.

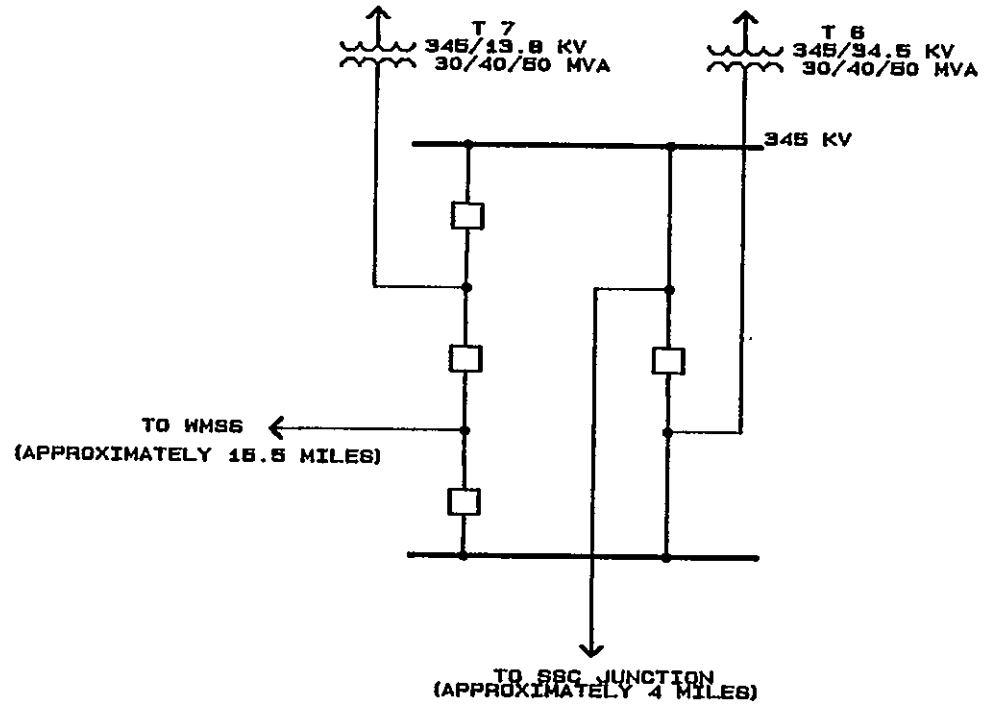

NEW MEXICO ESTANCIA BASIN		
SSC PROPOSAL		
Title SSC EAST MASTER SUBSTATION (EMSS) 345 KV		
Size	Document Number	REV
A	GW - 15B	5
Date:	June 24, 1987	Sheet 1 of 1

Figure 8.1-7.

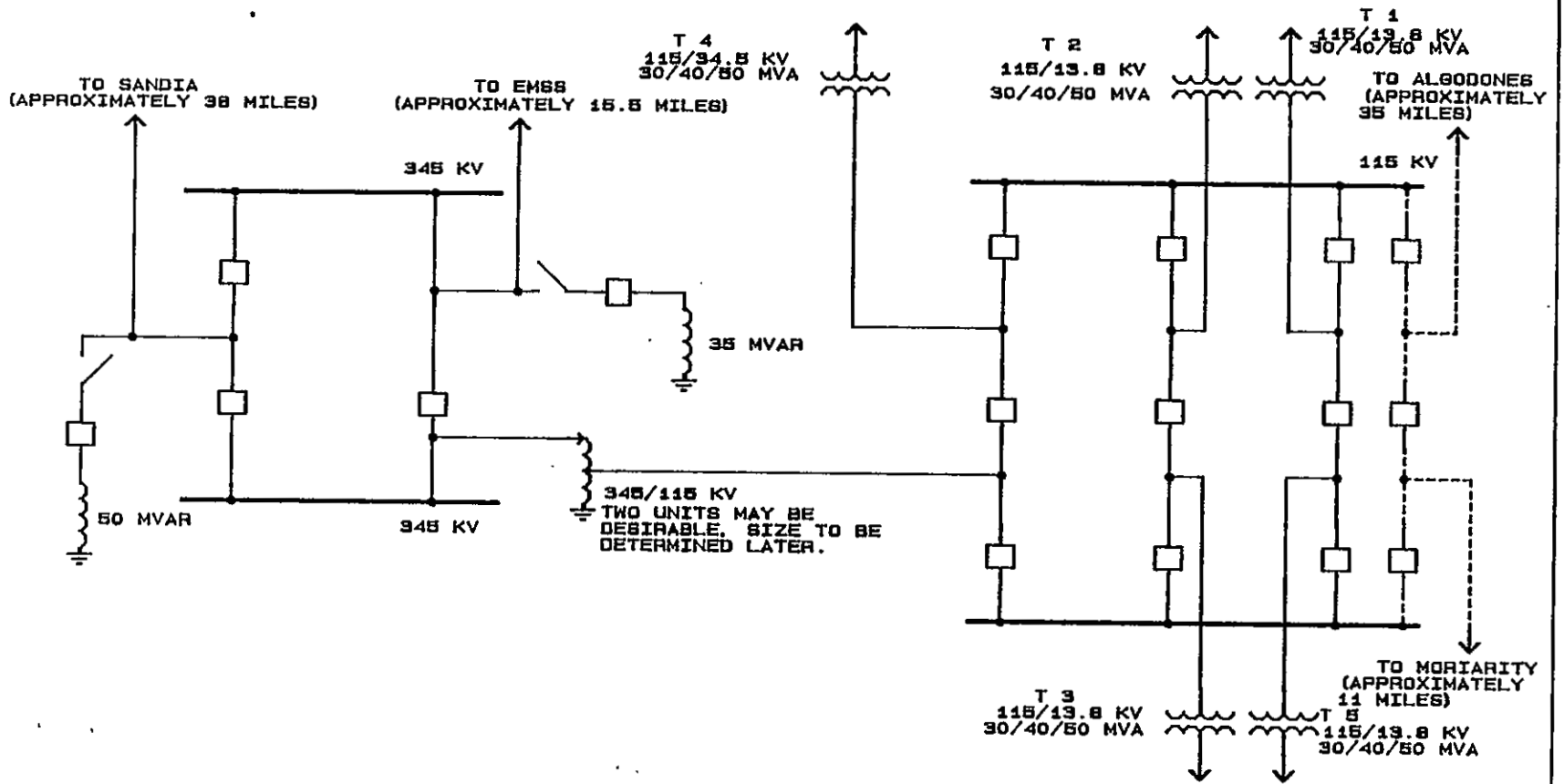

NEW MEXICO ESTANCIA BASIN		
SSC PROPOSAL		
Title SSC WEST MASTER SUBSTATION		
(WMS) 345/115 KV		
Size	Document Number	REV
A	GW - 14C	8
Date:	June 24, 1987	Sheet 1 of 1

Figure 8.1-8.

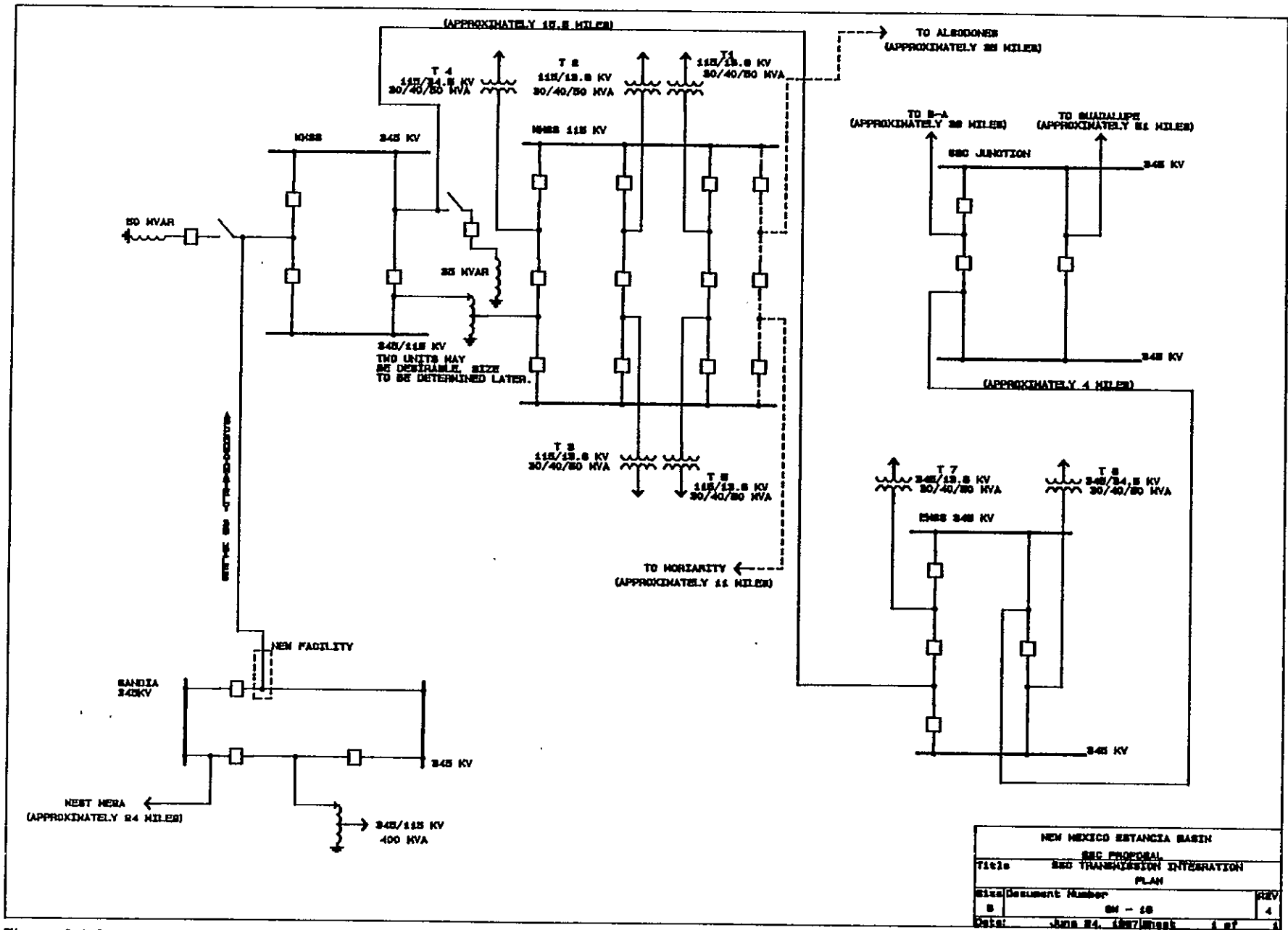

Figure 8.1-9.

LINE CAPACITY MVA = Megavolt-amperes

Capacities are given for New Mexico only, except where information was not available.

* Capacity not available

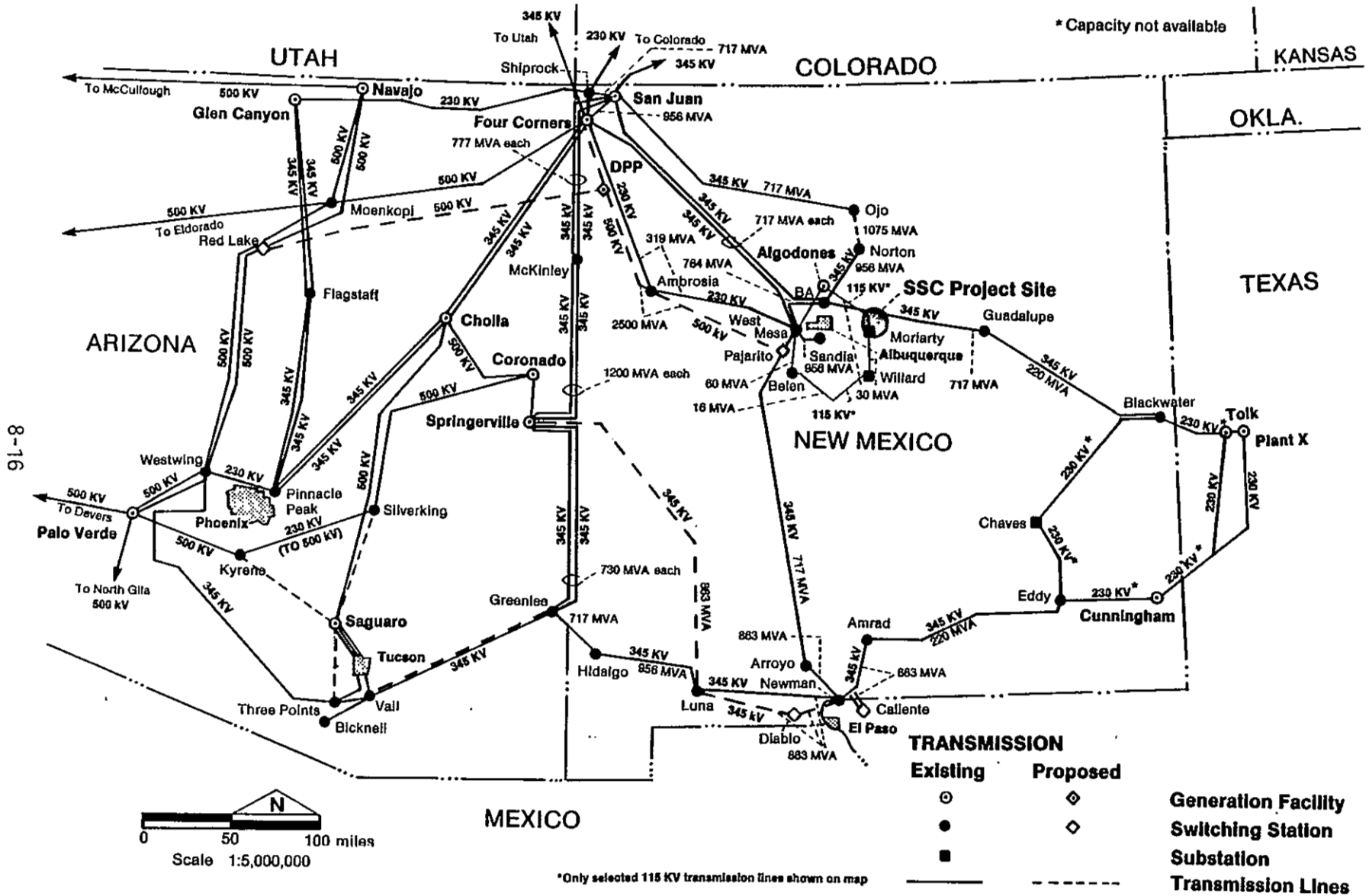

Figure 8.1-10. Regional Transmission Capacity Map.

8.1.3 POWER SYSTEM CAPABILITY AND STABILITY

Existing System Capabilities and Stability

The New Mexico EHV transmission system capability to import power is currently limited by voltage drops during transmission line contingencies. That transmission system limit is significantly lower than the system's thermal or stability limits. As prudent operators, the New Mexico utilities limit total imports from the west for system security during peak summer and winter load periods by using local gas-fired generation at the load centers, or by importing power from the SPP through the asynchronous ties at Blackwater and Eddy County.

System Capabilities With Planned Additions

The New Mexico transmission import limit will significantly increase as the planned transmission system additions discussed in Section 8.1.1 go into service. Transmission planning studies for those projects have shown that the import limit will remain voltage drop limited, well below thermal and stability limits. With the planned system additions, the expected transmission capability margin (above projected New Mexico load serving requirements) will have significant flexibility available to serve new loads such as the proposed SSC, with ample room for load growth. The use of local gas-fired generation at the load centers will remain available to further enhance system security as needed.

Should additional transfer capability be required by the final design of the SSC, installation of series capacitors in the 345 kV lines between the Four Corners region and the Albuquerque area is an available means to enhance system import capabilities. Also, the construction schedule for the DAP 500 kV Project, described in Section 8.1.1, could be accelerated for an earlier in-service date.

Benefit From Proposed SSC Transmission Additions

The system additions proposed for integrating the Estancia Basin SSC site into the New Mexico transmission grid would also have the secondary benefit of strengthening the EHV grid itself. A double-ended 345 kV feed would be made available to the Sandia 345 kV substation, which is now fed radially. Sandia substation serves Kirtland Air Force Base and the Sandia National Laboratory. Also, a 345 kV transmission loop would be formed around the Albuquerque load center, improving system reliability and stability.

8.1.4 UTILITY RATE SCHEDULES

Presently and well into the future, New Mexico utilities project abundant and as yet uncommitted power supplies which could be made available to the SSC. Much of this generating capacity is supplied from plentiful New Mexico coal and uranium reserves. The availability of these resources allows New Mexico utilities to offer a competitively low priced and assured power supply to the SSC, from now until the turn of the century. The New Mexico Public Service Commission is committed to economic

development in this state and encourages innovative, flexible, and competitive pricing by the utilities in achieving that goal.

There are no existing or anticipated customer loads in New Mexico similar to, or as significant as, that planned for the SSC. Therefore, current utility tariffs are not representative of rates which could apply to the SSC. New Mexico utility incremental costs are very low because of surplus capacity and low-cost fuels. These utilities are therefore quite willing and able to offer a wide range of flexibility in designing a competitive service package. This would include rates at both the retail and wholesale levels that could provide substantial discounts for special new loads in the first 10 years of operation, and subsequent market-based rates which will compete favorably with any other available U.S. power source.

It is anticipated that market rates for this region in the early to late 1990's will range from 3.6 to 4.6 cents per kWh in 1987 dollars for a customer with load characteristics similar to the SSC (84% load factor). These costs translate in 1990's dollars to approximately 5.0 to 6.5 cents per kWh. These energy costs include a demand component and cost of fuel but exclude transmission and interconnection costs which can be reasonably and reliably accomplished in accordance with New Mexico's SSC Transmission Integration Plan. Utilities under New Mexico Public Service Commission's jurisdiction are in a strong position currently, and through the 1990's, to offer firm and reliable power at competitive prices within this range largely because of the availability of abundant generation capacity and low-cost fuel sources within the state. It should also be noted that regulation in New Mexico is flexible enough to allow just and reasonable rate concessions based on contractual negotiations between suppliers and buyers for retail and wholesale transactions which can result in rates lower than these market-based range estimates.

Regarding firm commitments, a New Mexico utility has offered a 10-year commitment to serve the entire SSC load at prices as low as 3.6 to 3.9 cents/kWh in 1987 dollars beginning in 1994. This equates to 5 to 5.5 cents/kWh in 1994 dollars assuming 5 percent inflation. In addition, we expect these rates to decline in real terms over the 10-year period relative to 4 to 5 percent inflation rate. These price estimates exclude certain transmission and interconnection costs which can be reasonably and reliably accomplished in accordance with the integration plan described earlier at an estimated cost of \$32 million. This cost could be added to utility rates discussed above or other financing arrangements could be employed.

See Appendix 8-A for letters from the Public Service Commission of New Mexico, PNM, PGT, and EPE.

8.1.5 PROJECTION OF FUTURE POWER DEMANDS

New Mexico is confident of its utilities' abilities to comfortably serve the SSC load requirements now and into the next century at reasonable and regionally competitive prices. There are three principal electric

utilities that serve New Mexico from the WSCC grid: Public Service Company of New Mexico (PNM), Plains Electric Generation and Transmission Cooperative (PGT), El Paso Electric Company (EPE). Although we expect higher than national average growth in the region, we do not anticipate significant future cost increases due to additional generation, even with the addition of the SSC load. This is a consequence of the existing abundant supply of power.

To illustrate current resource levels, the predicted New Mexico power area peak load in 1987 is 2,263 MW and the utilities project a combined load growth rate of 2.8 percent per year for the next 10 years. In 1996 the New Mexico load is therefore projected to be 2,882 MW while resources are known to be 4,024 MW at that time, providing a statewide reserve margin of 32 percent (Figure 8.1-11). If the SSC load of 250 MW was added, the 1996 statewide reserve margin would remain significantly above the 15 to 20 percent planning reserve margin used to determine generation capacity additions. Furthermore, one of the two New Mexico utilities adjacent to the proposed New Mexico site, has enough reserve capacity to serve the entire 250 MW load beyond the turn of the century before that utility reaches a less than 20 percent reserve margin. In addition the Dineh Power Project, planned for the late 1990s (and not reflected in Figure 8.1-11), will be available to serve new loads into the next century from inexpensive and plentiful New Mexico coal deposits.

	<u>1987</u>	<u>1988</u>	<u>1989</u>	<u>1990</u>	<u>1991</u>	<u>1992</u>	<u>1993</u>	<u>1994</u>	<u>1995</u>	<u>1996</u>
Resources (MW)	3405	3611	3635	3840	3951	3961	3987	3974	4049	4024
Load (MW)	2263	2291	2350	2411	2490	2572	2679	2767	2808	2882
SSC	--	--	--	--	--	--	250	250	250	250
Reserves (%)										
W/O SSC	50%	58%	55%	59%	59%	54%	49%	44%	44%	40%
W/SSC	50%	58%	55%	59%	59%	54%	36%	32%	33%	28%

Figure 8.1-11. New Mexico loads and resources.

8.2 INDUSTRIAL COOLING WATER

8.2.1 AVAILABLE SOURCES AND SEASONAL VARIATIONS

Water rights to adequate high quality groundwater for industrial cooling of the SSC throughout its useful life are available in the Estancia Basin, and will be assigned to the Federal Government at no cost. There are no major water production or distribution facilities for sale of water within the site or in the vicinity of the site; however, water rights located within the site area and vicinity can be developed from underground sources, and the water can be piped to the required locations. Careful advanced planning can optimize utilization of water rights and minimize the cost of production and distribution facilities. This, in turn, should lead to very economical water costs. Please refer to Sections 3.3,

3.3.1, and 3.3.2 for the geohydrology characteristics of the several aquifers and the water resources in the study area. See also the letter from the State of New Mexico, Office of the State Engineer, Appendix 8-B, for an overall assessment of water supplies for the SSC and an expediting commitment.

There will be essentially no seasonal variations because production will be from underground sources.

8.2.2 WATER COST

The cost of water will be composed of fuel costs and amortization costs of production facilities because distribution systems will be required in any event. As stated in Section 8.2.1, flexibility exists to optimize use of water rights which will be made available at no cost. Careful planning will minimize the cost of distribution facilities as well as production facilities. The end result will be economical costs for required suppliers of both cooling water and potable water.

The estimated value of the water rights being offered is \$500 per acre foot. Converting the sum of cooling water and potable water requirements (2,200 gpm and 250 gpm, respectively) to acre feet results in an annual usage of approximately 3,954 acre feet. It is doubtful that production would be that large because the figure equates to constant production on a 24-hour basis. The computed value for 3,954 acre-feet is \$1,977,000.

8.2.3 WATER QUALITY

The quality of water varies from place to place within the Estancia Basin. This is influenced by the geologic stratum constituting the principal aquifer at a particular location. Sections 3.3, 3.3.1, and 3.3.2 of this proposal infer that in the areas of likely water withdrawal, water quality generally meets New Mexico Drinking Water Quality Standards given in Figure 8.2-1. It is certain that water will require minimal treatment for industrial purposes, and that adequate supplies of potable water are available.

8.3 POTABLE WATER

8.3.1 AVAILABLE SOURCES

Water withdrawn from underground sources on most of the site and in the vicinity of the site is potable, as stated in Sections 8.2.1 and 8.2.3.

8.3.2 WATER COST

Available data on potable water cost is identical to data on industrial water cost, as set forth in Section 8.2.2.

Arsenic	0.1 mg/l
Barium	1.0 mg/l
Cadmium	0.01 mg/l
Chromium	0.05 mg/l
Cyanide	0.2 mg/l
Fluoride	1.6 mg/l
Lead	0.05 mg/l
Mercury	0.002 mg/l
Nitrate	10.0 mg/l
Selenium	0.05 mg/l
Silver	0.05 mg/l
Uranium	5.0 mg/l
Radioactivity (Ra226 and Ra228)	30.0 pCi/l
Benzene	0.01 mg/l
Polychlorinated biphenyls	0.001 mg/l
Toluene	15.0 mg/l
Carbon Tetrachloride	0.01 mg/l
1,2-dichloroethane	0.02 mg/l
1,1-dichloroethylene	0.005 mg/l
1,1,2,2-tetrachloroethylene	0.02 mg/l
1,1,2-trichloroethylene	0.1 mg/l

Figure 8.2-1. New Mexico groundwater quality human health standards.

8.4 FUEL

8.4.1 FUEL SUPPLY DESCRIPTION

The campus facilities described in the SSC conceptual design document readily lend themselves to service from a centralized heating and cooling plant. This plant would utilize natural gas to produce both chilled water through use of adsorption chillers and either hot water or steam through the use of boilers. An abundant supply of natural gas is available near the proposed site that can be easily delivered.

New Mexico has 14.762 Trillion Cubic Feet (TCF) of proved, developed, and undeveloped reserves of natural gas. Production from these reserves, and others that may be contracted for in the future, provide New Mexico with a long-term reliable supply of gas for its customers and a secure base from which to provide gas for the Superconducting Super Collider facility. In addition, two major interstate pipelines provide access to gas produced in Texas and Oklahoma.

New Mexico produces approximately eight times the amount of natural gas that is consumed within the state, and several times that volume of natural gas passes through the state from suppliers in Oklahoma and Texas to markets in California and other western states. Because New Mexico is a significant producing state and also a conduit for extremely large volumes of natural gas flowing to other large markets, it provides a unique siting opportunity due to the security of natural gas supplies now and long into the future.

The above information demonstrates that New Mexico can supply secure long-term competitively priced natural gas supplies. New Mexico was one of the first states to implement mandatory contract carriage rules, and therefore, provides the mechanism for a qualifying customer to secure its own natural gas and have it transported by any distribution company. A demand requirement of more than 100 MMBtu/day qualifies a customer for brokerage and transportation services. New Mexico can provide a customer with secure, competitive natural gas service and the flexibility to choose from different suppliers.

Figure 8.4-1 shows the major natural gas pipelines located in New Mexico as well as the proposed line extension to serve the SSC site. The New Mexico fuel delivery system can easily provide the 55 million Btu/hr campus requirement. It can be expanded to provide additional capacity if needed.

8.4.2 NATURAL GAS PRICE FORECAST

Natural gas rates in New Mexico consist of two components: (1) cost of gas, and (2) cost of service. Historically the cost of gas in New Mexico has been one of the lowest in the United States.

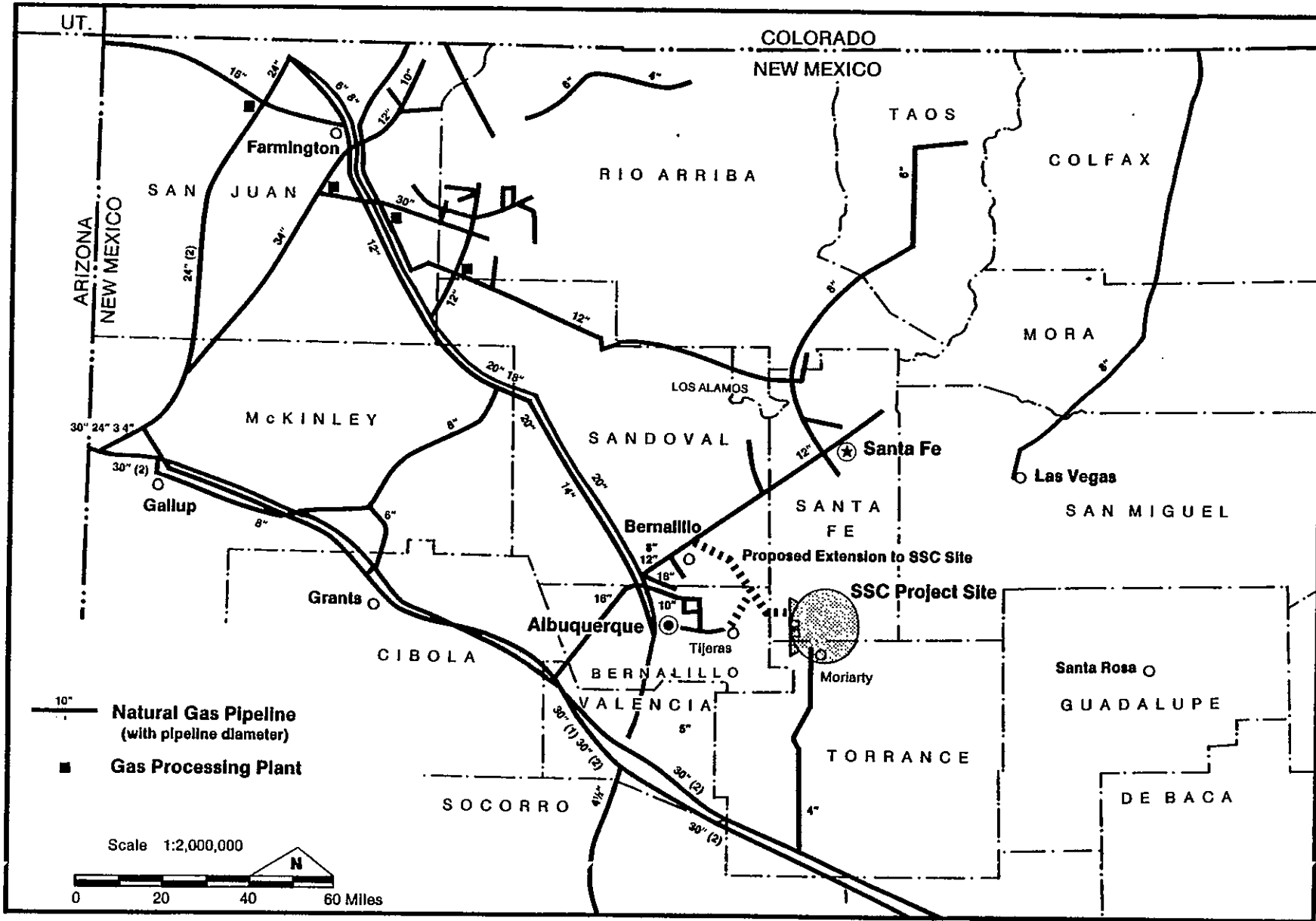

Figure 8.4-1 Regional Natural Gas Pipeline System.

Figure 8.4-2 is a cost projection for cost of gas and cost of service to a large load such as the SSC. The cost of gas is based on the American Gas Association Total Energy Resource Analysis Base Case published in the September 1986 Gas Energy Review. It is presented in constant 1987 dollars through the year 2000.

<u>Year</u>	<u>Gas Cost Per MMBtu In 1987 Dollars</u>	<u>Cost of Service Per MMBtu</u>	<u>Total Cost of Gas Plus Cost of Service Per MMBtu</u>
1987	\$2.05	\$0.59	\$2.64
1988	1.94	0.59	2.53
1989	1.95	0.59	2.54
1990	1.97	0.59	2.56
1991	2.02	0.59	2.61
1992	2.08	0.59	2.67
1993	2.14	0.59	2.73
1994	2.19	0.59	2.78
1995	2.25	0.59	2.84
1996	2.31	0.59	2.90
1997	2.37	0.59	2.96
1998	2.43	0.59	3.02
1999	2.49	0.59	3.08
2000	2.55	0.59	3.14

Figure 8.4-2. Projected gas costs plus cost of service.

New Mexico can provide the SSC facility with a secure, competitively priced natural gas service.

8.5 WASTE AND SEWAGE DISPOSAL

8.5.1 AVAILABLE TREATMENT FACILITIES

Currently, individuals use septic tank systems for domestic and light industrial uses. These systems are fully adequate for current uses.

The Estancia Basin site is a rural area and no adequate treatment facilities sufficient to handle wastes from an installation the size of the SSC are conveniently available. Sanitary wastes would require treatment on site. Discharges of waste water are covered under Water Quality Control Commission regulations. For further information see Sec. 5.2.3 and Figure 8.2-1.

8.5.2 TYPES AND CAPACITIES OF SOLID WASTE DISPOSAL RESOURCES

There are no approved disposal sites in New Mexico which accept either hazardous or mixed wastes at this time. Hazardous or mixed wastes would need to be stored on site. Hazardous wastes are currently being produced and stored on-site at other DOE facilities located within New Mexico. A regional effort is ongoing to establish a hazardous waste storage site.

The SSC site is remote from existing municipal landfills which have sufficient capacity to receive SSC solid waste. An on site landfill would be more suitable. Obtaining a permit for such a landfill is routine and would only require written notification from the New Mexico Environmental Improvement Division.

APPENDIX 8-A

Commitments to Supply Electric Power



NEW MEXICO PUBLIC SERVICE COMMISSION

POST OFFICE BOX 2205
SANTA FE, NEW MEXICO
87504-2205
(505) 827-6940

GARREY CARRUTHERS
GOVERNOR

MARIAN HALL, 224 EAST PALACE AVE., SANTA FE, NM 87501

JOSEPH E. SAMORA, JR.
CHAIRMAN
MARTIN J. BLAKE
COMMISSIONER
S. PETER BICKLEY
COMMISSIONER

June 26, 1987

Mr. Herman Roser
SSC Proposal Coordinator
1004 Daskalos, N.E.
Albuquerque, New Mexico 87123

Dear Mr. Roser:

The New Mexico Public Service Commission understands that the Department of Energy, in April 1987, issued its Invitation for Site Proposals for the Superconducting Super Collider Project (SSC).

The Commission fully supports the SSC Project and the potential benefits this project would have on the economic development of our State. We encourage and are fully committed toward achieving such development.

Based on our analysis, and the written analyses of the utilities under Commission jurisdiction, the Commission concludes that the utilities under our jurisdiction have the ability to serve the 250 MW SSC load requirement addressed in Section 3.2.4 of the Qualifications Criteria, now and into the next century with the existing state reserve margins. We have already received commitments from some of our jurisdictional utilities to serve the entire SSC load requirements at prices ranging from 5.0 to 6.5 cents per kwh (in 1990s dollars) in the 1990s beginning with full operation of the project.

If I may ever be of any assistance to you, please do not hesitate to call me.

Very truly yours,

Joseph E. Samora, Jr.
Chairman

JES/ts

NEW MEXICO SSC PROPOSAL JULY 31, 1987

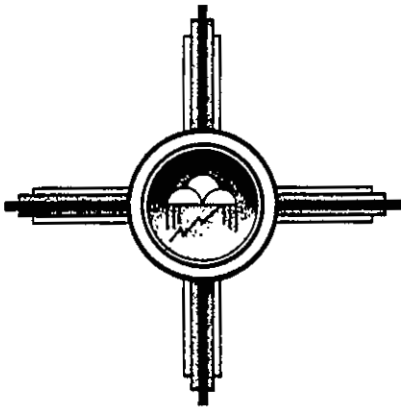

PLAINS ELECTRIC GENERATION AND TRANSMISSION COOPERATIVE, INC.

Albuquerque Headquarters
2401 Aztec Road, NE, P.O. Box 6551
Albuquerque, New Mexico 87197
Phone (505) 884-1881

Escalante Generating Station
P.O. Box 577
Prewitt, New Mexico 87045
Phone (505) 876-2271

June 22, 1987

Mr. John Herrington
Secretary of Energy
U. S. Department of Energy
1000 Independence Avenue SW
Washington, D. C. 20585

RECEIVED
JUN 22 10 17 AM '87
NEW MEXICO
PUBLIC
SERVICE
COMMISSION

Dear Mr. Herrington:

We believe that the Superconducting Super Collider is a research project of critical importance to the United States.

The proposed New Mexico SSC site is aligned in an area served by Plains' member, Central New Mexico Electric Cooperative, Inc. Plains and Central New Mexico would like to assure the DOE that, should the New Mexico SSC site be selected, we are willing and able to provide electric service to the facility.

Sincerely,

PLAINS ELECTRIC GENERATION AND
TRANSMISSION COOPERATIVE, INC.

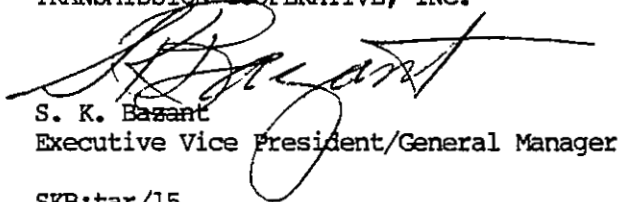
S. K. Bazant
Executive Vice President/General Manager

SKB:tar/15

NEW MEXICO SSC PROPOSAL JULY 31, 1987



PUBLIC SERVICE COMPANY OF NEW MEXICO

ALVARADO SQUARE ALBUQUERQUE, NEW MEXICO 87158 _ _ _ _

June 24, 1987

Mr. John Herrington
Secretary of Energy
U. S. Department of Energy
1000 Independence Avenue, SW
Washington, DC 20585

Dear Sir:

Subject: Superconducting Super
Collider (SSC)

This letter is to inform you, for purposes of New Mexico's SSC proposal, that the Public Service Company of New Mexico (PNM) has the capability and would be very pleased to provide 200 to 250 MW of firm electrical power to the SSC project.

PNM is a New Mexico corporation which, among other business activities, provides electric, gas, and water service within various portions of the State of New Mexico. As a public utility, PNM's retail services are subject to the jurisdiction of the New Mexico Public Service Commission, and certain wholesale transactions are subject to regulation by the Federal Energy Regulatory Commission.

PNM currently has uncommitted, installed generating capacity sufficient to serve the additional 250 MW SSC load to beyond the turn of the century. PNM's transmission system, which currently is within four miles of the proposed SSC site, includes a 345 kV line which would link that site to both the eastern (Southwest Power Pool) and western (Western States Coordinating Council) United States grids. This is one of very few lines in the United States with this reliability enhancing characteristic. New Mexico's proposal to serve the SSC site provides for an "integration plan" which would provide two separate 345 kV sources to the SSC site. This linkage would provide an extremely reliable and cost-effective source to the SSC.

In summary, PNM has generating capacity available which we are willing to commit to the SSC at a competitive price, and we have an existing high voltage delivery system at the proposed SSC site. We would be very pleased to secure firm service to the SSC should the Estancia

NEW MEXICO SSC PROPOSAL JULY 31, 1987

Mr. John Herrington

- 2 -

June 24, 1987

Valley site be selected. If you need additional information, please feel free to call my office anytime at (505) 848-2891.

Sincerely yours,

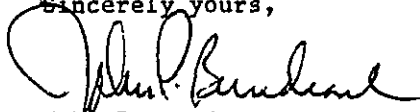

John P. Bundrant
President and Chief Operating
Officer, Electric Operations

BAK:sim

cc: Mr. Joseph E. Samora, Jr., Chairman
New Mexico Public Service Commission

NEW MEXICO SSC PROPOSAL JULY 31, 1987



El Paso Electric Company
Mesilla Valley Division
P.O. Box 910
Las Cruces, New Mexico 88004
(505) 526-5551

June 22, 1987

Mr. Domingo Sanchez, III
Public Utility Engineer
New Mexico Public Service Commission
Marian Hall
224 E. Palace Avenue
Santa Fe, New Mexico 87501-2013

RECEIVED
JUN 23 10 33 AM '87
NEW MEXICO
PUBLIC SERVICE
COMMISSION

Dear Mr. Sanchez:

**SUPERCONDUCTING SUPER COLLIDER
ESTANCIA BASIN SITE, NEW MEXICO**

The El Paso Electric Company fully supports the Superconducting Super Collider (SSC) Project and its potential for a new revolution in science, education, technology and commerce.

Our Company has the generation and transmission resources fully capable of providing reliable electric service to support the power requirements of the SSC at the Estancia Basin site. Because we have ample capacity, and the prospect of a continuing decline in fuel costs, we can be flexible in the design of a competitive pricing proposal to keep operating costs to a minimum. We can also provide two 345 KV transmission lines to this site for increased reliability.

El Paso Electric Company has provided firm, reliable electric service to White Sands Missile Range and Holloman Air Force Base in New Mexico for many years. Our commitment to provide this electric service at the lowest cost possible is of utmost importance to our Company.

We stand ready to assist SSC Project Officials wherever possible and if you have any questions, please call me at (505) 526-5551.

Sincerely,

L.M. Downum
Vice President

NEW MEXICO SSC PROPOSAL JULY 31, 1987

APPENDIX 8-B

Letter from State Engineer



STATE OF NEW MEXICO

STATE ENGINEER OFFICE

SANTA FE

S. E. REYNOLDS
STATE ENGINEER

BATAAN MEMORIAL BUILDING
STATE CAPITOL
SANTA FE, NEW MEXICO 87503

June 26, 1987

Mr. Herman E. Roser
Coordinator, New Mexico SSC
Site Evaluation Committee
2808 Central Avenue, N.E.
Albuquerque, N.M. 87110

Dear Mr. Roser:

I have reviewed information pertaining to the location of the Superconducting Super Collider (SSC) selected by your committee in the North Estancia Basin. The files of the State Engineer Office indicate that there are a number of irrigation wells located within one mile of the proposed alignment of the collider ring which have a reported water producing capacity of 450 to 1,000 gallons per minute.

A partial list of these wells, their location, and their reported capacity is:

Well	Location	Reported Capacity (gpm)
E-280	NW $\frac{1}{4}$ NW $\frac{1}{4}$ SW $\frac{1}{4}$ Sec. 8, T9N, R8E	750
E-1257 & E-1257-S	S $\frac{1}{2}$ NW $\frac{1}{4}$ Sec. 15, T9N, R8E	1,000 total
E-288	SW $\frac{1}{4}$ NW $\frac{1}{4}$ NE $\frac{1}{4}$ Sec. 24, T9N, R8E	440
E-288-S	SW $\frac{1}{4}$ NW $\frac{1}{4}$ NE $\frac{1}{4}$ Sec. 24, T9N, R8E	450
E-288-S-2	NE $\frac{1}{4}$ NW $\frac{1}{4}$ NE $\frac{1}{4}$ Sec. 24, T9N, R8E	450
E-193	SW $\frac{1}{4}$ SE $\frac{1}{4}$ Sec. 26, T9N, R8E	1,000
E-47	SE $\frac{1}{4}$ NW $\frac{1}{4}$ NE $\frac{1}{4}$ Sec. 35, T9N, R8E	500

It is my understanding that the SSC project will require a pumping capacity of 2200 gallons per minute (peak) from one or more wells for industrial purposes and 250 gallons per minute (average) for potable water purposes. The foregoing supports a conclusion that these capacities can be obtained for the proposed SSC site.

Information made available indicates as much as 3700 acre feet per year, may be required for the SSC. The inventory of the State Engineer indicates that that amount of unappropriated water is available within the vicinity of the ring; however, a permit for that amount may require acquisition and retirement of existing irrigation rights. The amount of such acquisition would depend on the well sites selected.

NEW MEXICO SSC PROPOSAL JULY 31, 1987

The administrative procedures required by the statutes and the rules and regulations of the State Engineer for relocation of wells or permits to appropriate groundwater will be expedited.

Sincerely,

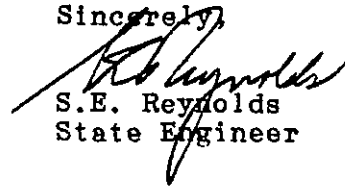
A handwritten signature in black ink, appearing to read "S.E. Reynolds", is written over the typed name and title.

S.E. Reynolds
State Engineer

lig

NEW MEXICO SSC PROPOSAL JULY 31, 1987