

2022 CATALOG WORLD'S FINEST HOOKS

GAMAKATSU®

## 2022 NEW PRODUCTS

### G-Finesse Feathered Treble MH

Based largely on the input of Major League Fishing pro Aaron Martens, the G-Finesse feathered trebles feature either white or chartreuse premium feathers and complementary tinsel, hand selected by Martens to tempt even the most finicky fish.

The G-Finesse feathered trebles feature TGW (Tournament-Grade Wire) construction, which is thinner, stronger and sharper than the standard wire. That means anglers will use fewer of them while ensuring better hook up percentages as the fishing day goes. To complete the job, they come with a Nano-Coat finish that makes penetration even easier. *Page 20.*



### G-Power Heavy Cover Flip and Punch

Designed by Aaron Martens, Gamakatsu has developed the new G-Power Heavy Cover Flip and Punch Hook. A step up from the G-Finesse Heavy Cover Hook, for serious flipping and punching with heavy fluorocarbon and braid.

The TGW (Tournament Grade Wire) hook, paired with its welded eye, make this the strongest Heavy Cover hook in Gamakatsu's G-Series lineup. Ideal for larger baits and weights, punching through grass mats and flipping into heavy timber. G-Power Flip and Punch ideally matches to all types of cover and able to withstand extreme conditions. *Page 26.*



### G-Finesse Cover Neko

By combining Gamakatsu's legendary quality and the design of Major League Fishing pro Shin Fukae, the perfect Neko hook now exists for this popular technique. The Cover Neko Hook consists of a shiner-style straight eye hook with an attached swivel to prevent line twist. There's also a strong, 90-degree wire keeper to lock plastics in place. Taken together, it's a tool that will let anglers easily fish through brush, laydowns and grass while maximizing hook-up percentages. *Page 22.*



### Treble SP XH

Replacing factory hooks on inshore plugs, jigs and spoons with Gamakatsu's heavy-duty SP XH treble hooks is an instant upgrade. The Tournament Grade Wire (TGW) construction is thinner, stronger and sharper than standard wire, making these Gamakatsu's strongest treble ever. Plus, the short shank design eliminates leverage that can lead to worn jaws and pulled hooks. *Page 28.*



**Siwash Open Eye** – NS Black color addition. *Page 45.*

### TGW Octopus

The TGW (Tournament Grade Wire) Octopus utilizes Gamakatsu's ultra-strong TGW wire that's thinner, sharper and stronger than the standard wire and ensures the hook point stays sharper, longer. This is combined with Gamakatsu's Nano Smooth Coat finish to provide a faster, deeper penetrating hook. The hook's all-purpose shape and forged construction makes it ideal for a variety of presentations. The TGW Octopus Hook also features an upturned eye to ease snelling or knotting directly to the eye. *Page 35.*



**Split Shot/Drop Shot** – Fluorescent color additions. Pink, Orange, Chartreuse, and Red. *Page 50.*

**Big Cat Circle** – 25 pack addition. *Page 54.*

### Spring Lock Spinner

The new Spring Lock Spinner from Gamakatsu makes your favorite swimbaits and other soft plastics even more effective by adding flash and vibration to attract fish from even greater distances. The revolutionary design features two retaining wires wound in parallel, making rigging simple and providing even more holding power, so baits won't slip no matter how hard you fish. The new rigging system has innovative features that draw strikes from pressured fish and is built on a premium 2x strong hook to handle the biggest predators. Combining the 28-degree hook eye and premium spring lock allows you to keep your bait in place, so it runs true every cast. *Page 72.*



### Round 26R Weedless

Like the original Round 26, the weedless version features a standard lead collar, but adds dual offset rebarb wire keepers to securely and firmly hold a wide range of soft plastic baits. It also features a dual-titanium, wire weed guard that will not break, offering the added versatility to fish in and around heavy cover, where the bigger, more elusive lunkers lie. *Page 77.*



### Under Spin Head Mini

The Under Spin Head Mini features Gamakatsu's premium size 1 Finesse Heavy Cover 60-degree hook, the wide gap design means you can still rig bulkier plastics and have plenty of bite. Ideal for smaller finesse presentations, the head profile is streamlined to glide through cover. Attention-getting recessed lifelike eyes and the small chrome willow leaf blade result in a combination that fish can't resist. Gamakatsu's Spring Lock holds swim baits and other plastics gently but firmly, keeping the presentation straight on the hook. *Page 73.*



### DuraScent Shrimp, Sandworm, Crab, Octopus and Salmon Eggs

DuraScent baits are infused with an all-natural blend of fish attracting scent that fish can't resist and are extremely durable, lasting longer than traditional soft plastics. The super-soft elastomer material provides extreme flexibility, stretching to over six times its length and the buoyant material provides a life-like presentation. Made from a non-toxic formula that's free from plastisol and phthalates making them environmentally friendly. *Page 85, 86, 87.*



### MaxEye Jig Pill Head

When it comes to drawing strikes from predatory fish such as walleye Gamakatsu's MaxEye jigs are as good as it gets. This premium jig features highly detailed life-like eyes and a durable paint finish that will not chip or flake. It also boasts a dual offset rebarb wire keeper and collar system, which will safely secure the softest and most-fragile plastics or live bait without tearing. The premium Big River Jig Hook sports an increased gap diameter to increase hook-ups and a special bend with an acute angle to provide better holding power. The MaxEye Pill Head jig has a unique shape which resists snags and imparts a unique action when it contacts the bottom. *Page 79*



### MaxEye Jig Swim Head

When it comes to drawing strikes from predatory fish such as walleye Gamakatsu's MaxEye jigs are as good as it gets. This premium jig features highly detailed life-like eyes and a durable paint finish that will not chip or flake. It also boasts a dual offset rebarb wire keeper and collar system, which will safely secure the softest and most-fragile plastics or live bait without tearing. The premium Big River Jig Hook sports an increased gap diameter to increase hook-ups and a special bend with an acute angle to provide better holding power. The MaxEye Swim Head jig has a special design that's great for use with any soft plastic swimbait, pairing perfectly with bulky plastics or smaller finesse baits. *Page 79.*

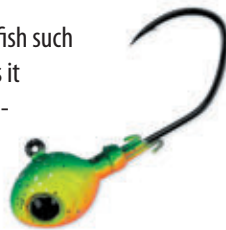

### Spiral Z

Gamakatsu introduces the Spiral Z, a beaded attractor that'll call trout and salmon from a distance while also doing double duty with other species. The Spiral Z offers up a new package with a distinct look, vibration and sound appeal. It is built around a stainless-steel wire with colored beads in a variety of colors for attraction and a ball-bearing line swivel to eliminate line twist. Anglers can add their favorite hook to the end, or it can also be used as an attractor by rigging it any distance in front of a favorite lure. Unlike a traditional spinner where the blade rotates on a clevis, with the Spiral Z, the entire package rotates, creating an undulating lifelike meal for gamefish of every species. Traditional dodgers and flashers will get left in the dust. *Page 82.*



### Tungsten Wobble Head

With a head design that unites the benefits of both a cobra head, for passing through grass, and a football head, for snag resistance on a hard bottom, the Tungsten Wobble Head creates a natural looking, slithering action that draws major attention from nearby bass. Ideal for slow-swimming retrieves, the head increases the action of any plastic bait along the bottom. The precision wire harness is tuned to exacting tolerances and a recessed line tie helps it stay weedless. Features a chip-proof black matte finish and the weight size is stamped on the side of the each weight. *Page 74.*



### G-Shield Tungsten Worm Weight

The G-Shield Tungsten Worm Weight features a specially designed composite insert that not only protects an angler's line, but also provides 360-degree protection for the knot. The insert is wider at the base than at the insertion hole so the hook can recess itself into the weight, creating a more compact, lifelike and snag resistant offering. The worm weight is the all-purpose champ, best for casting into light cover or dragging plastics across bare lake and river bottoms when subtlety is essential and features a stealthy, chip-proof black matte finish. For easy identification the weight size is stamped into the side of each weight. *Page 90.*



### G-Shield Tungsten Flipping Weight

The G-Shield Tungsten Flipping Weight features a specially designed composite insert that not only protects an angler's line, but also provides 360-degree protection for the knot. The insert is wider at the base than at the insertion hole so the hook can recess itself into the weight, creating a more compact, lifelike and snag resistant offering. The flipping weight is slightly wider and excels when flipped or pitched into heavy cover and features a stealthy, chip-proof black matte finish. For easy identification the weight size is stamped into the side of each weight. *Page 90.*



### G-Shield Tungsten Punch Weight

The G-Shield Tungsten Punch Weight features a specially designed composite insert that not only protects an angler's line, but also provides 360-degree protection for the knot. The insert is wider at the base than at the insertion hole so the hook can recess itself into the weight, creating a more compact, lifelike and snag resistant offering. The punch weight will penetrate thick overhead canopies that resist other shapes. It's bulbous at the front, creating a weight-forward design that builds inertia when it first contacts likely bass-holding cover and features a stealthy, chip-proof black matte finish. For easy identification the weight size is stamped into the side of each weight. *Page 90.*



**Nautilus Circle and Nautilus Circle with Ring** – New size addition *Page 94.*

**Live Bait** – New size addition. *Page 92.*

## 2022 NEW PRODUCTS

### Kraken Circle Monster

The Kraken Circle Monster was developed for use with larger chunk baits and provides the strength and size to target giant fish. The circle hook is a time-tested and proven design, and the wide gap ensures reliable hook-ups even with the largest jawed fish. Their monster-sized eye provides anglers a range of rigging options including heavy tuna cord, mono, fluoro and even wire. The straight eye design offers the option of snelling or crimping. *Page 96.*



### Kraken Outbarb Circle

The Kraken Outbarb Circle's distinctive outside barb provides several advantages when targeting giant sized fish. One is straight holding power, because the outbarb cannot back out like a traditional barbed hook, and hook damage typically occurs on the opposite side of the hook, further reducing potential pull-out. Another is better, easier penetration because the barb is opposite the side of the hook doing most of the work. It's also less likely anglers' line will catch on the barb if it wraps around the hook on the drop or cast. *Page 96.*



### Assist 700 Double NSC

If you're targeting larger fish, outfit your jigs with the Assist 700 Double. This rig doubles up on the standard slow pitch assist hooks to maximize hookups. Gamakatsu also applied their Nano Smooth Coat to the hooks; this super slick coating reduces resistance for deeper penetration. *Page 105.*



### Assist 530 Double Short and Double Long

The new Assist 530 Double comes in both long and short versions to suit various jig lengths. The polyethylene braided line features a fluorocarbon core making it stiffer, which reduces tangles and promotes deeper penetration when a fish is hooked. *Page 106*



### Assist 540 Double Bait Plus

For light tackle, micro jigging in saltwater, and vertical jig fishing for bass, Gamakatsu developed the new Assist 540 Double Bait Plus. For added attraction, Gamakatsu utilized a fish skin dressing. Each flashes just like your favorite sabiki rig, drawing strikes from the most reluctant fish. The leader is shorter on one side to increase visibility of each hook for maximum drawing power. This also further decreases the possibility of tangles, even with the most vigorous jigging techniques. *Page 104*



### Assist 560 Double

If fishing smaller profile jigs is your thing, check out the new Assist 560 Double. The smaller size minimizes fouling on light tackle and micro jigging applications. When the bass go deep, rig up your favorite jig with the 560 Double to up the catch rates with lethargic biters. *Page 104*



### Assist 550 Short

The new Assist 550 Short provides the brawn needed to land pelagic gamefish on lures typically reserved for inshore species. Unlike the long metal shanks on treble hooks, the flexible leader doesn't act like a lever to give fish a mechanical advantage that can defeat even the stoutest hook hangers. You can replace light-wire trebles with the heavier duty Assist 550 Short and retain the action that makes your favorite plug so effective *Page 107*



### French Hook Snell

The Gamakatsu French Hook Snell comes in red or bronze color, to add a little bit of extra attraction to any bait. Each of the five hook sizes are pre-tied to 24 inches of high-quality Japanese monofilament line of a suitable pound test for the hook size. As anglers would expect, these are rigged with premium Gamakatsu hooks. The Gamakatsu French Snell Rig will work for anything from trout to walleye, with a variety of live or artificial baits. *Page 116*



### G-Box Reversible 3200 Utility Case

Gamakatsu takes tackle storage to the next level with the new G-Box 3200 Reversible Utility Case. The innovative design places a lid on both sides of the box, effectively creating two separate containers in one unit. Each side of the G-Box 3200 Reversible Utility Case has its own lid, doubling tangle-free storage space in each container. The new design features V-shaped dividers that keep saltwater jigs, crankbaits and other favorites organized and ready to go. Stash a different type of lure on each side and switch fishing styles with a flip of a box. Wide, locking latches keep the boxes securely shut even if they bounce along in the boat or your bag. *Page 132*



### G-Box Reversible 3600 Utility Case

Gamakatsu takes tackle storage to the next level with the new G-Box 3600 Reversible Utility Case. The innovative design places a lid on both sides of the box, effectively creating two separate containers in one unit. Each side of the G-Box 3600 Reversible Utility Case has its own lid, doubling tangle-free storage space in each container. The new design features V-shaped dividers that keep saltwater jigs, crankbaits and other favorites organized and ready to go. Stash a different type of lure on each side and switch fishing styles with a flip of a box. Wide, locking latches keep the boxes securely shut even if they bounce along in the boat or your bag. *Page 133*



### G-Box 3700D2 Deep Utility Case

The G-Box 3700D2 Deep Utility Case features an open box layout with no dividers so anglers can easily stash bulky items like pliers, de-hooking tools, or bulk soft plastics. The hard shell keeps items protected, while the single-hand, easy-open lid clasp allows for easy access. In addition, the lid's tight tolerances ensure even small items can't work their way out when the boat encounters some chop or the road turns rough. *Page 134*



### Hybrid Duffel Backpack 110L

Gamakatsu's water-resistant Hybrid Duffel Backpack offers 110 liters of space to take gear wherever anglers may roam. The innovative pack can be carried in three different ways, thanks to the removable backpack straps, shoulder strap, or side-carrying handle. The main opening provides easy access to the pack's contents. The large, zippered internal pocket and zippered mesh pocket inside the main compartment opening keeps everything organized. The exterior zippered storage pocket and MOLLE-type webbing for attaching and securing gear further add to the organizing potential. The pack folds into itself for compact storage when not in use. *Page 141*



### Rolling Gear Duffel 90L

For those that prefer to roll along, Gamakatsu offers the Rolling Gear Duffel. The pair of sturdy wheels allow for easy transport of 90 liters of belongings. When anglers decide to pick it up, use the adjustable, removable padded shoulder strap or padded handles to carry in comfort. An external zippered pocket and a large inner zippered pocket keep things tidy. Water-resistant construction keeps the elements at bay, so anglers won't have to worry about rain clouds or rough boat rides. A convenient carrying case allows compact storage when anglers are not on the road or at the lake. *Page 141*



**Gear Duffel 30L** When anglers don't have a ton of stuff to tote around, Gamakatsu's water-resistant 30-liter Gear Duffel would be the best to pack up. The large main opening is secured with heavy-duty zippers for easy access, with an external zippered pocket that keeps oft-needed items at the ready. A separate, outer zippered access compartment for dirty clothes or gear keeps anglers clean stuff clean. An adjustable, padded removable shoulder strap lets anglers carry stuff hands-free, though the hook and loop fastener on the main carrying handles works as well. *Page 141*



### G-Bag EWM 5000 H Tackle Bag

The G-Bag EWM 5000 H Tackle Bag features an Extra Wide Mouth (EWM) opening for easy access. An internal wire frame keeps the main compartment in the open position allowing anglers to sort through their tackle and find that perfect bait with ease. Anglers can fit up to five Gamakatsu G-Box 3700 or eight 3600 utility cases inside. A quick-access magnetic front pocket flap also stays in an open position, letting anglers effortlessly grab often needed items from the handy pocket. The durable, 1680 denier polyester construction stands up to a rough life on the water, with a water- and slip-resistant EVA molded base that protects the contents against moisture. *Page 138*



### G-Bag EWM 300 Tackle Bag

The G-Bag EWM 300 is the largest size in the lineup and is designed to carry a variety of tackle comfortably, thanks to the adjustable, padded removable shoulder strap. The generous 13 x 8.5 x 11-inch bag lets anglers stockpile all of their finesse baits and power fishing lures in the same place so they can be prepared for anything. Stuff up to four Gamakatsu G-Box 3600 or eight 3200 utility cases into the G-Bag EWM 300 using the innovative Extra Wide Mouth opening. *Page 138*



## 2021 NEW PRODUCTS

### G-Bag EWM 200 Tackle Bag

The G-Bag EWM 200 Tackle Bag stows more gear using the same innovative easy-access stay-open top. The 9.5 x 5 x 7-inch size easily accommodates magnum packs of soft plastics and oversized bulk bags, so that anglers can stash their largest swimbaits or enough tubes for the season in one convenient location. In addition, there's enough space to store a wide variety of tackle and gear, so anglers can keep rigging tools and other essentials handy as well.

Page 139



### G-Bag EWM 100 Tackle Bag

The G-Bag EWM 100, is the perfect size for holding a variety of soft plastic packs. The Extra Wide Mouth (EWM) provides easy access to the interior, and the internal wire frame keeps the top open while finding the right bait. The 8 x 4 x 6-inch size stows easily in other bags, and anglers can take as many as needed while remaining organized. Pick up a few and keep all smaller items organized and ready.

Page 139



### Microfiber Towel

Gamakatsu throws in the towel on fish slime, scales and other grime that can prevent you from getting a solid grip on your rod. Keep your hands clean and ready to fish with Gamakatsu's new Microfiber Towel. The absorbent microfiber construction of the Microfiber Towel efficiently cleans and dries hands in one pass, so that you can get back to fishing quickly. Page 145



### T-Shirt Flag

90/10 cotton/polyester blend. Comfortable and lightweight classic fit.

Page 148



### Carhartt Midweight Hooded Sweatshirt

10.5 ounce 50/50 cotton/poly blend with attached drawcord closure hood. Stretchable, spandex-reinforced, rib knit cuffs and waistband Front hand warmer pocket. Page 151



### Premium Cuff Beanie

Cotton/poly blend with embroidered logo. Page 150



# HISTORY OF GAMAKATSU

## Invention of hooks

20,000 years ago, the invention of the fish hook marked the beginning of sport fishing. The first hooks were made of wood or bones. As technology improved, so did the hooks. Records show that copper hooks were made in Banchen 7,000 years ago and artificial flies were used in Egypt 4,000 years ago. Fishing was also a popular form of entertainment in ancient China.

Today, modern materials and manufacturing techniques have resulted in hundreds of styles of extremely high quality hooks, designed for specific types of fish and fishing methods.

## Quality of hooks

Gamakatsu hooks are the corner stone of the Gamakatsu company, and are famous worldwide. Material and technology are what makes these hooks superior to all other brands. The Gamakatsu company, in conjunction with a material manufacturer, developed a material known as High Carbon steel specifically for the manufacture of fish hooks. This material not only contains a higher percentage of carbon, but also has very few impurities. As a result, GAMAKATSU has earned Anglers' trust throughout the world. The life of a fish hook is measured by the sharpness, hardness, and viscosity of the point. Using low quality materials results in points that are weak and not truly sharp. In order to use High Carbon steel, Gamakatsu developed a unique electronic tempering process which enables hooks to be tempered in a stable condition. As a result, Gamakatsu is able to manufacture consistently high quality, extremely sharp hooks in large quantities.

## Hook producing

The methods used in creating Gamakatsu hooks is what makes it so superior to all other brands. First, only the most premium grade of high carbon steel is used. This insures against any blemishes in the metal which can weaken the hook.

Secondly, Gamakatsu has the most advanced tempering system in the world. Every hook is heated to the exact temperature that is perfect for that particular style and size then cooled in oil. This process produces hooks which are super strong, but not brittle. It is extremely difficult to achieve a balance between strength and flexibility, and it took many years for Gamakatsu to perfect this process.

Finally, and perhaps most importantly, our sharpening process is the most modern in the world, and results in a perfectly conical point that is unequalled in sharpness.

## Simply the best

Gamakatsu's dedication to producing the highest quality fish hook made, as well as the innovation they bring to the industry has kept the company at the forefront of the premium hook market. Among the innovative ideas that Gamakatsu has introduced are:

- **Durability** - A unique tempering process allowing us to make a hook of superior strength and durability.
- **Strength** - Hooks made of high carbon steel for superior strength.
- **Sharpness** - Conically needle honed points that are sharp from the package and stay sharp.
- **Color Variation** - Colored hooks in red, blue, green, gold, nickel, Bronze, black, shrimp and fluorescent colors F-red, F-chartreuse, F-pink, F-orange, F-glow, F-green, F-purple to match the color of your lure or bait.
- **Style Variation** - Innovative hook designs like the extra wide gap (EWG) that hook and hold fish better.

Gamakatsu makes a hook for any and every fishing situation. So go ahead, tie on a Gamakatsu because it is "Simply the best!"

## DISTRIBUTED BY:

### Western United States



P.O. Box 1797 • Tacoma, WA 98401  
3900-C1 Industry Drive. E, Tacoma, WA 98424  
253-922-8373 • Fax 800-223-9383

### Eastern United States



3655 Kennesaw 75 Pkwy, STE 135, Kennesaw GA 30144  
770-919-1722 • Fax 770-919-8141

# HISTORY OF GAMAKATSU

Gamakatsu started producing fish hooks in 1955. At that time, they were the smallest hook manufacturer in Japan and all of their hooks were made by hand. In 1963 they introduced a new automated heating facility which catapulted them to the forefront of the Japanese market. In 1974, they introduced fully automated hook making machines and found it necessary to build a second factory in order to meet the demand they had created.

In 1976, being well established as the leading Japanese hook manufacturer, Gamakatsu started building a new factory to produce high quality fishing rods for the Japanese market.

After upgrading the hook manufacturing machines in 1986, they expanded their product line. As a result, Gamakatsu Co. Ltd became a major manufacturer with a full line of high quality fishing rods, hooks, apparel, and fishing related items by 1987.

In 1988, after upgrading the automated tempering facilities and expanding the hook factory, Gamakatsu Co. Ltd opened Gamakatsu International Co., Ltd. in Thailand and Gamakatsu Shantou Co. Ltd. in China in 1989.

When anglers purchase Gamakatsu hooks, they are buying an original product made by GAMAKATSU. Many hook suppliers are using fabricated Japanese sounding names bought from several different manufacturers.



## Market Leader GAMAKATSU

Gamakatsu is the leading fish hook manufacturer in Japan. They are constantly testing new materials, trying to improve their product which already sets the standard for the rest of the industry.

In 1992 Gamakatsu USA Inc. was established to provide Gamakatsu brand hooks to the U.S. market. Obviously, Gamakatsu is well on it's way of achieving their goal of becoming the market leader in the USA and the world!

## Environment has our attention

Since 1955, Gamakatsu has strictly stuck to the theme of "Nature and Technology". We work hard to develop new, hi-tech products that benefit the outdoorsman without adversely effecting the environment.

---

***Gamakatsu's policy of technical development has always been "the best of quality". We are always searching for new ways to make our existing products better in addition to constantly looking for unique products which are not yet available. We believe that only this attitude can give our customers the best they deserve!***

---

## All over the world

Gamakatsu products are used worldwide. With offices located around the world, Gamakatsu is able to research its markets and develop unique products that meet the needs of even the most demanding anglers.

**Aaron Martens**  
Gamakatsu Pro



# COLORS AND CHARACTERISTICS ...



NICKEL

BRONZE

NS BLACK

RED

GREEN

BLUE

F-RED

CHARTREUSE

F-PINK

F-ORANGE

GLOW

F-GREEN

F-PURPLE

ULTRA VIOLET

NANO SMOOTH COAT



Tournament Grade Wire



EYE



OPEN EYE



BARB



BARBLESS



OUT-BARB



EWG - EXTRA WIDE GAP



WELDED EYE



MAGIC EYE

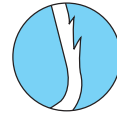

BARB(S) ON SHANK

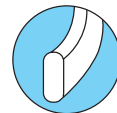

FORGED



OFF-SET POINT



CIRCLE HOOK



TIN KEEPER

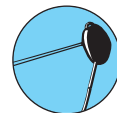

TITANIUM WEEDGUARD

# TABLE OF CONTENTS

<b>G-Finesse by Aaron Martens</b>	<b>Page</b>
G-Finesse Drop Shot	19
G-Finesse Heavy Cover Worm	19
G-Finesse Treble	19
G-Finesse Treble MH	20
<b>G-Finesse Feathered Treble MH NEW</b>	<b>20</b>
<b>G-Finesse by Shin Fukae</b>	
G-Finesse Swivel Shot	20
G-Finesse Swivel Shot Drop Shot	20
G-Finesse Swivel Shot Worm	21
G-Finesse Weedless Wacky	21
G-Finesse Jig Head Wacky	21
G-Finesse Tricky Head	21
<b>G-Finesse Cover Neko NEW</b>	<b>22</b>
G-Finesse Worm Light with Tin Keeper	22
G-Finesse Tournament Snap	22
<b>G-Finesse by Mike McClelland</b>	
G-Finesse Hybrid Worm	23
<b>G-Finesse by Brent Ehrler</b>	
G-Finesse Stinger	24
G-Finesse Weedless Stinger	24
<b>G-Power by Aaron Martens</b>	
<b>G-Power Heavy Cover Flip and Punch NEW</b>	<b>26</b>
G-Power Stinger Trailer	26
<b>Treble Double Hooks</b>	
Treble SP Medium Heavy Hypershield	28
<b>Treble SP XH NEW</b>	<b>28</b>
Treble Round Bend	29
Treble Round Bend Barbless	29
Treble 2x Strong Round Bend	29
Treble (Magic Eye) Round Bend	29
Treble Short Shank, (Magic Eye) Round Bend	29
Treble Extra Wide Gap (EWG)	30
Treble EWG Short Shank (Magic Eye)	30
Treble EWG Short Shank 2x Strong (Magic Eye)	30
Treble 4x Strong	30
Trout Treble	31
Feathered Treble	31
Double 22 Medium Shank	31
EWG Double	31
<b>All Purpose</b>	
Octopus	34
Walleye and Steelhead Assortment	35
Fluorescent Walleye and Steelhead Assortment	35

<b>All Purpose, continued</b>	<b>Page</b>
<b>TGW Octopus NEW</b>	<b>35</b>
Octopus Light	35
Octopus Barbless	36
Octopus Straight Eye	36
Octopus Straight Eye, 4x Strong	37
Octopus Straight Eye, 4x Strong (Inline-Point)	37
Octopus Circle (Offset-Point)	38
Octopus Circle (Inline-Point)	38
Octopus Circle Barbless (Inline-Point)	38
Octopus Circle Outbarb 1x Strong	39
Octopus Circle Straight Eye (Inline-Point)	40
Octopus Circle Straight Eye 4x Strong	40
Octopus Circle Straight Eye 4x Strong (Inline-Point)	41
Big River Bait	42
Big River Bait Barbless	43
Big River Bait Open Eye	43
Big River Bait Open Eye Barbless	44
Baitholder Hooks	44
<b>Siwash Open Eye NEW SIZE</b>	<b>45</b>
<b>Fresh Water Hooks</b>	
Spin Bait	48
TW Hook	48
Single Egg Hook	48
Aberdeen	48
Crappie Assortment	48
Walleye Wide Gap	49
Shiner Straight Eye	49
Shiner Upturned Eye	49
Wicked Wacky	50
<b>Split Shot/Drop Shot NEW COLORS</b>	<b>50</b>
Split Shot/Drop Shot Weedless	50
Finesse Wide Gap	51
Finesse Wide Gap Weedless	51
G-Stinger	51
Trailer Hook SP	52
Spinner Bait Trailer	52
Spinner Bait	52
<b>Ice Fishing</b>	
Micro V Gap	53
Micro Perfect Gap	53
Micro Wide Gap	53
<b>G-Carp</b>	
G-Carp Super Hook	53
G-Carp Specialist RX	53
G-Carp Specialist R	53
G-Carp Hump Back	53

<b>Fresh Water Hooks, continued</b>	<b>Page</b>
<b>Catfish</b>	
Big Cat Circle NEW PACK	54
Catfish Assortment	54
<b>Worm Hooks</b>	<b>Page</b>
Worm, Extra Wide Gap (EWG)	56
Worm, Superline Extra Wide Gap (EWG)	56
Worm, Superline EWG with Ring	56
Worm Superline EWG, Weighted	57
EWG Worm Assortment	57
Worm, G-Lock	57
Worm, Deep Throat Wide Gap	58
Worm, Super Deep Throat Wide Gap	58
Worm, Offset Shank, O'Shaughnessy Bend	58
Worm, Offset Shank, Round Bend	59
Worm Superline Offset Round Bend	59
Worm, Skip Gap	59
Extra Wide Gap (EWG) Monster	60
Extra Wide Gap (EWG) Monster, Weighted	60
Worm, Straight Shank, O'Shaughnessy Bend	61
Worm, Straight Shank, Wire Guard	61
Worm, Straight Shank, Light Wire	61
Worm, Straight Shank, Round Bend	62
Finesse Heavy Cover with Tin Keeper	62
Heavy Cover Worm with Tin Keeper	62
Super Heavy Cover Worm with Tin Keeper	62
Gika Rig	63
Gika Rig Weight	63
Superline Spring Lock	64
Superline Spring Lock, Weighted	64
Superline Spring Lock Monster, Weighted	65
<b>Jig Hooks</b>	<b>Page</b>
Jig 30 Extra Wide Gap (EWG)	68
Jig 60 Round Bend	68
Jig 60 Flat Eye, Light Wire, Round Bend	68
Jig 60 Flat Eye, Round Bend	69
Jig 60 Extra Wide Gap (EWG)	69
Jig 90	69
Jig 90 Round Bend	69
Jig 90 Heavy Wire Round Bend	70
Jig 90 Salty HD	70
Jig 90 Big River	70
<b>Jig Heads</b>	<b>Page</b>
Spring Lock Spinner NEW	72
Under Spin Head Mini NEW	73
Under Spin Head	73
Superline Swim Bait Head	74
Tungsten Wobble Head NEW	74

<b>Jig Heads, continued</b>	<b>Page</b>
Stand Up Alien Head	74
Skip Gap Head	75
Finesse Jig Head	75
Finesse Jig Head Offset	75
Bottom Knocker Offset	76
Crappie Jig Head	76
Round 26	76
Round 26R Weedless NEW	77
Round 211	77
Football 24	78
Darter 26	78
Tube Head	78
MaxEye Jig Pill Head NEW	79
MaxEye Jig Swim Head NEW	79
<b>Lures</b>	<b>Page</b>
Spiral Z NEW	82
<b>Baits</b>	<b>Page</b>
DuraScent Shrimp NEW	85
DuraScent Crab NEW	85
DuraScent Sandworm NEW	85
DuraScent Octopus NEW	86
DuraScent Salmon Eggs NEW	87
<b>Weights</b>	<b>Page</b>
G-Shield Tungsten Worm Weight NEW	90
G-Shield Tungsten Flipping Weight NEW	90
G-Shield Tungsten Punch Weight NEW	90
<b>Saltwater</b>	<b>Page</b>
Live Bait NEW SIZES	92
Live Bait with Solid Ring	92
Live Bait Light Wire	92
Live Bait Light Wire with Solid Ring	92
Live Bait Heavy Duty	93
Live Bait Heavy Duty with Solid Ring	93
Live Bait Heavy Duty Circle	94
Nautilus Circle NEW SIZES	94
Nautilus Circle with Solid Ring NEW SIZES	94
Nautilus Light	95
Nautilus Circle Heavy Duty	95
Nautilus Circle Heavy Duty with Solid Ring	95
Super Nautilus Circle	96
Kraken Circle Monster NEW	96
Kraken Outbarb Circle NEW	96
Octopus Circle, 4x Strong, Straight Eye	97
Octopus Circle, 4x Strong, Straight Eye (Inline-Point)	97

# TABLE OF CONTENTS

Saltwater, continued	Page
O'Shaughnessy	98
Single 510	98
Magic Eye Tuna Plug 3X	99
Tuned Tuna Plug with Ring	99
Big Eye Circle	100
Tuned Tuna with Welded Eye	101
Assist Hooks	Page
Double Assist 520	104
Assist 560 Double NEW	104
Assist 540 Double Bait Plus NEW	104
Assist 700 Double NSC NEW	105
Assist 530 Double Short NEW	106
Assist 530 Double Long NEW	106
Assist 550 Short NEW	107
Assist 510	107
Tuned Assist HD	108
Magnum Assist	108
Steel Assist with Magic Eye Swivel	109
Assist 520, Ringed	109
Assist 620 Heavy Duty with Solid Ring	110
Assist 720 Heavy Duty	110
Rigs and Snells	Page
Drop Shot Rig	112
Single Egg Hooks, Barb on Shank Snell	112
Baitholder Snell	112
Kokanee Two Hook Snell	113
EWG Wallye Snell	113
Walleye Snell with Glow Bead	113
Walleye LG Two Hook Rig	113
Treble Stinger Rig, Wire Leader	114
Treble Stinger Rig, Fluorocarbon Leader	114
Catfish Rig	114
Catfish Rig Circle	114
Mooching Rig (Slip Tie)	115
Mooching Rig (Solid Tie)	115
Mooching Rig (Slip Tie) Barbless	115
Mooching Rig Big River Bait (Slip Tie)	115
Two Hook Bait Rig	115
Salmon/Steelhead Leader	115
Sockeye Rig	116
French Hook Snell NEW	116
Top and Bottom Rig	116
Fluke Rig with Teaser	117
Striper Rig	117
Striper Rig with Sliding Sinker Lock	117
Jigging Rig, Gold	118
Jigging Rig, Nickel, Smelt/Herring	118

Rigs and Snells, continued	Page
Jigging Rig, Special Assorted Hook	118
Jigging Rig, Special Weighted Assorted Hook	118
Fly Hooks Executive Series	Page
S10 • Standard Down Eye	121
S10-B • Standard Down Eye Barbless	121
S10S • Straight Eye Dry	121
Jig Nymph • J20 Barbed	121
Jig Nymph • J20 Barbless	121
R10-B • Retainer Bend Barbless	121
R17-B • Retainer Bend Barbless 3x Fine	121
R18-B • Barbless 2x Strong	121
R19-B • Retainer Bend Barbless	121
B10S • Stinger, 1x Strong Forged	122
B10S • Tournament Grade Wire, Nano Smooth Coat	122
B10S • Stinger Fluorescent NEW	122
C14S • Glo Bug	122
C16-B • Crippled Emerger	122
C13U • Keel Balance	123
C15-BV • Vertical eye, Emerger, Barbless	123
C12-BM • Barbless Midge, Large Eye	123
Traditional Series	Page
S11-4L2H • Steamer, 4x Long, 2x Strong	123
S11S-4L2H • Straight Eye Streamer	123
L11S-3H • Salmon and Steelhead 3x Strong	123
C12 • Down Eye Scud	123
C12U • Caddis	123
C12-B • Down Eye Scud Barbless, Red	123
T10-3H • Salmon Dry 1x Fine	124
T10-6H • Salmon Tapered Loop Up-Eye	124
Russian River Fly	124
Double 22 Medium Shank	124
Saltwater Series	Page
SL12-S 1x Short • Big Game, Wide Gap	124
SL12S • Big Game, Wide Gap	125
SL45 • Bonefish	125
SC15-2H • Wide Gap	125
SL11-3H • 3x Strong	125
SS15 • Standard	126
SP11-3L3H • Perfect Bend	126
SC15 • Wide Gap	126
SC17 • Tarpon Fly	126
Terminal	Page
Silicone Stopper	130
Spring Lock	130
Superline Swivel	130
Duo Lock Snap w/ Superline Swivel	130

<b>Terminal , continued</b>	<b>Page</b>
Cross Lock Snap w/ Superline Swivel	130
Superline Split Ring	130
Superline Solid Ring	130
<b>Tackle Storage</b>	<b>Page</b>
G-Box 3200, Utility Case	132
G-Box 3200D Deep Utility Case	132
G-Box Reversible 3200 NEW	132
G-Box 3500D, Deep Utility Case	133
G-Box 3600, Utility Case	133
G-Box Reversible 3600 NEW	133
G-BOX 3700, Utility Case	134
G-Box 3700D Deep Utility Case	134
G-Box 3700D2 Deep Utility Case NEW	134
G-Box 250, Duo Side Case, Slit Foam	135
G-Box 3200, Slit Foam Case	135
G-Box 3600, Slit Foam Case	135
G-Box 318SD Pocket Utility Case	136
G-Box 388DD Pocket Utility Case	136
G-Case 7000	137
G-Case 7000 Jig Compartment	137
G-Case 7000 Rod Stand	137
G-Case 7000 Shoulder Strap	137
G-Bag EWM 5000 H Tackle Bag NEW	138
G-Bag EWM 300 Tackle Bag NEW	138
G-Bag EWM 200 Tackle Bag NEW	139
G-Bag EWM 100 Tackle Bag NEW	139
Shoulder Bag Tackle Storage	140
Backpack Tackle Storage	140
G-Finesse Dry Bag Backpack	140
Hybrid Duffel Backpack 110L NEW	141
Rolling Gear Duffel 90L NEW	141
Gear Duffel 30L NEW	141
Tuna Dry Bag Backpack	142
Dry Bag 10L	142
Dry Bag Backpack 20L	142
<b>Tools and Accessories</b>	<b>Page</b>
Fishing Pliers 6"	144
Fishing Pliers 7"	144
Micro Split Ring Plier	144
Folding Braid Scissors w/ Split Ring Opener	145
Micro Fiber Towel NEW	145
Finger Protector	145
Luxxe Fishing Line	145
<b>Apparel and Gear</b>	<b>Page</b>
Trucker Hat Mesh Bk/Charcoal	148
Flexfit Multicam Hat	148

<b>Apparel and Gear, continued</b>	<b>Page</b>
Sun Shield Gray	148
T-Shirt Heather Gray	148
T-Shirt Retro Logo Navy	148
T-Shirt Flag NEW	148
Performance LS Shirt Flag	148
Performance LS Shirt Steel	148
Performance LS Shirt (SKY)	148
Performance LS Shirt Gray	149
Performance LS Shirt Blue	149
Performance Shirt LS White	149
Performance Shirt LS Black	149
Ladies Performance LS Shirt Blue	149
Trucker Mesh Cap -Black with White Mesh	149
Trucker Mesh Cap -Navy with White Mesh	149
Pro Cotton Cap	149
Low Profile Visor	150
Alaska Hat	150
Premium Cuff Beanie NEW	150
G-Finesse Cap	150
G-Finesse Flat Bill	150
Flat Bill Triple Black	150
T-Shirt	150
G-Finesse T-Shirt	150
Luxxe T-Shirt	150
SoftShell Performance Jacket	150
Fleece Performance Jacket	150
Ladies Hooded Sweatshirt	151
Performance Hoodie Steel	151
Performance Hoodie Blue	151
Shadow Technical Hoodie	151
Hooded Sweatshirt	151
Carhartt Midweight Hooded Sweatshirt NEW	151
Japanese Chara T-Shirt	152
Samurai Fisherman Trucker Mesh Cap	152
Samurai Fisherman T-Shirt Black	152
Samurai Fisherman T-Shirt White	152
Samurai Fisherman Long Sleeve	152
<b>Decals</b>	<b>Page</b>
G-Finesse Decals - Yellow, White, Solid	153
Tuna Boat Decal - White, Red, Blue	153
Embroidered Patch	153
Small Boat Decal	153
Large Boat Decal	153
Small Decal Sheet	153
Gamakatsu Carpet Decal	153
<b>Representative Page</b>	<b>Page</b>
Gamakatsu Regions	155
SPRO Regions	155



*Gamakatsu continues to forge new paths by combining exciting new hook designs with industry-leading technology. The Gamakatsu **G-Finesse** and **G-Power** hooks are a perfect example of the brand's commitment to innovation.*

*The **G-Series** is a result of endless hours of product testing from some of the world's leading pro anglers. Every hook in this premium line was designed with a specific application, utilizing critical input from our professional fishing team. As a result, not only are these hooks, sharper, stronger and more durable, but they also create pro-type fishing advantages as seen in an increase in hook-ups, fewer lost fish, and overall superior fishability.*



The G-Finesse hooks are designed for technical and finesse fishing applications whereas the G-Power hooks are better suited for heavy cover and power techniques. Both G-Finesse and G-Power feature Tournament Grade Wire and Nano Smooth Coating.

Hook a few thousand bass a year and you know what works and what doesn't. That's exactly what Gamakatsu's pro team does year-in and year-out. Every cast, every hookset can be a game-changer... and that was the genesis of the **G-Series**. Designed and tested by bass fishing's top pro's, **G-Series** takes hook design, "sharp" and "strong" to new and unimagined levels of excellence. The top professionals' livelihoods depend on being the best and using the best equipment available and with G-Series, they have the competitive edge.

Gamakatsu's long held the reputation as the sharpest hooks on the water and the **G-Series** takes that to a whole new level. Using an ultra-strong material called **TGW (Tournament Grade Wire)**, that's thinner, stronger and sharper, Gamakatsu has been able to achieve what no other hook company has, the world's most effective fishing hooks.

But TGW is only part of the **G-Series** story. Gamakatsu's exclusive **Nano Smooth Coat** finish reduces resistance for superior penetration. A slicker, faster penetrating hook surface enhances the design and material attributes of the **G-Series**.

***G-Series is more than an innovative, revolutionary, new hook material and finish. Gamakatsu's exclusive, proprietary design makes these singularly unique hooks even better!***

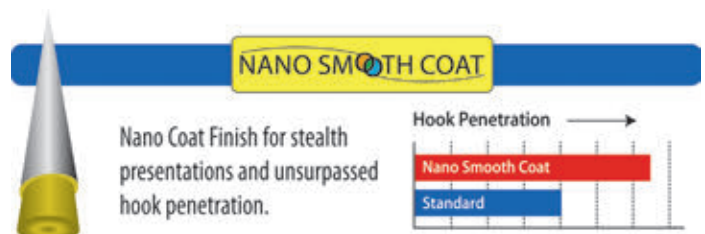



**G-FINESSE**

*SpaMakatsu<sup>®</sup>*

# G-FINESSE BY AARON MARTENS

## G-Finesse... A Ground-Breaking Achievement In Hook Design

Gamakatsu entered the market on the promise of the sharpest hooks produced. It was Gamakatsu that created the “super sharp” hook category and continues to add new application-specific hooks to its offering every year.

*“Over my entire career fishing Gamakatsu I envisioned making the best finesse hook in the world. Gamakatsu’s New G-Finesse Series combine Ultra Sharp Tournament Grade Wire with Nano Smooth Technology for the ultimate in hook penetration. This new technology will take my finesse fishing to a whole new level.” ~ Aaron Martens*



### G-Finesse Heavy Cover Worm

Aaron Martens Signature G-Finesse Heavy Cover Worm hook does what others can't. Extreme versatility.



*Martens says it best, “This hook let’s me do so much, easily the most versatile soft plastics hook on the market”.*

Featuring Aaron’s custom designed keeper that holds plastics tight for endless casts without rips or tears. The rock solid keeper is made of non-corrosive tin, not plastic or lead, so it won’t wear out or add unwanted weight. Like all G-Finesse hooks, tournament grade wire and Nano Smooth Coat finish perfect the design.

Available in sizes 2, 1, 1/0, 2/0, 3/0, 4/0.

### G-Finesse Treble Hook

Thinner, Stronger, Sharper, Better. Gamakatsu continues to expand its ground-breaking G-Finesse series hooks with the G-Finesse Treble Hook. Designed by Tournament pro, Aaron Martens, the G-Finesse Treble redefines “sharp” and “effective”.



Gamakatsu’s G-Finesse Treble Hook is patterned after traditional O’Shaughnessy style hooks. Aaron has long been a proponent of the O’Shaughnessy hook style with its distinctive acute angle at the bottom of the hook. Martens believes the addition of the O’Shaughnessy bend, hooks and holds fish better than round bend designs. He should know, a past B.A.S.S. Angler of the Year, had three second place finishes in Bassmaster’s Classics and is always in the hunt on the pro tours. When you fish as much as Aaron does, small details make a big difference. *The G-Finesse Treble Hooks is available in sizes 6,5,4,3,2, 1, 1/0. Nano Smooth Coat finish.*

### G-Finesse Treble Hook MH Hook

G-Finesse for big, tough fish that live in the heaviest cover. Aaron Martens frequently chases them and he asked us for medium heavy G-Finesse treble to meet those needs. We answered. The new G-Finesse Treble MH features a tougher medium heavy, tournament grade wire for additional strength. The same Nano Smooth Coat finish and short shank promote instant hook penetration. Available in Sizes 6, 5, 4, 3, 2, 1, 1/0.



### G-Finesse Drop Shot Hook

Martens has been instrumental in the development of Gamakatsu’s new G-Finesse Drop Shot Hook. Completely “pro-designed”, Gamakatsu’s new G-Finesse series is a giant leap forward in fishing hook technology.



### G-Finesse Feathered Treble MH

**NEW**

Based largely on the input of Major League Fishing pro Aaron Martens, the G-Finesse feathered trebles feature either white or chartreuse premium feathers and complementary tinsel, hand selected by Martens to tempt even the most finicky fish. The G-Finesse feathered trebles feature TGW (Tournament-Grade Wire) construction, which is thinner, stronger and sharper than the standard wire. That means anglers will use fewer of them while ensuring better hook up percentages as the fishing day goes. To complete the job, they come with a Nano-Coat finish that makes penetration even easier. Sizes 6, 4, 2, 1, 1/0



*Martens has been instrumental in the development of Gamakatsu’s G-Finesse Drop Shot Hook. Completely “pro-designed”, Gamakatsu’s G-Finesse series is a giant leap forward in fishing hook technology. “The G-Finesse Drop Shot Hook is like Gamakatsu’s standard Drop Shot Hook except that I had them pull the point more towards the eye to open up the gap. Also, the hook wire, called TGW (Tournament Grade Wire) is a smaller diameter, but just as strong as their other hooks.” Gamakatsu’s G-Finesse Drop Shot Hooks are available in sizes, 2, 1, 1/0 and 2/0. Nano Smooth Coat finish.*



# G-FINESSE BY SHINICHI FUKAE

## G-Finesse Swivel Shot

Drop-shot fishing for bass is nothing new but Gamakatsu's approach to it is. Our Swivel Shot eliminates line twist that's commonly associated with drop shotting and vastly improves rigging efficiency. Gamakatsu's produced a revolutionary "Twist Free" design using a premium swivel above the hook. The hook, a super-sharp Gamakatsu offset point Octopus hook, is strong enough to winch big bass out of slop --- another unique attribute of their Swivel Shot system. The Easy-Change weight system below the hook improves rigging efficiency and easy leader length adjustments without retying your rig. Pro Shinichi Fukae was instrumental in the development and testing of Gamakatsu's Swivel Shot and shared that it has been an essential element in his tournament success. Without a doubt, the Swivel Shot is an enormous leap forward in drop shot fishing that's sure to maximize angler's efficiency, increase hook-ups and land trophy-sized bass without the worry posed by conventional drop shot hooks and rigging.

*Available in NS Black. Sizes: 2 - 3/0*



Shinichi Fukae

## G-Finesse Swivel Shot Drop Shot

The original G-Finesse Swivel Shot changed the game and professional anglers were eager to play. Some, like Shin Fukae, recognized the G-Finesse advantage but didn't want to break from tradition entirely. The G-Finesse Swivel Shot Drop Shot features our top of the line Tournament Grade Wire Drop Shot hook. Both the hook and swivel system feature the benefits of a Nano Smooth Coat finish. *Available in sizes 2, 1, 1/0 and 2/0.*



## G-Finesse Swivel Shot Worm

This design is the origination of a revolutionary new technique made possible by Gamakatsu's industry-changing G-Finesse series. Pro Staff Shinichi Fukae spent the over a year perfecting the concept and proving its power. We've combined our G-Finesse Worm Light w/ Tin Keeper hook with the G-Finesse Swivel Shot System to create the Swivel Shot Worm. Unique in form, function and finesse. Texas Rig the Swivel Shot Worm to be fished in and around cover. The light wire allows for threading extremely small diameter worms, held firmly in place by the near weightless, tin keeper. The hook also features our unique Nano Smooth Coat Finish. Adding the "twist-free" advantage of the Swivel Shot allows super fast rigging without tangles. You can be assured the presentation is always perfect, and that translates into more strikes and more bent rods.

*Available in sizes 1, 1/0, 2/0. Nano Smooth Coat finish.*



## G-Finesse Tricky Head.

From the master finesse magician himself, Shin Fukae, comes the Tricky Head jig head. Designed to be fished with the popular shaky head technique, it brings several additional advantages to the tackle box. The Tricky Head is snag free. The weighted lead head is uniquely shaped to remain vertical during presentation, allowing the jig to bounce in and around structure while the worm or swimbait is held firmly in place by a lockdown tin keeper. You've got to see it to believe it. *Available in black or plain lead, in sizes 1/16, 3/32, 1/8 or 3/16 oz.*



## G-Finesse Weedless Wacky

Gamakatsu's Tournament-winning Pro Staffer, Shinichi Fukae, never rests. He worked tirelessly with Gamakatsu's engineers to develop the G-Finesse Weedless Wacky hook. Look closely and you'll see, it's not an ordinary weedless design. The weed guards are not plastic, they're titanium wire—solidly encased and directly molded to the hook shank. They won't come loose and they don't vibrate or add resistance. The extremely thin gauge wire retains its shape, yet is flexible enough to compress with even the gentlest nibbles. Bass won't feel a thing, until of course, the precision sharpened Gamakatsu hook does its job. The G-Finesse Weedless Wacky hook features Gamakatsu's exclusive Nano Smooth Coat finish to add stealth and reduce friction for effortless hook penetration. The hook itself features Tournament Grade Wire (TGW) that is a smaller diameter, yet stronger, than other Drop Shot hooks. *Available in sizes 2, 1, 1/0, 2/0 and 3/0*



## G-Finesse Worm Light with Tin Keeper

When conditions require finesse, the pros use G-Finesse Worm Light hooks. The light wire allows for threading of extremely small diameter worms with ease. Even the most fragile plastics are less likely to tear, saving on baits and increasing fishing time. The non-corrosive tin keeper doesn't add weight. Like all G-Finesse hooks, the Worm Light hook penetrates with significantly less force making them substantially more effective. *Available in sizes 1, 1/0, and 2/0, all with Nano Smooth Coat Finish.*



## G-Finesse Cover Neko

By combining Gamakatsu's legendary quality and the design of Major League Fishing pro Shin Fukae, the perfect Neko hook now exists for this popular technique. The Cover Neko Hook consists of a shiner-style straight eye hook with an attached swivel to prevent line twist. There's also a strong, 90-degree wire keeper to lock plastics in place. Taken together, it's a tool that will let anglers easily fish through brush, laydowns and grass while maximizing hook-up percentages. *Available in sizes 1, 1/0 and 2/0.*



## G-FINESSE BY SHINICHI FUKAE continued.

### G-Finesse Gamakatsu Tournament Snap

Gamakatsu's Tournament Snap is better by design. Primarily used on plugs for bass, walleye, salmon, stripers, steelhead, trout, panfish and other species, Gamakatsu's Tournament Snap is stainless steel and enables a full range of movement, enhancing the effectiveness of whatever plug is used. Better yet, and unlike other plug snaps, Gamakatsu's Tournament Snap will not accidentally open. The clever design of the Tournament Snap stays closed at all times as the plug eye is threaded onto the snap. It's easy and effective! Tested extensively and used under rigorous tournament conditions. *Gamakatsu's Tournament Snaps are available in two sizes, (M) Medium and (L) Large.*



### G-Finesse Jig Head Wacky

Gamakatsu's Jig Head Wacky is a vast improvement over other wacky jigs. The nickel/titanium weed guard is the first indication that Gamakatsu's raised the bass fishing bar. This weed guard is small but mighty as it effectively clears hazards yet maintains its shape and rigidity under the most demanding use. The jig head is an improvement as well. Better designed to resist snags the hook eye is recessed to prevent getting hung-up in structure. Even the hook is different, a custom addition that's based on a shiner hook but modified for the Jig Head Wacky. The result is a much higher ratio of hook-ups and landed fish than any other comparable brand. *Available in Black and Green Pumpkin. Sizes: 1/0-1/16, 1/0-3/32, 1/0-1/8, 1/0-3/16*



## G-FINESSE BY BRENT EHRLER

### G-Finesse Stinger

Tournament pro and Gamakatsu pro staff, Brent Ehrler, developed and fine-tuned the G-Finesse

Stinger for use with the popular Neko and Wacky rig techniques. The G-Finesse Stinger follows in the footsteps of similar, game-changing G-Finesse hooks engineered by Gamakatsu. It features Tournament Grade Wire (TGW) which is thinner and stronger than anything else on the market, and an application of Nano Smooth Coat to decrease penetration resistance. This hook can be perfectly positioned exactly where you want it, and even moved, without damaging the bait. When the bite is tough, G-Finesse opens new ways to stick it to'em. *Available in size 6 through 1/0.*



### G-Finesse Weedless Stinger

We heard from pro staff, Brent Ehrler, and many others, that anglers were spending far too much time tying custom weed guards with wire or heavy monofilament on their Neko rigs... because they couldn't find the right finesse hook with the right weed guard already attached. Problem solved! The G-Finesse Stinger Weedless is just what the tournament trail needed. Titanium wire weed guard, Nano Smooth Coat and Tournament Grade Wire. *Available in size 6 through 1/0.*



## G-FINESSE BY MIKE MCCLELLAND

### Mike McClelland Inspired G-Finesse Hybrid Worm

The G-Finesse Hybrid Worm is the brainchild of pro-staffer; Mike McClelland. He's spent more than a few hours on the water, competing in over 234 tournaments, including 10 times at the Bassmaster Classic.

Mike knows the subtleties of rigging worms and soft plastic like no one else, so he and Gamakatsu's designers combined the best of his current favorite Gamakatsu worm hook and incorporated a distinctive new



acute hook angle to keep baits aligned perfectly straight. Hence, the "Hybrid" name. The Nano Smooth Coat finish makes it easy to thread the thinnest finesse baits or the fattest Senkos with ease. Add industry-changing Tournament Grade Wire (TGW) to the package and things couldn't be more perfect. Take our word for it, or better yet, fish it yourself. *The G-Finesse Hybrid Worm is available in sizes 1/0 to 8/0.*

# G-FINESSE BY AARON MARTENS

"Over my entire career fishing Gamakatsu I envisioned making the best finesse hook in the world. **Gamakatsu's G-Finesse Series combine Ultra Sharp Tournament Grade Wire with Nano Smooth Technology for the ultimate in hook penetration.** This technology will take my finesse fishing to a whole new level." ~ Aaron Martens



## G-Finesse Drop Shot

Martens has been instrumental in the development of Gamakatsu's G-Finesse Drop Shot Hook. Completely "pro-designed", Gamakatsu's new G-Finesse series is a giant leap forward in fishing hook technology.

SIZES		2	1	1/0	2/0
Nano Smooth Coat	LS	338209(6)	338210(6)	338211(6)	338212(6)

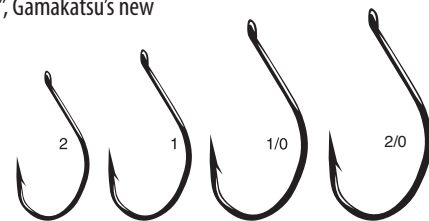

## G-Finesse Heavy Cover Worm

Aaron Martens designed Finesse Heavy Cover, now available in Tournament Grade Wire (TGW), Nano Smooth Coat finish and Aaron's custom designed Tin Keeper.

SIZES		2	1	1/0	2/0	3/0	4/0
Nano Smooth Coat	LS	357209(4)	357210(4)	357211(4)	357212(4)	357213(4)	357214(4)

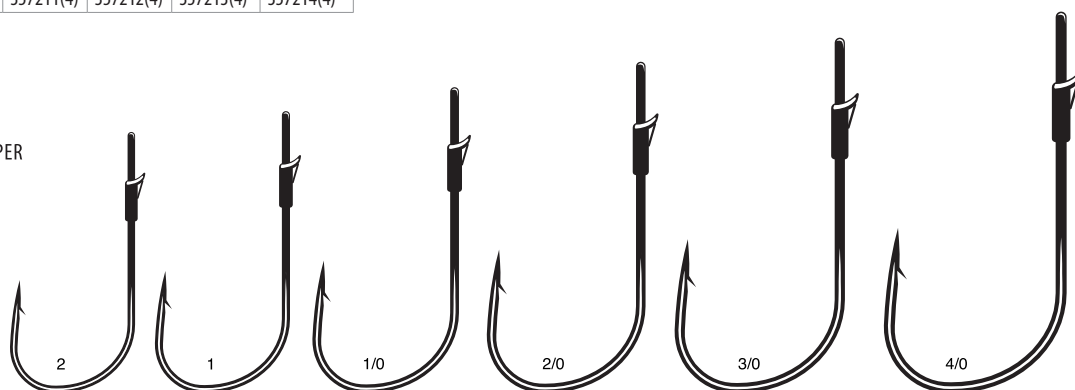
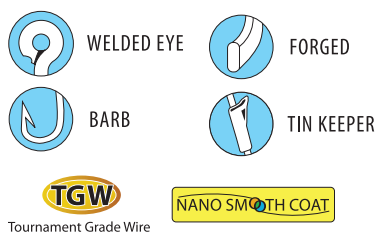

## G-Finesse Treble

Gamakatsu's G-Finesse Treble Hook is patterned after traditional O'Shaughnessy style hooks. Aaron has long been a proponent of the O'Shaughnessy hook style with its distinctive acute angle at the bottom of the hook. Martens believes the addition of the O'Shaughnessy bend, hooks and holds fish better than round bend designs.

SIZES		6	5	4	2	1	1/0
Nano Smooth Coat	LS	339207(6)	339207.5(6)	339208(6)	339209(6)	339210(6)	339211(6)

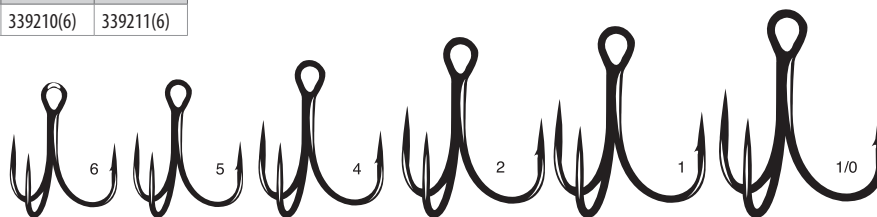
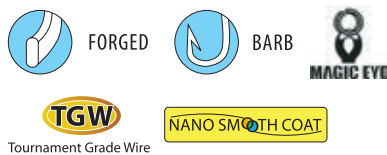

## G-Finesse Treble MH

Aaron Martens designed G-Finesse Treble MH features a tougher medium heavy Tournament Grade Wire (TGW) for additional strength and Nano Smooth Coat Technology for instant hook penetration.

SIZES		6	5	4	3	2	1	1/0
Nano Smooth Coat	LS	347207(6)	347207.5(6)	347208(6)	347208.5(6)	347209(6)	347210(6)	347211(6)

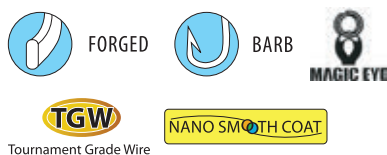

# G-FINESSE BY AARON MARTENS

## G-Finesse Feathered Treble MH

Based largely on the input of Major League Fishing pro Aaron Martens, the G-Finesse feathered trebles feature either white or chartreuse premium feathers and complementary tinsel, hand selected by Martens to tempt even the most finicky fish. The G-Finesse feathered trebles feature TGW (Tournament-Grade Wire) construction, which is thinner, stronger and sharper than the standard wire. That means anglers will use fewer of them while ensuring better hook up percentages as the fishing day goes. To complete the job, they come with a Nano-Coat finish that makes penetration even easier.

**NEW**



SIZES		6	4	2	1	1/0
Nano Smooth Coat	White/Tinsel	LS 417207-WT(2)	417208-WT(2)	417209-WT(2)	417210-WT(2)	417211-WT(2)
	Chartreuse/Tinsel	LS 417207-CT(2)	417208-CT(2)	417209-CT(2)	417210-CT(2)	417211-CT(2)

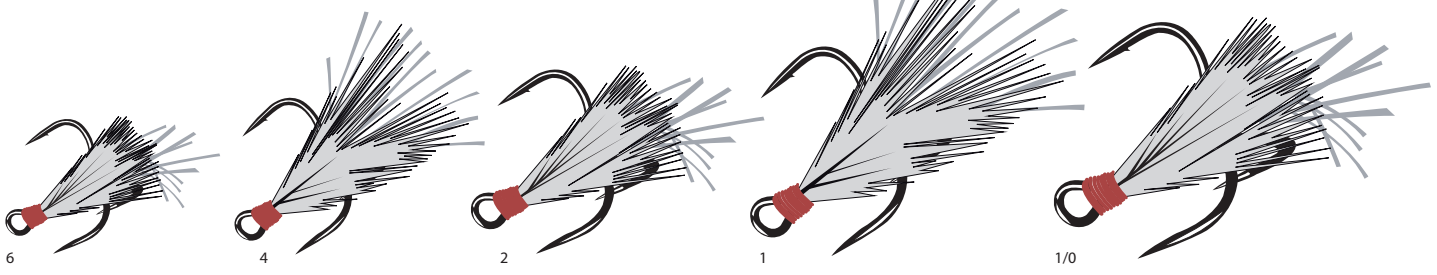

# G-FINESSE BY SHINICHI FUKAE

## Swivel Shot Drop Shot Features. Designed and endorsed by Pro Shinichi Fukae

- A. High quality swivel above the hook to minimize line twist.
- B. Easy-Change Weight System.
- C. Nano Smooth Coat finish for stealth presentations and unsurpassed hook penetration.
- D. Tournament Grade Wire - hook points stays sharper longer.

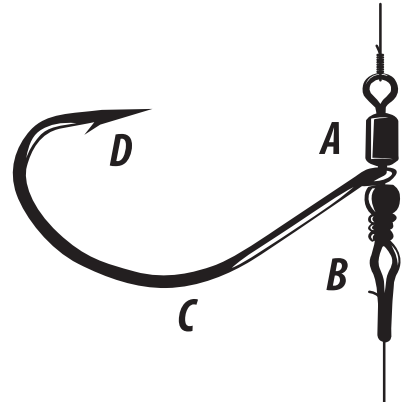

## G-Finesse Swivel Shot

SIZES		2	1	1/0	2/0	3/0
NS Black	LS	316409(3)	316410(3)	316411(3)	316412(3)	316413(3)

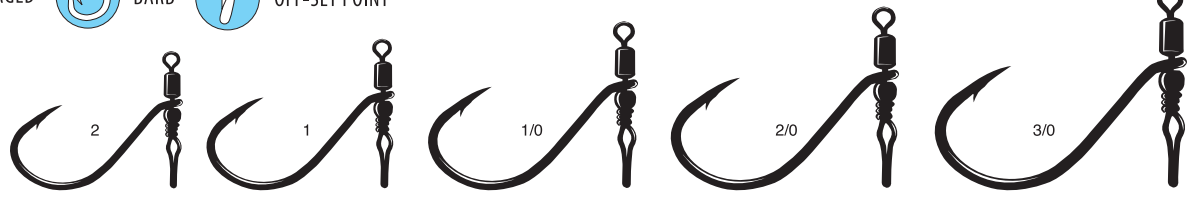

## G-Finesse Swivel Shot Drop Shot

SIZES		2	1	1/0	2/0
Nano Smooth Coat	LS	352209(3)	352210(3)	352211(3)	352212(3)



**NANO SMOOTH COAT**

Tournament Grade Wire

### G-Finesse Swivel Shot Worm

SIZES		1	1/0	2/0
Nano Smooth Coat	LS	362210(3)	362211(3)	362212(3)



NANO SMOOTH COAT

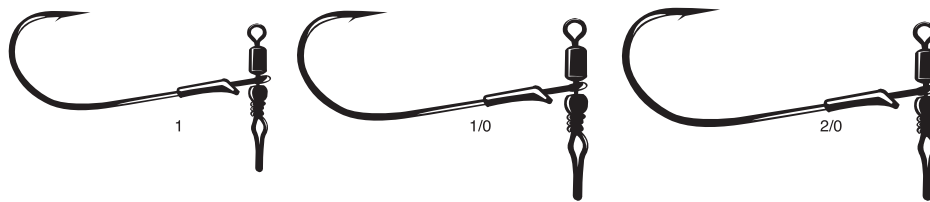

### G-Finesse Weedless Wacky

SIZES		2	1	1/0	2/0	3/0
Nano Smooth Coat	LS	367209(4)	367210(4)	367211(4)	367212(4)	367213(4)



NANO SMOOTH COAT

Tournament Grade Wire

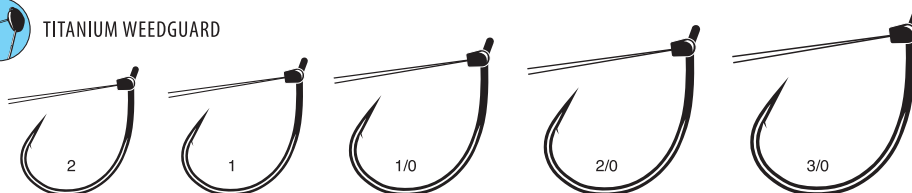

### G-Finesse Jig Head Wacky

Gamakatsu's Jig Head Wacky is a vast improvement over other wacky jigs. The nickel/titanium weed guard is the first indication that Gamakatsu's raised the bass fishing bar. This weed guard is small but mighty as it effectively clears hazards yet maintains its shape and rigidity under the most demanding use. The jig head is an improvement as well. Better designed to resist snags the hook eye is recessed to prevent getting hung-up in structure. Even the hook is different, a custom addition that's based on a shiner hook but modified for the Jig Head Wacky. The result is a much higher ratio of hook-ups and landed fish than any other comparable brand.

SIZES		1/0-1/16	1/0-3/32	1/0-1/8	1/0-3/16
Black	LS	312411-BK-1/16(3)	312411-BK-3/32(3)	312411-BK-1/8(3)	312411-BK-3/16(3)
Green Pumpkin	LS	312411-GP-1/16(3)	312411-GP-3/32(3)	312411-GP-1/8(3)	312411-GP-3/16(3)



Tournament Grade Wire

NANO SMOOTH COAT



### G-Finesse Tricky Head

From the master finesse magician himself, Shin Fukae, comes the Tricky Head jig head. Designed to be fished with the popular shaky head technique, it brings several additional advantages to the tackle box. The Tricky Head is snag free. The weighted lead head is uniquely shaped to remain vertical during presentation, allowing the jig to bounce in and around structure while the worm or swimbait is held firmly in place by a lockdown tin keeper. You've got to see it to believe it. Available in black or plain lead.

SIZES		3/0-1/16	3/0-3/32	3/0-1/8	3/0-3/16
Plain Lead	LS	370413-1/16(3)	370413-3/32(3)	370413-1/8(3)	370413-3/16(3)
Black	LS	370413-BK-1/16(3)	370413-BK-3/32(3)	370413-BK-1/8(3)	370413-BK-3/16(3)

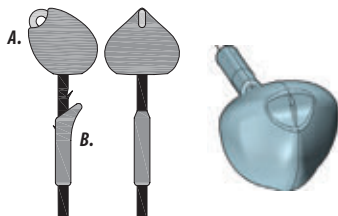

- A. Weedless Keel shape design glides effortlessly over and through structure
- B. Lock Down Keeper won't tear finesse plastics. Rig straight and secure every time

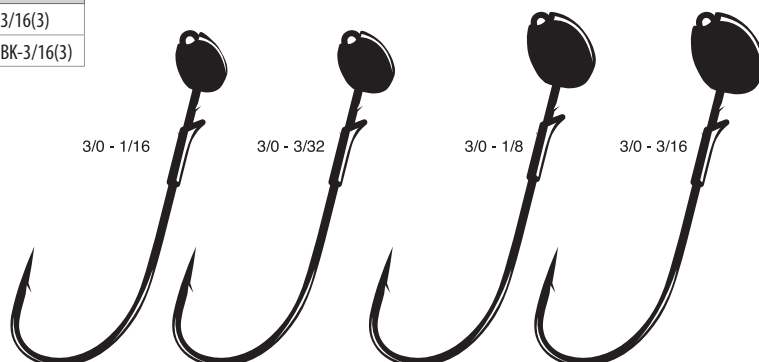

# G-FINESSE BY SHINICHI FUKAE

NEW

## G-Finesse Cover Neko

By combining Gamakatsu's legendary quality and the design of Major League Fishing pro Shin Fukae, the perfect Neko hook now exists for this popular technique. The Cover Neko Hook consists of a shiner-style straight eye hook with an attached swivel to prevent line twist. There's also a strong, 90-degree wire keeper to lock plastics in place. Taken together, it's a tool that will let anglers easily fish through brush, laydowns and grass while maximizing hook-up percentages.



SIZES	1	1/0	2/0
NS Black	LS 423410(3)	423411(3)	423412(3)

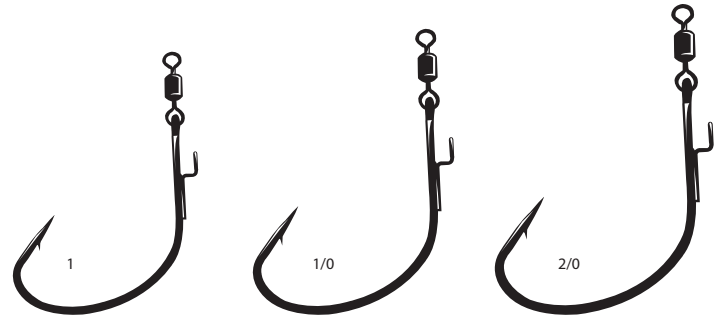

## G-Finesse Worm Light with Tin Keeper

When conditions require finesse, the pros use G-Finesse Worm Light hooks. The light wire allows for threading of extremely small diameter worms with ease. Even the most fragile plastics are less likely to tear, saving on baits and increasing fishing time. The non-corrosive tin keeper doesn't add weight. Like all G-Finesse hooks, the Worm Light hook penetrates with significantly less force making them substantially more effective.

SIZES	1	1/0	2/0
Nano Smooth Coat	LS 358210(4)	358211(4)	358212(4)

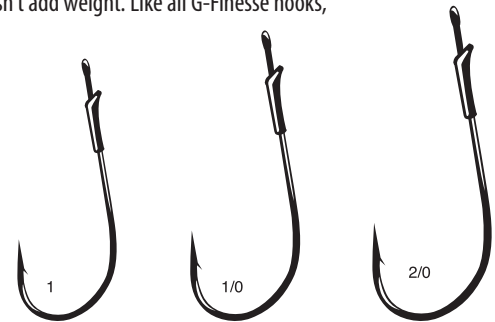

## G-Finesse Tournament Snap

SIZES	Medium (60 lb.)	Large (80 lb.)
LS	333000-M(10)	333000-L(10)

*Tournament Snap design intensifies the lures swimming action*

*High quality stress relieved stainless steel.*

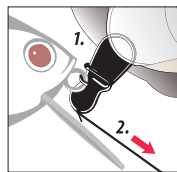

**1. TWIST & CLICK** - Hook the open end of the Tournament Snap inside the lure eye. Twist and click into place.

**2. PULL** - Keep you line tight and pull at a 90 degree angle away from the lure to finish setting.



# G-FINESSE BY MIKE MCCLELLAND

*Gamakatsu Hybrid Worm is the definitive choice for all of my soft plastic rigs on tour. The unique hybrid design helps me hook and land more fish than ever before. When combined with Tournament Grade Wire and Nano Smooth Coat technology, Hybrid Worm is the ultimate fish catching machine.*

~ Mike McClelland



## G-Finesse Hybrid Worm

The G-Finesse Hybrid Worm is the brainchild of pro-staffer; Mike McClelland. He's spent more than a few hours on the water, competing in over 234 tournaments, including 10 times at the Bassmaster Classic. Mike knows the subtleties of rigging worms and soft plastic like no one else, so he and Gamakatsu's designers combined the best of his current favorite Gamakatsu worm hook and incorporated a distinctive new acute hook angle to keep baits aligned perfectly straight. Hence, the "Hybrid" name. The Nano Smooth Coat finish makes it easy to thread the thinnest finesse baits or the fattest Senkos with ease. Add industry-changing Tournament Grade Wire (TGW) to the package and things couldn't be more perfect. Take our word for it, or better yet, fish it yourself.

SIZES		1/0	2/0	3/0	4/0	5/0	6/0	7/0	8/0
Nano Smooth Coat	LS	366211(4)	366212(4)	366213(4)	366214(4)	366215(4)	366216(4)	366217(4)	366218(4)



FORGED



BARB



Tournament Grade Wire

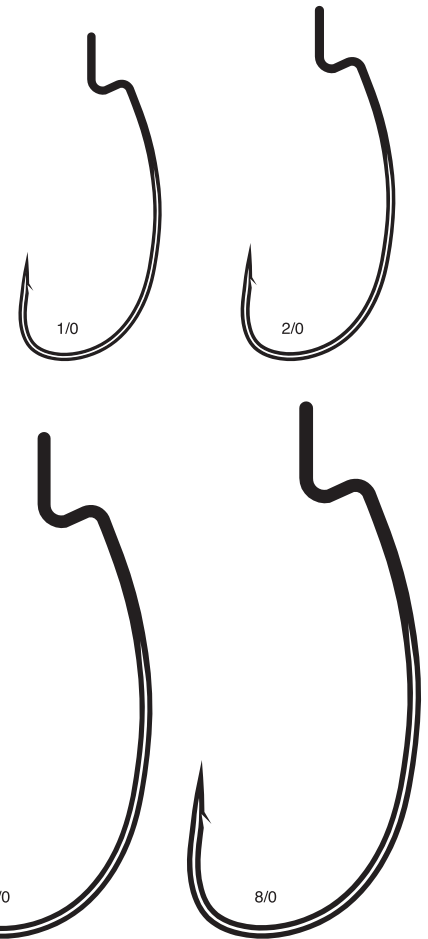

# G-FINESSE BY BRENT EHRLER



## G-Finesse Stinger

Tournament pro and Gamakatsu pro staff, Brent Ehrler, developed and fine-tuned the G-Finesse Stinger for use with the popular Neko and Wacky rig techniques. The G-Finesse Stinger follows in the footsteps of similar, game-changing G-Finesse hooks engineered by Gamakatsu. It features Tournament Grade Wire (TGW) which is thinner and stronger than anything else on the market, and an application of Nano Smooth Coat to decrease penetration resistance. This hook can be perfectly positioned exactly where you want it, and even moved, without damaging the bait. When the bite is tough, G-Finesse opens new ways to stick it to 'em.

SIZES	6	4	2	1	1/0
Nano Smooth Coat	LS 374207(6)	374208(6)	374209(6)	374210(6)	374211(6)

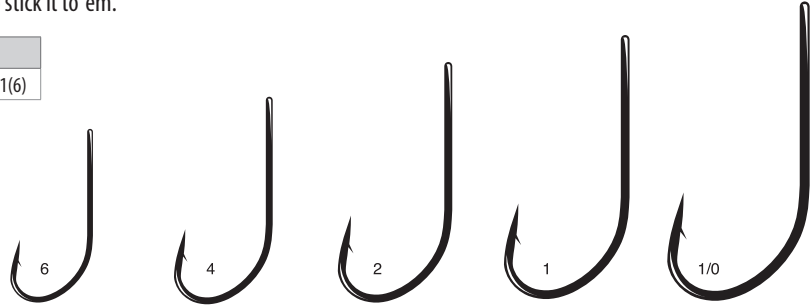

## G-Finesse Weedless Stinger

We heard from pro staff, Brent Ehrler, and many others, that anglers were spending far too much time tying custom weed guards with wire or heavy monofilament on their Neko rigs... because they couldn't find the right finesse hook with the right weed guard already attached. Problem solved! The G-Finesse Weedless Stinger is just what the tournament trail needed. Titanium wire weed guard, Nano Smooth Coat and Tournament Grade Wire.

SIZES	6	4	2	1	1/0
Nano Smooth Coat	LS 375207(4)	375208(4)	375209(4)	375210(4))	375211(4)

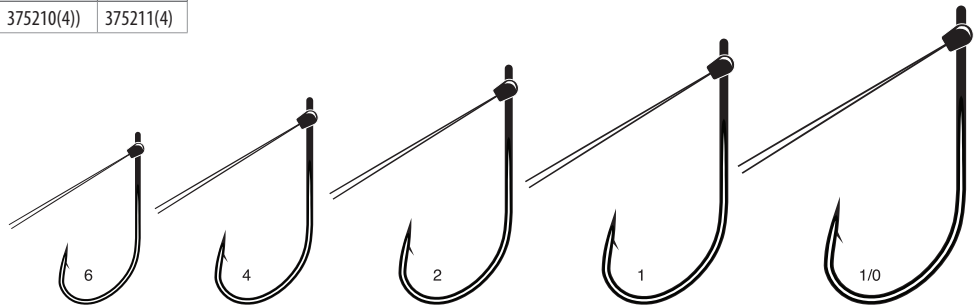
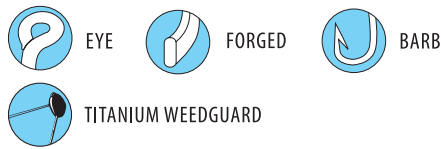





**G-POWER**

**SpaMakatsu<sup>®</sup>**



## G-POWER BY AARON MARTENS



### G-Power Heavy Cover Flip and Punch

Designed by Aaron Martens, Gamakatsu has developed the new G-Power Heavy Cover Flip and Punch Hook. A step up from the G-Finesse Heavy Cover Hook, for serious flipping and punching with Heavy fluorocarbon and braid. The TGW (Tournament Grade Wire) hook, paired with its welded eye, make this the strongest Heavy Cover hook in Gamakatsu's G-Series lineup. Ideal for larger baits and weights, punching through grass mats and flipping into heavy timber. G-Power Flip and Punch ideally matches to all types of cover and able to withstand extreme conditions.

SIZES	2/0	3/0	4/0	5/0
Nano Smooth Coat	LS 392212(4)	392213(4)	392214(4)	392215(4)

**NEW**

- WELDED EYE
- FORGED
- BARB
- TIN KEEPER

**TGW**  
Tournament Grade Wire

**NANO SMOOTH COAT**

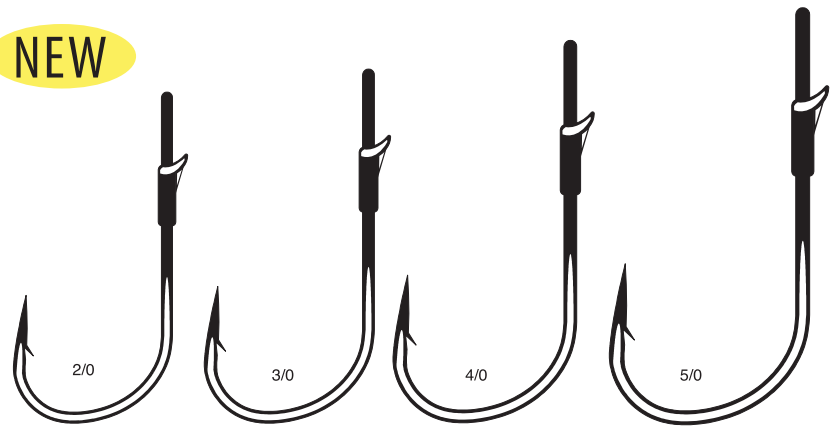

### G-Power Stinger Trailer

The new G-Power Stinger Trailer Hook brilliance comes from Gamakatsu's famous B10S series of fly hooks and the expertise of Professional Bass angler Aaron Martens. The Stinger Trailer has a strategically designed eye angle. This allows the hook to run straight through the water column at any retrieve speed which produces more hookups. To make this stinger hook even more efficient, Gamakatsu paired it with a silicone stopper to be placed just above the eye, preventing the hook from sliding over the barb of the main hook. Featuring Tournament Grade Wire, Nano Smooth Coat finish and the new silicone stopper, the G-Power Stinger Trailer Hook is a game-changer.

SIZES	2	1	1/0
Nano Smooth Coat	LS 411209(6)	411210(6)	411211(6)

- EYE
- FORGED
- BARB

**TGW**  
Tournament Grade Wire

**NANO SMOOTH COAT**





# TREBLE HOOKS

Spunkatsu®

### Treble SP Medium Heavy Hypershield

The Treble SP Medium Heavy Hypershield features TGW (Tournament Grade Wire) which is thinner, stronger and sharper than standard wire. Hypershield coating dramatically increases corrosion resistance allowing anglers to spend more time fishing and less time changing out old rusty hooks. Hypershield also keeps hooks sharper longer, making it the perfect treble hook for big, toothy fish. The Treble SP MH is paired with the iconic ME (Magic Eye), making it extremely simple to replace existing hooks on to any split ring of a crankbait or plug.

SIZES		6	4	2	1	1/0	2/0
Hyper Shield	LS	390807(6)	390808(6)	390809(5)	390810(5)	390811(4)	390812(4)



### Treble SP XH

Replacing factory hooks on inshore plugs, jigs and spoons with Gamakatsu's heavy-duty SP XH treble hooks is an instant upgrade. The Tournament Grade Wire (TGW) construction is thinner, stronger and sharper than standard wire, making these Gamakatsu's strongest treble ever. Plus, the short shank design eliminates leverage that can lead to worn jaws and pulled hooks.

SIZES		3	2	1	1/0	2/0	3/0	4/0	5/0	6/0
Tin	LS	391508.5(5)	391509(5)	391510(5)	391511(4)	391512(4)	391513(4)	391514(4)	391515(4)	391516(4)



### Treble Round Bend

When you want to get serious about your hard baits our Round Bend Treble is the standard worldwide.

SIZES	12	10	8	7	6	5	4	3	2	1	1/0	2/0
NS Black	LS			47406(12)	47406.5(12)	47407(12)	47407.5(10)	47408(11)	47408.5(8)	47409(8)	47410(8)	
	25			47406-25	47406.5-25	47407-25	47407.5-25	47408-25	47408.5-25	47409-25	47410-25	
Tin	LS			47006(12)		47007(12)		47008(11)		47009(9)	47010(7)	47011(6)
Bronze	LS	47104(12)	47105(12)	47106(12)		47107(12)	47107.5(11)	47108(11)	47108.5(9)	47109(9)	47110(7)	47111(6)
	25			47106-25		47107-25		47108-25		47109-25	47110-25	47111-25
Red	LS	47304(10)	47305(10)	47306(10)		47307(10)	47307.5(9)	47308(9)	47308.5(8)	47309(8)		

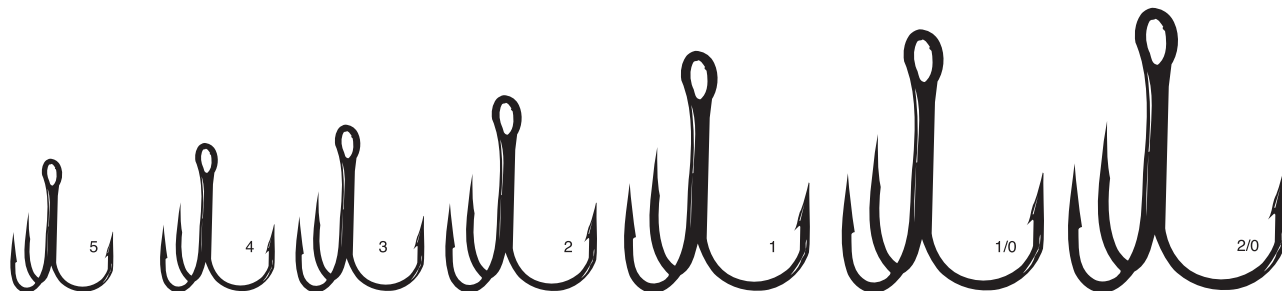

### Treble Round Bend Barbless

SIZES	8	6	4	2	1	1/0
Bronze	LS	64106(12)	64107(12)	64108(11)	64109(9)	64110(7)
					64111(6)	

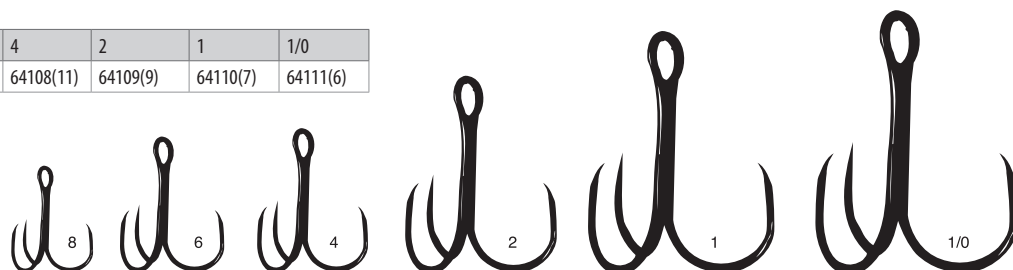
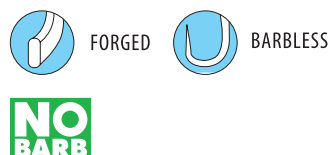

### Treble 2x Strong, Round Bend

Anytime your situation requires a stout Round Bend Treble our 2X strong is the answer. The perfect hook for hard charging Stripers or Peacock Bass.

SIZES	4	2	1	1/0
NS Black	LS	57408(11)	57409(9)	57410(7)
Red	LS	57308(9)	57309(8)	57310(7)
				57311(5)



### Treble Short Shank, (Magic Eye), Round Bend

Developed for the discerning hard bait angler. Featuring our award winning "Magic Eye". When rigged, the Short Shank hook points run parallel to the bait creating a perfect balance point. This is the ideal treble hook for optimal lure performance.

SIZES	6	4	2	1	1/0
NS Black	LS	298407(12)	298408(11)	298409(9)	298410(7)
					298411(6)

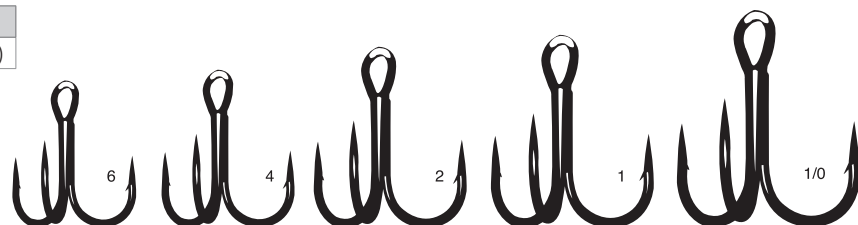

### Treble Extra Wide Gap (EWG)

SIZES		6	4	2
Bronze	LS	77107(12)	77108(11)	77109(9)
NS Black	LS	77407(12)	77408(11)	77409(9)
Red	LS	77307(10)	77308(9)	77309(8)



### Treble EWG, Short Shank, (Magic Eye)

For crankbaits of all types --- there's nothing better --- it's the perfect replacement hook. First, we opened the points of this treble up slightly for even better hooking performance. The Short Shank EWG Treble converts those fish that slash at your bait into sure hook-ups. The shorter shank and wide gap design provides less room for fish to throw the hook. In fact, this attribute actually wedges the fish between the hook and the crankbait...it's the ultimate in fish holding, which means fish landing performance. That's not all. It also features Gamakatsu's exclusive "Magic Eye" that makes changing hooks a breeze. The hook's inline points run parallel to the bait creating a perfect balance point so your crankbaits run true.

SIZES		6	4	2	1	1/0
NS Black	LS	330407(6)	330408(6)	330409(6)	330410(6)	330411(6)

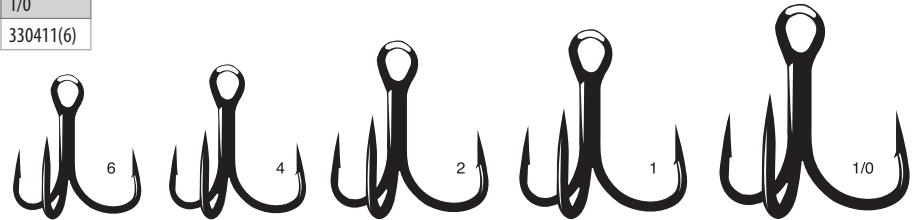

### Treble EWG, Short Shank, 2X Strong (Magic Eye)

All the attributes of the Short Shank EWG Treble just beefed up to 2X Strong dimensions for tackle-busting big game species like striper, musky and peacock bass.

SIZES		6	4	2	1	1/0
NS Black	LS	317407(6)	317408(6)	317409(6)	317410(6)	317411(6)

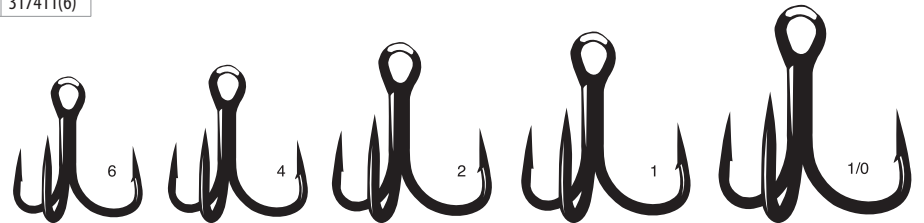

### Treble 4x Strong

SIZES		1	1/0	2/0	3/0	4/0	5/0
Tin	LS	62010(5)	62011(5)	62012(4)	62013(4)	62014(3)	62015(3)

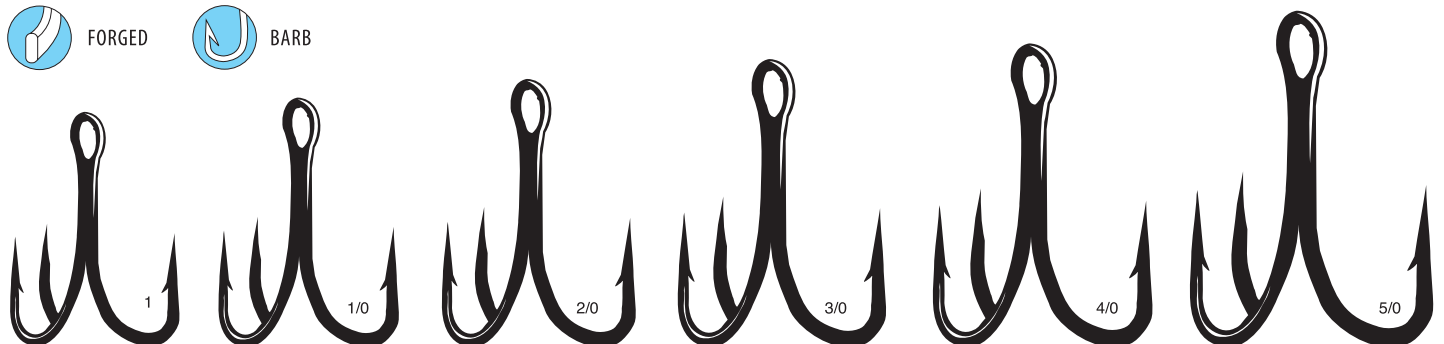

### Trout Treble

Developed for that discerning trout fishermen in mind. With the advances and popularity of artificial dough and paste type baits, it was only a matter of time that an added extra edge was needed. These high quality, sticky sharp trebles fit the bill. The light wire design will allow your bait to float higher and keep it more in the strike zone. Also, the fine wire design will allow for quick and deeper hook penetration.

SIZES		18	16	14
Red	LS	273301(4)	273302(4)	273303(4)
Gold	LS	273201(4)	273202(4)	273203(4)



### Feathered Treble

Add one of our Feathered Trebles to the back of any topwater bait and watch your lure come to life. Beautifully hand tied on our premium Round Bend treble.

SIZES		6	4	2
NS Black (White and White)	LS	216407-WW(2)	216408-WW(2)	216409-WW(2)
(White and Red)	LS	216407-WR(2)	216408-WR(2)	216409-WR(2)



FORGED



BARB



### Double 22 Medium Shank

Medium shank length designed with a straight eye manufactured in durable Nickel Silver Black.

SIZES		10	8
NS Black	LS	302405(12)	302406(12)



FORGED



BARB

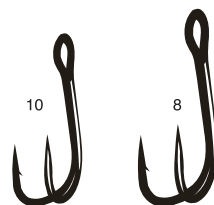

### EWG Double

The perfect hook for all your soft bodied frogs. The angle of the hook makes it ride weedless. The wide gap increases your hook up ratio.

SIZES		3/0	4/0
NS Black	LS	226413(3)	226414(3)



FORGED



BARB

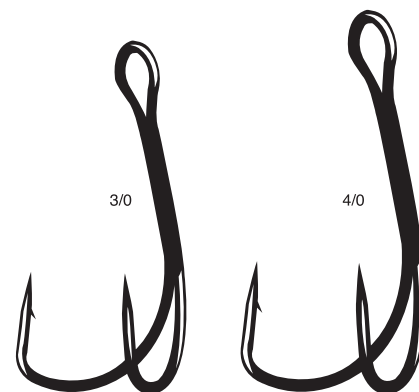





**ALL PURPOSE  
HOOKS**

*SpartanKatsu<sup>®</sup>*



### Octopus

Our most versatile hook, known for its durability and strength. The Octopus hook comes in a wide variety of colors and finishes including fluorescent.

SIZES	14	12	10	8	6	4	2	1	1/0	2/0	3/0	4/0	5/0	6/0	7/0	8/0	9/0	10/0	
Nickel	LS			02005(10)	02006(10)	02007(10)	02008(10)	02009(8)	02010(8)	02011(6)	02012(6)	02013(6)	02014(6)	02015(6)	02016(6)	02017(6)	02018(6)	02019(5)	02020(5)
	25				02006-25	02007-25	02008-25	02009-25	02010-25	02011-25	02012-25	02013-25	02014-25	02015-25	02016-25	02017-25	02018-25	02019-25	02020-25
	100					02007-100	02008-100	02009-100	02010-100	02011-100	02012-100	02013-100	02014-100	02015-100	02016-100	02017-100			
Bronze	LS				02106(10)	02107(10)	02108(10)	02109(8)	02110(8)	02111(6)	02112(6)	02113(6)	02114(6)	02115(6)					
	25					02106-25	02107-25	02108-25	02109-25	02110-25	02111-25	02112-25	02113-25	02114-25	02115-25				
	100					02106-100	02107-100	02108-100	02109-100	02110-100	02111-100	02112-100	02113-100	02114-100	02115-100				
NS Black	LS	02403(10)	02404(10)	02405(10)	02406(10)	02407(10)	02408(10)	02409(8)	02410(8)	02411(6)	02412(6)	02413(6)	02414(6)	02415(6)	02416(6)	02417(6)	02418(6)	02419(5)	02420(5)
	25				02406-25	02407-25	02408-25	02409-25	02410-25	02411-25	02412-25	02413-25	02414-25	02415-25	02416-25	02417-25			
	100				02406-100	02407-100	02408-100	02409-100	02410-100	02411-100	02412-100	02413-100	02414-100	02415-100	02416-100	02417-100	02418-100	02419-100	02420-100
Red	LS	02303(10)	02304(10)	02305(10)	02306(10)	02307(10)	02308(10)	02309(8)	02310(8)	02311(6)	02312(6)	02313(6)	02314(6)	02315(6)	02316(6)	02317(6)	02318(6)	02319(5)	02320(5)
	25				02306-25	02307-25	02308-25	02309-25	02310-25	02311-25	02312-25	02313-25	02314-25	02315-25	02316-25	02317-25			
	100				02306-100	02307-100	02308-100	02309-100	02310-100	02311-100	02312-100	02313-100	02314-100	02315-100	02316-100	02317-100			
Green	LS				02306-G(10)	02307-G(10)	02308-G(10)	02309-G(8)											
	25				02306-G-25	02307-G-25	02308-G-25	02309-G-25											
	100				02306-G-100	02307-G-100	02308-G-100	02309-G-100											
Blue	LS				02306-B(10)	02307-B(10)	02308-B(10)	02309-B(8)											
	25				02306-B-25	02307-B-25	02308-B-25	02309-B-25											
	100				02306-B-100	02307-B-100	02308-B-100	02309-B-100											
F-Red	LS			02606-FR(7)	02607-FR(7)	02608-FR(7)	02609-FR(6)	02610-FR(6)	02611-FR(5)	02612-FR(5)	02613-FR(5)								
Chartreuse	LS				02606-C(7)	02607-C(7)	02608-C(7)	02609-C(6)	02610-C(6)	02611-C(5)	02612-C(5)	02613-C(5)							
	25				02606-C-25	02607-C-25	02608-C-25	02609-C-25											
F-Pink	LS				02606-P(7)	02608-P(7)	02609-P(6)	02610-P(6)	02611-P(5)	02612-P(5)	02613-P(5)								
F-Orange	LS				02606-OR(7)	02607-OR(7)	02608-OR(7)	02609-OR(6)	02610-OR(6)	02611-OR(5)	02612-OR(5)	02613-OR(5)							
Glow	LS				02606-GL(7)	02607-GL(7)	02608-GL(7)	02609-GL(6)	02610-GL(6)										
F-Green	LS				02606-LG(7)	02607-LG(7)	02608-LG(7)	02609-LG(6)											
F-Purple	LS				02606-PU(7)	02607-PU(7)	02608-PU(7)	02609-PU(6)											
Ultra Violet	LS				02606-UV(7)	02607-UV(7)	02608-UV(7)	02609-UV(6)	02610-UV(6)	02611-UV(5)	02612-UV(5)	02613-UV(5)							

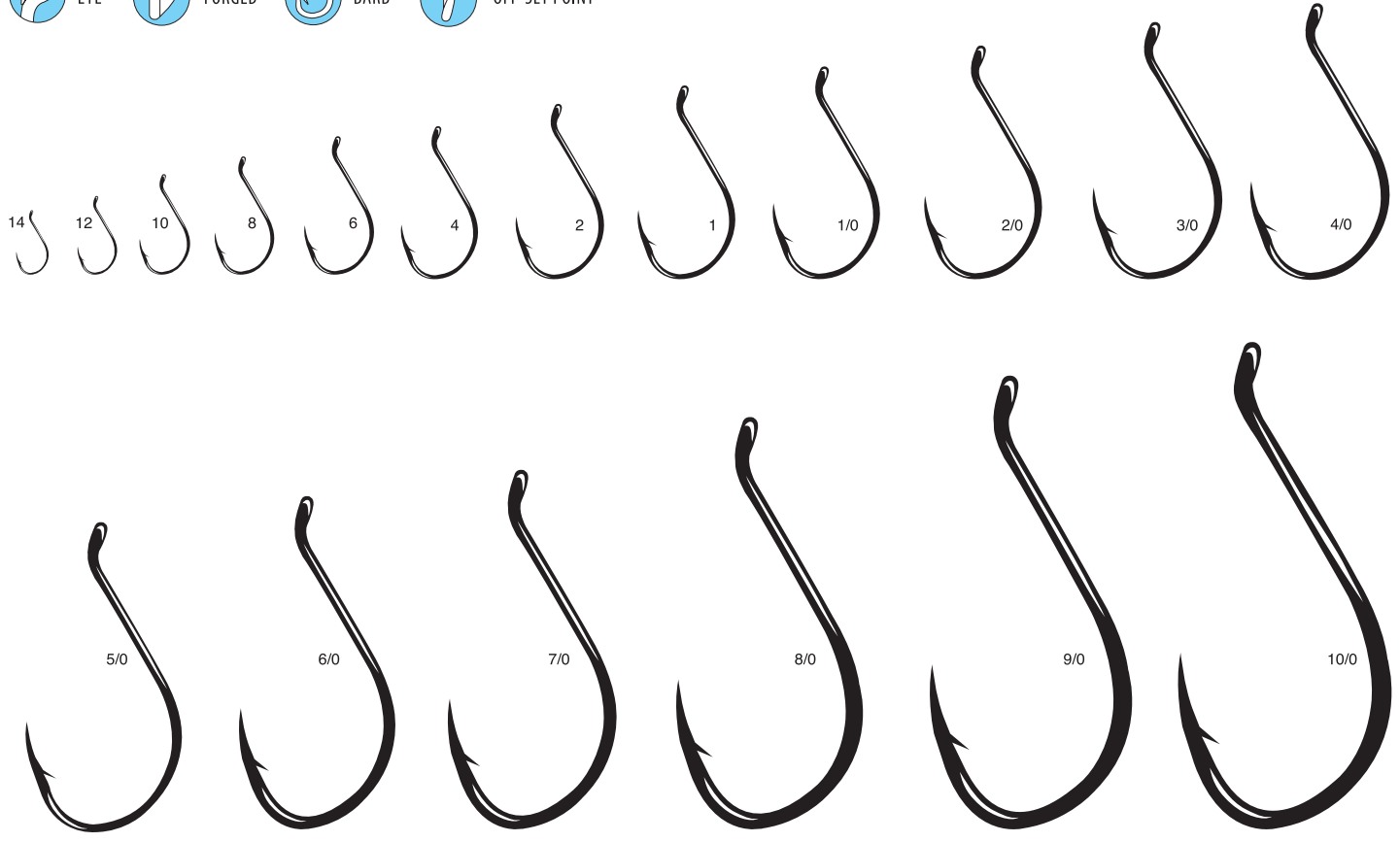

**Walleye And Steelhead Assortment**

SIZES	8	6	4	2	
Assortment	25	02506	02507	02508	02509

**5 Colors:**

- Green
- Blue
- Red
- Bronze
- Black

5 hooks per color, 25 hooks total

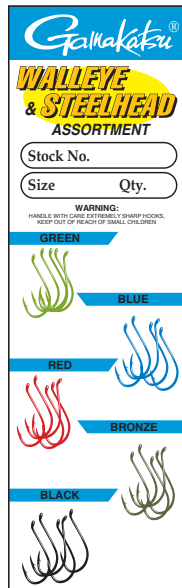

**Fluorescent Walleye And Steelhead Assortment**

SIZES	8	6	4	2	
Assortment	20	02706	02707	02708	02709

**5 Colors:**

- F-Red
- F-Pink
- F-Orange
- Chartreuse
- Glow

4 hooks per color, 20 hooks total

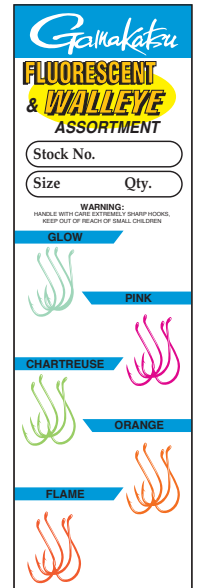

**TGW OCTOPUS**

The TGW (Tournament Grade Wire) Octopus utilizes Gamakatsu's ultra-strong TGW wire that's thinner, sharper and stronger than the standard wire and ensures the hook point stays sharper, longer. This is combined with Gamakatsu's Nano Smooth Coat finish to provide a faster, deeper penetrating hook. The hook's all-purpose shape and forged construction makes it ideal for a variety of presentations. The TGW Octopus Hook also features an upturned eye to ease snelling or knotting directly to the eye.

SIZES	6	4	2	1	1/0	2/0
Nano Smooth Coat	LS 424207(8)	424208(8)	424209(6)	424210(6)	424211(5)	424212(5)

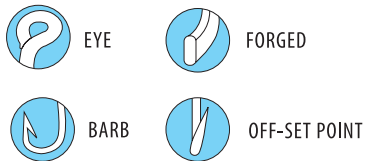

**NEW**

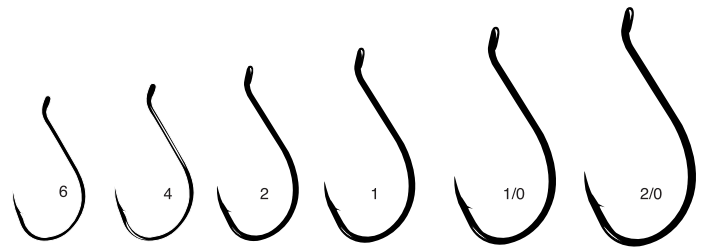

**Octopus Light**

Gamakatsu answered the call for a fine wire Octopus hook, the Octopus Light for use in drop shot and trout fishing. Gamakatsu's Octopus Light features an offset beak point for optimal penetration with bait or plastics. The smaller diameter hook wire enhances hook penetration and is a certain advantage when fishing timid or light-biting fish.

SIZES	8	6	4	2	1	1/0	2/0	3/0
NS Black	LS 341406(10)	341407(10)	341408(10)	341409(8)	341410(8)	341411(6)	341412(6)	341413(6)
Red	LS 341306(10)	341307(10)	341308(10)	341309(8)	341310(8)	341311(6)	341312(6)	341313(6)

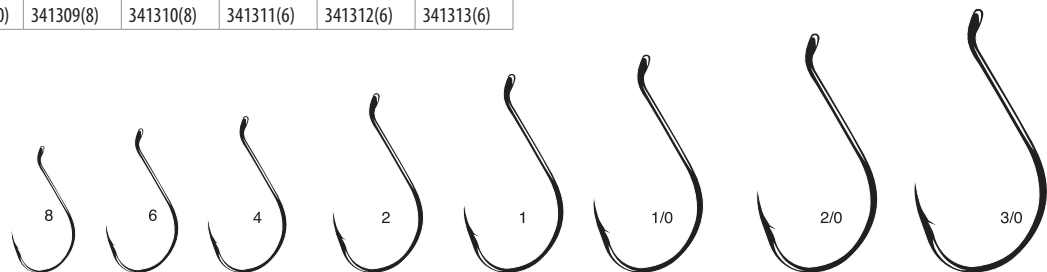
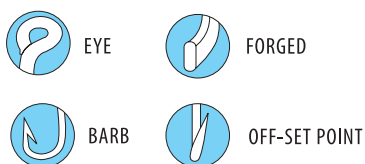

### Octopus Barbless

Specially designed bend allows the hook to penetrate quickly and hold, while still complying with the barbless hook regulations.

SIZES		4	2	1	1/0	2/0	3/0	4/0	5/0	6/0	7/0	8/0	10/0
Nickel	LS	75008(10)	75009(8)	75010(8)	75011(6)	75012(6)	75013(6)	75014(6)	75015(6)	75016(6)	75017(6)	75018(6)	75020(5)
	25	75008-25	75009-25	75010-25	75011-25	75012-25	75013-25	75014-25	75015-25	75016-25	75017-25		
	100	75008-100	75009-100	75010-100	75011-100	75012-100	75013-100	75014-100	75015-100				
Red	LS	75308(10)	75309(8)	75310(8)	75311(6)	75312(6)	75313(6)	75314(6)	75315(6)				
	25	75308-25	75309-25	75310-25	75311-25	75312-25	75313-25	75314-25	75315-25				
	100	75308-100	75309-100	75310-100	75311-100	75312-100	75313-100	75314-100	75315-100				
NS Black	LS	75408(10)	75409(8)	75410(8)	75411(6)	75412(6)	75413(6)	75414(6)	75415(6)				
	25	75408-25	75409-25	75410-25	75411-25	75412-25	75413-25	75414-25	75415-25				



EYE



FORGED



BARBLESS



OFF-SET POINT

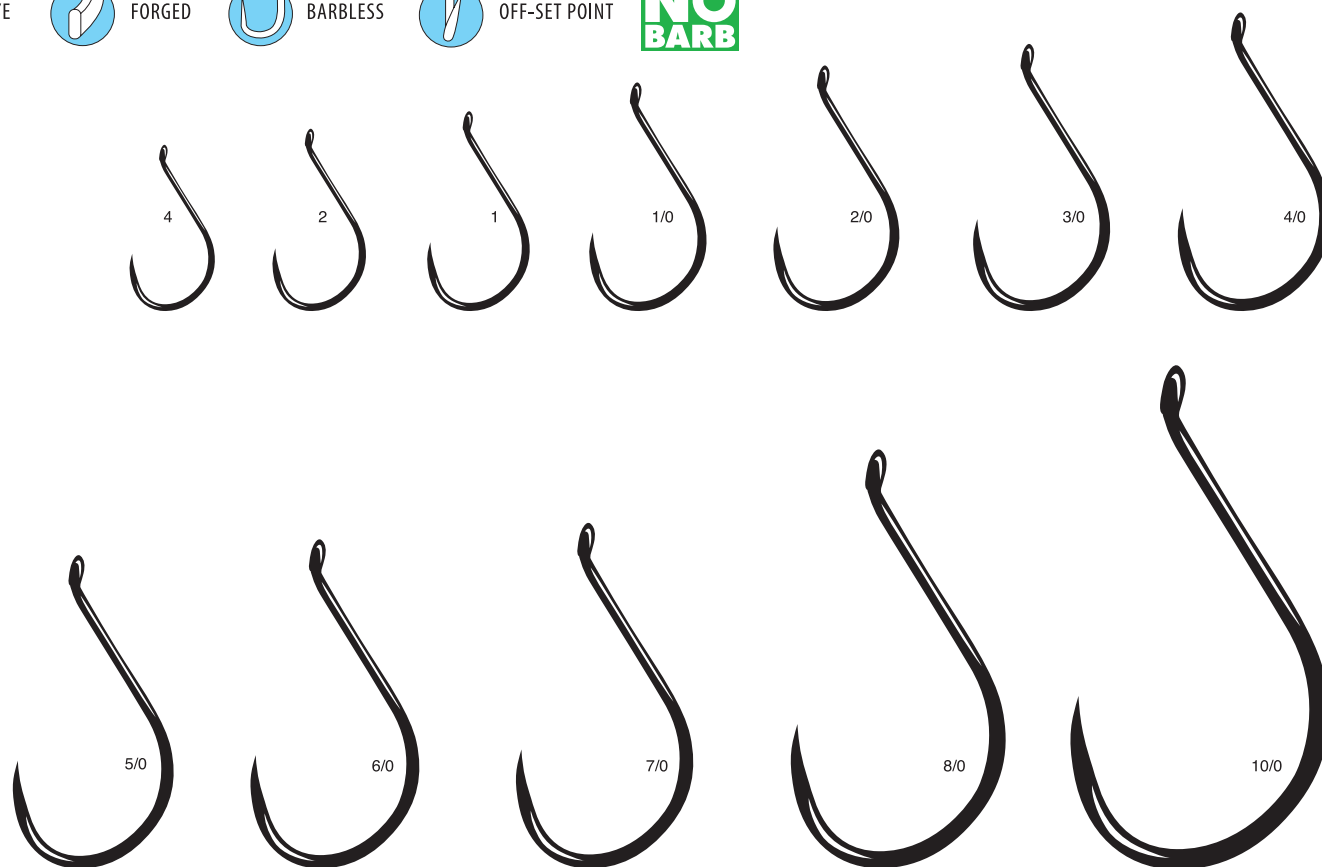

### Octopus Straight Eye

West coast anglers love salmon. Salmon love herring. Herring love to rip and tear apart when you rig them with traditional hooks. Hence, the reason we designed the Octopus Straight Eye hook. The ultra-thin, yet ultra-strong, wire slides through soft baits without damaging the tender tissue. The hook eye is narrower and smoother too, so it can slide through as well. The result is a herring with that perfect spin, followed by a chrome bright chinook or coho in the net shortly thereafter.

SIZES		8	6	4	2	1	1/0	2/0	3/0	4/0
NS Black	LS	387406(10)	387407(10)	387408(10)	387409(8)	387410(8)	387411(6)	387412(6)	387413(6)	387414(6)
	25	387406-25	387407-25	387408-25	387409-25	387410-25	387411-25	387412-25	387413-25	387414-25



EYE



FORGED



BARB



OFF-SET POINT

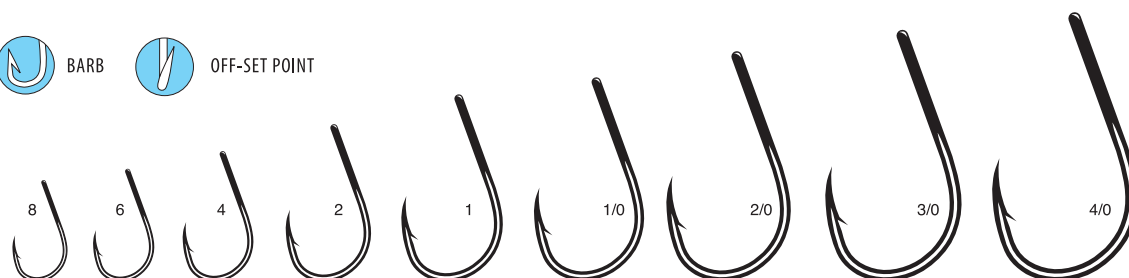

### Octopus Straight Eye, 4x Strong

One of the more versatile hooks in our line up, this hook is built to handle big fish. Used for everything from Catfish to Tarpon, the offset beak point penetrates quickly and can be used on either live baits or for chunk baits.

SIZES	1/0	2/0	3/0	4/0	5/0	6/0	7/0	8/0	9/0	10/0
NS Black	LS 98411(6)	98412(6)	98413(6)	98414(6)	98415(6)	98416(6)	98417(6)	98418(6)	98419(5)	98420(5)
	25				98415-25	98416-25	98417-25	98418-25		

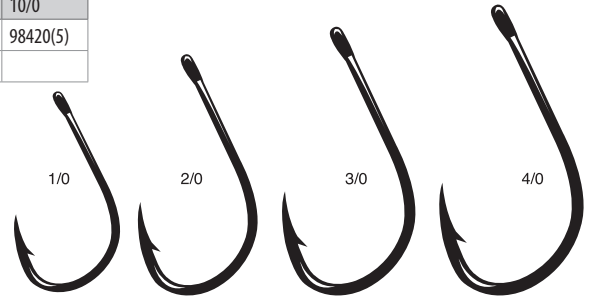

### Octopus Straight Eye, 4x Strong (Inline-point)

Same hook as the 4x Octopus Straight Eye, but without any offset. This makes a great trolling hook and will upgrade any trolling lures.

SIZES	4/0	5/0	6/0	7/0	8/0	9/0	10/0
NS Black	LS 263414(6)	263415(6)	263416(6)	263417(6)	263418(6)	263419(5)	263420(5)

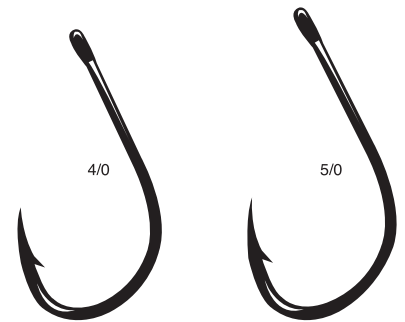

### Octopus Circle (Offset-point)

Specially designed to set in the corner of the fish's mouth, making it a great choice for the fresh and saltwater fisherman still wanting to use bait.

SIZES		8	6	4	2	1	1/0	2/0	3/0	4/0	5/0	6/0	7/0	8/0
NS Black	LS	208406(10)	208407(10)	208408(10)	208409(8)	208410(8)	208411(6)	208412(6)	208413(6)	208414(6)	208415(6)	208416(6)	208417(6)	208418(6)
	25 pk	208406-25	208407-25	208408-25	208409-25	208410-25	208411-25	208412-25	208413-25	208414-25	208415-25	208416-25	208417-25	208418-25



### Octopus Circle (Inline-point) **TOURNAMENT LEGAL**

Same design as the Octopus Circle, but without any offset to conform with some Billfish tournament regulations and some fisheries that require non-offset circle hooks.

SIZES		1/0	2/0	3/0	4/0	5/0	6/0	7/0	8/0
NS Black	LS	221411(6)	221412(6)	221413(6)	221414(6)	221415(6)	221416(6)	221417(6)	221418(6)
	25 pk	221411-25	221412-25	221413-25	221414-25	221415-25	221416-25	221417-25	221418-25
Red	LS	221311(6)	221312(6)	221313(6)	221314(6)	221315(6)	221316(5)	221317(5)	221318(4)

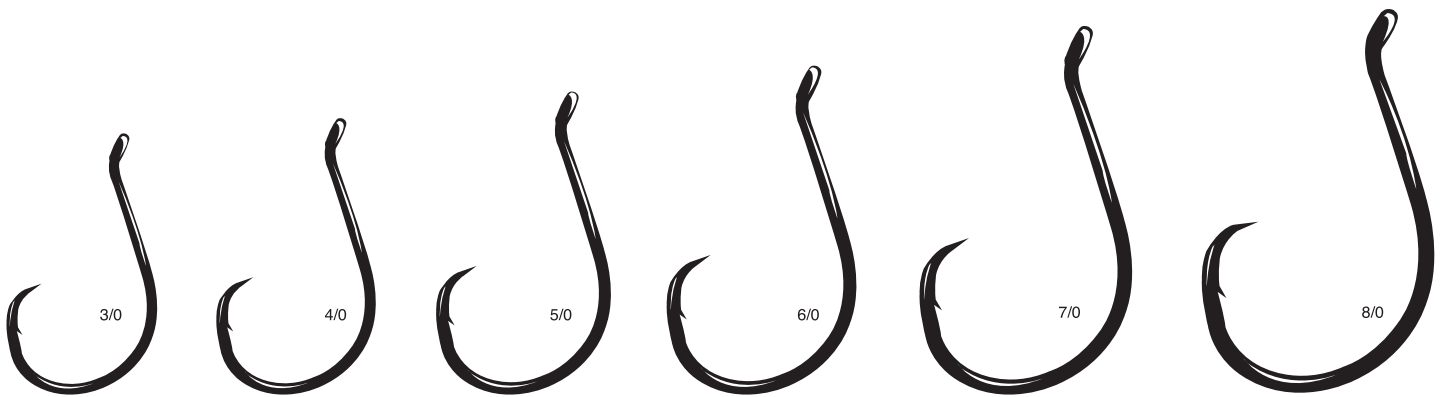
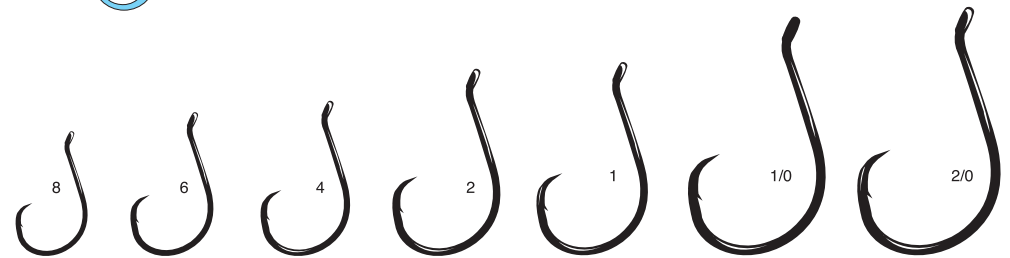

### Octopus Circle (Inline-point) Barbless **TOURNAMENT LEGAL**

SIZES		3/0	4/0	5/0
NS Black	LS	224413(6)	224414(6)	224415(6)

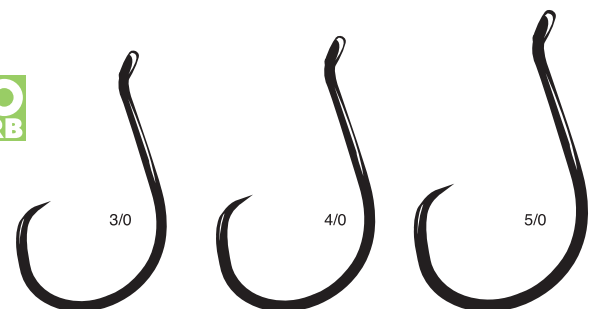

### Octopus Circle Out Barb, 1x Strong

Will Gamakatsu's Octopus Circle "Outbarb" 1x Strong hook change angling forever? There's a strong possibility, and for good reason. Traditional hooks place the barb on the inside of the hook bend. With certain techniques, like jigging, chunk baiting, and bottom fishing, if your line becomes limp or goes slack it could get entangled by the hook barb and possibly be nicked or cut. The outbarb design eliminates that risk. But there's more. Tests have proven that when an outbarb is combined with Gamakatsu's circle hook design, it results in deeper penetration and a higher hook retention rate. Think about it: a barb on the inner side of a hook bend is somewhat protected. A barb on the outside of the hook bend will come into contact with whatever flesh it touches and prevent movement in the opposite direction from which it entered. Consistently, Gamakatsu researchers and prostaffers documented increased retention of hooked species.

SIZES		3/0	4/0	5/0	6/0	7/0	8/0	10/0	12/0
NS Black	LS	363413(6)	363414(6)	363415(6)	363416(6)	363417(5)	363418(5)	363420(3)	363422(3)

-  EYE
-  FORGED
-  OUT-BARB
-  CIRCLE HOOK
-  OFF-SET POINT

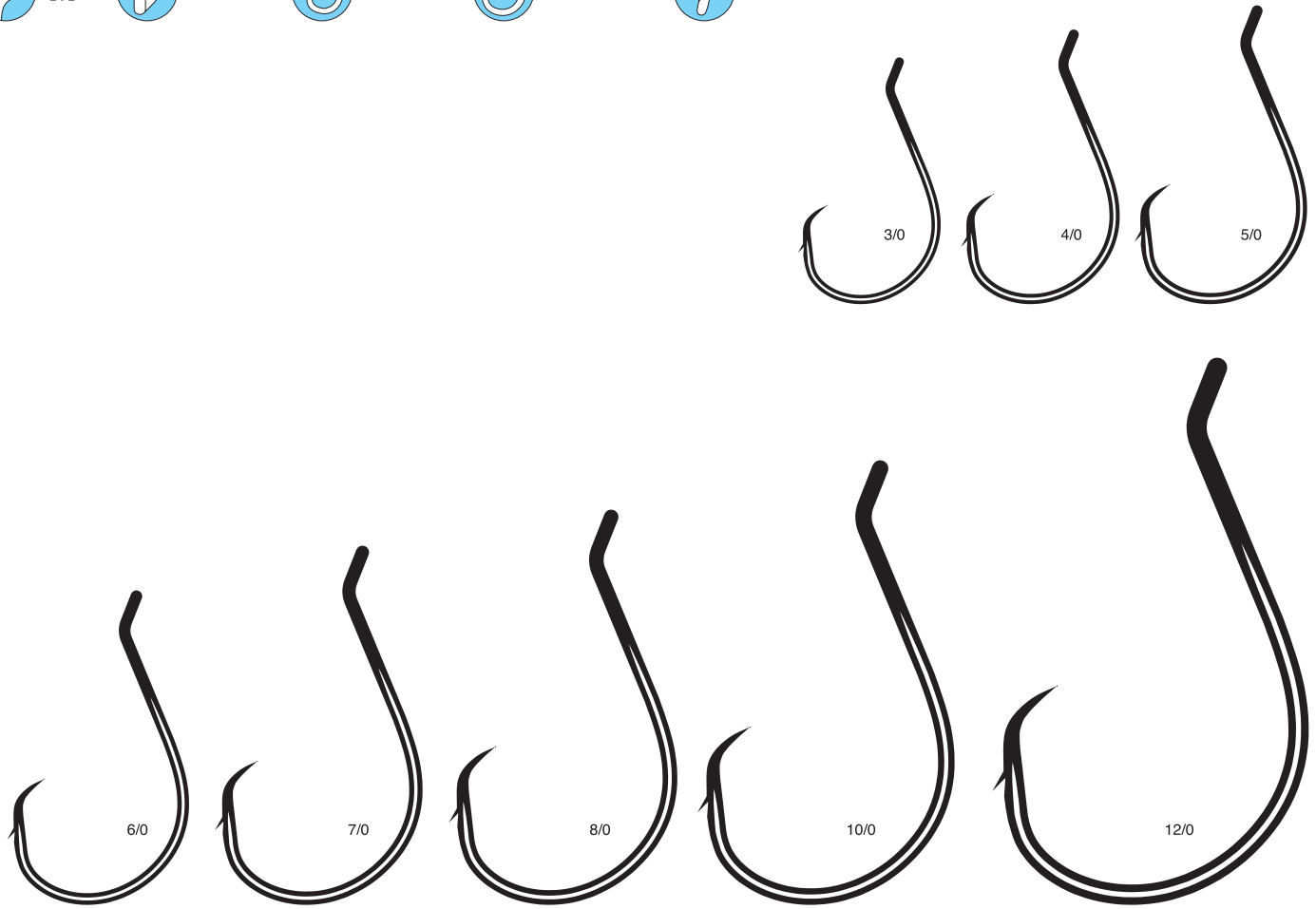

**Octopus Circle Straight Eye (Inline-point) TOURNAMENT LEGAL**

SIZES		1	1/0	2/0	3/0	4/0	5/0	6/0	7/0	8/0
NS Black	LS	265410(8)	265411(6)	265412(6)	265413(6)	265414(6)	265415(6)	265416(6)	265417(6)	265418(6)
	25 pk	265410-25	265411-25	265412-25	265413-25	265414-25	265415-25	265416-25	265417-25	265418-25
	100 pk				265413-100	265414-100	265415-100	265416-100		

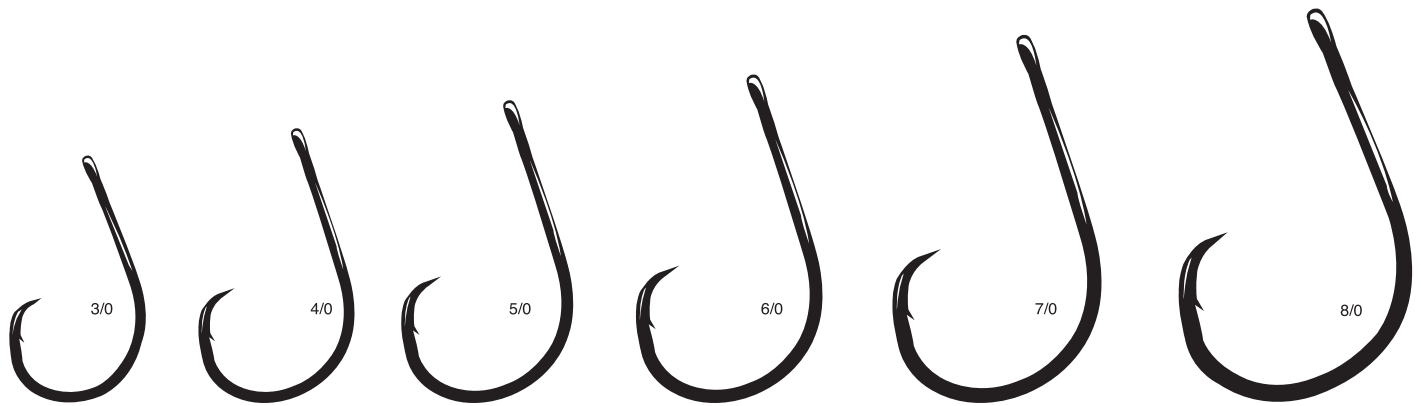
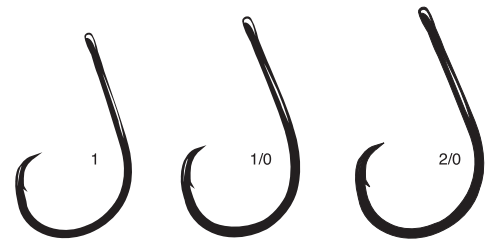
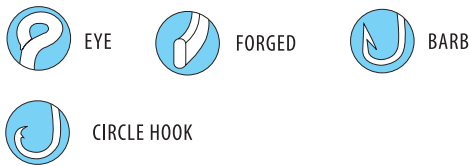

**Octopus Circle 4x Strong, Straight Eye**

This hook is designed for heavier lines and bigger fish. The offset point makes it a good choice for many chunk bait situations.

SIZES		1/0	2/0	3/0	4/0	5/0	6/0	7/0	8/0
NS Black	LS	209411(6)	209412(6)	209413(6)	209414(6)	209415(6)	209416(6)	209417(6)	209418(6)
	25					209415-25	209416-25	209417-25	209418-25

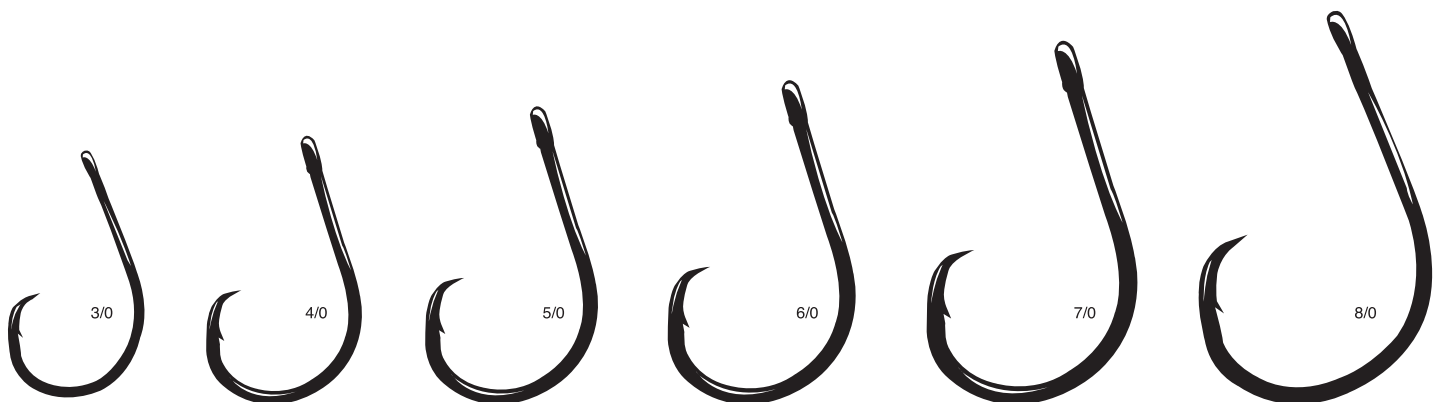
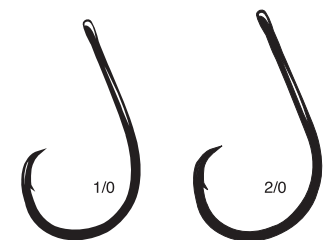



**Octopus Circle 4x Strong, Straight Eye (Inline-point), TOURNAMENT LEGAL**

To comply with new angling regulations in the Gulf of Mexico, we've redesigned and reinforced our most popular circle hook. The 4X Strong Circle Hook is built for the toughest battles in the deep sea. The straight eye, NS Black finish and inline point (not offset) complies with the new rules, but doesn't reduce the hook's effectiveness. This is the new "go-to" hook charter captains and professional anglers are using for deep dropping and reef and wreck fishing. Heavy up your rods, reels and line, because the 4X Strong Circle Hook will never give up when it comes to pulling snapper and monster grouper out of their fortified hangouts.

SIZES		1/0	2/0	3/0	4/0	5/0	6/0	7/0	8/0	9/0	10/0
NS Black	LS	360411(6)	360412(6)	360413(6)	360414(6)	360415(6)	360416(6)	360417(6)	360418(6)	360419(5)	360420(5)

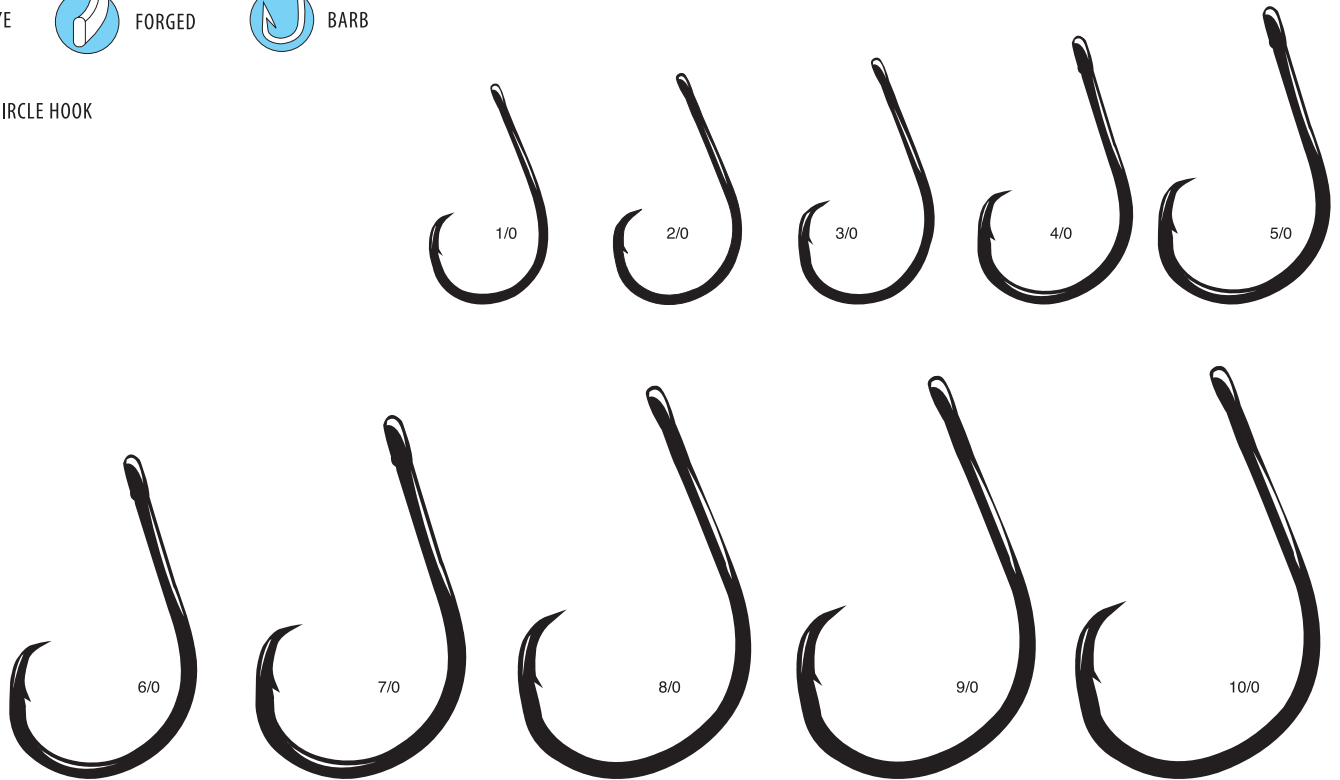
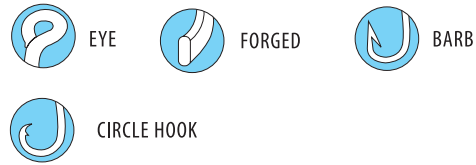

### Big River Bait

The Big River Bait hook is forged for extra strength with an up eye for easy snelling. The large gap allows for quick penetration and the unique bend offers great holding power. The NS Black finish is durable and corrosion resistant.

SIZES		4	2	1	1/0	2/0	3/0	4/0	5/0	6/0	7/0	8/0	9/0	10/0	12/0
NS Black	LS	225408(10)	225409(8)	225410(8)	225411(6)	225412(6)	225413(6)	225414(6)	225415(6)	225416(6)	225417(6)	225418(5)	225419(4)	225420(3)	225422(3)
	25 pk	225408-25	225409-25	225410-25	225411-25	225412-25	225413-25	225414-25	225415-25	225416-25	225417-25	225418-25			
Red	LS			225310(8)	225311(6)	225312(6)	225313(6)	225314(6)	225315(6)	225316(6)					
	25 pk			225310-25	225311-25	225312-25	225313-25	225314-25	225315-25	225316-25					

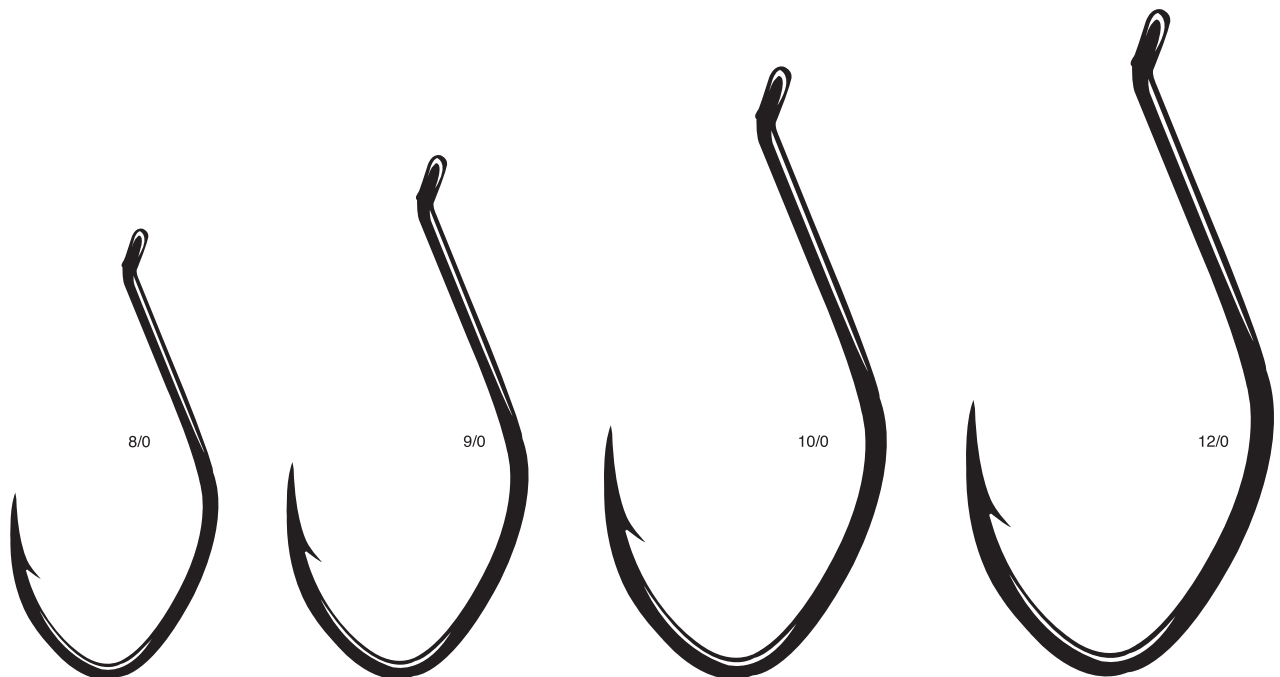
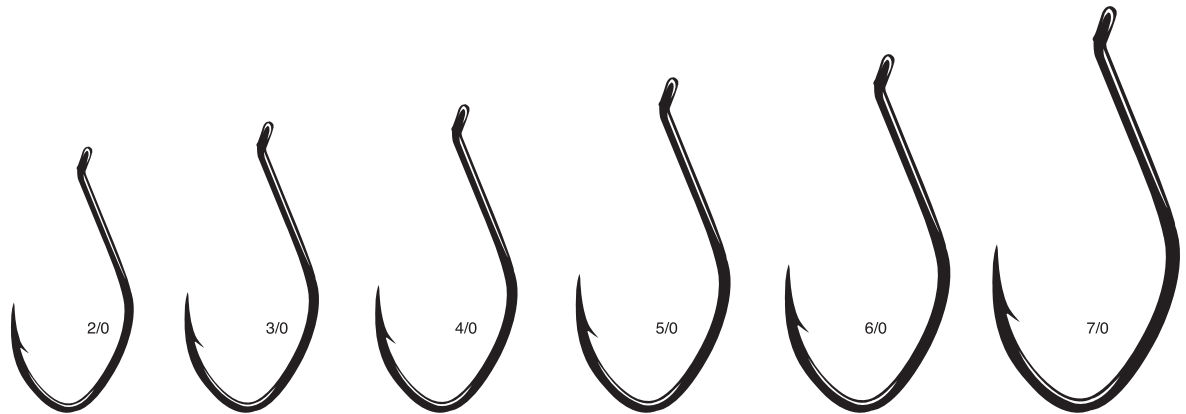
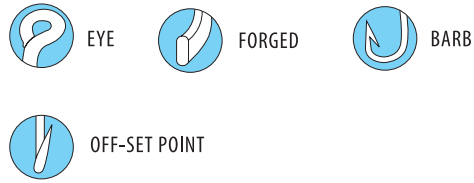

### Big River Bait Barbless

The innovative design has overtaken bait fisheries from coast to coast. Now the Big River Bait Hook is available as barbless to comply with conservation initiatives and new regulations. No need to pinch the barb on these forged shank hooks. The large gap and unique shape enable instant penetration and holding power. Corrosion resistant and available in all popular sizes.

SIZES		2/0	3/0	4/0	5/0	6/0
NS Black	LS	376412(6)	376413(6)	376414(6)	376415(6)	376416(6)
	25 pk	376412-25	376413-25	376414-25	376415-25	376416-25

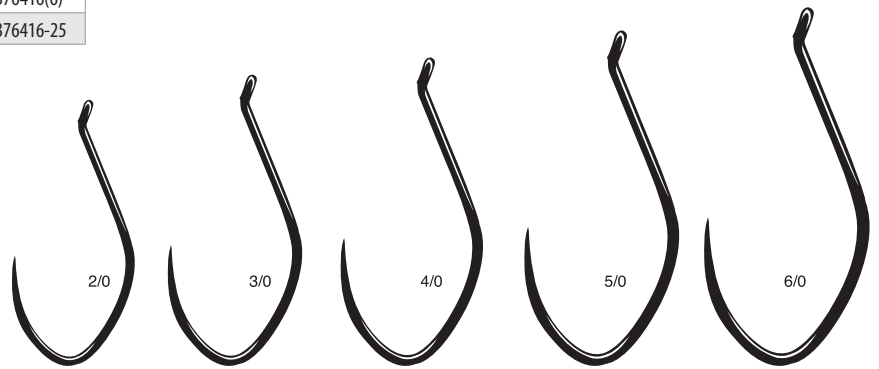
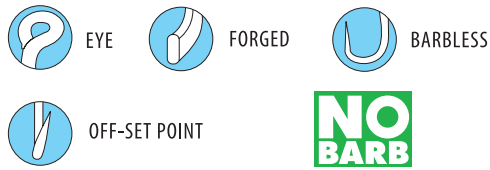

### Big River Bait Open Eye

The reception to our Big River Bait Hook has been so strong that angler's immediately began asking for a siwash-style hook they could use on their spinners, spoons and plugs for salmon. The answer... this fast penetrating hook holds better than conventional hook designs. When fished barbless (which requires pinching the barb down) it's the best barbless hook you'll find. The unique Big River hook design locks fish in place when hooked. Forged for exceptional strength and built Gamakatsu sharp the Big River Open Eye is sure to make great lures even better.

SIZES		1/0	2/0	3/0	4/0	5/0	6/0	7/0
NS Black	LS	225911(5)	225912(5)	225913(5)	225914(5)	225915(5)	225916(5)	225917(4)
	25	225911-25	225912-25	225913-25	225914-25	225915-25	225916-25	

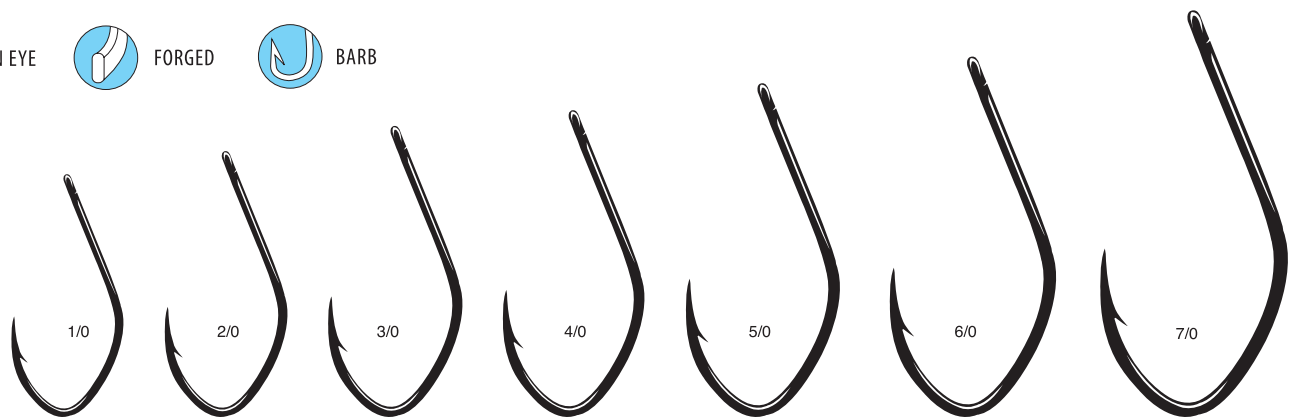

### Big River Bait Open Eye Barbless

The advantage of the Big River Open Eye over conventional siwash hooks, is the unique hook design that features an additional bend at the bottom of the hook. This innovative design feature hooks and holds fish tight. The "Open Eye" feature allows this hook to be easily attached to a split ring, barrel swivel, welded ring or hook hanger simply by closing the eye with a pair of pliers.

SIZES		1/0	2/0	5/0	6/0	7/0
NS Black	LS	340411(5)	340412(5)	340415(5)	340416(5)	340417(4)



OPEN EYE



FORGED

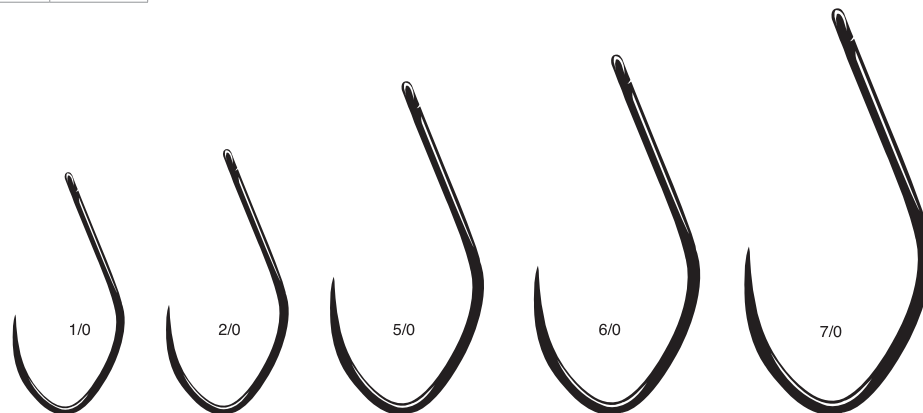

### Baitholder Hooks *(See page 112 for snells.)*

The ever popular baitholder hook is used for a variety of fish and comes in either a Bronze finish or a corrosion resistant NS Black finish for use in saltwater. It also comes in a handy snell pack.

SIZES		14	12	10	8	6	4	2	1	1/0	2/0	3/0	4/0	5/0	6/0
Bronze	LS	05103(10)	05104(10)	05105(10)	05106(10)	05107(10)	05108(10)	05109(8)	05110(8)						
	100	05103-100	05104-100	05105-100	05106-100	05107-100	05108-100	05109-100	05110-100						
	SNL	05603(10)	05604(10)	05605(10)	05606(10)	05607(10)	05608(10)	05609(8)	05610(8)						
NS Black	LS							05409(8)	05410(8)	05411(7)	05412(7)	05413(6)	05414(6)	05415(5)	05416(5)
	25							05409-25	05410-25	05411-25	05412-25	05413-25	05414-25	05415-25	05416-25



EYE



FORGED



BARB



OFF-SET POINT



BARB(S) ON SHANK

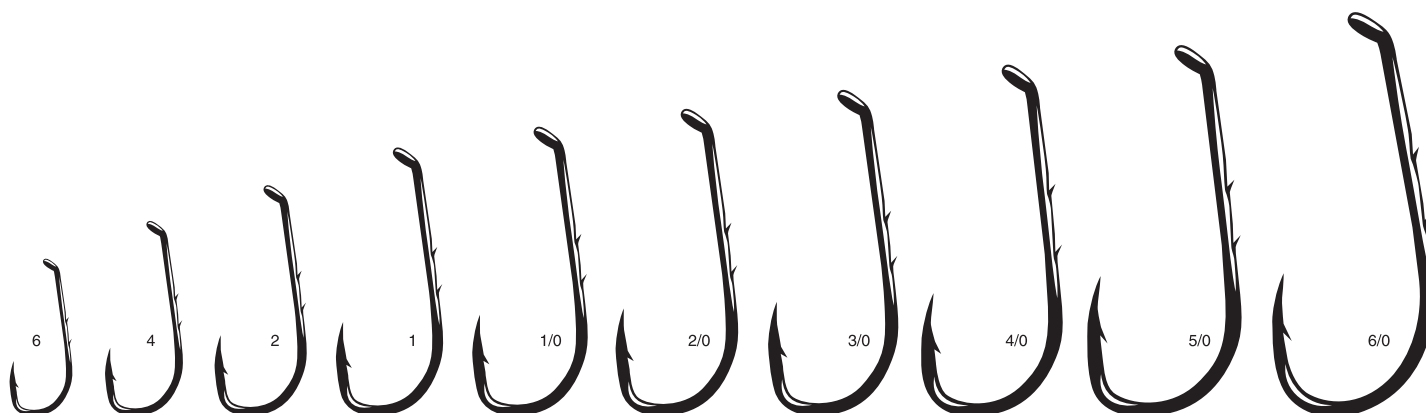

### Siwash Open Eye

A must have replacement hook for your favorite spinner, spoon, or plug. The open eye makes for fast and easy attachment and the closed eye is a popular hook for spinnerbait trailers.

SIZES		10	8	6	4	2	1	1/0	2/0	3/0	4/0	5/0	6/0	7/0	8/0
Nickel	LS	10005(10)	10006(10)	10007(10)	10008(10)	10009(8)	10010(8)	10011(6)	10012(6)	10013(6)	10014(6)	10015(6)	10016(5)	10017(4)	10018(3)
	25							10011-25	10012-25	10013-25	10014-25	10015-25	10016-25		
	Bulk	10005-100	10006-100	10007-100	10008-100	10009-100	10010-100	10011-100	10012-100	10013-100	10014-50	10015-50			
Red	LS							10311(6)	10312(6)	10313(6)	10314(6)	10315(6)			
NS Black	LS	NEW COLOR	10406(10)	10407(10)	10408(10)	10409(8)	10410(8)	10411(6)	10412(6)	10413(6)	10414(5)	10415(4)			







# FRESHWATER HOOKS

*Spinnaker<sup>®</sup>*

### Spin Bait

Walleye anglers across the Midwest have become dependent upon the spin style hooks for walleye rigs. The Spin Bait hook can be rigged behind spinner blades, prop blades or used alone with just a simple bead in front of them. It's unique design incorporates Gamakatsu swivels that is independent of the hook, giving the hook more freedom to spin while reducing line twist. The Spin Bait hook features Nano Smooth Coat for stealth presentations and unsurpassed hook penetration and the bait keeper barbs on the shank hold live and plastic baits on more securely.

SIZES		4	2	1	1/0
Nano Smooth Coat	LS	389208(4)	389209(4)	389210(4)	389211(4)

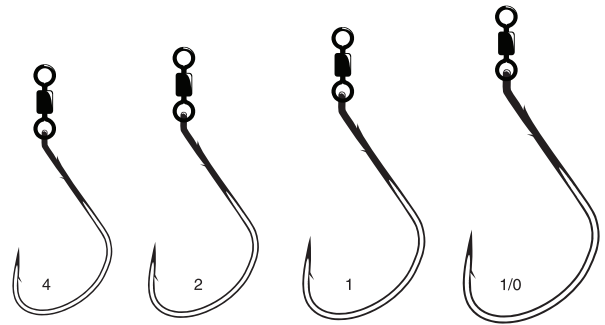
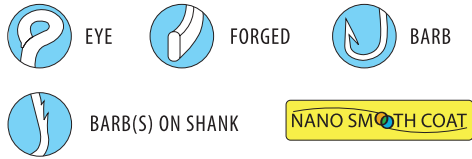

### TW Hook

The TW stands for "Trout Worm" and is the perfect hook for those soft plastic finesse worms that require a delicate presentation. It has the right gap to accommodate the worm and hold the fish.

SIZES		16	14	12	10	8	6
Bronze	LS	262102(10)	262103(10)	262104(10)	262105(10)	262106(10)	262107(10)

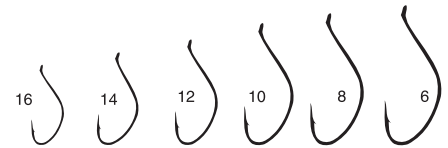

### Single Egg Hooks, Barb On Shank *(See page 112 for snells.)*

A premier bait hook for single eggs. Also great for floating trout bait.

SIZES		14	12	10	8	6
Red	LS	04303(10)	04304(10)	04305(10)	04306(10)	04307(10)
	SNL	04803(10)	04804(10)	04805(10)	04806(10)	04807(10)
Gold	LS	04203(10)	04204(10)	04205(10)	04206(10)	04207(10)
	SNL		04704(10)	04705(10)	04706(10)	04707(10)



### Aberdeen

Designed with a long shank, as a light wire bait hook.

SIZES		6	4	2	1
Bronze	LS	09107(10)	09108(10)	09109(8)	09110(8)

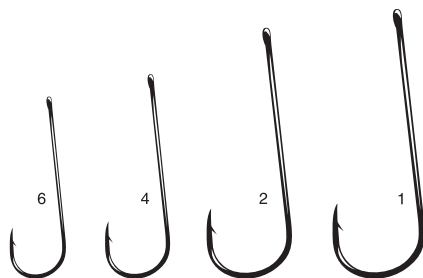

### Crappie Assortment

3 hooks per color, 15 hooks total

SIZES		8	6	4	2
5 COLORS	LS	02606	02607	02608	02609

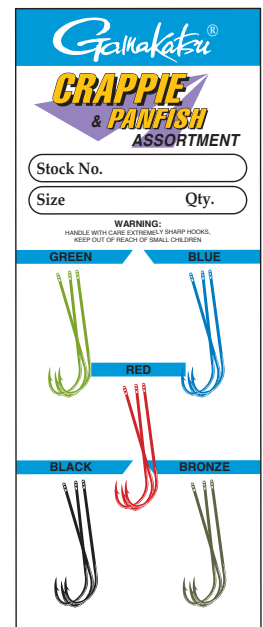



### Walleye Wide Gap

In-line needle point design won't roll or twist when trolled. Light weight for live bait presentations. Forged for extra strength.

SIZES		8	6	4	2	1
NS Black	LS	202406(10)	202407(10)	202408(10)	202409(8)	202410(8)
	25	202406-25	202407-25	202408-25	202409-25	202410-25

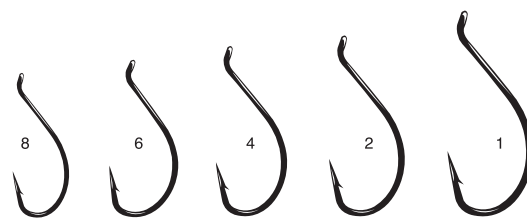

### Shiner Straight Eye

Great hook for live shiners, crawdads, and shrimp. This style is also very popular for many different types of Catfish baits.

SIZES		6	4	2	1	1/0	2/0	3/0	4/0	5/0
NS Black	LS	51407(8)	51408(7)	51409(7)	51410(6)	51411(6)	51412(6)	51413(5)	51414(4)	51415(4)
NS Black	25		51408-25	51409-25	51410-25	51411-25	51412-25	51413-25	51414-25	

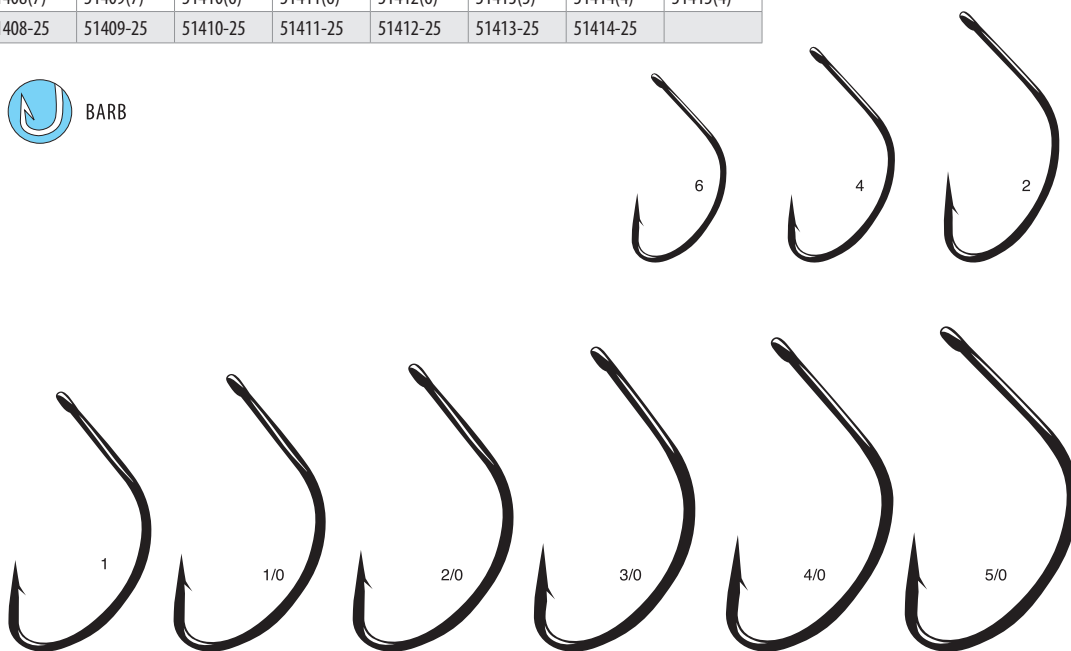

### Shiner Upturned Eye

Same great shape, only with an upturned eye, makes it great for snelling.

SIZES		1/0	2/0	3/0	4/0
NS Black	LS	52411(6)	52412(6)	52413(5)	52414(4)
	25	52411-25	52412-25	52413-25	52414-25

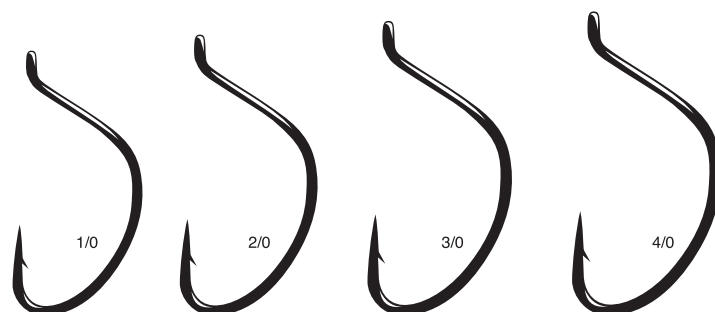

### Wicked Wacky

The new standard in wacky hook designs. Built on Gamakatsu proven Shiner hook, the Wicked Wacky features a durable hand tied weed guard that provides anglers the confidence to throw their wacky rig in and around heavy cover. In addition the Wicked Wacky takes the power drop shot to a new level. Gamakatsu designed an innovative hollow tube, hand tied on the shank. Simply run the tag end of your line through the tube, tie on your weight, and pitch into the heaviest cover for a whole new power drop shot presentation.

SIZES	1/0	2/0	3/0	4/0	5/0
NS Black	LS 306411(3)	306412(3)	306413(3)	306414(3)	306415(3)

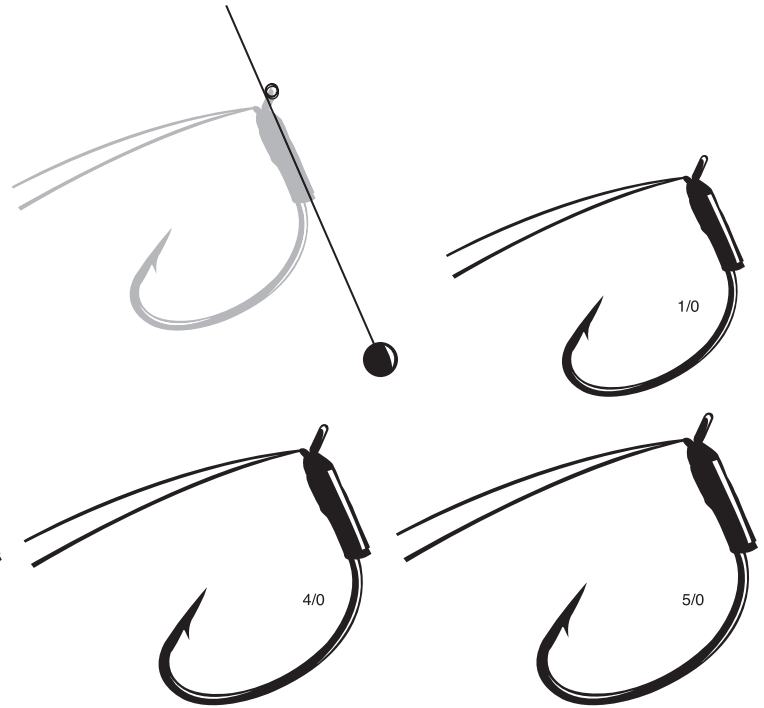

### Split Shot/Drop Shot

The ultimate hook for nose hooking a Roboworm, small Gitzit, or any number of soft plastic drop shot baits. When it's time to get serious about finesse fishing this hook will amaze you.

SIZES	4	2	1	1/0	2/0	3/0
NS Black	LS 50408(6)	50409(6)	50410(6)	50411(6)	50412(6)	50413(6)
	25 50408-25	50409-25	50410-25	50411-25	50412-25	50413-25
Red	LS 50308(6)	50309(6)	50310(6)	50311(6)		
	25 50308-25	50309-25	50310-25	50311-25		
Flourescent Pink	LS 50608-P(6)	50609-P(6)	50610-P(6)	< NEW COLOR		
Flourescent Orange	LS 50608-OR(6)	50609-OR(6)	50610-OR(6)	< NEW COLOR		
Chartreuse	LS 50608-C(6)	50609-C(6)	50610-C(6)	< NEW COLOR		
Flourescent Red	LS 50608-FR(6)	50609-FR(6)	50610-FR(6)	< NEW COLOR		

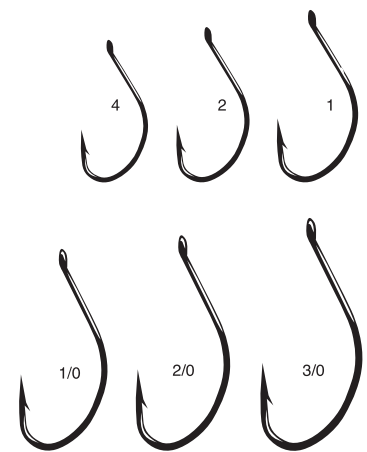

### Split Shot/Drop Shot Weedless

Gamakatsu has done it... again! Another fishing hook first with the introduction of the new Weedless Split Shot/Drop Shot Hook. The wide gap hook design is paired to a hair-trigger hand-tied, weed-guard for instant hook-ups. The weed guard maintains its shape and consistency fish-after-fish and is ultra-effective in staying weedless with exposed hook riggings.

SIZES	4	2	1	1/0	2/0	3/0
NS Black	LS 50908(5)	50909(5)	50910(5)	50911(5)	50912(5)	50913(4)

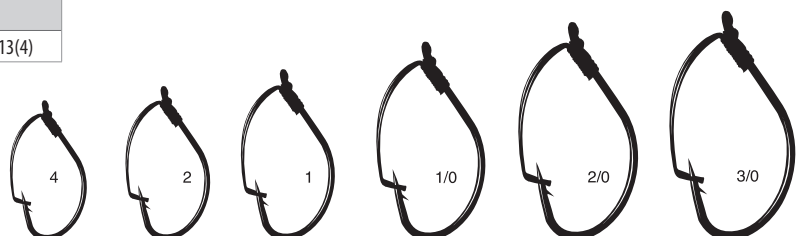

### Finesse Wide Gap

The perfect hook for wacky rigging for bass, also great for free drifting for salmon and steelhead with small baits.

SIZES		4	2	1	1/0	2/0	3/0	4/0	5/0
NS Black	LS	230408(6)	230409(6)	230410(6)	230411(6)	230412(6)	230413(5)	230414(5)	230415(5)
	25 pk	230408-25	230409-25	230410-25	230411-25	230412-25	230413-25	230414-25	230415-25
Red	LS	230308(6)	230309(6)	230310(6)	230311(6)	230312(6)	230313(5)	230314(5)	
	25 pk	230308-25	230309-25	230310-25	230311-25	230312-25	230313-25	230314-25	



### Finesse Wide Gap Weedless

Featuring an innovative nylon weed guard, allowing you to pitch your wacky rig into the heaviest cover.

SIZES		4	2	1	1/0	2/0	3/0	4/0	5/0
NS Black	LS	230908(5)	230909(5)	230910(5)	230911(5)	230912(5)	230913(4)	230914(4)	230915(4)

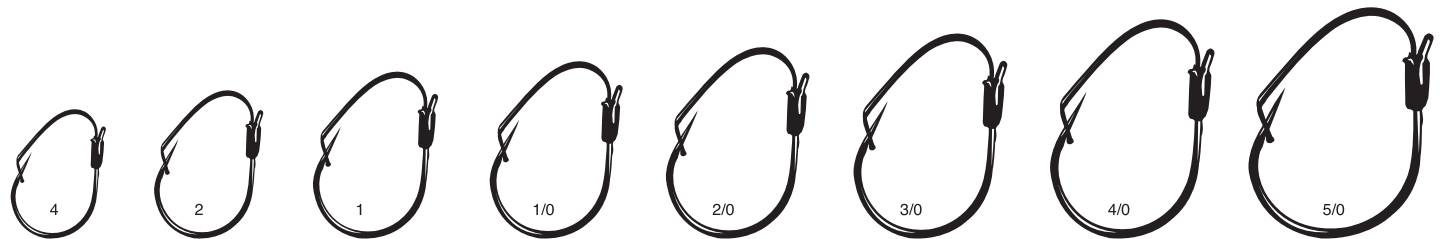

### G-Stinger

The ultimate utility hook. Easily attaches to any hook or lure. Great for spinnerbaits, buzz baits, jerkbaits and jigging spoons, braided line, sizes 1-2/0 have a 50 lb. loop.

SIZES		1	1/0	2/0
NS Black	LS	219410(4)	219411(4)	219412(4)

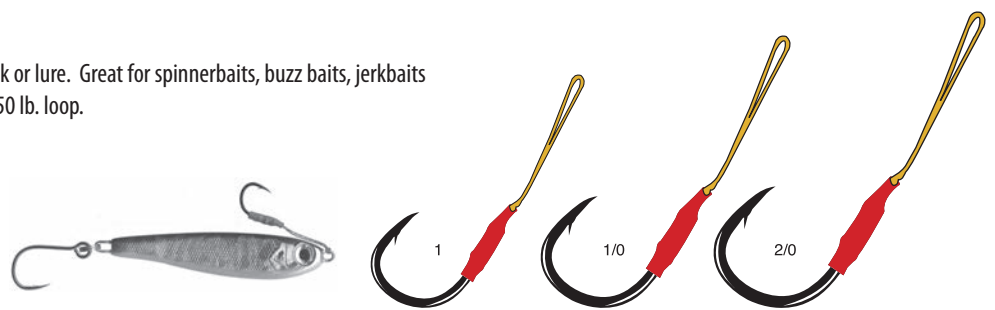

### Trailer Hook Sp

Speed up the process of attaching a trailer hook to your spinnerbait or buzzbait with our Trailer Sp. The hook features a rubberized coating molded on to the eye. Attaching is fast and secure.

SIZES		1	1/0	2/0	3/0
NS Black	LS	284410(5)	284411(4)	284412(4)	284413(4)
Red	LS	284310(5)	284311(4)	284312(4)	284313(4)



### Spinner Bait Trailer

Give any spinner bait or buzzbait that extra edge.

SIZES		1/0	2/0	3/0
Nickel	LS	210011(5)	210012(5)	210013(5)
Red	LS	210311(5)	210312(5)	210313(5)

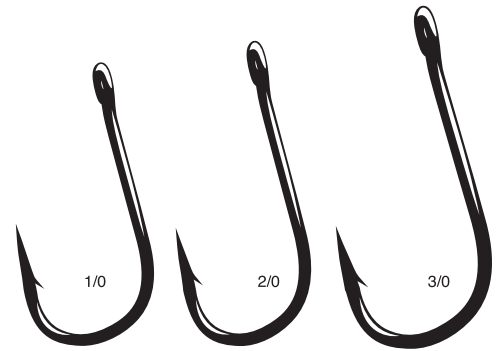
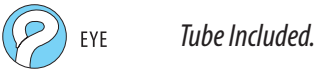

### Spinner Bait

SIZES		3/0	4/0	5/0
Nickel	25	55013-25	55014-25	55015-25
	100	55013-100	55014-100	55015-100

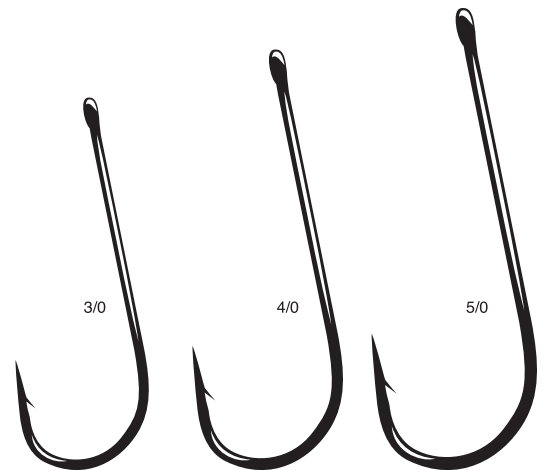

ICE FISHING-SERIES

**Gamakatsu Micro Gap hooks**

Offering sport fisherman the ultimate in design, the finest quality forged steel and unparalleled workmanship. Originally designed for finesse presentations for ice fishing, the Micro Gap selections are perfectly suited to many fly tying techniques as well. The fine wire design penetrates with less pressure, lessening tissue damage allowing for easier removal in catch and release fisheries. All Micro Gap hooks are finished in NS Black.

*The Micro Perfect Gap hook has an up-eye design for easy snelling and optimal gap for minnows or small plastics.*





*The Micro Wide Gap features a straight hook eye for minnow and soft plastics.*

*The Micro V Gap also features a straight hook eye, but adds a deep V bend to improve retention.*

**Micro V Gap •**

Natural & Man Made Baits





10 pk: Color: NSB

- 6  342407
- 8  342406
- 10  342405
- 12  342404

**Micro Perfect Gap •**

Minnow and Soft Plastics

10 pk: Color: NSB

- 4  344408
- 6  344407
- 8  344406
- 10  344405
- 12  344404

**Micro Wide Gap •**

Minnow and Soft Plastics

10 pk: Color: NSB

- 6  343407
- 8  343406
- 10  343405

G-CARP SERIES

**Gamakatsu G-Carp Hooks**

We've dialed in our carp hook selection to make it the best selling line of hooks in many European countries. There's two simple points that are critical for carp – hide the hook and hold the bait. That's why we've carefully shaped all the new G-Carp hooks to hide perfectly concealed within every type of bait. Furthermore, we've included unique micro barbs to grab onto soft dough balls and putty baits and hold them in place.





All G-Carp hooks are forged for strength and feature the innovative **Nano Smooth Coat** for fast penetration.



**G-Carp Super Hook •**

Natural & Man Made Baits







10 pk: Color: NSC

- 2  351209
- 4  351208
- 6  351207
- 8  351206

**G-Carp Specialist RX •**

Natural & Man Made Baits







10 pk: Color: NSC

- 2  350209
- 4  350208
- 6  350207
- 8  350206
- 10  350205
- 12  350204

**G-Carp Specialist R •**

Natural & Man Made Baits





10 pk: Color: NSC

- 2  349209
- 4  349208
- 6  349207
- 8  349206
- 10  349205
- 12  349204

**G-Carp Hump Back •**

Natural & Man Made Baits

10 pk: Color: NSC

- 2  348209
- 4  348208
- 6  348207
- 8  348206
- 10  348205

CATFISH SERIES

**Big Cat Circle**

There's a new dog in the fight for cat fishermen. The Gamakatsu Big Cat Circle Hook is designed specifically for tough-lipped, thick-mouthed catfish. The offset, precision sharpened hook point penetrates quickly even with light hook sets. It features an "up eye" so snelling is fast and easy. 2X strong forged steel is plenty of power for the biggest Blues -- even Wels and Mekong cats if you ever get the opportunity. It's the right hook for the job because it never stops working

SIZES		1/0	2/0	3/0	4/0	5/0	6/0	7/0	8/0	10/0	12/0
NS Black	LS	356411(6)	356412(6)	356413(6)	356414(6)	356415(6)	356416(6)	356417(5)	356418(5)	356420(3)	356422(3)
NS Black	25 NEW	356411-25	356412-25	356413-25	356414-25	356415-25	356416-25	356417-25	356418-25	356420-25	356422-25

- EYE
- FORGED
- CIRCLE HOOK
- BARB
- OFF-SET POINT



**Catfish Hook Assortment**

A 20 pack featuring 5 each of the best all around Catfish hooks. This pack includes 8/0 and 6/0 Octopus Circle Hooks, 4/0 Shiner Hooks, and 1/0 NS Black Baitholder hooks.

SIZES		VARIOUS
Assort	20	258000

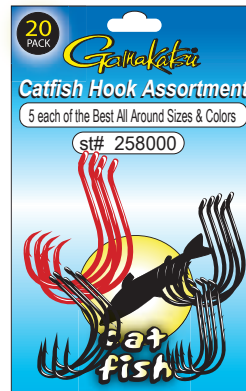



**WORM HOOKS**

*Spinnaker<sup>®</sup>*

### Worm, Extra Wide Gap (EWG)

Our most popular and versatile hook, the legendary EWG worm hook is the gold standard in high performance wide gap hook designs. This hook fishes a Senko to perfection. Use it to pitch a Brush Hog or Sweet Beaver to shoreline targets. It's great for Texas rigging or Carolina rigging a 10" worm. A soft plastic jerkbait fisherman's dream hook.

SIZES		4	2	1	1/0	2/0	3/0	4/0	5/0
NS Black	LS	58408(6)	58409(6)	58410(6)	58411(6)	58412(6)	58413(5)	58414(5)	58415(5)
	25	58408-25	58409-25	58410-25	58411-25	58412-25	58413-25	58414-25	58415-25
	100	58408-100	58409-100	58410-100	58411-100	58412-100	58413-100	58414-100	58415-100
Red	LS	58308(6)	58309(6)	58310(6)	58311(6)	58312(6)	58313(5)	58314(5)	58315(5)
	25	58308-25	58309-25	58310-25	58311-25	58312-25	58313-25	58314-25	58315-25

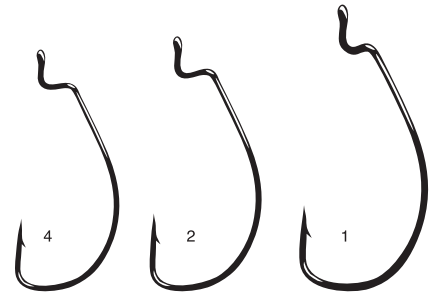

### Worm, Superline Extra Wide Gap (EWG)

An EWG on steroids. This high carbon heavy wire hook was designed to fish braided line in heavy cover. For serious flipping in the tules', overhead mats, or pads. The EWG Superline will increase your strike to hook ratio when you need to get nasty. Perfect when you require a quicker descent rate without increasing size or adding weights. Want to turn up the heat with a Senko? Go with a Superline for that deadly quick descent!

SIZES		2/0	3/0	4/0	5/0	6/0
NS Black	LS	74412(5)	74413(5)	74414(4)	74415(4)	74416(3)
	25	74412-25	74413-25	74414-25	74415-25	74416-25
	100	74412-100	74413-100	74414-100	74415-100	
Red	LS	74312(5)	74313(5)	74314(4)	74315(4)	74316(3)

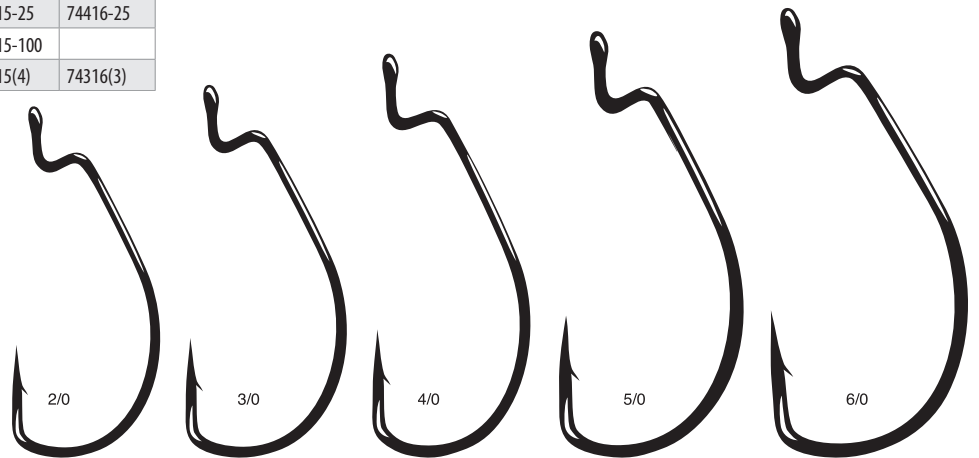

### SuperLine

### Worm, Superline EWG With Ring

There are times when calling up fish requires a little something extra. For this purpose we designed the EWG Ringed Superline. Need to fish a Horny Toad in the slop and want it to walk? Our solid piece ring allows the bait to swing freely. Fishing a Fluke for schooling smallmouth or big spots and want that super erratic action? This is your hook. Handles braided line and heavy monofilament with ease.

SIZES		2/0	4/0
NS Black	LS	74412R(4)	74414R(4)

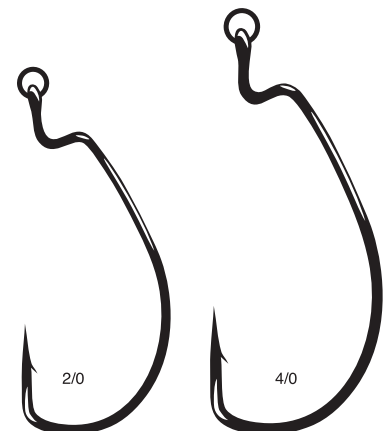



### Worm, Superline EWG Weighted

The Weighted EWG Superline is a perfect compliment to the EWG arsenal. Do you need more casting distance with a soft plastic frog? This hook will get you back in the junk. Want to flip into heavy cover without the hassle of pegging a bullet sinker? Consider the EWG Weighted Superline your new best friend. The Lead is strategically placed and milled to perfection.

SIZES	2/0 - 1/16	2/0 - 1/8	3/0 - 1/16	3/0 - 1/8	4/0 - 1/16	4/0 - 1/8	5/0 - 1/16	5/0 - 1/8
NS Black	LS 74412-1/16(5)	74412-1/8(5)	74413-1/16(5)	74413-1/8(5)	74414-1/16(5)	74414-1/8(5)	74415-1/16(5)	74415-1/8(5)

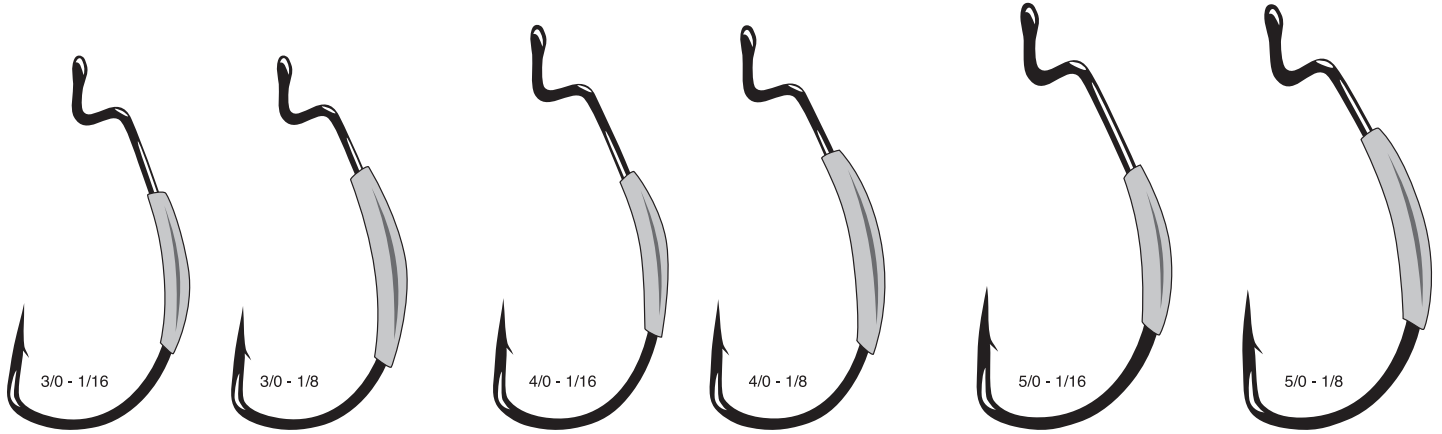

### EWG Worm Hook Assortment

A 25 pack featuring 5 each of the best all around worm hook sizes and colors. It includes 2 Red and 3 NS Black hooks in 3/0 and 4/0 Superline EWG, and the standard EWG in 2/0, 3/0 and 4/0.

SIZES	VARIOUS
Assort	25 257000



### Worm G-Lock

The unique G-Lock hook locks soft plastics tight and secure in any situation. Designed to be used in heavy cover.



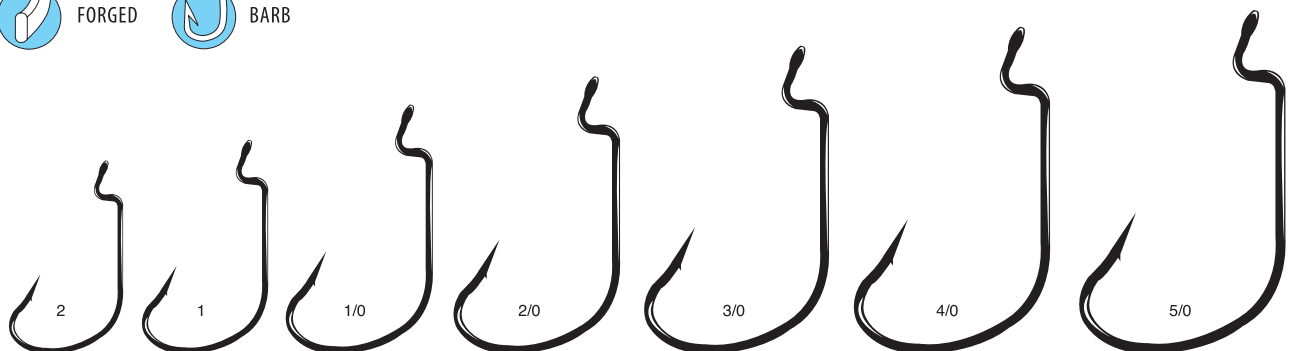

SIZES	2	1	1/0	2/0	3/0	4/0	5/0
NS Black	LS 204409(6)	204410(6)	204411(6)	204412(6)	204413(5)	204414(5)	204415(5)
	25		204411-25	204412-25	204413-25	204414-25	204415-25



### Worm, Deep Throat Wide Gap

The deeper throat, extended point, and locking offset make this a good hook for soft plastic frog baits.

SIZES		1/0	2/0	3/0	4/0	5/0
NS Black	LS	242411(6)	242412(6)	242413(5)	242414(5)	242415(5)
	25 pk	242411-25	242412-25	242413-25	242414-25	242415-25

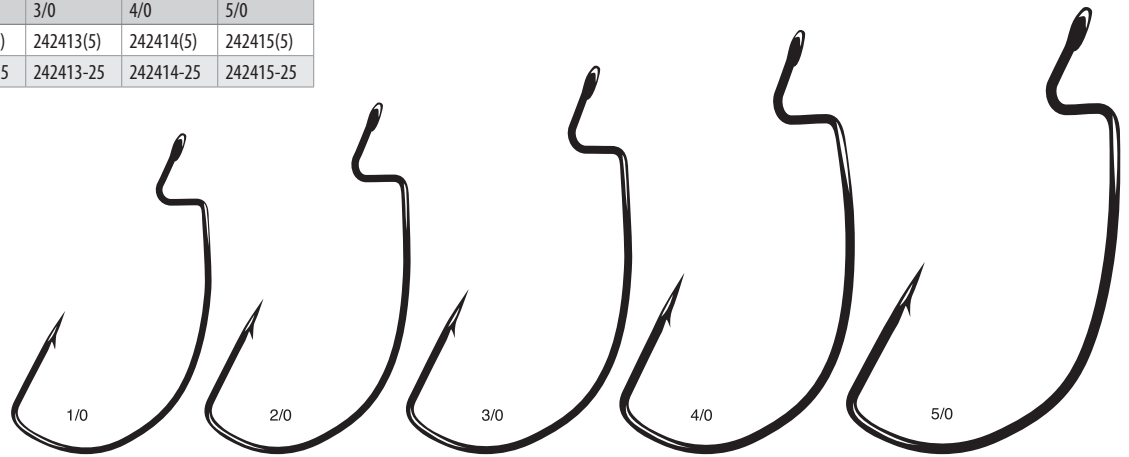

-  EYE
-  FORGED
-  BARB
-  EWG - EXTRA WIDE GAP



### Worm, Super Deep Throat Wide Gap

Deep Throat design, only heavier wire for "super lines".

SIZES		3/0	4/0	5/0
NS Black	LS	243413(5)	243414(4)	243415(4)

-  EYE
-  FORGED
-  BARB
-  EWG - EXTRA WIDE GAP

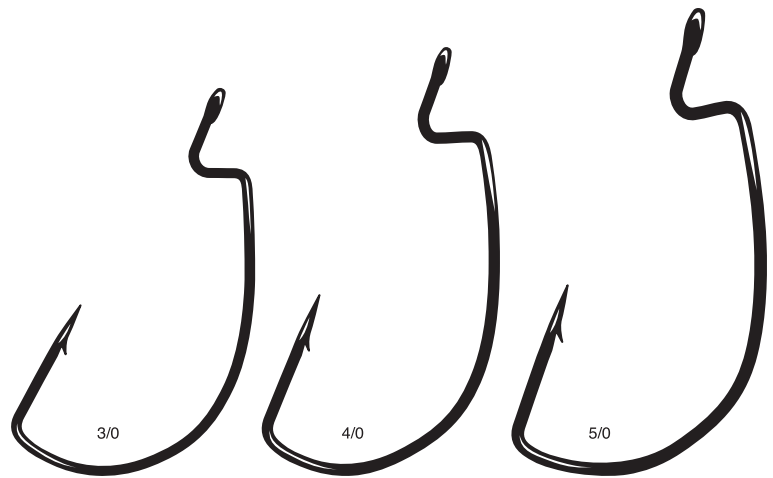



### Worm, Offset Shank, O'Shaughnessy Bend

This is our standard offset shank worm hook. The O'Shaughnessy bend is preferred by our top pro **Aaron Martens** for a variety of soft plastic rigging.

SIZES		2	1	1/0	2/0	3/0	4/0	5/0
Bronze	LS	07109(6)	07110(6)	07111(6)	07112(6)	07113(5)	07114(5)	07115(5)
	25	07109-25	07110-25	07111-25	07112-25	07113-25	07114-25	07115-25
	100	07109-100	07110-100	07111-100	07112-100	07113-100	07114-100	07115-100
NS Black	LS	07409(6)	07410(6)	07411(6)	07412(6)	07413(5)	07414(5)	07415(5)
	25	07409-25	07410-25	07411-25	07412-25	07413-25	07414-25	07415-25
	100	07409-100	07410-100	07411-100	07412-100	07413-100	07414-100	07415-100



-  EYE
-  FORGED
-  BARB

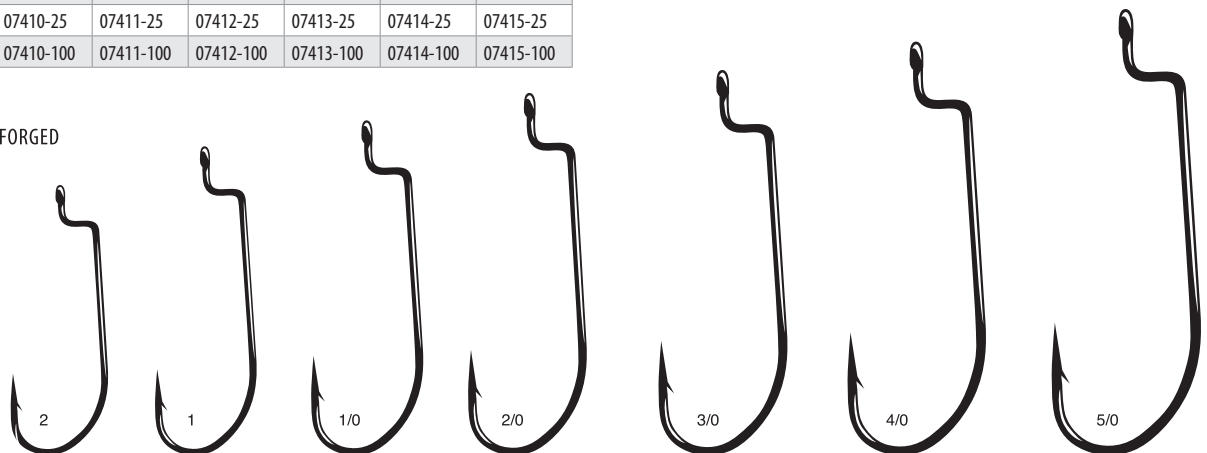

### Worm, Offset Shank, Round Bend

Our standard offset shank hook with a round bend to give a larger bite area. Perfect for Carolina rigging, or any time you need a stealthy presentation.

SIZES		1/0	2/0	3/0	4/0	5/0
Bronze	LS	54111(6)	54112(6)	54113(5)	54114(5)	54115(5)
	25	54111-25	54112-25	54113-25	54114-25	54115-25
	100	54111-100	54112-100	54113-100	54114-100	54115-100
NS Black	LS	54411(6)	54412(6)	54413(5)	54414(5)	54415(5)
	25	54411-25	54412-25	54413-25	54414-25	54415-25
	100	54411-100	54412-100	54413-100	54414-100	54415-100
Red	LS	54311(6)	54312(6)	54313(5)	54314(5)	

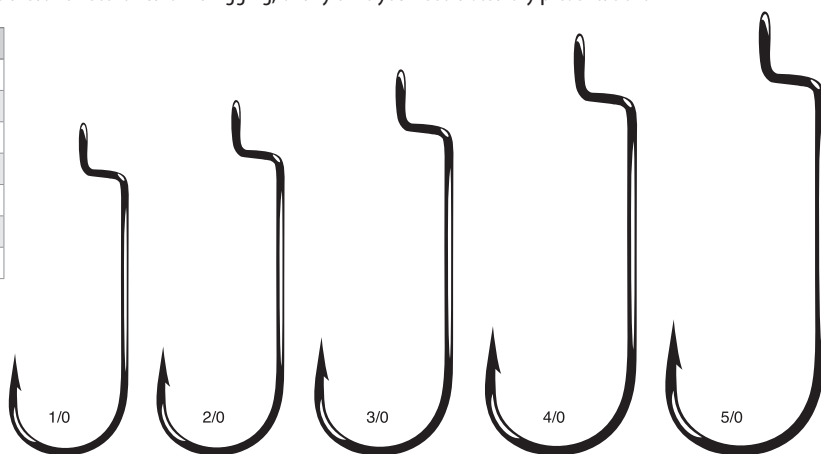

### Worm, Superline, Offset, Round Bend

Gamakatsu's Superline Offset Round Bend is designed with a heavier Superline wire best suited for heavy braided and fluorocarbon lines. This popular design in heavy wire enables anglers to fish any plastic in the heaviest of cover with no worries. The Round Bend offers a larger bite area perfect for any worm presentation while increasing your hook-up ratios. The newly enhanced Z-Bend holds your plastics on the hook longer, reducing the number of pull-offs and reducing damage to plastics. A more durable worm hook designed for heavier lines that hold your bait on longer.

SIZES		2/0	3/0	4/0	5/0
NS Black	LS	398412 (5)	398413(5)	398414(4)	398415(4)

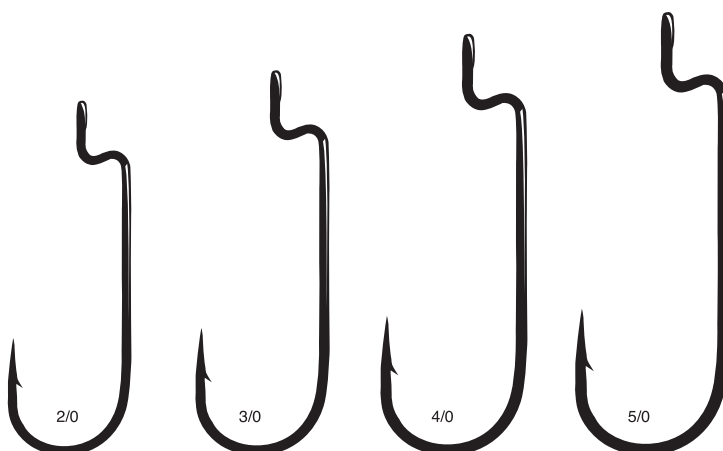

### Worm, Skip Gap

There is no better hook for skipping plastics under docks and cover. The Skip Gap is a multiple use hook that is perfect for a variety of soft plastic baits. Top water buzz frogs, Texas rigging, Carolina rigging, the Skip Gap can do it all!

SIZES		1/0	2/0	3/0	4/0	5/0
NS Black	LS	266411(6)	266412(6)	266413(5)	266414(5)	266415(5)
	25	266411-25	266412-25	266413-25	266414-25	266415-25

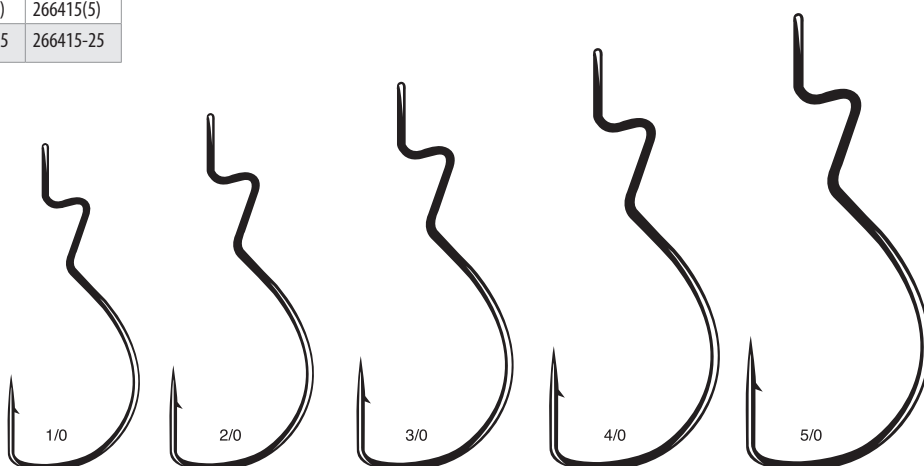

### Extra Wide Gap (EWG) Monster

When only a high carbon heavy wire hook will do your choice should be the EWG Monster. Hard core doesn't even begin to describe the Monster. Slings a Mission Fish back in the cover? We now have the perfect hook. Loading for bear with a giant Gitzit, Double Wide Beaver, or oversized Slug-O? The Monster has you covered. Headed to El Salto, Clear Lake, or the California Delta for double digit behemoths? Gamakatsu Monster is the choice when you are taking no prisoners. Heavy line, heavy rods, big baits, and big fish is EWG Monster time!

SIZES		5/0	6/0	7/0
NS Black	LS	283415(5)	283416(4)	283417(4)

- EYE
- FORGED
- BARB
- EWG - EXTRA WIDE GAP

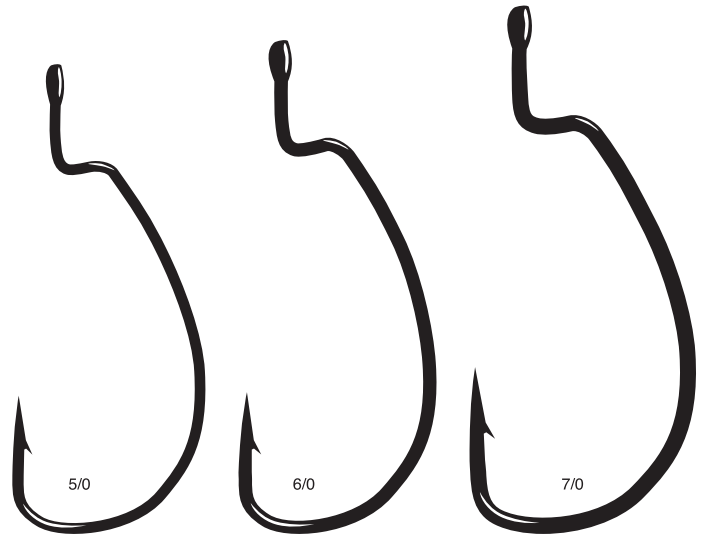

### Extra Wide Gap (EWG) Monster, Weighted

On the heels of the EWG Monster we have introduced the Weighted Monster. When the situation calls for a bulletproof weighted hook, look no further than the Monster Weighted. Strategically placed milled weights are perfectly balanced and serve as a keel for large swimbaits or any oversized offering. The hook also features a slightly higher hook point in relation to the eye to help aid in hook setting power.

SIZES		5/0 - 1/8	5/0 - 1/4	6/0 - 3/16	6/0 - 1/4	7/0 - 1/4	7/0 - 3/8
NS Black	LS	283415-1/8(3)	283415-1/4(3)	283416-3/16(3)	283416-1/4(3)	283417-1/4(3)	283417-3/8(3)

- EYE
- FORGED
- BARB
- EWG - EXTRA WIDE GAP

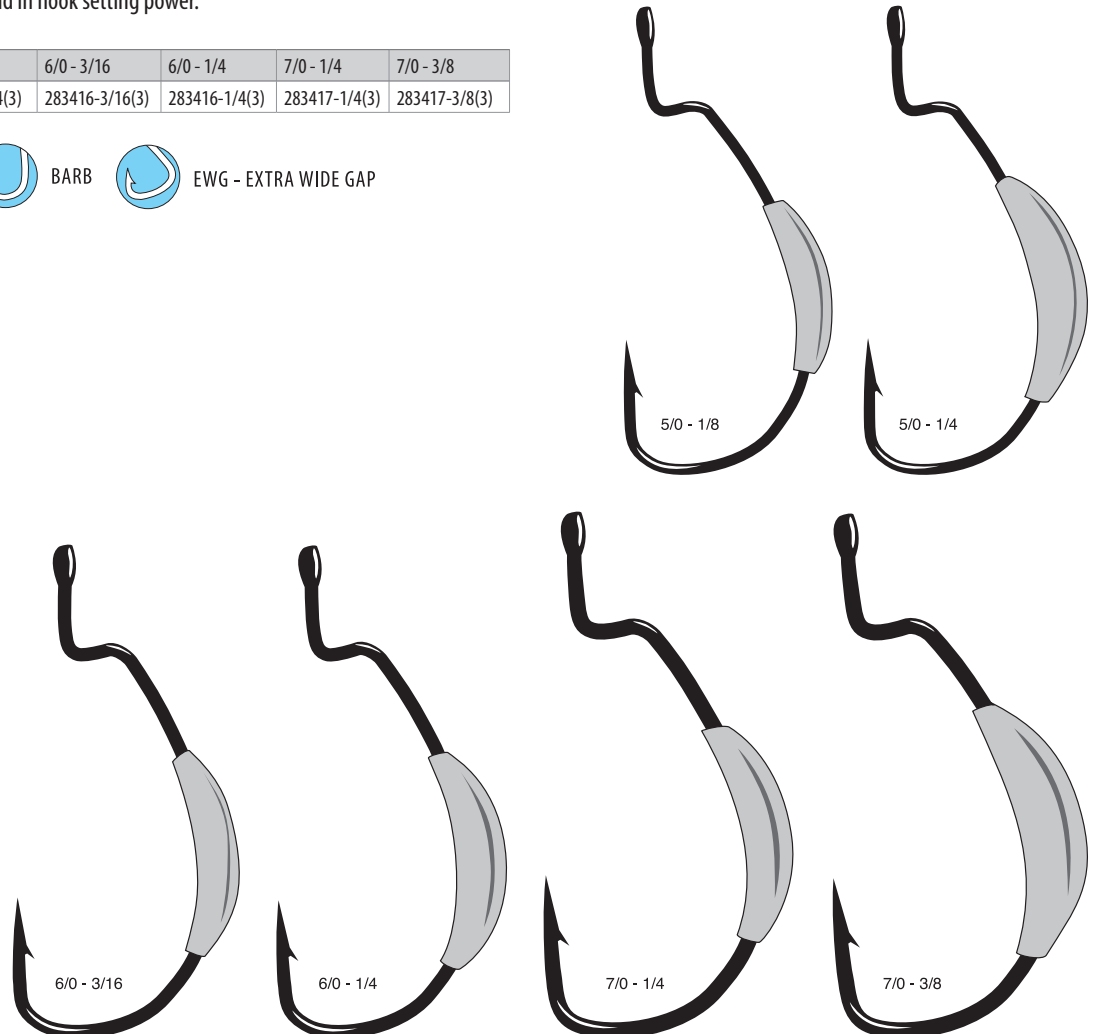

### Worm, Straight Shank, O'Shaughnessy Bend

Our standard straight shank worm hook.

SIZES		2	1	1/0	2/0	3/0	4/0	5/0
Bronze	LS	01109(6)	01110(6)	01111(6)	01112(6)	01113(5)	01114(5)	01115(5)
	25	01109-25	01110-25	01111-25	01112-25	01113-25	01114-25	01115-25
	100	01109-100	01110-100	01111-100	01112-100	01113-100	01114-100	01115-100
NS Black	LS	01409(6)	01410(6)	01411(6)	01412(6)	01413(5)	01414(5)	01415(5)
	25	01409-25	01410-25	01411-25	01412-25	01413-25	01414-25	01415-25
	100	01409-100	01410-100	01411-100	01412-100	01413-100	01414-100	01415-100

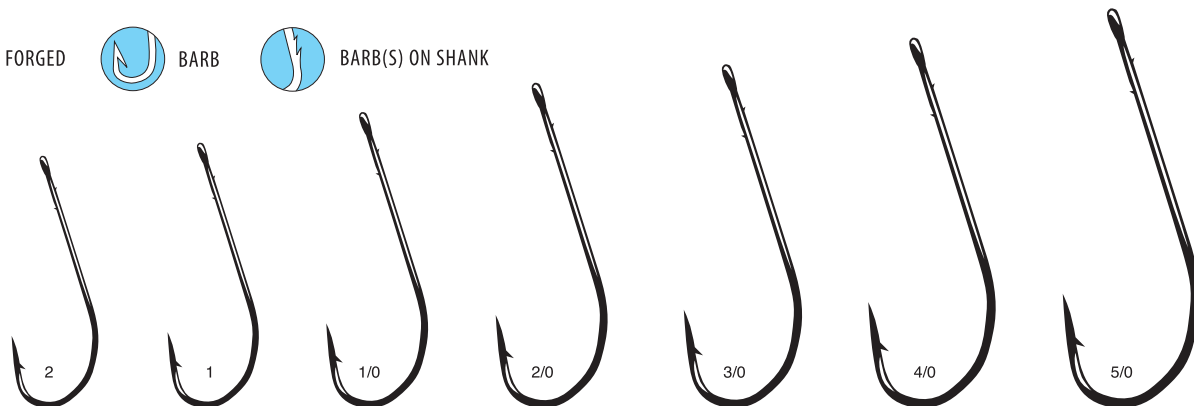

### Worm, Straight Shank, Wire Guard

Like our popular standard worm hook, only with a weed guard.

SIZES		1	1/0	2/0	3/0	4/0	5/0
Bronze	LS	65110(4)	65111(4)	65112(4)	65113(3)	65114(3)	65115(3)



### Worm, Straight Shank, Light Wire

We have all you finesse fishermen covered with this worm hook. The Light Wire excels when the bite gets tough.

SIZES		2	1	1/0	2/0
NS Black	LS	49409(6)	49410(6)	49411(6)	49412(6)
	25	49409-25	49410-25	49411-25	49412-25
	100	49409-100	49410-100	49411-100	49412-100

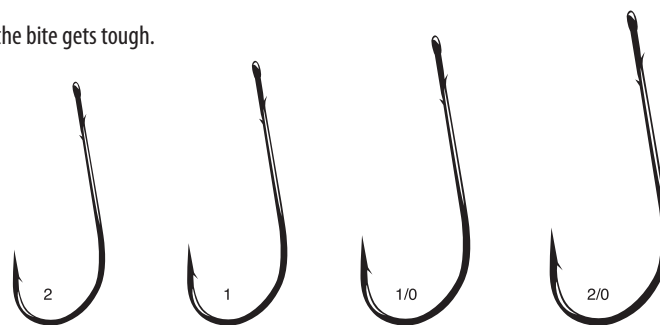

### Worm, Straight Shank Round Bend

Perfect round bend for a wider bite area and superior holding power.

SIZES		2/0	3/0	4/0	5/0
NS Black	LS	48412(6)	48413(5)	48414(5)	48415(5)
	25	48412-25	48413-25	48414-25	48415-25
	100	48412-100	48413-100	48414-100	48415-100



### Finesse Heavy Cover Worm with Tin Keeper

The Finesse Heavy Cover Worm Hook is a light wire, finesse hook that features the first wide gap straight shank hook for finesse worm fishing. Just like all the Heavy Cover Hooks the Finesse features a welded eye and wire keeper that assures your worm doesn't slide down the hook.

SIZES		1	1/0	2/0	3/0
NS Black	LS	311410(4)	311411(4)	311412(4)	311413(4)

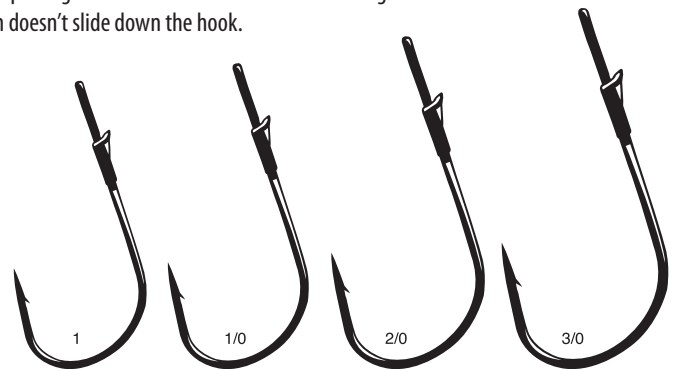

### Heavy Cover Worm with Tin Keeper

The Heavy Cover Worm hook has been built to the highest standards to fight the biggest fish in the heaviest cover. The Heavy Cover Worm features our rock solid welded eye, perfect for tying a Snell knot with braid. Gamakatsu has worked with our top pros to design an improved keeper. Instead of a bulky heat shrink barb, the Heavy Cover Worm features a small wire keeper. The keeper has a small compact profile and is strategically placed for superior holding power.

SIZES		3/0	4/0	5/0
NS Black	LS	304413(4)	304414(4)	304415(4)

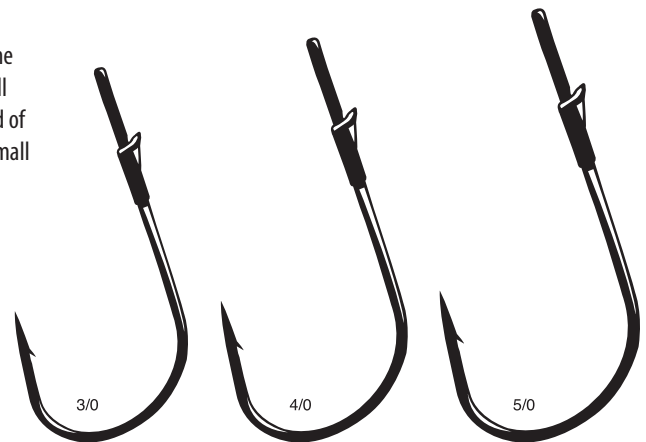

### Super Heavy Cover Worm with Tin Keeper

The Super Heavy Cover Worm Hook is indestructible with a welded eye and extra heavy duty cold-forged hook wire that will not flex. It's perfect for flipping into heavy cover or punching through thick overhead cover. The addition of an oversized barb holds hooked fish solid and the punch wire/keeper firmly secures worms so they stay rigged cast-after-cast.

SIZES		3/0	4/0	5/0
NS Black	LS	310413(4)	310414(4)	310415(4)

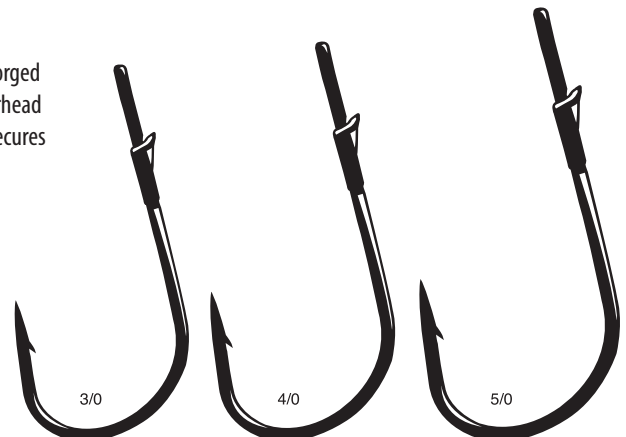

### Gika Rig

Gika Rig combines the natural presentation of finesse fishing with the speed of power fishing. The Gika Rig uses an off-set shank worm hook with an elongated drop shot style weight attached directly to the eye via a solid ring. The position of the weight allows anglers to 'feel' the bottom, detecting transitions in composition and helping find fish-holding structures. Gika Rig produces a natural swimming and dropping motion. The solid ring allows the plastic bait to float freely and rotate from side to side as it descends. It slips through vegetation with ease and grabs the attention of bass.

SIZES	2/0-1/8	2/0-3/16	3/0-3/16	3/0-1/4	4/0-1/4	4/0-3/8
Black	LS 399412-1/8 (2)	399412-3/16 (2)	399413-3/16(2)	399413-1/4(2)	399414-1/4 (2)	399414-3/8 (2)

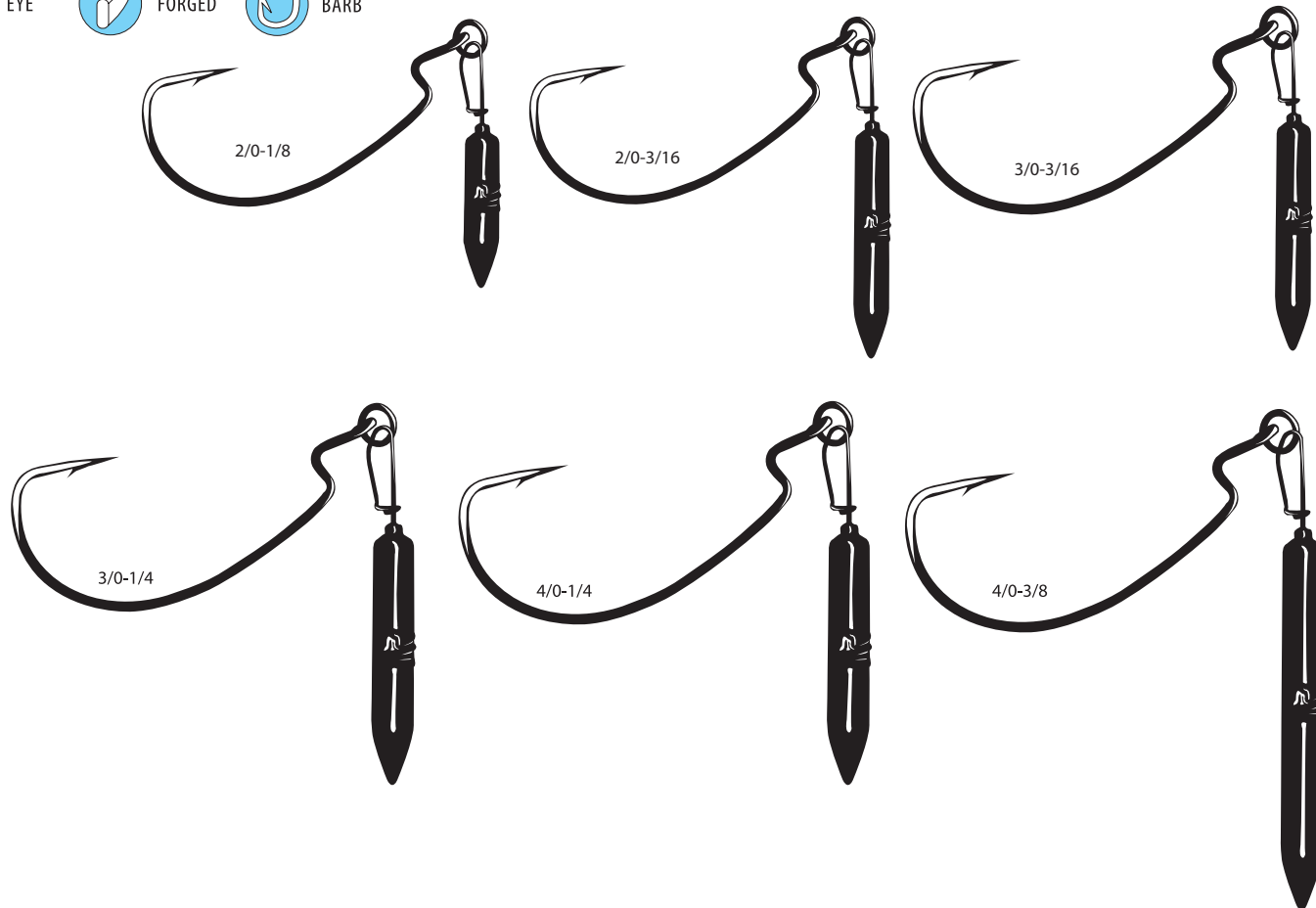

### Gika Rig Weight

Gika Rig weights attach directly to the Gika Rig eye via a solid ring. The weight features a snap that allows anglers to quickly change the size of the weight when the situation calls for it and is painted black for stealthy presentations. The weight size is permanently stamped into the side of each weight making it easy to identify when it's time to make a change. Changing weights controls the depth and drop speed of the bait adding to the rig's versatility.

SIZES	1/8	3/16	1/4	3/8
Black	LS 400400-1/8(4)	400400-3/16(4)	400400-1/4(4)	400400-3/8(4)

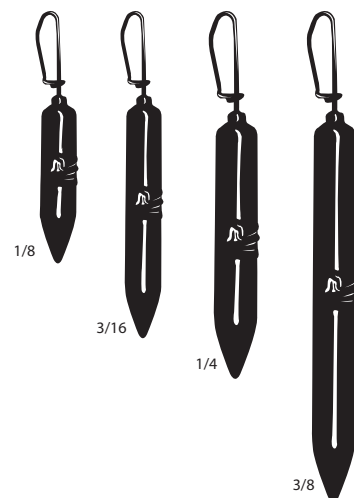

### Superline Spring Lock

The Superline Spring Lock is based on the proven Superline EWG. The Spring Lock features a 28 degree eye with a stress relieved stainless steel center point spring lock. This is the ideal soft plastic hook when the situation requires your bait to stay locked and secure.

SIZES	3/0	4/0	5/0	6/0	7/0
NS Black LS	296413(3)	296414(3)	296415(3)	296416(2)	296417(2)

- EYE
- FORGED
- BARB
- EWG - EXTRA WIDE GAP

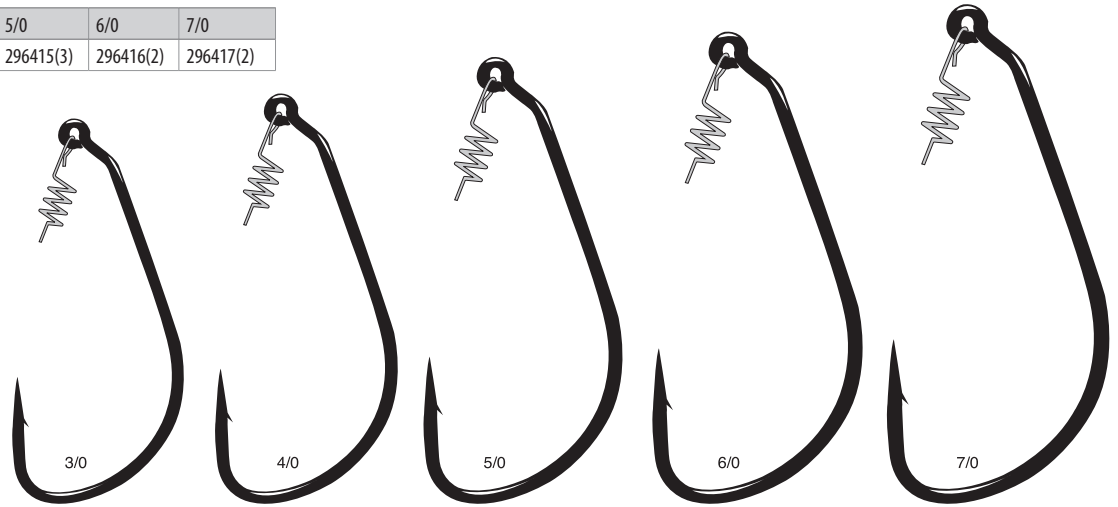

### Superline Spring Lock, Weighted

We designed the EWG Spring-Lock to be the perfect hook for paddle tail swim baits. Based on the proven Superline EWG hook, the Spring Lock features a new 28 degree eye with a stress relieved stainless steel center point spring lock so baits stay locked and secure. Beautifully milled, strategically placed weights help your bait track perfectly at any depth. Offered in a variety of sizes and weights to take your paddle tail swim bait fishing to a new level.

SIZES	3/0 - 1/16	3/0 - 1/8	4/0 - 1/16	4/0 - 1/8	5/0 - 3/16	5/0 - 1/4	6/0 - 3/16	6/0 - 1/4	7/0 - 1/4	7/0 - 3/8
NS Black LS	296413-1/16(4)	296413-1/8(4)	296414-1/16(4)	296414-1/8(4)	296415-3/16(4)	296415-1/4(4)	296416-3/16(4)	296416-1/4(4)	296417-1/4(4)	296417-3/8(4)

- EYE
- FORGED
- BARB
- EWG - EXTRA WIDE GAP

**SuperLine**

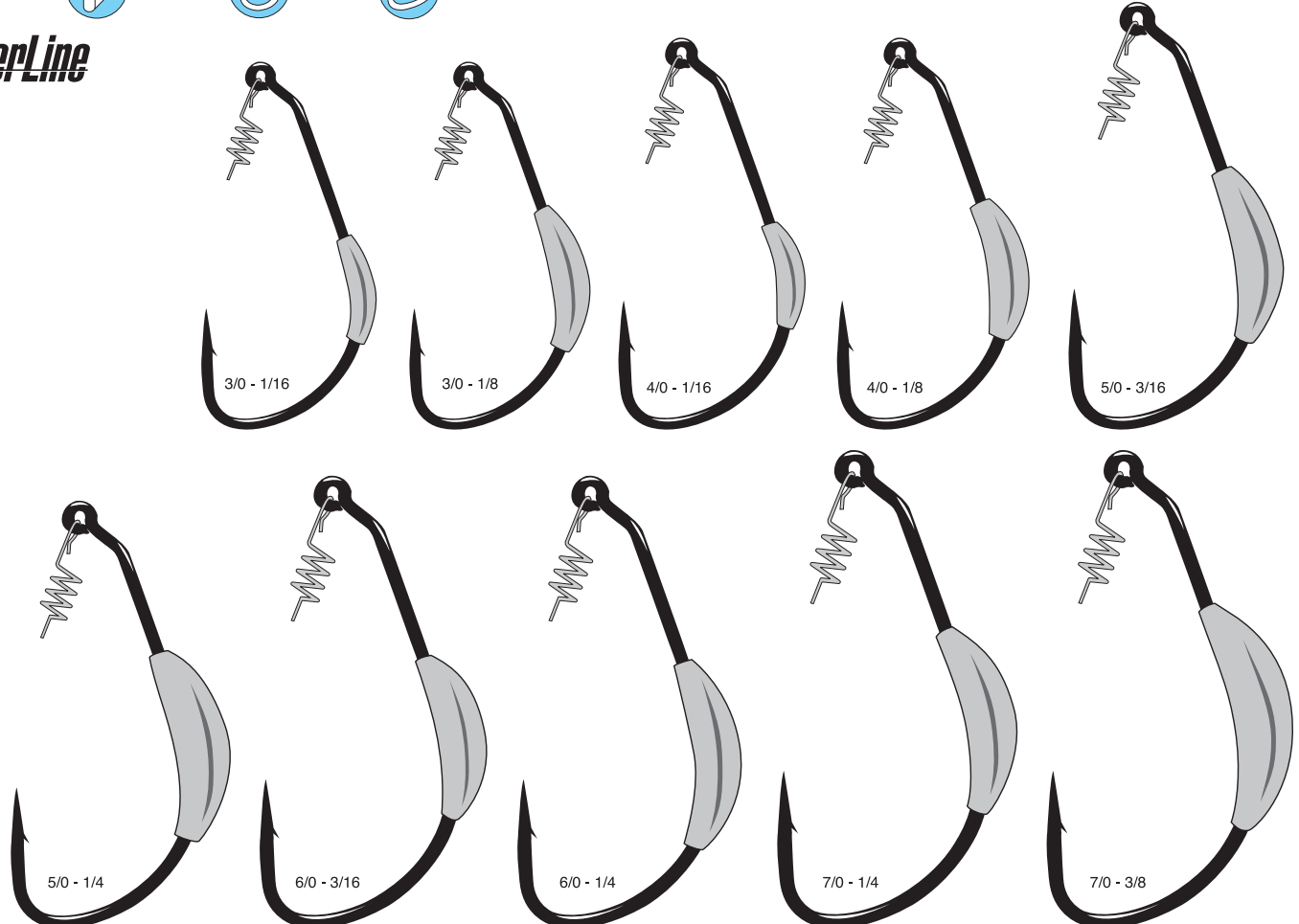



### Superline Spring Lock Monster, Weighted

Go big or go home. When conditions call for big baits, Gamakatsu's new Spring Lock Monster is precisely designed to hold and position them perfectly straight and firmly attached. Weighted with 3/8 or 1/2 ounce lead, the Spring Lock Monster stands up to aggressive casts and viciously hard hook sets. The "center point" spring lock is easy to start and tighten. Baits stay straight every time and all the time. 9/0, 10/0 or 12/0 hook sizes await trophy-caliber catches.

SIZES		9/0 - 3/8	10/0 - 3/8	12/0 - 3/8	9/0 - 1/2	10/0 - 1/2	12/0 - 1/2
NS Black	LS	371419-3/8(3)	371420-3/8(2)	371422-3/8(2)	371419-1/2(3)	371420-1/2(2)	371422-1/2(2)

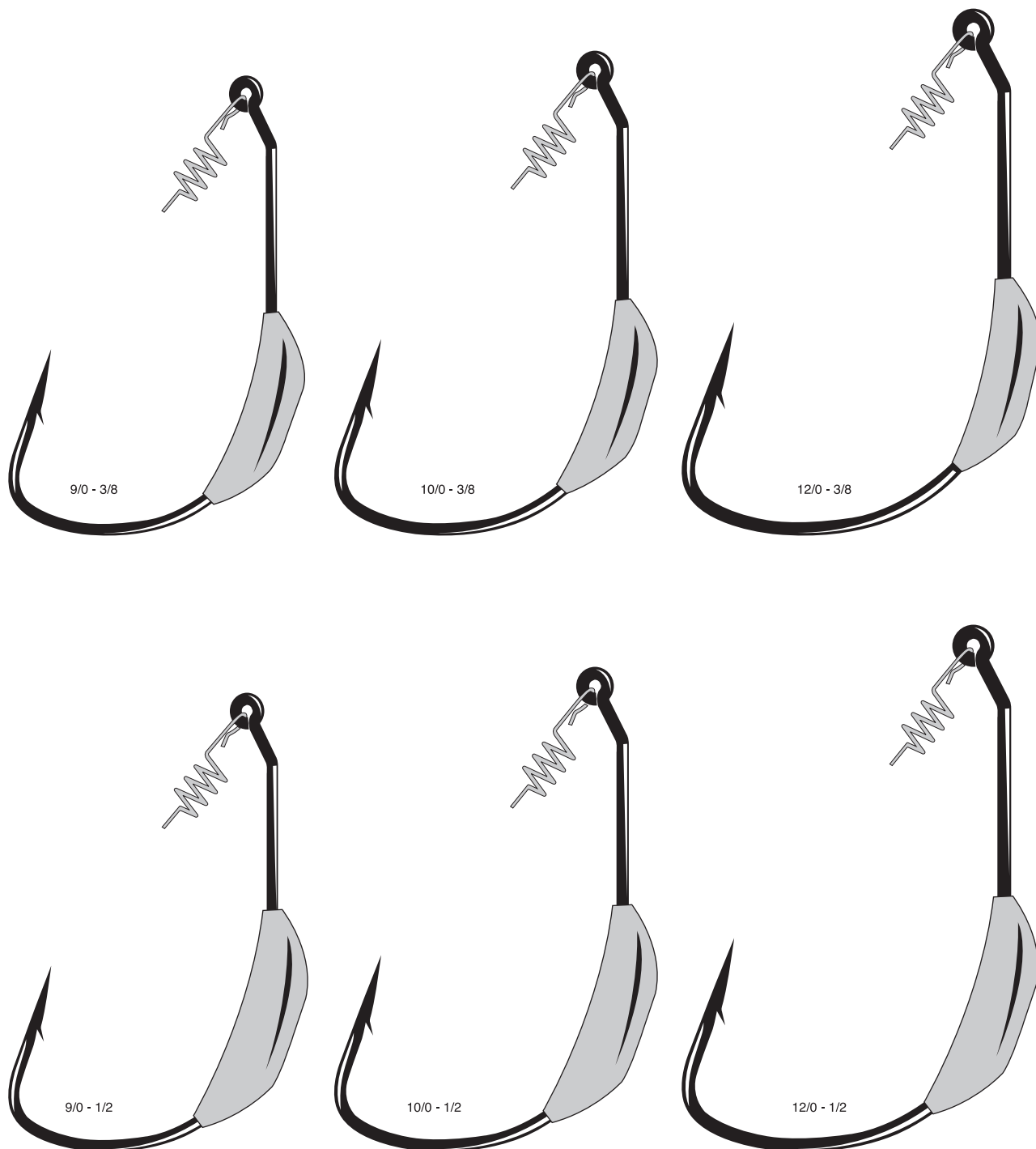









**JIG HOOKS**

*Spinnaker<sup>®</sup>*

### Jig 30° Extra Wide Gap (EWG)

Designed for a wide variety of popular techniques, emerging trends, and do-it-yourself lead jig head pouring. The 30° hook eye angle compliments the 60° and 90° jig hooks that have been the standard for decades. This extra wide gap (EWG) will handle larger baits too. The points are incredibly sticky-sharp right out of the package. Fits most 30° lead molds

SIZES		3/0	4/0	5/0	6/0	7/0
NS Black	25	382413-25	382414-25	382415-25	382416-25	382417-25
	100	382413-100	382414-100	382415-100	382416-100	382417-100

-  EYE
-  FORGED
-  BARB
-  EWG - EXTRA WIDE GAP

**SuperLine**

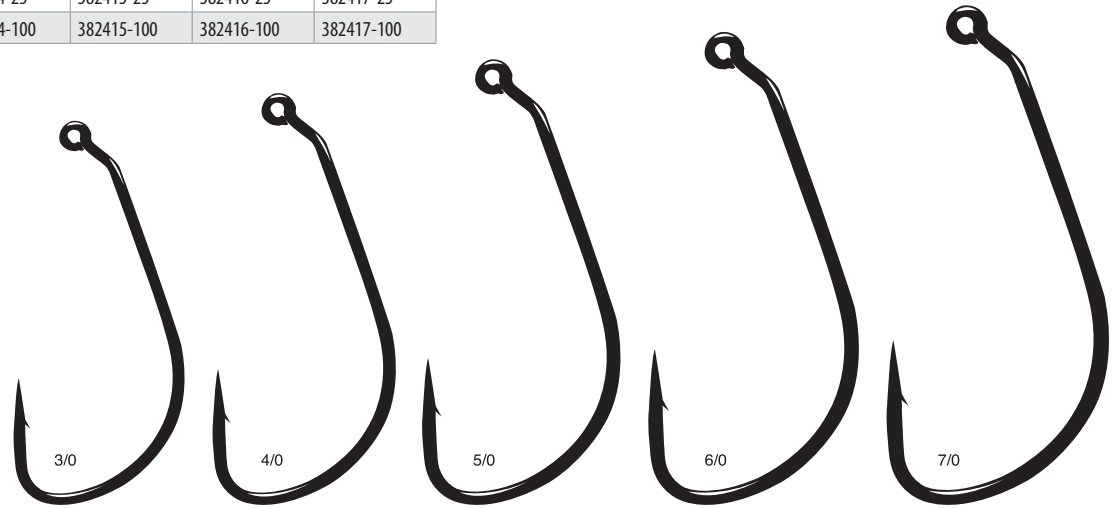

### Jig 60° Round Bend

The Jig 60 Round Bend hook delivers in terms of both simplicity and function for anglers and is now available in our popular NS Black (nickel silver black) color. The 60-degree round bend design makes this a go-to jig hook for flipping and pitching. The bite area is fantastic, helping anglers connect on difficult hooksets. Adding the NS Black color gives DIY anglers more options when pouring their own jigs

SIZES		2/0	3/0	4/0	5/0
NS Black	25	29412-25	29413-25	29414-25	29415-25
	100	29412-100	29413-100	29414-100	29415-100

-  EYE
-  FORGED
-  BARB

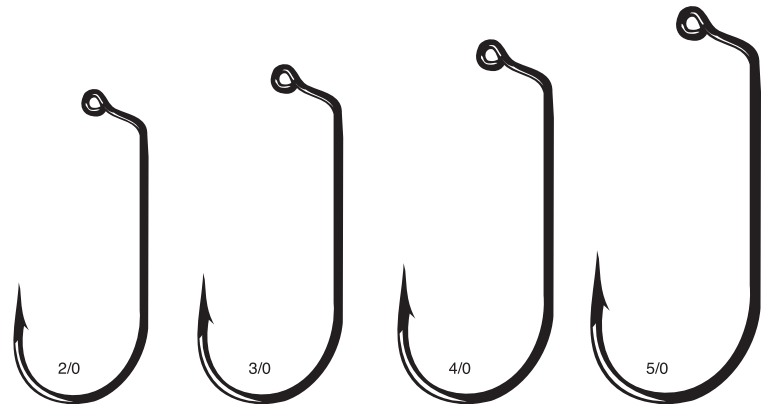

### Jig 60° Flat Eye, Light Wire, Round Bend

A light wire version for those finesse applications and lighter jigs.

SIZES		3/0	4/0	5/0
NS Black	25	61413-25	61414-25	61415-25
	100	61413-100	61414-100	61415-100

-  EYE
-  FORGED
-  BARB

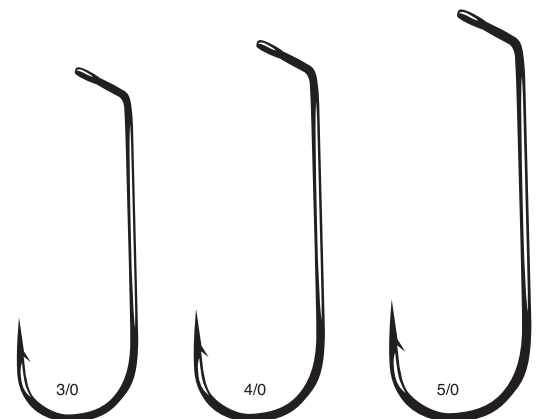

### Jig 60° Flat Eye, Round Bend

A heavy wire hook in a corrosion resistant NS Black finish for use in fresh or saltwater.

SIZES		2/0	3/0	4/0	5/0
NS Black	25	59412-25	59413-25	59414-25	59415-25
	100	59412-100	59413-100	59414-100	59415-100

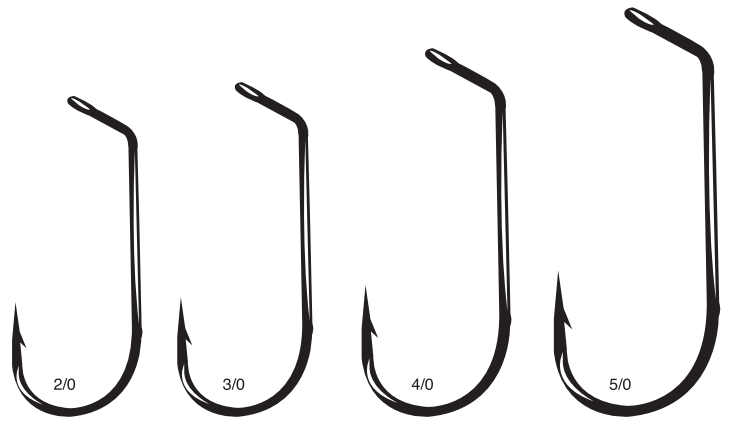

### Jig 60° Extra Wide Gap (EWG)

Designed with an extra wide gap for the larger bodied plastics and skirts. The extra wide gap gives you more surface area for better hook ups.

SIZES		3/0	4/0
NS Black	25	201413-25	201414-25
	100	201413-100	201414-100

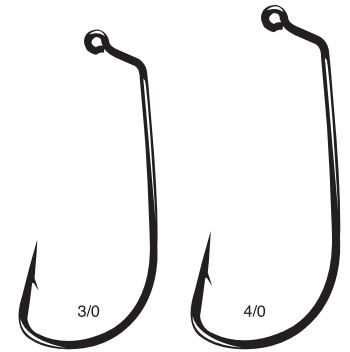

### Jig 90°

Our standard 90 degree jig hook, with a traditional O'Shaugnessy bend.

SIZES		1/0	2/0	3/0
Bronze	25	11111-25	11112-25	11113-25
	100	11111-100	11112-100	11113-100

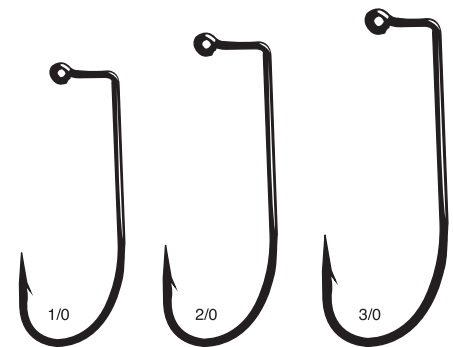

### Jig 90° Round Bend

SIZES		2	1	1/0	2/0	3/0	4/0	5/0
NS Black	25	11409-25	11410-25	11411-25	11412-25	11413-25	11414-25	11415-25
	100	11409-100	11410-100	11411-100	11412-100	11413-100	11414-100	11415-100

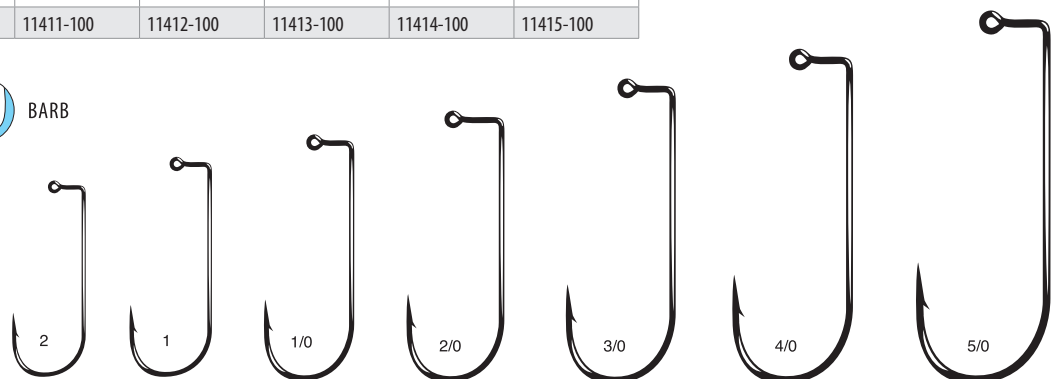

### Jig 90° Heavy Wire- Round Bend

Our most popular jig hook, and most versatile. Made with a heavy wire and is saltwater ready.

SIZES	2	1	1/0	2/0	3/0	4/0	5/0	6/0	7/0	8/0	
NS Black	25	60409-25	60410-25	60411-25	60412-25	60413-25	60414-25	60415-25	60416-25	60417- 25	60418- 25
	50									60417- 50	60418- 50
	100	60409-100	60410-100	60411-100	60412-100	60413-100	60414-100	60415-100	60416-100		

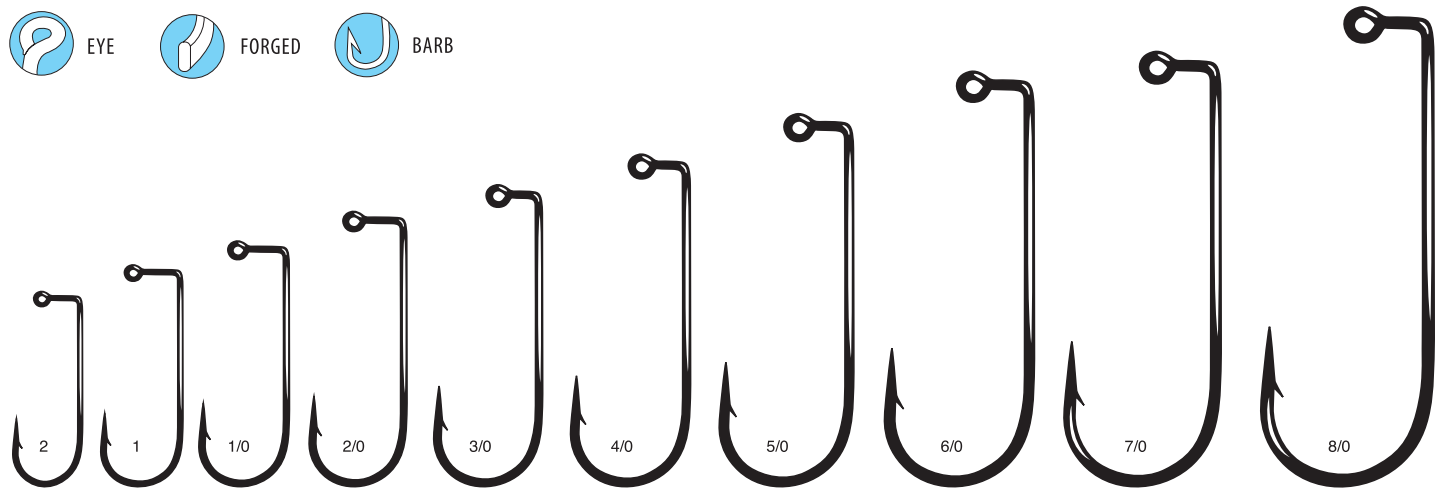

### Jig 90° Salty HD

In the saltwater world, few jig hooks are built to withstand the hardest fighting fish in the ocean. Hard strikes and wild runs from species like striped bass will test the strength of any hook. The Jig 90 Salty HD is specially made with a round bend and heavy wire that can hold form against the toughest fish out there. The Jig 90 Salty HD is forged for strength and the NS Black (nickel silver black) coating resists corrosion.

SIZES	6/0	7/0	8/0	
NS Black	25	223416-25	223417-25	223418-25

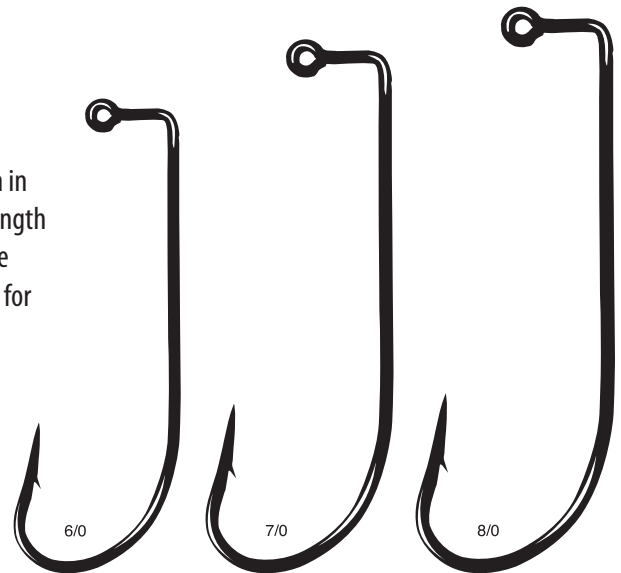

### Jig 90° Big River

The Jig 90 Big River will quickly become a staple for anglers desiring a versatile jig hook capable of performing in different environments and for a variety of species. The large gap and acute bend offer great holding power, locking fish in place when hooked. DIY anglers will like the longer shank to pour heavier jig heads on. This unique design comes in a wide range of sizes for fisherman, targeting everything from steelhead to walleye.

SIZES	2	1	1/0	2/0	3/0	4/0	
NS Black	25	412409-25	412410-25	412411-25	412412-25	412413-25	412414-25
	100	412409-100	412410-100	412411-100	412412-100	412413-100	412414-100

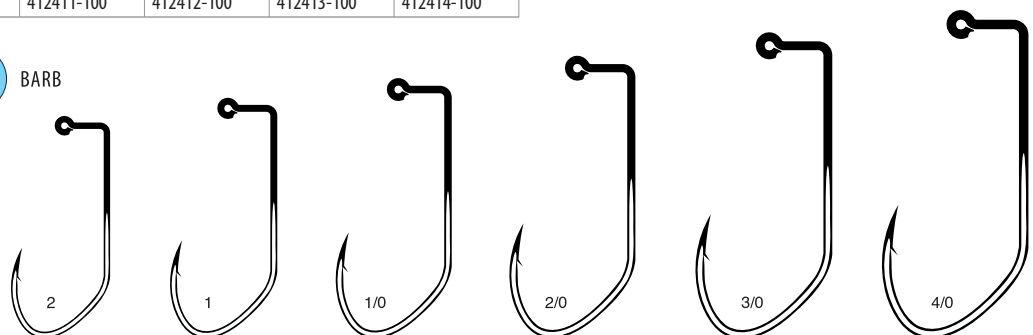



**JIG HEADS**

*Spaworks®*

### Spring Lock Spinner

The new Spring Lock Spinner from Gamakatsu makes your favorite swimbaits and other soft plastics even more effective by adding flash and vibration to attract fish from even greater distances. The revolutionary design features two retaining wires wound in parallel, making rigging simple and providing even more holding power, so baits won't slip no matter how hard you fish. The new rigging system has innovative features that draw strikes from pressured fish and is built on a premium 2x strong hook to handle the biggest predators. Combining the 28-degree hook eye and premium spring lock allows you to keep your bait in place, so it runs true every cast.

SIZES	3/0-3/16	5/0-1/4	6/0-3/8	7/0-3/8	9/0-3/8	10/0-1/2	12/0-3/4
	404413-3/16(1)	404415-1/4(1)	404416-3/8(1)	404417-3/8(1)	404419-3/8(1)	404420-1/2(1)	404422-3/4(1)



**NEW**

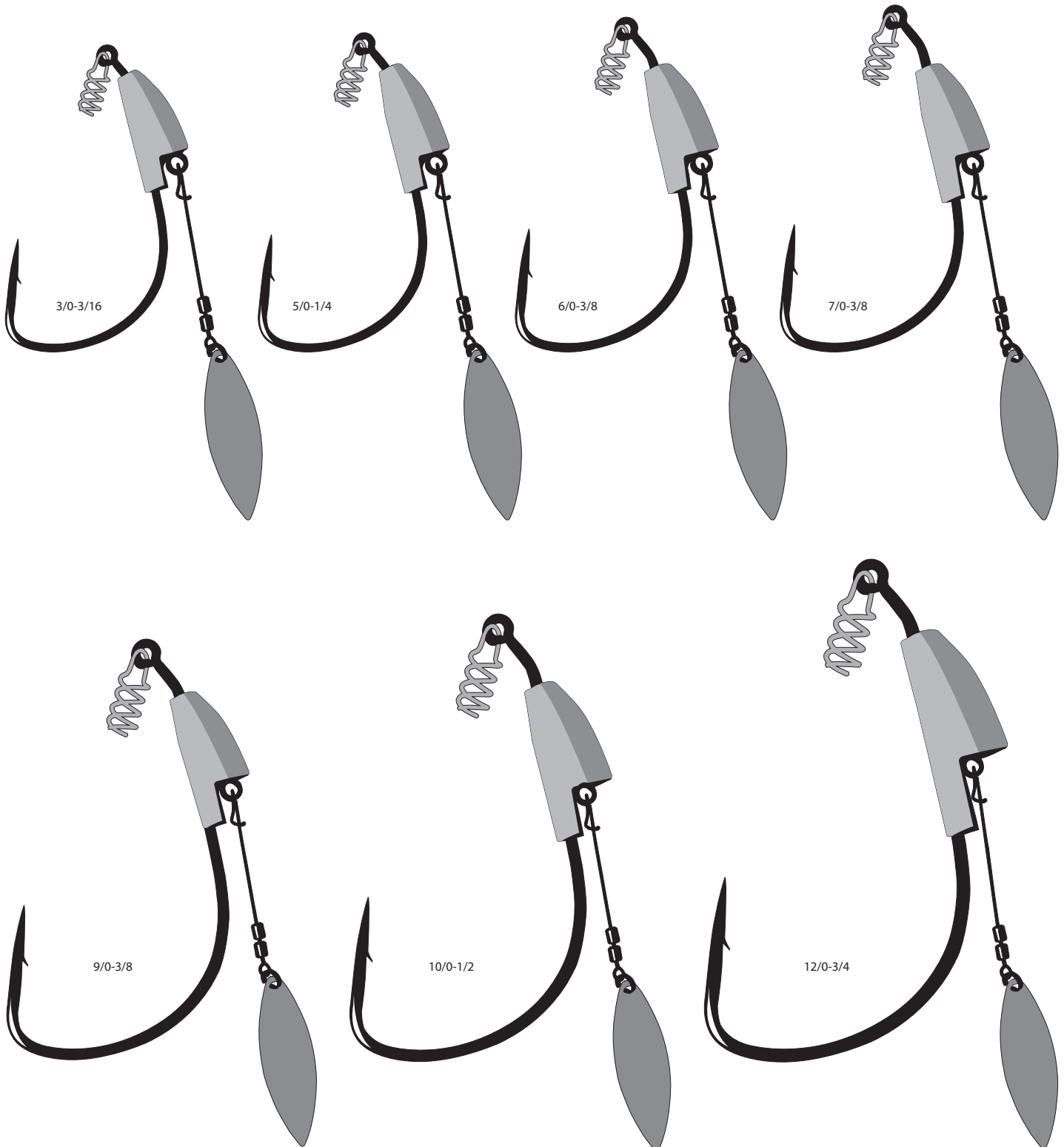



### Under Spin Head Mini

The Under Spin Head Mini features Gamakatsu's premium size 1 Finesse Heavy Cover 60-degree hook, the wide gap design means you can still rig bulkier plastics and have plenty of bite. Ideal for smaller finesse presentations, the head profile is streamlined to glide through cover. Attention-getting recessed lifelike eyes and the small chrome willow leaf blade result in a combination that fish can't resist. Gamakatsu's Spring Lock holds swim baits and other plastics gently but firmly, keeping the presentation straight on the hook.

SIZES		1	1	1	1
WEIGHT	LS	1/8	3/16	1/4	3/8
		435410-1/8(1)	435410-3/16(1)	435410-1/4(1)	435410-3/8(1)

NEW



-  EYE
-  FORGED
-  BARB

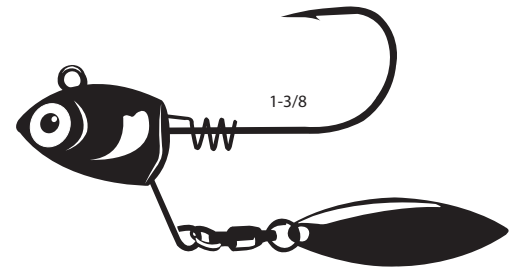
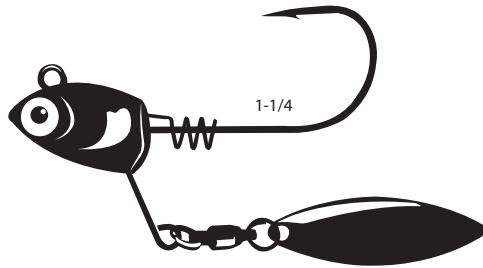
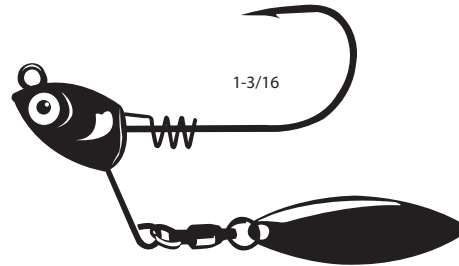
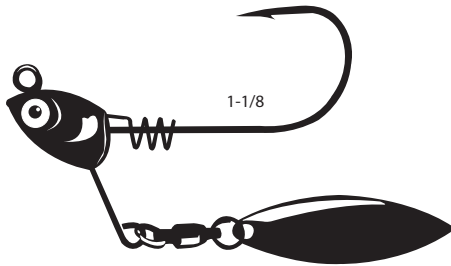

### Under Spin Head

The Under Spin Head features Gamakatsu Heavy Cover 60-degree hook. The heavy wire and wide gap design of the Heavy Cover gives anglers a better hook up ratio and retention when using bulky swim baits. Ideal for heavy braid or fluorocarbon line. The head profile is streamlined to glide through cover. Gamakatsu Spring Lock holds swim baits and other plastics gently but firmly, keeping your presentation straight on the hook. Recessed lifelike eyes on the Under Spin provide a focal point for predators. The small chrome blade is attached to a quality ball-bearing swivel allowing it to spin freely, even at the slowest retrieves, to simulate baitfish and create a subtle trigger.

SIZES	4/0-3/16	4/0-1/4	4/0-3/8	4/0-1/2
	394414-3/16(1)	394414-1/4(1)	394414-3/8(1)	394414-1/2(1)

-  EYE
-  FORGED
-  BARB

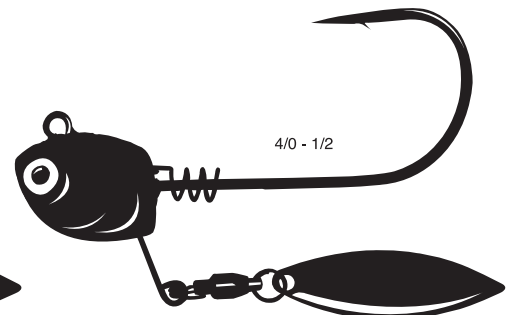
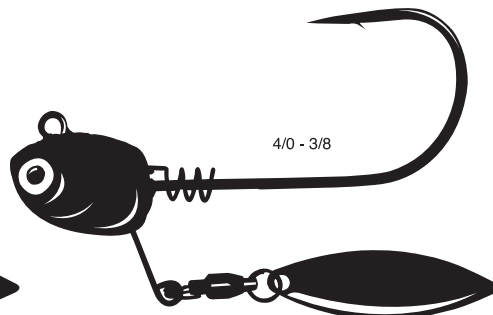
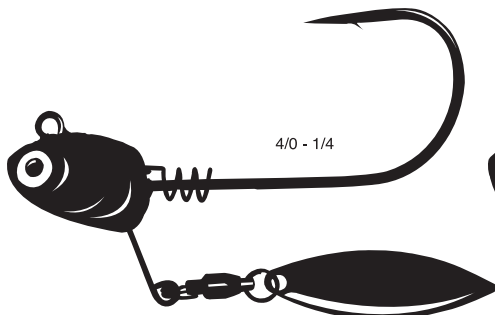
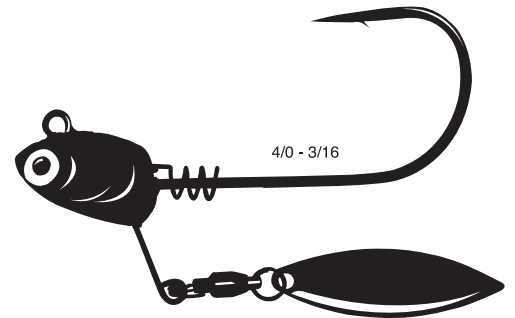

### Superline Swim Bait Head

Until now, you simply couldn't find a premium, swim bait jig head with a premium Gamakatsu hook. The new Superline Swim Bait Head changes all that. The head profile is streamlined for a natural action. Choose premium painted heads or unpainted for anglers that prefer a do-it-yourself custom look. A heavy wire, 60-degree Superline hook performs optimally with braided line and heavy monofilament. Completing the package, The Spring Lock keeper holds all soft plastic swim baits secure and tight.

SIZES		4/0 - 1/8	4/0 - 3/16	4/0 - 1/4	5/0 - 3/8	5/0 - 1/2
Clear	LS	353414-1/8(3)	353414-3/16(3)	353414-1/4(3)	353415-3/8(3)	353415-1/2(3)
Pearl White	LS	353414-PW-1/8(3)	353414-PW-3/16(3)	353414-PW-1/4(3)	353415-PW-3/8(3)	353415-PW-1/2(3)

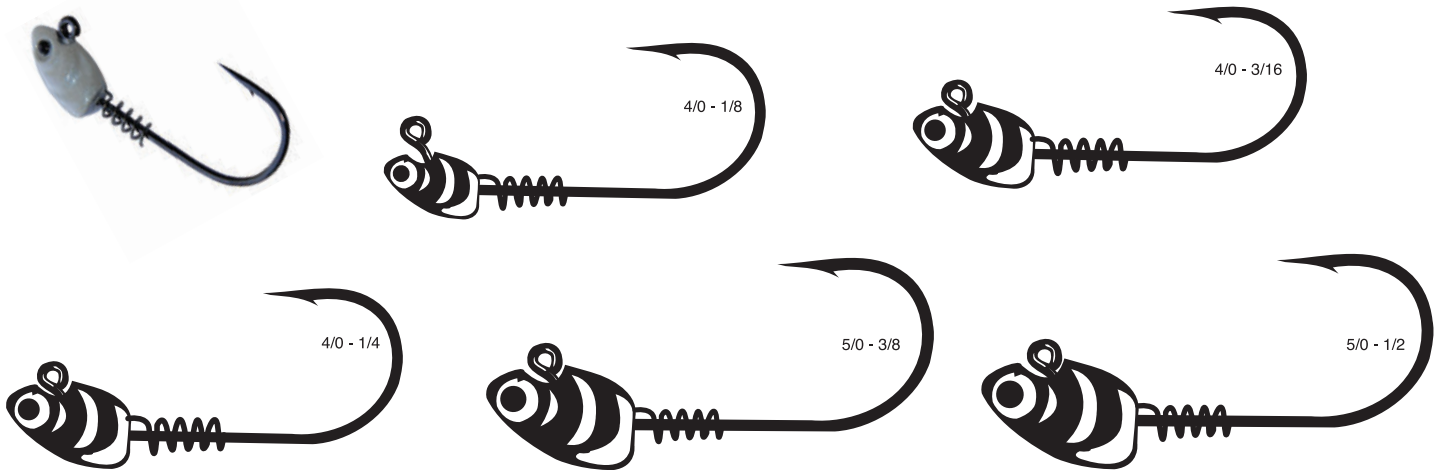

### Tungsten Wobble Head

With a head design that unites the benefits of both a cobra head, for passing through grass, and a football head, for snag resistance on a hard bottom, the Tungsten Wobble Head creates a natural looking, slithering action that draws major attention from nearby bass. Ideal for slow-swimming retrieves, the head increases the action of any plastic bait along the bottom. The precision wire harness is tuned to exacting tolerances and a recessed line tie helps it stay weedless. Features a chip-proof black matte finish and the weight size is stamped into the side of each weight.

SIZES	3/8	1/2	3/4	1
Matte Black	443000-3/8(1)	443000-1/2(1)	443000-3/4(1)	443000-1(1)



**NEW**

Product shown larger than actual size.

### Stand Up Alien Head

Looking for the quintessential stand-up jig head? Gamakatsu's developed the answer with its all-new Stand-Up Alien Head. Perfect for rock or hard bottom fishing, The innovative keeper pin holds plastics without tearing. The benefit is a better presentation, more casts and more mileage out of your plastics. Features a NS Black finesse hook and is available in Green Pumpkin and Black jig heads.

SIZES	3/0-1/8	3/0-3/16	3/0-1/4	3/0-5/16
Black	309413-BK-1/8(4)	309413-BK-3/16(4)	309413-BK-1/4(4)	309413-BK-5/16(4)
Green Pumpkin	309413-GP-1/8(4)	309413-GP-3/16(4)	309413-GP-1/4(4)	309413-GP-5/16(4)

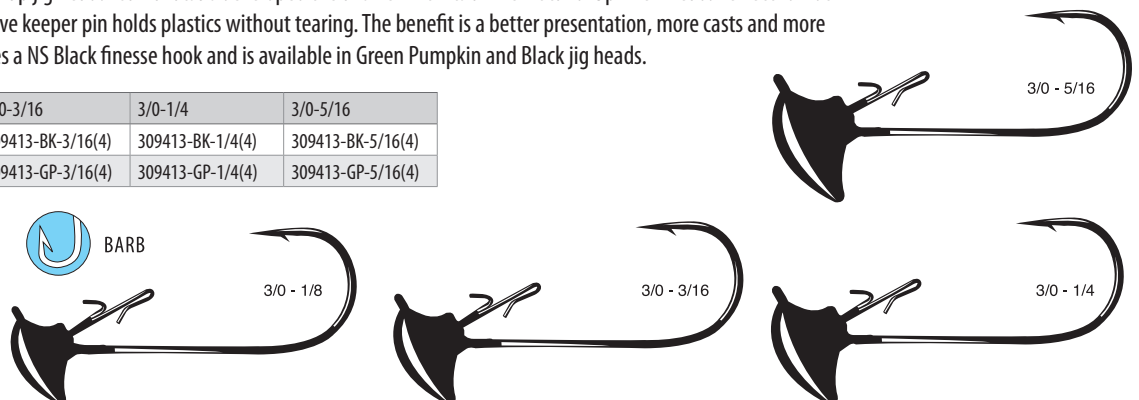

### Skip Gap Head

Gamakatsu has developed its own jig head based on the Skip Gap worm hook. It has the same innovative bend that holds your bait secure on the hook. There are no barbs or pegs that can tear apart a small finesse worm. The unique bend lends itself to simplicity and will change the way you shakly fish.

SIZES	3/0-1/8	3/0-3/16	4/0-3/16	4/0-1/4
Black	293413-BR-1/8(4)	293413-BR-3/16(4)	293414-BR-3/16(4)	293414-BR-1/4(4)
Green Pumpkin	293413-GP-1/8(4)	293413-GP-3/16(4)	293414-GP-3/16(4)	

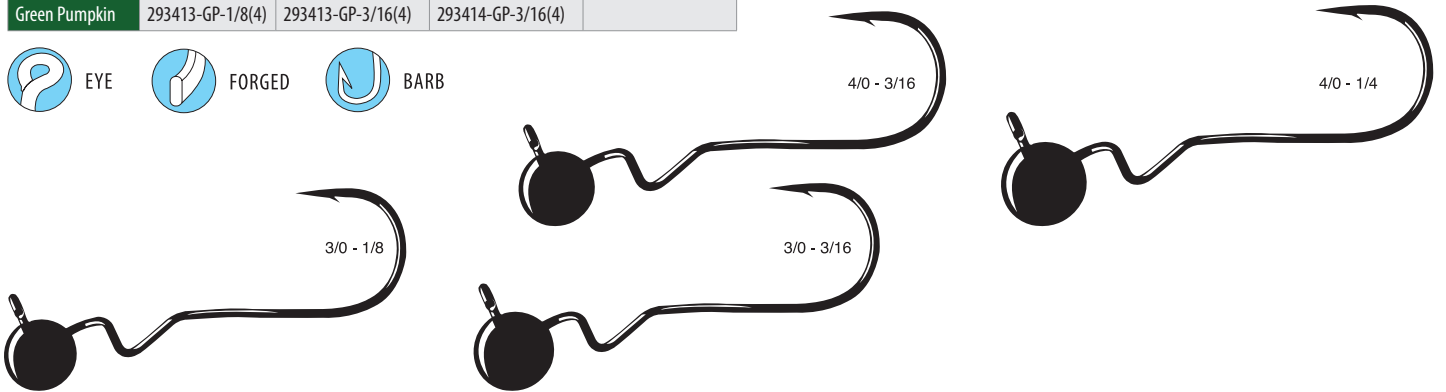

### Finesse Jig Head

When new tournament techniques emerge, our pro-staff are usually holding the rod. Case in point, the Finesse Jig Head is designed to optimize the "Ned Rig." It's all about precise positioning of small soft plastics in a manner that translates into that slow, gliding fall that big bass can't resist. The spring keeper and size #1 hook are critical features. Lead heads are unpainted allowing for easy customization.

SIZES		1	1	1
WEIGHT	LS	1/16	3/32	1/8
		506410-1/16(4)	506410-3/32(4)	506410-1/8(4)

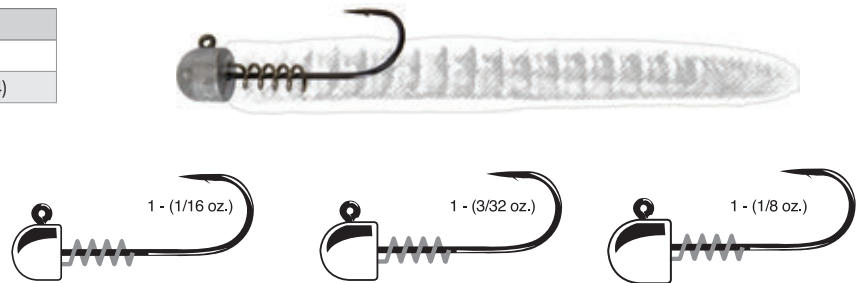

### Finesse Jig Head Offset

If you're familiar with the Ned rig technique, you probably haven't seen this before: An offset eye, countersunk into the jig head, with a premium forged steel Gamakatsu hook. Well, now you have. Reduce time rigging and spend more time fishing. This all-in-one design is tough to beat when bass are spooked or finicky in overfished conditions.

SIZES		1/0	1/0	1/0	1/0
WEIGHT	LS	3/32	1/8	3/16	1/4
		386411-3/32(4)	386411-1/8(4)	386411-3/16(4)	386411-1/4(4)

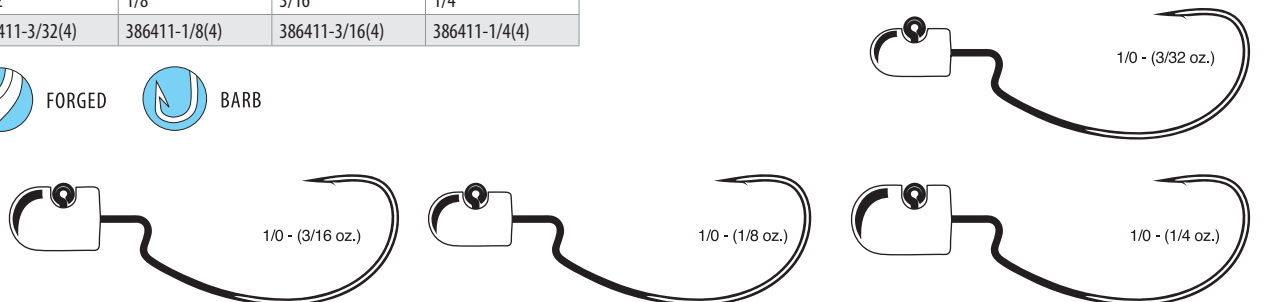

### Bottom Knocker Offset

Anglers on the other side of the “big pond” have been boasting about the advantages of using an offset bottom knocker for many years now. We put them in the hands of several of our most trusted pros and tackle testers in the U.S. and waited to hear what they had to say. What a surprise, they slay bigmouths here in the States as well. Notice the finesse football head designed for fishing deep structure, and the fact that the hook eye is offset to tantalize the “lay down” action. And of course, the genuine Gamakatsu hook is as sharp as they come.

SIZES		1/0	1/0	1/0	1/0
WEIGHT	LS	3/8	1/2	5/8	3/4
		383411-3/8(4)	383411-1/2(4)	383411-5/8(4)	383411-3/4(4)



### Crappie Jig Head

Designed for tournament focused crappie anglers. This premium design, specialized Crappie Jig Head, features a sticky sharp Gamakatsu hook fully molded through the lead head. The smooth eye won't burr even the lightest line. A heavy-duty spring lock keeper encircles the shank for nearly half its length. Soft plastics won't move a millimeter with this innovation. #2 light wire jig hooks in NS Black.

SIZES		2	2	2
WEIGHT	LS	1/16	3/32	1/8
		507409-1/16(5)	507409-3/32(5)	507409-1/8(5)

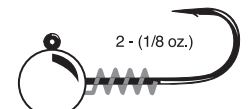
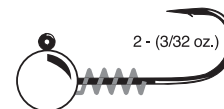
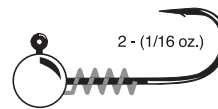

### Round 26

The standard round head design makes this a very versatile jig head. It features our 604 series jig hook which is very popular with Salmon and Steelhead anglers and also has two keeper type rings behind the head to hold soft plastic baits firmly in place.

SIZES		1/0	1/0	2/0	2/0	3/0	3/0
WEIGHT	LS	1/16	1/8	3/16	1/4	3/16	1/4
		500411-1/16(5)	500411-1/8(5)	500412-3/16(5)	500412-1/4(5)	500413-3/16(5)	500413-1/4(5)

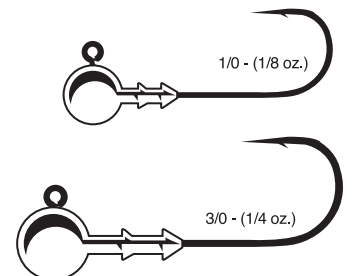
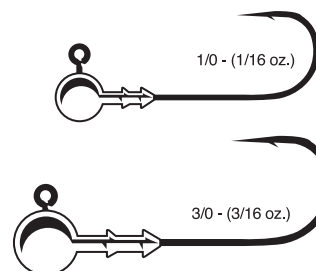
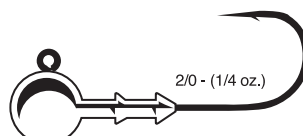
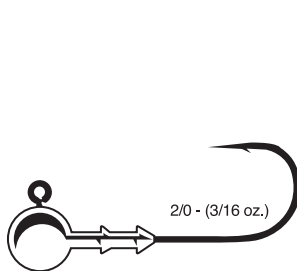

### Round 26 Weedless

Like the original Round 26, the weedless version features a standard lead collar, but adds dual offset rebarb wire keepers to securely and firmly hold a wide range of soft plastic baits. It also features a dual-titanium, wire weed guard that will not break, offering the added versatility to fish in and around heavy cover, where the bigger, more elusive lunkers lie.

SIZES		2/0	2/0	2/0	3/0	3/0	4/0	4/0
WEIGHT	LS	1/16	1/8	3/8	3/16	1/4	3/8	1/2
		420412-1/16(3)	420412-1/8(3)	420412-3/8(3)	420413-3/16(3)	420413-1/4(3)	420414-3/8(3)	420414-1/2(3)



**NEW**

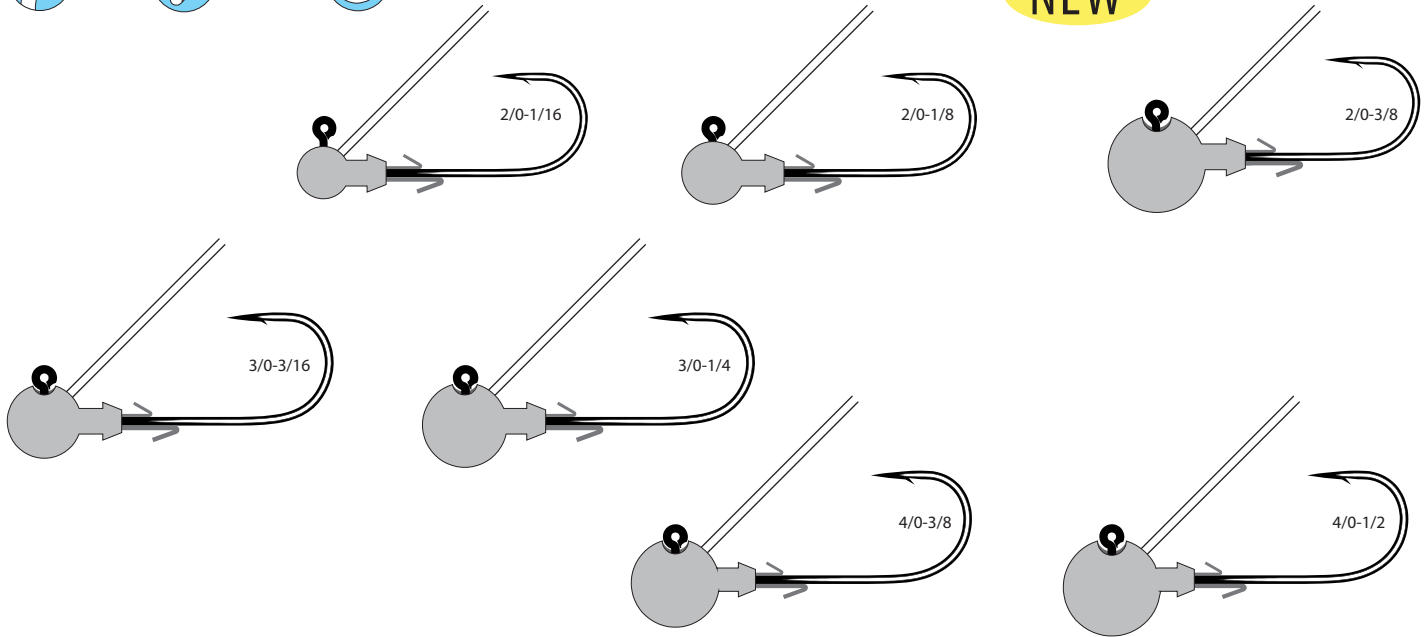

### Round 211

A totally unique design with a short shank and a matte black beak point. Great for live and finesse baits.

SIZES		2	2	2
WEIGHT	LS	1/32	1/16	1/8
		501409-1/32(5)	501409-1/16(5)	501409-1/8(5)

SIZES		1	1	1
WEIGHT	LS	1/32	1/16	1/8
		501410-1/32(5)	501410-1/16(5)	501410-1/8(5)



### Football 24

The Football 24 is the choice when fishing around rock or ledges. It is designed to be very snag resistant. The 24 is the way to go when dragging a Hula Grub or Beaver on deep structure. The 24 features a fine wire hook for fast penetration.

SIZES	1/0	2/0	2/0	3/0	5/0	5/0
WEIGHT	LS 3/16	1/4	3/8	1/2	3/4	1
	502411-3/16(5)	502412-1/4(5)	502412-3/8(5)	502413-1/2(5)	502415-3/4(4)	502415-1(4)

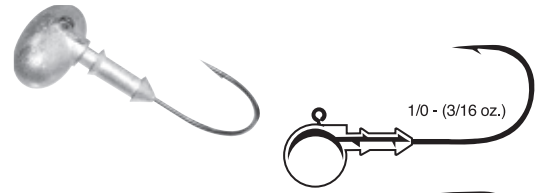

- EYE
- FORGED
- BARB

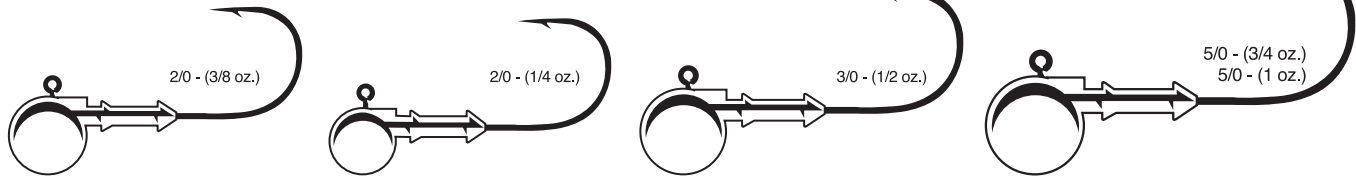

### Darter 26

This jig comes with optional nylon brush guards and features a heavy duty 90 degree jig hook. The streamlined head design makes it ideal in both fresh and saltwater applications.

SIZES	2/0	2/0	3/0	3/0
WEIGHT	LS 1/8	3/16	1/4	3/8
	505412-1/8(5)	505412-3/16(5)	505413-1/4(5)	505413-3/8(5)



5 Nylon Brush Guards Included

- EYE
- FORGED
- BARB

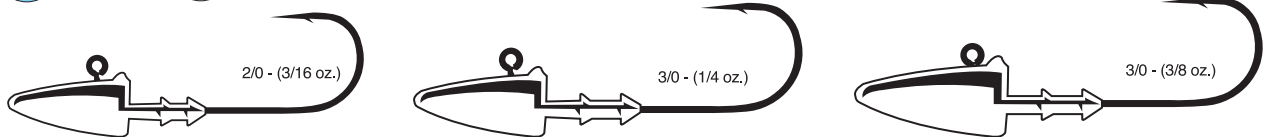

### Tube Head

The ultimate finesse tube head design for precise presentations and smaller baits. Comes on a strong, sticky sharp NS Black hook that ensures solid hook ups.

SIZES	2	2	2
WEIGHT	LS 1/32	1/16	1/8
	503409-1/32(5)	503409-1/16(5)	503409-1/8(5)

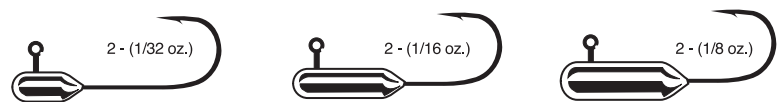

- EYE
- FORGED
- BARB

### MaxEye Jig Pill Head

When it comes to drawing strikes from predatory fish such as walleye Gamakatsu's MaxEye jigs are as good as it gets. This premium jig features highly detailed life-like eyes and a durable paint finish that will not chip or flake. It also boasts a dual offset rebarb wire keeper and collar system, which will safely secure the softest and most-fragile plastics or live bait without tearing. The premium Big River Jig Hook sports an increased gap diameter to increase hook-ups and a special bend with an acute angle to provide better holding power. The MaxEye Pill Head jig has a unique shape which resists snags and imparts a unique action when it contacts the bottom.

SIZES		1/0	1/0	2/0	2/0	2/0
WEIGHT	LS	1/8	3/16	1/4	3/8	1/2
Glow Silver Sparkle		439411-GL-1/8(3)	439411-GL-3/16(3)	439412-GL-1/4(3)	439412-GL-3/8(3)	439412-GL-1/2(3)
Chrome Chartreuse Sparkle		439411-CC-1/8(3)	439411-CC-3/16(3)	439412-CC-1/4(3)	439412-CC-3/8(3)	439412-CC-1/2(3)
Chrome Pink Sparkle		439411-CP-1/8(3)	439411-CP-3/16(3)	439412-CP-1/4(3)	439412-CP-3/8(3)	439412-CP-1/2(3)
Chrome Blue Sparkle		439411-CB-1/8(3)	439411-CB-3/16(3)	439412-CB-1/4(3)	439412-CB-3/8(3)	439412-CB-1/2(3)
Firetiger Sparkle		439411-FT-1/8(3)	439411-FT-3/16(3)	439412-FT-1/4(3)	439412-FT-3/8(3)	439412-FT-1/2(3)
Chrome Perch Sparkle		439411-CPER-1/8(3)	439411-CPER-3/16(3)	439412-CPER-1/4(3)	439412-CPER-3/8(3)	439412-CPER-1/2(3)

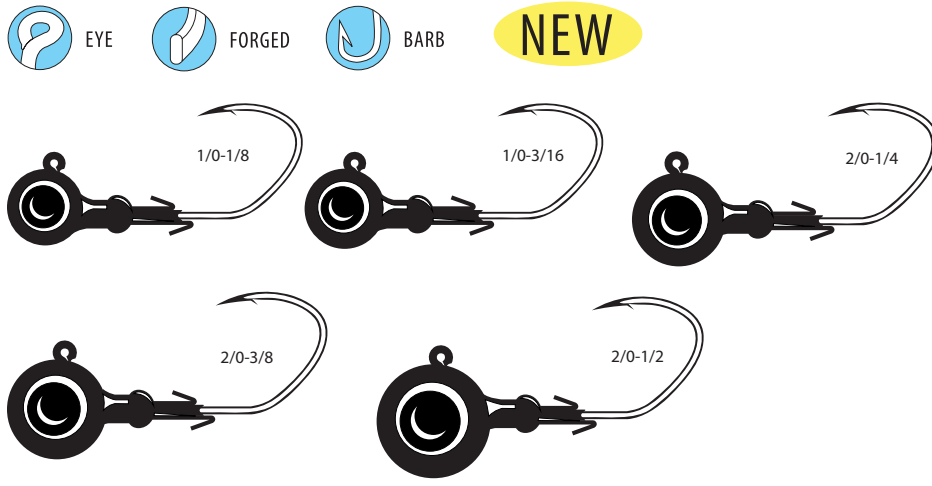

### MaxEye Jig Swim Head

When it comes to drawing strikes from predatory fish such as walleye Gamakatsu's MaxEye jigs are as good as it gets. This premium jig features highly detailed life-like eyes and a durable paint finish that will not chip or flake. It also boasts a dual offset rebarb wire keeper and collar system, which will safely secure the softest and most-fragile plastics or live bait without tearing. The premium Big River Jig Hook sports an increased gap diameter to increase hook-ups and a special bend with an acute angle to provide better holding power. The MaxEye Swim Head jig has a special design that's great for use with any soft plastic swimbait, pairing perfectly with bulky plastics or smaller finesse baits.

SIZES		3/0	3/0	4/0	4/0	4/0
WEIGHT	LS	1/4	3/8	1/2	5/8	3/4
Glow Silver Sparkle		440413-GL-1/4(3)	440413-GL-3/8(3)	440414-GL-1/2(3)	440414-GL-5/8(3)	440414-GL-3/4(3)
Chrome Chartreuse Sparkle		440413-CC-1/4(3)	440413-CC-3/8(3)	440414-CC-1/2(3)	440414-CC-5/8(3)	440414-CC-3/4(3)
Chrome Pink Sparkle		440413-CP-1/4(3)	440413-CP-3/8(3)	440414-CP-1/2(3)	440414-CP-5/8(3)	440414-CP-3/4(3)
Chrome Blue Sparkle		440413-CB-1/4(3)	440413-CB-3/8(3)	440414-CB-1/2(3)	440414-CB-5/8(3)	440414-CB-3/4(3)
Firetiger Sparkle		440413-FT-1/4(3)	440413-FT-3/8(3)	440414-FT-1/2(3)	440414-FT-5/8(3)	440414-FT-3/4(3)
Chrome Perch Sparkle		440413-CPER-1/4(3)	440413-CPER-3/8(3)	440414-CPER-1/2(3)	440414-CPER-5/8(3)	440414-CPER-3/4(3)

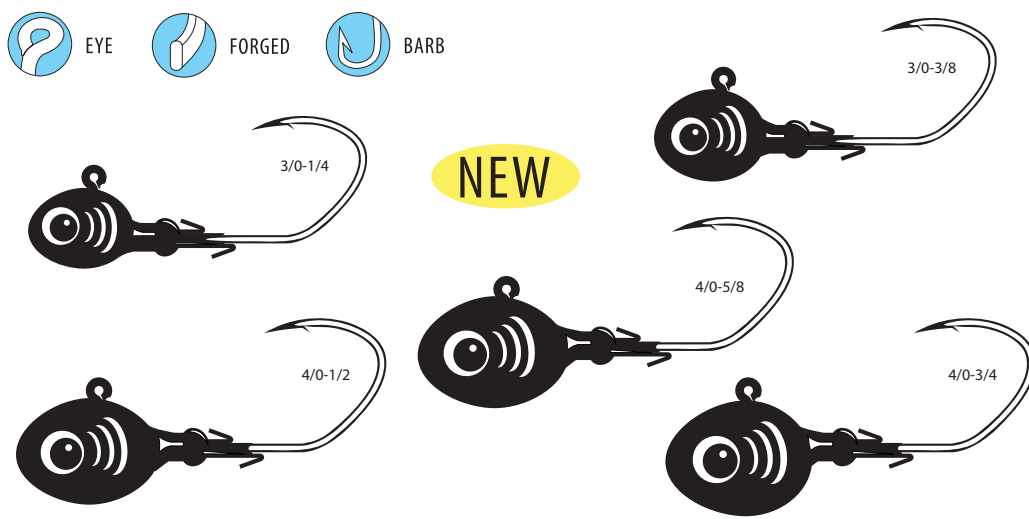







**LURES**

*Spinnaker<sup>®</sup>*

### Spiral Z

Gamakatsu introduces the Spiral Z, a beaded attractor that'll call trout and salmon from a distance while also doing double duty with other species. The Spiral Z offers up a new package with a distinct look, vibration and sound appeal. It is built around a stainless-steel wire with colored beads in a variety of colors for attraction and a ball-bearing line swivel to eliminate line twist. Anglers can add their favorite hook to the end, or it can also be used as an attractor by rigging it any distance in front of a favorite lure. Unlike a traditional spinner where the blade rotates on a clevis, with the Spiral Z, the entire package rotates, creating an undulating lifelike meal for gamefish of every species. Traditional dodgers and flashers will get left in the dust.

**NEW**

SIZES	2 in	2 3/4 in
Red	441000-R(1)	442000-R(1)
Pink	441000-P(1)	442000-P(1)
Orange	441000-O(1)	442000-O(1)
Chartreuse	441000-C(1)	442000-C(1)
Nickel	441000-N(1)	442000-N(1)
Gold	441000-G(1)	442000-G(1)



**BAITS**

*Garmakatsu<sup>®</sup>*

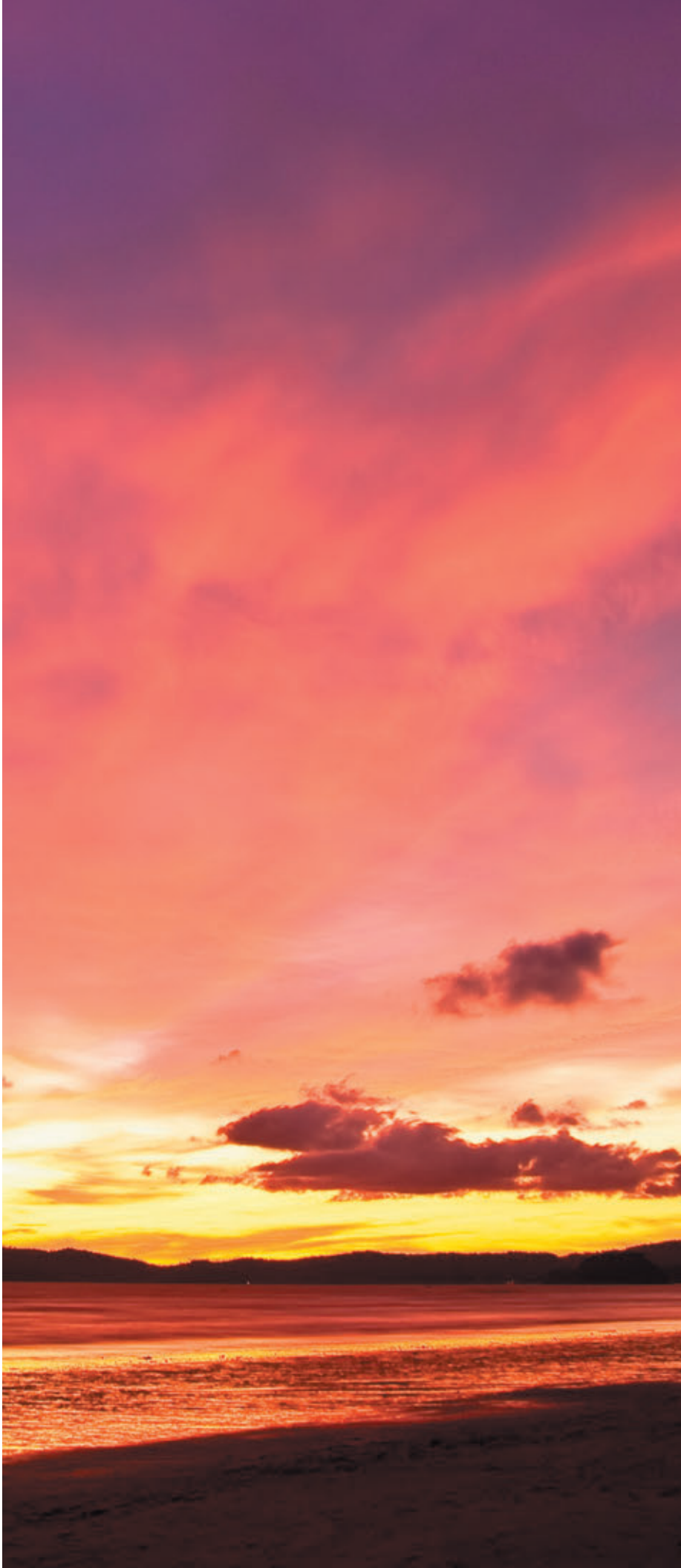

# Gamakatsu®

## DURASCENT

**Durable • Scented • Floats • Flexible**

Gamakatsu®, the longtime leader in hooks for everything from bluegills to blue marlin, has brought the company's unique talents for innovation into the soft bait market with the introduction of DuraScent baits. Whatever species anglers are chasing, there's a DuraScent offering tailor made for that purpose, with built-in features that outfish and outlast the competition.

All DuraScent baits are made in Japan to strict market standards which are reflected in both their hyper realism and their durability. DuraScent baits are extremely durable, lasting longer than traditional soft plastics which allows them to stand up to the toothiest fish. Super-soft elastomer provides extreme flexibility, allowing DuraScent baits to be stretched out to six times their original length. That means more time fishing, and less time re-rigging. DuraScent baits also float, which allows for a myriad of effective rigging options, taking advantage of natural currents to tempt anglers' prey.

DuraScent plastics are infused with an all-natural blend of fish-attracting scents including shrimp, crab, fish oil and squid. After extended use, the extreme scent in DuraScent baits can be "refreshed" with a good stretch or two. Made with a non-toxic formula that is free of plastisol and phthalates making them environmentally friendly.

**XTREME  
SCENT**

No matter which species is targeted for the day, there's a DuraScent plastic that'll catch them better than anything else. When other soft plastics get overlooked, these get chewed.

### DuraScent Shrimp

The DuraScent Shrimp perfectly emulates the favorite food of a wide variety of gamefish, from the natural body shape to the legs and antennae that move and sway in the water with only the slightest current or angler manipulation. Once fish spot it, they'll come in for a closer look, and the powerful shrimp scent will seal the deal. This is a soft plastic lure that can be fished from the top of the water column to the bottom, on weightless weedless hooks or a heavy jig. Rig it below a popping cork to target fish at a particular depth. The super-soft elastomer material floats and is extremely flexible stretching to over six times its length, making it far more durable than the competition, meaning anglers will spend more time reeling fish in and less time baiting hooks.

SIZES	2.3 in
Natural	448000-N(3)
Orange Glitter	448000-OG(3)
Angry Orange	448000-AO(3)

**NEW**

Actual size 2.3 inch.



### DuraScent Crab

The DuraScent Crab provides the look, smell and feel of the real thing, enough to tempt even the most neutral fish, with a combination of exceptional durability and lifelike characteristics. The super-soft elastomer material is buoyant, allowing the legs and claws to float upward to tempt curious fish from a distance, and once they get within sniffing range, they'll be brought closer by the all-natural crab infused scent. Gamakatsu's DuraScent crab is durable, lasts longer than traditional soft plastic baits and is extremely flexible, stretching up to six times its length. Whether bottom fishing, jigging, using a popping cork or just about any other presentation imaginable, this will bring in the most and biggest specimens of anglers desired inshore or offshore species.

SIZES	1 in
Red	451000-R(4)
Pumpkin	451000-PKN(4)
Green Gold Flake	451000-GGF(4)

**NEW**

Actual size 1 inch.

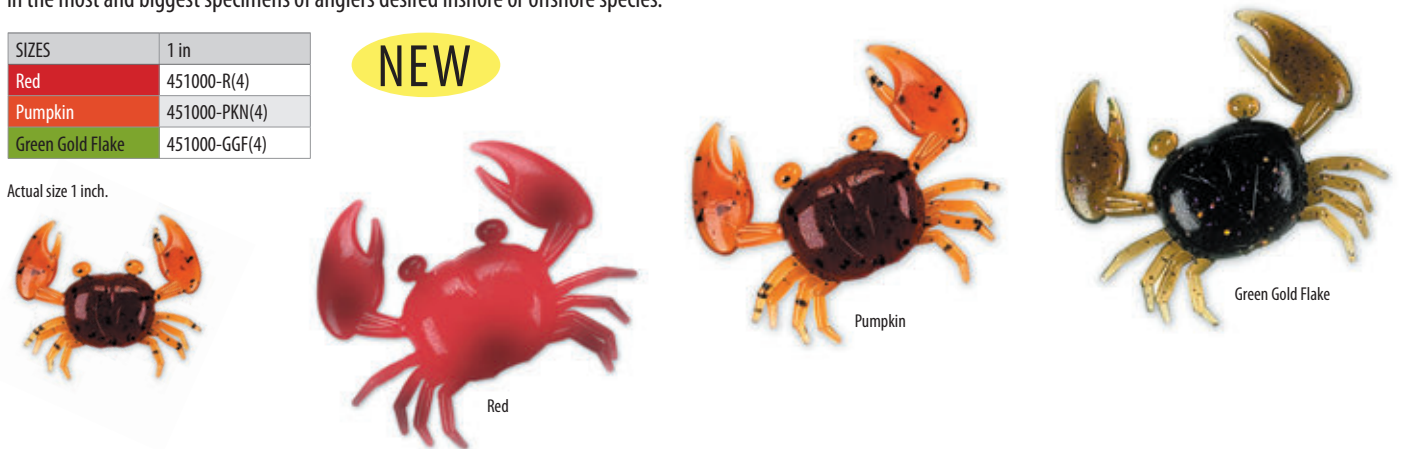

### DuraScent Sandworm

Gamakatsu's DuraScent Sandworm looks, moves, feels and smells like the real thing, providing lifelike motion with only the slightest bit of current or angler manipulation. Once fish see it, they'll be drawn in by the widely dispersed, all-natural fish oil scent, and once they bite, they'll hold on because it feels so lifelike. The super-soft floating elastomer material allows anglers to rig it in a wide variety of ways and is far more durable than traditional soft plastic baits or even actual worms. The DuraScent Sandworm offers extreme flexibility and can stretch to over six times its length. Whether surf fishing or chasing big fish in some other environment, this is the worm imitator anglers can't live without, a true gamechanger.

SIZES	3.3 in
Green Gold Flake	452000-GGF(5)
Blood Red	452000-R(5)
Pumpkin	452000-PKN(5)

**NEW**

Actual size 3 inch.



### DuraScent Octopus

The DuraScent Octopus brings eight legs of super durable and energetic action tempting fish with its undulating natural action. It comes in three sizes – 1.5 inches, 4.5 inches and 6 inches – to “match the hatch” and appeal to a wide array of gamefish. DuraScent Octopus are extremely durable lasting longer than traditional soft plastic octopus/hoochie style baits. Super-soft elastomer provides extreme flexibility and stretches to over 6 times its length. Its buoyant material floats, creating a natural look and feel that fish can’t resist. The 1.5 inch size is infused with shrimp scent and is ideal for targeting kokanee, trout, bass and panfish. The 4.5-inch size is infused with an all-natural blend of real squid extract and is perfect for salmon and other larger species. Rig it behind a dodger or flasher, and the natural action and extreme scent will help trigger more strikes. The 6-inch size excels when targeting a wide variety of bigger bottom fish like halibut.

SIZES	1.5 in	4.5 in	6 in
Pink	450000-P(5)	450002-P(4)	450004-P(2)
Orange	450000-O(5)	450002-O(4)	450004-O(2)
Chartreuse	450000-C(5)	450002-C(4)	450004-C(2)
Red	450000-R(5)	450002-R(4)	450004-R(2)
Green	N/A	450002-GR(4)	450004-GR(2)
Glow	450000-GL(5)	450002-GL(4)	450004-GL(2)
UV Pearl	450000-PRL(5)	450002-PRL(4)	450004-PRL(2)
UV Holo Flake	450000-HF(5)	450002-HF(4)	450004-HF(2)



Actual size 6 inch.



Actual size 1.5 inch.



Actual size 4.5 inch.



### DuraScent Salmon Eggs

DuraScent Salmon Eggs are so incredibly natural-looking that they're as good as the real thing. In fact, because of their exceptional durability and versatility, they may be better than the real thing. Whether fish are feeding by sight or scent, and whether anglers thread one egg on a hook or tie them in a cluster, the shrimp-infused extreme scent of these replicas will fool a wide variety of species into striking. Buoyant material that floats creates a natural look and feel that's deadly on steelhead, trout, salmon, panfish and just about any other species, versatile in both freshwater and saltwater. Anglers can tie several together using a series of overhand knots to adjust the amount of bait presented. Because of their incredible ability to stretch to over six times their length, anglers will spend less time rigging baits and more time reeling in fish.

SIZES	7 mm
Red	447000-R(5)
Creamside	447000-CRM(5)
Cerise	447000-CER(5)
Pearl Pink	447000-PP(5)
Pink Sheen	447000-PS(5)

**NEW**

Actual size 7mm diameter (0.275 inch).

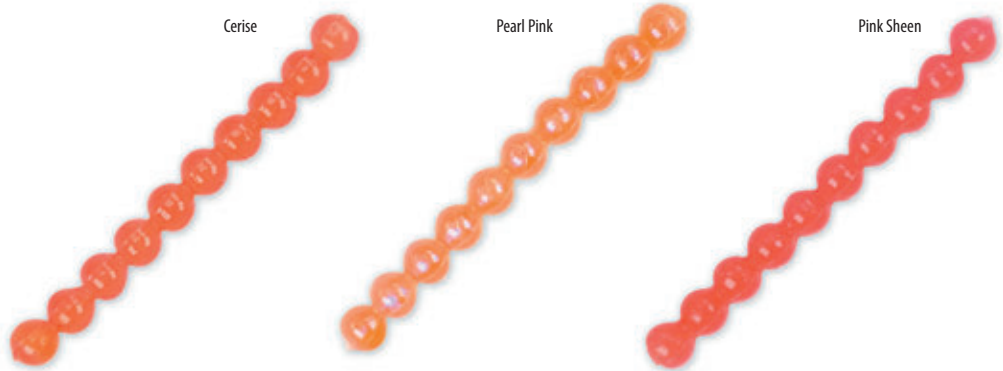
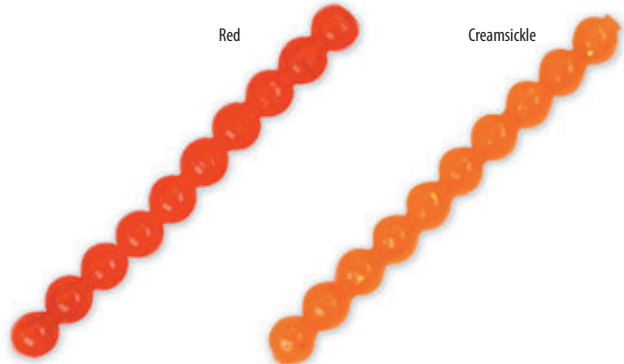







**WEIGHTS**

*SpaMakatsu<sup>®</sup>*

### G-Shield Tungsten Worm Weight

The G-Shield Tungsten Worm Weight features a specially designed composite insert that not only protects an angler's line, but also provides 360-degree protection for the knot. The insert is wider at the base than at the insertion hole so the hook can recess itself into the weight, creating a more compact, lifelike and snag resistant offering. The worm weight is the all-purpose champ, best for casting into light cover or dragging plastics across bare lake and river bottoms when subtlety is essential and features a stealthy, chip-proof black matte finish. For easy identification the weight size is stamped into the side of each weight.

SIZES	1/8	3/16	1/4	3/8	1/2	3/4
Matte Black	446000-1/8(4)	446000-3/16(4)	446000-1/4(4)	446000-3/8(3)	446000-1/2(2)	446000-3/4(2)

NEW



Product shown larger than actual size

### G-Shield Tungsten Flipping Weight

The G-Shield Tungsten Flipping Weight features a specially designed composite insert that not only protects an angler's line, but also provides 360-degree protection for the knot. The insert is wider at the base than at the insertion hole so the hook can recess itself into the weight, creating a more compact, lifelike and snag resistant offering. The flipping weight is slightly wider and excels when flipped or pitched into heavy cover and features a stealthy, chip-proof black matte finish. For easy identification the weight size is stamped into the side of each weight.

SIZES	3/8	1/2	5/8	3/4	1	1 1/4
Matte Black	444000-3/8(3)	444000-1/2(2)	444000-5/8(2)	444000-3/4(1)	444000-1(1)	444000-1 1/4(1)

NEW



Product shown larger than actual size

### G-Shield Tungsten Punch Weight

The G-Shield Tungsten Punch Weight features a specially designed composite insert that not only protects an angler's line, but also provides 360-degree protection for the knot. The insert is wider at the base than at the insertion hole so the hook can recess itself into the weight, creating a more compact, lifelike and snag resistant offering. The punch weight will penetrate thick overhead canopies that resist other shapes. It's bulbous at the front, creating a weight-forward design that builds inertia when it first contacts likely bass-holding cover and features a stealthy, chip-proof black matte finish. For easy identification the weight size is stamped into the side of each weight.

SIZES	3/4	1	1 1/4	1 1/2	2
Matte Black	445000-3/4(1)	445000-1(1)	445000-1 1/4(1)	445000-1 1/2(1)	445000-2(1)

NEW



Product shown larger than actual size

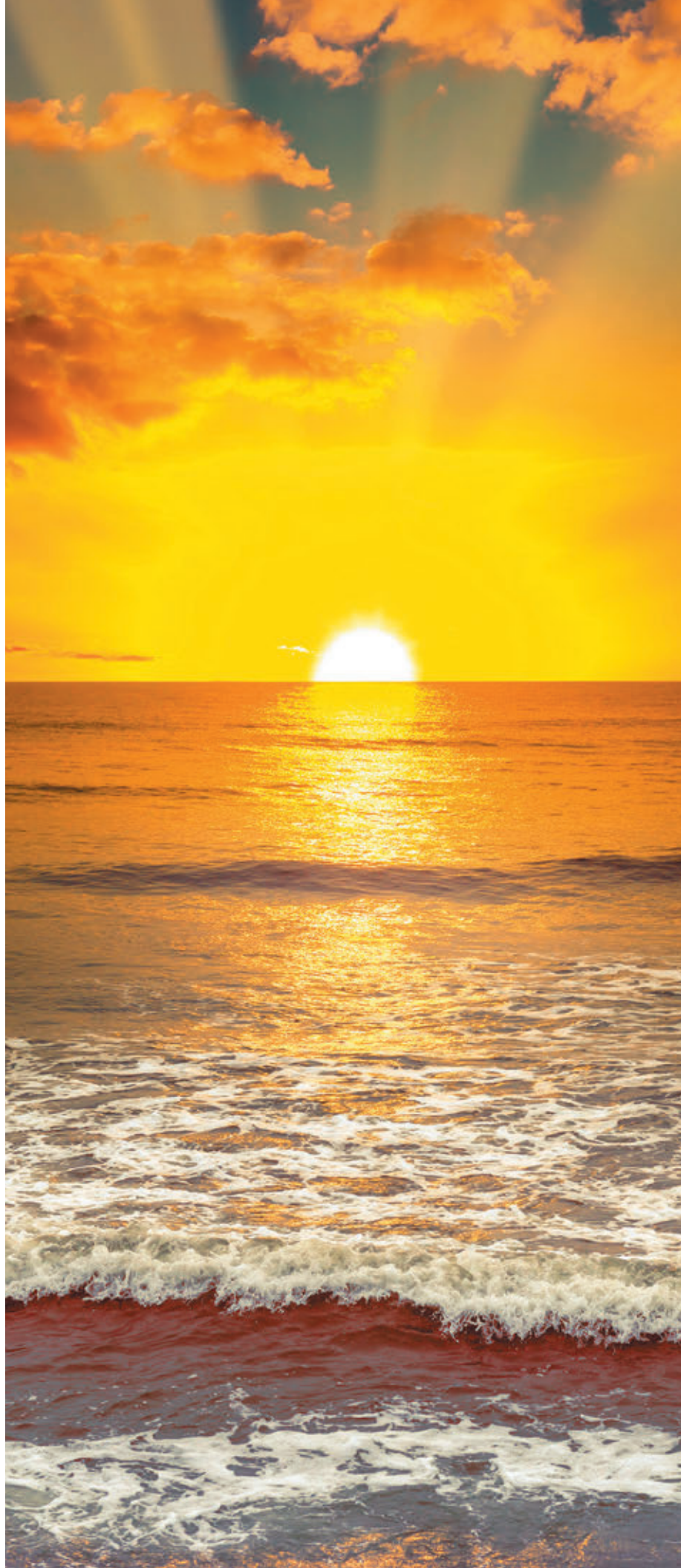

# SALTWATER HOOKS

*SpartanKatsu<sup>®</sup>*

### Live Bait

Our most versatile Live Bait Hook. Sticky sharp, super strong and designed to handle tough saltwater fish.

SIZES		12	10	8	6	4	2	1	1/0	2/0	3/0	4/0	5/0	6/0	7/0	8/0	9/0	10/0	11/0
NS Black	LS	18404(9)	18405(9)	18406(8)	18407(8)	18408(7)	18409(7)	18410(6)	18411(6)	18412(5)	18413(4)	18414(4)	18415(4)	18416(3)	18417(3)	18418(2)	18419(2)	18420(2)	18421(2)
	25			18406-25	18407-25	18408-25	18409-25	18410-25	18411-25	18412-25	18413-25	18414-25	18415-25	18416-25	18417-25	18418-25	18419-25	NEW SIZES	
	100	18404-100	18405-100	18406-100	18407-100	18408-100	18409-100	18410-100	18411-100	18412-100	18413-100	18414-100	18415-100	18416-100	18417-100	18418-50	18419-50		



### Live Bait with Solid Ring

Our standard Live Bait hook with a solid one piece ring for a natural presentation. Much smoother than any welded ringed hook, these are designed for larger baits and heavier lines.

SIZES		2	1	1/0	2/0	3/0	4/0
NS Black	LS	18409R(7)	18410R(6)	18411R(6)	18412R(5)	18413R(5)	18414R(4)
	25	18409R-25	18410R-25	18411R-25	18412R-25	18413R-25	18414R-25

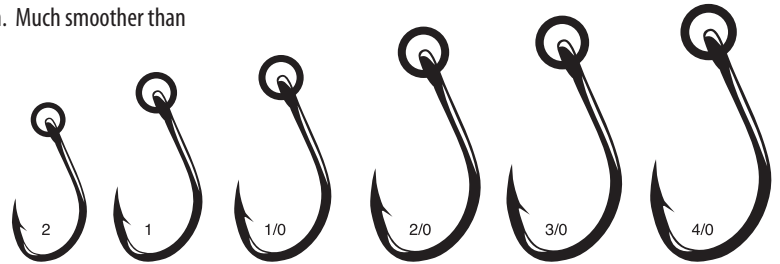

### Live Bait Light Wire

SIZES		6	4	2	1	1/0	2/0	3/0
NS Black	LS	220407(8)	220408(7)	220409(7)	220410(6)	220411(6)	220412(5)	220413(5)

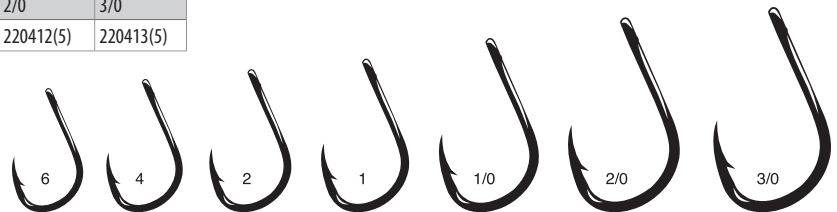

### Live Bait Light Wire with Solid Ring

Super smooth solid one piece ring attached to the Light Wire Live Bait hook. The perfect hook for small live baits and delicate presentations.

SIZES		6	4	2	1
NS Black	LS	220407R(7)	220408R(7)	220409R(7)	220410R(6)
	25	220407R-25	220408R-25	220409R-25	220410R-25

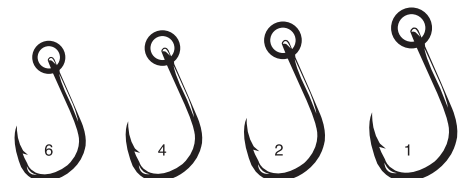

### Live Bait Heavy Duty

Heavy wire and forged for extra strength, this hook is the go to hook for big fish on big baits.

SIZES		1/0	2/0	3/0	4/0	5/0	6/0	7/0	8/0	9/0	10/0	11/0	12/0
NS Black	LS	00411(8)	00412(7)	00413(7)	00414(6)	00415(6)	00416(5)	00417(5)	00418(4)	00419(4)	00420(3)	00421(3)	00422(2)
	25	00411-25	00412-25	00413-25	00414-25	00415-25	00416-25	00417-25	00418-25	00419-25	00420-25	00421-25	00422-25
	Bulk	00411-100	00412-100	00413-100	00414-100	00415-100	00416-100	00417-100	00418-50	00419-50	00420-50	00421-50	00422-40

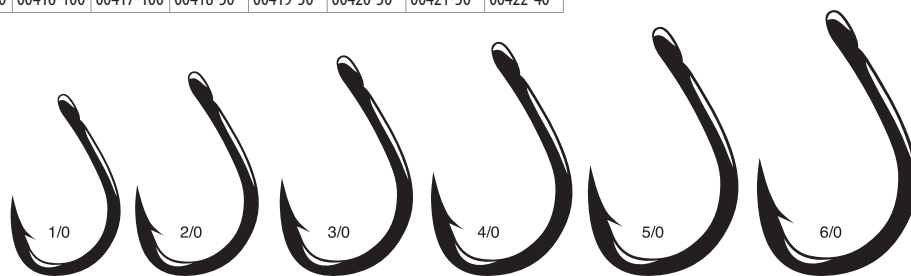

### Live Bait Heavy Duty with Solid Ring

A heavier Live Bait hook with a ring. Designed for bigger baits and heavier lines.

SIZES		1/0	2/0	3/0	4/0	5/0	6/0
NS Black	LS	00411R(5)	00412R(5)	00413R(5)	00414R(4)	00415R(4)	00416R(4)
	25	00411R-25	00412R-25	00413R-25	00414R-25	00415R-25	00416R-25



### Live Bait Heavy Duty Circle, **TOURNAMENT LEGAL**

Same design as the Live Bait Heavy Duty, but with a non-offset circle hook point. The perfect hook for giant fish on big chunk baits.

SIZES		5/0	6/0	7/0	8/0	9/0	10/0	11/0	12/0
NS Black	LS	210415(6)	210416(5)	210417(5)	210418(4)	210419(3)	210420(3)	210421(2)	210422(2)

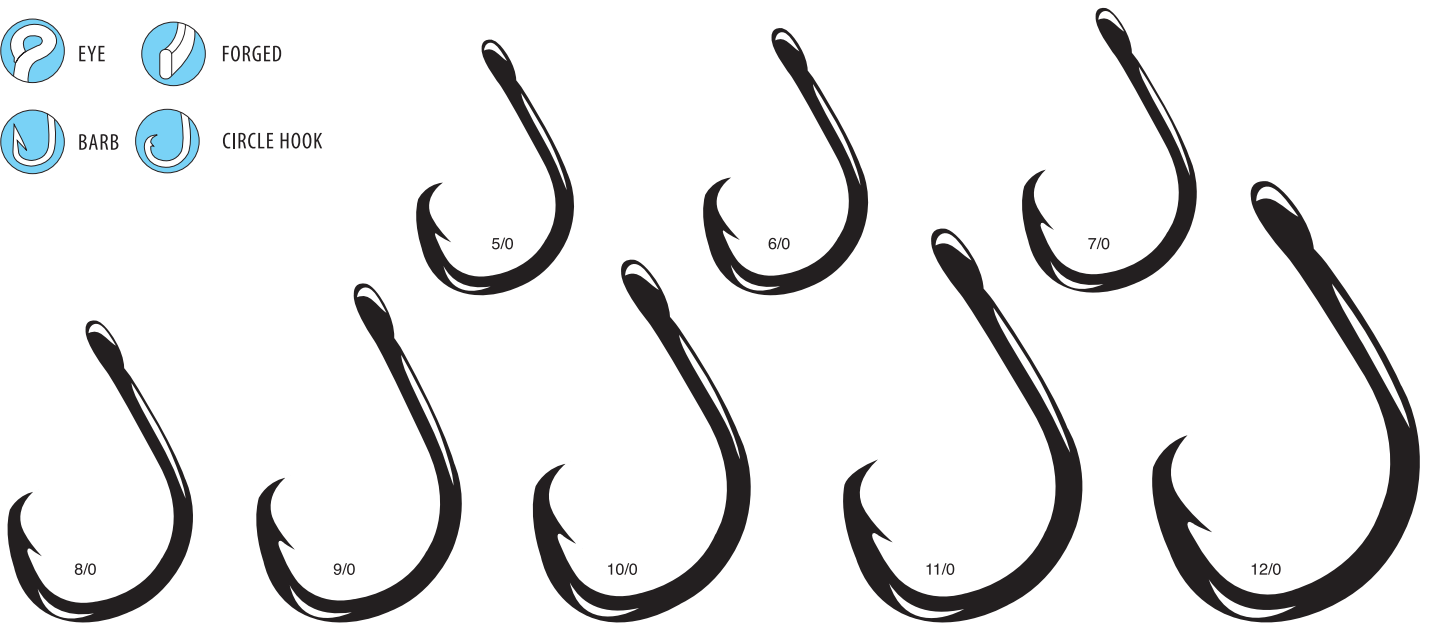
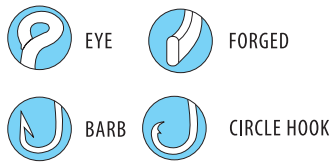

### Nautilus Circle

One of the meanest circle hook designs around. The Nautilus grabs its prey and simply doesn't let go. This hook can be used for live bait or chunk bait presentations and has proven its strength many times.

SIZES		4	2	1	1/0	2/0	3/0	4/0	5/0	6/0
NS Black	LS	42408(8)	42409(8)	42410(8)	42411(7)	42412(7)	42413(6)	42414(6)	42415(5)	42416(5)
	25	NEW SIZES		42410-25	42411-25	42412-25	42413-25	42414-25	42415-25	42416-25

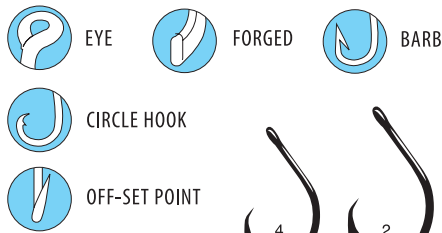

### Nautilus Circle with Solid Ring

The most popular circle hook with solid ring, grabs its prey and simply does not let go.

SIZES		4	2	1	1/0	2/0	3/0	4/0	5/0	6/0
NS Black	LS	42408R(5)	42409R(5)	42410R(5)	42411R(5)	42412R(5)	42413R(5)	42414R(4)	42415R(4)	42416R(4)
	25	NEW SIZES				42412R-25	42413R-25	42414R-25	42415R-25	42416R-25

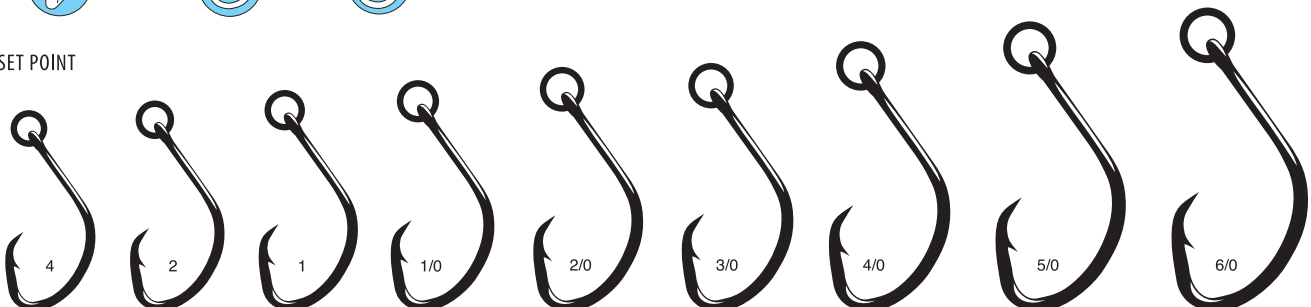

### Nautilus Light

A light wire hook that was developed for fishing fragile live baits. Produced from forged high carbon steel, it features a straight eye and offset point for superior hooking performance. The unique circle hook shape is designed to hook and hold which is precisely why more saltwater anglers make Gamakatsu their hook-of-choice. Superior strength, sharpness and design add-up to make a sure bet for live bait and chunk bait anglers from coast-to-coast.

Sizes	2	1	1/0	2/0	3/0	4/0	5/0	6/0	7/0	8/0
NS Black	LS 332409(8)	332410(8)	332411(7)	332412(6)	332413(5)	332414(5)	332415(4)	332416(3)	332417(3)	332418(3)

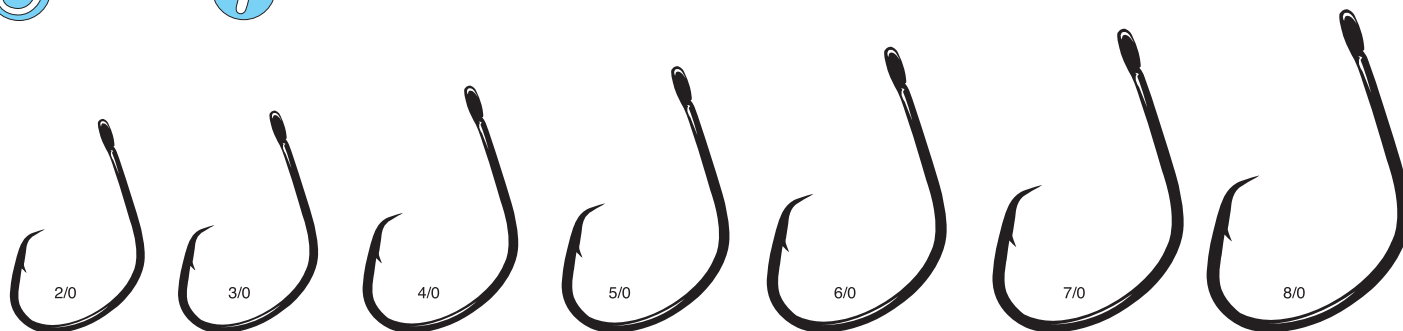
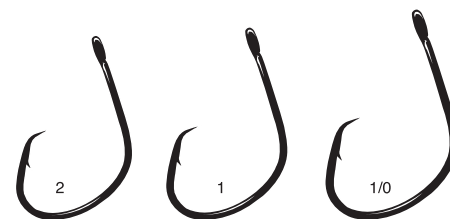
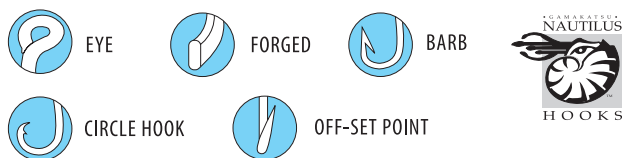

### Nautilus Circle Heavy Duty

To go ringed or not to go ringed... that is the question! And we've got the answer, whichever you prefer. The standard Nautilus HD hook features a ringless eye and 30% heavier wire than the regular Nautilus. (Roughly 50% less heavy than the Super Nautilus.) Whether you simply prefer the stealthiness of having less metal in the water or just have great confidence in the loop knots you've tied for years, the standard Nautilus HD hook will do the trick. You can feel the superiority by just holding it in your hand. Be careful when checking the sharpness; it doesn't differentiate between fish or fingers.

SIZES	2/0	3/0	4/0	5/0	6/0
NS Black	LS 377412(7)	377413(6)	377414(6)	377415(5)	377416(5)
	25 377412-25	377413-25	377414-25	377415-25	377416-25

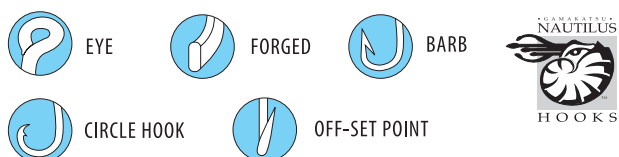

### Nautilus Circle Heavy Duty With Solid Ring

The new solid, one-piece ringed version of the Nautilus HD hook allows live bait to swim more freely, keeping it alive longer and enticing more prey to engulf its goodness. At that point, the finest high carbon steel penetrates deep and locks in tight for the battle ahead. The Ringed Nautilus HD features 30% heavier wire than the regular Nautilus and 50% less than the Super Nautilus. While its core credibility has been proven in the southern California Bluefin Tuna fisheries, there is absolute evidence of its prowess in many other heavyweight bouts with monster gamefish worldwide. Therefore, you owe it to yourself to try the Nautilus HD Ringed for all live bait techniques and bottomfish applications. Big blues and channel cats? Absolutely! Sturgeon? Oh yeah. Halibut? It's a no-brainer. Tie one on without a single regret.

SIZES	2/0	3/0	4/0	5/0	6/0
NS Black	LS 377412R(5)	377413R(5)	377414R(4)	377415R(4)	377416R(4)
	25 377412R-25	377413R-25	377414R-25	377415R-25	377416R-25

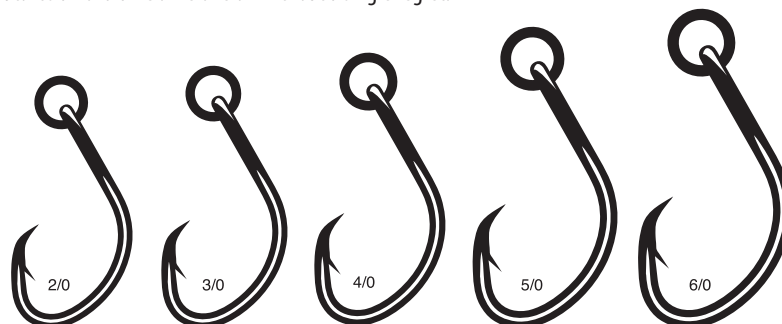
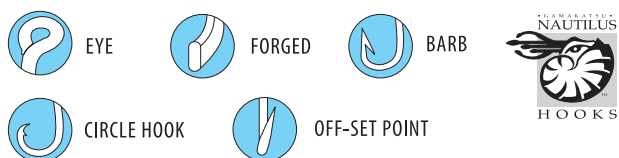

### Super Nautilus Circle

Made of high carbon steel, it's a heavier wire hook than our standard "Nautilus" and forged for quality and added strength. This hook has become a favorite amongst demanding saltwater fishermen.

SIZES	10/0	11/0
NS Black LS	272420(3)	272421(2)

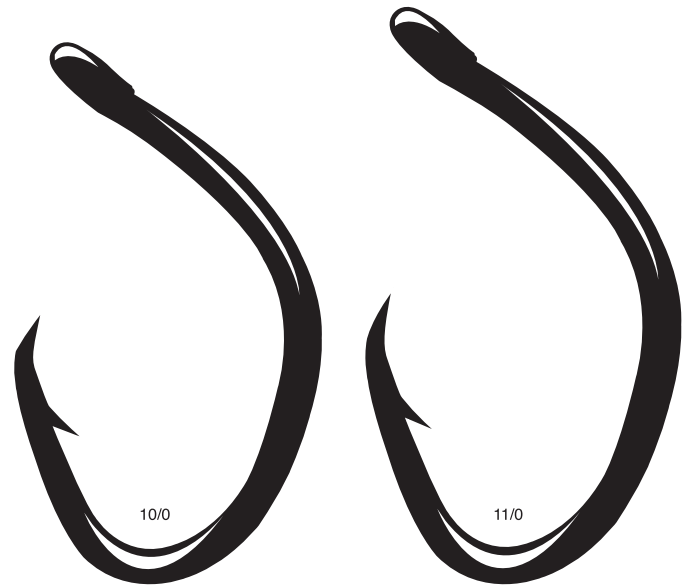
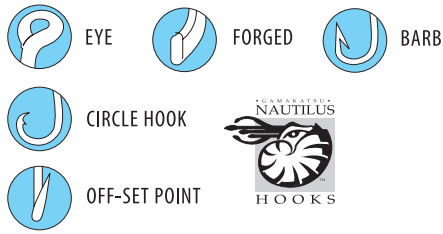

### Kraken Outbarb Circle (Inline-point) **TOURNAMENT LEGAL**

The Kraken Outbarb Circle's distinctive outside barb provides several advantages when targeting giant sized fish. One is straight holding power, because the outbarb cannot back out like a traditional barbed hook, and hook damage typically occurs on the opposite side of the hook, further reducing potential pull-out. Another is better, easier penetration because the barb is opposite the side of the hook doing most of the work. It's also less likely anglers' line will catch on the barb if it wraps around the hook on the drop or cast.

SIZES	1/0	2/0	3/0	4/0	5/0	6/0	7/0	8/0	9/0	10/0
NS Black LS	438411(7)	438412(7)	438413(7)	438414(6)	438415(6)	438416(6)	438417(5)	438418(4)	438419(4)	438420(3)

**NEW**

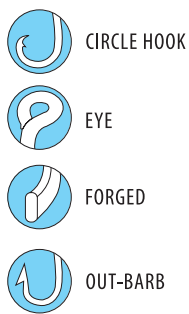

### Kraken Circle Monster (Inline-point) **TOURNAMENT LEGAL**

The Kraken Circle Monster was developed for use with larger chunk baits and provides the strength and size to target giant fish. The circle hook is a time-tested and proven design, and the wide gap ensures reliable hook-ups even with the largest jawed fish. Their monster-sized eye provides anglers a range of rigging options including heavy tuna cord, mono, fluoro and even wire. The straight eye design offers the option of snelling or crimping.

SIZES	14/0	16/0
NS Black LS	436424(2)	436426(2)

**NEW**

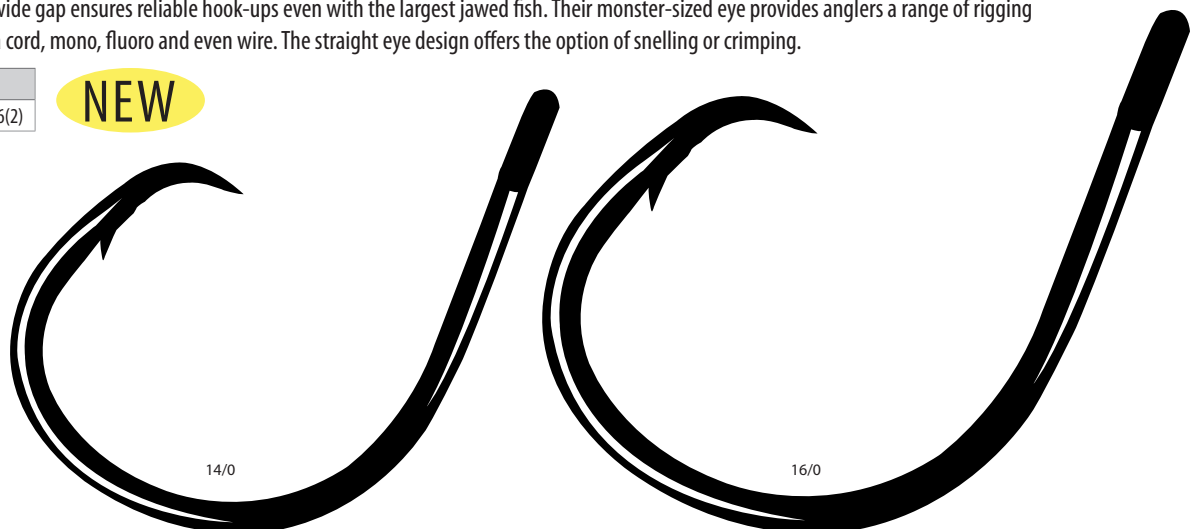
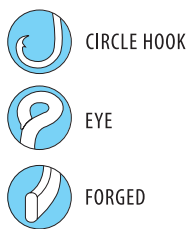



### Octopus Circle, 4x Strong, Straight Eye

This hook is designed for heavier lines and bigger fish. The offset point makes it a good choice for many chunk bait situations.

SIZES		1/0	2/0	3/0	4/0	5/0	6/0	7/0	8/0
NS Black	LS	209411(6)	209412(6)	209413(6)	209414(6)	209415(6)	209416(6)	209417(6)	209418(6)
	25					209415-25	209416-25	209417-25	209418-25

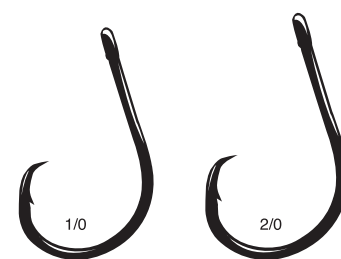
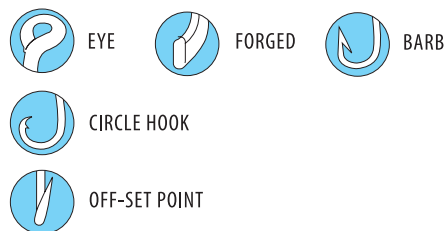

### Octopus Circle, 4x Strong, Straight Eye (Inline-point) **TOURNAMENT LEGAL**

To comply with new angling regulations in the Gulf of Mexico, we've redesigned and reinforced our most popular circle hook. The new 4X Strong Circle Hook is built for the toughest battles in the deep sea. The straight eye, NS Black finish and inline point (not offset) complies with the new rules, but doesn't reduce the hook's effectiveness. This is the new "go-to" hook charter captains and professional anglers are using for deep dropping and reef and wreck fishing. Heavy up your rods, reels and line, because the 4X Strong Circle Hook will never give up when it comes to pulling snapper and monster grouper out of their fortified hangouts.

SIZES		1/0	2/0	3/0	4/0	5/0	6/0	7/0	8/0	9/0	10/0
NS Black	LS	360411(6)	360412(6)	360413(6)	360414(6)	360415(6)	360416(6)	360417(6)	360418(6)	360419(5)	360420(5)

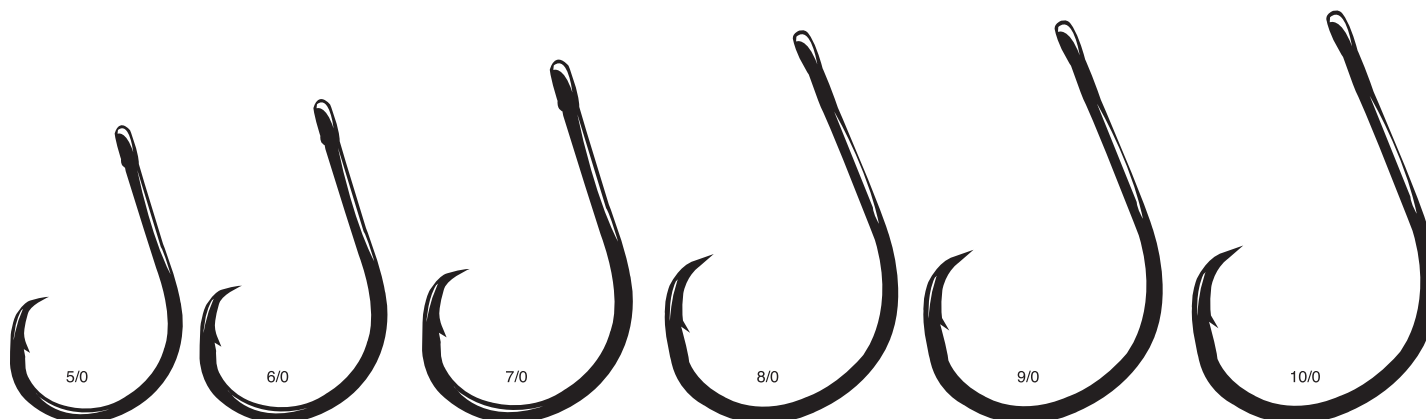
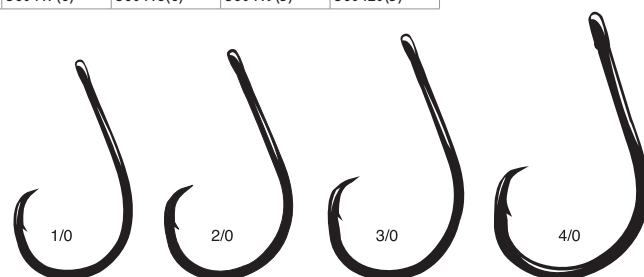

### O'Shaughnessy

Traditional saltwater style for trolling or general purpose bait fishing.

SIZES		1/0	2/0	3/0	4/0	5/0	6/0	7/0	8/0	9/0	10/0
Tin	LS	13011(6)	13012(5)	13013(5)	13014(4)	13015(4)	13016(3)	13017(3)	13018(2)	13019(2)	13020(2)
	100	13011-100	13012-100	13013-100	13014-100	13015-100	13016-50	13017-50	13018-30	13019-30	13020-20



### Single 510

Single 510 has an open eye so it can be used as a replacement hook for spoons, plugs and other lures. It features a sticky sharp curved point with an outbarb for fast penetration and secure hook ups.

SIZES		1/0	2/0	3/0	4/0
Tin	LS	232511(5)	232512(5)	232513(4)	232514(4)
	25	232511-25	232512-25	232513-25	232514-25



### Magic Eye Tuna Plug 3X

You've likely heard about the advantages of using tandem Gamakatsu double, single-point hooks instead of factory trebles on your favorite tuna plugs. Hookup ratios increase and releases are far kinder to our finned friends. Magic Eye Tuna Plug 3X Hooks make rigging the system dramatically easier because the hook eyes are beveled so they slide right on a split ring without needing special pliers or tools. It's faster, easier and foolproof. Attach with hook points opposed.

SIZES		3/0	4/0	5/0	6/0	7/0
TIN	LS	365513(5)	365514(5)	365515(5)	365516(4)	365517(4)



FORGED



BARB



MAGIC EYE

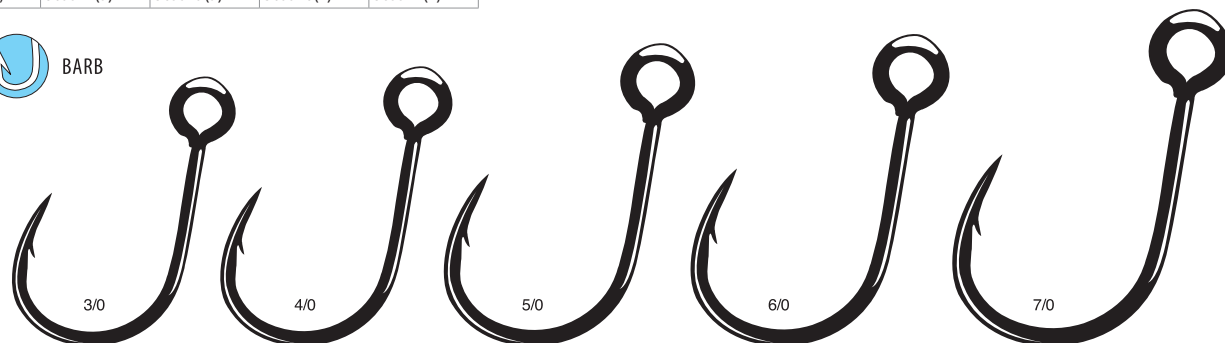

### Tuned Tuna Plug with Ring

Angler preferences can differ on whether to use a ringed hooked or not. And that's just fine with us because we manufacture both. Our Tuned Tuna Plug hook is now available with a welded ring. The ring provides more freedom for the hook(s) to swing unencumbered. Anglers have also found success using the ringed Tuned Tuna Plug hook for stiff rigs, thus eliminating the need for a shackle. Without reservation, they're ready for battle.

SIZES		10/0	11/0	12/0
TIN	LS	379520(2)	379521(2)	379522(2)



WELDED EYE



FORGED



BARB

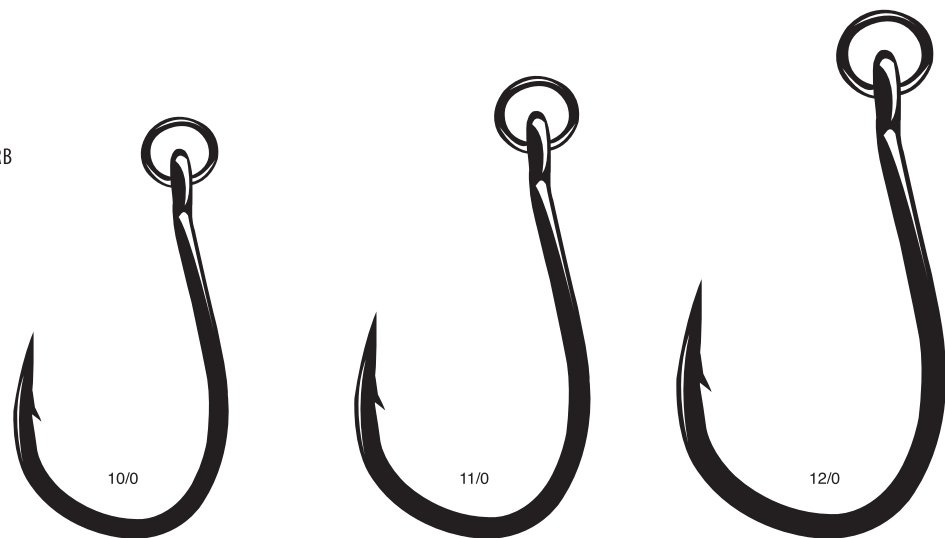

**Big Eye Circle TOURNAMENT LEGAL**

Our standard circle hook designed with a big eye for rigging heavier monos or dacrons. Also good for chunking for tuna and halibut.

SIZES		6/0	7/0	8/0	9/0	10/0	11/0	12/0
TIN	LS	12050(5)	12051(4)	12052(4)	12053(3)	12054(3)	12055(2)	12056(2)

-  EYE
-  FORGED
-  BARB
-  CIRCLE HOOK



### Tuned Tuna With Welded Eye

A great hook for Stiff Rigs and other trolling applications. The forged needle point helps ensure a solid hook set. New welded eye will not open or flex.

SIZES	8/0	9/0	10/0	11/0
TIN	LS 369018(3)	369019(3)	369020(2)	369021(2)



WELDED EYE



FORGED



BARB

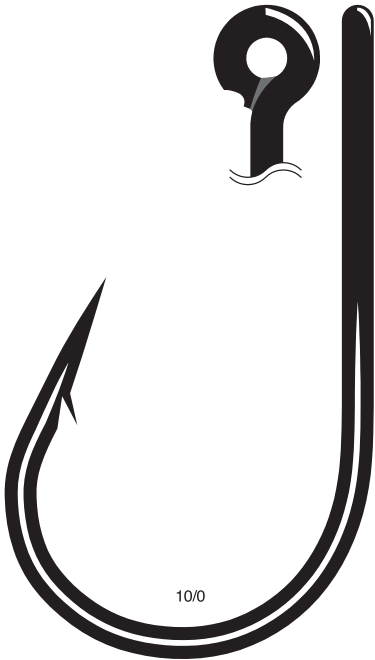
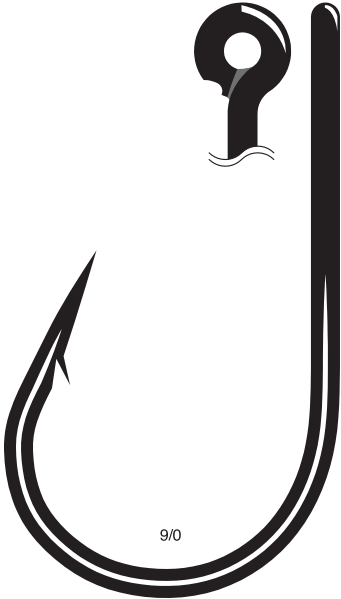
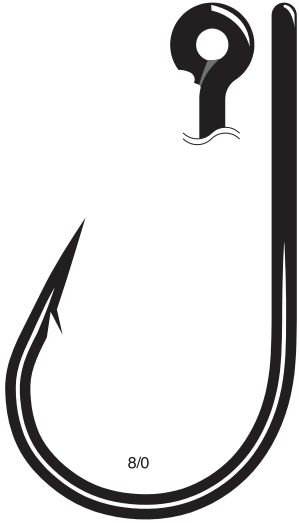





**ASSIST HOOKS**

*SpaMokatsu<sup>®</sup>*

### Double Assist 520

New vertical jigging techniques like “slow pitch” and “shore” jigging are gaining attention at a rapid rate. Many of the top anglers are using two assist hooks instead of one. Think about it, you’re doubling your odds of hooking short or soft biters. Gamakatsu’s Double Assist hooks are designed for fast and easy replacement on all types of butterfly, flat fall and “iron” jigs. The 6” super strong braided line loop can be adjusted to position each hook at the exact desired length, even or offset. Red heat shrink tubing on the hook shank is an added attractor and prevents chafing and bite-offs. And there’s no concern of knots coming undone. Hooks are forged and barbed. Available in 2/0 and 4/0 in packages of two.

SIZES		2/0	4/0
Tin	LS	368512(2)	368514(2)

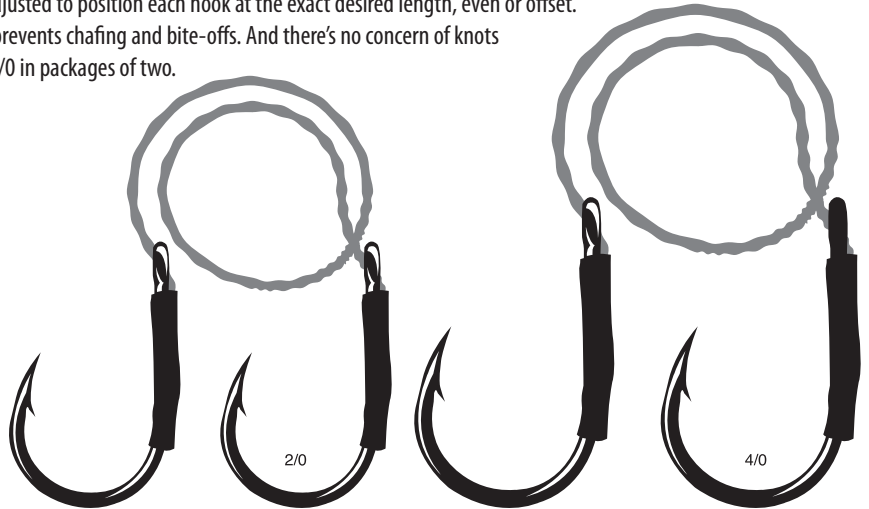
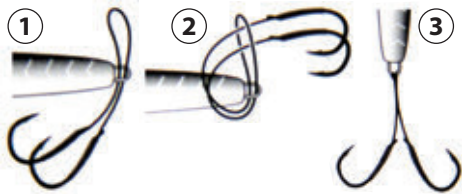

### Assist 560 Double

If fishing smaller profile jigs is your thing, check out the new Assist 560 Double. The smaller size minimizes fouling on light tackle and micro jigging applications. When the bass go deep, rig up your favorite jig with the 560 Double to up the catch rates with lethargic biters.

SIZES		2	1	1/0
Tin	LS	428509(2)	428510(2)	428511(2)

**NEW**



### Assist 540 Double Bait Plus

For light tackle, micro jigging in saltwater, and vertical jig fishing for bass, Gamakatsu developed the new Assist 540 Double Bait Plus. For added attraction, Gamakatsu utilized a fish skin dressing. Each flashes just like your favorite sabiki rig, drawing strikes from the most reluctant fish. The leader is shorter on one side to increase visibility of each hook for maximum drawing power. This also further decreases the possibility of tangles, even with the most vigorous jigging techniques.

SIZES		2	1	1/0
Tin	LS	427509(2)	427510(2)	427511(2)

**NEW**

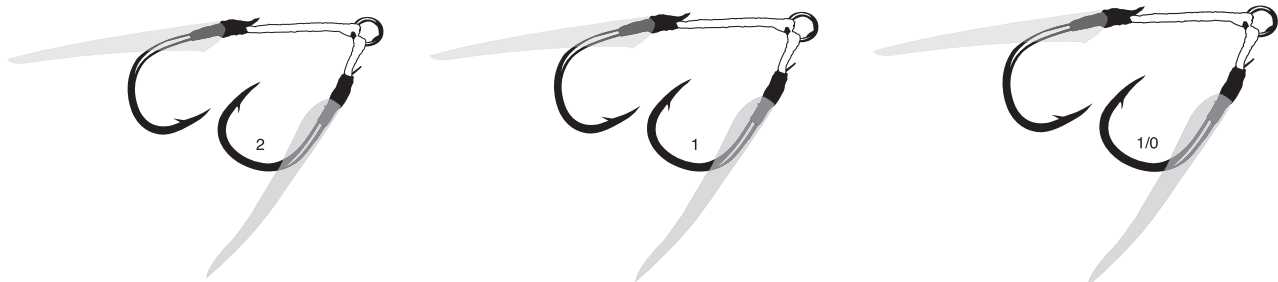



### Assist 700 Double NSC

If you're targeting larger fish, outfit your jigs with the Assist 700 Double. This rig doubles up on the standard slow pitch assist hooks to maximize hookups. Gamakatsu also applied their Nano Smooth Coat to the hooks; this super slick coating reduces resistance for deeper penetration.

SIZES		3/0	4/0	5/0
Nano Smooth Coat	LS	425213(2)	425214(2)	425215(2)

NEW



FORGED



BARB



### Assist 530 Double Short and Double Long

The new Assist 530 Double comes in both long and short versions to suit various jig lengths. The polyethylene braided line features a fluorocarbon core making it stiffer, which reduces tangles and promotes deeper penetration when a fish is hooked.

**NEW**

SIZES		1/0	2/0	3/0
Tin SHORT	LS	426511-S(2)	426512-S(2)	426513-S(2)



SIZES		1/0	2/0	3/0
Tin LONG	LS	426511-L(2)	426512-L(2)	426513-L(2)

**NEW**



### Assist 550 Short

The new Assist 550 Short provides the brawn needed to land pelagic gamefish on lures typically reserved for inshore species. Unlike the long metal shanks on treble hooks, the flexible leader doesn't act like a lever to give fish a mechanical advantage that can defeat even the stoutest hook hangers. You can replace light-wire trebles with the heavier duty Assist 550 Short and retain the action that makes your favorite plug so effective

SIZES		1	1/0	2/0
Tin	LS	429510(2)	429511(2)	429512(2)

**NEW**



### Assist 510

The Assist 510 features a curved point with an outbarb that will not nick the leader if it were to catch the line. No vertical jig should be fished without one. The super strong braided line loop easily attaches to any jig. One of the first Assist hooks introduced in this country and still the best designed.

SIZES		1/0	2/0	3/0	4/0
Tin	LS	219511(4)	219512(3)	219513(3)	219514(2)

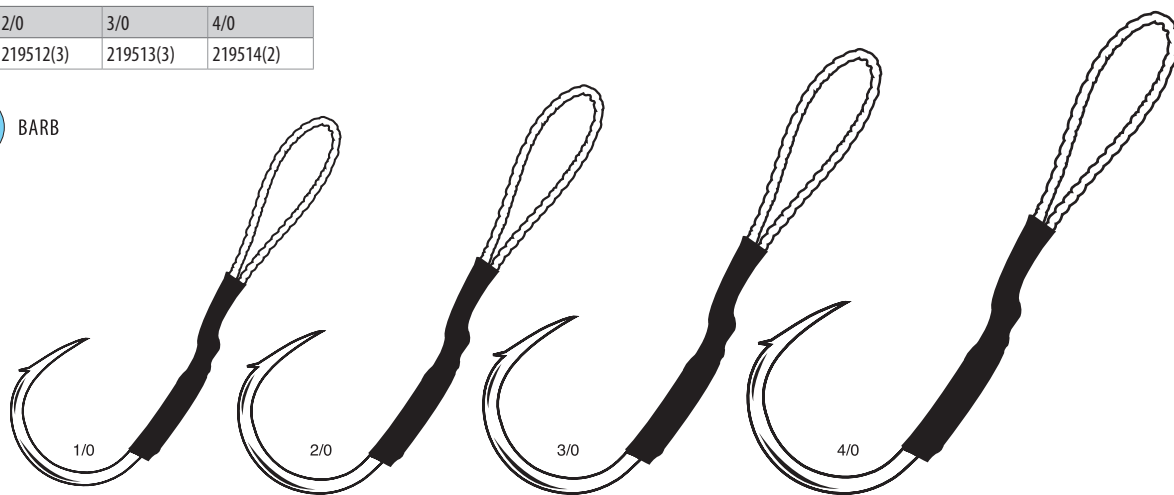

### Tuned Assist HD

This addition to our Assist hook line up is for deep jigging and big fish. These heavy duty assist hooks come in two sizes, 8/0 and 10/0 with 270lb braided line. Both feature a solid ring at the top for easy and secure attachment to the jig.

SIZES		8/0	10/0
Tin	LS	270518(1)	270520(1)



### Magnum Assist

Featuring a 200lb. braided line loop and our 4x Strong Octopus hook in 8/0 and 10/0, the Magnum Assist is perfect for larger Halibut jigs and deep drop speed jigs.

SIZES		8/0	10/0
NS Black	LS	256418(2)	256420(2)

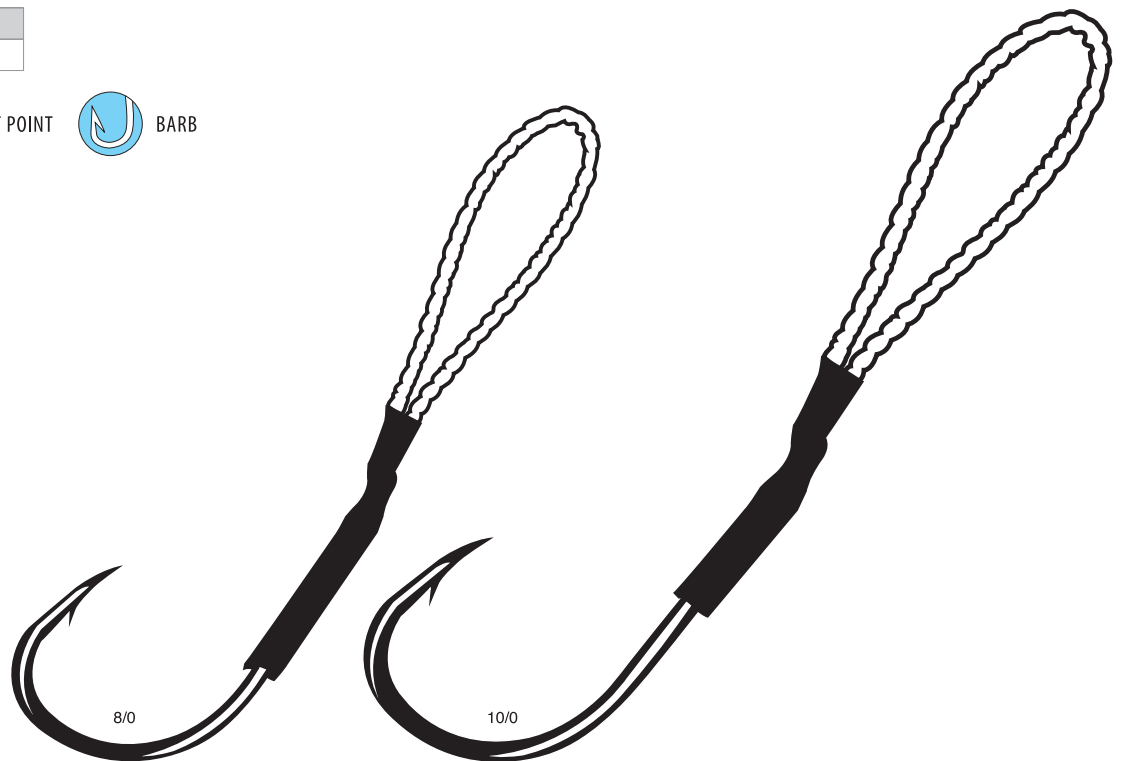

### Steel Assist with Magic Eye Swivel

Don't sacrifice your favorite jig to toothy fish like Wahoo and Mackerel. This Assist Hook features our Magic Eye Swivel for fast and easy attachment to the split ring on any jig. No pliers needed. 90lb. wire and a 4x Strong Straight Eye Octopus hook make this the ultimate big game, toothy fish Assist hook. Comes in a 3/0 short version and 5/0 long version for bigger jigs.

SIZES		3/0	5/0
NS Black	LS	269413(2)	269415(2)



### Assist 520, Ringed

In our relentless pursuit of perfection, and simplicity, we added a welded ring to our tournament-winning Assist 520 hook. The constant jigging motion is tough on looped monofilament, fluorocarbon, and braid. We took every nuance of uncertainty out of the technique by adding a welded ring. Not only is it nearly unbreakable, but the ring is also much faster and easier to connect to the jig eye using a split ring. *Rigged with 160 lb. (3/0, 4/0) and 220 lb. (5/0, 6/0) braided line.*

SIZES		3/0	4/0	5/0	6/0
Tin	LS	380513(2)	380514(2)	380515(2)	380516(2)



### Assist 620 Heavy Duty with Solid Ring

When you pursue the fish of a lifetime, chances are it's going to be really, really big; and have really, really, really sharp teeth. Take no chances! We call these "heavy-duty" Assist 620 hooks but they'll live up to tenacious-duty, gargantuan-duty or leviathan-duty equally as well. There's nothing stronger. One-piece solid rings make connections easy. Rigged with 270 lb. (5/0, 6/0) and 400 lb. (7/0, 8/0) braided line.

SIZES		5/0	6/0	7/0	8/0
Hypershield	LS	381515(1)	381516(1)	381517(1)	381518(1)



### Assist 720 Heavy Duty

Gamakatsu calls the Assist 720 hooks "heavy-duty," but that's an understatement with these bruisers! Gamakatsu's Assist 720 Heavy Duty is the ultimate in big game fish rigging and uses an ultra-strong, incredibly sharp Gamakatsu saltwater hook. A four-strand braid of abrasion-resistant polyethylene cord provides a whopping 880-lb combined test strength, while the ring makes it fast and easy to connect the assist hook to the jig eye using a split ring.

SIZES		10/0	11/0	12/0
Tin	LS	395520(1)	395521(1)	395522(1)





# RIGS AND SNELLS

*Spinnaker<sup>®</sup>*

### Drop Shot Rig

Each leader is 6' long with the hook tied in the middle using high quality clear monofilament.

Hook Size	4	2	1
Line Size	6	8	8
NS Black	LS 214408-06(3)	214409-08(3)	214410-08(3)

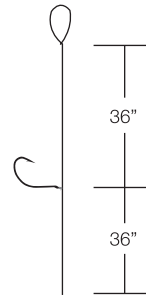

### Single Egg Hooks, Barb On Shank Snell

A premier bait hook for salmon eggs. Also great for floating dough baits.

SIZES		14	12	10	8	6
Red	LS	04303(10)	04304(10)	04305(10)	04306(10)	04307(10)
	SNL	04803(10)	04804(10)	04805(10)	04806(10)	04807(10)
Gold	LS	04203(10)	04204(10)	04205(10)	04206(10)	04207(10)
	SNL		04704(10)	04705(10)	04706(10)	04707(10)

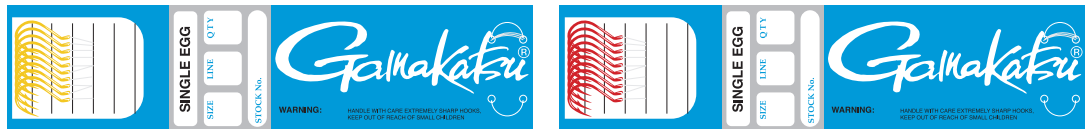
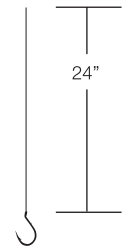

### Baitholder Snell

The ever popular Baitholder hook available in pre packed snells.

SIZES		14	12	10	8	6	4	2	1
Bronze	LS	05103(10)	05104(10)	05105(10)	05106(10)	05107(10)	05108(10)	05109(8)	05110(8)
	100	05103-100	05104-100	05105-100	05106-100	05107-100	05108-100	05109-100	05110-100
	SNL	05603(10)	05604(10)	05605(10)	05606(10)	05607(10)	05608(10)	05609(8)	05610(8)

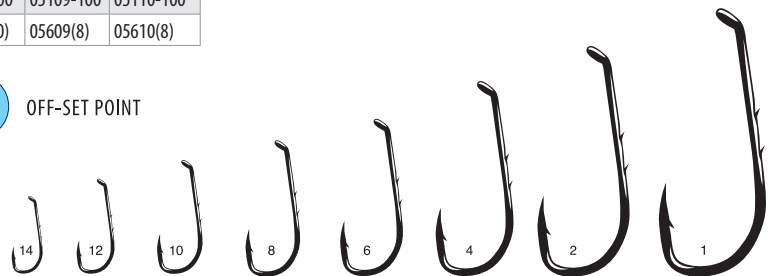



### Kokanee Two Hook Snell

The Kokanee Two Hook Snell rigs are geared for chasing kokanee and other freshwater species like walleye and trout. The fluorescent colored octopus hooks used on the rigs add an attractant and are pre-tied on 6' of premium Japanese monofilament. Anglers can use these pre-tied rigs straight out of the package and customize as desired with blades and beads or your favorite hoochie rig combinations.

Color	Hook Size	Line(LB)	Stock#
Red	4	12	415308(3)
F-Red	4	12	415608-FR(3)
Chartreuse	4	12	415608-C(3)
F-Pink	4	12	415608-P(3)
F-Orange	4	12	415608-OR(3)
F-Purple	4	12	415608-PU(3)
Ultra Violet	4	12	415608-UV(3)
Glow	4	12	415608-GL(3)



### EWG Walleye Snell

Red wide gap baitholder hook with 7 feet of premium clear 8 lb. monofilament. A molded glow bead secures and covers the snell for extra knot strength and added attraction. *Three rigs per pack.*

Hook Size	Line (LB)	Stock #
6	8	228307-08(3)
4	8	228308-08(3)
2	8	228309-08(3)



### Walleye Snell with Glowbead

Our Walleye Snell blends all of the premium components walleye anglers have come to expect from the premium hook leader. Featuring our sticky sharp Octopus hook in the most popular walleye catching colors. All tied on a 7' premium Japanese 8 lb. monofilament.

SIZES	6-08	4-08	2-08
F-Red	297607-FR-08(5)	297608-FR-08(5)	297609-FR-08(5)
Chartreuse	297607-C-08(5)	297608-C-08(5)	297609-C-08(5)
F-Pink	297607-P-08(5)	297608-P-08(5)	297609-P-08(5)
F-Orange	297607-OR-08(5)	297608-OR-08(5)	297609-OR-08(5)
Glow	297607-GL-08(5)	297608-GL-08(5)	297609-GL-08(5)
Red	297607-R-08(5)	297608-R-08(5)	297609-R-08(5)

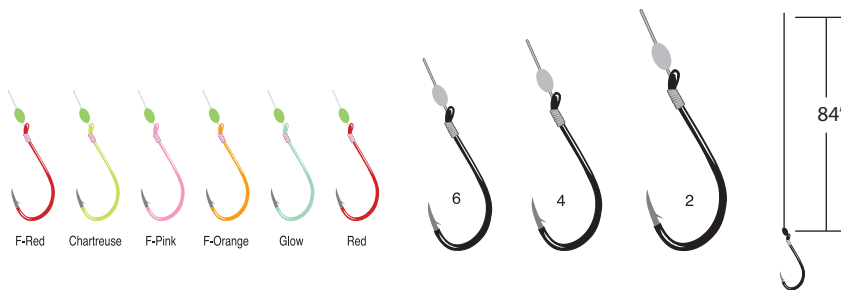

### Walleye LG Two Hook Rig

Two hook rig with adjustable top hook. Includes glowbead and tube.

Hook Size	6	4
Line Size	8	10
NS Black	LS 278307-08(10)	278308-10(10)

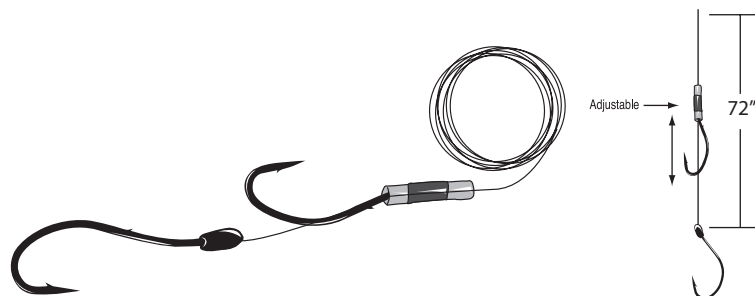

### Treble Stinger Rig, Wire Leader

It's widely known that trailing stinger rigs are the ticket for catching short-biting walleyes when jigging in cold water conditions. For years, seasoned anglers have painstakingly tied their own stinger rigs using premium Gamakatsu hooks. Now, we've done all the work for you. Gamakatsu Treble Hook Stinger Rigs are 100% ready to use and will outlast most others on the market. A coated steel wire is machine crimped and then dipped in a durable rubberized coating; allowing it to hang perfectly behind your jig or bait. And since they're connected to a premium Gamakatsu treble hook, they'll stay sticky sharp, fish after fish, after fish. Save time. Save money. Keep fishing longer with Gamakatsu Treble Hook Stinger Rigs.

Hook Size	12	10	8	6
NS Black	364404(3)	364405(3)	364406(3)	364407(3)



### Treble Stinger Rig, Fluorocarbon Leader

Bass and walleye will certainly grab hold of this stealthier version of our trailing stinger rig. We've pre-tied two inches of premium, 16-pound test fluorocarbon line instead of the coated steel wire. It works well with a wide variety of baits; however, it is most suited for trolling baits or any scenarios where fish are coming from behind and just striking the tail of the bait. Many anglers consider it mandatory for cold weather angling when fish are sluggish.

Hook Size	12	10	8
Red	378304(3)	378305(3)	378306(3)

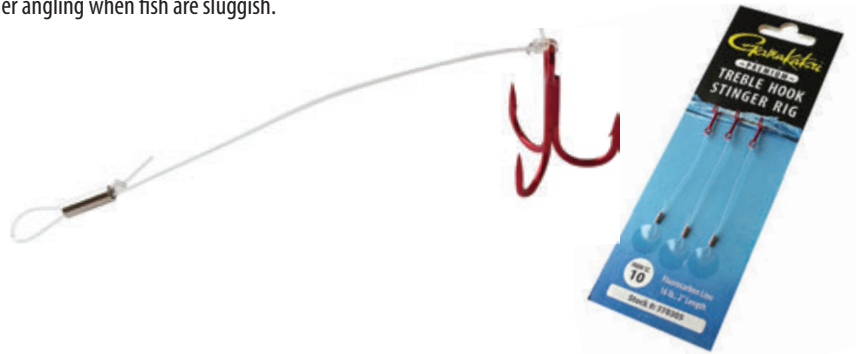

### Catfish Rig

The new Catfish Rigs are pre-tied and ready to fish. Both rigs are tied with 28" of 50 lb. premium Japanese monofilament and a SPRO Power Swivel.

SIZES	5/0	6/0	7/0	8/0
NS Black	299415-50(2)	299416-50(2)	299417-50(2)	299418-50(2)

- EYE
- FORGED
- BARB
- OFF-SET POINT

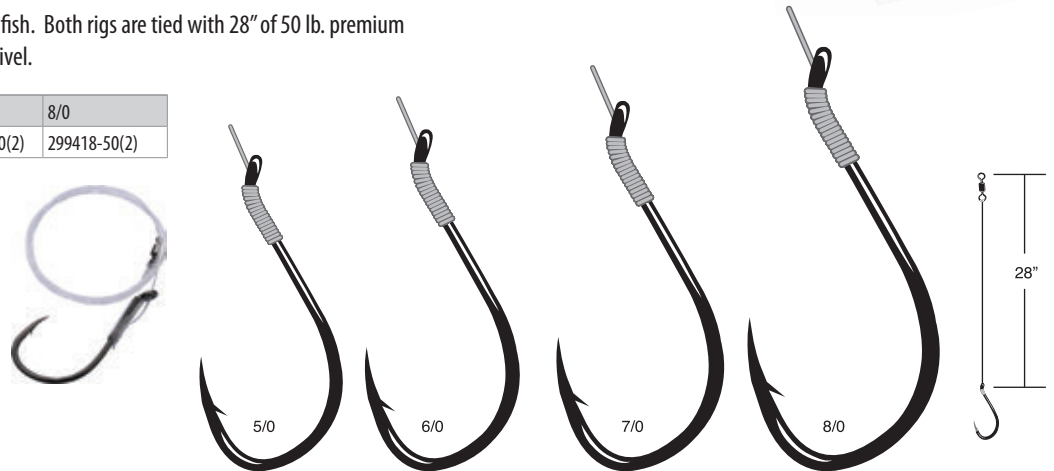

### Catfish Rig Circle

SIZES	5/0	6/0	7/0	8/0
NS Black	300415-50(2)	300416-50(2)	300417-50(2)	300418-50(2)

- EYE
- FORGED
- BARB
- OFF-SET POINT
- CIRCLE HOOK



**Mooching Rig (Slip Tie)** "3 individually packed leaders, 6 ft. rig."

Line (LB.)	Hook Size	Nickel	Red
20	2/0, 3/0	215023-20(3)	
20	3/0, 4/0	215034-20(3)	
25	2/0, 3/0	215023-25(3)	
25	3/0, 4/0	215034-25(3)	
30	3/0, 4/0	215034-30(3)	215334-30(3)
30	4/0, 5/0	215045-30(3)	215345-30(3)
30	5/0, 6/0	215056-30(3)	215356-30(3)
40	4/0, 5/0	215045-40(3)	215345-40(3)
40	5/0, 6/0	215056-40(3)	215356-40(3)

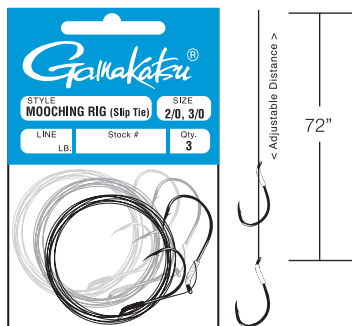

**Mooching Rig (Solid Tie)** "3 individually packed leaders, 6 ft. rig."

Line (LB.)	Hook Size	Stock#
15	2/0, 3/0	218023-15(3)
15	3/0, 4/0	218034-15(3)
20	2/0, 3/0	218023-20(3)
20	3/0, 4/0	218034-20(3)
25	2/0, 3/0	218023-25(3)
25	3/0, 4/0	218034-25(3)
30	3/0, 4/0	218034-30(3)
30	4/0, 5/0	218045-30(3)
30	5/0, 6/0	218056-30(3)
40	4/0, 5/0	218045-40(3)
40	5/0, 6/0	218056-40(3)



**Mooching Rig (Slip Tie) Barbless**

As barbless hook regulations expand, Gamakatsu has met the challenge with a better designed, sharper and stronger Barbless Octopus hook. Designed expressly for the application, Gamakatsu's Barbless Octopus hooks feature a slightly wider gap that provides better fish-holding benefits than traditional barbed Octopus hooks. These hooks comply with state regulations requiring "barbless hooks". Proven effective for a variety of species, Gamakatsu's Barbless hooks are now available in pre-tied mooching rigs. Tied on premium monofilament line with 6 foot leaders, Gamakatsu Barbless Mooching Rigs are packaged individually. "3 individually packed leaders, 6 ft. rig!"

Line (LB)	Hook Size	Nickel
25	3/0, 4/0	337034-25(3)
30	3/0, 4/0	337034-30(3)
30	4/0, 5/0	337045-30(3)
30	5/0, 6/0	337056-30(3)
40	4/0, 5/0	337045-40(3)
40	5/0, 6/0	337056-40(3)



**Mooching Rig Big River Bait (Slip Tie)**

The innovative design of the Big River Hook has gained popularity from coast to coast. It's unique acute bend is designed to hold fish tight once hooked. The rigs are slip tied to adjust to various sized baits and are pre-tied on 6' of premium Japanese monofilament. Anglers can use these pre-tied rigs straight out of the package for all mooching and trolling applications.

Line (LB.)	Hook Size	Stock#
30	3/0	414413-30(3)
30	4/0	414414-30(3)
40	4/0	414414-40(3)
40	5/0	414415-40(3)

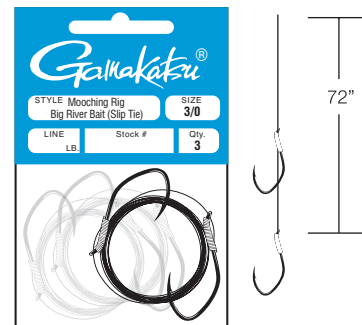

**Two Hook Bait Rig**

Two red hooks snelled about 1 inch apart to 6 ft piece of premium monofilament. Perfect for fishing salmon egg clusters. "3 rigs per pack!"

Hook Size	Line (LB)	Stock #
3/0, 4/0	25	233334-25(3)
3/0, 4/0	30	233334-30(3)
4/0, 5/0	30	233345-30(3)
5/0, 6/0	30	233356-30(3)
4/0, 5/0	40	233345-40(3)
5/0, 6/0	40	233356-40(3)
6/0, 7/0	40	233367-40(3)



**Salmon/Steelhead Leader**

"3 individually packed leaders, 4 ft rig!"

Line (LB.)	Hook Size	Stock#
8	2	217309-08(3)
8	1	217310-08(3)
10	1	217310-10(3)
10	1/0	217311-10(3)
12	1/0	217311-12(3)
12	2/0	217312-12(3)
15	2/0	217312-15(3)
20	3/0	217313-20(3)
30	3/0	217313-30(3)
30	4/0	217314-30(3)
40	4/0	217314-40(3)
30	5/0	217315-30(3)
40	5/0	217315-40(3)



### Sockeye Rig

When the sockeye start running, you better be ready to get in the game fast. With our Sockeye Rigs, you are geared up in seconds. Tied on 30 lbs. leaders with sticky sharp 3/0 red Octopus hooks, available in 2 colors - chartreuse or flame red. Nothing is easier or faster, except maybe your limit. We've done the work for you to maximize your time on the water.

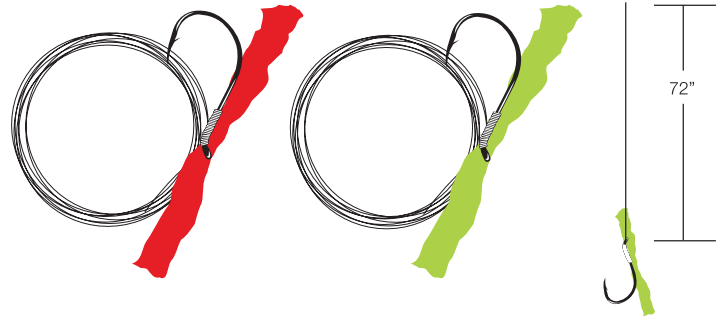

Hook Size	Line (lb)	Stock #
3/0 Chartreuse	30	372313-C-30(3)
3/0 Flame Red	30	372313-FR-30(3)

### French Hook Snell

The Gamakatsu French Hook Snell comes in red or bronze color, to add a little bit of extra attraction to any bait. Each of the five hook sizes are pre-tied to 24 inches of high-quality Japanese monofilament line of a suitable pound test for the hook size. As anglers would expect, these are rigged with premium Gamakatsu hooks. The Gamakatsu French Snell Rig will work for anything from trout to walleye, with a variety of live or artificial baits.

SIZES		10 (6 lb)	8 (6 lb)	6 (8 lb)	4 (8 lb)	2 (10 lb)
Bronze	SNL	413605 (10)	413606 (10)	413607 (10)	413608 (10)	413609 (10)
Red	SNL	413805 (10)	413806 (10)	413807 (10)	413808 (10)	413809 (10)



### Top And Bottom Rig

Designed primarily for bottom fishing, this rig uses two size 2 NS Black Baitholder hooks attached to a 40lb. leader so they stick out about 4" from the main line and are spaced about 10" apart. It includes a barrel swivel at the top of the rig and a cross lock for easy weight attachment at the bottom.

Hook Size	Line (lb)	Stock #
2	30	238409(1)

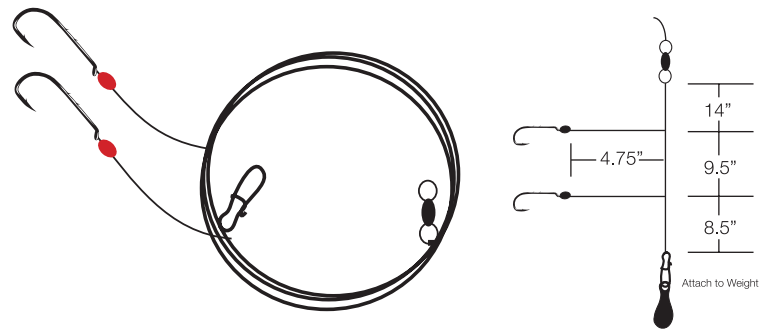

### Fluke Rig With Teaser

Two different color combination fluke rigs available in a size 2/0 hooks with a 40 lb. leader. The Fluke Rigs feature a spinner blade and a teaser made with synthetic hair material that is more tooth resistant and durable in saltwater. The teasers are in either red and white or a chartreuse and white combination with either red or green beads to match. They also feature a 3 way swivel with a crosslock to attach the weight.

Hook Size	Line (lb)	Stock #
2/0 White/Red	40	239412-RW(1)
2/0 White/Chartreuse	40	239412-CW(1)

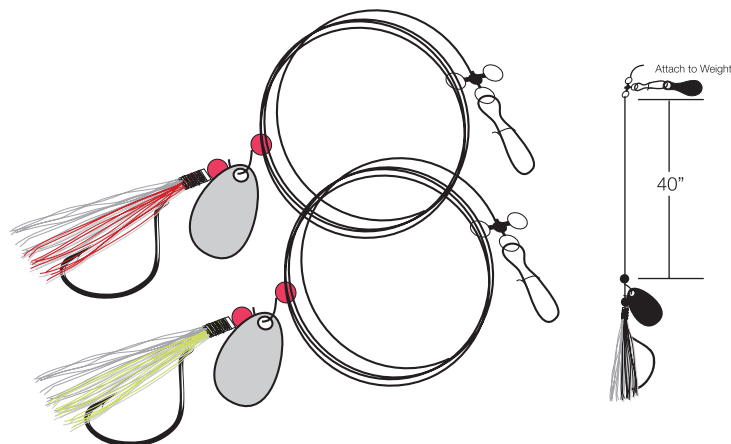

### Striper Rig

Striper fishermen are a demanding group. Striper anglers have asked for a dependable pre-tied rig to meet their needs and Gamakatsu has answered. The Striper Rig features a proven Octopus hook, tied on 28" of premium 40 lb. monofilament. The rig also includes a high quality #4 Gamakatsu barrel swivel rated at 130 lb. This rig is sure to give any striped fisherman the confidence they need to catch that trophy of a lifetime.

Hook Sizes	4/0	5/0	6/0	7/0	8/0
NS Black	305414-40(2)	305415-40(2)	305416-40(2)	305417-40(2)	305418-40(2)



### Striper Rig With Sliding Sinker Lock

This rig features a 5/0 NS Black Baitholder hook snelled to a 80 lb. clear leader with a 100 lb. barrel swivel and a sliding sinker lock that goes on the main line above the swivel.

Hook Size	Line (lb)	Stock #
5/0	80	241415(2)

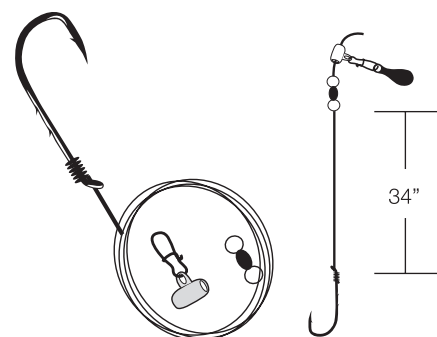

### Jigging Rig, Gold

SIZES		8	6	4
Fish Skin	Rig	64306(1)	64307(1)	64308(1)
Glow	Rig	62306-G(1)	62307-G(1)	62308-G(1)

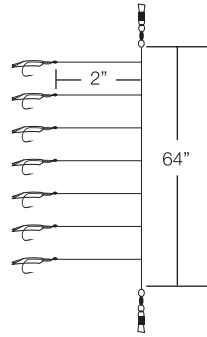

### Jigging Rig, Nickel, Smelt/Herring

SIZES		5	4	4
Fish Skin	Rig	58108(1)	58109(1)	64308(1)

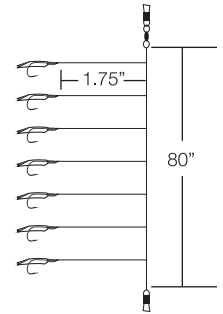
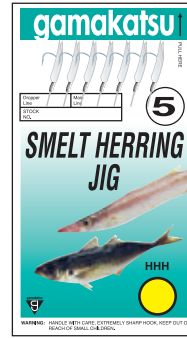

### Jigging Rig, Special Assorted Hook

SIZES		5
Fish Skin	Rig	207307 (Gold, Nickel, Red, Green)(1)

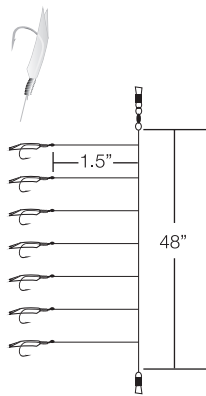

### Jigging Rig, Special Weighted Assorted Hook

SIZES		5
Fish Skin	Rig	206307 (Gold, Nickel)(1)

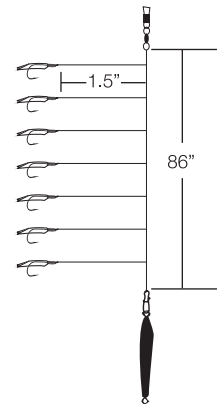



**FLY HOOKS**

*Speckkatsu<sup>®</sup>*

## FLY HOOK REPRESENTATIVES

**Skip Gibson**

5145 Bigelow Rd, Bozeman, MT. 59718  
 Ph: 406-556-0822 Fx: 406-556-0823  
 skipflyh20@aol.com  
**ID, WY, MT**

**Bob Lamson**

152 Gates Rd, Lebanon, CT. 06249  
 Ph: 860-423-2911 Fx: 973-423-4500  
 flyfishrep@earthlink.net  
**ME, VT, MA, RI, CT, NH, NY (North of Route 84)**

**Ken Lagerveld**

175 Tamboer Drive  
 North Haledon, NJ. 07508  
 Ph: 973-216-8979 Fx: 860-423-7825  
 flyrodrep@aol.com  
**NJ, Metro NY (NYC, Long Island and area north of NYC to Route 84) PA, Maryland, Delaware, Virginia**

**Dan Marshall - Northwest Outdoor Sales**

3409 140th St Ct NW, Gig Harbor, WA  
 Ph: 800-445-8150 Fx: 253-445-8153  
 flymandan1@yahoo.com  
**OR, WA, AK**

**Marty Holding - L H French Co**

Ph: 801-302-8448 Cl: 801-580-7290  
 Fx: 801-302-8449 mholding@lhfrench.com  
**UT, MT, Southern Idaho**

**Len Vinci - L H French Co**

Ph: 916-543-8690 Cl: 916-718-3926  
 Fx: 916-543-8698 lvinci@lhfrench.com  
**Northern CA, Northern NV**

**Guy Tillotson - Grand Slam Group LLC**

1580 Eileen PL, Englewood, FL 34223  
 Cl: 904-347-3138  
 guy@grandslamgroup.com  
**FL, GA, NC, SC**

**Tom Jindra - Grand Slam Group LLC**

2501 Prancer St, New Orleans, LA 70131  
 Ph: 504-392-7511 Fx: 504-324-1889  
 tomjindra@cox.net | www.tomjindra.com  
**AL, AR, LA, MS, TN, TX**

**Tom Timmerberg**

6604 Devonshire Ave 1 So, St Louis, MO 63109  
 Ph: 314-255-3692 tomtimmerberg@hotmail.com  
**MO, KS, IL, MN, WI, IA**

**Ben Hunting**

6777 Old Darby Trail NE, Ada, MI 49301  
 Ph: 616-901-1926 benhunting@comcast.net  
**OH, MI, IN, KY**

**Gamakatsu** has been making premium quality hooks since 1955. Every hook is made using Gamakatsu's own high quality, high carbon steel and is meticulously crafted to the highest of standards. Unlike other hook manufacturers, Gamakatsu hooks are made in their own facility which is one of the most technologically advanced in the world and their consistency is unmatched. What you'll find in this catalog are super sharp, super strong fly hooks made for the serious fly tyer and fly angler who will settle for nothing but the best. While an investment in a good fly rod, fly reel, fly line and the knowledge on how to properly use them can enhance the fly fishing experience, the hook is the one piece of equipment at the end of it all that has to hang on to the object of pursuit. Don't settle for anything less than Gamakatsu quality.

**The Executive Series - The most advanced fly hook available.**

Executive Series fly hooks offer some very unique designs like the R10B Retainer Bend and the C13U Keel Balance. Hooks like the S10 series of hooks have beak points that allow for effortless penetration, especially with light tippets and a slightly wider gap. They also have a shank length just a little longer than standard dry fly hooks. While the R10B and C13U are matte black, the B10S Stinger hooks and the rest of the Executive series have a beautiful NS Black finish that not only looks good, but is also very corrosion resistant. There's no other hook series like it.

- Corrosion Resistant NS Black Finish
- Beak Points
- Unique Designs

**Traditional Series - A necessity for patterns of time honored tradition.**

The Traditional Series hooks are mostly all Bronze finished, have needle points, and are designed to match up in style and size with other popular hook brands. The key difference being the quality of the steel used in them and the sharpness of the hook. The Traditional Series hooks also feature the traditional Salmon/Steelhead tapered loop up eye hooks, but in non-traditional finishes like Red in addition to the traditional NS Black finish. The styles all match, but the quality is unmatched.

- Traditional Sizing
- Traditional Bronze Finish
- Gamakatsu Strength and Sharpness

**Saltwater Series - The most complete line of saltwater fly hooks.**

By far and away the finest selection of Saltwater fly hooks available. Multiple styles featuring our most popular SC15 and other hooks ranging in sizes from 18 to 10/0. The SC15 is used for many different patterns but is also a great hook for tube flies. The SP11-3L3H makes a great popper hook. There's a hook style for every saltwater application imaginable. Every Saltwater Series fly hook is made from the highest quality high carbon steel and has a durable tin plating or NS Black finish for corrosion resistance. Because of the steel used, even the 3x strong hooks are surprisingly light for their size and their strength is unparalleled. These hooks will hold a point much better than stainless steel hooks and are sticky sharp right out of the bag. No sharpening is ever needed before fishing with a Gamakatsu hook and because they're not stainless, they will eventually corrode out of a fish's mouth if the hook is taken deep and cannot be removed. From the flats to blue water, there's no hook selection better than this.

- Corrosion Resistant Tin Finish
- Multiple styles to choose from
- Innovative designs





**S10 •**

**Standard Down Eye**

Multi-use Dries and Wets  
25 pk & 100 pk. Color: NSB

6		08407-25 08407-100
8		08406-25 08406-100
10		08405-25 08405-100
12		08404-25 08404-100
14		08403-25 08403-100
16		08402-25 08402-100
18		08401-25 08401-100

**R17-B •**

**Retainer Bend Barbless 3x Fine**

Multi-use. Unique Bend holds fish firm. Nano Smooth Coat  
20 pk. Color:

NANO SMOOTH COAT

12		335204-20
14		335203-20
16		335202-20
18		335201-20
20		335200-20
22		335299-20
24		335298-20

**R10-B •**

**Retainer Bend Barbless**

Multi-use. Unique Bend holds fish firm  
25 pk & 100 pk. Color: MB

10		85405-25 85405-100
12		85404-25 85404-100
14		85403-25 85403-100
16		85402-25 85402-100
18		85401-25 85401-100
20		85400-25 85400-100

**S10-B •**

**Standard Down Eye Barbless**

Multi-use Dries and Wets  
25 pk & 100 pk. Color: NSB

6		41407-25 41407-100
8		41406-25 41406-100
10		41405-25 41405-100
12		41404-25 41404-100
14		41403-25 41403-100
16		41402-25 41402-100

**R18-B •**

**Barbless 2x Strong**

Multi-use. Unique Bend holds fish firm. Nano Smooth Coat  
20 pk. Color:

NANO SMOOTH COAT

8		346206-20
10		346205-20
12		346204-20
14		346203-20
16		346202-20

**S10S •**

**Straight Eye Dry**

Multi-use and Specialty Dry Flies  
25 pk & 100 pk. Color: NSB

4		33408-25 33408-100
12		33404-25 33404-100
14		33403-25 33403-100

**R19-B •**

**Retainer Bend Barbless**

Multi-use. Unique Bend holds fish firm. Nano Smooth Coat  
20 pk. Color:

NANO SMOOTH COAT

10		373205-20
12		373204-20
14		373203-20
16		373202-20
18		373201-20

This new hook utilizes a customized bend that holds fish tight and offers a revolutionary advancement in true barbless hook design. A nano smooth coating and razor-sharp hook point reduce resistance, creating more penetrating power and a seriously effective hookset.

**Jig Nymph • J20**

Beads and Slotted Beads  
20 pk. Color: MB

10		354405-20
12		354404-20
14		354403-20
16		354402-20

**Jig Nymph • J20-B**

**Barbless**

Beads and Slotted Beads  
20 pk. Color: MB

10		355405-20
12		355404-20
14		355403-20
16		355402-20

**Numbering System**

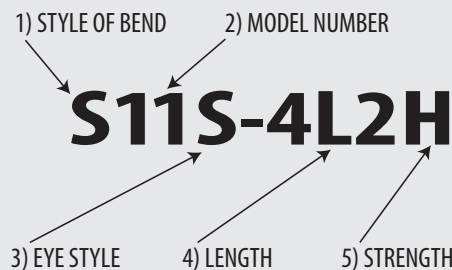

**1) STYLE OF BEND**

(S) Sproat (L) Limerick (P) Perfect (T) Tapered (C) Curve  
(R) Retainer (B) Bend

**2) MODEL NUMBER**

(S) Straight (U) Up

**4) LENGTH**

(L) Long (S) Short

**5) STRENGTH**

(F) Fine (H) Hard/Strong

**Examples:**

2H = 2x Hard/Strong  
1F = 1x Fine

S11S-4L2H = Sproat Bend, Model 11,  
Straight Eye, 4X Long and 2X Strong

**B10S •**

**Stinger, 1x Strong Forged**

Hair Bugs, Streamers

25 pk & 100 pk: Color: NSB

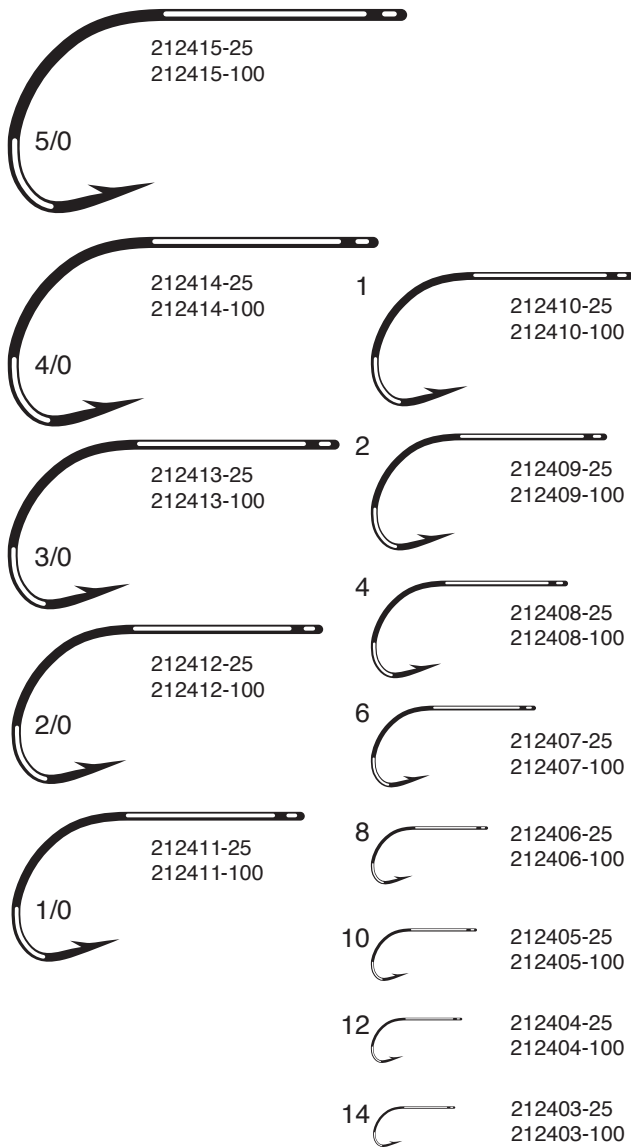

**B10S Stinger •**

**Tournament Grade Wire,**

**Nano Smooth Coat**

Hair Bugs, Streamers • 20 pk:



Tournament Grade Wire

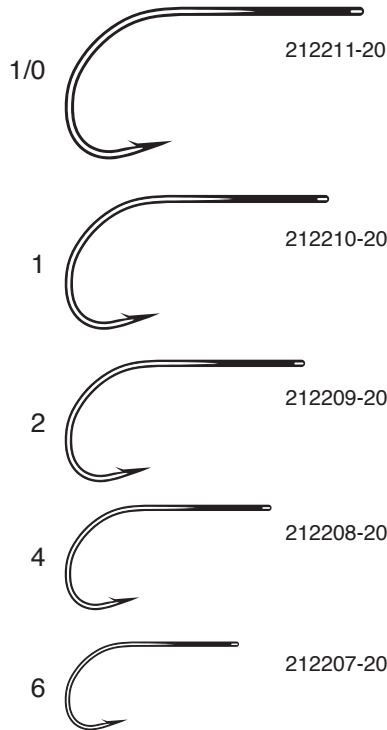

**C14S •**

**Glo Bug**

Glo Bugs and other Egg Patterns

25 pk & 100 pk: Color: NSB

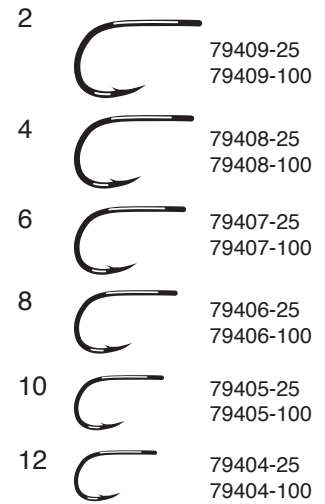

**C16-B •**

**Crippled Emerger**

Emerger Patterns, Multi-use

25 pk & 100 pk: Color: NSB

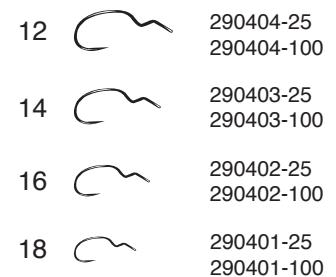

**B10S Stinger • Fluorescent**

**Stinger, 1x Strong Forged**

Hair Bugs, Streamers

The B10S Stinger is one of Gamakatsu's most popular fly hooks and it just got better with the addition of fluorescent colors. The fluorescent UV coating provides a subtle glow which has been scientifically proven to attract fish and provides a focal point when they decide to eat. The B10S Stinger is beneficial in both freshwater and saltwater fly patterns and the 1X strong wire gives you that extra confidence when a trophy fish is on the line.



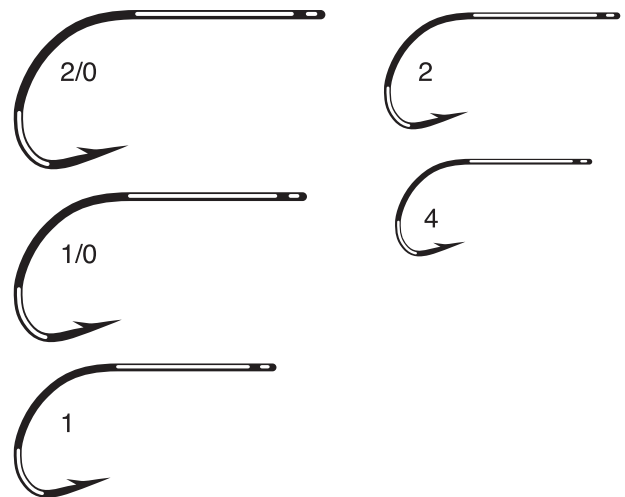



SIZES	4	2	1	1/0	2/0
Ultra Violet	212408-UV(20)	212409-UV(20)	212410-UV(20)	212411-UV(20)	212412-UV(20)
F-Red	212408-FR(20)	212409-FR(20)	212410-FR(20)	212411-FR(20)	212412-FR(20)
F-Pink	212408-P(20)	212409-P(20)	212410-P(20)	212411-P(20)	212412-P(20)
Chartreuse	212408-C(20)	212409-C(20)	212410-C(20)	212411-C(20)	212412-C(20)



**C13U •**

**Keel Balance**





Multi-use and Keel Style dry Flies  
25 pk & 100 pk: Color: MB

- 10  90405-25  
90405-100
- 12  90404-25  
90404-100
- 14  90403-25  
90403-100
- 16  90402-25  
90402-100
- 18  90401-25  
90401-100
- 20  90400-25  
90400-100

**C15-BV •**

**Vertical Eye, Emerger,  
Barbless**



25 pk & 100 pk: Color: NSB

- 12  267404-25  
267404-100
- 14  267403-25  
267403-100
- 16  267402-25  
267402-100
- 18  267401-25  
267401-100

**C12-BM •**

**Barbless Midge, Large Eye**

25 pk & 100 pk: Color: NSB

- 26  277497-25  
277497-100
- 28  277496-25  
277496-100
- 30  277495-25  
277495-100

**S11-4L2H •**

**Streamer, 4x long, 2x strong**



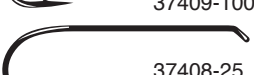
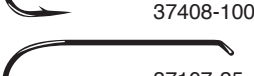
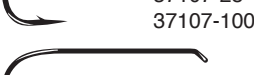
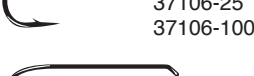
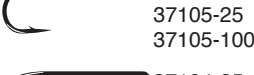

Streamers and Large Wet Flies  
25 pk & 100 pk: Color: BR, NSB

- 2  37409-25  
37409-100
- 4  37408-25  
37408-100
- 6  37107-25  
37107-100
- 8  37106-25  
37106-100
- 10  37105-25  
37105-100
- 12  37104-25  
37104-100

**C12 •**

**Down Eye Scud**





Scud and Shrimp Patterns  
25 pk & 100 pk: Color: BR

- 10  87105-25  
87105-100
- 12  87104-25  
87104-100
- 14  87103-25  
87103-100
- 16  87102-25  
87102-100

**S11S-4L2H •**

**Straight Eye Streamer,**







4x long, 2x strong  
Woolly Buggers, Streamers and Large  
Wet Flies  
25 pk & 100 pk: Color: BR

- 6  32107-25  
32107-100
- 8  32106-25  
32106-100
- 10  32105-25  
32105-100
- 12  32104-25  
32104-100

**C12U •**

**Caddis**





Caddis and other Pupae Patterns  
25 pk & 100 pk: Color: BR

- 6  34107-25  
34107-100
- 8  34106-25  
34106-100
- 10  34105-25  
34105-100
- 12  34104-25  
34104-100
- 14  34103-25  
34103-100
- 16  34102-25  
34102-100

**L11S-3H •**

**Salmon & Steelhead 3x strong**





Heavy Salmon/Steelhead Flies  
and tube fly trailer. .  
20 pk: Color: NSB

- 2  13109-20
- 4  13108-20
- 6  13107-20
- 8  13106-20
- 10  13105-20

**C12-B •**

**Down Eye Scud**

Barbless, Red  
Scud and Shrimp patterns  
25 pk & 100 pk: Color: RD

- 12  268304-25  
268304-100
- 14  268303-25  
268303-100
- 16  268302-25  
268302-100
- 18  268301-25  
268301-100
- 20  268300-25  
268300-100

**T10-3H •**

Salmon Dry 1x Fine  
Salmon/Steelhead Dry Flies  
20 pk: Color: NSB

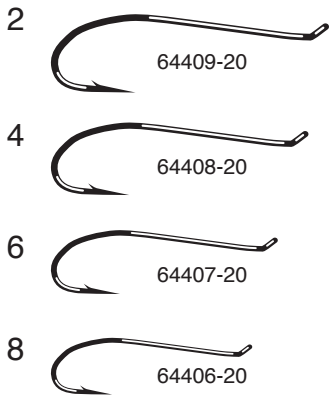

**T10-6H •**

Salmon Tapered Loop Up-eye  
Salmon/Steelhead Wet Flies

10 pk: Color: NSB, RD      20 pk: Colors: NSB, RD  
Sizes: 1/0, 2/0      Sizes: 8 - 1

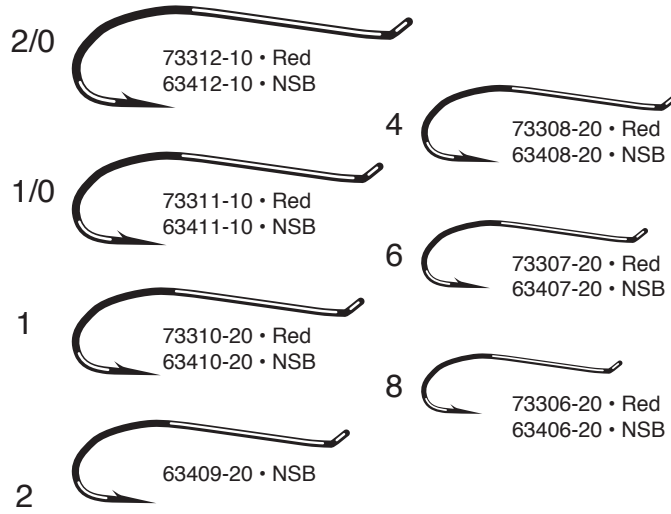

**Russian River Fly**

Streamers  
Meets Russian River Regulations  
25 pk, 100 pk: Color: BR, RD

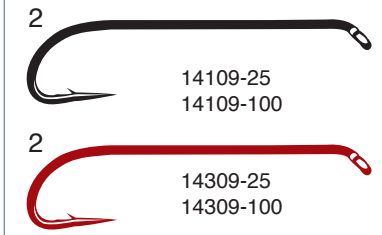

**Double 22 Medium Shank**

Medium shank length designed with a straight eye manufactured in durable Nickel Silver Black.

SIZES		10	8
NS Black	LS	302405(12)	302406(12)

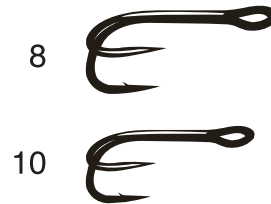

FLY HOOKS - SALTWATER SERIES

**SL12-S 1X Short •**

Big Game • Wide Gap

Tarpon and Billfish Flies • Loose pk, 100 pk: Color: NSB

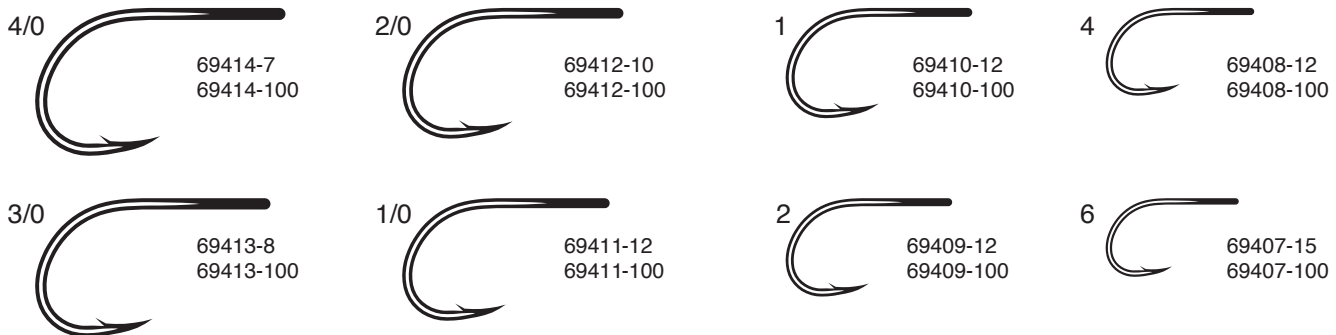

**SL12S •**

**Big Game • Wide Gap**

Tarpon and Billfish Flies

Loose: Color: TN Sizes: 2, 1/0, 2/0, 4/0, 6/0, 8/0, 10/0

50 pk: Color: TN Sizes: 8/0, 10/0

100 pk: Color: TN Sizes: 2, 1/0, 2/0, 4/0, 6/0

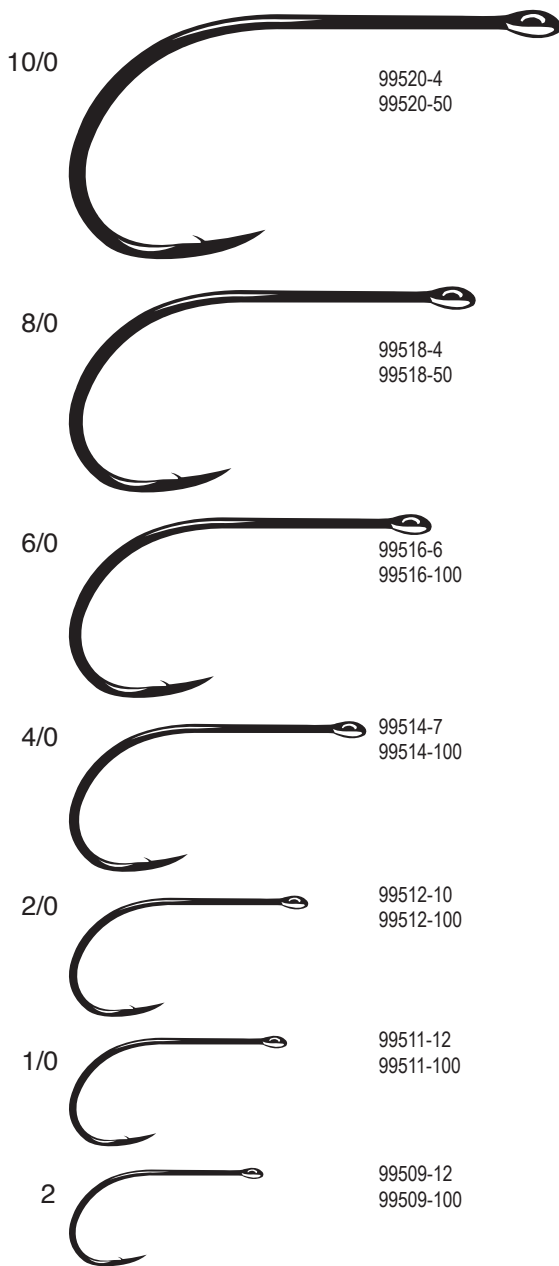

**SL45 •**

**Bonefish**

Small Bonefish Flies

Loose: Color: MB Sizes: 10-4



**SC15-2H •**

**Wide Gap • 2x Strong**

Tarpon and Billfish Flies

Loose: Color: TN Sizes: 3/0 - 5/0

100 pk: Color: TN Sizes: 3/0 - 5/0

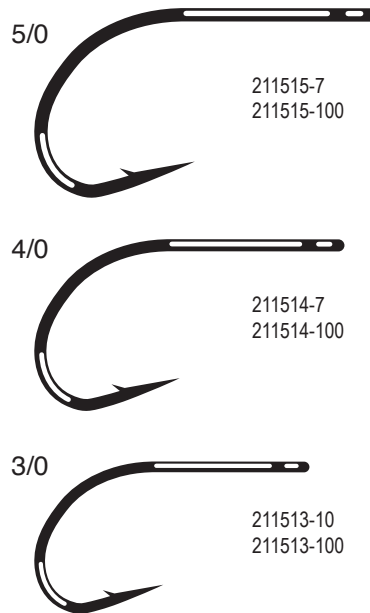

**SL11-3H •**

**3x strong**

Standard Bonefish/Tarpon Flies and Billfish Flies

Loose: Color: TN Sizes: 8 - 4/0

100 pk: Color: TN Sizes: 8 - 4/0

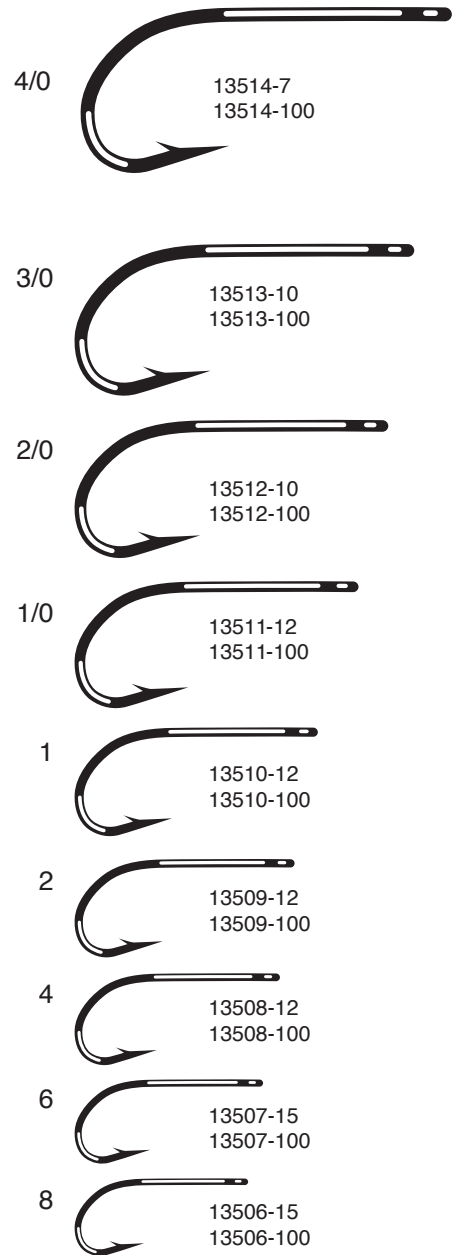

**SS15 •**

**Standard**

Standard Inshore Flies and Surface Patterns

Loose: Color: TN Sizes: 10 - 2/0  
100 pk: Color: TN Sizes: 10 - 2/0

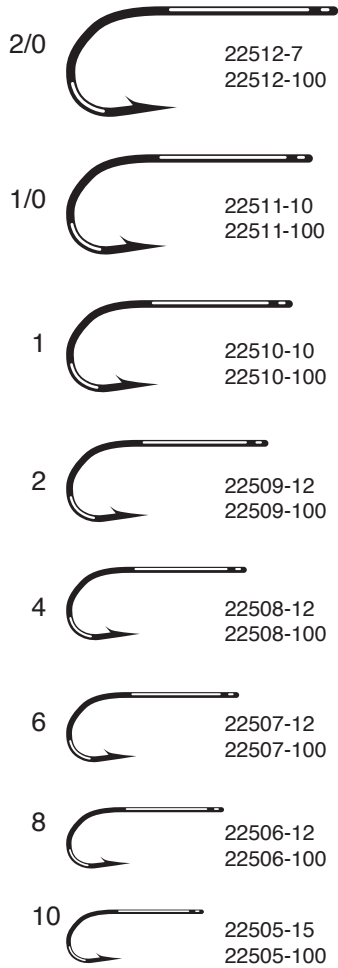

**SP11-3L3H •**

**Perfect Bend**

Longer Saltwater Streamers, Poppers and Billfish Flies

Loose: Color: TN Sizes: 8 - 3/0  
100 pk: Color: TN Sizes: 8 - 3/0

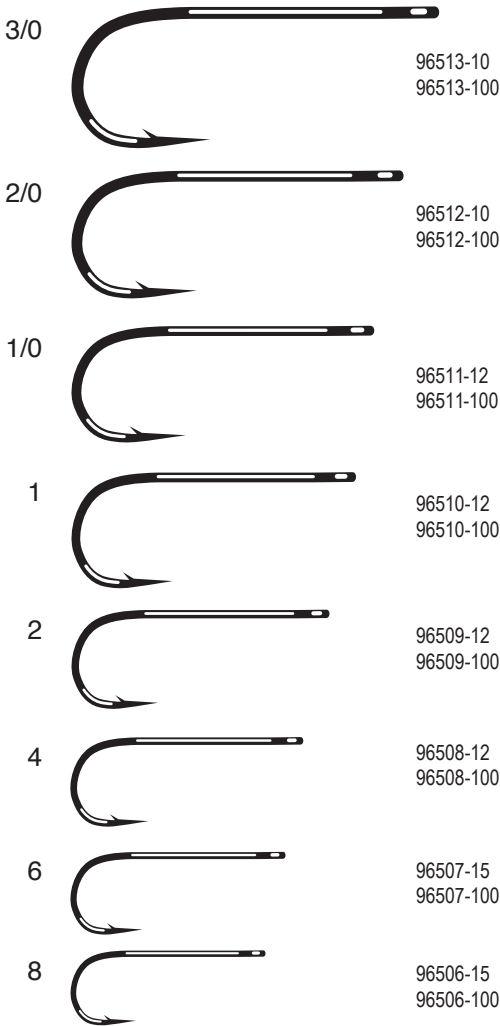

**SC15 •**

**Wide Gap**

Shrimp, Small Tarpon Flies, Tube Fly Trailer

Loose: Color: TN Sizes: 8 - 3/0  
100 pk: Color: TN Sizes: 8 - 3/0

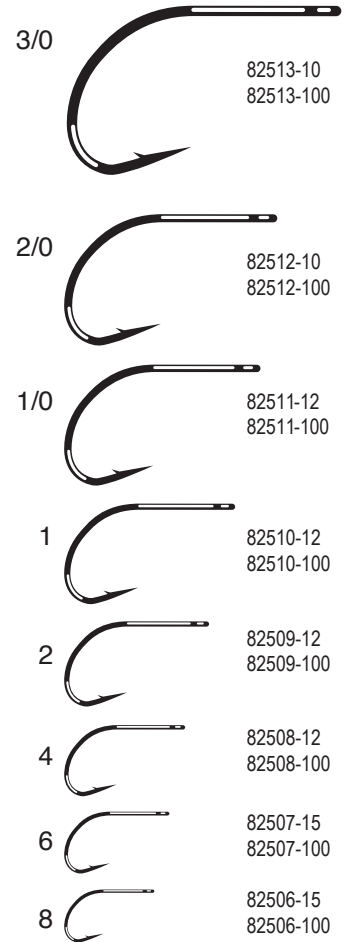









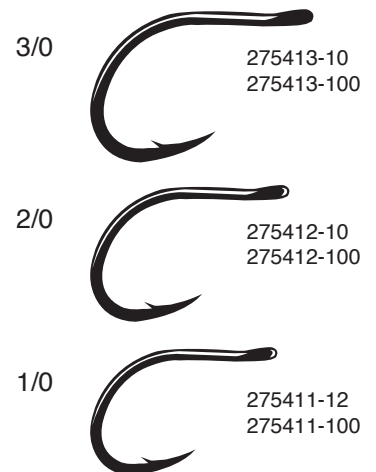



























**SC17 •**

**Tarpon Fly**

Tarpon Flies

Loose pk & 100 pk: Color: NB



DESCRIPTION	GAMAKATSU Model #	MUSTAD	TIEMCO	DAIICHI	DAI-RIKI
 Standard Down Eye	S10	94840	5210	1170	300
 Standard Down Eye Barbless	S10B	94845	900BL	1190	
 Straight Eye Dry	S10S	94859	101	1110	310
 Retainer Bend Barbless	R10-B				
 Retainer Bend Barbless 3X Fine	R17B				
 Retainer Bend Barbless 2X Strong	R18B				
 Retainer Bend Barbless	R19-B				
 Stinger 1x Strong Forged	B10S	37187		2720	
 TGW / Nano Smooth	B10S				
 Stinger Fluorescent	B10S				
 Glo Bug	C14S	9479	105	1510	
 Keel Balance	C13U				
 Vertical Eye Emerger Barbless	C15-BV				
 Emerger Patterns Multi Use	C16-B				
 Barbless Midge Large Eye	C12-BM				
 Jig Nymph Barbed	J-20				
 Jig Nymph Barbless	J-20		C403BL		
 Salmon Steelhead 3x Strong	L11S-3H	3406	800	2451	
 Streamer 4x Long 2x Strong	S11-4L2H	79580	9395	2220	700
 Streamer 4x Long 2x Strong SE	S11S-4L2H	9674	9395	2220	
 Scud	C12	80250	2487	1130	
 Caddis	C12U	37160	205BL	1140	
 Scud, Barbless	C12-B		2487BL		
 Salmon Steelhead Dry 1x Fine	T10-3H	90240	7989	2421	
 Salmon Steelhead Wet	T10-6H	36890	7999	2161	899
 Russian River Fly	Russian River	36717			
 Double Hook Medium Shank	Double 22				
 Saltwater Big Game	SL12S				
 Bonefish	SL45				
 Saltwater 3x Strong	SL11-3H				
 Standard Saltwater	SS15	34007	8115	2546	930
 Saltwater Perfect Bend	SP11-3L3H				
 Saltwater Wide Gap	SC15				
 Saltwater Wide Gap 2x Strong	SC15-2H				
 Tarpon Fly	SC17				
 Saltwater	SL12-S 1X Short				







**TERMINAL**

*SpaMakatsu<sup>®</sup>*

### Silicone Stopper

The premium quality Silicone Stopper aids in keeping a trailer hook from getting tangled in the skirt when fishing spinnerbaits and buzzbaits. It prevents the hook from sliding up and down the hook shank, and ensures that when bass bite, they get hooked. Although designed for spinnerbaits and buzzbaits, the Silicone Stopper can be used with Texas-rigged worms, too. The only limit to their application is your imagination.

SIZES	Medium	Large	Extra Large	X Extra Large
Black	393000-M(12)	393000-L(12)	393000-XL(10)	393000-XXL(10)



### Spring Lock

The new Gamakatsu Spring Lock makes rigging plastics easy with the stress relieved stainless steel center point. The center point makes it easy to find the exact midpoint of the bait. It's then just a simple matter of twisting the plastic on to the Spring Lock where it stays fastened and secure. Lures stay centered and run straight and true.

SIZES	Large	Extra Large
Stainless Steel	397000-L(5)	397000-XL(5)

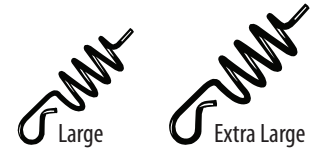

### Superline Swivel

The Superline Swivel is manufactured from premium components offering a superior strength to size ratio and an NS Black (nickel silver black) coating is applied for a stealthy finish that resists corrosion. Swivels are available in sizes 10 to 1, with break strengths of 35 to 330 pounds. Whether you chase Bluegill or Bigeye, Gamakatsu has a swivel for you.

SIZES	10 (35 lb)	8 (50 lb)	7 (75 lb)	6 (80 lb)	5 (120 lb)	4 (130 lb)	2 (230 lb)	1 (330 lb)
NS Black	405400-10(10)	405400-8(8)	405400-7(8)	405400-6(8)	405400-5(8)	405400-4(8)	405400-2(6)	405400-1(5)

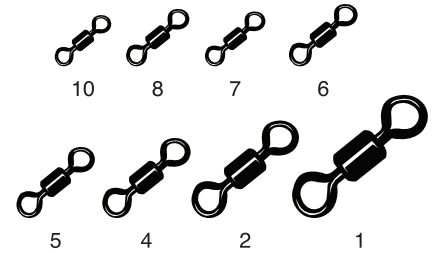

### Duo Lock Snap with Superline Swivel

Freshwater anglers, and those employing light tackle out in saltwater will gravitate toward the lightweight Duo Lock Snap with Superline Swivel, rated from 12- to 120-pound test, in sizes from 12 to 5. Featuring an NS Black (nickel silver black) coating that provides stealth and corrosion resistance with strength beyond its size.

SIZES	12 (35 lb)	10 (35 lb)	8 (50 lb)	7 (75 lb)	5 (120 lb)
NS Black	406400-12(5)	406400-10(5)	406400-8(5)	406400-7(5)	406400-5(5)

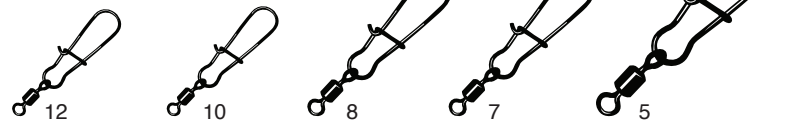

### Cross Lock Snap with Superline Swivel

The Cross Lock Snap with Superline Swivel was designed for anglers chasing larger quarry and is offered in sizes 7 through 2 rated from 75 to 230 pounds. This heavy-duty version offers superior strength to size ratio and features an NS Black (nickel silver black) coating providing a stealthy presentation.

SIZES	7(75 lb)	6(80 lb)	4(130 lb)	2(230 lb)
NS Black	407400-7(4)	407400-6(4)	407400-4(4)	407400-2(4)

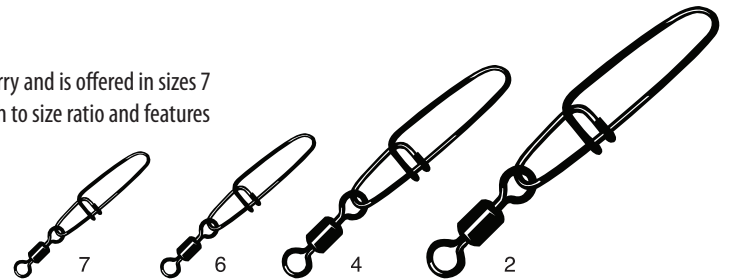

### Superline Split Ring

The new Superline Split Ring is available in sizes to outfit everything from panfish spinners to baits intended for hard-chargers such as roosterfish. The Japanese-made split ring is constructed of high strength stainless steel giving you confidence that it can handle that trophy catch. All of the edges are rounded, preventing wear on your line during the most intense battle.

SIZES	1 (10 lb)	2 (18 lb)	3 (44 lb)	4 (48 lb)	5 (97 lb)	6 (130 lb)	7 (180 lb)	8 (255 lb)
Stainless Steel	408000-1(12)	408000-2(12)	408000-3(12)	408000-4(10)	408000-5(9)	408000-6(8)	408000-7(7)	408000-8(5)

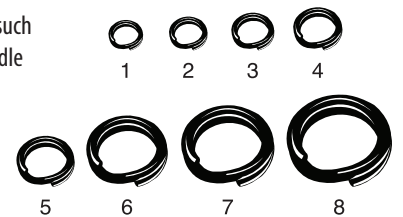

### Superline Solid Ring

Gamakatsu's new Superline Solid Ring is the perfect complement to their line of assist hooks, providing a solid connection that even the most headstrong tuna can't bust. The solid ring is completely rounded to keep your line in good shape as the battle enters extra innings. When you need to apply extra pressure on that fish of a lifetime, the welded high strength stainless steel construction won't let you down.

SIZES	4 (200 lb)	5 (350 lb)	6 (400 lb)	7 (700 lb)
Stainless Steel	409000-4(10)	409000-5(8)	409000-6(7)	409000-7(6)

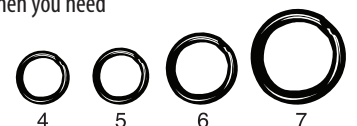



# TACKLE STORAGE

Spinnaker<sup>®</sup>

**G-Box 3200, Utility Case**

- Size 8.1" x 5.7" x 1.6".
- Great for terminal tackle and small lures.
- Micro Rib System- Micro Adjustable Dividers.
- Easily opened with one hand.
- Does not open when dropped.
- Tackle stays in place and does not go to other compartments.
- Rounded corners easy to get out of tackle bags or boat compartments.

Item #G3200

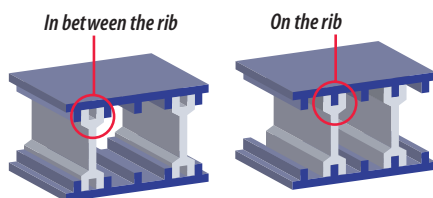

Micro Rib System - Micro Adjustable Dividers

**G-Box 3200D Deep Utility Case**

The G-Box 3200D Deep Utility Case features the single-hand, easy-open lid clasp and offers adjustable storage with micro-slit compartmental dividers. This feature allows the angler to adjust each bin size to fit specific gear. Tight tolerances ensure that small terminal tackle doesn't jump from one compartment to the other. The 3200D is made in Japan and is an excellent storage solution for both terminal tackle and lures.

- Size 8.1" x 5.7" X 3.2"
- Great for terminal tackle and small lures.
- Micro Rib System- Micro Adjustable Dividers.
- Easily opened with one hand.
- Does not open when dropped.
- Tackle stays in place and does not go to other compartments.
- Rounded corners easy to get out of tackle bags or boat compartments.

Item #G3200D



**G-Box Reversible 3200 Utility Case**

Gamakatsu takes tackle storage to the next level with the new G-Box 3200 Reversible Utility Case. The innovative design places a lid on both sides of the box, effectively creating two separate containers in one unit. Each side of the G-Box 3200 Reversible Utility Case has its own lid, doubling tangle-free storage space in each container. The new design features V-shaped dividers that keep saltwater jigs, crankbaits and other favorites organized and ready to go. Stash a different type of lure on each side and switch fishing styles with a flip of a box. Wide, locking latches keep the boxes securely shut even if they bounce along in the boat or your bag.

- Size 8.1" x 5.7" X 2"
- Opens on both sides of the box
- Easily opened with one hand.
- Does not open when dropped.
- Rounded corners easy to get out of tackle bags or boat compartments.

Item #G3200RV

**NEW**



### G-Box 3500D Deep Utility Case

The G-Box 3500 is nearly 2.4" deep, so big-lipped and fat-bodied, baits fit with ease. It's 7.4" wide to accommodate stick baits, long spinners and spinner blades. The clear top lets you see what's inside and the one-handed, easy-opening design makes access exceptionally convenient. Of course, the dividers are fully adjustable too

- Size 10" x 7.4" x 2.4".
- Great for plastic baits and hardbaits.
- Micro Rib System- Micro Adjustable Dividers.
- Easily opened with one hand.
- Does not open when dropped.
- Adjustable Layout Vertically and Horizontally.
- Tackle stays in place and does not go to other compartments.
- Rounded corners easy to get out of tackle bags or boat compartments.

Item #G3500D



### G-Box 3600, Utility Case

- Size 10.8" x 7.4" x 1.7".
- Great for plastic baits and hardbaits.
- Micro Rib System- Micro Adjustable Dividers.
- Easily opened with one hand.
- Does not open when dropped.
- Adjustable Layout Vertically and Horizontally.
- Tackle stays in place and does not go to other compartments.
- Rounded corners easy to get out of tackle bags or boat compartments.

Item #G3600



### G-Box Reversible 3600 Utility Case

Gamakatsu takes tackle storage to the next level with the new G-Box 3600 Reversible Utility Case. The innovative design places a lid on both sides of the box, effectively creating two separate containers in one unit. Each side of the G-Box 3600 Reversible Utility Case has its own lid, doubling tangle-free storage space in each container. The new design features V-shaped dividers that keep saltwater jigs, crankbaits and other favorites organized and ready to go. Stash a different type of lure on each side and switch fishing styles with a flip of a box. Wide, locking latches keep the boxes securely shut even if they bounce along in the boat or your bag.

- Size 10" x 7.5" X 2.4"
- Opens on both sides of the box
- Easily opened with one hand.
- Does not open when dropped.
- Rounded corners easy to get out of tackle bags or boat compartments.

Item #G3600RV

NEW



**G-Box 3700, Utility Case**

- Size 14" x 9" x 2".
- Great for terminal tackle and small lures.
- Micro Rib System- Micro Adjustable Dividers.
- Easily opened with one hand.
- Does not open when dropped.
- Tackle stays in place and does not go to other compartments.
- Rounded corners easy to get out of tackle bags or boat compartments.

Item #G3700

**G-Box 3700D Deep Utility Case**

The G-Box 3700D Deep Utility Case is perfect for those larger bulky lures and features the single-hand, easy-open lid clasp. Adjustable storage with micro-slit compartmental dividers allows the angler to adjust each bin size to fit specific gear. Tight tolerances ensure that small terminal tackle doesn't jump from one compartment to the other. The 3700D is made in Japan and is an excellent storage solution for a variety of larger tackle.

- 14" x 9" x 3.2"
- Great for terminal tackle and small lures.
- Micro Rib System- Micro Adjustable Dividers.
- Easily opened with one hand.
- Does not open when dropped.
- Tackle stays in place and does not go to other compartments.
- Rounded corners easy to get out of tackle bags or boat compartments.

Item #G3700D

**G-Box 3700D2 Deep Utility Case**

The G-Box 3700D2 Deep Utility Case features an open box layout with no dividers so anglers can easily stash bulky items like pliers, de-hooking tools, or bulk soft plastics. The hard shell keeps items protected, while the single-hand, easy-open lid clasp allows for easy access. In addition, the lid's tight tolerances ensure even small items can't work their way out when the boat encounters some chop or the road turns rough.

- 14" x 9" x 3.2"
- Great for large bulky items.
- Easily opened with one hand.
- Does not open when dropped.
- Rounded corners easy to get out of tackle bags or boat compartments.

Item #G3700D2

NEW



**G-Box 250, Duo Side Case, Slit Foam**

- Size 7" x 4.2" x 1.6"
- Great for Rigs, Hooks, Flies and Jig Heads.
- Easy to See Slit Foam on one side.
- Micro Rib System- Micro Adjustable Dividers on other side.
- Easily opened with one hand.
- Product stays in place and organized.
- Rounded corners easy to get out of tackle bags or boat compartments.

Item #G250DS

**G-Box 3200, Slit Foam Case**

- Size 8.1" x 5.7" x 1.6"
- Great for Rigs, Hooks, Flies and Jig Heads.
- Easy to See Slits.
- Easily opened with one hand.
- Product stays in place and organized.
- Rounded corners easy to get out of tackle bags or boat compartments.

Item #G3200SF

**G-Box 3600, Slit Foam Case**

- Size 10" x 7.5" x 1.1"
- Great for Rigs, Hooks, Flies and Jig Heads.
- Easy to See Slits.
- Easily opened with one hand.
- Product stays in place and organized.
- Rounded corners easy to get out of tackle bags or boat compartments.

Item #G3600SF



**G-Box 318SD Pocket Utility Case**

The G-Box 318SD Pocket Utility Case is made for anglers on the move. The 318SD is designed for adventurous anglers who walk the shorelines of lakes and rivers in search of secret spots and untouched fish. The G318SD features adjustable dividers one side allowing anglers to customize their terminal tackle storage. Carry the essentials and always have critical terminal tackle and spare lures at your fingertips without hauling a heavy pack.

- Size 4.8 x 3.4 x 1.3
- Great for Hooks, Flies and Jig Heads.
- Easily opened with one hand.
- Product stays in place and organized.
- Rounded corners easy to get out of tackle bags or boat compartments.

Item #G318SD

**G-Box 388DD Pocket Utility Case**

The G-Box 388DD Pocket Utility Case is made for anglers on the move. The 388DD is designed for adventurous anglers who walk the shorelines of lakes and rivers in search of secret spots and untouched fish. The G388DD compartments are not adjustable but have multiple compartments that are designed to carry a wide variety of terminal tackle. Carry the essentials and always have critical terminal tackle and spare lures at your fingertips without hauling a heavy pack.

- Size 4.8" x 3.8" x 1.3"
- Great for Hooks, Flies and Jig Heads.
- Easily opened with one hand.
- Product stays in place and organized.
- Rounded corners easy to get out of tackle bags or boat compartments.

Item #G388DD





### G-Case 7000

The G-Case 7000 is an ultra-durable, hard-sided tackle storage case that is compatible with G-Boxes in all sizes, creating a flexible system that has endless storage configuration possibilities. The G-Case 7000 utilizes a strong, sturdy handle and the lid can be opened from either side, allowing for quick access. The interior has an open tray for loose items like line spools and tools. Add the optional rod stand, jig compartment, and shoulder strap to transform the G-Case 7000 into a real-time fishing asset.

- Size 19" x 13" x 13"

Item #G7000



### G-Case 7000 Jig Compartment

Anglers are always changing lures and cycling through gear, and the optional exterior side mounted jig compartment attaches securely to the G-Case 7000 and offers an open, top-slotted compartment for quick access to your go-to lures. Store and dry them after use as well before moving lures back into permanent G-Box utility cases. This exterior storage option is a time saver when quick changes are needed in the field.

- Size 10 x 5.7 x 2.2

Item #G7000-JC



### G-Case 7000 Rod Stand

The G-Case 7000 has three different positions on either side to attach the optional rod stand. A simple mounting bracket makes a firm connection, transforming the case into a rod holder with a permanent locking mechanism. The rod stand offers rod height adjustments to hold a variety of rod types. In addition, the rod stand features an adjustable foot, making it a sturdy base for the G-Case.

- Size 2.6 x 2.8 x 13

Item #G7000-RS



### G-Case 7000 Shoulder Strap

If you need to free up your hands while trying to carry all your gear simply add the optional shoulder strap to make carrying the G-Case 7000 a breeze.

- Size 1.5" x 79"

Item #G7000-SS



**G-Bag EWM 5000 H Tackle Bag**

The G-Bag EWM 5000 H Tackle Bag features an Extra Wide Mouth (EWM) opening for easy access. An internal wire frame keeps the main compartment in the open position allowing anglers to sort through their tackle and find that perfect bait with ease. Anglers can fit up to five Gamakatsu G-Box 3700 or eight 3600 utility cases inside. A quick-access magnetic front pocket flap also stays in an open position, letting anglers effortlessly grab often needed items from the handy pocket. The durable, 1680 denier polyester construction stands up to a rough life on the water, with a water- and slip-resistant EVA molded base that protects the contents against moisture.

16" x 11" x 13.25" • Item #GB-EWM-5000H

NEW



**G-Bag EWM 300 Tackle Bag**

The G-Bag EWM 300 is the largest size in the lineup and is designed to carry a variety of tackle comfortably, thanks to the adjustable, padded removable shoulder strap. The generous 13 x 8.5 x 11-inch bag lets anglers stockpile all of their finesse baits and power fishing lures in the same place so they can be prepared for anything. Stuff up to four Gamakatsu G-Box 3600 or eight 3200 utility cases into the G-Bag EWM 300 using the innovative Extra Wide Mouth opening. 13 x 8.5 x 11 • Item #GB-EWM-300

NEW



**G-Bag EWM 200 Tackle Bag**

The G-Bag EWM 200 Tackle Bag stows more gear using the same innovative easy-access stay-open top. The 9.5 x 5 x 7-inch size easily accommodates magnum packs of soft plastics and oversized bulk bags, so that anglers can stash their largest swimbaits or enough tubes for the season in one convenient location. In addition, there's enough space to store a wide variety of tackle and gear, so anglers can keep rigging tools and other essentials handy as well. 9.5 x 5 x 7 • Item #GB-EWM-200

NEW

**G-Bag EWM 100 Tackle Bag**

The G-Bag EWM 100, is the perfect size for holding a variety of soft plastic packs. The Extra Wide Mouth (EWM) provides easy access to the interior, and the internal wire frame keeps the top open while finding the right bait. The 8 x 4 x 6-inch size stows easily in other bags, and anglers can take as many as needed while remaining organized. Pick up a few and keep all smaller items organized and ready.

8 x 4 x 6 • Item #GB-EWM-100

NEW



### Shoulder Bag Tackle Storage

The perfect mobile storage solution when you're on the go and need fast, easy access to your gear. Designed for over-the-shoulder carrying: Swing bag to your chest for access, swing around to your back when walking, casting or battling fish. Includes two (2) G3200 G-Boxes in the main compartment and features multiple, heavy-duty zippered pockets to store everything else. The 1680 denier ballistic nylon is tough so it will hold up for years of use and the padded shoulder strap is adjustable for length.

Item #BAG006



### Backpack Tackle Storage

When you need to carry enough tackle for wherever your angling adventure may lead you, strap on our Backpack Tackle Storage solution. Made from 1680 Denier Ballistic Nylon, it's tough, light and easy to carry. The interior pouch can be adjusted from one large compartment to two smaller ones. Exterior carry pockets on both sides are designed to hold fishing rods or water bottles. Includes two (2) G3600 and one (1) G3500D G-Boxes.

- Dimensions: 17" x 12" x 8".
- Backpack design with adjustable waist strap.
- Comfortable 3d mesh padding.

Item #BAG005



### G-Finesse Dry Bag Backpack

Secure your gear and keep it dry with our Waterproof Backpack. Double sealed seams are impervious to moisture even when submerged. The top closures open wide for easy access, then roll down tight and buckles quick to protect contents. Padded shoulder straps and waist belt complete the package.

- Waterproof PVC Material.
- Backpack design with adjustable waist strap.
- Velcro and latch closure cinches down for water tight transport.

Item #BAG001



### Hybrid Duffel Backpack 110L

Gamakatsu's water-resistant Hybrid Duffel Backpack offers 110 liters of space to take gear wherever anglers may roam. The innovative pack can be carried in three different ways, thanks to the removable backpack straps, shoulder strap, or side-carrying handle. The main opening provides easy access to the pack's contents. The large, zippered internal pocket and zippered mesh pocket inside the main compartment opening keeps everything organized. The exterior zippered storage pocket and MOLLE-type webbing for attaching and securing gear further add to the organizing potential. The pack folds into itself for compact storage when not in use.

30 x 15.5 x 13 • Item #GB-DF-110



NEW



### Rolling Gear Duffel 90L

For those that prefer to roll along, Gamakatsu offers the Rolling Gear Duffel. The pair of sturdy wheels allow for easy transport of 90 liters of belongings. When anglers decide to pick it up, use the adjustable, removable padded shoulder strap or padded handles to carry in comfort. An external zippered pocket and a large inner zippered pocket keep things tidy. Water-resistant construction keeps the elements at bay, so anglers won't have to worry about rain clouds or rough boat rides. A convenient carrying case allows compact storage when anglers are not on the road or at the lake.

27 x 15.5 x 13 • Item #GB-DF-90



NEW

### Gear Duffel 30L

When anglers don't have a ton of stuff to tote around, Gamakatsu's water-resistant 30-liter Gear Duffel would be the best to pack up. The large main opening is secured with heavy-duty zippers for easy access, with an external zippered pocket that keeps off-needed items at the ready. A separate, outer zippered access compartment for dirty clothes or gear keeps anglers clean stuff clean. An adjustable, padded removable shoulder strap lets anglers carry stuff hands-free, though the hook and loop fastener on the main carrying handles works as well.

Item #GB-DF-30

NEW



**Tuna Dry Bag Backpack**

Designed specifically for teams competing in the Los Cabos Tuna Jackpot, these highly-coveted drybag backpacks are now available for all. This mid-sized, extra-tough, ultra-dry backpack is perfect for storing clothes and gear on those wet and wild offshore runs. Made from ballistic nylon, it will take a beating without putting the contents in jeopardy. The interior pouch is wide open to fit boots, rain gear, bulky jackets or heaps of tackle. Easy to carry with padded straps and waist belt. Compacts tightly for storage when not in use.

- Waterproof PVC Material.
- Backpack design with adjustable waist strap.
- Velcro and latch closure cinches down for water tight transport.

Item #BAG002

**Dry Bag 10L**

For extreme conditions where rain, waves, boat spray, or unforeseen accidents could really dampen the fun, store your gear in our Dry Bag 10L. 100% waterproof with sealed seams and convenient shoulder strap for easy carrying. Top rolls and clip securely to prevent leakage. The front zippered pocket is perfect for wallets, phones, licenses, or other valuables. Compacts tightly for storage when not in use.

- Waterproof PVC Material.
- Convenient shoulder strap.
- Closure cinches down for water tight transport.

Item #BAG003

**Dry Bag Backpack 20L**

When you need guaranteed watertight storage for long walks out to the boat, down the beach or deep into the woods, just let this Dry Bag Backpack 20L carry the load. 100% waterproof with sealed seams and breathable back padding for comfort. Top rolls and clips securely to prevent leakage. The front zippered pocket protects valuables. Compacts tightly for storage when not in use. Large enough for any overnight or multi-day trip.

- Waterproof PVC Material.
- Backpack design with adjustable straps.
- Velcro and latch closure cinches down for water tight transport.

Item #BAG004





# TOOLS AND ACCESSORIES

GarmaKatsu®

**Fishing Pliers 6"**

Made of stainless steel to ward off corrosion and rust, Gamakatsu's heavy-duty pliers will become the tool you reach for whether you're an avid salt or freshwater angler. The Gamakatsu Stainless Steel Pliers have precise crimping jaws to fit various sizes of sleeves. The precision split ring feature on the needle nose tool makes changing or replacing split rings easy. The multi-tasking jaws on the pliers are able to cut braid, mono or fluorocarbon, and also feature a PTFE coating to aid against corrosion and rust. The handles feature a non-slip grip that helps you hold on during wet conditions. Included is a lanyard and sheath so the pliers are right where you need them. Item #P002



**Fishing Pliers 7"**

Made of stainless steel to ward off corrosion and rust, Gamakatsu's heavy-duty pliers will become the tool you reach for whether you're an avid salt or freshwater angler. The Gamakatsu Stainless Steel Pliers have precise crimping jaws to fit various sizes of sleeves. The precision split ring feature on the needle nose tool makes changing or replacing split rings easy. The multi-tasking jaws on the pliers utilize an outside cutter and are able to cut braid, mono or fluorocarbon, and also feature a PTFE coating to aid against corrosion and rust. The handles feature a non-slip grip that helps you hold on during wet conditions. Included is a lanyard and sheath so the pliers are right where you need them. Item #P003



**Micro Split Ring Plier**

The 5-inch long pliers are made from stainless steel and feature a premium non-slip grip giving anglers a secure hold for fine operations like manipulating split rings. A spring in the handle holds the pliers open during use, and a corresponding lock keeps them closed for storage. Its precision micro-tip grips and opens super small split rings, and it is just as effective on large ones, too. A built-in braided line cutter cleanly shears tough fishing line. Item #P004





**Folding Braid Scissors w/ Split Ring Opener**

The Folding Braid Scissors with Split Ring Opener is a compact multi-function fishing scissor with similar construction elements as other Gamakatsu fishing tools. Its sharp stainless-steel blades will provide years of hard use snipping mono and cutting braided fishing line. The scissor's tips feature a handy split ring opener. The blades fold safely into the tool's blue handles for safe storage. When open, the 4-inch scissors proudly display the Gamakatsu name. A quality tool at a value-price.

Item #SC001



**Gamakatsu Microfiber Towel**

Gamakatsu throws in the towel on fish slime, scales and other grime that can prevent you from getting a solid grip on your rod. Keep your hands clean and ready to fish with Gamakatsu's new Microfiber Towel. The absorbent microfiber construction of the Microfiber Towel efficiently cleans and dries hands in one pass, so that you can get back to fishing quickly. 12" x 12" Item #TW30

NEW



**Gamakatsu Fingertip Protector**

Protects your finger from the abuse of stripping line all day. One size.

**Updated with new Kevlar reinforced finger protection.**

Item #GF003(1)



**Gamakatsu Luxxe Fishing Line**

A PE based filament, that is much stronger than classic braided line. It is a 4 strand braided line, along with the PE fibers makes it more abrasion resistant and has less memory. In turn the benefits are less tangles, and better casting distances. Available in the following test # 8, 10, 12, 14, 16.

TEST#	8	10	12	14	16
164 YD Spool	19511-08	19511-10	19511-12	19511-14	19511-16







# APPAREL AND GEAR

*Sportswear*<sup>®</sup>



**Trucker Hat Mesh Blk/Charcoal**  
60/40 cotton/polyester. 100% polyester back. Structured, mid-profile, six panel. Pre-curved contrast stitched visor. Underbill matches the color of the visor. Adjustable plastic snapback. Item #H015



**Flexfit Multicam Hat**  
98/2 cotton/spandex. Structured, mid-profile, six-panel, 3 1/2" crown. Permacurv visor with silver undervisor. Item #H016 • S/M-L/XL



**Sun Shield Gray**  
100% Polyester Microfiber. Seamless. Speed Dry. Size 20" L x 9 1/8" W. One size fits most. Item #SS001



**T-Shirt Heather Gray**  
90/10 cotton/polyester blend . Retail fit. Unisex Sizing. Comfortable Ringspun Cotton. Sizes S-XXXL • Item #T010



**T-Shirt Retro Logo Navy**  
4.2 ounce 100% ringspun cotton. Retail fit. Unisex sizing. Sizes S-XXXL • Item #T011



**NEW**

**T-Shirt Flag**  
90/10 cotton/polyester blend. Comfortable and lightweight classic fit. Sizes S-XXXL • Item #T013

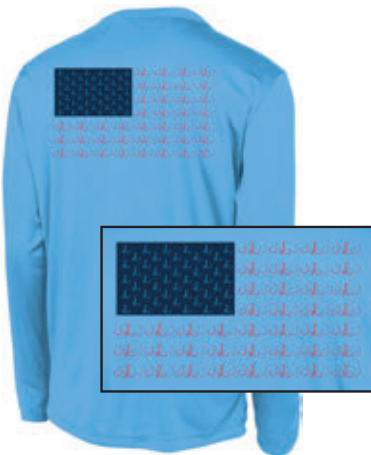

**Performance LS Shirt Flag**  
3.8 ounce 100% polyester. Lightweight, roomy and highly breathable. Moisture wicking. Sizes S-XXXL • Item #T009BL



**Performance Shirt LS (STEEL)**  
98/2 Polyester/Elastane. Vertical rear venting. Dual front pockets with snap closure. UPF 50 sun protection. Stain Resistant ultralight fabric. Classic fit. Sizes S-XXL • Item #SHIRT005



**Performance Shirt LS (SKY)**  
98/2 Polyester/Elastane. Vertical rear venting. Dual front pockets with snap closure. UPF 50 sun protection. Stain Resistant ultralight fabric. Classic fit. Sizes S-XL • Item #SHIRT004



**Performance LS Shirt Gray**  
 3.8 ounce 100% polyester.  
 Lightweight, roomy and highly  
 breathable. Moisture wicking.  
 Sizes M-XXXL • Item #T008GY



**Performance LS Shirt Blue**  
 100% Polyester, lightweight, roomy and  
 highly breathable, moisture wicking.  
 Sizes M-XXXL • Item #T008BL



**Performance LS Shirt, White**  
 Long sleeve, dry wicking performance  
 material. Screen Printed logo.  
 Sizes S- XXXL  
 Item #T008W



**Performance LS Shirt, Black**  
 Long sleeve, dry wicking  
 performance material. Screen  
 Printed logo. Sizes S-XXXL  
 Item #T008B



**Ladies Performance LS Shirt Blue**  
 3.8 ounce 100% polyester. Lightweight,  
 roomy and highly breathable. Moisture  
 wicking. Sizes S-XXL • Item #T012BL



**Trucker Mesh Cap**  
 Mid-profile cap made from cotton twill  
 fabric. Breathable nylon mesh in back.  
 Embroidered logo. Black with white mesh.  
 Velcro closure. Item #H010



**Trucker Mesh Cap**  
 Mid-profile cap made from cotton twill  
 fabric. Breathable nylon mesh in back.  
 Embroidered logo. Navy with white mesh.  
 Velcro closure. Item #H014



**Pro Cotton Cap**  
 100% cotton material. Embroidered logos  
 on both front and back. Velcro closure.  
 Black, Item #H007



**Low Profile Visor**  
100% garment washed cotton.  
Embroidered Logo. Adjustable Velcro  
closure in back. Black, Item #V002



**Alaska Hat**  
100% cotton material.  
Embroidered logo. Flex Fit.  
Black, Item #H012-S/M  
Black, Item #H012-L/XL



**NEW**  
**Knit Beanie**  
8"cap stretches to most head  
sizes. Made of cotton/poly  
knit blend. Embroidered  
logo. Black Item #B002



**G-Finesse Cap**  
100% cotton material.  
Embroidered logo.  
Flex Fit. Black,  
Item #H009



**G-Finesse Flat Bill**  
100% cotton material.  
Embroidered logo.  
Snap Back. Black.  
Item #H011



**Flat Bill Triple Black**  
100% cotton material.  
Embroidered logo.  
Adjustable Snap Back  
Closure. Triple Black.  
Item #H013



**T-Shirt**  
100% cotton short sleeve  
t-shirt. Screen printed logo.  
White. Sizes M-2XL.  
Item #T001



**G-Finesse T-Shirt**  
100% cotton short sleeve .  
Screen printed design.  
Sizes M-XL.  
Item #T007W



**Luxe T-Shirt White**  
100% cotton Beefy T short sleeve. Screen  
Printed logo. White. Sizes L  
Item #53358-23-0



**Softshell Performance Jacket**  
Polyester stretch fabric bonded to  
soft microfleece inside.  
Embroidered logo.  
Wind and water resistant.  
Black. Sizes M-2XL.  
Item # J001



**Fleece Performance Jacket**  
13 oz fleece material with nylon  
capped shoulders. Full zipper.  
Adjustable waist. Embroidered  
logo. Gray with black trim.  
Sizes M-2XL.  
Item #F001



**Ladies Hooded Sweatshirt**

7.3 ounce 60/40 cotton/polyester fleece. Front pouch pockets. Ribbed cuffs and waistband. Sizes S-XXL • Item #S004



**Performance Hoodie Steel**

92/8 Polyester/Spandex. Antimicrobial treatment for odor control. UPF 50 sun protection. Stain resistant. Quick dry, moisture wicking. Active fit. Sizes S-XXXL • Item #PF001ST



**Performance Hoodie Blue**

92/8 Polyester/Spandex. Antimicrobial treatment for odor control. UPF 50 sun protection. Stain resistant. Quick dry, moisture wicking. Active fit. Sizes S-XXXL • Item #PF001BL



**Shadow Technical Hoodie**

100% Poly Bonded Microfleece. Hood shock-cord cinch stopper. Velcro Pocket Closure. Active fit. Sizes S-XXXL • Item #S003



**Hooded Sweatshirt**

9.3 oz cotton/poly material shoulders. Adjustable drawstring. Kangaroo pouch. Screen printed logo. Navy. Sizes S-2XL. Item #S002



**Carhartt Midweight Hooded Sweatshirt**

10.5 ounce 50/50 cotton/poly blend with attached drawcord closure hood. Stretchable, spandex-reinforced, rib knit cuffs and waistband Front hand warmer pocket. Sizes M-2XL. Item #S005



**Japanese Chara**

100% cotton short sleeve t-shirt with pocket. Screen printed logo. Black.  
 Sizes M-XL.  
 Item #T006B



**Samurai Fisherman**

Trucker Mesh Cap Mid-profile cap made from cotton twill fabric. Breathable nylon mesh in back. Embroidered logo. Black with black mesh. Snap Back closure. Item #H008



**Samurai Fisherman**

100% cotton short sleeve t-shirt. Screen printed design. Black.  
 Sizes M-2XL.  
 Item #T004B

**Samurai Fisherman**

100% cotton short sleeve t-shirt. Screen printed design. White.  
 Sizes M-2XL.  
 Item #T004W



**Long Sleeve Samurai Fisherman**

100% cotton long sleeve t-shirt. Screen printed design. White.  
 Sizes M-2XL.  
 Item #T005W







**G-Finesse Decal**  
 Yellow #21  
 White #20  
 Solid #19



**Tuna Boat Decal**  
 9 inch - white #14  
 9 inch - red #18  
 9 inch -blue #15



**Embroidered Patch**  
 4 1/2 inch  
 #124



**Small Boat Decal**  
 7 inch  
 White #7  
 Blue #7-B  
 Lime Green #7-LG



**Large Boat Decal**  
 18 inch  
 Blue #1  
 White #2



**Small Decal Sheet**  
 Aprox 3", 2", 1.25"  
 White #23-W  
 Blue #23-B

**Gamakatsu Carpet Sticker**  
 18 Inch. Item #24





GAMAKATSU USA  
P.O. Box 1797 Tacoma, WA 98401  
253-922-8373 • Fax 800-223-9383

SPRO Corporation  
3655 Kennesaw 75 Pkwy, Suite 135  
Kennesaw, GA 30144  
770-919-1722 • FAX 770-919-8141

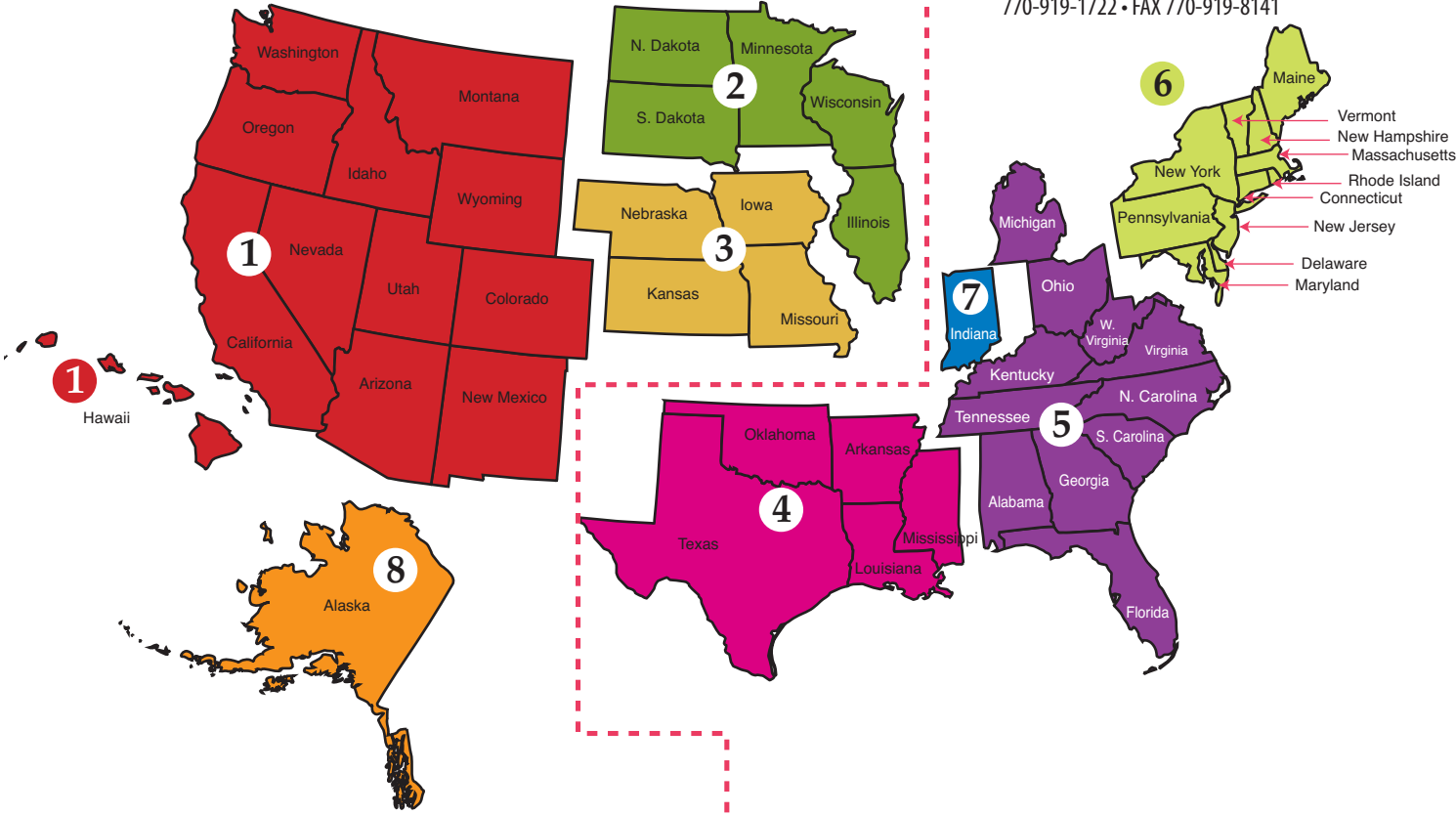

**Regions 1, 2, 3, 8 Call:  
Gamakatsu USA ... 253-922- 8373  
or the following representatives:**

**REGION 1: L.H. French Company**  
1071 West 251st Street • Harbor City, CA 90710  
310-326-6543 (Corporate Office)  
  
17019 NE 136 Place • Redmond, WA 98052  
425-869-7909 (Northwest Office)  
TERRITORY: Washington, Oregon, Idaho, Montana, Wyoming, California,  
Nevada, Utah, Colorado, Arizona, New Mexico, Hawaii

**REGION 2: Schueler LaFond and Associates**  
334 E. Colfax St. A-1 • Paltine, IL 60067  
847-991-6119  
TERRITORY: Wisconsin, Minnesota, N. Dakota, S. Dakota, Illinois

**REGION 3: Alexander and Townsend, Inc.**  
503 N. Mur-Len Road, Suite A • Olathe, KS 66062  
913-829-3266  
TERRITORY: Missouri, Iowa, Nebraska, Kansas

**REGION 8: Skyline Sales & Service**  
20734 Crabtree St. • Chugiak, AK 99567  
907-688-9993  
TERRITORY: Alaska

**Regions 4, 5, 6, 7 Call:  
SPRO Corporation ... 770-919-1722  
or the following representatives:**

**REGION 4: Frontier Marketing**  
6227 Paddle Wheel • Katy, TX 77449  
281-345-4650  
TERRITORY: Arkansas, Louisiana, Mississippi, Oklahoma, Texas

**REGION 5 : Outdoor Brand Team**  
645 Hwy T-14, Pella, IA 50219  
641-780-2510  
TERRITORY: Alabama, Florida, Georgia, Kentucky, Michigan, North Carolina, Ohio, South  
Carolina, Tennessee, Virginia and West Virginia

**REGION 6: Sheridan - Nisito Marketing**  
9 Academy Road • Hatboro, PA 19040  
215-674-5222  
TERRITORY: Delaware, Maryland, Maine, Vermont, New Hampshire, Massachusetts, New York,  
New Jersey, Connecticut, Pennsylvania, and Rhode Island

**REGION 7: Heinzman and Associates**  
11 Terry Drive • Jacksonville, IL 62650  
217-245-2504  
TERRITORY: Indiana

*Gamakatsu*<sup>®</sup>

WORLD'S FINEST HOOKS

[www.gamakatsu.com](http://www.gamakatsu.com)