

EPSON[®]
EXCEED YOUR VISION



PowerLite[®] 1835 MULTIMEDIA PROJECTOR



Flexibility, connectivity, brightness, value.

Enhance your presentations in any boardroom or classroom with the affordable and convenient PowerLite 1835. Images can be adjusted using horizontal and vertical keystone correction plus the Quick Corner[®] feature can accommodate almost any room setup. You have even more flexibility with a 1.6x optical zoom, which displays images up to 40% larger than competing projectors with a 1.2x optical zoom — without a change in image quality. The PowerLite 1835 features 3500 lumens of color and white light output¹ and XGA resolution, for sharp, vibrant images.

Flexible setup — advanced image adjustments, higher tilt and optical zoom

Comprehensive, future-ready connectivity — HDMI digital input, USB display, PC-free and network presentations, document camera compatibility and optional wireless connectivity

Advanced networking features — EasyMP[®] for remote monitoring/control; message broadcasting; seamless integration with Crestron RoomView,[®] without the need for an A/V control box



PowerLite® 1835 MULTIMEDIA PROJECTOR

The best-selling projectors in the world.

Epson offers a wide range of high-quality projectors to meet most any need. Built with image quality and reliability in mind, Epson projectors enhance communication and inspire collaboration, while offering a low total cost of ownership. From ultraportable projectors designed for educational settings to boardroom-ready business projectors, Epson has the model made for you.



3LCD technology — for quality and color that's beyond amazing

- 3 chips for full-time, vibrant color
- 25% less electricity required per lumen of brightness when compared to 1-chip DLP projectors²
- Over 20 years of road-tested reliability built into every projector

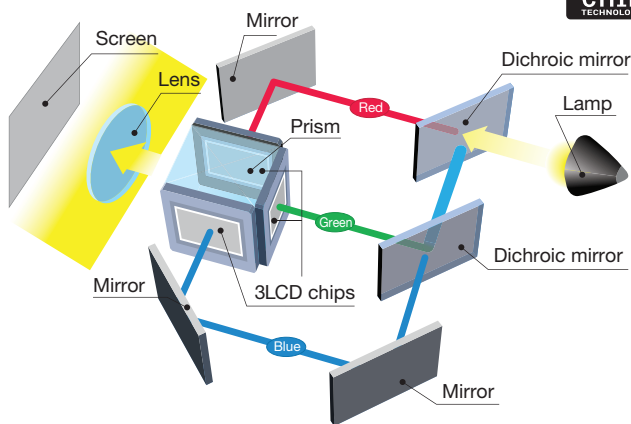

▲ 3LCD, 3-chip technology

Energy-efficient E-TORL® lamp, exclusively from Epson

- Delivers more lumens per watt and lasts up to 6000 hours³
- Minimizes both light diffraction and light leakage
- E-TORL lamps maximize your presentation time, while minimizing your costs

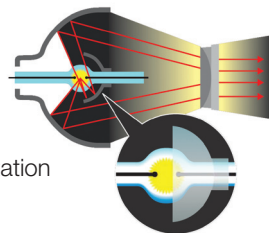

▲ E-TORL lamp

Amazing color and white light output

Rich color and detail are critical for presentations — that's why it's important to understand that color light output is an essential ingredient in achieving optimum performance. The PowerLite 1835 delivers 3500 lumens of color light output and 3500 lumens of white light output¹ for bright, vibrant, colorful images.



High color light output

Low color light output

Actual photographs of images taken from two competing projectors run in default mode. Price, resolution and brightness (white light output) are the same for both projectors.

Long-lasting lamp and filter life

- Easy-to-replace lamp and filter
- Lamp replacement cycle of 4000/6000 hours³ (Normal/Eco Mode)
- Filter maintenance cycle of 5000 hours⁴



Better Products for a Better Future™

For more information on Epson's environmental programs, go to eco.epson.com

Eco Features

- Energy-efficient 3LCD light engine
- Energy-efficient E-TORL lamp
- Low power consumption of 0.3 W in Standby Mode (network communication off)
- Designed to be recycled⁵
- RoHS compliant
- Epson America, Inc. is a SmartWaySM Transport Partner⁶



Flexible setup

New, innovative horizontal keystone adjustment

- +/- 30 degrees — for the ultimate flexibility when the projector is placed off center; the presenter can stand in front of the screen without blocking the image
- Present from a u-shaped tabletop, without moving the table or putting a stand in the center

Without Horizontal Keystone

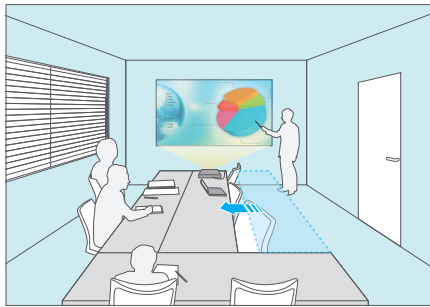

With Horizontal Keystone

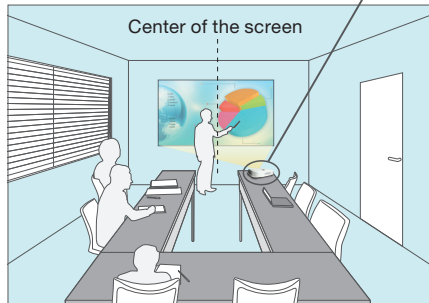

Quick Corner

This innovative feature allows you to move any of the four corners of an image independently at setup, using the remote control to adjust each corner for a perfectly rectangular picture.



More visible with higher tilt

With up to 16 degrees tilt angle, the PowerLite 1835 can project images higher up on the screen or wall, even from a low stand or table, ensuring the whole audience, including those in the back, can get a full view

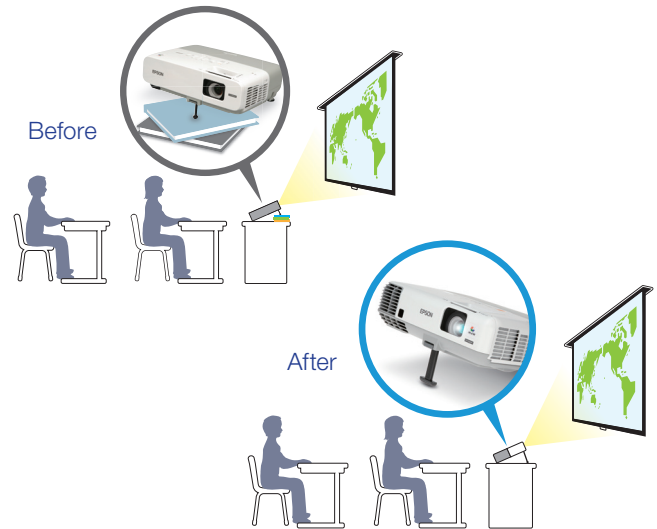

1.6x optical zoom

- Equipped with a 1.6x optical zoom, the projector enables you to enlarge images 40% more than with competitive models that use a 1.2x optical zoom
- Since the zoom is achieved through optical lenses, image quality is not negatively affected
- A higher zoom means you don't need to position the projector far away from the screen, which creates dead space between the screen and the projector

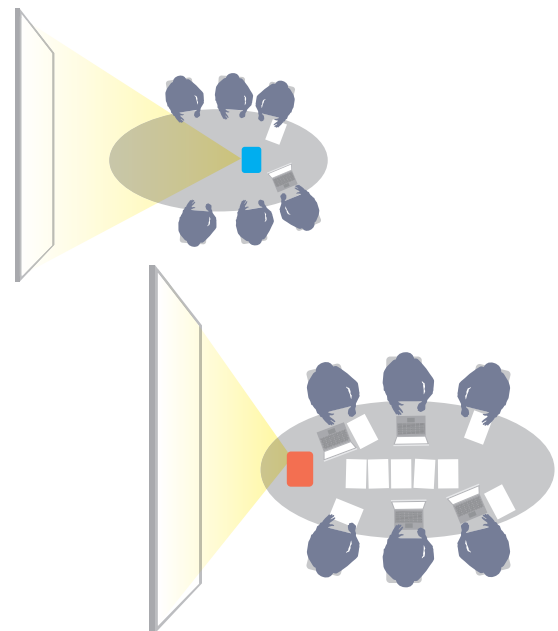

Leading-edge technology

HDMI input for high-quality, high-definition video

- Deliver both audio and brilliant HD video content with just one cable
- Compatible with the latest laptops, Blu-ray® and media players



PC-free presentations

- Just plug your USB memory device into the USB port, and you are ready to display whichever slide you choose from the drive
- Compatible with the following file formats: JPG/BMP/GIF/PNG/FSE/SIT
- Create a slideshow using files on the USB drive

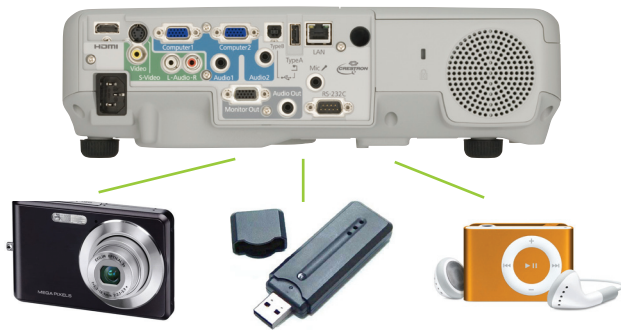

Wireless connectivity — 802.11 b/g/n

The optional wireless LAN module allows you to connect to a wireless infrastructure and make a presentation or monitor/control your projector over the wireless network.

You can also use the Quick Connect Wireless USB key to set up an ad hoc (peer-to-peer) wireless connection with a PC and make presentations from your computer, wirelessly.



USB Plug 'n Play 3-in-1

- Three features, all with one connection — display your presentation, transmit audio and use your remote control as a mouse to control your presentation
- No more computer function keys or bulky VGA and audio cables
- Just plug in a standard USB cable and instantly project — compatible with Windows® and Mac®

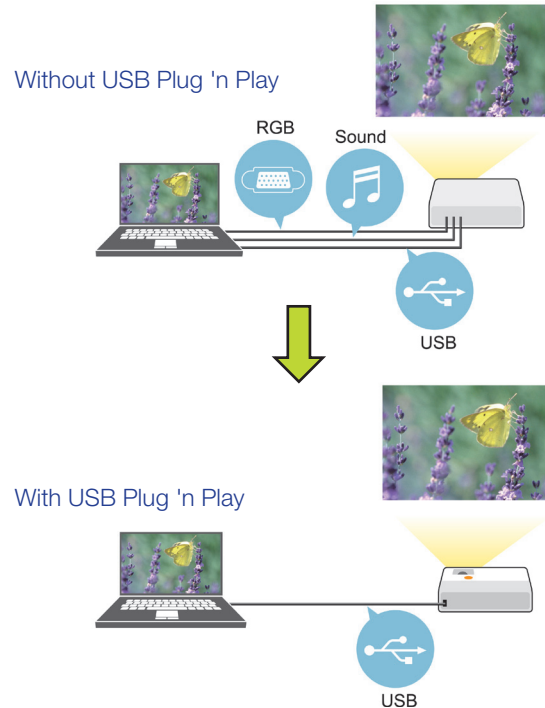

Document camera

Partner your projector directly with Epson's DC-06 document camera and make more effective presentations to enhance the overall teaching experience.



Advanced networking and more

Monitor and control

Easily monitor/control up to 1024 networked Epson projectors using the RJ-45 connector and included EasyMP software

- Schedule remote power on/off functionality; saves energy, money and time
- Check the status of each projector as part of your maintenance routine
- Access maintenance alerts for connected projectors, right from your office
- Crestron RoomView enabled — monitor and control your projector with RoomView software, without the need for an A/V control box



Network presentations

- Present in up to four classrooms from one networked location
- Ideal for distance learning applications
- Use for multi-display configurations to create a panoramic image
- Also works wirelessly with the optional Wireless LAN Module

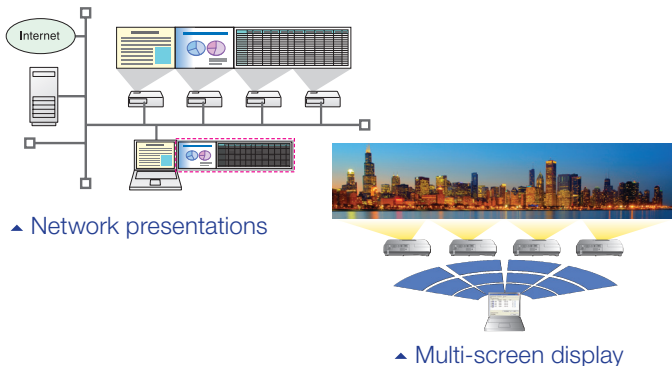

Message broadcasting

Broadcasts customized and scheduled alerts/messages over the network for announcements or instructions

- Sends messages to up to 1024 projectors at the same time
- Sends ordinary messages as JPEG files, so you can create slides/charts/images
- Create a slideshow by using multiple files within a folder



Built-in 16 W speaker and microphone input

- Engage your students with 16 W of sound — enable all students in the room to hear your lessons, without purchasing costly speakers or straining the professor's voice
- Works with wired or wireless dynamic or condenser microphones
- Adjust the volume using the projector remote control

Added features

- Instant Off® — no cool-down time required, so it's ready to shut down when you are
- A/V Mute Slide — control your presentation; it's right at your fingertips
- Sleep Mode — set from 1 to 30 minutes to save energy when the A/V Mute Slide is closed or no signal is detected
- Direct Power On/Off — power the projector on and off with the flip of a wall switch

Built-in closed captioning

- Essential for education — helps meet ADA508 requirements for students with hearing impairments
- Helps save money — no need to pay for an additional decoder and its installation
- Effective and easy to use — easily enabled or disabled through the projector remote or menu



PowerLite® 1835

Multimedia Projector

Product Name	Product Code	UPC
PowerLite 1835	V11H389020	0 10343 88050 4
Genuine Epson Lamp	V13H010L61	0 10343 88052 8
Replacement Air Filter	V13H134A29	0 10343 88051 1

Specifications

Projection System

Epson 3LCD, 3-chip technology

Projection Method

Front/rear/ceiling mount

Driving Method

Epson Poly-silicon TFT Active Matrix

Pixel Number

786,432 pixel x 3 LCDs (1024 x 768)

Native Resolution

1024 x 768 (XGA)

Aspect Ratio

4:3

Color Light Output¹

3500 Lumens

White Light Output¹

3500 Lumens (ISO 21118 standard)

Contrast Ratio

(High Brightness, Dynamic Mode)

2000:1

Brightness Uniformity (typical)

89%

Color Reproduction

16.7 million colors

Size (projected distance)

30" – 300"

Keystone Correction

Vertical: ± 30 degrees - auto

Horizontal: ± 30 degrees - manual

Lamp Type

230 W UHE E-TORL

Lamp Life²

4000 hours (Normal Mode)

6000 hours (ECO Mode)

Effective Scanning Frequency Range

Pixel Clock

13.5 MHz – 162 MHz (up to UXGA 60 Hz)

Horizontal

15 kHz – 92 kHz

Vertical

50 Hz – 85Hz

Video I/O

Display Performance

NTSC: 480 line

PAL: 576 line

(depends on the observation of the multi-burst pattern)

Input Signal

NTSC/NTSC4.43/PAL/M-PAL/N-PAL/

PAL60/SECAM

480i/576i/480p/576p/720p/1080i/1080p

Interfaces

HDMI x 1

Computer: D-sub 15pin x 2

Monitor-out: D-sub 15pin x 1

Video: RCA x 1

S-Video x 1

Network: RJ-45 x 1, 100 Mbps

Wireless LAN: Optional 802.11 b/g/n

Serial: RS-232c

USB: Type-A x 1, Type-B x 1

Microphone: Mini stereo x 1

Audio: Mini stereo x 2

Audio: RCA (L and R)

Audio out: Mini stereo x 1

USB Plug 'n Play

Video (1024 x 768)

Audio

Mouse and Keyboard

PC and Mac compatible

Projection Lens

Type

Powered focus/Manual zoom

F-number

1.51 – 1.99

Focal Length

18.2 mm – 29.2 mm

Zoom Ratio

Optical zoom 1.0 – 1.6

Throw Ratio Range

1.38 – 2.24

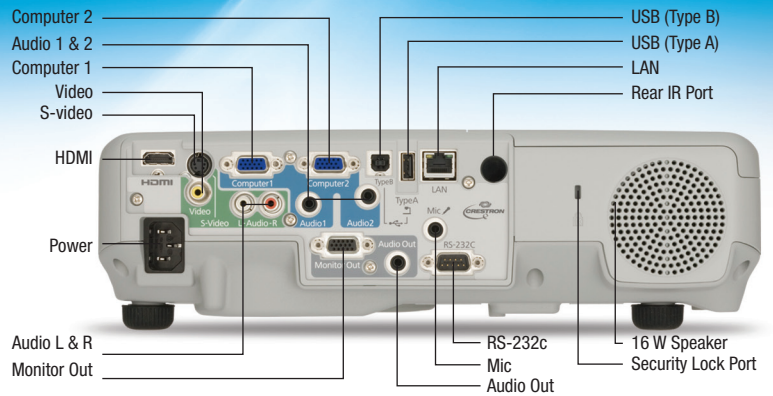

Other

Speaker

16 W (mono)

Operating Temperature

41° to 95° F (5° to 35° C)

Power Supply Voltage

100 – 240 V ± 10%, 50/60 Hz AC

Power Consumption

355 W (Normal Mode)

263 W (ECO Mode)

8.9 W Standby (Communication On)

0.29 W Standby (Communication Off)

Fan Noise

37 dB (Normal Mode)

29 dB (ECO Mode)

Security

Security cable hole, Kensington® lock provision

Dimensions (W x D x H)

Including feet: 13.58" x 10.35" x 5.17"

Excluding feet: 13.58" x 10.35" x 3.66"

Weight: 7.4 lb

Remote Control

Features

Power, source search selection, computer, video, A/V mute, freeze, user, ID num, auto, aspect, color mode, page up and down, E-zoom, volume, help, menu, enter, esc and pointer functions

Operating Angle

Right/left:

Front: ± 30 degrees

Rear: ± 30 degrees

Upper/lower:

Front: ± 30 degrees

Rear: ± 30 degrees

Operating Distance

19.6 ft

Support

The Epson ConnectionSM

Pre-sales support

U.S. and Canada 800-463-7766

Internet website www.epson.com

Service Programs

Two-year limited warranty, Epson Road Service program, PrivateLine® dedicated toll-free support (U.S. and Canada only) and 90-day limited lamp warranty

What's In The Box

PowerLite 1835 projector, power cable, computer cable (VGA), projector remote control with batteries, user manual CD, EasyMP software CD, password protection sticker

Accessory Part Numbers

Genuine Epson lamp	V13H010L61
Replacement air filter	V13H134A29
Soft carrying case	V12H001K64
50" portable roll screen	ELPSC06
60" portable roll screen (4:3)	ELPSC27
80" portable roll screen (4:3)	ELPSC28
100" roll screen (4:3)	ELPSC29
53" magnet type screen (4:3)	ELPSC30
64" magnet type screen (4:3)	ELPSC31
70" magnet type screen (16:10)	ELPSC23
80" magnet type screen (16:10)	ELPSC24
90" magnet type screen (16:10)	ELPSC25
6' computer cable	ELPKC02
10' computer cable	ELPKC09
65' computer cable	ELPKC10
Component video cable	ELPKC19
HD-TV cable	ELPKC22
Universal projector ceiling mount	ELPMBPJF
Pipe 450 mm	ELPFP13
Pipe 700 mm	ELPFP14
Wireless LAN module	V12H418P12
Quick Connect Wireless USB key	V12H005M08
USB document camera	V12H321001
Ceiling mount speaker AP-60	V12H329020
Wireless mic unit	ELPMC01
DC-06 document camera	V12H377020
Interactive unit (wall type)	V12H415020

Packaging Specifications

PowerLite 1835

Dimensions 14.1" x 19.1" x 6.7" (W x D x H)

Weight 11.33 lb

Genuine Epson Lamp

Dimensions 6.3" x 5.6" x 5.6" (W x D x H)

Weight 0.7 lb

Master Carton

Dimensions 28.4" x 13.1" x 6.8" (W x D x H)

Weight 9.5 lb

Units Per Master Carton 10

Replacement Air Filter

Dimensions 4.9" x 3.9" x 1.2" (W x D x H)

Weight 0.1 lb

Master Carton

Dimensions 12.7" x 5.2" x 4.6" (W x D x H)

Weight 1.1 lb

Units Per Master Carton 10

1 Color and white light output will vary depending on mode selected. White light output measured using ISO 21118 standard.

2 Data source: ProjectorCentral.com, Jan. 2011. Average of 1038 shipping models for which the manufacturers provided lumens and total power data, all resolutions and brightness levels.

3 Lamp life will vary depending upon mode selected, environmental conditions and usage. Lamp brightness decreases over time.

4 Recommendation based on normal room conditions. Cleaning requirements may vary depending on use, environment and other conditions. Cleaning intervals may be adjusted to accommodate the environment in which the projector is used.

5 See our website for convenient and reasonable recycling options at www.epson.com/recycle

6 SmartWay is an innovative partnership of the U.S. Environmental Protection Agency that reduces greenhouse gases and other air pollutants and improves fuel efficiency.

Epson America, Inc.

3840 Kilroy Airport Way, Long Beach, CA 90806

Epson Canada Limited

185 Renfrew Drive, Markham, Ontario L3R 6G3

www.epson.com

www.epson.ca