

Product Overview

NSR31 series is 150mA low-dropout linear regulator designed for battery-direct-connection automotive applications. Wide supply voltage range from 3V to 40V makes NSR31 series a good fit for severe operating conditions including load dump, cold cranking and start-stop.

With 5µA quiescent current at light loads, NSR31 series is quite suitable for always-on automotive applications where standby power consumption is strictly restricted.

With integrated compensation implementation, NSR31 series can be stable with low-ESR (1mΩ to 5Ω) ceramic output capacitor, ranging from 2.2µF to 100µF.

The device features integrated short-circuit-to-GND and thermal shutdown protections. This device operates in ambient temperatures from -40°C to 125°C.

Key Features

- Qualified for Automotive Applications
- 3V to 40V Wide Supply Voltage Range
- Output Current Range: Up to 150mA
- Low Quiescent Current:
 - 5µA (Typ.) at No Load
- Low Dropout Voltage: 650mV Typical at 150mA Load
- Low ESR Ceramic Output Stability Capacitor (2.2µF – 100µF)
- Integrated Fault Protection:
 - Short-Circuit-to-GND protection
 - Thermal Shutdown

Applications

- Infotainment
- Power Train
- Cluster
- Body Control Module
- Battery Connected Always-On System

Device Information

Part Number	Package
NSR31025-Q1	SOT-223, SOT-23-5, DFN-8
NSR31033-Q1	SOT-223, SOT-23-5, DFN-8
NSR31050-Q1	SOT-223, SOT-23-5, DFN-8
NSR31133-Q1	SOT-23-5
NSR31150-Q1	SOT-23-5

Typical Application

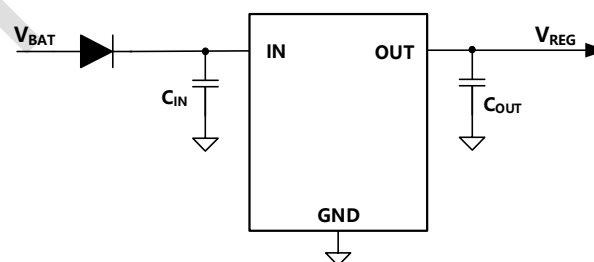

Index

1. PIN CONFIGURATION AND FUNCTIONS	3
2. ABSOLUTE MAXIMUM RATINGS	4
3. RECOMMENDED OPERATING CONDITIONS	5
4. THERMAL INFORMATION	5
5. SPECIFICATIONS	5
5.1. ELECTRICAL CHARACTERISTICS.....	5
5.2. TYPICAL PERFORMANCE CHARACTERISTICS.....	6
6. DETAILED DESCRIPTION	8
6.1. OVERVIEW	8
6.2. BLOCK DIAGRAM	8
6.3. FEATURE DESCRIPTION	9
6.3.1. <i>Input</i>	9
6.3.2. <i>Input Under-voltage Lockout (UVLO)</i>	9
6.3.3. <i>Output</i>	9
6.3.4. <i>Output Current Limit</i>	9
6.3.5. <i>Thermal Shutdown (TSD)</i>	9
6.4. TYPICAL APPLICATION.....	9
6.4.1. <i>Application Circuit</i>	9
6.4.2. <i>Input and Output Capacitor</i>	9
7. PACKAGE INFORMATION	10
7.1. SOT-223	10
7.2. SOT-23-5.....	10
7.3. DFN-8.....	11
8. ORDER INFORMATION	12
9. REVISION HISTORY	13

1. Pin Configuration and Functions

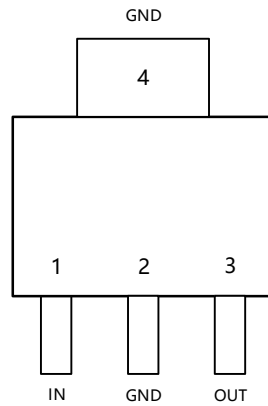

Figure 1 SOT-223 Pin-out (Top View)

PIN NO.	SYMBOL	FUNCTION
1	IN	Power supply pin.
2, 4	GND	Ground reference.
3	OUT	Regulated output voltage pin.

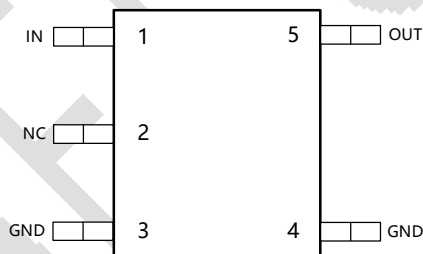

Figure 2 SOT-23 (NSR310 Version) Pin-out (Top View)

PIN NO.	SYMBOL	FUNCTION
1	IN	Power supply pin.
2	NC	Not connected.
3, 4	GND	Ground reference.
5	OUT	Regulated output voltage pin.

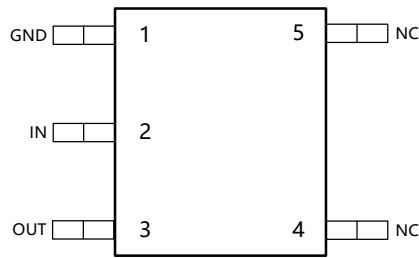

Figure 3 SOT-23 (NSR311 Version) Pin-out (Top View)

PIN NO.	SYMBOL	FUNCTION
1	GND	Ground reference.
2	IN	Power supply pin.
3	OUT	Regulated output voltage pin.
4, 5	NC	Not connected.

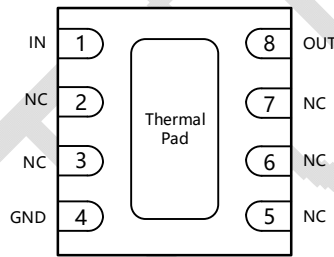

Figure 4 DFN-8 Pin-out (Top View)

PIN NO.	SYMBOL	FUNCTION
1	IN	Power supply pin.
2,3,5,6,7	NC	Not connected.
4	GND	Ground reference.
8	OUT	Regulated output voltage pin.

2. Absolute Maximum Ratings

<i>Parameters</i>	<i>Symbol</i>	<i>Min</i>	<i>Typ</i>	<i>Max</i>	<i>Unit</i>
Input Voltage of IN	V _{IN}	-0.3		45	V
Regulated Output Voltage	V _{OUT}	-0.3		20 ($\leq V_{IN} + 0.3$)	V
Junction Temperature	T _J	-40		150	°C
Storage Temperature	T _{stg}	-40		150	°C
Electrostatic discharge, Human-body model	HBM	-2000		2000	V
Electrostatic discharge, Charged-device model	CDM	-750		750	V

3. Recommended Operating Conditions

<i>Parameters</i>	<i>Symbol</i>	<i>min</i>	<i>typ</i>	<i>max</i>	<i>unit</i>
Power Supply Voltage	V _{IN}	3		40	V
Output Current Range	I _{OUT}			150	mA
Input Capacitor Value	C _{IN}	0.1	1		μF
Output Capacitor Value	C _{OUT}	2.2		100	μF
Output Capacitor ESR Value	ESR	0.001		5	Ω

4. Thermal Information

<i>Parameters</i>	<i>Symbol</i>	<i>SOT-223</i>	<i>SOT-23-5</i>	<i>DFN-8</i>	<i>Unit</i>
IC Junction-to-Air Thermal Resistance	θ _{JA}	49.6	77.1	48.0	°C/W
Junction-to-board thermal resistance	θ _{JB}	6.3	16	2.0	°C/W

5. Specifications

5.1. Electrical Characteristics

V_{IN}=13.5V, T_a=-40°C to 125°C. Unless otherwise noted, typical value is at T_a = 25°C.

<i>Parameters</i>	<i>Symbol</i>	<i>Min</i>	<i>Typ</i>	<i>Max</i>	<i>Unit</i>	<i>Comments</i>
Supply voltage	V _{IN}	3		40	V	

Parameters	Symbol	Min	Typ	Max	Unit	Comments
Supply voltage threshold (Rising)	$V_{IN,TH1}$			2.9	V	V_{IN} ramps up
Supply voltage threshold (Falling)	$V_{IN,TH2}$	2.7			V	V_{IN} ramps down
Quiescent current	I_Q		5	8	μA	$I_{OUT} = 0mA$
			6	10	μA	$I_{OUT} = 0.2mA$
Output current limit	I_{OUT_CL}	150			mA	
Dropout voltage	$V_{Dropout}$		650		mV	$V_{OUT} = V_{OUT_SET} \times 0.95$ $I_{OUT} = 150mA$
Output voltage accuracy	V_{OUT_ERR}	-2		2	%	
Line regulation	V_{Line_Reg}			30	mV	$V_{IN} = 6$ to $40V$, $I_{OUT} = 30mA$
Load regulation	V_{Load_Reg}			10	mV	$V_{IN} = 13.5V$, $I_{OUT} = 1mA$ to $150mA$
Power supply ripple rejection	PSRR		70		dB	$V_{Ripple_pp} = 0.5V$, $I_{OUT} = 10mA$, frequency = $100Hz$, $C_{OUT} = 2.2\mu F$
			40		dB	$V_{Ripple_pp} = 0.5V$, $I_{OUT} = 10mA$, frequency = $1kHz$, $C_{OUT} = 2.2\mu F$
Device thermal shutdown temperature	T_{SD}		175		$^{\circ}C$	
Device thermal shutdown temperature hysteresis	T_{HYST}		20		$^{\circ}C$	

5.2. Typical Performance Characteristics

$V_{IN} = 13.5V$, $T_a = -40^{\circ}C$ to $125^{\circ}C$. Unless otherwise noted, typical value is at $T_a = 25^{\circ}C$.

NSR31 series

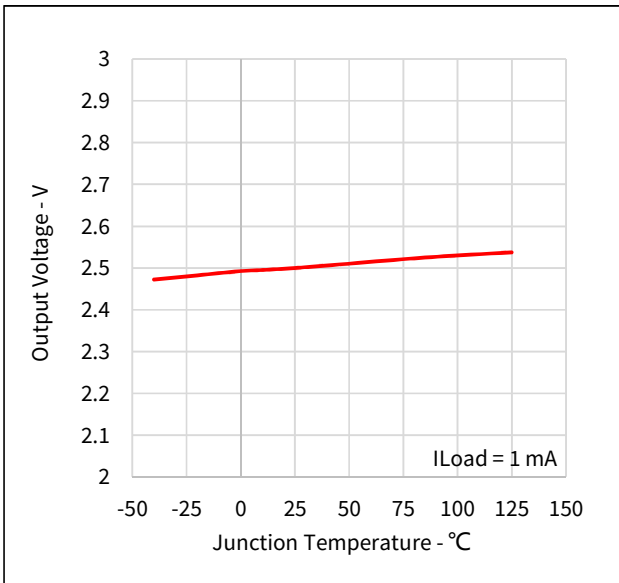

Figure 5 2.5-V Output Voltage vs Junction Temperature

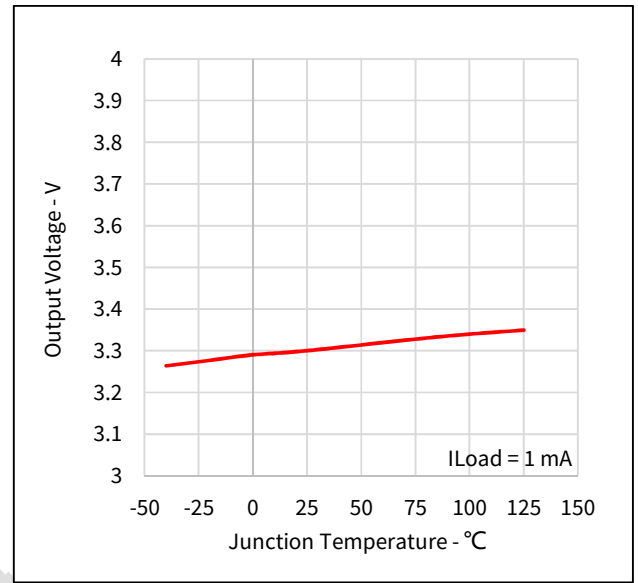

Figure 6 3.3-V Output Voltage vs Junction Temperature

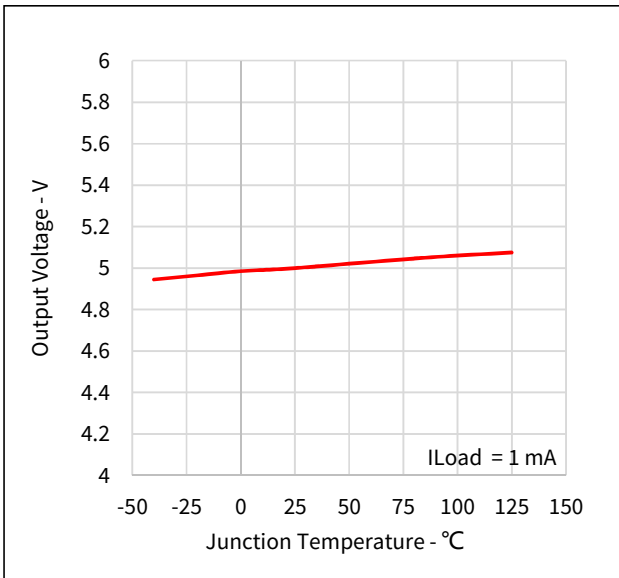

Figure 7 5-V Output Voltage vs Junction Temperature

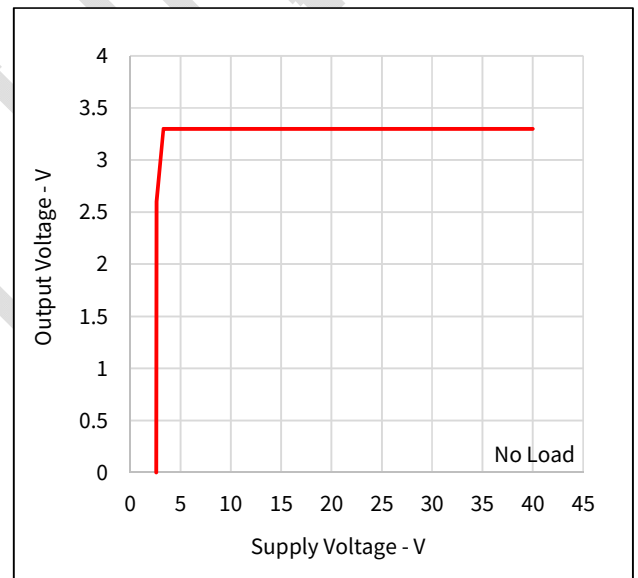

Figure 8 3.3-V Output Voltage vs Supply Voltage

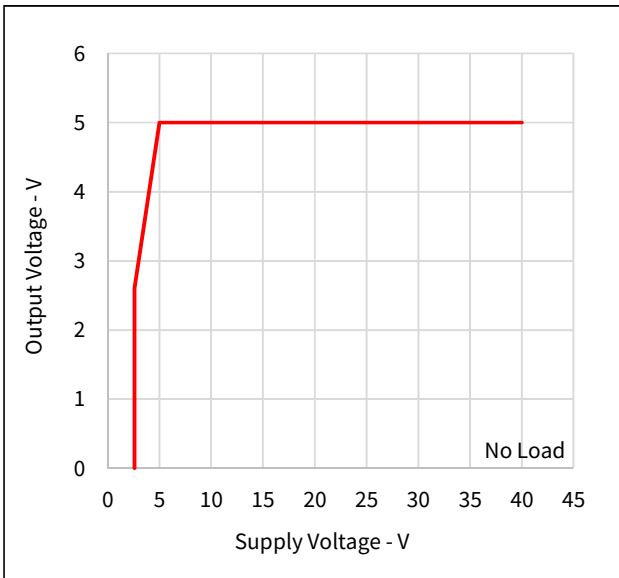

Figure 9 5-V Output Voltage vs Supply Voltage

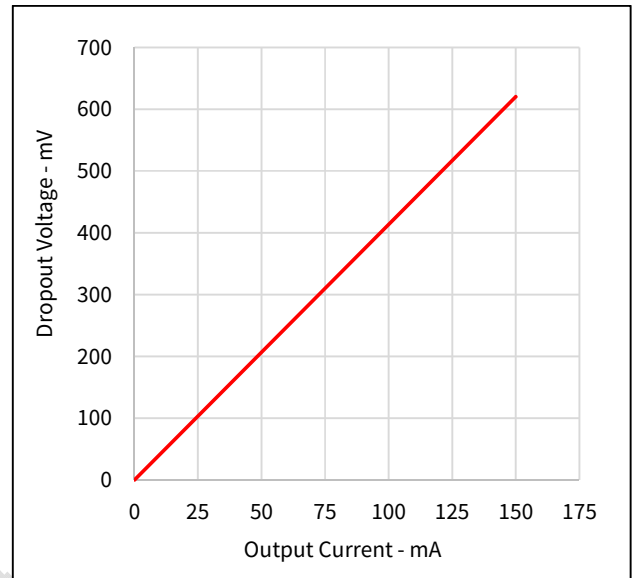

Figure 10 Dropout Voltage vs Output Current

6. Detailed Description

6.1. Overview

NSR31 series is 150mA low-dropout linear regulator designed for battery-direct-connection automotive applications. Wide supply voltage range from 3V to 40V makes NSR31 series a good fit for severe operating conditions including load dump, cold cranking and start-stop. With 5µA quiescent current at light loads, NSR31 series is quite suitable for always-on automotive applications where standby power consumption is strictly restricted. With integrated compensation implementation, NSR31 series can be stable with low-ESR (1mΩ to 5Ω) ceramic output capacitor, ranging from 2.2µF to 100µF.

6.2. Block Diagram

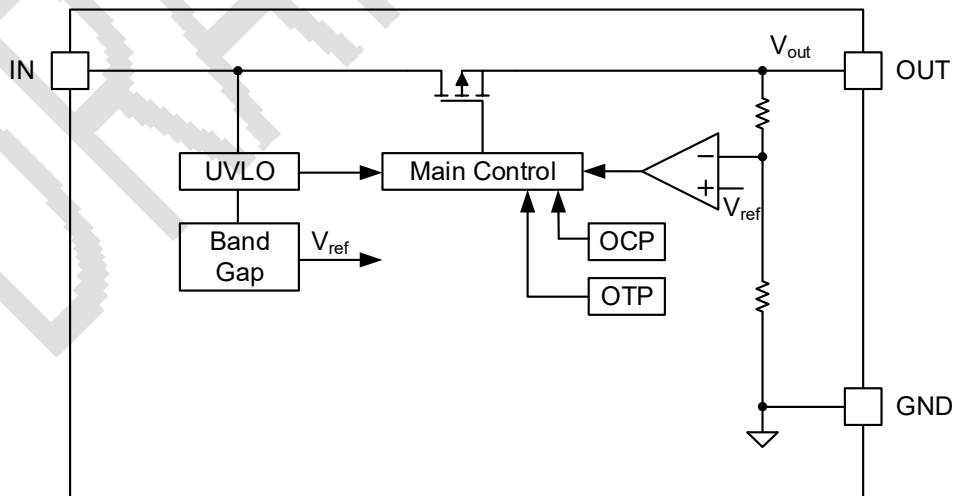

Figure 11 Functional Block Diagram

6.3. Feature Description

6.3.1. Input

The IN pin is a high-voltage-tolerant pin. A capacitor with a value higher than 0.1 μF is recommended to be connected close to this pin to better the transient performance.

6.3.2. Input Under-voltage Lockout (UVLO)

When input voltage is lower than UVLO threshold, output is shut off as the device shuts down.

6.3.3. Output

The OUT pin is the regulated by internal reference to 2.5V, 3.3V and 5V. To obtain a desired output voltage, a higher level input voltage is needed to apply in input pin. When input voltage is very close to desired output voltage in heavy load, or lower than desired output, the output tracks the input minus a drop based on the load current.

6.3.4. Output Current Limit

The output has a current limit protection, when load current is higher than current limit threshold or output is shorted to ground, output current is limited at threshold level.

6.3.5. Thermal Shutdown (TSD)

In normal working condition, the junction temperature should not exceed 150°C for long-time working stability. When junction temperature exceeds thermal protection threshold, the device shuts down immediately. When the junction temperature falls below the TSD trip point minus the hysteresis of TSD, the output turns on again.

6.4. Typical Application

6.4.1. Application Circuit

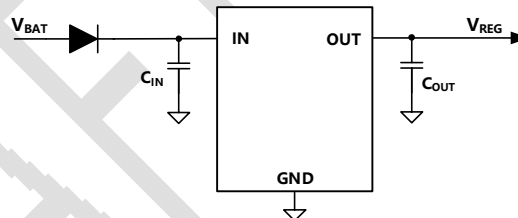

Figure 12 Typical application circuit of NSR31 series

6.4.2. Input and Output Capacitor

For input, a decoupling capacitor is needed with a minimum 0.1 μF capacitance. The voltage rating must be greater than the maximum input voltage. A low ESR, X5R- or X7R-type ceramic capacitor is recommended.

For output, the device requires an output capacitor for loop stability. The output capacitor value should be between 2.2 μF and 100 μF . The ESR value range should be less than 5 Ω . A low ESR, X5R- or X7R-type ceramic capacitor is recommended.

7. Package Information

7.1. SOT-223

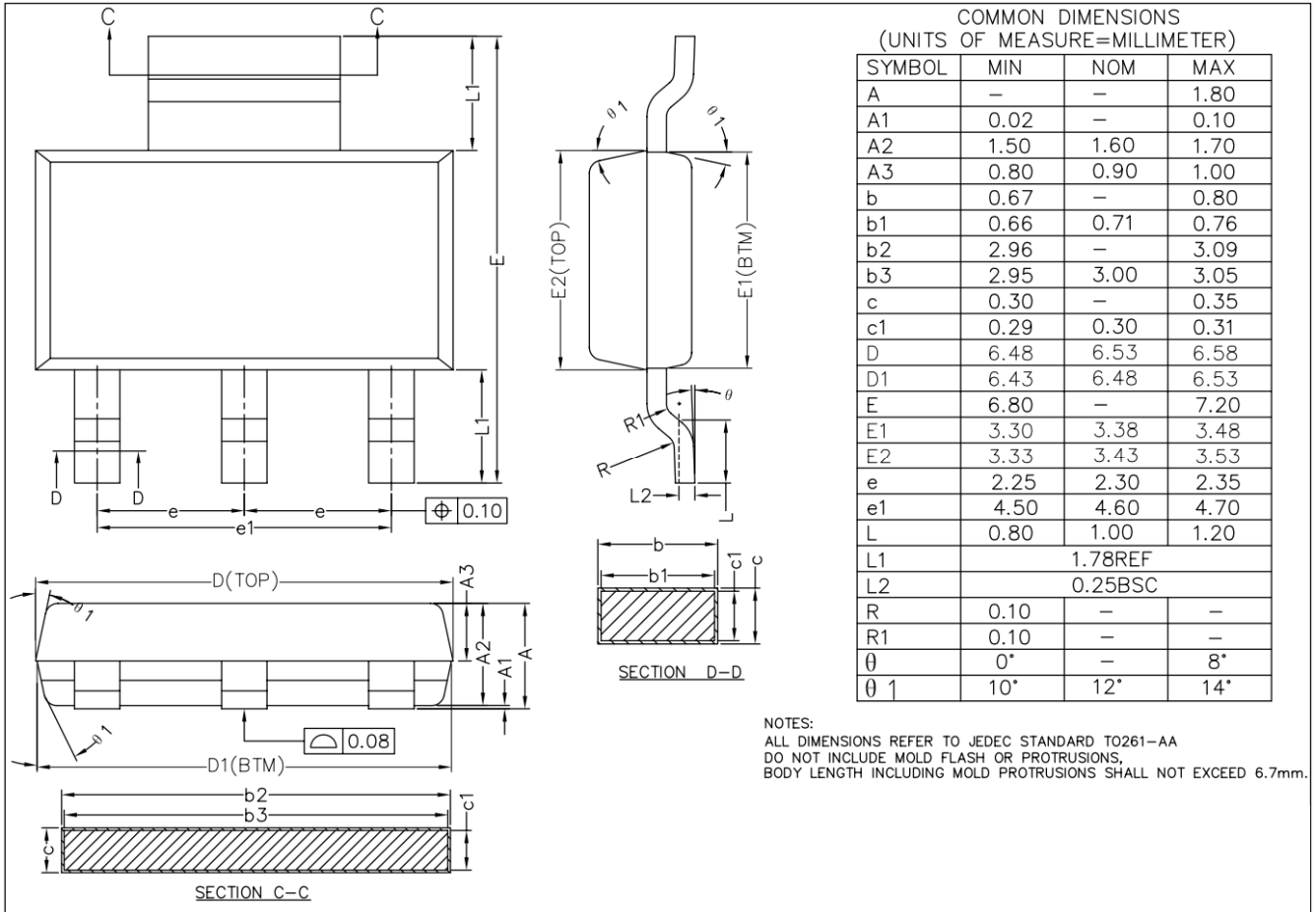

7.2. SOT-23-5



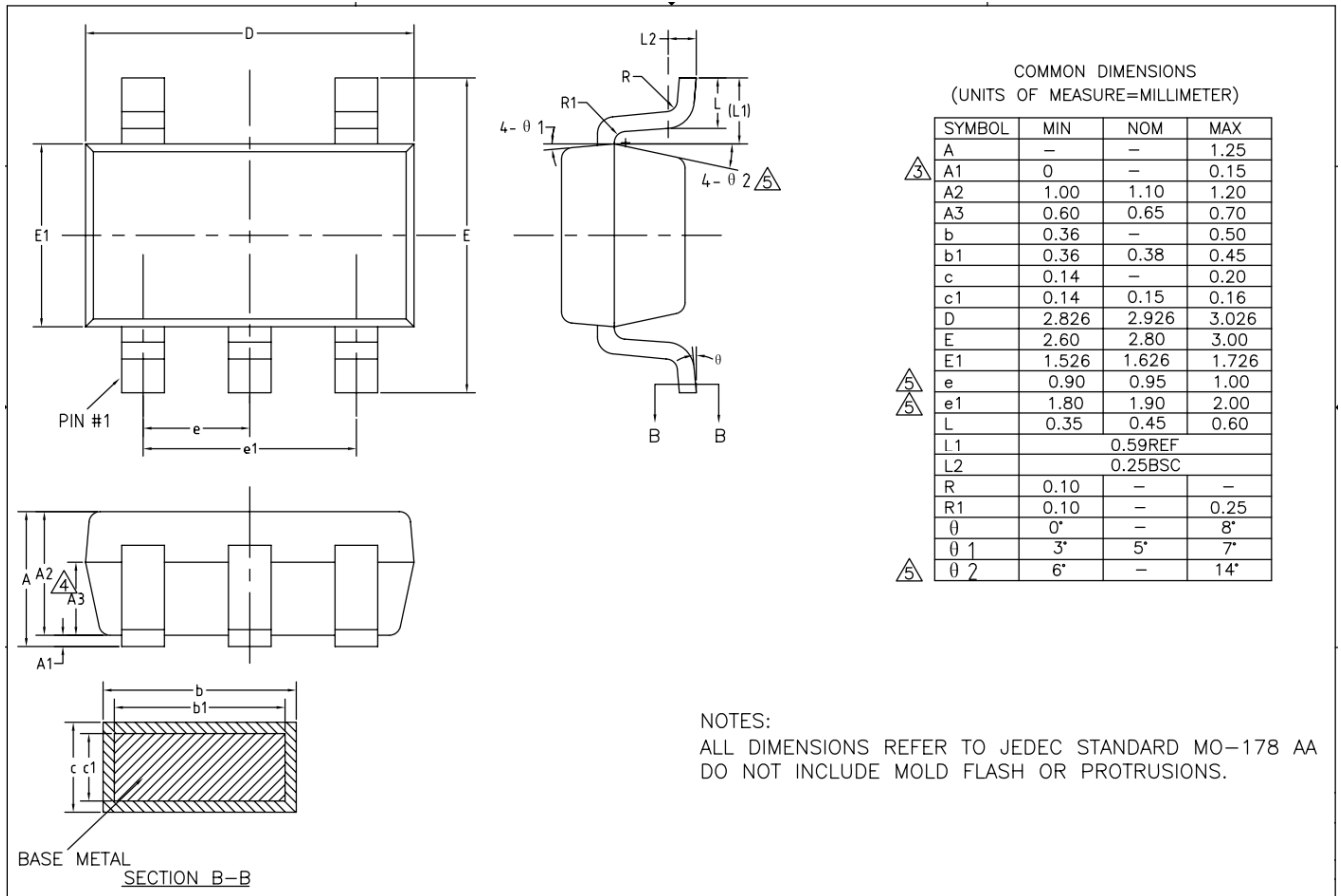

7.3. DFN-8

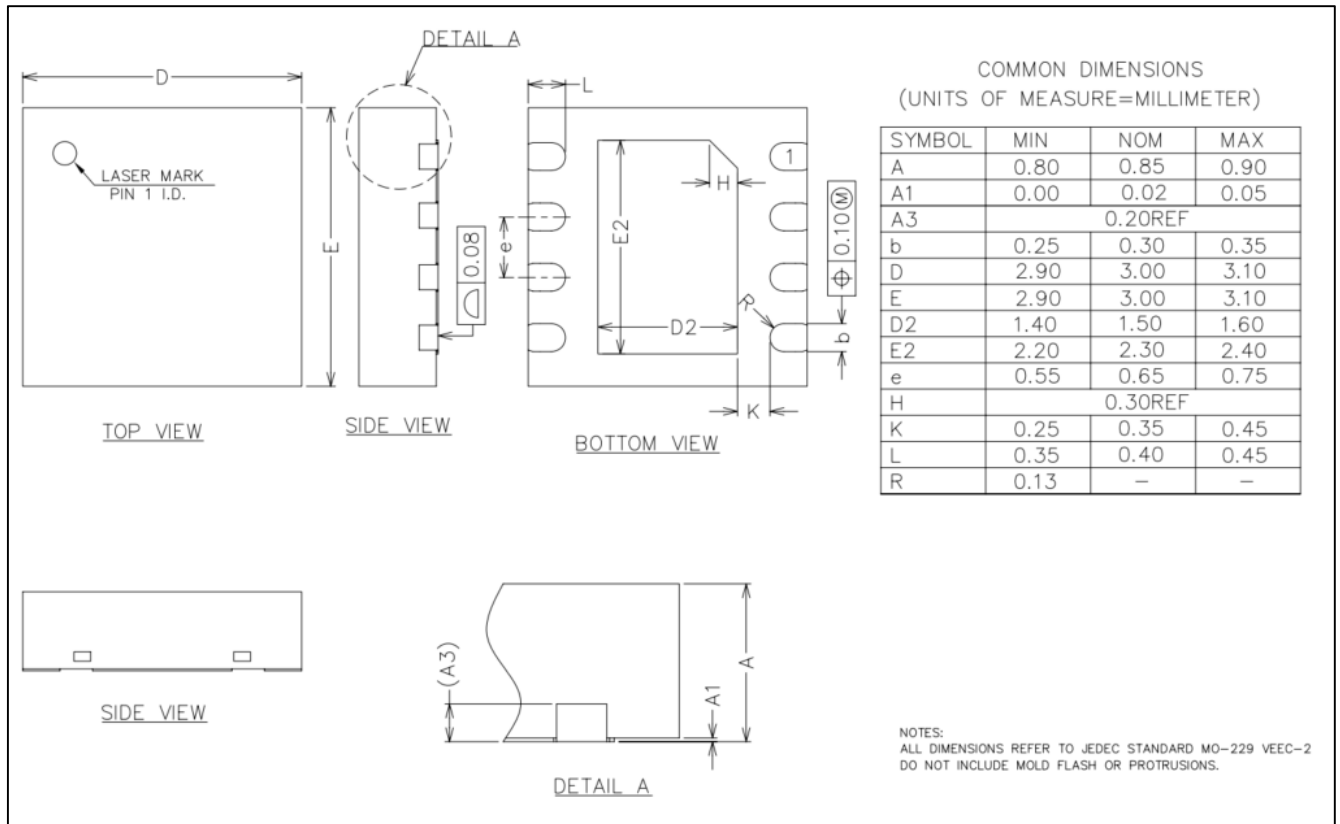

8. Order Information

Orderable Part Number	MSL	Package	SPQ
NSR31050-QSTBR	3	SOT-223	2500
NSR31033-QSTBR	3	SOT-223	2500
NSR31025-QSTBR	3	SOT-223	2500
NSR31050-QSTAR	3	SOT-23-5	3000
NSR31033-QSTAR	3	SOT-23-5	3000
NSR31025-QSTAR	3	SOT-23-5	3000
NSR31050-QDNR	3	DFN-8	3000
NSR31033-QDNR	3	DFN-8	3000
NSR31025-QDNR	3	DFN-8	3000
NSR31150-QSTAR	3	SOT-23-5	3000
NSR31133-QSTAR	3	SOT-23-5	3000

9. Revision history

Revision	Description	Date
0V1	Initial version	2021/08
0V2	Key spec updates	2022/01
0V3	Order Information updates	2022/03
0V4	Typical performance characteristics updates	2022/04