



# Trigger marks sensor

## OBP120-R100-2EP-IO-V31-L



- Miniature design with versatile mounting options
- For detecting black trigger marks on a white background
- DuraBeam Laser Sensors - durable and employable like an LED
- Extended temperature range  
-40 °C ... 60 °C
- High degree of protection IP69K
- IO-Link interface for service and process data

### Laser trigger marks sensor



# IO-Link

### Function

The R100 series miniature optical sensors are the first devices of their kind to offer an end-to-end solution in a small single standard design — from thru-beam sensor through to a distance measurement device. As a result of this design, the sensors are able to perform practically all standard automation tasks.

The entire series enables sensors to communicate via IO-Link.

The DuraBeam laser sensors are durable and can be used in the same way as a standard sensor.

The use of Multi Pixel Technology gives the standard sensors a high level of flexibility and enables them to adapt more effectively to their operating environment.

### Dimensions

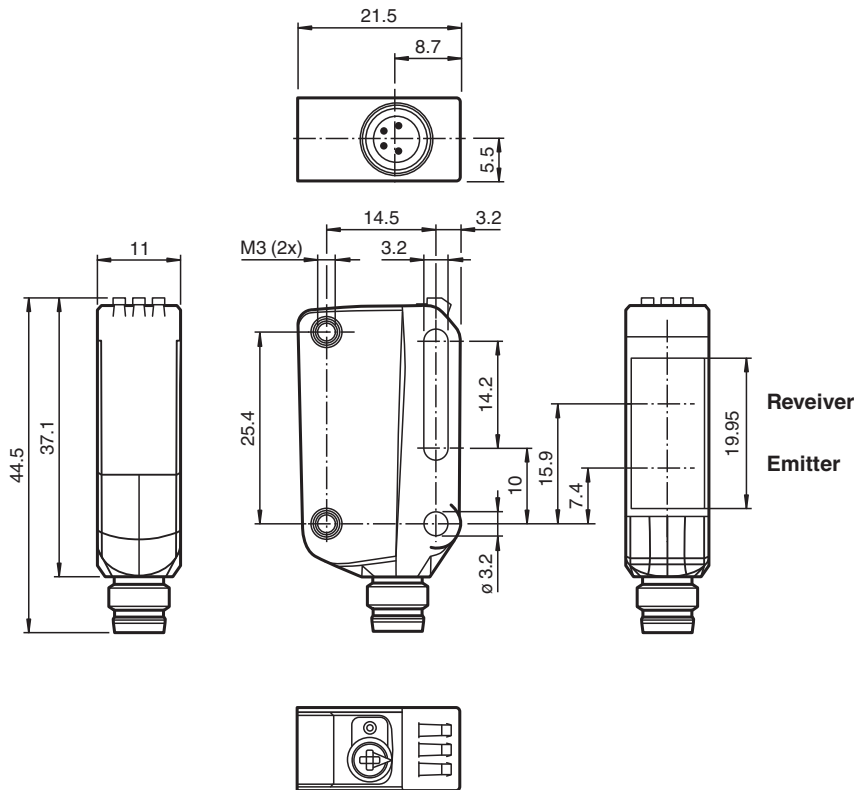

Release date: 2023-03-28 Date of issue: 2023-03-28 Filename: 267075-100510\_eng.pdf

Refer to "General Notes Relating to Pepperl+Fuchs Product Information".

Pepperl+Fuchs Group  
www.pepperl-fuchs.com

USA: +1 330 486 0001  
fa-info@us.pepperl-fuchs.com

Germany: +49 621 776 1111  
fa-info@de.pepperl-fuchs.com

Singapore: +65 6779 9091  
fa-info@sg.pepperl-fuchs.com

**PEPPERL+FUCHS**

## Technical Data

General specifications		
Detection range		25 ... 120 mm
Adjustment range		25 ... 120 mm
Reference target		standard white, 100 mm x 100 mm
Light source		laser diode
Light type		modulated visible red light
Laser nominal ratings		
Note		LASER LIGHT , DO NOT STARE INTO BEAM
Laser class		1
Wave length		680 nm
Beam divergence		> 5 mrad d63 < 1 mm in the range of 50 mm ... 250 mm
Pulse length		1.6 µs
Repetition rate		approx. 28.5 kHz
max. pulse energy		10.4 nJ
Optical resolution		Trigger mark [black, 6%] of 1 mm-wide on a white background [white, 90%]; Contrast difference of min. 50%
Diameter of the light spot		< 1 mm at a distance of 60 mm
Opening angle		approx. 0.3 °
Ambient light limit		EN 60947-5-2 : 40000 Lux
Teach-In		static and dynamic Teach-In
Functional safety related parameters		
MTTF <sub>d</sub>		560 a
Mission Time (T <sub>M</sub> )		20 a
Diagnostic Coverage (DC)		0 %
Indicators/operating means		
Operation indicator		LED green: constantly on - power on flashing (4Hz) - short circuit flashing with short break (1 Hz) - IO-Link mode
Function indicator		LED yellow: constantly on - object detected constantly off - object not detected
Control elements		Teach-In key
Control elements		5-step rotary switch for operating modes selection
Electrical specifications		
Rated operating voltage	U <sub>e</sub>	10 ... 30 V DC
Ripple		max. 10 %
No-load supply current	I <sub>0</sub>	< 20 mA at 24 V supply voltage
Protection class		III
Interface		
Interface type		IO-Link ( via C/Q = pin 4 )
IO-Link revision		1.1
Device profile		Smart Sensor
Device ID		0x110C01 (1117185)
Transfer rate		COM2 (38.4 kBit/s)
Min. cycle time		2.3 ms
Process data width		Process data input 1 Bit Process data output 2 Bit
SIO mode support		yes
Compatible master port type		A
Output		
Switching type		The switching type of the sensor is adjustable. The default setting is: C/Q - Pin4: NPN normally open / light-on, PNP normally closed / dark-on, IO-Link /Q - Pin2: NPN normally closed / dark-on, PNP normally open / light-on
Signal output		2 push-pull (4 in 1) outputs, short-circuit protected, reverse polarity protected, overvoltage protected
Switching voltage		max. 30 V DC

Release date: 2023-03-28 Date of issue: 2023-03-28 Filename: 267075-100510\_eng.pdf

## Technical Data

Switching current	max. 100 mA , resistive load	
Usage category		DC-12 and DC-13
Voltage drop	$U_d$	$\leq 1.5$ V DC
Switching frequency	$f$	3300 Hz
Response time	125 $\mu$ s	
<b>Conformity</b>		
Communication interface	IEC 61131-9	
Product standard	EN 60947-5-2	
Laser safety	EN 60825-1:2014	
<b>Approvals and certificates</b>		
Protection class		
Rated insulation voltage	$U_i$	30 V
Rated impulse withstand voltage	$U_{imp}$	800 V
UL approval	E87056 , cULus Listed , class 2 power supply , type rating 1	
FDA approval	IEC 60825-1:2007 Complies with 21 CFR 1040.10 and 1040.11 except for deviations pursuant to Laser Notice No. 50, dated June 24, 2007	
<b>Ambient conditions</b>		
Ambient temperature	-40 ... 60 °C (-40 ... 140 °F)	
Storage temperature	-40 ... 70 °C (-40 ... 158 °F)	
Pollution degree	3	
<b>Mechanical specifications</b>		
Housing width	11 mm	
Housing height	44.5 mm	
Housing depth	21.5 mm	
Degree of protection	IP67 / IP69 / IP69K	
Connection	M8 x 1 connector, 4-pin	
Material		
Housing	PC (Polycarbonate)	
Optical face	PMMA	
Mass	approx. 10 g	

## Connection

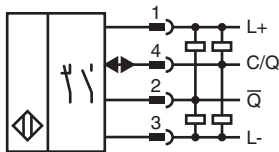

## Connection Assignment



Release date: 2023-03-28 Date of issue: 2023-03-28 Filename: 267075-100510\_eng.pdf

## Connection Assignment

Wire colors in accordance with EN 60947-5-2

1	BN	(brown)
2	WH	(white)
3	BU	(blue)
4	BK	(black)

## Assembly

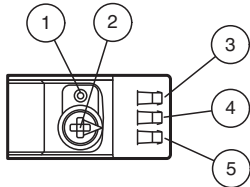

1	Teach-in button
2	Mode rotary switch
3	Operating indicator / dark on
4	Signal indicator
5	Operating indicator / light on

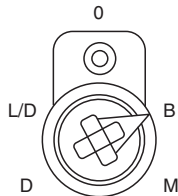

B	Teach-In background
M	Teach-In mark
D	Teach-In dynamic
L/D	Switching type
o	Keylock

## Safety Information

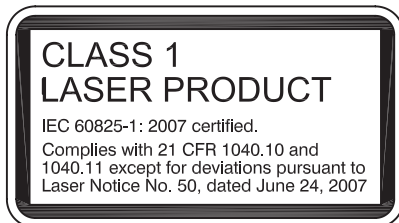

Release date: 2023-03-28 Date of issue: 2023-03-28 Filename: 267075-100510\_eng.pdf

Refer to "General Notes Relating to Pepperl+Fuchs Product Information".

## Interface

### IO-Link Function

The IO-Link operating mode is indicated by the green LED indicator with a short interruption ( $f = 1 \text{ Hz}$ ). IO-Link communication simultaneously provides process data (measurement data from the sensor) and access to service data.

The service data contains the following information:

#### Identification

- Manufacturer information
- Product ID
- User-specific ID

#### Device parameters

- Teach-in parameters
- Operating parameters
- Configuration parameters
- Device commands

#### Diagnostic messages and warnings

## Commissioning

### Teach-In Using the Rotary Switch

The settings for the following teach-ins can be adjusted directly on the device:

- Two-value teach-in
- Dynamic teach-in

Use the rotary switch to select the required teach-in mode.

#### Two-Value Teach-In

Align the light beam of the sensor to the background at the required operating distance.

##### Teaching in a Background:

1. Turn the rotary switch to the "B" (Background) position.
2. Press the "TI" button until the yellow and green LEDs flash in phase (approx. 1 s).
3. Release the "TI" button. Teach-in starts. => Yellow and green LEDs flash out of phase.
4. Wait until the green LED lights up permanently and the yellow LED flashes quickly.

The sensor is now ready for the 2<sup>nd</sup> teach-in value (mark) to be taught in.

##### Teaching in a Mark:

1. Turn the rotary switch to the "M" (Mark) position.
2. Position the mark in front of the light beam of the sensor at the required operating distance.
3. Press the "TI" button until the yellow and green LEDs flash in phase (approx. 1 s).
4. Release the "TI" button. Teach-in starts.
5. Wait until the green LED lights up permanently.

The teach-in process is now complete.

Alternatively, you can teach in the mark before the background.

**Note:** To exit two-value teach-in mode, a teach-in must always be performed in both the "B" and "M" rotary switch positions.

##### Teaching in a Mark Without a Background:

You can teach in an object as the background ("B") and as the mark ("M") if it is located at the required operating distance. Proceed as described for the two-value teach-in process.

- The sensor detects the object as a mark. => Sensor switches on.
- A lighter object color is detected as the background. => Sensor switches off.

#### Dynamic Teach-In

Requirement: The moving object to be detected has areas with sufficient contrast difference (mark/background).

1. Align the light beam of the sensor to the section of the object that will be used as the background at the required operating distance.
2. Turn the rotary switch to the "D" (Dynamic) position.

#### Starting the Teach-In Process:

1. Press the "TI" button until the yellow and green LEDs flash in phase (approx. 1 s).
2. Release the "TI" button. The dynamic teach-in process starts. => The green LED lights up permanently, while the yellow LED flashes quickly.
3. For each change in contrast, move the object between the mark and the background.

#### Ending the Dynamic Teach-In Process:

1. Press the "TI" button again until the yellow and green LEDs flash in phase (approx. 1 s).
2. Wait until the green LED lights up permanently.

The teach-in process is now complete.

#### Teach-in Errors

The teach-in may not be set correctly if there is insufficient contrast difference between the mark and the background. If so, the yellow and green LEDs flash quickly in antiphase (8 Hz).

After the visual error message has been acknowledged, the sensor continues to operate using its last valid settings.

#### Sensor Operation with Taught-In Values

For the sensor to use the taught-in values in the application, set the rotary switch to the "O" (Operate) position.

#### Switching between Light on/Dark on

Set the rotary switch to "L/D" (Light on / Dark on).

##### Changing the Switching Type:

Press the "TI" button for > 1 s.

=> Changeover successful: The respective operating indicator LED (L/D) lights up green.

##### Resetting the Switching Type:

Press the "TI" button for > 4 s.

=> Reset successful: The respective operating indicator LED (L/D) lights up green. The operating indicator is reset to the last active switching type.

#### Resetting to Default Settings

Set the rotary switch to "O."

Press the "TI" button for > 10 s until the yellow and green LEDs go out.

Release the "TI" button. The yellow LED lights up.

After completing the reset, the sensor will immediately operate with the factory settings.

## Parameterization

















For parameterization and diagnosis, the sensor can be addressed via the integrated IO-Link interface. This interface transmits process data in a cyclic manner, and diagnosis data acyclically.

For this, connect the sensor to an IO-Link primary device and connect the relevant primary device port to the IO-Link device. When communication is established successfully, the green operation display LED flashes briefly every 1 s. The sensor can then be configured or diagnosed by the overlying application and send its process data.

The sensor parameters are device-specific and are described in the standardized IO Device Description file (IODD). The IODD can be read into different engineering tools using IODD support from different system providers. The sensor can then be configured or diagnosed using the relevant tool and a user interface generated from the IODD.

The IODD file, the FDT framework application and the IODD interpreter are available in the corresponding product description under Software on our homepage [www.pepperl-fuchs.com](http://www.pepperl-fuchs.com).

## Accessories

	<b>V31-WM-2M-PUR</b>	Female cordset single-ended M8 angled A-coded, 4-pin, PUR cable grey
	<b>OMH-R10X-01</b>	Mounting bracket
	<b>OMH-R10X-02</b>	Mounting bracket
	<b>OMH-R10X-04</b>	Mounting bracket
	<b>OMH-R10X-10</b>	Mounting bracket
	<b>OMH-R1000-01</b>	Mounting bracket
	<b>OMH-R1000-02</b>	Mounting aid for R1000 series, Quick clamp and adjustment system
	<b>OMH-R101</b>	Mounting Clamp
	<b>OMH-R101-Front</b>	Mounting Clamp
	<b>OMH-R103-01</b>	Mounting bracket
	<b>ICE2-8IOL-G65L-V1D</b>	EtherNet/IP IO-Link master with 8 inputs/outputs
	<b>ICE3-8IOL-G65L-V1D</b>	PROFINET IO IO-Link master with 8 inputs/outputs
	<b>ICE1-8IOL-G30L-V1D</b>	Ethernet IO-Link module with 8 inputs/outputs
	<b>ICE1-8IOL-G60L-V1D</b>	Ethernet IO-Link module with 8 inputs/outputs
	<b>ICE2-8IOL-K45P-RJ45</b>	EtherNet/IP IO-Link master with 8 inputs/outputs, DIN rail, push-in connectors
	<b>ICE2-8IOL-K45S-RJ45</b>	EtherNet/IP IO-Link master with 8 inputs/outputs, DIN rail, screw terminal
	<b>ICE3-8IOL-K45P-RJ45</b>	PROFINET IO IO-Link master with 8 inputs/outputs, DIN rail, push-in terminals

Release date: 2023-03-28 Date of issue: 2023-03-28 Filename: 267075-100510\_eng.pdf

Refer to "General Notes Relating to Pepperl+Fuchs Product Information".

Pepperl+Fuchs Group  
www.pepperl-fuchs.com



USA: +1 330 486 0001  
fa-info@us.pepperl-fuchs.com

Germany: +49 621 776 1111  
fa-info@de.pepperl-fuchs.com

Singapore: +65 6779 9091  
fa-info@sg.pepperl-fuchs.com

 **PEPPERL+FUCHS**

## Accessories

	<b>ICE3-8IOL-K45S-RJ45</b>	PROFINET IO IO-Link master with 8 inputs/outputs, DIN rail, screw terminal
	<b>IO-Link-Master02-USB</b>	IO-Link master, supply via USB port or separate power supply, LED indicators, M12 plug for sensor connection