



# Ultrasonic direct detection sensor

## UB100-F77-E2-V31

- Miniature design
- Program input
- Degree of protection IP67
- Switching status indicator, yellow LED

Ultrasonic direct detection sensor



### Dimensions

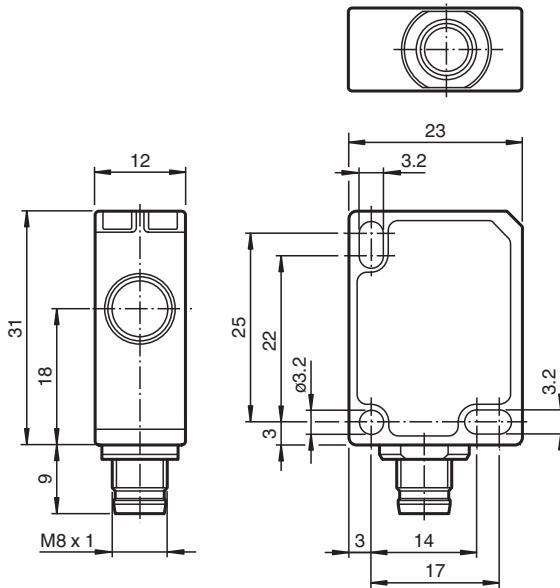

### Technical Data

#### General specifications

Sensing range	10 ... 100 mm
Adjustment range	30 ... 100 mm
Dead band	0 ... 10 mm
Standard target plate	20 mm x 20 mm
Transducer frequency	approx. 400 kHz
Response delay	≤ 50 ms

#### Limit data

Permissible cable length	max. 300 m
--------------------------	------------

#### Indicators/operating means

Release date: 2023-02-16 Date of issue: 2023-02-16 Filename: 256272\_eng.pdf

Refer to "General Notes Relating to Pepperl+Fuchs Product Information".

Pepperl+Fuchs Group  
www.pepperl-fuchs.com

USA: +1 330 486 0001  
fa-info@us.pepperl-fuchs.com

Germany: +49 621 776 1111  
fa-info@de.pepperl-fuchs.com

Singapore: +65 6779 9091  
fa-info@sg.pepperl-fuchs.com

**pf** PEPPERL+FUCHS

## Technical Data

LED yellow		switching state and flashing: Teach-In
<b>Electrical specifications</b>		
Rated operating voltage	$U_e$	24 V DC
Operating voltage	$U_B$	20 ... 30 V DC , ripple 10 % <sub>SS</sub> ; 12 ... 20 V DC sensitivity reduced to 90 %
No-load supply current	$I_0$	≤ 20 mA
Time delay before availability	$t_v$	≤ 150 ms
<b>Input</b>		
Input type		1 program input
Level		low level : 0 ... 0.7 V (Teach-In active) high level : $U_B$ or open input (Teach-In inactive)
Input impedance		16 kΩ
Pulse length		≥ 3 s
<b>Output</b>		
Output type		1 switch output PNP, NO
Rated operating current	$I_e$	200 mA , short-circuit/overload protected
Voltage drop	$U_d$	≤ 2 V
Repeat accuracy		± 1 mm
Switching frequency	f	10 Hz
Range hysteresis	H	typ. 2.5 mm
Off-state current	$I_r$	≤ 0.01 mA
Temperature influence		0.17 %/K
<b>Compliance with standards and directives</b>		
Standard conformity		
Standards		EN IEC 60947-5-2:2020 IEC 60947-5-2:2019
<b>Approvals and certificates</b>		
UL approval		cULus Listed, Class 2 Power Source
CCC approval		CCC approval / marking not required for products rated ≤36 V
<b>Ambient conditions</b>		
Ambient temperature		-10 ... 50 °C (14 ... 122 °F)
Storage temperature		-40 ... 85 °C (-40 ... 185 °F)
Shock resistance		30 g , 11 ms period
Vibration resistance		10 ... 55 Hz , Amplitude ± 1 mm
<b>Mechanical specifications</b>		
Connection type		M8 x 1 connector , 4-pin
Degree of protection		IP67
Material		
Housing		Polycarbonate
Transducer		epoxy resin/hollow glass sphere mixture; polyurethane foam
Installation position		any position
Mass		10 g
Tightening torque, fastening screws		max. 0.2 Nm
<b>Factory settings</b>		
Output		Switching point: 100 mm

## Connection

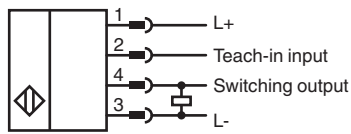

## Connection Assignment



Wire colors in accordance with EN 60947-5-2

1	BN	(brown)
2	WH	(white)
3	BU	(blue)
4	BK	(black)

## Characteristic Curve

### Characteristic response curve

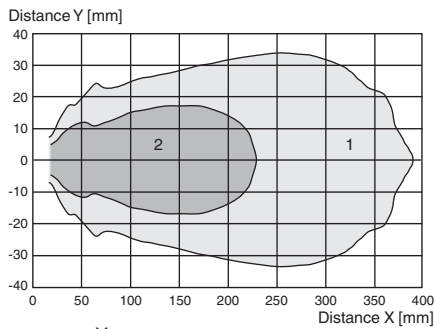

Curve 1: flat surface 100 mm x 100 mm  
 Curve 2: round bar, Ø 25 mm



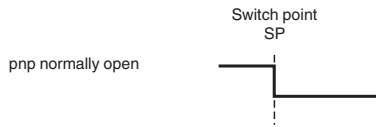

Release date: 2023-02-16 Date of issue: 2023-02-16 Filename: 256272\_eng.pdf

## Characteristic Curve

### Switch point mode



## Accessories

	<b>UB-PROG4-V31</b>	Programming unit for ultrasonic sensors with Teach-in input at pin 2
	<b>OMH-ML7-01</b>	Mounting aid for ML7 and ML8 series, Mounting bracket
	<b>V31-GM-2M-PVC</b>	Female cordset single-ended M8 straight A-coded, 4-pin, PVC cable grey
	<b>V31-WM-2M-PVC</b>	Female cordset single-ended M8 angled A-coded, 4-pin, PVC cable grey

Release date: 2023-02-16 Date of issue: 2023-02-16 Filename: 256272\_eng.pdf

Refer to "General Notes Relating to Pepperl+Fuchs Product Information".

Pepperl+Fuchs Group  
www.pepperl-fuchs.com

USA: +1 330 486 0001  
fa-info@us.pepperl-fuchs.com

Germany: +49 621 776 1111  
fa-info@de.pepperl-fuchs.com

Singapore: +65 6779 9091  
fa-info@sg.pepperl-fuchs.com

## Additional Information

### Adjustment possibilities

The sensor is equipped with a switching output with 1 adjustable switch point. The switch point is adjusted using the teach-in input of the sensor.

### Further Documentation

For information on programming via teach-in input you may refer to the commissioning instruction.