

MSK 002 Asuka and Shinji

Matthew Skala

March 1, 2015

Contents

General notes	3
Specifications	3
This package	3
PCBs and mounting	3
Panel	4
Jacks	4
Transistors	4
IC op amp	6
Capacitors	6
Resistors	7
Voltage	8
Use and contact information	8
Safety and other warnings	9
Bill of materials	10
Build step-by-step	11
Preliminaries	11
Resistors	12
Semiconductors	13
Capacitors	15
Final assembly	16
Patch ideas	20
Circuit explanation	21
Input	21
Transistor amplifier	22
Mixing network	23
Third-stage amplifier	24
The rest of the circuit	25
Waveform samples	26

General notes

This is documentation for the MSK 002 Asuka and Shinji. This is a dual fuzz/distortion module for use in a Eurorack modular synthesizer. The circuit is designed to make interesting use of some vintage electronic components that came into my possession. It uses roughly the same circuit topology the venerable Mosrite Fuzzrite guitar pedal designed in the 1960s by Ed Sanner, but with significant modifications to use available parts and work with Eurorack power and signal levels. Please note that it does not and is not meant to *sound just like* a Fuzzrite; it is merely a *similar circuit topology*.

I designed this module around the parts I had on hand, some of which would be difficult to source if I did not already have them. Although I am providing plans and instructions to build a module exactly like mine, what I expect is that someone using these plans will probably *not* really build a module exactly like mine, but instead modify it as necessary to suit their own taste and available parts, creating a unique result.

As such, this project, although electrically quite simple and relatively fool-proof, is intended for more advanced builders who are comfortable with making changes to the plans and doing their own thing.

I strongly recommended that you should bread-board your version of this circuit with the specific components you will use, try a few variations, and choose the one you like best, before constructing it in a more permanent form.

Specifications

This module, as I built it and in normal use, draws about 10mA from both the +12V and -12V Eurorack supplies. In output-clipping conditions with a low impedance connected to the output, it may draw more. It does not use +5V power.

The input impedance is roughly 700k Ω per channel. If only one input cable is connected, it will drive the two inputs in parallel, and see about 350k Ω . No ordinary voltage level on the input will damage it.

The outputs are op amp outputs (no specified short-circuit current in the data sheet that I could

find) with 1k Ω protection resistors, probably capable of sourcing or sinking about 8mA into a dead short.

The maximum output voltage is about $\pm 10V$, that is, 20V peak to peak. *Note this is significantly more than Eurorack standard.* Driving the Asuka and Shinji module into such a condition will not damage the Asuka and Shinji module, but you are responsible for knowing and respecting the limits of whatever you plug it into.

This package

You should have received this as a ZIP file containing:

- This PDF file.
- A Schaeffer “Front Panel Designer” .fpd file for a Eurorack 8HP front panel.
- Various Gerber .gbr and drill machine .cnc files that may be used to manufacture boards. These were generated by gEDA PCB on its default setting and are the exact files I used to have my boards manufactured at OSH Park. Most PCB fabs can probably read them.

PCBs and mounting

The enclosed PCB design is for a basic two-layer board with top and bottom ground planes. There shouldn't be anything terribly difficult about getting it fabricated by OSH Park or any other contractor. The circuit could, of course, also be built on strip-board, with point-to-point wiring, or by any other method.

As I built it, this is a *dual* fuzz module, with two circuit boards; if you are building one just like mine, you will need to make two identical PCBs and then populate them slightly differently. A little bit of circuitry is shared between the two boards; in particular, the op amp is a dual unit (because that is what the one I wanted to use, was) and the second board just connects back to it instead of having a second op amp chip. The power connector is similarly shared, and the inputs are normalised across so one can drive both fuzz units with a single input. In principle, one

could make a multi-channel unit with more than two of these boards, or a single-channel unit with only one.

Each PCB is 4.3"×1.7", or 109.2mm×43.2mm. They are designed to mount perpendicular to the panel (using the jacks and pots for support) in a Eurorack case at least 44mm deep, but the boards include mounting holes that could be used to support them in some other configuration, for instance in another format.

Panel

The enclosed panel design is compatible with Eurorack (8HP for a dual module) and Schaeffer AG's manufacturing service. Front Panel Express is the US arm of the same business and should also be able to fabricate this design. There are plenty of other options for making a panel and this one is not necessarily the cheapest or best, but the result is very pretty, anyway. I used 2.0mm anodized aluminum. The jacks I used will not work well with anything thicker.

My panel layout is based on mounting both the jacks and the pots directly on the PCB. That puts their centres at different distances from the PCB (5.5mm for the jacks and 6.95mm for the pots); so the holes in the panel are placed accordingly and these holes do not line up horizontally when viewed from the front in the finished module. Also, the overall horizontal alignment of the potentiometer holes is centred on the panel. That places one of the boards very near the edge of the panel, with some of the component legs sticking out a millimetre or so further, into the next module's space allocation. These things may not be the ideal physical design.

If I were doing it over, I would consider placing the holes for the pots slightly off centre, or horizontally closer together, or both, in order to move that board away from the edge of the panel and increase the horizontal clearance to the next module. There is also enough spare length in the jack legs that it might be possible to mount those with some clearance from the board instead of firmly seated on it, with the legs still far enough into the holes to solder, so that all the holes in each column end up aligned or closer to aligned than in my original construction. That might look nicer. Of course, using different pots or different jacks might also be possibilities. These are the kinds of things I would attempt to sort out definitively if I were designing modules for sale on a commercial scale. As a one-off module for my own use and a

set of plans shared with other hobbyists who will be making their own modifications, it's fine as it stands.

Jacks

My PCBs were designed for use with Lumberg 1503 12 switched mono 1/8" barrel jacks, but I ended up also using some CUI Inc. MJ-3536 jacks in the final build. The CUI jacks are slightly deeper, but still fit reasonably well in the PCB footprint designed for the Lumberg jacks; there is enough extra space in the circular holes to accommodate the change in pin location. One could instead mount jacks of any kind to the panel and not the board, with wires connecting them to the appropriate locations on the board.

Transistors

Musicians and manufacturers have built up a mystique around vintage components, especially the transistors in fuzz pedals. You can find endless discussion of the merits of germanium versus silicon, PNP versus NPN, different kinds of capacitors and resistors, and so on. You can buy individual transistors selected for specific artistic effects in specific circuits and described with the kinds of adjectives beloved by wine reviewers. *This is almost all bunk.* Such claims make little to no electrical sense, especially at audio frequencies. What a fuzz pedal does to a signal is, electrically speaking, not all that complicated and not all that subtle.

Nonetheless, superstitious attention to components is fun, and it's somewhat unavoidable in a module like this one. I can tell you the detailed story of where and how I got the older-than-I-am metal-can germanium PNP transistors in the Asuka channel of my prototype module, and someone with more historical knowledge than me could tell you all about how Jimi Hendrix helped popularize the "warm" germanium fuzz sound, even though his most famous work used the "cold" *silicon* fuzz sound, and so on, and all that has some value in making this piece of electronic equipment a work of art. It is not necessary for such considerations to really make an audible difference that could be detected in blind A/B tests on the signal that comes out.

So to play this game, put yourself into the frame of mind of someone who thinks component selection really matters, and choose the transistors you will use on the basis of whatever considerations you think are relevant. Get out your Ouija board. . .

I tested the following transistor models:

- 2N3904: silicon NPN, TO-92 package, rated for

$h_{FE} \geq 80$ at 1mA and maximum gain at 10mA. This is a generic low-end general-purpose transistor, used as a scratch monkey (i.e. to make sure the circuit worked at all when I first powered it up) rather than risking a more expensive transistor.

- 2N4401: silicon NPN, TO-92 package, rated for $h_{FE} \geq 40$ at 1mA and maximum gain at 150mA. A general-purpose amplifier transistor, running (in this circuit) significantly below its gain peak.
- 2N2222A: silicon NPN, TO-18 package, rated for $h_{FE} \geq 75$ at 1mA and maximum gain somewhere between 10mA and 150mA. Another very popular transistor, mostly intended for use as a switch.
- 2N4126: silicon PNP, TO-92 package, rated for $h_{FE} \geq 120$ at 2mA and $h_{FE} \geq 60$ at 50mA. The Fairchild data sheet implies this transistor is closely related to the 2N3906 (maybe a selected cut of 2N3906 production?); that in turn is the complementary partner to the 2N3904.
- 2N1274: germanium PNP, TO-5 package. I bought these many years ago from an old-timer, and I think they may have once come from a Heathkit package. Data is hard to find, but the damn “Data sheets here, sorry, actually this is just a link to a Chinese factory that is willing to custom-manufacture transistors in general that may or may not be compatible!” Web sites seem to agree that this type should be rated for h_{FE} minimum about 25 or 30, with 100 typical, and maximum current 150mA.

I decided to build my module using 2N2222A and 2N1274 transistors, largely just because I like the metal can packages and have stories to tell about these particular transistors, but also based on the sound and my desire to have the two channels in the module sound different from each other. As discussed in more detail below, I think h_{FE} , and whether the transistors in a given channel are the same or opposite NPN/PNP type, are the main factors influencing the sound. Silicon or germanium makes a difference indirectly because it correlates to lower or higher h_{FE} . The circuit design is such that almost any bipolar transistor can be used for each of the four transistors (two each in two channels) in the module.

I call the two channels of my module “Asuka” for the germanium 2N1274 channel on the left, and

“Shinji” for the silicon 2N2222A channel on the right. Mnemonic: “Asuka” is a German character in a famous Japanese anime series, and that board is built with *germanium* transistors; “Shinji” (another character from the same series) can be spelled “*Sinji*” (no “h”) depending on your transliteration standard, and Si is the chemical symbol for silicon. It also seems reasonable to use characters of opposite sex because people sometimes refer to the PNP/NPN distinction as the sex of a transistor. I had to call them something. Those names are used in these build instructions to designate the two boards where they differ.

If you build a different configuration from mine, you’re on your own for how to name any channels that mix silicon and germanium in the same channel, or two or more channels using the same semiconductor. There are a few other differences between the two boards in my module: the Eurorack power cable connects to the Asuka board and the power gets filtered there before being fed to the Shinji board through discrete wiring, and the op amp IC is mounted only on the Asuka board.

Whether a transistor is NPN or PNP affects which side of the signal will be clipped when the signal clips against ground, as happens in this circuit. With a symmetrical signal and only one transistor clipping stage, it makes no difference whether the plus or minus side is being clipped; the two will sound the same. But because the Fuzzrite topology plays off two transistors against each other, that creates a transistor-selection issue that does have very solid electrical validity: if you use two transistors of opposite type (one NPN and one PNP) in the same channel of this circuit, you get a different result from what you get if you use two that are the same type (two NPNs, or two PNP). With the same type, the first stage clips one side and inverts the signal, so that the second stage clips the other side. With differing types, both stages end up clipping the same side of the signal because of the inversion between stages. This is real and visible on an oscilloscope trace, and it also makes some definite audible difference depending on the control settings.

After trying each possibility, I think using transistors of the same type (both NPN or both PNP) in each channel sounds a lot better, and I don’t recommend trying to combine an NPN with a PNP in the same channel of a Fuzzrite-topology circuit. However, my PCBs are designed with separate configuration jumpers for the two transistors of each channel, so you *can* build it like that if you want to. In such a

case you must be sure to provide both kinds of power (+12V and -12V) to the board in question; that will be mentioned again at the appropriate point in the step-by-step build instructions.

Mixing two transistors of the same NPN/PNP type, but different models of transistor and even different materials (that is, one silicon and one germanium) is perfectly possible given the circuit design and it may well be a good idea. I have not tried very many configurations of this kind, but encourage you to do so.

My subjective unscientific conclusion from breadboard experiments is that what's really going on with transistor selection here is that the transistor's *gain* (β or h_{FE} , which have different technical definitions but measure basically the same thing*) is what matters to the sound in this circuit. Other effects are insignificant by comparison. Present-day digital multimeters often have a "transistor gain" range which will give you a quantitative measurement of this parameter, but be warned that it may not work properly on germanium transistors because their higher leakage current throws off the measurement.

Germanium transistors usually have lower gain, and have gain that varies more on a per-transistor basis, making selection of individual germanium transistors a reasonable proposition. Silicon transistors usually have higher gain, and more consistent gain among different individuals of the same model.

For a warmer and more vintage-type sound, you want relatively low gain, which points toward germanium as a good choice. For a colder and more modern-type sound, you want relatively high gain, which points toward silicon. For the widest range of different sounds accessible through the control knobs, you want the first transistor (Q1) to have somewhat though not overwhelmingly lower gain than the second (Q3). This is *not* an exponential converter, where you would want matched transistors. To really push the distortion to the maximum, you might want the first transistor to have higher gain than the second. You want the two transistors to be of the same NPN/PNP type, and germanium transistors more often tend to be PNP whereas silicon transistors more often tend to be NPN, but NPN/PNP type does not otherwise matter. That summary seems to well explain all the transistor-related effects in this circuit

*Note I am using DC gain where I have a choice, both because it's more often specified in transistor data sheets, and because audio is usually closer to DC than to the high frequencies where they measure AC characteristics anyway.

that I observed in my testing and am sure really exist. Anything else I am inclined to attribute to superstition.

Transistors should be rated for the full power supply voltage used, but this is unlikely to be an issue in practice.

IC op amp

This circuit under some extreme control settings is capable of causing clipping *in the IC op amp stage* instead of the transistors, and in principle, one could talk about selecting an op amp chip for the best sound. I used a vintage metal can 1458 op amp in my module because it looks cool and has a story, but I don't believe that this really makes a difference to the sound. I think nearly any op amp in this circuit, even an old one, will produce the same type of clean clipping and won't have an audibly different effect.

The PCBs have dual footprints for an 8-pin TO-5 metal can like mine, or an 8-pin DIP (probably much easier to source). Use a standard 8-pin dual op amp chip. Virtually all of these share the same pinout and will fit in one or the other of the two footprints. One such chip is required for two channels of fuzz; on the second board the footprint is left empty, with jumpers back to the first board to make use of the second channel on the op amp chip.

You must use an op amp chip rated for your power supply voltage, and this may be especially relevant if you are using the circuit in a $\pm 15V$ synthesizer format instead of Eurorack. The 1458 is good up to $\pm 18V$, but some others are limited to $\pm 12V$.

If you build an odd number of channels, then you will have one op amp left over, and you are on your own for making appropriate connections to neutralize it safely.

Capacitors

When I built this circuit I had a pile of old $0.47\mu F$ ceramic disc capacitors I wanted to use, and the circuit is designed around them for coupling between stages and power supply decoupling. Ceramic disc capacitors, especially in such large values, are no longer so common as they once were. Bearing in mind that these were never fancy capacitors to begin with, I would not recommend trying very hard to source identical capacitors to mine. They will be expensive and not worth it. Instead, you should use what you have or can easily get, in roughly the same size and value. That will likely end up being plastic film, or maybe the "multi-layer" ceramic capacitors sold

nowadays, which are really just surface-mount chip capacitors with leads attached and dipped in conformal coating so you can pretend they are through-hole components. Seriously, break one apart sometime. Of course you can also spend as much as you want on fancy vintage capacitors. I think the “tropical fish” style are very pretty.

The holes on the PCBs are $0.400''=10.16\text{mm}$ apart. Any substitute capacitor should either have similar spacing, or axial leads that can be bent, or else you’ll have to find some other way of mounting it. Be aware of the horizontal sizes of your capacitors (especially relevant with plastic film-in-a-box type) and make sure they will fit side by side; it’s not only necessary that the leads should be the right distance apart. The PCB footprints for the capacitors are on $0.150''=3.81\text{mm}$ centres and capacitors wider than that may cause trouble.

I think it should be okay to substitute values for these capacitors from $0.2\mu\text{F}$ to $1.0\mu\text{F}$ (i.e., up or down by a factor of two) without needing to change resistor and other component values. Using $0.1\mu\text{F}$ throughout would be convenient and could *maybe* work, but I’d be concerned that that might be pushing it too far, and kill the bass response. *Test your selection before building permanently.*

The circuit as I built it also uses one $0.1\mu\text{F}$ capacitor per board at C2. This was chosen empirically after breadboard testing, to suppress ultrasonic ringing from feedback between the two transistor stages when the input level is very low. See comments in the circuit explanation. The optimal value for this capacitor may change depending on transistors and substitutions you make to the other capacitors; and this capacitor may not be absolutely necessary at all; but the $0.1\mu\text{F}$ value seems to work well across the board in my tests. I tried using another of my surplus $0.47\mu\text{F}$ discs and that was too large; it harmed the sound. Even $0.1\mu\text{F}$ limits the high-frequency response in a measurable way, but it sounds good to me. Unless you’re willing to spend some time going through the whole circuit with test equipment, my suggestion is not to change or omit the suggested capacitor. I used axial-lead ceramic capacitors here, with the same $0.400''$ footprint as the discs.

Finally, I have specified two $22\mu\text{F}$ aluminum electrolytic capacitors for power supply filtering, again because those were what I had handy. Other capacitors of the same general type and values up to a few hundred μF would be fine; this is not a critical part of the fuzz circuit, just an effort to cut down

on the global hum and noise problems that come from my Eurorack case’s poorly-filtered power rails. Aluminum electrolytic capacitors should be rated for a working voltage at least the power supply voltage (12V for Eurorack) but not far more than that, because the dielectrics will degrade if they run far below rated voltage.

Resistors

I used the resistors I had in the specified values, which were an assortment of many different types ranging from $1/8\text{W}$ to $1/2\text{W}$ (and a few that look like they might be 1W , but I’m not sure). None of the resistance values is critical; 10% tolerance would be fine, though in practice you are unlikely to easily find any worse than 5% unless they are very old indeed.

I have read just one credible article making a case for why carbon composition resistors might sound different from others—in certain very limited cases. The thing is that because the “composition” from which they are made is a granular kind of material, the electricity flows through very many junctions between differing substances, and *at high voltages*, namely hundreds of volts, those junctions can start to act like point-contact diodes, with nonlinear current/voltage curves. That would reasonably be expected to create even harmonics, and a sound people might like. Such an effect can be observed in the laboratory if you take pains to isolate it. But if it has an audible effect in real life at all, it would only be relevant when there are hundreds of volts across the resistor, as in some parts of some tube amplifier circuits. This does not translate into any legitimate reason to prefer carbon composition in low-voltage solid-state guitar pedals or a synthesizer module like the “Asuka and Shinji.”

After some experimentation with resistor values, I like the ones shown in these instructions for all the transistors I tested. In principle, one could imagine that different transistors and different sonic styles would be better served by different choices of resistor values, particularly the bias resistors R3, R4, R6, and R7. If you want, you can try experimenting with other values and use the ones you like. Think about how much current you will be placing through the transistors and whether they are rated for it (both in terms of power limits and gain performance) before you make any really drastic changes to bias.

With the specified resistance values, most common present-day transistors will self-bias to an operating point around 1mA and 4V at the collector. You want the collector to end up roughly midway between

ground and the nominal 12V supply. A nice property of the self-bias configuration is that it is to a large extent self-adjusting, and will automatically provide a reasonable bias across a wide range of transistor parameters without fine tuning. The ratio of resistances I suggest implies an assumption that each transistor's DC current gain is on the order of 100, which is a little low for modern transistors but intended to accommodate lower-gain vintage components too. If it is drastically different from reality (like by a factor of more than five) in either direction, then a change in the resistance ratio might be necessary to get a reasonable collector voltage. Most transistors achieve their maximum gain at somewhat higher current levels than in my circuit, and are intended by their manufacturers to be used (as *non*-distorting amplifiers) at the operating point where they achieve maximum gain, but my experiments suggest that the distortion sounds better at gain levels below the maximum.

Resistor values may also be relevant to input and output signal levels. The ones shown (particularly the 680k Ω resistor R1 at the input) are chosen for compatibility with my Eurorack devices; with these values, the module also has just barely enough gain to be used as a relatively non-distorting amplifier for the headphone signal from a Gakken NSX-39 "Pocket Miku," bringing that up to modular levels. I could imagine someone possibly wanting a smaller input resistor, to increase the output level from the first transistor stage (changing the sweet spots on the mixture control) and reduce this resistor's contribution to the overall noise level. The resistor ratios around the op amp stage, which set its gain, may also be of interest to experimenters.

Voltage

This circuit is designed and tested for $\pm 12\text{V}$ Eurorack power. I expect it should work unmodified in a $\pm 15\text{V}$ environment as long as you use components rated for the appropriate voltage; I have not tested that. The output level (which can go as hot as the op amp chip will allow) may be slightly higher than most $\pm 15\text{V}$ synthesizers expect, since they usually keep more headroom between the power and signal voltages than is typical in Eurorack. You could reduce the output gain somewhat by decreasing the value of R11, reducing the likelihood of driving the op amp to clipping levels, but actually reducing the maximum possible output level would require more significant changes to the circuit.

Use and contact information

The basic circuit topology is well known, and any patents on it have long since expired. I cannot claim that to be original. This PCB design, and the specific details of component selection (which define the sound) are original with me. I am happy to have people build and modify this design *even commercially* without further permission, but I want to be credited as the designer of whichever parts of my work you use.

I'm posting this and other electronics projects at <http://ansuz.sooke.bc.ca/electronics.php>. That would be a good place to look for updated versions or other related material. My Soundcloud account, which usually includes tracks recorded with this and other homemade electronics, is at <https://soundcloud.com/matt-skala/>. I can be found on the Muff Wiggler Forum as "mskala," but although others are welcome to do so, I don't plan to host build threads for this or my other projects there.

Email should be sent to mskala@ansuz.sooke.bc.ca.

Safety and other warnings

I offer no warranties whatsoever regarding these instructions and you follow them at your own risk.

Ask an adult to help you.

Soldering irons are very hot.

Solder splashes and cut-off bits of component leads can fly a greater distance and are harder to clean up than you might expect. Spread out some newspapers or similar to catch them.

Lead solder is toxic, as are some fluxes used with lead-free solder. Do not eat, drink, smoke, pick your nose, or engage in sexual activity while using solder, and wash your hands when you are done using it.

Solder flux fumes are toxic, *especially* from lead-free solder because of its higher working temperature. Use appropriate ventilation.

Some lead-free solder alloys produce joints that look “cold” (i.e. defective) even when they are correctly made. This effect can be especially distressing to those of us who learned soldering with lead solder and then switched to lead-free. Learn the behaviour of whatever alloy you are using, and then trust your skills.

Water-soluble solder flux must be washed off promptly (within less than an hour of application) because if left in place it will corrode the metal. Solder with water-soluble flux should not be used with stranded wire because it is nearly impossible to remove from between the strands. Stranded wire is recommended for the connections between boards in this module, and those connections, at least, should *not* be soldered with water-soluble flux.

This module has a high enough impedance in the input circuit that residue from traditional rosin-based solder flux could possibly interfere with normal circuit operation. If your soldering leaves a lot of such residue then it might be advisable to clean that off. I used a “no-clean” rosin flux throughout my module, it produced very little residue, and this was not an issue for me.

Voltage and current levels in some synthesizer circuits may be dangerous.

Building your own electronic equipment is seldom cheaper than buying equivalent commercial products,

due to commercial economies of scale from which you as small-scale home builder cannot benefit. If you think getting into DIY construction is a way to save money, you will probably be disappointed.

Bill of materials

Part references marked with a star \star are mounted only on one board; all *others* are for both boards and therefore counted twice in the quantity. The transistors are a special case—both boards have parts named Q1 and Q3, but they are different parts between the two boards and so listed separately.

Qty	Ref	Value/Part No.	
10	C1, C3, C4, C6 \star , C8 \star , C9	0.47 μ F	ceramic disc, 0.4" lead spacing
2	C2	0.1 μ F	axial ceramic
2	C5 \star , C7 \star	22 μ F	radial aluminum electrolytic, 0.1" lead spacing
2	D1 \star , D2 \star	1N4001	silicon rectifier diode
4	J1, J5	1503 12	audio jack (Lumberg; or use CUI MJ-3536)
1	J3 \star	2 \times 5	0.1" pin header (Eurorack power connection)
2	Q1 \star , Q3 \star	2N1274	germanium PNP transistor, TO-5 case
2	Q1 \star , Q3 \star	2N2222A	silicon NPN transistor, TO-18 case
6	R1, R3, R6	680k Ω	
4	R2, R9	100k Ω	logarithmic PCB-mount panel pot, conductive plastic (TT Electronics P260 series)
4	R4, R7	6.8k Ω	
2	R5	47k Ω	
2	R8	100k Ω	linear PCB-mount panel pot, conductive plastic (TT Electronics P260 series)
2	R10	10k Ω	
2	R11	100k Ω	
2	R12	1k Ω	
1	U1 \star	1458	bipolar dual op amp, 8-pin TO-5 package

Also necessary: two PCBs, hookup wire, solder, front panel, knobs, Eurorack power cable, beer, etc.

Tolerances, temperature coefficients, and so on are not critical on any components, and power rating is not critical on resistors.

A few reference designators may seem to be missing from this BOM because they were allocated by the schematic capture software to holes in the PCB that do not need to be purchased as separate parts—for instance, J2 is a place where a wire jumper can be mounted, and Q4 is an alternate footprint for versatility in mounting Q3.

Build step-by-step

Note that although I'm describing a separate step for each component value, and that's how I built mine so as to have plenty of photo opportunities, if you are reasonably confident about your skills you may find it easier to populate all or most of the board (i.e. put the components in place) and then solder them in a single step. Except where noted, the order in which you add components does not matter much.

Preliminaries

If you are using the recommended P260 potentiometers, the linear and logarithmic ones look nearly identical. *As soon as you unpack them*, label the pots so you can tell them apart! I marked my log pots "log" with a permanent felt pen and left the others unmarked.



It is strongly recommended that you should breadboard and test the circuit with the components you will actually use, and swap values according to taste if necessary, before committing it to solder. Even if you have only exactly the right number of each thing and no possibility of substitution, you may want to make a decision about which transistor will be Q1 and which will be Q3 on each board. Especially if they are germanium, two transistors with the same part number may differ enough that swapping them around will make a difference to the sound. Label the transistors so you can tell them apart (for instance, by

sticking them to pieces of masking tape) if you have made such a decision. With wide-tolerance components, swapping could possibly even be meaningful for things like resistors, too.

This photo is not identical to the design I ended up building; it is one of the variations I tested.

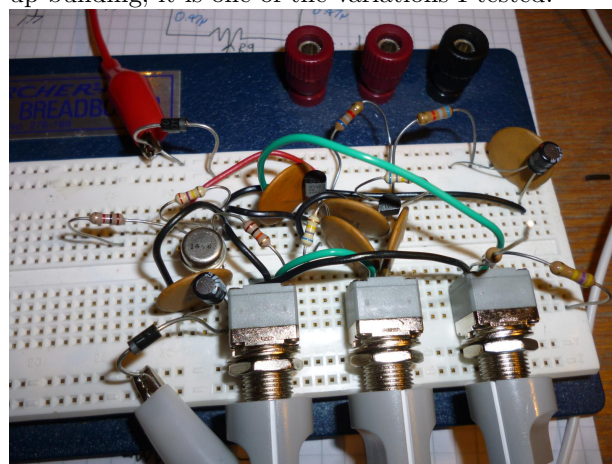

Count out the right number of everything according to the bill of materials.



Install wire jumpers at J2 and J4 according to the type of transistors you will install. The Asuka board (left in photo) has PNP transistors, so the jumpers go from the middle hole in each group to the outside (pin 3, round pad, labelled PNP). The Shinji board has NPN transistors, so the jumpers go from the middle

hole in each group to the inside (pin 1, square pad, labelled NPN).

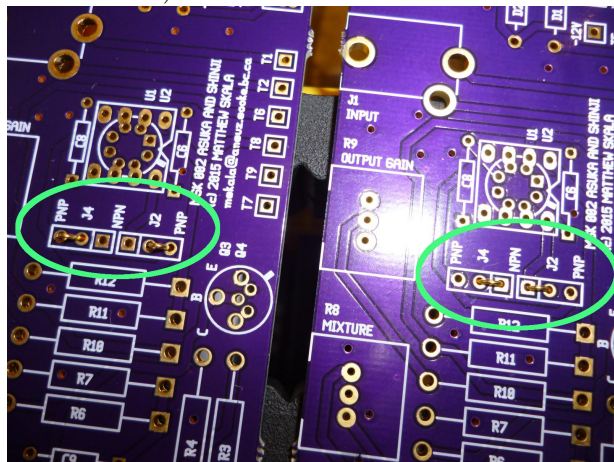

Pairing an NPN with a PNP transistor on the same board is not the recommended configuration (see notes elsewhere in this document), but it is possible, and should you wish to do it, configure J2 for the first-stage amplifier (Q1) and J4 for the second-stage amplifier (Q3); and then, as will be noted later, you must make sure to supply both flavours of power to the board.

These jumpers form the power connection for each transistor amplifier stage, to either the -12V rail for PNP or +12V for NPN. The consequence of setting them wrong is that the transistors will probably be destroyed (by junction breakdown) at power-up. If that happened and it were the only assembly problem, you could probably fix it by re-doing the jumpers correctly and replacing the transistors—other components would probably not be damaged.

Resistors

Resistors are never polarized. I like to install mine in a consistent direction for cosmetic reasons, but this is electrically unnecessary.

Install the 680k Ω resistors (colour code blue-grey-yellow, or blue-grey-black-orange on resistors with an extra band, like some of mine seen in the photo) R1, R3, and R6, on both boards. R1 attenuates the input signal from hot Eurorack level to something more like the guitar level needed by the Fuzzrite and by guitar fuzz circuits in general. R3 and R6 are bias resistors for the transistor amplifiers; they set the operating point, which is a default level of DC current and voltage that can be modified by the changing input signal.

Do not confuse these with the 6.8k Ω resistors,

which have a red band in the colour code instead of yellow. Mixing them up, depending on exactly which ones are wrong, will probably result in one or both fuzz stages giving almost no output, or extreme clipping at the input and possible damage to the first-stage transistor.

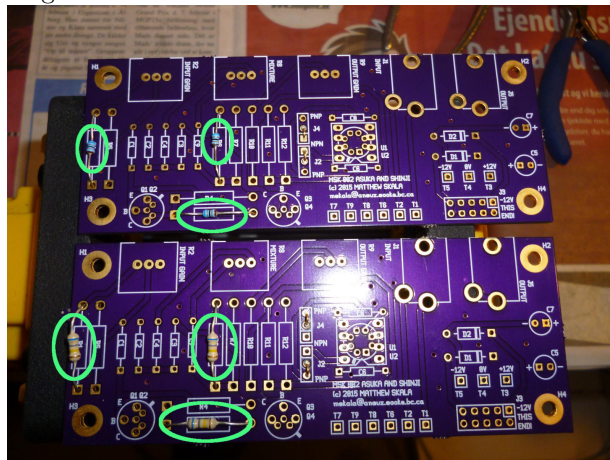

Install the 47k Ω resistors (colour code yellow-violet-orange) R5 on both boards. R5 was added to the circuit as a result of breadboard testing; it alters the response curve of the input gain pot in an attempt to make the “sweet spots” where this control has interesting effects on the sound, wider.

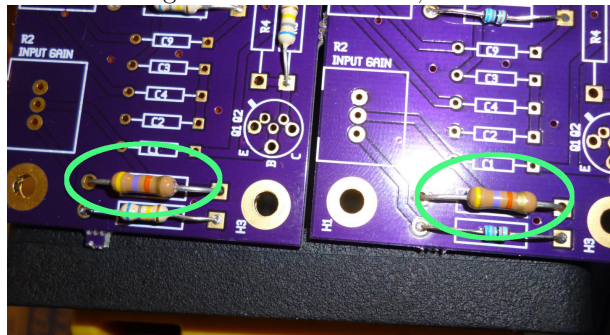

Install the 6.8k Ω resistors (colour code blue-grey-red) R4 and R7 on both boards. These are bias resistors for the transistor amplifiers and work in combination with R3 and R6 to set the operating point. As mentioned, do not confuse them with the more numerous 680k Ω resistors.

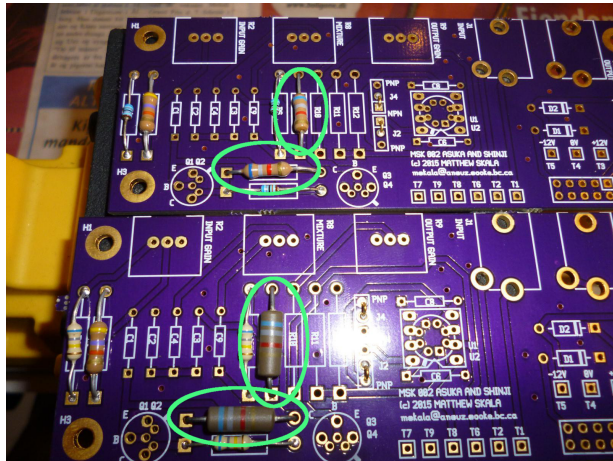

Watch out! The next three resistor values are all similar (all powers of ten) and they have similar colour codes. It is important not to confuse them. Likely consequences if you do swap them around are output level much too low, or extreme square-wave fuzz that does not change with the control settings. Other damage is unlikely.

Install the 10kΩ resistors (colour code brown-black-ORANGE) R10 on both boards. These are input resistors that help set the gain for the third (IC) amplifier stage.

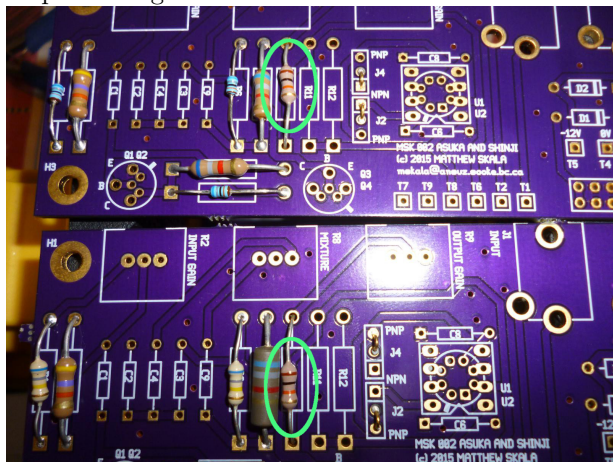

Install the 100kΩ resistors (colour code brown-black-YELLOW) R11 on both boards. These are feedback resistors that set the gain for the third (IC) amplifier stage in combination with R10. The negative voltage gain is the ratio between the two resistances: $100k\Omega/10k\Omega = 10$.

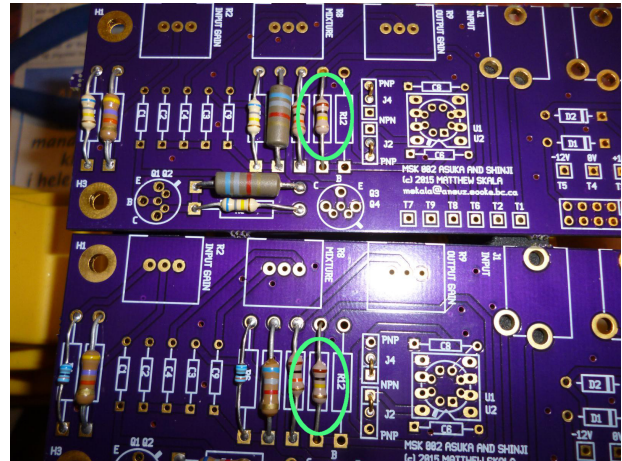

Install the 1kΩ resistors (colour code brown-black-RED) R12 on both boards. These are current-limiting resistors for the IC op amp outputs. They supplement the op amp's built-in short-circuit protection for additional safety against excessive current draw by the MSK 002 and (concievable, though not really very likely) damage to the *other* module in the event that the MSK 002's output should be incorrectly patched to some other module's output.

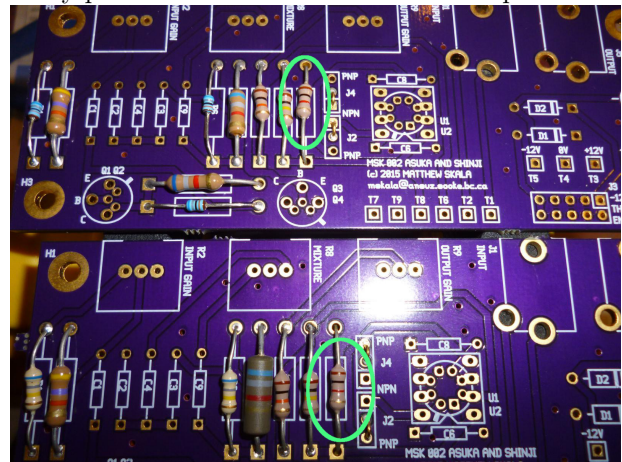

Semiconductors

Install the diodes D1 and D2 *on the Asuka board only*. These diodes are meant to protect the module against backward connection of the unpolarized Eurorack power cable (which is a very common error on the part of synthesizer users). These are polarized components. The cathode should be marked on each diode with a stripe around the diode body. The correct orientation is as shown in this photo, and also indicated on the PCB by a silkscreened picture of the diode body and by a square pad for soldering the cathode.

If you reverse the diodes, or the power connection, but not both, then the module will not work at all until you correct this situation, but there should be no permanent damage. If you reverse the diodes (or defeat them, for instance by putting in pieces of wire instead) and also connect the power backwards, then the IC and transistors are likely to be destroyed.

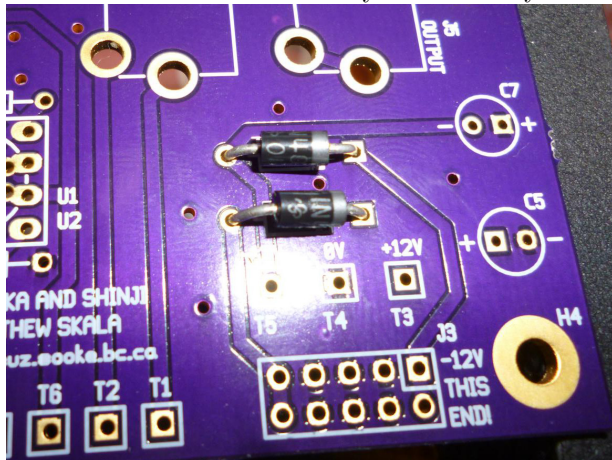

Install the dual op amp IC U1 *on the Asuka board only*. This is the third-stage amplifier shared by both channels in the module. The PCB provides a choice of two footprints for use with either an 8-pin TO-5 metal can like mine or a (much more common nowadays) 8-pin DIP.

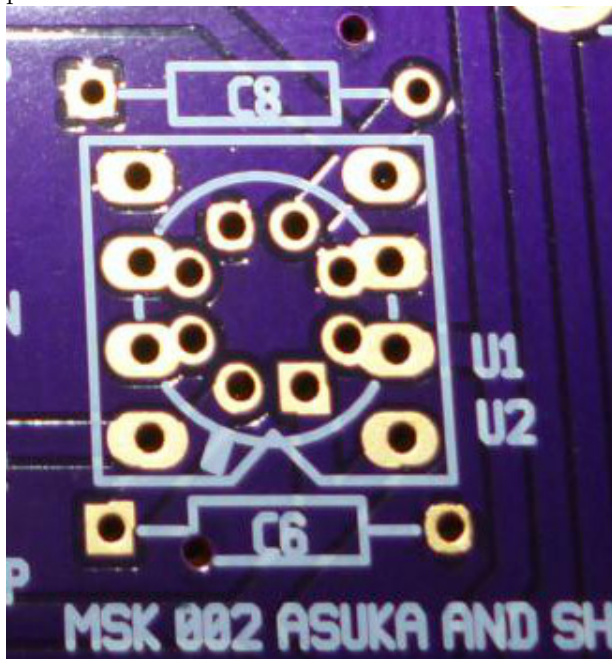

If using a metal can: the leads fit into the ring of holes in the middle of the overlaid footprint. Eight

configurations are physically possible, and only one is correct. The little tab on the can indicates pin number 8, and it should match the orientation shown on the PCB silkscreen and in the following photo. If you are familiar with DIP pin numbering and peer through the solder mask, you should also be able to see that the metal can pin 8 is nearest and electrically connected to pin 8 of the DIP footprint. Pin 1 (not 8) of the TO-5 footprint is also marked by being square instead of circular.

If using a DIP: the leads fit into two rows of holes with oblong pads on opposite sides of the central ring. The DIP should have a dot or indentation on it at one end. That is the end with pins 1 and 8, and the DIP should be plugged into the board in such a way that the marked end matches the V-shaped indentation shown in the silkscreened outline, nearest to the C6 footprint and the title and copyright marking on the board.

The likely consequence of installing either kind of chip in the wrong orientation is that the chip will be destroyed on power-up.



Install the transistors Q1 and Q3 on both boards. These serve as not-very-linear amplifiers, creating most of the “fuzz” effect that is the main purpose of the module.

Install the correct type of transistor on each board: PNP for Asuka and NPN for Shinji, or whatever modified arrangement you have chosen. It is important that the transistor types should match those selected by the wires you installed at J2 and J4. If you have selected individual transistors for the two stages during breadboarding, then also make sure that you install the individual transistors in the stages for which you selected them.

The PCB is designed with holes for TO-5 and TO-

18 packages, which are respectively large cans like 2N1274 and small cans like 2N2222A. The pinout for these packages is reasonably standardized, and the arrangement of leads is the same for TO-5 as for TO-18, just larger. Nearly all transistors that come in these packages will have the same pinout as the ones I used. The can bears a little tab, which will be nearest the emitter lead. The correct orientation of the tab is shown on the PCB silkscreen. The leads are also arranged in a triangular shape that will only fit comfortably into the board in one way, the correct way.

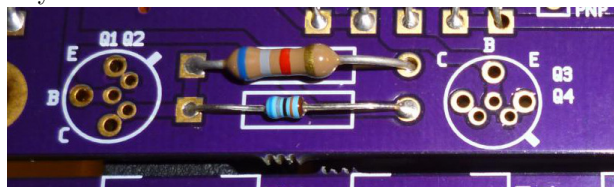

Nonetheless, especially if you are using rare parts that you cannot replace, it is preferable to check the data sheet for the exact parts you are using, if it can be found, and make sure that the emitter, collector, and base leads are going into the holes marked “E,” “C,” and “B” on the board silkscreen.

If your transistors are in TO-92 packages (the ubiquitous little plastic D-shapes), or something else (TO-220; TO-3 (!); surface mount or microwave; obsolete American, Russian, and Japanese package styles; and so on), then the pinout may be variable and you *must* figure it out and connect the transistor to the appropriate holes. With TO-92, at least, it should be possible to bend the leads without damaging them such that they fit into the correct holes in the TO-18 footprint, regardless of which pinout you start from.

Because of the proximity of the TO-5 footprint holes to the TO-18 footprint, it is possible that the metal can of a TO-18 part mounted flush against the PCB may short against one or more of the exposed TO-5 pads, and that would be a bad thing. For this reason I recommend mounting TO-18 transistors with a small air gap from the board surface. In my own build I accomplished that by putting a tiny roll of tissue paper underneath the transistor to space it away from the board while soldering it, and then pulling that away afterward to leave a gap.

Germanium transistors are especially easy to damage with soldering heat. Try to use no more heat than necessary. You may wish to consider soldering them with a heat sink on the component side of the board to protect the transistor, though doing this

with each leg individually will be a very fiddly procedure. I did not use a heat sink, and my transistors seem to have survived. Our forefathers, in the days when transistors cost tens of dollars each and dollars were worth more too, would have soldered in a “transistor socket” instead of soldering to the transistors directly at all.

Installing transistors in the wrong orientation, or of a type that does not match the jumper selection, will probably result in the destruction of the transistors when power is applied.

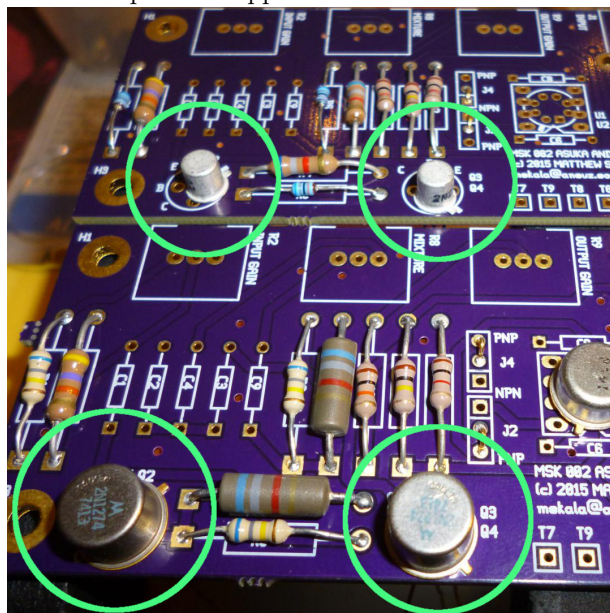

Capacitors

Install the 0.1 μ F capacitors C2. These capacitors suppress ultrasonic ringing caused by feedback between the two transistor amplifier stages. They are not polarized and their orientation does not matter.

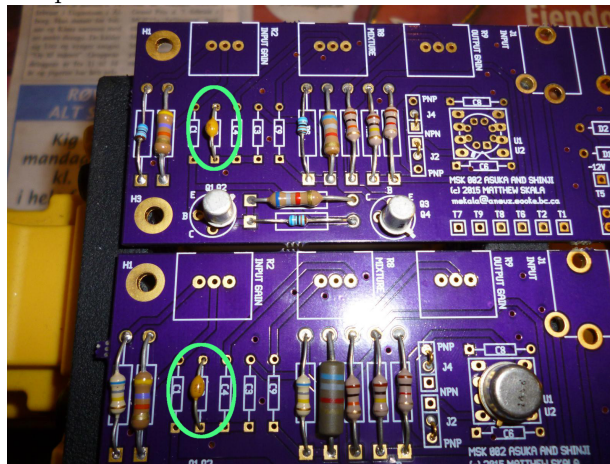

Install the $22\mu\text{F}$ capacitors C5 and C7 *on the Asuka board only*. These filter the power to reduce transfer of noise from the power supply into the output, though at the lowest output levels some may still be audible.

These are polarized components. These capacitors will at least be destroyed, will probably leak corrosive electrolyte, and may explode and take out surrounding components, if they are connected backwards. The negative leg of each capacitor will be marked, usually by means of a stripe and minus signs on the plastic wrapping of the capacitor body. The negative leg of the capacitor will usually also be shorter, though that is less reliable than the body markings. My capacitors were also marked with red text (traditionally a “positive” colour) on the positive side, but I would trust that sign least of all. On the PCB, the positive and negative pads are marked with positive and negative signs in the silkscreen, and the pads themselves are round for negative and square for positive.

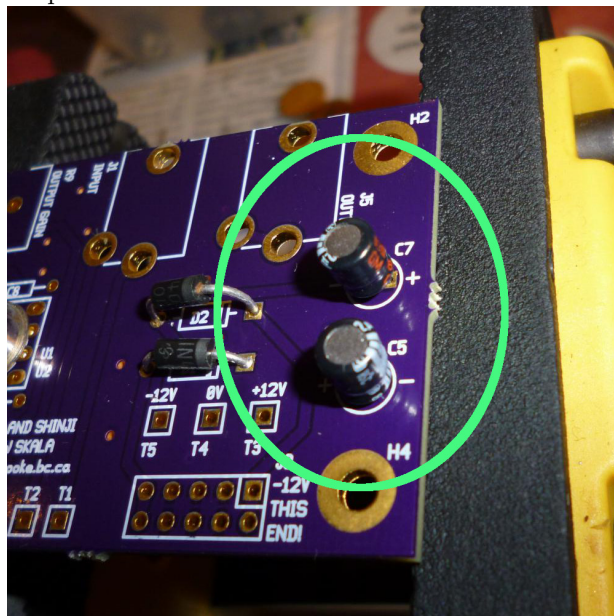

Install the $0.47\mu\text{F}$ capacitors: C1, C3, C4, and C9 on both boards, and C6 and C8 on the Asuka board only. These are unpolarized components and their orientation does not matter. The ones that go on both boards are coupling capacitors, which serve to isolate the input from the first amplifier and all three amplifiers from each other as far as DC bias voltages are concerned, while still passing AC signals. The two capacitors that only go on the Asuka board are power supply bypass capacitors for the third-stage amplifier

IC.

Note the marking “474” on the capacitors in my photo. That means, much like a resistor code, that their nominal value is the digits 47 followed by 4 zeros, measured in picofarads: $470000\text{pF}=0.47\mu\text{F}$.

I bent my capacitors at an angle, as shown, to prevent them from interfering with the board above when the boards would be stacked close together in the finished module. In fact, that was probably not necessary even with my very tall vintage disc capacitors, and if you are substituting more modern capacitors it is even less likely to be needed.

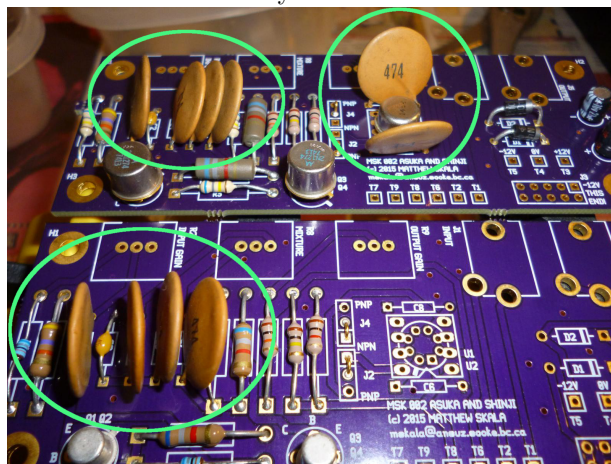

Final assembly

Install the 10-pin power header J3 *on the Asuka board only*. If you use one identical to mine, it is not polarized in the horizontal plane, but the legs are plated with tin on one end and gold on the other. The tin ends should go through the board for soldering, and the gold ends should be erect to mate with the power cable.

Euro rack power connections are polarized even if the connectors are not. Although the MSK 002 contains some protection against such damage, connecting Euro rack modules in general incorrectly can damage or destroy the module so connected, the power supply, and maybe even other modules in the system, although there are few credible reports of that last actually happening. Connecting the power backwards is a sufficiently common beginner’s mistake that some people say that you’re not a true “wiggler” until you’ve earned your stripes by having destroyed at least one valuable module this way.

If you do not wish such a consummation, try to make sure that pin 1 of the connectors and cables always carries the -12V supply, corresponds to

the stripe on the cable, and matches the appropriate markings on the PCB. Pin 1 is also usually at the bottom when the module is installed, but that is not very reliable. Markings on the PCB may typically consist of a single different (such as square instead of round) solder pad for pin 1; a single heavy line drawn on the silkscreen near the pin 1 end; a round dot; or text indicating that it is pin 1 or should carry the negative voltage. If the different pin 1 indications disagree with each other, proceed very cautiously. Pin header connectors exist in polarized versions, with plastic shrouds that prevent them from mating in any manner prohibited by Leviticus, but cables and boards have been observed in the wild with connectors of this type installed backwards, so they should not be depended upon.

In the case of the MSK 002, pin 1 on the PCB is marked with a square instead of circular pad, a square box around that pin on the silkscreen (covered by the component body once the component is installed), and the text "-12V THIS END!"; the pin 1 end is also nearest the bottom when the module is installed in a rack.

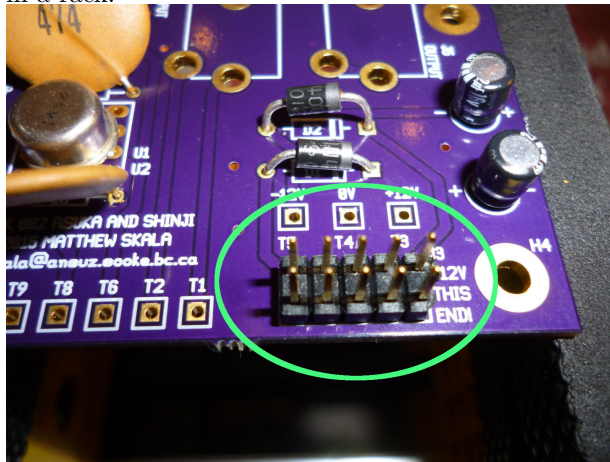

The potentiometers and jacks are a little tricky because they are structural in the assembled module. It's important to make sure that they line up perfectly with the holes in the panel, which implies soldering them to the PCB while they are assembled in the panel.

Take the hardware (washers, nuts, and so on) off of two log pots, a linear pot, and two jacks, and place, but *do not solder*, them in the Asuka board. In the photo below, I neglected to take off the hardware first, and ended up having to pull the parts out and try again.

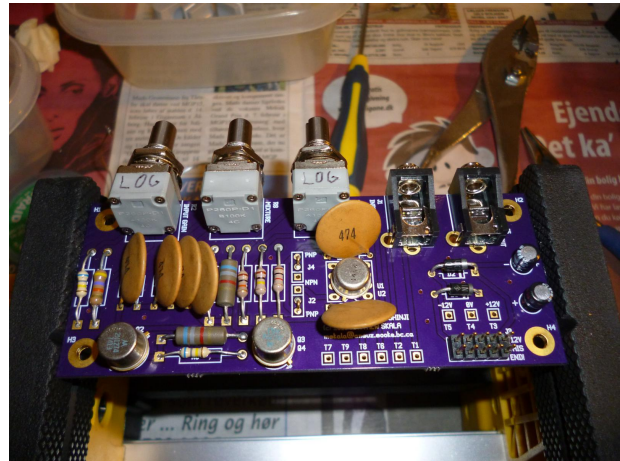

Without removing the components from the board, fit them through the holes in the panel. Make sure you have the correct row of holes: the ones that will be on the left when the finished module is mounted. Fasten them by hand with nuts and flat washers, but omit any lockwashers, and don't torque the nuts beyond what's easy to do with your fingers. This is a temporary assembly, just to hold the parts in place for soldering. The board will probably be fairly well held in place by friction at this point.



Flip the board and solder the pots and jacks. I used enough solder to fill all the holes in the board, figuring it would provide some structural support, even though that is a fair bit more than necessary for electrical continuity.

Then follow the same steps for the Shinji board: remove hardware, stuff the board, fit the stuffed board into the panel, and temporarily assemble the hardware without lockwashers. This photo shows the stage where the Asuka board has been soldered and the Shinji board is ready to be soldered.

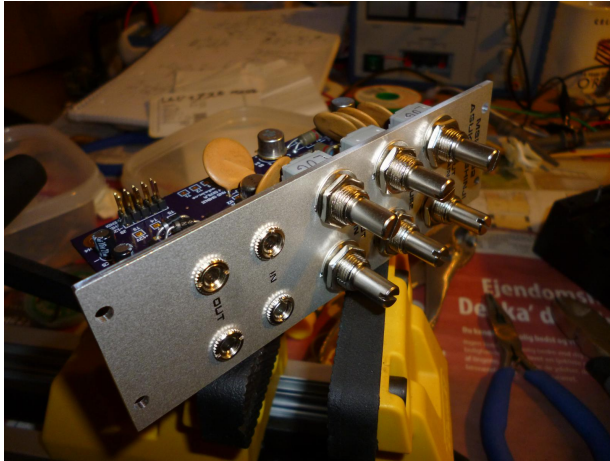

Disassemble the boards from the panel. This step is necessary to free them up for the board-to-board wiring, which couldn't be done earlier because it would have gotten in the way of conveniently soldering the front panel components.

Make the necessary connections between the boards. In my build, these were as follows (all others left unconnected):

Asuka		Shinji	
T1	—	T2	normalling
T2	—	T1	normalling
T3	—	T3	+12V
T4	—	T4	ground
T7	—	T6	op amp
T9	—	T8	op amp

Note the connections for normalling are *swapped*: T1 on each board connects to T2 on the other. These allow a single cable plugged into either input to feed both boards, but the boards can still have independent inputs if cables are plugged into both jacks. If you are building three or more boards, it would make sense to connect them cyclically: T1 on each board to T2 on the next, and then from the last back to the first.

Because my Shinji board has NPN transistors on it, it needs the +12V power connection. It doesn't need the -12V connection (T5) because it doesn't have PNP transistors. If you built some other configuration, you might need to make the -12V connection (T5 to T5) instead, or even both of them. Any board with an op amp chip (Asuka in my configuration) needs to be supplied with both +12V and -12V, either through the Eurorack power connector or wires to another board.

The remaining connections are so that the Shinji board can make use of the spare op amp in the chip

mounted on Asuka. See the schematic for details of these.

Here is a photo of my connections, but please excuse the poor technique; I was trying to use some salvaged wire that had the wrong kind of insulation for this situation, and I had trouble with tinning and stripping it. The mounting hole H4, not used in the standard Eurorack build, provided a convenient place to route some of the wires instead of having them interfere with the power connector.



Now assemble the boards to the panel, permanently this time. Use the lockwashers. My pots each came with a spring washer (basically a flat ring with a little bit of conical bending to it), a lockwasher with teeth, and a nut. In that case the correct order is panel, spring washer, lockwasher, nut. The lockwasher must always be next to the nut in order to serve its purpose of preventing the nut from loosening. I assembled the spring washers such that the slope went from the outside on the panel to the inside on the lockwasher, but I am not absolutely sure that is the best way nor that it makes a difference at all. My thinking was that doing it this way would spread the load out onto a larger area of the panel.

Add knobs of your choice; I used grey pointer-type knobs from Small Bear Electronics because I like the way they look, but they are a little large for these closely-spaced pots, and you might prefer to choose smaller ones. Add a power cable. Your module is finished.



Patch ideas

Feed a sine wave through either channel to produce a guitar-like sound. The VCA is before the fuzz module, not after, because the distortion changes with the signal level. Turn up the release time on the envelope generator for guitar-like “sustain.”



Two out-of-phase sine waves go through the two channels, with separate envelopes, for a complex evolving timbre.

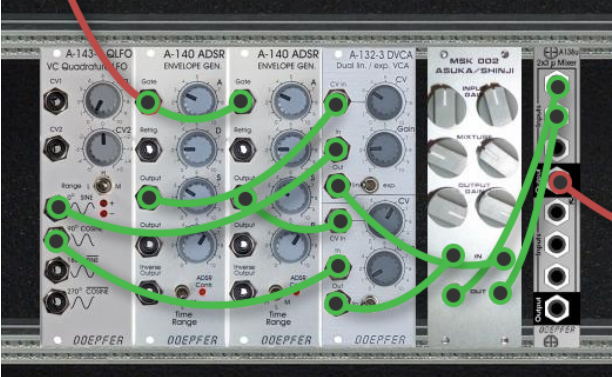

The Asuka and Shinji can be used as a relatively non-distorting amplifier to raise to modular level a lower-level signal such as the headphone output of the Pocket Miku shown here. With appropriate cabling, you can use the two channels for the two sides of a stereo signal.

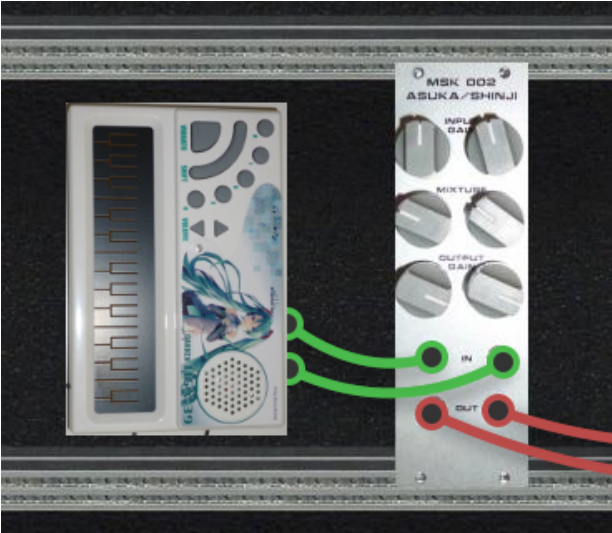

Mixing multiple frequencies before the input, as with this triple VCO, causes them to interact with each other in the distortion, in a way that ranges from subtle added noise to complete trasy chaos. Two frequencies near each other will usually sound somewhat like ring modulation.



Circuit explanation

Let me remind you that although the Asuka and Shinji synthesizer module uses a very similar circuit topology to the Mosrite Fuzzrite guitar pedal, it does not and is not meant to sound exactly like a Fuzzrite. I am not sure that the description here of how the Asuka and Shinji works, accurately describes the Fuzzrite's theory of operation too. Looking around on the Net, I have found a number of different choices of resistor values claimed to be the ones from the Fuzzrite, and many of the circuits make no sense at all from the point of view of the theory of transistor biasing I'm putting forward here.

Maybe the real Fuzzrite simply operated on a different basis; there were certainly several different models and editions of the original Fuzzrite and they may well have differed from each other quite a lot; and probably some of the circuits I've seen on the Web are simply *wrong*, would never work, and were not tested by the people who posted them. *I have really built mine*, and I have a pretty good idea of how it works electrically, too.

Comparing the sound I get from my device to audio samples claimed to be Fuzzrites or Fuzzrite clones, it is clear that they are doing at least *sort of* the same things to the signal, but as a matter of preference I usually run my synth module at lower distortion levels than it is capable of producing, whereas many guitarists who use Fuzzrites run them at the absolute maximum distortion level all the time. That makes comparisons iffy.

With those caveats in mind, here is a summary of how the Asuka and Shinji module works.

In very general terms, one channel of this module consists of three amplifiers. The input signal goes through two transistor stages, each of which applies significant gain and distortion. The second one, at least, will usually clip severely. Then a variable mixture of the outputs of the first two stages goes into the third stage, which is a simple fixed-gain IC op amp circuit. Every stage inverts the voltage. Because the second stage does, the outputs of the first two stages will partially cancel each other when mixed; but that effect is primarily significant for the main *undistorted*

signal, meaning that the distortion will cancel less than the main signal and thus be disproportionately represented in the final output.

Input

Signals coming into the module go first through an input network that attenuates them and blocks DC. Bear in mind that the Fuzzrite was originally a guitar pedal, working directly with the signal from the guitar pickups. Eurorack signal levels are much stronger than what comes directly out of a guitar pickup, and would possibly damage the transistors, certainly not produce the desired kind of distortion, if applied directly to the transistors.

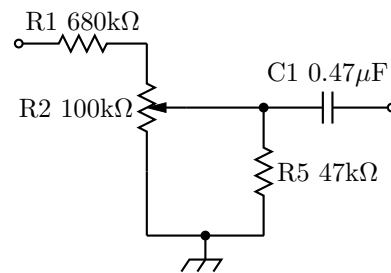

The parallel combination of R2 and R5 works out to at most about 32kΩ, so the voltage divider formed with R1 will reduce a nominal 10V peak to peak Eurorack signal to somewhere between 0 and about 450mV. That is enough to get some distortion from the first-stage transistor amplifier, but (especially in the case of a lower-gain germanium transistor at Q1) not drive it all the way into clipping.

With a log pot at R2 in parallel with R5, the response curve of the combination relative to the control knob position is a little weird. I settled on this combination after trying several others. The most interesting ranges of settings are when the “gain” (actually, lack of attenuation) through this network is nearly zero, a little more than that, and at or near the maximum. I think (based on listening rather than careful examination with test equipment) that as the input gain increases these sweet spots correspond to the onset of serious distortion, first in the second stage and then in the first. This parallel combina-

tion of resistors attempts to make all three of those ranges as easy to hit as possible. I'm still not entirely sure I got it right.

The capacitor C1 prevents DC in the input network from messing up the bias of Q1. With this value and a worst-case 30.5kΩ input impedance (i.e., the parallel combination of all three resistors), the inverse of the RC time constant works out to 69.6Hz. That gives a quick-and-dirty estimate of the frequency below which this input network considered as a high-pass filter will start to cut off the signal. It's high enough you might notice such an effect, but low enough not to totally destroy the bass.

Transistor amplifier

The two transistor amplifier stages in a given channel are exactly the same in my build. I will describe the circuit as if using an NPN transistor; it operates the same way with PNP, just with the voltages reversed.

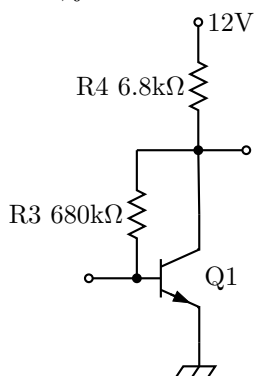

Consider how this behaves at DC, with nothing attached to the input or output. The base of Q1 is one diode drop, let's say 0.6V, above ground. Suppose the collector is at 6V. Then we have 5.4V across R3, which will pass a current of 7.96μA by Ohm's Law. Suppose Q1 has a current gain of 99. Then its collector current will be $99 \times 7.96\mu\text{A} = 786\mu\text{A}$. Both currents, a total of 794μA, pass through R4, causing it to drop 5.4V from the supply. . . which is really 11.4V, not 12V, because of the diode drop in the protection diode not shown above!

If we suppose that Q1 may actually have a little more gain, then about 8μA into the base would cause it to pull *more* than 800μA through R4. That causes the drop across R4 to increase and the collector voltage to fall, reducing the voltage across R3, and so the base current will really be somewhat less than 8μA. With a gain of something like 200, the transistor wants 200 (really 201) times as much current through R4 as through R3, so given the 100:1 resis-

tance ratio, R4 will drop twice as much voltage as R3 and neglecting the diode drops, the collector will end up at one third the supply voltage, or 4V. On the other hand, with a lower-gain transistor (let's say 49), Q1 wants 50 times as much current through R4 as through R3, then R4 wants to drop half as much voltage as R3, and again neglecting the diode drops, the collector of Q1 will end up at 8V, two thirds the supply. The collector current varies by a 2:1 ratio between these high and low examples, as the transistor gain varies by 4:1.

This configuration is called a "self-bias" circuit. The transistor effectively chooses its own operating point. It's a nice circuit for this kind of application because it is very tolerant of variations in the components; as long as the transistor gain and the ratio of the two resistances are sort of in the same ballpark, we end up with a halfway reasonable collector voltage.

The reason the collector voltage is significant is that when we apply a signal to the input, the amplified signal will appear as variations in the collector voltage; and it can never go above the supply or below ground. So to get the maximum possible amount of signal out of the amplifier, we want the DC operating point around which the AC signal varies to be halfway between the supply and ground.

Current through a transistor is an exponential function of the voltage across the base/emitter junction. With a small input signal, it wiggles the base up and down just a little, the relevant chunk of the exponential function looks like a steep line, and so the current through the collector wiggles a fair bit. Increasing current through the collector of Q1 increases the voltage across R4, and decreases the collector voltage. So pushing up the base a little pulls down the collector a lot. There's a large negative voltage gain through this circuit.

If the input signal gets larger, its high peaks will hit a part of the exponential curve that is steeper, and its low peaks will hit a part of the exponential curve that is shallower. The gain depends somewhat on the instantaneous voltage. So one side of a sine wave will be flattened, and the other side will become pointier. You can see that effect (confused a little by phase shifts) in the oscilloscope traces later in this section; and in the frequency domain, it is even-harmonic distortion.

If the input signal is really large, Q1 will try to conduct more current than the 12V supply can possibly provide through R4 (that is only 1.76mA, not

really a whole lot of current in the grand scheme of things). At that point the collector just hits ground and stays there; this is “clipping”. On the other side, if the base goes far enough negative, Q1 will effectively conduct no collector current at all, and (except for a small offset created by the R3/R4 voltage divider) the collector will hit the 12V power rail. That is hard to achieve on the first stage amplifier because of the massive input attenuation, but it can happen pretty easily with the second stage amplifier, which is looking at the hot output of the first stage.

So that is the basic operation of one transistor stage: it’s an amplifier, with self-adjusting bias and a lot of voltage gain, tending to distort when the input signal is significant and to clip when it gets really large. In the Asuka and Shinji, the first stage will usually be distorting, and the second stage will usually be clipping, but that depends somewhat on the transistors and the input level.

I have seen Fuzzrite-topology circuits in which the ratio between the collector and base resistors is much different from the 100:1 I suggest here. I’ve seen recommendations as low as 1:1, as high as 450:1, and also a few similar circuits with no base resistor at all, in effect an infinite resistance ratio (to the extent permitted by transistor leakage, solder flux residue, and so on). I don’t know what ratio or ratios were used in various editions of the vintage guitar pedals, and even knowing that wouldn’t necessarily mean those same ratios should be used here, because of the differences caused by running at synth levels. Modern, higher-gain transistors also make a difference.

Pushing the resistance ratio to either extreme may give more distortion by preventing the transistor from ever behaving like a clean amplifier at all, but I don’t really think maximizing the distortion per stage is optimal for the overall sound. There will always be plenty of distortion available from the output of the second stage when you want it, and having a relatively clean first-stage signal to cancel against allows for a greater variety of sounds as you change the mixture. Especially in a synth module, I want *expressiveness*, not just lots and lots of fuzz. But, as with everything in this project, your taste may vary.

Mixing network

The three amplifiers are connected by a network of resistors and capacitors that block DC and allow the user to choose the relative amounts of signal from the first and second transistor stages, as well as the overall amount going into the IC amplifier.

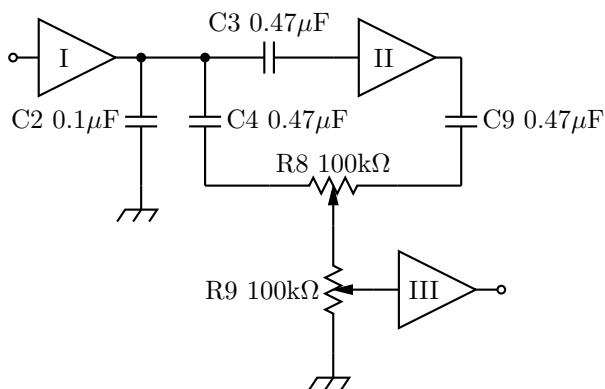

Note that there’s a loop in this diagram. Signal from the output of the second amplifier can go through C9, the entire length of R8, C4, and C3 in that order and return to the input of the same amplifier. That’s asking for trouble.

At DC, an increasing signal on the output of the second-stage amplifier would increase the input, tending to *decrease* the output because it’s an inverting amplifier, and just like the negative feedback in the bias circuit, the whole thing would stabilize itself. But there are three capacitors blocking DC in the feedback loop anyway; DC is not the problem. The problem is that with all the resistors and capacitors in this part of the circuit, the whole thing looks like some kind of RC filter network, and there is probably some frequency at which there will be a phase shift of 180° around the loop. Combined with the 180° inversion of the amplifier itself, we end up with a situation where the tiniest amount of noise at whatever that frequency may be will be amplified, fed back, and amplified further, until it grows to the maximum power level the amplifier is capable of producing. At that point it’s not an amplifier anymore, it is an oscillator. Since these transistors are probably capable of amplifying well into the megahertz range, there’s a good chance that the frequency at which it ends up oscillating will not even be an audio frequency.

Things may not really be so bad. In my breadboard testing on the first version of the circuit, I wasn’t actually able to get sustained oscillations out of it under any conditions reasonably likely to actually occur. I think there is enough signal lost as it passes through R8 that the gain around the loop cannot actually reach unity, which is what it would take to turn the stage two amplifier into an oscillator. However, I did see a lot of ultrasonic ringing under some signal conditions, usually with low input levels. Instead of nice clean square waves from clipping the audio input, the circuit would bounce a few times at

maybe 100kHz or so immediately after each edge in the square wave. That's undesirable: it's hard on speakers, may cause radio interference, and indicates the circuit is starting to get close to the border of stability. If the circuit parameters changed a bit more (like maybe by substituting in some other transistor I didn't test, or temperature changes causing component values to drift), it could go over the line into really serious instability.

I added C2 to improve stability. It's meant to kill any sufficiently high frequencies at that point in the circuit. The capacitive reactance of $0.1\mu\text{F}$ at 100kHz is about 16Ω . Note that the general impedance level at the output of the first amplifier stage is roughly the size of that amplifier's collector resistor, $6.8\text{k}\Omega$: so the capacitor basically kills any 100kHz energy completely. By my rule of thumb of taking the inverse of the RC time constant, I can say that the frequency where this capacitor will start to roll off the frequency response is about $1/(0.1\mu\text{F} \times 6.8\text{k}\Omega) = 1470\text{Hz}$. That is low enough to have an audible impact, and it's probably part of the reason that in the scope traces below, we don't see a lot of extreme distortion coming out of the first stage amplifier. The anti-oscillation capacitor is eating a lot of those harmonics.

On the other hand, we don't *need* a lot of extreme distortion from the first stage amplifier because we have the second stage for that, and indeed, rolling off at about this frequency creates a bump in the midrange that I think sounds sweet, and it's a pretty gentle roll-off anyway. So I'm calling this the intended behaviour of the circuit, not a flaw. Someone who disagreed might want to make C2 a little smaller, to pass more treble. But it can't be a whole lot smaller and still suppress the ultrasonic ringing; I tried $0.01\mu\text{F}$ and that didn't seem to help much when using the higher-gain transistors.

Be aware that I may not have fully understood the stability situation here or exactly how C2 affects the circuit. It seems to *work*, but there's a lot I don't understand about stability theory.

Third-stage amplifier

Although a single transistor on a 12V supply is capable of producing a lot more output power than a typical modular signal, the output impedance of the Fuzzrite circuit is too low (meaning too much current and too little voltage) to reliably drive a modular synth input. So I added a third amplifier stage, not found in the classic Fuzzrite, to boost the voltage. This also gave me a chance to use a nifty old

metal-can op amp chip I had, and possibly creates a few more opportunities for adding some character to the sound (although, as I think I've mentioned, I think much of the mystique of specific opamps is superstition).

The third stage amplifier looks like this:

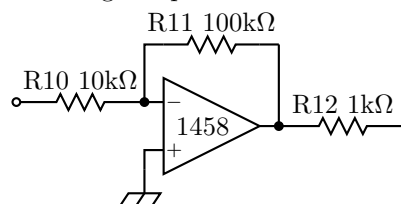

The one basic rule for understanding negative-feedback operational amplifier circuits like this one is that *the op amp will always try to keep its inputs at the same voltage*. The positive input is tied to ground; so as long as the op amp is capable of doing so, it will keep its negative input at 0V also, as a “virtual ground.”

If we pretend the op amp does not source or sink any current through its inputs, then any current flowing through R10 must match the current flowing through R11. By Ohm's Law, the ratio of voltages on these two resistors, given that they have the same current, must be the same as the ratio of their resistances: ten. Any voltage that appears on the input, between R10 and the virtual ground, must be matched by *ten times as much* voltage in the opposite direction on the op amp output, to keep the currents balanced and the negative input of the op amp at ground.

Really, it's not quite that simple. All op amps have a certain amount of bias current that they must source or sink through their inputs. With some modern CMOS op amps this is almost zero (but never *quite* zero). With a bipolar-input op amp like the 1458 I used, it may be more than a trivial amount. The data sheet for the 1458 in particular specifies that it may be up to 500nA, with 200nA typical. Across the 10kΩ input resistor that could amount to an error of up to 5mV (50mV after amplification), which I'm choosing to ignore given the other distortion that's occurring deliberately in the circuit. Someone building a more high-fidelity circuit with bipolar op amps might add a resistor to the positive input to balance out the error introduced by the bias currents.

Another issue ignored in this design is the idea of phase compensation on the op amp. When using an op amp at *low* gain, it is possible for there to be a stability issue where the phase behaviour of the op amp

is less than ideal, usually at high frequencies, allowing the amplifier to act as an oscillator in the manner discussed above for the transistor stages. You will sometimes see people adding capacitors in parallel with the feedback resistors on op amps, especially in low-gain circuits, in order to prevent this kind of situation. When the 1458 was first introduced, one of its selling points was that it had built-in compensation and wouldn't usually require such a capacitor. Nowadays that is a standard feature of op amps, but it was new at the time. With modern op amps, compensating capacitors are usually only required in special circumstances, such as when driving capacitive loads, where the internal compensation isn't enough. (Compensation comes at a cost in reducing high-frequency performance, which is why they don't just build huge amounts of it into every chip.) Anyway, at a voltage gain of ten as in this circuit, very few op amps would require a compensating capacitor.

When the signal out of the transistor amplifiers is sufficiently hot, and the output gain control is set high enough, the op amp in the Asuka and Shinji will clip, with its output going as near the power rails as it's capable of going. This hard clipping sounds a lot different from the soft clipping of the transistor stages, and it may be another interesting part of the sonic palette. Note that under these conditions the voltage from the output will be something like 20V peak-to-peak, a fair bit hotter than modular signals are usually expected to be, so it *will* probably overload whatever you plug it into.

The 1k Ω resistor R12 is intended to prevent anything really dangerous from happening. The 1458, like most op amps, is rated to withstand a short circuit on the output indefinitely, with the caveat that it may eventually overheat if you actually attempt that. If another module is sensitive to output short circuits, then plugging the output of the 1458 directly into the other module's output might cause the other module to enter a dangerous situation even if this module tolerates it. Output short circuits happen pretty often, both from patching mistakes and because many audio jacks briefly short the signal line to ground when a cable is plugged in or removed. So the resistor R12 is added as an extra layer of protection: with it, the absolute most current that can flow through the output is 24mA (assuming the op amp output is at one power rail and the module output is plugged directly into the other rail), really a fair bit less than that because that's not how op amps perform at high current, and it's unlikely to be a problem for this module

or any other.

The rest of the circuit

There are just a few other things visible on the schematic and not discussed already. I have brought out the signal and switching contacts from the input jacks to pads on the circuit board. The intention is that you can cross-connect them between the two boards, so that with a signal plugged into just one input jack, it will drive both channels (Asuka and Shinji), but with signals plugged into both inputs, they each get only their own.

There are more pads for sharing the power supplies between the two boards (discussed in the build instructions) and allowing the second board to use the second channel of the dual op amp chip mounted on the first board.

Power supply handling is straightforward. I put in two 22 μ F capacitors for bypassing the entire module because I had some of those spare, but any reasonable value in roughly that range would be fine. I also put in two of my 0.47 μ F ceramic discs, specifically to bypass the op amp chip. I used a couple of plain old silicon rectifier diodes for polarity protection. In general, people like Schottkys for this, so as to lose as little of the power supply voltage as possible, but in this particular case we have volts to spare and ordinary diodes are fine.

In principle, some op amp circuits may be sensitive to the sequencing of power application, if the positive or negative supply comes online significantly before the other one. I subjected the circuit to a lot of such conditions as I was hooking things up and tearing them down on the breadboard—sometimes for a few minutes at a time, because of clip leads disconnecting and leaving me wondering why all the measured voltages were wrong—and I didn't see any latch-up, so I'm inclined to think it's not a problem in this circuit. All the op amp inputs in the Asuka and Shinji are isolated by coupling capacitors from DC sources other than ground and the op amp outputs, so as long as the power rails are not actually given the wrong polarity, the IC will never see an input signal at a DC voltage it did not create itself. In a more complicated op amp circuit I might be inclined to add additional diodes between each power rail and ground, to be more certain of never applying an out-of-bounds signal to an op amp that has not yet fully powered up.

Waveform samples

On the following pages are some waveforms captured from my module with a digital scope. In the two-trace images, the top trace is a 1kHz sine wave from a Tiptop Z3000 oscillator (not very clean; this is a saw-core oscillator and generates its sines by waveshaping), applied to the input. The bottom trace is the output from the module. I've adjusted the output gain to generally avoid clipping in the op amp stage and get a reasonable output level; but the output level does vary a fair bit depending on the settings of the other knobs. At some settings the module can barely provide 6V or 7V peak to peak with its output gain set to maximum; at others (with op amp clipping), it is close to 20V, and will overload whatever it is plugged into.

First, a series of waveforms from Asuka (germanium transistors) as the input level goes from the minimum that gets a signal through at all, up to the maximum; mixture control hard counterclockwise, so we are basically seeing only the output of the first stage. At this frequency there's some nontrivial amount of phase shifting going on because of all the RC networks; I haven't analysed this carefully. Note thickening of the traces (indicating high-frequency noise) at the lowest input levels. At the lowest level, the waves are flattened a lot on one side as the transistor base gently bounces off of ground level; that creates even harmonics. The transistor actually seems to give a little *less* distortion at moderate levels, but as the level increases further, the waves get pointier, indicating a significant shift into low odd harmonics.

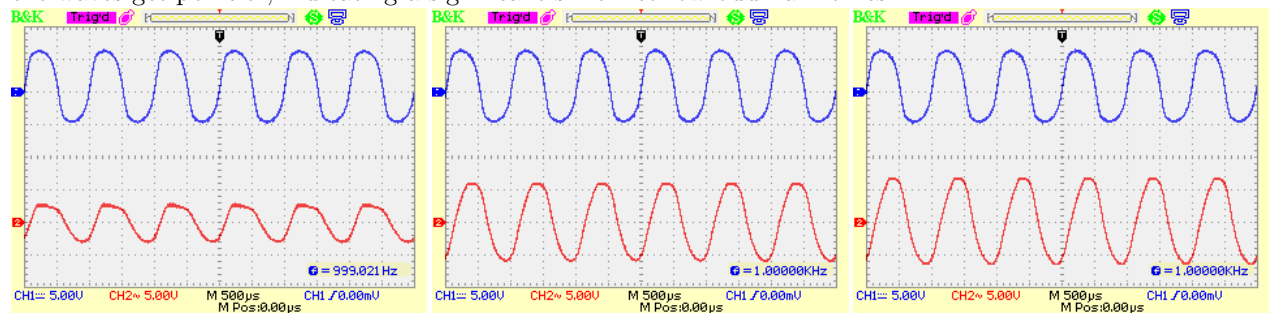

Now, increasing input level on Asuka with the mixture control hard clockwise, so we see the output from the second stage. Now even at the lowest level the waveform is more or less symmetrical (bearing in mind that the two transistors clip on opposite sides), but almost immediately, the second stage starts to clip, resulting in a pulse waveform. That is the essence of the Fuzzrite sound: one amplifier that distorts a lot, and an adjustable cancelling mixture between the two.

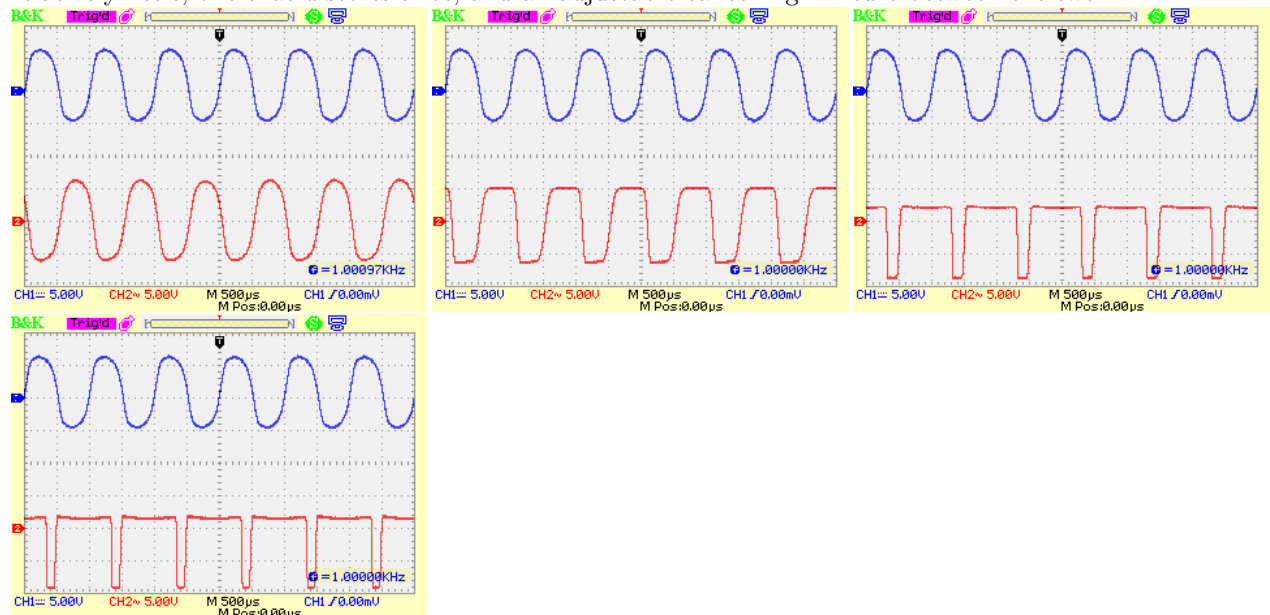

The next series shows the effect of the mixture control: Asuka with fairly high input level, and mixture going from hard counterclockwise to hard clockwise.

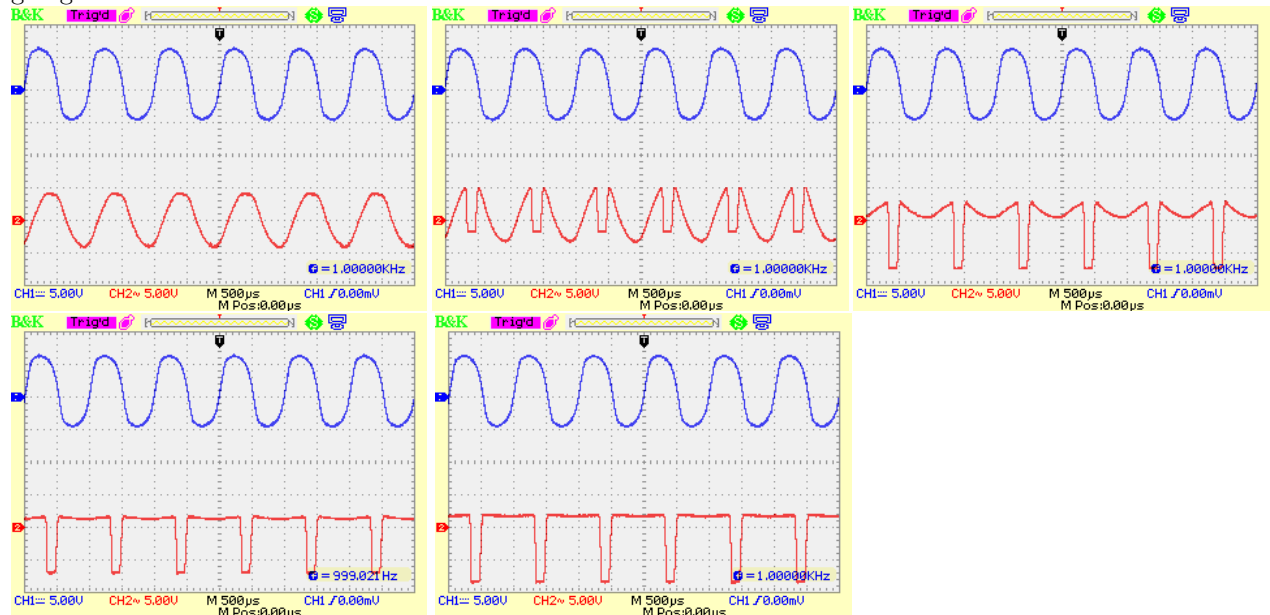

Now we do the same thing with Shinji (silicon transistors). First, input level from zero to maximum and mixture set to first stage only. At the minimum level, the flattening effect is a little nicer, maybe because of the higher gain of these transistors.

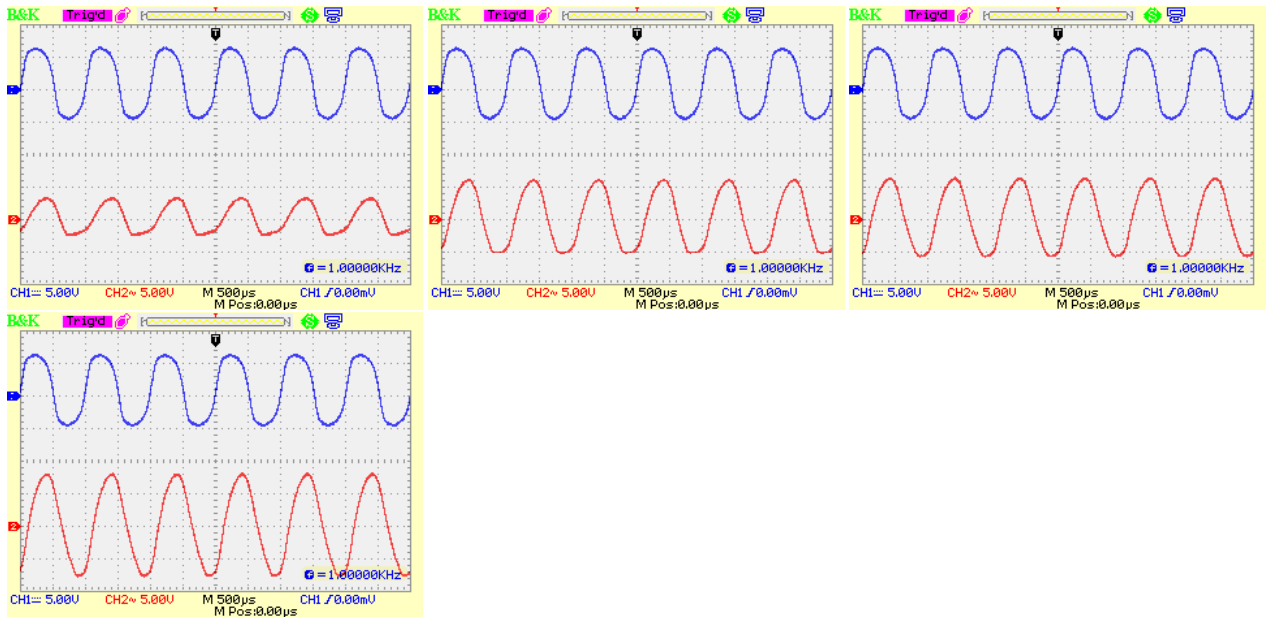

Now, increasing the input level with the mixture set hard clockwise, to examine the second stage. Note that at the very highest level, the distortion folds back just a little. I think at that setting, the first stage amplifier is actually producing so much signal that the mixture *can't* be set to second stage only; there is always a little bit of signal from the first stage making it through the potentiometer and causing the flat part of the waveform to bulge upward.

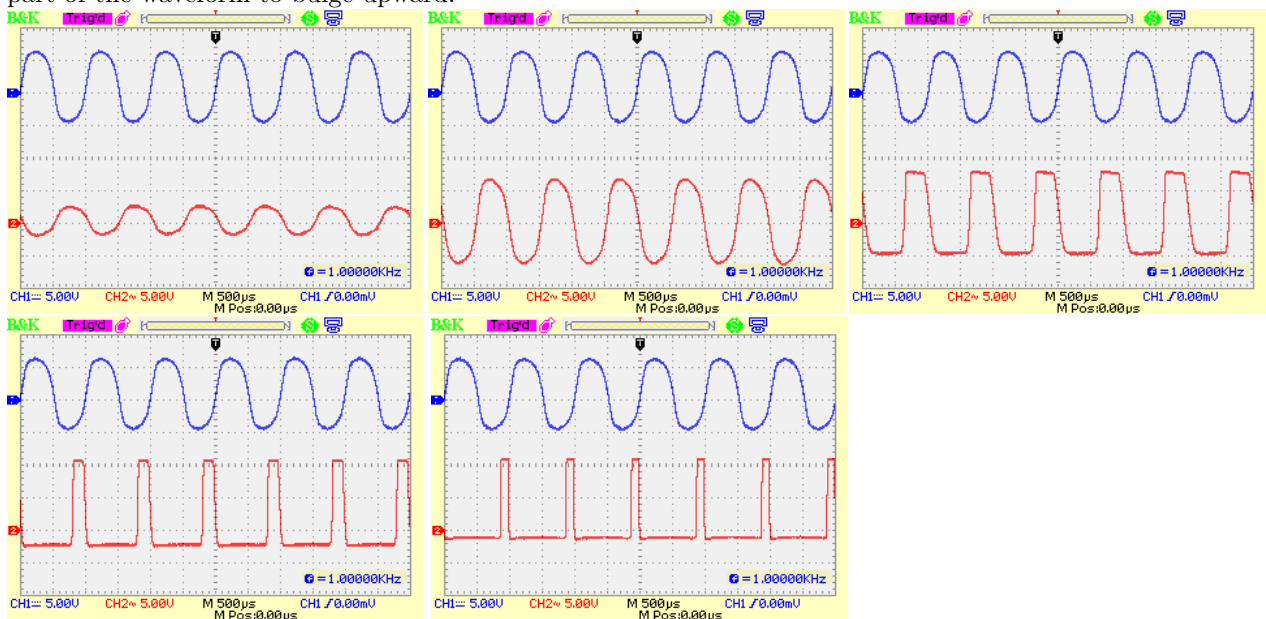

As with the other channel, here is a series showing different settings of the mixture, from all first stage to all second stage. Note that because these are NPN transistors, the pulses go in the opposite direction from those produced on the PNP channel. Higher gain makes them narrower along the time dimension.

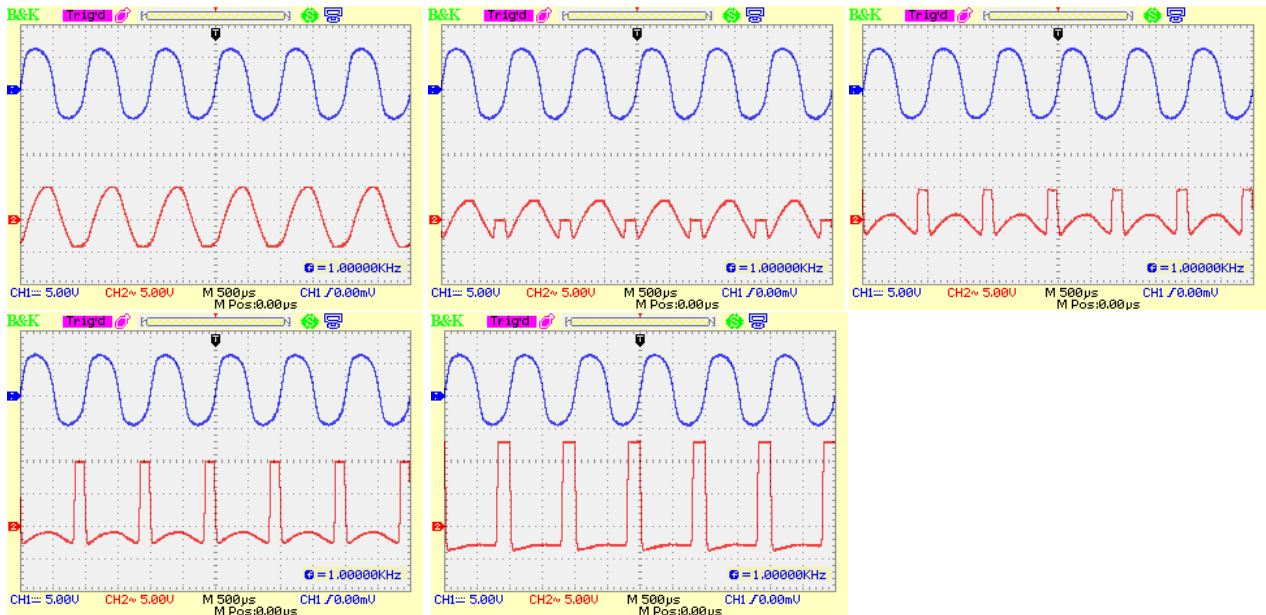

Just for fun I tried feeding the output of Shinji into Asuka and adjusting the controls for an interesting waveform. Many different kinds of results are possible; here is just one.

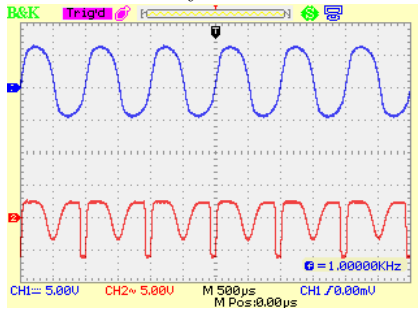

Finally, here's a frequency sweep: 16Hz to the Z3000's upper limit of about 30kHz an octave at a time, with scope in XY mode, input along the horizontal axis and output along the vertical. This is for the Shinji channel, with the levels and mixture roughly in the middle of their ranges. Plotting the input and output in XY mode like this gives some idea of what is happening to the phase, and that's even more dramatic when wiggling the controls and watching the scope in real time. It really looks like the figure is rotating through three-dimensional space as the frequency changes.

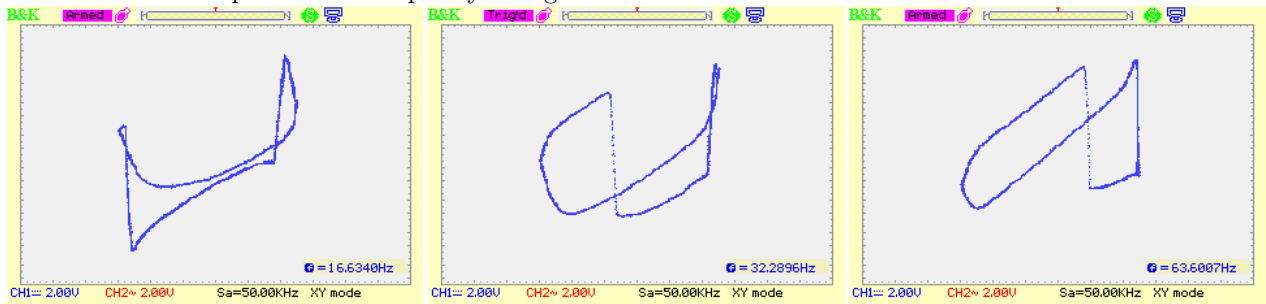



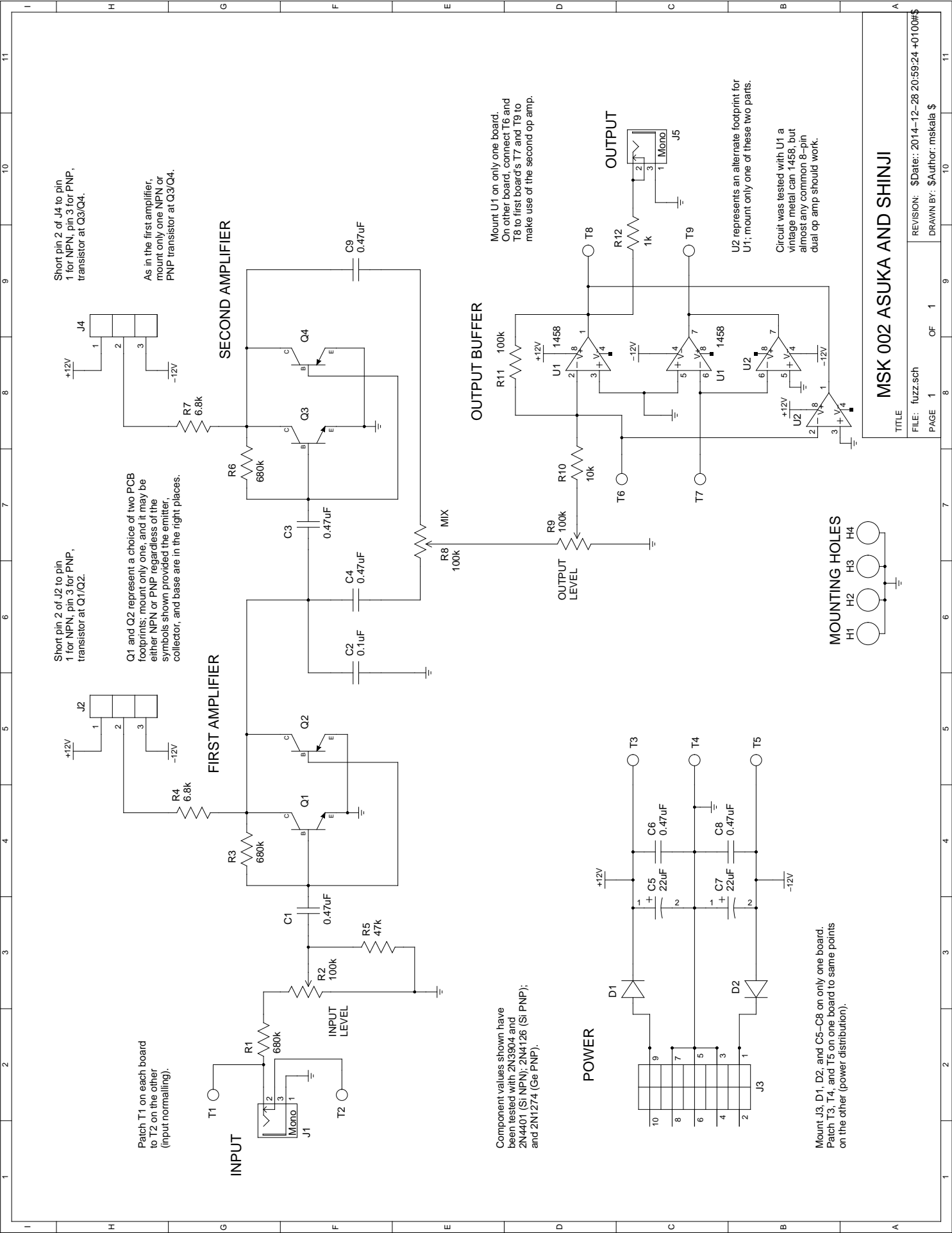

Short pin 2 of J2 to pin 1 for NPN, pin 3 for PNP, transistor at Q1/Q2.

Short pin 2 of J4 to pin 1 for NPN, pin 3 for PNP, transistor at Q3/Q4.

Patch T1 on each board to T2 on the other (input normaling).

Q1 and Q2 represent a choice of two PCB footprints; mount only one, and it may be either NPN or PNP regardless of the symbols shown provided the emitter, collector, and base are in the right places.

As in the first amplifier, mount only one NPN or PNP transistor at Q3/Q4.

Component values shown have been tested with 2N3904 and 2N4401 (Si NPN); 2N4126 (Si PNP); and 2N1274 (Ge PNP).

Mount U1 on only one board. On other board, connect T6 and T8 to first board's T7 and T9 to make use of the second op amp.

U2 represents an alternate footprint for U1; mount only one of these two parts.

Circuit was tested with U1 a vintage metal can 1458, but almost any common 8-pin dual op amp should work.

Mount J3, D1, D2, and C5-C8 on only one board. Patch T3, T4, and T5 on one board to same points on the other (power distribution).

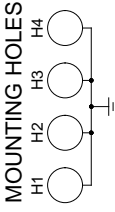

MSK 002 ASUKA AND SHINJI

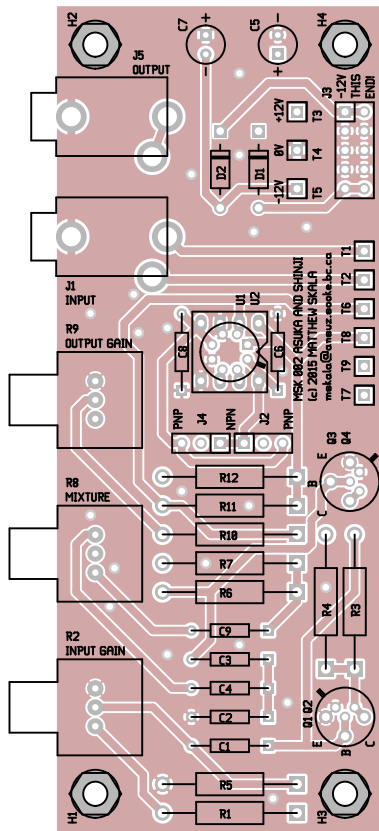

MSK 002
ASUKA/SHINJI

**INPUT
GAIN**



MIXTURE



**OUTPUT
GAIN**



IN



OUT