

TeraStation 1000

User Manual

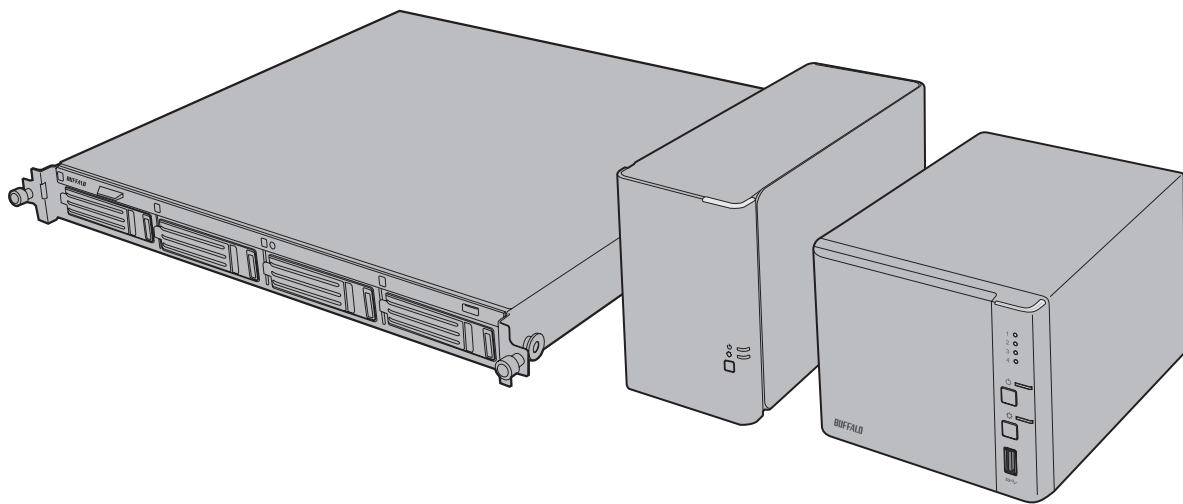

Americas: www.buffaloamericas.com
Europe: www.buffalo-technology.com

35020519-08
2016.11

Contents

Chapter 1 Getting Started	6
Diagrams.....	6
Turning the TeraStation On and Off.....	8
Changing the Administrator Password	8
Chapter 2 Configuration	11
Opening Advanced Settings	11
Opening Easy Admin	13
Chapter 3 Sharing Files	15
Configuring Shared Folders	15
Adding a Shared Folder.....	15
Recycle Bin.....	18
Read-Only Shares.....	18
Hidden Shares	18
Configuring Users	18
Adding a User	18
Importing User Information.....	21
Creating Sequential Users.....	21
Adding a Group	23
Configuring Access Restrictions	25
Local Users and Groups	25
Active Directory	27
NT Domain.....	30

Chapter 4 Managing Storage..... 33

RAID Modes	33
Working with RAID Arrays	34
Using JBOD.....	34
Changing RAID Mode	35
RMM (RAID Mode Manager).....	37
RAID Scanning.....	39
Adding an External Hard Drive	40
Connecting an External Drive	40
Compatibility	40
Dismounting Drives	41
Dismounting with the Function Button	41
Dismounting from Settings	41
Checking Drives	42
Formatting Drives	43
Encrypting Drives.....	45
Erasing Data on the TeraStation Completely	45
Drive Quotas.....	46
Quotas for Users.....	46
Quotas for Groups	46
Hard Drive Replacement	47
Step 1 - Replacing a Hard Drive	48
Step 2 - Rebuild the RAID Array	52

Chapter 5 Remote Access..... 56

WebAccess	56
FTP.....	58

Chapter 6 Backup	61
Back Up from the TeraStation	61
Preparing a Backup Destination.....	61
Configuring a Backup Job	63
Replication.....	67
Preparing a Replication Destination	67
Configuring a Replication Task	68
Backing Up Your Mac with Time Machine	71
Copying from a USB Device	75
Chapter 7 Multimedia	77
DLNA	77
Playing Files	78
Connected DLNA-compatible Devices	78
Streaming to DLNA-compatible Devices	79
Disabling Playback from Specific Devices	80
iTunes Server	81
BitTorrent.....	83
Chapter 8 Advanced Features	86
Email Notification	86
Sleep Mode	87
UPS (Uninterruptible Power Supply)	89
Connecting a Printer	90
Offline Files.....	91
Accessing from an NFS Client.....	92

Encrypting Data Transmission	95
Encrypting Settings Data	95
Encrypting FTP Transfer Data	95
SSL Keys	95
Web Server.....	96
MySQL Server	97
Saving and Applying Settings.....	99
Saving Settings	99
Applying Settings	100
Restoring Factory Defaults.....	101
Initializing with Function Button	101
Initializing from Settings	102
Logs	102
Updating the Firmware.....	104
Name, Date, Time, and Language	104
Jumbo Frames	106
Changing the IP Address	108
Chapter 9 Utilities.....	110
<hr/>	
NAS Navigator2 for Windows.....	110
Mount as Network Drive.....	112
Changing the IP Address	113
NAS Navigator2 for Mac	114
Mount as Network Drive.....	116
Changing the IP Address	117
NovaBACKUP	117
Installing from CD	117

Installing from Website 118

Chapter 10 Appendix 119

When the LED Blinks Red..... 119

When the LED Blinks Amber..... 120

Default Settings 121

Specifications 122

Chapter 11 Regulatory Compliance Information.... 124

For Customers in the United States 124

For Customers in Europe 125

Chapter 1 Getting Started

Diagrams

TS1200D

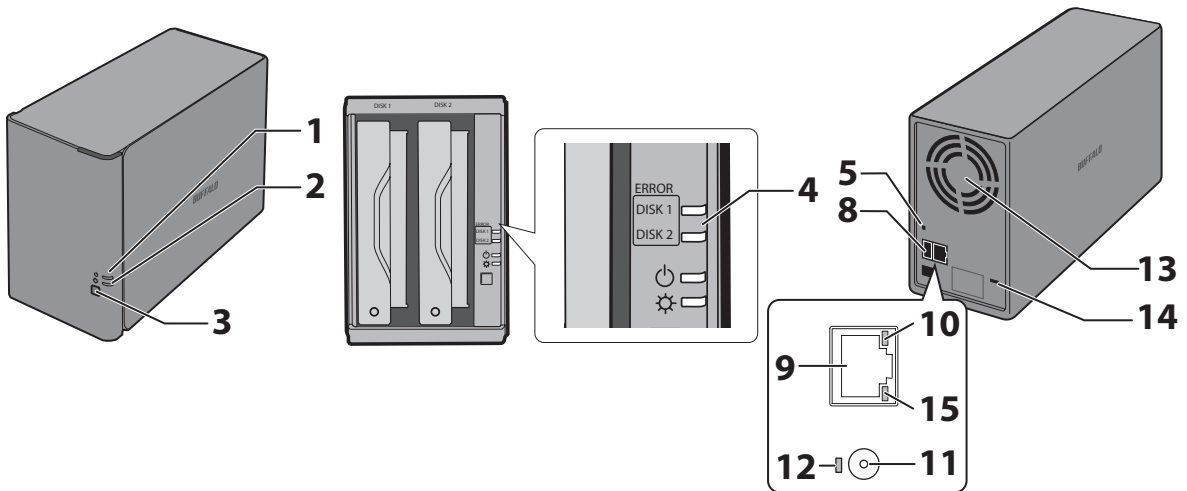

TS1400D

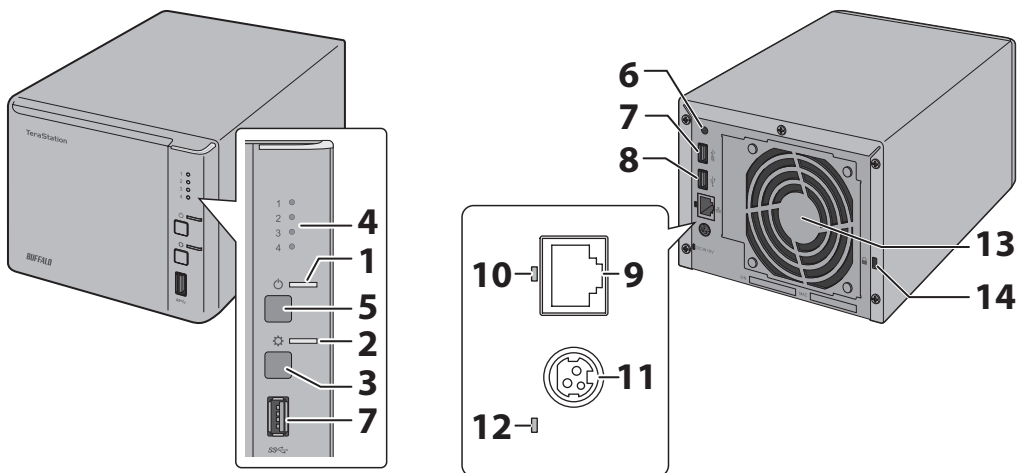

TS1400R

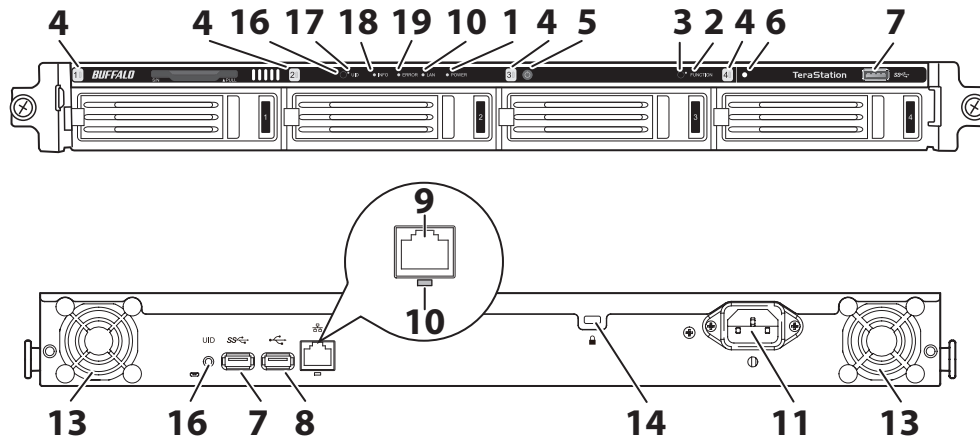

1 Power LED (🔌)

The power LED will light up white while the TeraStation is on.
The power LED blinks white during boot or shutdown.

For TS1200D and TS1400D models, if an error occurs, the power LED will blink red. If there is a status message, the power LED will blink amber. If there is a new firmware available, the power LED will glow amber.

2 Function LED (⚙️)

This LED glows while the TeraStation is being initialized and while dismantling USB devices.

3 Function Button

Use this button for Direct Copy, dismantling USB devices, rebuilding RAID arrays, and initializing settings.

4 Drive Status LED

If an error occurs on a drive, its corresponding LED will light or blink. For TS1400D and TS1400R models, this LED will blink green to indicate that drive status is normal.

5 Power Switch/Power Button (🔌)

For TS1200D models, move the switch up and down to power on and off. For TS1400D and TS1400R models, press the button to power on and hold it down until the TeraStation beeps twice to power off.

If your TS1400D or TS1400R model beeps, you can press the power button once to stop the beeping.

6 Init Button

Use this button when applying saved settings from a USB drive.

7 USB 3.0 Port (SS🔌)

Compatible Buffalo USB 3.0 hard drives, USB flash drives, digital cameras, and USB printers can be connected. USB hubs are not supported.

8 USB 2.0 Port (🔌)

Compatible Buffalo USB hard drives, USB flash drives, digital cameras, USB UPS connection, and USB printers can be connected. USB hubs are not supported.

9 LAN Port (🌐)

Connect to a router, hub, or switch on your Ethernet network with the included Ethernet cable.

10 Link and Activity LED

This LED shows network activity. It blinks green when the TeraStation is accessed over the network.

11 Power Connector

Use the included power cable to connect to a surge protector or outlet.

Note: Disconnecting the AC cable from the TeraStation, even if it is not powered on, may cause the TeraStation's time to become incorrect.

12 Power Status LED

The LED glows green when the power cable is connected.

13 Fan

Spins to avoid overheating inside. Do not block the fan.

14 Anti-Theft Security Slot (🔒)

Use this slot to secure your TeraStation with a cable lock (not included).

15 Not in use.

16 UID Button

Press the UID button on the front or the back of the unit to turn the blue UID LED on or off.

17 UID LED

This LED turns on or off whenever the UID button is pressed. The LED glows blue when on.

18 Info LED

If there is a status message, the info LED will glow amber.

19 Error LED

If there is an error, the error LED will glow red.

Turning the TeraStation On and Off

For TS1200D models, move the power switch on the back of the TeraStation to the "on" position to turn it on. To turn it off, move the switch to the "off" position and wait for the unit to fully shut down before unplugging it.

For TS1400D and TS1400R models, press the power button on the TeraStation to turn it on. To turn off the TeraStation, hold down the power button until the TeraStation beeps twice. The power LED will flash as the unit shuts down. You can also shut down or restart the TeraStation remotely from Settings.

Never unplug the AC adapter without properly shutting down the TeraStation first.

When all the LEDs on the front of the TeraStation turn off, the shutdown process is complete.

Changing the Administrator Password

After initial setup, follow this procedure to change your password.

- 1 Double-click the  icon to start NAS Navigator2.

- 2 Right-click on your TeraStation's icon and select *Settings*. On the Mac, select the TeraStation's icon while holding down the control key, then select *Settings*.

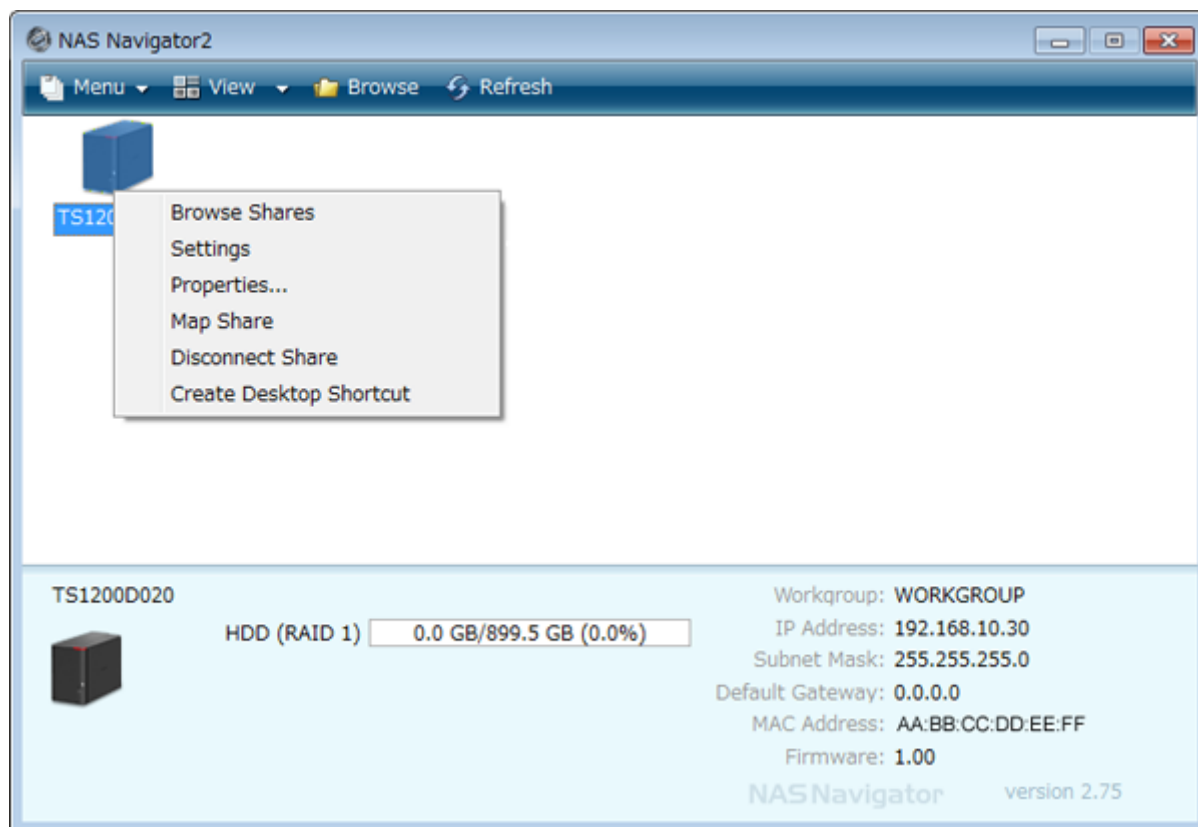

- 3 Click *Easy Admin*.

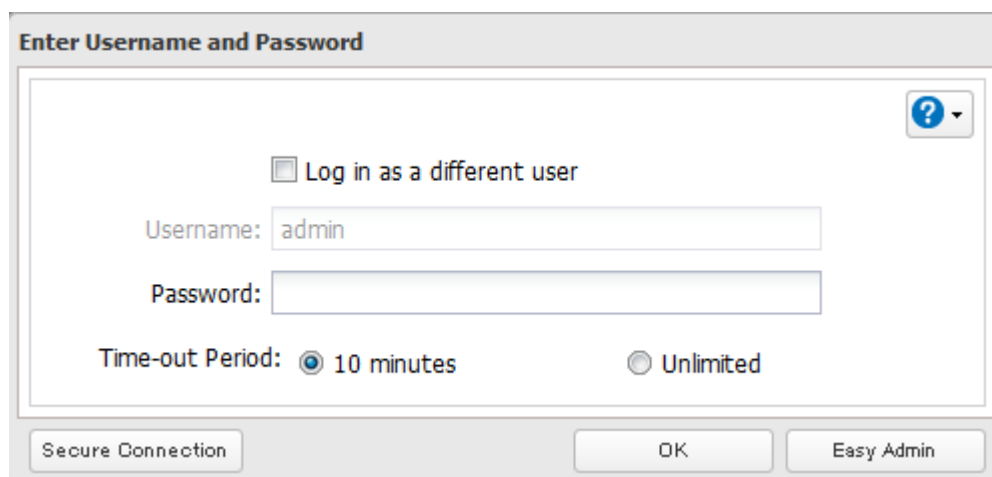

- 4 Click *Change Password*.

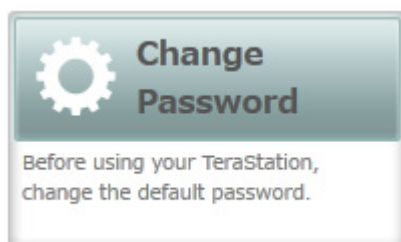

5 If this screen is displayed, enter the current password and click *OK*. The default password is "password".

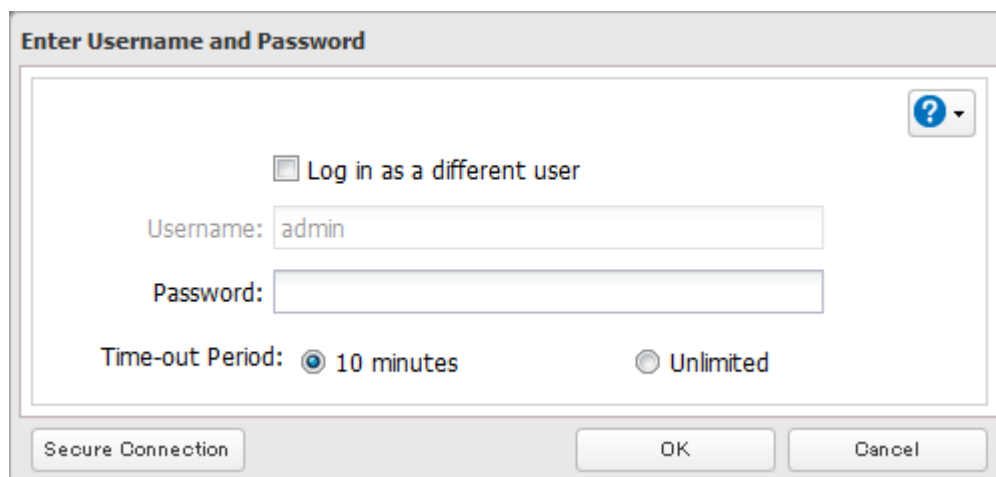

6 Enter the new password (twice) and click *Next*.

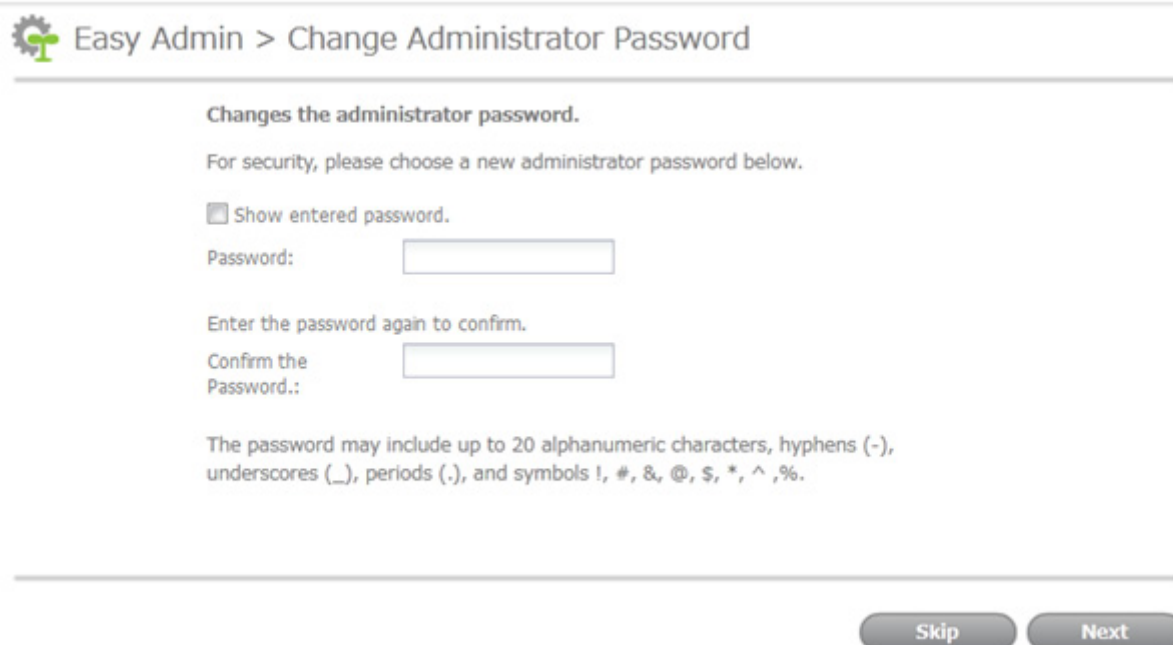

7 Click *OK*. You have changed the admin password.

Chapter 2 Configuration

Configure and manage your TeraStation using the Settings interface, accessible from a browser window. Open the interface using the procedure below or type the TeraStation's IP address in the URL field of your browser. Within Settings, the Easy Admin page gives you quick access to commonly used settings.

Note: Microsoft Edge, Firefox, Google Chrome, Internet Explorer 9 or later, and Safari 9 or later are supported. If you have difficulty viewing Settings, check the following:

- If there are a large number of registered users, groups, or shared folders, use another browser instead of Internet Explorer.
- If you have a proxy server enabled in the browser settings, disable the proxy server.
- With Internet Explorer, set security to *Local intranet*. On Windows Server operating systems, higher-level security is configured by default. Set the security to a lower level temporarily.
- On a Mac, you can also use Bonjour to log in to Settings. Click *Bookmarks - Bonjour - TeraStation name* from the menu bar of Safari.

Opening Advanced Settings

1 Double-click the  icon to start NAS Navigator2.

2 Right-click on your TeraStation's icon in NAS Navigator2 and select *Settings*. For macOS, click your TeraStation's icon while holding down the control key, then select *Settings*.

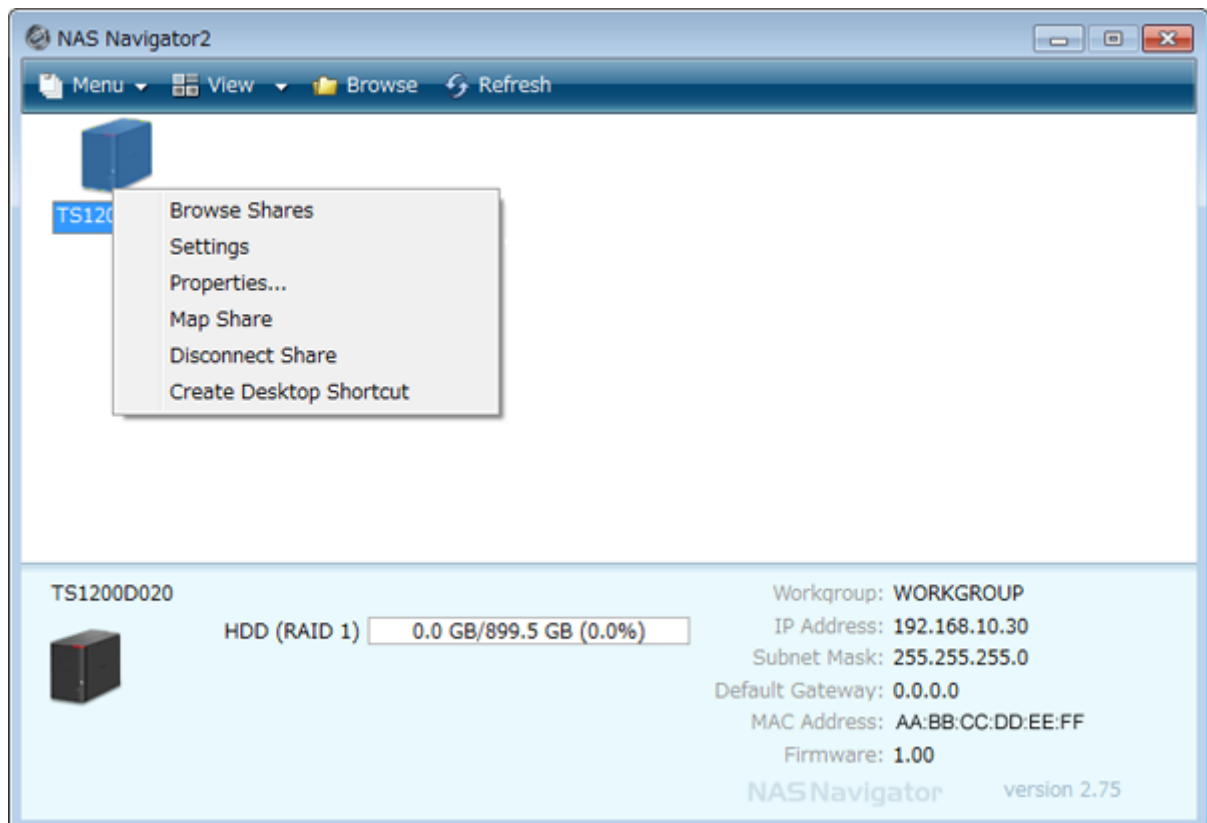

3 Enter the username and password and click *OK*.

Notes:

- If the time-out period is set to "10 minutes", you will be logged out of Settings after 10 minutes of inactivity.
- Click *Secure Connection* to log in with an encrypted connection.

4 Settings will open.

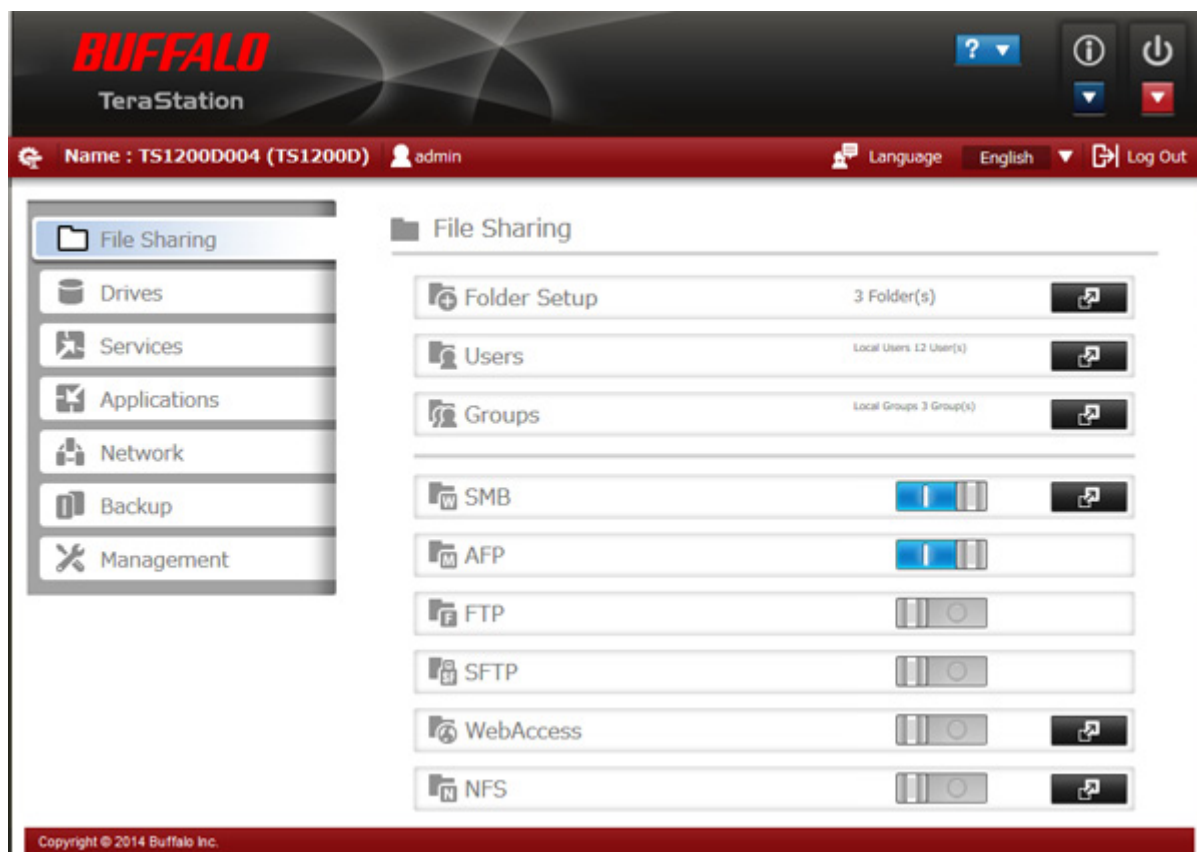



Notes:

- Username/Password Combinations:

Username	Password	Settings Available
admin	password	All
guest	blank	System information (read-only)

Username	Password	Settings Available
Your username	Your password	If a user is assigned as an administrator, all settings are available. If assigned as a general user, the user can only access read-only system information and change their own password, If assigned as a power user, the user can create and edit shared folders, users, and general users groups.

- Click  to open Easy Admin.
- The TS1400D and TS1400R supports the "I'm here" function for easy location. Click the  icon in Settings and the TeraStation will start to beep.

Opening Easy Admin

The Easy Admin page makes it easy to change common settings. Follow the steps below to open Easy Admin.

1 Double-click the  icon to start NAS Navigator2.

2 Right-click on your TeraStation's icon and choose *Settings*. For macOS, click the TeraStation icon while holding down the control key, then select *Settings*.

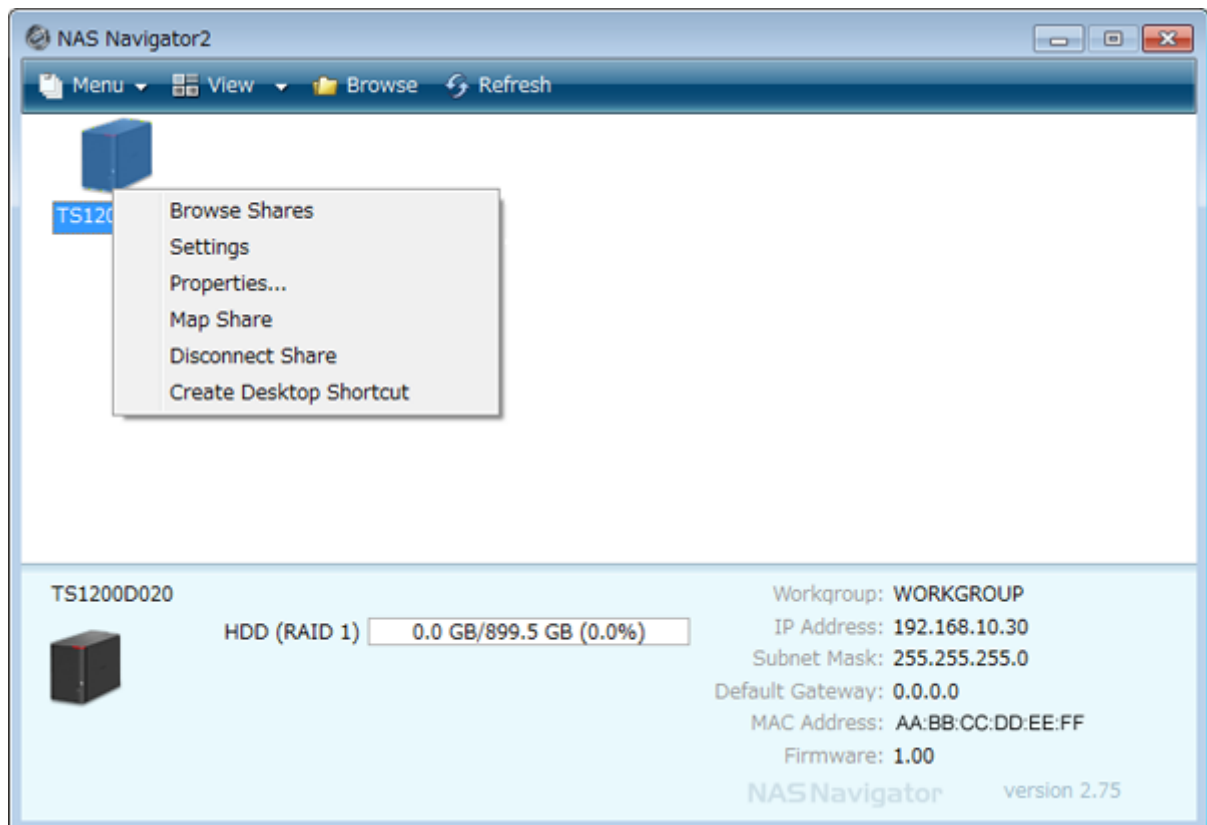

3 Click *Easy Admin*.

Enter Username and Password

Log in as a different user

Username:

Password:

Time-out Period: 10 minutes Unlimited

Secure Connection OK Easy Admin

4 The Easy Admin screen will open.

BUFFALO
TeraStation

Name : TS1200D004 (TS1200D) Not logged in Language English

Easy Admin

- WebAccess**
Create a free personal cloud and access and share your files anytime, anywhere over the Internet.
- Access Restrictions**
Create users, groups, and new folders.
- RAID Settings**
Change RAID settings.
- Active Domain**
Enable to sync TeraStation with Active Directory domain.
- Backup**
You can back up files on the TeraStation to an attached USB drive or to another folder on the
- Change Password**
Before using your TeraStation, change the default password.

Advanced Settings All TeraStation functions can be configured from Advanced Settings.

Copyright © 2014 Buffalo Inc.

Note: If you click any buttons , you will need to enter a username and password.

Chapter 3 Sharing Files

Configuring Shared Folders

Adding a Shared Folder

1 In Settings, click *File Sharing*.

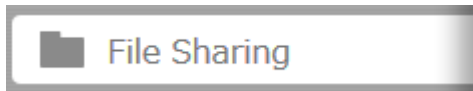

2 Click  to the right of "Folder Setup".

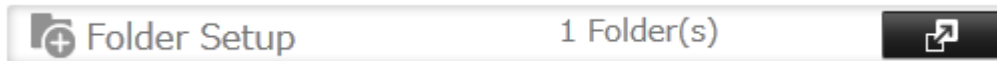

3 Click *Create Folder*.

4 You can create up to 20 shared folders at a time. Enter a folder name and description (optional), then click *Create Folder*.

The dialog box titled "Create Shared Folder(s)" contains a table with the following columns: Name, Description, Volume, and Details. The "Name" column has a red asterisk indicating it is required. The "Volume" column shows "Disk 1" for each row. The "Details" column has an "Edit" button for each row. There are 20 rows in total. At the bottom, there are buttons for "Select All", "Unselect All", "Create Folder", and "Cancel".

Name *	Description	Volume	Details
		Disk 1	Edit
		Disk 1	Edit
		Disk 1	Edit
		Disk 1	Edit
		Disk 1	Edit
		Disk 1	Edit
		Disk 1	Edit
		Disk 1	Edit
		Disk 1	Edit
		Disk 1	Edit
		Disk 1	Edit
		Disk 1	Edit
		Disk 1	Edit
		Disk 1	Edit
		Disk 1	Edit
		Disk 1	Edit
		Disk 1	Edit
		Disk 1	Edit
		Disk 1	Edit
		Disk 1	Edit
		Disk 1	Edit

If you want to configure any shared folders, click *Edit* and configure desired settings. Click *OK* when finished.

Shared Folder Settings

Name: * Required ?

Basic Settings | **Advanced Settings** | **Access Restrictions**

Copy settings from: List has no content.

Name * :

Shared Folder Description:

Volume: Disk 1

Attribute: Read Only Read & Write

OK Cancel

5 Click *OK* when the following message is displayed.

Create Shared Folder(s)

Create the following 1 shared folder(s)?

share

OK Cancel

- An incomplete file may be copied and the file can no longer be deleted. If this happens, restart the TeraStation, delete the file, and perform the copy operation again.
- When you access a shared folder from a Windows PC, you may be asked to enter a username and password. In such a case, enter "guest" for the username and the password is blank.

Recycle Bin

To protect your data from accidental deletion, you may configure your TeraStation to use a recycle bin instead of deleting files immediately. The recycle bin will only work with SMB connections. To empty the recycle bin, click *File Sharing - Folder Setup - Empty Recycle Bin* in Settings.

Note: You can prevent guests and other users from emptying the trash by navigating to *File Sharing - SMB - Recycle Bin Permissions* and selecting "Administrator only".

Read-Only Shares

By default, new shares are set with read and write access, but you may change the attribute to *Read Only* in *Attribute*. Read-only shares and HFS Plus-formatted USB hard drives will have "(Read Only)" added to comments in Explorer.

Note: Configure read-only file attribute in Settings. Configuring them from within Windows is not supported and may cause unexpected behavior.

Hidden Shares

If hidden shares are enabled, shared SMB folders will not be displayed in Network, and only certain users are allowed to access them. To hide a shared SMB folder, follow the instructions below.

- 1** In Settings, navigate to *File Sharing - Folder Setup* and choose a shared folder or a USB drive to configure hidden shares.
- 2** Select the "Hidden Share (SMB Only)" checkbox and click *OK*.

Notes:

- If protocols other than "SMB" or "Backup" under "LAN Protocol Support" are enabled, the hidden shares option will be grayed out and cannot be selected.
- Configure hidden share attribute in Settings. Configuring them from within Windows is not supported and may cause unexpected behavior.

To access a hidden folder, open File Explorer in your computer and enter "\\TeraStation name\Shared folder name\$" for the name. For example, if the TeraStation name is "TSXXX001" and the shared folder name is "share", enter "\\TSXXX001\share\$" to open it.

Configuring Users

Adding a User

Note: The TeraStation can register a maximum 300 of users, which includes the default users "admin" and "guest".

- 1** In Settings, click *File Sharing*.

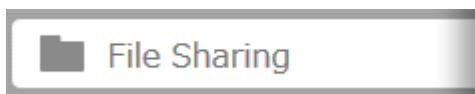

- 2** Click  to the right of "Users".



3 Click *Create User*.

4 You can create up to 20 users at a time. Enter a username and password (twice), then click *Create User*.

The screenshot shows a 'Create User(s)' dialog box. At the top left, there are buttons for 'Delete', '* Required', and 'Create Sequential Users'. Below these is a table with five columns: 'Username *', 'Password *', 'Confirm Password *', 'Description', and 'Details'. The table contains 20 empty rows. Each row has a small square checkbox on the left and an 'Edit' button on the right. At the bottom of the dialog, there are buttons for 'Select All', 'Unselect All', 'Create User', and 'Cancel'.

	Username *	Password *	Confirm Password *	Description	Details
<input type="checkbox"/>					Edit
<input type="checkbox"/>					Edit
<input type="checkbox"/>					Edit
<input type="checkbox"/>					Edit
<input type="checkbox"/>					Edit
<input type="checkbox"/>					Edit
<input type="checkbox"/>					Edit
<input type="checkbox"/>					Edit
<input type="checkbox"/>					Edit
<input type="checkbox"/>					Edit
<input type="checkbox"/>					Edit
<input type="checkbox"/>					Edit
<input type="checkbox"/>					Edit
<input type="checkbox"/>					Edit
<input type="checkbox"/>					Edit
<input type="checkbox"/>					Edit
<input type="checkbox"/>					Edit
<input type="checkbox"/>					Edit
<input type="checkbox"/>					Edit
<input type="checkbox"/>					Edit
<input type="checkbox"/>					Edit

If you want to configure any users, click *Edit* and configure desired settings. Click *OK* when finished.

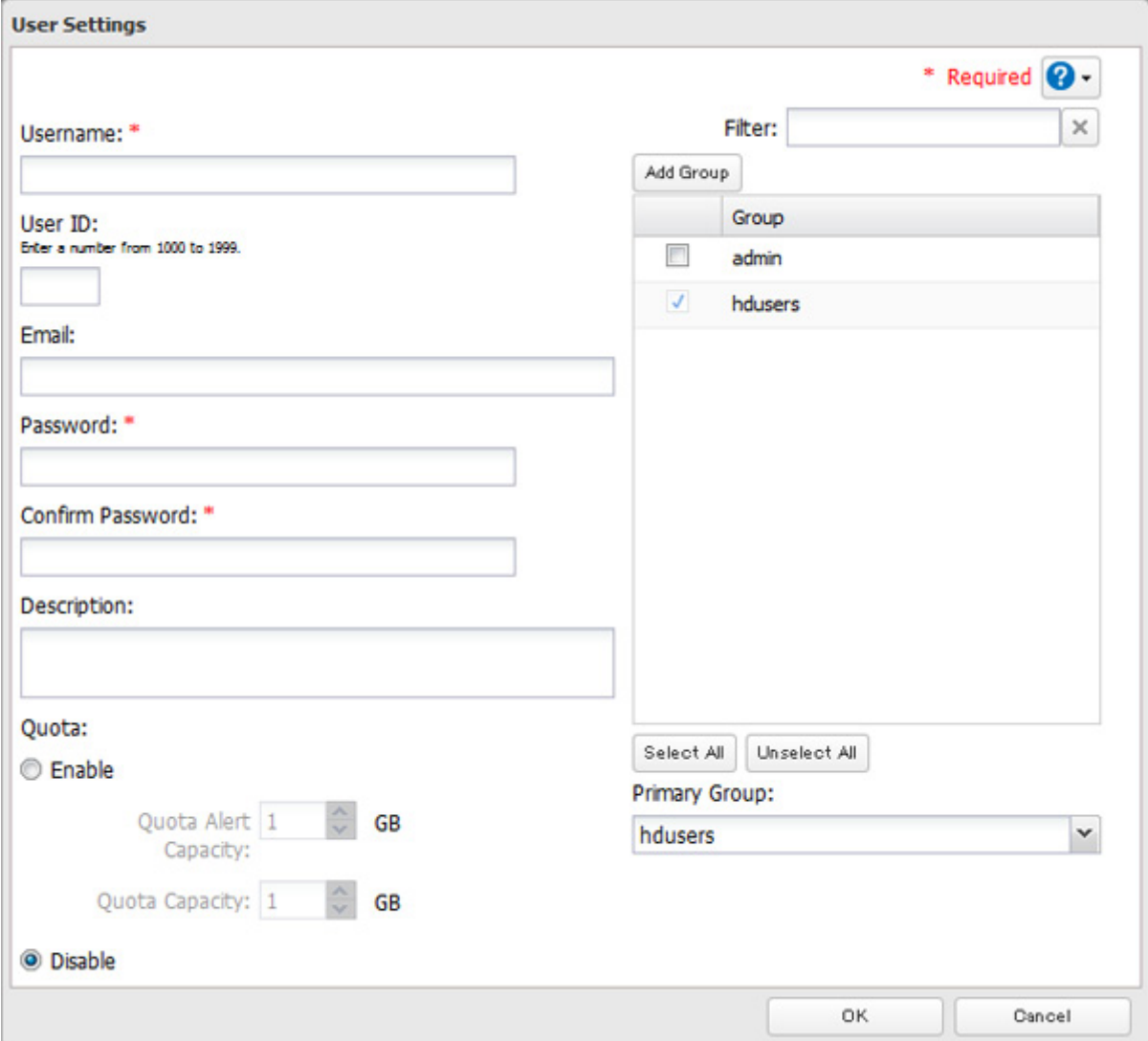

The **User Settings** dialog box contains the following fields and controls:

- Username:** * (Required) [Text Input]
- User ID:** Enter a number from 1000 to 1999. [Text Input]
- Email:** [Text Input]
- Password:** * (Required) [Text Input]
- Confirm Password:** * (Required) [Text Input]
- Description:** [Text Input]
- Quota:**
 - Enable
 - Quota Alert Capacity: 1 GB
 - Quota Capacity: 1 GB
 - Disable

On the right side of the dialog:

- * Required** [Help Icon]
- Filter:** [Text Input]
- Add Group** [Button]
- Group** [Table]

	Group
<input type="checkbox"/>	admin
<input checked="" type="checkbox"/>	hdusers

- Select All** [Button] **Unselect All** [Button]
- Primary Group:** hdusers [Dropdown]

Buttons: **OK** [Button] **Cancel** [Button]

5 Click *OK* when the following message is displayed.



The **Create User(s)** dialog box displays the following message:

Create the following 1 user(s)?

user

Buttons: **OK** [Button] **Cancel** [Button]

Notes:

- Usernames may contain up to 128 characters, including hyphens (-), underscores (_), periods (.), !, #, &, @, \$, *, ^, and %. Do not use a symbol as the first character.
- The user ID should be a number from 1000 to 1999. Each user ID should be unique. If this field is left blank, a user ID is assigned automatically.
- Do not duplicate user IDs, group IDs, usernames, or group names. Each should be distinct and unique.
- The description may contain up to 75 alphanumeric characters, hyphens (-), underscores (_), and spaces. Do not use a symbol or space as the first character.
- Passwords may contain up to 20 alphanumeric characters and the following characters: - _ @ ! # \$ % & ' () * + , . / ; < > = ? " [] ^ { } | ~. Do not use a symbol other than an underscore (_) as the first character.
- Use the same username and password for both Windows and the TeraStation or you may not be able to access shared folders.
- Do not use any of the following words for a username as these words are reserved for internal use by the TeraStation: adm, admin, administrator, all, apache, backup, bin, daemon, dbus, disk, ftp, ftpuser, guest, haldaemon, halt, hdusers, kmem, lp, mail, man, mysql, news, nobody, nogroup, none, operator, proxy, root, rpc, rpcuser, shadow, shutdown, splx, sshd, sync, sys, tty, users, utmp, uucp, www, www-data

Importing User Information

You can import users in *File Sharing - Users* by clicking *Import CSV File*.

Format for user data: Username (required), password (required), and user description (optional).

Example 1: Importing usernames, passwords, and comments

```
username1,password1,comment1
username2,password2,comment2
username3,password3,comment3
```

Example 2: Importing usernames and passwords

```
username1,password1,
username2,password2,
username3,password3,
```

Guidelines:

- Use commas (,) as separators. Do not put spaces before or after commas. If you don't want user descriptions, use a comma after password at the end.
- If a line has an incorrect format, the user on that line will not be registered.
- If a username already exists, the new user information will overwrite the old information.
- Do not use commas (,) in the username, password, or user description.

Note: Imported users are added to the "hdusers" group automatically.

Creating Sequential Users

The TeraStation can create multiple sequential users. Sequential users will have a desired username and a number assigned based on the maximum number of users in the sequence (e.g. user01, user02, etc.).

1 In Settings, click *File Sharing*.

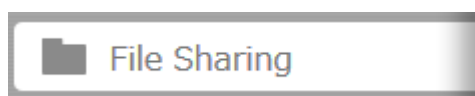

2 Click  to the right of "Users".



3 Click *Create User*.

4 Click *Create Sequential Users*.

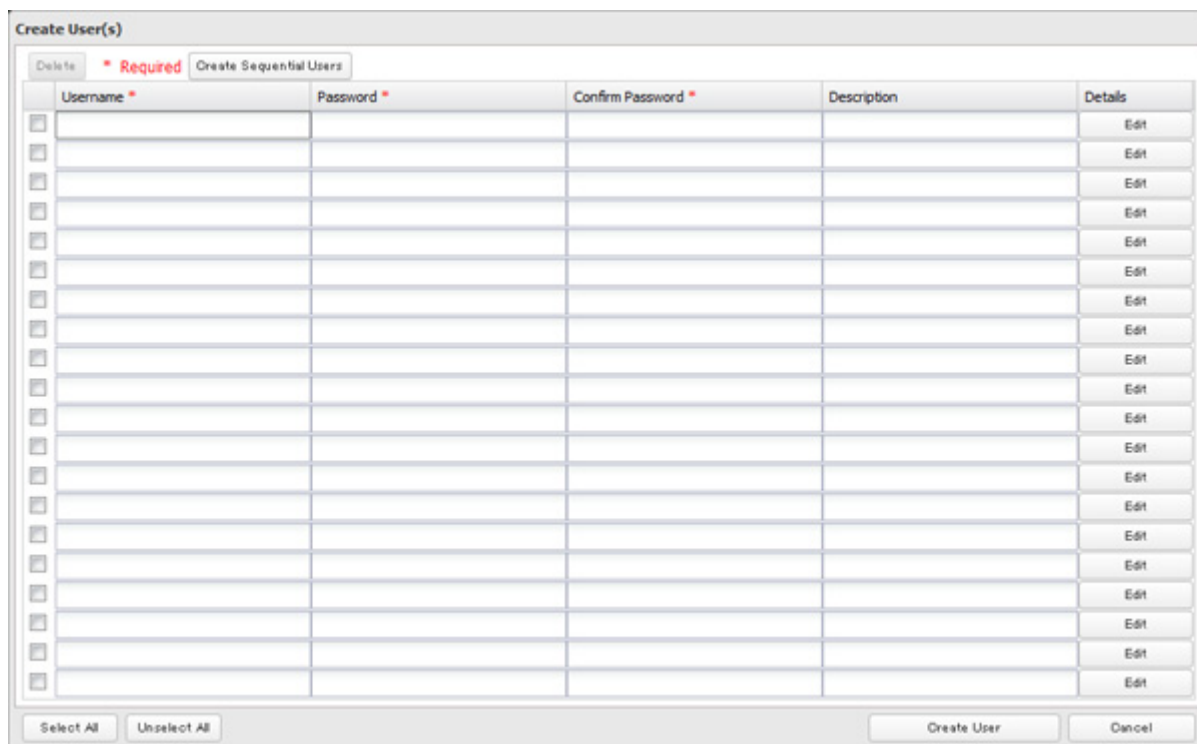

The 'Create User(s)' dialog box features a header with 'Delete', '* Required', and 'Create Sequential Users' options. Below is a table with five columns: 'Username *', 'Password *', 'Confirm Password *', 'Description', and 'Details'. The table contains 15 empty rows, each with a checkbox on the left and an 'Edit' button in the 'Details' column. At the bottom, there are 'Select All', 'Unselect All', 'Create User', and 'Cancel' buttons.

	Username *	Password *	Confirm Password *	Description	Details
<input type="checkbox"/>					Edit
<input type="checkbox"/>					Edit
<input type="checkbox"/>					Edit
<input type="checkbox"/>					Edit
<input type="checkbox"/>					Edit
<input type="checkbox"/>					Edit
<input type="checkbox"/>					Edit
<input type="checkbox"/>					Edit
<input type="checkbox"/>					Edit
<input type="checkbox"/>					Edit
<input type="checkbox"/>					Edit
<input type="checkbox"/>					Edit
<input type="checkbox"/>					Edit
<input type="checkbox"/>					Edit
<input type="checkbox"/>					Edit
<input type="checkbox"/>					Edit

- 5 Enter a username, password (twice), number of users to create, and select the digit to add after each username from the drop down menu.

Create Sequential Users

* Required ?

Username: *

user

Number of Users to Create: *

10 Add 2-digit number to username (from "01")

Examples:

user01,
user02,
...,
user10

Password for All Sequential Users: *

Confirm Password: *

Quota for All Sequential Users:

Enable

Quota Alert Capacity: 1 GB

Quota Capacity: 1 GB

Disable

Filter:

Add Group

Group
<input type="checkbox"/> admin
<input checked="" type="checkbox"/> hdusers

Select All Unselect All

Primary Group for All Sequential Users:

hdusers

Create shared folders for each user

OK Cancel

- 6 Click *OK*. The number of users you specified are created.

Notes:

- The username for sequential users may contain up to 24 alphanumeric characters, hyphens (-), and underscores (_). Do not use hyphens (-) and underscores (_) as the first character. A two or three-digit number will be added after the username.
- If "Create shared folders for each user" is checked, a shared folder will be created for each sequential user. This folder will have the same name as the sequential user, and only be accessed by the sequential user with the same name.
- Do not use any of the following words as a username: root, bin, daemon, sys, adm, tty, disk, lp, sync, shutdown, halt, operator, nobody, mail, news, uucp, ftp, kmem, utmp, shadow, users, nogroup, all, none, hdusers, admin, guest, man, www, sshd, administrator, ftpuser, apache, mysql, splx

Adding a Group

- 1 In Settings, click *File Sharing*.

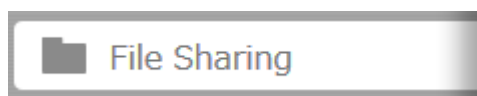

2 Click  to the right of "Groups".



3 Click *Add Group*.

4 Enter the desired settings, then click *OK*.

Group Settings

Group Name: *

Group ID:
(*Enter a number from 1000 to 1999.)

Group Privileges:
General Users

Select a recipient for group notifications:
 User (with email address configured)
Disabled
 Email address

Description:

Quota:
 Enable (Units: GB)
Quota Alert Capacity: 1
Quota Capacity: 1
 Disable

Filter:

Username	
<input checked="" type="checkbox"/>	admin

Select All Unselect All

OK Cancel

Notes:

- Group names may contain up to 20 alphanumeric characters, hyphens (-), underscores (_), and periods (.). Do not use a symbol other than an underscore (_) as the first character.
- Group descriptions may contain up to 75 alphanumeric characters, hyphens (-), underscores (_), and spaces. Do not use a symbol or space as the first character.
- If the group ID field is left blank, a group ID is automatically assigned. Use numbers between 1000 and 1999 to set a group ID manually. Don't use duplicate group IDs.
- You may register up to 300 groups with the TeraStation.

- If you are logged in as a member of the general users group, you can only change your own password. If you're logged in as an administrator, you can change any settings, including other users' passwords. If you are logged in as a member of the power users group, you can create and edit shared folders, users, and groups.
- Do not use any of the following words for a group name as these words are reserved for internal use by the TeraStation: root, bin, daemon, sys, adm, tty, disk, lp, sync, shutdown, halt, operator, nobody, mail, news, uucp, ftp, kmem, utmp, shadow, users, nogroup, all, none, hdusers, admin, guest, man, www, sshd, administrator, ftpuser, apache, mysql, splx

Configuring Access Restrictions

You may restrict access to specific shared folders, including external USB drives.

Notes:

- Access restrictions can be set separately for each shared folder, but not for folders within the shared folders.
- Configure access restrictions through Settings. Configuring access restrictions through Windows is not supported and may cause unexpected behavior.
- You can also configure users, groups, and shared folders from Easy Admin by clicking *Access Restrictions*.
- Shared folders with limited access can still be used as backup destinations.
- If you change access restrictions for a user or group while they are accessing files, unexpected behavior may result.

Local Users and Groups

1 In Settings, click *File Sharing*.

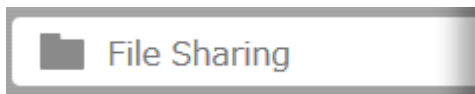

2 Click  to the right of "Folder Setup".



3 Click the shared folder that you want to set access restrictions for.

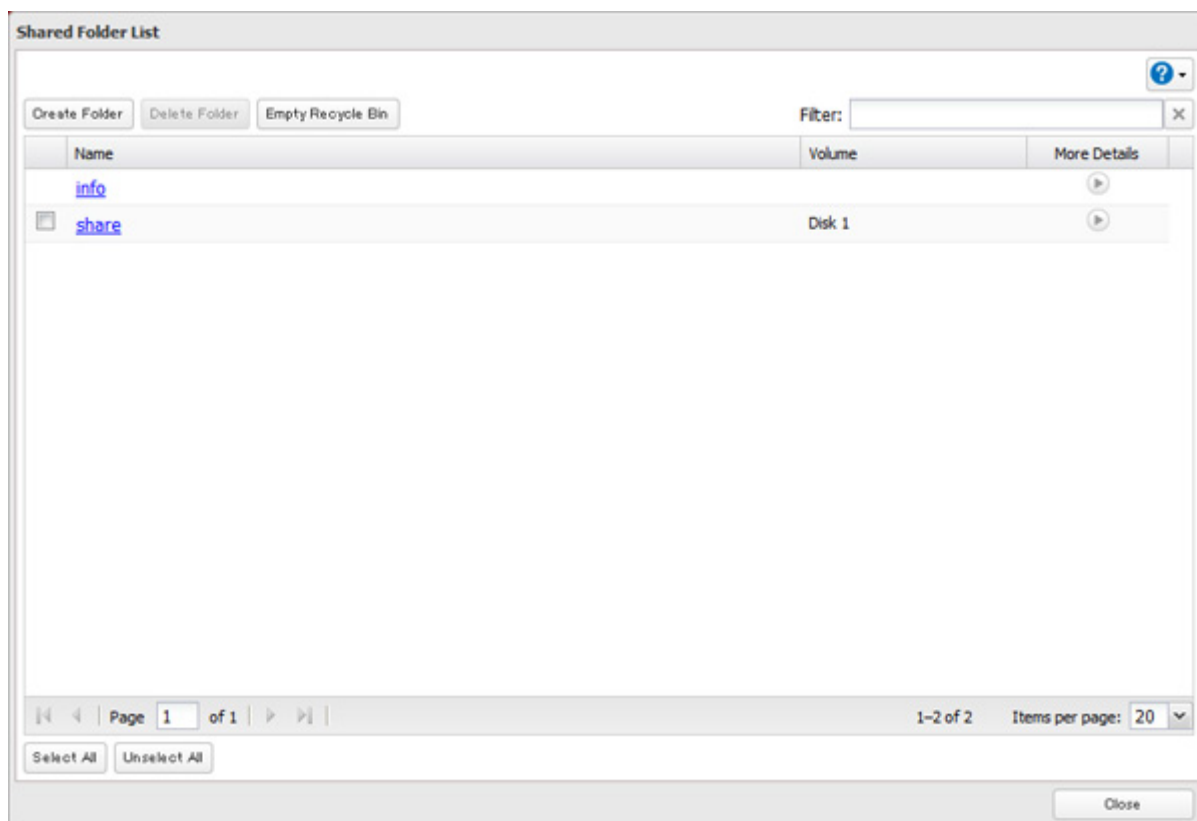

4 Click the *Access Restrictions* tab.

5 Enable "Access Restrictions".

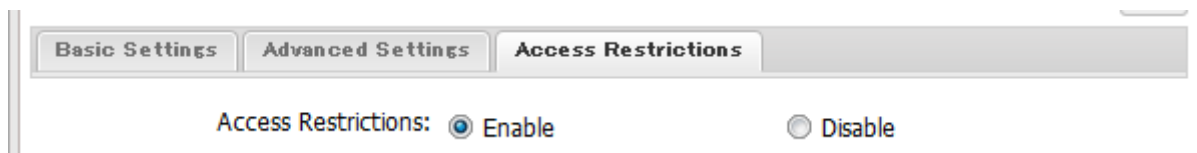

6 Select the level of access for the user or group you added.

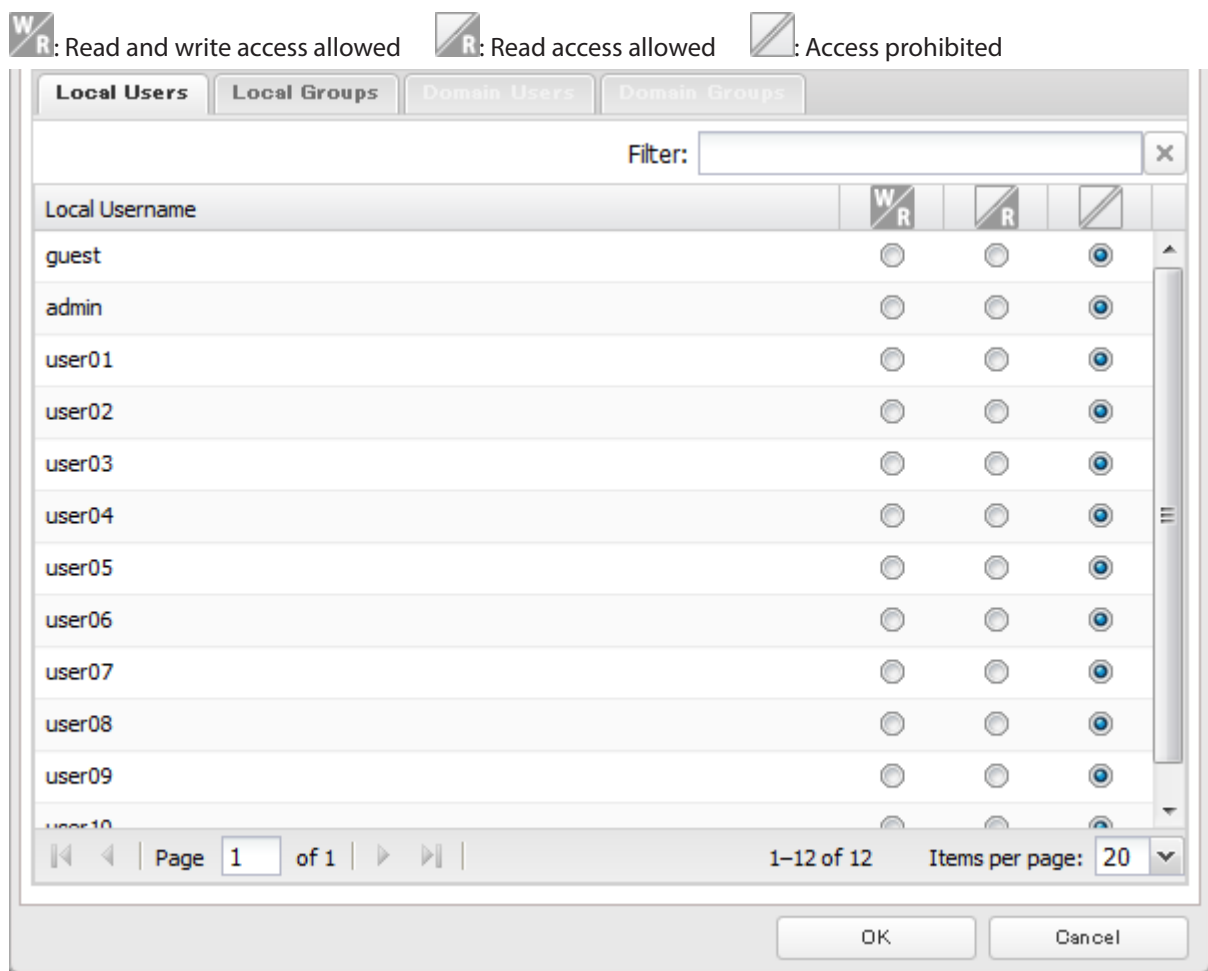

7 Click *OK*.

Notes:

- The example above shows access restriction by user. To restrict access by group, click the *Local Groups* tab and select group permissions.
- If both read-only and read and write permissions are given to a user, the user will have read-only access. The most restrictive access always applies.
- For an access-restricted shared folder, if you change the access restrictions of all users and groups from read and write or read only to access prohibited from the user or group list page in Settings, that shared folder can only be accessed by admin users.

Active Directory

If there is an Active Directory environment, the TeraStation will use account information from the Active Directory domain controller to set access restrictions for TeraStation's shared folders. There is no need to perform individual account management for the TeraStation. If multiple TeraStations are installed on the network, the account information is centrally managed in Active Directory, greatly reducing the operations required for installation and management.

Notes:

- If usernames or group names from Active Directory include multi-byte characters, you will not be able to configure access restrictions for them.
- The TeraStation supports a domain environment with a maximum of 1000 users and 1000 groups.

1 In Settings, click *Network*.



2 Click  to the right of "Workgroup/Domain".



3 Click *Edit*.

4 Select "Active Directory", then click *Next*.

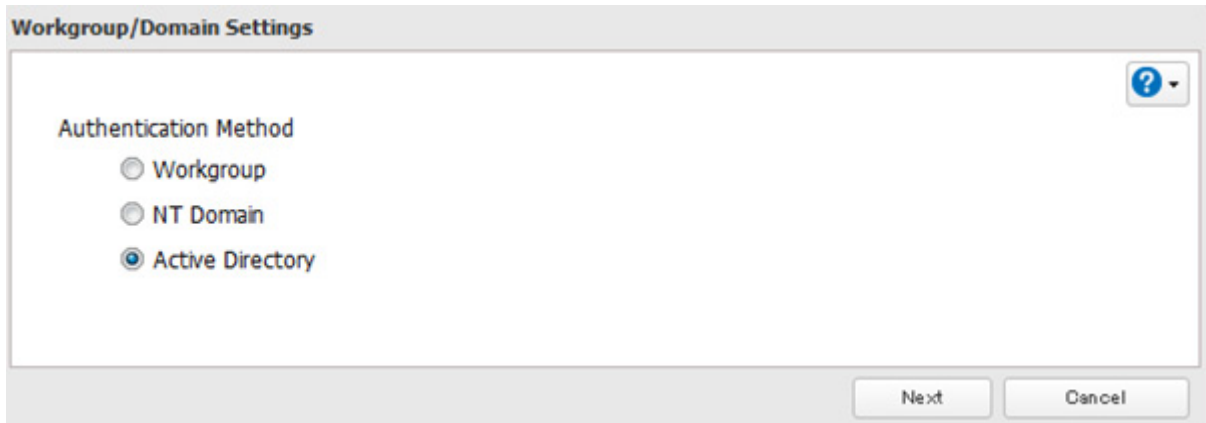

5 Click *Yes*.

6 Enter the desired settings, then click *OK*.

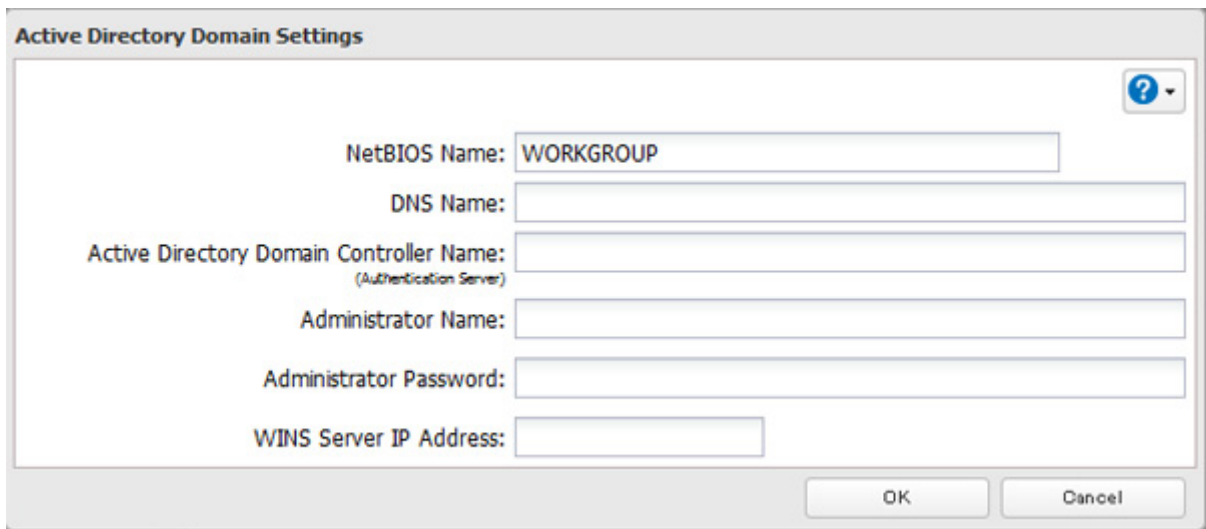

7 Click  to the right of "Folder Setup".



8 Click a shared folder that you want to set access restrictions for.

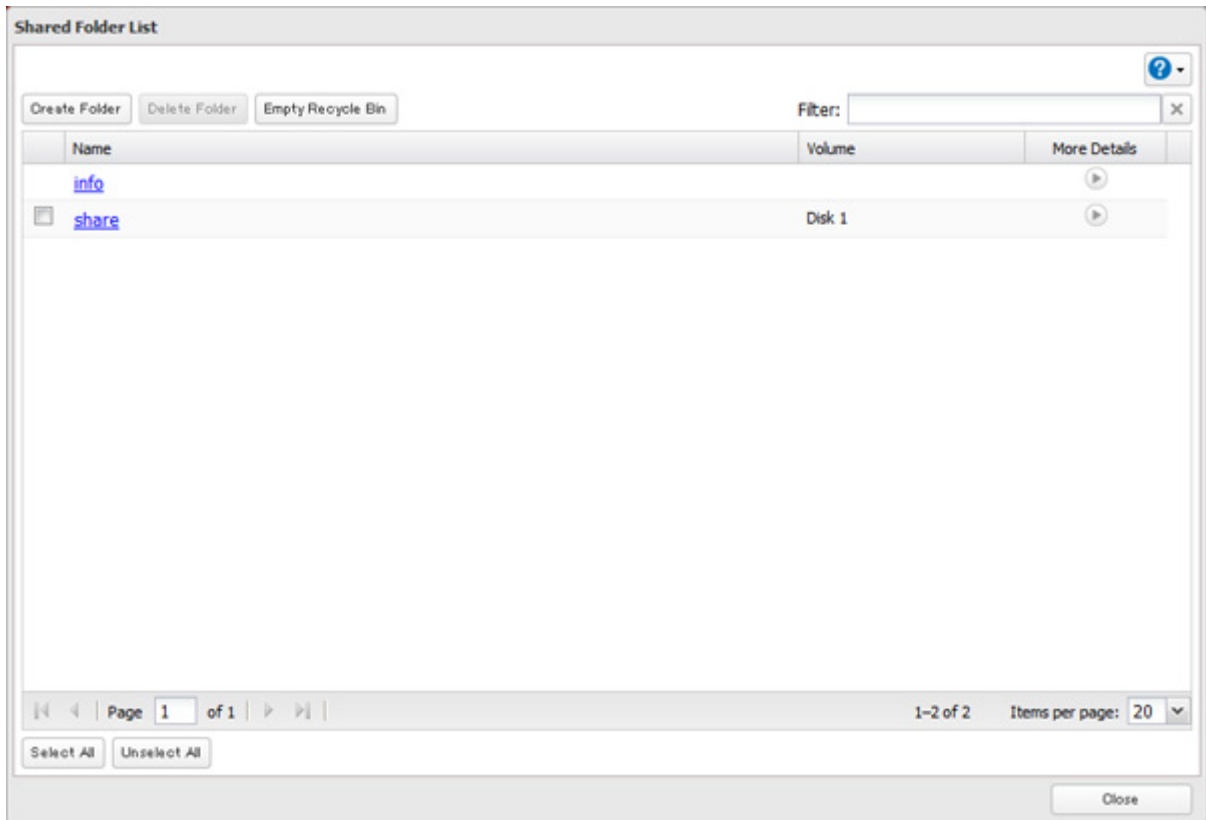

9 Click the *Access Restrictions* tab.

10 Enable "Access Restrictions".

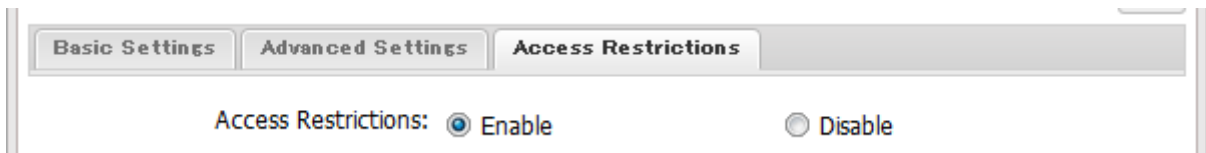

11 Select the level of access for the user or group.



12 Click *OK*.

Notes:

- If you change the TeraStation's name, you will no longer be able to use domain users and groups or access restrictions. To repair this, rejoin the domain.
- To have the TeraStation join an Active Directory domain, configure it to use a DNS server that can resolve names for the Active Directory domain.
- After building an Active Directory domain, the administrator password for joining the domain must be changed at least once, or joining the Active Directory domain will fail.
- The DNS name and NetBIOS name of Active Directory domains should be identical.
- If both read-only and read and write permissions are given, the user will have read-only access. The most restrictive access setting will apply.
- If there is a difference of more than 5 minutes between the TeraStation's clock and the domain controller's clock, joining the domain or authenticating domain users and groups may fail. For best results, use an NTP server to set the time for all network devices.

- To use the TeraStation as a member server in an Active Directory domain, the TeraStation should be logged in to the domain and accessed from a computer that is not a member of the domain with a valid domain account.
- If the TeraStation is a member server of an Active Directory domain, you cannot connect as a guest user via AFP.
- If your TeraStation is a member server in an Active Directory domain and you change the authentication method to "Workgroup", the account on the domain controller will not be deleted automatically.
- If the TeraStation joins a domain network, you cannot connect to it via FTP.
- Don't disable the SMB protocol while Active Directory is used for access restrictions. If you do, you will need to enable SMB again and reconfigure AD from scratch.
- For an access-restricted shared folder, if you change the access restrictions of all users and groups from read and write or read only to access prohibited from the user or group list page in Settings, that shared folder can only be accessed by admin users.

NT Domain

In an NT domain environment, the TeraStation uses account information from the NT domain server to set access restrictions for files and folders on the TeraStation. There's no need to perform individual account management for the TeraStation. If multiple TeraStations are installed on the network, the account information is centrally managed in the NT domain, greatly reducing the operations required for installation and management.

Note: The TeraStation supports a NT domain environment with a maximum of 1000 users and 1000 groups. 10,000 users and 10,000 groups can be downloaded from the domain controller but are not supported.

1 Create an account on the domain controller for the TeraStation.

2 In Settings, click *Network*.

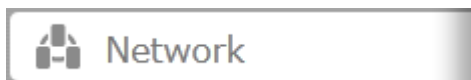

3 Click  to the right of "Workgroup/Domain".



4 Click *Edit*.

5 Select "NT Domain", then click *Next*.

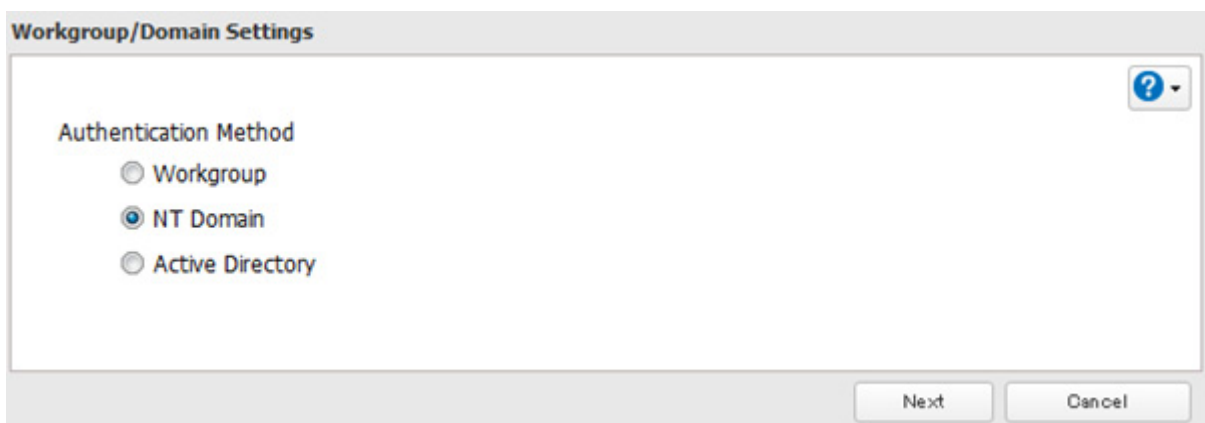

6 Click *Yes*.

7 Enter settings and click OK.

NT Domain Settings

NT Domain Name:
(NetBIOS Name)

NT Domain Controller Name:
(Computer Name)



Administrator Name:

Administrator Password:

WINS Server IP Address:

OK Cancel



8 Click  to the right of "Folder Setup".

 Folder Setup 1 Folder(s) 

9 Click a shared folder for which you want to set access restrictions.

Shared Folder List

Create Folder Delete Folder Empty Recycle Bin Filter:

Name	Volume	More Details
info		
<input checked="" type="checkbox"/> share	Disk 1	

Page 1 of 1 1-2 of 2 Items per page: 20

Select All Unselect All Close

10 Click the *Access Restrictions* tab.

11 Enable "Access Restrictions".

Basic Settings Advanced Settings **Access Restrictions**

Access Restrictions: Enable Disable

12 Select the level of access for the domain user or group.



: Read and write access allowed



: Read access allowed



: Access prohibited

13 Click *OK*.

Notes:

- If you change the TeraStation's name, you will no longer be able to use domain users and groups or access restrictions. To repair this, rejoin the domain.
- If both read-only and read and write permissions are given to a user, the user will have read-only access.
- If a domain username is more than 20 bytes long, the TeraStation truncates it to 20 bytes.
- To use the TeraStation as a member server in an NT domain, the TeraStation should be logged in to the domain and accessed from a computer that is not a member of the domain with a valid domain account.
- If the TeraStation is a member server of an NT domain, you cannot connect as a guest user via AFP.
- When you change the user or group settings on the domain controller, these changes may not take effect immediately on the TeraStation until it is rebooted.
- If your TeraStation is a member server in an NT domain and you change the authentication method to "Workgroup", the account on the domain controller will not be deleted automatically.
- If the TeraStation joins a domain network, you cannot connect to it via FTP.
- Don't disable the SMB protocol while an NT domain server is used for access restrictions. If you do, you will need to enable SMB again and reconfigure the NT domain settings from scratch.
- For an access-restricted shared folder, if you change the access restrictions of all users and groups from read and write or read only to access prohibited from the user or group list page in Settings, that shared folder can only be accessed by admin users.

Chapter 4 Managing Storage

RAID Modes

TeraStations support many types of RAID. The type of RAID arrays available for use depends on how many drives are installed in your TeraStation.

TeraStation	Default RAID Mode	Available Modes
TS1400D, TS1400R	RAID 5	RAID 5, 6, 10, 1, 0, and JBOD
TS1200D	RAID 1	RAID 1, 0, and JBOD

Notes:

- If you change the RAID mode, all data on the array is deleted. This is true for every procedure in this chapter. Always back up any important data before performing actions that affect your RAID array.
- Hard drive capacity is shown in Settings in actual gigabytes. The Properties window in Windows may show GiB instead, which will be a smaller number.
- After the RAID mode is changed (except when creating a RAID 0 array or JBOD), the TeraStation performs a RAID check that will take about 10 hours per TB. File transfers are slower during this period. While the I17 message is displayed in NAS Navigator2, do not turn off the TeraStation. If you do, the RAID check will start over.
- If the TeraStation is restarted or shut down while changing the RAID mode, the message displayed in NAS Navigator2 changes from I46 or I47 to I18.
- RAID 5, 6, and 10 are only available for 4-drive models.

RAID 6

RAID 6 arrays are available for TeraStations with 4 or more hard drives. RAID 6 combines 4 or more drives into a single array. The usable space is equal to the sum of the capacity of all drives minus the capacity of two drives. For example, if 4 drives are combined into a RAID 6 array, the usable space is the sum of the capacity of 2 drives. If 2 drives in the array are damaged, you can recover data by replacing them. If 3 or more drives are damaged, your data is lost.

RAID 5

RAID 5 arrays are available for TeraStations with 3 or more hard drives. RAID 5 combines 3 or more drives into a single array. The usable space is equal to the sum of the capacity of the hard drives minus the capacity of one drive. For example, if 4 drives are combined into a RAID 5 array, the usable space is the sum of 3 drives. If one drive in the array is damaged, you can recover data by replacing the damaged drive. If two or more drives are damaged at the same time, your data is lost.

RAID 10

RAID 10 arrays are available for TeraStations with 4 or more hard drives. In this mode, mirrored pairs of drives in RAID 1 arrays are combined into a RAID 0 array. The usable space is equal to the capacity of the smallest drive multiplied by the number of hard drives divided by 2.

RAID 1

Combines 2 or more drives into a mirrored array. The available space in the array is the capacity of a single drive. Identical data is written to each drive. If a drive is damaged, data can be recovered by replacing the damaged drive. As long as one drive in the array remains undamaged, all data in the array can be recovered.

RAID 0

Combines 2 or more drives into a single array. The usable drive space is the total space of all drives used. This simple RAID mode offers faster performance than RAID modes that include parity. If a single drive in the array fails, then all data in the array is lost.

JBOD

This mode uses the hard drives inside the TeraStation as individual drives. The drive space you can use is the total capacity of all drives in the TeraStation. If any drive is damaged, then the data on that drive is lost.

Working with RAID Arrays

To change RAID settings, navigate to *Drives - RAID* in Settings.

Using JBOD

With JBOD, each hard drive in the TeraStation is addressed separately. To put drives from an array into JBOD, follow the steps below.

- 1 In Settings, click *Drives*.



- 2 Click  to the right of "RAID".



3 Click the array to delete.

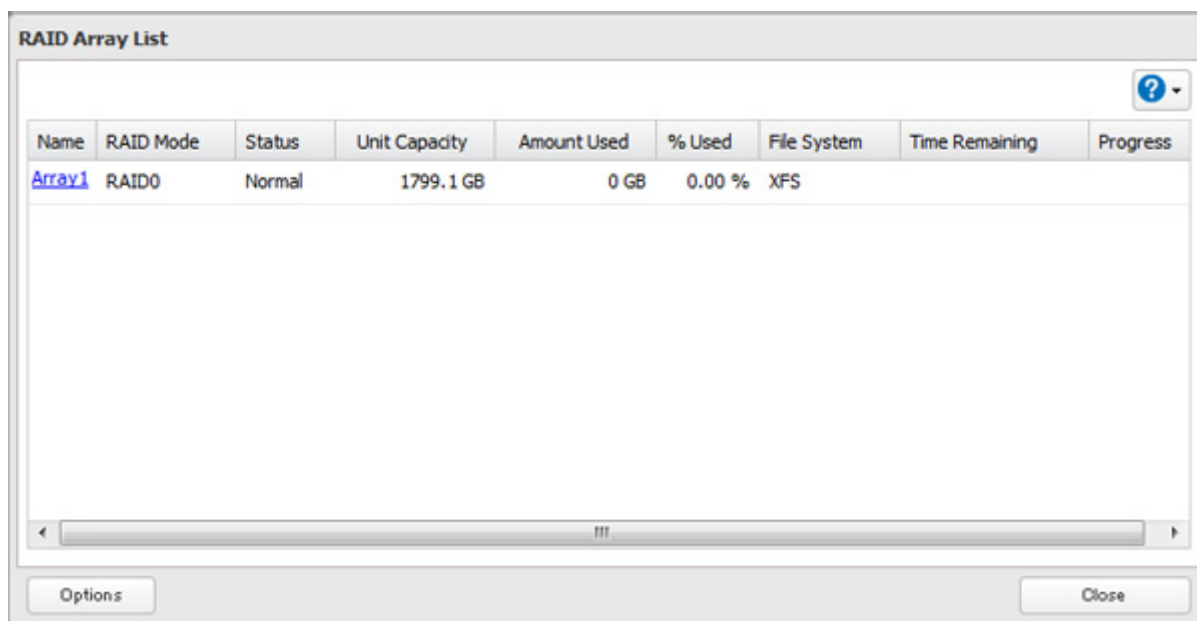

4 Click *Delete RAID Array*.

5 The "Confirm Operation" screen will open. Enter the confirmation number, then click *OK*.

6 Click *OK* when finished.

Once JBOD is configured, create shared folders on each drive to use them.

Changing RAID Mode

To change the RAID mode, first put the drives in JBOD.

1 In Settings, click *Drives*.



2 Click  to the right of "RAID".



3 Click the array to delete.

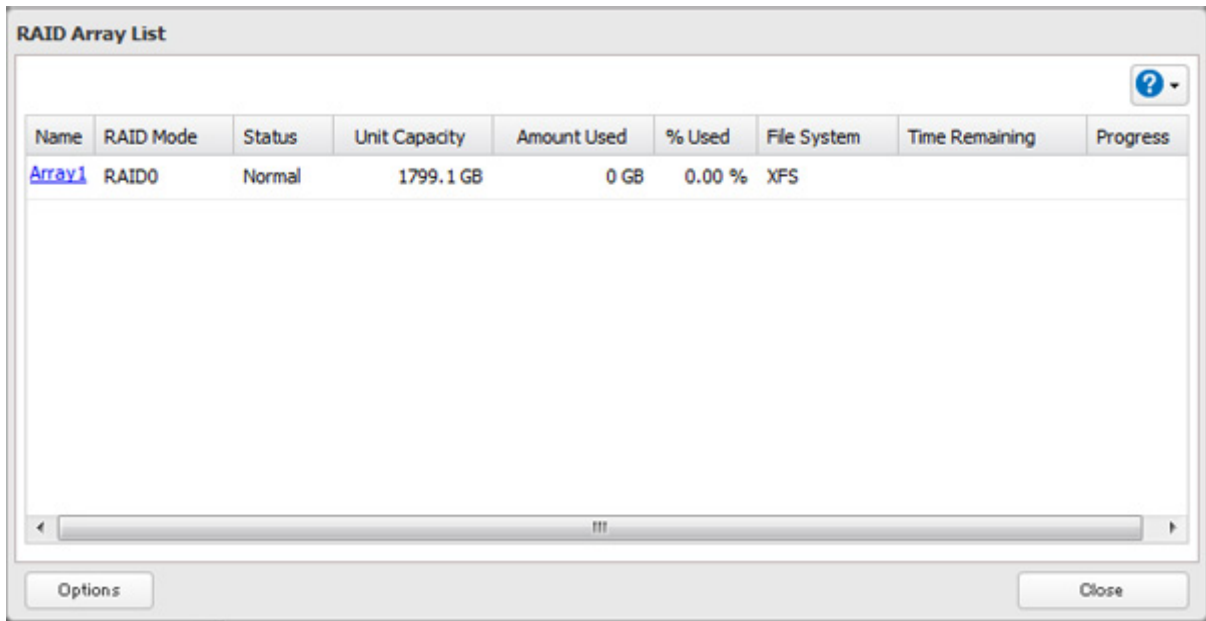

4 Click *Delete RAID Array*.

5 The "Confirm Operation" screen will open. Enter the confirmation number, then click *OK*.

6 Click *OK*.

7 Choose a RAID array.

8 Select a RAID mode and the drives to be used, then click *Create RAID Array*.

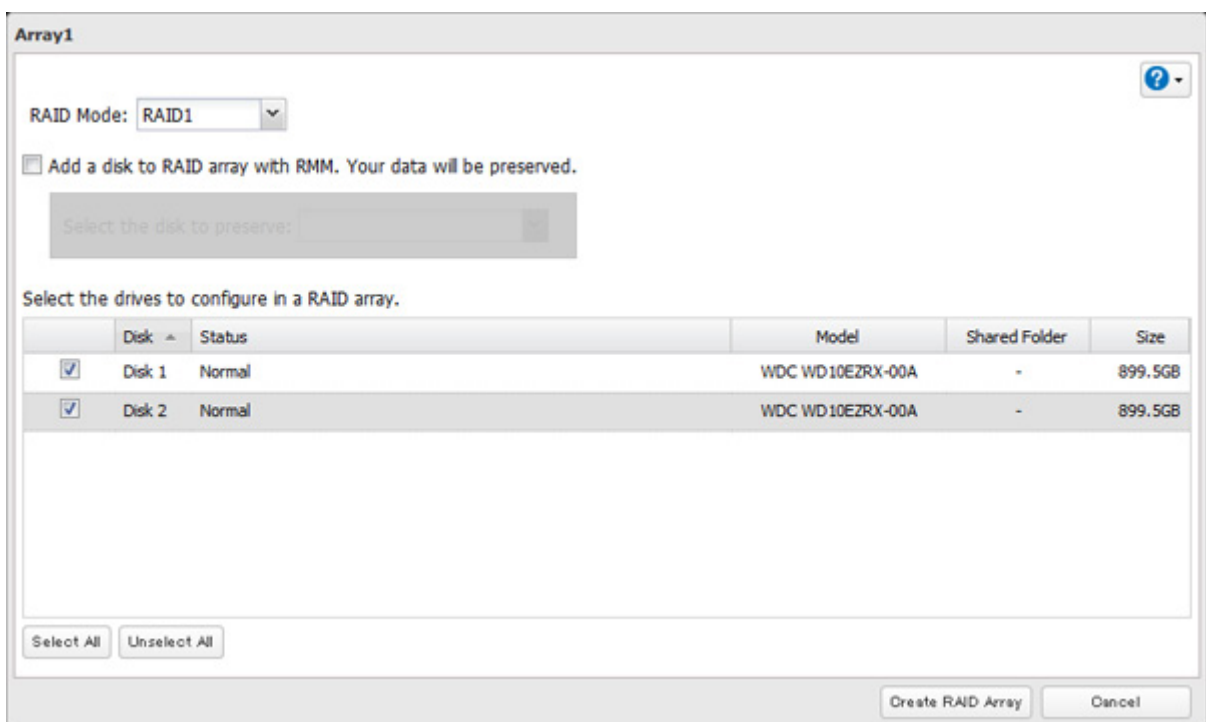

9 The "Confirm Operation" screen will open. Enter the confirmation number, then click *OK*.

10 Click *OK* when finished.

Notes:

- You can also configure RAID settings from Easy Admin.
- After changing the RAID mode, create a shared folder.

RMM (RAID Mode Manager)

With RMM, you can create or expand a RAID array without erasing the data on the drives. Before using RMM, make sure all inserted internal drives are the same size into the slots.

Changing from JBOD to RAID 1

Hard drives that aren't in a RAID array show "Normal". You must have at least two drives available in JBOD (not in a RAID array) to build the RAID 1 array with RMM.

1 In Settings, click *Drives*.



2 Click  to the right of "RAID".

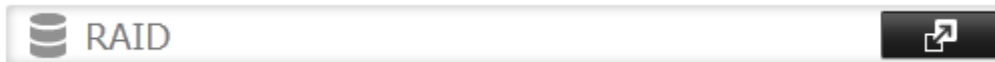

3 Choose a RAID array.

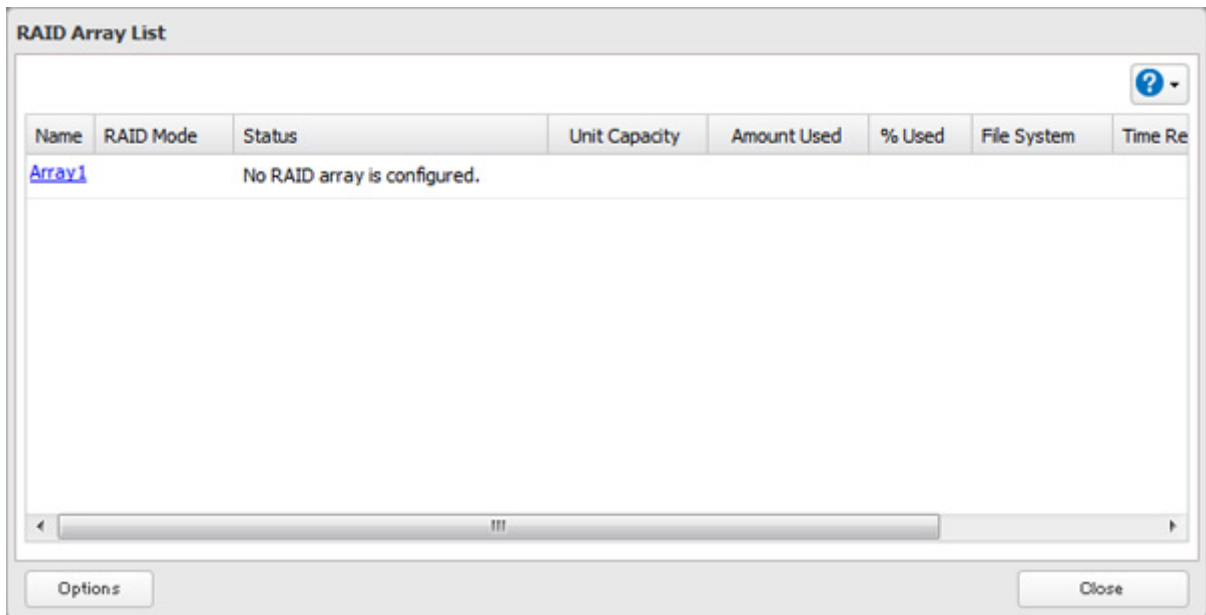

4 Set the RAID mode to "RAID 1".

5 Select the "Add a disk to RAID array with RMM. Your data will be preserved." checkbox.

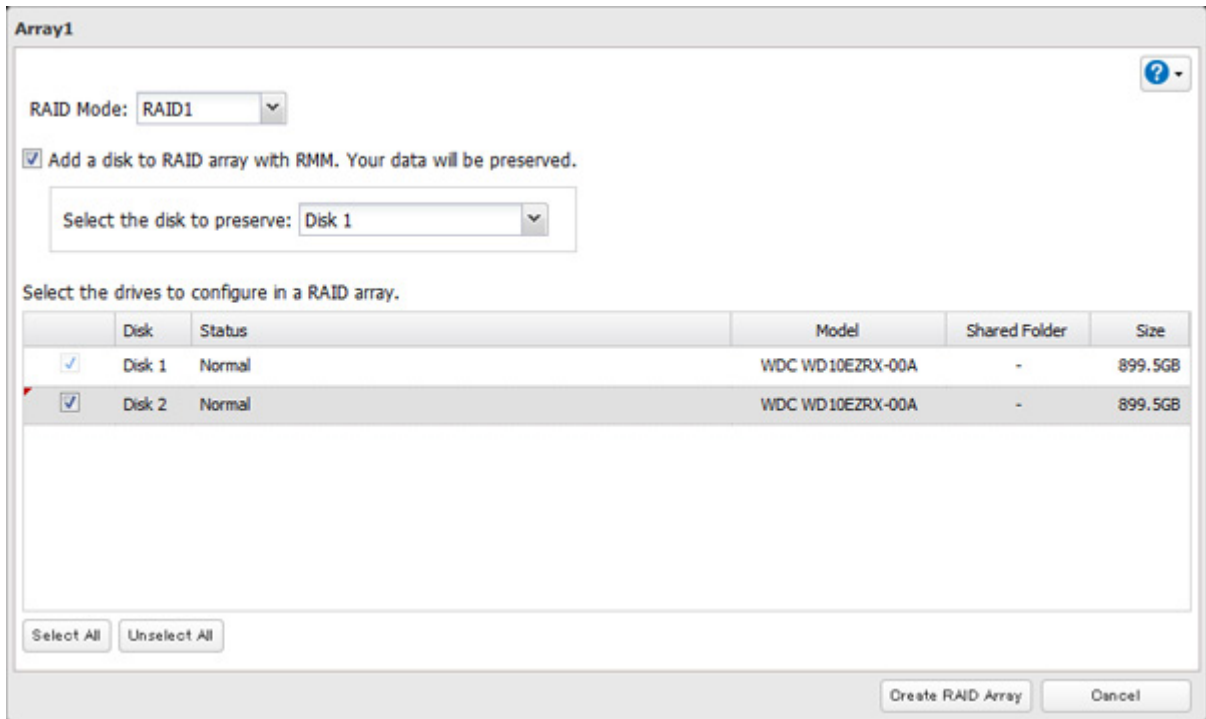

6 Select the drive whose data will be saved from the drop-down list.

7 Select the drive to add to the RAID array.

8 Click *Create RAID Array*.

9 The "Confirm Operation" screen will open. Enter the confirmation number, then click *OK*.

Adding a Drive to an Existing RAID Array (For TS1400D and TS1400R Models)

You can add a drive to a RAID 1 or RAID 5 array. Drives that can be added to the RAID array show "Normal".

Note: RMM can be used to expand an array by one drive per operation. To expand by two or more drives, RMM must be performed multiple times.

1 In Settings, click *Drives*.



2 Click  to the right of "RAID".



3 Choose a RAID array.

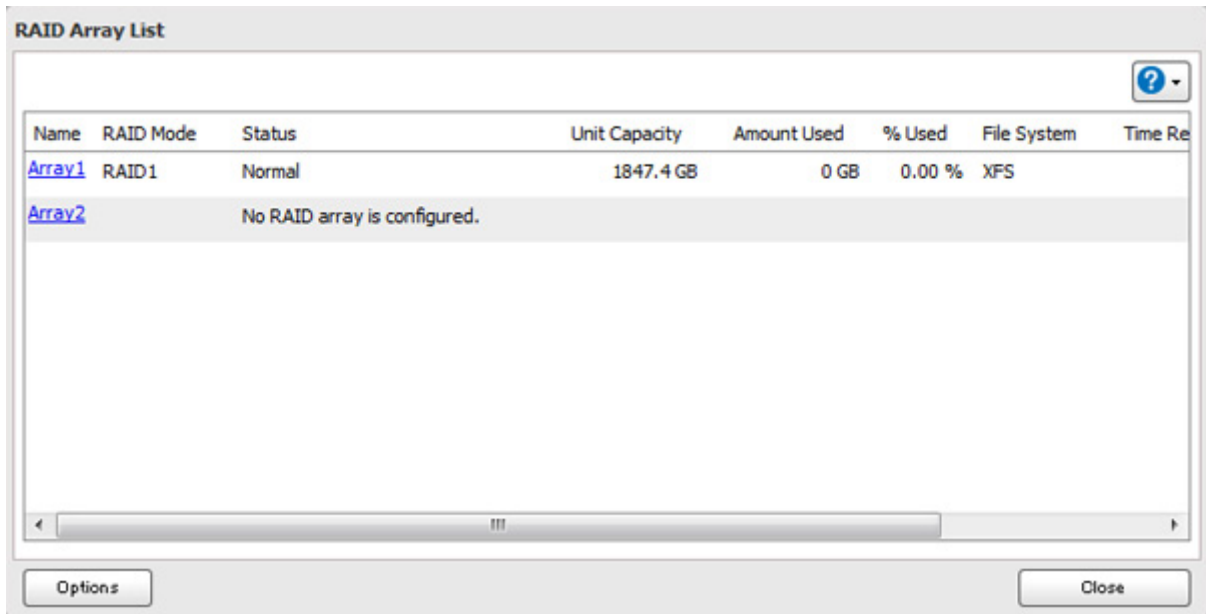

4 Select the drive to add to the RAID array.

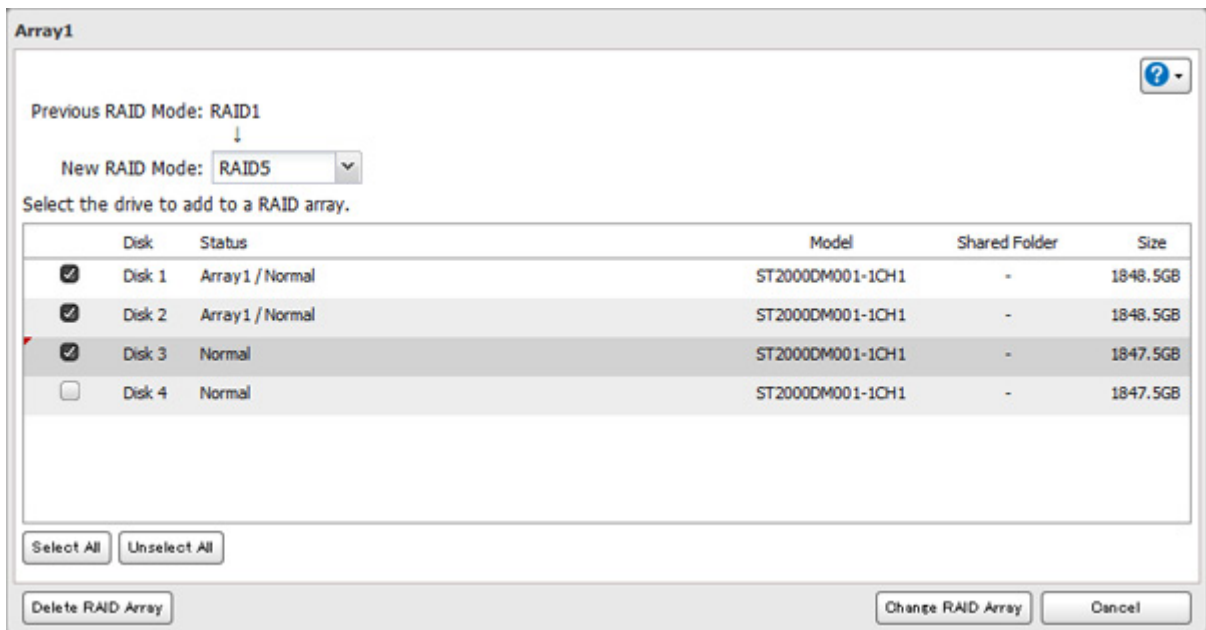

5 Click *Create RAID Array*.

6 The "Confirm Operation" screen will open. Enter the confirmation number, then click *OK*.

7 Click *OK* when finished.

Changing the RAID Mode While Adding a Drive (For TS1400D and TS1400R Models)

Select the drive you want to add to the RAID array and choose the mode for the array. Enter the "Confirm Operation" number and click *OK*.

RAID Scanning

A RAID scan checks your RAID array for bad sectors and if it finds any it automatically repairs them. Arrays other than RAID 0 are supported. For best results, run a RAID scan regularly.

1 In Settings, click *Drives*.



2 Move the RAID scanning switch to the  position to enable RAID scanning.



3 Click  to the right of "RAID Scanning".



4 Click *Edit*.

5 Select when to run the scan and click *OK*.

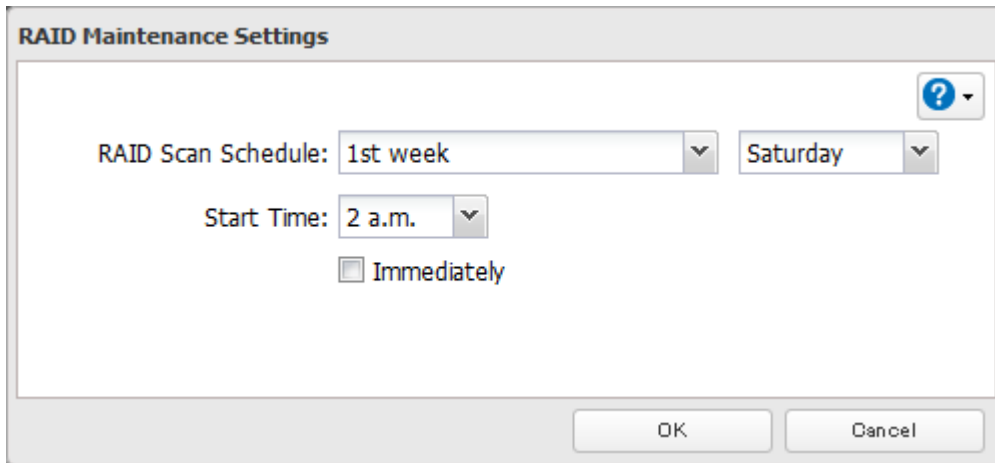

Notes:

- Select the "Immediately" checkbox to run a RAID scan immediately.
- To stop a RAID scan, click *Cancel RAID Scan*.
- If a RAID scan is configured to start while the TeraStation is in sleep mode, the RAID scan will not run.

Adding an External Hard Drive

Connecting an External Drive

Your TeraStation includes USB ports (the number of ports depends on your model), and you can connect external drives to these ports. Once connected, they appear as shared folders on the TeraStation. Formatted drives are detected automatically. Unformatted drives should be formatted in Settings.

After a USB drive is recognized, Windows adds "usbdisk x" under the TeraStation in "Network", where "x" is the USB port where the hard drive is connected.

Compatibility

The following USB devices are supported by the TeraStation:

- USB storage devices
- Card readers (except for card readers that can recognize two or more memory cards)

Buffalo external USB drives are recommended but DUB and DIU series drives are not supported.

Supported file systems for external drives are below:

- FAT32
- EXT3
- XFS
- NTFS
- HFS Plus (read-only)

Connect only one device to each USB port of the TeraStation. Some external drives with automatic power-on don't turn on automatically when connected to the TeraStation. Use their manual power switch to turn them on. Note that only the first partition of a connected USB hard drive is mounted. Additional partitions are not recognized.

Note: Backup data from macOS may include characters that cannot be written to FAT16 or FAT32 drives such as ".DS_Store". For best results, reformat the drive before using it as a backup target.

Dismounting Drives

If the TeraStation is powered on, dismount drives (internal and external) before unplugging them. You may dismount external drives with the function button, or any drive from Settings. If the TeraStation is off, then all drives are already dismounted and may be unplugged safely.

Note: If dismounting multiple drives at the same time, dismount all drives first; when the status is displayed as "Dismounted / Plugged" in Settings for all drives, disconnect them.

Dismounting with the Function Button

Hold down the function button for 3 seconds for TS1200D models or until the function LED glows for TS1400D or TS1400R models. The function LED will remain lit for 30 seconds as all attached USB drives are dismounted. After dismounting is finished, the function LED will turn off. You may now unplug the USB drives safely.

Note: After 60 seconds, the function LED will turn on again and any drives that have not yet been unplugged will be remounted.

Dismounting from Settings

1 In Settings, click *Drives*.



2 Click *Drives* to dismount an internal drive or *USB Drives* to dismount an external drive.



- 3** Select the drive to dismount and click *Dismount Disk*.

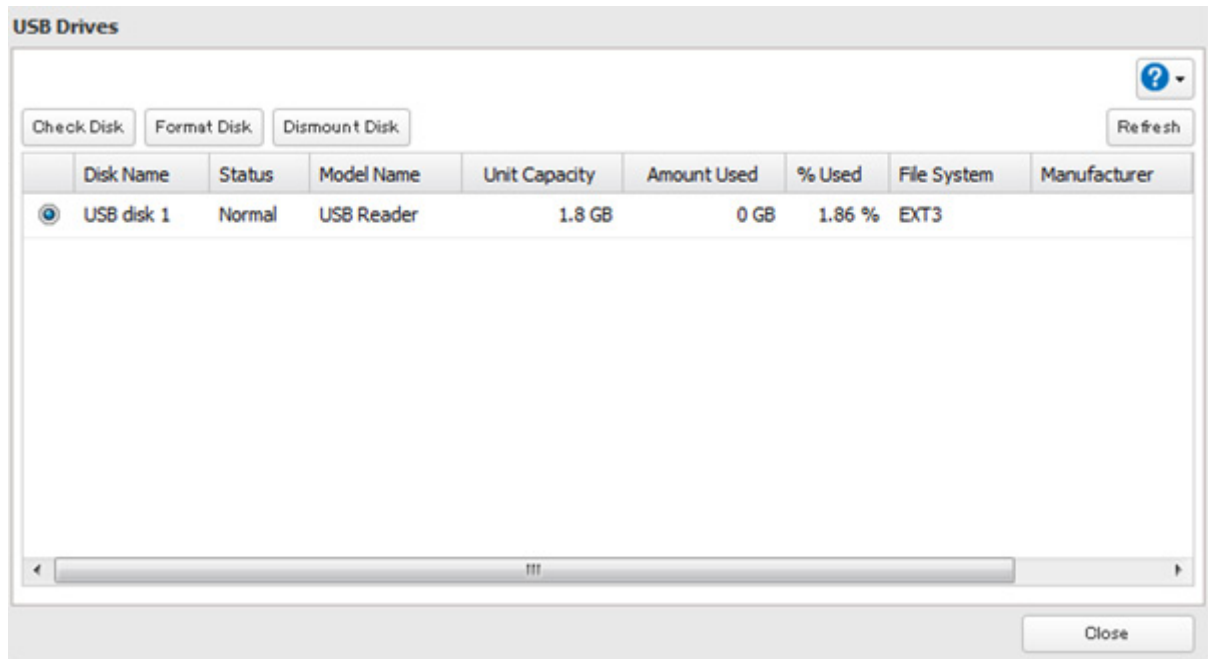

- 4** The "Confirm Operation" screen will open. Enter the confirmation number, then click *OK*. It will take about 30 seconds for the drive to be dismounted.

- 5** When the following message is displayed, it is safe to unplug the drive.

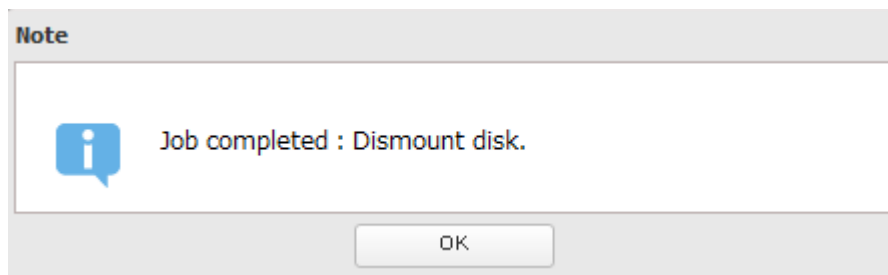

Note: To remount the drive, unplug it and then plug it back in when the function LED extinguishes.

Checking Drives

A drive check tests the data on a drive in the TeraStation or one that is connected via USB for integrity. Errors are fixed automatically. With large drives, a drive check may run for many hours. Shared folders cannot be accessed during a drive check. Do not turn off the TeraStation until the drive check is finished. Use the procedure below to run a drive check.

- 1** In Settings, click *Drives*.



- 2** Select *Drives* to check an internal drive or *USB Drives* to check an external drive.



3 Select the drive or the array to test, then click *Check Disk*.

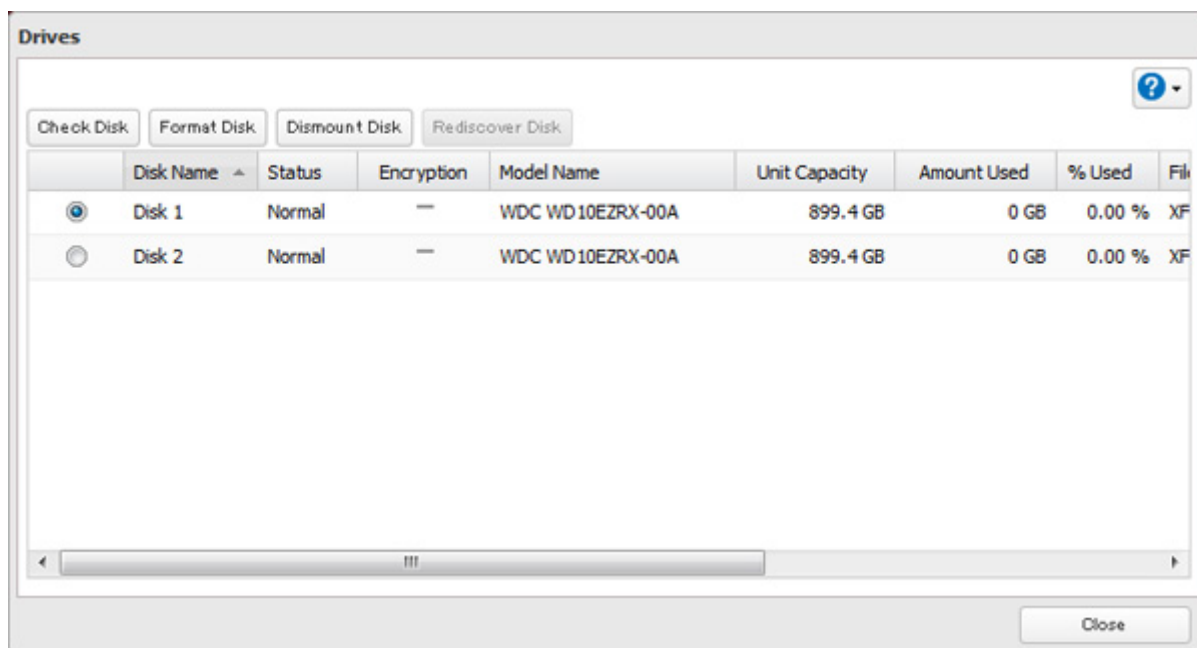

4 Click *Check*. You have the option of deleting information files from macOS during the check if desired.

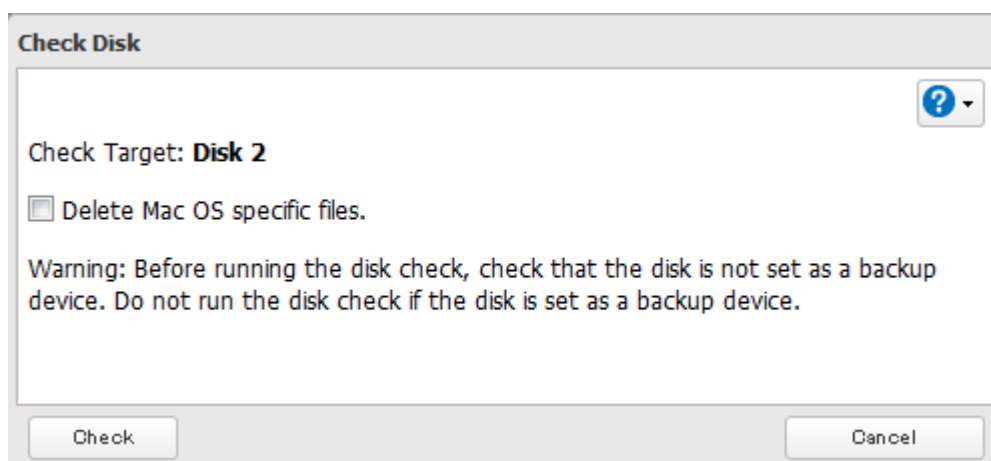

Formatting Drives

Notes:

- Under some circumstances, data deleted when a drive is formatted can be recovered. To ensure that data is "gone forever", a format might not be sufficient. See the "Erasing Data on the TeraStation Completely" section below.
- After a drive is formatted, the "% Used" and "Amount Used" in Settings will not be 0. This is because some drive space is used for the system area.

1 In Settings, click *Drives*.



2 Select *Drives* to format an internal drive or *USB Drives* to format an external drive.



3 Select the drive or the array to format, then click *Format Disk*.

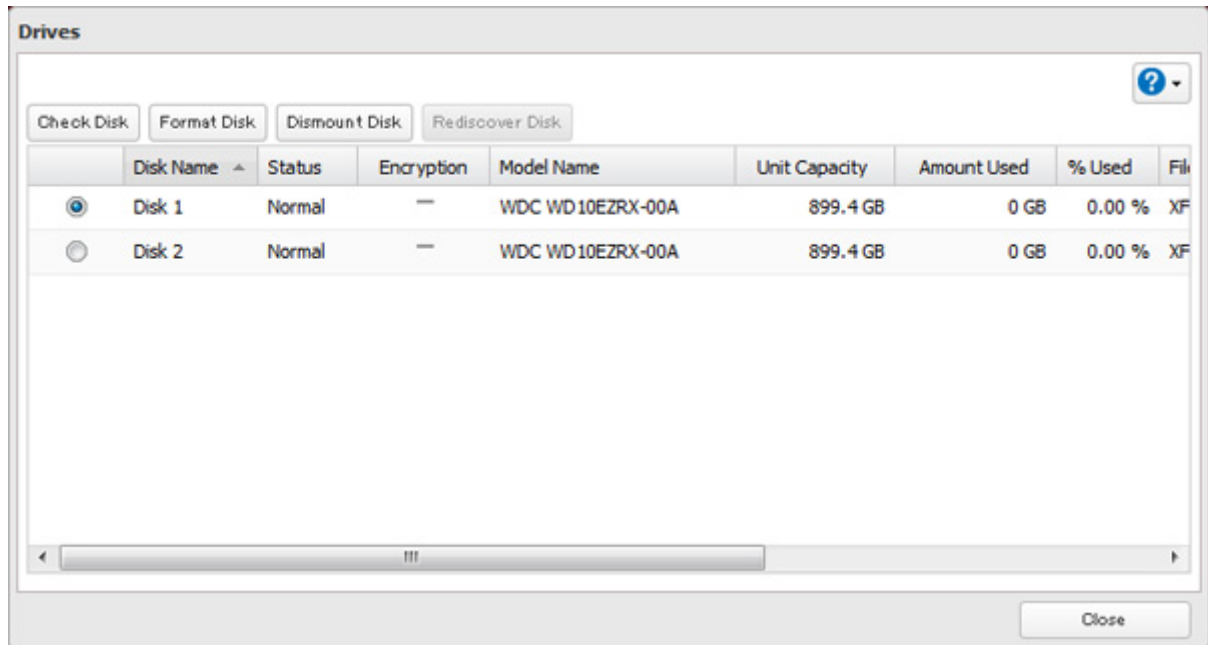

4 Select a format type, then click *Format*.

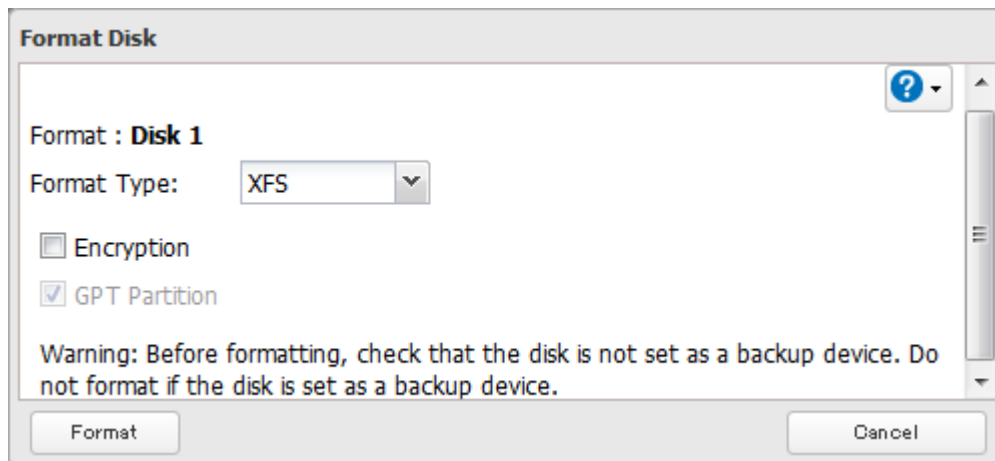

5 The "Confirm Operation" screen will open. Enter the confirmation number, then click *OK*.

6 Depending on the size and the formatted file system of your drive, the format may take several minutes or several hours to complete. "Formatting" will be displayed in Settings or NAS Navigator2 until the format is complete. Click *OK* when finished.

Notes:

- Do not turn off or disconnect power to the TeraStation while formatting a hard drive.
- For drives of 2.2 TB or larger, make sure that the "GPT Partition" checkbox is selected.

Encrypting Drives

Internal drives (and arrays) can be encrypted with 128-bit AES during formatting. Encrypted drives and arrays are then readable only from that specific TeraStation. To decrypt a drive or array, clear the "Encryption" checkbox and format it again.

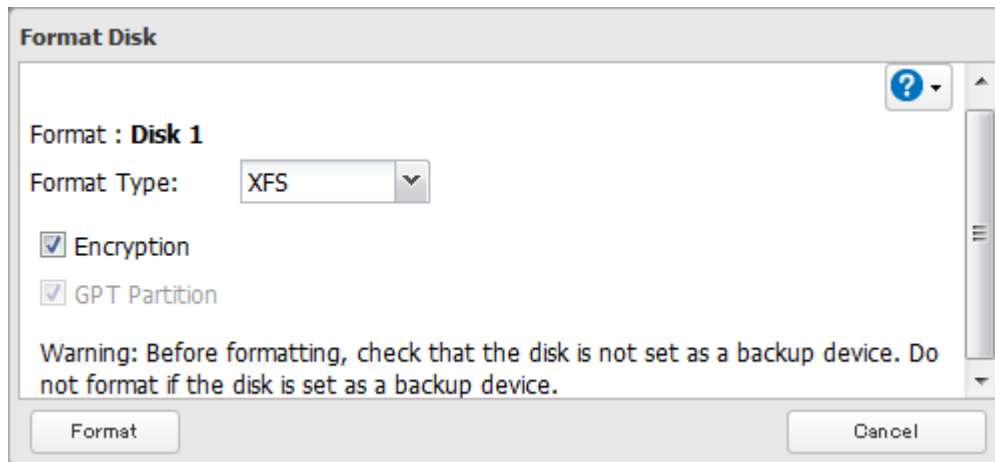

Erasing Data on the TeraStation Completely

Under some circumstances, data from formatted drives can be recovered. The drive erasure process in this section does a much more thorough job of erasing data. This procedure is recommended for removing all data from a drive in a way that makes it nearly impossible to recover with current tools. The TeraStation will then be in the following state:

- All drives in JBOD
- An empty shared folder on each drive
- All settings returned to their default values
- All logs deleted

To run the complete format, all drives should be inserted into the drive slots.

1 In Settings, click *Management*.

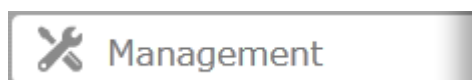

2 Click  to the right of "Restore/Erase".



3 Click *Erase TeraStation*.

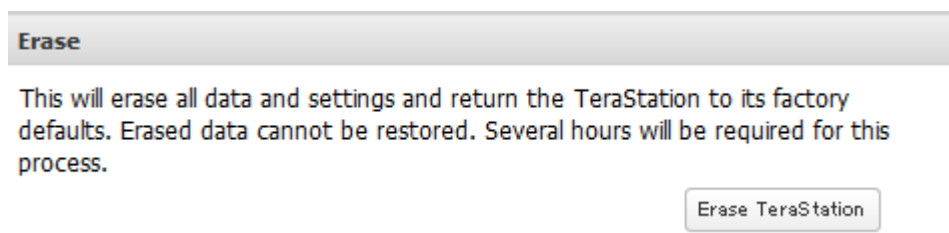

4 The "Confirm Operation" screen will open. Enter the confirmation number, then click *OK*.

5 All data on the TeraStation will be permanently erased.

Drive Quotas

You can set a drive quota to limit drive space for each user or group. You can also set a threshold. If the drive space exceeds the set threshold, an email notification will be sent. To configure email notifications for drive quota, refer to the "Email Notification" section in chapter 8.

Notes:

- When using quotas, disable the recycle bin or empty the trash folder often. The limited space includes the space used for trash.
- Quotas apply per drive or per array. If a quota is set to 1 GB, each array or drive can use a maximum of 1 GB.
- If both user and group quotas are configured for a user, the most restrictive quota will always apply.
- Make sure that SMB2 is disabled before using quotas on the TeraStation.

Quotas for Users

Follow this procedure to limit the shared folder drive space available for a user.

1 In Settings, click *File Sharing*.

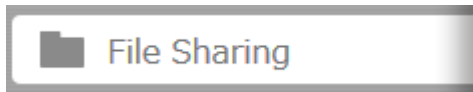

2 Click  to the right of "Users".



3 Select the user whose space will be limited.

4 Enable quotas, choose the maximum space the user will be allowed to use, and click *OK*.

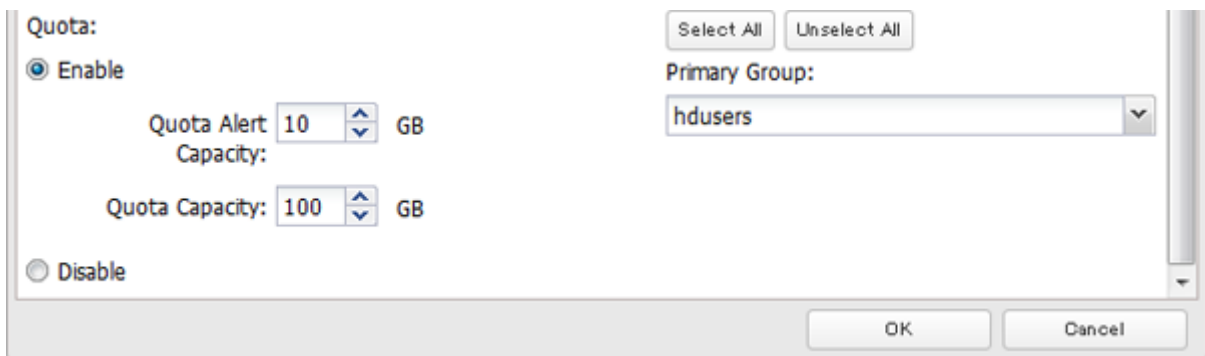

Note: If you change the primary group, restart the TeraStation to apply the quota settings.

5 Click *OK*.

Quotas for Groups

Follow the procedure below to limit the space for shared folders that each group can use.

1 In Settings, click *File Sharing*.

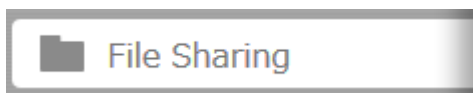

2 Click  to the right of "Groups".



3 Select the group whose space will be limited.

4 Enable quotas, choose the maximum space the group is allowed, and click OK.

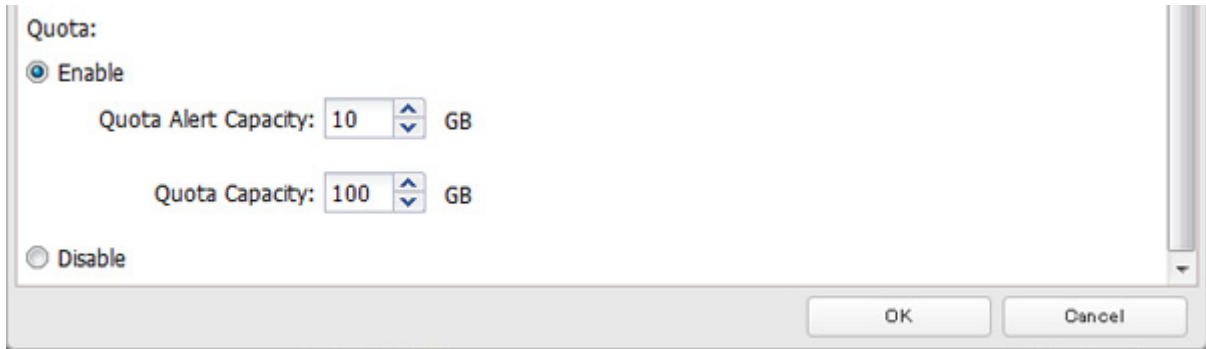

5 Click *Close*.

6 Click  to the right of "Users".

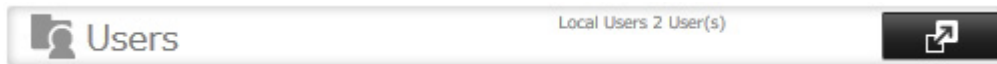

7 Select the user who will inherit the group quota settings.

8 Change the user's primary group to the group with the quota, then click OK.

9 Click OK.

Hard Drive Replacement

If a drive fails, NAS Navigator2 and Settings will show an error message. Follow the instructions below to replace a failed drive with a new drive and rebuild the RAID array.

Replacing the hard drive will require the following 2-step procedure:

- **Step 1 - Replace the failed drive with a new drive.**
- **Step 2 - Rebuild the RAID array.**

Notes:

- Do not unplug a running drive. Dismount it first or shut down the TeraStation before swapping a working drive. If you remove the drive without properly dismounting it, data may be lost or the TeraStation may malfunction.
- For the replacement drive, use a Buffalo OP-HDBST series drive for TS1200D and TS1400D, and a OP-HDS series drive for TS1400R. The new drive should be the same size (if using RMM) or larger. If a larger drive is used, the extra space will not be usable in a RAID array.
- Because TS1000 series TeraStations do not support media cartridges, you cannot connect hard drives that were used as media cartridges in another TeraStation.
- If sending a defective drive to Buffalo for replacement, please keep the cartridge as Buffalo will only replace the hard drive and not the cartridge.

- To avoid damaging the TeraStation with static electricity, ground yourself by touching something made of metal before handling any sensitive electronic parts.
- After a drive is replaced, it will take about 30 minutes before normal file reading and writing are restored. Settings may not be accessible during this period.
- Do not change the order of the hard drives in the TeraStation. For example, pulling out drive 1 and replacing it with drive 2 may cause data to be corrupted or lost.
- If a new drive is not recognized after installing it, click *Rediscover Disk* in Settings.
- For TS1400D models, do not replace 2 or more drives at the same time with new drives while the TeraStation is on. If you do, it may cause unexpected behavior.

Step 1 - Replacing a Hard Drive

Instructions for TS1200D and TS1400D Models

- 1 Squeeze the left side of the front panel and pull the panel off.

TS1200D

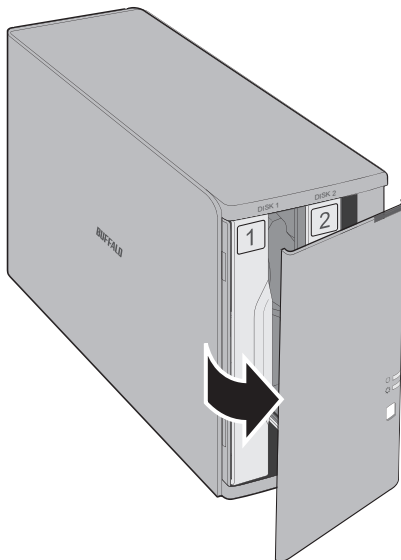

TS1400D

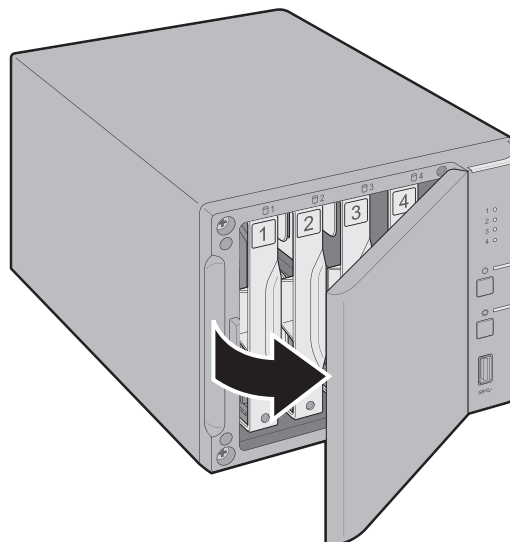

2 Pull the failed drive out from the TeraStation.

TS1200D

TS1400D

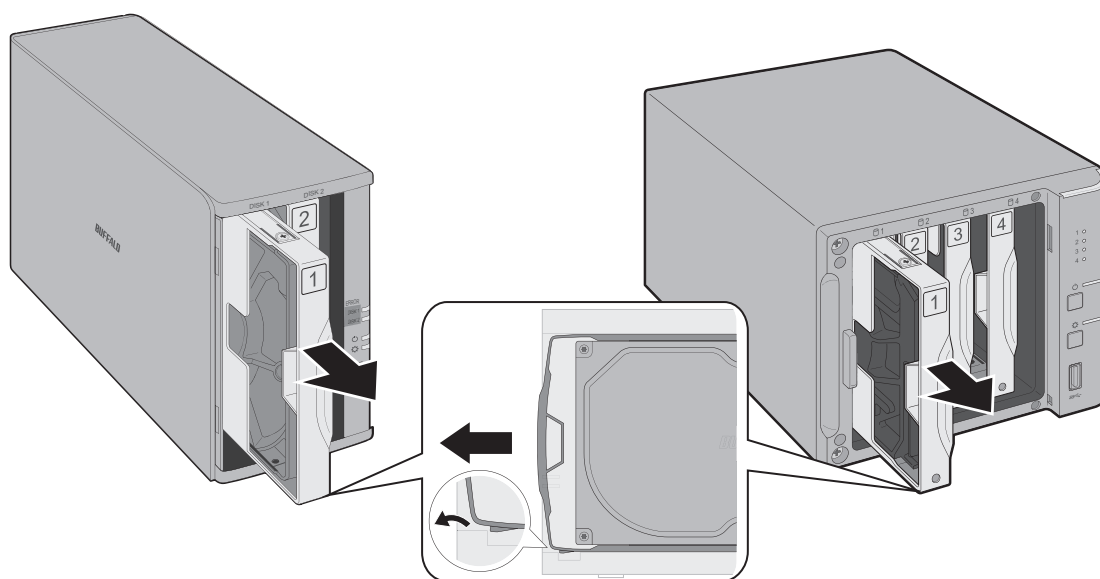

Notes:

- Do not press hard on the top of the TeraStation.
- Pull the drive straight out the front of the chassis.

3 Remove the drive from the cartridge.

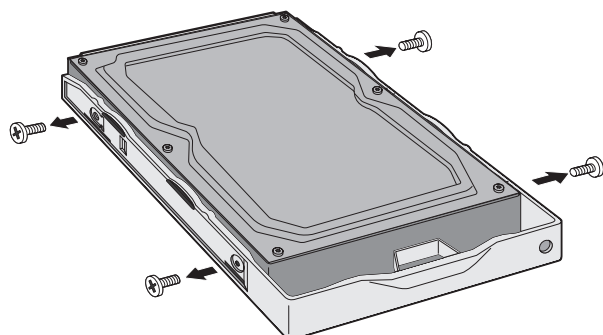

4 Install a new drive (sold separately) into the cartridge.

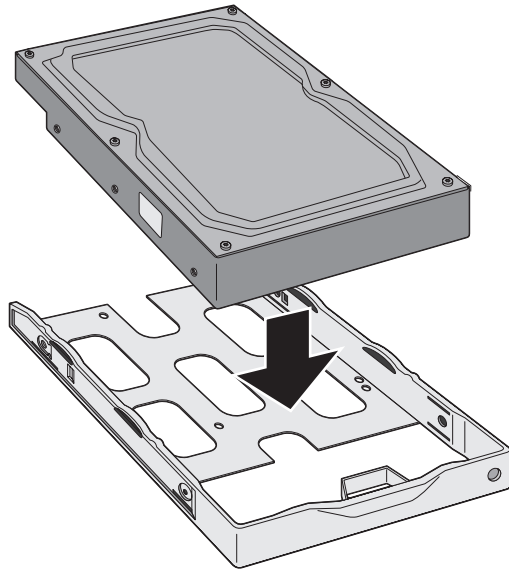

5 Replace the four screws.

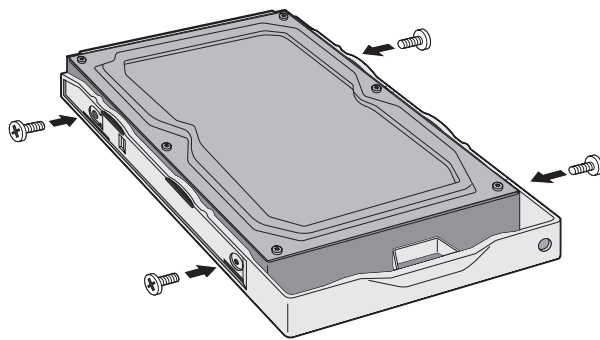

6 Insert the new drive into the empty slot.

TS1200D

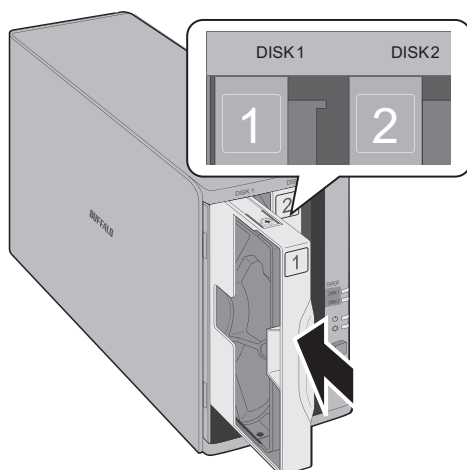

TS1400D

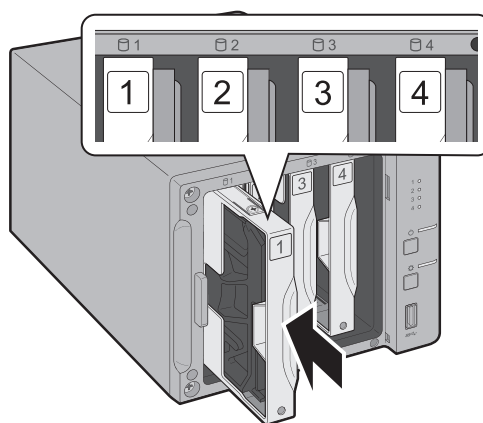

7 Close the front panel.

TS1200D

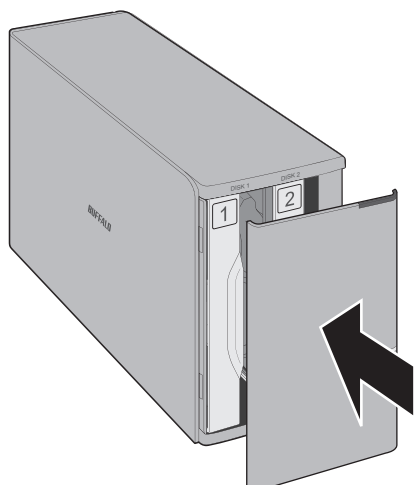

TS1400D

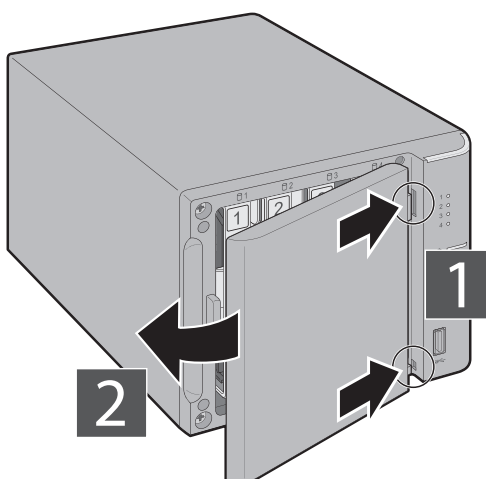

8 Replacing a defective hard drive is finished. Go to the "Step 2 - Rebuild the RAID Array" section below.

Instructions for TS1400R Models

1 Push the drive's unlock button and swing the lock mechanism out.

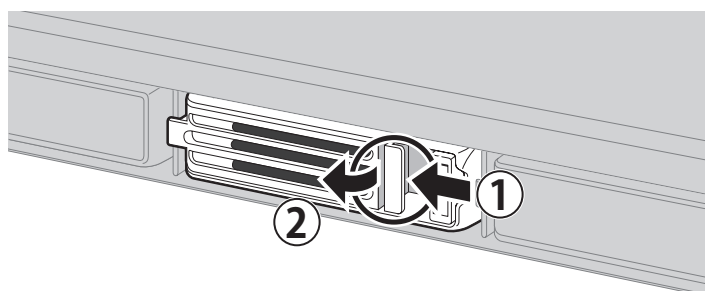

Note: If your TeraStation is on and the red status LEDs are lit, the hard drives are still on. Do not unplug or remove them.

2 Pull out the failed drive and remove it from the TeraStation.

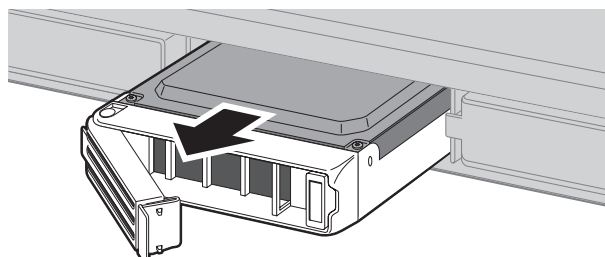

- 3 Insert the new drive into the empty slot. Slide the drive in with the locking mechanism open.

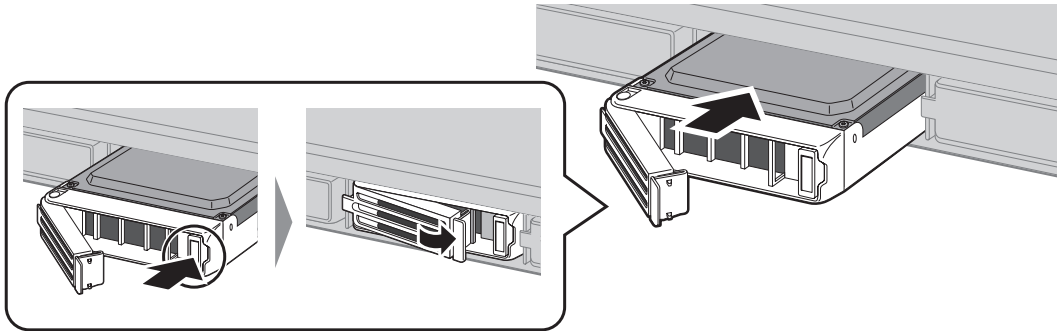

- 4 Swing the lock back down until it clicks into place.

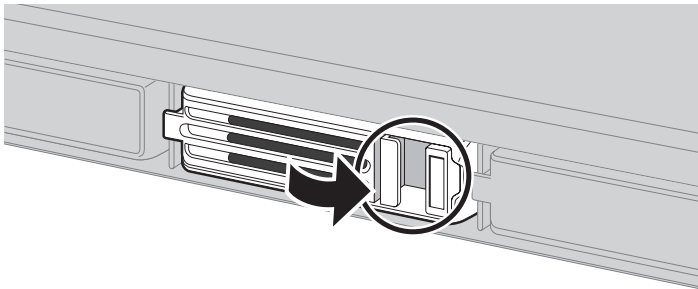

- 5 Replacing a defective hard drive is finished. Go to the "Step 2 - Rebuild the RAID Array" section below.

Step 2 - Rebuild the RAID Array

Depending on your RAID configuration, the rebuilding procedure will be different. Follow the corresponding procedure below that matches your RAID configuration.

Using a Redundant RAID Mode (Other Than RAID 0)

This section describes rebuilding a drive if you configure the RAID mode from RAID 1, 10, 5, or 6.

If you enabled auto-shutdown, your TeraStation will automatically shut down if a drive fails so your TeraStation will be **off**.

If you disabled auto-shutdown, your TeraStation will work in degraded mode if a drive fails so your TeraStation will be **on**.

- 1 Follow the drive replacement procedure described above and replace a failed drive with a new drive.
- 2 If your TeraStation is off, turn it on and wait until the bootup finishes.
- 3 When the replacement hard drive is recognized, an I31 message will be displayed in NAS Navigator2.

4 Hold down the function button on the front of the TeraStation for 3 seconds.

TS1200D

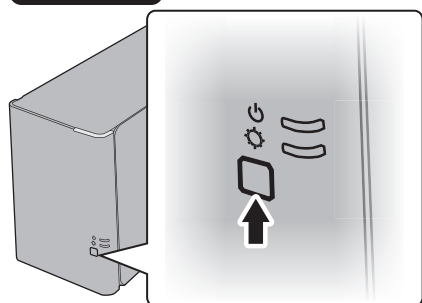

TS1400D

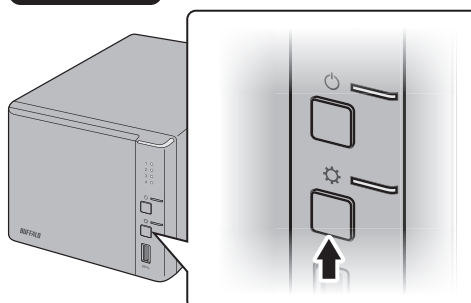

TS1400R

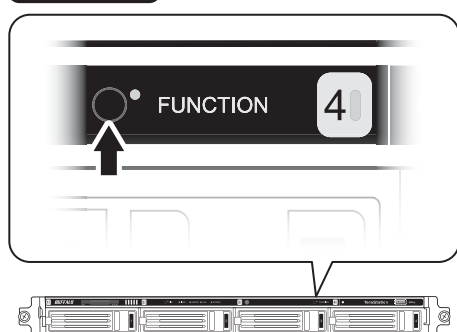

5 The TeraStation will start rebuilding the RAID array. After a few minutes, the I18 message will be displayed in NAS Navigator2. Wait until the drive finishes rebuilding; the I18 message will be extinguished.

Notes:

- It may take about 5 minutes before the I18 message appears.
- If the TeraStation shuts down while rebuilding the RAID array, the RAID rebuild will cancel and will not start again after the TeraStation boots. To restart the RAID rebuild, log in to Settings and go to *Drives - RAID*, then click *Recover RAID Array*.

Using JBOD

This section describes if your TeraStation is working in JBOD.

- 1** Follow the drive replacement procedure described above and replace a failed drive with a new drive.
- 2** When the replacement hard drive is recognized, an I31 message will be displayed in NAS Navigator2.

3 Hold down the function button on the front of the TeraStation for 3 seconds.

TS1200D

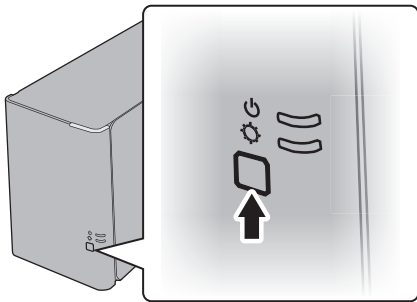

TS1400D

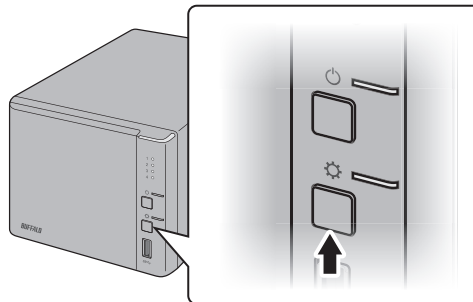

TS1400R

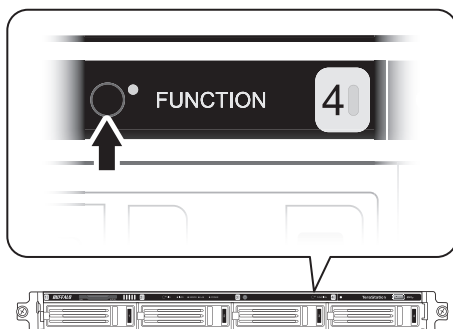



4 The drive will be formatted as an individual drive. Create a shared folder on the drive before use.

Using RAID 0

Drives in a RAID 0 array do not automatically turn off in the event of a malfunction. Before replacing the failed drive, either dismount the drive from Settings, or shut down the TeraStation.

This section describes the process of recreating a RAID 0 array with [the TeraStation on](#).

- 1** Follow the drive replacement procedure described above and replace a failed drive with a new drive.
- 2** When the replacement drive is recognized, the I32 message will be displayed in NAS Navigator2.
- 3** In Settings, navigate to *Drives - RAID*.
- 4** Select the RAID array and click *Delete RAID Array*.
- 5** Click  to the right of "Drives".
- 6** Click *Format Disk* to format the new drive.
- 7** Click  to the right of "RAID".
- 8** Choose a RAID array.
- 9** Select a RAID 0 in the RAID mode drop-down menu and the drives to be used, then click *Create RAID Array*.
- 10** The "Confirm Operation" screen will open. Enter the confirmation number, then click *OK*.

Once RAID 0 array is configured, create a shared folder before use.

Chapter 5 Remote Access

WebAccess

WebAccess is a program that allows you to remotely access files in the your TeraStation's shared folder from your computer or mobile device through the Internet. **Be careful when configuring WebAccess. Certain settings can make the files in the shared folder available to anyone on the Internet, without any access restrictions.**

Notes:

- You can also configure WebAccess from Easy Admin.
- WebAccess supports downloading up to 60,000 files. Attempting to download more than 60,000 files may result in unexpected behavior.

1 In Settings, click *File Sharing*.

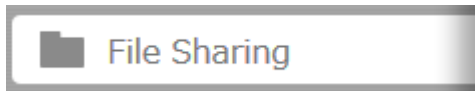

2 Click  to the right of "WebAccess".

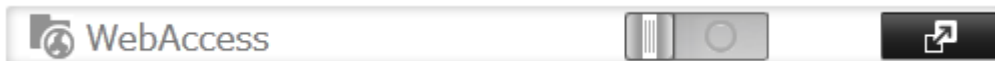

3 Click *Edit*.

A screenshot of the "WebAccess Settings" dialog box. The settings are as follows:

- HTTPS/SSL Encryption: Disabled
- BuffaloNAS.com Registration: Enabled
 - BuffaloNAS.com Name: [Redacted]
 - BuffaloNAS.com Key: [Redacted]
- Other DNS Service Hostname: [Text Field]
- Automatic Router Setup (UPnP): Enabled
 - External Port: [Redacted]
- NAS Internal Port: 9000
- Exclusive Session: Disabled
- Session Timeout: 30 minutes

At the bottom right, there are "Edit" and "Close" buttons.

4 Configure the desired settings, then click *OK*.

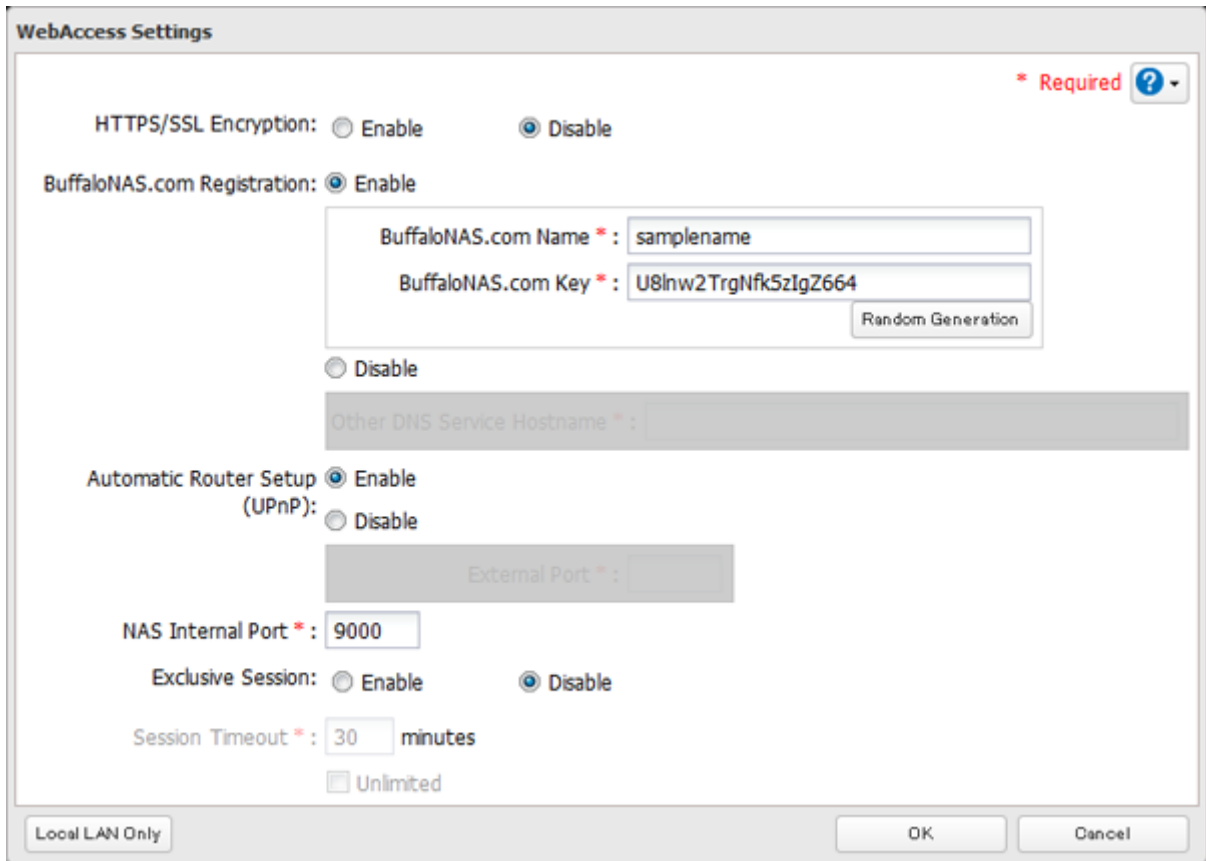

The image shows the 'WebAccess Settings' dialog box. It has a title bar and a close button. The settings are as follows:

- HTTPS/SSL Encryption: Enable Disable
- BuffaloNAS.com Registration: Enable
- BuffaloNAS.com Name *: samplename
- BuffaloNAS.com Key *: U8lnw2TrgNfk5zIgZ664
- Random Generation button
- Disable
- Other DNS Service Hostname *: (disabled field)
- Automatic Router Setup (UPnP): Enable Disable
- External Port *: (disabled field)
- NAS Internal Port *: 9000
- Exclusive Session: Enable Disable
- Session Timeout *: 30 minutes
- Unlimited
- Local LAN Only button
- OK button
- Cancel button

- You may use the default BuffaloNAS.com registration, or select "Disable" to use a different DNS server.
- Choose a "BuffaloNAS.com Name" and "BuffaloNAS.com Key" for your WebAccess account. Names and keys may contain 3 to 20 alphanumeric characters, underscores (_), and hyphens (-).
- If "Exclusive Session" is enabled, users cannot log multiple computers into WebAccess. Only the last login will be active.
- Enter a time in minutes (1 to 120, or "Unlimited") before inactive users are logged out of WebAccess.

5 Click *OK*.

6 Move the WebAccess switch to the  position to enable WebAccess.

7 Click  to the right of "Folder Setup".

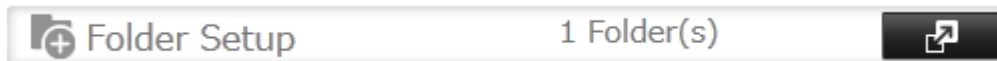

8 Select a shared folder to publish.

Notes:

- For best results, create a new dedicated share for WebAccess.
- When accessing shared folders through WebAccess from a remote location, a username and password may be required for certain operations. For best results, create a user account with permissions on the WebAccess share before using WebAccess.

9 Click the *Advanced Settings* tab.

10 Under "LAN Protocol Support", check "WebAccess" and click *OK*.

Notes:

- The following levels of security are available:
 "Allow Anonymous" - Anyone can access (view) shared folders.
 "Allow All Groups and Users" - All groups and users registered on the LinkStation or TeraStation can use WebAccess.
 "Use Inherited Folder Permissions" - Users and groups have the same access permissions with WebAccess that they do locally. If access restrictions are not set for the shared folder, then this option will not be shown.
- When a user or group can access a folder through WebAccess depends on a combination of WebAccess settings and the shared folder's settings.

Folder Setup	WebAccess Public Mode	Allow Anonymous		Allow All Groups and Users		Use Inherited Folder Permissions	
	Folder Attribute	Read & Write	Read Only	Read & Write	Read Only	Read & Write	Read Only
WebAccess Account	Not logged in	R	R	-	-	-	-
	User with read & write access	R/W	R	R/W	R	R/W	R
	User with read-only access	R/W	R	R/W	R	R	R
	Group with read & write access	R/W	R	R/W	R	R/W	R
	Group with read-only access	R/W	R	R/W	R	R	R
	Other users	R/W	R	R/W	R	-	-

R: Read only, R/W: Read and write, -: No access

11 There are many ways to access WebAccess folders depending on your device.

- From a computer, supported browsers include Internet Explorer 8, Firefox 3.6, and Safari 4.
 Instructions: <http://buffalonas.com/manual/en/>
- To access from an iOS device, install the "WebAccess i" application from the App Store.
 Instructions: <http://buffalonas.com/manual/i/en/>
- To access from an Android device, install the "WebAccess A" application from Google Play.
 Instructions: <http://buffalonas.com/manual/a/en/>
- To access from a Windows Phone, install "WebAccess" from the Windows Phone Store.
 Instructions: <http://buffalonas.com/manual/wp/en/>

FTP

By default, the TeraStation's shares are only accessible by users connected to the same network or router as the TeraStation. The optional FTP server allows users outside the local network to access the TeraStation.

Notes:

- FTP is intended for users who already have FTP client software and have experience with it.
- If the TeraStation has joined a domain network, you cannot connect to it via FTP.

1 In Settings, move the FTP switch to the  position to enable FTP.



2 Click  to the right of "Folder Setup".



3 Choose a folder to enable remote FTP access on.

4 Select read-only or read & write for the shared folder's attribute in the "Basic Settings" tab; under "LAN Protocol Support", select the "FTP" checkbox in the "Advanced Settings" tab and click *OK*.

Accessing the TeraStation with an FTP Client

- To access the TeraStation via FTP, configure your FTP client software with the following settings:
Hostname: IP address of the TeraStation
Username: The TeraStation's username
Password: The TeraStation's password
Port: 21
- Shared folders connected by FTP are available from the "/mnt" directory. The default locations are:
For RAID 0, RAID 5, or RAID 1:
 /mnt/array1/share
 /mnt/usbdisk1
 /mnt/usbdisk2
 /mnt/usbdisk3
For RAID 1 (two arrays):
 /mnt/array1/share
 /mnt/array2/share2
 /mnt/usbdisk1
 /mnt/usbdisk2
 /mnt/usbdisk3
For JBOD:
 /mnt/disk1/share
 /mnt/disk2/share2
 /mnt/disk3/share3
 /mnt/disk4/share4
 /mnt/usbdisk1
 /mnt/usbdisk2
 /mnt/usbdisk3

Accessing the TeraStation with an Anonymous User*

- To allow anonymous access to your FTP share, disable access restrictions.
- To access the TeraStation via anonymous FTP, configure your FTP client software with the following settings:
Hostname: IP address of the TeraStation
Username: anonymous
Password: any character string
Port: 21

Notes:

- If a file was created or copied by AFP, you may not be able to delete it using an FTP connection. If this occurs, use an SMB or AFP connection instead to delete the file.

- For FTP connections, make sure that the total filename including directory path is 250 single-byte characters or less.

Chapter 6 Backup

Back Up from the TeraStation

You can back up TeraStation folders to:

- A different folder on the TeraStation
- Another LinkStation on the network
- Another TeraStation on the network

You can also configure backup jobs from Easy Admin.

Preparing a Backup Destination

First, configure a folder as a backup destination.

- 1 In Settings, click *File Sharing*.

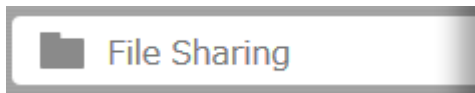

- 2 Click  to the right of "Folder Setup".



- 3 Choose the folder to set as a backup destination.

- 4 Click the *Advanced Settings* tab.

- 5 Under "LAN Protocol Support", check "Backup" and click *OK*.

Note: If a backup password is configured for the shared folder, that folder will not show up as a target for the backup source or destination when configuring a backup job on another LinkStation or TeraStation. To configure a backup password, enter it into the "Remote Backup Password" box. Leave this box blank if you don't want a backup password.

Backing Up to a LinkStation or TeraStation on Another Network When Connected via VPN

You can back up to a LinkStation or TeraStation on another network as long as the two networks are connected by a VPN. Follow this procedure to enter the IP address or hostname of the destination LinkStation or TeraStation.

If your setup meets the requirements below, you don't have to configure these settings:

- The source and target LinkStations or TeraStations are on the same network.
- No backup password is set for the target LinkStation or TeraStation.
- No LinkStation or TeraStation from outside the subnet, or connected by a VPN, is used.

- 1 In Settings, click *Backup*.



2 Click  to the right of "Backup".



3 Click *List of LinkStations and TeraStations*.

Backup List

Backup Password: ?

Filter:

Task	Scheduled	Day	Time	Operation Mode	Status
------	-----------	-----	------	----------------	--------

- 4 Click *Add* under "Off-subnet Devices", enter the IP address or hostname of the destination LinkStation or TeraStation, and click *Close*.

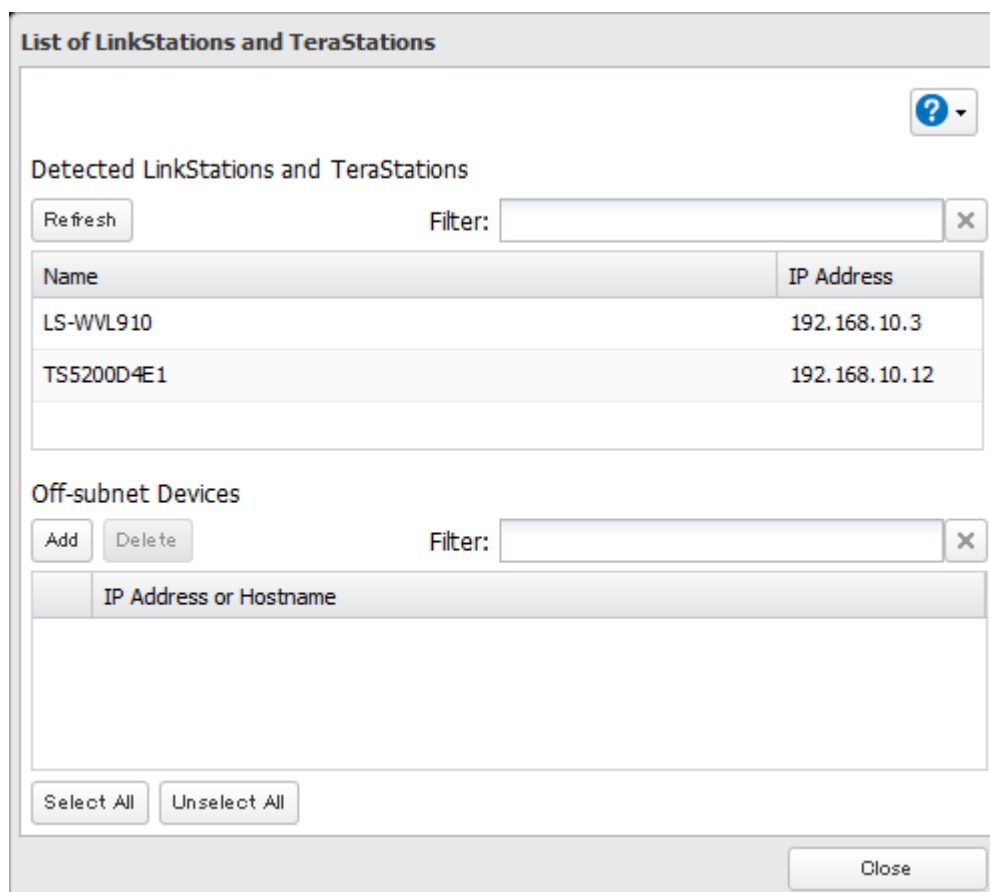

Notes:

- To back up data between LinkStations or TeraStations on a network using jumbo frames, make sure that both devices are configured to use identical (or similar) Ethernet frame sizes. If Ethernet frame sizes are significantly different, the backup job may not be properly performed. In such a case, select the default frame size (1500 bytes).
- You can also specify hostname by a fully qualified domain name (FQDN).

Configuring a Backup Job

- 1 In Settings, click *Backup*.



- 2 Click  to the right of "Backup".



3 Click *Create New Job*.

The screenshot shows a window titled "Backup List". At the top right is a help icon (question mark in a blue circle). Below it is a "Backup Password:" label with a "Set" button. Underneath is a text box containing "List of LinkStations and TeraStations". Below that are two buttons: "Create New Job" and "Delete Job(s)". To the right of these buttons is a "Filter:" label followed by an empty text input box and a close button (X). Below the buttons and filter is a table with the following columns: "Task", "Scheduled", "Day", "Time", "Operation Mode", and "Status". The table body is currently empty. At the bottom left of the table area are two buttons: "Select All" and "Unselect All". At the bottom right of the window is a "Close" button.

Note: Up to 8 backup jobs can be configured.

4 Select backup settings such as date and time to run.

The following types of backup jobs may be selected:

Type	Files included
Normal backup	All files in the source will be backed up to the destination.
Overwrite (incremental)	The first time the backup job runs like a normal backup. In subsequent backups, files added to the source as well as files deleted from the source are kept in the backup folder.
Overwrite (differential)	The first backup job runs like a normal backup. As each additional backup job runs, files are added to and deleted from the backup folder. The backup destination folder is always the same size as the backup source folder.

Type	Files included
Management backup	<p>Each time a backup is executed, management information is stored, and only files that have changed are copied or deleted. Data is retrieved from the previous backup file for files that were not changed. This is useful for making backups with limited space or for referencing status at a particular point in time (for use for data snapshot applications). The destination folder for a management backup should be a local folder on this TeraStation or on a USB drive attached to it. The destination folder will be set to read-only. Do not use folders from drives formatted with FAT.</p> <p>You can specify how many backup versions to keep from 1–400, or select "Unlimited" to keep all backups until the drive is full. The backup destination folder should be on the same TeraStation that the backup job is configured from, or on an external USB drive attached to that TeraStation.</p>

5 Click *Add*.

6 Click *Browse* under "Backup Source Folder Name".

7 Select the shared folder that will be the backup source, then click *OK*.

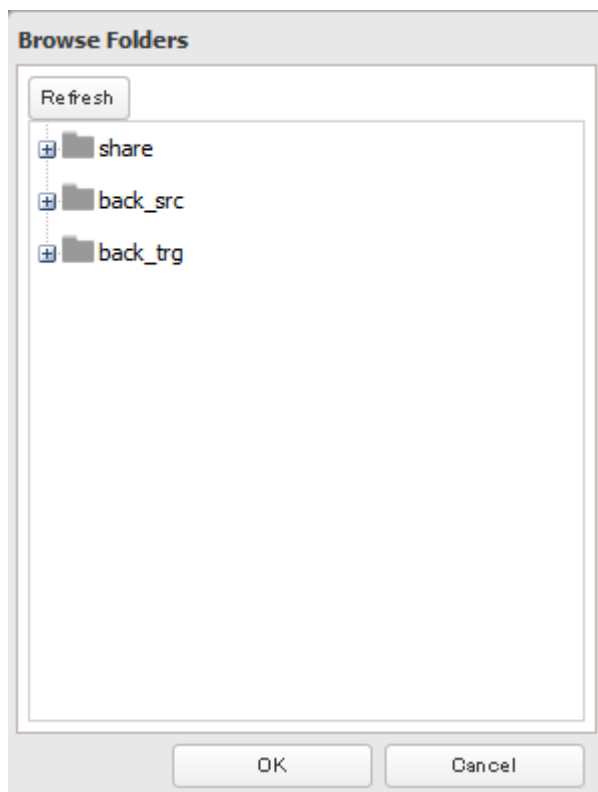

Note: Do not select a folder that contains a space in its folder name, or the backup job may fail.

8 Click *Browse* under "Backup Target Folder Name".

9 Select the backup destination and click *OK*.

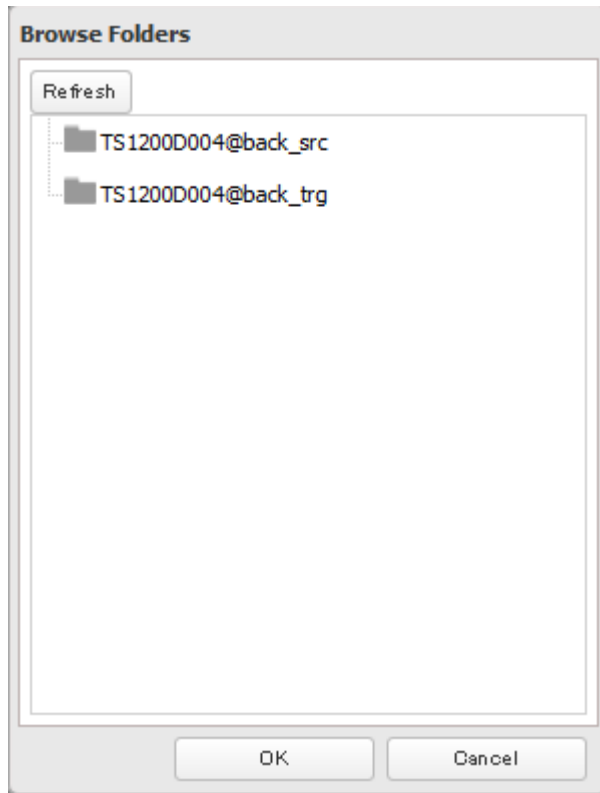

10 Click *OK*. Jobs added to "Backup List" are displayed.

11 Click *Close*.

Replication

Replication copies all data from a share to a share on a different TeraStation. This is an easy way to configure a reliable system to provide data protection in the event your main TeraStation fails. To configure replication, connect an Ethernet cable to the LAN port of each TeraStation and follow the steps below.

Notes:

- For best results, use static IP addresses for both replication TeraStations (source and destination). These IP addresses should be the same network segment.
- Replication source data is copied to the replication destination folder with a differential overwrite. Any data that is not in the replication source will be overwritten.

Preparing a Replication Destination

First, configure a folder as a replication destination.

1 In Settings, click *File Sharing*.

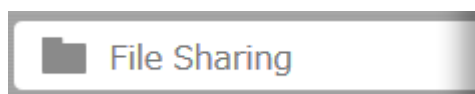

2 Click  to the right of "Folder Setup".



3 Choose the folder to set as a replication destination.

4 Click the *Advanced Settings* tab.

5 Under "LAN Protocol Support", select the "Backup" checkbox and click *OK*.

Note: Do not configure a backup password for the shared folders. Folder with a backup password set cannot be selected as replication destinations.

Configuring a Replication Task

1 In Settings, click *Backup*.



2 Click  to the right of "Replication".



3 Click *Edit*.

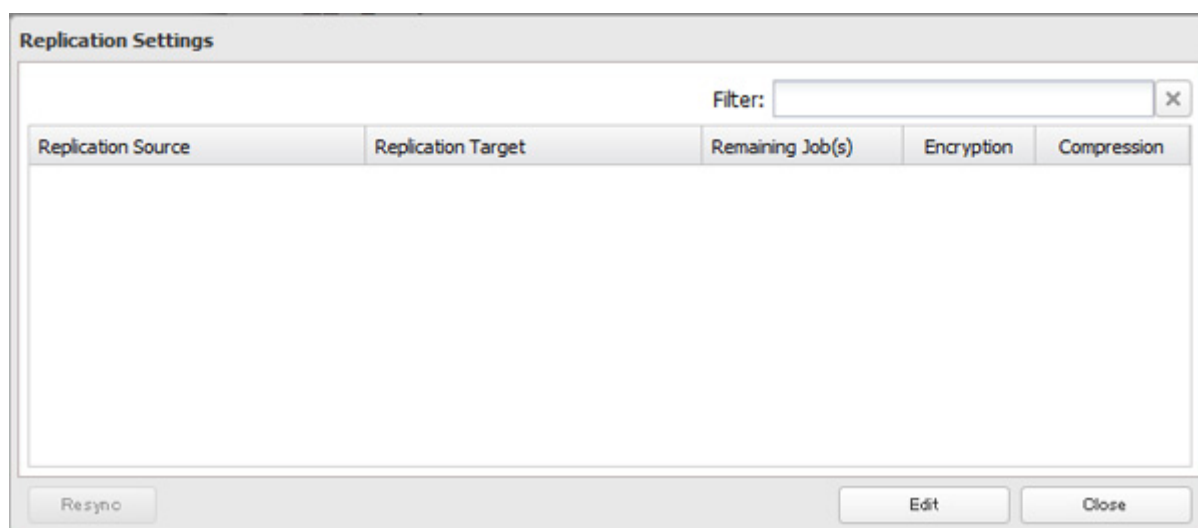

4 Click *Add*.

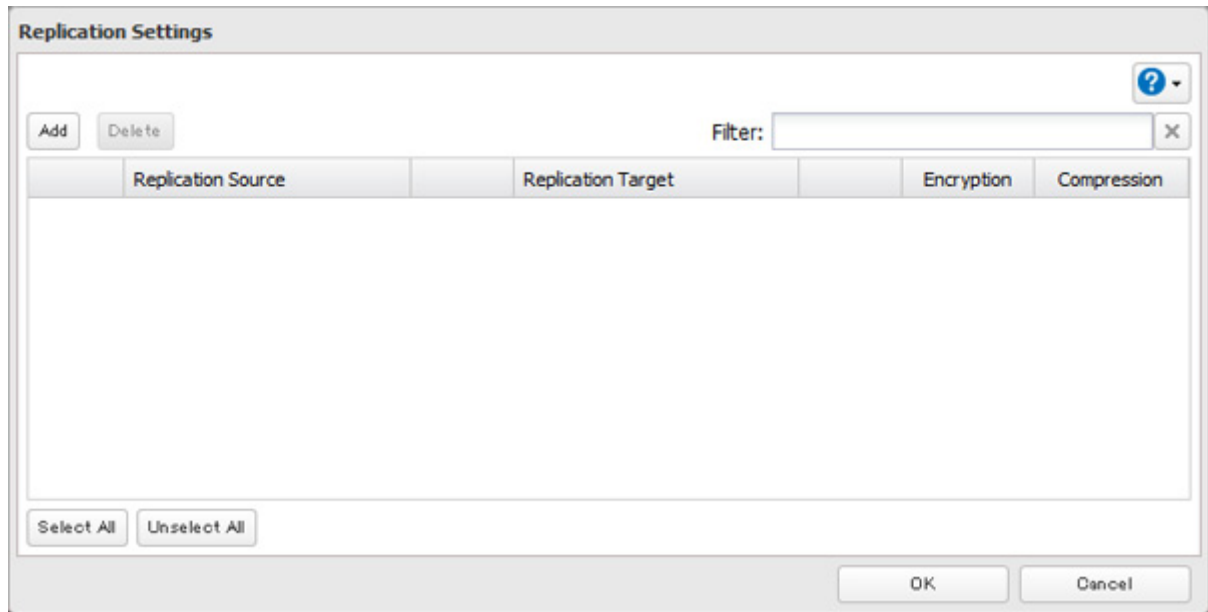

5 Click *Browse* under "Replication Source".

6 Select the shared folder that will be the replication source, then click *OK*.

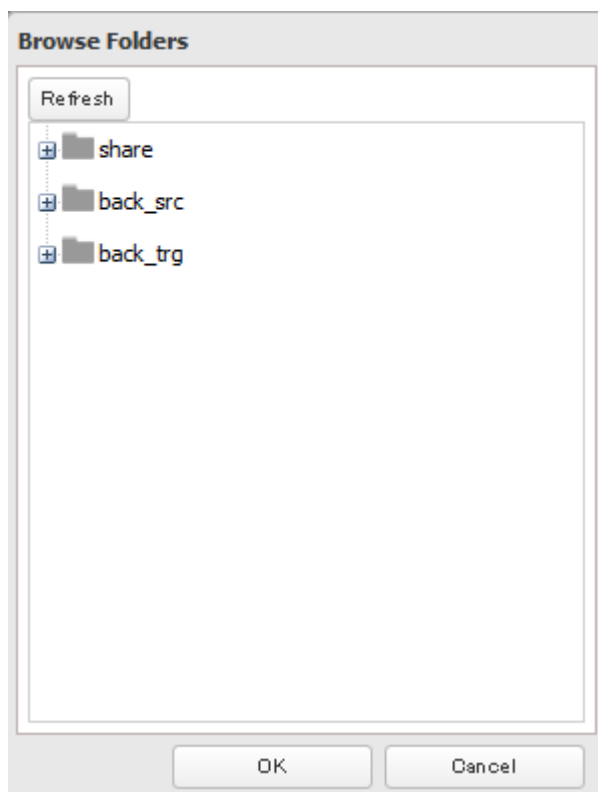

7 Click *Browse* under "Replication Target".

8 Select the shared folder that will be the replication destination, then click *OK*.

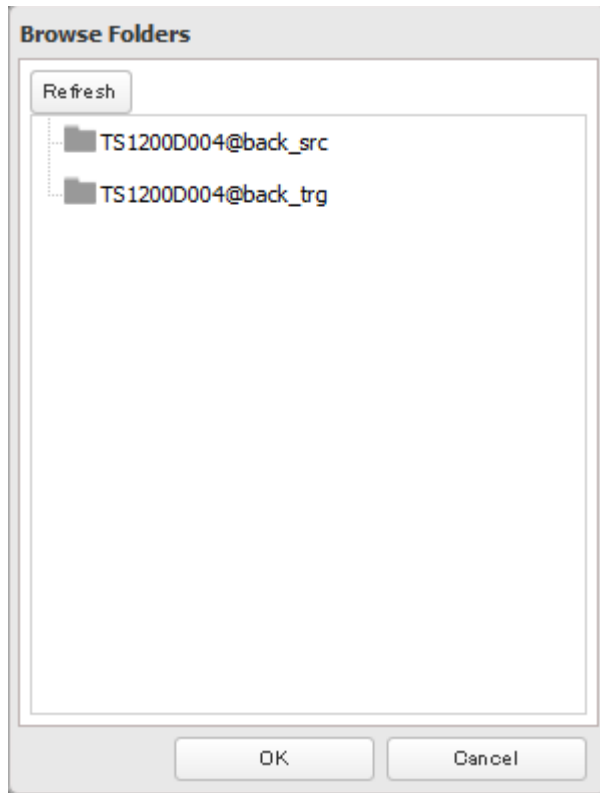

9 Click *OK*.

10 Click *Yes*.

Notes:

- During setup, you may choose to encrypt and/or compress replication data. Encrypted data will be transferred securely on the network. Compressed data will ease network loading and is recommended for slow or heavily loaded network connections. Either will increase the CPU load on the source TeraStation. Encrypted and compressed data will be unencrypted and decompressed on the target TeraStation.
- A maximum of 2 shared folders can be configured for replication.
- Replication can also be used to copy all data from a share to a share on an attached external drive. Format the drive with ext3 or XFS before using it for replication. Drives with FAT32 and HFS Plus partitions are not supported with replication.
- You can select subfolders as the replication source. Folders whose names contain more than 80 alphanumeric characters cannot be selected.
- Don't use the same TeraStation for both replication and Time Machine.
- Don't configure replication from one source folder to multiple destination folders.

- If a network problem causes a replication error, unsynced data may be shown as "0" even though replication is incomplete. Click *Resync* to recover from the replication error. All files from the source folder will be copied to the destination folder.

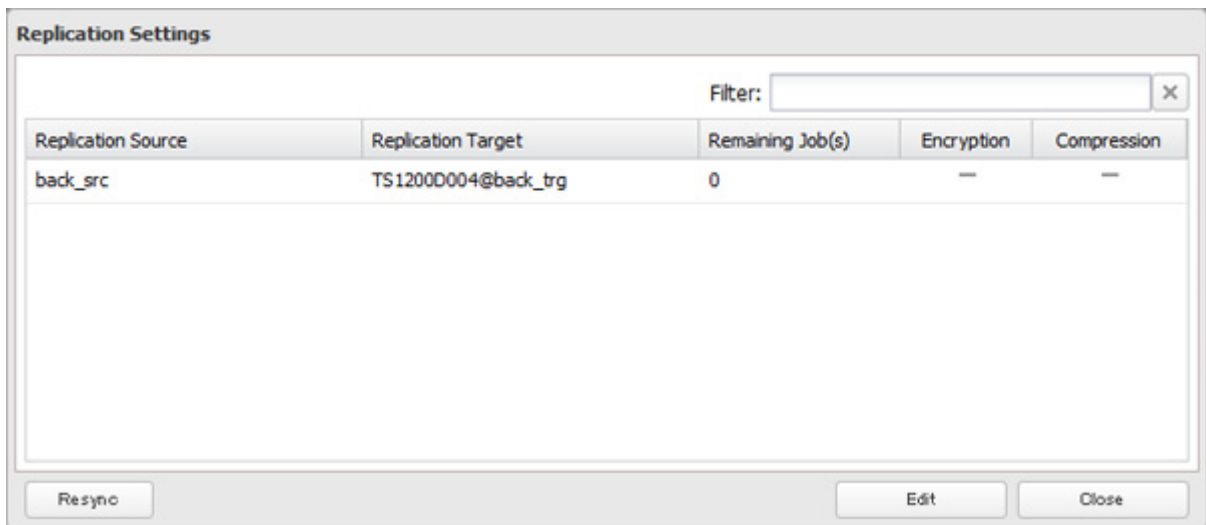

Backing Up Your Mac with Time Machine

Time Machine is a backup program included with macOS 10.5 or later. Configure your TeraStation as shown to use Time Machine.

- 1 In Settings, click *File Sharing*.

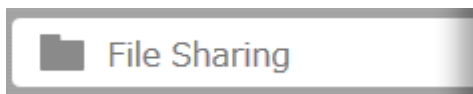

- 2 Move the AFP switch to the  position to enable AFP.



- 3 Click  to the right of "Folder Setup".



- 4 Choose a shared folder as your backup destination for Time Machine.

- 5 Click the *Advanced Settings* tab.

- 6 Under "LAN Protocol Support", select the "AFP (Mac)" checkbox and click *OK*.

- 7 Click *OK*.

- 8 Click *Close*.

- 9 Click *Backup*.



10 Click  to the right of "Time Machine".



11 Click *Edit*.

12 Click *Browse*.

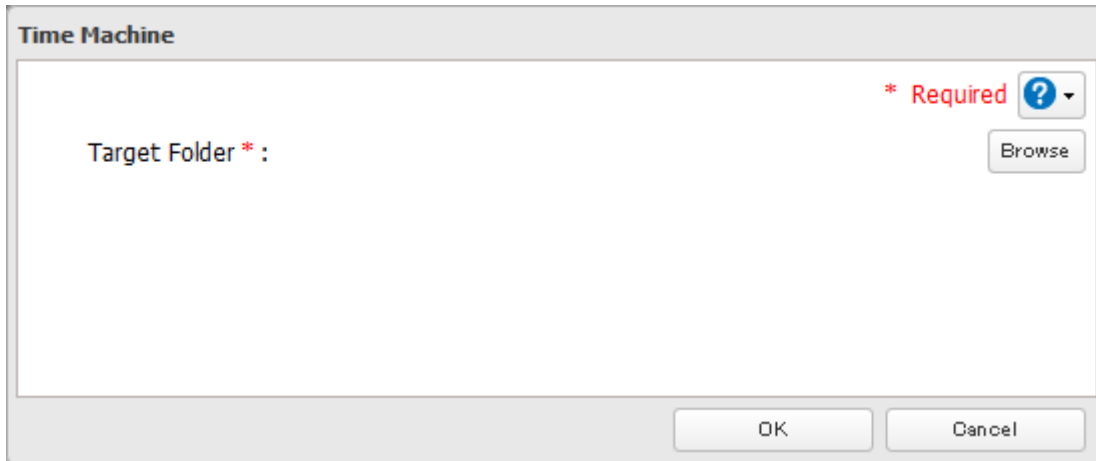

13 Select the shared folder that you enabled AFP for "LAN Protocol Support", then click *OK*.

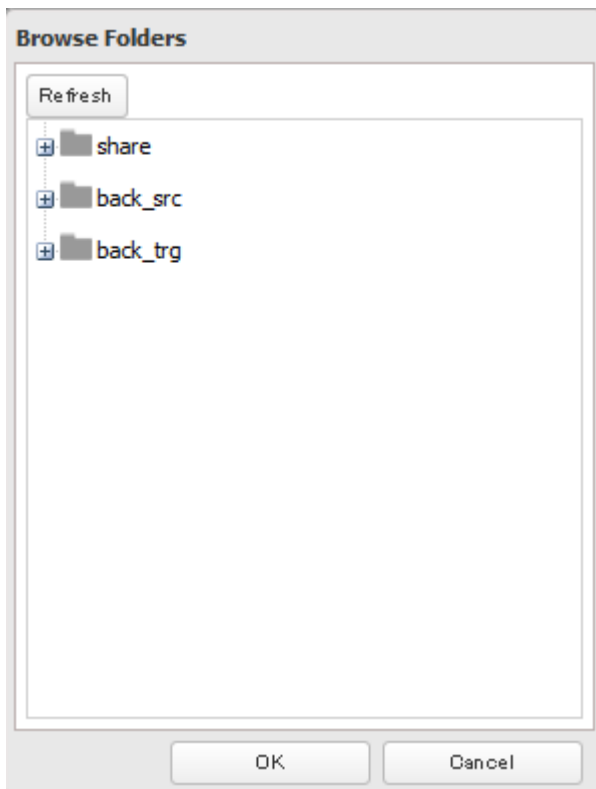

14 Click *OK*.

15 Click *OK*.

16 Move the Time Machine switch to the  position to enable Time Machine.



17 On the Mac, open *System Preferences*.

18 Click *Time Machine*.

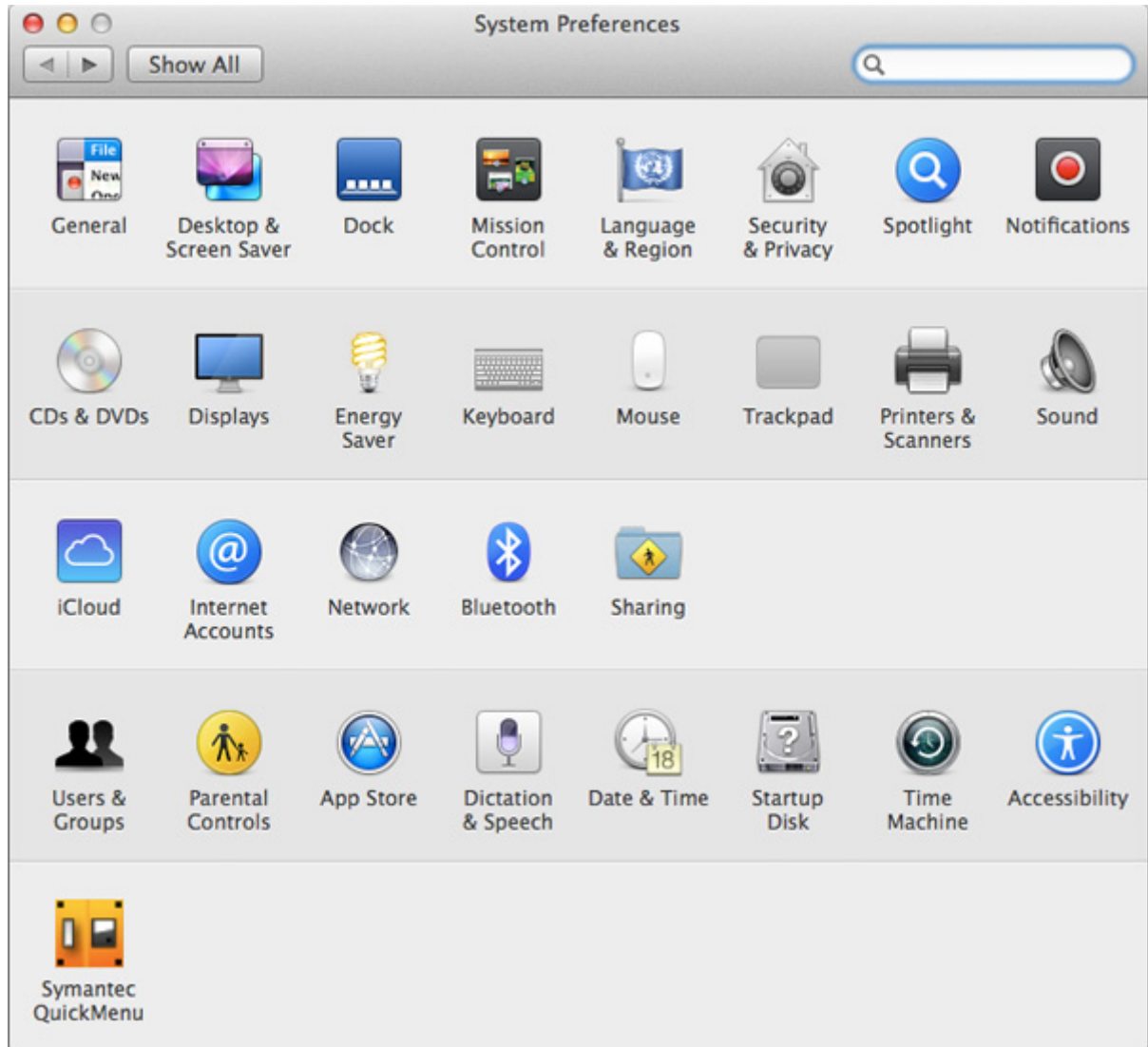

19 Click *Select Backup Disk*.



20 Select the TeraStation, then click *Use Disk*.

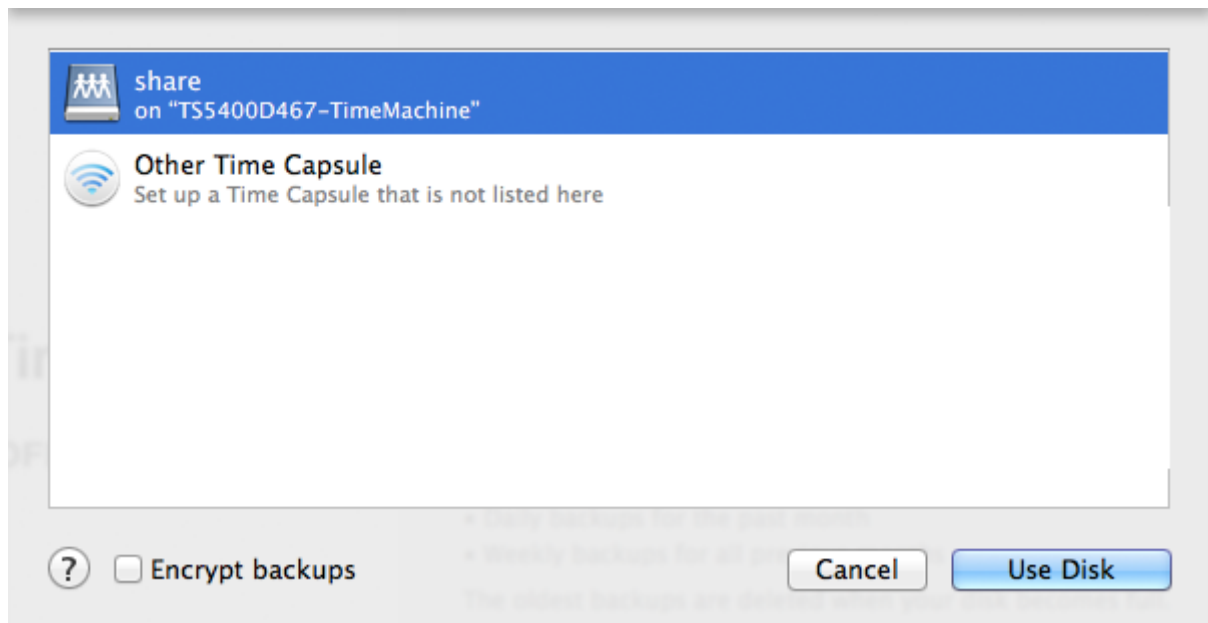

21 Enter a username and password with the rights to access the shared folder of the TeraStation, then click *Connect*.

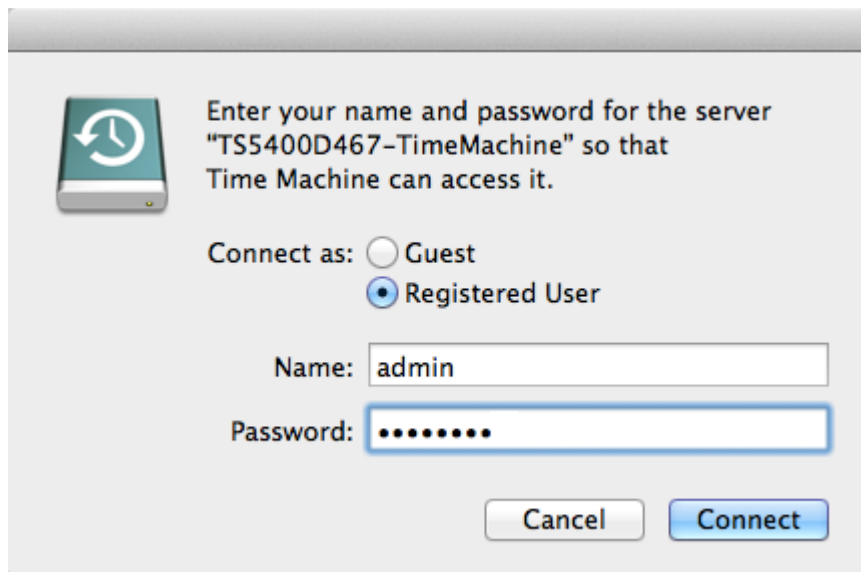

Note: If access restrictions are not configured on the destination share, log in with the administrator account. The default username and password for the administrator account are "admin" and "password". If access restrictions are configured, log in with an account with write privileges.

22 Time Machine will count down from 120 seconds, and the backup will begin.

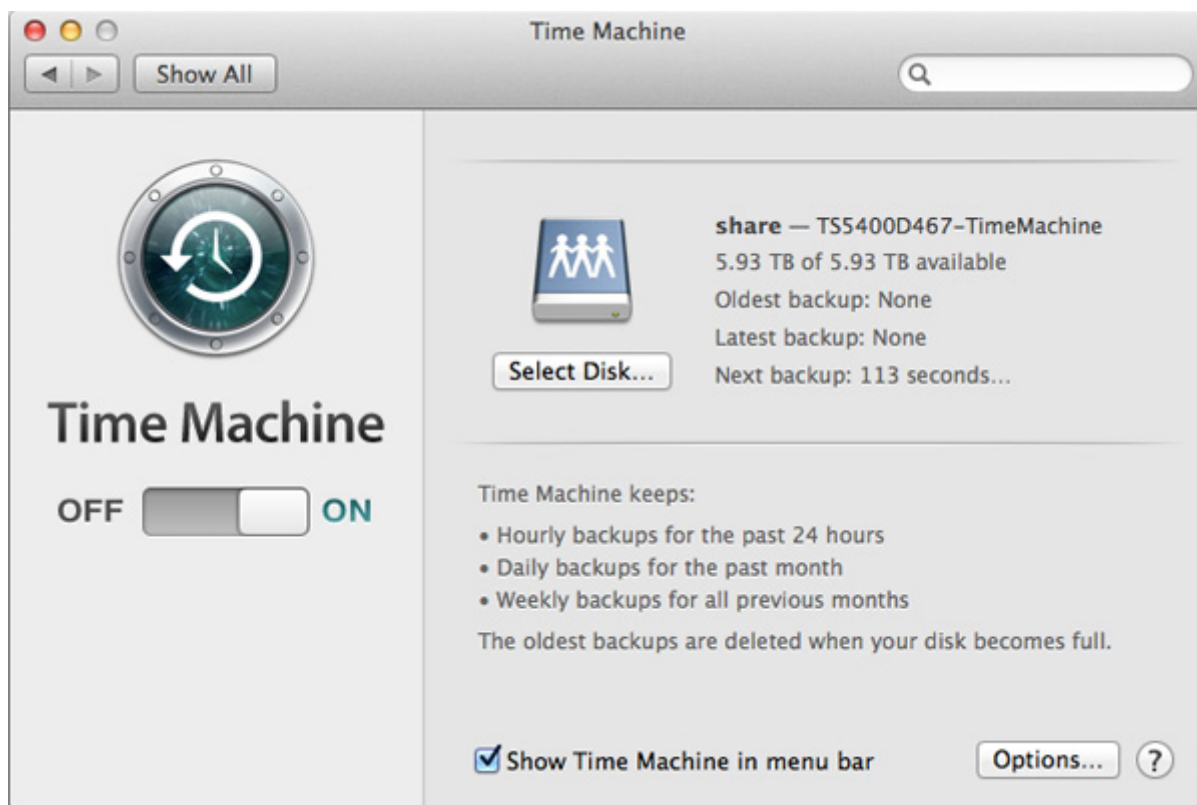

Copying from a USB Device

Use Direct Copy to copy data from a USB device directly to the TeraStation.

Note: To use Direct Copy, connect only one USB device at a time.

These devices are supported:

- USB mass storage devices
- Card readers (except for card readers that can recognize two or more memory cards)
- Digital cameras and other PTP devices

1 In Settings, click *Backup*.



2 Move the Direct Copy switch to the  position to enable Direct Copy.

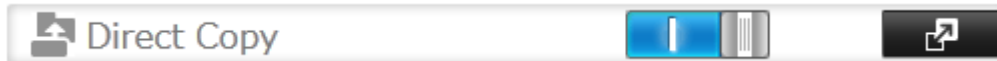

3 Connect the USB device. When it mounts (about 10 seconds), the function LED will light up.

Note: Unsupported devices will not cause the function LED to light.

4 You now have 60 seconds to press the function button. For TS1400D and TS1400R models, press and hold it down until the unit beeps. If you do, the function LED will flash as all the files on the USB device are copied to the Direct Copy folder ("share" is configured as a default) of the TeraStation.

Notes:

- While the function LED is flashing, press the function button once to cancel Direct Copy.
- For digital cameras that are not in the USB mass storage class, all files in the digital camera are copied.
- To change the Direct Copy target folder, navigate to *Backup - Direct Copy - Edit*, select a new folder, and click *OK*.

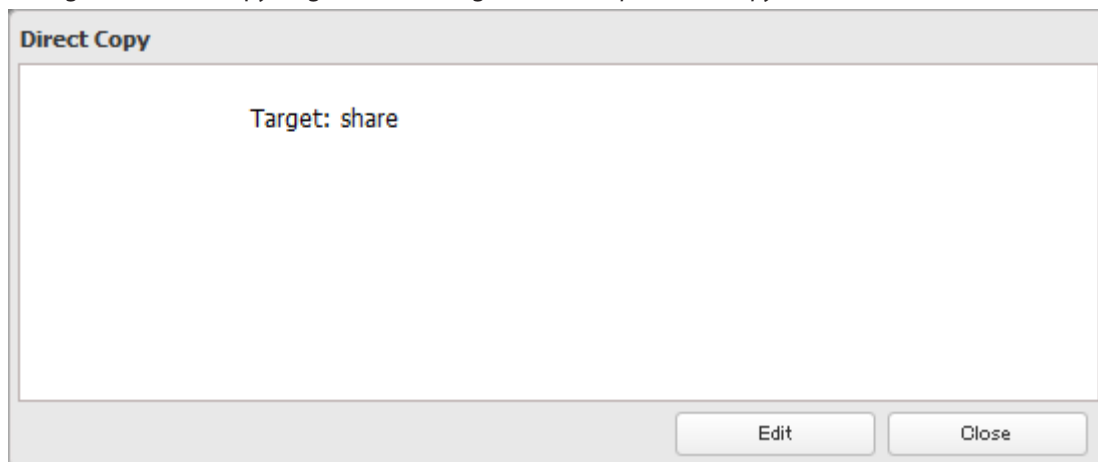

5 When the copy operation is finished, the access LED of the USB device will stop flashing and the function LED on the TeraStation will be extinguished. Dismount the USB device from the TeraStation referring to the "Dismounting Drives" section in chapter 4. Direct Copy is now finished.

Chapter 7 Multimedia

DLNA

DLNA is a set of guidelines for sharing digital media. The TeraStation includes a DLNA server compliant with the DLNA guidelines. The movies, photos, and music saved on this product can be played back on DLNA-compatible TVs, stereo equipment, game consoles, and other devices within the network.

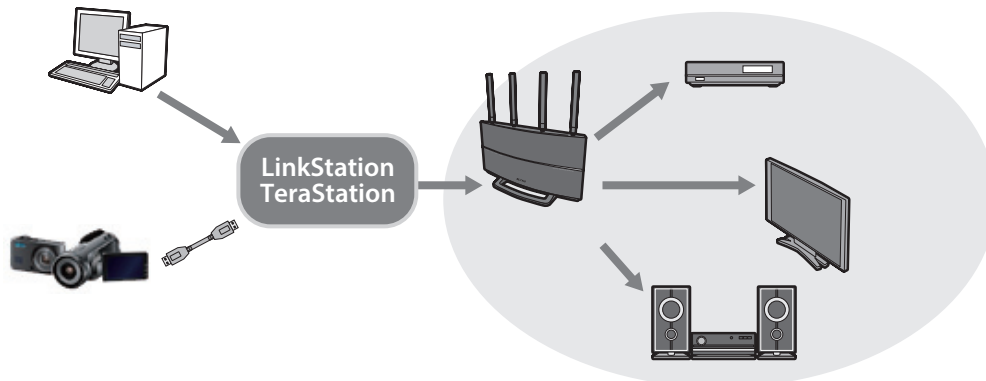

1 In Settings, click *File Sharing*.

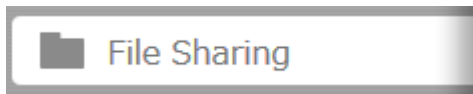

2 Click  to the right of "Folder Setup".



3 Select the folder that you want to share with media players and other DLNA-compatible devices.

4 Click the *Advanced Settings* tab.

5 Under "LAN Protocol Support", check "DLNA" and click *OK*.

6 Click *Close*.

7 Click *Services*.



8 Move the DLNA switch to the  position to enable DLNA.



9 Click  to the right of "DLNA Server".

10 Click *Edit*.

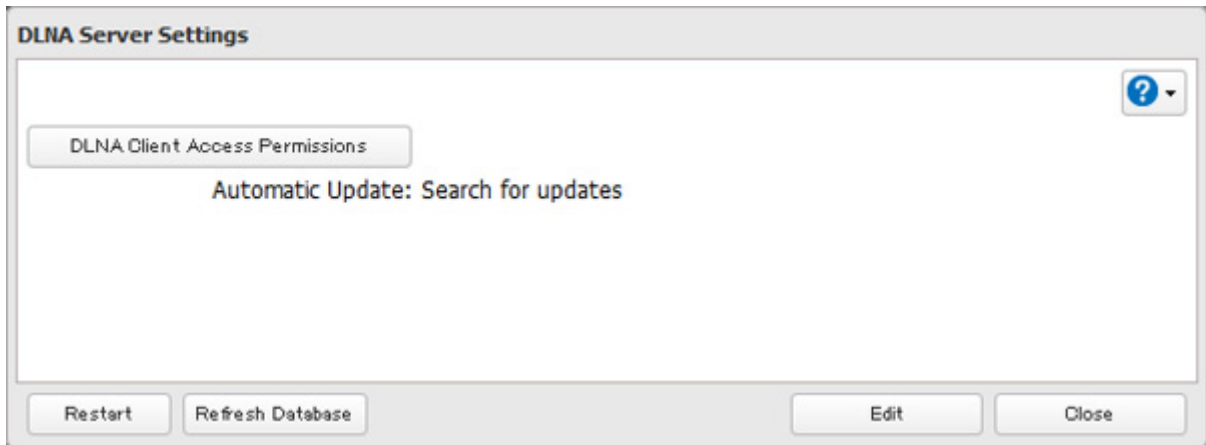

11 Select an interval for DLNA server database updates and click *OK*.

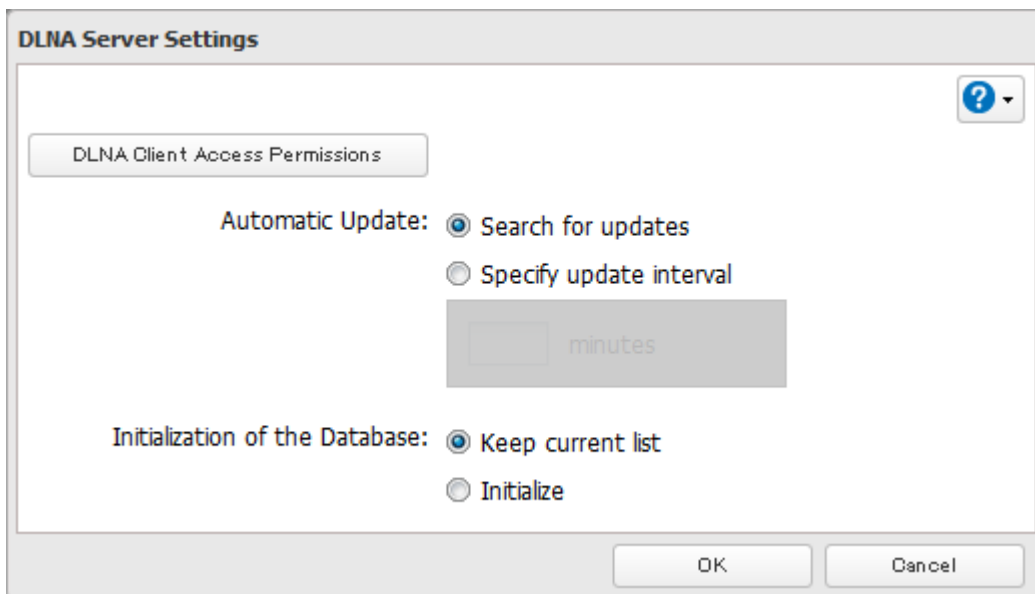

12 Click *OK*.

Playing Files

To play back content from a DLNA-compatible device:

- 1** Connect the DLNA-compatible device to the same network as the TeraStation and turn it on.
- 2** Select the TeraStation in the software of the DLNA-compatible device.
- 3** Select the content to be played back.

Note: For more information on playing files, see the DLNA-compatible devices' manuals.

Connected DLNA-compatible Devices

Follow the procedure below to view the DLNA-compatible devices connected to your TeraStation.

- 1** In Settings, click *Services*.



2 Click  to the right of "DLNA Server".



3 Click *DLNA Client Access Permissions*.

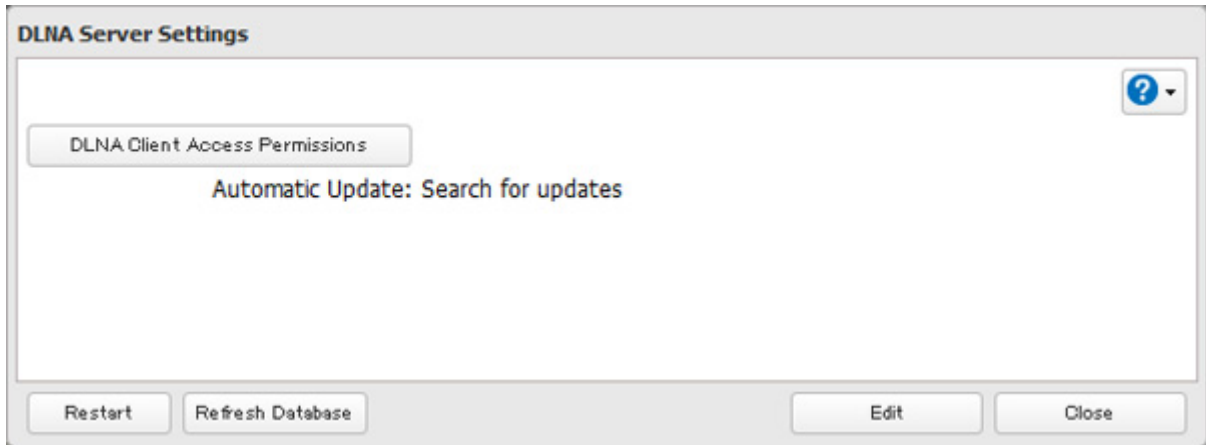

4 A list of the MAC addresses, IP addresses, and device names of the DLNA-compatible devices connected to the same network as the TeraStation is displayed. If your device is not listed, click *Refresh Database*.

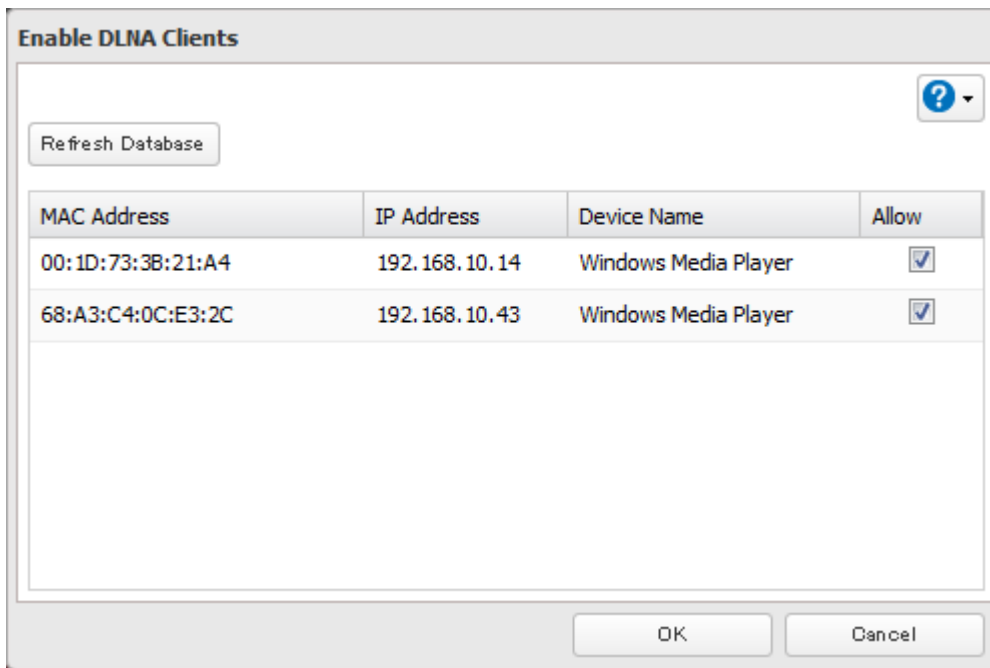

Streaming to DLNA-compatible Devices

When new movies, photos, and music files are added to the TeraStation's DLNA folder, the database must be updated before the new file can be streamed. By default, the database is updated at startup and again every 60 minutes. You can change this interval or update the database manually.

1 In Settings, click *Services*.



2 Click  to the right of "DLNA Server", then click *Edit*.



3 You may change the update interval, or select *Refresh Database* to update the database immediately.

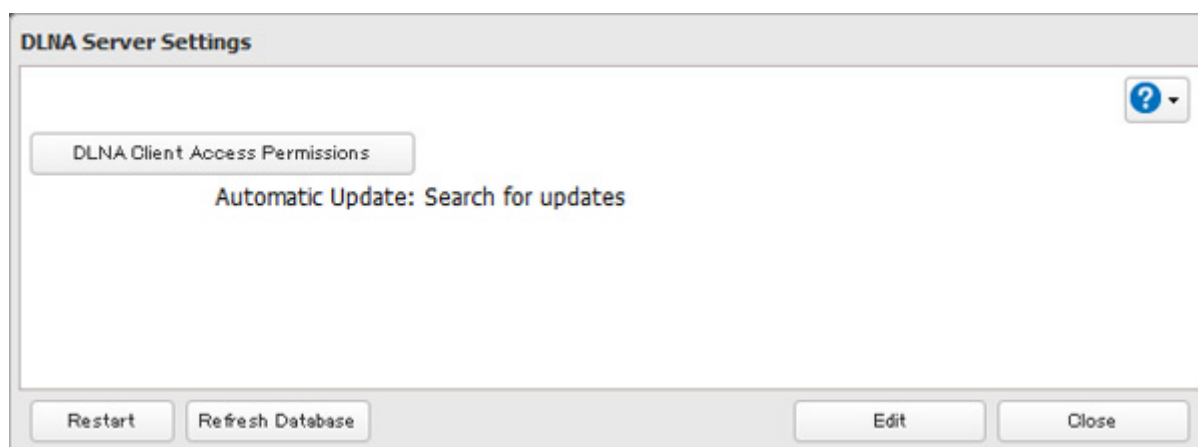

Disabling Playback from Specific Devices

You may block specific DLNA devices from playing back media content.

1 In Settings, click *Services*.



2 Click  to the right of "DLNA Server".



3 Click *DLNA Client Access Permissions*.

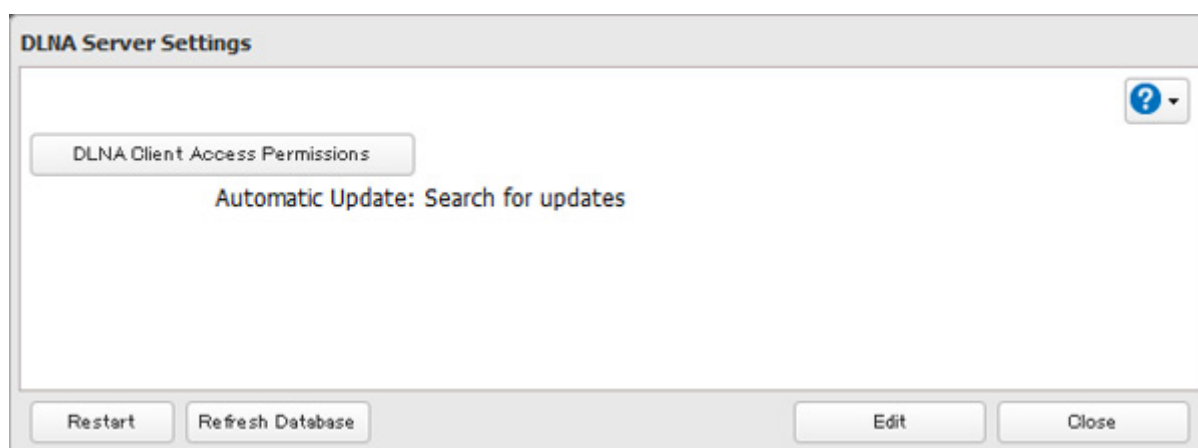

4 Uncheck the devices you do not want to allow to play media and click *OK*.

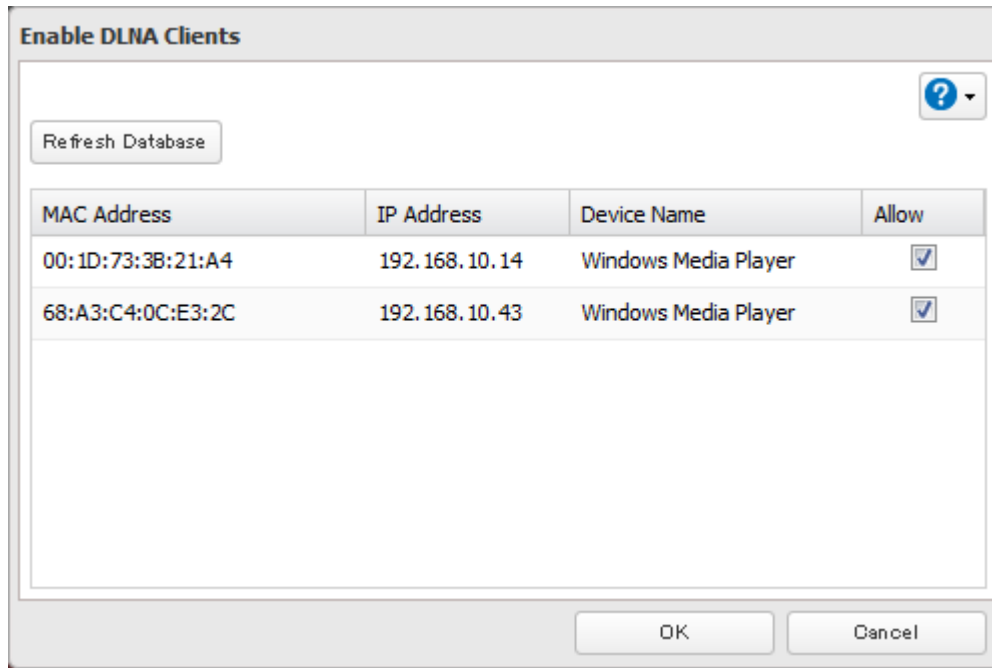

5 Click *Restart* to apply changes.

Supported File Types

The TeraStation supports DLNA streaming of files with the extensions below.

Type	File Extensions
Video files	.avi, .divx, .asf, .mpg, .mpe, .m1v, .vob, .mts, .m2ts, .m2t, .mpeg, .mpeg2, .vdr, .spts, .tp, .ts, .3gp, .mov, .m4v, .wmv, .dvr-ms, .xvid, .mp4, .m4v
Picture files	.jpg, .jpeg, .gif, .png, .tif, .tiff, .yuv, .bmp
Music files	.mp3, .mpa, .wma, .aac, .apl, .ac3, .lpcm, .pcm, .wav, .m3u, .m4a, .mp4, .3gp, .m4b, .aif, .aiff, .flac, .ogg, .mp2, .mp1, .mp4

iTunes Server

If iTunes server is enabled, computers on your network with iTunes can play music files stored on the TeraStation and transfer them to iPod, iPhone, and iPad devices. iTunes server supports playback from up to five computers.

1 In Settings, click *Services*.



2 Click  to the right of "iTunes Server".



3 Click *Edit*.

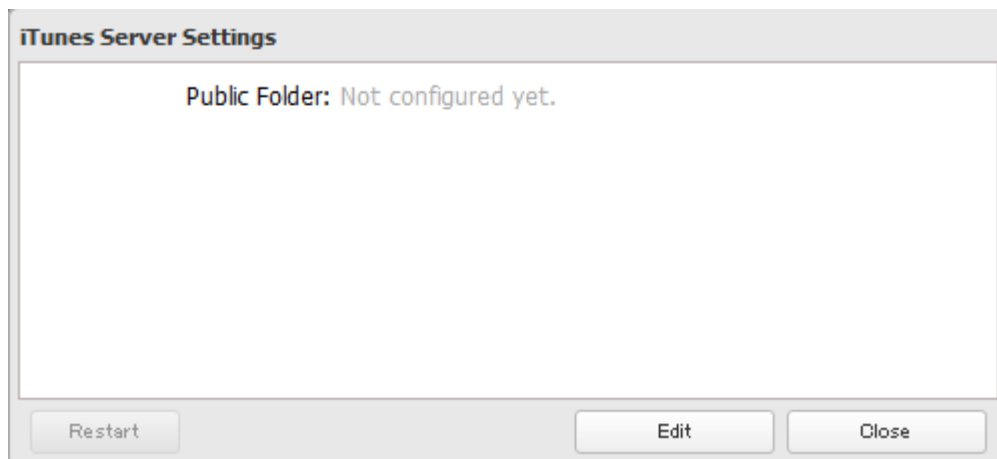

4 Click *Browse*.

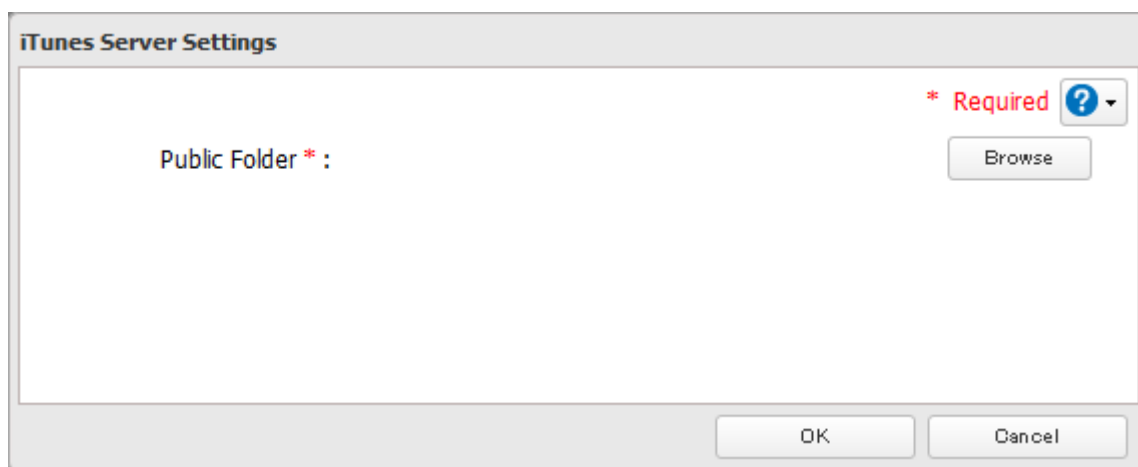

5 Select the shared folder that you want to make available to iTunes, then click *OK*.

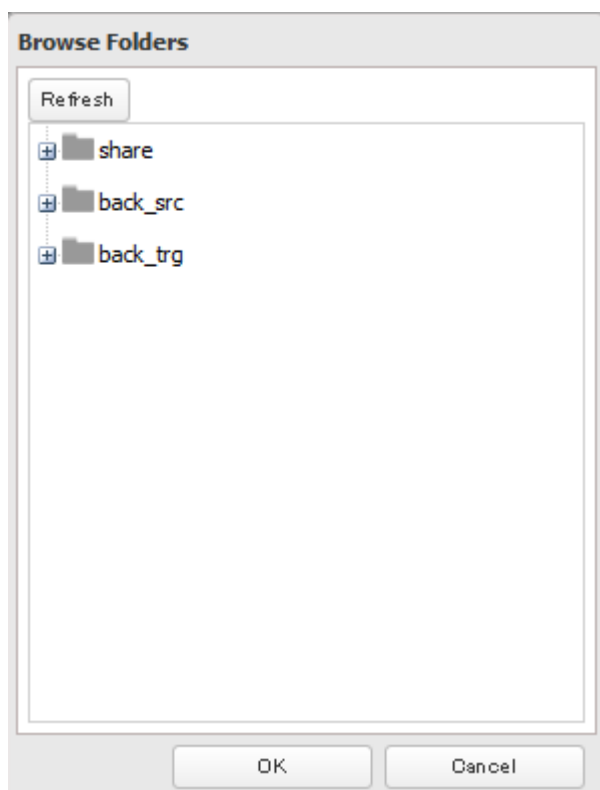

6 Click *OK*, then *OK* again.

7 Move the iTunes server switch to the  position.



BitTorrent

BitTorrent is a protocol for distributing large amounts of data efficiently. The information in this chapter is for users who are familiar with BitTorrent.

1 In Settings, click *Applications*.

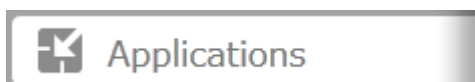

2 Click  to the right of "BitTorrent".



3 Click *Edit*.

4 Click *Browse*.

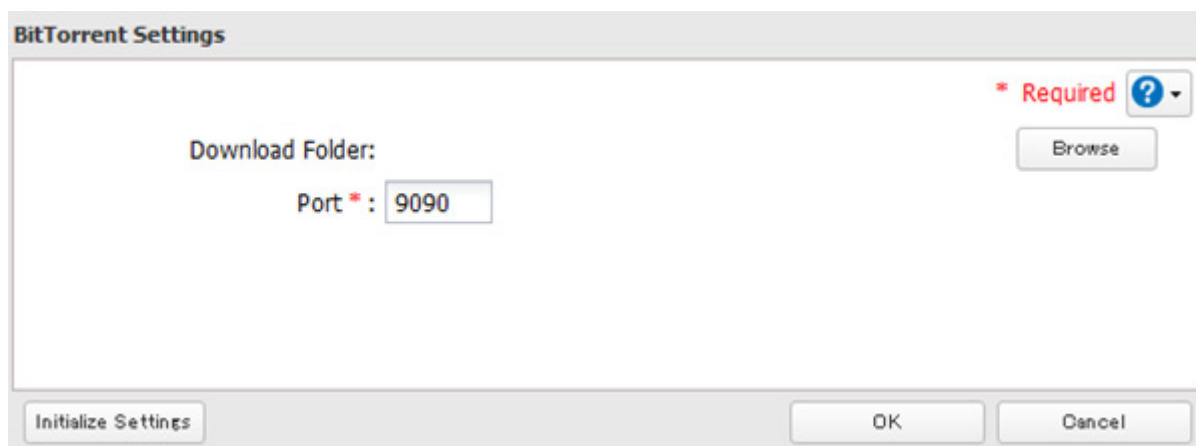

5 Select the shared folder where the downloaded file will be saved, then click *OK*.

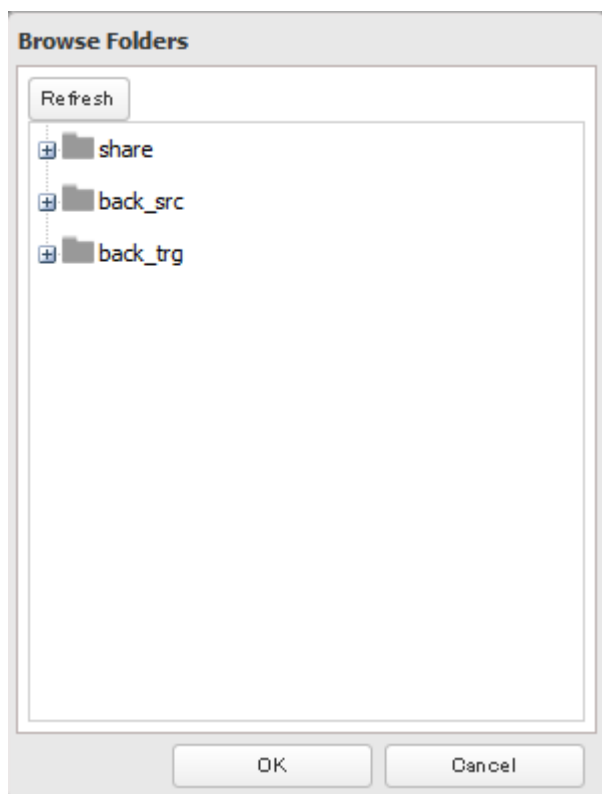

6 Click *OK*.

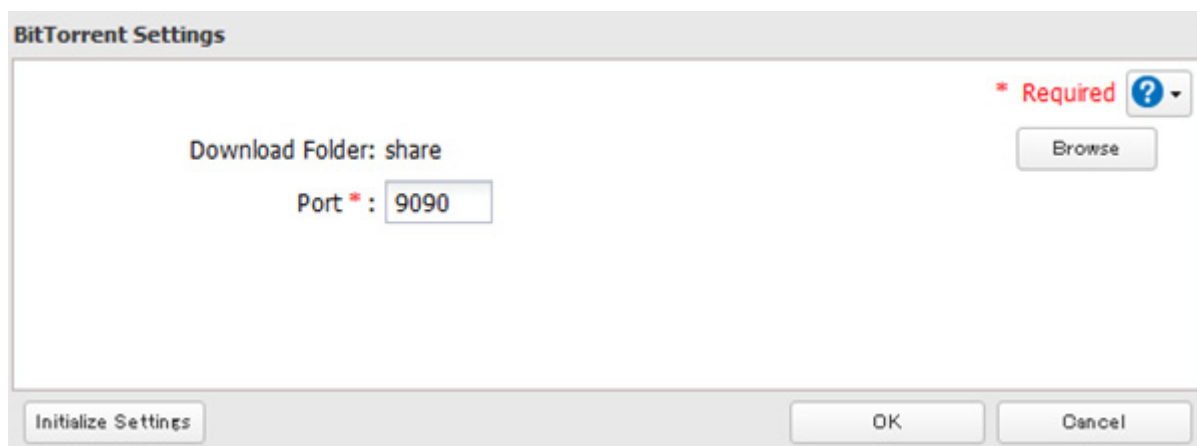

7 Move the BitTorrent switch to the  position to enable BitTorrent.



8 Click  to the right of "BitTorrent".

9 Click *Open Download Manager*. The default username is "admin" and the default password is blank (no password).

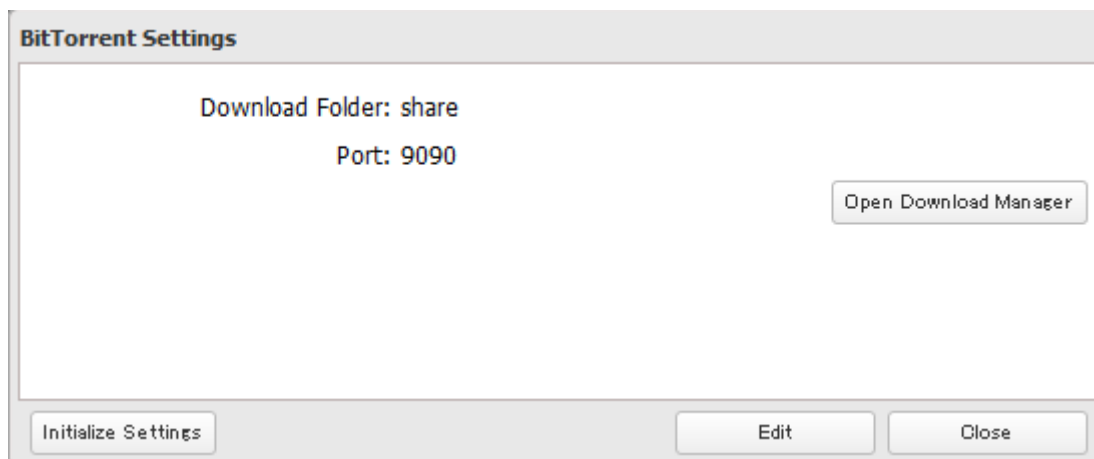

10 The download manager will open.

Chapter 8 Advanced Features

Email Notification

Your TeraStation can send you email reports daily, or when settings are changed or an error occurs. Notification emails may be triggered by any of the following events:

- Scheduled hard drive status notification (includes quota exceeded notification)
- Backup job completed
- RAID error
- Fan error
- Hard drive read error
- Hard drive replacement
- RAID configuration change
- System bootup/shutdown

1 In Settings, click *Management*.

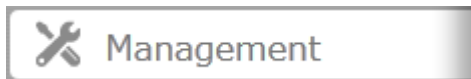

2 Move the email notification switch to the  position to enable email notification.



3 Click  to the right of "Email Notification".

4 Click *Edit*.

- 5** Enter your email server settings and choose which events will trigger notifications. Click *OK* to send a test email.

The screenshot shows the 'Email Notification' configuration window. It includes fields for SMTP Server Address, SMTP Port (set to 25), Sender Address, Authentication Type (set to Disable), POP3 Server Address, POP3 Port (set to 110), SSL/TLS (set to Disable), Username, Password, and Subject (set to 'TeraStation Status Report'). There are also buttons for 'Add', 'Delete', and 'Select from List' for recipients. A table for recipients is shown with columns for Name, Recipient(s), and Class. Below the table are 'Select All' and 'Unselect All' buttons. At the bottom, there are checkboxes for system events: HDD status report (checked), Fan error (checked), Disk error (checked), Backup complete (checked), Quota report (checked), and System alert (checked). A dropdown menu is set to '00' and 'Hour'. 'OK' and 'Cancel' buttons are at the bottom right.

Sleep Mode

To save energy, you can specify times to put the TeraStation into sleep (standby) mode, during which the hard drive and LEDs are turned off.

- 1** In Settings, click *Management*.

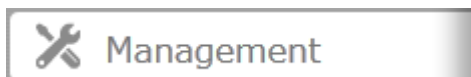

- 2** Click  to the right of "Sleep Timer".



- 3** Click *Edit*.

4 Specify the timer interval, wake-up time, and time to go into sleep mode, then click OK.

The screenshot shows the 'Sleep Timer Settings' dialog box with three timer sections:

- Timer 1:** Schedule: Weekly. Days: Monday, Tuesday, Wednesday (checked). Wake Up at: 07:00. Begin Sleep at: 22:00.
- Timer 2:** Schedule: Disable. Days: None. Wake Up at: 00:00. Begin Sleep at: 00:00.
- Timer 3:** Schedule: Disable. Days: None. Wake Up at: 00:00. Begin Sleep at: 00:00.

Notes:

- Up to three timers can be set.
- The time to enter sleep mode can be set from 12:00 a.m. to 3:45 a.m. of the next day.
The time to wake from sleep mode can be set from 12:00 a.m. to 11:45 p.m.
If the time to enter sleep mode is after 12:00 a.m., the wake-up time setting may be from 4:00 a.m. to 11:45 p.m.
- The time to enter sleep mode should not be set at the same time as or before the start time.
- If a timer is scheduled during a drive check, drive format, backup process, and backup job, or within 5 minutes of the current time, the TeraStation will not change to standby mode when the configured time is reached.
- If scheduled times in the timer overlap, operation is performed using the widest time interval.
- Examples of multiple timer settings are shown below.

Example 1:

If running at a current time of 10:00 a.m. Wednesday

Timer 1: Daily 12:00–24:00

Timer 2: Not used

Timer 3: Not used

No operation is performed at 12:00 p.m. and the unit goes into sleep mode at 12:00 a.m.

Example 2:

If running at a current time of 10:00 a.m. Wednesday

Timer 1: Daily 9:00–18:00

Timer 2: Wednesday 10:00–20:00

Timer 3: Not used

On days other than Wednesday, normal operation begins at 9:00 a.m. and the unit goes into sleep mode at 6:00 p.m. On Wednesday, the unit goes into sleep mode at 8:00 p.m.

Example 3:

If running at the current time of 10:00 a.m. Wednesday

Timer 1: Daily 9:00–18:00

Timer 2: Wednesday 10:00–1:00 a.m. of the next day

Timer 3: Not used

On days other than Wednesday, normal operation begins at 9:00 a.m. and the unit goes into sleep mode at 6:00 p.m. On Wednesday, normal operation begins at 10:00 a.m. and the unit goes into sleep mode at 1:00 a.m. of the next day.

Example 4:

If running at a current time of 10:00 a.m. Wednesday

Timer 1: Daily 9:00–18:00

Timer 2: Wednesday 7:30–22:00

Timer 3: Not used

On days other than Wednesday, normal operation begins at 9:00 a.m. and the unit goes into sleep mode at 6:00 p.m. On Wednesday, normal operation begins at 7:30 a.m. and the unit goes into sleep mode at 10:00 p.m.

- To wake the TeraStation from sleep mode manually, press the power button.

UPS (Uninterruptible Power Supply)

If a UPS (sold separately) is attached, the TeraStation can be automatically shut down to protect data in the event of a power outage.

- 1** Plug the power cable of the UPS to a wall socket.
- 2** Connect the AC cable of the TeraStation to the UPS.
- 3** Connect the UPS and TeraStation using a USB cable.
- 4** Turn on the UPS, then the TeraStation.
- 5** In Settings, click *Management*.

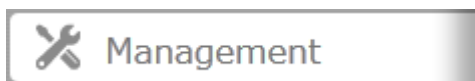

- 6** Click  to the right of "UPS Sync".



- 7** Click *Edit*.

8 Configure the desired settings, then click *OK*.

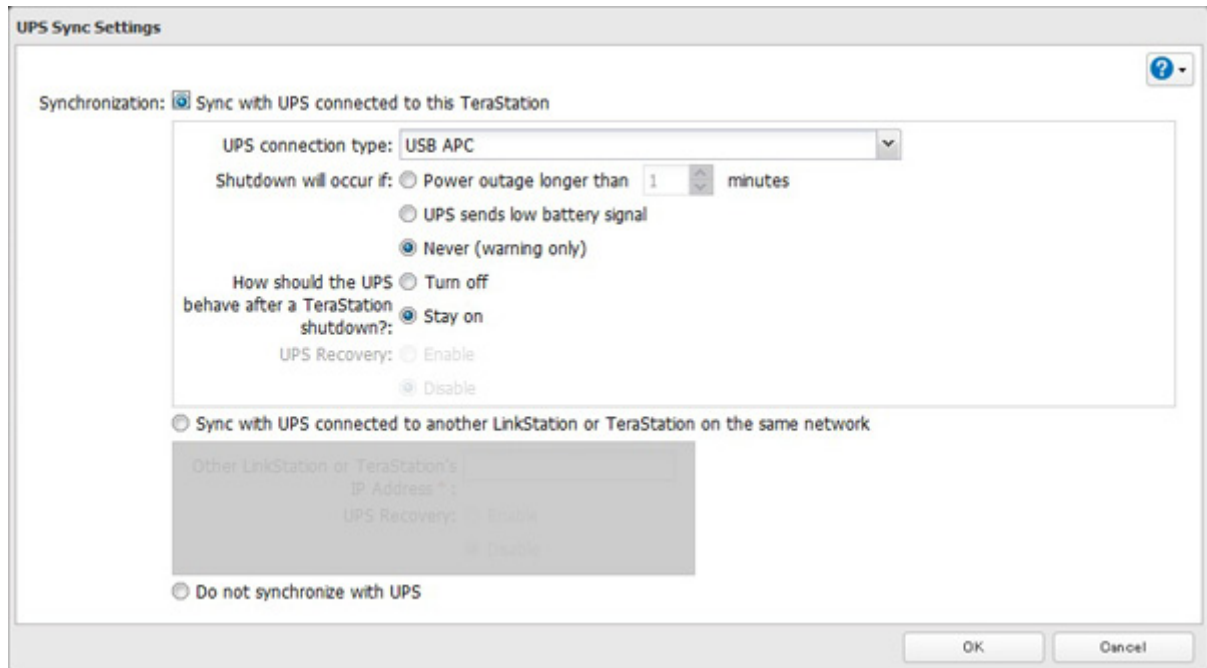

Notes:

- If the TeraStation is connected directly to a UPS, select "Sync with UPS connected to this TeraStation". If a different TeraStation is connected to the UPS, select "Sync with UPS connected to another LinkStation or TeraStation on the same network". After making this selection, enter the IP address of the TeraStation that will be the sync source in "Other LinkStation or TeraStation's IP Address".
- When the TeraStation is rebooted after an automatic shutdown (such as from a power outage or power supply problem), verify that the power supply has been restored. If the TeraStation is turned on while it is still running on the UPS and without the power supply restored, automatic shutdown is not performed, even after the specified time has elapsed.
- If the power supply from the UPS to the TeraStation is stopped and restarted when UPS recovery is enabled, the TeraStation is automatically restarted.

Connecting a Printer

You can connect a printer to the USB port on the TeraStation.

Notes:

- Only one USB printer can be connected to the TeraStation.
- Bidirectional communication is not supported i.e., remaining ink quantities and other printer status information is not displayed.
- If a multifunctional printer is connected, only the printer function can be used. Other functions such as scanning will not be available.
- The print server does not support macOS.
- Don't disable the SMB protocol while the print server is enabled. If you do, you will need to enable SMB again and reconfigure the print server from scratch.

- 1 In Settings, click *Services*.



2 Move the print server switch to the  position to enable the print server.

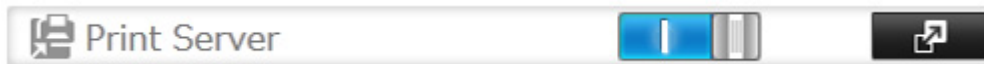

3 Refer to the manual supplied with the printer and install the printer drivers.

4 Launch NAS Navigator2. Double-click your TeraStation's icon.

5 Double-click the icon of the connected printer (shared name is displayed).

6 Click *OK*.

7 Select your printer, then click *OK*.

8 Register the printer.

Offline Files

The "offline files" feature that is included with many versions of Windows can be used with files on the TeraStation. You will be able to work on files stored on the TeraStation even when your PC is disconnected from the network. When you next connect to the network, the updated files are written and synchronized. Follow the procedure below to configure offline files.

1 In Settings, click *File Sharing*.

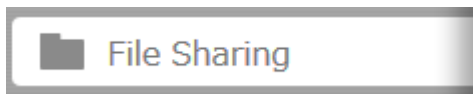

2 Click  to the right of "Folder Setup".



3 Click the shared folder for offline files.

4 Click the *Advanced Settings* tab.

5 Choose "Manual File Caching", "Automatic File Caching", or "Automatic Program and File Caching", then click *OK*.

- "Manual File Caching" - User selects files that are cached.
- "Automatic File Caching" - Opened files can be cached locally for offline use. Previous versions of files that are not synchronized are automatically replaced by the latest versions.
- "Automatic Program and File Caching" - Opened files can be cached locally for usage offline. Previous versions of files and applications executed from the network that are not synchronized are automatically replaced by the latest version of the files and applications.

6 Click *OK*.

7 Click *Close*.

8 Right-click the icon of the shared folder on the TeraStation for which you have set the offline feature, then click *Always available offline*. If the offline file wizard opens, follow the instructions on the screen.

9 When the offline settings and sync settings are completed, the files and folders set appear as shown:

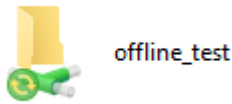

10 If the computer is disconnected from the network after synchronization is completed, the offline file function can be used.

Offline files can be accessed by the original Universal Naming Convention (UNC) where the data was saved.

Accessing from an NFS Client

Note: (US purchasers only) Buffalo's customer support will help configure the NFS settings on your TeraStation, and will support VMware and Windows clients but will not provide support for configuring your Linux or other UNIX clients. There are many types of UNIX and the procedures for configuring NFS with them will vary considerably. For help configuring your NetWare, Linux, or other UNIX clients for NFS support please consult each client's own documentation and support.

1 In Settings, click *File Sharing*.

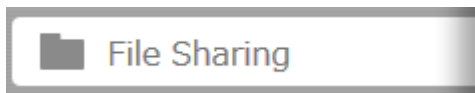

2 Click  to the right of "Folder Setup".



3 Choose the shared folder that will be accessible to the NFS client.

4 Click the *Advanced Settings* tab.

5 Under "LAN Protocol Support", check "NFS" and click *OK*.

Note the NFS path. It will be used later for accessing data from NFS clients.

6 Click *Close*.

7 Move the NFS switch to the  position to enable NFS.

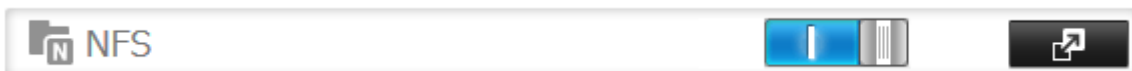

8 Click  to the right of "NFS".

9 Click *Client Settings*.

10 Click *Add Client*.

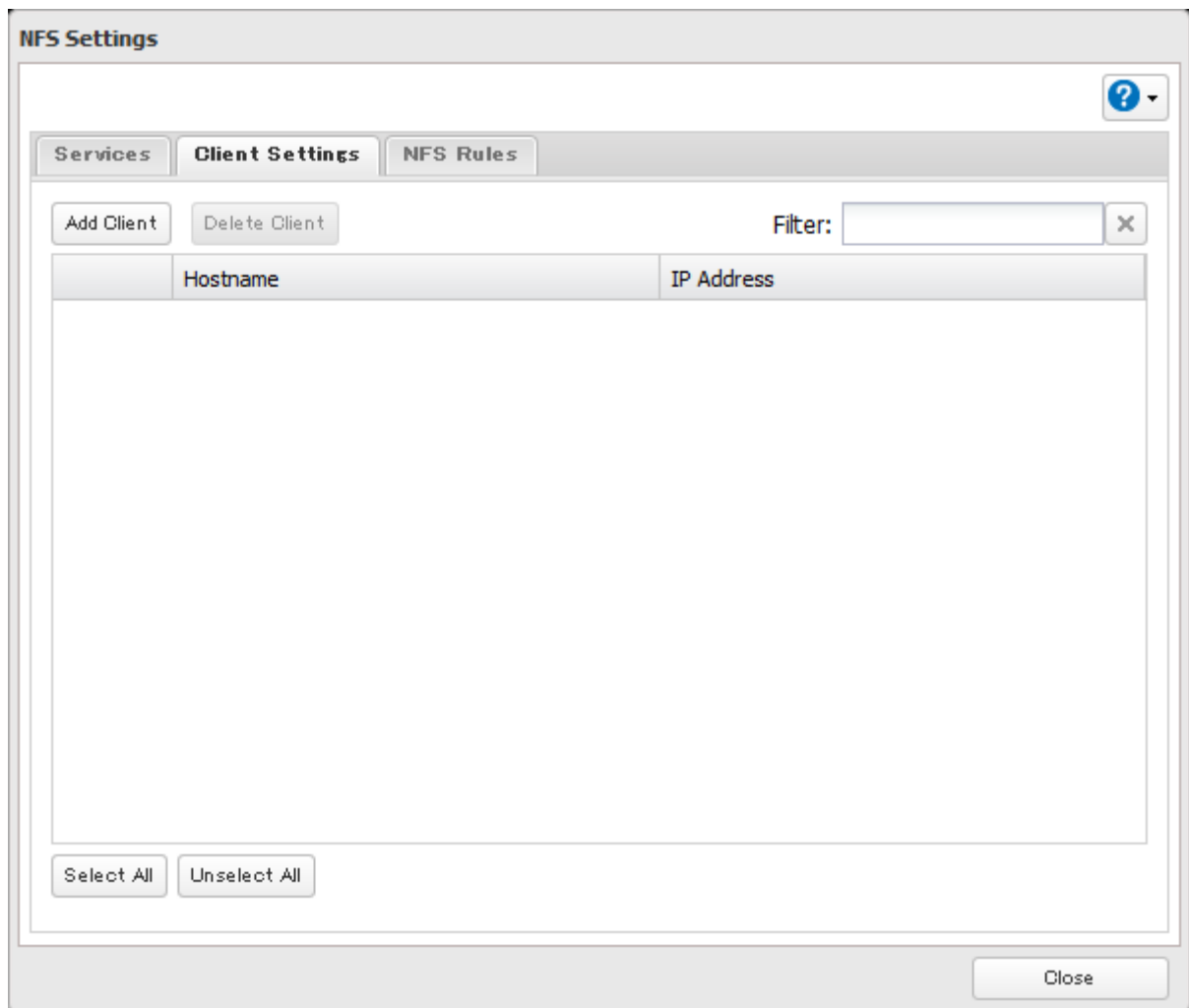

Note: To delete a client, check the hostname and click *Delete Client*.

11 Enter the IP address and hostname of the NFS client, then click *OK*.

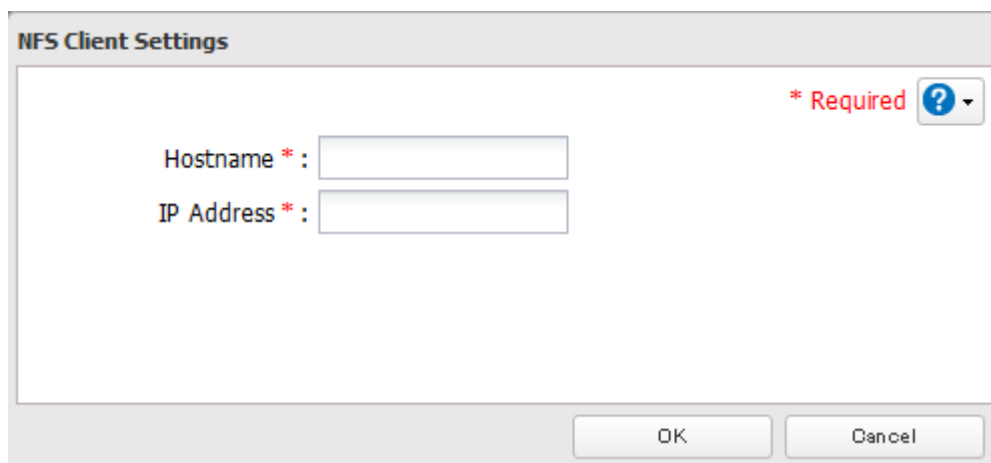

12 Click *Close*.

13 Enter the mount command to access the shared folder from the NFS client.

The mount command depends on your operating system. The examples below assume that IP address of your TeraStation is 192.168.11.10, "/mnt/array1/share" is the desired NFS path, and "/mnt/nas" or drive letter "z" is the mount point.

For Linux:

```
mount -t nfs 192.168.11.10:/mnt/array1/share /mnt/nas
```

For Windows Service for Unix 3.5:

```
mount 192.168.11.10:/mnt/array1/share z:
```

For Solaris 10:

```
mount -F nfs 192.168.11.10:/mnt/array1/share /mnt/nas
```

Notes:

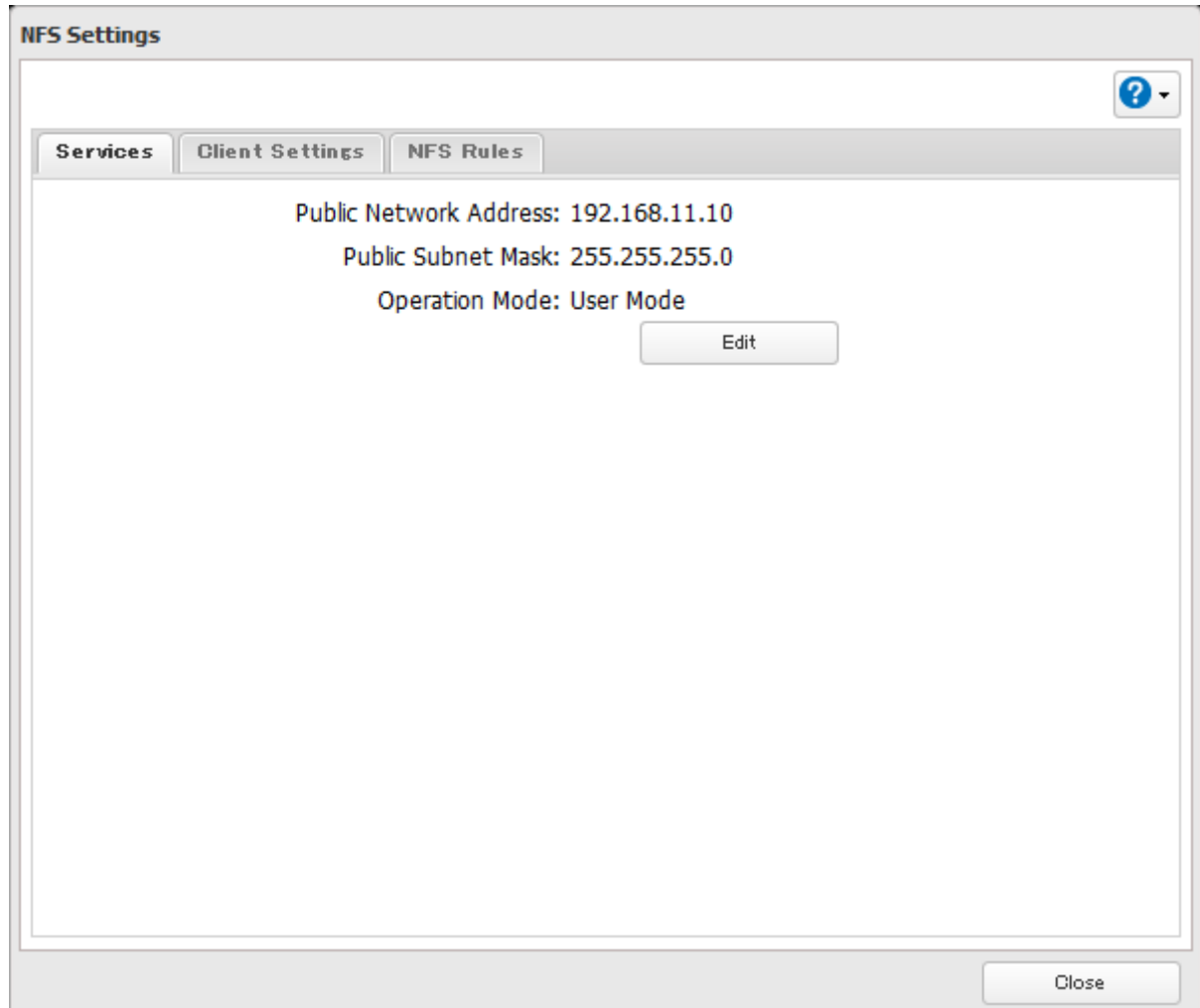

- To restrict NFS access to a specific network or client, navigate to *File Sharing - NFS - Services* and click *Edit*. Enter the address of the network. For example, if your local network subnet has a router at 192.168.1.1 and clients with IP addresses in the range from 192.168.1.2 through 192.168.1.48 with subnet mask 255.255.255.0, then the "Public Network Address" would be 192.168.1.0 and the "Public Subnet Mask" would be 255.255.255.0. This would mean that only clients on this local network would be able to access the NFS share. If the default settings are used (0.0.0.0 for both the public network address and the public subnet mask), then access to the NFS share will not be restricted.
- To use NFS folders with VMware ESX/ESXi or Citrix, navigate to *Services - Edit* and change the operation mode from "User Mode" to "Kernel Mode".
- Async is the default for NFS rules. Sync is available only when the device is in kernel mode.
- To restrict access to a NFS share for specific clients, navigate to *File Sharing - NFS - NFS Rules* and click *Add Rule*. Choose the folder to restrict access to, and enter the clients that will have restricted access in the "Hosts" field. Clients may be entered by hostname, IP address, or IP address range. Wildcards are supported. Separate multiple

entries with commas. You may assign read-only or read & write access to the listed clients. Rules override settings made from the *Services* tab.

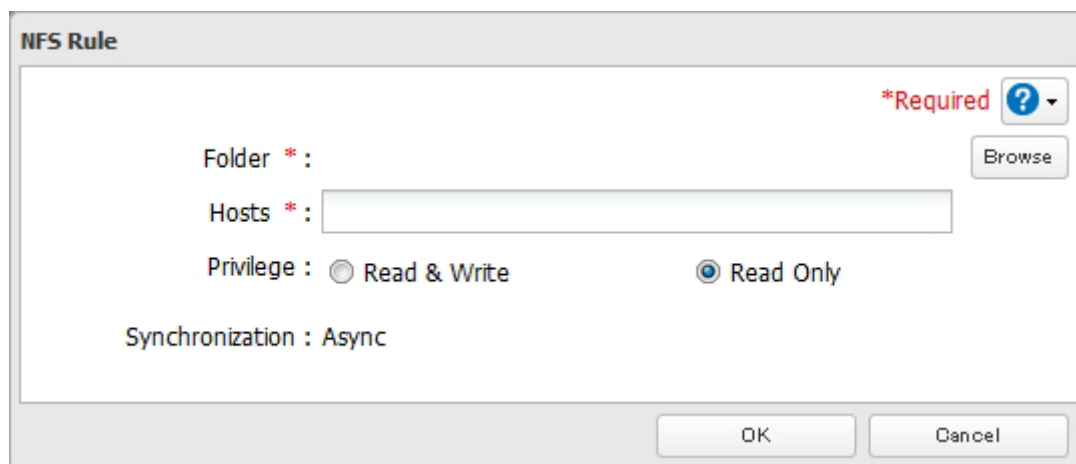

The screenshot shows a dialog box titled "NFS Rule". It contains the following fields and options:

- Folder ***: A text input field with a "Browse" button to its right.
- Hosts ***: A text input field.
- Privilege**: Two radio buttons, "Read & Write" (unselected) and "Read Only" (selected).
- Synchronization**: A label "Synchronization : Async".
- *Required**: A red label with a blue question mark icon in a dropdown menu.
- Buttons**: "OK" and "Cancel" buttons at the bottom.

Encrypting Data Transmission

Encrypting Settings Data

All communication with Settings can use SSL encryption if you access the Settings page by changing "http://" to "https://" in the browser address bar or click *Secure Connection* from the login window. Once you logged in by the HTTPS connection and disabled SSL encryption, click *Normal Connection* from the login window.

Encrypting FTP Transfer Data

Using SSL/TLS Encryption

You can encrypt passwords and files using SSL/TLS for secure FTP communication. First, open a shared folder's settings and click *Edit*; under "LAN Protocol Support", select the "FTP" checkbox and click *OK*. Enable SSL security in the setup screen for your FTP client. The procedure depends on the FTP client software.

Using SSH Encryption

You can encrypt passwords using SSH for secure FTP communication. First, open a shared folder's settings and click *Edit*; under "LAN Protocol Support", select the "SFTP" checkbox and click *OK*. Also, you have to enable the SFTP service by moving the SFTP switch to the on position on "File Sharing".

SSL Keys

SSL keys are used during setup screen operations and FTP communication. SSL (Secure Socket Layer) is a type of encryption system called public key encryption. Generally, SSL is managed by the two files below.

server.crt (SSL Certificates)

The TeraStation sends the file to a computer, and the computer uses it to perform encryption. The TeraStation receives the encrypted data and uses server.key (the private key) to decrypt the data.

In SSL, this key contains the server certificate, and depending on your computer environment, a check may be performed to determine the trustworthiness of the certificate. The server certificate included in the TeraStation in the default settings was created by Buffalo, and in some cases the message "There is a problem with this website's security certificate" may be displayed in your browser or other software. Disregard this message and continue.

server.key (SSL Private Key)

This file is used as a pair with server.crt (server certificate). This is required for decrypting the data that was encrypted by the server certificate, and this is normally not revealed.

Note: The passphrase for the private key must be removed before importing to the TeraStation.

Updating SSL Key Files

To update a server certificate and a private key for SSL, follow this procedure.

- 1** In Settings, click *Management*.
- 2** Click *SSL*.
- 3** Register "server.key" for "Secret Key" and "server.crt" for "Server Certificate (.crt)", then click *Import*.

Notes:

- Place the SSL key files (server.key, server.crt) directly below the C root drive. The SSL key files may not be able to be updated if it is placed in folders or paths that contain multi-byte characters.
- If Settings cannot be displayed after updating, initialize the TeraStation settings.
- Updating the firmware initializes an SSL key.

Web Server

The TeraStation can be used as a web server. In addition to HTML files, images, and JavaScript, the TeraStation also allows installation of Perl script and PHP script files.

- 1** In Settings, click *Services*.



- 2** Move the web server switch to the  position to enable the web server.



- 3** Click  to the right of "Web Server".

- 4** Click *Edit*.

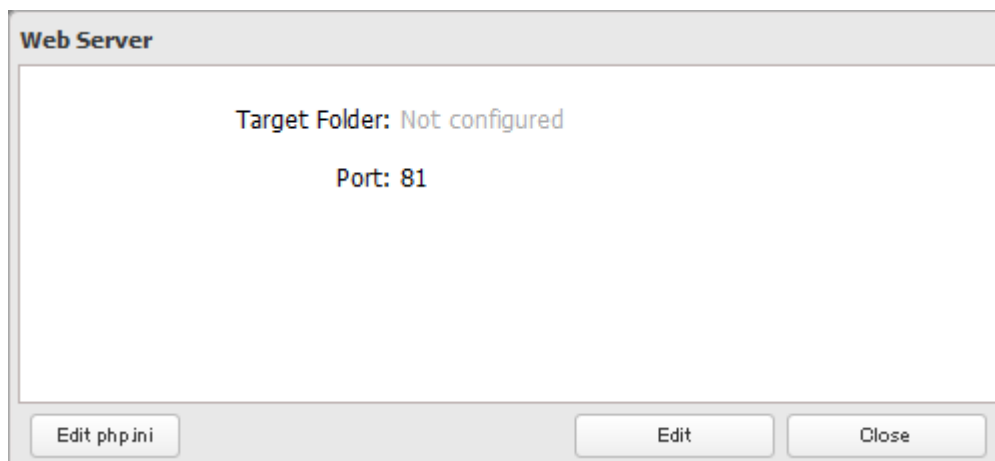

Note: The settings of the PHP language interpreter can be changed from "Edit php.ini".

5 Click *Browse*.

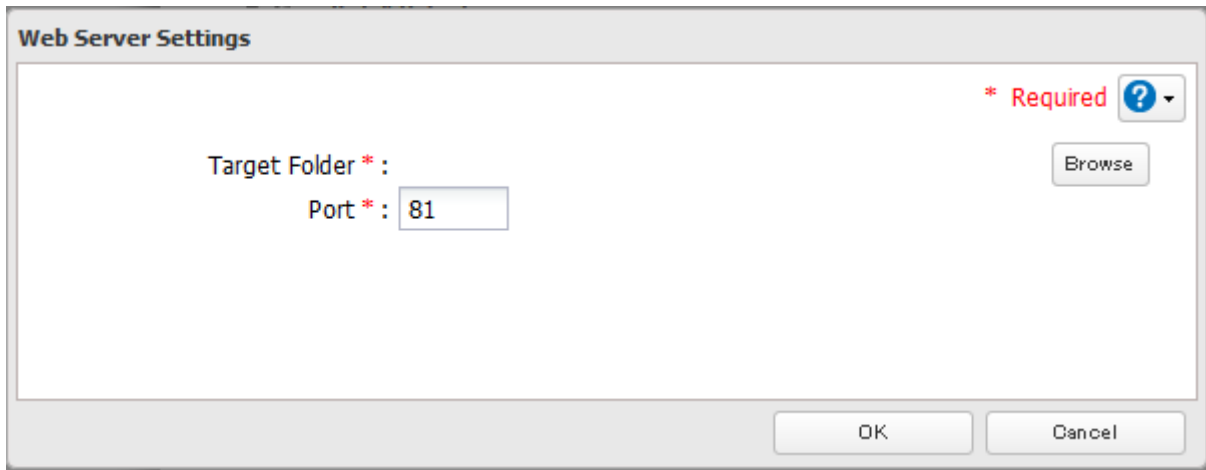

6 Choose a shared folder for the web server , then click *OK*.

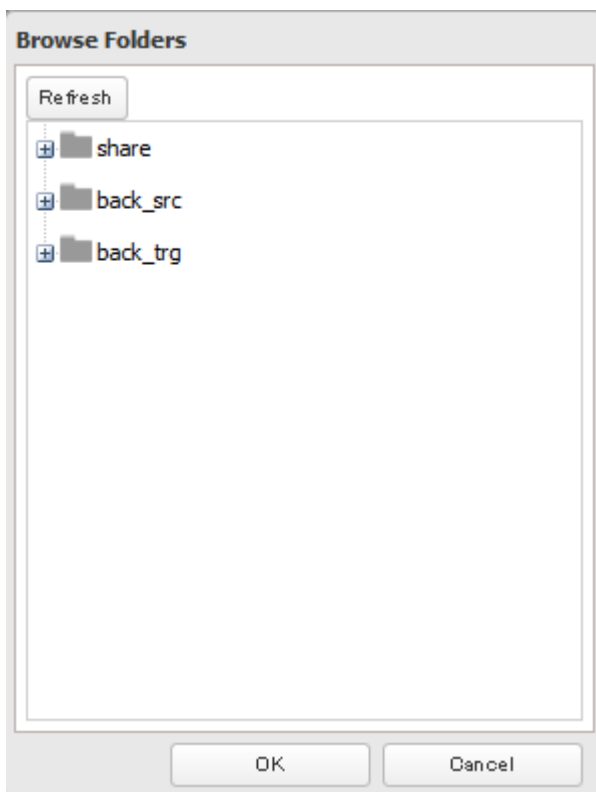

7 Choose an external port, then click *OK*.

MySQL Server

The TeraStation can be used as a MySQL server. A MySQL database may be installed and linked with the web server.

1 In Settings, click *Services*



2 Move the MySQL server switch to the  position to enable the MySQL server.

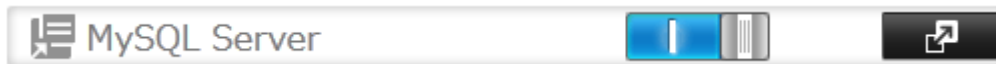

3 Click  to the right of "MySQL Server".

4 Click *Edit*.

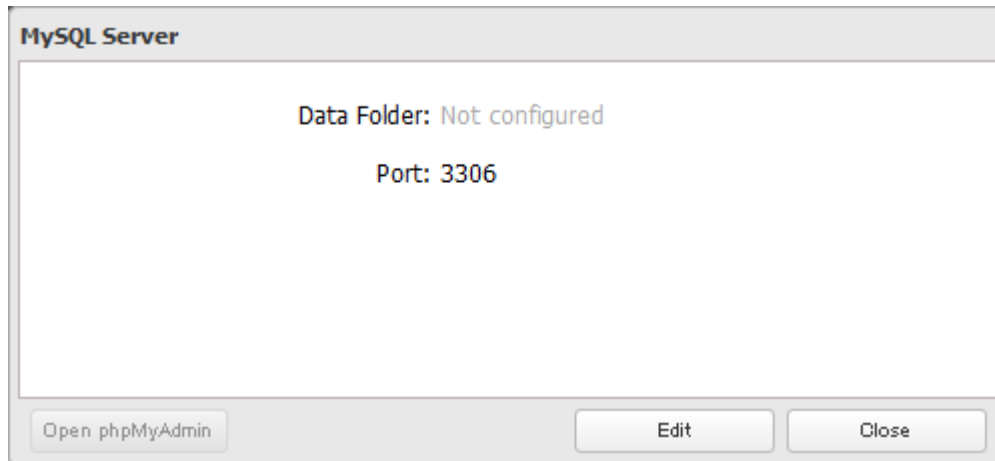

5 Click *Browse*.

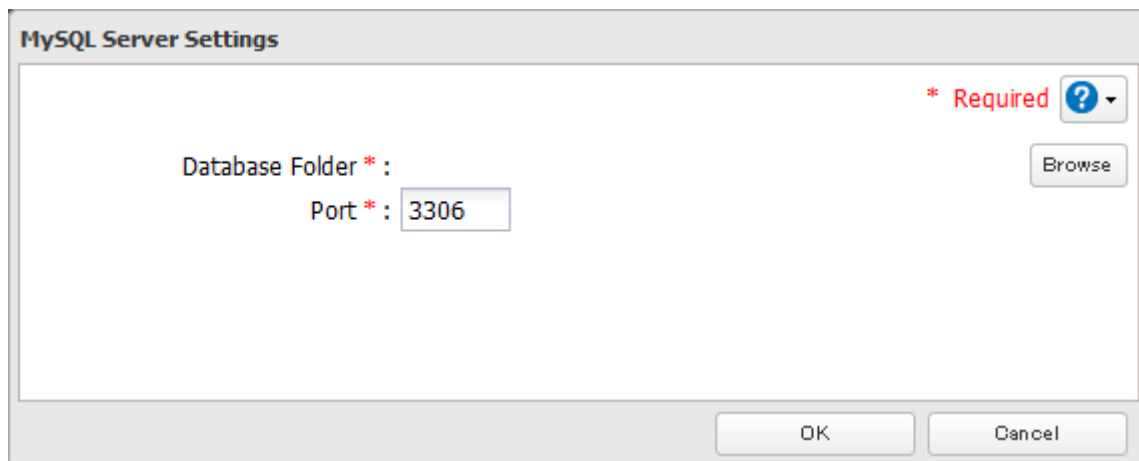

6 Choose a shared folder for the MySQL server, then click *OK*.

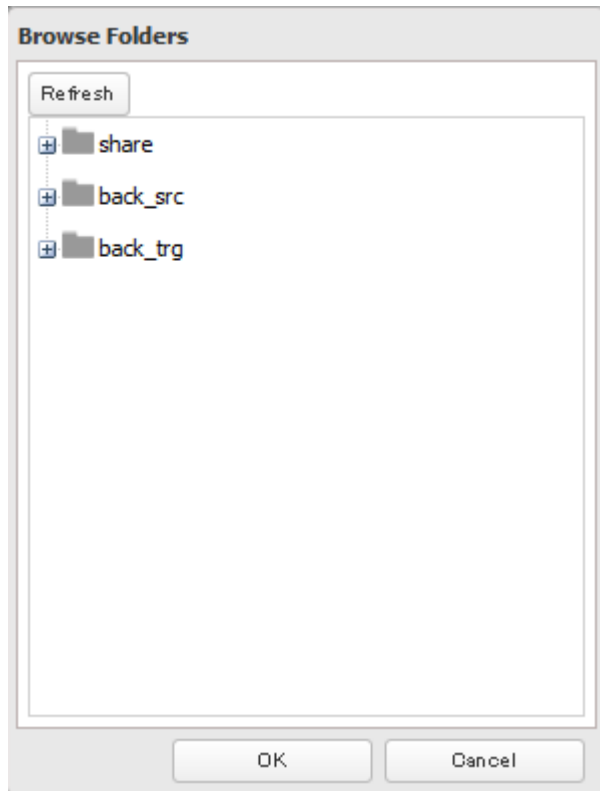

7 Choose an external port, then click *OK*.

Saving and Applying Settings

The TeraStation's settings can be saved to a USB drive and restored to another TeraStation. Use this function to back up and copy settings to a new TeraStation.

Make a note of the hard drive configuration (number of hard drives, RAID, etc.) of the TeraStation where the settings were saved. Make sure that any TeraStation that you apply these settings to has exactly the same hard drive configuration before you apply the settings. If the drive configuration is different, you may get unexpected results.

The following settings are not saved or restored:

Category	Settings
File Sharing	Shared folder information in USB drive
Drives	All settings in "Drives"
	All settings except for scan speed in "RAID" - "Options" - "RAID Array Settings"
	USB drive information
Network	All settings except for Ethernet frame size in "IP Address"
Management	The TeraStation's hostname
	All settings in "UPS Sync"
	All settings in "SSL"
	Display language in Settings

Saving Settings

1 Connect a 1 GB or larger USB drive (not included) into a USB 2.0 port on the TeraStation.

Note: All data on the USB drive will be erased.

2 In Settings, click *Management*.



3 Click  to the right of "Restore/Erase".



4 From "Target USB drive", select the USB drive that is connected to the USB 2.0 port on the TeraStation.

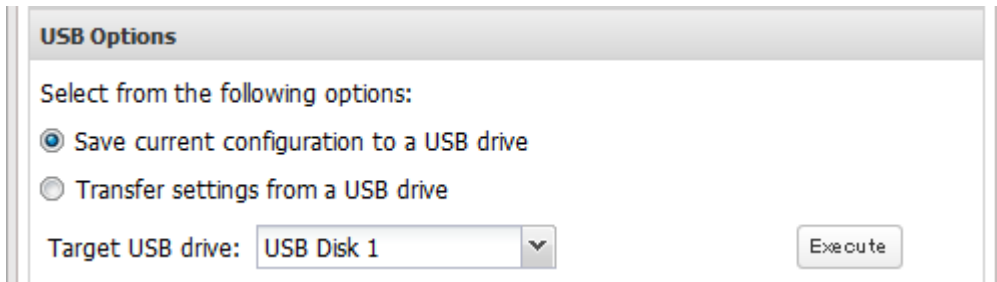

5 Select "Save current configuration to a USB drive", then click *Execute*.

6 The "Confirm Operation" screen will open. Enter the confirmation number, then click *OK*.

7 When the "finished" message is displayed, saving settings is finished. Click *OK*.

Troubleshooting:

If the settings are not saved to the USB drive successfully, you may receive the error message "The specified operation cannot be executed.". Verify:

- The USB drive has a capacity of 1 GB or larger.
- The USB drive is not write-protected.

Note: If you changed any hostname or network settings since your last backup, save your settings to the USB drive again.

Applying Settings

The saved settings can be applied to a different TeraStation of the same series. If applying settings to another TeraStation, the unit's current firmware version will be changed to the version used to save the settings.

There are two ways to apply settings from the USB drive.

Applying from Settings

1 Connect the USB drive with the saved settings into a USB 2.0 port (not a USB 3.0 port) on the TeraStation.

2 In Settings, click *Management*.

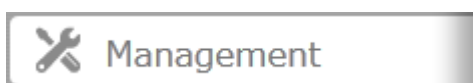

3 Click  to the right of "Restore/Erase".



4 From "Target USB drive", select the USB drive that is connected to the USB 2.0 port on the TeraStation.

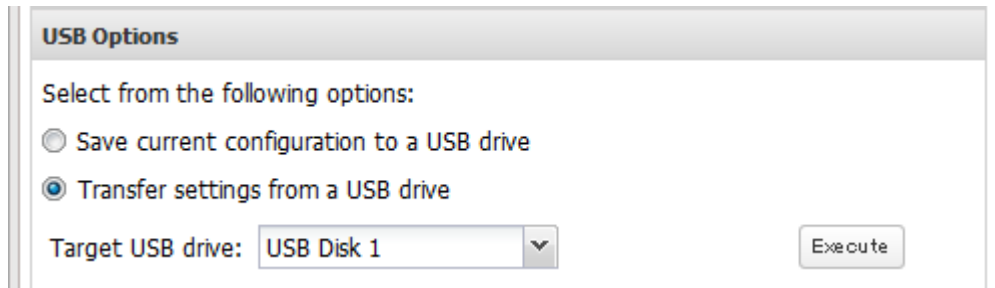

5 Select "Transfer settings from a USB drive", then click *Execute*.

6 The "Confirm Operation" screen will open. Enter the confirmation number, then click *OK*.

Note: Do not press the function button while applying settings from the USB drive.

7 When the "finished" message is displayed, applying settings is finished. Click *OK*.

Applying with Init Button (For TS1400D and TS1400R Models)

1 Turn off the TeraStation.

2 Connect the USB drive with the saved settings into a USB 2.0 port (not a USB 3.0 port) on the TeraStation.

3 While holding down the init button on the back of the TeraStation, press the power button.

4 Hold down the init button until the function LED glows. When it glows, let go of the button.

5 When the TeraStation is ready, the I41 message will be displayed in NAS Navigator2. For TS1400D models, the power LED will start blinking red. For TS1400R models, the error LED will start blinking red.

6 Hold down the function button until the TeraStation beeps. Applying settings will start.

7 It will take several minutes for the settings to apply. When finished, the TeraStation will shut down.

8 Remove the USB drive, then power on the TeraStation.

Restoring Factory Defaults

There are two ways to initialize the TeraStation. Follow one of the procedures below.

Initializing with Function Button

If you forget the admin username or password, or wrong IP address was configured accidentally, follow the procedure below to initialize these settings.

Notes:

- The following settings will be initialized: admin username, admin password, IP address, and Ethernet frame size.
- To disable initializing the admin username and password, navigate to *Management - Restore/Eraser - Edit* and change "Restore factory default settings" to "Keep current settings". Be careful with this option! If this is selected and you lose your admin password, you will not be able to reset it.

1 Turn off the TeraStation.

- 2 Turn the TeraStation on while holding down the function button. The function LED will flash.
- 3 Press the function button again while the LED is flashing.
- 4 Initialization will take 5 to 10 minutes. Do not power down the TeraStation while it is initializing and showing an I23 information message in NAS Navigator2 and with the power LED. When initialization is finished, reboot your TeraStation.

Initializing from Settings

To initialize the TeraStation to its factory defaults from Settings, follow this procedure.

- 1 In Settings, click *Management*.

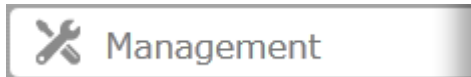

- 2 Click  to the right of "Restore/Erase".

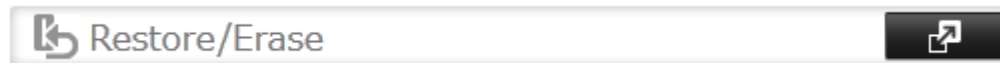

- 3 Click *Initialize TeraStation*.

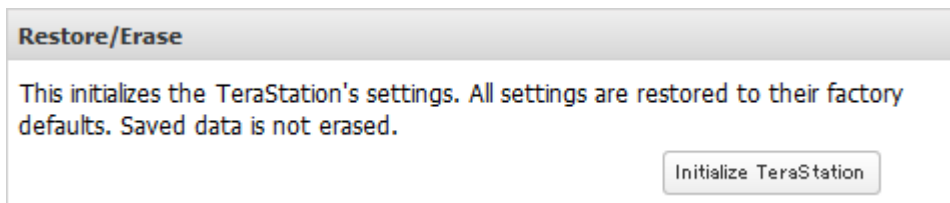

- 4 The "Confirm Operation" screen will open. Enter the confirmation number, then click *OK*. The TeraStation will be restored to its factory default settings.

- 5 When the "finished" message is displayed, restoring settings is finished. Click *OK*.

Logs

Follow the procedure to check the TeraStation's logs.

- 1 In Settings, click *Management*.

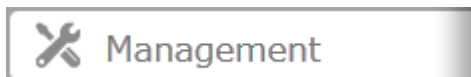

- 2 Click  to the right of "Logs".



3 Select a log to view.

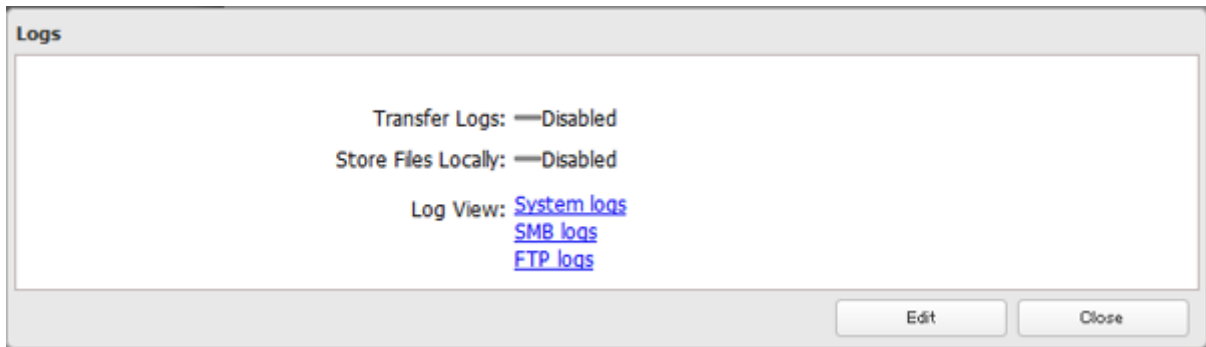

The file operation log stores file operations performed on the internal hard drives. File operations on USB drives are not logged.

Note: All logs are encoded in UTF-8 format. To show them correctly, change the software encoding to "UTF-8".

Transferring Logs to the Syslog Server

1 In Settings, click *Management*.

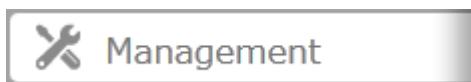

2 Click  to the right of "Logs".



3 Click *Edit*.

4 Enable "Syslog Transfer".

5 Enter the IP address of the syslog server where you want to transfer the logs to.

6 Select the type of log that you want to transfer from "Logs to Transfer".

7 Click *OK*.

Note: FTP logs cannot be written to a syslog server.

Creating a Link to the Logs in the Shared Folder

1 In Settings, click *Management*.

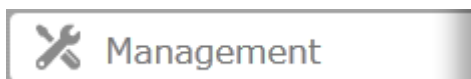

2 Click  to the right of "Logs".



3 Click *Edit*.

4 Enable "Share Link to Logs".

5 Click *Browse* and select the shared folder where the link will be created in "Target Shared Folder". Click *OK*.

6 Click *OK*.

Under the selected shared folder, a folder named "system_log" will now contain the logs.

Updating the Firmware

If a new firmware is available, a message is displayed when the TeraStation boots. You can update the firmware by following the procedure below:

1 In Settings, click *Management*.



2 Click  to the right of "Update".



3 Click *Install Update*.

You can also download the latest firmware from the Buffalo website.

Note: Settings is not available while the firmware is updating. Don't try to access Settings from another computer until the update is complete.

Name, Date, Time, and Language

Configure the TeraStation's hostname, date, time, and language as shown below.

1 In Settings, click *Management*.

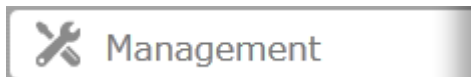

2 Click  to the right of "Name/Time/Language".



3 Click *Edit*.

4 Click the *Name* tab, then configure the TeraStation's name and description.

The screenshot shows a configuration window titled "Name/Time/Language". The "Name" tab is selected. The window contains two text input fields: "Name" with the value "TS1200D004" and "Description" with the value "TeraStation". A red asterisk and a question mark icon indicate a required field. At the bottom, there are "OK" and "Cancel" buttons.

5 Click the *Time* tab. Enable the NTP server and select the "Use Default NTP Server" checkbox. Click *Use Local Date/Time* to use your computer's time settings for the TeraStation.

The screenshot shows the same configuration window, but the "Time" tab is selected. Under "Date/Time Source:", the "Enable" radio button is selected. The "NTP IP Address" field contains "ntp.jst.mfeed.ad.jp". The "Use Default NTP Server" checkbox is checked. The "NTP Synchronization Frequency" is set to "Daily". The "Disable" radio button is unselected. Below it, the "Date" field shows "07/24/2014" and the "Time" field shows "4 : 30 : 53". A "Use Local Date/Time" button is visible. The "Time Zone" dropdown is set to "(UTC-06:00) Central America". "OK" and "Cancel" buttons are at the bottom.

By default, the TeraStation adjusts its clock automatically by using a default NTP server. This NTP server belongs to Internet Multi Feed Inc. For more information, visit <http://www.jst.mfeed.ad.jp>.

To use a different NTP server, clear the "Use Default NTP Server" checkbox and enter a new NTP IP address or its hostname. If an NTP server is specified by name instead of IP address, make sure that a DNS server is configured for the TeraStation.

If an NTP is not used, enter the time and date manually. Click *Use Local Date/Time* to import the time and date from your computer.

Notes:

- The internal clocks of the TeraStation and other devices on your network may run at slightly different speeds. Over a long period of time your network devices may show somewhat different times, which can cause network problems. If clocks on your network vary by more than 5 minutes it may cause unexpected behavior. For best results, keep all clocks on the network set to the same time by adjusting them regularly, or use an NTP server to correct them all automatically.
- Disconnecting the AC cable from the TeraStation, even if it is not powered on, may cause the TeraStation's time settings to become incorrect. This will affect scheduled settings such as backup jobs or sleep mode. If this occurs, correct the time settings.

6 Click the *Language* tab. Select the language to be used and click *OK*.

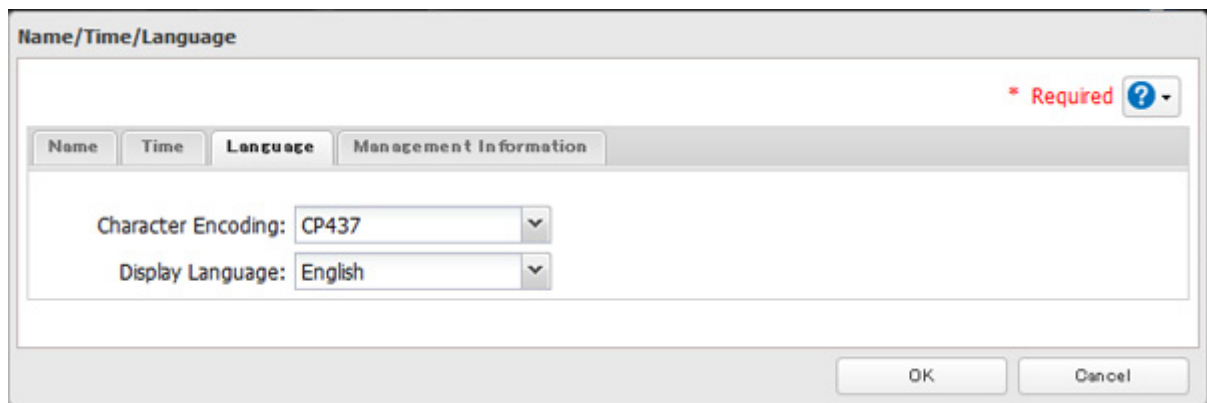



Note: This tab changes the language used by the TeraStation for email notifications, DLNA, and other functions. To change the language displayed in Settings, go to Advanced Settings or Easy Admin and click *Language* in the menu bar. Choose your desired language from the drop-down menu.

Jumbo Frames

If your other network devices support jumbo frames, you may be able to increase network performance.

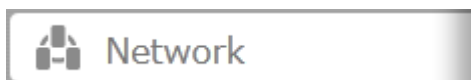
1 In Settings, click *Network*.



2 Click  to the right of "IP Address".







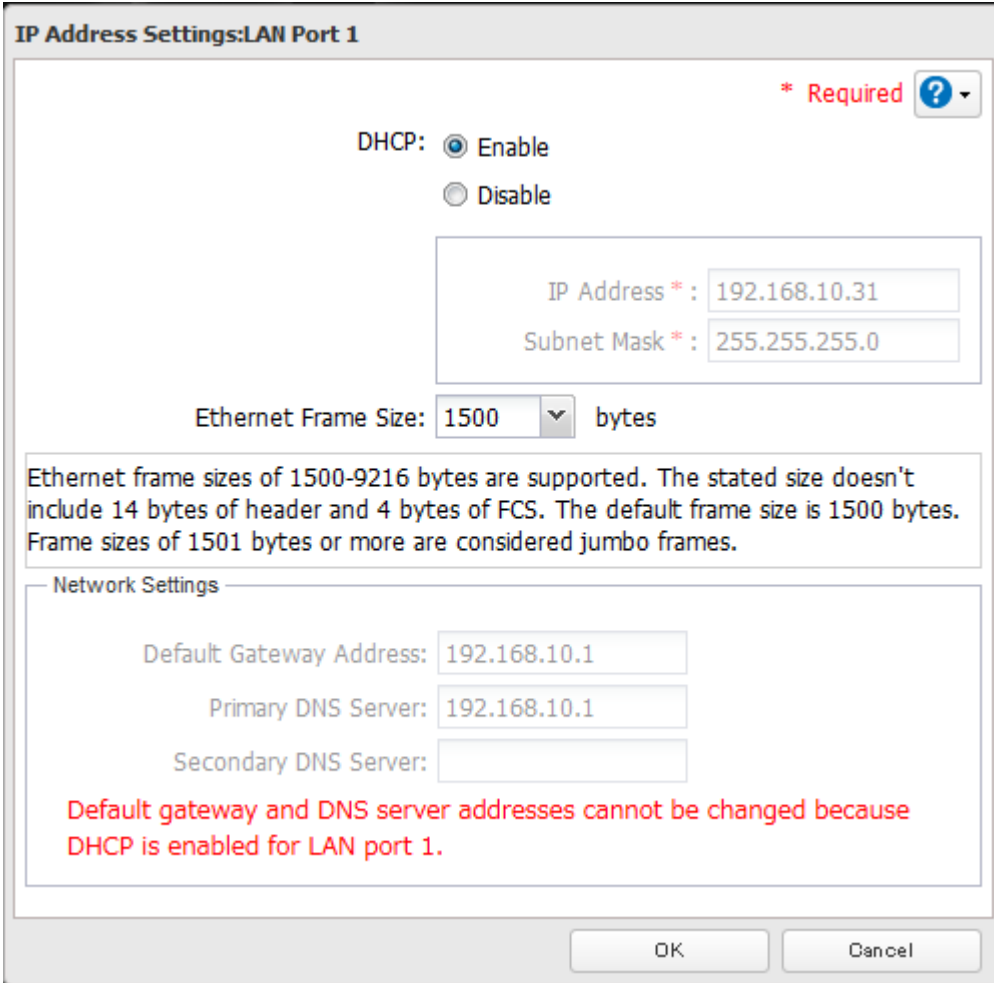



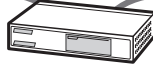



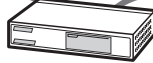

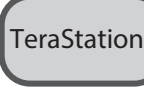
3 Click the LAN port where the jumbo frames will be used.

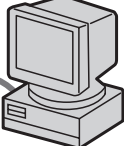
4 Select the desired Ethernet frame size and click *OK*.

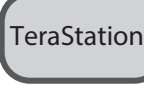

The image shows a dialog box titled "IP Address Settings:LAN Port 1". In the top right corner, there is a red asterisk followed by the word "Required" and a blue question mark icon. Below this, the "DHCP" section has two radio buttons: "Enable" (which is selected) and "Disable". To the right of these is a text box containing "IP Address * : 192.168.10.31" and another text box containing "Subnet Mask * : 255.255.255.0". Below the DHCP section, there is a label "Ethernet Frame Size:" followed by a dropdown menu showing "1500" and the word "bytes". A text box below this contains the following text: "Ethernet frame sizes of 1500-9216 bytes are supported. The stated size doesn't include 14 bytes of header and 4 bytes of FCS. The default frame size is 1500 bytes. Frame sizes of 1501 bytes or more are considered jumbo frames." Below this is a section titled "Network Settings" with three text boxes: "Default Gateway Address: 192.168.10.1", "Primary DNS Server: 192.168.10.1", and "Secondary DNS Server:". At the bottom of the dialog, there is a red message: "Default gateway and DNS server addresses cannot be changed because DHCP is enabled for LAN port 1." At the very bottom of the dialog are two buttons: "OK" and "Cancel".

Connection			Transmission	
				Transfer data in jumbo frames.
				Transfer data not using jumbo frames.
				Transfer data not using jumbo frames.
				Any data cannot be transferred.

Note: Make sure the TeraStation's Ethernet frame size is smaller than the hub or router's. Larger frame sizes may not transfer the data to the TeraStation correctly.

Changing the IP Address

Normally, the TeraStation's IP address is set automatically from a DHCP server on your network. If you prefer, you can set it manually. An easy way to do this is to change it from NAS Navigator2 running on a computer connected to the same router (subnet) as the TeraStation. The procedure to change the IP address in Settings below.

- 1 In Settings, click *Network*.

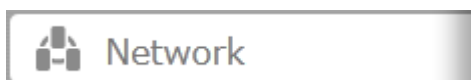

- 2 Click  to the right of "IP Address".



- 3 Click the LAN port where the IP address will be changed.

4 Disable "DHCP" and enter the desired IP address and subnet mask.

IP Address Settings:LAN Port 1

* Required ?

DHCP: Enable
 Disable

IP Address * : 192.168.10.31
Subnet Mask * : 255.255.255.0

Ethernet Frame Size: 1500 bytes

Ethernet frame sizes of 1500-9216 bytes are supported. The stated size doesn't include 14 bytes of header and 4 bytes of FCS. The default frame size is 1500 bytes. Frame sizes of 1501 bytes or more are considered jumbo frames.

Network Settings

Default Gateway Address: 192.168.10.1
Primary DNS Server: 192.168.10.1
Secondary DNS Server:

OK Cancel

5 Under "Network Settings", enter the default gateway and DNS server addresses. If no changes are necessary, keep them as is.

6 Click *OK*.

Note: The following IP addresses are reserved and should not be used. If you configure one of them by accident, initialize IP address settings with the function button on the TeraStation.

Local loopback address: 127.0.0.1, 255.255.255.0

Network address: 0.0.0.0, 255.255.255.0

Broadcast address: 255.255.255.255, 255.255.255.0

The IP address range from 224.0.0.0 to 255.255.255.255

Chapter 9 Utilities

NAS Navigator2 for Windows

NAS Navigator2 is a utility that makes it easy to display Settings, change the TeraStation's IP address, or check its hard drive. If you installed the TeraStation with the TeraNavigator CD, NAS Navigator2 was installed automatically.



Double-click the  icon to start NAS Navigator2.

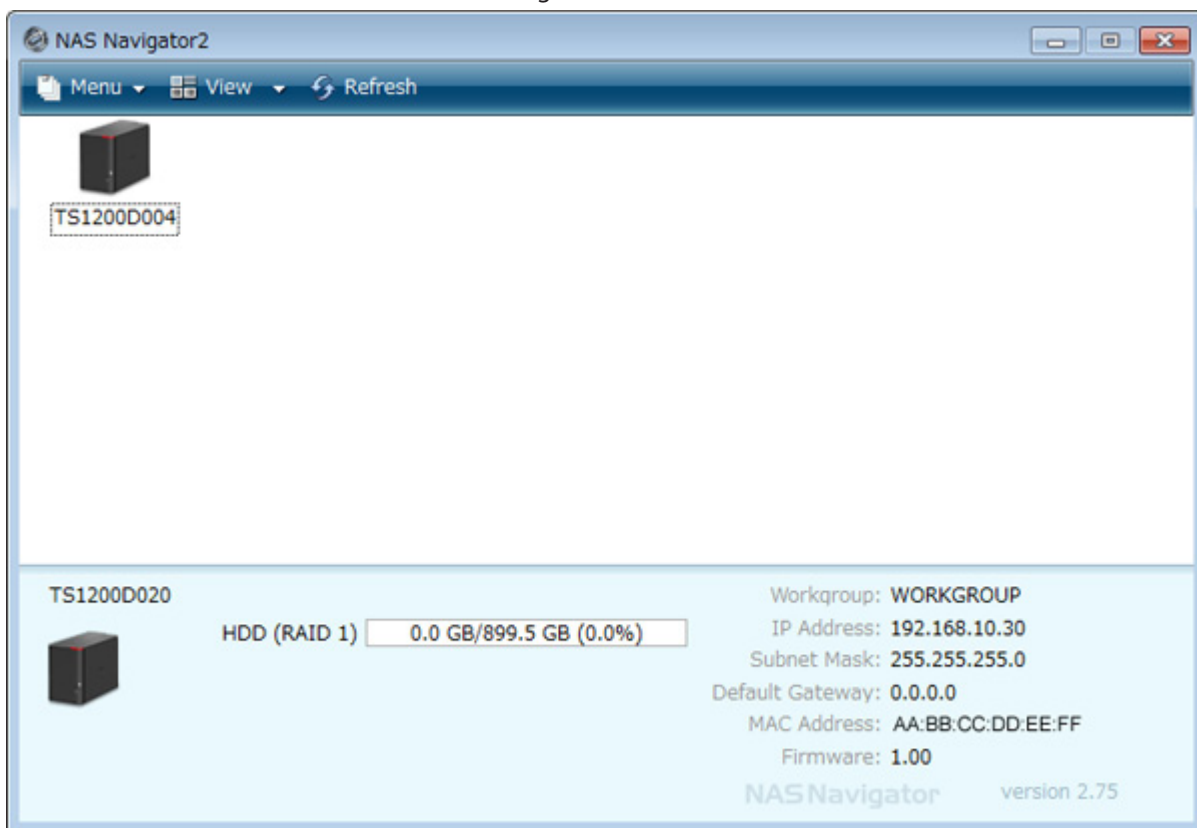

Click your TeraStation's icon to open a share on the TeraStation and display:

- Total capacity
- Capacity in use
- IP address
- Workgroup
- Subnet mask
- Default gateway
- MAC address
- Firmware version

Name		Description
Menu	Map Share*	Assigns the TeraStation's shared folder as a network drive.
	Disconnect Share*	Unmaps the network drive.
	Map All Remote Shares to Drive Letters	Assigns all the TeraStation's shared folders as network drives.
	Create Desktop Shortcut*	Creates a shortcut icon on the desktop to the shared folder "share".
	Launch NAS Navigator2 on Startup	Launches NAS Navigator2 in the system tray when Windows boots.
	Display Errors	If an error occurs, an error message will pop up from the NAS Navigator2 icon in the system tray.
	Properties*	Opens the selected TeraStation's properties page.
	Close	Closes NAS Navigator2.
View	View	Icons: Displays icons. Details: Displays hostname, product name, workgroup, IP address, subnet mask, and default gateway.
	Sort by	Selects the sort order from the following to display when multiple TeraStations are found: Hostname, product name, workgroup, IP address, subnet mask, default gateway
Browse*		Opens the TeraStation's shared folder.
Refresh		Refreshes list of NAS devices on the network.
I'm here*,**		Causes your TeraStation to beep.
Right-click your device's icon to show these options.	Browse Shares	Opens the TeraStation's shared folder.
	Settings	Opens Settings for the selected TeraStation.
	Properties	Opens the TeraStation's properties page.
	Map Share	Assigns the TeraStation's shared folder as a network drive.
	Disconnect Share	Unmaps the network drive.
	Create Shortcut	Creates a shortcut icon on the desktop to the shared folder "share".
	I'm here**	Causes your TeraStation to beep.

*Click on the TeraStation's icon to display these options.

**"I'm here" is available on TS1400D and TS1400R models. When clicked, the TeraStation will beep and its power, function, and drive status LEDs will blink red.

When NAS Navigator2 is minimized, right-click on the NAS Navigator2 icon in the system tray for the following options.

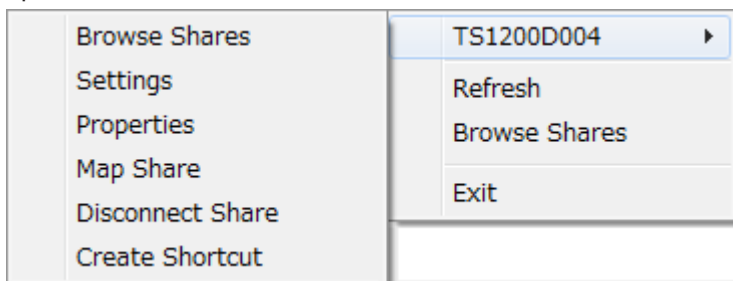

Name	Description	
TeraStation Name	Browse Shares	Opens the TeraStation's shared folder "share".
	Settings	Opens Settings for the selected TeraStation.
	Properties	Opens the TeraStation's properties page.
	Map Share	Assigns the TeraStation's shared folder as a network drive.
	Disconnect Share	Unmaps the network drive.
	Create Shortcut	Creates a shortcut icon on the desktop to the shared folder "share".
	I'm here*	Causes your TeraStation to beep.
Refresh	Refreshes list of NAS devices on the network.	
Browse Shares	Shows a list of shared folders on the selected NAS device.	
Exit	Exits NAS Navigator2.	

*"I'm here" is available on TS1400D and TS1400R models. When clicked, the TeraStation will beep and its power, function, and drive status LEDs will blink red.

The following tasks may be performed from the TeraStation's properties page.

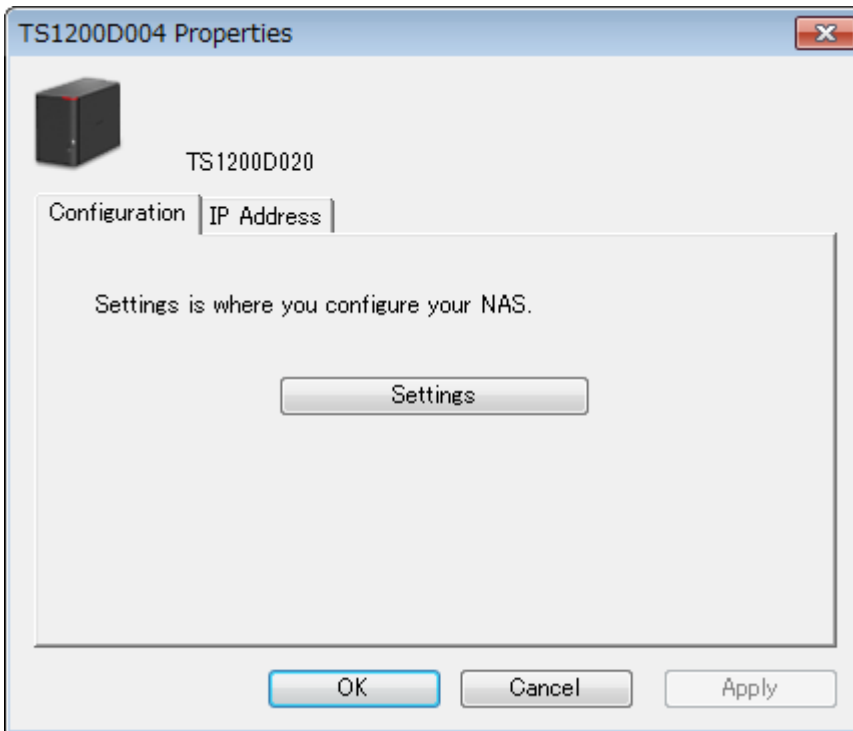

Name	Description
Configuration	Click <i>Settings</i> to open the configuration interface.
IP Address	Check <i>Use DHCP</i> to assign an IP address from the DHCP server automatically. If there is no DHCP server on the network, you cannot use this function. Check <i>Renew IP address</i> to obtain an IP address from the DHCP server. Uncheck <i>Use DHCP</i> and enter an IP address, subnet mask, and default gateway to manually configure them.

Mount as Network Drive

You can easily map a shared folder as a network drive using NAS Navigator2.



- 1 Double-click the  icon to start NAS Navigator2.
- 2 Right-click on the TeraStation's icon, then click *Map Share*.

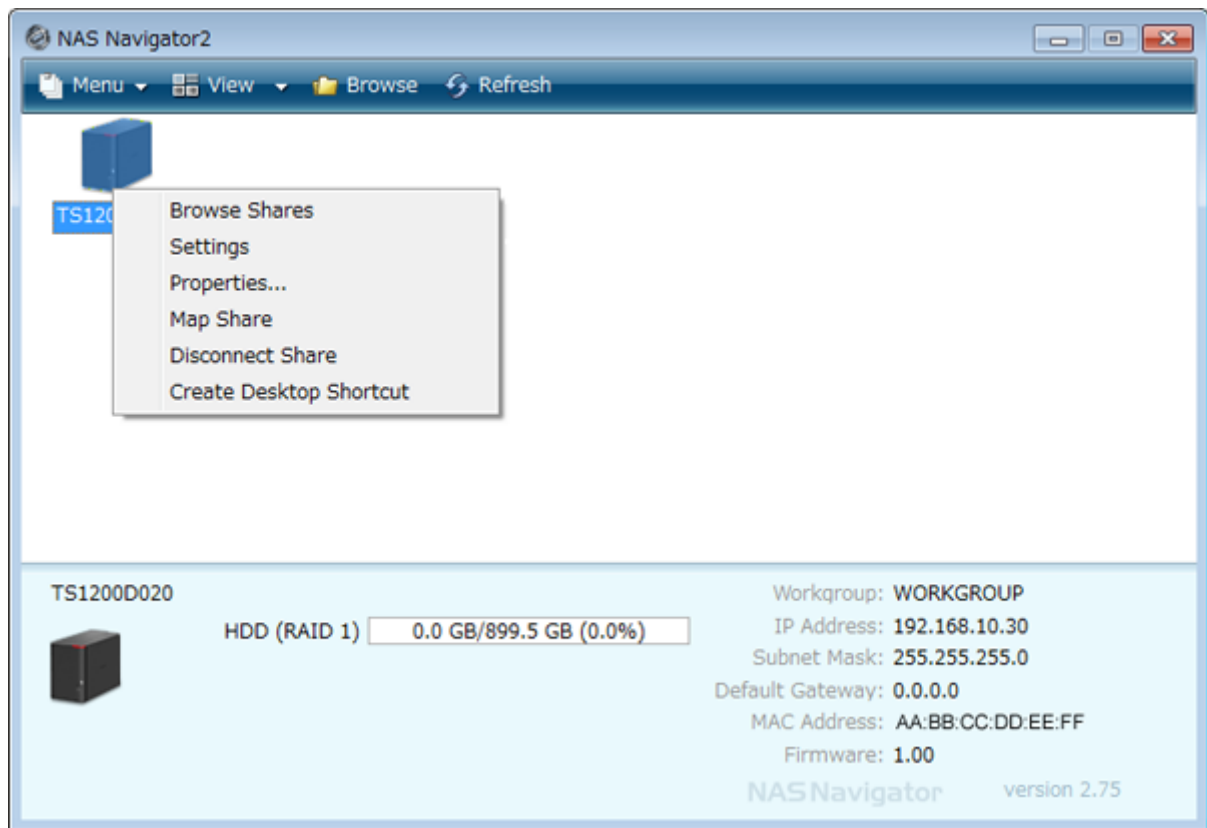

- 3 An icon for the mapped share will appear in Computer or My Computer. You can use this network drive just like any other hard drive.



Changing the IP Address



- 1 Double-click the  icon to start NAS Navigator2.
- 2 Right-click on your TeraStation's icon and choose *Properties - IP Address*.

- 3** Uncheck "Use DHCP" and enter the desired settings, then click *OK*. If the username and password prompt appears, enter the admin username and password.

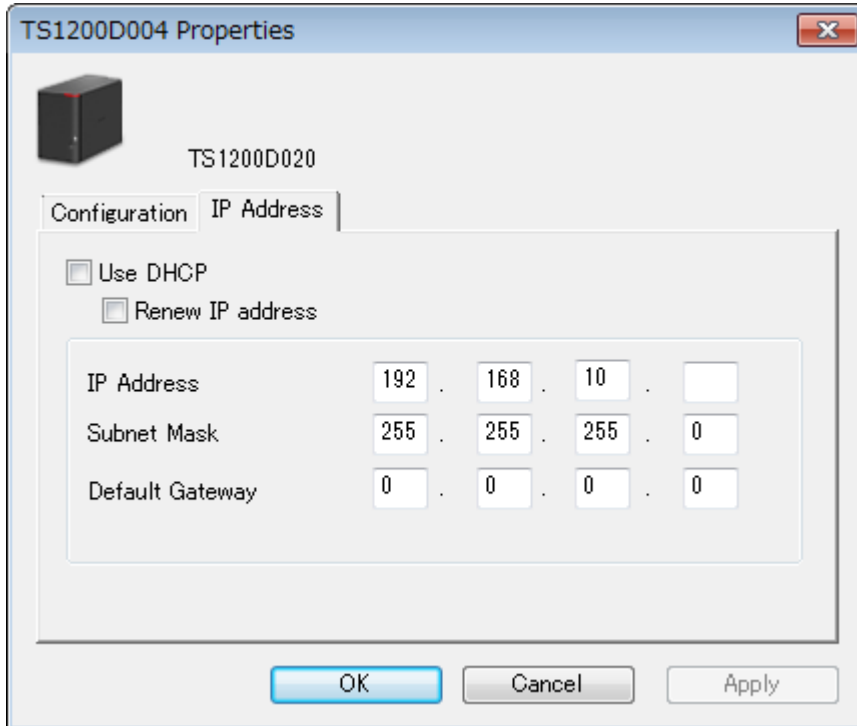

Note: The following IP addresses are reserved and should not be used. If you configure one of them by accident, initialize IP address settings with the function button on the TeraStation.

Local loopback address: 127.0.0.1, 255.255.255.0

Network address: 0.0.0.0, 255.255.255.0

Broadcast address: 255.255.255.255, 255.255.255.0

The IP address range from 224.0.0.0 to 255.255.255.255

NAS Navigator2 for Mac

NAS Navigator2 is a utility program that makes it easy to display Settings, change the TeraStation's IP address, or check its hard drive.

If you installed the TeraStation with the TeraNavigator CD, NAS Navigator2 was installed automatically. Click the



icon in the Dock to start NAS Navigator2.

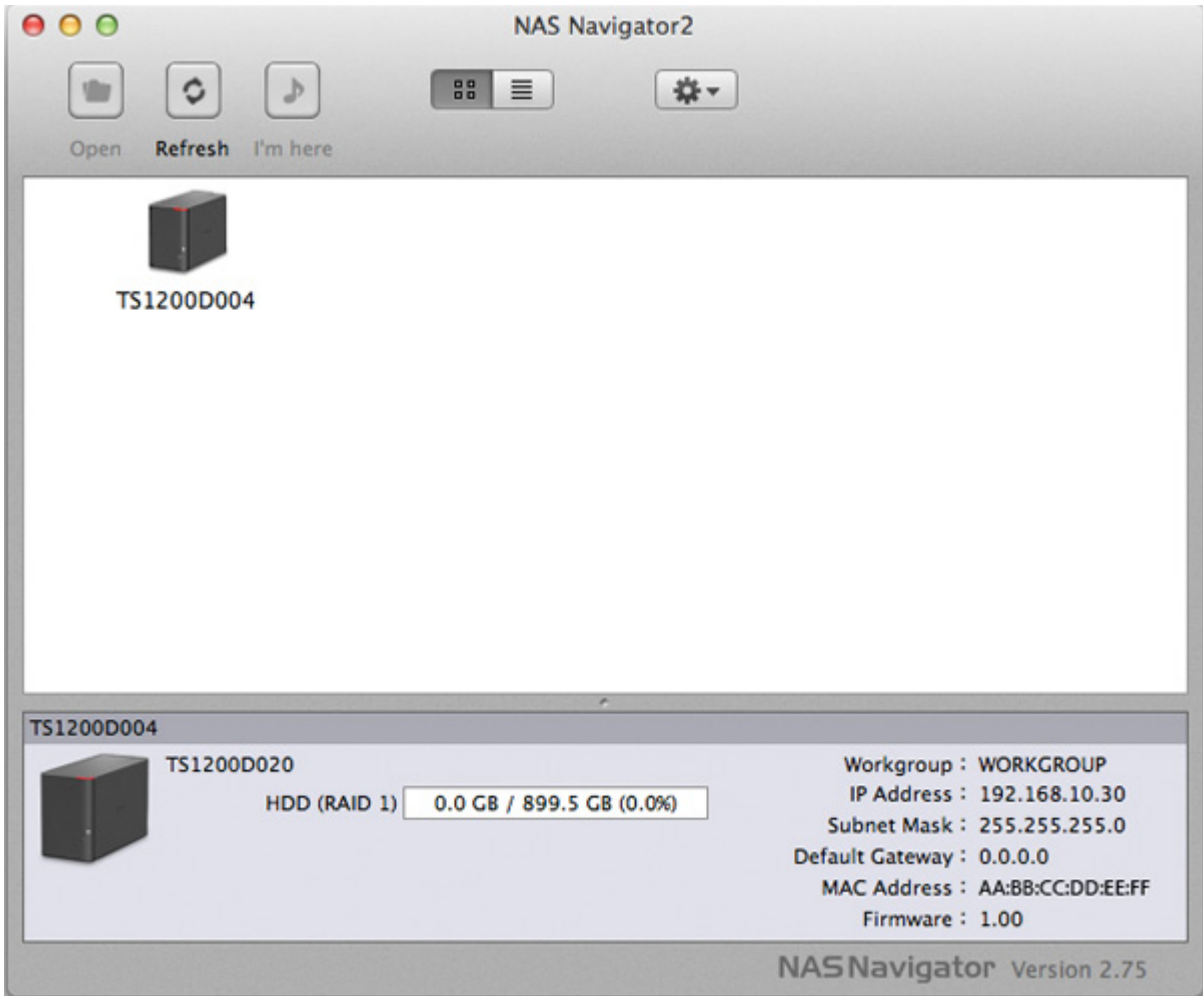

Click on a TeraStation's icon to display:

- Total capacity
- Used capacity
- Workgroup
- IP address
- Subnet mask
- Default gateway
- MAC address
- Firmware version

Double-click it to open a share on the TeraStation.

Name	Description
Open	Opens the default shared folder for a selected TeraStation.
Refresh	Searches for NAS devices on the network again.
I'm here*	Causes your TeraStation to beep.
Settings	Opens Settings for the selected TeraStation.
Configure	Opens a window that lets you change the NAS's IP address or open Settings.
Label Color	Selects the color of the name displayed below the icon.
View Options	Lets you choose icon size, position, and view mode.
Auto Power Mode	Auto power mode can turn supported TeraStations and LinkStations on the network on and off automatically.

Name	Description	
To display these options, hold down the control key and click your TeraStation's icon.	Open Folder	Opens the TeraStation's shared folder.
	Settings	Opens Settings for the selected TeraStation.
	Configure	Opens a window that lets you configure NAS's IP address or open Settings.
	I'm here*	Causes your TeraStation to beep.
	Label Color	Selects the color of the name displayed below the icon.

*"I'm here" is available on TS1400D and TS1400R models. When clicked, the TeraStation will beep and its power, function, and drive status LEDs will blink red.

Mount as Network Drive

You can map the shared folder as a network drive using NAS Navigator2 on macOS.



1 Click the icon in the Dock to start NAS Navigator2.

2 Double-click the TeraStation icon or click the TeraStation icon while holding down the control key, then select *Open Folder*. Enter a username and password with the rights to access the shared folder.

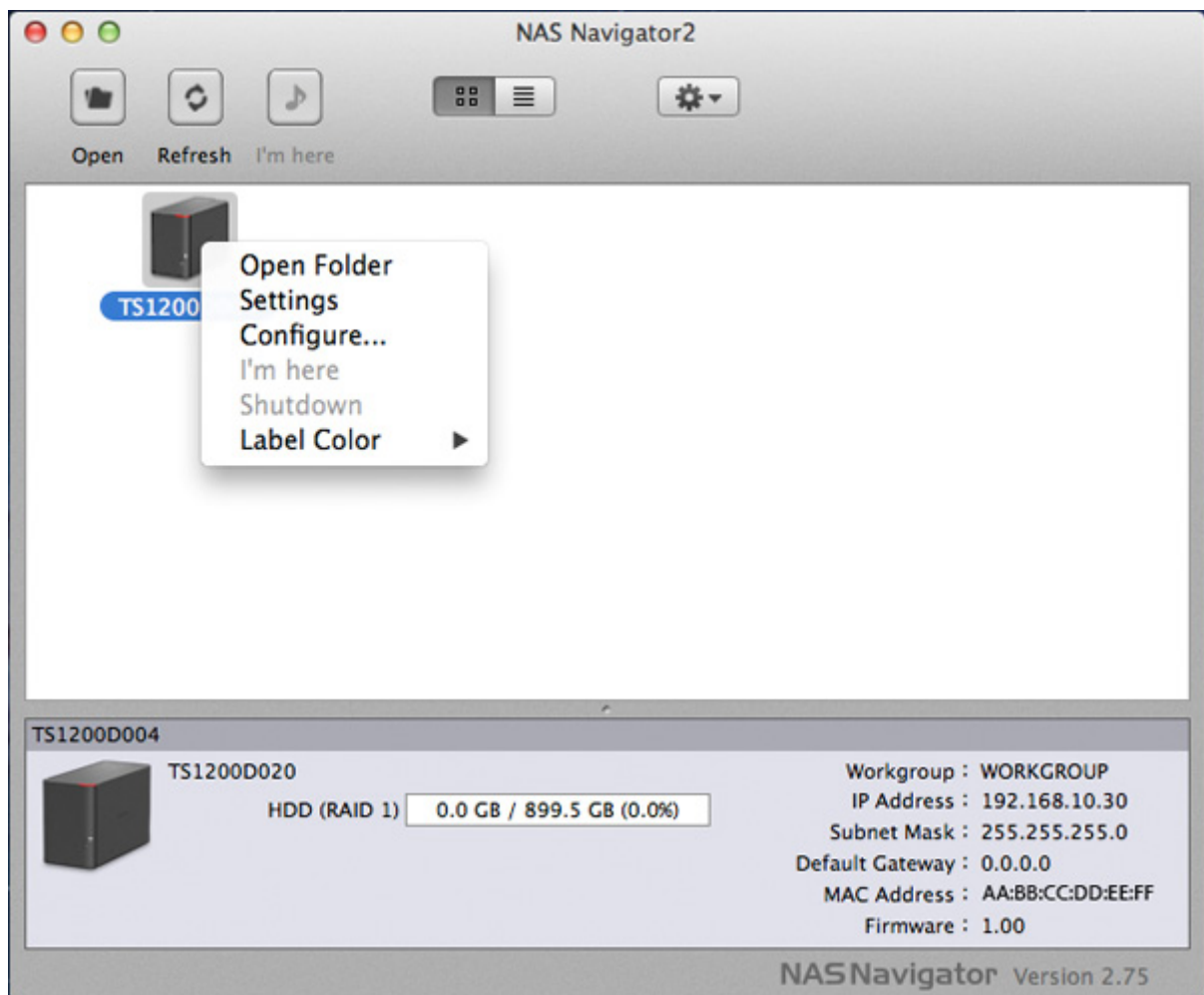

3 Select the shared folder that you want to mount, then click *OK*.

4 The shared folder is now mounted as a network drive.

Changing the IP Address



- 1 Click the icon in the Dock to start NAS Navigator2.
- 2 Click the TeraStation icon while holding down the control key, then choose *Configure - IP Address*.
- 3 Uncheck "Use DHCP"; enter the desired settings, and enter the administrator password, then click *Apply*.

The screenshot shows the 'IP Address' configuration window in NASNavigator2. The window title is 'NASNavigator2'. It displays a TeraStation icon and two device IDs: TS1200D004 and TS1200D020. There are two tabs: 'Configuration' and 'IP Address'. Under the 'IP Address' tab, there are checkboxes for 'Use DHCP' (unchecked) and 'Renew IP address' (unchecked). Below these are input fields for 'IP Address' (192, 168, 10, and an empty field), 'Subnet Mask' (255, 255, 255, 0), and 'Default Gateway' (four empty fields). At the bottom, there is an 'Administrator Password' field, a 'Cancel' button, and an 'Apply' button.

Note: The following IP addresses are reserved and should not be used. If you configure one of them by accident, initialize IP address settings with the function button on the TeraStation.

Local loopback address: 127.0.0.1, 255.255.255.0

Network address: 0.0.0.0, 255.255.255.0

Broadcast address: 255.255.255.255, 255.255.255.0

The IP address range from 224.0.0.0 to 255.255.255.255

NovaBACKUP

NovaBACKUP is a Windows utility that lets you back up the data on your computer or TeraStations.

Installing from CD

The installation methods are different depending on which version of TeraNavigator CD you have. If your TeraNavigator CD is version 1.10 or earlier, install NovaBACKUP from the included TeraNavigator CD.

- 1 Insert the TeraNavigator CD to your computer.
- 2 Launch TSNavi.exe from the TeraNavigator CD.

3 Click *Options - Additional Software Installation*.

4 Select "NovaBACKUP" and click *Install*. Follow the procedure to finish installing NovaBACKUP.

Installing from Website

If your TeraNavigator CD is version 1.20 or later, install the software from

http://buffalo.jp/support_s/guide2/manual/ts/1000/manual.html. Select the region and model to go to the d.buffalo site of your specific product model.

To download the installer, you will need the serial number of your TeraStation. The serial number is printed on the label on the back of the unit.

Chapter 10 Appendix

When the LED Blinks Red

Power or Error LED

If there is an error, the power LED on TS1200D and TS1400D models, or the error LED on TS1400R models will blink. For TS1200D models, the following blink patterns will give the error code. You can also see any errors in NAS Navigator2.

Place of Error Code	Status
10s Place of Error Code	The LED flashes for 1.0 second every 0.3 seconds. This gives the tens place of the error code.
1s Place of Error Code	The LED flashes for 0.5 seconds every 0.3 seconds. This gives the ones place of the error code.

Error Code	Description	Corrective Action
E10	The TeraStation is running on the UPS battery due to a power outage. The system will now be shut down safely.	Check that power is being supplied to the UPS, and if there are no problems, turn on the TeraStation.
E11	An error occurred in the fan speed.	Check the fan. Use compressed air or tweezers to remove any dust or foreign objects. Confirm that the fan is spinning normally. If it is not, contact Buffalo technical support for assistance.
E12	The system is overheating.	Do not place objects in the area around the TeraStation. Also, move the TeraStation to a cool location.
E13	An error occurred in the RAID array. The TeraStation is in degraded mode.	Replace the defective drive. Reboot the TeraStation and rebuild the RAID array.
E14	RAID array cannot be mounted.	Run the RAID array disk check in Settings.
E15	The bad sectors have reached a dangerous level.	Replace the defective drive.
E16	Unable to find hard drive.	Hard drive may be disconnected or may have failed. Shut down the TeraStation and reinstall the hard drive.
E22	Mounting of hard drive failed.	Format the hard drive. After formatting, if the error still appears after rebooting, replace the hard drive. If the error is displayed again, contact Buffalo technical support for assistance.
E23	An error occurred, so the hard drive was removed from the RAID array.	Replace the faulty drive.
E30	A hard drive error occurred.	Replace the faulty drive.

Drive Status LED

If an error occurs on a drive, its corresponding LED will light up or blink. Refer to the "Hard Drive Replacement" section in chapter 4 and replace the failed drive with a new drive.

When the LED Blinks Amber

If there is a status message, the power LED on TS1200D and TS1400D models, or the info LED on TS1400R models will blink amber. For TS1200D models, the following blink patterns will give the information code. You can also see any status messages in NAS Navigator2.

Place	Status
10s Place	The LED flashes for 1.0 seconds every 0.3 seconds. This gives the tens place of the information code.
1s Place	The LED flashes for 0.5 seconds every 0.3 seconds. This gives the ones place of the information code.

Information Code	Description	Corrective Action
I10	The TeraStation is overheating.	Move the TeraStation to a cool location. Do not place objects in the area around the TeraStation.
I11	The bad sectors in hard drive may have reached a dangerous level.	Replace hard drive.
I12	The RAID array is operating in degraded mode.	Check the drive where the error occurred and replace it with a new hard drive. For the replacement method, refer to the "Hard Drive Replacement" section in chapter 4.
I13	Formatting RAID array.	-
I14	Checking RAID array.	-
I15	The data on RAID array is being scanned for errors. Note: Transfer speeds are slower during the scan.	-
I16	Creating RAID array.	-
I17	Resynchronizing RAID array. Note: Transfer speeds are slower during resynchronization.	Wait until the RAID resynchronization finishes. It will take about 10 hours per terabyte.
I18	Rebuilding RAID array. Note: Transfer speeds are slower during the rebuilding process.	-
I19	Writing 0s to RAID array, erasing all data.	-
I20	Formatting hard drive.	-
I21	Checking hard drive.	-
I22	All data on drive is being overwritten with 0s.	-
I23	Initializing all settings.	-
I25	Updating the TeraStation firmware.	Don't turn off the TeraStation.
I26	Initializing all settings.	Don't turn off the TeraStation.
I27	Checking USB hard drive.	-
I28	Formatting USB hard drive.	Don't turn off the TeraStation.

Information Code	Description	Corrective Action
I31	Displayed when a new drive is detected after replacing hard drive.	Press the function button to rebuild the RAID array.
I32	Displayed after replacing hard drive when the RAID needs to be rebuilt in Settings or formatting is necessary.	In Settings, either rebuild the RAID array or format the hard drive.
I33	An error occurred in replication, or synchronization between the main TeraStation and the backup TeraStation failed during the replication configuration.	In Settings, navigate to <i>Backup - Replication</i> and click <i>Resync</i> to execute resynchronization. If the error is displayed again, contact Buffalo technical support for assistance.
I37	System recovery in progress.	-
I38	System recovery is complete.	-
I41	Press the function button on the front to start the recovery process.	-
I42	Preparing to start the recovery process.	-
I45	Recovery failed.	-
I46	Data migration or conversion (RAID migration) is in progress.	Don't turn off the TeraStation.
I47	Data migration or conversion (RAID migration) is in progress.	Don't turn off the TeraStation.
I52	A new firmware version has been released.	Update the firmware.
I54	A backup job has failed.	Make sure that the backup job is configured correctly. Make sure that the NAS is on and not in standby mode. If the backup job still fails to run correctly, check the status of the NAS, network, and backup source and destinations.
I55	Authentication during recovery of settings failed.	Settings can only be restored for the TeraStation whose settings were originally saved. To restore settings, insert the USB memory device, turn on the TeraStation while holding down the init button on the rear of the TeraStation, and restart the TeraStation. Or, settings can be restored from Settings with the TeraStation powered on.

If the LED glows amber

When the power or info LED glows a steady amber, a new firmware version is available. Update the firmware to the newest version.

Default Settings

Administrator's Name	admin
Password	password
Shared Folders	"share" (for both Windows and Mac computers). The recycle bin is enabled on "share" by default.

DHCP Client	Normally, the TeraStation will get its IP address automatically from a DHCP server on the network. If no DHCP server is available, then an IP address will be assigned as follows: IP address: 169.254.xxx.xxx (xxx is assigned randomly when booting the TeraStation.) Subnet mask: 255.255.0.0	
Registered Groups	"hdusers", "admin", and "guest" are default groups and cannot be edited or deleted.	
Microsoft Network Group Settings	WORKGROUP	
Ethernet Frame Size	1500 bytes (not including 14 bytes of header and 4 bytes of FCS)	
SMB	Enabled	
	SMB2 Protocol	Disabled
	Recycle Bin Permissions	All users
AFP	Enabled	
FTP	Disabled	
SFTP	Disabled	
WebAccess	Disabled	
NFS	Disabled	
RAID Scanning	Disabled	
DLNA Server	Disabled	
iTunes Server	Disabled	
Print Server	Enabled	
Web Server	Disabled	
MySQL Server	Disabled	
BitTorrent	Disabled	
Time Machine	Disabled	
Direct Copy	Disabled	
NTP	Enabled	
Email Notification	Disabled	
RAID Mode	TS1200D: RAID 1 TS1400D and TS1400R: RAID 5	

Specifications

Check the Buffalo website for the latest product information and specifications.

LAN Port	Interface	IEEE 802.3ab (1000BASE-T) IEEE 802.3u (100BASE-TX) IEEE 802.3 (10BASE-T)
	Transfer Speed	1000 Mbps full duplex (auto-negotiation) 100 Mbps full duplex/half duplex (auto-negotiation) 10 Mbps full duplex/half duplex (auto-negotiation)
	Number of Ports	1 port (supports auto-MDIX)
	Connector Type	RJ-45 8-pin
	Protocol	TCP/IP
	Access Method	CSMA/CD
	File Sharing	SMB/CIFS, AFP, FTP, SFTP, NFS, HTTP/HTTPS
	Management	HTTP/HTTPS
Jumbo Frames	1500, 4084, 7404, and 9216 byte modes are supported. (not including 14 bytes of header and 4 bytes of FCS)	
USB Port	TS1200D: 1 USB 2.0 port (type A) TS1400D and TS1400R: 2 USB 3.0 ports and 1 USB 2.0 port (type A) Note: Compatible USB devices include printers, USB UPS devices, and Buffalo USB hard drives. USB hubs are not supported.	
Internal Hard Drive	If a hard drive in your TeraStation malfunctions, replace it with a Buffalo drive of the same capacity or larger. Use a Buffalo OP-HDBST series drive for TS1200D and TS1400D, and a OP-HDS series drive for TS1400R. The drives listed above are available from the Buffalo website.	
Power Supply	AC 100–240 V, 50/60 Hz	
Dimensions (W x H x D)	TS1200D: 87 x 127.5 x 205 mm; 3.4 x 5.0 x 8.1 in TS1400D: 177 x 127.5 x 227 mm; 6.96 x 5.02 x 8.93 in TS1400R: 429.5 x 44.3 x 430 mm; 16.9 x 1.74 x 16.9 in	
Weight	TS1200D: Approx. 2.4 kg; 5.3 lb TS1400D: Approx. 5.4 kg; 11.9 lb TS1400R: Approx. 9.0 kg; 19.8 lb	
Power Consumption (Max.)	TS1200D: 48 W TS1400D: 150 W TS1400R: 100 W	
Operating Environment	Temperature: 5–35°C; 41–95°F Environment humidity: 20–80% (no condensation)	
Compatibility	Windows PCs, Macs, and mobile devices* with wired or wireless Ethernet connections. *Android 4.0 or later, iOS 6.0 or later, Windows Phone 7.5 Note: The TeraStation requires a network connection with your computer for operation. It cannot be connected via USB.	
Supported OS	Windows 10*, Windows 8.1*, Windows 8*, Windows 7*, Windows Vista*, Windows Server 2012 R2, Windows Server 2012, Windows Server 2008 R2, Windows Server 2008, Windows Server 2003 R2, Windows Server 2003 macOS 10.12, 10.11, 10.10, 10.9, 10.8, 10.7 *32-bit and 64-bit	

Chapter 11 Regulatory Compliance Information

For Customers in the United States

FCC Statement

For TS1200D models:

This equipment has been tested and found to comply with the limits for a Class B digital device, pursuant to Part 15 of the FCC Rules. These limits are designed to provide reasonable protection against harmful interference in a residential installation.

This equipment generates, uses and can radiate radio frequency energy and, if not installed and used in accordance with the instructions, may cause harmful interference to radio communications. However, there is no guarantee that interference will not occur in a particular installation.

If this equipment does cause harmful interference to radio or television reception, which can be determined by turning the equipment off and on, the user is encouraged to try to correct the interference by one or more of the following measures:

- Reorient or relocate the receiving antenna.
- Increase the separation between the equipment and receiver.
- Connect the equipment into an outlet on a circuit different from that to which the receiver is connected.
- Consult the dealer or an experienced radio/TV technician for help.

This device complies with Part 15 of the FCC Rules. Operation is subject to the following two conditions: (1) this device may not cause harmful interference, and (2) this device must accept any interference received, including interference that may cause undesired operation.

Only use the cables and accessories that are included in the package. Don't use other accessories or cables unless specifically instructed to in the documentation.

For TS1400D and TS1400R models:

This equipment has been tested and found to comply with the limits for a Class A digital device, pursuant to part 15 of the FCC Rules. These limits are designed to provide reasonable protection against harmful interference when the equipment is operated in a commercial environment. This equipment generates, uses, and can radiate radio frequency energy and, if not installed and used in accordance with the instruction manual, may cause harmful interference to radio communications. Operation of this equipment in a residential area is likely to cause harmful interference in which case the user will be required to correct the interference at his own expense.



This device complies with Part 15 of the FCC Rules. Operation is subject to the following two conditions: (1) this device may not cause harmful interference, and (2) this device must accept any interference received, including interference that may cause undesired operation.

Only use the cables and accessories that are included in the package. Don't use other accessories or cables unless specifically instructed to in the documentation.

MET

The socket-outlet shall be installed near the equipment and shall be easily accessible.

Label Information

	Direct current
	Polarity of DC connector

Proposition 65

WARNING:

This product and its components contain chemicals known to the State of California to cause cancer and birth defects, or reproductive harm. Wash hands after handling.

For Customers in Europe

CE



Dansk

Dette er et Klasse A-produkt. I et hjemmemiljø kan dette produkt skabe radiointerferens, hvormed det kan være nødvendigt for brugeren at tage passende forholdsregler.

Dette produkt kan forårsage interferens hvis det bruges i beboelsesområder. En sådan anvendelse skal undgås, medmindre brugeren tager specielle foranstaltninger for at reducere elektromagnetiske emissioner for at forhindre interferens med modtagelse af radio- og tv-udsendelser.

Der må kun bruges de kabler og det tilbehør der er inkluderet i pakken. Der må ikke bruges andet tilbehør eller kabler, medmindre det er udtrykkeligt beskrevet i dokumentationen.

Brug ikke USB-kabler, der er 3 meter eller længere for at tilslutte USB enheder til denne TeraStation serie.

Deutsch

Dies ist ein Produkt der Klasse A. In einer häuslichen Umgebung kann dieses Produkt Funkstörungen verursachen. Um diese zu beheben, müssen ggf. entsprechende Maßnahmen ergriffen werden.

Bei einer Nutzung in Wohngebieten können bei diesem Produkt Störungen auftreten. Eine solche Nutzung soll vermieden werden, außer der Nutzer ergreift bestimmte Maßnahmen, um elektromagnetische Strahlung zu reduzieren und Störungen der Radio- und Fernsehübertragung zu vermeiden.

Verwenden Sie ausschließlich die Kabel und Zubehörteile, die im Lieferumfang enthalten sind. Andere Zubehörteile oder Kabel dürfen nur dann verwendet werden, wenn dies in der Dokumentation ausdrücklich vorgeschrieben ist.

Verwenden Sie keine USB-Kabel, die 3 Meter lang oder länger sind, um USB-Geräte an TeraStation dieser Serie anzuschließen.

English

This is a class A product. In a domestic environment, this product may cause radio interference, in which case the user may be required to take adequate measures.

This product may cause interference if used in residential areas. Such use must be avoided unless the user takes special measures to reduce electromagnetic emissions to prevent interference to the reception of radio and television broadcasts.

Only use the cables and accessories that are included in the package. Don't use other accessories or cables unless specifically instructed to in the documentation.

Do not use USB cables that are 3 meters or longer to connect USB devices to this TeraStation series.

Español

Este es un producto de Clase A. En una situación doméstica, este producto puede producir interferencias de radio, en ese caso el usuario deberá tomar las medidas adecuadas.

Este producto puede causar interferencias al utilizarlo en áreas residenciales. Debe evitarse utilizarlo así, salvo si el usuario adopta medidas especiales para reducir las emisiones electromagnéticas e impedir que se produzcan interferencias con la recepción de emisiones de radio y televisión.

Utilice únicamente los cables y accesorios incluidos en el paquete. No utilice otros accesorios ni cables a menos que así se indique en la documentación.

Utilice cables de una longitud inferior a 3 metros para conectar los dispositivos USB a este tipo de TeraStation.

Français

Cet appareil est un produit de Classe A. Dans un environnement domestique, ce produit est susceptible de provoquer des interférences radio, auquel cas l'utilisateur peut être mis en demeure de prendre des mesures appropriées.

Utilisé dans un environnement domestique, cet appareil génère des interférences. Ce type d'utilisation est donc à éviter si l'utilisateur n'a pas pris de mesures spécifiques visant à réduire les émissions électromagnétiques pour éviter les interférences avec la réception de programmes de radio et de télévision.

Utilisez uniquement les câbles et accessoires inclus dans ce package. N'utilisez aucun autre accessoire ou câble sauf instruction spécifique de la documentation.

Utilisez des câbles d'une longueur de moins 3 mètres pour connecter les périphériques USB à ce type de TeraStation.

Italiano

Questo è un prodotto di Classe A. In ambienti domestici il prodotto può causare radiointerferenza, nel qual caso potrebbe rendersi necessaria l'adozione di opportune misure.

Questo prodotto può causare interferenze se usato in zone residenziali. Evitare l'uso in queste zone a meno che l'utente non intraprenda azioni specifiche per ridurre le emissioni elettromagnetiche e impedire le interferenze alla ricezione di trasmissioni radio-televisive.

Utilizzare esclusivamente i cavi e gli accessori inclusi nell'imballaggio. Non utilizzare altri accessori o cavi a meno che non sia specificamente indicato nella documentazione.

Non utilizzare cavi USB lunghi 3 metri o più per collegare dispositivi USB a questa TeraStation.

Nederlands

Dit is een Klasse A product. Dit product kan in een huishoudelijke omgeving radiostoring veroorzaken in welk geval de gebruiker adequate maatregelen dient te nemen.

Dit product kan storing veroorzaken wanneer gebruikt in woongebieden. Dergelijk gebruik dient te worden vermeden tenzij de gebruiker speciale maatregelen treft om de elektro-magnetische uitstraling te beperken zodat storing van de ontvangst van radio- en televisieuitzendingen wordt voorkomen.

Gebruik alleen de kabels en toebehoren die zich in de verpakking bevinden. Gebruik geen ander toebehoren of kabels tenzij dit uitdrukkelijk in de handleiding wordt aangegeven.

Gebruik geen USB-kabels die 3 meter of langer zijn om USB-apparaten met deze TeraStation series te verbinden.

Norsk

Detta er et produkt i klasse A. I et hjemmemiljø kan dette produktet forårsake radiointerferens, noe som gjør at brukeren i så fall må foreta passende tiltak.

Dette produktet kan forårsake interferens dersom det brukes i boligområder. Slik bruk må unngås med mindre brukeren tar spesielle tiltak for å redusere elektromagnetisk stråling for å unngå interferens med mottak av radio- og TV-sendinger.

Bruk kun kabler og tilbehør som er inkludert i pakken. Ikke bruk annet tilbehør eller kabler med mindre spesielt instruert til å gjøre det i dokumentasjonen.

Bruk ikke USB-kabler på tre meter eller mer for å koble USB-enheter til denne TeraStation-serien.

Português

Este é um produto de Classe A. Num ambiente doméstico, este produto pode provocar interferências de rádio, pelo que o utilizador poderá ter de tomar medidas adequadas.

Este produto poderá causar interferências se utilizado em áreas residenciais. A utilização deverá ser evitada, salvo se o utilizador tomar medidas especiais para reduzir as emissões electromagnéticas e assim prevenir interferências na recepção de rádio e televisão.

Utilizar apenas cabos e acessórios incluídos na embalagem. Não utilizar outros acessórios ou cabos, salvo se especificamente indicado na documentação.

Não usar cabos USB de 3 metros ou mais para ligar dispositivos USB a esta série TeraStation.

Suomi

Tämä on luokan A tuote. Tämä tuote voi aiheuttaa radiohäiriöitä kotikäytössä, jolloin käyttäjän on ehkä ryhdyttävä tarvittaviin toimenpiteisiin.

Tämä tuote saattaa aiheuttaa häirintää, jos sitä käytetään asuinalueella. Sellaista käyttöä on vältettävä, ellei ryhdytä erityistoimenpiteisiin sähkömagneettisen säteilyn vähentämiseksi häiriöiden estämiseksi radio- ja televisiolähetysissä.

Käytä ainoastaan pakkauksen mukana toimitettuja kaapeleita ja varusteita. Älä käytä muita varusteita tai kaapeleita ellei näin ole erityisesti ohjeistettu asiakirjoissa.

Älä käytä 3m tai pitempiä USB-kaapeleita USB-laitteiden liittämiseen näille TeraStation-sarjoille.

Svensk

Detta är en Klass A-produkt. I en hushållsmiljö kan denna produkt orsaka radiostörningar, och användaren kan i så fall begäras att vidta lämpliga åtgärder.

Den här produkten kan orsaka störningar om den används i bostadsområden. Sådan användning måste undvikas om inte användaren vidtar speciella åtgärder för att minska elektromagnetiska sändningar för att förhindra störningar i mottagningen av radio- och tv-sändningar.

Använd bara kablar och tillbehör som ingår i förpackningen. Använd inte andra tillbehör eller kablar om du inte får uttryckliga instruktioner om det i dokumentationen.

Använd inte USB-kablar som är 3 meter eller längre för att ansluta USB-enheter till den här TeraStation-serien.

Türk

Bu, A Sınıfı bir üründür. Evde kullanım sırasında bu ürün radyo girişimine yol açabilir ve bu durumda kullanıcının gerekli önlemleri alması gerekebilir.

Bu ürün yerleşim bölgelerinde kullanılırsa parazite neden olabilir. Kullanıcı radyo ve televizyon yayınlarında parazitli önlemek üzere elektromanyetik salınımları azaltacak özel önlemler almadıkça bu şekilde kullanımdan kaçınılmalıdır. Yalnızca pakette bulunan kablo ve aksesuarları kullanın. Belgelerde özellikle belirtilmedikçe başka aksesuar ve kablolar kullanmayın.

USB aygıtları bu TeraStation serisine bağlamak için 3 metre ve daha uzun USB kabloları kullanmayın.

AC Adapter

TS1200D	Asian Power Devices Inc. DA-48P12
---------	-----------------------------------

TS1400D	Asian Power Devices Inc. DA-150C19
---------	------------------------------------

CB

The socket-outlet shall be installed near the equipment and shall be easily accessible.

Norsk



Utstyr som er koplet til beskyttelsesjord via nettplugg og/eller via annet jordtilkoplede utstyr – og er tilkoplede et kabel-TV nett, kan forårsake brannfare.

For å unngå dette skal det ved tilkoplede av utstyret til kabel-TV nettet installeres en galvanisk isolator mellom utstyret og kabel-TV nettet.

Svenska

Utrustning som är kopplad till skyddsjord via jordat vägguttag och/eller via annan utrustning och samtidigt är kopplad till kabel-TV nät kan i vissa fall medföra risk för brand. För att undvika detta skall vid anslutning av utrustningen till kabel-TV nät galvanisk isolator finnas mellan utrustningen och kabel-TV nätet.

Label Information

	Direct current
	Polarity of DC connector