

# Level Switch Products



- ▶ **Pressure**
  - Electronic Pressure Switches
  - Mechanical Pressure Switches
  - Pressure Transducer
- ▶ **Valves & Regulators**
- ▶ **Temperature**
- ▶ **Level**
- ▶ **Flow**
- ▶ **Air Suspension Valves**

# Barksdale

CONTROL PRODUCTS

## Table of Contents

### Level Switch Products

<b>UNS-VA 1/4 NPT-K1-VA52</b> - Level Switch 1/4NPT Stainless Steel <i>(Formerly BLS 1950 Series)</i>	3
<b>UNS-MS 1/4 NPT-BN30</b> - Level Switch 1/4NPT Brass <i>(Formerly Series BLS 1900)</i>	5
<b>UNS-MS 1/8NPT-BN30</b> - Level Switch NPT Brass <i>(Formerly Series BLS 1800)</i>	7
<b>UNS-VA1/8NPT-VA27</b> - Level Switch NPT Stainless Steel <i>(Formerly BLS 1750 Series)</i>	9
<b>UNS-MS or VA 1/8NPT-BN25</b> - Level Switch NPT Brass or Stainless Steel <i>(Formerly Series BLS 1700)</i>	11
<b>UNS-MS 1/4NPT-BN30/1(2)-TPXX/2</b> - Dual Level/Temperature Switch <i>(Formerly Series BLS-810)</i>	13
<b>UNS-2000 Series</b> - Multi Level Switch <i>(Formerly Series BLS 800)</i>	15
<b>UNS-1000 Series</b> - Multi Level Switch <i>(Formerly Series BLS 700)</i>	18
<b>UNS-PA or PP</b> - Level Switch - Plastic <i>(Formerly Series BLS-7)</i>	21
<b>UNS-VA/SB5 or B4</b> - Bilge Guard Level Switch	23
<b>Model LMSSM, LMTBM, LMTSM, LMSBM</b> - Mini LevelSite	25
<b>Model LSSM, LTBM, LTSM, LSBM</b> - LevelSite®	27
<b>LevelSite® Accessories</b>	29
<b>LevelSite® Supplemental Guide</b>	31

# Level Switch 1/4 NPT Stainless Steel

**UNS-VA 1/4 NPT-K1-VA52**

*Formerly BLS 1950 Series*

## Features

- ▶ Compact size for easy installation
- ▶ Ideal for small tanks & vessels
- ▶ Reversible switch logic
- ▶ Broad media compatibility
- ▶ All models incorporate hermetically sealed magnetically actuated reed switches

## Applications

- ▶ Sump tanks
- ▶ Hydraulic power units
- ▶ Storage tanks
- ▶ Solvent recovery systems
- ▶ Lube oil console systems



Level switch made of stainless steel with 1/4" NPT mounting thread

## General Specifications\*

<b>Switch Rating:</b> SPST:	250 V AC/DC; 3.0 A / 100 VA/W
SPDT:	140 V AC/DC / 1.0 A / 60 VA/W
<b>Switch Configuration:</b>	Shipped as normally open as standard. Can be changed to normally closed by rotating float 180°
<b>Contact Mode*:</b>	1 - SPST-switch (NO) 2 - SPST-switch (NC) 3 - SPDT-switch
<b>Wetted Parts:</b> Stem:	316 stainless steel (VA)
Float:	316 stainless steel (VA)
Mounting:	1/4" NPT male
<b>Electrical Connection:</b>	PVC-cable - max 3 x 0.34mm <sup>2</sup> 1m/3m/5m length

\* The contact modes (NO or NC) are defined on the basis of an empty tank and for a level switch mounted through the top.

<b>Minimum Specific Gravity:</b> Stainless Steel Float:	0.78
<b>Protection Class:</b>	IP54
<b>Approvals:</b> UL/CSA:	Pending
<b>Operating Temperature:</b>	14° to +220°F (-10° to +105°C), PVC-cable
Option/ High Temp:	-40° to +302°F (-40° to +150°C), silicone cable (-HT), cable consult factory
<b>Operating Pressure:</b> Stainless Steel Float:	580 psig (40 bar)
<b>Weight:</b>	Approx. 150 grams (5.3 oz.)

## Wiring Color / Code

**NO (NC)**

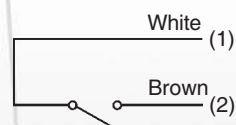

**SPDT**

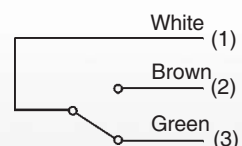

## Technical Drawing

Dimensions in inch (mm)

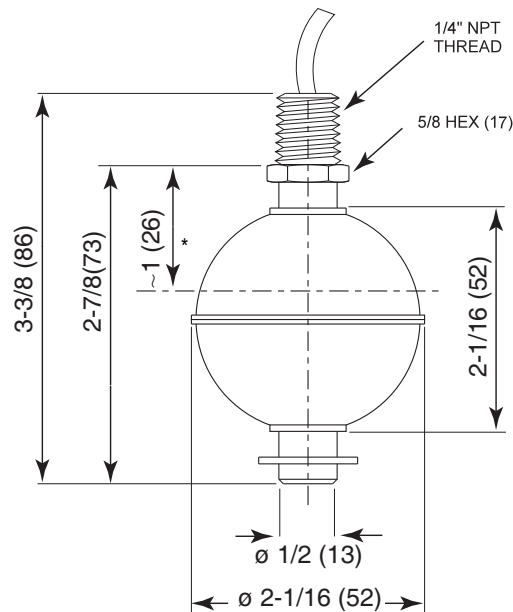

\* Switchpoint and immersion depth at density 1 = 36 mm ± 2 mm

## Order Number Key / Options

Description	Contact Mode	Cable Type / Length	Order Number
UNS-VA1/4NPT-K1-VA52/1(2)	NO (NC) <sup>1,2</sup>	PVC / 1 m	0111-589
UNS-VA1/4NPT-K3-VA52/1(2)	NO (NC) <sup>1,2</sup>	PVC / 3 m	0111-590
UNS-VA1/4NPT-K5-VA52/1(2)	NO (NC) <sup>1,2</sup>	PVC / 5 m	0111-591
UNS-VA1/4NPT-K1-VA52/3	SPDT	PVC / 1 m	0111-592
UNS-VA1/4NPT-K3-VA52/3	SPDT	PVC / 3 m	0111-593
UNS-VA1/4NPT-K5-VA52/3	SPDT	PVC / 5 m	0111-594

Note:

1. Shipped as NO (standard). Rotate float by 180° for NC.
2. If NC is requested, then add suffix "-NC" to ordering number (i.e. 0111-589-NC).

## Level Switch 1/4 NPT Brass

**UNS-MS 1/4 NPT-BN30**

*Formerly Series BLS 1900*

### Features

- ▶ Compact size for easy installation
- ▶ Ideal for small tanks & vessels
- ▶ Reversible switch logic
- ▶ Broad media compatibility
- ▶ All models incorporate hermetically sealed magnetically actuated reed switches

### Applications

- ▶ Sump tanks
- ▶ Hydraulic power units
- ▶ Storage tanks
- ▶ Solvent recovery systems
- ▶ Lube oil console systems



Level switch made of brass with 1/4" NPT mounting thread

### General Specifications\*

<b>Switch Rating:</b> SPST:	250 VAC/DC, 3A. / 100 VA/W
SPDT:	140 VAC/DC, 1A. 60 VA/W
<b>Switch Configuration:</b>	Shipped as normally open as standard. Can be changed to normally closed by rotating float 180°
<b>Contact Mode*:</b>	1 - SPST-switch (NO) 2 - SPST-switch (NC) 3 - SPDT-switch
<b>Wetted Parts:</b> Stem:	Brass (MS)
Float:	NBR foam (BUNA)
Mounting:	1/4" NPT male
<b>Electrical Connection:</b>	PVC-cable - max 3 x 0.34mm <sup>2</sup> 1m/3m/5m length

<b>Minimum Specific Gravity:</b> NBR Foam Float:	0.60 g/cm <sup>3</sup>
<b>Protection Class:</b>	IP54
<b>Approvals:</b> UL/CSA:	Pending
<b>Operating Temperature:</b>	-4° to +220°F (-20° to +100°C) - oil -4° to +180°F (-20° to +80°C) - water
<b>Operating Pressure:</b> NBR Foam (BUNA):	220 psig (15 bar)
<b>Weight:</b>	Approx. 150 grams (5.3 oz.)

\* The contact modes (NO or NC) are defined on the basis of an empty tank and for a level switch mounted through the top.

### Wiring Color / Code

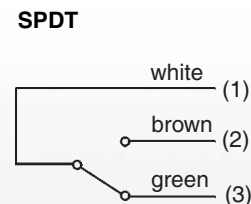
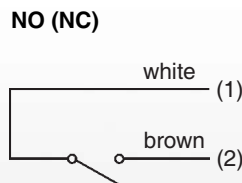

## Technical Drawing

Dimensions in inch (mm)

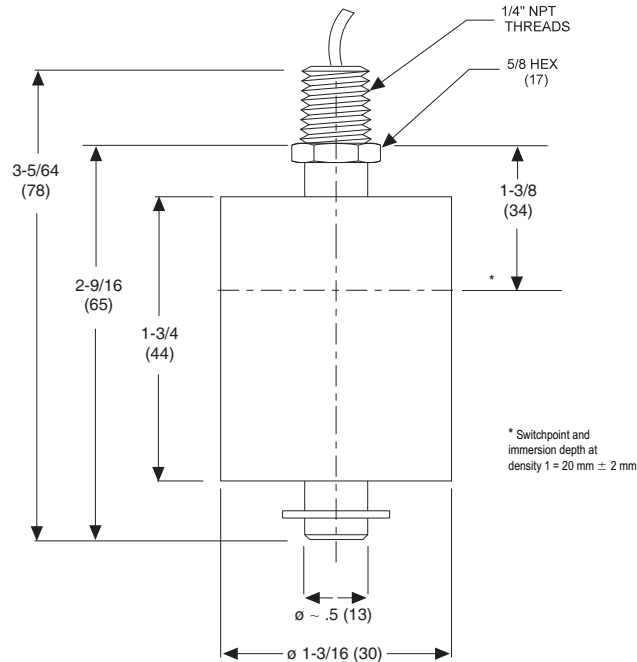

## Order Number Key / Options

Description	Contact Mode	Cable Type/Length	Ordering Number
UNS-MS1/4NPT-K1-BN30/1(2)	NO (NC) <sup>1,2</sup>	PVC / 1 m	0111-583
UNS-MS1/4NPT-K3-BN30/1(2)	NO (NC) <sup>1,2</sup>	PVC / 3 m	0111-584
UNS-MS1/4NPT-K5-BN30/1(2)	NO (NC) <sup>1,2</sup>	PVC / 5 m	0111-585
UNS-MS1/4NPT-K1-BN30/3	SPDT	PVC / 1 m	0111-586
UNS-MS1/4NPT-K3-BN30/3	SPDT	PVC / 3 m	0111-587
UNS-MS1/4NPT-K5-BN30/3	SPDT	PVC / 5 m	0111-588

Note:

1. Shipped as NO (standard). Rotate float by 180° for NC.
2. If NC is requested, then add suffix "-NC" to ordering number (i.e. 0111-573-NC).

# Level Switch 1/8" NPT Brass

## UNS-MS 1/8NPT-BN30

Formerly Series BLS 1800

### Features

- ▶ Compact size for easy installation
- ▶ Ideal for small tanks & vessels
- ▶ Reversible switch logic
- ▶ Broad media compatibility
- ▶ All models incorporate hermetically-sealed, magnetically actuated reed switches

### Applications

- ▶ Sump tanks
- ▶ Hydraulic power units
- ▶ Storage tanks
- ▶ Solvent recovery systems
- ▶ Lube oil console systems



Level switch made of brass with BUNA float and 1/8" NPT mounting thread

### General Specifications\*

<b>Switch Rating:</b> SPST:	NO/NC: 230 VAC/DC-2A; 40 VA/W  150 VAC/100 VDC; 0.2A, 3VA/W
<b>Switch Configuration:</b>	Shipped as Normally Open as standard. Can be changed to Normally Closed by rotating float 180°.
<b>Contact Mode*:</b>	1 - SPST-switch (NO) 2 - SPST-switch (NC)
<b>Wetted Parts:</b> Stem:	Brass (MS)
Float:	NBR foam (BUNA)
Mounting:	1/8" NPT Male
<b>Electrical Connection:</b>	PVC cable 1m in length

<b>Minimum Specific Gravity:</b> NBR Foam (BUNA) float:	0.57 g/cm <sup>3</sup>
<b>Protection Class:</b>	IP54
<b>Approvals:</b> UL/CSA:	Pending
<b>Operating Temperature:</b>	-4° to +220°F (-20° to +100°C) - oil -4° to +180°F (-20° to +80°C) - water
<b>Operating Pressure:</b> NBR Foam Float (BUNA):	220 psig (15 bar)
<b>Weight:</b>	Approx. 45 grams (1.6 oz.)

\* The contact modes (NO or NC) are defined on the basis of an empty tank and for a level switch mounted through the top.

### Wiring Color / Code

NO (NC)

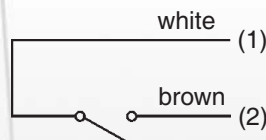



## Technical Drawing

Dimensions in inch (mm)

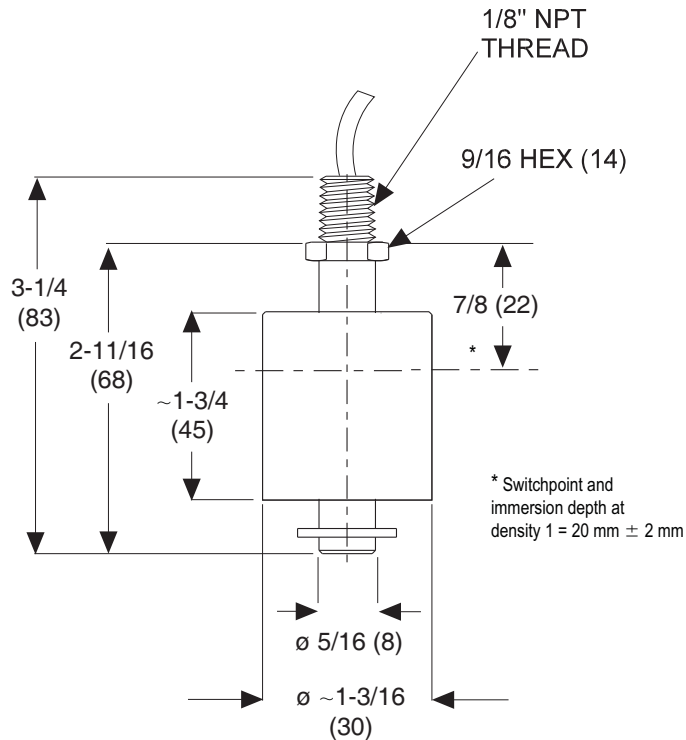

## Order Number Key / Options

Description	Contact Mode	Cable Type/Length	Ordering Number
UNS-MS1/8NPT-K1-BN30/1(2)	NO (NC) <sup>1,2</sup>	PVC / 1 m	0111-195

Note:

1. Shipped as NO (standard). Rotate float by 180° for NC.
2. If NC is required, then add suffix-"NC" to ordering number (i.e. 0111-195-NC).



# Level Switch 1/8" NPT Stainless Steel

**UNS-VA1/8NPT-VA27**

*Formerly BLS 1750 Series*

## Features

- ▶ Compact size for easy installation
- ▶ Ideal for small tanks & vessels
- ▶ Reversible switch logic
- ▶ Broad media compatibility
- ▶ All models incorporate hermetically-sealed, magnetically actuated reed switches

## Applications

- ▶ Sump tanks
- ▶ Hydraulic power units
- ▶ Storage tanks
- ▶ Solvent recovery systems
- ▶ Lube oil console systems
- ▶ Marine applications



Level switch made of stainless steel and 1/8" NPT mounting thread

## General Specifications\*

<b>Switch Rating:</b> SPST:	230 VAC/DC; 2A; 40 VA/W
SPDT:	150 VAC/100 VDC; 0.2A, 3VA/W
<b>Switch Configuration:</b>	Shipped as normally open as standard. Can be changed to normally closed by rotating float 180°.
<b>Contact Mode*:</b>	1 - SPST-switch (NO) 2 - SPST-switch (NC) 3 - SPDT-switch
<b>Wetted Parts:</b> Stem:	316 stainless steel (VA)
Float:	316 stainless steel (VA)
Mounting:	1/8" NPT male
<b>Electrical Connection:</b>	PVC cable max 3 x 0.34mm <sup>2</sup> 1m/3m/5m length

\* The contact modes (NO or NC) are defined on the basis of an empty tank and for a level switch mounted through the top.

<b>Minimum Specific Gravity:</b> Stainless Steel Float:	0.71 g/cm <sup>3</sup>
<b>Protection Class:</b>	IP54
<b>Approvals:</b> UL/CSA:	Pending
<b>Operating Temperature:</b>	14° to +220°F (-10° to +105°C), PVC-cable
Option/ High Temp:	-40° to +302°F (-40° to +150°C), silicone cable (-HT), cable consult factory
<b>Operating Pressure:</b> Stainless Steel Floats:	220 psig (15 bar)
<b>Weight:</b>	Approx. 90 grams (3.2 oz.)

## Wiring Color / Code

**NO (NC)**

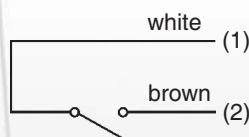

**SPDT**

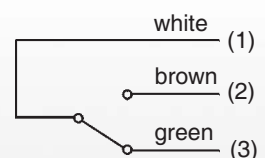

**Barksdale**

CONTROL PRODUCTS

CRANE Barksdale, Inc./Barksdale GmbH  
A Subsidiary of Crane Co.

## Technical Drawing

Dimensions in inch (mm)

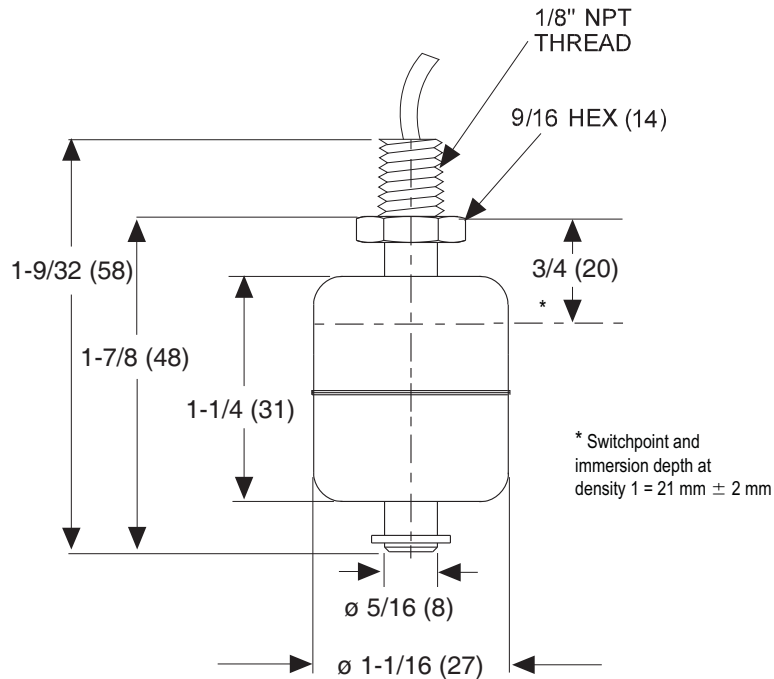

## Order Number Key / Options

Description	Contact Mode	Cable Type/Length	Ordering Number
UNS-VA1/8NPT-K1-VA27/1(2)	NO (NC) <sup>2</sup>	PVC / 1 m	0111-577
UNS-VA1/8NPT-K3-VA27/1(2)	NO (NC) <sup>2</sup>	PVC / 3 m	0111-578
UNS-VA1/8NPT-K5-VA27/1(2)	NO (NC) <sup>2</sup>	PVC / 5 m	0111-579
UNS-VA1/8NPT-K1-VA27/3	SPDT	PVC / 1 m	0111-580
UNS-VA1/8NPT-K3-VA27/3	SPDT	PVC / 3 m	0111-581
UNS-VA1/8NPT-K5-VA27/3	SPDT	PVC / 5 m	0111-582

Note:

1. Shipped as NO (standard). Rotate float by 180° for NC.
2. If NC is requested, then add suffix "-NC" to ordering number (i.e. 0111-577-NC).

## Level Switch 1/8"NPT Brass or Stainless Steel *UNS-MS or VA 1/8NPT-BN25*

*Formerly Series BLS 1700*

### Features

- ▶ Compact size for easy installation
- ▶ Ideal for small tanks & vessels
- ▶ Reversible switch logic
- ▶ Broad media compatibility
- ▶ All models incorporate hermetically-sealed, magnetically actuated reed switches

### Applications

- ▶ Sump tanks
- ▶ Hydraulic power units
- ▶ Storage tanks
- ▶ Solvent recovery systems
- ▶ Lube oil console systems



Level switch made of brass or stainless steel with BUNA float and 1/8" NPT mounting thread

### General Specifications\*

<b>Switch Rating:</b> SPST:	NO/NC: 230 VAC/DC-2A; 40 VA/W
SPDT:	150 VAC/100 VDC; 0.2A, 3VA/W
<b>Switch Configuration:</b>	Shipped as Normally Open as standard. Can be changed to Normally Closed by rotating float 180°.
<b>Contact Mode*:</b>	1 - SPST-switch (NO) 2 - SPST-switch (NC) 3 - SPDT-switch
<b>Wetted Parts:</b> Stem:	Brass (MS) or stainless steel (VA)
Float:	NBR foam (BUNA)
Mounting:	1/8" NPT male
<b>Electrical Connection:</b>	PVC cable max 3 x 0.34mm <sup>2</sup> 1m/3m/5m in length

\* The contact modes (NO or NC) are defined on the basis of an empty tank and for a level switch mounted through the top.

<b>Minimum Specific Gravity:</b> NBR Foam (BUNA) float:	0.57 g/cm <sup>3</sup>
<b>Protection Class:</b>	IP54
<b>Approvals:</b> UL/CSA:	Pending
<b>Operating Temperature:</b>	-4° to +220°F (-20° to +100°C) - oil -4° to +180°F (-20° to +80°C) - water
<b>Operating Pressure:</b> NBR Foame Float (BUNA):	220 psig (15 bar)
<b>Weight:</b>	Approx. 40 grams (1.4 oz.)

### Wiring Color / Code

#### NO (NC)

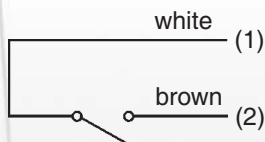

#### SPDT

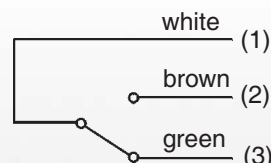

## Barksdale

CONTROL PRODUCTS

CRANE Barksdale, Inc./Barksdale GmbH  
A Subsidiary of Crane Co.

# Level Switch 1/8"NPT Brass or Stainless Steel *UNS-MS or VA 1/8NPT-BN25*

Formerly Series BLS 1700

## Technical Drawing

Dimensions in inch (mm)

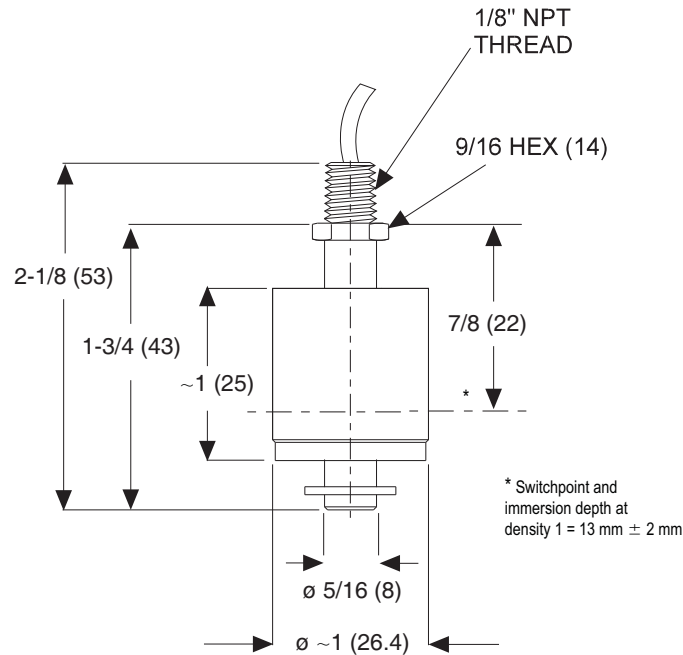

## Order Number Key / Options

Description	Contact Mode	Cable Type/Length	Ordering Number
UNS-MS1/8NPT-K1-BN25/1(2)	NO (NC) <sup>1</sup>	PVC / 1 m	0111-571
UNS-MS1/8NPT-K3-BN25/1(2)	NO (NC) <sup>1</sup>	PVC / 3 m	0111-572
UNS-MS1/8NPT-K5-BN25/1(2)	NO (NC) <sup>1</sup>	PVC / 5 m	0111-573
UNS-MS1/8NPT-K1-BN25/3	SPDT	PVC / 1 m	0111-574
UNS-MS1/8NPT-K3-BN25/3	SPDT	PVC / 3 m	0111-575
UNS-MS1/8NPT-K5-BN25/3	SPDT	PVC / 5 m	0111-576
UNS-VA1/8NPT-K1-BN25/4(2)	NO (NC) <sup>1,2</sup>	PVC / 1 m	0111-607
UNS-VA1/8NPT-K3-BN25/1(2)	NO (NC) <sup>1,2</sup>	PVC / 3 m	0111-608
UNS-VA1/8NPT-K5-BN25/1(2)	NO (NC) <sup>1,2</sup>	PVC / 5 m	0111-609
UNS-VA1/8NPT-K1-BN25/3	SPDT	PVC / 1 m	0111-610
UNS-VA1/8NPT-K3-BN25/3	SPDT	PVC / 3 m	0111-611
UNS-VA1/8NPT-K5-BN25/3	SPDT	PVC / 5 m	0111-612

Note:

1. Shipped as NO (standard). Rotate float by 180° for NC.
2. If NC is required, then add suffix-"NC" to ordering number (i.e. 0111-571-NC).

## Dual Level/Temperature Switch *UNS-MS1/4NPT-BN30/1(2)-TPXX/2*

*Formerly Series BLS-810*

### Features

- ▶ Temperature & level sensing in a single unit
- ▶ Compact size for easy installation
- ▶ Ideal for small tanks & vessels
- ▶ Broad media compatibility
- ▶ Ideal to use in oils and water

### Applications

- ▶ Sump tanks
- ▶ Hydraulic power units
- ▶ Storage tanks
- ▶ Solvent recovery systems
- ▶ Lube oil console systems
- ▶ Marine applications
- ▶ Food & beverage applications



### General Specifications\*

<b>Switch Rating:</b> SPST:	250/120 VAC/DC, 3A./max 100 VA/W
Temperature:	12 to 24 VDC, max 3 amps
<b>Switch Configuration:</b>	Shipped as Normally Open as standard. Can be changed to Normally Closed by rotating float 180° (For limit switch only).
<b>Contact Mode* :</b>	1- SPST- switch (NO) 2- SPST- switch (NC)
Temperature:	2- NC position only, only available in 122°, 140°, 158°, 176° and 194°F (50°, 60°, 70°, 80° and 90°C)
<b>Wetted Parts:</b> Stem:	Brass (MS)
Float:	NBR Foam (BUNA)
<b>Mounting:</b>	1/4" NPT Male
<b>Electrical Connection:</b>	PVC- cable- max 4 x 0.5mm <sup>2</sup> 1m/ length
<b>Minimum Specific Gravity:</b>	
NBR Foam Float:	0.60g / cm <sup>3</sup>

<b>Approvals:</b> UL/CSA:	Pending
<b>Operating Temperature:</b>	-4° to +212°F (-20° to + 100°C)- oil -4° to +176°F (-20° to + 80°C)- water
<b>Operating Pressure:</b> NBR Foam: (BUNA)	220 psig (15 bar)
<b>Weight:</b>	Approx. 150 grams (5.3 oz.)

### Wiring Color/Code

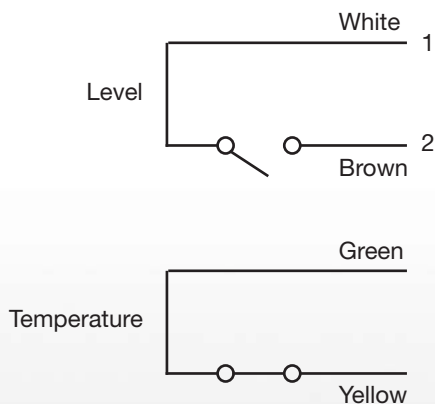

\* The contact modes (NO and NC) are defined on the basis of an empty tank and for a level switch mounted through the top.

# Dual Level/Temperature Switch *UNS-MS1/4NPT-BN30/1(2)-TPXX/2*

Formerly Series BLS-810

## Technical Drawing

Dimensions in inch (mm)

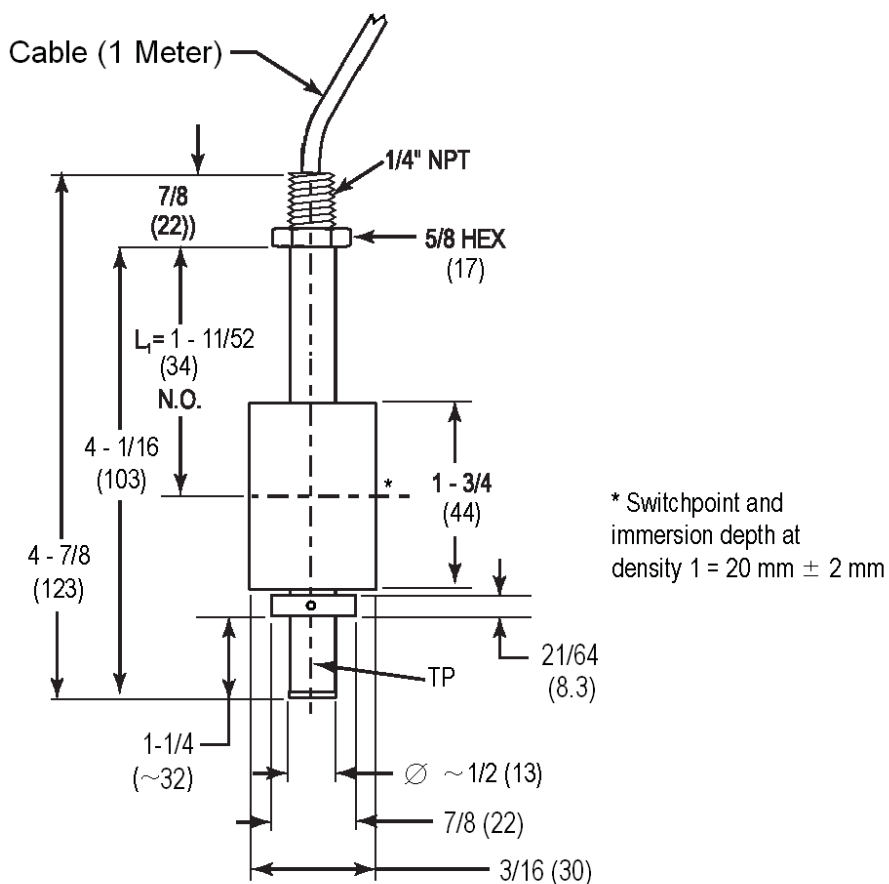

## Order Number Key / Options

DESCRIPTION:	CONTACT MODE: (Limit switch)	TEMPERATURE MODE:	ORDERING NUMBER:
UNS-MS 1/4 NPT-K1-BN30/ 1(2)- TP50/2	NO <sup>1,2</sup>	NC only <sup>3</sup>	0111-615
UNS-MS 1/4 NPT-K1-BN30/ 1(2)- TP60/2	NO <sup>1,2</sup>	NC only <sup>3</sup>	0111-641
UNS-MS 1/4 NPT-K1-BN30/ 1(2)- TP70/2	NO <sup>1,2</sup>	NC only <sup>3</sup>	0111-616
UNS-MS 1/4 NPT-K1-BN30/ 1(2)- TP80/2	NO <sup>1,2</sup>	NC only <sup>3</sup>	0111-642
UNS-MS 1/4 NPT-K1-BN30/ 1(2)- TP90/2	NO <sup>1,2</sup>	NC only <sup>3</sup>	0111-617

<sup>1</sup> Shipped as NO (standard). Rotate float by 180° for NC.

<sup>2</sup> If NC contact mode is required, then add suffix "-NC" to ordering number (i.e. 0111-611-NC).

<sup>3</sup> NO temperature mode available upon request with minimum of 25 pcs. order.

# Multi Level Switch

# UNS-2000 Series

Formerly Series BLS 800

## Features

- ▶ Fully customizable
- ▶ Up to 6 independent switch points
- ▶ Reversible switch logic
- ▶ Suitable for high viscosity liquids
- ▶ Optional integral temperature switch
- ▶ Hermetically sealed reed switches

## Applications

- ▶ Sump tanks
- ▶ Hydraulic power units
- ▶ Storage tanks
- ▶ Solvent recovery systems
- ▶ Lube oil console systems
- ▶ Marine applications



## General Specifications\*

<b>Max. Operating Pressure:</b>	580 PSI (40 bar), depends on mounting element and float
<b>Minimum Specific Gravity:</b>	
NBR (BUNA):	0.6 g/cm <sup>3</sup>
S.S.:	0.78 g/cm <sup>3</sup>
<b>Mounting Position:</b>	Vertical, ±30°, through top or bottom
<b>Protection Class:</b>	IP65 for ST-, KL- and PG-design IP67, IP68 on request IP54 for K-design

\* See Product Configurator for additional options.

<b>Operating Temperature:</b>	+14 °F to +221 °F (-10 °C to +105 °C), PVC-cable
<b>Special Design Options: (On Request)</b>	DR - Damping Tube HT - High Temperature Application - (-40 °C up to +150 °C) F- Silicone Cable U - Mounting location through bottom PT100 - PT100-Element TP - Temperature switch V V - Vertical Adjustment EXi - ATEX-approval EEx ia
<b>Contact Mode:</b>	NO or NC are defined on the basis of an empty tank and for installation through the top
<b>Weight:</b>	Depends on length and design

## Max. Switchpoints

	KL6C AL Terminal Box	KL12C AL Terminal Box	ST1 DIN Connector	ST2 DIN Connector	PG Cable gland
Connect Group 1	5	6	2	5	6
Connect Group 2	2	4	1	2	4
Connect Group 3	3	4	1	3	4
Connect Group 4	2	3	1	2	3

## Wiring Color / Code

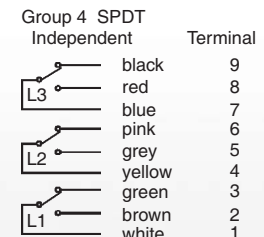
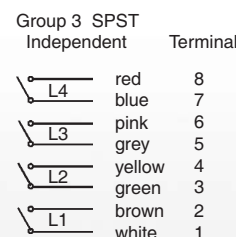
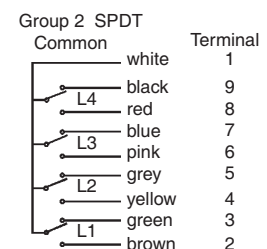
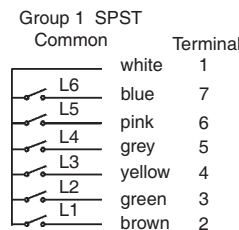

## Combinations

Material	Mounting	Electrical Connection	Float
Stainless Steel (VA)	T1-1/4 NPT T2 NPT FLAS	DIN Connector (ST1 & ST2) Terminal box (KL6C or KL12C) Cable gland (PG) PVC Cable (K)	Stainless Steel (VA52)
	1/2 NPT	Cable gland (PG) PVC Cable (K)	
Brass (MS)	T1-1/4 NPT T2 NPT	DIN Connector (ST1 & ST2) Terminal box (KL6C or KL12C) Cable gland (PG) PVC Cable (K)	NBR (Buna-N) (BN30)
	1/2 NPT	Cable gland (PG) PVC Cable (K)	

**Barksdale**  
CONTROL PRODUCTS

Barksdale, Inc./Barksdale GmbH  
A Subsidiary of Crane Co.





## Technical Drawing

Formerly Series BLS 800

Dimensions in inch (mm)

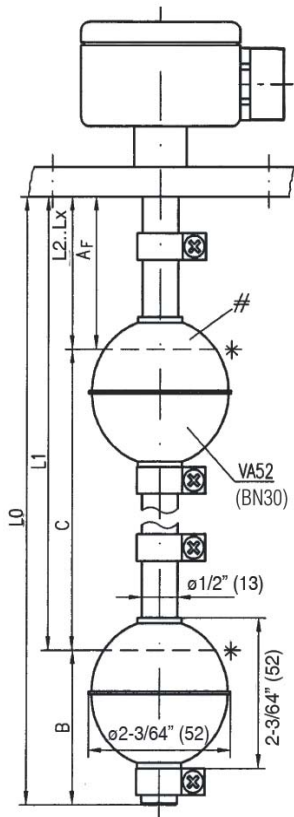

With Aluminum Junction Box and 1/2" NPT female conduit (KL6C or KL12C)

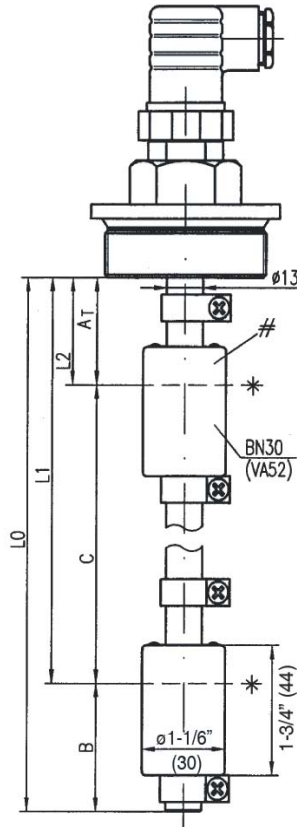

With DIN Connector (ST1)

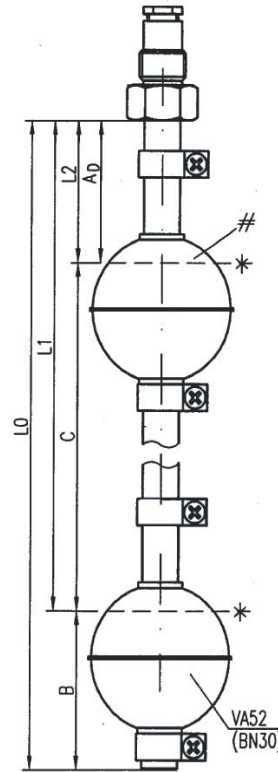

With Cable gland (PG)

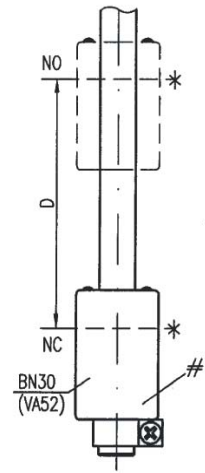

Dual switching (1 float for 2 switchpoints)

1. Length tolerance  $\pm 3$  mm
2. L0 = max. 3000 mm (118 inches)

\* Immersion depth at density 1:  
VA52 =  $36 \pm 2$  mm  
BN30 =  $20 \pm 2$  mm

# Float position:

- VA52 = NO/NC  $\Rightarrow$  see float marking
- SPDT  $\Rightarrow$  NO-function
- BN30 = NO  $\Rightarrow$  compound points at bottom
- NC  $\Rightarrow$  compound points at top
- SPDT  $\Rightarrow$  compound points at bottom

Dimensions	Min. distances in mm					
	A <sub>F</sub>	A <sub>T</sub>	A <sub>D</sub>	B	C	D
VA52	32	32	32	55	85	55
BN30	40	40	40	39	77	55

When using -DR: Dimension B + 20 mm!

### Mounting Types:

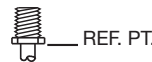

1/2" NPT



T1-1/4" or T2" NPT

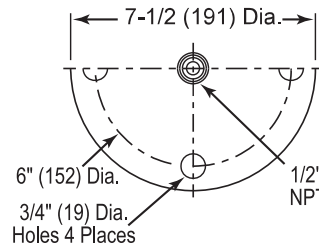

**FLA5**  
3" 150# Flange with 1/2" NPT Male Fitting (per applicable ANSI specifications)  
Flange only available in stainless steel.

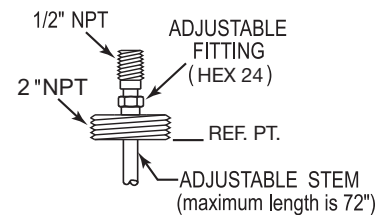

**Adjustable Stem**  
Only available with flange and 'T' type connections

# Multi Level Switch

**UNS-2000 Series**

## UNS-2000 Series Order Form

Formerly Series BLS-800

Check Boxes to Select Specification Requirements

Description:

UNS 2000 -

### Product Configurator

Example	UNS 2000	-VA	/ T2NPT	-KL6C	-VA52	L2	/ 2.1	-(DR)-(VV)-HT-U-PT100-TP/XX.X-Exi
---------	----------	-----	---------	-------	-------	----	-------	-----------------------------------

#### Basic Configuration

UNS 2000 Level switches type

Check Required Specs

#### Material of Stem

- VA SS316
- MS Brass

#### Mounting Element

- 1/2NPT 1/2" NPT mounting (inside tap)
- T1-1/4NPT 1-1/4" NPT tank screw
- T2NPT 2" NPT tank screw
- FLA5 3" Blind flange (150#)

#### Electrical Connection

- ST1 Cube plug DIN 43650, 3-pin + GND
- ST2 Angle plug DIN 43651, 6-pin + GND
- KL6C Aluminum terminal box, 6 terminals with 1/2" NPT conduit
- KL12C Aluminum terminal box, 9 terminals with 1/2" NPT conduit
- PG PG-cable gland with 1 m PVC-cable
- K PCV-cable sealed, specify length at order.
- KXPC Explosion proof junction box with 1/2" conduit
- C 1/2" NPT male conduit (VA only)

#### No. of Switchpoints<sup>2</sup>

L=Level, T=Temperature

- L1 1 Switchpoint @ \_\_\_\_\_ in/mm
- L2 2 Switchpoints @ \_\_\_\_\_ in/mm
- L3 3 Switchpoints @ \_\_\_\_\_ in/mm
- L4 4 Switchpoints @ \_\_\_\_\_ in/mm
- L5 5 Switchpoints @ \_\_\_\_\_ in/mm
- L6 6 Switchpoints @ \_\_\_\_\_ in/mm

See also Connection Groups in table "Max. Switchpoints"

#### Options, please specify when needed

- DR Damping tube
- HT High temperature silicone cable (max 6 wires), (up to +150 °C) 302°F
- U Mounting through bottom
- PT100 PT100-element
- VV Vertical adjustment
- Exi ATEX approval EEx ia
- TP 3A, 12 or 24V DC
- X Contact mode 2 (NC)
- XX Setpoint at rising in °C
- Standard +122 °F / +158 °F / +194 °F (+50 °C / +70 °C / +90 °C)  
Others on request

#### Float Type

	Min. Density	Material	Form	Ø	Max. Temp.	Max. Bar
<input type="checkbox"/> BN30	0.6 g/cm <sup>3</sup>	NBR	Cylinder	30 mm 1-3/16	212 °F (100 °C) - Oil 176 °F (80 °C) - Water	15
<input type="checkbox"/> VA52	0.78 g/cm <sup>3</sup>	Stainless steel, 316	Ball	52 mm 2-1/16	302 °F (150 °C)	40

#### Contact Type of Float

Contact Mode	Contact Rating
<input type="checkbox"/> 1-SPST (NO)	250 V AC / DC, 3 A, 100 VA / W
<input type="checkbox"/> 2-SPST (NC)	250 V AC / DC, 3 A, 100 VA / W
<input type="checkbox"/> 3-SPDT	140 V AC / DC 1 A, 60 VA / W

### Must specify with your orders

Check List:

1 - Overall stem length: L0= \_\_\_\_\_ (in/mm) (Upto 3000mm std.)

2 - Add dimensional position of float

3 - Pick wiring code:

#### Group 1

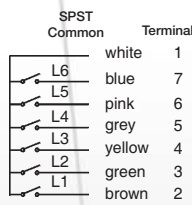

#### Group 2

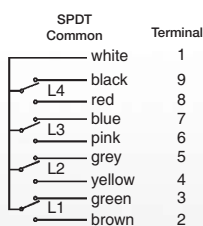

#### Group 3

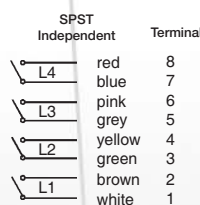

#### Group 4

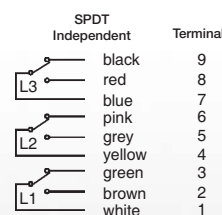

# Multi Level Switch

## UNS-1000 Series

Formerly Series BLS 700

### Features

- ▶ Fully customizable
- ▶ Up to 5 independent switch points
- ▶ Reversible switch logic
- ▶ Suitable for high viscosity liquids
- ▶ Optional integral temperature switch
- ▶ Hermetically sealed reed switches

### Applications

- ▶ Sump tanks
- ▶ Hydraulic power units
- ▶ Storage tanks
- ▶ Solvent recovery systems
- ▶ Lube oil console systems
- ▶ Marine applications



### General Specifications\*

<b>Max. Operating Pressure:</b>	220 psig (15 bar), NBR (BUNA), and SS float
<b>Minimum Specific Gravity:</b>	NBR (BUNA) - .57 g/cm <sup>3</sup> SS - .71 g/cm <sup>3</sup>
<b>Mounting Position:</b>	Vertical, ±30°, through top or bottom
<b>Protection Class:</b>	IP65 for ST-, KL- and PG-design IP67, IP68 on request IP54 for K-design

\* See Product Configurator for additional options.

<b>Operating Temperature:</b>	+14 °F to +221 °F (-10 °C to +105 °C), PVC-cable
<b>Special Design Options: (On Request)</b>	DR - Damping tube HT - High temperature silicone-cable -40 °F to +302 °F (-40 °C to +150 °C) U - Mounting location through bottom PT100 - PT100-element VV - Vertical adjustment Exi - ATEX approval EEx ia
<b>Contact Mode:</b>	NO or NC are defined on the basis of an empty tank and for installation through the top.
<b>Weight:</b>	Dependent on length and design

### Max. Switchpoints

	KL6C AL Terminal Box	KL12C AL Terminal Box	ST1 DIN Connector	ST2 DIN Connector	PG Cable gland
Connect Group 1	5	5	2	5	3
Connect Group 2	2	4	1	2	1
Connect Group 3	3	4	1	3	2
Connect Group 4	2	3	1	2	1

### Combinations

Material	Mounting	Electrical Connection	Float
Stainless Steel (VA)	T1 NPT FLA3	DIN Connector (ST1 & ST2) Terminal box (KL6C or KL12C) Cable gland (PG) PVC Cable (K)	316 Stainless Steel (VA27)
	1/8 NPT 1/2 NPT	Cable gland (PG) PVC Cable (K)	
Brass (MS)	T1 NPT	DIN Connector (ST1 & ST2) Terminal box (KL6C or KL12C) Cable gland (PG) PVC Cable (K)	NBR BUNA-N (BN25)
	1/8 NPT 1/2 NPT	Cable gland (PG) PVC Cable (K)	

### Wiring Color / Code

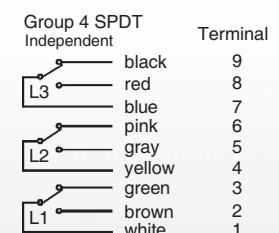
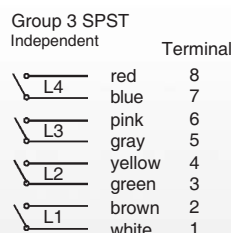
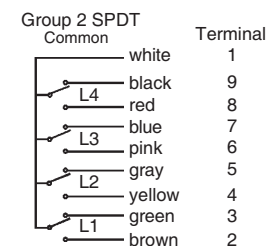
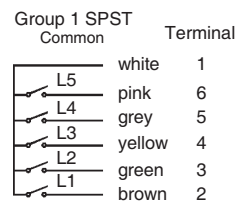

**Barksdale**  
CONTROL PRODUCTS

Barksdale, Inc./Barksdale GmbH  
A Subsidiary of Crane Co.

# Multi Level Switch

# UNS-1000 Series

## Technical Drawing

## Formerly Series BLS 700

Dimensions in inch (mm)

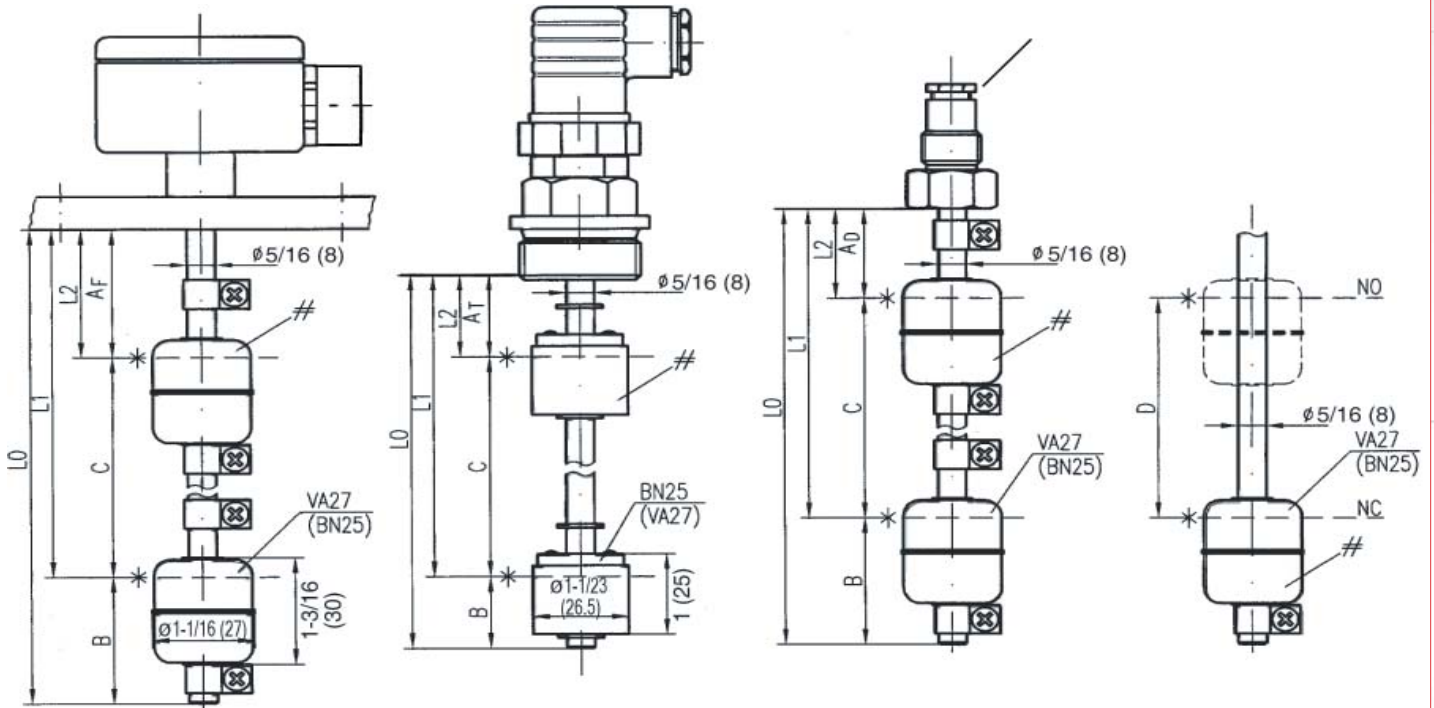

With Aluminum Junction Box and 1/2" NPT Female Conduit (KL6C or KL12C)

With DIN Connector (ST1)

With Cable gland (PG)

Dual switching (1 float for 2 switchpoints)

1. Length tolerance  $\pm 1/8"$  ( $\pm 3$  mm)
2. L0 = max. 40 in. (1000 mm)

\* Immersion depth at density 1:

VA27 = 13/16 in  $\pm 0.1$  in (21  $\pm 2$  mm)

BN25 = 1/2 in  $\pm 0.1$  in (13  $\pm 2$  mm)

Temperature sensor PT100=dimension B+10mm

# Float position:

VA27 = NO/NC  $\Rightarrow$  see float marking

SPDT  $\Rightarrow$  NO-function

BN25 = NO  $\Rightarrow$  compound points at bottom

NC  $\Rightarrow$  compound points at top

SPDT  $\Rightarrow$  compound points at bottom

Dimensions	Min. distances in inch/mm					
	A <sub>F</sub>	A <sub>T</sub>	A <sub>D</sub>	B	C	D
Float type						
VA27	1/26	1/26	1/26	1.6/40	2.56/65	1.25/32
BN25	.86/22	.86/22	.86/22	1/25	1.78/45	1.25/32

(When using -DR: Dimension B + 3/4" (20 mm)!) on request

### Mounting Types:

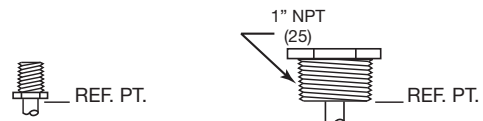

1/8" or 1/2" NPT Male

T1" NPT

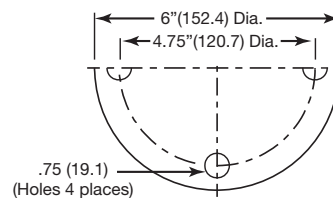

FLA3

2" 150# Flange  
Flange DJN2527  
DN50/PN16

# Multi Level Switch

# UNS-1000 Series

## UNS-1000 Series Order Form

Formerly Series BLS 700

Check Boxes to Select Specification Requirements

Description:

UNS 1000 - \_\_\_\_\_ / \_\_\_\_\_ - \_\_\_\_\_ - \_\_\_\_\_ - \_\_\_\_\_ / \_\_\_\_\_ - \_\_\_\_\_

Special P/N to be assigned once order is received: L700XXX

### Product Configurator

Example	UNS 1000	-VA	/ T1NPT	-KL6C	-VA27	-L2	/ 2.1	-U-HT-(DR)-(VV)-PT100-Exi
---------	----------	-----	---------	-------	-------	-----	-------	---------------------------

#### Basic Configuration

UNS-1000 Series Level switch type

#### Material of Stem

<input type="checkbox"/>	VA	316 SS
<input type="checkbox"/>	MS	Brass

#### Mounting Element

<input type="checkbox"/>	1/8NPT	1/8" NPT, mounting thread (inside tap)
<input type="checkbox"/>	1/2NPT	1/2" NPT, mounting thread (inside tap)
<input type="checkbox"/>	T1NPT	1" NPT tank screw
<input type="checkbox"/>	FLA3	Blind flange, 2" 150 lbs RF (ANSI) (VA only)

#### Electrical Connection

<input type="checkbox"/>	ST1	Cube plug DIN 43650, 3-pin + earth
<input type="checkbox"/>	ST2	Angle plug DIN 43651, 6-pin + earth
<input type="checkbox"/>	KL6C	Aluminum terminal box, 6 terminals w/ 1/2" NPT conduit
<input type="checkbox"/>	KL12C	Aluminum terminal box, 9 terminals w/ 1/2" NPT conduit
<input type="checkbox"/>	PG	PG-cable gland with 1 m PVC-cable (22 AWG)
<input type="checkbox"/>	K	PCV-cable sealed std 1 meter (22 AWG)
<input type="checkbox"/>	KXPC	Explosion proof junction box with 1/2" conduit female
<input type="checkbox"/>	C	1/2" NPT male conduit (VA only)

#### No. of Switchpoints\*\*\*

<input type="checkbox"/>	L1	1 Switchpoint @ _____ in / mm
<input type="checkbox"/>	L2	2 Switchpoints @ _____ in / mm
<input type="checkbox"/>	L3	3 Switchpoints @ _____ in / mm
<input type="checkbox"/>	L4	4 Switchpoints @ _____ in / mm
<input type="checkbox"/>	L5	5 Switchpoints @ _____ in / mm

#### Float Type

	Min. Density	Material	Form	Dia. (Ø)	Max. Temp.	Pressure (+20 °C)
<input type="checkbox"/>	BN25	0.57 g/cm <sup>3</sup>	BUNA NBR	Cylinder 1" / 25 mm	212 °F (100 °C)	15 bar
<input type="checkbox"/>	VA27	0.71 g/cm <sup>3</sup>	Stainless steel, 316	Cylinder 1-1/16" / 27 mm	302 °F (150 °C)	15 bar
<input type="checkbox"/>	VA44	0.67 g/cm <sup>3</sup>	Stainless steel, 316	Ball 1-3/4" / 44 mm	302 °F (150 °C)	15 bar

#### Contact Type of Float(s)

	Contact Mode	Contact Rating
<input type="checkbox"/>	1-SPST (NO)	230 V AC / DC, 2 A, 40 VA / W
<input type="checkbox"/>	2-SPST (NC)	230 V AC / DC, 2 A, 40 VA / W
<input type="checkbox"/>	3-SPDT	150 V AC / 100 V DC, 0.2 A, 3 VA / W

### IMPORTANT

#### Must specify with your orders

1 - Overall stem length: L0= \_\_\_\_\_ in/mm max. 40" (1000 mm)

2 - Dimensional position of float\*\*\*

3 - Pick wiring code:

#### Group 1

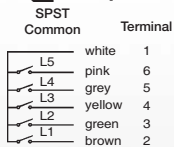

#### Group 2

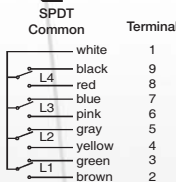

#### Group 3

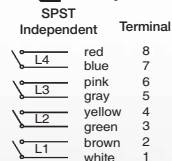

#### Group 4

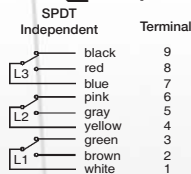

#### Options

Please specify when needed

<input type="checkbox"/>	DR	Damping tube
<input type="checkbox"/>	HT	High temperature silicone-cable (-40 °F to +302 °F (-40 °C to +150 °C))
<input type="checkbox"/>	U	Mounting through bottom
<input type="checkbox"/>	PT100	PT100-element
<input type="checkbox"/>	VV	Vertical adjustment
<input type="checkbox"/>	Exi	ATEX approval EEx ia (Enclosure)

# Level Switch - Plastic

**UNS-PA or PP**

**Formerly Series BLS-7**

## Features

- ▶ Convenient side mount
- ▶ Compact size for easy installation
- ▶ Ideal for small tanks and vessels
- ▶ Durable yet economical
- ▶ Broad media compatibility
- ▶ Hermetically sealed reed switches

## Applications

- ▶ Sump tanks
- ▶ Hydraulic power units
- ▶ Storage tanks
- ▶ Solvent recovery systems
- ▶ Lube oil console systems
- ▶ Food & beverage applications



Level switch made of nylon or polypropylene for side mounting

## General Specifications

<b>Switch Rating:</b>	230 VAC / 3.0 A / 60 VA/W
<b>Switch Configuration*:</b>	Normally open or normally closed; switch can be changed by inverting the assembly 180°
<b>Wetted Parts:</b>	Nylon (Blue - PA) or Polypropylene (Red - PP)
<b>Electrical Connection:</b>	1 meter, PVC cable length; 2-conductor, Max 2 x 0.34mm <sup>2</sup> (22 awg)
<b>Mounting Element:</b>	
External Type:	1/2" NPT thread
Internal Type:	Threaded with jam nut for 5/8" diameter hole (M16x2 metric THD) with silicon gasket
<b>Min. Fluid Specific Gravity:</b>	0.7 g/cm <sup>3</sup> - Nylon 0.65 g/cm <sup>3</sup> - Polypropylene
<b>Protection Class:</b>	IP54

<b>Approvals:</b>	
UL/CSA:	PENDING
<b>Max. Operating Temperature:</b>	
Nylon Versions:	-4 to +248°F (-20 to +120°C)
Polypropylene Versions:	-4 to +194°F (-20 to +90°C)
<b>Operating Pressure:</b>	70 psig @ 70°F (5 bar at 21°C)
<b>Mounting Position:</b>	Horizontal
<b>Max. Starting Torque:</b>	23.6 in/lbs (external mount)
<b>Weight:</b>	Approx. 40 grams (1.4 oz.)

\* The contact modes (NO or NC) are defined on the basis of an empty tank and orientation of the level switch mounted.



### Technical Drawing

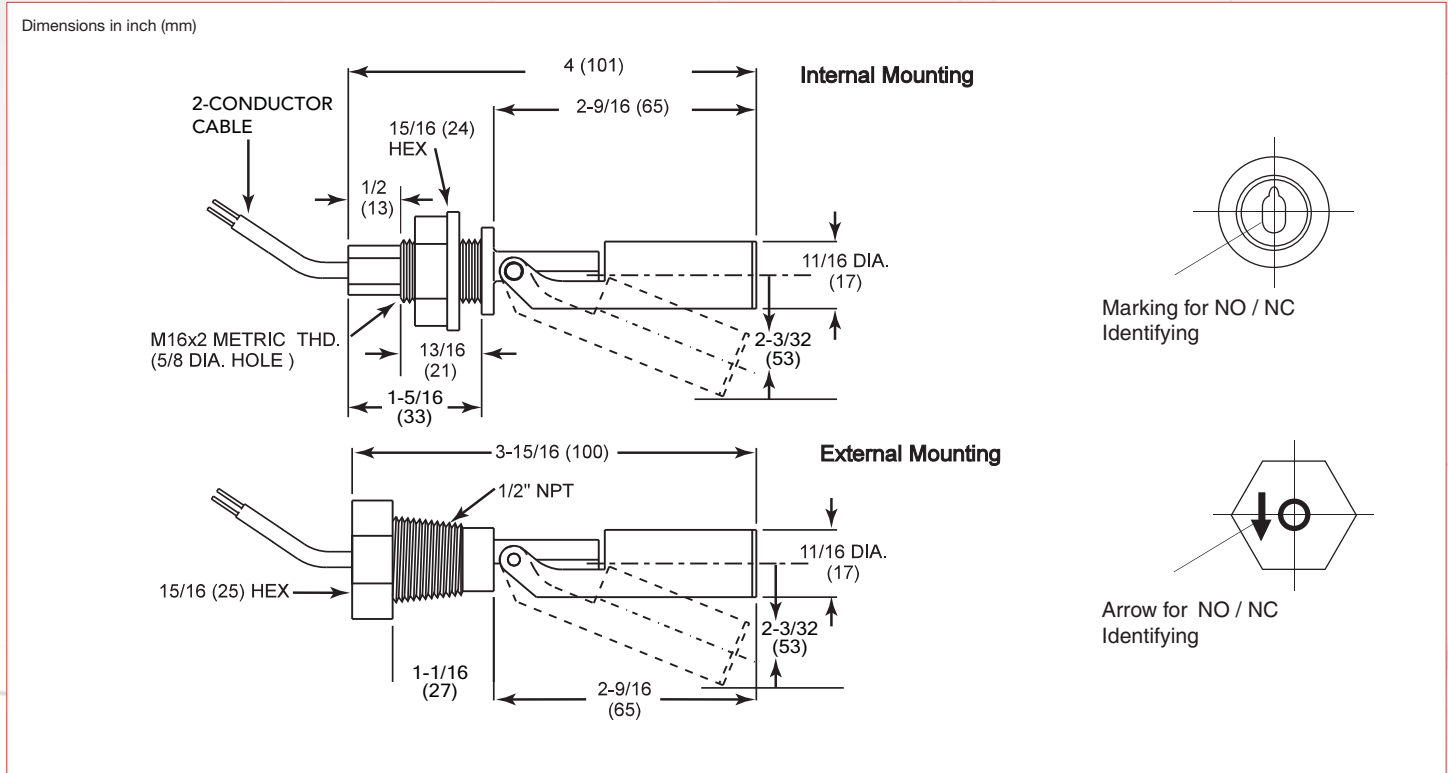

### Order Number Key / Options

MATERIAL	MOUNTING OPTION	Type	Order No.
Nylon (Blue)	1/2" NPT External	UNS-PA1/2" NPT-PA18	0111-203
	Internal (for 5/8" diameter hole)	UNS-PA16 NPT-PA18	0111-199
Polypropylene (Orange / Red)	1/2" NPT External	UNS-PP1/2" NPT-PP18	0111-327
	Internal (for 5/8" diameter hole)	UNS-PP16 NPT-PP18	0111-210

\* NOTE: for longer cables please add -suffix -Wxx  
xx=inches



## Bilge Guard Level Switch

**UNS-VA/SB5 or B4**

### Features

- ▶ Rugged 316 stainless steel
- ▶ Built-in slosh shield
- ▶ Ideal for high viscosity liquid
- ▶ Reversible switch logic
- ▶ Hermetically sealed reed switches

### Applications

- ▶ Sump tanks
- ▶ Storage tanks
- ▶ Solvent recovery systems
- ▶ Lube oil console systems
- ▶ Marine applications



### General Specifications\*

<b>Switch Rating SPST:</b>	230 VAC/VDC @ 2.0 amps (Max.); 40 VA/W
<b>Switch Configuration:</b>	Shipped as Normally Open (NO); Can be converted to Normally Closed (NC) by rotating float 180°.
<b>Wetted Parts:</b> Stem, Bracket & Slosh Shield:	316 Stainless Steel
Float:	Polyethylene (PE)
Cable:	Halogen-free polymer, UL-VO
Strain Relief:	Polyamide (PA)

<b>Electrical Connection:</b>	Polymer jacketed cable, 2-conductor 18 AWG (yellow cable)
<b>Mounting:</b>	Suspended from cable / vertical $\pm 15^\circ$
<b>Minimum Specific Gravity:</b>	0.8 g/cm <sup>3</sup>
<b>Operating Temperature:</b>	-4° to +158°F (-20° to +70°C)
<b>Operating Pressure:</b>	45 psig (3 bar) at 20°C
<b>Cable Length:</b>	6 ft., 30 ft., or 45 ft.
<b>Weight:</b>	Approx. 180 gram

\* See Order Number Key for additional options.

### Wiring Color / Code

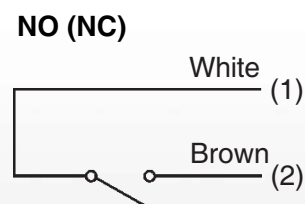

## Technical Drawing

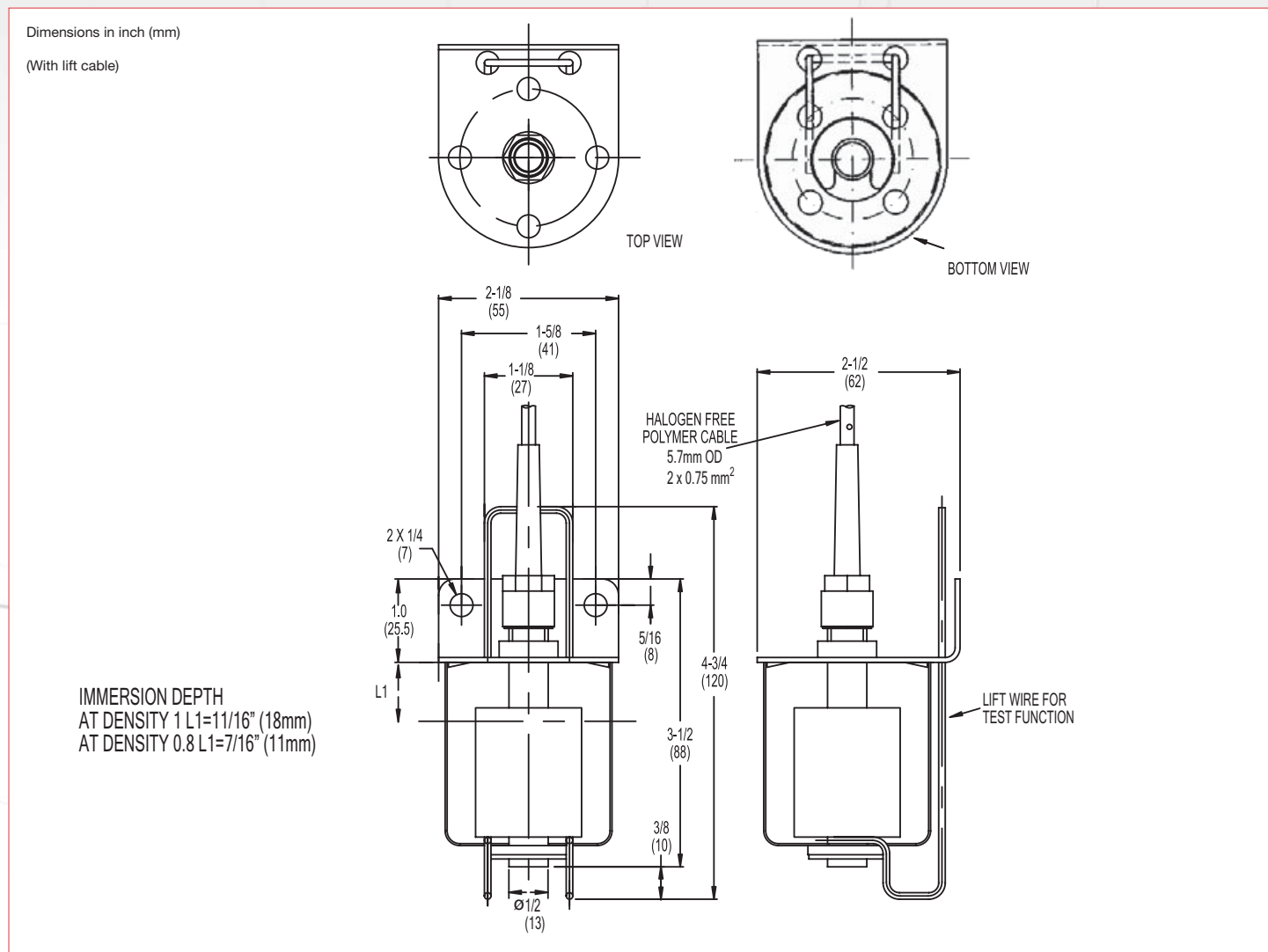

## Order Number Key / Options

With Lift Wire

TYPE MODE	CONTACT	MODE	CABLE TYPE/LENGTH	ORDER NO.
UNS-VA/SB5 Bilge Guard	(NO) NC <sup>1,2</sup>	Reversible	Polymer / 6 ft (2 m)	0111-510
	(NO) NC <sup>1,2</sup>	Reversible	Polymer / 30 ft (10 m)	0111-531
	(NO) NC <sup>1,2</sup>	Reversible	Polymer / 45 ft (15 m)	0111-534

Without Lift Wire

TYPE MODE	CONTACT	MODE	CABLE TYPE/LENGTH	ORDER NO.
UNS-VA/SB4 Bilge Guard	(NO) NC <sup>1,2</sup>	Reversible	Polymer / 6 ft (2 m)	0111-509
	(NO) NC <sup>1,2</sup>	Reversible	Polymer / 30 ft (10 m)	0111-524
	(NO) NC <sup>1,2</sup>	Reversible	Polymer / 45 ft (15 m)	0111-528

Note: All switch contacts are SPST

<sup>1</sup> Shipped as NO (standard). Rotate float by 180° for NC.

<sup>2</sup> If NC is required, then add suffix-"NC" to ordering number (i.e. 0111-510-NC).

## Features

- ▶ Easy replacement for sight glasses
- ▶ Small diameter ideal for use in tight spaces
- ▶ Rugged construction for long life and maintenance free use
- ▶ Customized to meet your exact specifications

## Applications

- ▶ Lube oil console systems
- ▶ Hot water/condensate steam systems
- ▶ Industrial refrigeration
- ▶ Storage tanks
- ▶ Solvent recovery systems
- ▶ Marine applications
- ▶ Industrial refrigeration
- ▶ Scrubbers
- ▶ Semi-conductor industry



## General Specifications\*

<b>Ranges:</b>	Standard polycarbonate flag assembly to 302°F (150°C)
Temperature:	
Pressure:	Vacuum to 240 psig (16 bar) @ 100°F (38°C)
Proof Pressure:	1.5 x operating pressure
<b>Accessories:</b>	<ul style="list-style-type: none"> <li>- Limit switches</li> <li>- Measuring scale</li> <li>- Remote continuous tank level indicating system</li> <li>- ANSI flange fittings</li> <li>- ABS approval for shipboard services</li> </ul>
<b>Maximum Length:</b>	<ul style="list-style-type: none"> <li>- 10 feet - continuous (3000 mm)</li> <li>- 20 feet - maximum</li> </ul>
<b>Inner Float Housing Diameter:</b>	1-1/2" (40 mm)
<b>Viscosity:</b>	< 2500 cP
<b>Float Housing Material:</b>	316 Series stainless steel Titanium and BUNA available <sup>1</sup>

<b>Process Connection Size:</b>	See configurator
<b>Operating Pressure Max.:</b>	240 psi (16 bar)
<b>Operating Temperature Max.:</b>	302°F (150°C)
<b>Rotating Flag Assembly:</b>	Polycarbonate 302°F (150°C)
<b>Flag Colors:</b>	White/Red
<b>Float Size:</b>	1.25" dia. x 5.9" (32 x 150 mm) (std)
<b>Float Material:</b>	316 stainless steel (std)
<b>Min. Specific Gravity of Liquid:</b>	0.85 g/cm <sup>3</sup> stainless steel and titanium 0.62 Lg/cm <sup>3</sup> for BUNA
<b>Internal O-Ring:</b>	Teflon®
<b>Vent &amp; Drain Plugs:</b>	1/2" NPT (standard)
<b>Mounting Brackets:</b>	Every 3 feet (standard)

\* See product configurator for additional options.

<sup>1</sup> Titanium float recommended for temperatures greater than 302°F.

## Technical Drawing

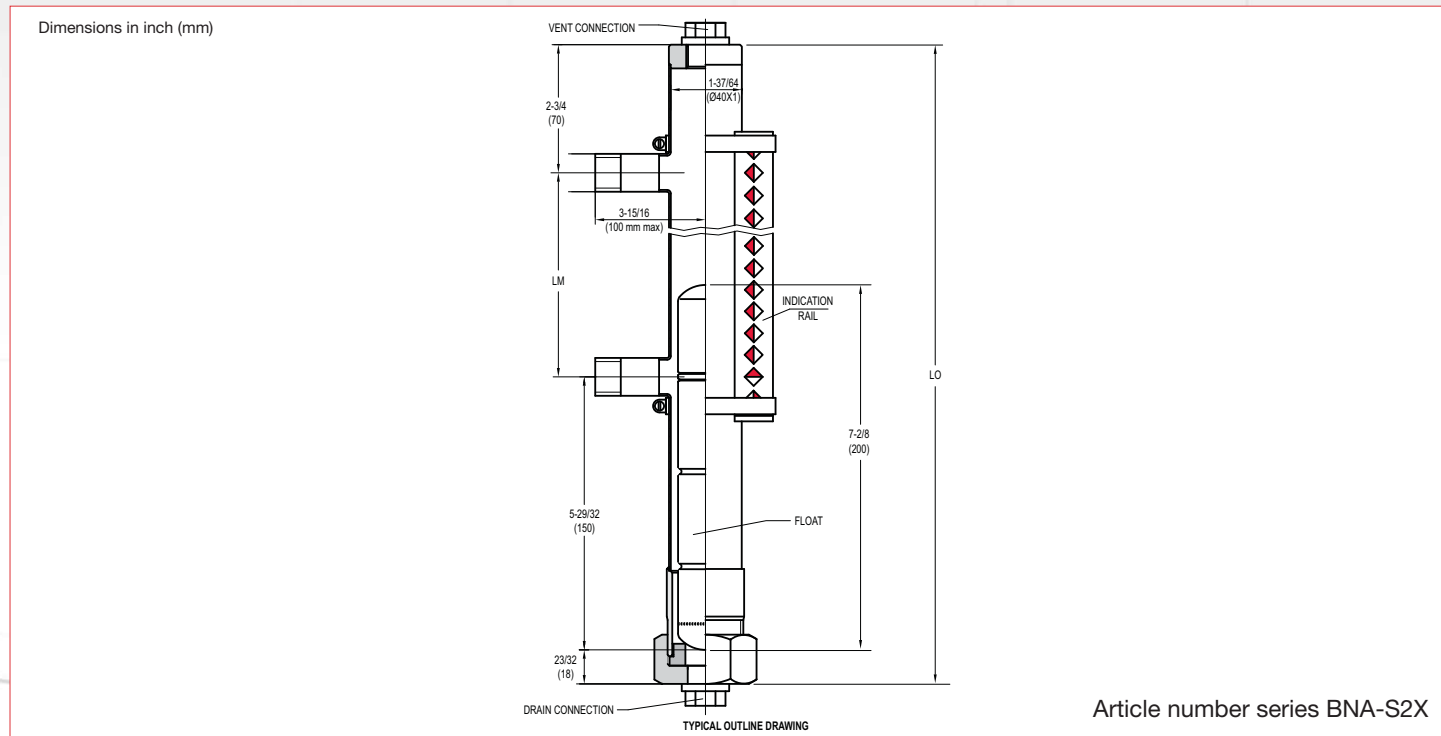

## Order Number Key / Options

Example	LMSSM	F01	GP	28.00	L	
---------	-------	-----	----	-------	---	--

### Base Configuration

LMSSM	Top/bottom process connections
LMTBM	Top/side process connections
LMTSM	Side/side process connections
LMSBM	Side/bottom process connections

### Process Connection

N01	1/2" NPT male
N02	3/4" NPT male
N03	1 NPT male (for LMSSM models only)
N06	1/2" NPT female
N07	3/4" NPT female
F01	ANSI Class 150 1/2" raise face flange
F02	ANSI Class 150 3/4" raise face flange
F03	ANSI Class 1" raise face flange

Metric connections available upon request

### Options

-T	Optional 4-20 mA level transmitter (round up to nearest inch)
-SK	Calibrated self-adhesive scale in Cm (Scotch 467 MP Hi)

Limit switches available - separate line item.

### Flag Assembly

L	Polycarbonate flag assembly 302°F (150°C)
---	---

### Float Type

GP	Stainless steel float (specific gravity = 0.85 or higher). Temp: 302°F (150°C). Pressure: 350 psi (24 bar)
GT	Titanium float (specific gravity = 0.85). Temp: 305°F (150°C). Pressure: 580 psi (40 bar)
GQ	Buna float (specific gravity = 0.65 min). Temp: 212°F (100°C). Pressure: 150 psi (10 bar)

### Length

LL.LL	Measuring length in inches
-------	----------------------------

\* Min. quantity may apply for select configurations.

**Features**

- ▶ Safe, accident-proof design
- ▶ Rugged, welded stainless steel construction
- ▶ Maintenance-free - no need to be removed from service for cleaning

**Applications**

- ▶ Lube oil console systems
- ▶ Hot water/condensate steam systems
- ▶ Industrial refrigeration
- ▶ Storage tanks
- ▶ Solvent recovery systems
- ▶ Marine applications
- ▶ Industrial refrigeration
- ▶ Scrubbers
- ▶ Semi-conductor industry



**General Specifications\***

<b>Ranges:</b> Temperature:	To 302°F (150°C)
Pressure:	Vacuum to 1,000 psig (68 bar) at 100°F (38°C)
Proof Pressure:	1.5 times maximum flange pressure @ 72°F (22°C)
<b>Accessories:</b>	- Limit switches - Measuring scale - Remote continuous tank level indicating system - Aluminum rotating flag assembly
<b>Maximum Length:</b>	- 20 feet - continuous (6,000 mm) - 65 feet - multiple (19,800 mm)
<b>Inner Housing Diameter:</b>	2-3/8" (60 mm)
<b>Wall Thickness:</b>	5/64" (2 mm)
<b>Float Housing Material:</b>	316 stainless steel or titanium <sup>1</sup>

<b>Process Connection Size:</b>	See configurator		
<b>Operating Pressure Max. @ 100°F (38°C):</b>	150 psig (10 bar)	600 psig (40 bar)	960 psig (64 bar)
<b>Operating Temperature Max.:</b>	302°F (150°C) maximum		
<b>Rotating Flag Assembly:</b>	Polycarbonate: 302°F (150°C), Optional: painted aluminum to 600°F (316°C)		
<b>Flag Colors:</b>	White/Red		
<b>Float Size:</b>	2-5/64" (58.67 mm) diameter x 7-7/8 (200.2 mm) length		
<b>Float Material:</b>	316 stainless steel		
<b>Min. Specific Gravity of Liquid:</b>	0.65 stainless steel 0.65 Titanium		
<b>Vent &amp; Drain Plugs:</b>	1/2" NPT (standard)		
<b>Mounting Brackets:</b>	Every 3 feet (standard)		

\* See product configurator for additional options.

<sup>1</sup> Titanium float recommended for temperature greater than 302°F.

Technical Drawing

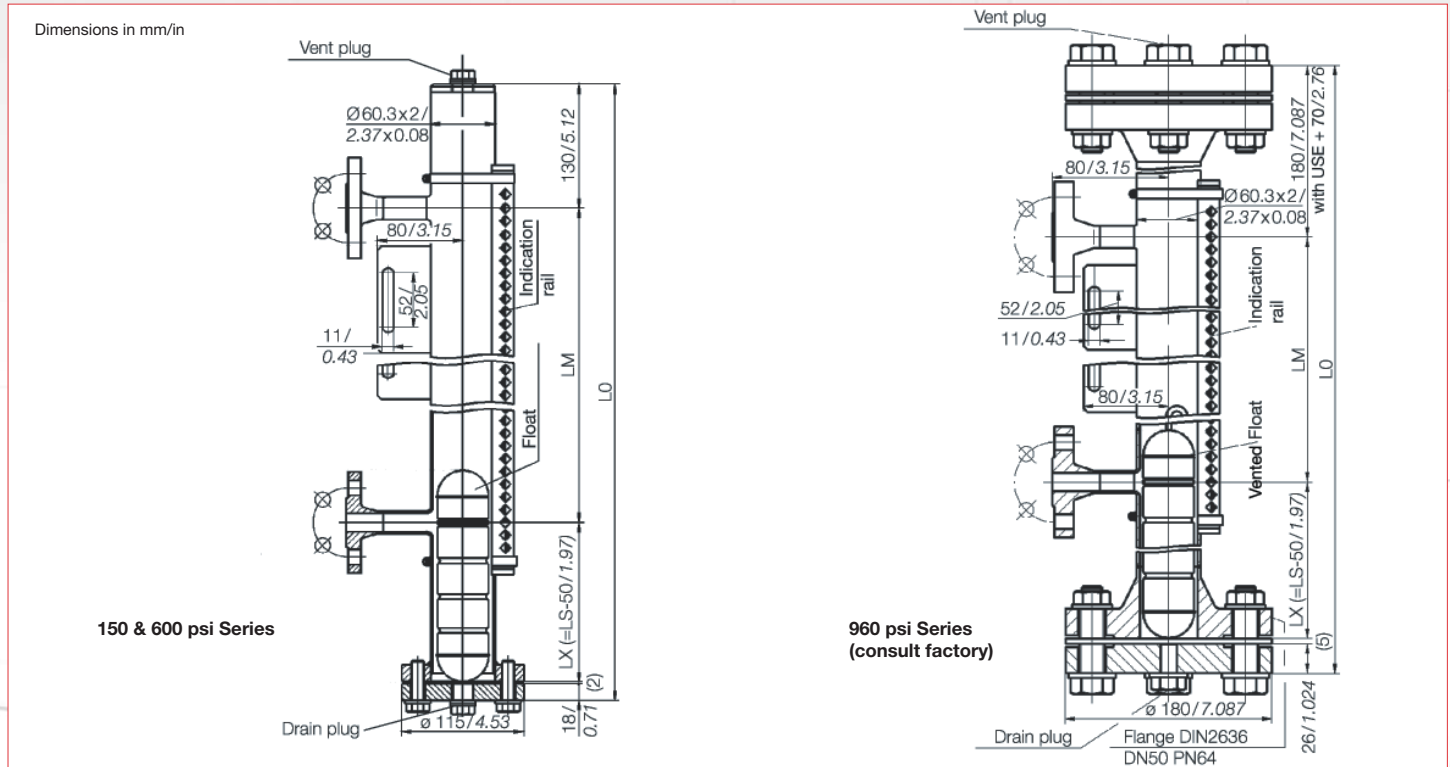

Order Number Key / Options

Example	600	LSSM	N02	GA	75.25	L	-T
---------	-----	------	-----	----	-------	---	----

System Pressure

150 psi	BNA-S3X
600 psi	BNA-S4X
960 psi	BNA-S5X

Process Connection

N01	1/2" NPT male
N02	3/4" NPT male
N03	1" NPT male (for LMSSM models only)
N04	1-1/2" NPT Male
N06	1/2" NPT Female
N07	3/4" NPT Female
N08	1" NPT Female
N09	1-1/2" NPT Female
N10	2" NPT Female
F01	ANSI Class 150 1/2" Raised Face Flange
F02	ANSI Class 150 3/4" Raised Face Flange
F03	ANSI Class 150 1" Raised Face Flange
F04	ANSI Class 150 1-1/2" Raised Face Flange
F05	ANSI Class 150 2" Raised Face Flange
F06	ANSI Class 300 1/2" Raised Face Flange
F07	ANSI Class 300 3/4" Raised Face Flange
F08	ANSI Class 300 1" Raised Face Flange
F09	ANSI Class 300 1-1/2" Raised Face Flange
F10	ANSI Class 300 2" Raised Face Flange

Options

-T	Optional 4-20 mA level transmitter (round up to nearest inch)
-SK	Calibrated self-adhesive scale in Cm (Scotch 467 MP Hi)

Limit switches available - separate line item

Base Configuration

LTBM	Top/bottom process connections
LTSM	Top/side process connections
LSSM	Side/side process connections
LSBM	Side/bottom process connections
LTMM	Top mount configuration

Flag Assembly

L	Polycarbonate flag assembly (302°F)
M	Anodized aluminum flag assembly (400°F)
H	Painted aluminum flag assembly (600°F)

Length

LL.LL	Measuring length in inches
-------	----------------------------

Float Type <sup>1</sup>

GA	Stainless steel (specific gravity = 0.75 min). Temp: 302°F (150°C). Pressure: 360 psi (25 bar) Can only be installed in the BNA-S3X
GF	Titanium (specific gravity = 0.60 min). Temp: 608°F (320°C). Pressure: 580 psi (40 bar)

<sup>1</sup> Special float required for pressure greater than 580 psi



# LevelSite® Accessories

## Limit Switches

Barksdale offers a line of limit switches that can be positioned on the outside of the LevelSite® housing to activate alarms, pumps, or valves when the fluid reaches a prescribed level. The number of limit switches that can be attached to the LevelSite® is limited only by the available space on the exterior surface of the housing. Switches can be located in any radial position 360° around the housing. This flexibility allows other control components to be mounted at the same level. Limit switches are easily installed with stainless steel clips and a screwdriver. Switches rated for use in hazardous areas are available (an approved safety barrier device may be required).

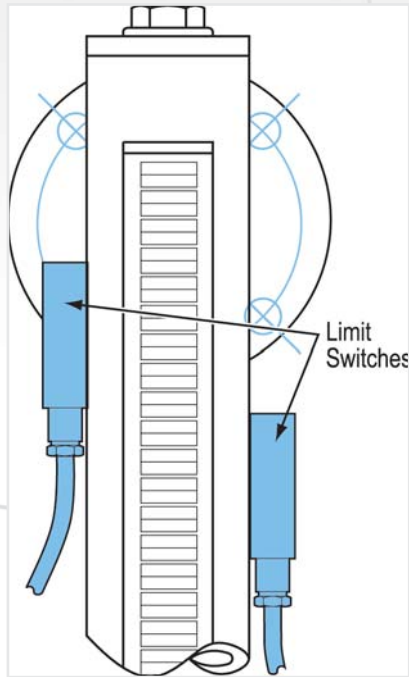

Limit Switches, SPDT w/ 1 meter cable	
Operating Temperature	Contact Rating
-67°F to +284°F	60 VA 0.8 A at 230 VAC 0.8A at 220 VDC

Order No.	Limit Switch
0303-031	GK03 1m PVC cable
0303-028	GK03 1m Si cable
0303-032	GK03 3m PVC cable
0303-029	GK03 3m Si cable
0303-033	GK03 5m PVC cable
0303-030	GK03 5m Si cable
0303-035	GK03-EXI 1m PVC cable
0303-036	GK03-EXI 5m PVC cable
0303-003	GKHT1 high temperature

## Indicating Scales

To qualify the visual indication provided by the rotating flags, a calibrated scale can be attached to the flag housing. Standard calibration of the scale is in inches, and custom scale graduations are available. Scales are printed in black letters on white Mylar film and bonded on aluminum backing.

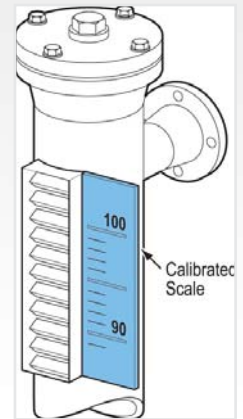

Part No.	Description
31850-XX	Printed Mylar scale on aluminum backing <sup>1</sup>

## Electronic Tank Level Indicators (4-20 mA):

As a supplement to the visual indication provided by a LevelSite®, Barksdale's continuous Tank Level Indicating (TLI) system provides a continuous 4-20 mA output signal, which can be used in remote process controls and indicators. The TLI is mounted externally on the LevelSite® housing with stainless steel clips. Since it does not come in contact with the media, it is easy to maintain and remains accurate and reliable through many years of service.

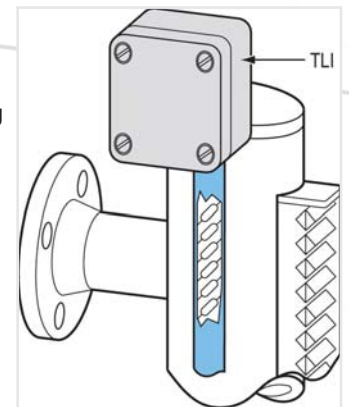

Part No.	Description
LTIM-30-XX	Tank Level Indicator (4-20mA)

Spare Floats	
Part No.	Description
905-0158	Stainless Steel float for Mini LevelSite®
905-0179	Stainless Steel float for LevelSite® <sup>2</sup>
905-0188	Titanium float for LevelSite® <sup>2</sup> High pressure float for LevelSite® (Rated to 1,000 psig)

Spare Flag Assemblies	
Part No.	Description
361155-XX	Ploycarbonate (To 250°F) (MA)
361153-XX	Andonized Aluminum (To 400°F) (A1)
361154-XX	Painted aluminum (To 6,000°F) (A2)

NOTE: '-XX' = length in inches



# LevelSite® Accessories

## Features / Description

All GK switches have bi-stable reed contacts. They can be mounted in any position around the tube of a magnet-controlled level indicator with stainless steel clamps, however the cable direction should preferably be downward. The magnet system in the float will switch over the contact whenever the switch is passed. This permits an arbitrary arrangement of many switches on the tube surface without the switches disturbing each other. The switch position must be checked before installation; it can be set with a ring magnet or the float. The switch hysteresis depends on the distance to the magnet system in the float and is smallest when the switches are installed closely along the indication rail.

## Applications

Limit value measuring on magnetically controlled level indicators

## General Specifications\*

<b>Housing:</b> GK 03: GK HT1:	1.4305 and M 16 x 1.5 cable gland Aluminum, 65x65x40 mm and PG 9 Cable gland
<b>Cable:</b> GK 03:	Silicone 3 x 0.5 mm <sup>2</sup> , length 1.3 m or 5 m, or PVC 3 x 0.34 mm <sup>2</sup> other lengths or versions on request
<b>Protection class:</b>	IP 65
<b>Switching power:</b> GK 03:	220 V AC / 1.0 A / 60 VA, 220 V AC / 1.0 A / 40 VA,
<b>Temperature range:</b> GK 03: GK HT1:	-67 °F... +284 °F (-55 °C... +140 °C) -67 °F... +662 °F (-55 °C... +350 °C)
<b>Option:</b> GK 03:	Grounding clip
<b>Approvals:</b> GK 03:	EX II GD EEx ia IIC T6 / ISSeP03ATEX119X

## Order Numbers

Order No.	Limit Switch
0303-031	GK03 1m PVC cable
0303-028	GK03 1m Si cable
0303-032	GK03 3m PVC cable
0303-029	GK03 3m Si cable
0303-033	GK03 5m PVC cable
0303-030	GK03 5m Si cable
0303-035	GK03-EXI 1m PVC cable
0303-036	GK03-EXI 5m PVC cable
0303-003	GKHT1 high temperature



## Technical Drawing

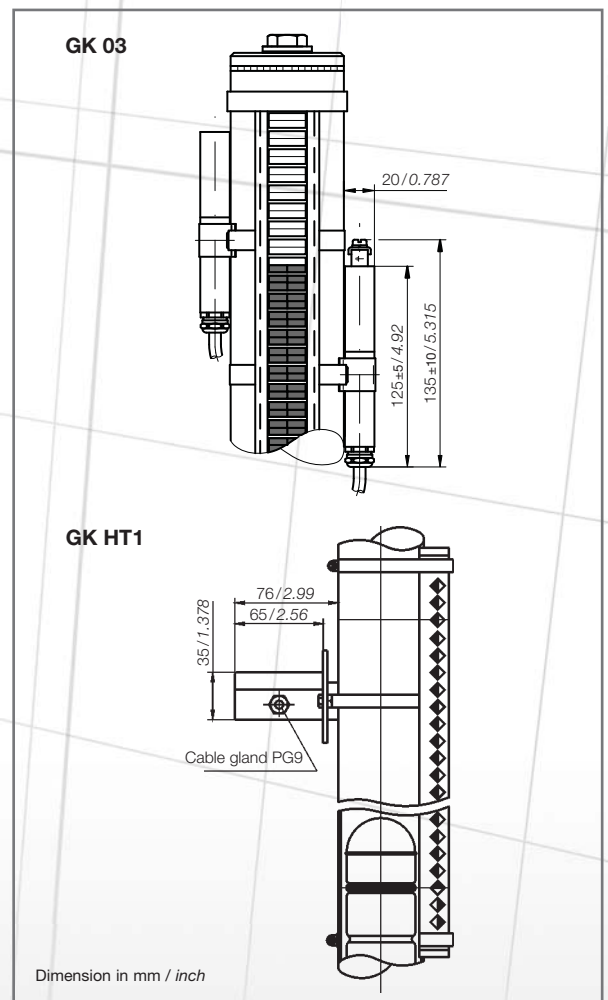

# LevelSite® Supplemental Guide

## Features

Model LSSM  
in Typical System

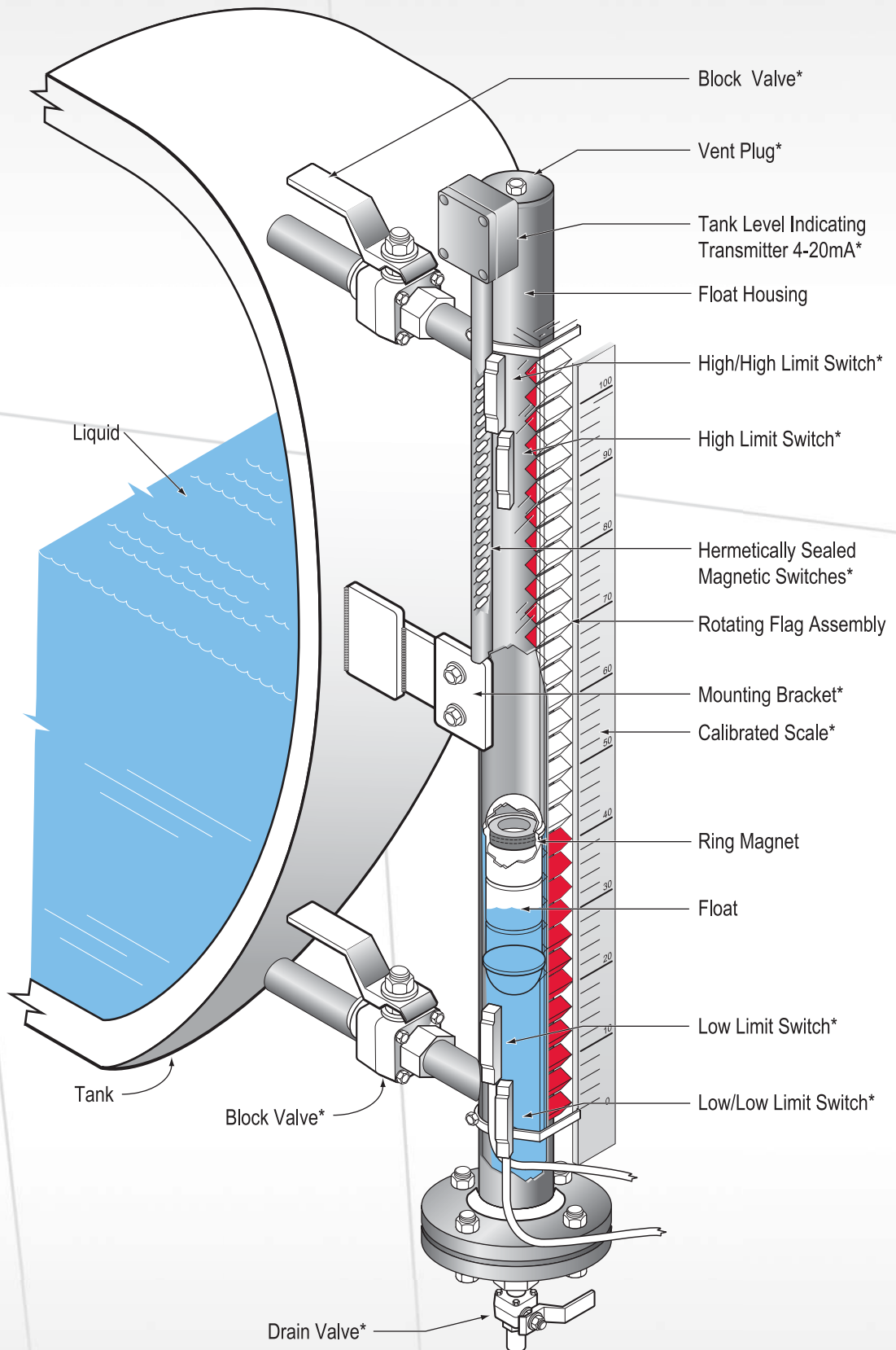
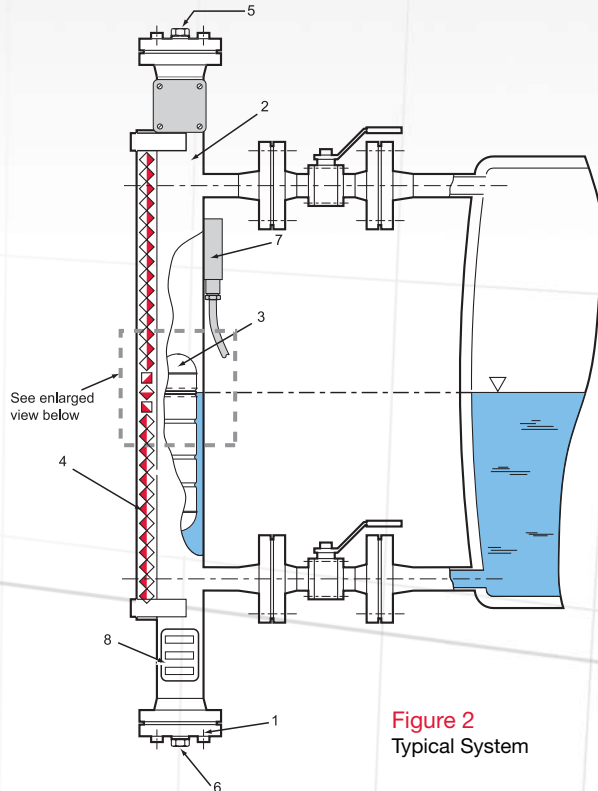

Figure 1

## Operating Principle

LevelSite® is a magnetic rotary indicator. It is a reliable level measurement system for applications with operating pressures to 4500 psig (310 bar), operating temperatures to 600°F (316°C), and with liquid to a minimum specific gravity of 0.5049.



**Figure 2**  
Typical System

LevelSite®'s visual indicators and electrical switches are isolated from the liquid; the tank remains sealed from the surrounding environment (See Figure 2). Accidental spills from sight-glass breakage are eliminated.

LevelSite® consists of 3 major components: the float housing, a magnetic float, and the rotating flag assembly. The float housing is an engineered pressure vessel which is externally mounted to the tank. The float housing is designed to handle the same temperatures and pressures found in the tank. It is fabricated from a variety of materials, depending on the application. The alloy models are usually stainless steel. Engineered plastic models use polyvinylchloride (PVC), polypropylene (PP) or polyvinylidene fluoride (PVDF). Other materials are available on request.

The float (See Figure 3), is equipped with a permanent ring magnet assembly. This assembly rides at the surface of the liquid contained within the float housing, rising and falling as the liquid in the tank rises and falls.

As the float moves up and down, a magnetic flux field maintains continuous contact with the rotating flags mounted on the outside of the float housing. Flag rotation occurs as the flux

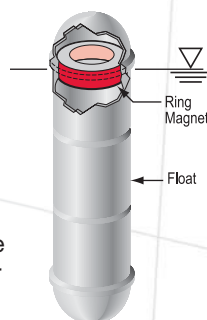

**Figure 3**  
Standard Alloy Float

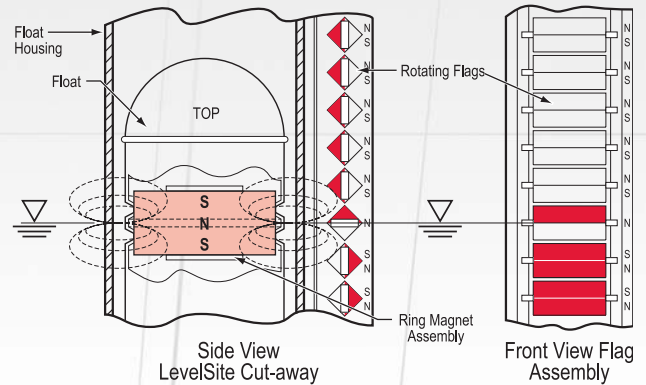

**Figure 4**  
Interaction between Float and Flags

field from the permanent ring magnet acts on the magnets embedded in each flag (See Figure 4). The rotating flags below the level of the liquid in the float housing show their red side and those above show their white side.

The special permanent ring magnet design provides a 360 degree magnetic flux field. This allows the rotating flag assembly, limit switches and continuous level sensors to be located anywhere around the float housing. Troublesome guide wires and rods, and magnetic tape on the indicating flag housing are eliminated.

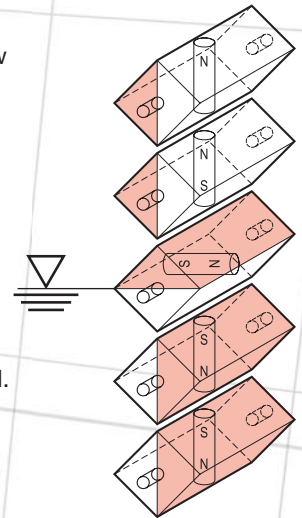
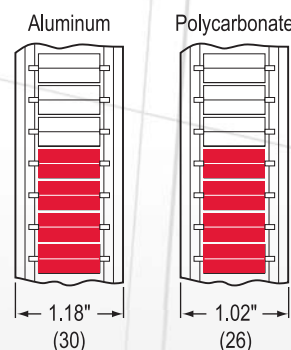

**Figure 5**

## Visual Indication

LevelSite®'s rotating flag assembly provides maximum visibility and has a resolution of 1/2" (12.7 mm). Rotating flags have a square profile with embedded permanent magnets. The flux field generated by the ring magnet in the float interacts with the flag magnets causing them to rotate as the float moves up and down inside the housing. After the flags rotate to the new position, the embedded magnets lock the flags in place, making the flags less sensitive to vibration (See Figures 4 and 5).

LevelSite®'s rotating flags are mounted in a housing fabricated of extruded aluminum or polycarbonate. The assembly is attached to the outside of the float housing with stainless steel clamps. The ends are sealed against dust and moisture. Since the flags are never in contact with the liquid, they never need to be cleaned and they can't discolor. If the rotating flag assembly is accidentally crushed, there is no danger of a liquid spill. The rotating flag assembly is available in aluminum or polycarbonate and measures 1.18" (30 mm) and 1.02" (26 mm) wide, respectively (See Figure 6).



**Figure 6**

Aluminum flags are offered in an anodized finish of red and silver or painted in red and white. Anodized flags are suitable for service up to 400°F (200°C); painted versions can be subjected to 600°F (316°C). A glass pane protects the flags. The housing is extruded, black anodized aluminum.

Polycarbonate flag housings are clear and impact-resistant. They offer 180° visibility of the flags; level can be seen from front and sides (See Figure 5). Housing and flags can withstand temperatures to 250°F (121°C). Standard flag colors are red and white.

## System Specifications

LevelSite®s are designed according to the unique requirements of each application. Based on information provided by the user regarding operating temperature, pressure, and “normal” specific gravity of the liquid, a float is selected appropriate to the application. Maximum and minimum conditions are evaluated to ensure that the LevelSite® will function not only at the normal condition, but at each extreme. Maximum temperature and pressure are parameters used to design the pressure vessel (float housing).

Barksdale applies their own standards in the design of LevelSite®s. Figures 8 and 9 can be used as a guide in selecting the ANSI class flanges and materials appropriate for your temperature and pressure conditions.

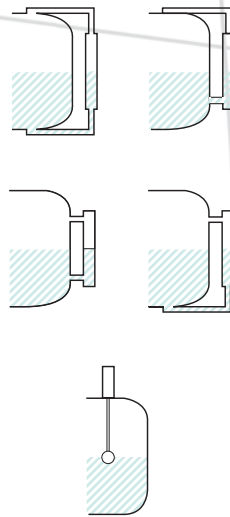

Figure 7

## Configuration

Barksdale’s LevelSite® is a unique system that can be custom designed for many types of applications, from a stand-alone, no-power-required level indicator to a fully-integrated electronic component within a process control system. It can be supplied with process connections located for any of the four standard patterns: top/bottom, top/side, side/side, or side/bottom (See Figure 7). For applications where tank-side mounting of the LevelSite is not practical or desired, top mounted versions are available. Liquid interface configurations require three process connections (See Figure 7).

## Quality

Quality and dependability are built into every Barksdale LevelSite. As a registered ISO 9001 manufacturer, Barksdale meets the most demanding international standards. LevelSite® can be certified to ASME, ANSI, DIN, BSP and other codes.

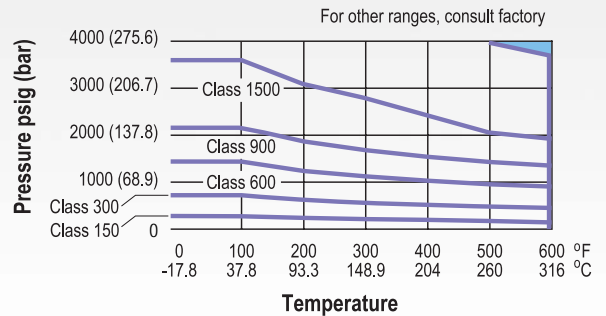

## Material

Pressure/temperature performance parameters for LevelSite housing constructed of 316 stainless steel are specified in the chart. Please consult the factory with pressures/temperatures requiring other alloys.

Figure 8

Alloy - maximum operating pressure vs. temperature for ANSI classification.

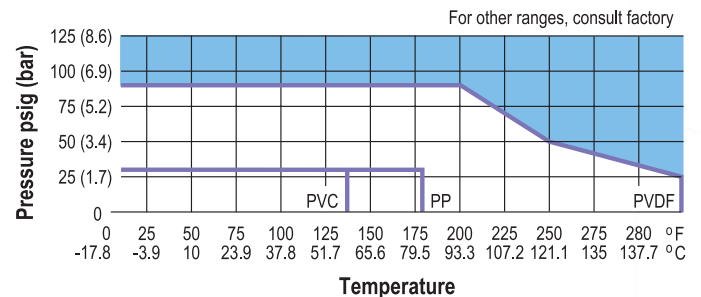

## Material

Pressure/temperature performance parameters for LevelSite housing constructed of PVC, PP or PVDF are specified in the chart. Please consult the factory with pressures/temperatures requiring other materials.

Figure 9

Engineered plastic - maximum operating pressure vs. temperature



## General Installation

LevelSite®s are measuring instruments and must be properly treated as such. Make sure that all parts are available and the connecting flanges on the tank correspond to those on the indicator. The float and limit switches (if applicable) are enclosed in a separate box. Remove the bottom connection flange (1) of the float chamber and insert the float with the top uppermost. Replace the bottom flange with the gasket, fixing it to the chamber by tightening all the bolts securely. The LevelSite® must be raised slowly and carefully so that the float is not damaged by severe impact.

## Mechanical Installation

It is essential to ensure that the flanges on the tank are accurately aligned with the flanges on the LevelSite®. Non-alignment of the flanges causes distortion of the float chamber (2) with the possibility that the float (3) will stick. The LevelSite® must always be mounted vertically. Before commissioning, the flags in the flag assembly (4) must be aligned by means of a magnet so that they all show the color white (polycarbonate) or silver (aluminum). NOTE: It is essential for all flange bolts, the vent-plug (5) and the drain-plug (6) to be fully tightened.

## Electrical Installation

The electrical limit switches (7) may be attached at any point in the range on the indicator bar by means of a stainless steel clip. Ensure that the stainless steel clips are installed under the flag assembly. The maximum electrical switching capacity is specified on the nameplate of the limit switch (7) and must not be exceeded. IMPORTANT: The operation of the LevelSite® is based on the magnetic field principle. Ferrous strips, clamps, or screws must not be used.

## Commissioning

LevelSite®s are always application specific. The most important technical data such as pressure and temperature limits are specified accurately on the nameplate (8). However, the sales drawing for the model number referenced on the nameplate is specific and detailed to the application and is the governing specification document. Before commissioning, a check must be made to ensure that the technical data shown on the nameplate corresponds exactly with the plant requirements. NOTE: Test pressure and test temperature of the plant must NOT exceed the specifications.

## Tank Level Indicator (TLI) Installation

The transmitter is installed on the side of the LevelSite® housing, utilizing stainless steel clips, with the transmitter's probe along the housing. The transmitter may be used in addition to a visual indicator (rotating flag assembly) to provide electronic monitoring of fluid level. If the transmitter is used with a flag assembly, it may be necessary to slide the transmitter's clamps under the flag assembly. The transmitter is supplied with a mark on its probe. This mark must line-up with the centerline of the process

connector on the LevelSite®. If the transmitter's probe spans the entire measuring range (center-to-center of the process connections), the probe will be marked to show the measuring range. Electrical Connections: Ground the transmitter's housing if necessary. The cable length may be up to 3 miles. The transmitter is designed to be maintenance-free and is not field-serviceable. If the unit is not operating properly, replace the entire unit. For more information, refer back to "Tank Level Indicating Transmitter".

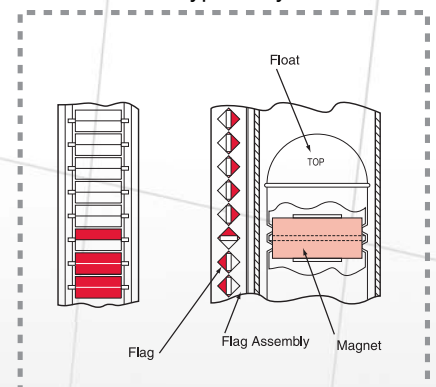
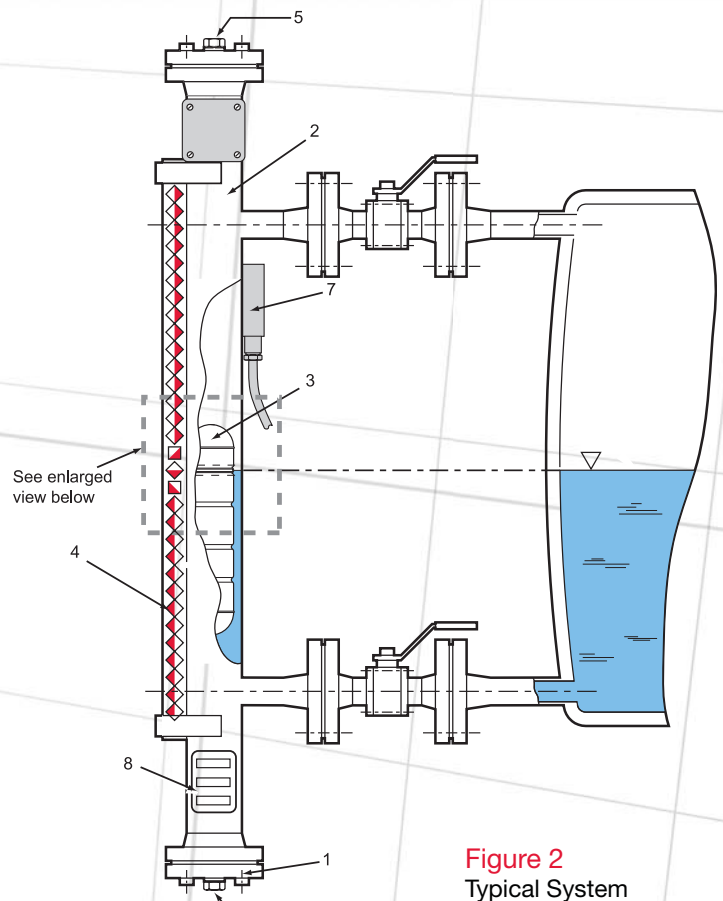



## Global Presence

Global Presence

### **Barksdale Inc.**

3211 Fruitland Ave.  
Los Angeles, CA 90058-0843  
U.S.A.  
Phone: (800) 835-1060  
Fax: (323) 589-3463  
Email: [sales@barksdale.com](mailto:sales@barksdale.com)  
[www.barksdale.com](http://www.barksdale.com)

### **Barksdale GmbH**

Dorn-Assenheimer Strasse 27  
61203 Reichelsheim, Germany  
Phone: (49) 6035-949-0 (main office)  
(49) 6035-949-204 (sales)  
Fax: (49) 6035-949-111/-113  
Email: [info@barksdale.de](mailto:info@barksdale.de)  
[www.barksdale.de](http://www.barksdale.de)

### **Barksdale GmbH**

Dorn-Assenheimer Strasse 27  
61203 Reichelsheim, Germany  
Phone: (49) 6035-949-0 (main office)  
(49) 6035-949-204 (sales)  
Fax: (49) 6035-949-111/-113  
Email: [info@barksdale.de](mailto:info@barksdale.de)  
[www.barksdale.de](http://www.barksdale.de)

### **Barksdale India**

SF- 43, Ansal Fortune Arcade  
Sector – 18  
India-201301 Noida  
Phone: +91-120 25 10 522  
Fax: +91-120 25 10 520  
[manojsingh@barksdale.in](mailto:manojsingh@barksdale.in)

**Barksdale**  
CONTROL PRODUCTS