

Stainless Steel & Glass Hardware Collection

Volume 4





Style. Design. Innovation.

EURO ARCHITECTURAL COMPONENTS (EAC) has been your #1 source for custom-made Components and is Canada's largest distributor of Architectural Components for the Railing, Fence, and Glass industries. We pride ourselves on our ability to develop new products, create trends and design styles you desire. In recent years, we have added a wide variety of new product lines, including but not limited to Elite Posts - Handrail Series and Frameless Series, Glass Wall Channels, Patch Fittings, Glass Panels, Shower Fittings, and more.

Style

We listen to our customers and are encouraged to remain current with the latest looks. Recently, we expanded our extensive colour line by offering custom powder coating in Satin Black, Textured Black, Matte White, Gold and many more.

Design

In addition to expanding our existing TILT-LOCK™ Base Shoes and Spigots, we are thrilled to introduce our new Adjustable Glass Standoffs, which include a lockable feature developed under the TILT-LOCK™ product line, combining aesthetics, efficiency, and strength for commercial and residential frameless Glass Railing systems.

Innovation

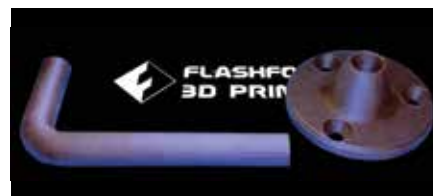
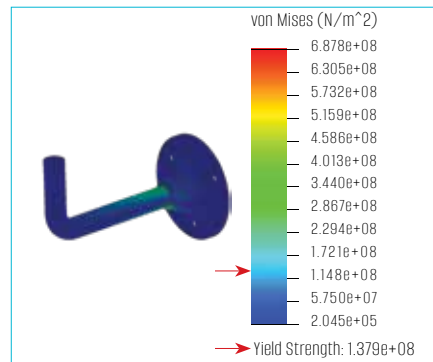
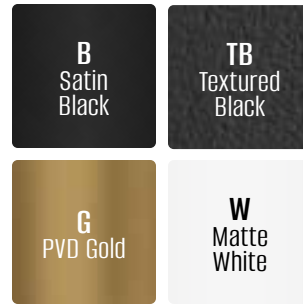
Many years of experience in the architectural industry drives our desire to craft innovative products. Our team of experts will help turn your designs into reality by providing product development services for exclusive custom products from ideation all the way through to final testing and certification.

Simplicity, precision, and quality are the key features that our engineering team aims for during product development by using the latest state-of-the-art CAD/CAE programs and equipment such as 3D printers.

Our goal is to develop and innovate every product meticulously, ensuring that the final product meets or exceeds standard strength requirements while taking into consideration aesthetics and ease of installation.

Our in-house testing and certification procedure helps ensure that new products undergoing integrated developing stages comply with national and provincial building codes.

For more details on product development and to inquire about sourcing your exclusive design, please contact engineering@euroeac.com.





TILT-LOCK™ Base Shoes



Spigots

- 25 TILT-LOCK™ Spigots
- 31 Standard Spigots



Standoffs

- 37 TILT-LOCK™ T3 Adjustable Standoffs
- 41 Standard Non-Adjustable Standoffs



TILT-LOCK™ Mini Posts



Posts & Accessories

- 49 Elite Posts
- 59 Standard Posts
- 69 Heavy Duty Posts



Post Bases

- 77 Round Discs, Base Plates, Flanges, Mounts, Covers
- 79 Square Base Plates, Flanges, Mounts, Covers



Glass Clips & Connectors

- 83 Glass Clips & Gaskets
- 87 Glass Connectors



Glass Railing Tops

- 93 Stainless Steel Cap Rails & Fittings
- 97 Aluminum Cap Rails & Fittings
- 101 Top Channels & Fittings
- 103 Top Edge Covers



Tubes / Rods / Bars

- 107 Round Fittings
- 111 Square Fittings
- 112 Rectangular Fittings



Handrail Components

- 117 Handrail Attachment Plates
- 118 Handrail Connectors
- 119 Tube Supports
- 121 Handrail Brackets

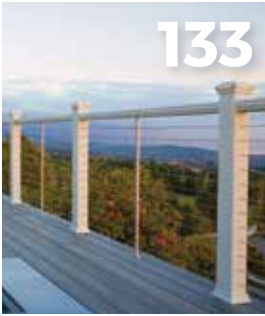


Rod Railing Components

- 130 Rod Connectors, Holders & Accessories



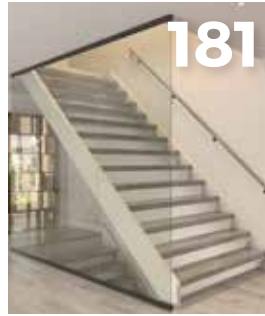
Horizontal Tubing



133

CableRail®

- 143 CableRail® Conceal Kit
- 145 Design Rail



181

Glass Wall Channels



153

Coloured Stainless Steel Balusters



187

Sliding Glass Door Hardware



157

LumaRail LED Lighting



191

Wine Cellar Collection

- 192 Wine Cellar Pegs
- 195 Wood Crates & Glass Holders



161

Glass Panels & Accessories

- 164 Tools & Glass Handling



197

Fasteners, Drill Bits & Taps

- 197 Screws, Rods & Accessories
- 199 Bolts, Anchors, & Accessories
- 202 Drill Bits & Taps



165

Glass Pool Gate Hardware

- 167 Standard Hinges & Latches
- 169 Polaris Hinges & Latches
- 172 Door Stop



203

Metal Machinery, Tools & Accessories

- 205 Bandsaws & Metal Saws
- 207 Grinding Tools & Accessories
- 209 Metal Finishing
- 210 Notching Systems



173

Glass Door Hardware

- 175 Patch Fittings & Accessories
- 178 Handles
- 179 Locks



211

Cleaners, Protectors, & Silicones

- 213 Protective Coating
- 216 Cleaning Kits
- 218 Sprays / Silicones / Paint / Adhesive
- 219 Glass Care

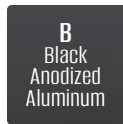
TYLT-LOCK™

Tilt Adjustable Glass Railing Technology

Ready-to-Install
Easily Adjustable
From Residential to Commercial



TILT-LOCK™ BASE SHOES



Our **Ready-to-Install TILT-LOCK™** Adjustable Base Shoes are available in 5 models: **M2, M3, M4, M5, and M6**, accommodating Glass sizes from **12-26.52mm**.

Our Base Shoes are available as **TOP MOUNT**, which can be **RECESSED** and finished with optional Top Cover Cladding. **SIDE MOUNT** options are available with our **M3** and **M6Y** models only. Kits come Non-Cladded or with your choice of Cladding: Satin Anodized Aluminum, Black Anodized Aluminum, or 316 Grade Satin Stainless Steel.



Our patented technology allows a **2°** front and back tilt of the Glass within the Shoe, giving you faster and easier installation with exact alignment every time. This is all achievable from one side, making your projects more efficient.

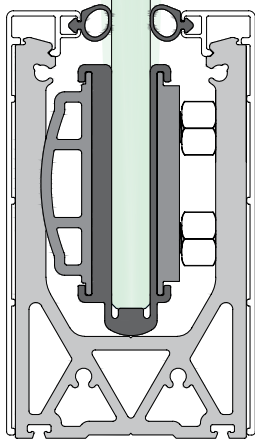
TILT-LOCK™ Adjustable Base Shoes are **Ready-to-Install** with pre-drilled holes and fully concealed components, offering a clean, finished, and perfectly aligned look. Additional accessories are available.

Features

- Fully engineered for the National Building Code of Canada.



Patented in Canada, the U.S., the U.K., Europe, Australia, New Zealand, and China.



Curved Base Shoe

Base Shoes could be formed to support curved Glass Panels.

SPECIAL ORDER ONLY.
Please inquire.



Base Shoes Overview

CLADDING OPTIONS

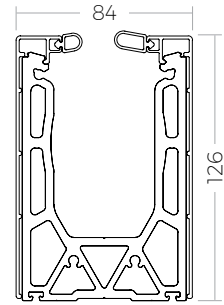
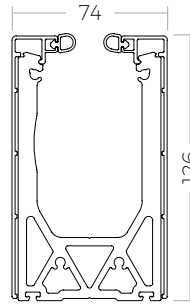
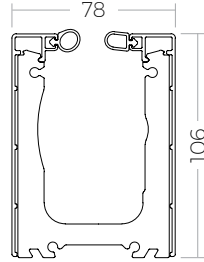
Residential Shoe Kits come Cladded and Non-Cladded and include Base Shoe, Gaskets, Grips, and End Caps.

Commercial Shoe Kits require your choice of Glass Kit option to accommodate your Glass size.



*Glass Kits are a package including Grips and Gaskets tailored for specific Glass thicknesses. Select your desired Glass Kit for M4 (Pg 14), M5 (Pg 18), & M6 (Pg 21,22).

Use 1/2" or M12 Fasteners. Refer to pages 198-200



NEW **M2**
SSSM2SHOE
Residential

M3
SSSM3SHOE
Residential

M4
SSSM4SHOE
Commercial

GLASS THICKNESS (mm)	12 - 12.76	12 - 12.76	12 - 17.52
12 - 12.76	Kit	Kit	—
12 - 13.52	—	—	Base + Glass Kit*
14.28 - 15	—	—	Base + Glass Kit*
16 - 17.52	—	—	Base + Glass Kit*
19 - 21.52	—	—	—
24.76 - 26.52	—	—	—
LENGTH	10'	10' & 20'	10'
NUMBER OF HOLES	10	10 for 10' / 20 for 20'	20
HOLE SPACE	12"	12"	6"
TOP MOUNT	Kit 10'	Kit 10' & 20'	Kit 10'
SIDE MOUNT	—	Kit 10'	Custom Order
RECESSED	Yes	Yes	Yes
CLADDING OPTIONS	A, B, S	A, B, S	A, B, S
INSTALLATION VIDEO			

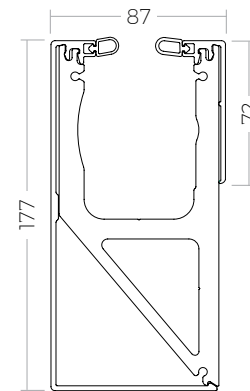
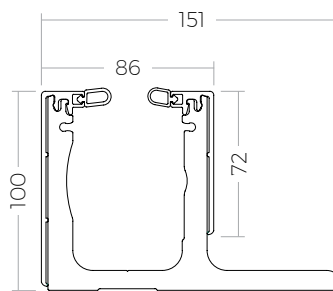
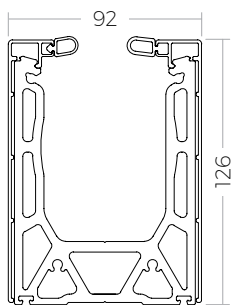
Aluminum Kits (A) & (B)

- **SHOE:** Alkaline Anodized Aluminum 6063-T6.
- **CLADDING:** Satin Anodized Aluminum 6463-T5 with attached Gaskets.
- **END CAPS:** Satin Anodized Aluminum to match Cladding.

Stainless Steel Kits (S)

- **SHOE:** Alkaline Anodized Aluminum 6063-T6.
- **CLADDING:** Stainless Steel 316L in Satin finish and small Aluminum Clip-on Channel with attached Gaskets.
- **END CAPS:** Stainless Steel 316L in Satin finish to match Cladding.

M6 Shoes are custom order.
Please Inquire.






*Glass Kits are a package including Grips and Gaskets tailored for specific Glass thicknesses. Select your desired Glass Kit for M4 (Pg 14), M5 (Pg 18), & M6 (Pg 21,22).

Use 1/2" or M12 Fasteners.
Refer to pages 198-200

M5
SSSM5SHOE
Commercial

NEW **M6L**
SSSM6SHOEL
Commercial

NEW **M6Y**
SSSM6SHOEY
Commercial

GLASS THICKNESS (mm)	19 - 26.52	19 - 26.52	19 - 26.52
12 - 12.76	—	—	—
12 - 13.52	—	—	—
14.28 - 15	—	—	—
16 - 17.52	—	—	—
19 - 21.52	Base + Glass Kit*	Base + Glass Kit*	Base + Glass Kit*
24.76 - 26.52	Base + Glass Kit*	Base + Glass Kit*	Base + Glass Kit*
LENGTH	10'	10'	10'
NUMBER OF HOLES	20	20	20
HOLE SPACE	6"	6"	6"
TOP MOUNT	Kit 10'	Kit 10'	—
SIDE MOUNT	Custom Order	—	Kit 10'
RECESSED	Yes	—	—
CLADDING OPTIONS	A, B, S	A, B, S	A, B, S
INSTALLATION VIDEO			

M2

BASE SHOE



PHOTO: Fort Rouge Glass Ltd.

TILT-LOCK™

Tilt Adjustable Glass Railing Technology

NEW

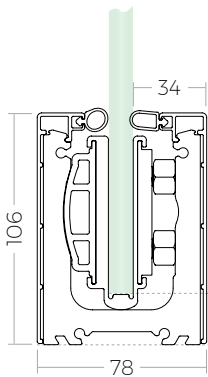
M2 BASE SHOE

Residential
Interior / Exterior

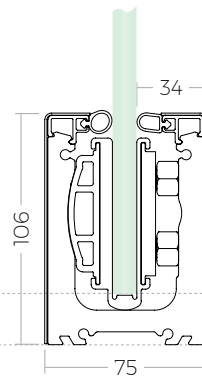


TILT-LOCK™ M2 Base Shoes

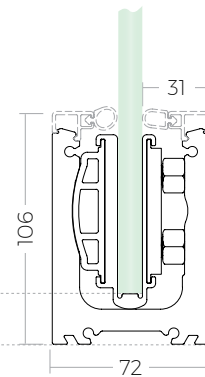
Top Mount
Aluminum Cladding



Top Mount
Stainless Steel Cladding



Recessed or
No Cladding



Glass sits
23mm
above ground

Kit Includes

PART #	Shoe Length	Full Cover Cladding	Glass Grips	End Caps	Joining Pins	Glass Gap
Top Mount Cladded Kits						
SSSM2SHOE10A	10'	2 x 10'	10	2	4	1 x 4"
SSSM2SHOE10B	10'	2 x 10'	10	2	4	1 x 4"
SSSM2SHOE10S	10'	2 x 10'	10	2	4	1 x 4"
Top Mount Non-Cladded Kit						
SSSM2SHOE10	10'	N/A	10	2	4	1 x 4"

Use 1/2" or M12 Fasteners. Refer to pages 198-200.



Cladding

Top Cover Cladding

Sold as a pair with Gaskets for **12-12.76mm** Glass thickness.

- SSSM3TCC10A** 10' Clear Anodized Aluminum.
- SSSM3TCC10B** 10' Black Anodized Aluminum.

Top Mount Cladding 10' Lengths

Sold individually with installed Gasket for **12-12.76mm** Glass included.

- SSSM2CLADA** Satin Anodized Aluminum.
- SSSM2CLADB** Black Anodized Aluminum.
- SSSM2CLADS** Satin Stainless Steel SS316.



Cladding Tape

Can be used when installing Cladding.

- SSSMCLADTAPE** Double-sided, 108' length.



90° Base Shoe Corners

90° Aluminum extruded 6" mitered corners with 2 Holes, 2 Washers, and 4 Joining Pins.

- SSSM2CCSHOEI** Inside.
- SSSM2CCSHOEO** Outside.

90° Corner Cut Cladding Kits

90° Mitered Corner Cladding Kits match Top Mount Base Shoe. Each Kit consists of 2 outside and 2 inside pieces to complete the corner. 12" in length.

Includes: Cladding And Gaskets.

- SSSM2CCKITA** Satin Anodized Aluminum.
- SSSM2CCKITB** Black Anodized Aluminum.
- SSSM2CCKITS** Satin Stainless Steel SS316.



Drain Blocks

Anodized Aluminum. Sold in a package of 10.

- SSSM2DRAINT** For M2. 3/8" thick.





End Caps Top Mount Installations

Sold in a package of 2.

- SSSM2ENDCP1X** Satin Anodized Aluminum.
- SSSM2ENDCP2X** Black Anodized Aluminum.
- SSSM2ENDCP3X** Satin Stainless Steel SS316.

Top Mount Stair Installations

Sold Individually.

- SSSM2ENDCAP1** Satin Anodized Aluminum.
- SSSM2ENDCAP2** Black Anodized Aluminum.
- SSSM2ENDCAP3** Satin Stainless Steel SS316.



Leveling Shims

Anodized Aluminum. Sold in a package of 5.

- SSSM2SHIM** 1.5mm thick.



Grips

Sold in a package of 2 for **12-12.76mm** Glass.

- SSSM2GRIPS**



Gap Rubber Spacer

Glass Spacer to fill the gap between Glass Panels.

- SSSM2GAP**



Joining Pins

Sold in a package of 4. Pins are used to attach sections of the extruded Base Shoe together.

- SSSM3JOINPIN**



Tools

Wrenches for Base Shoe Grips. Open End Wrench size: 19mm or 3/4".

- SSWRENCH1** Standard Wrench.
- SSWRENCH3** Ratcheting Wrench.

M3

BASE SHOE

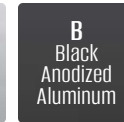


TILT-LOCK™

Tilt Adjustable Glass Railing Technology

M3 BASE SHOE

Residential
Interior / Exterior



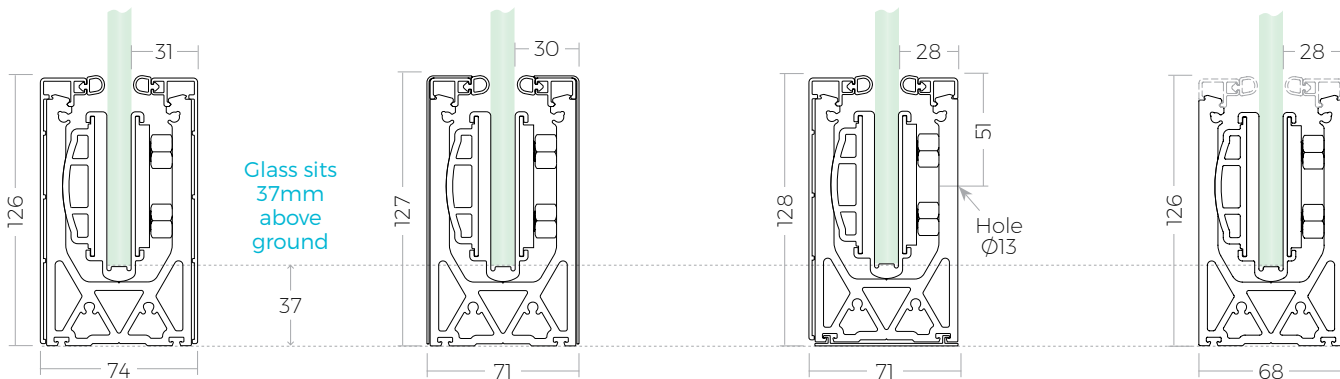
TILT-LOCK™ M3 Base Shoes

Top Mount
Aluminum Cladding

Top Mount
Stainless Steel Cladding

Side Mount
Aluminum Cladding

Recessed or
No Cladding



Kit Includes

PART #	Shoe Length	Full Cover Cladding	Glass Grips	End Caps	Joining Pins	Glass Gap	Stabilizing Washers
Top Mount Cladded Kits							
SSSM3SHOE10A	10'	2 x 10'	10	2	4	1 x 4"	10
SSSM3SHOE10B	10'	2 x 10'	10	2	4	1 x 4"	10
SSSM3SHOE10S	10'	2 x 10'	10	2	4	1 x 4"	10
SSSM3SHOE20A	20'	2 x 20'	20	2	8	1 x 8"	20
SSSM3SHOE20S	20'	2 x 20'	20	2	8	1 x 8"	20
Top Mount Non-Cladded Kits							
SSSM3SHOE10	10'	N/A	10	2	4	1 x 4"	10
SSSM3SHOE20	20'	N/A	20	2	8	1 x 8"	20
Side Mount Cladded Kits							
SSSM3SIDE10A	10'	1 x 10'	10	2	4	1 x 4"	10
SSSM3SIDE10B	10'	1 x 10'	10	2	4	1 x 4"	10

Use 1/2" or M12 Fasteners. Refer to pages 198-200.



Cladding

Top Cover Cladding

Sold as a pair with Gaskets for **12-12.76mm** Glass thickness.

- SSSM3TCC10A** 10' Clear Anodized Aluminum.
- SSSM3TCC10B** 10' Black Anodized Aluminum.

Top Mount Cladding 10' Lengths

Sold individually with installed Gasket for **12-12.76mm** Glass included.

- SSSM3CLADA** Satin Anodized Aluminum.
- SSSM3CLADB** Black Anodized Aluminum.
- SSSM3CLADC** Mill Finish Aluminum.
- SSSM3CLADS** Satin Stainless Steel SS316.
- SSSM3CLADM** Mirror Stainless Steel SS316.

20' Lengths

Sold individually with installed Gasket for **12-12.76mm** Glass included.

- SSSM3CLADA1** Satin Anodized Aluminum.
- SSSM3CLADS1** Satin Stainless Steel SS316.

Side Mount Cladding 10' Lengths

Sold Individually with installed Gasket for **12-12.76mm** Glass included.

- SSSM3CLADXA** Satin Anodized Aluminum.
- SSSM3CLADXB** Black Anodized Aluminum.

Cladding Tape

Can be used when installing Cladding.

- SSSMCLADTAPE** Double-sided, 108' length.

90° Base Shoe Corners For Top Mount Shoes Only

90° Aluminum extruded 6" mitered corners with 2 Holes, 2 Washers, and 4 Joining Pins.

- SSSM3CCSHOEI** Inside.
- SSSM3CCSHOEO** Outside.

90° Corner Cut Cladding Kits For Top Mount Shoes Only

90° Mitered Corner Cladding Kits match Top Mount Base Shoe. Each Kit consists of 2 outside and 2 inside pieces to complete the corner. 12" in length.

Includes: Cladding and Gaskets.

- SSSM3CCKITA** Satin Anodized Aluminum.
- SSSM3CCKITB** Black Anodized Aluminum.
- SSSM3CCKITS** Satin Stainless Steel SS316.

Drain Blocks

Anodized Aluminum. Sold in a package of 10.

- SSSM3DRAINT** For M3 Top Mount Shoe. 3/8" thick.
- SSSM3DRAINS** For M3 Side Mount Shoe. 3/8" thick.



End Caps

Top Mount Installations

Sold in a package of 2.

SSSM3ENDCP1X	Satin Anodized Aluminum.
SSSM3ENDCP3X	Black Anodized Aluminum.
SSSM3ENDCP2X	Satin Stainless Steel SS316.
SSSM3ENDCP4X	Mirror Stainless Steel SS316.



Top Mount Stair Installations

Sold Individually.

SSSM3ENDCAP1	Satin Anodized Aluminum.
SSSM3ENDCAP5	Black Anodized Aluminum.
SSSM3ENDCAP2	Satin Stainless Steel SS316.
SSSM3ENDCAP7	Mirror Stainless Steel SS316.

Side Mount Stair Installations

Sold Individually.

SSSM3ENDCAP3	Satin Anodized Aluminum.
---------------------	--------------------------

Leveling Shims

Anodized Aluminum. Sold in a package of 5.

SSSM3SHIM1	1.5mm thick.
SSSM3SHIM2	3mm thick.



Grips

Sold in a package of 2 for **12-12.76mm** Glass.

SSSM3GRIPS



Gap Rubber Spacer

Glass Spacer to fill the gap between Glass Panels.

SSSM3GAP



Joining Pins

Sold in a package of 4. Pins are used to attach sections of the extruded Base Shoe together.

SSSM3JOINPIN



Tools

Wrenches for Base Shoe Grips. Open End Wrench size: 19mm or 3/4".

SSWRENCH1	Standard Wrench.
SSWRENCH3	Ratcheting Wrench.



M4

BASE SHOE



TILT-LOCK™

Tilt Adjustable Glass Railing Technology

M4 BASE SHOE

Residential / Commercial
Interior / Exterior



A
Satin
Anodized
Aluminum

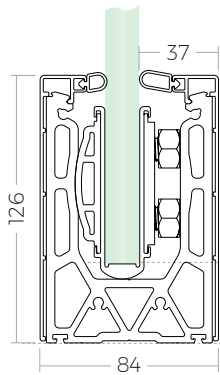
B
Black
Anodized
Aluminum

S
Satin
Stainless
Steel

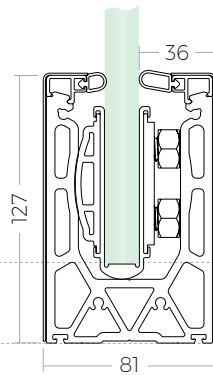


TILT-LOCK™ M4 Base Shoes

Top Mount
Aluminum Cladding

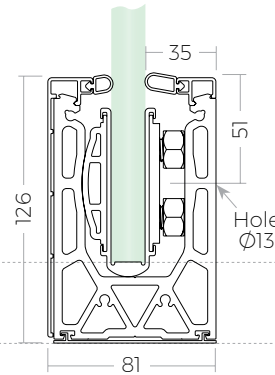


Top Mount
Stainless Steel Cladding

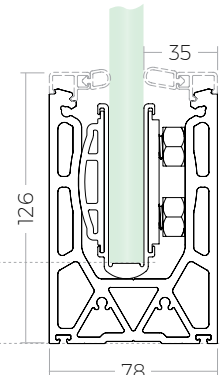


Glass sits
37mm
above
ground

Side Mount
Aluminum Cladding
CUSTOM ORDER



Recessed or
No Cladding



Kit Includes

PART #	Shoe Length	Full Cover Cladding	*Glass Grips	End Caps	Joining Pins	Glass Gap	Stabilizing Washers
Top Mount Cladded Kit							
SSSM4SHOE10A	10'	2 x 10'	10	2	4	1 x 4"	10
SSSM4SHOE10B	10'	2 x 10'	10	2	4	1 x 4"	10
SSSM4SHOE10S	10'	2 x 10'	10	2	4	1 x 4"	10
Top Mount Non-Cladded Kit							
SSSM4SHOE10	10'	N/A	10	2	4	1 x 4"	10

*10 Glass Grips are included in Glass Kit Options below. Select Glass Kit option to suit your Glass thickness.

Glass Kit Options

PART #	Glass Thickness (mm)
SSSM4GLASS1	12-13.52
SSSM4GLASS2	14.28-15
SSSM4GLASS3	16-17.52

Use 1/2" or M12 Fasteners. Refer to pages 198-200.



Cladding Top Cover Cladding

Sold as a pair. Use the Gaskets provided in the Glass Kit.

- SSSM3TCC10A** 10' Satin Anodized Aluminum.
- SSSM3TCC10B** 10' Black Anodized Aluminum.

10' Lengths

Sold as a pair. Use the Gaskets provided in the Glass Kit.

- SSSM3CLADA** Satin Anodized Aluminum.
- SSSM3CLADB** Black Anodized Aluminum.
- SSSM3CLADC** Mill Finish Aluminum.
- SSSM3CLADS** Satin Stainless Steel SS316.
- SSSM3CLADM** Mirror Stainless Steel SS316.



20' Lengths

Sold as a pair. Use the Gaskets provided in the Glass Kit.

- SSSM3CLADA1** Satin Anodized Aluminum.
- SSSM3CLADS1** Satin Stainless Steel SS316.



Cladding Tape

Can be used when installing Stainless Steel Cladding.

- SSSMCLADTAPE** Double-sided, 108' length.



90° Base Shoe Corners For Top Mount Shoes Only

90° Aluminum extruded 6" mitered corners with 2 Holes, 2 Washers, and 4 Joining Pins.

- SSSM4CCSHOEI** Inside.
- SSSM4CCSHOEO** Outside.



90° Corner Cut Cladding Kits For Top Mount Shoes Only

90° Mitered Corner Cladding Kits match Top Mount Base Shoe. Each Kit consists of 2 outside and 2 inside pieces to complete the corner. 12" in length.

Includes: Cladding. Use the Gaskets provided in the Glass Kit.

- SSSM3CCKITA** Satin Anodized Aluminum.
- SSSM3CCKITB** Black Anodized Aluminum.
- SSSM3CCKITS** Satin Stainless Steel SS316.



Drain Blocks

Anodized Aluminum. Sold in a package of 10.

SSSM4DRAINT For M4 Top Mount. 3/8" thick.



End Caps

Top Mount Installations

Sold in a package of 2.

SSSM4ENDCAP3 Black Anodized Aluminum.

SSSM4ENDCAP2 Satin Stainless Steel SS316.

Top Mount Stair Installations

Sold Individually.

SSSM4ENDCAP1 Satin Anodized Aluminum.



Leveling Shims

Anodized Aluminum. Sold in a package of 5.

SSSM4SHIM1 1.5mm thick.

SSSM4SHIM2 3mm thick.



Grips

Sold in a package of 2 for **16-17.52mm** Glass.

SSSM4GRIPS



Gap Rubber Spacer

Glass Spacer to fill the gap between Glass Panels.

SSSM4GAP



Joining Pins

Sold in a package of 4. Pins are used to attach sections of the extruded Base Shoe together.

SSSM3JOINPIN



Tools

Wrenches for Base Shoe Grips. Open End Wrench size: 19mm or 3/4".

SSWRENCH1 Standard Wrench.

SSWRENCH3 Ratcheting Wrench.

M5

BASE SHOE



TILT-LOCK™

Tilt Adjustable Glass Railing Technology

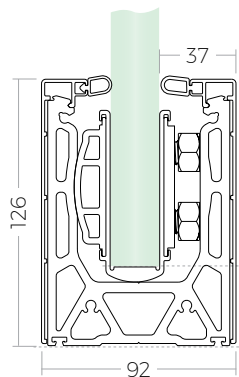
M5 BASE SHOE

Residential / Commercial
Interior / Exterior

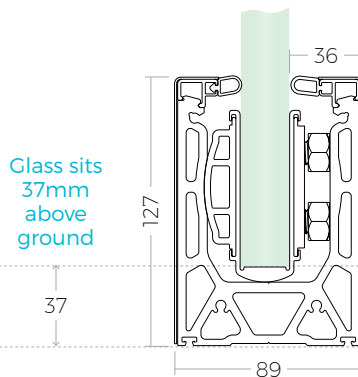


TILT-LOCK™ M5 Base Shoes

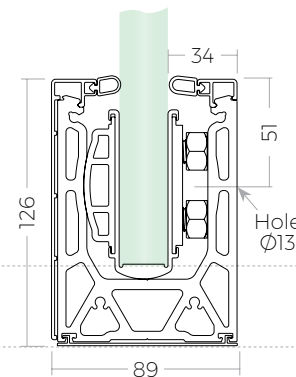
Top Mount
Aluminum Cladding



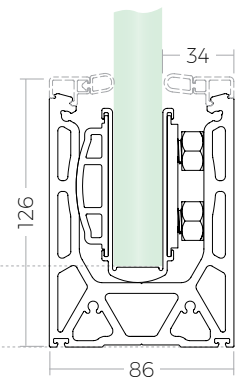
Top Mount
Stainless Steel Cladding



Side Mount
Aluminum Cladding
CUSTOM ORDER



Recessed or
No Cladding



Kit Includes

PART #	Shoe Length	Full Cover Cladding	*Glass Grips	End Caps	Joining Pins	Glass Gap	Stabilizing Washers
Top Mount Cladded Kit							
SSSM5SHOE10A	10'	2 x 10'	10	2	4	1 x 4"	10
SSSM5SHOE10B	10'	2 x 10'	10	2	4	1 x 4"	10
SSSM5SHOE10S	10'	2 x 10'	10	2	4	1 x 4"	10
Top Mount Non-Cladded Kit							
SSSM5SHOE10	10'	N/A	10	2	4	1 x 4"	10

*10 Glass Grips are included in Glass Kit Options below. Select Glass Kit option to suit your Glass thickness.

Glass Kit Options

PART #	Glass Thickness (mm)
SSSM5GLASS1	19-21.52
SSSM5GLASS2	24.76-26.52

Use 1/2" or M12 Fasteners. Refer to pages 198-200.



Cladding

Top Cover Cladding

Sold as a pair. Use the Gaskets provided in the Glass Kit.

- SSSM3TCC10A** 10' Satin Anodized Aluminum.
- SSSM3TCC10B** 10' Black Anodized Aluminum.

10' Lengths

Cladding. Use the Gaskets provided in the Glass Kit.

- SSSM3CLADA** Satin Anodized Aluminum.
- SSSM3CLADB** Black Anodized Aluminum.
- SSSM3CLADC** Mill Finish Aluminum.
- SSSM3CLADS** Satin Stainless Steel SS316.
- SSSM3CLADM** Mirror Stainless Steel SS316.



20' Lengths

Cladding. Use the Gaskets provided in the Glass Kit.

- SSSM3CLADA1** Satin Anodized Aluminum.
- SSSM3CLADS1** Satin Stainless Steel SS316.



Cladding Tape

Can be used when installing Cladding.

- SSSMCLADTAPE** Double-sided, 108' length.



90° Base Shoe Corners For Top Mount Shoes Only

90° Aluminum extruded 6" mitered corners with 2 Holes, 2 Washers, and 4 Joining Pins.

- SSSM5CCSHOEI** Inside.
- SSSM5CCSHOEO** Outside.



90° Corner Cut Cladding Kits For Top Mount Shoes Only

90° Mitered Corner Cladding Kits match Top Mount Base Shoe. Each Kit consists of 2 outside and 2 inside pieces to complete the corner. 12" in length.

Includes: Cladding. Use the Gaskets provided in the Glass Kit.

- SSSM3CCKITA** Satin Anodized Aluminum.
- SSSM3CCKITB** Black Anodized Aluminum.
- SSSM3CCKITS** Satin Stainless Steel SS316.



Drain Blocks

Anodized Aluminum. Sold in a package of 10.

SSSM5DRAINT For M5, 3/8" thick.



End Caps

Top Mount Installations

Sold in a package of 2.

SSSM5ENDCAP3 Black Anodized Aluminum.

SSSM5ENDCAP2 Satin Stainless Steel SS316.

Top Mount Stair Installations

Sold Individually.

SSSM5ENDCAP1 Satin Anodized Aluminum.



Leveling Shims

Anodized Aluminum. Sold in a package of 5.

SSSM5SHIM1 1.5mm thick.

SSSM5SHIM2 3mm thick.



Grips

Sold in a package of 2 for **19-21.52mm** Glass.

SSSM5GRIPS



Gap Rubber Spacer

Glass Spacer to fill gap between Glass Panels.

SSSM5GAP



Joining Pins

Sold in a package of 4. Pins are used to attach sections of the extruded Base Shoe together.

SSSM3JOINPIN



Tools

Wrenches for Base Shoe Grips. Open End Wrench size: 19mm or 3/4".

SSWRENCH1 Standard Wrench.

SSWRENCH3 Ratcheting Wrench.

TVLT-LOCK™

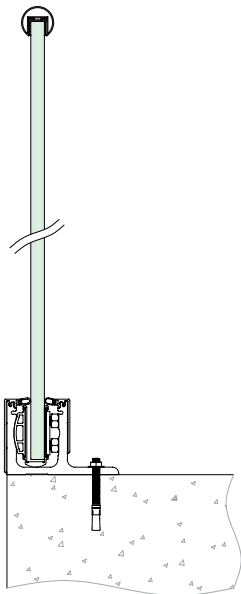
Tilt Adjustable Glass Railing Technology

NEW

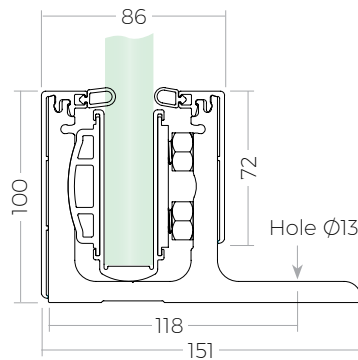
M6L BASE SHOE

Commercial
Interior / Exterior

CUSTOM ORDER. Please Inquire.



Top Mount
Aluminum Cladding



Kit Includes

PART #	Shoe Length	Full Cover Cladding	*Glass Grips	End Caps	Joining Pins	Glass Gap
Top Mount Cladded Kits						
SSSM6SHOELA	10'	2 x 10'	10	2	4	1 x 4"
SSSM6SHOELB	10'	2 x 10'	10	2	4	1 x 4"
SSSM6SHOELS	10'	2 x 10'	10	2	4	1 x 4"

*10 Glass Grips are included in Glass Kit options below. Select Glass Kit option to suit your Glass thickness.

Glass Kit Options

PART #	Glass Thickness (mm)
SSSM6GLASS1	19
SSSM6GLASS2	20-21.52
SSSM6GLASS3	24.76-25.52
SSSM6GLASS4	26.52

M6L Base Shoe Accessories

Use 1/2" or M12 Fasteners. Refer to pages 198-200.



Drain Blocks

Anodized Aluminum.
Sold in a package of 10.

SSSM6DRAINL For M6L. 3/8" thick.



Leveling Shims

Anodized Aluminum.
Sold in a package of 5.

SSSM6SHIM1 1.5mm thick.

SSSM6SHIM2 3mm thick.



Gap Rubber Spacer

Glass Spacer to fill the gap between Glass Panels.

SSSM5GAP

TVLT-LOCK™

Tilt Adjustable Glass Railing Technology

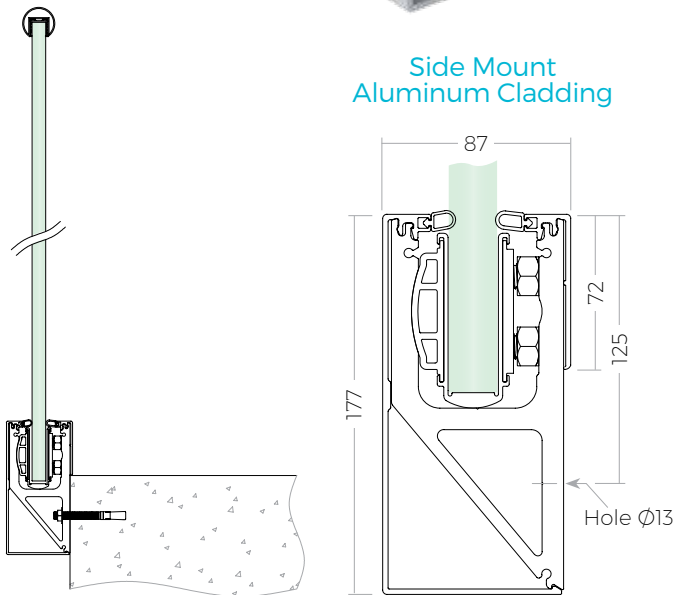
NEW M6Y BASE SHOE

Commercial Interior / Exterior

CUSTOM ORDER. Please Inquire.



Side Mount Aluminum Cladding



Kit Includes

PART #	Shoe Length	Full Cover Cladding	*Glass Grips	End Caps	Joining Pins	Glass Gap
Side Mount Cladded Kits						
SSSM6SHOEYA	10'	2 x 10'	10	2	4	1 x 4"
SSSM6SHOEYB	10'	2 x 10'	10	2	4	1 x 4"
SSSM6SHOEYS	10'	2 x 10'	10	2	4	1 x 4"

*10 Glass Grips are included in Glass Kit options below. Select Glass Kit option to suit your Glass thickness.

Glass Kit Options

PART #	Glass Thickness (mm)
SSSM6GLASS1	19
SSSM6GLASS2	20-21.52
SSSM6GLASS3	24.76-25.52
SSSM6GLASS4	26.52

M6L Base Shoe Accessories

Use 1/2" or M12 Fasteners. Refer to pages 198-200.



Drain Blocks

Anodized Aluminum.
Sold in a package of 10.
SSSM6DRAINL For M6L. 3/8" thick.



Leveling Shims

Anodized Aluminum.
Sold in a package of 5.
SSSM6SHIM1 1.5mm thick.
SSSM6SHIM2 3mm thick.



Gap Rubber Spacer

Glass Spacer to fill the gap between Glass Panels.
SSSM5GAP

Spigots

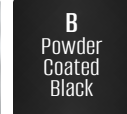


PHOTO: Millan Glass & Mirror

Spigots Overview



- Front & back tilt with vertical adjustability.
- Stainless Steel Duplex 2205.



160

TILT-LOCK™
Top Mount
 Square Base Plate Cover
 Model
 Pg 27.



155

TILT-LOCK™
Top Mount
 Center Concealed
 Mounting Model
 Pg 28.



152
310

TILT-LOCK™
Edge Mount
 Pg 29.

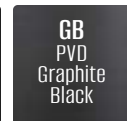
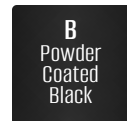


150

TILT-LOCK™
Side Mount
 Mounts to the fascia of the
 deck and is not visible from
 the deck surface.
 Pg 30.

STANDARD TOP MOUNT MODELS

- Vertical adjustability.
- Stainless Steel Duplex 2205.



160

STANDARD TOP MOUNT
6" Model
 Recommended for Landing only. Pg 31.



202

STANDARD TOP MOUNT
8" Model
 Recommended for Landing and Stairs
 with a Stopper Pin. Pg 32.



254

STANDARD TOP MOUNT
10" Model
 Matches the look of our
 TILT-LOCK™ Spigots. Pg 34.

TYLT-LOCK™
Tilt Adjustable Glass Railing Technology

Duplex 2205 Ultra Marine Grade Stainless Steel
Superior Strength
Superior Corrosion Resistance



TILT-LOCK™ ADJUSTABLE SPIGOTS

The **TILT-LOCK™** Adjustable Spigots are available in 4 models to suit almost every possible mounting requirement for **12-17.52mm** Glass:

- Top Mount Square Base Plate Model.
- Top Mount Centre Concealed Model.
- Edge Mount Model.
- Side Mount Model.

Our **TILT-LOCK™** Adjustable Spigots are available in 4 finishes: Satin, Graphite Black, Matte Black, and Powder Coated Black. These Spigots have clean architectural lines, creating a unique façade and providing a very cost-efficient modern solution for structural Glass Railings. We also offer Standard Spigots in the same finishes.

The **No-Holes-in-the-Glass** system along with our patented technology allows a **2°** front and back tilting of the Glass in the Spigots, giving you a perfect installation every time by simply tightening the upper or lower Screw. All adjustments can be achieved from one side. This strong, reliable Glass Mounting System is highly recommended for pools and decks, where there is constant exposure to the elements in the Exterior environment.

Features

- Duplex 2205 low carbon Ultra Marine Grade Stainless Steel, allowing for superior corrosion resistance as well as more tensile strength than 316 Grade Stainless Steel.
- Highly suitable for use in Exterior structures with a high degree of corrosion due to chlorine or sulphur dioxide load, high humidity, and accumulation of harmful substances (e.g. coastal regions and swimming pool environments).
- Fully engineered for the National Building Code of Canada.



Patented in Canada, U.S., U.K., Europe, Australia, New Zealand, and China.



DISCLAIMER: Please be aware that chlorine, dirt, and other particles can get sprayed onto the Spigots if using a power washer while cleaning your Spigot environment. To avoid potential Stainless Steel contamination, remove any residue on Spigots with warm water and soap or mild detergent, then rinse thoroughly with clear hot water.



TILT-LOCK™ Adjustable Spigots

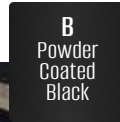
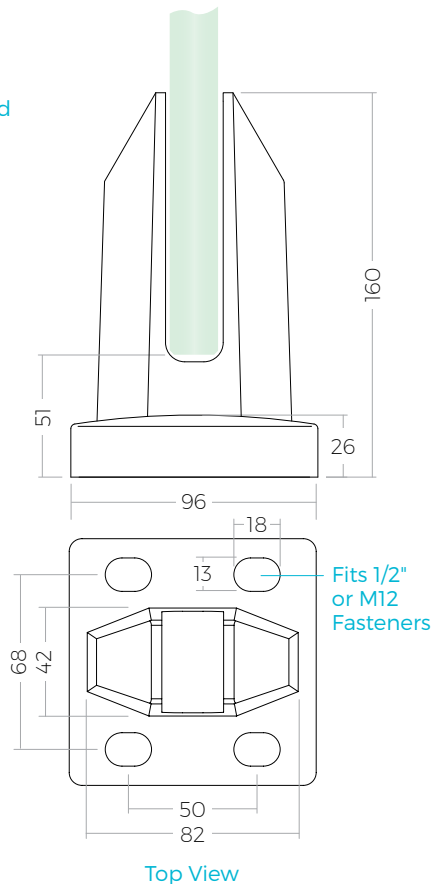
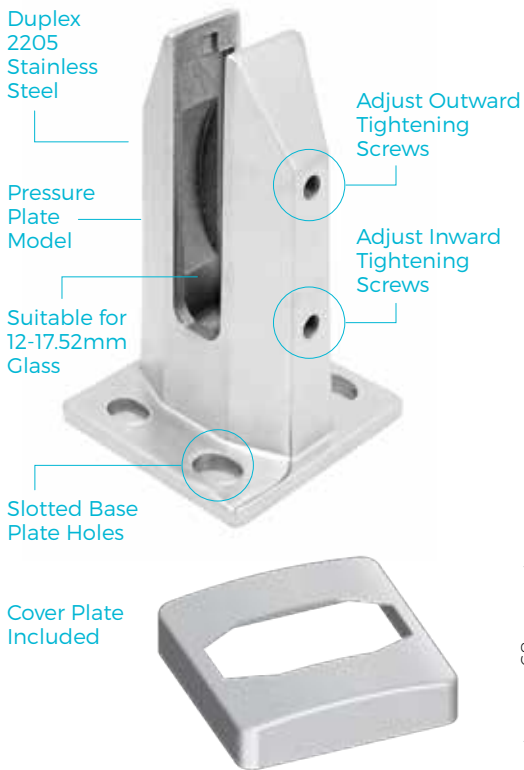


PHOTO: DM l'Equipeur

TILT-LOCK™ TOP MOUNT SPIGOT Square Base Plate Cover Model



SPIGOT PART #	Finish
SSSPIGOTADJ	S
SSSPIGOTADJB	B
SSSPIGOTAGB	GB
SSSPIGOTAMB	MB

Fastener Options

(Sold Separately - See pg 197-202)
Choose according to your needs. Refer to engineering for Fastener sizing.

For Wood:
• 1/2" Lag Bolt.

Thru-Bolt:
• SSSPIGOTBOLT

For Concrete:
• 1/2" or M12 Wedge Anchors.

• 1/2" or M12 Threaded Rod with Nut, Washer and Epoxy.



Scan for more info and installation procedure. Inquire about engineering.

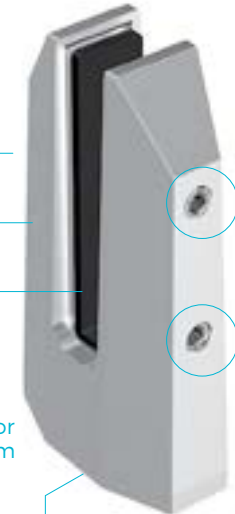


TILT-LOCK™ TOP MOUNT SPIGOT
Center Concealed Mounting Model

Duplex
2205
Stainless
Steel

Pressure
Plate
Model

Suitable for
12-17.52mm
Glass

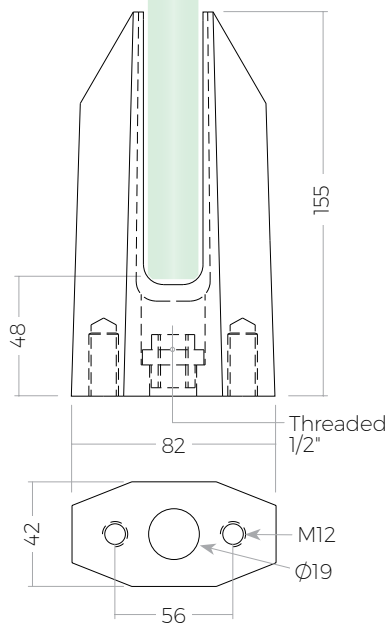


No Cover
Plate
Required

Adjust Outward
Tightening
Screws

Adjust Inward
Tightening
Screws

Engineered
Fastening Kit
SSSPIGOTADJP
Available



Bottom View

SPIGOT PART #	Finish
SSSPIGOTADJN	S

Fastening Kit (Sold Separately)
SSSPIGOTADJP Engineered Fastening Kit

- 2 Stainless Steel M16 x 170mm Threaded Rod and M16 Nut secured by Epoxy for concrete or as a Thru-Bolt.

Fastener Options
(Sold Separately - See pg 197-202)
Choose according to your needs.
Refer to engineering for Fastener sizing.

- For Wood:**
- 1/2" Threaded Rod with Nut and Washer used as Thru-Bolt.

- For Concrete:**
- 1/2" or Wedge Anchors.
 - 1/2" or Threaded Rod with Nut, Washer and Epoxy.

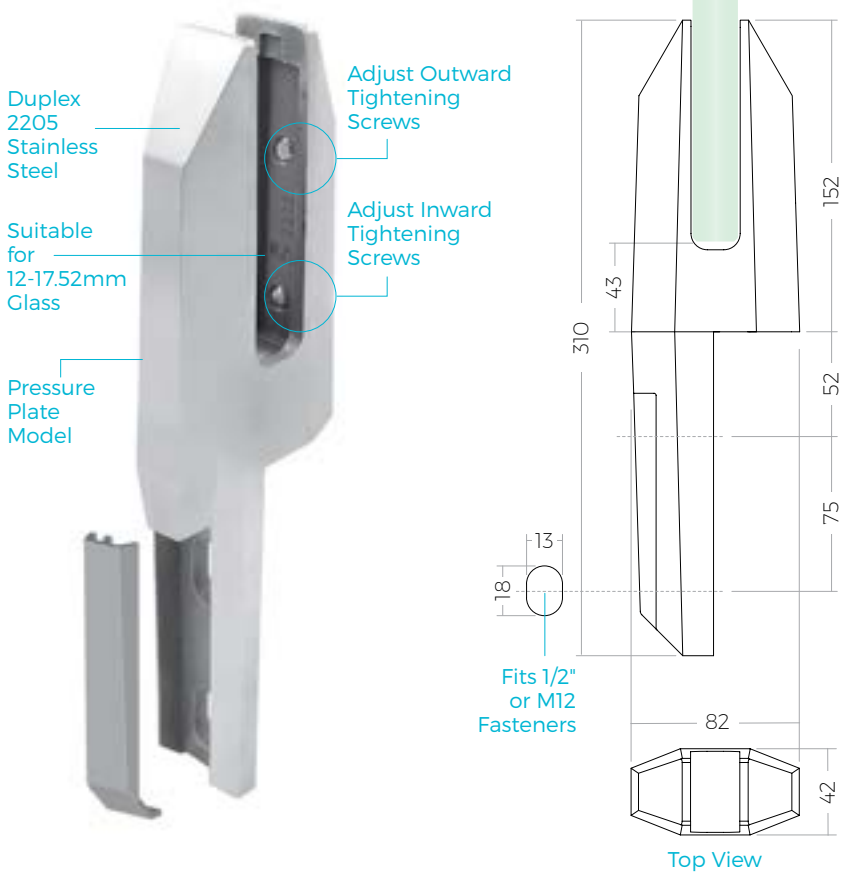


Scan for more info and installation procedure. Inquire about engineering.

Engineered for windscreen applications by using a special Fastener Kit **SSSPIGOTADJP**.



TILT-LOCK™ EDGE MOUNT SPIGOT



SPIGOT PART #	Finish
SSSPIGOTEDGE	S
SSSPIGOTEDB	B
SSSPIGOTEGB	GB
SSSPIGOTEMB	MB

Fastener Options
 (Sold Separately - See pg 197-202)
 Choose according to your needs. Refer to engineering for Fastener sizing.

For Wood:

- 1/2" Lag Bolt.

Thru-Bolt:

- SSSPIGOTBOLT

For Concrete:

- 1/2" or M12 Wedge Anchors.
- 1/2" or M12 threaded Rod with Nut, Washer and Epoxy.

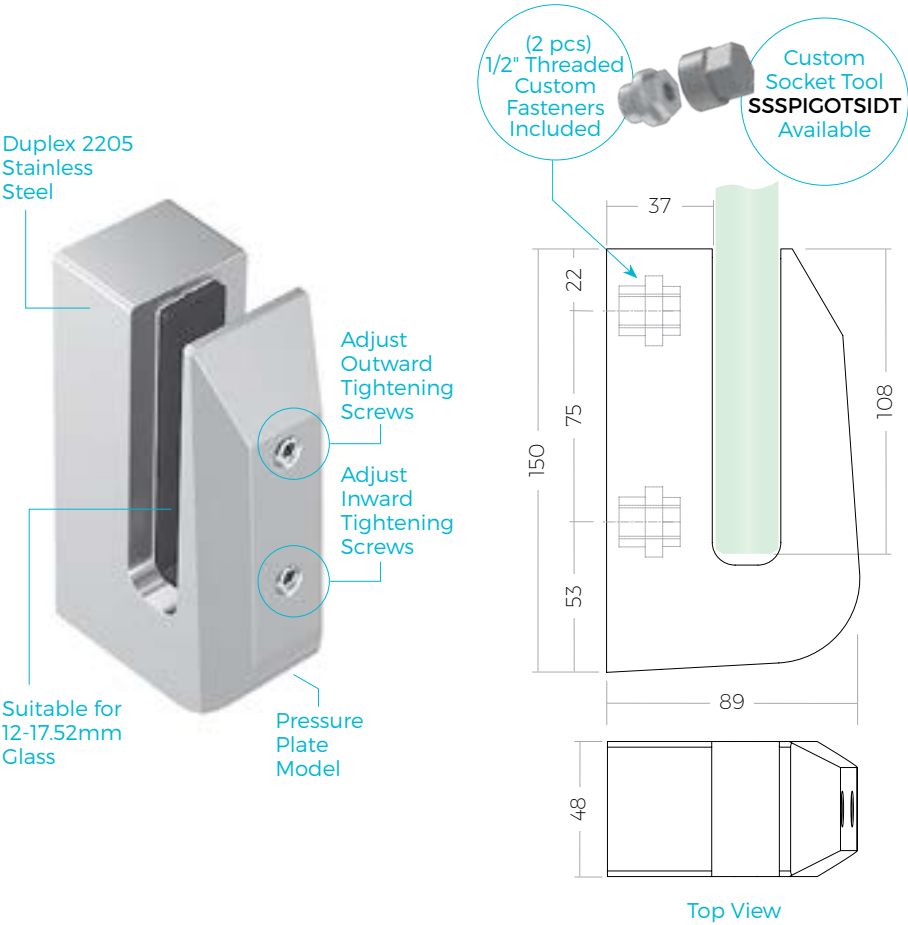
Scan for more info and installation procedure. Inquire about engineering.

TILT-LOCK
The Adjustable Glass Railing Technology



TILT-LOCK™ Spigots

TILT-LOCK™ SIDE MOUNT SPIGOT



SPIGOT PART #	Finish
SSSPIGOTSIDE	S
SSSPIGOTSIDB	B
SSSPIGOTSIGB	GB
SSSPIGOTSIMB	MB

(2 pcs.) 1/2" Threaded Custom Fastener included.

Fastener Options
(Sold Separately - See pg 197-202)
Choose according to your needs. Refer to engineering for Fastener sizing.

For Wood: • 1/2" Hanger Bolt, or Thru-Bolt.

For Concrete: • 1/2" Wedge Anchors.

• 1/2" Threaded Rod and Epoxy.

Scan for more info and installation procedure. Inquire about engineering.

Standard Top Mount Spigots

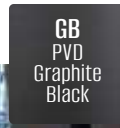
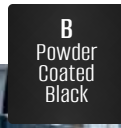
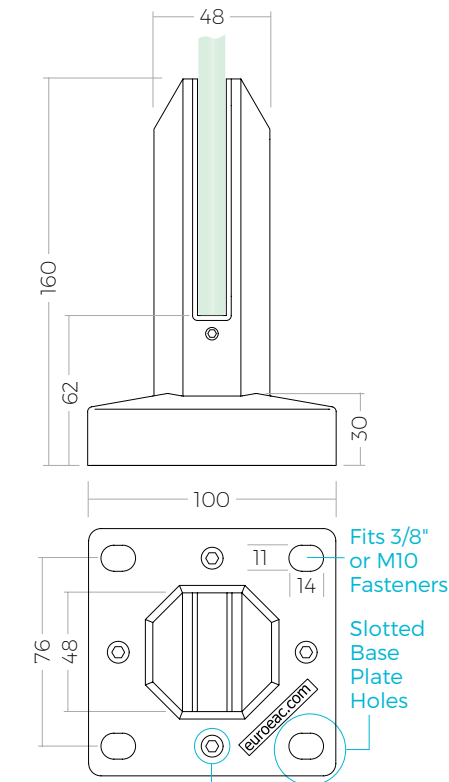
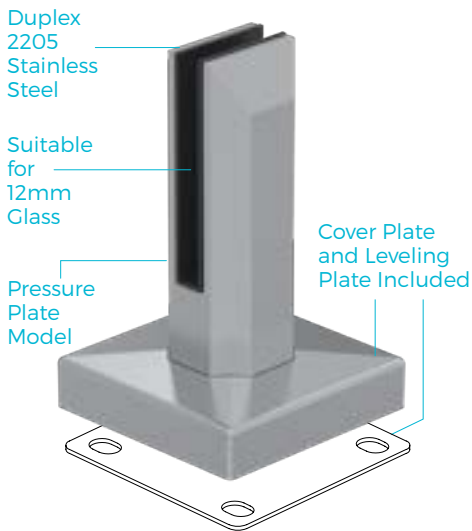


PHOTO: Millan Glass & Mirror

6" STANDARD TOP MOUNT SPIGOT



4 Adjustment Screws for Leveling Plate

SPIGOT PART #	Finish
SSSPIGOTS6S	S
SSSPIGOTS6B	B
SSSPIGOTS6GB	GB
SSSPIGOTS6MB	MB
SSSPIGOTS6G	G

Fastener Options

(Sold Separately - See pg 197-202)
Choose according to your needs.
Refer to engineering for Fastener sizing.

For Wood:

- 3/8" Lag Bolt.



For Concrete:

- 3/8" or M10 Wedge Anchors.



- 3/8" or M10 Threaded Rod with Nut, Washer and Epoxy.

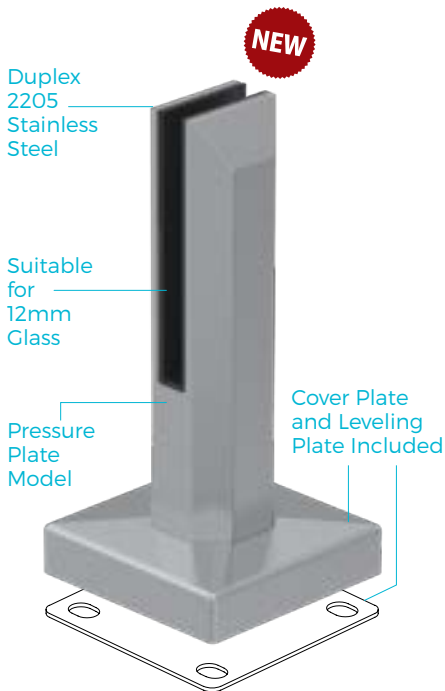


Scan for more info and installation procedure. Inquire about engineering.

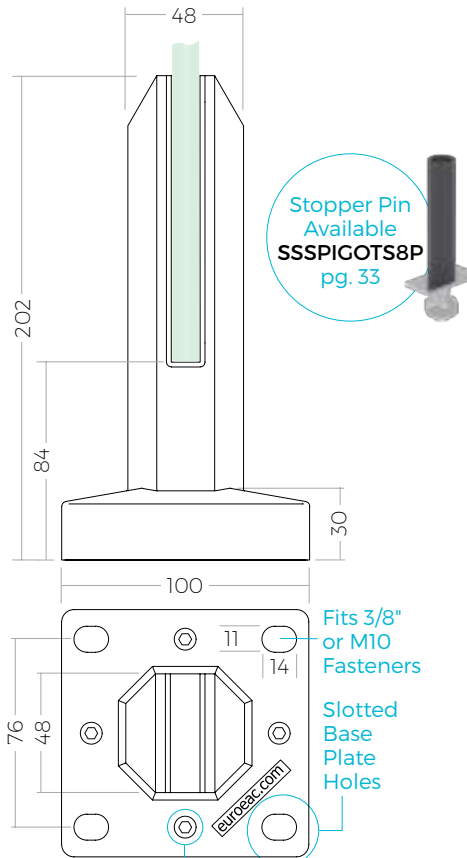


PHOTO: Millan Glass

8 || STANDARD TOP MOUNT SPIGOT



NEW



4 Adjustment Screws for Leveling Plate

SPIGOT PART #	Finish
SSSPIGOTS8S	S
SSSPIGOTS8B	B
SSSPIGOTS8GB	GB
SSSPIGOTS8G	G

Fastener Options

(Sold Separately - See pg 197-202)
Choose according to your needs. Refer to engineering for Fastener sizing.

For Wood:

- 3/8" Lag Bolt.



For Concrete:

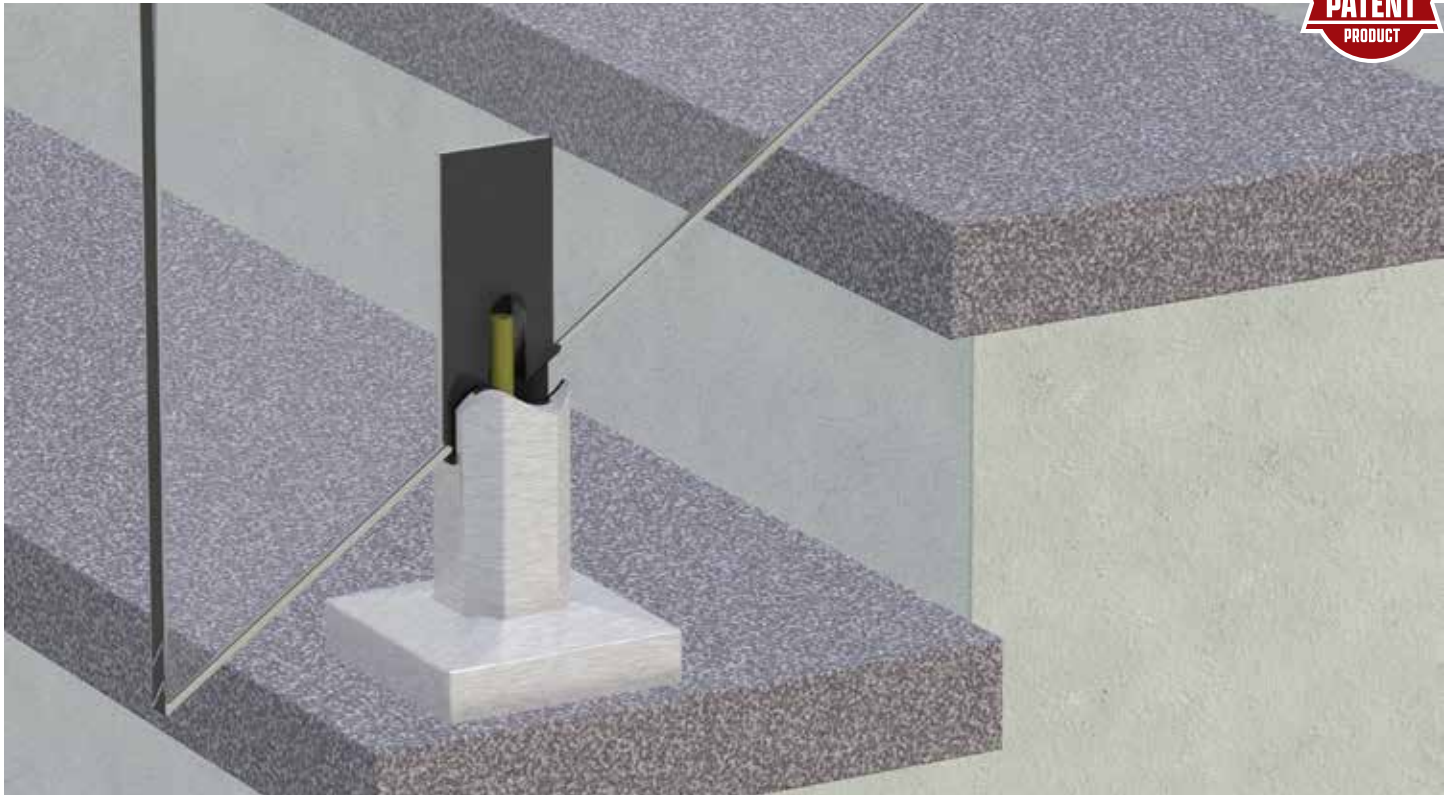
- 3/8" or M10 Wedge Anchors.



- 3/8" or M10 Threaded Rod with Nut, Washer and Epoxy.



Scan for more info and installation procedure. Inquire about engineering.



STOPPER PIN - Stopper Pin For 8" Standard Top Mount Model Only (pg 32).

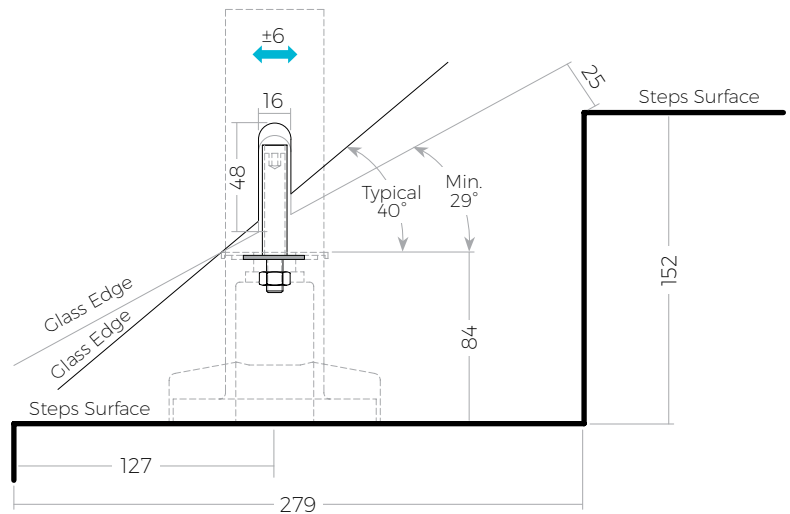
SSSPIGOTS8P

- Stopper Pin prevents Glass Panel from sliding for Stair applications.
- Patent pending in Canada and U.S.

NEW



SSSPIGOTS8P



NOTE: Install the STOPPER PIN before securing the Spigot to the floor. There is a possibility to adjust the STOPPER PIN up to a max of ±6 mm sideways without removing the Spigot.

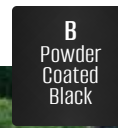
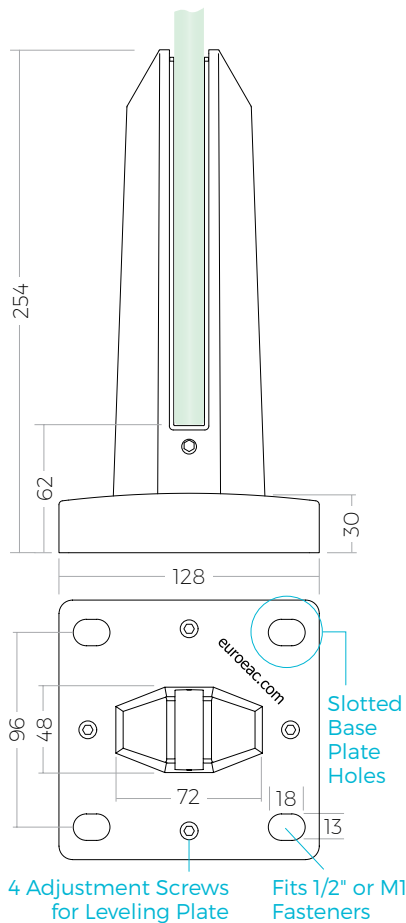
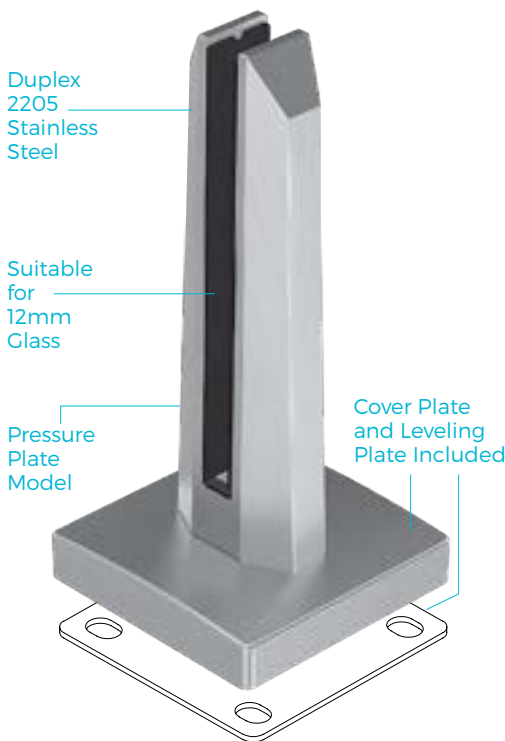


PHOTO: Vitrierie Pros

Standard Spigots

10" STANDARD TOP MOUNT SPIGOT



SPIGOT PART #	Finish
SSSPIGOTIOS	S
SSSPIGOTIOB	B
SSSPIGOTIOGB	GB

Fastener Options

(Sold Separately - See pg 197-202)
Choose according to your needs. Refer to engineering for Fastener sizing.

For Wood: 
• 1/2" Lag Bolt.

For Concrete: 
• 1/2" or M12 Wedge Anchors.


• 1/2" or M12 Threaded Rod with Nut, Washer and Epoxy.



Scan for more info and installation procedure. Inquire about engineering.

TYLT-LOCK™

Tilt Adjustable Glass Railing Technology



PHOTO: Karawood Industries



TILT-LOCK™ T3 ADJUSTABLE STANDOFF

Introducing our **TILT-LOCK™ Adjustable Lockable T3 Series** Glass Standoffs, available in 1 1/2" and 2" diameters in various lengths. All sizes are available in Satin finish, with some available in Powder Coated Black, PVD Graphite Black, Matte Black, and Gold.

Our **T3 Series** Standoffs have been engineered with **3D Adjustability** allowing vertical, horizontal, and front-to-back alignment of Glass Panels, for easier and incredibly precise alignment every time. They also feature an **Internal Locking Mechanism** with a clean design that conceals the Threads in the Spacer.

Features

- **NEW** increased range of Glass Sizes from 3/8"-7/8", suitable for commercial and residential projects.
- **Locking System** secures Standoff in adjusted position, preventing misalignment once the Cap is assembled or disassembled.
- **3D Adjustability** allows $\pm 3^\circ$ tilt of Glass Railings, while the slot hole provides vertical and horizontal adjustment allowing for more fastening options.
- Cap and Threaded Rod come as one cast piece for superior strength.
- Duplex-2205 Ultra Marine-Grade Stainless Steel, solid material.
- Designed by EAC and fully engineered for the National Building Code of Canada.
- **Patent pending in Canada and U.S.**

STANDARD GLASS STANDOFFS

Our popular **Standard** Glass Standoffs are made of high-quality 316-Grade Stainless Steel and are available Round or Square to suit your design needs. (They are finished in Satin with most sizes offering Graphite Black and Powder Coated Black).

Features

- 316-Grade Stainless Steel, solid material.
- Includes Imperial Thread and is available in 3 finishes: Satin, Graphite Black, and SS304 Powder Coated Black.
- The Spacer design has a short lip to provide a smooth surface for Glass to be held in place for installation.
- Imperial Fastening options are available. For Threaded Rods and Hanger Bolts, use the same Thread size as the Spacer.



Round TILT-LOCK™ T3 Lockable Adjustable Glass Standoffs

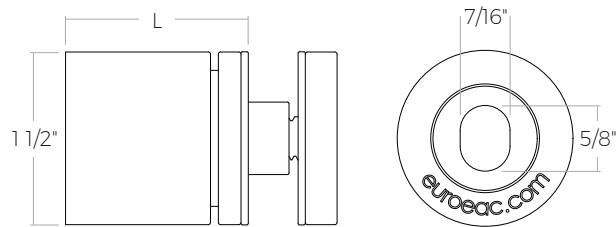
- **NEW** increased range of Glass sizes from 3/8"-7/8", suitable for Commercial and Residential projects.
- **Locking System** secures Standoff in adjusted position, preventing misalignment once the Cap is assembled or disassembled. Pg 39.
- **3D Adjustability** allows $\pm 3^\circ$ tilt of Glass Railings, while the slot hole provides vertical and horizontal adjustment allowing for more fastening options.

- Duplex-2205 Ultra Marine-Grade Stainless Steel, solid material.
- Designed by EAC and fully engineered for the National Building Code of Canada.
- Cap and Threaded Rod come as one cast piece for superior strength.
- **Patent pending in Canada and U.S.**



1 1/2" Diameter

Accommodates **10-16mm** Glass.
Recommended Glass Hole size 3/4".
Recommended Fastener M10 or 3/8". See pg 44.

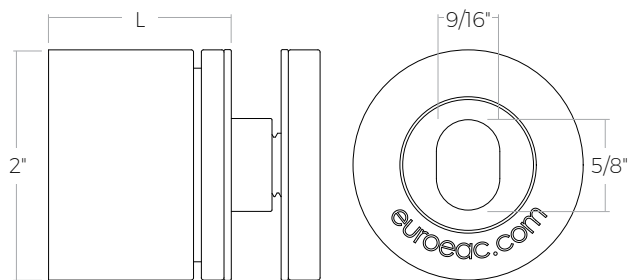


PART #	L (Length)	Max. L (Length)	Glass Size	Finish
SSJ112114	1 1/4"	1 1/2"	10-16mm	S
SSJ112112	1 1/2"	1 3/4"	10-16mm	S / B / GB / MB / G
SSJ1122	2"	2 3/8"	10-16mm	S / B / GB / MB

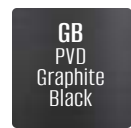
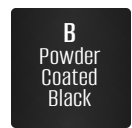
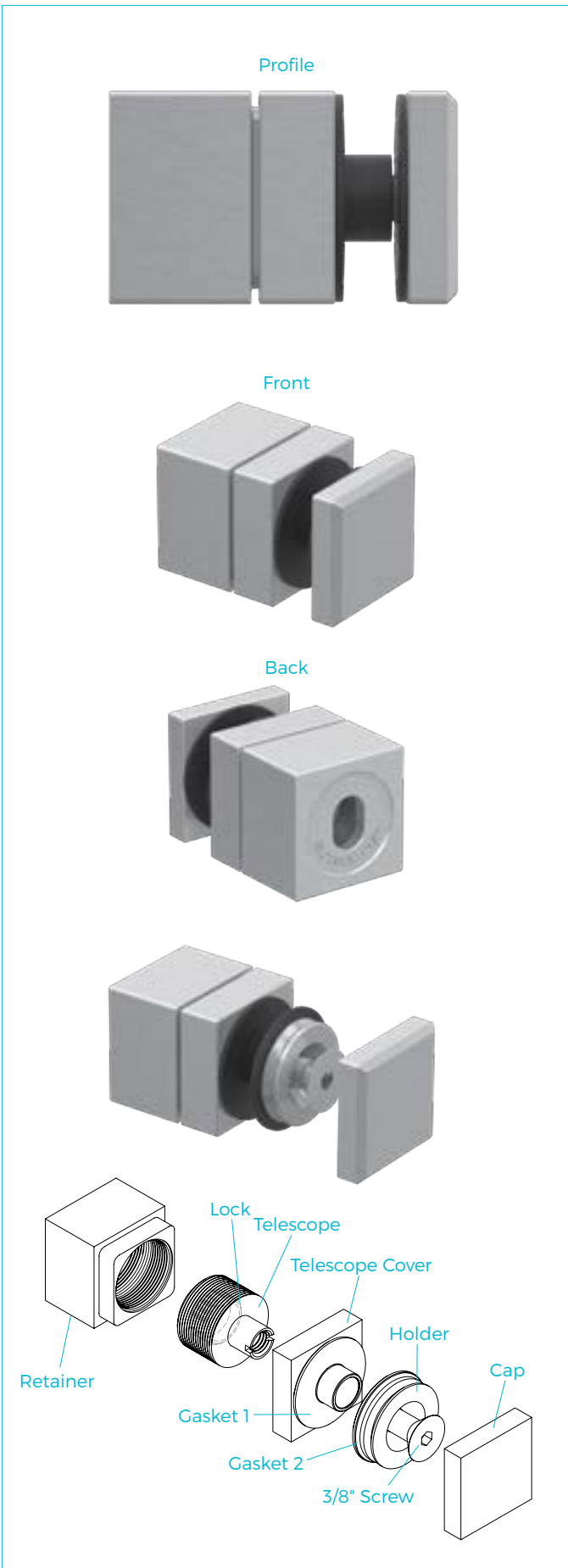


2" Diameter

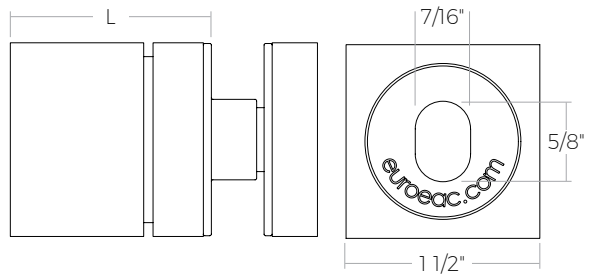
Accommodates **12-22mm** Glass.
Recommended Glass Hole size 1".
Recommended Fastener M12 or 1/2". See pg 44.



PART #	L (Length)	Max. L (Length)	Glass Size	Finish
SSJ2112	1 1/2"	1 3/4"	12-19mm	S / B / GB / G
SSJ22	2"	2 3/8"	12-22mm	S / B / GB



1 1/2" Diameter
 Accommodates 10-16mm Glass.
 Recommended Glass Hole size 3/4".
 Recommended Fastener M10 or 3/8". See pg 44.



PART #	L (Length)	Max. Length	Glass Size	Available Finish
SSJQ112	1 1/2"	1 3/4"	10-16mm	S / B / GB / G

Tilt-Lock™ Glass Standoff Tool

3°

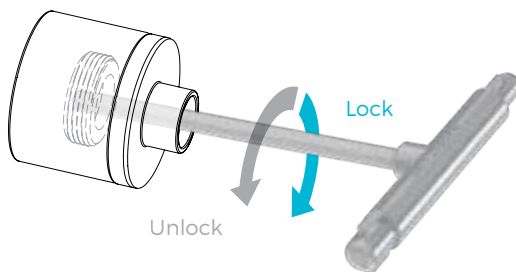
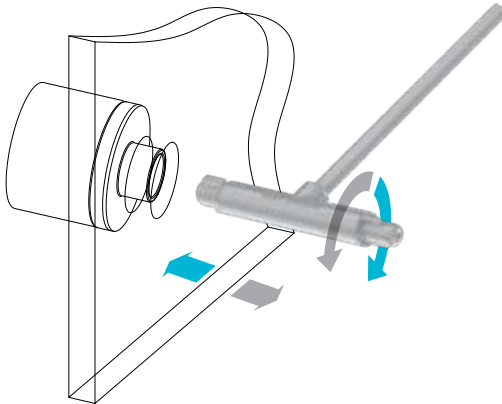


ADJUSTABILITY

Adjust horizontally side to side.

Adjust vertically up and down.

Adjust forward or backward to allow a $\pm 3^\circ$ adjustment, then lock into place.



Follow the fastener recommendations on pg. 40 in order to activate the lock properly.

This Tool is designed by EAC to facilitate adjustments to our Adjustable Glass Standoffs. The 2 Rounded ends are for adjusting 1 1/2" and 2" diameters respectively. The Allen Key is used to lock and secure the Standoffs in place.

PART #

SSJTI Adjustable Standoff Tool.



PHOTO: Innovative Metal Works

CONCRETE APPLICATION

Threaded Rods with Epoxy or Wedge Anchors are two options to install Standoffs on Concrete.

1 1/2" Dia. Standoffs

Option A: Threaded Rod with Epoxy.

- SSKF381** - SS Threaded Rod 3/8" x 5".
- SSNUT3816** - SS Nut 3/8"-16.
- PWS38VP** - SS Flat Washer 3/8".
- FR5-10MX** - FLO-ROK® Epoxy (Fills 39 holes 7/16" x 4 1/2").

Option B: Wedge Anchor.

- ISS38334** - SS Wedge Anchor 3/8" x 3 3/4".

2" Dia. Standoffs:

Option A: Threaded Rod with Epoxy.

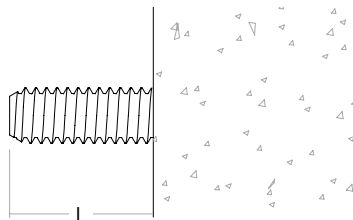
- SSKF121** - SS Threaded Rods 1/2" x 5".
- SSNUT1213** - SS Nut 1/2"-13.
- PWS12CT** - SS Flat Washer 1/2".
- FR5-10MX** - FLO-ROK® Epoxy (Fills 28 holes 9/16" x 4 1/2").

Option B: Wedge Anchors

- ISS12334** - SS Wedge Anchor 1/2" x 3 3/4".
- ISS12412** - SS Wedge Anchor 1/2" x 4 1/2".

NOTE: Make sure the length of the Threaded Rods or Wedge Anchors protruding from the surface matches length "L" shown in the chart below:

PART #	L
SSJ112114	9/16"
SSJ112112	5/8"
SSJ1122	3/4"
SSJQ112	3/4"
SSJ2112	3/4"
SSJ22	3/4"

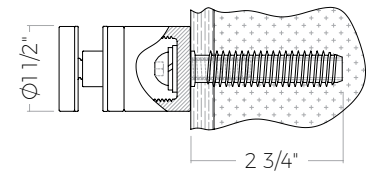


WOOD APPLICATION

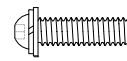
When installed, our Wood Fasteners transfer the load to the Wood structure without compressing the surface material such as Drywall or Siding.

1 1/2" Dia. Standoffs

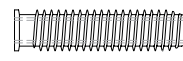
Standoffs are secured to Wood Insert by the 3/8" Machine Screws below.



For **SSJ112114**

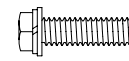


Use **SSFLPK1**
SS Screw 3/8" x 2"

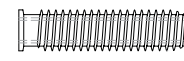


SSKFW38234
SS Wood Insert

For **SSJ112112**

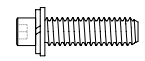


Use **SSFLPK2**
SS Screw 3/8" x 2"



SSKFW38234
SS Wood Insert

For **SSJ1122** or **SSJQ112**



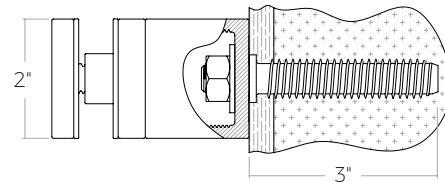
Use **SSFLPK3**
SS Screw 3/8" x 2"



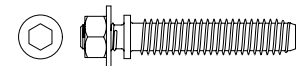
SSKFW38234
SS Wood Insert

2" Dia. Standoffs

SS Hanger Bolt sets are used to secure the Standoffs.



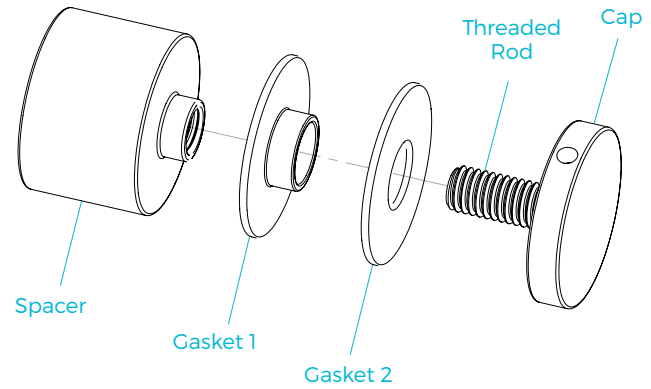
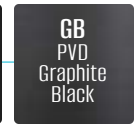
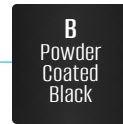
For **SSJ2112** or **SSJ22**
Use **SSJHB124SS** SS Hanger Bolt Set.



Pilot hole for Wood Insert and Hanger Bolt set:
Soft Wood: 1/2" · Hard Wood: 3/16"



PHOTO: Trueline Moulding Group Inc.



- 316-Grade Stainless Steel, solid material.
- Includes Imperial Thread and is available in 3 finishes: Satin, Graphite Black, and SS304 Powder Coated Black.
- The Spacer design has a short lip to provide a smooth surface for Glass to be held in place for installation.
- Imperial Fastening options are available. For Threaded Rods and Hanger Bolts, use the same Thread size as the Spacer.



PHOTO: Venetian Iron Design

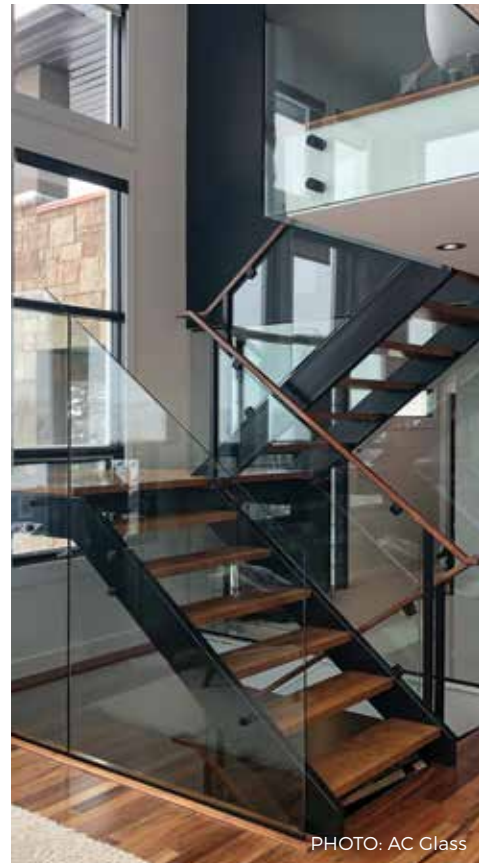
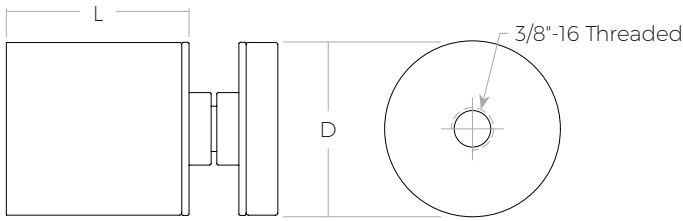


PHOTO: AC Glass



SPACERS

1 1/4" Diameter

Recommended Glass Hole size 5/8".
Recommended Fastener 5/16".



PART #	L (Length)	Thread (UNC)	SS Grade	Finish
SSK114126S	1/2"	5/16"	316	S

1 1/2" Diameter

Recommended Glass Hole size 3/4".
Recommended Fastener 3/8".



PART #	L (Length)	Thread (UNC)	SS Grade	Finish
SSK112126S	1/2"	3/8"	316	S
SSK112126S	1"	3/8"	316	S
SSK11214B	1"	3/8"	304	B
SSK11216GB	1"	3/8"	316	GB
SSK1121146S	1 1/4"	3/8"	316	S
SSK1121126S	1 1/2"	3/8"	316	S
SSK1121124B	1 1/2"	3/8"	304	B
SSK1121126GB	1 1/2"	3/8"	316	GB
SSK1121346S	1 3/4"	3/8"	316	S
SSK11226S	2"	3/8"	316	S
SSK11224B	2"	3/8"	304	B
SSK11226GB	2"	3/8"	316	GB

2" Diameter

Recommended Glass Hole size 3/4".
Recommended Fastener 3/8".



PART #	L (Length)	THREAD (UNC)	SS Grade	Finish
SSK2126S	1/2"	3/8"	316	S
SSK2346S	3/4"	3/8"	316	S
SSK216S	1"	3/8"	316	S
SSK214B	1"	3/8"	304	B
SSK216GB	1"	3/8"	316	GB
SSK21146S	1 1/4"	3/8"	316	S
SSK21126S	1 1/2"	3/8"	316	S
SSK21124B	1 1/2"	3/8"	304	B
SSK21126GB	1 1/2"	3/8"	316	GB
SSK21346S	1 3/4"	3/8"	316	S
SSK226S	2"	3/8"	316	S
SSK224B	2"	3/8"	304	B
SSK226GB	2"	3/8"	316	GB

INCLUDES: Gasket (2 pcs) & 3/8-16" x 1 1/8" Threaded Rod for 10-13.52mm Glass (1 pc).

CAPS

PART #	Thread (UNC)	SS Grade	Finish
1 1/4" Diameter			
SSKCAP1146S	5/16"	316	S
1 1/2" Diameter			
SSKCAP1126S	3/8"	316	S
SSKCAP1124B	3/8"	304	B
SSKCAP1126GB	3/8"	316	GB
2" Diameter			
SSKCAP26S	3/8"	316	S
SSKCAP24B	3/8"	304	B
SSKCAP26GB	3/8"	316	GB



THREADED RODS FOR CAPS

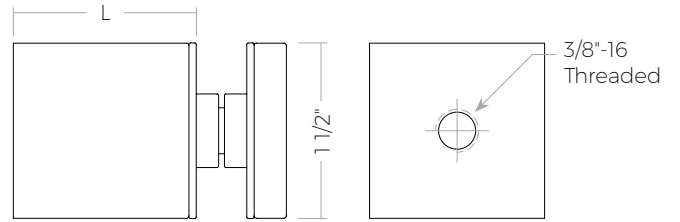
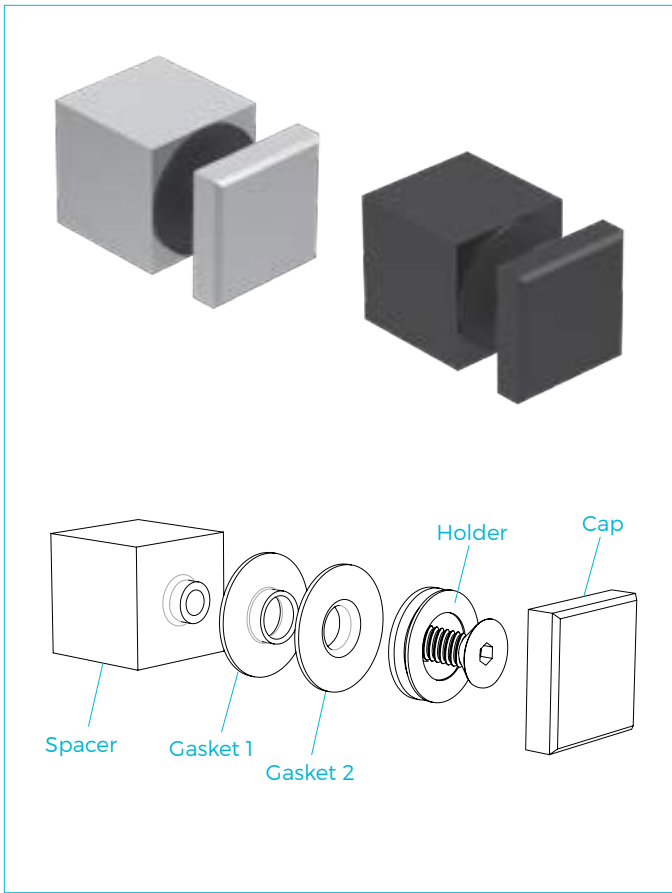
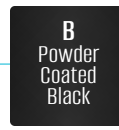
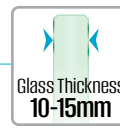
PART #	Thread (UNC)	Length	Glass Size
SSKF384	3/8"	1 1/8"	10-13.52
SSKF383	3/8"	1 9/16"	15-19



GASKETS (2 pcs)

PART #	D (Diameter)	Finish
SSKCAP114GAS	1 1/4"	Clear Plastic
SSKCAP112GAS	1 1/2"	Clear Plastic
SSKCAP2GAS	2"	Clear Plastic
SSKCAP112GAX	1 1/2"	Black Plastic
SSKCAP2GAX	2"	Black Plastic

Square Standard Glass Standoffs



Cap, Spacer, and Gaskets included.

1 1/2" Square

Recommended Glass Hole size 3/4".

Recommended Fastener 3/8".

PART #	L (Length)	Thread (UNC)	SS Grade	Finish
SSK112SQR	1 1/2"	3/8"	316	S
SSK112SQRB	1 1/2"	3/8"	316	B
SSK112SQRGB	1 1/2"	3/8"	316	GB



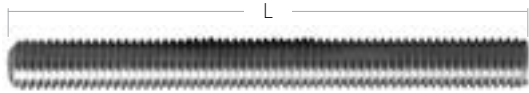
PHOTO: Bloor Railing



PHOTO: Bloor Railing

Fastening Options & Essentials

The following Fastening options and essentials are available for our Adjustable and Standard Glass Standoffs. All items are sold separately and are not included with the Standoffs.



THREADED RODS

PART #	Thread (UNC)	L (Length)
SSKF5161	5/16"	4"
SSKF384	3/8"	1 1/8"
SSKF383	3/8"	1 9/16"
SSKF382	3/8"	3 9/16"
SSKF381	3/8"	5"
SSKF121	1/2"	5"



HANGER BOLTS

PART #	Thread (UNC)	L (Length)
SSKFHB5161	5/16"	3"
SSKFHB38212	3/8"	2 1/2"
SSKFHB38314	3/8"	3 1/4"
SSKFHBI3835	3/8"	3 1/2"
SSKFHBI384	3/8"	4"
SSKFHB384	3/8"	4"



WOOD INSERT

PART #	Thread (UNC)	L (Length)
SSKFW382	3/8"	2"
SSKFW38234	3/8"	2 3/4"



ESSENTIALS

PART #	Description
--------	-------------

- SSSPANNER1** Spanner for 3/4"-2" Diameter (Small).
- SSSPANNER2** Spanner for 1 1/4"-3" Diameter (Large).
- SSSPANNER3** Spanner Kit for 1 1/2" and 2" Standoff Caps. Includes: 2 Standoff Cap Covers with Plastic Liner, 1 Ratchet Spanner, and 1 Allen Key.



- FR5-10MX** FLO-ROK® FR5 MAX 10 oz. Injection Anchoring Adhesive/Epoxy.
- PA100** FLO-ROK® FR5 MAX 10 oz. Manual Dispensing Tool.

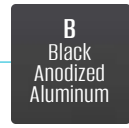
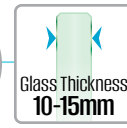
TYLT-LOCK™

Tilt Adjustable Glass Railing Technology



PHOTO: Excel Enclosures & Railings

TILT-LOCK™ Mini Posts



Features

- Engineered for Interior and Exterior Landing and Stairway applications.
- Includes **TILT-LOCK™** Adjustable Glass Standoffs Lockable T3 Series, equipped with a locking system to secure Standoff in an adjusted position, preventing misalignment once the Cap is assembled or disassembled.
- Adjustable Standoffs secure Glass Panels, providing tilt adjustability for Glass Panels by extending in length.
- TILT-LOCK™ Mini Posts are available in 316-Grade Satin Stainless Steel and Black Anodized Aluminum. Accompanying Standoffs are made of solid Duplex-2205 Stainless Steel and are available in Satin and Black Powder Coated finishes.
- Recommended hole size for Glass is 3/4".



Patent pending in Canada and U.S.

Mini Posts



PHOTO: Custom Glass Railings

TOP MOUNT

Designed with TILT-LOCK™ T3 Series Standoffs. (pg 37)



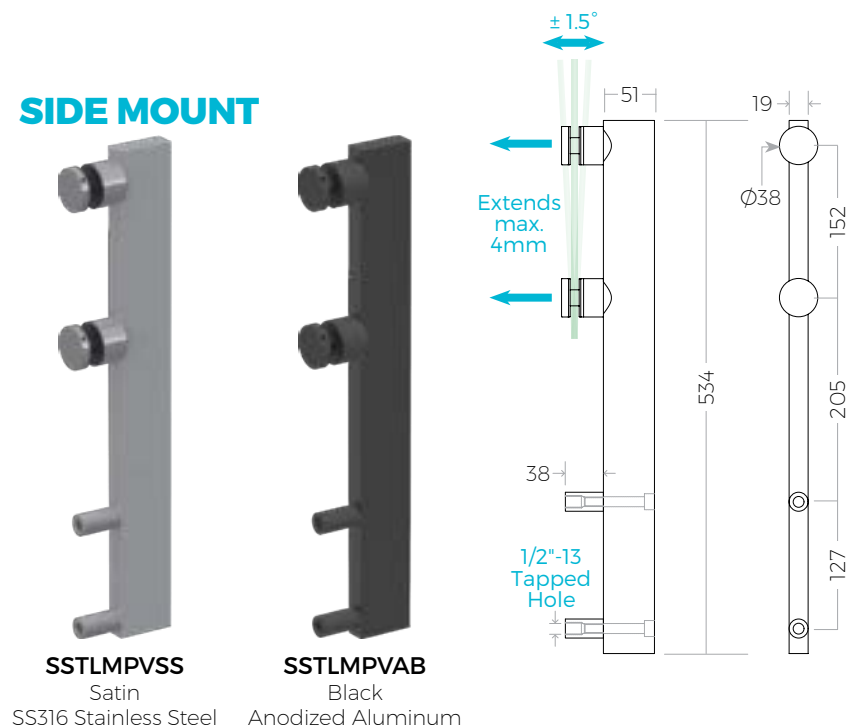
SSTLMPSS
Satin
SS316 Stainless Steel

SSTLMPAB
Black
Anodized Aluminum



PHOTO: Excel Enclosures & Railings

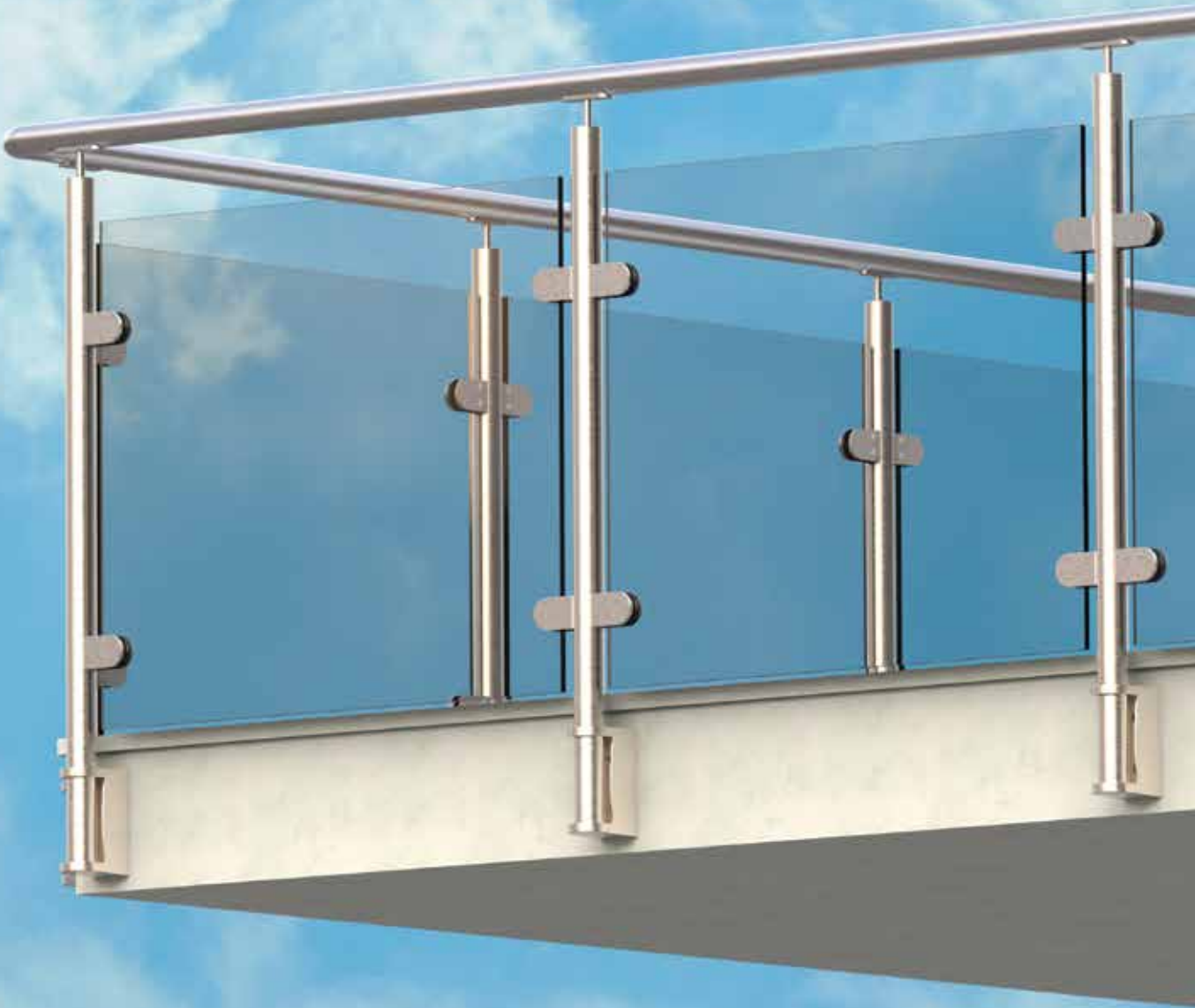
SIDE MOUNT



SSTLMPVSS
Satin
SS316 Stainless Steel

SSTLMPVAB
Black
Anodized Aluminum

Posts & Accessories

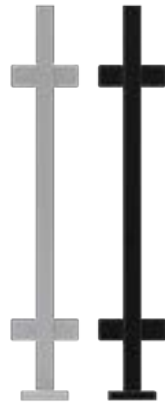


Posts and Accessories Overview

NEW



ELITE HANDRAIL
Residential



ELITE FRAMELESS
Residential



STANDARD TOP MOUNT
Residential



STANDARD SIDE MOUNT
Residential



HEAVY DUTY
Commercial

MOUNT	Top	Top	Top	Side	Top
STYLE	Square 40 x 40mm	Square 40 x 40mm	Round Φ 42.4mm Square 40 x 40mm	Round Φ 42.4mm Square 40 x 40mm	Round Φ 50mm Square 50 x 50mm
MATERIAL & FINISH	SS304 Satin & Black	SS316 - Satin SS304 - Black	SS316 - Satin	SS316 - Satin	SS316 - Satin
HEIGHT & APPLICATION	915 (36") Landing/Stairs	915 (36") Landing / Stairs ----- 1070 (42") Landing	915 (36") Landing / Stairs ----- 1070 (42") Landing	915 (36") Landing / Stairs ----- 1070 (42") Landing	1070 (42") Landing / Stairs
FEATURES	<ul style="list-style-type: none"> Seamless Top Cap. Welded Tube Support (Fixed/Swivel). Small Glass Clips. 	<ul style="list-style-type: none"> Seamless Top Cap. Large Glass Clips. 	<ul style="list-style-type: none"> Customizable Top Cap & Tube Support. Large Glass Clips. 	<ul style="list-style-type: none"> Customizable Top Cap & Tube Support. Large Glass Clips. 	<ul style="list-style-type: none"> Seamless Top Cap. Height Adjustable Tube Support. Suits Glass Clips, Arm Fittings, and Spiders.
POST WALL THICKNESS					
GLASS THICKNESS					Based on chosen Glass hardware
INSTALLATION	76 (3") Base. 5/16" Fasteners. 3/8" GRK.	100 (4") Base. 3/8" Fasteners.	100 (4") Base. 3/8" Fasteners.	Side Mount Support for Round & Square available; Refer to pg 67-68 1/2" Fasteners.	125 (5") Base. 1/2" Fasteners.
BLANK POST OPTIONS	Available for Landing / Stairs.	Available for Landing 42".	Different options available.	Not available.	Suits Core Mount without Base Plate. Base Plate & Cover sold separately.
PAGE	50	55	59	67	70

Posts & Accessories

ElitePosts

PRE-FAB POSTS FOR GLASS RAILINGS

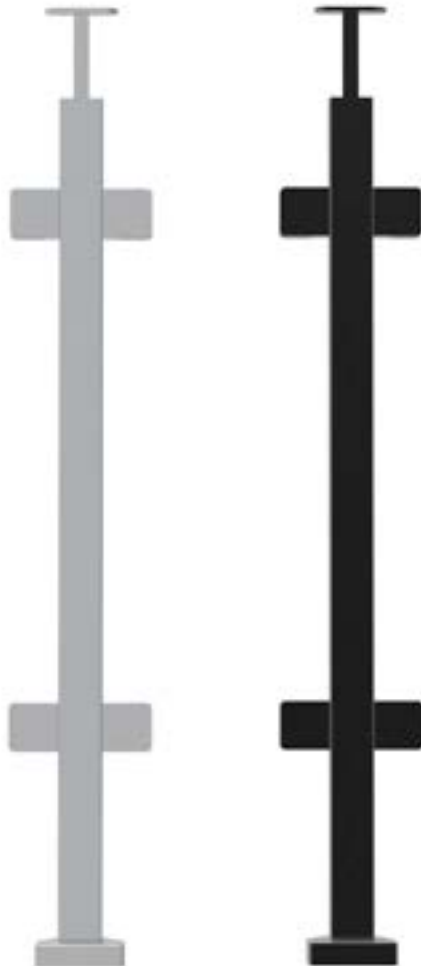


Introducing **ELITE POSTS**, our READY-TO-INSTALL, Prefabricated Square Posts for Glass Railings. Elite Posts are fully engineered and made of durable SS304 and SS316 Grade Stainless Steel. They arrive pre-assembled to fit all parts of your stairway and are available in Satin and Black finishes. They are also complete with Glass Clips and Bases for quick, easy, and convenient applications.

Elite Posts are available in two series:

1. **Handrail Series:** Intended for Interior residential use. Included with Handrail Attachment Plates (Handrail not included).
2. **Frameless Series:** Features a flat top for unobstructed views, intended for both Interior and Exterior use.

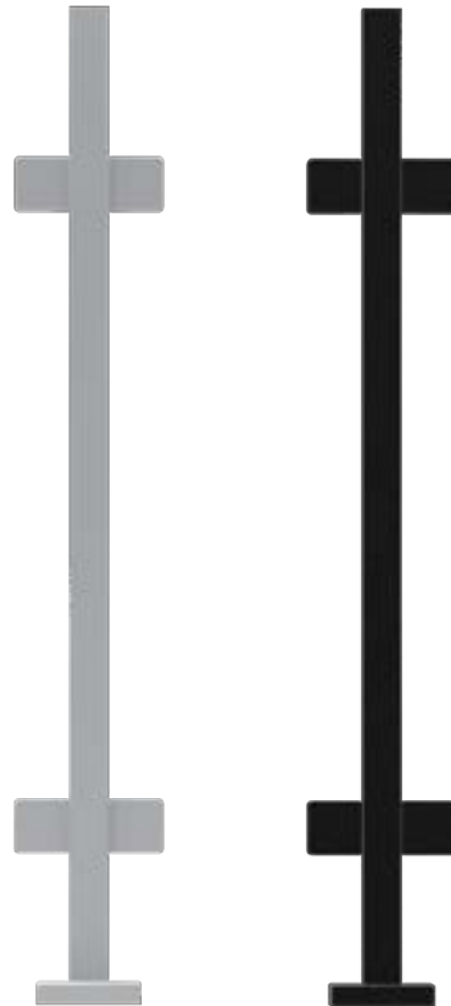
HANDRAIL SERIES



SS304 Satin (S)

SS304 Black (B)

FRAMELESS SERIES



SS316 Satin (S)

SS304 Black (B)

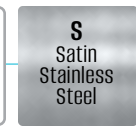
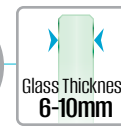
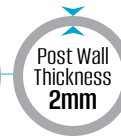
Sure to impress, the **HANDRAIL SERIES** is fully engineered and designed for today's minimalist look. Available in Satin (S) and Black (B), they create a stylish, elegant look for your **Interior** Railings when paired with your choice of Handrail.

Our newly added **FRAMELESS SERIES** are fully engineered and designed for **Interior and Exterior** projects. Available in Satin (S) and Black (B), our Frameless Series offers you a sleek, contemporary look while opening up the space in your surroundings.

For complete details, please ask for a brochure or scan the code to visit our site.



Elite Posts Handrail Series



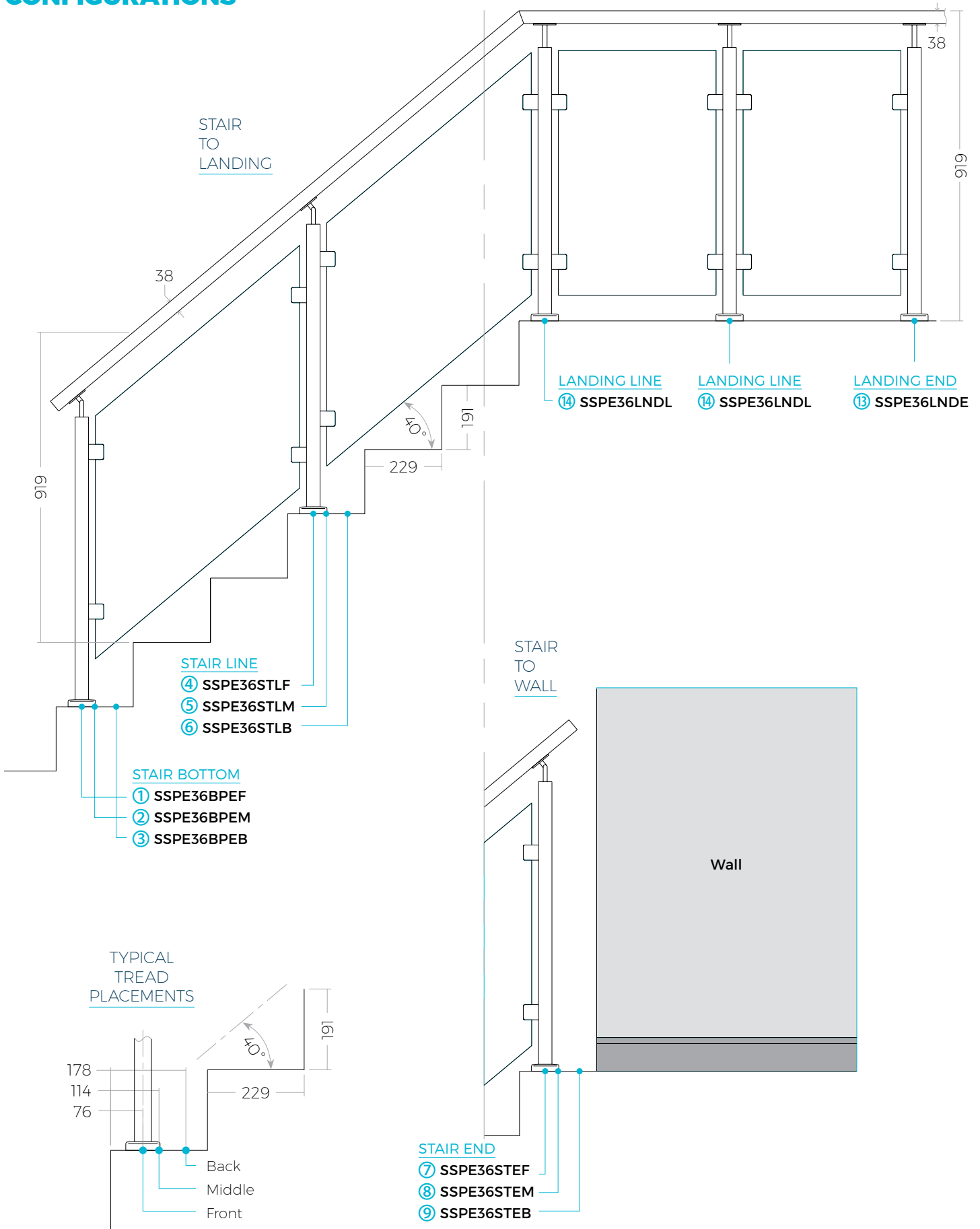
- Fully engineered for **Interior Residential** applications.
- Material is SS304, in both Satin and Powder Coated Black.
- Provides placement on the front, middle, and back of the tread for 36" high Railings.
- Fully Welded Tube Supports with a solid Square Stem, providing a modern and clean look.

- Fully Welded Solid Cast Stainless Steel Base Plates.
- Small Square Glass Clips are secured by included M8 x 20. Stainless Steel Fasteners.
- Flat Handrail Attachment Plates and Base Plate Covers are also included.
- 10mm Gasket included. Additional Gaskets available. (Pg 84).

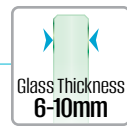
PART #	Description	PART #	Description
① SSPE36BPEF	Stair Bottom Post - Front.	⑩ SSPE36STBF	Stair Blank Post - Front.
② SSPE36BPEM	Stair Bottom Post - Middle.	⑪ SSPE36STBM	Stair Blank Post - Middle.
③ SSPE36BPEB	Stair Bottom Post - Back.	⑫ SSPE36STBB	Stair Blank Post - Back.
④ SSPE36STLF	Stair Line Post - Front.	⑬ SSPE36LNDE	Landing End / Turn Post 36".
⑤ SSPE36STLM	Stair Line Post - Middle.	⑭ SSPE36LNDL	Landing Line Post 36".
⑥ SSPE36STLB	Stair Line Post - Back.	⑮ SSPE36LNDC	Landing Corner Post.
⑦ SSPE36STEF	Stair End Post - Front.	⑯ SSPE36LNDB	Landing Blank Post.
⑧ SSPE36STEM	Stair End Post - Middle.	⑰ SSPE42LNDE	Landing End Post 42".
⑨ SSPE36STEB	Stair End Post - Back.	⑱ SSPE42LNDL	Landing Line Post 42".



CONFIGURATIONS

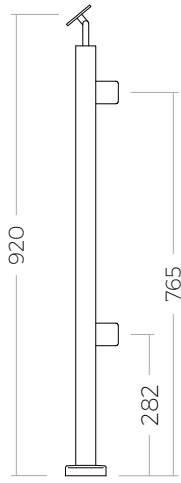


Elite Prefabricated Posts

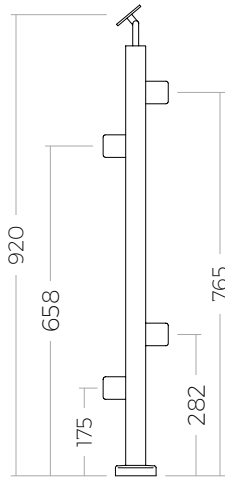


POSTS FOR STAIRS

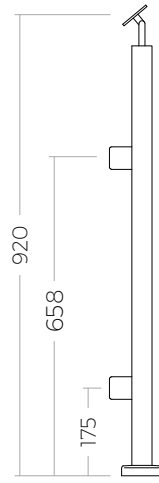
Front



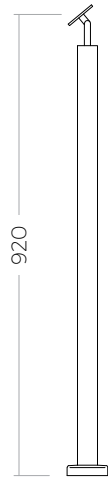
① **SSPE36BPEF**
Bottom



④ **SSPE36STLF**
Line

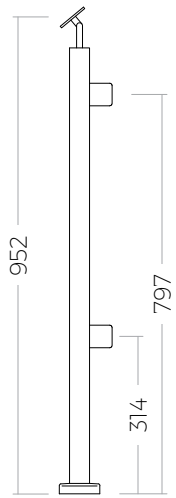


⑦ **SSPE36STEF**
End

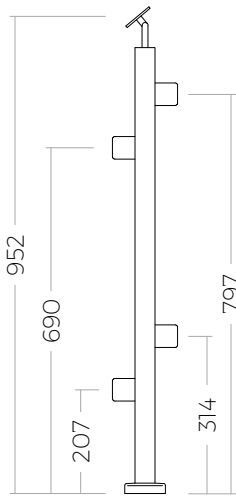


⑩ **SSPE36STBF**
Blank

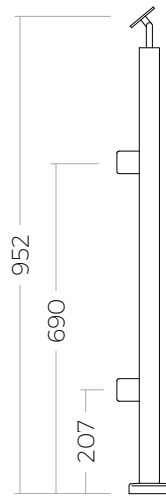
Middle



② **SSPE36BPEM**
Bottom



⑤ **SSPE36STLM**
Line

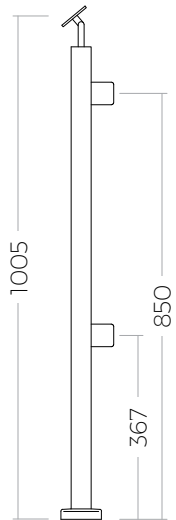


⑧ **SSPE36STEM**
End

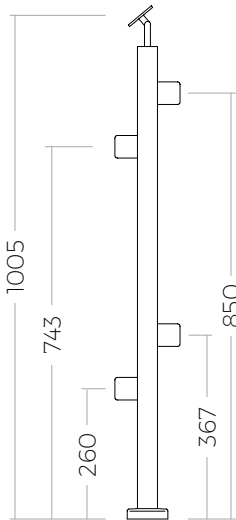


⑪ **SSPE36STBM**
Blank

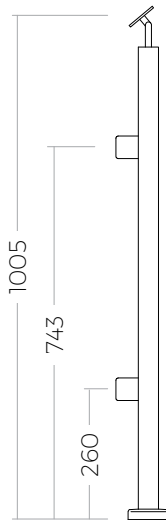
Back



③ **SSPE36BPEB**
Bottom



⑥ **SSPE36STLB**
Line



⑨ **SSPE36STEB**
End



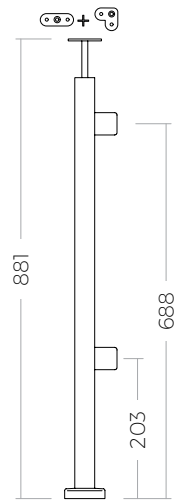
⑫ **SSPE36STBB**
Blank

POSTS FOR LANDING

36"

42"

NEW



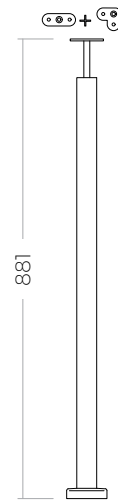
13 SSPE36LNDE
End Stair/
Landing Turn



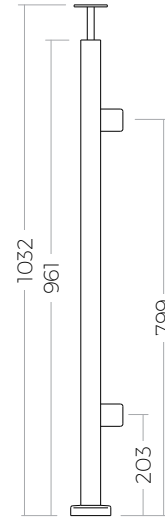
14 SSPE36LNDL
Line



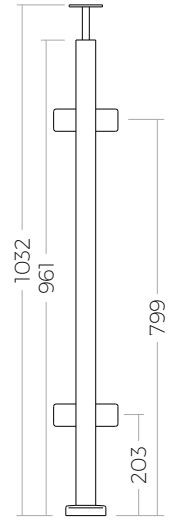
15 SSPE36LNDC
Corner



16 SSPE36LNDB
Blank



17 SSPE42LNDE
Landing End

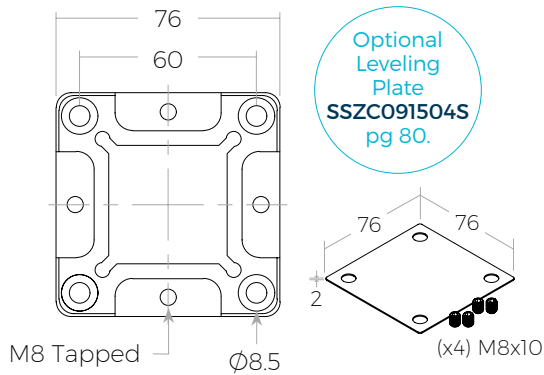


18 SSPE42LNDL
Landing Line

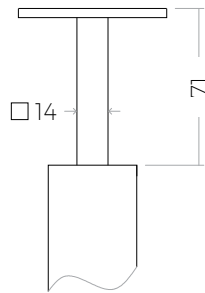
Elite Prefabricated Posts

COMPONENTS

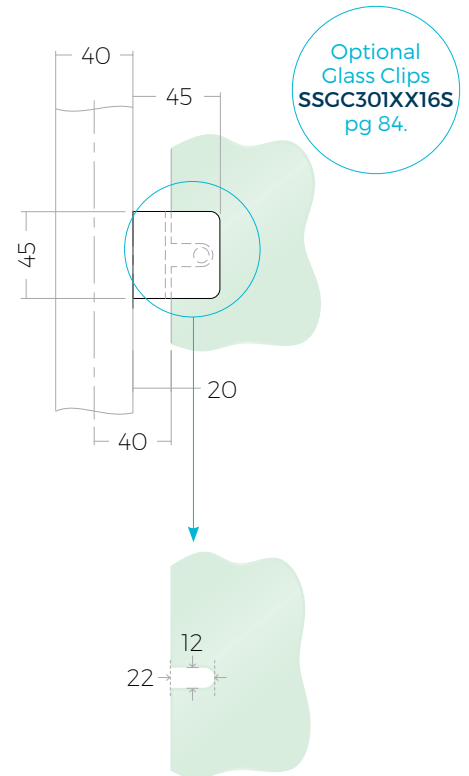
Base Plate



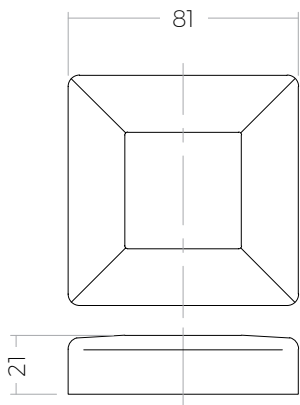
Fixed Tube Supports



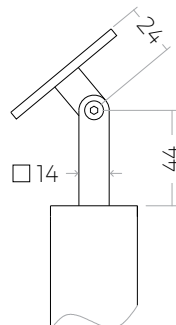
Glass Clip



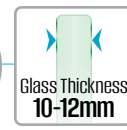
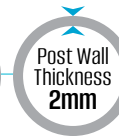
Base Plate Cover



Swivel Tube Supports



36" Elite Posts Frameless Series

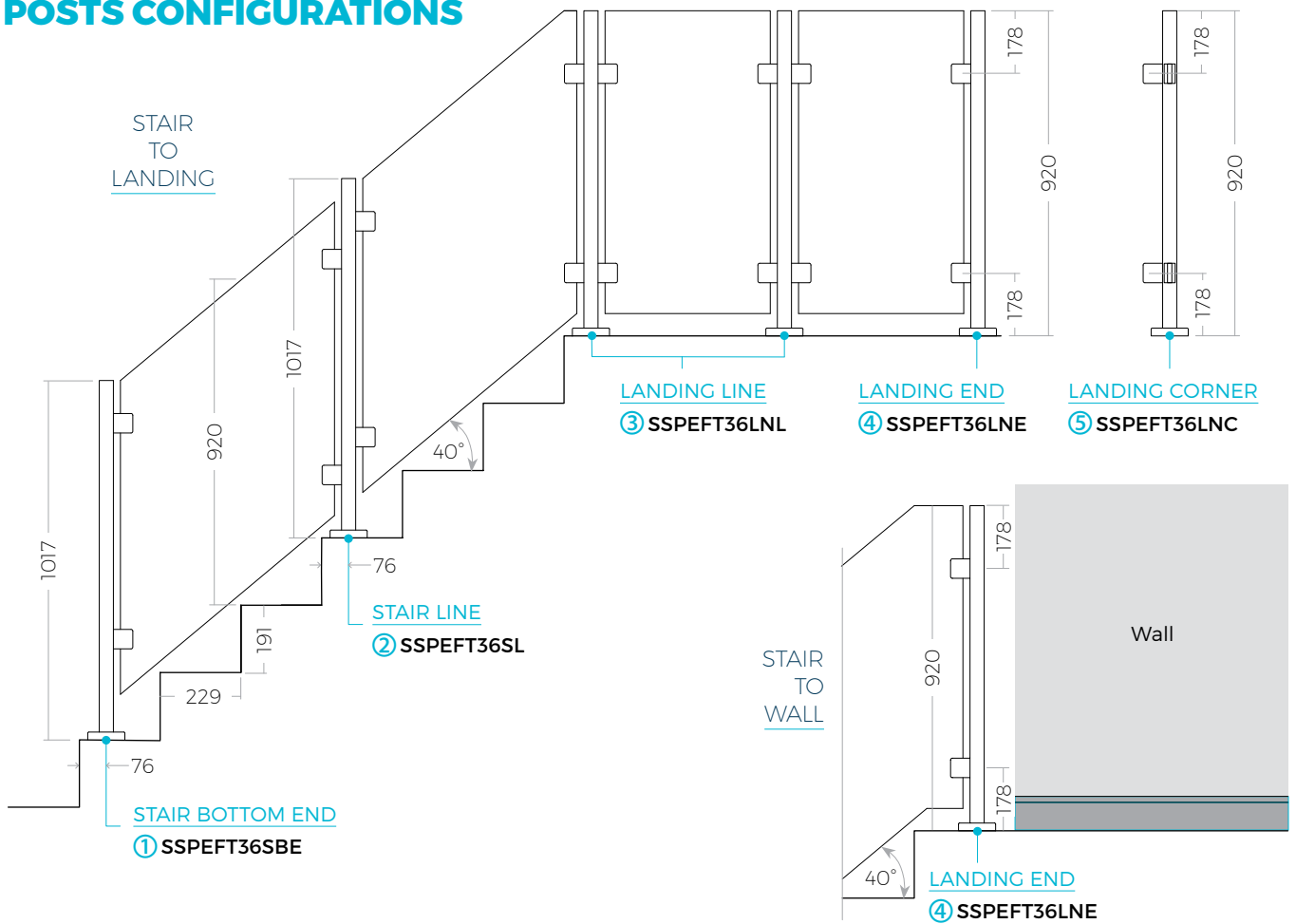


- Fully engineered for **Interior and Exterior Residential** applications.
- Material is SS316 for Satin and SS304 for Powder Coated Black.
- Provides 36" high Railings for Stair/Landing and 42" high option for Landing.
- Fully Welded End Caps provide an open and Frameless look for an unobstructed view.
- Fully Welded 4" Solid Cast Stainless Steel Plates with Flat Push-fit Base Plate Covers.
- Includes Large Square Glass Clips secured by an M8 x 20 Stainless Steel Fastener through Flow-drilled and Tapped Holes to the Posts.
- 10 and 12mm Gaskets included.

PART #	Description	PART #	Description
① SSPEFT36SBE	Stair Bottom End Post 36".	④ SSPEFT36LNE	Landing End Post 36".
② SSPEFT36SL	Stair Line Post 36".	⑤ SSPEFT36LNC	Landing Corner Post 36".
③ SSPEFT36LNL	Landing Line Post 36".		

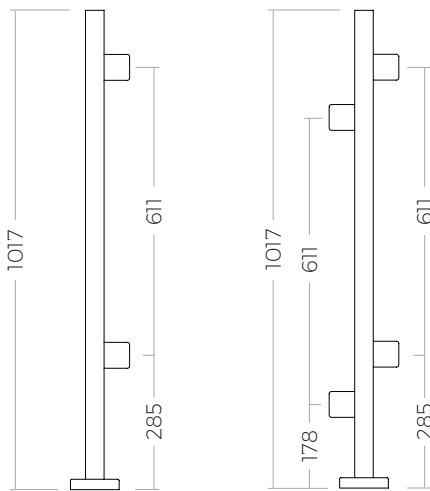


36" POSTS CONFIGURATIONS



Elite Frameless Prefabricated Posts

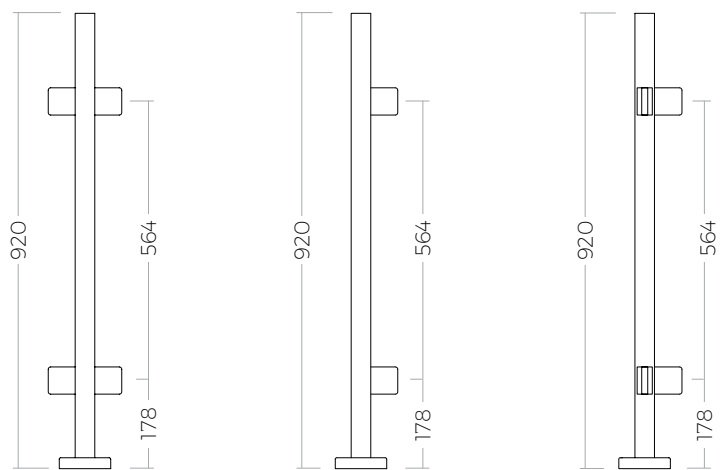
For Stairs



① SSPEFT36SBE
Bottom End

② SSPEFT36SL
Line

For Landing

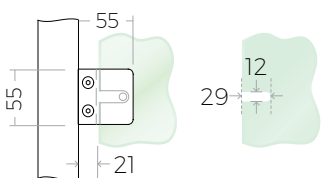


③ SSPEFT36LNL
Line

④ SSPEFT36LNE
End

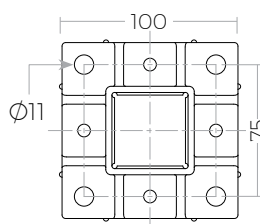
⑤ SSPEFT36LNC
Corner

Glass Clips

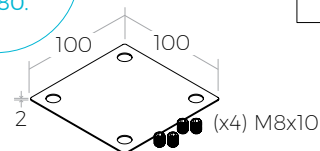


Optional
Glass Clip
SSGC431XX16B
pg 84.

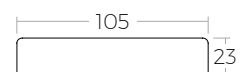
Base Plate



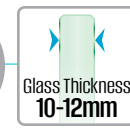
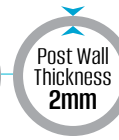
Optional
Leveling Plate
SSZC091616S
pg 80.



Base Plate Cover



42" Elite Posts Frameless Series

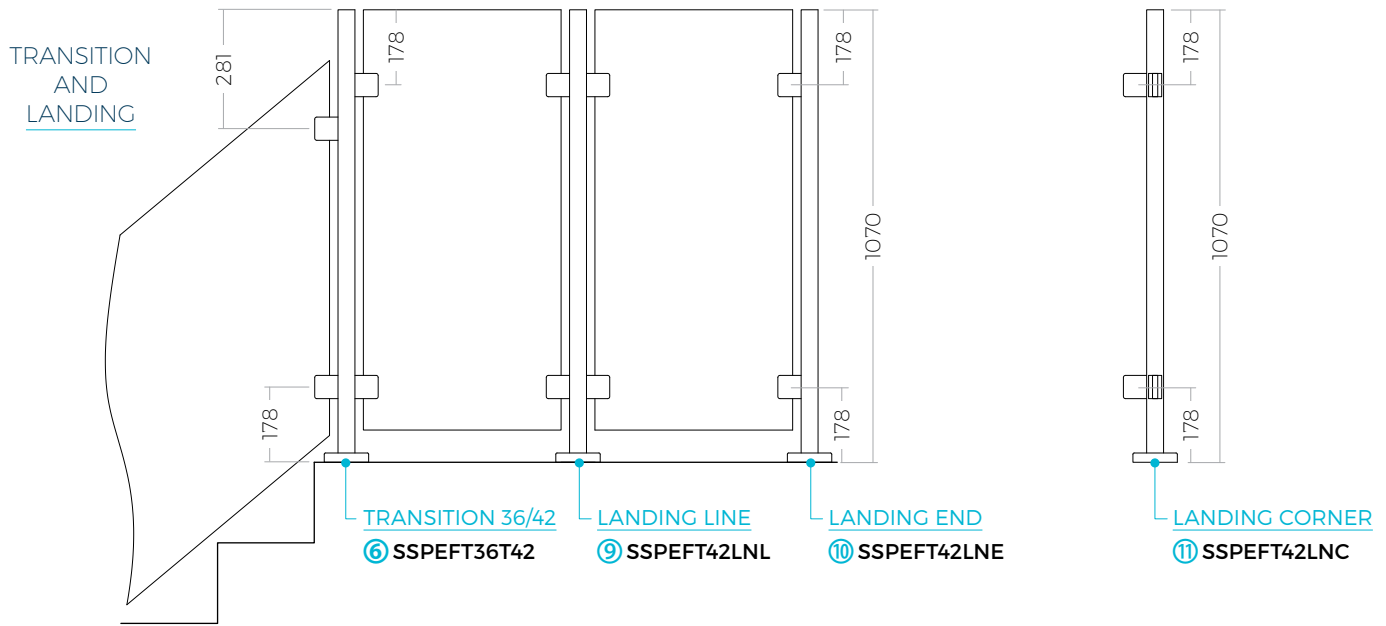


- Fully engineered for **Interior and Exterior** applications.
- Material is SS316 for Satin and SS304 for Powder Coated Black.
- Provides 36" high Railings for Stair/Landing and 42" high option for Landing.
- Fully Welded End Caps provide an open and Frameless look for an unobstructed view.
- Fully welded 4" solid cast Stainless Steel Base Plates with Flat Push-fit Base Plate Covers.
- Includes Large Square Glass Clips secured by an M8 x 20 Stainless Steel Fastener through Flow-drilled and Tapped Holes to the Posts.
- 10 and 12mm Gaskets Included.

PART #	Description	PART #	Description
⑥ SSPEFT36T42	Transition Line Post from 36"-42".	⑨ SSPEFT42LNL	Landing Line Post 42".
⑦ SSPEFT36TL	Transition Left Post from 36"-42".	⑩ SSPEFT42LNE	Landing End Post 42".
⑧ SSPEFT36TR	Transition Right Post from 36"-42".	⑪ SSPEFT42LNC	Landing Corner Post 42".
		⑫ SSPEFT42BL	Blank Post 42".

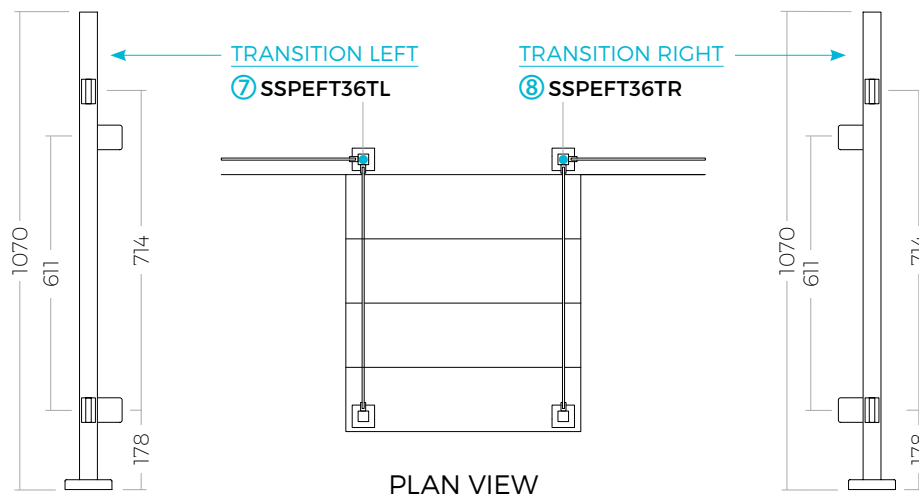
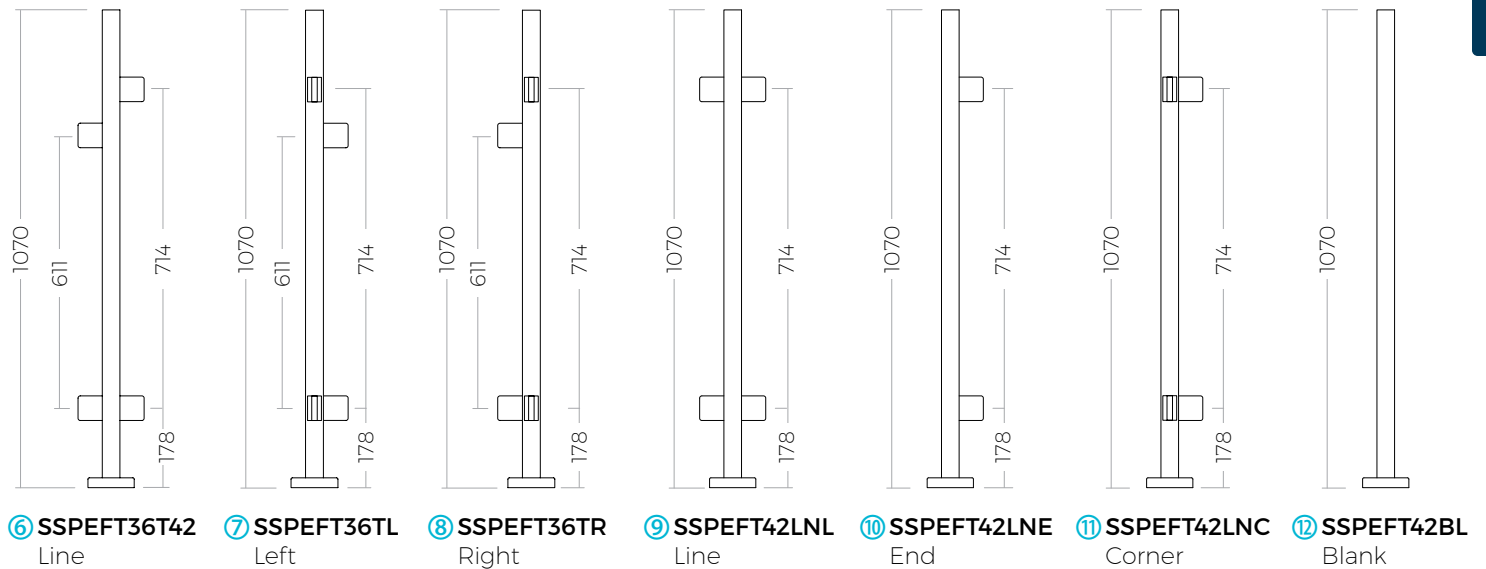


42" POSTS CONFIGURATIONS



Transition from 36" to 42"

For Landing



Elite Frameless Prefabricated Posts

Round Prefabricated Standard Posts for Glass



ASSEMBLY-READY Round Posts are Prefabricated with Flow-drilled & Tapped Holes and are fully engineered for Interior and Exterior applications.

SPECS:

- SS316 Grade Stainless Steel.
- Tube Size: $\Phi 42.4$ (1.66") x 2mm.
- Available Heights: **36", 40", 42"** (Height includes Handrail).

INCLUDES:

- Large Round Stainless Steel Glass Clips with M8 x 20 Screws.
- Gaskets for **10mm** and **12mm** Glass Thickness.
- Fully Welded 4" Solid Cast Stainless Steel Base Plate and Plate Cover.
- Choice of Tube Support with Handrail Attachment Plate, or Post Cap.

Post Orientation



End



Line

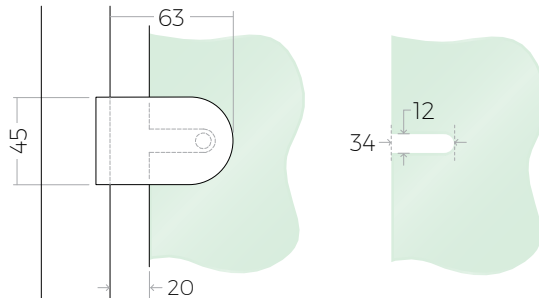


Corner

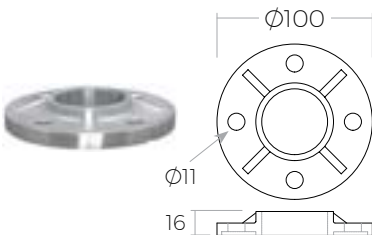
Glass Clip



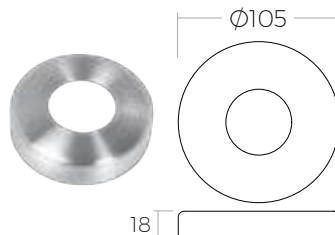
Additional Round Clips **SSGC203XX16S** for $\Phi 42.4$ mm pg 83.



Base Plate



Base Plate Cover



EXAMPLES OF POST FINISHING OPTIONS

Your Prefabricated Posts include choices of the following accessories.

With Handrails

Tube Supports

See more choices on pg 119.



Fixed **SSTF2030016S**



Swivel **SSTS2030016S**



Handrail Attachment Plates

See more choices on pg 117.



Straight Curved **SSUA0010316S**



90° Curved **SSUA0012316S**

Without Handrails

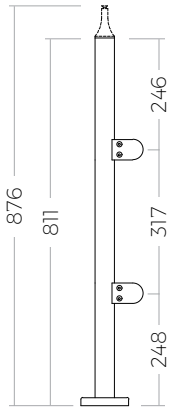
Post Caps

See more choices on pg 109.

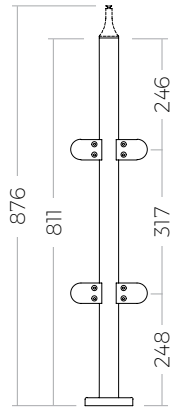


Flat **SSEP0010216S**

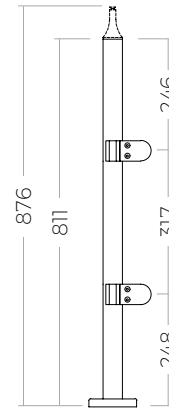
36" with Handrail



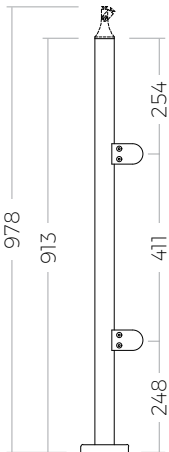
SSPG166L36E
Landing End 36"



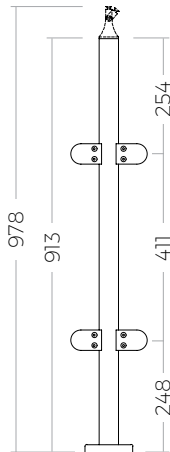
SSPG166L36L
Landing Line 36"



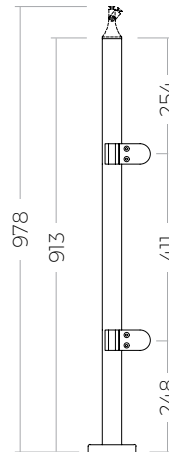
SSPG166L36C
Landing Corner 36"



SSPG166S40E
Stair End 40"

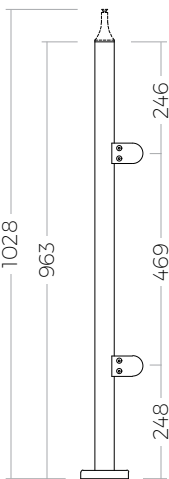


SSPG166S40L
Stair Line 40"

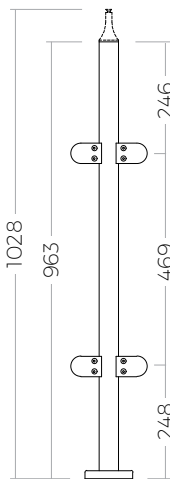


SSPG166S40C
Stair Corner 40"

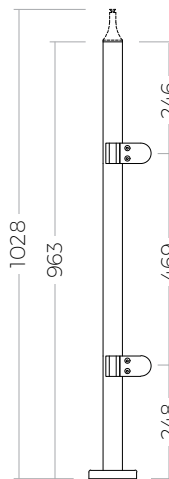
42" with Handrail



SSPG166L42E
Landing End 42"



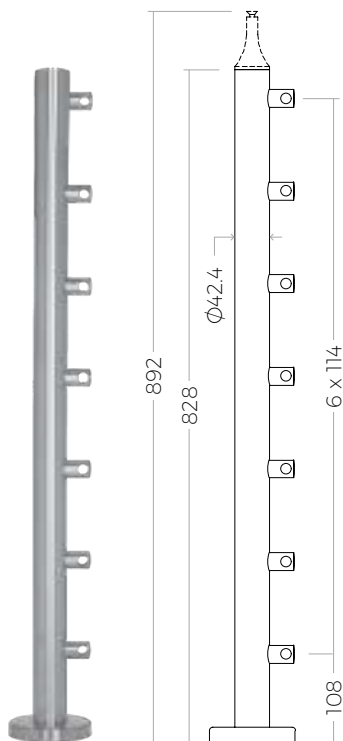
SSPG166L42L
Landing Line 42"



SSPG166L42C
Landing Corner 42"



PHOTO: Spanish Fer Ornamental



PREFABRICATED POSTS FOR RODS

ASSEMBLY-READY Round Posts for Rods are Prefabricated with 7 Rod Holders and are fully engineered for Interior and Exterior applications.

SPECS:

- SS316-Grade Stainless Steel.
- Tube Size: $\Phi 42.4$ (1.66") x 2mm. Tube Height: 892 (35 1/8").
- Rod Holder for $\Phi 12\text{mm}$ ($\Phi 1/2$ ") Rods.

INCLUDES:

- 7 Prefabricated Rod Holders per Post.
- Choice of Tube Support with Handrail Attachment Plate, or Plate Cover.
- Fully welded solid cast Stainless Steel Base Plate and Plate Cover.

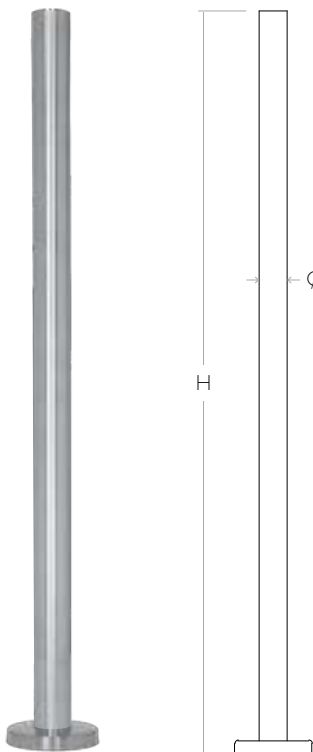
PART

SSPR166L36 See Rods on page 106.



PHOTO: Spanish Fer Ornamental

Standard Prefabricated Posts



PREFABRICATED BLANK POSTS

ACCESSORIES SOLD SEPARATELY:

- Tube Support (pg 119).
- Handrail Attachment Plates (pg 117).
- Post End Caps (pg 109).

SPECS:

- SS316-Grade Stainless Steel

INCLUDES:

- Fully welded solid cast Stainless Steel Base Plate and Plate Cover.

PART #	H (Height)	Ø (Tube Diameter)
SSPG1540	1016 (40")	38.1 (1 1/2")
SSPG16640	1016 (40")	42.4 (1 11/16")
SSPG16642	1067 (42")	42.4 (1 11/16")
SSPG240	1067 (42")	50.8 (2")

Square Prefabricated Standard Posts for Glass



ASSEMBLY-READY Square Posts are Prefabricated with Flow-drilled & Tapped Holes and are fully engineered for Interior and Exterior applications.

SPECS:

- SS316-Grade Stainless Steel.
- Tube Size: 40 x 40 x 2mm.
- Available Heights with Handrail: **36", 40", 42"**.

INCLUDES:

- Large Square Stainless Steel Glass Clips with M8 x 20 Screws.
- Gaskets for **10mm** and **12mm** Glass Thickness.
- Fully welded 4" solid cast Stainless Steel Base Plate and Plate Cover.
- Choice of Tube Support with Handrail Attachment Plate, or Post Cap.

Post Orientation



End



Line

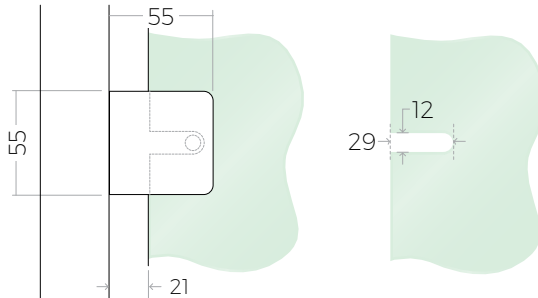


Corner

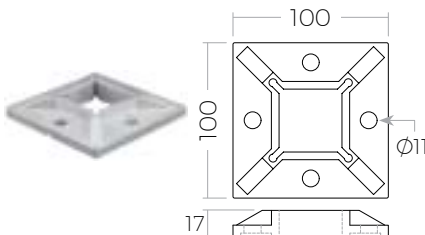
Glass Clip



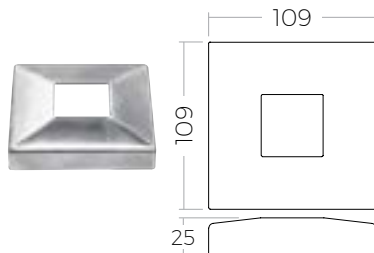
Additional Square Clips
SSGC431XX16S
pg 84.



Base Plate



Base Plate Cover



EXAMPLES OF POST FINISHING OPTIONS

Your Prefabricated Posts include choices of the following accessories.

With Handrails

Tube Supports

See more choices on pg 120.



Fixed with Plate
SSZT0404016S



Swivel with Plate
SSZT1404016S



Handrail Attachment Plates

See more choices on pg 117.



Straight
SSUA0010116S



90°
SSUA0012116S

Without Handrails

Post Caps

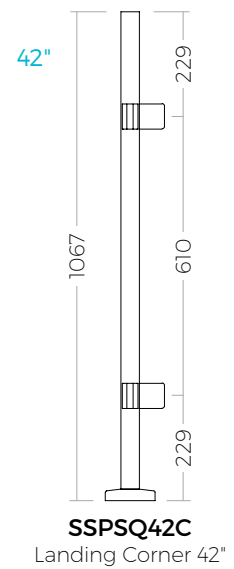
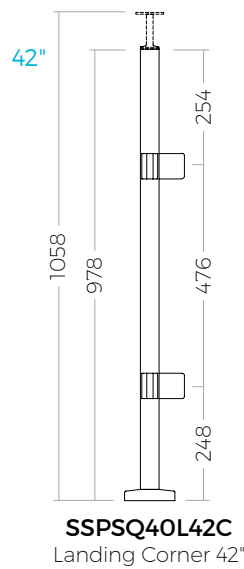
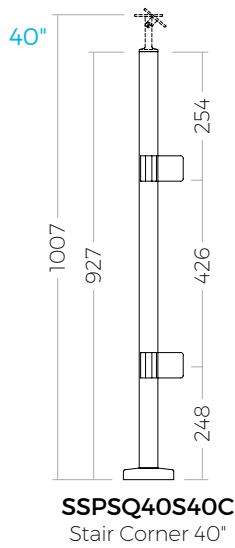
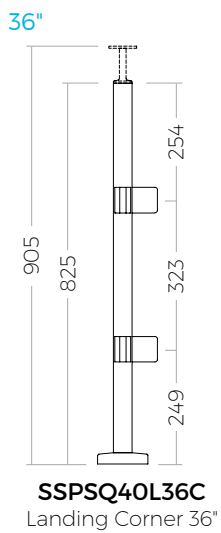
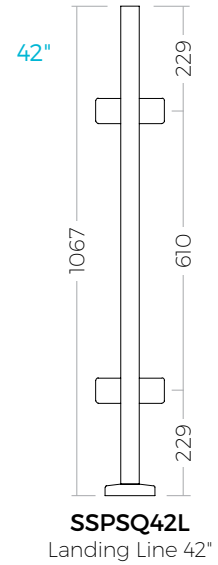
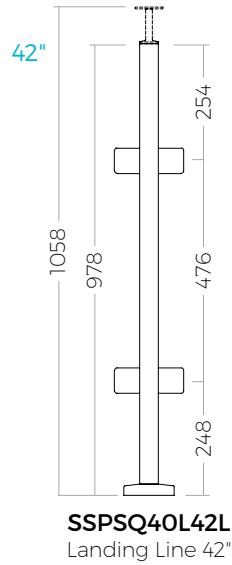
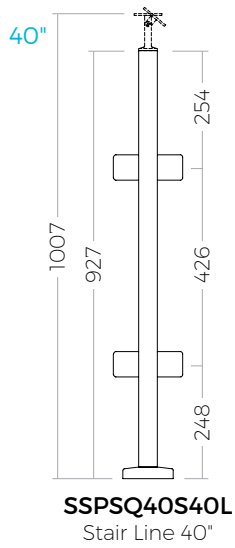
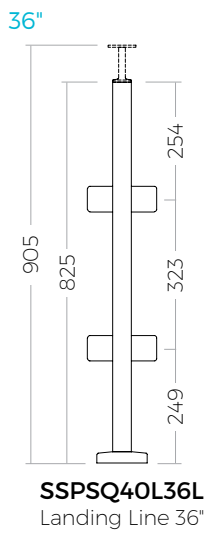
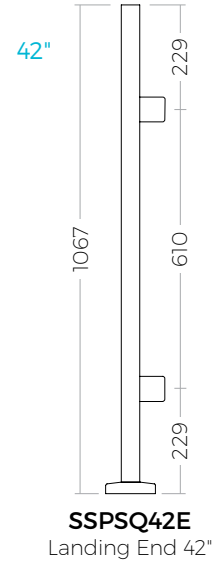
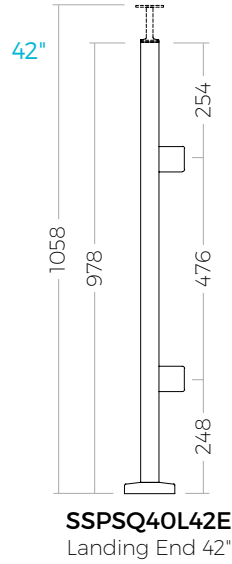
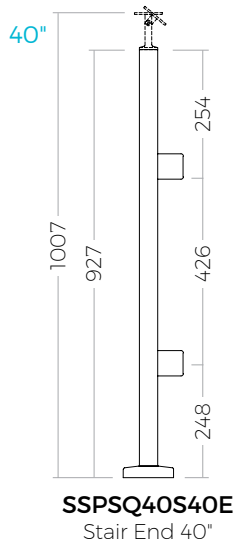
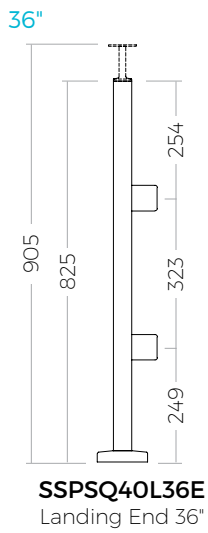
See more choices on pg 111.



Flat
SSZP0404016S

With Handrail

Without Handrail



Standard Prefabricated Posts

Square Prefabricated Standard Posts

Square Blank Posts are fully engineered for Interior and Exterior applications.



ACCESSORIES (Sold separately)

- Tube Support (pg 120) / Handrail Attachment Plates (pg 117) / Post End Caps (pg 111).

SPECS:

- SS316-Grade Stainless Steel

INCLUDES:

- Fully welded solid cast Stainless Steel Base Plate and Plate Cover.

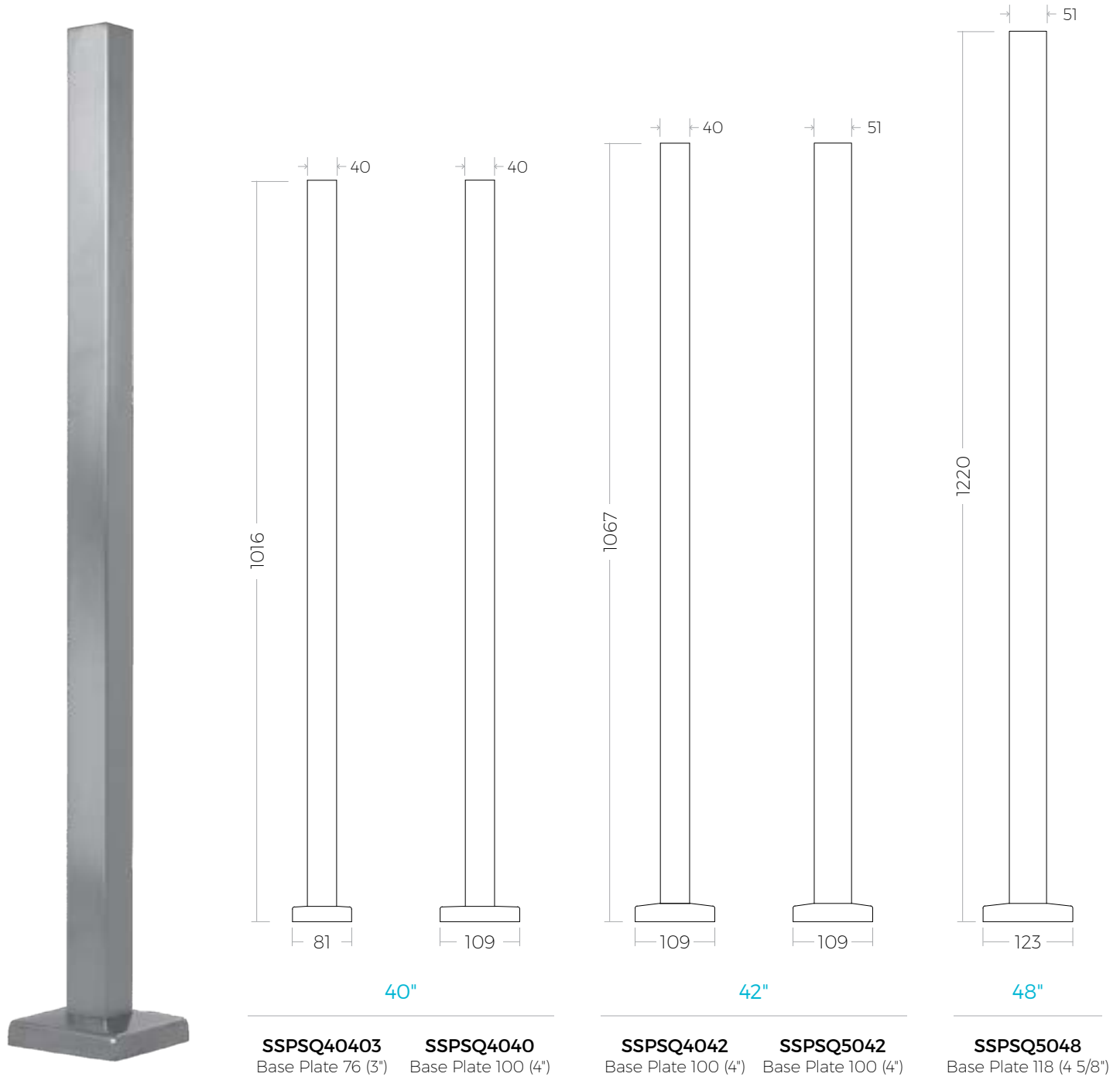
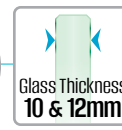
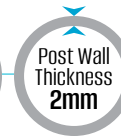




PHOTO: Escaliers Gilles Grenier

Round Prefabricated Side Mount Posts for Glass

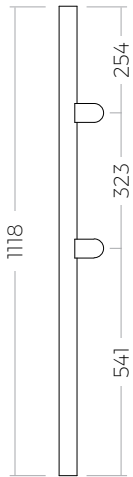


- Prefabricated Stainless Steel Side Mount **ROUND** Posts are fully engineered for Interior and Exterior applications.
- Post material is Round Tube $\Phi 42.4 \times 2\text{mm}$ ($\Phi 1.66"$) in SS316.
- Post height options are 36" and 42" applicable for Landings and Stairs.
- Includes Stainless Steel Large Round Glass Clips secured by an M8 x 20 Stainless Steel Fastener through Flow-drilled and Tapped Holes to the Posts.
- Gaskets for **10mm and 12mm** Glass Thickness are included in the box with the Post.

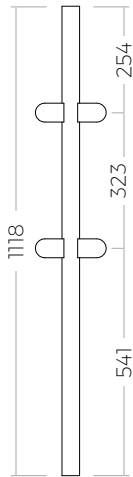
36" Prefabricated Side Mount Post

42" Prefabricated Side Mount Post

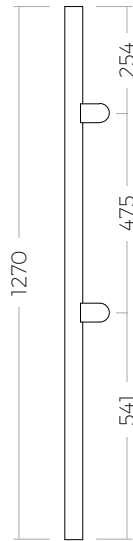
Glass Clips



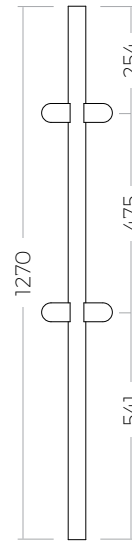
SSPPG166X36E
End Post 36"



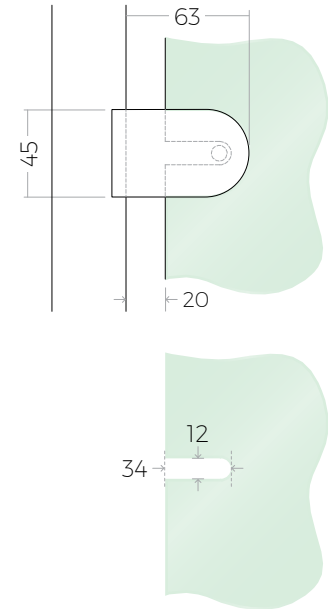
SSPG166X36L
Line Post 36"



SSPPG166X42E
End Post 42"



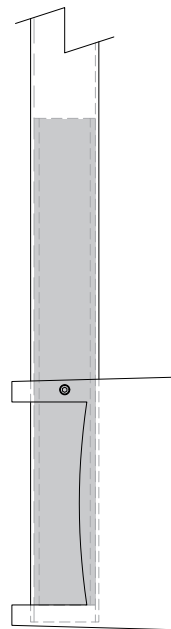
SSPG166X42L
Line Post 42"



Side Mount Support for Round Side Mount Post



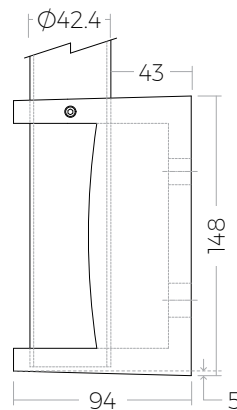
SSUC601



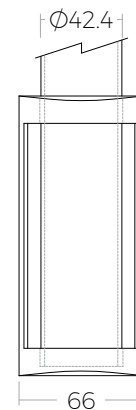
Use Side Mount Tube Supports **SSUC601** to secure the Round Prefabricated Side Posts for Stairs and Landing guard installations.

- Fully engineered for Interior and Exterior applications.
- Applicable for Landing and Stair Railing installations.
- Solid cast material SS316 in Satin finish.
- Suits 1/2" or M12 Fasteners.

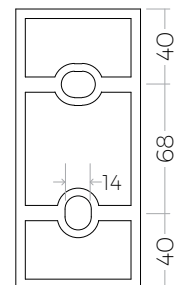
! Included Inner Sleeve installed at the Post bottom for reinforcement specified on the Engineering.



Side View

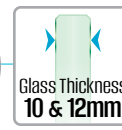


Front View



Back View

Square Prefabricated Side Mount Posts for Glass

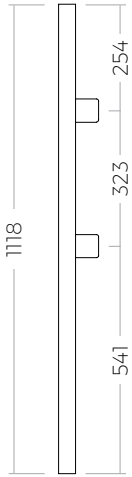


- Prefabricated Stainless Steel Side Mount **SQUARE** Posts are fully engineered for Interior and Exterior applications.
- Post material is Round Tube 40 x 40 x 2mm in SS316.
- Options for Posts height are 36" and 42" applicable for Landings and Stairs.
- Includes Stainless Steel Large Square Glass Clips secured by an M8 x 20 Stainless Steel Fastener through Flow-drilled and Tapped Holes to the Posts.
- Gaskets for **10mm and 12mm** Glass Thickness are included in the box with the Post.

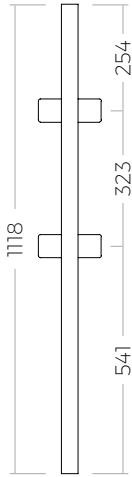
36" Prefabricated Side Mount Post

42" Prefabricated Side Mount Post

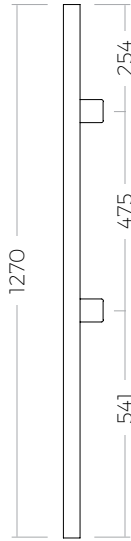
Glass Clips



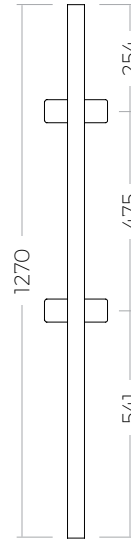
SSPSQ40X36E
End Post 36"



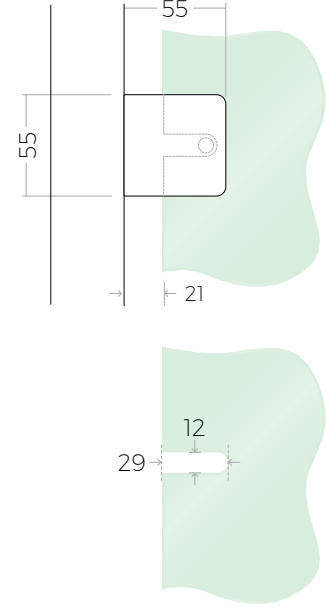
SSPSQ40X36L
Line Post 36"



SSPSQ40X42E
End Post 42"



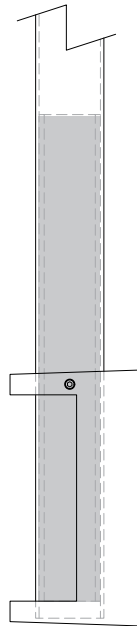
SSPSQ40X42L
Line Post 42"



Side Mount Support for Square Side Mount Post

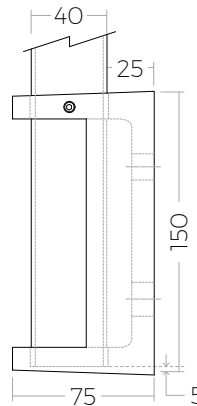


SSUC701

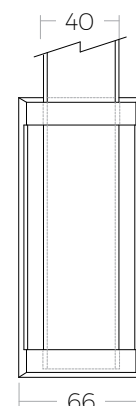


Use Side Mount Tube Supports **SSUC701** to secure the Square Prefabricated Side Posts for Stairs and Landing guard installations.

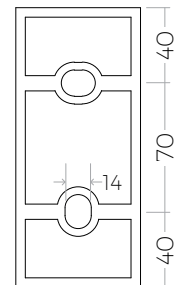
- Fully engineered for Interior and Exterior applications.
- Applicable for Landing and Stair Railing installations.
- Solid cast material SS316 in Satin finish.
- Suits 1/2" or M12 Fasteners.



Side View



Front View



Back View

! Included Inner Sleeve installed at the Post bottom for reinforcement specified on the Engineering.

Heavy Duty Posts

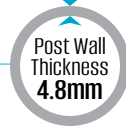




NEW

Features

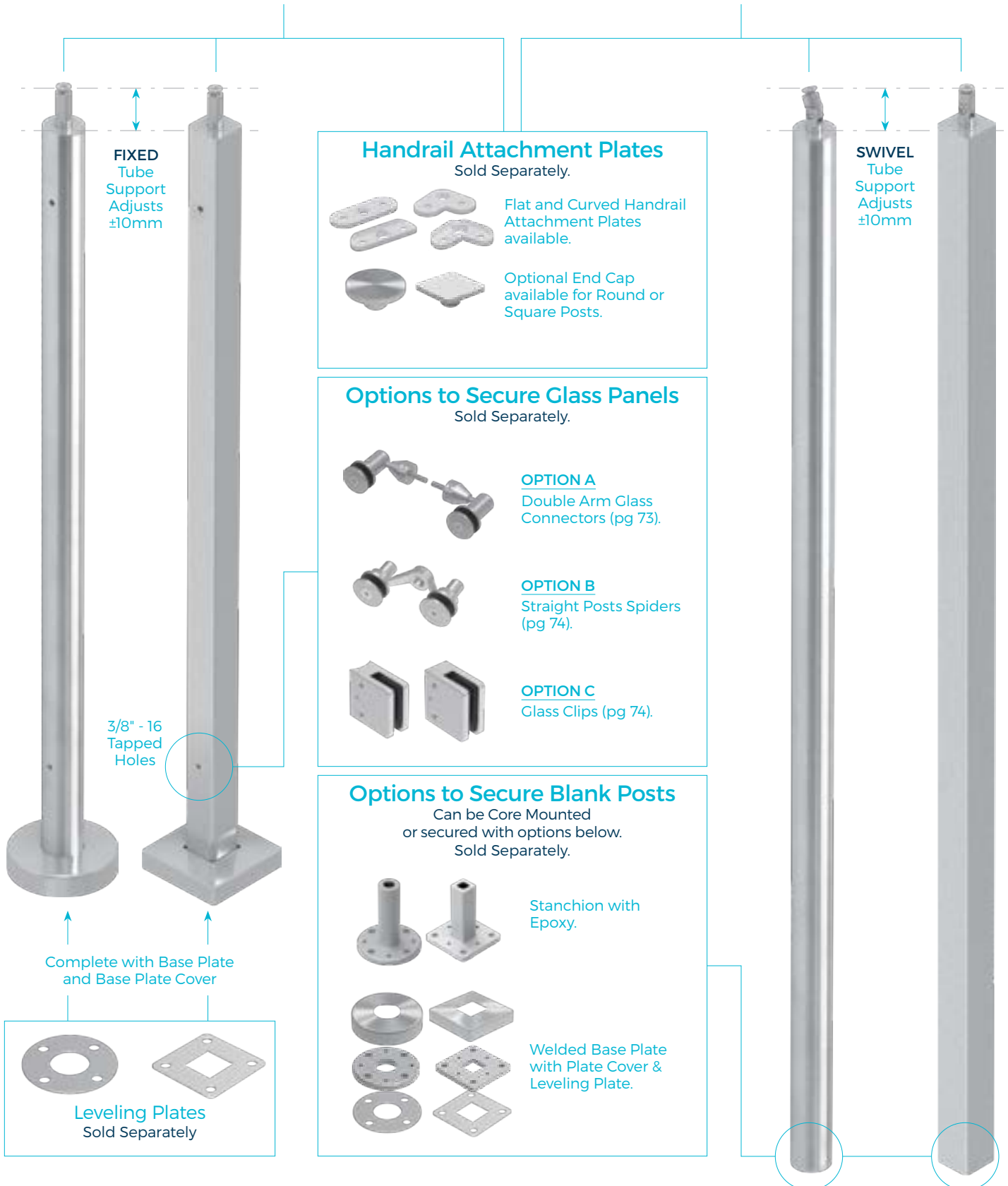
- Heavy duty Stainless Steel Round and Square Posts are fully engineered for Interior and Exterior applications.
- Post material is **4.8mm** thick Tube in SS316 Satin finish.
- End, Line, and Corner Posts are designed for 1070mm (42 1/8") high **Landing** applications (with Handrail). Included with Posts: Fixed Tube Support at the top, and fully welded 12mm thick solid cast Stainless Steel Base Plate and Snap-fit Plate Cover at the bottom. Handrail Attachment Plates for Tube Support and End Cap sold separately. Leveling Plate also sold separately.
- Blank Posts are designed for **Stairway** applications. Included: Swivel Tube Support at the top. Handrail Attachment Plates for Tube Support and End Cap sold separately. All Post bottom options sold separately: Stanchion, Base Plate, Plate Cover, and Leveling Plate. Core Mount installation possible.
- Fully welded End Cap with Tube Support Adjustable by a max. of ± 10 mm.
- 3/8"-16 Tapped Holes on Posts suit a variety of Fittings to secure Glass Panels.



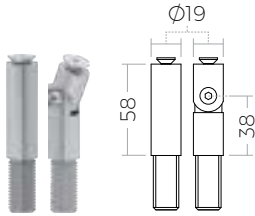
COMPONENT AND INSTALLATION METHODS

Landing Posts with Welded Bases
Designed for End, Line, and Corner Post configurations.

Blank Posts
Designed for Stair and Core Mount installations.

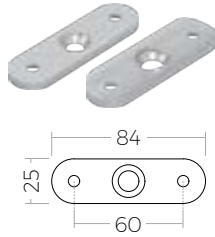


Post Top Options for both Round & Square Posts



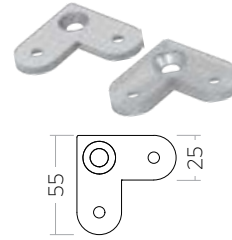
Tube Support Included

SSHPZAC01
Fixed
SSHPZAC02
Swivel



Straight Handrail Attachment Plate Sold Separately

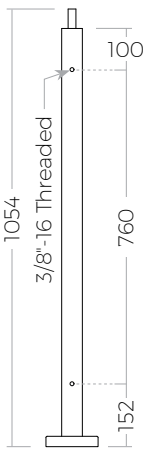
SSHPZAC05
Flat
SSHPZAC03
Curved



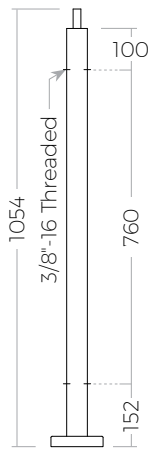
90° Handrail Attachment Plate Sold Separately

SSHPZAC06
Flat
SSHPZAC04
Curved

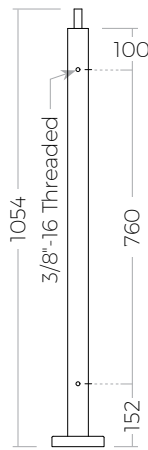
Round Heavy Duty Posts



SSHPRND50E
End Post



SSHPRND50L
Line Post



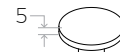
SSHPRND50C
Corner Post



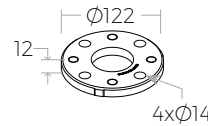
SSHPRND50B
Blank Post

Options for Round Posts

Sold Separately



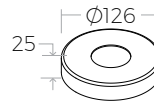
SSHPRND50X2
End Cap



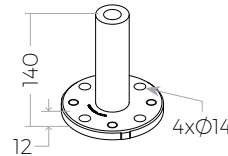
SSHPRND50X3
Base Plate



SSHPRND50X4
Leveling Plate

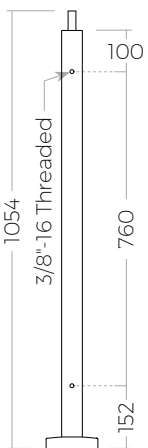


SSHPRND50X5
Plate Cover

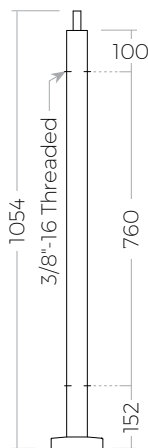


SSHPRND50X6
Stanchion

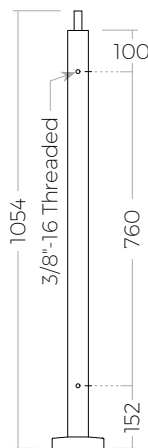
Square Heavy Duty Posts



SSHPQR50E
End Post



SSHPQR50L
Line Post



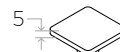
SSHPQR50C
Corner Post



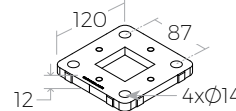
SSHPQR50B
Blank Post

Options for Square Posts

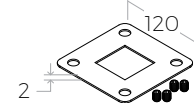
Sold Separately



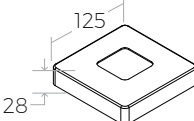
SSHPQR50X2
End Cap



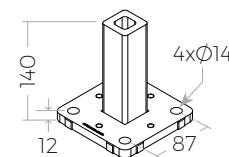
SSHPQR50X3
Base Plate



SSHPQR50X4
Leveling Plate

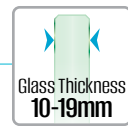


SSHPQR50X5
Plate Cover



SSHPQR50X6
Stanchion

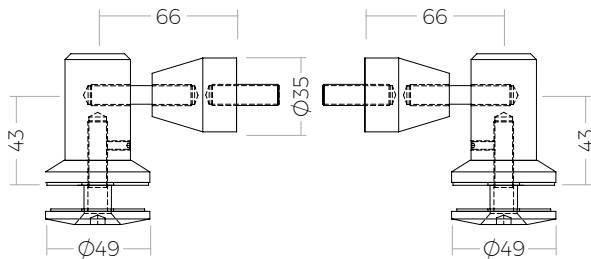
Heavy Duty Post Glass Panel Attachment Options



OPTION A - Double Arm Glass Connectors

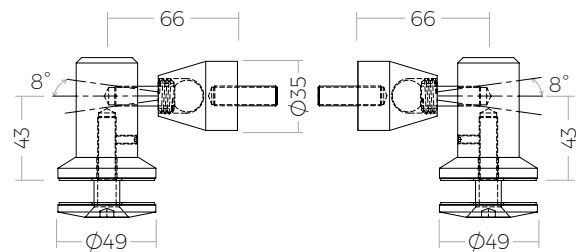
- Used for Landing & Stairway Railings and other Glass installations for Interior and Exterior applications.
- Solid material SS316 in Satin finish.
- Suitable for **10-19mm** Glass.
- Available in Fixed and Swivel models; come as a set of two.
- Recommended Glass Hole size 19mm.
- Stainless Steel Threaded Rod 3/8"-16 x 1 1/4" included to secure Glass Connectors to Posts.
- Swivel Nut Wrench (SSHPZAC14) available for use with Swivel Double Arm Glass Connector (SSHPZAC13).
- Adapter for Round Post Ø50mm (2") available.

Use Swivel Nut Wrench **SSHPZAC14** to adjust the angle for Swivel Glass Connector.



Double Arm Fixed Glass Connector

PART #	Description
SSHPZAC12	Fixed.



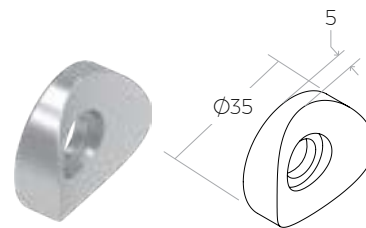
Double Arm Swivel Glass Connector

PART #	Description
SSHPZAC13	Swivel.

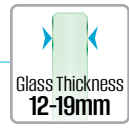
Accessories



PART #	Description
SSHPZAC14	Swivel Nut Wrench for Swivel Connector.

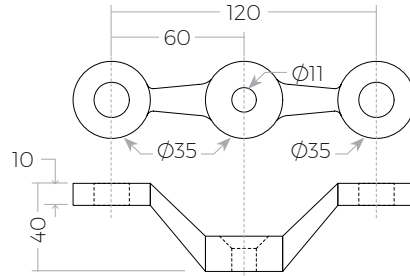


PART #	Description
SSHPZAC09	Arm Glass Connector Adapter for Ø50 (2") Round Post.



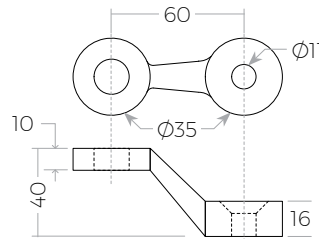
OPTION B - Straight Post Spiders

- Used for Landing & Stairway Railings and other Glass installations for Interior and Exterior applications.
- Solid material SS316 in Satin finish.
- Suitable for **12-19mm** Glass.
- Available in Single Arm and Double Arm models; Set of two.
- Spiders need to be used with either Fixed or Swivel Glass Connectors to secure Glass Panels.
- Recommended Glass Hole size 19mm.
- Stainless Steel Screw 3/8"-16 x 1 1/4" included to secure Spiders to Posts.
- Adapter for Round Post $\varnothing 50\text{mm}$ (2") available.



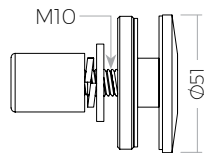
Straight Post Double Arm Spider

PART #	Description
SSHZAC08	Double Arm.

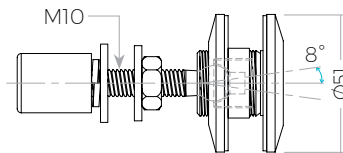


Straight Post Single Arm Spider

PART #	Description
SSHZAC07	Single Arm.



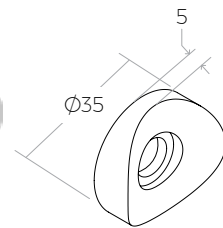
PART #	Description
SSHZAC10	Fixed Glass Connector.



PART #	Description
SSHZAC11	Swivel Glass Connector.

Must use Connectors with Spider Arms above

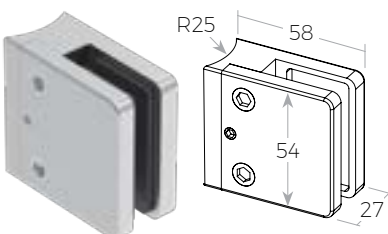
Accessories



PART #	Description
SSHZAC09	Arm Glass Connector Adapter for $\varnothing 50$ (2") Round Post.

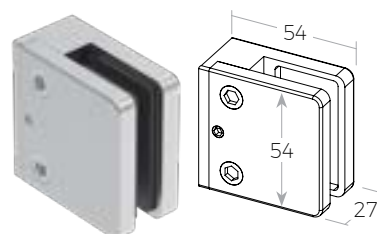
OPTION C - Glass Clips

- Used for Landing & Stairway Railings and other Glass installations for Interior and Exterior applications.
- Solid material SS316 in Satin finish.
- Suitable for **12-13.52mm** Glass.
- Available in Curved and Flat Back for Round and Square Posts 50mm (2") respectively.
- Stainless Steel Screw 3/8" - 16 x 1" included to secure Glass Clips to Posts.
- Stainless Steel Set Screw on Cap to properly secure Glass Panels.



Curved Back

PART #	Description
SSHPRND50X1	For Round Heavy Duty Posts.



Flat Back

PART #	Description
SSHPSQR50X1	For Square Heavy Duty Posts.



Post Bases





Discs



Base Plates

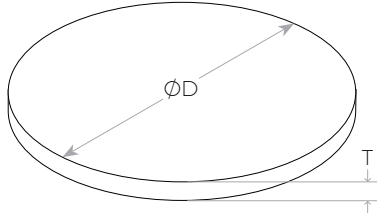


Flanges

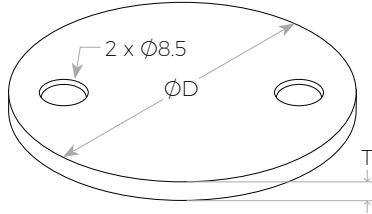


Covers

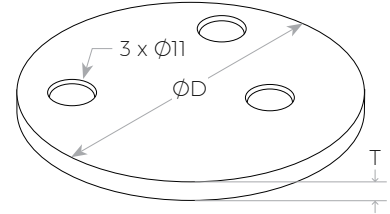
Discs



PART #	ØD (Plate Dia)	T (Thickness)
SSPLO800616S	80	6
SSPL1000116S	100	6

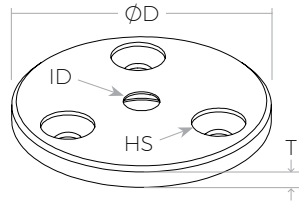


PART #	ØD (Plate Dia)	T (Thickness)
SSPW0801116S	80	6

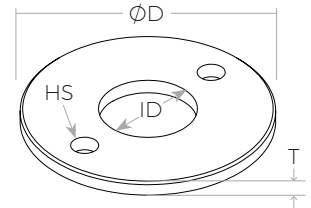


PART #	ØD (Plate Dia)	T (Thickness)
SSPW1001216S	100	6

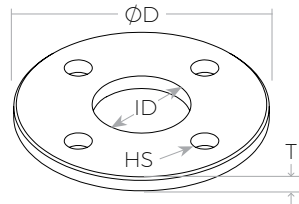
Round Base Plates



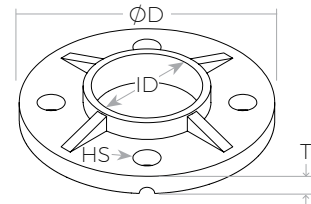
PART #	ØD (Plate Dia)	T (Thickness)	HS (Hole Size)	ID (Tube Size)
SSPW0581516S	58	5	3 x Ø6.5	8.2
SSPW0701516S	68	5	3 x Ø6.5	8.2



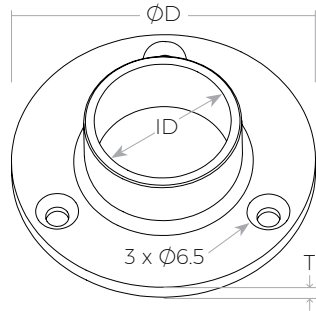
PART #	ØD (Plate Dia)	T (Thickness)	HS (Hole Size)	ID (Tube Size)
SSPW1001616S	100	6	2 x Ø11	38.1



PART #	ØD (Plate Dia)	T (Thickness)	HS (Hole Size)	ID (Tube Size)
SSPW44216S	100	8	4 x Ø11	42.4
SSPW45016S	120	10	4 x Ø14	50.8

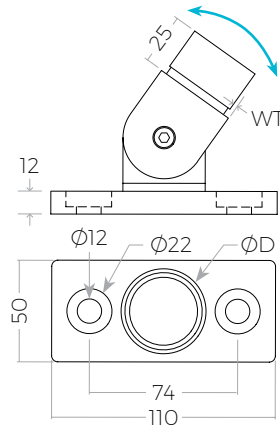


PART #	ØD (Plate Dia)	T (Thickness)	HS (Hole Size)	ID (Tube Size)
SSPW1071316N Cast Base Plate	100	8	4 x Ø11	42.4



Base Flange

PART #	ØD (Plate Dia)	ID (Tube Size)	T (Thickness)
SSUC0010616S	85	38.1	5
SSUC0010316S	85	42.4	5



Flexible Stringer Round Post Mount

PART #	ØD (Tube Size)	WT
SSFSRND100	42.4	2.0

WT represents the Wall Thickness of the Tube used with this Mount.

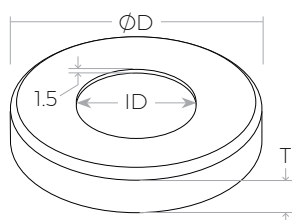
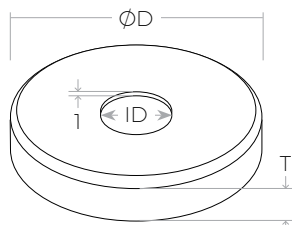
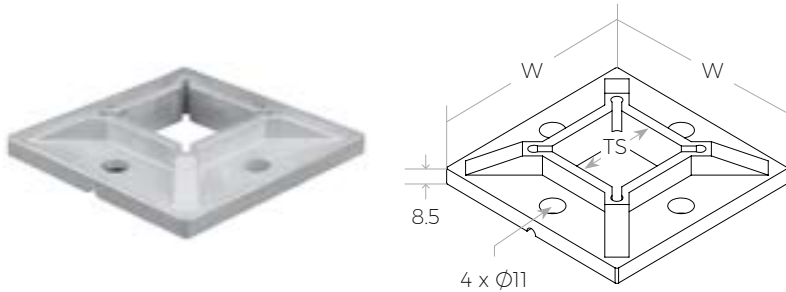


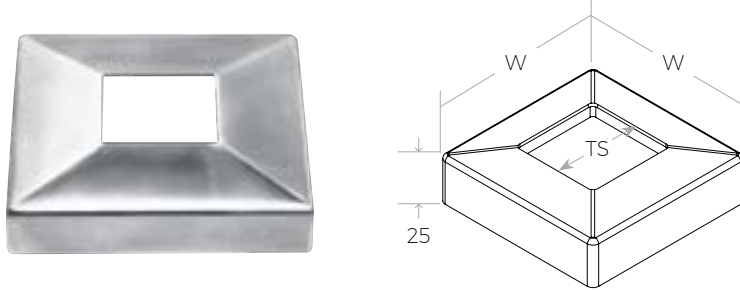
Plate Covers

PART #	ØD (Plate Dia)	ID (Tube Size)	T (Thickness)
SSPC0600116S	60	12.5	12
SSPC0761316S	76	38.1	12
SSPC0850416S	85	38.1	16
SSPC1051316S	105	38.1	25
SSPC1050216S	105	42.4	16
SSPC1050116S	105	42.4	25
SSPC1051416S	105	50.8	25
SSPC1251416S	125	50.8	25



Cast Base Plate

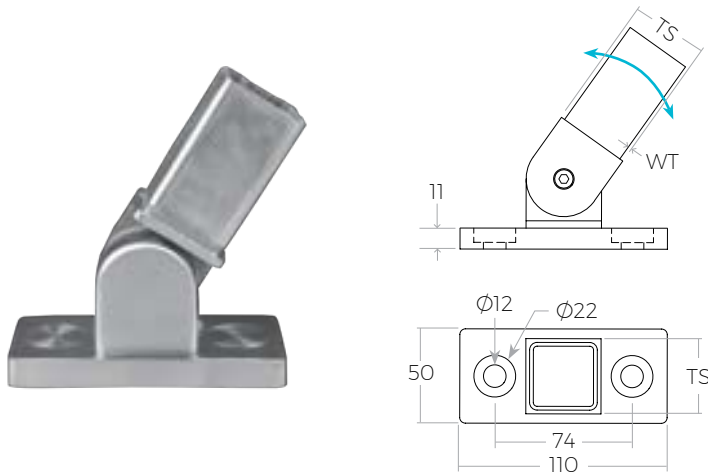
PART #	TS (Tube Size)	W (Width)
SSZW1000516N	50.8 x 50.8	100 x 100



Chamfered Plate Cover

For use with Plate above

PART #	TS (Tube Size)	W (Width)
SSZC0814016S	40 x 40	75 x 75
SSZC1054016S	40 x 40	105 x 105
SSZC1085016S	50.8 x 50.8	110 x 110



Flexible Stringer Square Post Mount

PART #	TS (Tube Size)	WT
SSFSSQR100	40 x 40	2.0

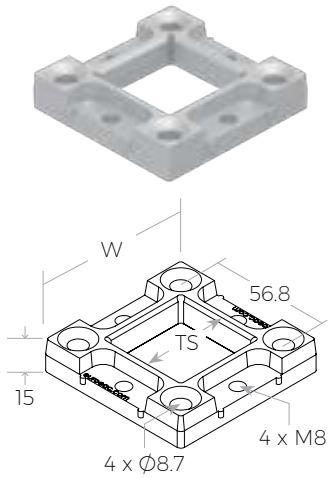
WT represents the Wall Thickness of the Tube used with this Mount.



Base Plate Cover Only

USE WITH ELITE POST HANDRAIL SERIES

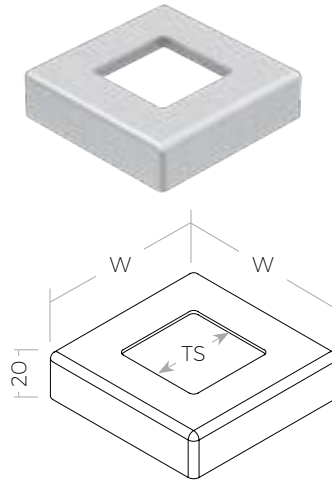
Cast Base Plate



PART #	TS (Tube Size)	W (Width)
SSZW1000316N	40 x 40	76 x 76
Mill finish Used for both S & B Finishes.		

Flat Base Plate Cover

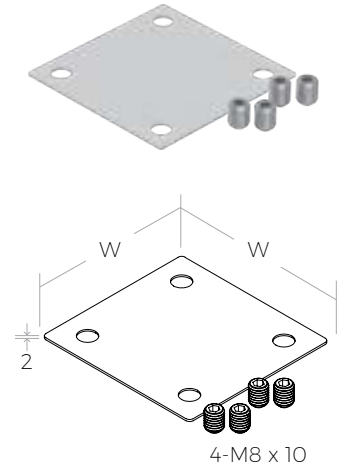
Use with **SSZW1000316N**



PART #	TS (Tube Size)	W (Width)	Finish
SSZC0914004S	40 x 40	81 x 81	S
SSZC0914004B	40 x 40	81 x 81	B

Leveling Plate

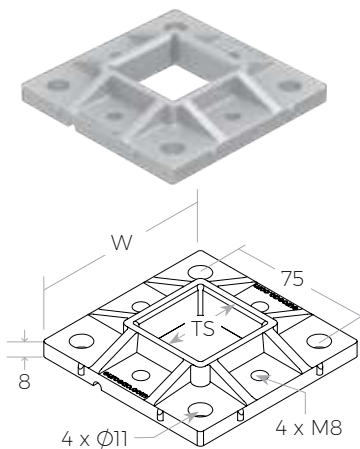
Use with **SSZW1000316N** only.
Recommended for concrete applications.



PART #	W (Width)
SSZC091504S	76 x 76
Mill finish Used for both S & B Finishes.	

USE WITH ELITE POST FRAMELESS SERIES

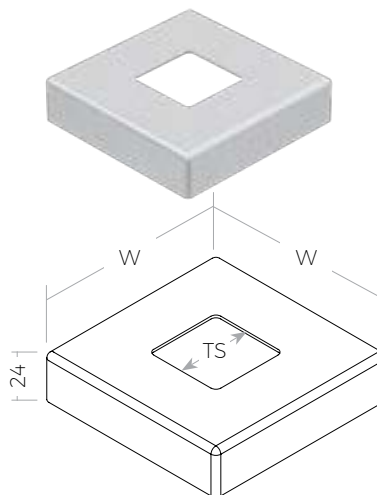
Cast Base Plate



PART #	TS (Tube Size)	W (Width)
SSZW1000416N	40 x 40	100 x 100
Mill finish Used for both S & B Finishes.		

Flat Base Plate Cover

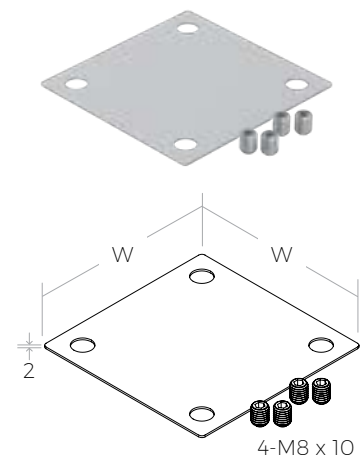
Use with **SSZW1000416N**



PART #	TS (Tube Size)	W (Width)	Finish
SSZC0914005S	40 x 40	105 x 105	S
SSZC0914005B	40 x 40	105 x 105	B

Leveling Plate

Use with **SSZW1000416N** only.
Recommended for concrete applications.



PART #	W (Width)
SSZC091616S	100 x 100
Mill finish Used for both S & B Finishes.	

Glass Clips & Glass Connectors



GLASS CLIPS

Our Glass Clips are available in Round and Square designs, with flat backs for Wall or Square Post applications, or a curved back for Round Post applications. All options are available in Satin, and most offering Black finishes as well. Our Small and Large Glass Clips accommodate Glass Thicknesses ranging from 6-12mm and our Thick Glass Clips accommodate Glass Thicknesses ranging from 13.52-21.52mm.

Our Glass Clips are made of high quality 316 Grade Stainless Steel, giving them superior strength and longevity around high traffic areas and in Exterior environments.

Our "ZINC" Glass Clips are Zamak, which is a family of alloys with a Base Metal of Zinc and alloying elements of Aluminum, Magnesium, and Copper. The addition of Magnesium and Copper provides it with diverse properties and allows it to cast. Zamak alloys exhibit an excellent combination of cost, strength, ductility, impact strength, and finishing characteristics. Our Zinc Glass Clips are recommended for Interior use only.



To avoid installed Glass slipping over time, it is recommended to use the **SAFETY PIN** that comes with the Glass Clips, particularly for the bottom Glass Clips installed on either side of the Glass. **SSM820** - Recommended Screw for attaching Glass Clips to Metal Posts.

GLASS CONNECTORS

Our Ultra Slim Collection consists of Standard Connectors to accommodate **10-12mm** Glass, and the Heavy Duty Connectors for up to **21.52mm** Glass. They both include Gaskets and Single Grub Screws. Our Glass Connectors are made of Duplex 2205, which has superior strength and corrosion resistance when compared to SS316. Many of our Standard Connectors are available in Satin, Graphite Black, and Matte Black Stainless Steel.

To see more Connectors, go to page 89 or visit our Website.

euroeac.com

Glass Clip



Glass Connector

Round Glass Clips with Pin



S
Satin
Stainless
Steel

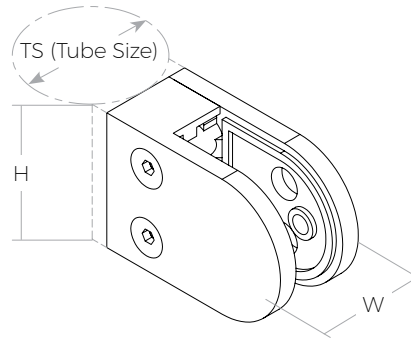
Round Clip Flat Back



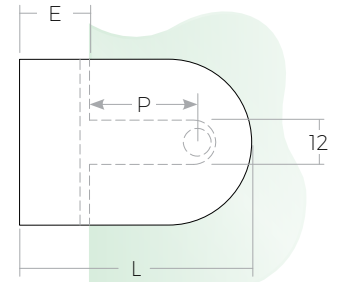
Round Clip Curved Back



Installed on a Wall
or Square Tubing.



Distance from Glass
to Post/Wall.



Small Clips

SS316	Back	TS	L	P	E	W	H	Finish
SSGC101XX16S	Flat	-	50	20	18	27	40	S
SSGC106XX16S	Curved	38.1	50	20	18	27	40	S
SSGC103XX16S	Curved	42.4	50	20	18	27	40	S



Applicable Gaskets

PART #	Class Thickness
SSGR10001RBN	6
SSGR10002RBN	8
SSGR10003RBN	10



Large Clips

SS316	Back	TS	L	P	E	W	H	Finish
SSGC201XX16S	Flat	-	63	28	19	30	45	S
SSGC206XX16S	Curved	38.1	63	28	19	30	45	S
SSGC203XX16S	Curved	42.4	63	28	19	30	45	S
SSGC207XX16S	Curved	50.8	63	28	19	30	45	S
ZINC	Back	TS	L	P	E	W	H	Finish
SSGC201XXZMS	Flat	-	63	28	19	30	45	S
SSGC206XXZMS	Curved	38.1	63	28	19	30	45	S
SSGC203XXZMS	Curved	42.4	63	28	19	30	45	S
SSGC207XXZMS	Curved	50.8	63	28	19	30	45	S



Applicable Gaskets

PART #	Class Thickness
SSGR20001RBN	6
SSGR20002RBN	8
SSGR20003RBN	10
SSGR20004RBN	12

Square Glass Clips with Pin



S
Satin
Stainless
Steel

B
Powder
Coated
Black

Square Clip
Flat Back



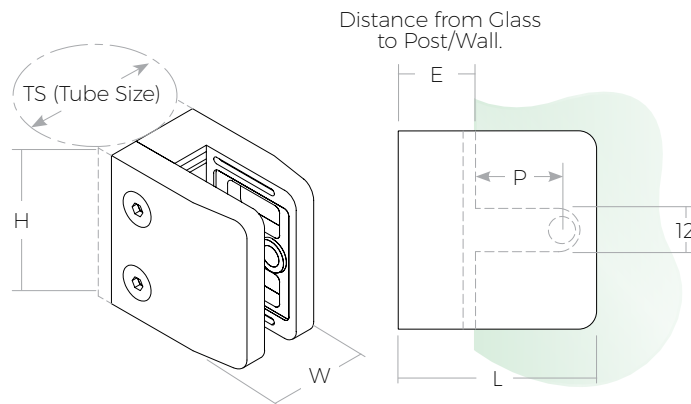
Square Clip
Flat Back with
Set Screw



Square Clip
Curved Back



Installed on a Wall
or Square Tubing.



Small Clips Curved back available only in Satin.

SS316	Back	TS	L	P	E	W	H	Finish
SSGC301XX16S	Flat	-	45	16	19	26	45	S
SSGC301XX16B	Flat	-	45	16	19	26	45	B
SSGC306XX16S	Curved	38.1	45	16	19	26	45	S
SSGC303XX16S	Curved	42.4	45	16	19	26	45	S
ZINC	Back	D	L	P	E	W	H	Finish
SSGC301XXZMS	Flat	-	45	16	19	26	45	S
SSGC301XXZMB	Flat	-	45	16	19	26	45	B



Applicable Gaskets

PART #	Class Thickness
SSGR30001RBN	6
SSGR30002RBN	8
SSGR30003RBN	10



Large Clips

SS316	Back	TS	L	P	E	W	H	Finish
SSGC431XX16S	Flat	-	55	24	20	35	55	S
SSGC431XX16B	Flat	-	55	24	20	35	55	B
SSGC433XX16S	Curved	42.4	55	24	20	35	55	S
SSGC437XX16S	Curved	50.8	55	24	20	35	55	S
SSGC431XXSET	Flat with Set Screw	-	55	18	20	28	55	S
ZINC	Back	TS	L	P	E	W	H	Finish
SSGC431XXZMS	Flat	-	55	24	20	35	55	S
SSGC431XXZMB	Flat	-	55	24	20	35	55	B



Applicable Gaskets

PART #	Class Thickness
SSGR41001RBN	6
SSGR41002RBN	8
SSGR41003RBN	10
SSGR41004RBN	12

Glass Clips

Square Glass Clips with Bottom Plate



S
Satin
Stainless
Steel

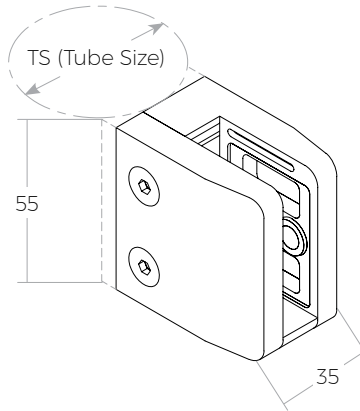
B
Powder
Coated
Black

Square Clip
Flat Back

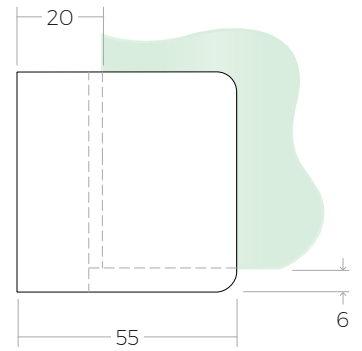


Installed on a Wall
or Square Tubing.

Square Clip
Curved Back



Distance from Glass
to Post/Wall



Large Clips Curved back available only in Satin.

SS316	Back	TS	L	E	W	H	Finish
SSGC411XX16S	Flat	-	55	20	35	55	S
SSGC411XX16B	Flat	-	55	20	35	55	B
SSGC413XX16S	Curved	42.4	55	20	35	55	S
SSGC417XX16S	Curved	50.8	55	20	35	55	S
ZINC	Back	TS	L	E	W	H	Finish
SSGC411XXZMS	Flat	-	55	20	35	55	S
SSGC411XXZMB	Flat	38.1	55	20	35	55	B

Applicable Gaskets



PART #	Glass Thickness
SSGR41001RBN	6
SSGR41002RBN	8
SSGR41003RBN	10
SSGR41004RBN	12



PHOTO: Spanish Fer Ornamental

Round Clip with Curved Back



Square Clip with Curved Back



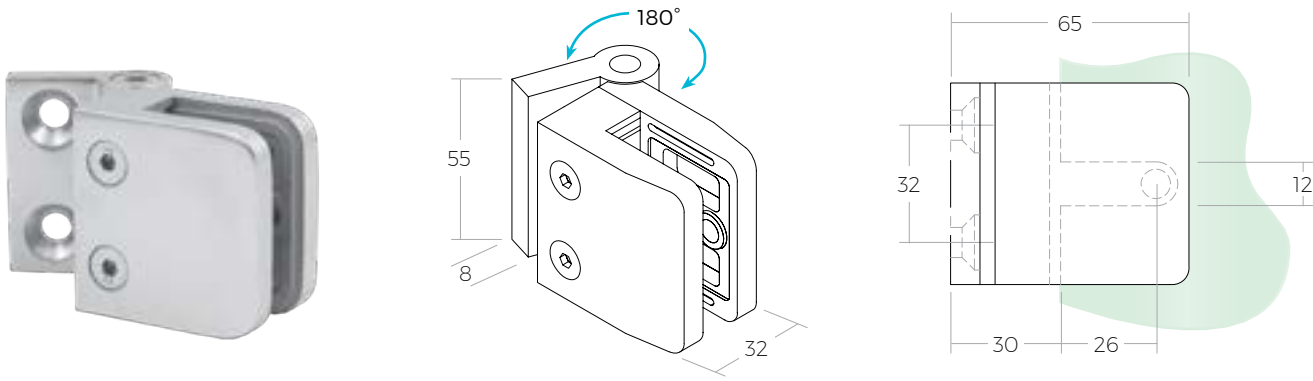
PHOTO: Sierra Glass

Square Clip with Flat Back

Hinged Glass Clip with Pin



S
Satin
Stainless
Steel



Large Hinged Clips

Two M8 Screws and Gaskets included.

SS316	Back
SSGCH40116S	Flat

Applicable Gaskets

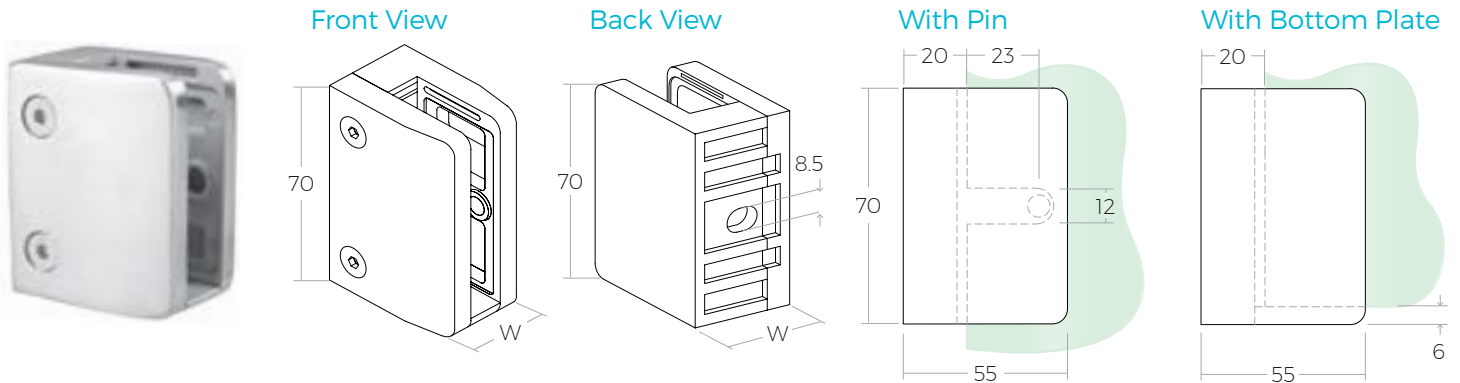


PART #	Glass Thickness
SSGR41001RBN	6
SSGR41002RBN	8
SSGR41003RBN	10
SSGR41004RBN	12

Thick Glass Application Clips



S
Satin
Stainless
Steel



Thick Glass Clips

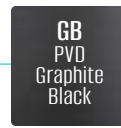
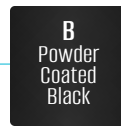
SS316	Back	Glass Thickness	W
SSGC461XX16S	Flat	13.52 / 15 / 17.52	40
SSGC451XX16S	Flat	19 / 21.52	45

Applicable Gaskets

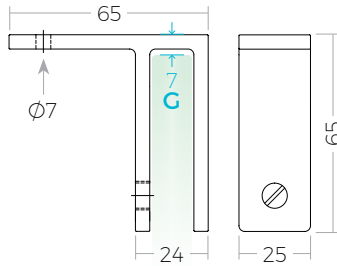


PART #	Glass Thickness
SSGR513RBN	13.52
SSGR515RBN	15
SSGR517RBN	17.52
SSGR519RBN	19
SSGR521RBN	21.52

Standard Ultra Slim Series

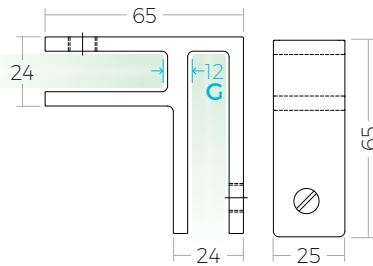


- Single Grub Screw.
- Made of **Duplex 2205**, which has superior strength and corrosion resistance than SS316.
- Minimum gap space between Panels represented by **G**.



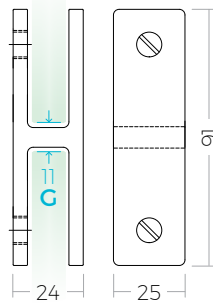
Glass To Wall

PART #	Finish
SSPFEBWALL	S / B / GB / MB / G



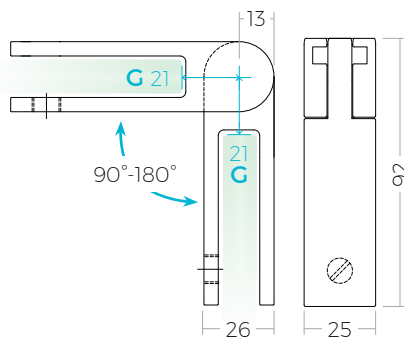
90° Glass to Glass

PART #	Finish
SSPFEB90	S / B / GB / MB / G



180° Glass to Glass

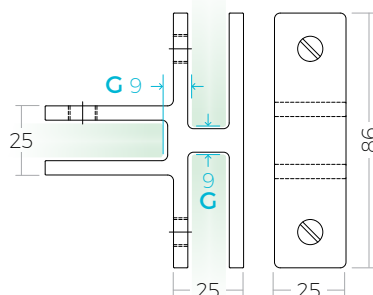
PART #	Finish
SSPFEB180	S / B / GB / MB / G



Adjustable Glass to Glass

PART #	Finish
SSPFEBADJ	S / B / GB / MB / G

Adjustment from 90° - 180°. Slide and rotate. No screw assembly.

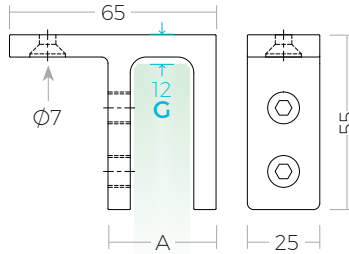


T-Connector Glass to Glass

PART #	Finish
SSPFEBT	S

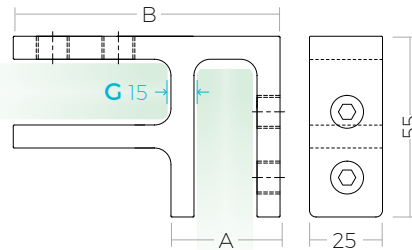


- Gaskets included.
- Double Grub Screws.
- Made of **Duplex 2205**, which has superior strength and corrosion resistance than SS316.
- Minimum gap space between Panels represented by **G**.



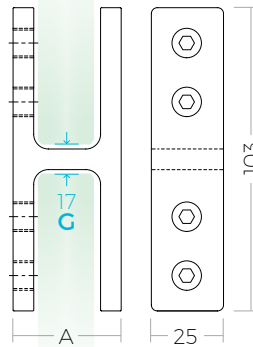
Glass To Wall

PART #	A	Glass Thickness
SSPFEBWALL1	34	12-15.88mm
SSPFEBWALL2	40	16.76-21.52mm



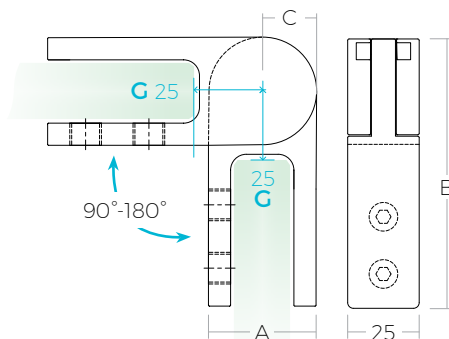
90° Glass to Glass

PART #	A	B	Glass Thickness
SSPFEB901	34	82	12-15.88mm
SSPFEB902	40	88	16.76-21.52mm



180° Glass to Glass

PART #	A	Glass Thickness
SSPFEB1801	34	12-15.88mm
SSPFEB1802	40	16.76-21.52mm



Adjustable Glass to Glass

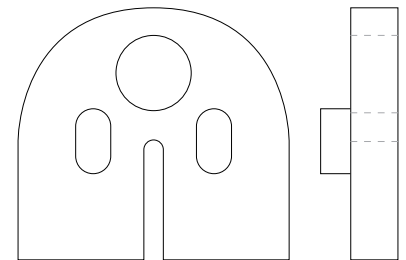
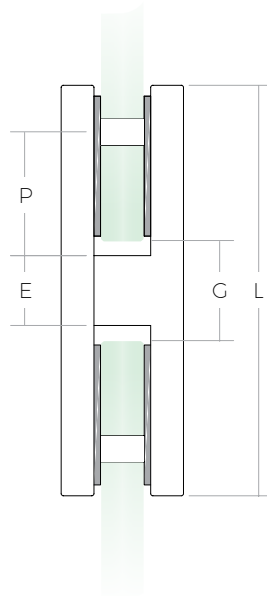
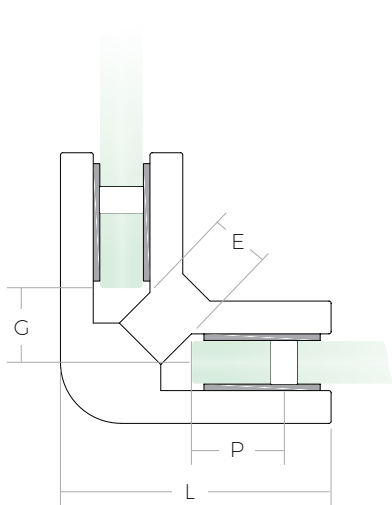
PART #	A	B	C	Glass Thickness
SSPFEBADJ1	34	85	17	12-15.88mm
SSPFEBADJ2	40	91.5	20	16.76-21.52mm

Adjustment from 90° - 180°. Slide and rotate. No screw assembly.

Standard Glass Connectors



- Accommodates **8-12mm**.
- Made of **SS316** Marine Grade Satin Stainless Steel.



Glass to Glass 90°

PART #	L	P	E	G
SSGC014XX16S	74	33	15.5	15

Glass to Glass 180°

PART #	L	P	E	G
SSGC015XX16S	106	30	14	19

Applicable Gasket

PART #	Glass Thickness
SSGR20002RBN	8
SSGR20003RBN	10
SSGR20004RBN	12



PHOTO: Excel Enclosures & Railings



PHOTO: Custom Glass Railings



PHOTO: Airport Railings



PHOTO: Airport Railings

Glass Railing Tops



PHOTO: Millan Glass & Mirror

WE GOT YOU COVERED! Cap your Glass Railings to function as a Railing, or simply protect the edges. Whether it's Stainless Steel or Aluminum, we offer Cap Rails in Round, Square, or Rectangular to suit your look. Aluminum Cap Rails are available in Satin and Black Anodized Aluminum. Stainless Steel Cap Rails are available in Satin and some sizes are available in Powder Coated Black. All sizes can be custom Powder Coated to your liking. Please contact us to inquire.



STAINLESS STEEL CAP RAILS & FITTINGS

- Cap Rails and Fittings are a high Grade Stainless Steel.
- Available in Satin and some sizes in Powder Coated Black.
- Standard 19' lengths.
- Gaskets and full range of Fittings available.



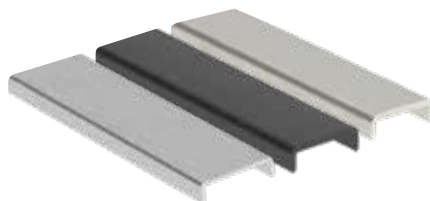
ALUMINUM CAP RAILS & FITTINGS

- Brushed Anodized Aluminum 6063.
- Available in Satin, Black Anodized Aluminum, and Powder Coated Black Aluminum.
- Suitable for **10-21.52mm** Glass.
- Standard 19' lengths.
- Gaskets and full range of Fittings available.



TOP CHANNELS & FITTINGS

- Stainless Steel 316L Grade.
- Available in Satin. Inquire about Powder Coated Black.
- Suitable for **10-19mm** Glass.
- 19' length; 1.2-3mm Wall thickness.
- Gaskets and full range of Fittings available.

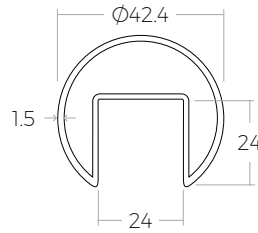
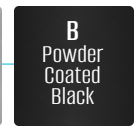
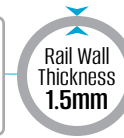
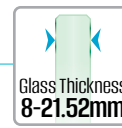


TOP EDGE COVERS

- Ultra slim edge design.
- Available in Satin and Black Anodized Aluminum, and SS316 Satin Stainless Steel.
- All finishes match our TILT-LOCK™ Base Shoe line.
- Suitable for Interiors and Exterior installations.
- Suitable for **12-25.52mm** Glass.
- Wall Thickness: 1.5mm for Aluminum, 1mm for Stainless Steel.
- Standard 19' lengths.
- Adhesive strip included.

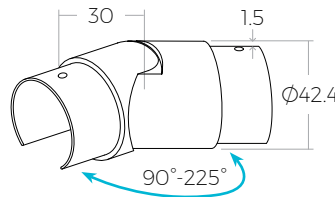
Round Stainless Steel Cap Rails & Fittings

• Gaskets available. See pg 96.



Ø42.4mm Cap Rail

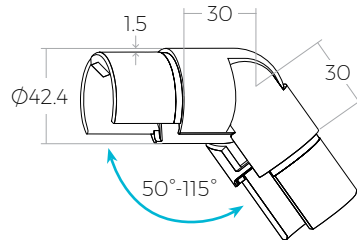
PART #	L (Length)	SS Grade	Finish
SSUTRND4240	19'	316	S
SSUTRND4240B	19'	304	B



Fittings

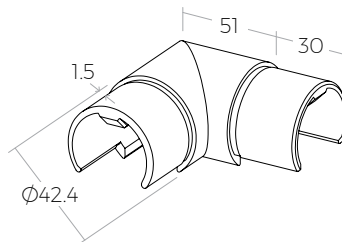
Swivel Horizontal Elbow

PART #	SS Grade	Finish
SSUTRND4241	Duplex 2205	S



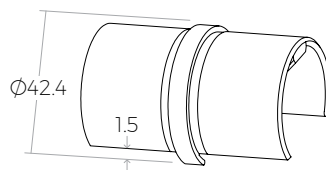
Swivel Vertical Elbow

PART #	SS Grade	Finish
SSUTRND4242	Duplex 2205	S



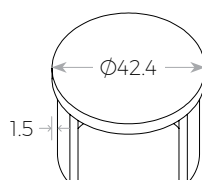
Horizontal 90° Elbow

PART #	SS Grade	Finish
SSUTRND4243	Duplex 2205	S



Straight Connector

PART #	SS Grade	Finish
SSUTRND4245	Duplex 2205	S

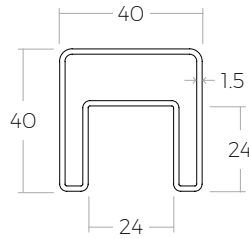
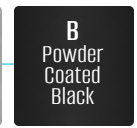
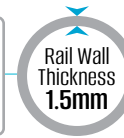
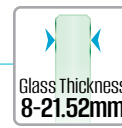


End Cap

PART #	SS Grade	Finish
SSUTRND4246	316	S
SSUTRND4246B	304	B
SSUTRND4247 (with center hole)	316	S

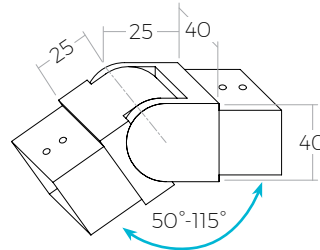
Square Stainless Steel Cap Rails & Fittings

- Gaskets available. See pg 96.



40mm Cap Rail

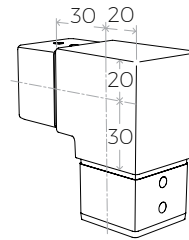
PART #	L (Length)	SS Grade	Finish
SSUTSQ40000	19'	316	S
SSUTSQ40B	19'	304	B



Fittings

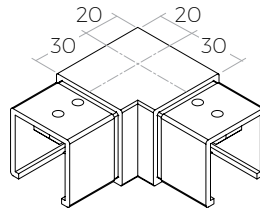
Swivel Vertical Elbow

PART #	SS Grade	Finish
SSUTSQ40004	Duplex 2205	S



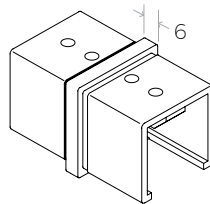
Vertical 90° Elbow

PART #	SS Grade	Finish
SSUTSQ40005	Duplex 2205	S



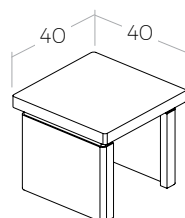
Horizontal 90° Elbow

PART #	SS Grade	Finish
SSUTSQ40003	Duplex 2205	S



Straight Connector

PART #	SS Grade	Finish
SSUTSQ40002	Duplex 2205	S

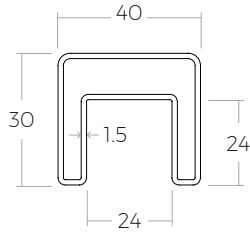
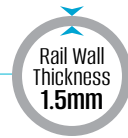
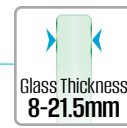


End Cap

PART #	SS Grade	Finish
SSUTSQ40001	316	S
SSUTSQ401B	304	B

Rectangular Stainless Steel Cap Rails

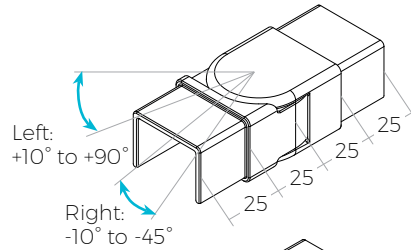
Gaskets available. See pg 96.



40mm Cap Rail

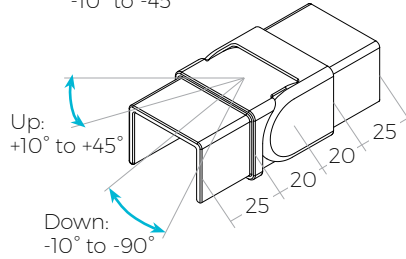
PART #	L (Length)	SS Grade	Finish
SSUTREC400	19'	316	S

Fittings



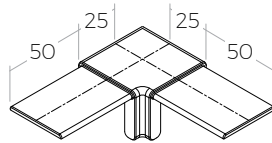
Swivel Horizontal Elbow

PART #	SS Grade	Finish
SSUTREC402	Duplex 2205	S



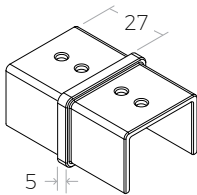
Swivel Vertical Elbow

PART #	SS Grade	Finish
SSUTREC403	Duplex 2205	S



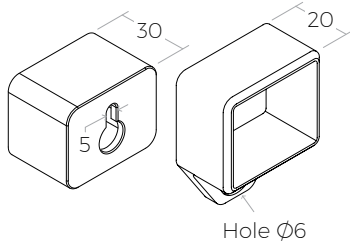
Horizontal 90° Elbow

PART #	SS Grade	Finish
SSUTREC404	Duplex 2205	S



Straight Connector

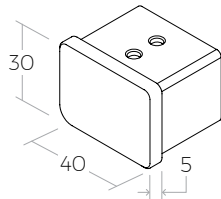
PART #	SS Grade	Finish
SSUTREC405	Duplex 2205	S



Wall Brackets

PART #	SS Grade	Finish
SSUTREC406 (with hole)	Duplex 2205	S
SSUTREC407 (with tab)	Duplex 2205	S

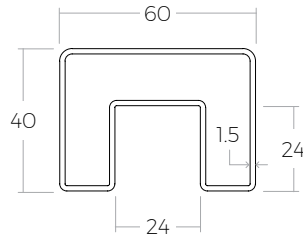
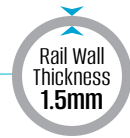
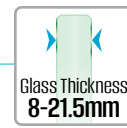
Can be affixed to Wall or Post.



End Cap

PART #	SS Grade	Finish
SSUTREC401	Duplex 2205	S

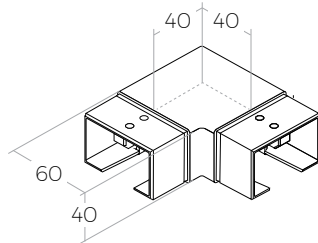
Gaskets available. See bottom of this page.



60mm Cap Rail

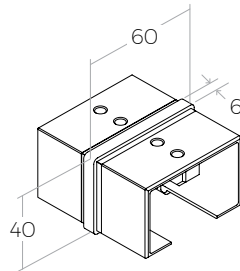
PART #	L (Length)	SS Grade	Finish
SSUTREC600	16'	316	S

Fittings



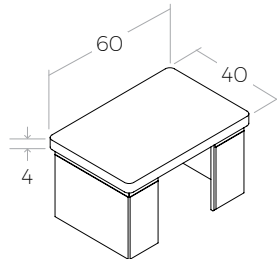
Horizontal 90° Elbow

PART #	SS Grade	Finish
SSUTREC601	316	S



Straight Connector

PART #	SS Grade	Finish
SSUTREC602	316	S



End Cap

PART #	SS Grade	Finish
SSUTREC603	316	S

Gaskets

- Suits Cap Rails with 24x24mm slots.



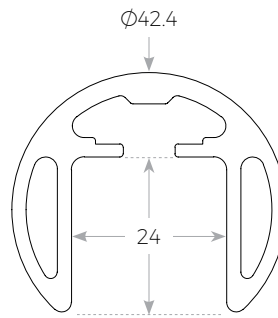
PART #	Glass Size (mm)	Length
SSUTGASKET1	8-10	19'
SSUTGASKET2	12-13.52	19'
SSUTGASKET2A	15	19'
SSUTGASKET3	16-17.52	19'
SSUTGASKET3A	19	19'
SSUTGASKET4	20-21.52	19'



Aluminum Cap Rails

- Brushed Anodized Aluminum 6063.
- Standard 19' lengths.
- Gaskets and full range of Fittings available.
- **NO WELDING REQUIRED** using our recommended SSRK-1500 Adhesive.

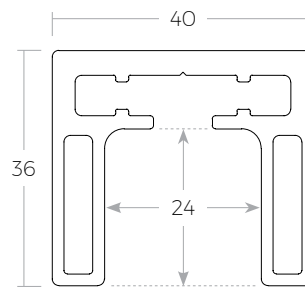
A Satin Anodized Aluminum	B Black Anodized Aluminum	SB Anodized Satin Black
---	---	---



Round

PART #	Finish
SSUTALROCA	A
SSUTALROB	B

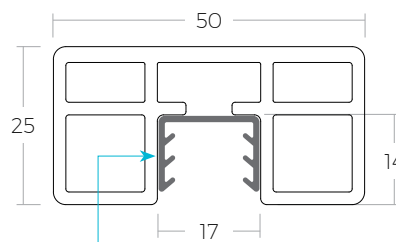
Choose Gasket (pg 102) to accommodate your Glass size.



Square

PART #	Finish
SSUTALSOCA	A
SSUTALSOB	B
SSUTALSOSB	SB

Choose Gasket (pg 102) to accommodate your Glass size.



Rectangular

PART #	Finish
SSUTALRECOCA	A
SSUTALRECOB	B
SSUTALRECOB	SB

1/2" Gasket included to accommodate 10-13.52mm Glass

A
Satin
Anodized
Aluminum

B
Black
Anodized
Aluminum

SB
Anodized
Satin
Black

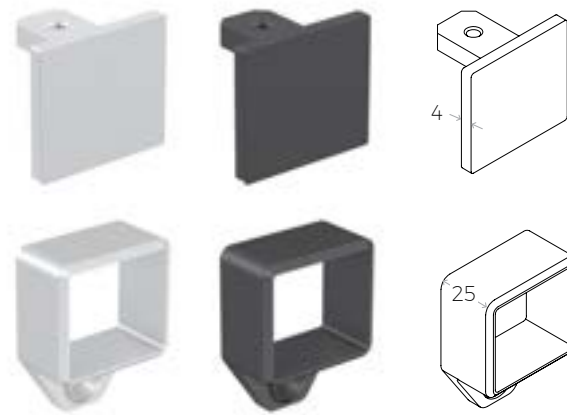


Round End Cap

PART #	Finish
SSUTALR1CA	A
SSUTALR1B	B

Wall Bracket

PART #	Finish
SSUTALR2CA	A
SSUTALR2B	B

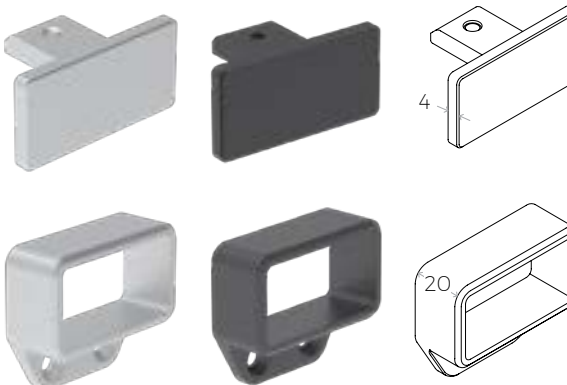


Square End Cap

PART #	Finish
SSUTALS1CA	A
SSUTALS1B	B
SSUTALS1SB	SB

Wall Bracket

PART #	Finish
SSUTALS2CA	A
SSUTALS2B	B
SSUTALS2SB	SB



Rectangular End Cap

PART #	Finish
SSUTALREC1CA	A
SSUTALREC1B	B
SSUTALREC1SB	SB

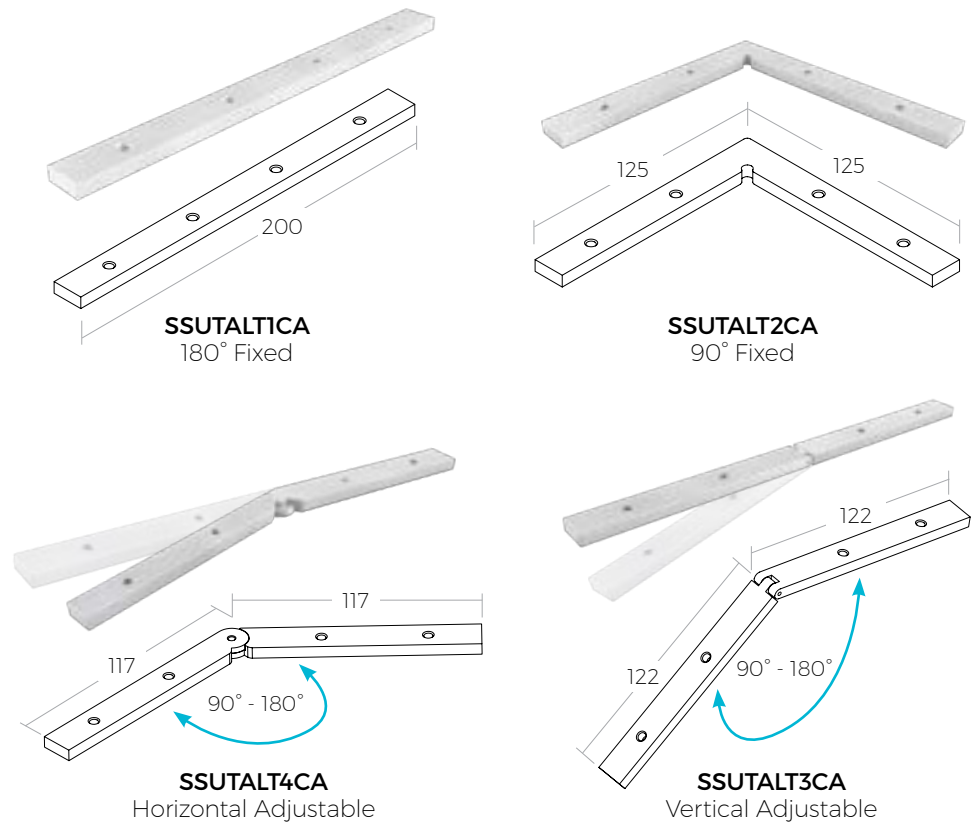
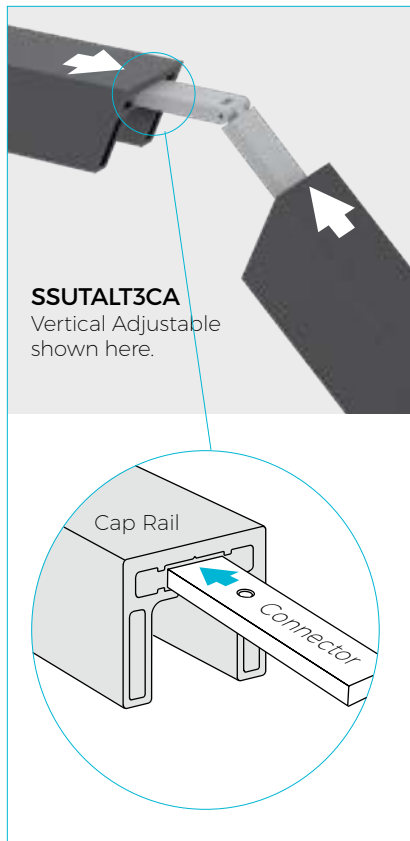
Wall Bracket

PART #	Finish
SSUTALREC2CA	A
SSUTALREC2B	B
SSUTALREC2SB	SB

Connectors & Handrail Adapter Kit

Connectors

- Connectors are inserted into the top slot of the Cap Rails to connect them together.
- Mitre Cap Rail ends to required angle, slide Connectors in place, push Cap Rails to fit. Tighten Connector Screws on both sides.
- Satin Anodized Aluminum. Used with either Round, Square, or Rectangular Aluminum Cap Rails for both finishes.



Aluminum Cap Rails & Accessories

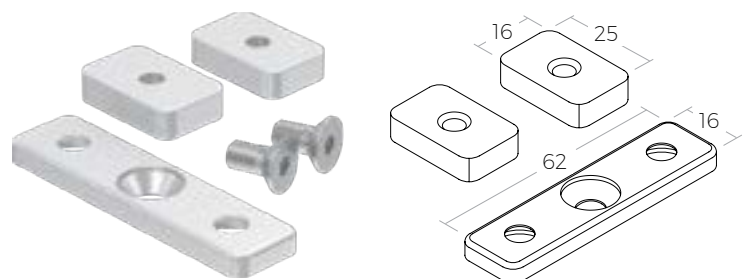
Handrail Adapter Kit NEW

SSUTALT5: Easily convert your Aluminum Cap Rail into a Handrail with the Handrail Adapter Kit. Choose your Handrail Bracket for either Off-the-wall or Off-the-glass. Can also be used with LumaRail. (pg 157).

Kit Includes:

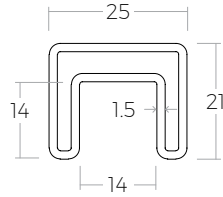
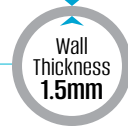
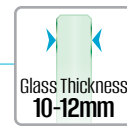
- Saddle (1pc).
- Rectangular Nut (2pcs).
- M6 Screws (2pcs).

Various applications demonstrated below:



Top Channels & Fittings

- Powder Coated Black available. Please inquire.
- **NO WELDING REQUIRED** using our recommended SSRK-1500 Adhesive.



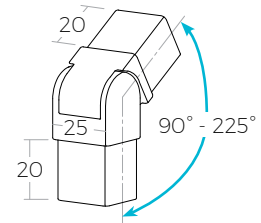
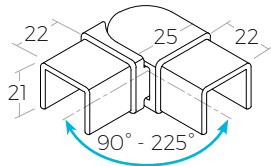
25x21mm Top Channel Rail

PART #	L (Length)	SS Grade	Finish
SSUTCH100	19'	316	S

Gaskets

PART #	Glass Thickness	Length
SSUTCH101	10-11	19'
SSUTCH102	12	19'

Fittings

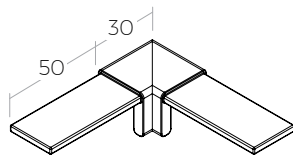


Swivel Horizontal Elbow

PART #	SS Grade	Finish
SSUTCH103	Duplex 2205	S

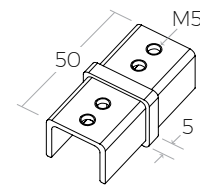
Swivel Vertical Elbow

PART #	SS Grade	Finish
SSUTCH104	Duplex 2205	S



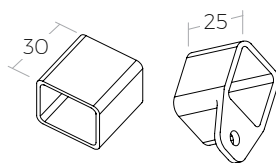
Horizontal 90° Elbow

PART #	SS Grade	Finish
SSUTCH105	Duplex 2205	S



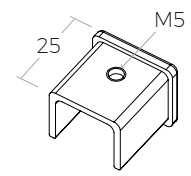
Straight Connector

PART #	SS Grade	Finish
SSUTCH106	Duplex 2205	S



Wall Brackets - Affix to Wall or Post.

PART #	SS Grade	Finish
SSUTCH108 (with hole)	Duplex 2205	S
SSUTCH109 (with tab)	Duplex 2205	S

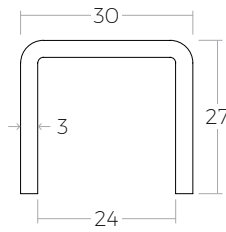
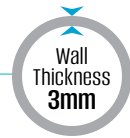
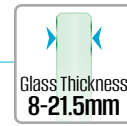


End Cap

PART #	SS Grade	Finish
SSUTCH107	Duplex 2205	S

Heavy Duty Top Channels & Fittings

- Powder Coated Black available. Please inquire.
- **NO WELDING REQUIRED** using our recommended SSRK-1500 Adhesive.



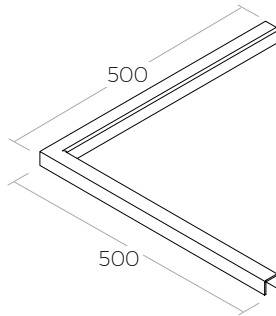
30x27mm Top Channel Rail

PART #	L (Length)	SS Grade	Finish
SSUTCH300	19'	316	S



Gaskets

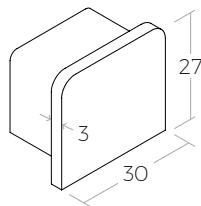
PART #	Glass Thickness	Length
SSUTGASKET1	8-11	19'
SSUTGASKET2	12-13.52	19'
SSUTGASKET2A	15	19'
SSUTGASKET3	16-17.52	19'
SSUTGASKET3A	19	19'
SSUTGASKET4	20-21.52	19'



Fittings

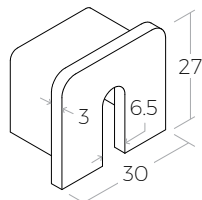
Horizontal 90° Elbow

PART #	SS Grade	Finish
SSUTCH303	316	S



Solid End Cap

PART #	SS Grade	Finish
SSUTCH301	316	S



Stabilizing End Cap

Connect to Wall through slot using 1/4" Fasteners.

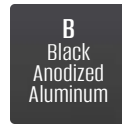
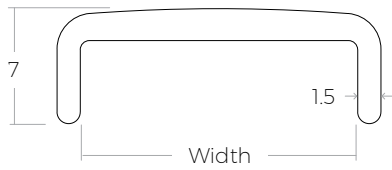
PART #	SS Grade	Finish
SSUTCH302	316	S



EDGE PROTECTION FOR GLASS RAILINGS

- Ultra Slim edge design.
- Satin & Black Anodized Aluminum and SS316 Satin Stainless Steel options available.
- All finishes match our TILT-LOCK™ Base Shoe line.
- Suitable for Interior and Exterior installations.
- Suitable for Glass thicknesses **12-25.52mm**.
- Wall Thickness: 1.5mm for Aluminum, 1mm for Stainless Steel.
- Standard 19' lengths (5800mm).
- Adhesive strip included.

Anodized Aluminum

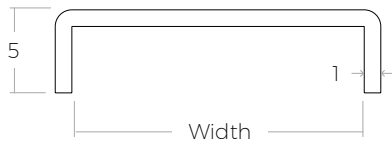


PART #	Width	Class Thickness	Finish
SSUTCH230A	15	12-14.28	A
SSUTCH230B	15	12-14.28	B
SSUTCH231A	18	15-17.52	A
SSUTCH231B	18	15-17.52	B
SSUTCH232A	22	19-21.52	A
SSUTCH232B	22	19-21.52	B
SSUTCH233A	26	25.52	A
SSUTCH233B	26	25.52	B

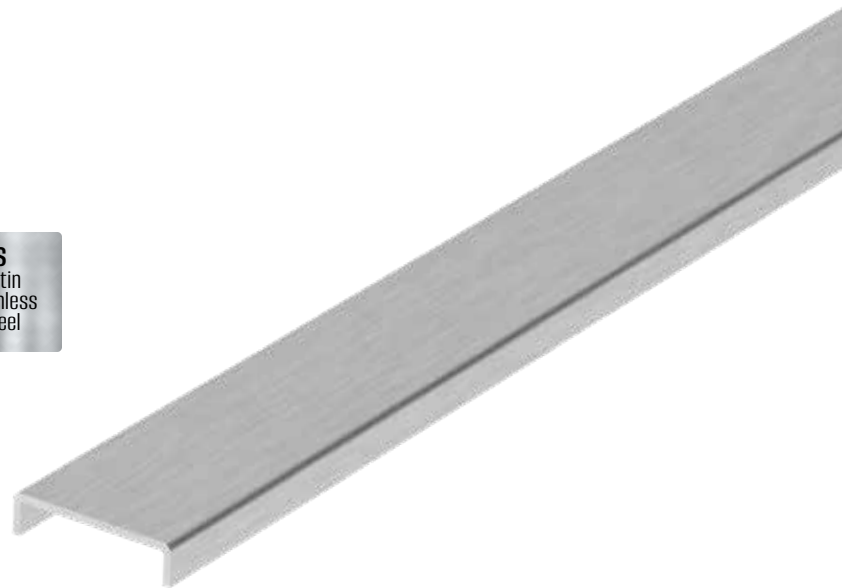


Top Edge Covers

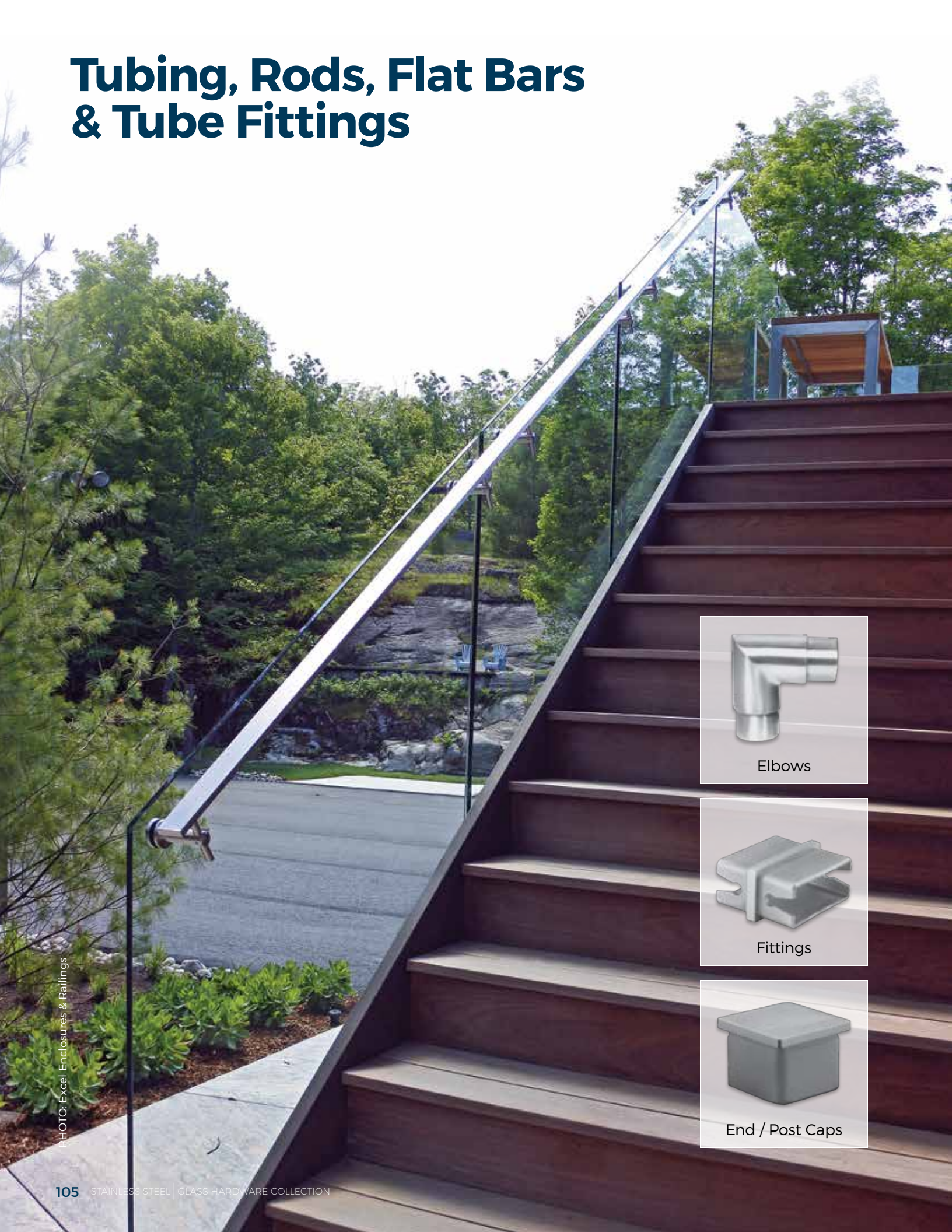
Stainless Steel



PART #	Width	Class Thickness	Finish
SSUTCH212	14	12-13.52	S
SSUTCH217	18	15-17.52	S
SSUTCH221	22	19-21.52	S



Tubing, Rods, Flat Bars & Tube Fittings



Elbows



Fittings



End / Post Caps

PHOTO: Excel Enclosures & Railings

S
Satin
Stainless
Steel

B
Powder
Coated
Black

TUBES



Round 19' Lengths

PART #	ØD	Wall Thickness	SS Grade	Finish
SST1215304	1/2"	1.5	304	S
SST5815304	5/8"	1.5	304	S
SST3415304	3/4"	1.5	304	S
SST11215304	1 1/2"	1.5	304	S
SST11215316	1 1/2"	1.5	316	S
SST1662304	1.66"	2.0	304	S
SST1662304B	1.66"	2.0	304	B
SST1662316	1.66"	2.0	316	S
SST215304	2"	1.5	304	S

RODS / BARS



Round 19' Lengths

PART #	ØD	Wall Thickness	SS Grade	Finish
SSROD12304	1/2"	N/A	304	S



Square 19' Lengths

PART #	W	Wall Thickness	SS Grade	Finish
SSTSQ1215304	1/2"	1.5	304	S
SSTSQ3415304	3/4"	1.5	304	S
SSTSQ402304	40	2.0	304	S
SST1215304B	40	2.0	304	B
SSTSQ402316	40	2.0	316	S
SSTSQ22304	2"	2.0	304	S



Square 19' Lengths

PART #	W	Wall Thickness	SS Grade	Finish
SSRODSQ12304	1/2"	N/A	304	S



Rectangular 19' Lengths

PART #	W x H	Wall Thickness	SS Grade	Finish
SSTREC11212	1 1/2" x 1/2"	1.5	316	S
SSTREC5010	50 x 10	1.5	316L	S
SSTREC212	2" x 1/2"	1.5	316	S
SSTREC21	2" x 1"	1.5	316	S
SSTREC21B	2" x 1"	1.5	316	B



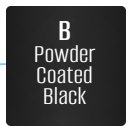
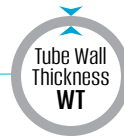
Rectangular 19' Lengths

PART #	W x H	Wall Thickness	SS Grade	Finish
SSFB212304	2" x 1/2"	N/A	304	S

Tubing, Rods & Flat Bars

Round Tubing Fittings

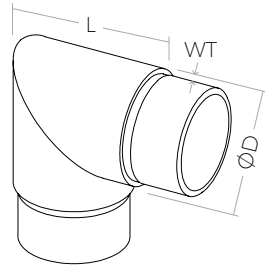
ØD = Diameter of Tube Applied · WT = Wall Thickness of Tube Applied · L = Length
 38.1mm = 1½" · 42.4mm = 1.66" · 50.8mm = 2"



Round Tube

19' Lengths

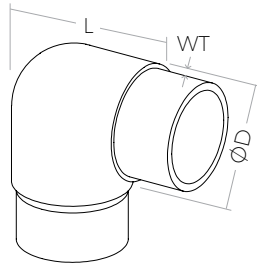
PART #	ØD (Tube Dia)	WT	SS Grade	Finish
SST1215304	12.7 (1/2")	1.5	304	S
SST5815304	15.85 (5/8")	1.5	304	S
SST3415304	19.05 (3/4")	1.5	304	S
SST11215304	38.1 (1 1/2")	1.5	304	S
SST11215316	38.1 (1 1/2")	1.5	316	S
SST1662304	42.4 (1.66")	2.0	304	S
SST1662304B	42.4 (1.66")	2.0	304	B
BSST1662316	42.4 (1.66")	2.0	316	S
SST215304	50.8 (2")	1.5	304	S



Elbows for Round Tube

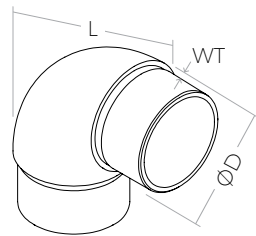
Sharp 90°

PART #	ØD (Tube Dia)	WT	L
SSEB1040316S	38.1	1.5	45
SSEB1020116S	42.4	2.0	50



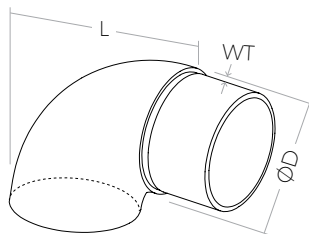
Soft 90°

PART #	ØD (Tube Dia)	WT	L
SSEB2040316S	38.1	1.5	45
SSEB2020116S	42.4	2.0	50



Round 90°

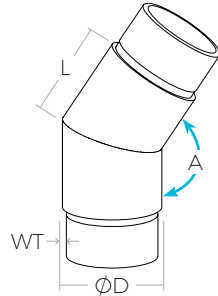
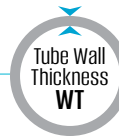
PART #	ØD (Tube Dia)	WT	L
SSEB3040316S	38.1	1.5	45
SSEB3020116S	42.4	2.0	50
SSEB3021116S	42.4	2.0	65
SSEB3050316S	50.8	1.5	70



Capped Elbow

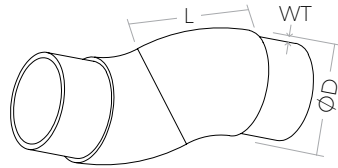
PART #	ØD (Tube Dia)	WT	L
SSEB1340316S	38.1	1.5	45
SSEB1320116S	42.4	2.0	50
SSEB1350316S	50.8	1.5	70

A = Angle · ØD = Diameter of Tube Applied · WT = Wall Thickness of Tube Applied · L = Length
 38.1mm = 1½" · 42.4mm = 1.66" · 50.8mm = 2"



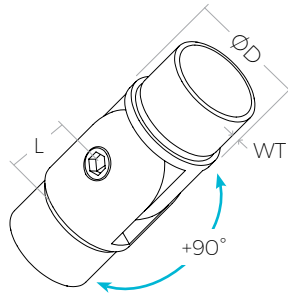
Angled

PART #	A	ØD (Tube Dia)	WT	L
SSEB4040304S	135°	38.1	1.5	35
SSEB4020116S	135°	42.4	2.0	38
SSEB4140316S	147°	38.1	1.5	35
SSEB4120116S	147°	42.4	2.0	38



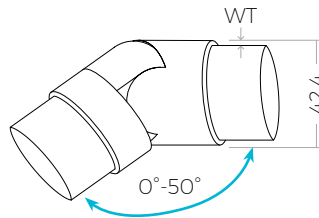
Rotating

PART #	ØD (Tube Dia)	WT	L
SSEB7040304S	38.1	1.5	38.5
SSEB7020104S	42.4	2.0	45



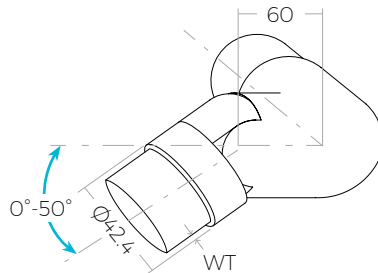
Flexible 90

PART #	ØD (Tube Dia)	WT	L
SSEB8040316S	38.1	1.5	24
SSEB8020116S	42.4	2.0	27
SSEB8050316S	50.8	1.5	32



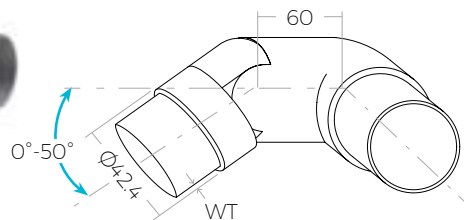
Flexible 50

PART #	ØD (Tube Dia)	WT
SSEBLNDFLUSH	42.4	2.0



Swivel Left

PART #	ØD (Tube Dia)	WT
SSEBLNDLEFT	42.4	2.0



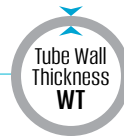
Swivel Right

PART #	ØD (Tube Dia)	WT
SSEBLNDRIGHT	42.4	2.0

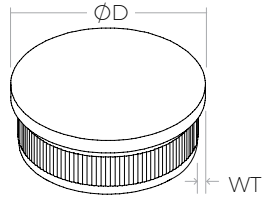
Elbows for Round Tubing

Fittings for Round Tubing

∅D = Diameter of Cap and Tube Applied · WT = Wall Thickness of Tube Applied
 38.1mm = 1½" · 42.4mm = 1.66" · 50.8mm = 2"

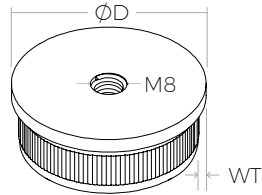


End / Post Caps for Round Tubes



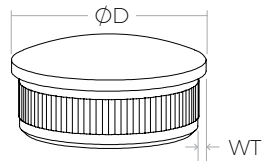
Flat

PART #	∅D	WT	SS Grade	Finish
SSEP0012416S	38.1	1.5	316	S
SSEP0010216S	42.4	2.0	316	S
SSEP001021B	42.4	2.0	304	B
SSEP0012516S	50.8	1.5	316	S



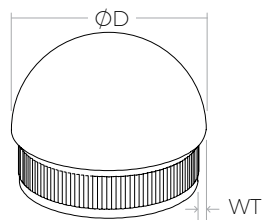
Flat with Threaded Hole

PART #	∅D	WT	SS Grade	Finish
SSEP0022404S	38.1	1.5	304	S
SSEP0020216S	42.4	2.0	316	S



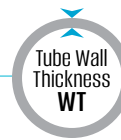
Curved

PART #	∅D	WT	SS Grade	Finish
SSEP0032416S	38.1	1.5	316	S
SSEP0030216S	42.4	2.0	316	S
SSEP0032504S	50.8	1.5	304	S



Domed

PART #	∅D	WT	SS Grade	Finish
SSEP0072416S	38.1	1.5	316	S
SSEP0070216S	42.4	2.0	316	S
SSEP0072516S	50.8	1.5	316	S

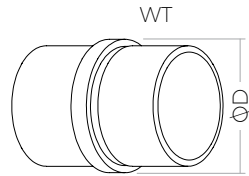


ΦD = Diameter of Tube Applied · WT = Wall Thickness of Tube Applied · L = Length
 $38.1\text{mm} = 1\frac{1}{2}"$ · $42.4\text{mm} = 1.66"$ · $50.8\text{mm} = 2"$

Connectors for Round Tubes

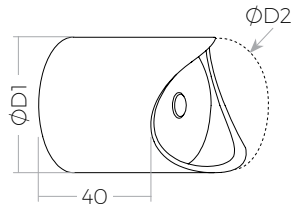
Straight

PART #	ΦD	WT	SS Grade	Finish
SSEB9040316S	38.1	1.5	316	S
SSEB9020116S	42.4	2.0	316	S
SSEB9050316S	50.8	1.5	316	S



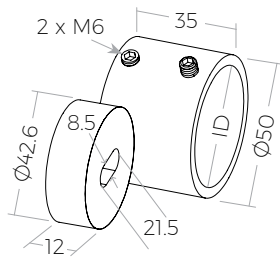
Post Adapter

PART #	$\Phi D1$	$\Phi D2$	SS Grade	Finish
SSEB8110116S	42.4	42.4	316	S



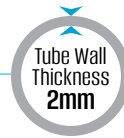
Handrail Wall Connector

PART #	ID	SS Grade	Finish
SSEB8100216S	42.4	316	S



Square Tubing & Fittings

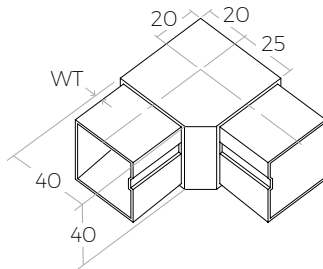
OD = Outer Dimensions of Tube · WT = Wall Thickness of Tube Applied
38.1mm = 1½" · 42.4mm = 1.66" · 50.8mm = 2"



Square Tube

19' Lengths

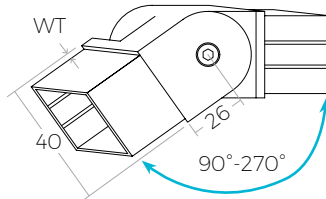
PART #	W x H	WT	SS Grade	Finish
SSTSQ402304	40 x 40	2.0	304	S
SSTSQ402304B	40 x 40	2.0	304	B
SSTSQ402316	40 x 40	2.0	316	S
SSTSQ22304	50 x 50	2.0	304	S



Fittings For Square Tube Above

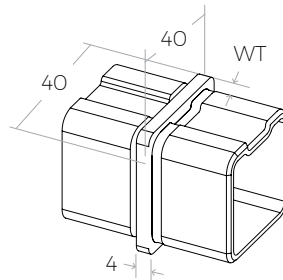
90° Fixed Elbow

PART #	W x H	WT	SS Grade	Finish
SSZE0404016S	40 x 40	2.0	316	S
SSZE0404016B	40 x 40	2.0	316	B



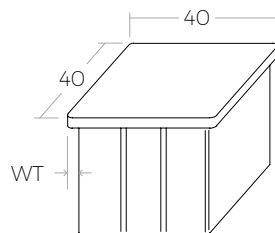
90° Swivel Elbow

PART #	W x H	WT	SS Grade	Finish
SSZE1404016S	40 x 40	2.0	316	S
SSZE1404016B	40 x 40	2.0	316	B



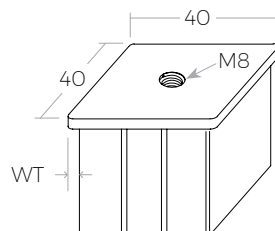
Straight Connector

PART #	W x H	WT	SS Grade	Finish
SSZE0404116S	40 x 40	2.0	316	S
SSZE0404116B	40 x 40	2.0	316	B



Flat Cap

PART #	W x H	WT	SS Grade	Finish
SSZP0404016S	40 x 40	2.0	316	S
SSZP0404016B	40 x 40	2.0	304	B
SSZP0505016S	50 x 50	2.0	316	S

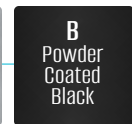
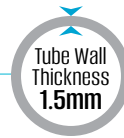


Flat Cap with Threaded Hole

PART #	W x H	WT	SS Grade	Finish
SSZP0600116S	40 x 40	2.0	316	S

Standard Rectangular Tubing & Fittings

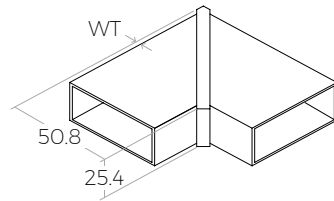
OD = Outer Dimensions of Tube · WT = Wall Thickness of Tube Applied
38.1mm = 1½" · 42.4mm = 1.66" · 50.8mm = 2"



Standard Rectangular Tube

19' Lengths

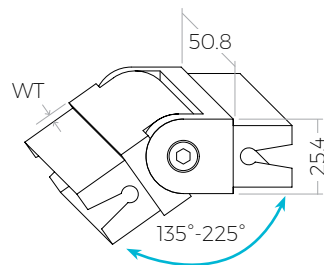
PART #	W x H	WT	SS Grade	Finish
SSTREC11212	38 x 12.7 (1 1/2" x 1/2")	1.5	316	S
SSTREC212	50.8 x 12.7 (2" x 1/2")	1.5	316	S
SSTREC21	50.8 x 25.4 (2" x 1")	1.5	316	S
SSTREC21B	50.8 x 25.4 (2" x 1")	1.5	304	B



Fittings For Rectangular Tube Above

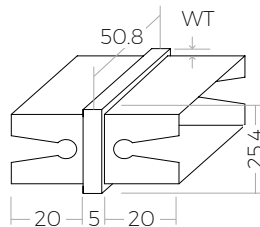
2" x 1" 90° Fixed Elbow

PART #	W x H	WT	SS Grade	Finish
SSEBREC2101	50 x 25 (2" x 1")	1.5	316	S
SSEBREC211B	50 x 25 (2" x 1")	1.5	316	B



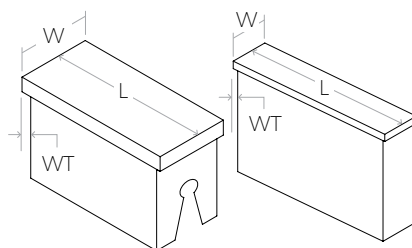
2" x 1" Swivel Elbow

PART #	W x H	WT	SS Grade	Finish
SSEBREC2103	50 x 25 (2" x 1")	1.5	316	S
SSEBREC213B	50 x 25 (2" x 1")	1.5	316	B



2" x 1" Straight Connector

PART #	W x H	WT	SS Grade	Finish
SSEBREC2102	50 x 25 (2" x 1")	1.5	316	S
SSEBREC212B	50 x 25 (2" x 1")	1.5	316	B



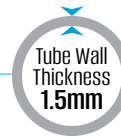
Flat Cap

PART #	OD (L x W)	WT	SS Grade	Finish
SSEPREC11212	38 x 12.7 (1 1/2" x 1/2")	1.5	316	S
SSEPREC212	50.8 x 12.7 (2" x 1/2")	1.5	316	S
SSEPREC21	50.8 x 25.4 (2" x 1")	1.5	316	S
SSEPREC21B	50.8 x 25.4 (2" x 1")	1.5	304	B

Fittings for Square & Rectangular Tubing

Slim Line Rectangular Tubing & Fittings

OD = Outer Dimensions of Tube • WT = Wall Thickness of Tube Applied
 38.1mm = 1½" • 42.4mm = 1.66" • 50.8mm = 2"

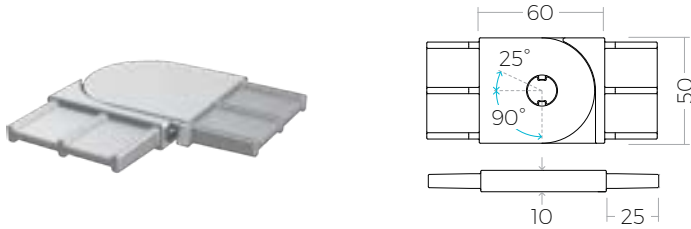


Slim Line Rectangular Tube

- Powder Coated Black available. Please inquire.
- NO WELDING REQUIRED using our recommended SSRK-1500 Adhesive.

19' Lengths

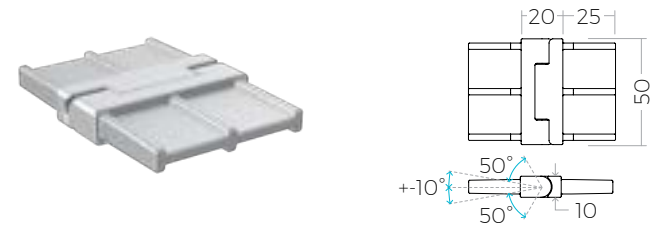
PART #	OD (W x H)	WT	SS Grade	Finish
SSTREC5010	50 x 10	1.5	316	S



Fittings For Slim Line Tube Above

Swivel Horizontal Elbow

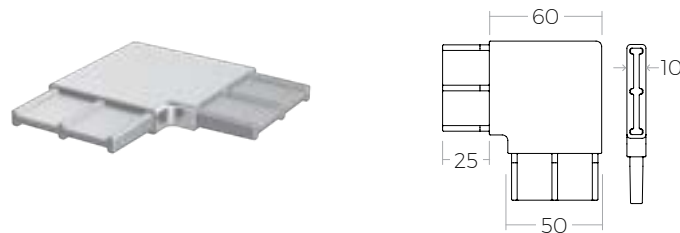
PART #	OD (W x H)	WT	SS Grade	Finish
SSEBREC501	50 x 10	1.5	2205	S



Swivel Vertical Elbow

PART #	OD (W x H)	WT	SS Grade	Finish
SSEBREC502	50 x 10	1.5	2205	S

Tack weld on Hinge is recommended for +/-10° angles.



90° Fixed Elbow

PART #	OD (W x H)	WT	SS Grade	Finish
SSEBREC503	50 x 10	1.5	2205	S



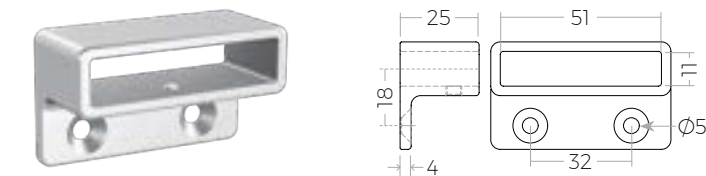
Straight Connector

PART #	OD (W x H)	WT	SS Grade	Finish
SSEBREC504	50 x 10	1.5	2205	S



End Cap

PART #	OD (W x H)	WT	SS Grade	Finish
SSEPREC501	50 x 10	1.5	2205	S



Wall Bracket with Tab

PART #	ID (W x H)	SS Grade	Finish
SSEPREC502	51 x 11	2205	S



PHOTO: Sierra Glass

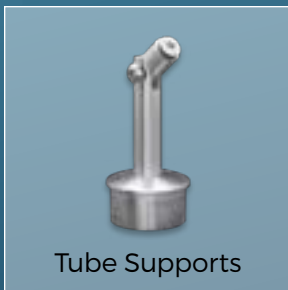
Fittings for Slim Line Tubing

Handrail Components





Attachment Plates



Tube Supports



Handrail Brackets

Our Handrail Components are available for both Round and Square applications. They consist of Handrail Attachment Plates, Tube Supports, Elbows, End Caps, and Post Caps. We also offer a large variety of Handrail Brackets for Off-the-Wall, Off-the-Glass, or Off-the-Post applications. They are made of durable 316 Grade Stainless Steel, and are all available in **(S)** Satin finish, with some available in **(GB)** PVD Graphite Black, **(B)** Powder Coated Black, and our new **(G)** Gold.

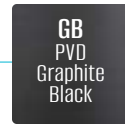
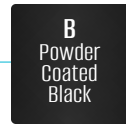
Round Handrail Bracket Series:

- Standard
- Standard Concealed
- Standard Welded
- Height Adjustable
- Heavy Duty
- Modern / Length Adjustable

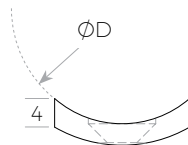
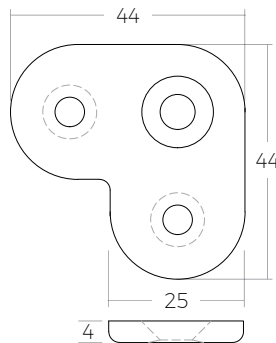
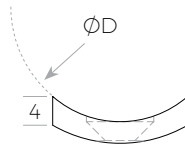
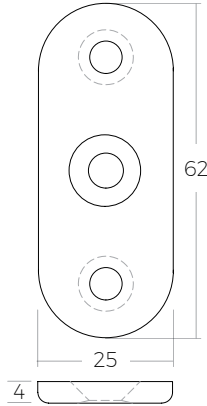
Square Handrail Bracket Series:

- Standard
- Standard Concealed
- Height Adjustable
- Heavy Duty

Handrail Attachment Plates



All Attachment Plates are 316 Grade Stainless Steel.



Straight Flat

PART #	ØD	Finish
SSUA0010116S	Flat	S
SSUA0010116B	Flat	B
SSUA0010116GB	Flat	GB
SSUA0010116C	Flat	G

Straight Curved

PART #	ØD (Tube Dia)	Finish
SSUA0010616S	38.1 (1 1/2")	S
SSUA0010616B	38.1 (1 1/2")	B
SSUA0010616GB	38.1 (1 1/2")	GB
SSUA0010316S	42.4 (1.66")	S
SSUA0010316B	42.4 (1.66")	B
SSUA0010316GB	42.4 (1.66")	GB
SSUA0010716S	50.8 (2")	S

90° Flat

PART #	ØD (Tube Dia)	Finish
SSUA0012116S	Flat	S
SSUA0012116B	Flat	B
SSUA0012116GB	Flat	GB
SSUA0012116C	Flat	G

90° Curved

PART #	ØD (Tube Dia)	Finish
SSUA0012616S	38.1 (1 1/2")	S
SSUA0012316S	42.4 (1.66")	S
SSUA0012716S	50.8 (2")	S

EXAMPLE OF CREATING HANDRAIL BRACKETS FOR POSTS

Choose Required Handrail Attachment Plate above.



SSUA0010616S

Choose Required Tube Support (pg 119).



SSTS1060016S

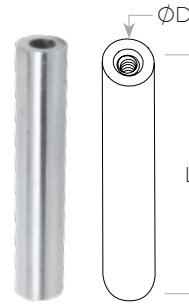


Fixed Rod



Single Pin Fixed Rod

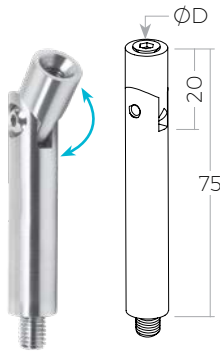
PART #	ØD	Pin Thread	Hole Thread
SSFP0012116S	12	M8	M6
SSFP0022116S	14	M8	M6



Double Hole Fixed Rod

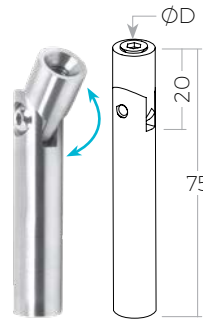
PART #	ØD	L (Length)	Hole Thread
SSFP0012216S	12	75	M6, M8
SSFP0022216S	14	75	M6, M8
SSFP0112216S	12	52	M6, M8

Swivel Rod



Single Pin Swivel Rod

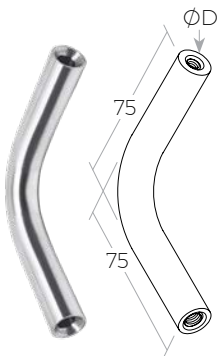
PART #	ØD	Pin Thread	Hole Thread
SSSP0012116S	12	M8	M6
SSSP0022116S	14	M8	M6



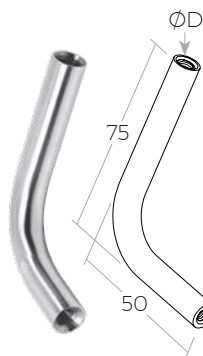
Double Hole Swivel Rod

PART #	ØD	Hole Thread
SSSP0012216S	12	M6, M8
SSSP0122016S	14	M6

Angled Rod



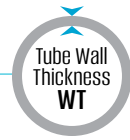
PART #	ØD	Hole Thread
SSFB0012216S	12	M6, M8
SSFB0022216S	14	M6, M8



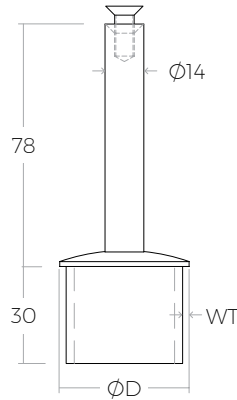
PART #	ØD	Hole Thread
SSFB0032216S	12	M6, M8

Tube Supports for Round Tubes

ØD = Diameter of Tube Support Base and Tube Applied • WT = Wall Thickness of Tube Applied
 38.1mm = 1½" • 42.4mm = 1.66" • 50.8mm = 2"

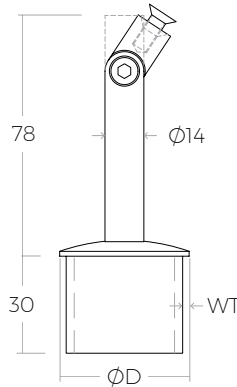


316 Grade



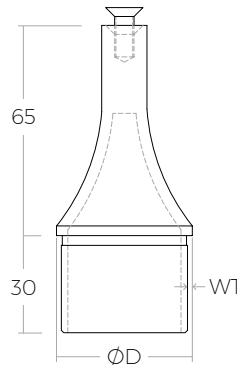
Round Fixed

PART #	ØD (Tube Diameter)	WT
SSTF1050016S	38.1	1.5
SSTF0030016S	42.4	2.0
SSTF1060004S	50.8	1.5



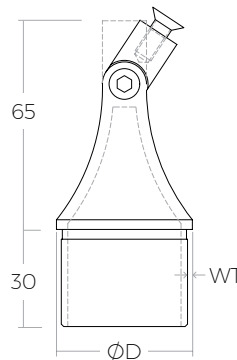
Round Swivel

PART #	ØD (Tube Diameter)	WT
SSTS1060016S	38.1	1.5
SSTS0030016S	42.4	2.0
SSTS1070004S	50.8	1.5



Cone Fixed

PART #	ØD (Tube Diameter)	WT
SSTF2050016S	38.1	1.5
SSTF2030016S	42.4	2.0
SSTF2060016S	50.8	1.5

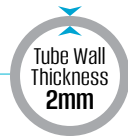


Cone Swivel

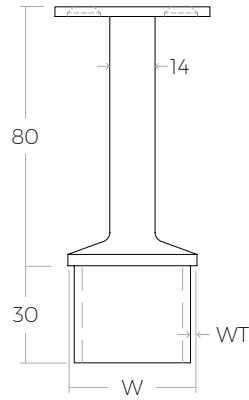
PART #	ØD (Tube Diameter)	WT
SSTS2050016S	38.1	1.5
SSTS2030016S	42.4	2.0
SSTS2060016S	50.8	1.5

Tube Supports for Square Tubes

D = Dimension of Tube Support and Tube Applied · WT = Wall Thickness of Tube Applied
 38.1mm = 1½" · 42.4mm = 1.66" · 50.8mm = 2"

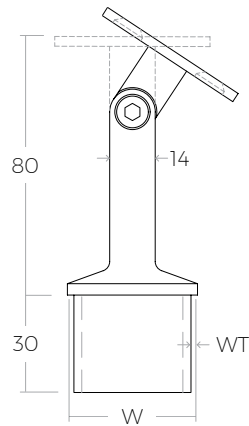


316 Grade



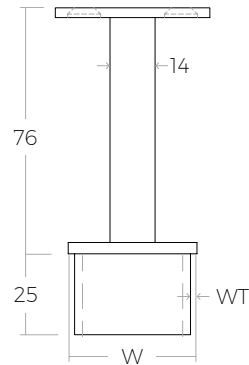
Chamfered Fixed

PART #	W (Tube Dimensions)	WT
SSZT0404016S	40 x 40	2.0



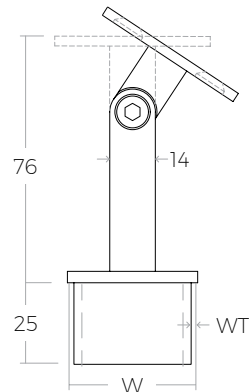
Chamfered Swivel

PART #	W (Tube Dimensions)	WT
SSZT1404016S	40 x 40	2.0



Flat Top Fixed

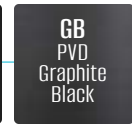
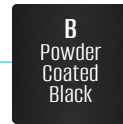
PART #	W (Tube Dimensions)	WT
SSZT24016S	40 x 40	2.0



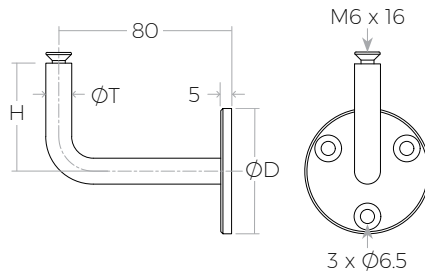
Flat Top Swivel

PART #	W (Tube Dimensions)	WT
SSZT34016S	40 x 40	2.0

Handrail Tube Supports



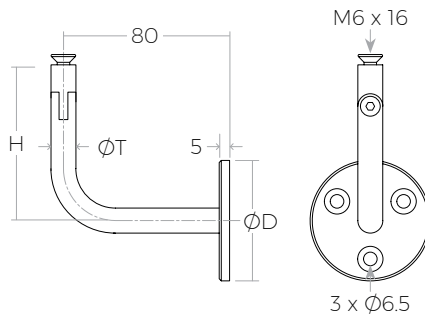
RDI SERIES - Standard



Off-the-Wall

Fixed

PART #	H (Height)	ØD (Plate Dia)	ØT (Rod Dia)	Finish
SSWB0100016S	50	58	12	S
SSWB0100016B	50	58	12	B
SSWB0100016GB	50	58	12	GB
SSWB1301116S	75	58	12	S
SSWB2311116S	75	68	14	S



Swivel

PART #	H (Height)	ØD (Plate Dia)	ØT (Rod Dia)	Finish
SSWB1109016S	75	58	12	S

EXAMPLE OF CREATING AN OFF-THE-GLASS BRACKET

Choose Required Handrail Attachment Plate. (pg 117)

Choose Required Off-the-Glass Handrail Bracket. (pg 122-125.)



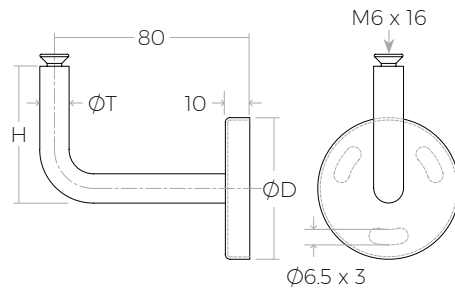
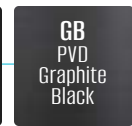
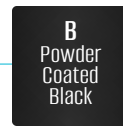
SUA0010116S



SSGF11GM16S



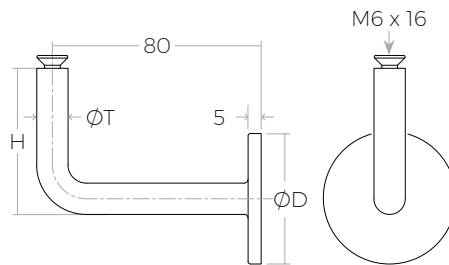
RD2 SERIES - Standard Concealed



Off-the-Wall

PART #	H (Height)	ØD (Plate Dia)	ØT (Rod Dia)	Finish
SSWB111216S	50	58	12	S
SSWB111216B	50	58	12	B
SSWB111216GB	50	58	12	GB
SSWB111416S	50	58	14	S
SSWB111416B	50	58	14	B
SSWB111416GB	50	58	14	GB
SSWB111426S	72	58	14	S

RD3 SERIES - Standard Welded



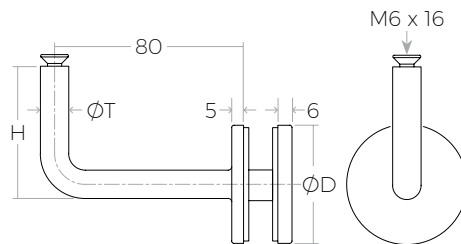
Installed with M10 Hanger Bolt
(Not included).

Off-the-Wall

PART #	H (Height)	ØD (Plate Dia)	ØT (Rod Dia)	Finish
SSWB3116S	50	38	12	S
SSWB3116B	50	38	12	B
SSWB3116GB	50	38	12	GB
<i>The above match our 1 1/2" Standoffs.</i>				
SSWB3216S	50	50	12	S
SSWB3216B	50	50	12	B
SSWB3216GB	50	50	12	GB
<i>The above match our 2" Standoffs.</i>				
SSWB3316S	75	50	14	S
<i>The above match our 2" Standoffs.</i>				



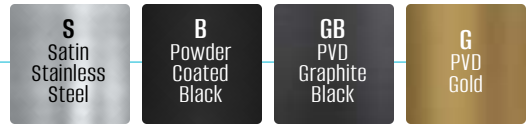
Off-the-Glass



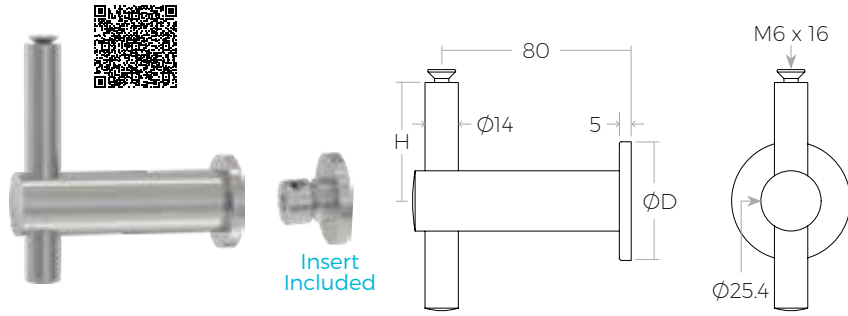
PART #	H (Height)	ØD (Plate Dia)	ØT (Rod Dia)	Finish
SSGF11GM17S	50	38	12	S
SSGF11GM17B	50	38	12	B
<i>The above match our 1 1/2" Standoffs.</i>				
SSGF11GM18S	50	50	12	S
SSGF11GM18B	50	50	12	B
<i>The above match our 2" Standoffs.</i>				
SSGF11GM16S	50	58	12	S
SSGF11GM16B	50	58	12	B
SSGF11GM16GB	50	58	12	GB
SSGF10GX16S	50	50	14	S
SSGF10GM16S	75	50	14	S

Round Handrail Brackets

RD4 SERIES - Height Adjustable

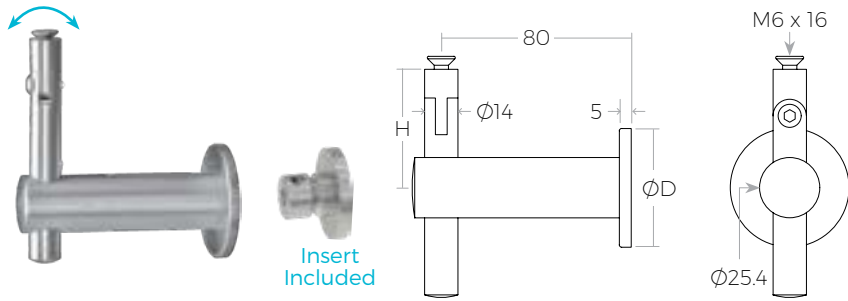


All Handrail Brackets are 316 Grade Stainless Steel.



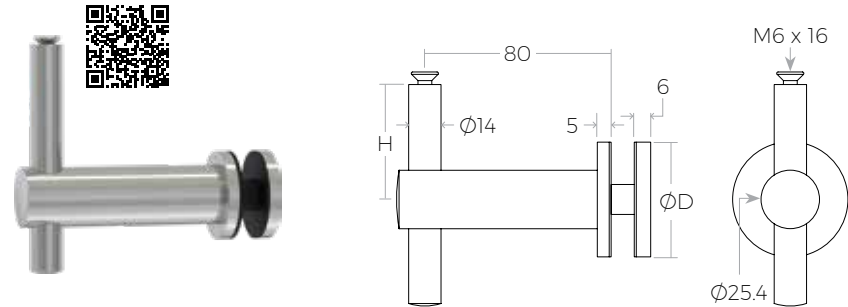
Insert Included

M8 Hanger Bolt required



Insert Included

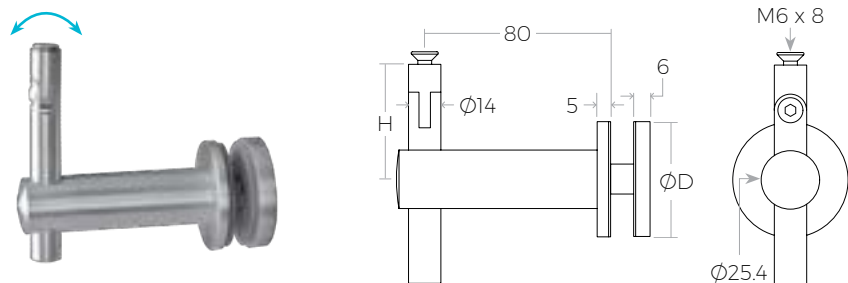
M8 Hanger Bolt required



Off-the-Glass

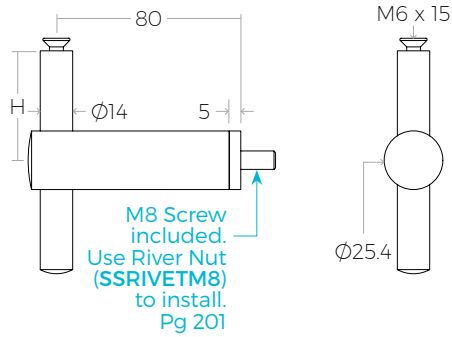
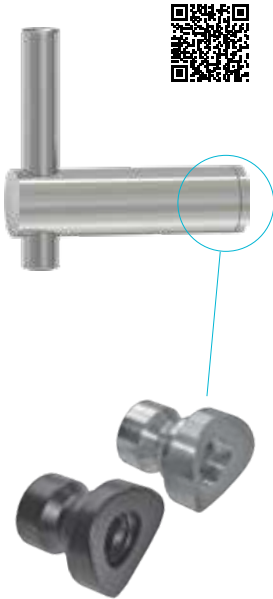
Fixed

PART #	H (Height)	ØD (Plate Dia)	Finish
SSGF100X16S	20-76	38	S
SSGF100X16B	20-76	38	B
SSGF100X16GB	20-76	38	GB
SSGF100X16G	20-76	38	G
The above match our 1 1/2" Standoffs.			
SSGF0010016S	20-76	50	S
SSGF0010016B	20-76	50	B
SSGF0010016GB	20-76	50	GB
SSGF0010016G	20-76	50	G
The above match our 2" Standoffs.			

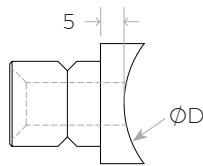


Swivel

PART #	H (Height)	ØD (Plate Dia)	Finish
SSGS0010016S	40-76	50	S



Use these Adapters to apply above Bracket to a Round Post.



Off-the-Post Bracket with Flat Adapter

PART #	H (Height)	Finish
SSWF20016S	20-76	S
SSWF20016B	20-76	B

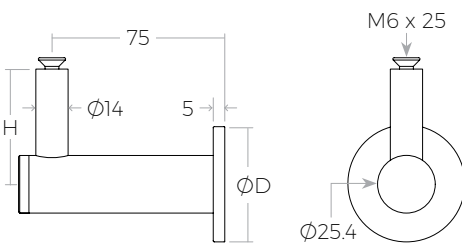
Adapters for Round Posts

PART #	ØD (Post Dia)	Finish
SSWF20116S	42.4	S
SSWF20116B	42.4	B
SSWF20216S	50.8	S
SSWF20216B	50.8	B

RD5 SERIES - Heavy Duty



Insert Included

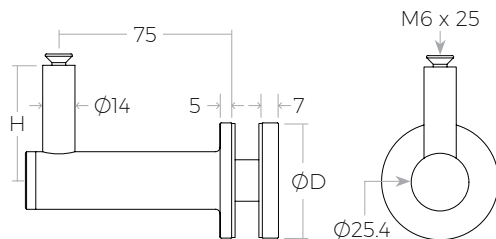


M8 Hanger Bolt required

Off-the-Wall

PART #	H (Height)	ØD (Plate Dia)	Finish
SSWF0020016S	50	50	S

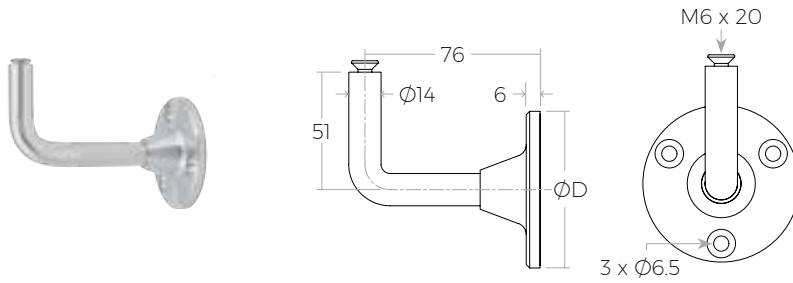
Matches our 2" Standoffs.



Off-the-Glass

PART #	H (Height)	ØD (Plate Dia)	Finish
SSGF200X16S	50	38	S
Matches our 2" Standoffs.			
SSGF0020016S	50	50	S
Matches our 1 1/2" Standoffs.			

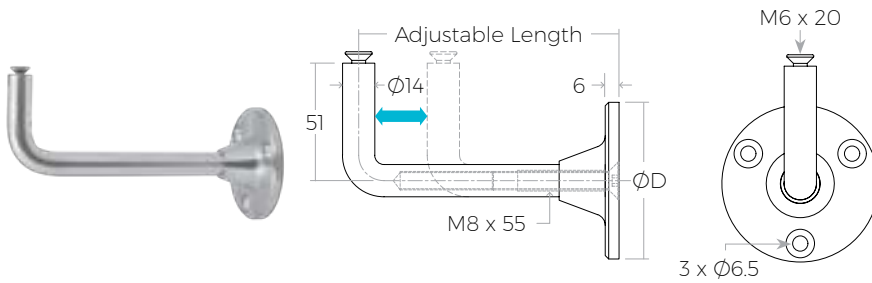
RD6 SERIES - Heavy Duty / Length Adjustable



Off-the-Wall

Fixed

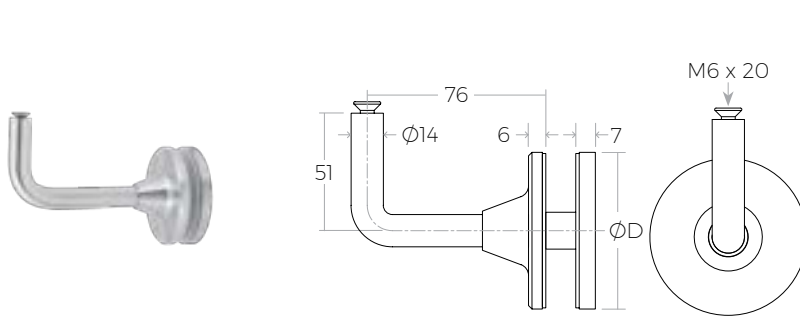
PART #	ØD (Plate Dia)	Finish
SSWB0100116S	68	S



Adjustable Length

PART #	ØD (Plate Dia)	Adjustable Length	Finish
SSWB0100216S	68	76-114	S
SSWB0100316S	68	114-152	S

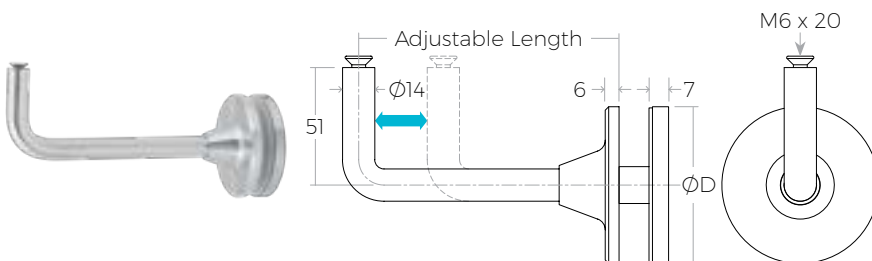
Cut to desired length; Collar design conceals cut Rod.



Off-the-Glass

Fixed

PART #	ØD (Plate Dia)	Finish
SSGF12GM16S	68	S



Adjustable Length

PART #	ØD (Plate Dia)	Adjustable Length	Finish
SSGF13GM16S	68	76- 14	S
SSGF14GM16S	68	114-152	S

Cut to desired length; Collar design conceals cut Rod.

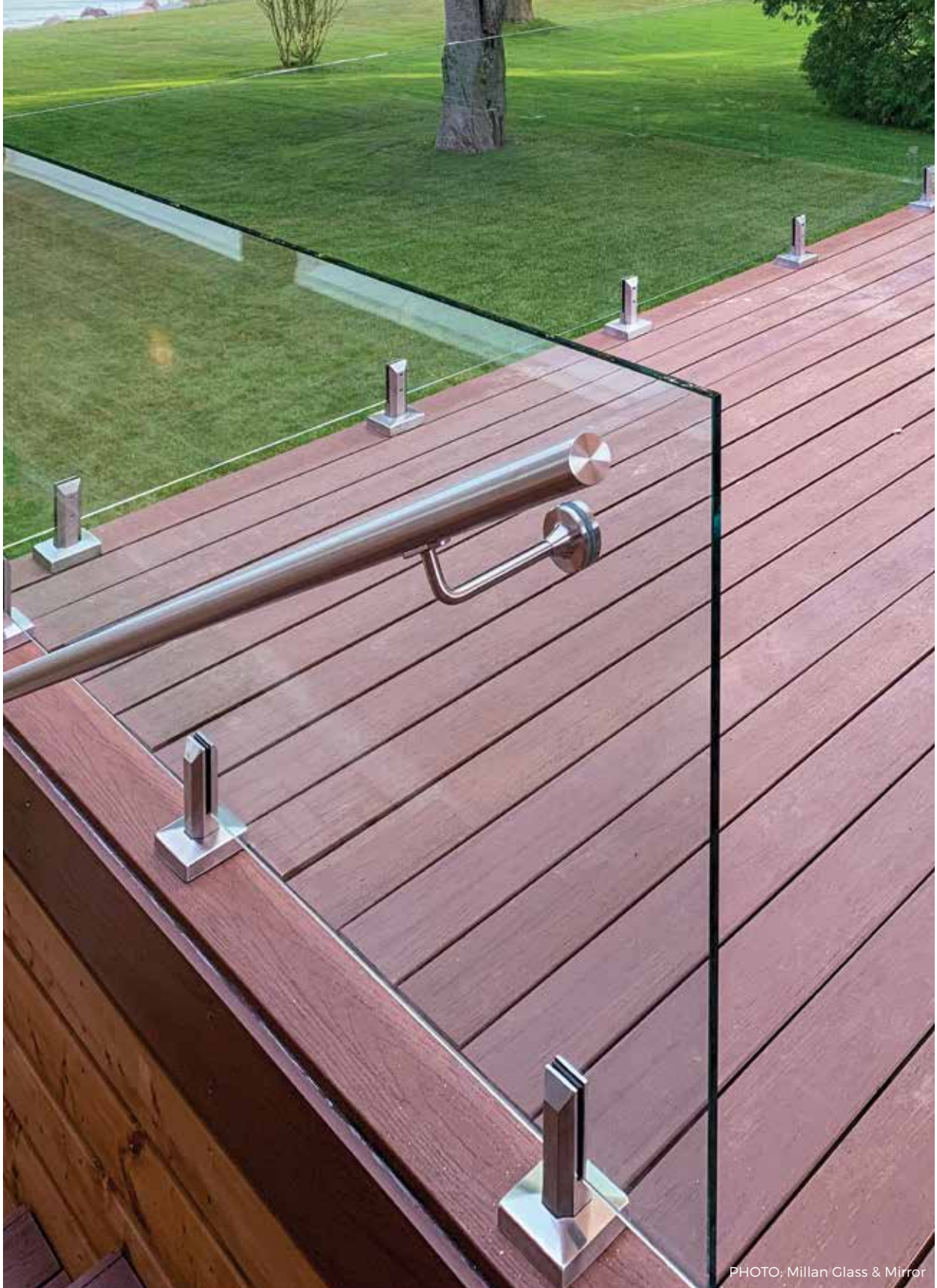
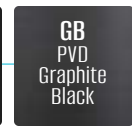
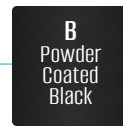


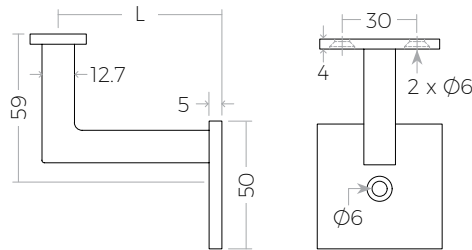
PHOTO: Millan Glass & Mirror

Round Handrail Brackets

Square Handrail Brackets



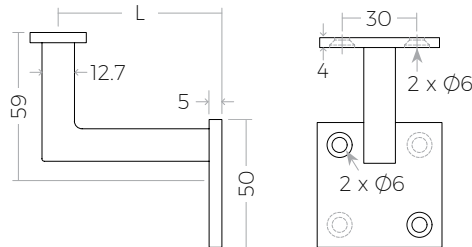
SQ1 SERIES - Standard



Off-the-Wall

Single Hole

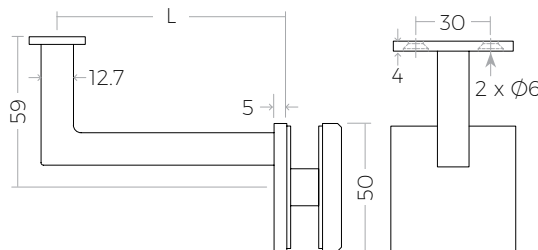
PART #	L (Length)	Finish
SSZH0070116S	64	S
SSZH0072116S	90	S
SSZH007216GB	90	GB



Double Hole

PART #	L (Length)	Finish	Top Hole on Plate
SSZH0070100S	64	S	Left
SSZH0070101S	64	S	Right
SSZH0071116S	90	S	Left
SSZH0071115S	90	S	Right

Showing left configuration.

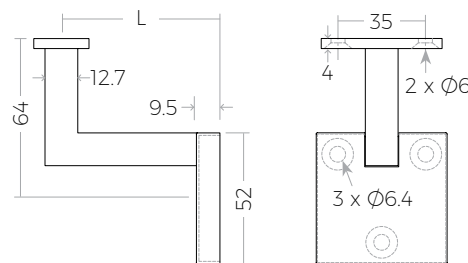


Off-the-Glass



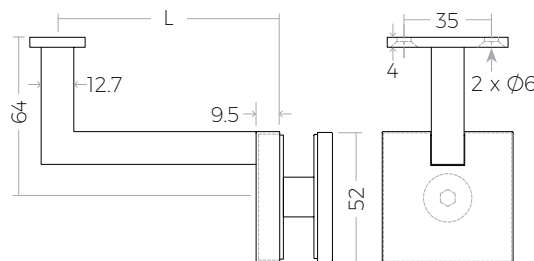
PART #	L (Length)	Finish
SSZH1071116S	90	S
SSZH107111GB	90	GB

SQ2 SERIES - Standard Concealed



Off-the-Wall

PART #	L (Length)	Finish
SSZH21216S	64	S
SSZH31216S	90	S
SSZH31216B	90	B
SSZH31216GB	90	GB



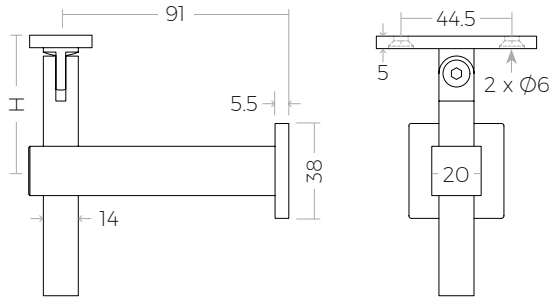
Off-the-Glass



PART #	L (Length)	Finish
SSZH31226S	90	S
SSZH31226B	90	B
SSZH31226GB	90	GB



SQ4 SERIES - Height Adjustable

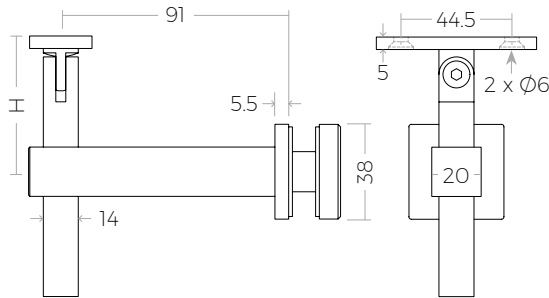
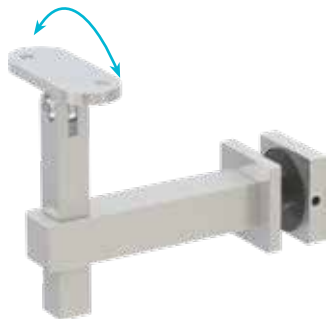


Installed with M8 Hanger Bolt
(Not included).

Off-the-Wall Swivel

PART #	H (Height)	Finish
SSZH40116S	30-70	S

Matches our 2" Standoffs.

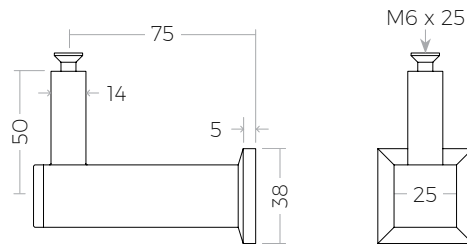


Off-the-Glass Swivel

PART #	H (Height)	Finish
SSZH40216S	30-70	S

Matches our 2" Standoffs.

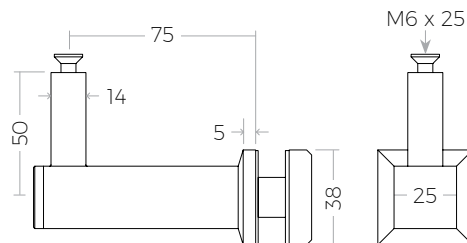
SQ5 SERIES - Heavy Duty



Installed with M8 Hanger Bolt
(Not included).

Off-the-Wall Fixed

PART #	Finish
SSZH0073116S	S



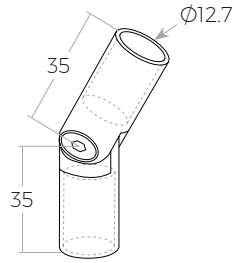
Off-the-Glass Fixed

PART #	Finish
SSZH0073216S	S

Rod Railing Components



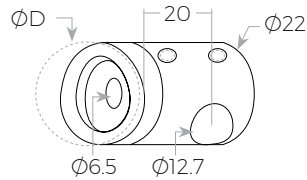
PHOTO: Accurate Stairs & Railings



Adjustable Rod Connector

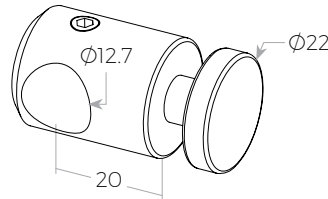
PART #

SSHDADJUST



Round Rod Holder

PART #	ϕD Tube Diameter	Rod Diameter
SSHD0010404S	Flat	12.7
SSHD0060404S	38.1	12.7
SSHD0030404S	42.4	12.7



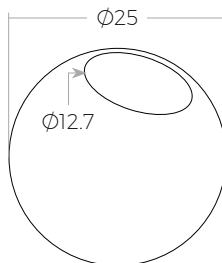
Round Rod Holder for Glass

PART #

Glass Size

SSHDGLASS

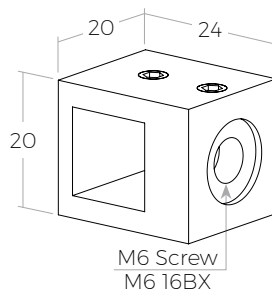
6-12



Solid Ball Cap Ends for Round Rods

PART #

SSHDEND12



Square Rod Holder

PART #

Rod Size

SSHDSQR04S

12.7

Horizontal Tubing



PHOTO: ProRail Systems Ltd.

Available in
8ft & 19ft
lengths.

Round Tube



PART #	OD	Length
SST583048	5/8"	96"

Square Tube



PART #	OD	Length
SSTSQ123048	1/2" x 1/2"	96"



Our Tubular Horizontal Series are available in Round and Square in 96" lengths. These Tubes can be cut to your desired length and are available in Stainless Steel.

To see our full line of Balusters, please pick up a copy of our STYLES catalogue or scan the code to view online.



CABLE·RAIL[®]

by feeney[®]



- Attractive, affordable, and very low-maintenance.
- Invisible appearance will not impair views.
- Made from strong and weather-tough type 316 Stainless Steel Cable.
- Can be used on new or existing Metal or Wood Railing frames.
- Simple, fast, do-it-yourself installation using prefabricated assemblies.
- Special easy-to-use Fittings are hidden in the End Posts.
- Made from over 70% recycled materials.
- Versatile uses: Railings, Trellises, Fences, Interior, Exterior, Residential, Commercial.

CABLE ASSEMBLY CARE & MAINTENANCE

The protective chromium oxide film on the surface of Stainless Steel gives it superior corrosion resistance. Properly maintained Stainless Steel provides excellent luster, strength, and durability. In most applications, Stainless Steel will not rust or stain even after many years of service, but it is NOT rust or stain proof. When Stainless comes in contact with chloride salts, sulfides, or other rusting metals, it can discolour or even rust and corrode. However, with proper care and maintenance, Stainless Steel can remain beautiful and functional for years.

- Clean Stainless with soap and warm water. Never clean with mineral acids or bleaches.
- Never use coarse abrasives like sandpaper or Steel wool on Stainless. Use synthetic Scotch pads instead.
- Never leave Stainless in contact with iron, Steel, or other metals. This can cause rust spots or corrosion.
- Always remove stains or rust spots as soon as possible with either soap and water or a Brass, Silver, Stainless, or chrome cleaner.
- It is important to periodically inspect Cable assemblies for proper tension and re-tension as needed.

10 year warranty

Feeney Inc. warrants that all CableRail® Stainless Steel Cable and Connectors shall be free from defects in material and workmanship under normal use, conditions, installation, and maintenance in accordance with product specifications for ten years from date of purchase. The complete text of this warranty is available upon request.



DETERMINE WHAT YOU'LL NEED BEFORE YOU START

Carefully Review:

Read all of the product descriptions, installation instructions, and frame recommendation pages in this catalogue. Contact us should you have any inquiries.

Section Frames:

Divide your Railing frame into sections by determining which corner and end Posts will be the Cable termination Posts. Remember that straight runs should not exceed 50' and runs with bends (2 corner bends at most) should not exceed 40'.

Determine Lengths:

Measure the outside lengths of each of your sections from step 2 and select the Cable assembly lengths that will fit each section. Be sure that the assemblies are at least 1' longer than the length of the section.

Calculate Quantities:

The number of assemblies depends on your Railing design. Remember that each horizontal Cable is a separate assembly and that the Cables should not be spaced further than 3" apart. Calculate the quantities needed for each of your assembly lengths.

Check Accessories & Tools:

Count up all the end Caps, protector sleeves, beveled washers, cutters, lacing needles, drills, saws, and abrasive discs you may need (see Tools Checklist on the Installation Instruction pages).

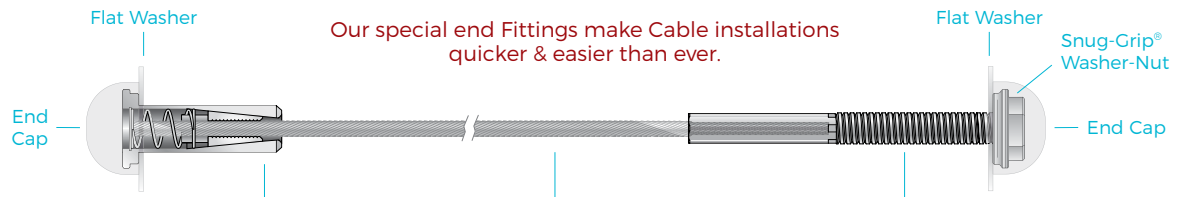
Fill Your Order:

Visit our office locations to take a look at our CableRail® display and order in person or online via our Website:

euroac.com

Easy to Install

PREFABRICATED CABLE ASSEMBLIES are an attractive, budget-friendly, and low-maintenance alternative to commonly-used Metal and Wood Picket infill. Assemblies use 1/8" diameter high-strength, weather-tough type 316 Stainless Steel Cable and come in a wide range of standard lengths that can be quickly trimmed to size in the field. Each assembly includes special, easy-to-use Threaded Terminal and Quick-Connect®SS End Fittings that remain concealed in your End Posts. The result: an extremely durable, virtually invisible Railing infill that leaves the view open and unimpaired.



Our special end Fittings make Cable installations quicker & easier than ever.

The Stainless Quick-Connect®SS Fitting is attached to the Cable in the field without special tools. One-way jaws allow the Cable to easily slide through the Fitting in one direction but automatically grab and lock-on when the Cable is released. Just slip it on, pull the Cable tight, cut off the excess, and finish with an End Cap. Size: 3/8" OD x 1 1/4" length.

The Cable is 1/8" diameter, 1x19 construction, type 316 Stainless Steel for strength, durability, and weather protection. Cables come in standard assembly lengths from 5'-70'. Snug-Grip® Washer-Nut and Flat Washers are all included. Coloured and Stainless End Caps are also available to cover, protect, and finish both ends (Caps sold separately).

The Stainless Threaded Terminal Fitting is fastened (swaged) to one end of the Cable at the factory. Attach it to an End Post using a special Snug-Grip® Washer-Nut and spin the Nut to adjust final tension in the line. Finish with an End Cap. Size: 1/4" OD x 4 1/4" length or 1/4" OD x 7 1/2" length.

Cable Assemblies

Everything you need for your basic Cable project is listed in this section. Choose your assembly lengths, a preferred style of End Cap, accessory items, and you're good to go. Each assembly includes the selected length of 1/8" diameter type 316 Stainless Steel Cable with a Threaded Terminal Fitting pre-attached to one end, one Stainless Steel Quick-Connect®SS Fitting, two Flat Washers, and one Stainless Steel Snug-Grip® Washer-Nut. (3/16" and 1/4" Cable and Fittings available upon request).

Assembly Lengths	Metal* Assembly #	Wood** Assembly #	*Includes 4 1/4" Threaded Terminals and Nylon Washers. **Includes 7 1/2" Threaded Terminals and Stainless Steel Washers.
5'	SSCBKIT4145	SSCBKIT7125	
10'	SSCBKIT41410	SSCBKIT71210	
15'	SSCBKIT41415	SSCBKIT71215	
20'	SSCBKIT41420	SSCBKIT71220	
25'	SSCBKIT41425	SSCBKIT71225	
30'	SSCBKIT41430	SSCBKIT71230	
40'	SSCBKIT41440	SSCBKIT71240	
50'	SSCBKIT41450	SSCBKIT71250	
70'	SSCBKIT41470		

End Caps (Sold Separately)

Select a preferred End Cap style to cover, protect, and finish each end.



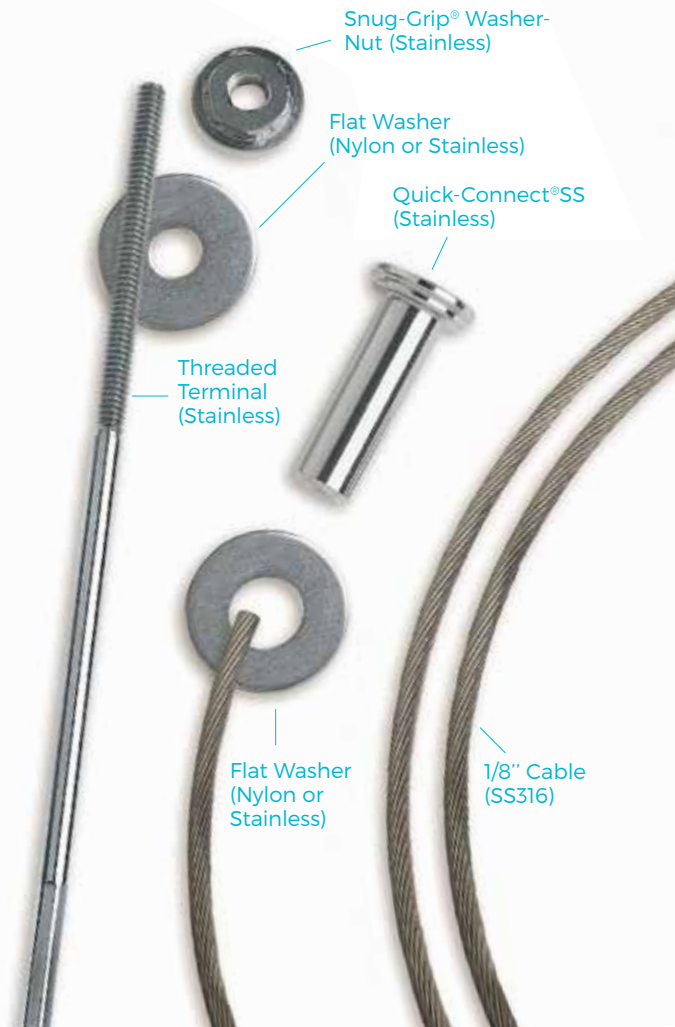
Coloured Polyethylene (Sold 10 per package)

SSCBECBL Black 3/4" OD x 3/8" H



Stainless (Sold 4 per package)

SSCBECSSDO Dome 3/4" OD x 3/8" H
SSCBECSSCH Chamfer 3/4" OD x 3/8" H



Cable Accessories

All accessories complement our 1/8" diameter Cable Assembly Kits.



Metal Post Nylon Protector Sleeves (Sold individually)

For protecting corner and Stairway transition Posts from Cable abrasion. For Landing only.

- 1 **SSCBIB14516** 1/8" (Threaded Terminal ends).
- 2 **SSCBIB31614** 1/8" (Intermediate Posts).
- 3 **SSCBIB381532** 1/8" (Quick-Connect®SS ends).



Wood Post Stainless Steel Protector Sleeves (Sold 10 per package)

For protecting corner and Stairway transition Posts from Cable abrasion. For Landing only.

- SSCBSL1478** 1/4" OD x 7/8" long (Fits 1/4" diameter drill holes).



Stainless Beveled Washers (Sold 4 per package)

For providing a flat bearing surface when attaching Fittings at 32° angled Stair terminations.

- SSCBBW3834** 3/4" OD x 3/8" ID (Quick-Connect®SS ends).
- SSCBBW93234** 3/4" OD x 9/32" ID (Threaded Terminal ends).



Rubber Grommets (Sold individually)

Rubber Grommet for Intermediate Posts.

- SSCBRG18**



Cable Cutters (Sold 1 per package)

For shearing excess Cable.

- SSCBWCUT18** 8" long, coated handles, hardened jaws.



Tension Gauge (Sold 1 per package)

Easy-to-use tool for checking Cable tension.

- SSCBTG** Designed for 1/8" CableRail® Cable.



Tensioning Tool (Sold 1 per package)

Designed for 1/8" CableRail Cable.

- SSCBTT**



Cable Lacing Needle (Sold 1 per package)

For quickly lacing Cable Ends through Posts without snagging.

- SSCBNE18** 4 1/2" long, reusable.



Quick-Connect® Release Tool (Sold 1 per package)

For temporarily releasing the jaws of the Quick-Connect®SS Fitting to remove or adjust the position.

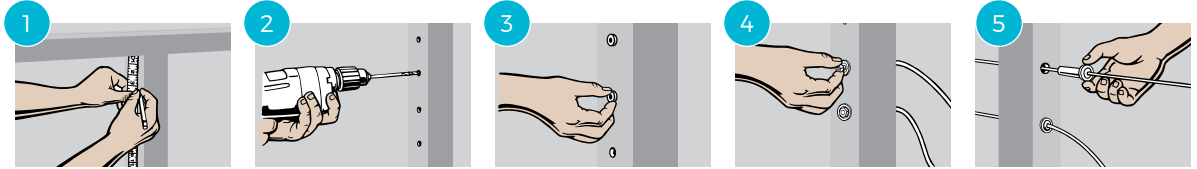
- SSCBRT18** 1/2" OD x 1 1/8" long, reusable.

STEP-BY-STEP INSTALLATION FOR METAL FRAMES

Installing the Standard 1/8" Cable System is easy. Just follow these simple steps:

TOOLS CHECKLIST

- Safety Glasses
- Work Gloves
- Pencil
- Measuring Tape
- Electric Drill
- Drill Bits
- Hammer
- Cable Cutters
- Vise-Grip Pliers
- 7/16" Wrench
- Electric Grinder with Grinding Disc & Cut-Off Disc
- Hacksaw or Electric Reciprocating Saw
- Cable Lacing Needle
- Feeney Tension Gauge



Mark drill hole locations on Posts.

To minimize Cable deflection, space Cables no more than 3" apart and have a Post or Vertical Spacer at least every 3 feet. Also, straight runs of Cable (no turns/dips) should not exceed 70 feet. Runs with corners (2 bends at most) should not exceed 40 feet. See Metal Frame Requirements on opposite page.

Drill holes in Posts. Hole diameter depends on Cable size and type of Fitting. See below.

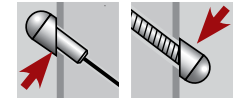
Cable Size	Threaded Term. Post	Intermediate Posts	Quick-Connect Post
1/8"	5/16"	1/4"	3/8"

If desired, Quick-Connect®SS Posts may be through-drilled at 1/4" and then counterbored with the recommended Quick-Connect®SS drill to countersink the Fitting.

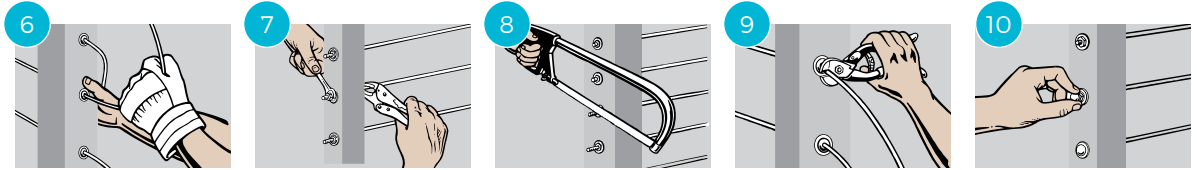
If using Isolation Bushings or Grommets (optional), insert them into their corresponding Post holes.

Insert the Threaded Terminal through the Terminal End Post and attach a Flat Washer and Snug-Grip® Washer-Nut. Spin the Nut 2 full turns. Strong resistance will be felt as the Snug-Grip® threads engage, so hold the Terminal shaft with pliers.

Lace the free end of the Cable through the Intermediate Posts and Quick-Connect®SS End Post. Slide on a Flat Washer and Quick-Connect®SS Fitting until they rest against the face of the Post. Use a Lacing Needle if snagging becomes a problem.



Use Beveled Washers for Stair termination Posts with angled holes. Available for Threaded Terminal and Quick-Connect®SS Fittings. Always install the Quick-Connect®SS Fittings in the top Stair Post to prevent rain water from running down the Cable into the Fittings.



Hold the Quick-Connect®SS Fitting with one hand and pull the Cable tight with the other. The Fitting automatically locks when you release the Cable.

Tension the Cables by holding the Threaded Terminal shaft with Vise-Grip Pliers and spinning the Snug-Grip® Washer-Nuts with a Wrench. A Feeney Tension Gauge may be used to check uniform tension.

See tensioning sequence diagram at bottom left.

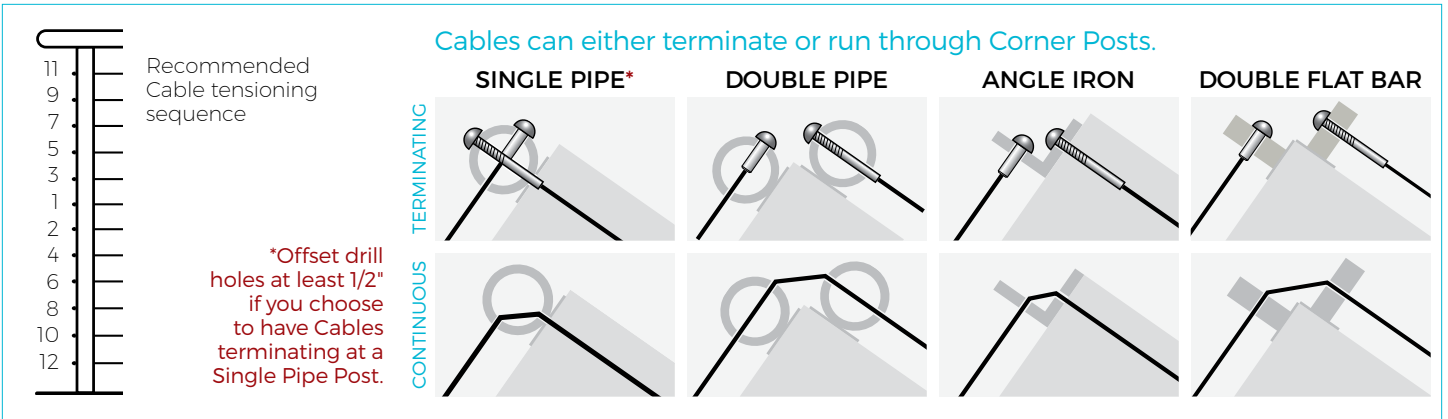
Use Hacksaw, Reciprocating Saw, or Electric Grinder with Cut-Off Disc to saw off the excess threads as close to the Snug-Grip® Washer-Nut as possible. Touch up with Electric Grinder. The special Snug-Grip® threads prevent the Nut from loosening.

Use Cable Cutters or Electric Grinder with Cut-off Disc to trim the excess Cable. Grind flush the exposed Cable ends with an Electric Grinder.

Snap on End Caps over the exposed Quick-Connect®SS Fittings and the Snug-Grip® Washer-Nuts. You're done.

SSCLEANER can be applied for lasting protection of Stainless Steel Cable and parts.

IMPORTANT NOTE: If using electric or pneumatic tools to tighten the Washer-Nuts, spin the nuts very slowly; otherwise, they will heat up, causing the threads to seize.



Metal Frame Requirements

Frames need to Support the tension of properly installed Cables.

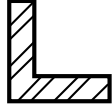
They need to be designed and built strong enough for the end and Corner Posts to Support a load in excess of 300 lbs. for each Cable. Here are some basic guidelines to help you prepare your Railing frames for Cable infill.

Minimum sizes for all Corner and End Posts.

All other Posts should be sized as required for Cap Rail Support strength or for code.



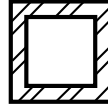
FLAT BAR
2" Wide, 1" Thick



ANGLE IRON
2" Wide, 1/2" Thick



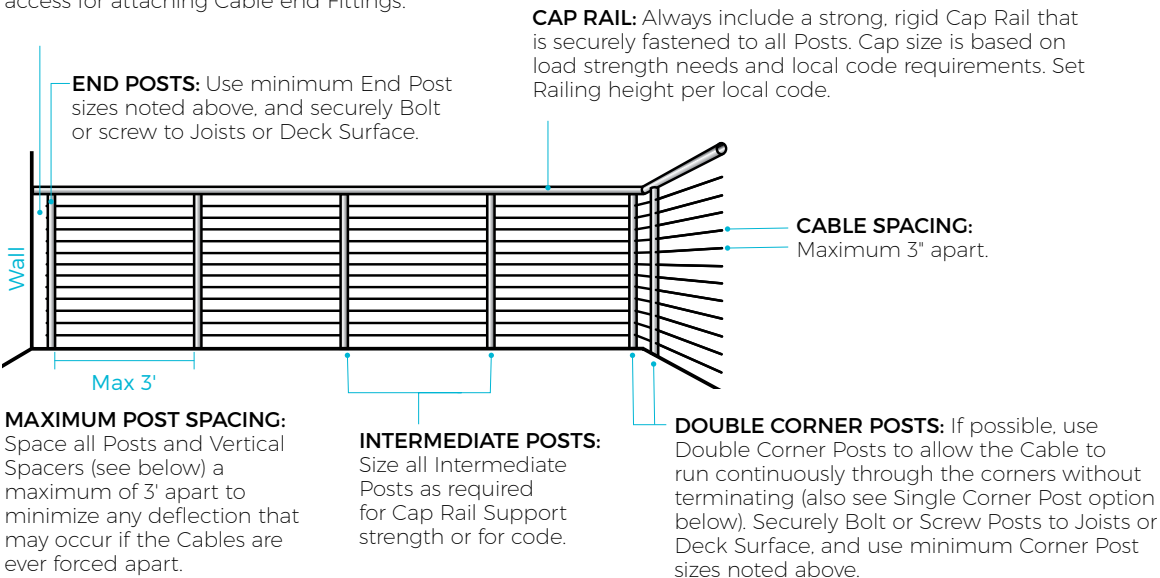
EXTRA STRONG PIPE
1 1/2" ID, 1 7/8" OD



SQUARE TUBE
2" Wide, 1/4" Thick

The Basic Frame Design

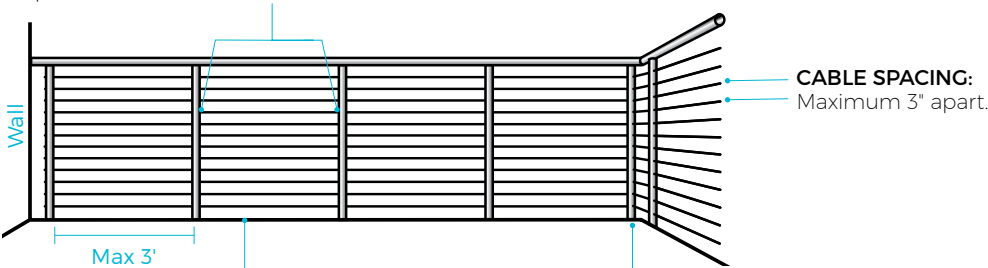
SPACING FROM WALLS: Set End Posts 3-4" away from the house/Wall face to allow access for attaching Cable end Fittings.



And Some Other Options

Vertical Spacers (Optional):

Slender Spacers may be used instead of some of the larger Intermediate Posts to achieve a more open Railing design. These are non-structural members and are only intended to maintain Cable spacing and minimize deflection. Examples are 1" Metal Tubing or 1/4" Flat Bar. Attach Spacers to the Cap Rail and either the Foot Rail, Deck Surface, or Joists.



FOOT RAILS (Optional):

Foot Rails should be spaced no more than 4" above the deck surface, or as required by local code, and should be sized as needed for Support strength and design appearance.

SINGLE CORNER POST (Optional):

In most cases with Single Corner Posts, Cables must be terminated. Exceptions are Angle Iron Posts or Tubular Metal Posts. When terminating on a Single Corner Post, be sure to offset the drill holes at least 1/2" to allow internal clearance for the Cable Fittings. Use minimum End Post sizes noted above and securely Bolt or Screw to Joists or Deck Surface.

IMPORTANT

For Railings, we recommend spacing the Cables no more than 3" apart and placing Posts or vertical members no more than 3' apart.

Please note that since building codes vary by province and city, our recommendations may not comply with code requirements in all areas.

Always consult with your local building department before starting your project.

CONSTRUCTION CHECKLIST

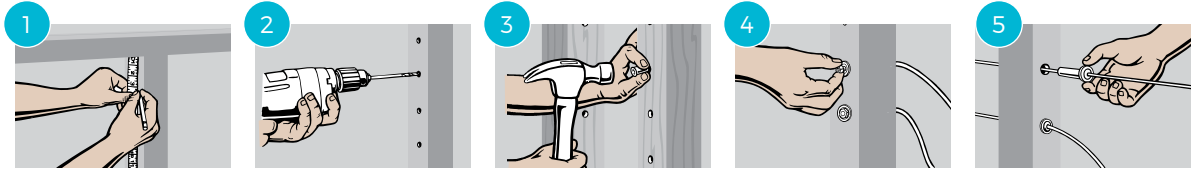
- Space Cables maximum 3" apart.
- Space Posts/verticals maximum 3' apart.
- Observe minimum end/corner Post sizes shown above.
- Securely fasten all Posts and Cap Rails.
- Carefully plan all termination and corner Posts for proper clearance, positioning, and maximum Cable run lengths.
- Straight runs of Cable (no turns/dips) should not exceed 70'; runs with corner bends (2 bends at most) should not exceed 40'.

STEP-BY-STEP INSTALLATION FOR WOOD FRAMES

Installing the Standard 1/8" Cable System is easy. Just follow these simple steps:

TOOLS CHECKLIST

- Safety Glasses
- Work Gloves
- Pencil
- Measuring Tape
- Electric Drill
- 1/4", 5/16" & 3/8" Drill Bits
- Hammer
- Cable Cutters or Cut-Off Disc
- Vise-Grip Pliers
- 7/16" Wrench
- Electric Grinder & Disc
- Hacksaw
- Cable Lacing Needle
- Feeney Tension Gauge



Mark drill hole locations on Posts.

To minimize Cable deflection, space Cables no more than 3" apart and have a Post or Vertical Spacer at least every 3 feet. See Wood Frame Requirements on opposite page.

Drill 5/16" holes in one End Post for the Threaded Terminal Fitting, 3/8" holes in the other End Post for the Quick-Connect® Fitting, and 1/4" holes in all other Posts.

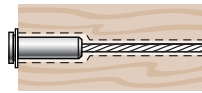
If desired, the Quick-Connect® Posts may be through-drilled with a 1/4" bit and then countersunk to 1 1/2" deep with a 3/8" bit to countersink the Fitting.

Insert Protector Sleeves at necessary locations. Tap in until flush.

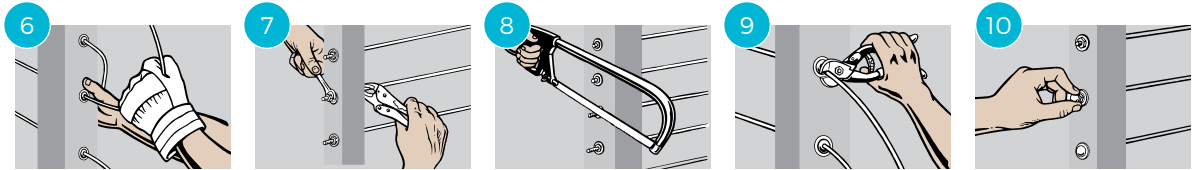
See Special Parts section below.

Insert the Threaded Terminal through the Terminal End Post and attach a Flat Washer and Snug-Grip® Washer-Nut. Spin the Nut 2 full turns. Strong resistance will be felt as the Snug-Grip® threads engage, so hold the Terminal shaft with pliers.

Lace the free end of the Cable through the Intermediate Posts and Quick-Connect® End Post. Slide on a Flat Washer and Quick-Connect® Fitting until they rest against the face of the Post. Use a Lacing Needle if snagging becomes a problem.



Use Beveled Washers for Stair termination Posts with angled holes. Available for Threaded Terminal and Quick-Connect® SS Fittings. Always install the Quick-Connect® SS Fittings in the top Stair Post to prevent rain water from running down the Cable into the Fittings.



Hold the Quick-Connect®SS Fitting with one hand and pull the Cable tight with the other. The Fitting automatically locks when you release the Cable.

Tension the Cables by holding the Threaded Terminal shaft with Vise-Grip Pliers and spinning the Snug-Grip® Washer-Nuts with a Wrench. A Feeney Tension Gauge may be used to check uniform tension.

See tensioning sequence diagram at bottom left.

Use Hacksaw, Reciprocating Saw, or Electric Grinder with Cut-off Disc to saw off the excess threads as close to the Snug-Grip® Washer-Nut as possible. Touch up with Electric Grinder. The special Snug-Grip® threads prevent the Nut from loosening.

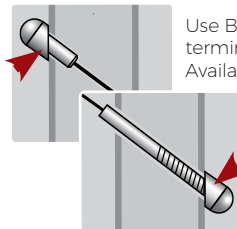
Use Cable cutters or Electric Grinder with Cut-off Disc to trim the excess Cable. Grind flush the exposed Cable ends with an Electric Grinder.

Snap on End Caps over the exposed Quick-Connect®SS Fittings and the Snug-Grip® Washer-Nuts. You're done.

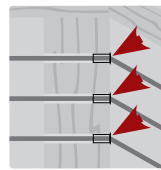
SSCLEANER can be applied for lasting protection of Stainless Steel Cable and parts.

Special parts for special situations

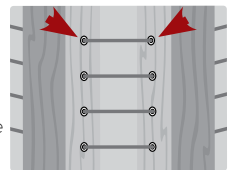
Recommended Cable tensioning sequence.



Use Beveled Washers for Stair termination Posts with angled holes. Available for both Threaded Terminal & Quick-Connect® Fittings. Always install the Quick-Connect® Fitting in top Stair Post to prevent rain water from running down the Cable into the Fitting.



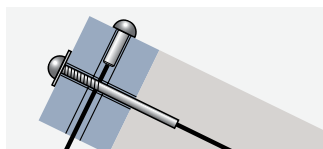
Protector Sleeves prevent abrasion at angled transitions on Wood Posts (e.g., Stair transition Posts or outside faces of Double Corner Posts). Fits 1/4" diameter drill holes.



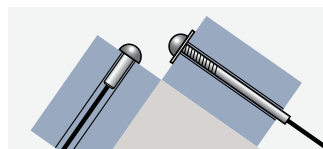
Cables can either terminate or run through Corner Posts.

TERMINATING

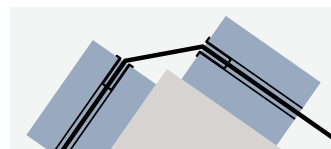
CONTINUOUS



SINGLE WOOD POST
Offset drill holes at least 1/2".



DOUBLE WOOD POST



DOUBLE WOOD POST

Wood Frame Requirements

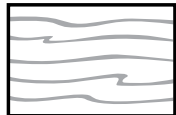
Frames need to Support the tension of properly installed Cables.

They need to be designed and built strong enough for the End and Corner Posts to Support a load in excess of 300 lbs. for each Cable. Here are some basic guidelines to help you prepare your Railing frames for Cable infill.

Minimum Post Sizes

END AND CORNER POSTS: The End and Corner Posts are the Cable termination/transition Posts and Support the full load of the Taut Cables; therefore, the minimum recommended size for these critical Posts is standard 4 x 6 Wood.

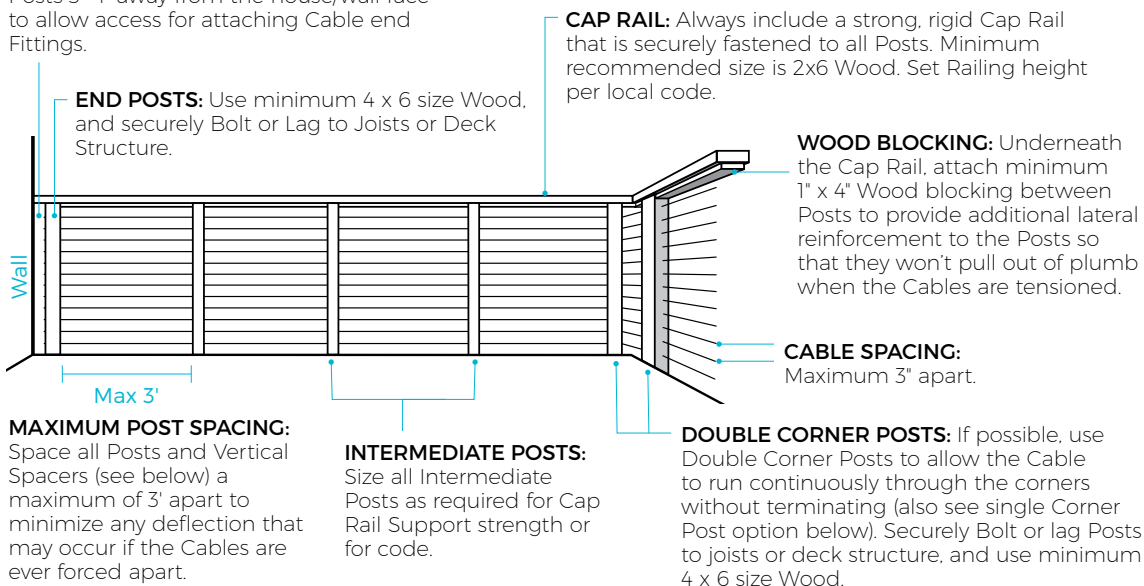
INTERMEDIATE POSTS: The remaining Intermediate Posts do not Support any tension load since the Cables pass straight through, so they can be sized as required for Cap Rail Support or for code.



4 x 6 WOOD
3 1/2" Wide, 5 1/2" Thick

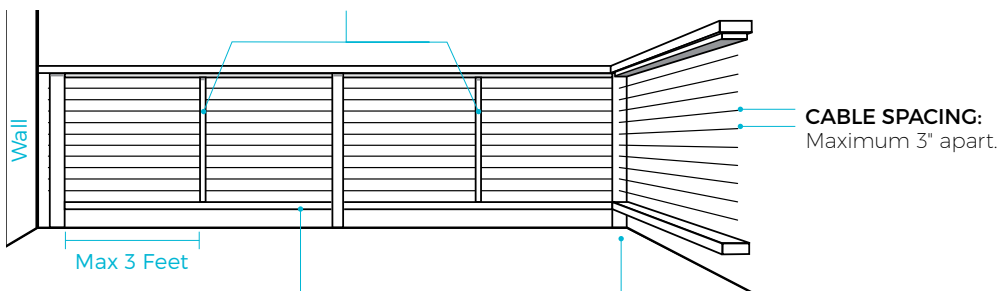
The Basic Frame Design

SPACING FROM WALLS: Always set End Posts 3"-4" away from the house/wall face to allow access for attaching Cable end Fittings.



And Some Other Options

VERTICAL SPACERS (Optional): Slender Spacers may be used instead of some of the larger Intermediate Posts to achieve a more open Railing design. These are non-structural members and are only intended to maintain Cable spacing and minimize deflection. Typical examples are 2" x 2" Wood Strips, Copper Tubing. Attach them to the Cap Rail and either the Foot Rail, Deck Surface, or Joists.



FOOT RAILS (Optional): Recommend minimum 2 x 4 size Wood spaced no more than 4" (or as per code) above the deck surface.

SINGLE CORNER POST (Optional): Cables must be terminated at the corners if Single Posts are used. Use minimum 4 x 6 size Wood and securely Bolt or lag to joists or deck structure. Be sure to offset the Cable drill holes by at least 1/2" to allow internal clearance for the Cable Fittings.

IMPORTANT

For Railings, we recommend spacing the Cables no more than 3' apart and placing Posts or vertical members no more than 3' apart.

Please note that since building codes vary by province and city, our recommendations may not comply with code requirements in all areas.

Always consult with your local building department before starting your project.

CONSTRUCTION CHECKLIST

- Space Cables maximum 3' apart.
- Space Posts/verticals maximum 3' apart.
- Use minimum 4 x 6 size Wood for all end and corner Posts
- Securely fasten all Posts and Cap Rails.
- Carefully plan all termination and corner Posts for proper clearance, positioning, and maximum Cable run lengths.
- Straight runs of Cable (no turns/dips) should not exceed 70'; runs with corner bends (2 bends at most) should not exceed 40'.

Installation Videos

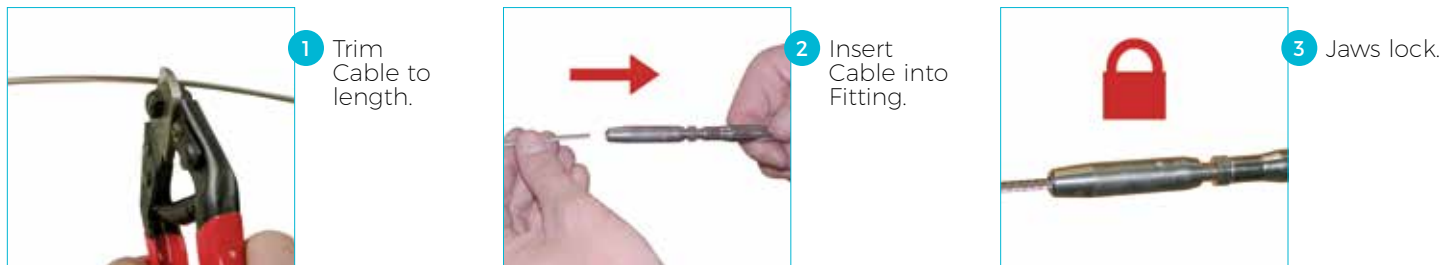


QUICK-CONNECT® CABLE HARDWARE

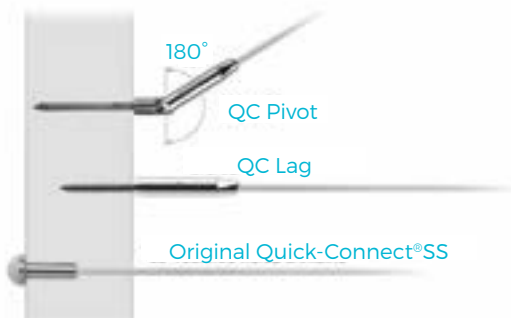


We've taken our automatic-locking-jaw design from our original Quick-Connect® Fitting and applied it to an entire line of Cable End Fittings. Now, you can select from a wide variety of sleek and versatile Cable End Fittings that offer the flexibility of assembling Cables in the field and the simplicity, speed, and gripping power of our Quick-Connect® Jaws: no more cumbersome crimp tools or time-consuming wedge-type compression Fittings. Simply trim your Cable to length, push the end into the Quick-Connect® Fitting, and the Spring-Loaded Jaws automatically engage. You're ready to go! Made from Marine Grade 316 Stainless Steel for weather-tough durability, low maintenance, and lasting beauty. Fittings also come with a silicone protection seal pre-inserted into the end, providing added protection against dirt and debris entering the body of the Fitting. If necessary, a reusable release tool is available to disengage and remove or re-adjust the Fitting (see **SSCBRT18** pg 136).

So Easy

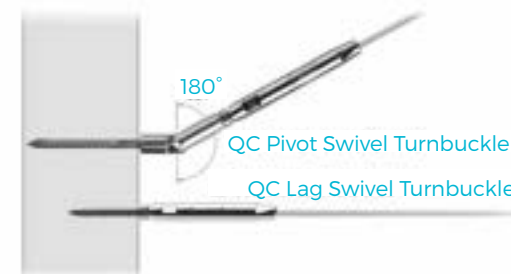


2 Types of Quick-Connect® Fittings



Fixed End Fittings

- Non-Adjustable end termination Fittings, sometimes referred to as "dead ends."
- Have no tensioning Capabilities.
- Each Fixed End Fitting must be paired with at least one Tension Adjustment Fitting.



Swivel Tension Adjustment Fittings

- Include Turnbuckles and Swivel Fittings that are used to tighten the Cable lines.
- Tension is adjusted by spinning the tubular body on the Turnbuckles and Swivel Fittings.
- Tension Adjustment Fittings can be paired with either a Fixed End Fitting or another Tension Adjustment Fitting.

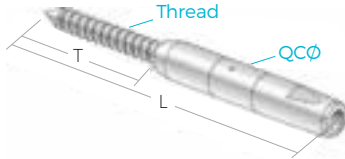


QUICK-CONNECT® FITTINGS • 316 Grade Stainless Steel

Fixed End Fittings

Quick-Connect® LAG

- Screws into the face of a Wood Post or Wall using a Hanger Bolt with lag thread (included).
- Typically paired with a Quick-Connect® Lag Swivel Turnbuckle.

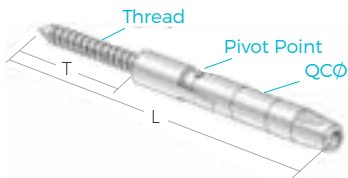


Part #	CableØ	Thread	T	L	QCØ	Pilot DrillØ
SSCBQCLAG	1/8"	1/4" lag	2"	4 1/4"	7/16"	*7/64"

*Drill pilot hole slightly larger if using hardwood Posts.

Quick-Connect® Pivot

- Screws into the face of a Wood Post or Wall using a Hanger Bolt with lag thread (included).
- 180° pivoting allows for angled Stair terminations.
- Typically paired with a Quick-Connect® Pivot Swivel Turnbuckle.



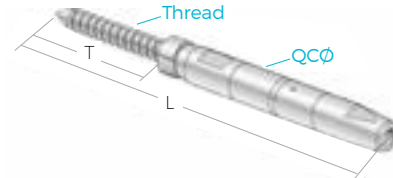
Part #	CableØ	Thread	T	L	QCØ	Pilot DrillØ
SSCBQCP18	1/8"	1/4" lag	2"	4 3/8"	7/16"	*7/64"

*Drill pilot hole slightly larger if using hardwood Posts.

Tension Adjustment Fittings

Quick-Connect® LAG Swivel Turnbuckle

- Screws into the face of a Wood Post or Wall using a Hanger Bolt with lag thread (included).
- Typically paired with a Quick-Connect® Lag or another Quick-Connect® Lag Swivel Turnbuckle.



Installation Video

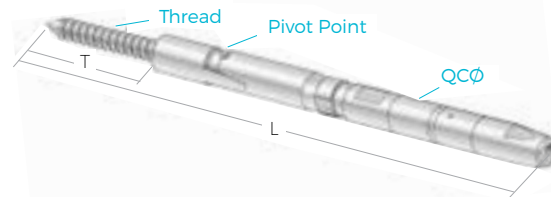


Part #	CableØ	Thread	T	L Closed (Open)	QCØ	Pilot DrillØ
SSCBQCLAG1	1/8"	1/4" lag	2"	5 1/4" (5 3/4")	7/16"	*7/64"

*Drill pilot hole slightly larger if using hardwood Posts.

Quick-Connect® Pivot Swivel Turnbuckle

- Screws into the face of a Wood Post or Wall using a Hanger Bolt with lag thread (included).
- 180° pivoting allows for angled Stair terminations.
- Typically paired with a Quick-Connect® Pivot or another Quick-Connect® Pivot Swivel Turnbuckle.



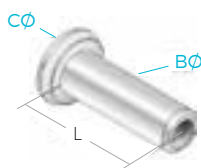
Installation Videos

Part #	CableØ	Thread	T	L Closed (Open)	QCØ	Pilot DrillØ
SSCBQCPST18	1/8"	1/4" lag	2"	7" (7 3/4")	7/16"	*7/64"

*Drill pilot hole slightly larger if using hardwood Posts.

The Original! Quick-Connect® SS

- Fits into a hole drilled in End Post, and the lip rests against the outside Post face.
- Design allows the Cable to pass entirely through the Fitting in one direction only; any excess Cable is trimmed.
- Use Beveled Washers **SSCBBW3834** or **SSCBBW93234** (pg 136) for angled Stair termination and Flat Washers for added bearing surface on Wood Posts.
- Exposed end is covered with Coloured End Caps **SSCBECBL** or Stainless End Caps **SSCBECSSDO**, **SSCBECSSCH** (pg 135).
- Can be paired with any Tension Adjustment Fitting.



Part #	CableØ	CØ	BØ	L	DrillØ
SSCBQC18	1/8"	5/8"	3/8"	1 1/8"	3/8"

CableRail® Coils (1x19 Construction)



Part #	CableØ	L	Grade
SSCB18100	1/8"	100'	SS316
SSCB18250	1/8"	250'	SS316

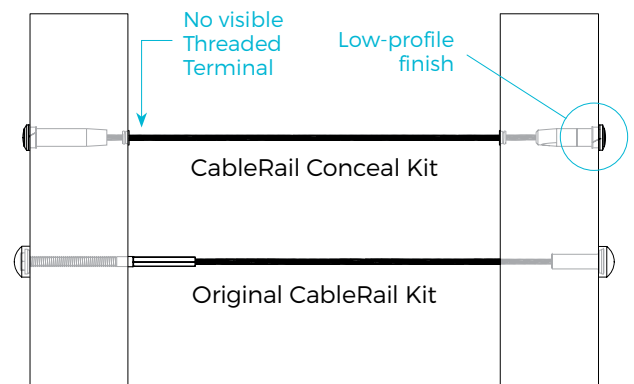
The swivel line of turnbuckles have a special swiveling body that's integrated with the Quick-Connect® Fitting, creating a shorter overall turnbuckle design with a sleek appearance and fewer exposed threads. Machined flats allow wrenches to securely grip and spin the body to adjust tension without marring the polished surface. Swivel turnbuckles are perfect for short to medium-length Cable runs.



CableRail® Conceal Kit

CABLERAIL® GETS EVEN SLEEKER!

Introducing the new CableRail® Conceal Kit. This easy to install Cable railing system provides an alternative solution to our Original CableRail® Kits for customers looking for the look and feel of a lower profile of the End Posts.

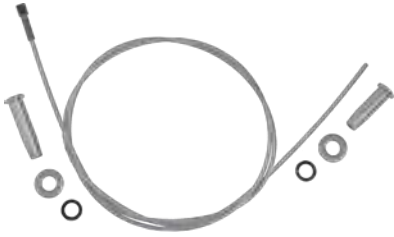


- A beautiful low profile alternative to our Original CableRail® kits.
- Creates a similar look on both ends of the assembly with no visible Threaded Terminal end.
- Uses a specially designed tension Fitting on one end and a QuickConnect® Fitting on other end for easy installation.
- Sold as assemblies in 5' increments from 5'-30'.
- Available for 1/8" diameter Cable only.



End Caps
in Black
and Silver

CableRail® Conceal Kit



PART #	Length
SSCBCONKIT5	5'
SSCBCONKIT10	10'
SSCBCONKIT15	15'
SSCBCONKIT20	20'
SSCBCONKIT25	25'
SSCBCONKIT30	30'

Tools & Accessories

Sold Separately



Conceal Tool Kit

SSCBCONCRKIT

- 1 T-handle Wrench.
- 2 9/16" Ratcheting Box Wrench.
- 3 Star Driver Tool (**SSCBCONSTAR**).
In Kit or sold separately.
Required for installation.



CableRail Conceal Cap Removal Tool

SSCBCONCRT

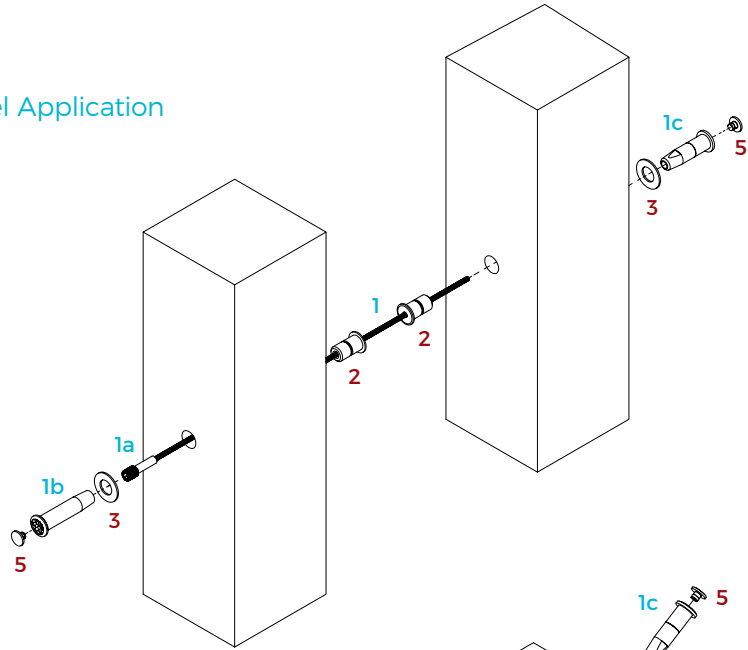


CableRail Conceal End Cap

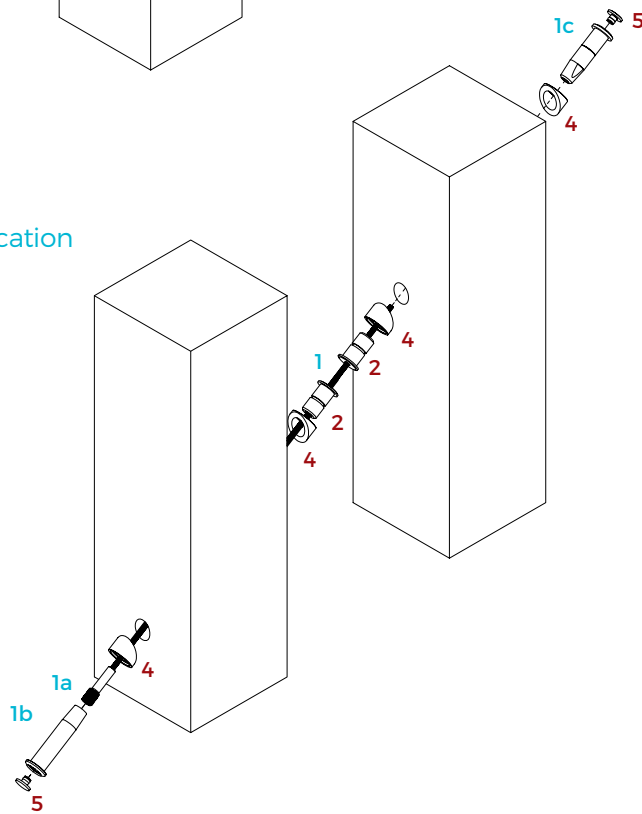
PART #	Finish
SSCBCONECBL	Black
SSCBCONECSS	Silver

CABLERAIL CONCEAL APPLICATION FOR WOOD

Level Application



Stair Application



1 CableRail Conceal Kit:

- 1a 1/8" diameter Cable with swaged CR Conceal Terminal.
- 1b CR Conceal Receiver.
- 1c CR Conceal Quick-Connect®.

Accessories (Sold Separately)

- 2 **SSCBCONBIW** Bushing for Wood.
- 3 **SSCBCONFWL** Flat Washer for Level application.
- 4 **SSCBCONBWS** Bevelled Washer for Stair application.
- 5 **SSCBCONECSS** CableRail® Conceal Cap.



DesignRail® Kits

by feeney®

MODULAR ALUMINUM RAILING KITS

Create beautiful Railings inside and out with DesignRail® Kits. Installation is fast and easy with our modular kits and CableRail® Stainless Steel infill.

Design Your Own Railing

These **SPECIAL ORDER** Rail and Post Kits feature 6000 series Aluminum and AAMA-2604 Powder Coated finishes for long lasting beauty and durability, and are available for 36" and 42" high Railings. Your Railing system will require specific quantities and types of kits and parts depending on the configuration of your project.



Design Your Own Railing

Rail Kits

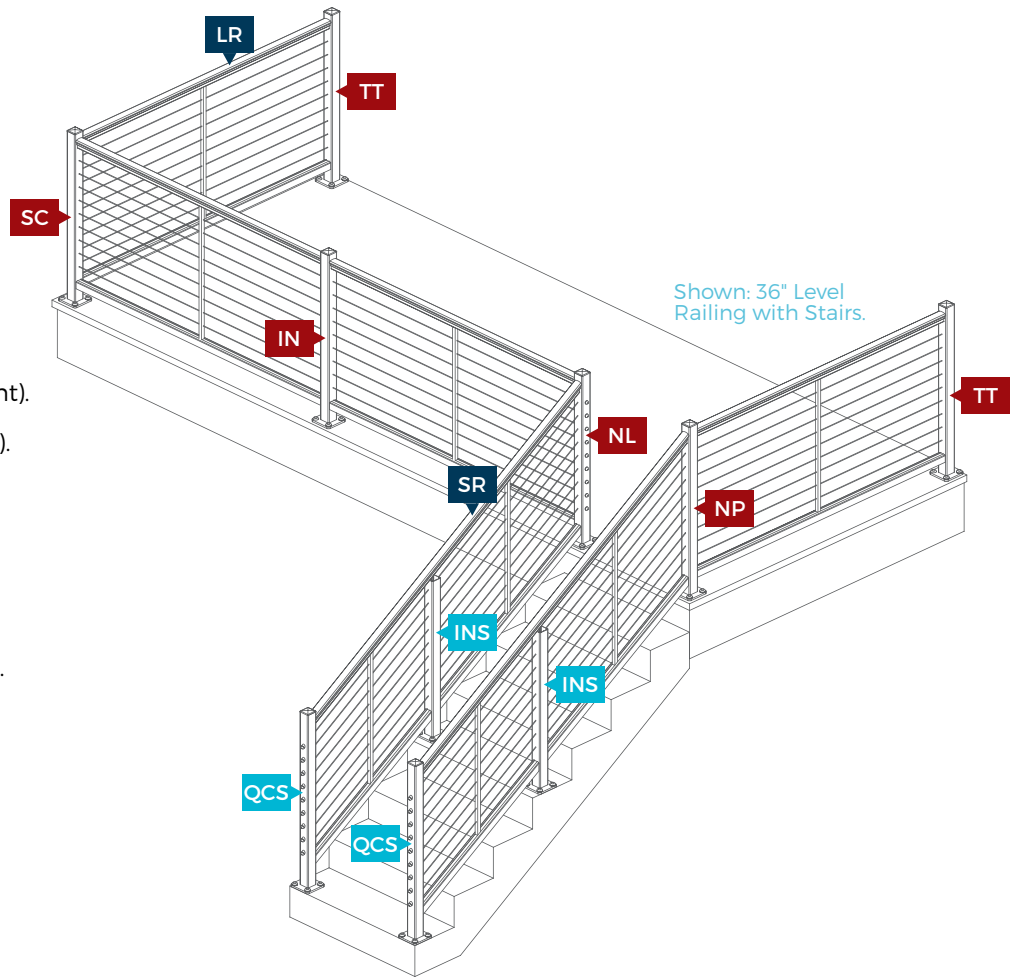
- LR** Level Rail Kit.
- SR** Stair Rail Kit.

Level Post Kits

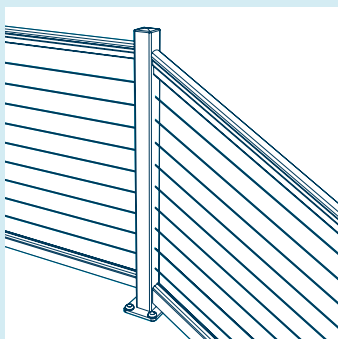
- IN** Intermediate Post Kit.
- TT** Threaded Terminal Post Kit.
- QC** Quick-Connect® Post Kit.
- SC** Single Corner Post Kit.
- NR** Newel Termination Post Kit (Right).
- NL** Newel Termination Post Kit (Left).
- NP** Newel Passthrough Post Kit.

Stair Post Kits

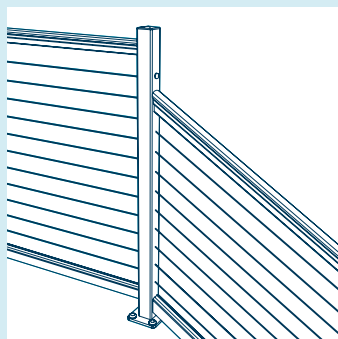
- INS** Intermediate Stair Post Kit.
- TTS** Threaded Terminal Stair Post Kit.
- QCS** Quick-Connect® Stair Post Kit.



Transitioning to Stairs with a Newel Passthrough Post.

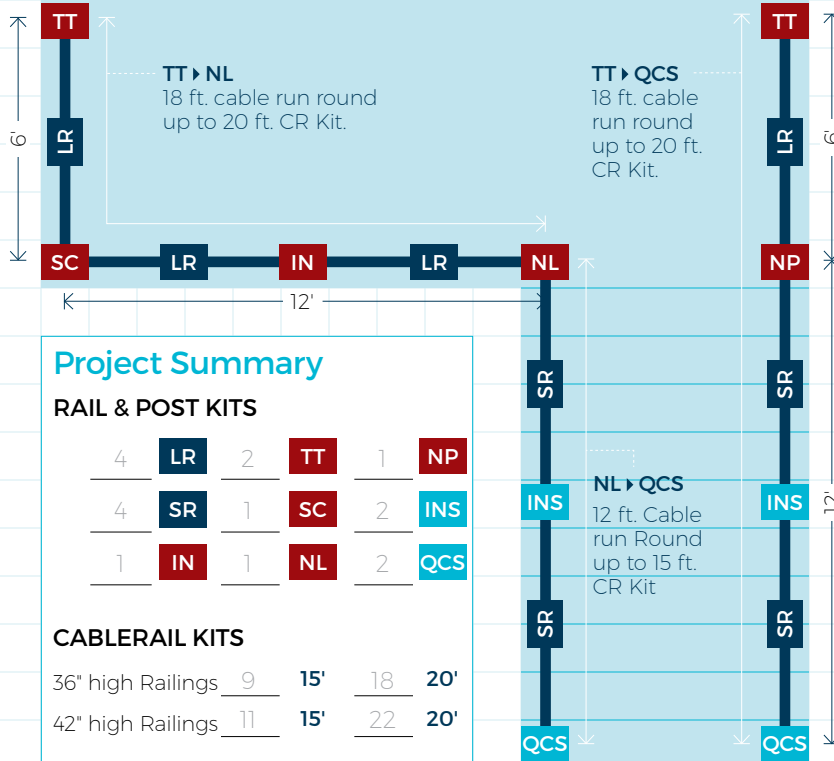


36" RAILINGS



42" RAILINGS

Terminate the top two Cable Runs because of the change in height.



Project Summary

RAIL & POST KITS

4	LR	2	TT	1	NP
4	SR	1	SC	2	INS
1	IN	1	NL	2	QCS

CABLERAIL KITS

36" high Railings	9	15'	18	20'
42" high Railings	11	15'	22	20'

Installation Tips

- Position Posts 3 to 3 3/4" away from a Wall for easier installation of Cables.
- Max. 6' between major Posts (Quick-Connect®, Threaded Terminal, Intermediate, and Newel Posts).
- Use an Intermediate Picket (included in the Rail Kit) at least every 3' to reduce Cable deflection.
- Use End Caps (sold separately) for a finished look.
- Use Beveled Washers (sold separately) on the Cable End Fittings to create a flat bearing surface on Stairs.
- Use Rail Cut Kits (sold separately) if you are dividing the Rail Kits to create multiple shorter length Rails.
- Use Isolation Bushings (sold separately) in each Post when installing in a harsh environment, such as near salt water.

Design Your Project

STEP 1: Sketch your layout.

STEP 2: Select your height 42" 36".

STEP 3: Select your Rail & Post Kits.

_____	LR	_____	NP
_____	SR	_____	NL
_____	IN	_____	NP
_____	TT	_____	INS
_____	QC	_____	TTS
_____	SC	_____	QCS

STEP 4: Select your CableRail Kits.

Use 9 CableRail Kits per run for 36" systems and 11 for 42" systems.

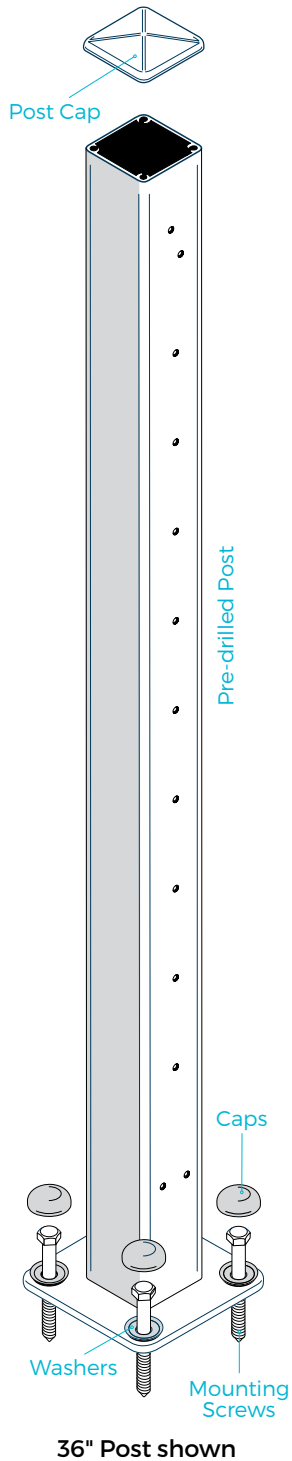
_____	5'	_____	25'
_____	10'	_____	30'
_____	15'	_____	40'
_____	20'	_____	50'

Post Kits

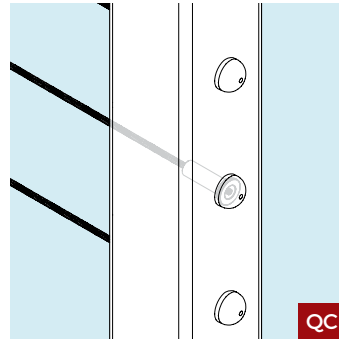
MB
Matte
Black

TB
Textured
Black

Each Post Kit includes a Post with a pre-attached Base Plate, a Post Cap, and Mounting Screws with Caps. All Posts come pre-drilled for the Cable Fittings or for Cables to pass through, and can accommodate Isolation Bushings when required. Stair Posts are pre-drilled at an angle to accommodate a Stair slope of between 29 and 34 degrees. Level Post Kits are available for Railings in two heights: 36" with 9 Cable holes, or 42" with 11 Cable holes. Stair Post Kits are available for 36" Stair Railings. Isolation Bushings are recommend for installations in harsher climates, such as areas near salt water.



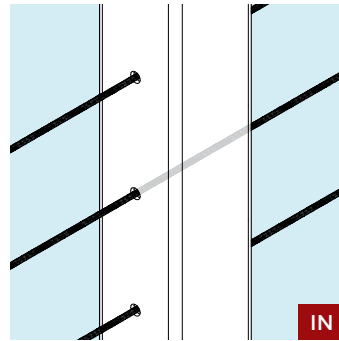
Level Posts



Quick-Connect® End Post Kit

Pre-drilled for CableRail® Quick-Connect® End Fittings.

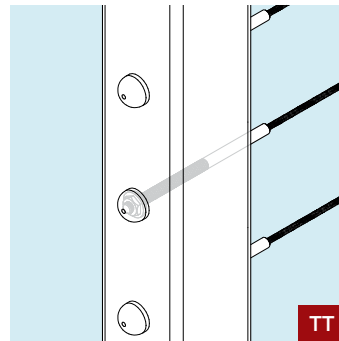
PART #	Height
SSDRKQC36	36"
SSDRKQC42	42"



Intermediate Post Kit

Pre-drilled for Cable to pass through.

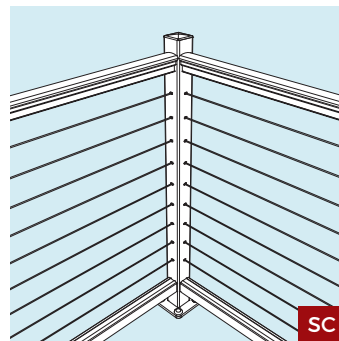
PART #	Height
SSDRKIN36	36"
SSDRKIN42	42"



Threaded Terminal End Post Kit

Pre-drilled for CableRail® Threaded Terminal End Fittings.

PART #	Height
SSDRKTT36	36"
SSDRKTT42	42"

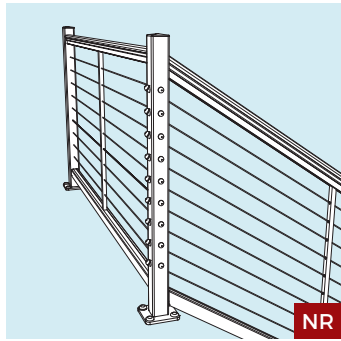


Single Corner Post Kit

Specially designed for use at corners. Pre-drilled for CableRail® to run continuously through the Post.

PART #	Height
SSDRKSC36	36"
SSDRKSC42	42"

Level to Stair Posts



Newel Termination Post Kit Right

Designed for Level to Stair Railing transitions that have a right 90 degree turn from the Stairs. Use Quick-Connect® Fitting in level holes and Threaded Terminal Fitting in angled holes.

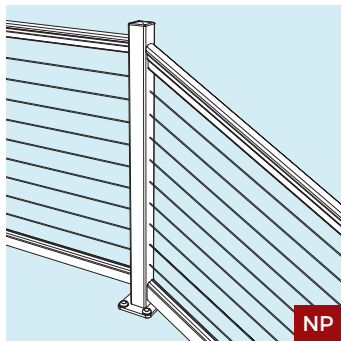
PART #	Height
SSDRKNR36	36"
SSDRKNR42	42"



Newel Termination Post Kit Left

Designed for level to Stair Railing transitions that have a left 90 degree turn turn from the Stairs. Use Quick-Connect® Fitting in level holes and Threaded Terminal Fitting in angled holes.

PART #	Height
SSDRKNL36	36"
SSDRKNL42	42"

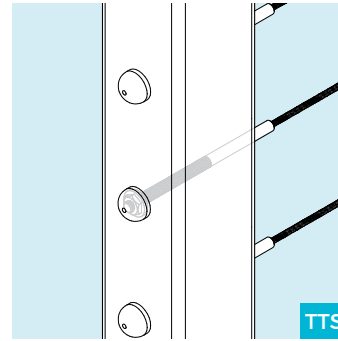


Newel Passthrough Post Kit

Designed for Level to Stair Railing transitions where Cables continue through.

PART #	Height
SSDRKNP36	36"
SSDRKNP42	42"

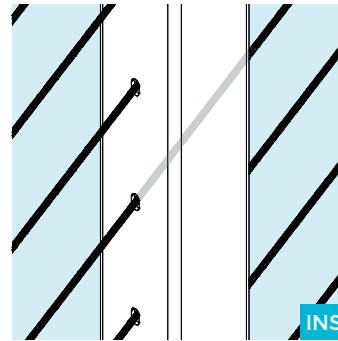
Stair Posts



Threaded Terminal Stair End Post Kit

Pre-drilled for CableRail® Threaded Terminal End Fittings.

PART #	Height
SSDRKTTS36	36"

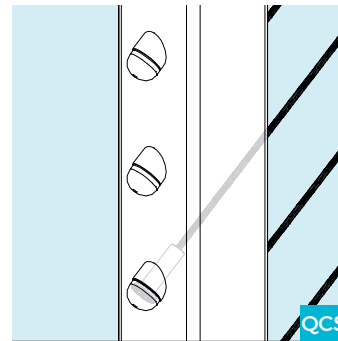


Intermediate Stair Post Kit

Pre-drilled for Cable to pass through. Includes a Post Adapter for connecting two Stair Rail Kits.



PART #	Height
SSDRKINS36	36"



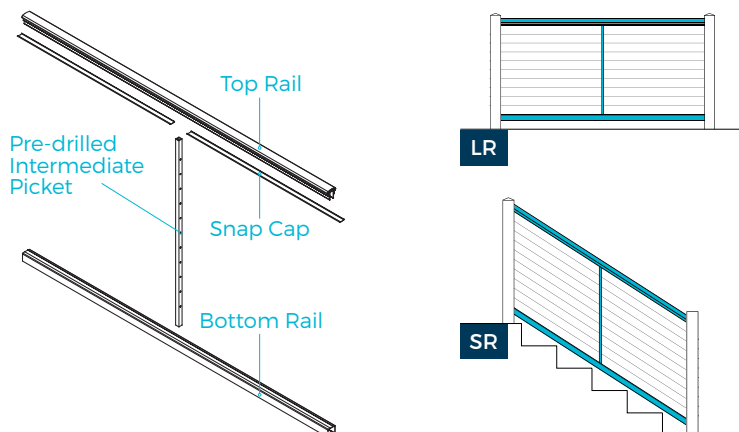
Quick-Connect® Stair End Post Kit

Pre-drilled for CableRail® Quick-Connect® End Fittings.

PART #	Height
SSDRKQCS36	36"

Rail Kits

Rail Kits contain the Rails that run between the Posts. Each kit includes a 6 ft. Top and Bottom Rail, a pre-drilled Intermediate Picket, and all necessary attachment hardware. Top and Bottom Rails can be trimmed to exact length and Stair slope in the field. Use Rail Cut Kits if cutting a single Rail Kit for use in multiple smaller sections. Rail Kits can be used with DesignRail® Post Kits or between your own Wood Posts.

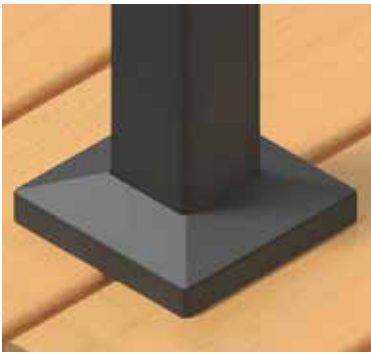


Level Rail Kit

PART #	Height	Attachment Hardware
SSDRKLR36	36"	
SSDRKLR42	42"	

Stair Rail Kit

PART #	Height	Attachment Hardware
SSDRKSR36	36"	



Base Plate Covers

These easy to install 2 piece Covers conceal the Lag Screw heads and Post Base Plates to give the Railing a beautiful finishing touch. Great for retrofitting existing DesignRail® installations too.

PART #	Finish
SSDRAPCB	Matte Black
SSDRAPCTB	Textured Black



Isolation Pad

High density Neoprene Pads that protect Posts and Base Plates from chemical corrosion that may be caused by contact with concrete or pressure treated Wood surfaces.

PART #	Finish
SSDRAIPAD	NA



Touch-Up Paint

Color matched to help cover small abrasions

PART #	Finish
SSDRAPAINTB	Matte Black



Rail Cut Kits

Use Rail Cut Kits when cutting a Single Rail Kit into multiple parts for smaller Railing sections, reducing costs and wasted material.

PART #	Finish
SSDRARCLVL	Matte Black
SSDRARCSTR	Matte Black



Isolation Bushings

Use Isolation Bushings in pre-drilled CableRail® holes when installing a Railing in areas with harsher environments.

PART #	Description	Usage
SSDRAIBINT	22/pk	For Intermediate Posts.
SSDRAIBTT	22/pk	For Threaded Terminal Posts.
SSDRAIBQC	22/pk	For Quick Connect Posts.
SSDRAIBTTS + SSDRAIBQC		For Newel Termination Posts (left and right).
SSDRAIBTTS	18/pk	For Threaded Terminal Stair Posts.
SSDRAIBQCS	18/pk	For Quick Connect Stair Posts.
SSDRAIBSCIS	22/pk	For Single Corner, Intermediate Stair, & Newel Passthrough Posts.



Balusters





GOLD

SATIN
BRONZE

GRAPHITE
BLACK

COLOURED STAINLESS STEEL COLLECTION

The latest in contemporary
Balusters and accessories.

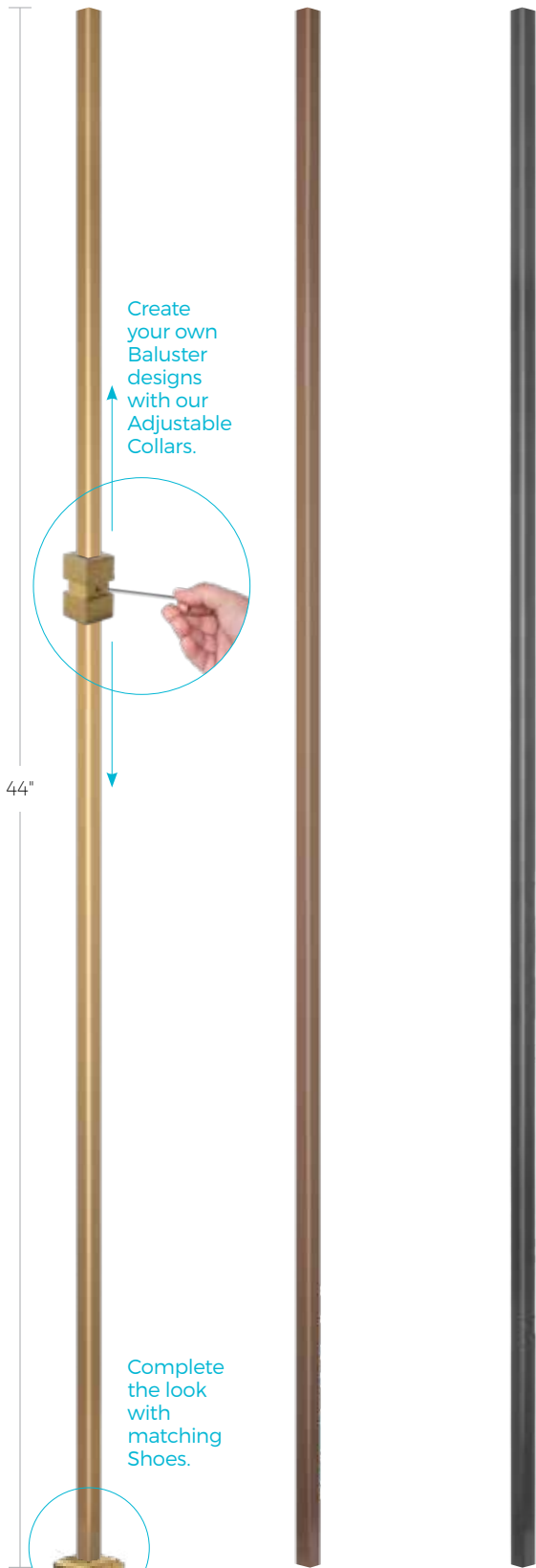
Add a splash of colour to your staircase
with our Stainless Steel coloured line.
Available in Square or Round.

To see our full line of Balusters, please pick
up a copy of our STYLES Catalogue or scan
the code below to view online.



Square 1/2" Coloured Stainless Steel Tube

Balusters

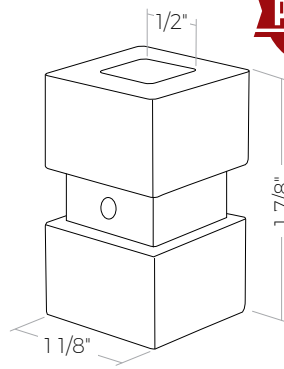


SSBSQ1244TC
Gold

SSBSQ1244TSB
Satin Bronze

SSBSQ1244TGB
Graphite Black

Collars



PSMC112SSSG
Gold



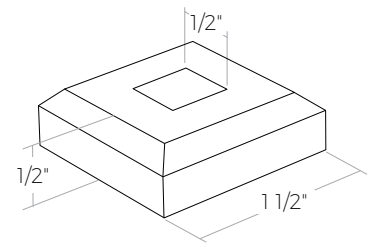
PSMC112SSSB
Satin Bronze



PSMC112SSGB
Graphite Black

*Industrial design patent registered. NO.187510.

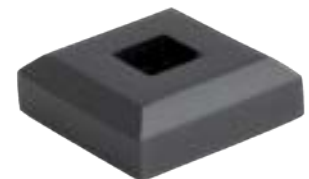
Shoes



SSSH1239G
Gold



SSSH1239SB
Satin Bronze



SSSH1239GB
Graphite Black

*Industrial design patent registered. NO.156698.

Round 5/8" Coloured Stainless Steel Tube

Balusters

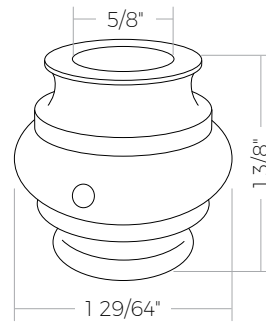


SSB5844TC
Gold

SSB5844TSB
Satin Bronze

SSB5844TGB
Graphite Black

Collars



683RSS58G
Gold

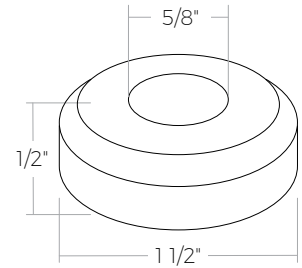


683RSS58SB
Satin Bronze



683RSS58GB
Graphite Black

Shoes



SSSHRD58G
Gold



SSSHRD58SB
Satin Bronze



SSSHRD58GB
Graphite Black

*Industrial design patent registered. NO.157438.

Coloured Stainless Steel Balusters

LumaRail™

LED HANDRAIL SYSTEM





ADD SAFETY AND BEAUTY INSIDE YOUR HOME.

LumaRail™ combines our Hardware Kit and Electrical Kit for 4877mm (16 ft.) of LED lighting for your choice of Handrail.

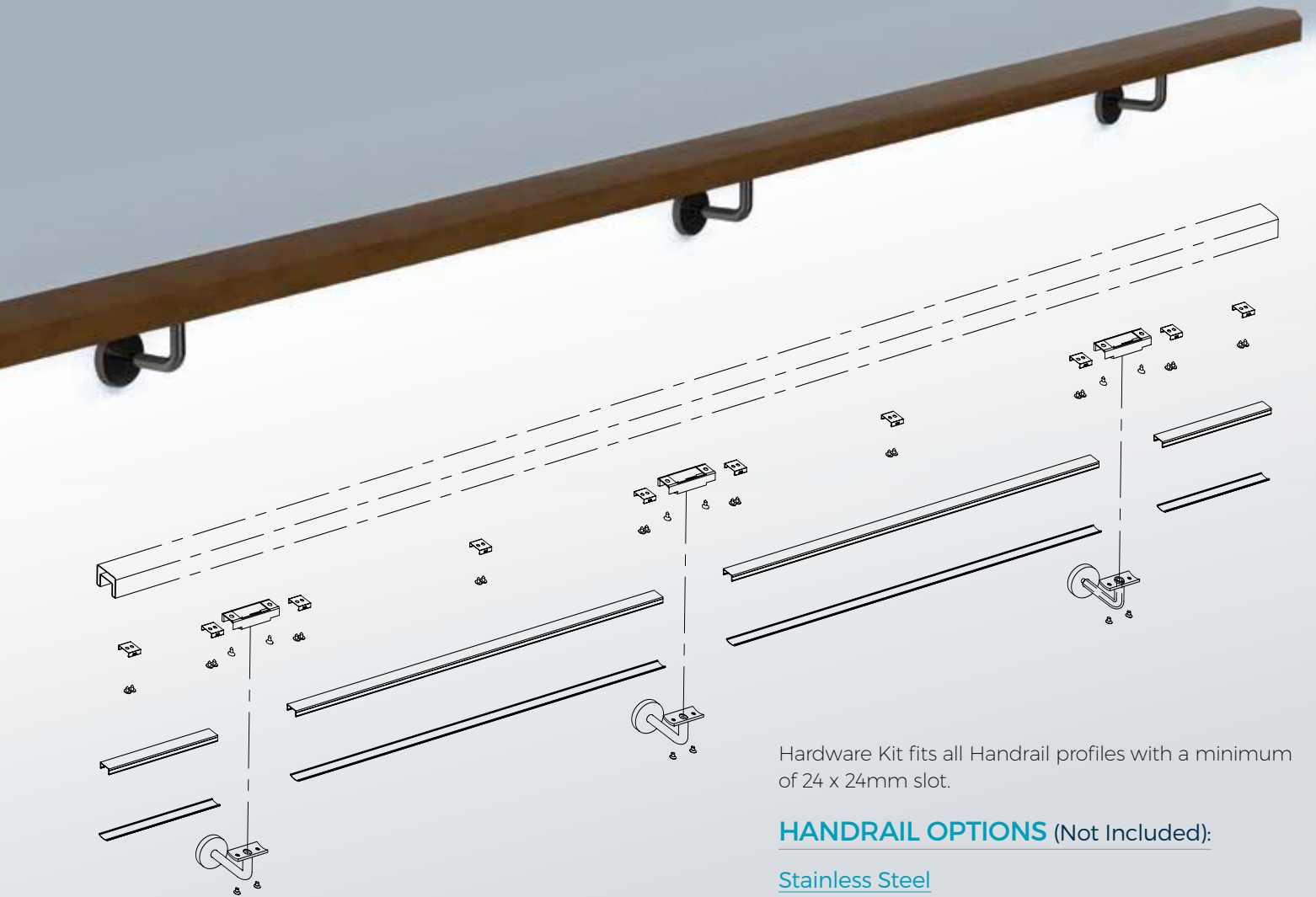
Hardware is SS316 material, and is available in Satin (S) and Graphite Black (GB) finishes.

Electrical Kit is certified for Interior applications only.

All items can be purchased separately to accommodate desired length of Handrail.

Consult an electrician before installing.





Hardware Kit fits all Handrail profiles with a minimum of 24 x 24mm slot.

HANDRAIL OPTIONS (Not Included):

Stainless Steel

- SSUTRND4240** Round
- SSUTSQ40000** Square
- SSUTREC400** Rectangle
- SSUTREC600** Rectangle

Wood (Oak)

- WH4134324GO** Rectangle

Aluminum

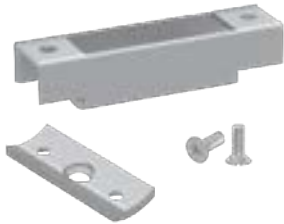
- SSUTALROCA** Round Satin Anodized Aluminum.
- SSUTALROB** Round Black Anodized Aluminum.
- SSUTALSOCA** Square Satin Anodized Aluminum.
- SSUTALSOB** Square Black Anodized Aluminum.



Handrail Adapter Kit (SSUTALT5) required to attach Aluminum Cap Rails to Handrail Brackets. See page 100 for more details.

Hardware Kit (SSLIKIT)

Includes hardware for 4877mm (16 ft.) of LED lighting. Material is 316 Grade Stainless Steel.



SSL1WB101S
(x6) Adapter



SSWB111416S
(x4) Solid Wall Bracket 3" x 2"



SSL1WB100S
(x2) Wiring Wall Bracket 3" x 2"
Can be installed closer to available power supplies.



SSL1WB101GB
(x6) Adapter



SSWB111416GB
(x4) Solid Wall Bracket 3" x 2"



SSL1WB100GB
(x2) Wiring Wall Bracket 3" x 2"
Can be installed closer to available power supplies.

Electrical Kit (SSL2KITELEC) Supplies 16 ft. of lighting.



SSL2LED1
(x1) LED Strip 4200 K (Daylight)



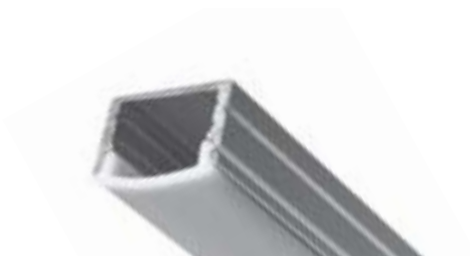
SSL2LED2
(x1) 24V Power Supply (Dimmable)



SSL2LED3
(x1) LED Cable Connector Kit



SSL2LED4
(x4) Mounting Clips

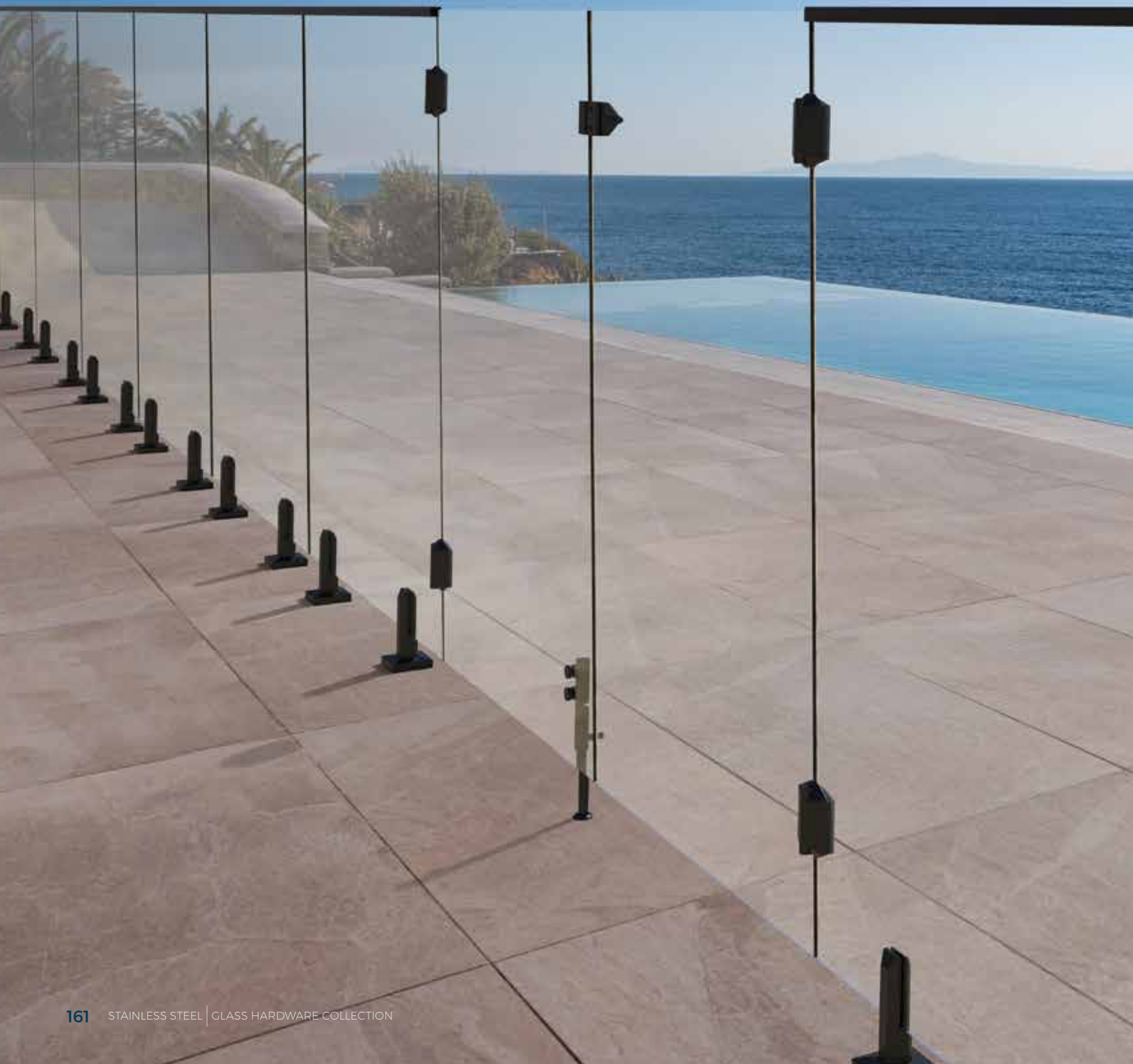


SSL2LED5
(x2) LED Enclosure (8 ft.)
*Sold separately as individual 8' lengths.



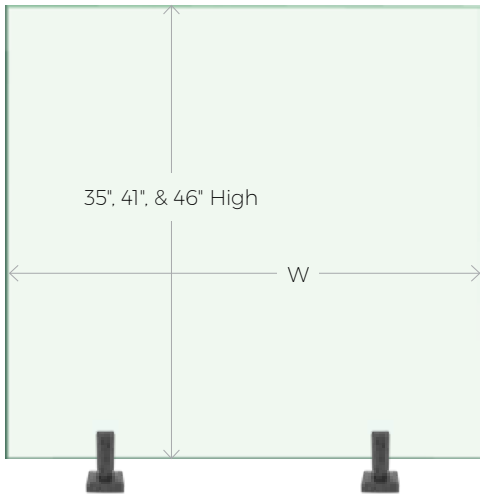
SSUTALT5
Handrail Adapter Kit

Glass Panels





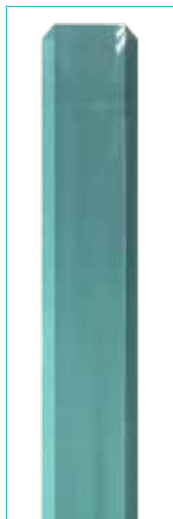
Class Panels



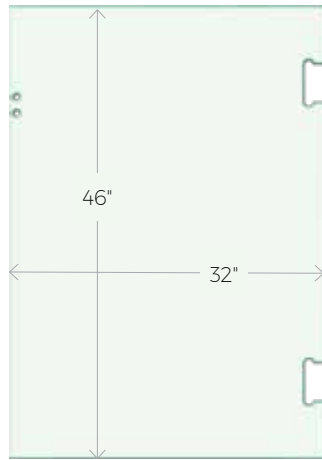
PLAIN PANEL

35" High x W 41" High x W 46" High x W

PART #	W	PART #	W	PART #	W
GGT123530	30"	GGT124112	12"	GGT124624	24"
GGT123532	32"	GGT124116	16"	GGT124628	28"
GGT123534	34"	GGT124118	18"	GGT124632	32"
GGT123536	36"	GGT124120	20"	GGT124636	36"
GGT123538	38"	GGT124122	22"	GGT124640	40"
GGT123540	40"	GGT124124	24"	GGT124642	42"
GGT123542	42"	GGT124126	26"	GGT124644	44"
GGT123544	44"	GGT124128	28"	GGT124646	46"
GGT123546	46"	GGT124130	30"	GGT124648	48"
GGT123548	48"	GGT124132	32"	GGT124650	50"
GGT123550	50"	GGT124134	34"	GGT124652	52"
GGT123554	54"	GGT124136	36"	GGT124654	54"
GGT123560	60"	GGT124138	38"	GGT124656	56"
GGT123572	72"	GGT124140	40"	GGT124658	58"
		GGT124142	42"	GGT124660	60"
		GGT124144	44"	GGT124662	62"
		GGT124146	46"	GGT124664	64"
		GGT124148	48"	GGT124666	66"
		GGT124150	50"	GGT124668	68"
		GGT124152	52"	GGT124670	70"
		GGT124154	54"	GGT124672	72"
		GGT124156	56"		
		GGT124158	58"		
		GGT124160	60"		
		GGT124162	62"		
		GGT124164	64"		
		GGT124166	66"		
		GGT124168	68"		
		GGT124172	72"		



Glass Profile



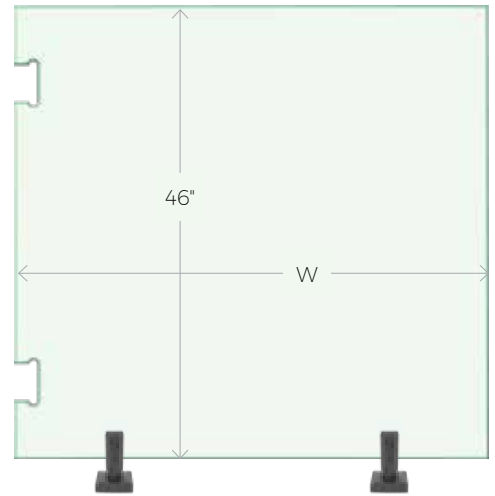
GATE PANEL

Series 1

PART #	H	W
GGT124632G1	46"	32"

Series 2

PART #	H	W
GGT124632G2	46"	32"



HINGE PANEL

Series 1

PART #	H	W
GGT124648G1	46"	48"

Series 2

PART #	H	W
GGT124648G2	46"	48"
GGT124654G2	46"	54"
GGT124660G2	46"	60"

Series 1 and Series 2 Gate and Hinge Panels have designated cut-outs to accommodate the Hinges and latches specified on the opposite page.

Custom Glass

We offer custom Glass preparations for your projects. Please contact us for more information.



HINGES

Use with Series 1 Panels



PART #	Type	Application
SSPFHHGGS	Hydraulic	Glass to Glass



PART #	Type	Application
SSPFHHGWS	Hydraulic	Glass to Wall or Square Post



PART #	Type	Application
SSPFH130G	Polaris 130	Glass to Glass

Use with Series 2 Panels



PART #	Type	Application
SSPFH125G	Polaris 125	Glass to Glass



PART #	Type	Application
SSPFH125W	Polaris 125	Glass to Wall or Square Post

GLASS HANDLING

Glass Trolleys



PART #	Size (LxWxH)
GGTTROLLEYS	1000 x 1100 x 1120mm
GGTTROLLEY	1500 x 1100 x 1120mm



Single Cup Lifter

PART #	Capacity
SSLIFTELITE	57kg / 125 lbs.



Double Cup Lifter

PART #	Capacity
SSLIFTELITE2	60kg / 132 lbs.

LATCHES

Use with Series 1 Panels



PART #	Type	Application
SSPFGL180SSS	Standard	Glass to Glass



PART #	Type	Application
SSPFGL180S SSPFGL180B	Standard Keyed	Glass to Glass



PART #	Type	Application
SSPFGLWSSS	Standard	Glass to Wall or Square Post



PART #	Type	Application
SSPFGLWS SSPFGLWB	Standard Keyed	Glass to Wall or Square Post



PART #	Type	Application
SSPFGL90SSS	Standard	Glass to Glass 90°

Use with Series 2 Panels



PART #	Type	Application
SSPFGL601G	Polaris 600	Glass to Glass



PART #	Type	Application
SSPFGL601W	Polaris 600	Glass to Wall or Square Post

GLASS CARE

Sprayway Glass Cleaner



PART #	Size
GGCLEANER	539g / 19 oz.

Glass Scrub® Water Spot & Stain Remover



PART #	Size
GGCLEANER2	500mL / 16 fl. oz.

Invisible Shield® Protective Glass & Surface Coating



PART #	Size
GGCLEANER3	500mL / 16 fl. oz.

Glass Pool Gate Hardware





HINGES & LATCHES

Our Hinges and Latches are made of durable SS316 Stainless Steel material. **Hydraulic** and **Spring Loaded Hinges** are available in Satin finish for Glass to Glass and Glass to Wall/Square Post applications. **Latches** are available in full or partial Stainless Steel body in Satin finish.

Constructed to be used Exterior in varying conditions, our Hinges and Latches maintain their great look and functionality to accommodate various sizes, thicknesses, and weights of Glass doors. For Glass Panels that are compatible with our Hinges and Latches, please refer to pg 163.

POLARIS SOFT CLOSE HINGE

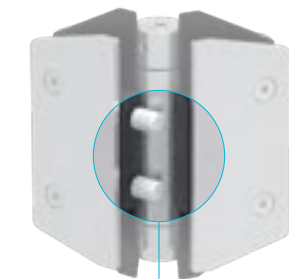
We also carry the popular **Polaris Soft Close Hinge**, a unique self-closing Hinge in Duplex 2205 Marine Grade Stainless Steel for use in all Interior and Exterior Frameless Glass applications. It was designed and rigorously tested through 2500 cycles to meet the tough requirements of Frameless Glass Pool Fencing so that it can be used in all applications where Glass doors or gates are required. Furthermore, the Polaris Soft Close Hinge is designed to be resistant to chemicals, to operate in a wet environment, and to withstand constant Exterior use as well as harsh weather.

The sleek Stainless Steel construction makes it strong and durable, yet stylish and attractive at the same time. As an architectural feature, it is minimalist and its design is compatible with the Glass that it Supports. Available in both Satin and Black finishes.

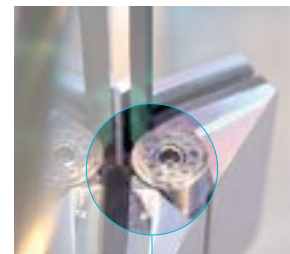
The Polaris Soft Close Hinge uses *spring and shock absorbers to ensure gentle closing* every time from any position, whether fully or partially open. The Polaris Soft Close Hinge closes with a soft and light action, not only making it safe, but also quiet in operation. In addition, the newly upGraded version of the 125 SERIES integrates a *"QUICK-ADJUST" Ratchet for quick and simple speed adjustment*. The Soft Close Dampers can also be interchangeable, providing low-cost maintenance and leak-free solutions patented by Polaris. If you need to have spare parts replaced, such as the Spring, Dampers, Screws, and other Components, please do not hesitate to contact us for availability of parts and how we can assist you with easy maintenance of these Hinges.

The Polaris Soft Close Hinge is a state-of-the-art product that is ahead of its rivals in design, style, and safety. Besides the 125 SERIES, browse our 130, 155, and 156 SERIES to see what would be best suited for your project needs. Moreover, we offer **Polaris Latches** in SS316 to match their Hinge counterpart for a cohesive look on your Glass Door or Gate.

If you are looking for **Door Stops**, we are Introducing a 6" version in Satin and Black finishes to complete your installation.

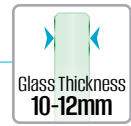


Spring and shock absorbers to ensure gentle closure.



"QUICK-ADJUST" ratchet for quick and simple speed adjustment.

Hinges

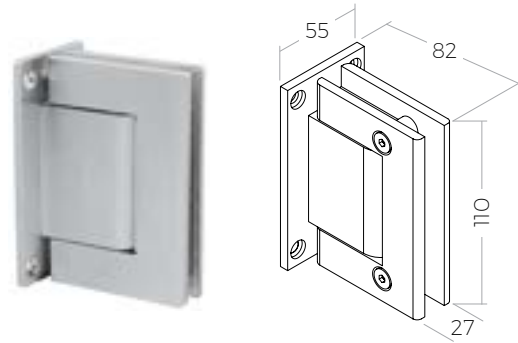
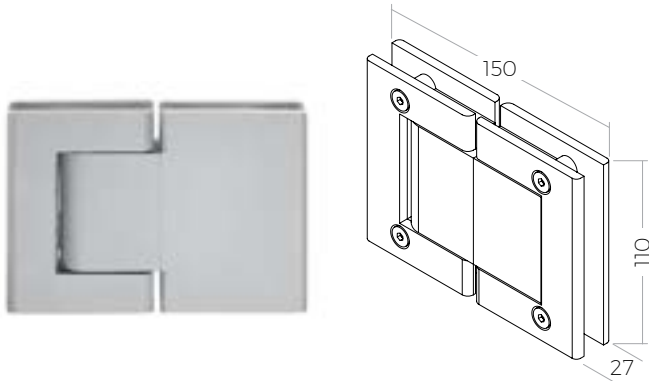


Hydraulic Hinge

- Made of SS316.
- Suitable for **10-12mm** Glass.
- Maximum Door leaf weight: 65kg/pair (143 lb/pair).
- Maximum Door leaf width: 1000mm.
- Maximum Door open angle: +95°.
- Valve adjustment available for closing speed control.

Glass Unit Weights

GLASS THICKNESS:	8mm	10mm	12mm
Glass Weight (kg/m ²)	18.2	22.7	27.3
Glass Weight (lb/ft ²)	3.7	4.6	5.6



Glass to Glass 180°

PART # Finish

SSPFHHGGS S

Use with Series **1** Panels pg 163.

Glass to Wall / Square Post

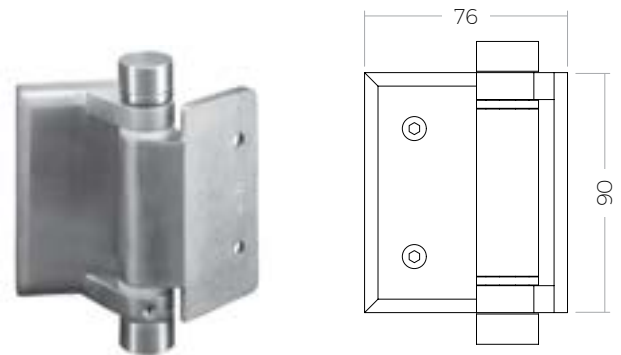
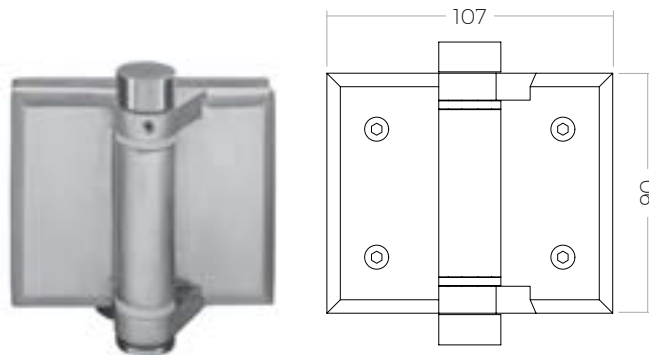
PART # Finish

SSPFHHGWS S

Use with Series **1** Panels pg 163.

Spring Loaded Hinge

- Made of SS316.
- Suitable for **8-12.7mm** Glass.
- Maximum door leaf weight: 30kg/pair.
- Maximum door leaf width: 900mm.
- Spring can be adjusted for closing speed control.



Glass to Glass 180°

PART # Finish

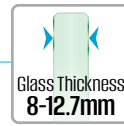
SSPFHSLGGS S

Glass to Wall / Square Post

PART # Finish

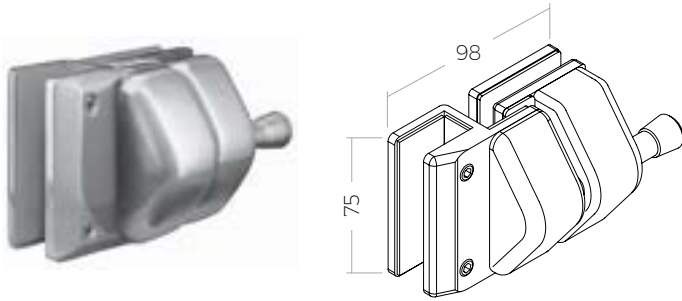
SSPFHSLGWS S

Latches



Standard Stainless Steel Latch

- All Stainless Steel Latches are 316 Grade Stainless Steel.
- Suitable for **8-12.7mm** Glass thickness. Use with our pre-cut Glass Panels for optimal results.

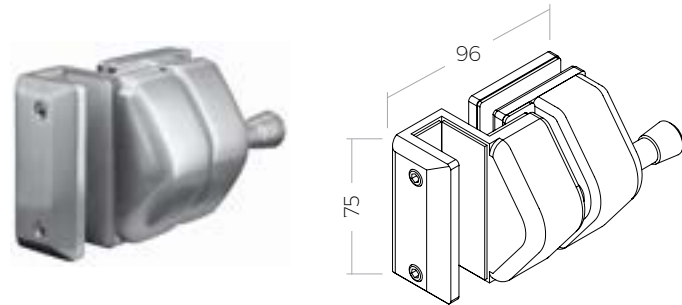


Glass to Glass 180°

PART # Finish

SSPFGL180SS S

Use with Series **1** Panels pg 163.

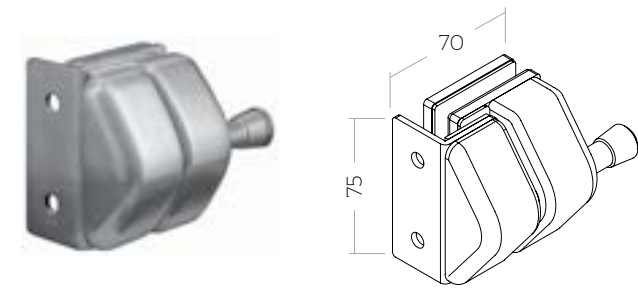


Glass to Glass 90°

PART # Finish

SSPFGL90SS S

Use with Series **1** Panels pg 163.



Glass to Wall / Square Post

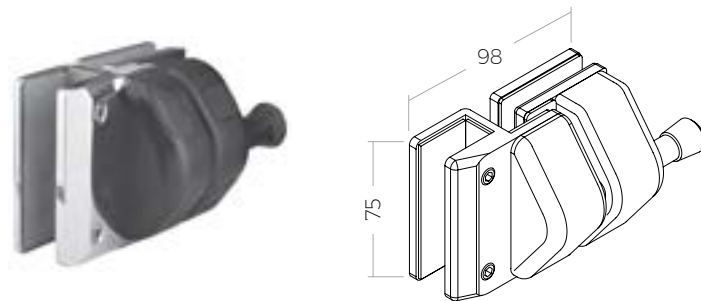
PART # Finish

SSPFGLWSS S

Use with Series **1** Panels pg 163.

Keyed Latch

- Suitable for **8-12.7mm** Glass thickness. Use with our pre-cut Glass Panels for optimal results.
- Keys included.



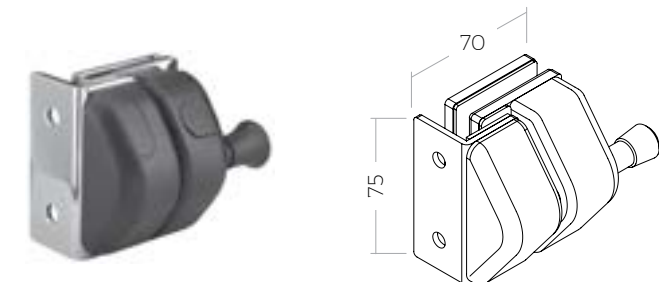
Glass to Glass 180°

PART # Finish

SSPFGL180S S

SSPFGL180B B

Use with Series **1** Panels pg 163.



Glass to Wall / Square Post

PART # Finish

SSPFGLWS S

SSPFGLWB B

Use with Series **1** Panels pg 163.

Polaris Soft Close Hinges



Glass to Glass



Glass to Wall or Square Post

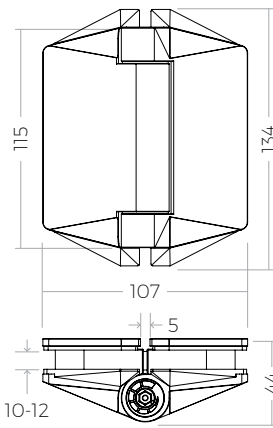


- Duplex 2205 Marine Grade Stainless Steel.
- Satin Stainless Steel & Powder Coated Black.
- Single action.
- Soft Close with speed adjustment.
- Max Door leaf weight 45kg/pair (99 lb/pair).
- Max Door 900 x 1500 (W x H).
- Non-hold open.
- Anti-fothold Cover.

See Post Brackets below for attaching to Wall or Posts.



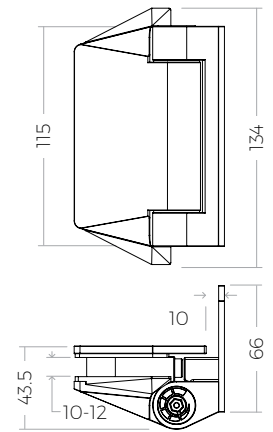
125 Series - Stainless Steel Hinge - Opens 90°



Glass to Glass

PART #	Finish
SSPFH125GS	S
SSPFH125GB	B

Use with Series 2 Panels pg 163.



Glass to Wall

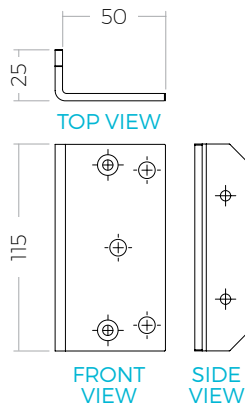
PART #	Finish
SSPFH125WS	S
SSPFH125WB	B

Use with Series 2 Panels pg 163.
Use Post Brackets below for Post applications.



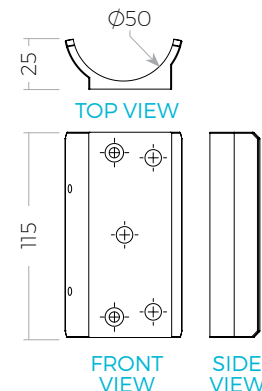
Post Brackets - Designed to fit with Polaris 125 Glass to Wall for Post Hinge.

Duplex 2205 Marine Grade Stainless Steel.



Square Post

PART #	Finish	Use
SSPFH125SPS	S	Use with SSPFH125WS
SSPFH125SPB	B	Use with SSPFH125WB

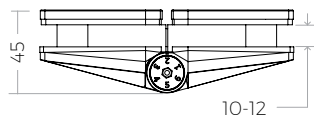
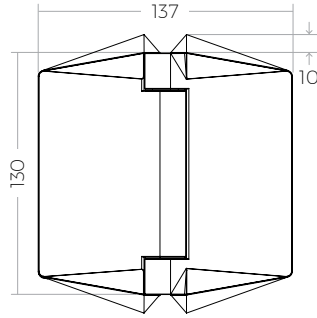


Round Post

PART #	Finish	Use
SSPFH125RPS	S	Use with SSPFH125WS
SSPFH125RPB	B	Use with SSPFH125WB



130 Series - Stainless Steel Hinge - Opens 90°.



Glass to Glass

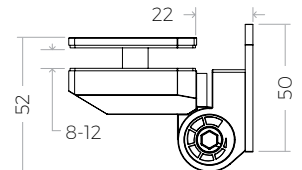
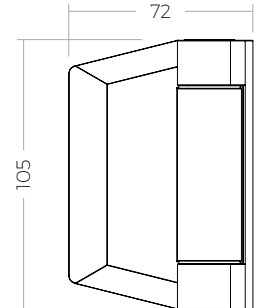
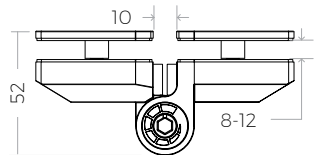
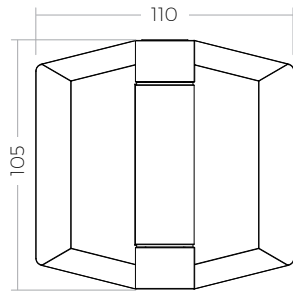
PART #	Finish
SSPFH130GS	S
SSPFH130GB	B

Use with Series 1 Panels pg 163.



155 Series - Stainless Steel Hinge - Opens 180°.

Hole required for installation, no cut-outs required. Retrofit for Spring Loaded Hinges.



Glass to Glass

Retrofit for **SSPFHSLGGS**.

PART #	Finish
SSPFH155GS	S
SSPFH155GB	B

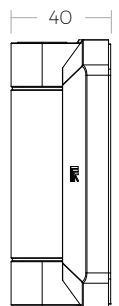
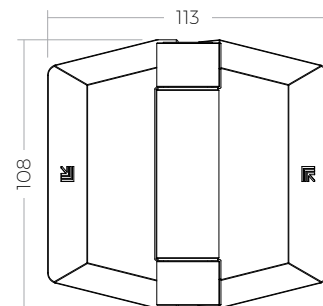
Glass to Wall/Square Post

Retrofit for **SSPFHSLGWS**.

PART #	Finish
SSPFH155WS	S
SSPFH155WB	B

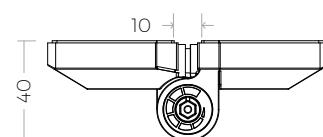
156 Series - Stainless Steel Hinge - Opens 180°.

Satin with Black Covers (compatible with spray paint). Designed for Metal & Wood Doors and Gates.



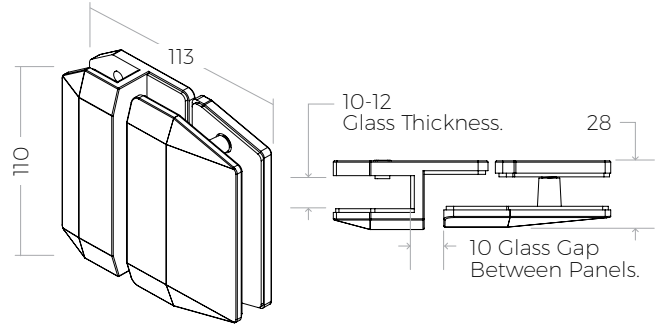
Gate to Gate / Wall to Gate

PART #	Finish
SSPFH156B	Satin with Black Covers



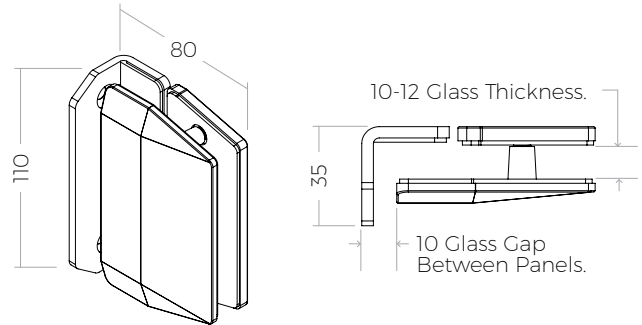
Stainless Steel Latch

- All Stainless Steel Latches are 316 Grade Stainless Steel.
- Suitable for **10-12mm** Glass thickness. Use with our pre-cut Glass Panels for optimal results.



Glass to Glass Use with Series **2** Panels pg 163.

PART #	Finish
SSPFGL601GS	S
SSPFGL601GB	B



Glass to Wall or Square Post Use with Series **2** Panels pg 163.

PART #	Finish
SSPFGL601WS	S
SSPFGL601WB	B

D&D MagnaLatch with Lock

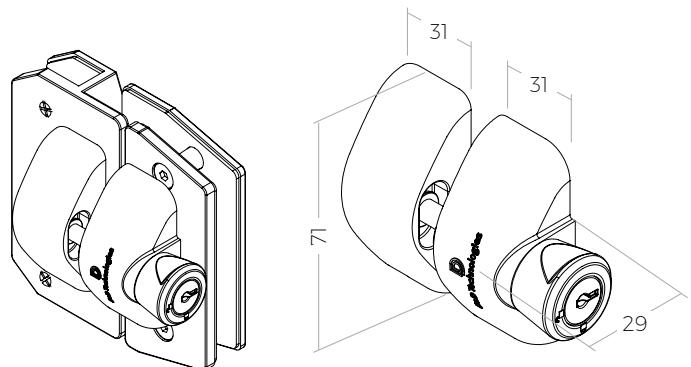


Included with Polaris Latches above to create a lockable Gate.

PART # **MLSPS2L**

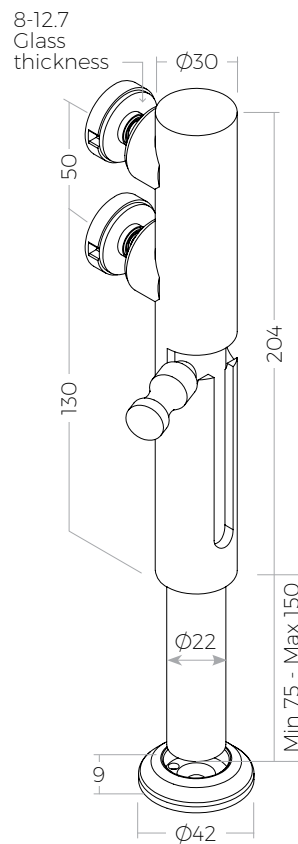


Shown with SSPFGL601 Polaris Latch.





Door Stop



Stainless Steel Door Stop

PART #	SS Grade	Finish
SSPFSTOP7S	316	S
SSPFSTOP7B	316	B

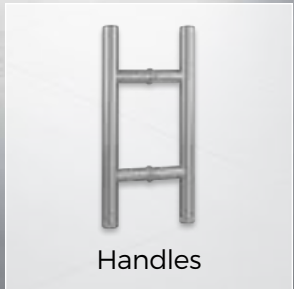
*Floor Flange secured by #14 Flat Head Screw (not included).

Glass Door Hardware

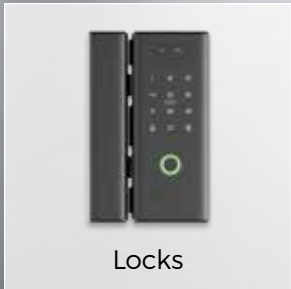




Patch Fittings



Handles

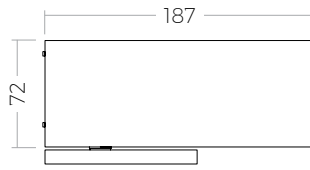


Locks

A
Satin
Anodized
Aluminum

S
Satin
Stainless
Steel

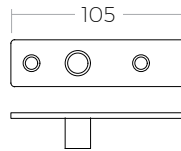
B
Powder
Coated
Black



Hydraulic Patch Door Kit

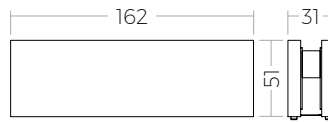
Includes Bottom and Top Patch with Pivot Bracket.

SSGWPF90 90° Hold open.
SSGWPFNH Non-hold open.



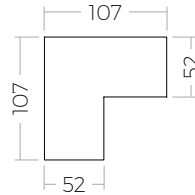
Pivot Bracket for Top Patch

SSGWPFPIVOT
Used with all finishes.



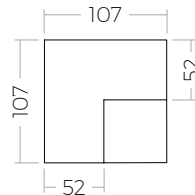
Top / Bottom Patch

SSGWPFX6



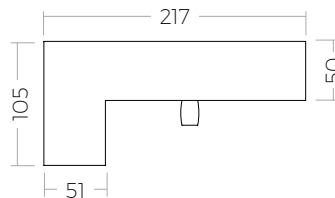
Sidelite Transom Patch

SSGWPFX1



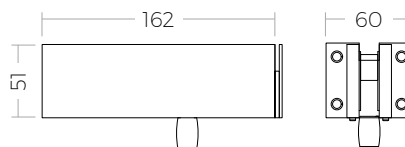
Sidelite Transom Patch with Stopper

SSGWPFX2



Sidelite Mount Transom Patch

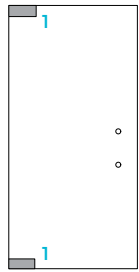
SSGWPFX3



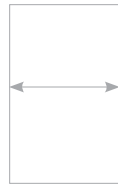
Wall Mount Transom Patch

SSGWPFX4

Patch Fitting Configurations



- 1. **SSGWPF90** Hydraulic Patch Door Kit (90° Hold open), or
- SSGWPFNH** Hydraulic Patch Door Kit (Non-hold open).



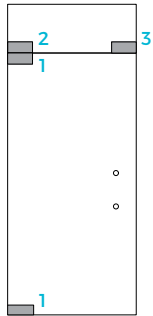
Maximum Door Width
1000mm (39 3/8")



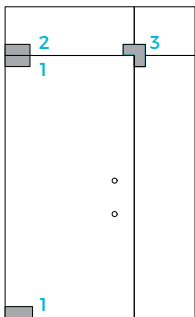
Glass Thickness
8-13mm (5/16"-1/2")



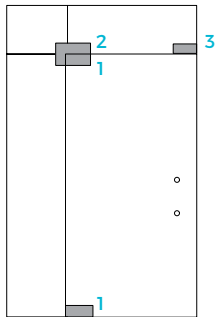
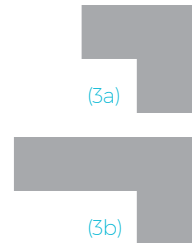
Maximum Door Weight
100kg (220 lbs)



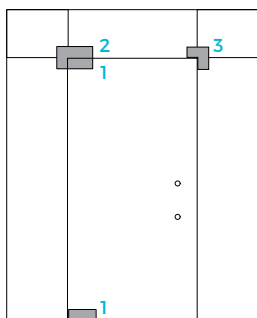
- 1a **SSGWPF90** Hydraulic Patch Door Kit (90° Hold open).
- SSGWPFX5** Cladding Cover Plate for Top Patch.
- 1b **SSGWPFNH** Hydraulic Patch Door Kit (Non-hold open).
- SSGWPFX5** Cladding Cover Plate for Top Patch.
- 2 **SSGWPFX4** Wall Mount Transom Patch.
- 3 **SSGWPFX4** Wall Mount Transom Patch.
- SSGWPFSTOP** Door Stop for Transom Patch (Optional - not included).



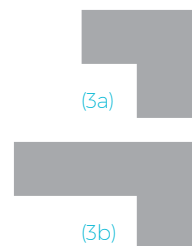
- 1a **SSGWPF90** Hydraulic Patch Door Kit (90° hold open).
- SSGWPFX5** Cladding Cover Plate for Top Patch.
- 1b **SSGWPFNH** Hydraulic Patch Door Kit (Non-hold open).
- SSGWPFX5** Cladding Cover Plate for Top Patch.
- 2 **SSGWPFX4** Wall Mount Transom Patch.
- 3a **SSGWPFX1** Sidelite Transom Patch, or
- SSGWPFX2** Sidelite Transom Patch with Stopper.
- 3b **SSGWPFX3** Sidelite Mount Transom Patch.
- SSGWPFSTOP** Door Stop for Transom Patch (Optional - not included).

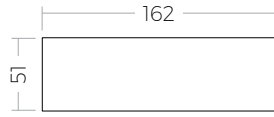


- 1a **SSGWPF90** Hydraulic Patch Door Kit (90° hold open).
- SSGWPFX5** Cladding Cover Plate for Top Patch.
- 1b **SSGWPFNH** Hydraulic Patch Door Kit (Non-hold open).
- SSGWPFX5** Cladding Cover Plate for Top Patch.
- 2 **SSGWPFX3** Sidelite Mount Transom Patch.
- 3 **SSGWPFX4** Wall Mount Transom Patch.
- SSGWPFSTOP** Door Stop for Transom Patch (Optional - not included).



- 1a **SSGWPF90** Hydraulic Patch Door Kit (90° hold open).
- SSGWPFX5** Cladding Cover Plate for Top Patch.
- 1b **SSGWPFNH** Hydraulic Patch Door Kit (Non-hold open).
- SSGWPFX5** Cladding Cover Plate for Top Patch.
- 2 **SSGWPFX3** Sidelite Mount Transom Patch.
- 3a **SSGWPFX1** Sidelite Transom Patch, or
- SSGWPFX2** Sidelite Transom Patch with stopper.
- 3b **SSGWPFX3** Sidelite Mount Transom Patch.
- SSGWPFSTOP** Door Stop for Transom Patch (Optional - not included).

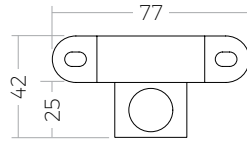




Cladding Cover Plate for Top Patch

Fits **SSGWPFX6**.

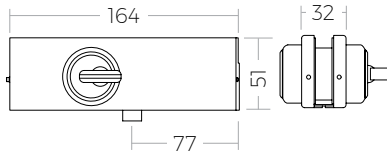
- SSGWPFX5SA** Satin Anodized Aluminum.
- SSGWPFX5SS** Satin Stainless Steel.
- SSGWPFX5B** Powder Coated Black.



Door Stop for Transom Patch

- Used for all finishes.

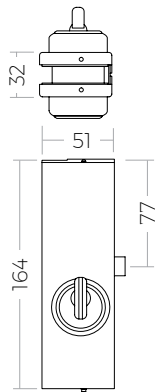
SSGWPFSTOP



Bottom Mount Patch Lock with Strike Plate

- Installed at the bottom corner of the Glass Door.
- Glass-to-Floor applications.
- American type cylinder.
- Stainless Steel Cover with Aluminum Cast Body.

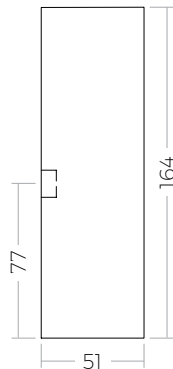
- SSGWPFX7SA** Satin Anodized Aluminum.
- SSGWPFX7SS** Satin Stainless Steel.
- SSGWPFX7B** Powder Coated Black.



Center Mount Patch Lock with Strike Plate

- Glass-to-Wall applications.
- Installed vertically at the side of the Glass Door.
- American type Cylinder.
- Stainless Steel Cover with Aluminum Cast Body.

- SSGWPFX8SA** Satin Anodized Aluminum.
- SSGWPFX8SS** Satin Stainless Steel.
- SSGWPFX8B** Powder Coated Black.



Strike Box for Patch Lock

- Used with Center Mount Patch Lock.
- Installed on Sidelite for Glass-to-Glass Patch Lock applications.

- SSGWPFX9SA** Satin Anodized Aluminum.
- SSGWPFX9SS** Satin Stainless Steel.
- SSGWPFX9B** Powder Coated Black.

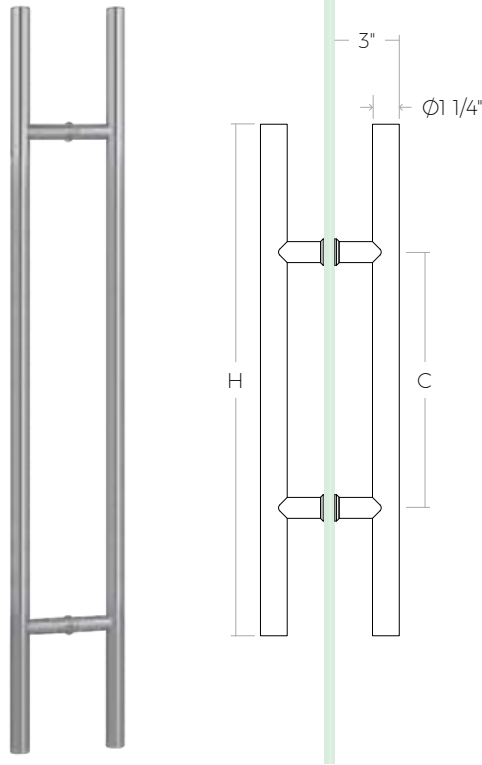


Round Ladder Pull Handles

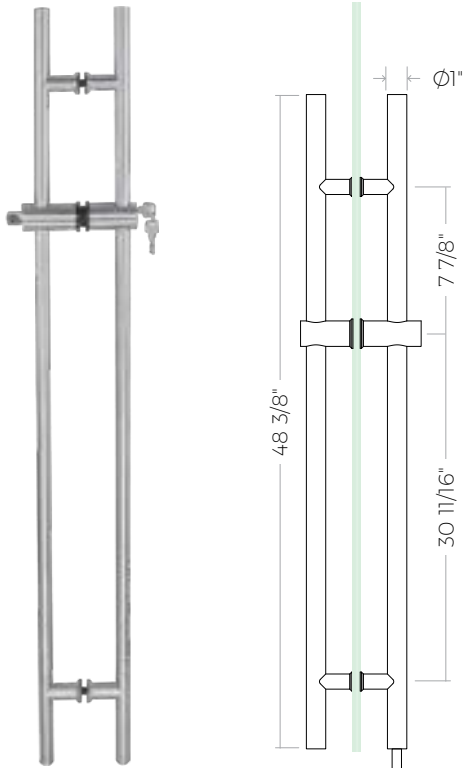


Standard Non-Lockable

- Modern and elegant design for office and commercial settings.
- Non-Lockable Ladder Handles with 1 1/4" diameter available in 6 heights.
- SS316 material with accompanying 1 1/4" Washers.
- Suitable for **8-12mm** Glass.
- Glass hole size is 9/16".



PART #	Height (H)	Hole Space (C)	Tube Thickness	Finish
SSGWPFY12S	12"	6"	1/16"	S
SSGWPFY12B	12"	6"	1/16"	B
SSGWPFY24S	24"	12"	1/16"	S
SSGWPFY24B	24"	12"	1/16"	B
SSGWPFY36S	36"	24"	1/16"	S
SSGWPFY36B	36"	24"	1/16"	B
SSGWPFY48S	48"	36"	1/8"	S
SSGWPFY48B	48"	36"	1/8"	B
SSGWPFY60S	60"	48"	1/8"	S
SSGWPFY60B	60"	48"	1/8"	B
SSGWPFY72S	72"	60"	1/8"	S
SSGWPFY72B	72"	60"	1/8"	B

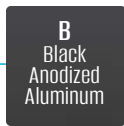
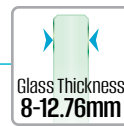


Lockable

- Modern and elegant design for office and commercial settings.
- Lockable Ladder Handle with 1" diameter available in 48 3/8" height.
- Suitable for **10-12mm** Glass.
- Glass hole size is 9/16".

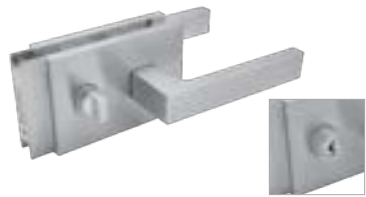
PART #	Height (H)	Hole Space	Tube Thickness	Finish
SSGWPFZ48S	48 3/8"	7 7/8" top 30 11/16" bottom	1/16"	S

Magnetic Lock



This series of M-Locks incorporates a Magnetic Lock/Latch at its core. With only 31mm thickness, this sleek, stylish, and quiet Lock Set is a superior choice to traditional Lock Sets.

The Lock Set material is Aluminum with options for Single Action and Dual Action. There are 3 designs, including Lockable, Non-Lockable, and with Knob. Available in 2 finishes: Satin Anodized Aluminum (A) and Black Anodized Aluminum (B).



Other side



Other side



Other side



Other side

PART #	Description
--------	-------------

SSGWLM1	Lockable, Single Action - Key, Thumbturn, and Handles included.
----------------	---



SSGWLM2	Non-lockable, Single Action - Handles included.
----------------	---



SSGWLM3	With Knob, Single Action - Thumbturn and Handles included.
----------------	--



PART #	Description
SSGWLM4	Lockable, Dual Action - Key, Thumbturn, and Handles included.



SSGWLM5	Non-lockable, dual Action - Handles included.
----------------	---



SSGWLM6	With Knob, Dual Action - Thumbturn and Handles included.
----------------	--



M-Lock Single Action

The M-Lock Single Action Lock Set is for doors that only swing in one direction. The design of the Wall Strike has a ledge to prevent the door from swinging in both directions. Also, the indentation on the M-Lock Single Action sits against the ledge of the Wall Strike. Only Wall Strike is included with the Single Action Lock Set.

Specifications

- Door Type: Glass.
- Usage: Hinge Door.
- Handing Position / Opening Side: Reversible for Left or Right.
- Strike Plate Type: Wall Strike.
- Dimensions (L x W x H): 120 x 31 x 70mm.
- Door Thickness: **8-12.76mm**.
- Material: Aluminum.

M-Lock Dual Action

The M-Lock Dual Action Lock Set is for doors that can swing freely in both directions. The Wall Strike does not have a ledge on it, and the lock does not have the same indentation as the M-Lock Single Action. Both Wall and Glass Strikes are included with the Dual Action Lock Set.

Specifications

- Door Type: Glass.
- Usage: Hinge Door.
- Handing Position/Opening Side: Reversible for Left or Right.
- Strike Plate Type: Wall Strike and Glass Strike.
- Dimensions (L x W x H): 120 x 31 x 70mm.
- Door Thickness: **8-12.76mm**.
- Material: Aluminum.

Electronic Lock



This E-Lock is a Wireless Electronic Lock for Swing and Sliding Glass Doors that combines functionality with versatility. Keyless entry and no wiring needed. Available in Black.



PART #	Description
SSGWLEGG	Glass-to-Glass Applications.
SSGWLEGW	Glass-to-Wall Applications.

E-Lock



Features

- No Glass processing is required.
- Easy to install.
- Battery powered with 4 x AA 6V batteries required (not included).
- 4 locking/unlocking modes:
 1. Bluetooth via a downloadable smartphone app.
 2. Fingerprint.
 3. Numerical code.
 4. FOB badge.
- Possibility to generate timed entrance and unlocking codes.
- Record of access available via downloadable app.

Specifications

- Door Type: Glass.
- Usage: Hinge Door, Sliding Door.
- Handing Position/Opening Side: Reversible for Left or Right.
- Strike Plate Type: Glass Strike.
- Dimensions (W x H): 63 x 162mm.
- Door Thickness: **10-12mm**.
- Working Temperature: -25°C-60°C.
- Working Humidity: 20%-90%.
- Material: Metal.



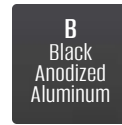
Glass Wall Channel Kits





The Glass Channel Kit creates a safe and clean, modern finish to your Glass Walls or Partitions.

- Packed as a 12 ft. Kit, including top and Bottom Channels, End Caps, and Gaskets.
- Designed for Top and Side Mount applications.
- Easy installation with removable Cover.
- Full-frame Glazing (4 sides) possible.



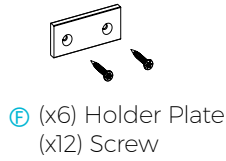
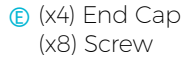
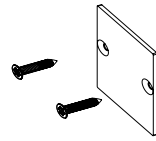
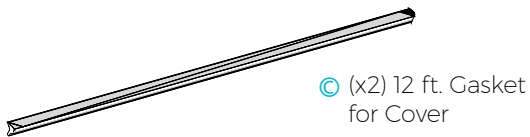
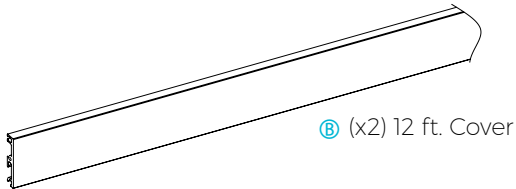
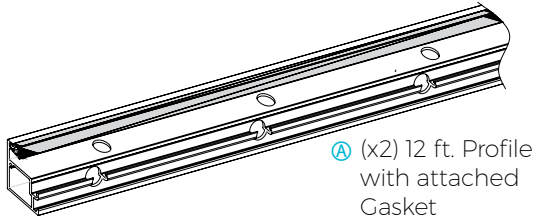
SSGWCH200A
Satin Anodized Aluminum

SSGWCH200B
Black Anodized Aluminum

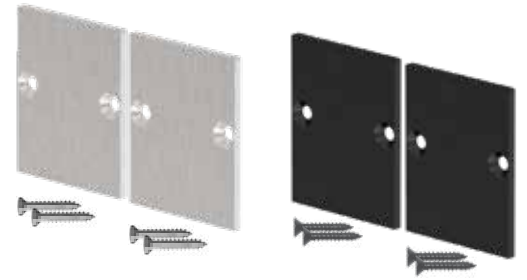


Glass Channel Kit

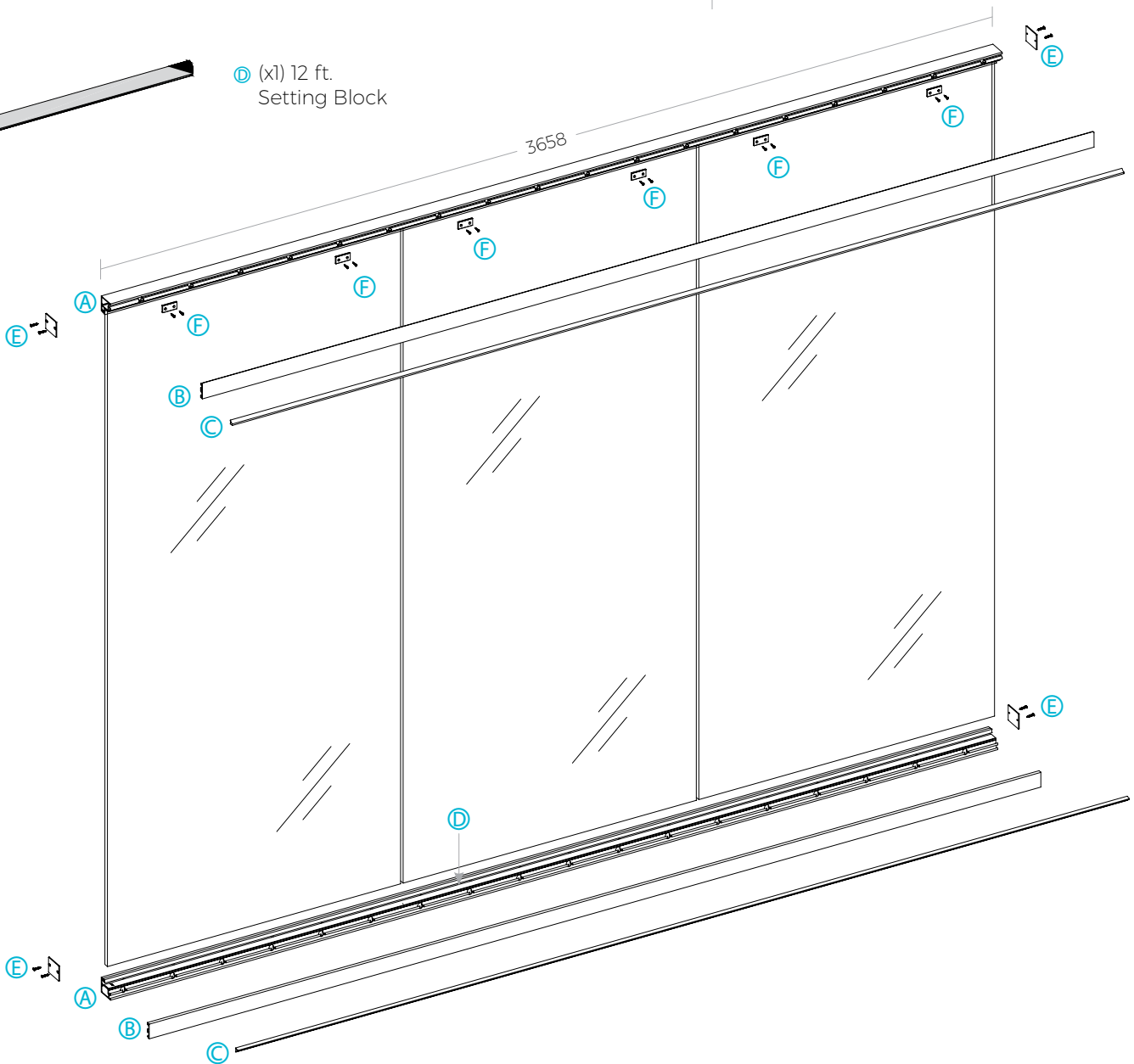
Kit Includes

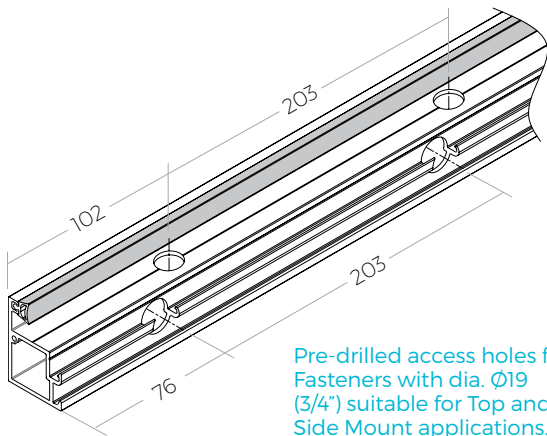
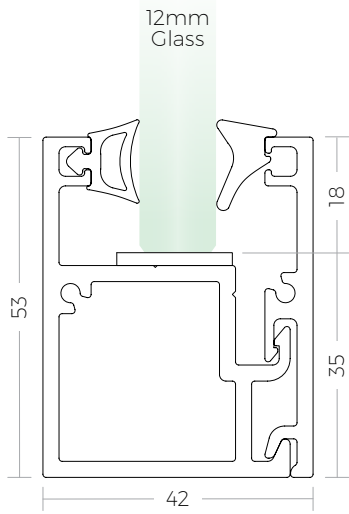


Need extra End Caps?
Sold separately in packs of 2



PART #	Finish
SSGWCH200ECA	Satin Anodized Aluminum
SSGWCH200ECB	Black Anodized Aluminum





Pre-drilled access holes for Fasteners with dia. $\text{\O}19$ (3/4") suitable for Top and Side Mount applications.

Top Mount

Side Mount

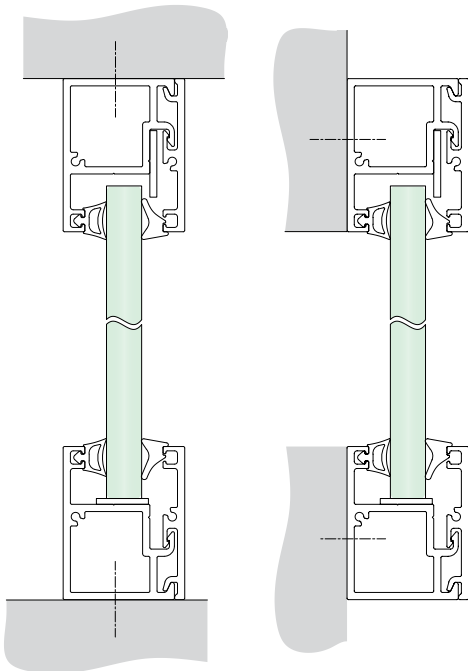
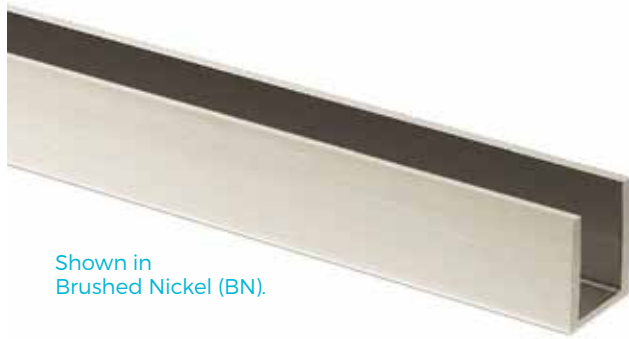
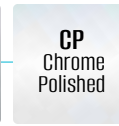
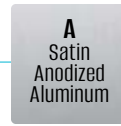
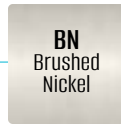
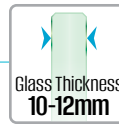
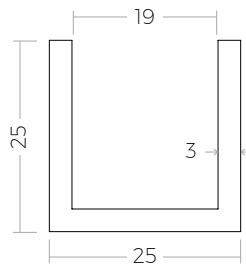


PHOTO: Custom Glass Railings

Glass Channels



Shown in
Brushed Nickel (BN).



1" x 1"

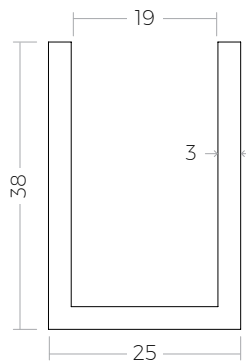
PART #	Finish
SSGWCH11BN	BN
SSGWCH11CA	A
SSGWCH11CP	CP
SSGWCH11B	B

Available End Cap

PART #	Finish
SSGWCH11E	BN, A, CP, B



Shown in
Chrome Polish (CP).

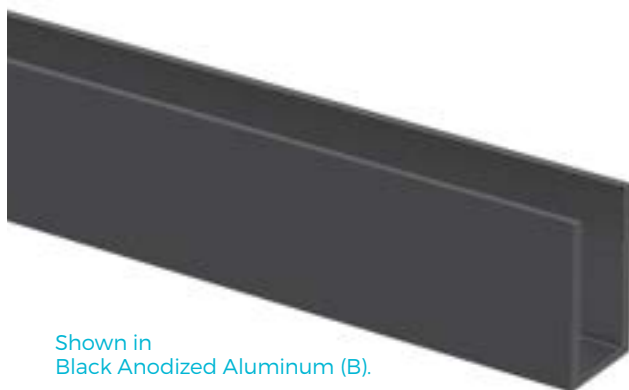


1" x 1 1/2"

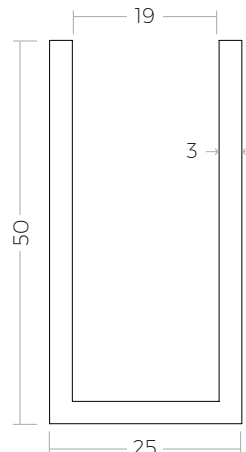
PART #	Finish
SSGWCH112BN	BN
SSGWCH112CA	A
SSGWCH112CP	CP
SSGWCH112B	B

Available End Cap

PART #	Finish
SSGWCH112E	BN, A, CP, B



Shown in
Black Anodized Aluminum (B).



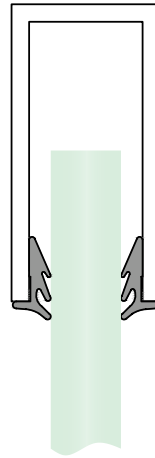
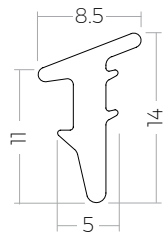
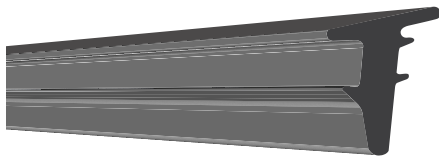
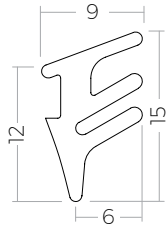
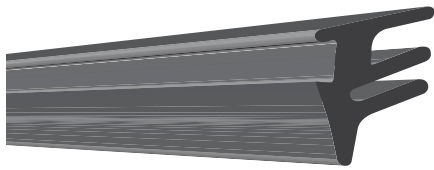
1" x 2"

PART #	Finish
SSGWCH12BN	BN
SSGWCH12CA	A
SSGWCH12CP	CP
SSGWCH12B	B

Available End Cap

PART #	Finish
SSGWCH12E	BN, A, CP, B





Glazing Rubber Gaskets

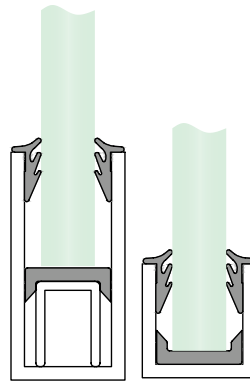
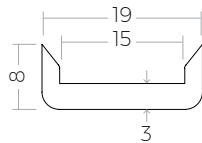
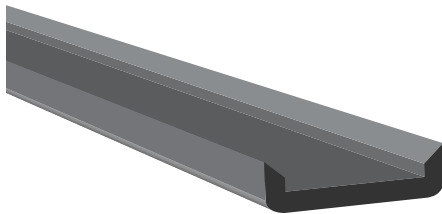
Use with **SSGWCH** Channels (pg 185).

PART #	Class Size	Roll Size
SSGWCHSEAL1	10	100'
SSGWCHSEAL2	12	100'



Spline to Install Gaskets

PART #
SSGWSPLINE

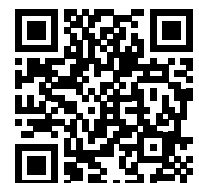


Rubber Setting Blocks

Use with **SSGWCH** Channels (pg 185).

PART #	Length	Package
SSGWCHSEAL3	100	10 pcs

For further information on our Glass Channels please ask for our Shower Hardware Collection Catalogue or scan the code to visit our Website.



Sliding Glass Door Kits





Our Sliding Glass Door Kits are Single Sliders that combine a sleek and simple look with easy functionality. Perfect for use in smaller spaces to avoid swinging doors and bulky Hinges, and can be mounted to a Wall or Glass. The hardware is made of SS316 Stainless Steel for the Satin finish, and SS304 in Black Stainless Steel.

Our Kits feature an extra security advantage where the Ball Bearing Rollers are equipped with Anti-lift mechanisms to prevent the door from lifting off of the Track. With the 6 Glass Mount Clamps securely fastened to the Glass Wall, the door remains stable during handling. The addition of 2 Floor Mount Door Stops, together with the left and right Track Stops ensure no recoil if the door is moved suddenly.

Glass Thickness
10-12mm

S
Satin
Stainless
Steel

B
Powder
Coated
Black



SINGLE SLIDING GLASS DOOR KIT WALL MOUNT

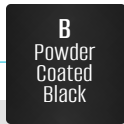
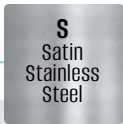
SSDS110 - Satin Stainless Steel (SS316).

SSDS111 - Powder Coated Black (SS304).

- Suitable for **10-12mm** (3/8"-1/2") Glass.
- Track is 1" (25mm) dia. and 104" (2650mm) long.
- Maximum Door weight: 220 lbs (100kg).

Kit Includes: 1 Top Track, 6 Wall Mount clamps, 2 Sliding Door Rollers, 2 Top Track/Door Stops (left and right side), 2 Floor Mount Door Stops, 1 Floor Guide, Allen Key, Wrench, Fasteners.





SINGLE SLIDING GLASS DOOR KIT GLASS MOUNT

SSDS112 - Satin Stainless Steel (SS316).

SSDS113 - Powder Coated Black (SS304).

- Suitable for **10-12mm** (3/8"-1/2") Glass.
- Track is 1" (25mm) dia. and 104" (2650mm) long.
- Maximum Door weight: 220 lbs (100kg).

Kit Includes: 1 Top Track, 6 Glass Mount Clamps (including Surface and Flush Mount Fittings), 2 Top Track/Door Stops (left and right side), 2 Floor Mount Door Stops, 1 Floor Guide, Allen Key, Wrench, Fasteners.



Wine Cellar Collection



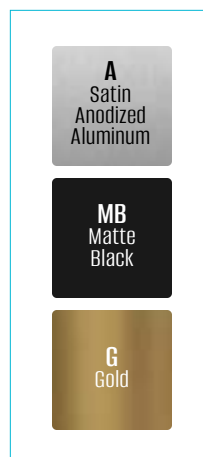
WINE PEGS

Our Wall-Mounted Wine Pegs offer a refined and functional Wine Storage System to professional trades, architects, Interior designers, and handy homeowners. They hold 750mL standard bottles and add a modern touch and high-quality finish to your Wine Cellar or Wall with our precision-made, patented systems. Choose from the Pieno, Leggero, or Vitigno 1-2-3 based on your design and layout preference – robust or minimalist look with bottles held in place either perpendicular or parallel to the Wall. Available in 3 finishes: Satin Anodized Aluminum, Matte Black, and Gold.

Features

- Solid Anodized Aluminum material.
- 5 models available in 3 finishes. Each box of Pegs allows you to store 4-6 bottles, depending on the model.
- Nitrile or Silicone Rubber O-rings are pre-installed on the Pegs, providing non-slip stability and considerably reducing installation time.
- Screws are included along with Spring Lock Washers to help maintain the Pegs stay tightly in place. No visible hardware.
- Fully customizable configurations and easy to install Pegs according to our recommended layout or create your own.
- Freedom to design a complete Wine Cellar or a simple Wall Panel to hang in your kitchen to your exact specifications.

Wine Pegs require a Wall Panel for secure installation. The Panel thickness and design will determine the type of hardware required. (Hardware sold separately). Configurations & Installation Instructions are available on our Website: euroeac.com



Wine Pegs



Pieno

Pegs are installed perpendicular to the wall with the cork facing outwards.

Dimensions = $\varnothing 1" \times 7 \frac{1}{16}"$ L

Each box includes 6 Pegs.

There is 1 JCB-B Bolt and
1 Spring Lock Washer per Peg.

Stores 5 bottles in one row, or 4 bottles in
two rows. (2 bottles are held on 3 Pegs).

Nitrile Rubber O-rings are
pre-installed on the Pegs.



Leggero

Dimensions = $\varnothing \frac{1}{2}" \times 7 \frac{1}{16}"$ L

Each box includes 6 pairs of Pegs.

There is 1 JCB-B Bolt and
1 Spring Lock Washer per Peg.

Stores 6 bottles,
1 per pair.

Nitrile Rubber O-rings are
pre-installed on the Pegs.



WC500010A
Satin



WC500900B
Matte Black



WC500165C
Gold



WC400010A
Satin



WC400900B
Matte Black



WC400165C
Gold



Vitigno 1

Pegs are designed to support the bottle by the neck and bottom with the bottle parallel to the wall.

Dimensions = $\varnothing 3/4"$ x 3 3/8"L

Each box includes 6 pairs of Pegs.

There is 1 JCB-B Bolt and 1 Spring Lock Washer per Peg.

Stores 6 bottles,
1 per pair.

Silicone Rubber O-rings are pre-installed on the Pegs.



Vitigno 2

Dimensions = $\varnothing 3/4"$ x 7 1/16"L

Each box includes 3 pairs of Pegs.

There is 1 JCB-B Bolt and 1 Spring Lock Washer per Peg.

Stores 6 bottles,
2 per pair.

Silicone Rubber O-rings are pre-installed on the Pegs.



Vitigno 3

Dimensions = $\varnothing 3/4"$ x 11 13/16"L

Each box includes 2 pairs of Pegs.

There is 1 JCB-B Bolt and 1 Spring Lock Washer per Peg.

Stores 6 bottles,
3 per pair.

Silicone Rubber O-rings are pre-installed on the Pegs.



WC601010A
Satin



WC602010A
Satin



WC603010A
Satin



WC601900B
Matte Black



WC602900B
Matte Black



WC603900B
Matte Black



WC601165C
Gold



WC602165C
Gold



WC603165C
Gold

Accessories by Special Order Only

Wood Racks

Our classic Wood Racks come in a variety of sizes to suit your Wine Cellar needs. Racks are in Torrefied Trembling Aspen finish. Wall Support included. Safe for long-term storage of bottles. Easy to assemble; no cutting required.

CLASSIC STANDARD RACKS store 750mL standard bottles. The space to place the bottle in the rack is 3 1/2"W x 2 7/8"H.

CLASSIC DIAMOND RACK bottle capacity refers to 750mL standard bottles. Bottle capacity may differ when storing different sizes of bottles.



WCCIS124551
Standard
12 bottles
5"W x 45"H x 9"D



WCCID323051
Standard
32 bottles
17 1/2"W x 30"H x 9"D



WCCID484551
Standard
48 bottles
17 1/2"W x 45"H x 9"D



WCCID643051
Standard
64 bottles
35"W x 30"H x 9"D



WCCID964551
Standard
96 bottles
35"W x 45"H x 9"D



WCDIA363051
Diamond
36 bottles
17 1/2"W x 30"H x 9"D

Under Cabinet Stemware Holders

SPECIAL ORDER



Our Under Cabinet Stemware Holders are made of Steel and are available in several sizes in various finishes. All Stemware Holders are accompanied by Mounting Hardware along with a back bracket to use for face frame cabinet applications. Stemware Holders help you organize your collection of Stemware and match your Kitchen/Bar. Ideal storage solution for several types of wine glasses, making them easy to reach.

All openings of the Holders are 3 1/2" wide x 3/4" high and accommodates Glass bases less than 15/16" wide.



11" Holder

4 1/4"W x 1 1/2"H x 11"D
Holds 2-3 Wine Glasses

WC315011BR - BR
WC315011CP - CP
WC315011ORB - ORB
WC315011SN - SN



16" Holder

4 1/4"W x 1 1/2"H x 16"D
Holds 4 Wine Glasses

WC315016BR - BR
WC315016CP - CP
WC315016ORB - ORB
WC315016SN - SN



18" Holder

4 1/4"W x 1 1/2"H x 18"D
Holds 5 Wine Glasses

WC315018CP - CP
WC315018ORB - ORB
WC315018SN - SN



Quad Holder

4 Holders attached together
4 1/4"W x 1 1/2"H x 11"D
Holds 8-12 Wine Glasses

WC345011CP - CP
WC345011ORB - ORB
WC345011SN - SN

Z-Shaped Moulding

Solid Aluminum Z-shaped Moulding in Mill finish. Ideal for Cabinets, Panels, and Furniture for Showrooms and Trade Shows. For Fasteners on Wood substrates, use #14 Pan Head Wood Screws between 2 1/2" to 4" in length. For other substrates, contact us to inquire.

Width = 1/4" · Height = 1 3/8" · Thickness = 1/8" · Lift-off = 3/8"

WC318708D10 8' Length
WC318712D10 12' Length



Wine Cellar Collection

Fasteners, Drill Bits & Taps

Screws & Rods

All Products are Stainless Steel unless specified as (Zinc).

Scan to view all fasteners



Self-Tapping Screws



PART #	Description	Uses
SSPH12X34PK	#12 x 3/4" Flat Head	Handrail Attachment Plates into Metal Handrail. (50 pcs).
SSPH620X38	6-20 x 3/8" Pan Head	SSL2LED4 Mounting Clips. (50 pcs).

Machine Screws



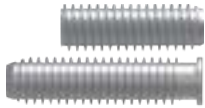
PART #	Description	Uses
SSM4	M4 x 10mm Flat Head	Cover of Edge Mount Spigots.
SSM612BX	M6 x 12mm Flat Head	Handrail Attachment Plates into Tube Supports & Handrail Brackets; Rod Holders into Post. (100/box).
SSM616BX	M6 x 16mm Flat Head	Side Screws for Glass Clips. (100/box).
SSM620BX	M6 x 20mm Flat Head	Handrail Attachment Plates into Tube Supports & Handrail Brackets; Rod Holders into Post.
SSM625	M6 x 25mm Flat Head	Handrail Attachment Plates into Tube Supports & Handrail Brackets; Rod Holders into Post.
SSM812	M8 x 12mm Flat Head	Back Plate of Wall Bracket to Elbow.
SSM816	M8 x 16mm Flat Head	Back Plate of Wall Bracket to Elbow.
SSM820	M8 x 20mm Socket Head	Glass Clips into Post.
SSSPIGOTBOLT	M12 x 178mm	For use as Thru-Bolt for all installation applications.
SSFLPK1	3/8" x 2" Button Head	Wood Fastener for SSJ112114 .
SSFLPK2	3/8" x 2" Hex Head	Wood Fastener for SSJ112112 .
SSFLPK3	3/8" x 2" Socket Head	Wood Fastener for SSJ1122 or SSJQ112 .

Wood Screws



PART #	Description	Uses
SSFL8X1	#8 x 1"	Handrail Attachment Plates into Wood Handrail.
FKAS1234VP	#12 x 3/4"	Handrail Attachment Plates into Wood Handrail. (50pcs/pk).
SSFL12X2	#12 x 2"	Wall Brackets into Wall (Wood).
SSFL14X2	#14 x 2"	Wall Brackets into Wall (Wood).

Wood Screw Inserts



PART #	Description	Uses
SSKFW382	3/8" x 2"	Standard Standoffs (SSK 1 1/2" and 2" dia.) into Wood.
SSKFW38234	3/8" x 2 3/4"	Adjustable Standoffs (SSJ 1 1/2" dia.) into Wood (with Drywall).

Reducer Screws



PART #	Description	Uses
SSFPM6TOM8	M6 to M8	Connecting M6 hole to M8 hole for Rod Systems.
SSFPM8TOM10	M8 to M10	Connecting M8 hole to M10 hole for Rod Systems.

Threaded Rods

PART #	Description	Uses
--------	-------------	------

Metric



SSM505	M5 x 5mm	Stainless Steel Collars Set Screw replacement.
---------------	----------	--



SSM850SET	M8 x 50mm	Off-the-Glass Handrail Brackets.
------------------	-----------	----------------------------------

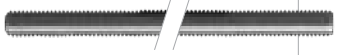
SSM8100SET	M8 x 100mm	Off-the-Glass Handrail Brackets.
-------------------	------------	----------------------------------



SSM1060SET	M10 x 60mm	
-------------------	------------	--

SSM1080SET	M10 x 80mm	
-------------------	------------	--

SSM10100SET	M10 x 100mm	
--------------------	-------------	--



SSM8ROD	M8 x 1m (Zinc)	
----------------	----------------	--

SSM10ROD	M10 x 1m (Zinc)	
-----------------	-----------------	--

SSM12ROD	M12 x 1m (Zinc)	
-----------------	-----------------	--

Imperial



SSKF5161	5/16"-18 x 4"	Standard Standoffs (SSK 1 1/4" dia.) with Epoxy into concrete.
-----------------	---------------	--

SSKF384	3/8"-16 x 1 1/8"	Standard Standoffs Caps (SSK 1 1/2" & 2" dia.).
----------------	------------------	---

SSKF383	3/8"-16 x 1 9/16"	Standard Standoffs (SSK 1 1/2" & 2" dia.).
----------------	-------------------	--



SSKF382	3/8"-16 x 3 1/2"	Standard Standoffs (SSK 1 1/2" & 2" dia.), Adjustable Standoffs (SSJ 1 1/2" dia.).
----------------	------------------	---

SSKF381	3/8"-16 x 5"	Standard Standoffs (SSK 1 1/2" & 2" dia.), Adjustable Standoffs (SSJ 1 1/2" dia.).
----------------	--------------	---



SSKF121	1/2"-13 x 5"	Adjustable Standoffs (SSJ 2" dia.), Base Shoes, Top/Side/Edge Mount Adjustable Spigots, Heavy Duty Posts with Epoxy into concrete.
----------------	--------------	--

Anchoring

PART #	Description	Uses
--------	-------------	------



FR5-10MX	10 oz.	FLO-ROK® FR5 MAX Injection Anchoring Adhesive/Epoxy.
-----------------	--------	--


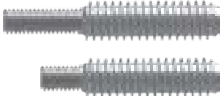
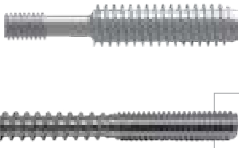
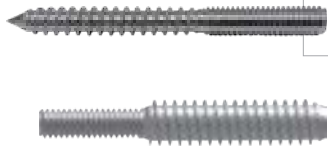





PA100		FLO-ROK® FR5 MAX 10 oz. Manual Dispensing Tool.
--------------	--	---



ROCKITE	50 lbs Pail	Anchoring & Patching Cement (Gypsum-Based).
----------------	-------------	---


Hanger Bolts Imperial

	PART #	Description	Uses
	HB12312	1/2" x 3 1/2" (Zinc)	Adjustable Standoffs (SSJ 2" dia.), Side Mount Spigots into Wood.
	HB124SS	1/2" x 4"	Adjustable Standoffs (SSJ 2" dia.), Side Mount Spigots into Wood.
	HB125	1/2" x 5" (Zinc)	Adjustable Standoffs (SSJ 2" dia.), Side Mount Spigots into Wood.
	HB125SS	1/2" x 5"	Adjustable Standoffs (SSJ 2" dia.), Side Mount Spigots into Wood.
	SSKFHB5161	5/16" x 3"	Standard Standoffs (SSK 1 1/4" dia.) Into Wood.
	SSKFHB38212	3/8" x 2 1/2"	Standard Standoffs (SSK 1 1/2" and 2" dia. in 1 1/2", 1 3/4" & 2" lengths) into Wood.
	SSKFHB38314	3/8" x 3 1/4"	Standard Standoffs (SSK 1 1/2" and 2" dia. in 1 1/2", 1 3/4" & 2" lengths) into Wood.
	SSKFHB13835	3/8" x 3 1/2"	Standard Standoffs (SSK 1 1/2" and 2" dia. in 1 1/2", 1 3/4" & 2" lengths) into Wood.
	SSKFHB1384	3/8" x 4"	Standard Standoffs (SSK 1 1/2" and 2" dia. in 1 1/2", 1 3/4" & 2" lengths) into Wood.
	SSKFHB384	3/8" x 4" 2" dia. in 3/4" & 2" lengths) into Wood.	Standard Standoffs (SSK 1 1/2" dia. in 1/2" & 2" lengths and 2" dia. in 3/4" & 2" lengths) into Wood.
	SSJHB124SS	1/2" x 4"	Adjustable Standoffs (SSJ 2" dia.) into Wood.
	HBD38	3/8"	Hanger Bolt Driver for 3/8" Hanger Bolts.
	HBD12	1/2"	Hanger Bolt Driver for 1/2" Hanger Bolts.



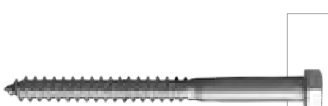

Hanger Bolts Metric

	PART #	Description	Uses
	HBM850	M8 x 50mm	
	HBM880	M8 x 80mm	Wall Brackets into Wood.
	HBM8100	M8 x 100mm	Wall Brackets into Wood.
	HBM1050	M10 x 50mm	
	HBM1080	M10 x 80mm	Wall Brackets into Wood.
	HBM10100	M10 x 100mm	Wall Brackets into Wood.
	HBM12120	M12 x 120mm	Adjustable Standoffs (SSJ 2" dia.) into Wood.


Torpedo Bolts (Zinc)

	PART #	Description	Uses
	UTB14214BX	1/4" x 2 1/4" (100/box)	
	UTB143BX	1/4" x 3" (100/box)	
	UTB38212	3/8" x 2 1/2" (50/box)	
	UTB384	3/8" x 4" (50/box)	Posts, Standard Spigots 6" & 8", and SSJ112 into concrete.

Lag Bolts

	PART #	Description	Uses
	LAG383	3/8" x 3" (Zinc)	Posts and Standard Spigots 6" & 8" into Wood.
	LAG383SS	3/8" x 3"	Posts and Standard Spigots 6" & 8" into Wood.
	LAG384	3/8" x 4" (Zinc)	Posts and Standard Spigots 6" & 8" into Wood.
	HLZ384L	3/8" x 4" (50/box) (Zinc)	Posts and Standard Spigots 6" & 8" into Wood.
	LAG384SS	3/8" x 4"	Posts and Standard Spigots 6" & 8" into Wood.
	HLS384CT	3/8" x 4" (25/box)	Posts and Standard Spigots 6" & 8" into Wood.
	LAG385	3/8" x 5" (Zinc)	Posts and Standard Spigots 6" & 8" into Wood.
	HLZ385L	3/8" x 5" (50/box) (Zinc)	Posts and Standard Spigots 6" & 8" into Wood.
	LAG385SS	3/8" x 5"	Posts and Standard Spigots 6" & 8" into Wood.
	HLS385CT	3/8" x 5" (20/box)	Posts and Standard Spigots 6" & 8" into Wood.
	HLS385-BX	3/8" x 5" (200/box)	Posts and Standard Spigots 6" & 8" into Wood.
	LAG123SS	1/2" x 3"	Edge Mount Spigots & Side Mount Base Shoe into Wood.
	LAG124SS	1/2" x 4"	Edge Mount Spigots & Side Mount Base Shoe into Wood.
	LAG125	1/2" x 5" (Zinc)	Top Mount Adjustable Spigots, Top Mount Base Shoe into Wood.
	LAG125SS	1/2" x 5"	Top Mount Adjustable Spigots, Top Mount Base Shoe into Wood.

Wedge Anchors

	PART #	Description	Uses
	ISS12234	1/2" x 2 3/4"	
	ISS12334	1/2" x 3 3/4"	Adjustable Standoffs (SSJ 2" dia.) into concrete.
	ISS12412	1/2" x 4 1/2"	Adjustable Standoffs (SSJ 2" dia.), Base Shoes, Top/Side/Edge Mount Adjustable Spigots into concrete.
	ISS12512	1/2" x 5 1/2"	Adjustable Standoffs (SSJ 2" dia.), Base Shoes, Top/Side/Edge Mount Adjustable Spigots, Heavy Duty Posts with Epoxy into concrete.
	ISS34512	3/4" x 5 1/2"	
	ISS38214	3/8" x 2 1/4"	
	ISS38234	3/8" x 2 3/4"	
	ISS383	3/8" x 3"	Posts, Standard Spigots 6" & 8", & SSJ112 into concrete.
	ISS38334	3/8" x 3 3/4"	Posts, Standard Spigots 6" & 8", & SSJ112 into concrete.
	ISS385	3/8" x 5"	Posts, Standard Spigots 6" & 8", & SSJ112 into concrete.
	WED12234-BX	1/2" x 2 3/4" (50/box) (Zinc)	
	WED12334-BX	1/2" x 3 3/4" (50/box) (Zinc)	Adjustable Standoffs (SSJ 2" dia.) into concrete.
WED12412-BX	1/2" x 4 1/2" (50/box) (Zinc)	Adjustable Standoffs (SSJ 2" dia.), Base Shoes, Top/Side/Edge Mount Adjustable Spigots into concrete.	
WED12512-BX	1/2" x 5 1/2" (50/box) (Zinc)	Adjustable Standoffs (SSJ 2" dia.), Base Shoes, Heavy Duty Post, Top/Side/Edge Mount Adjustable Spigots into concrete.	
WED34512-BX	3/4" x 5 1/2" (20/box) (Zinc)		
WED38214-BX	3/8" x 2 1/4" (50/box) (Zinc)		
WED38234-BX	3/8" x 2 3/4" (50/box) (Zinc)		
WED383-BX	3/8" x 3" (50/box) (Zinc)	Posts, Standard Spigots 6" & 8", & SSJ112 into concrete.	
WED38334-BX	3/8" x 3 3/4" (50/box) (Zinc)	Posts, Standard Spigots 6" & 8", & SSJ112 into concrete.	
WED385-BX	3/8" x 5" (100/box) (Zinc)	Posts, Standard Spigots 6" & 8", & SSJ112 into concrete.	

Sleeve Anchors (Zinc)



PART #	Description	Uses
SLE12214-BX	1/2" x 2 1/4" (25/box)	Adjustable Standoffs (SSJ 2" dia.) into concrete.
SLE123-BX	1/2" x 3" (25/box)	
SLE124-BX	1/2" x 4" (25/box)	
SLE34414-BX	3/4" x 4 1/4" (10/box)	
SLE34614-BX	3/4" x 6 1/4" (10/box)	Posts, Standard Spigots 6" & 8", & SSJ112 into concrete.
SLE383-BX	3/8" x 3" (50/box)	
SLE384-BX	3/8" x 4" (50/box)	

Washers & Nuts

PART #	Description	Uses
--------	-------------	------

Washers



PWZ516VP	5/16" Flat (100/box) (Zinc)
PWS516VP	5/16" Flat (100/box)
PWZ14VP	1/4" Flat (100/box) (Zinc)
PWS14VP	1/4" Flat (100/box)
PWZ39VP	3/8" Flat (75/box) (Zinc)
PWS38VP	3/8" Flat (100/box)
PWZ12CT	1/2" Flat (75/box) (Zinc)
PWS12CT	1/2" Flat (100/box)

Nuts



SSNUT3816	3/8"-16 Hex Nut (50/box)
SSNUT1213	1/2"-13 Hex Nut (50/box)



SSRIVETM6	M6 Rivet Nut (50/box)	Polaris Hinges (Series 125) & hydraulic Hinges into Posts.
SSRIVETM8	M8 Rivet Nut (50/box)	Glass Clips & off-the-Post Handrail Brackets into Posts.
SSRIVET38	3/8"-16 Rivet Nut (50/box)	Double Arm Glass Connector, Straight Arm Spider, and Glass Clip into Blank Heavy Duty Posts.

Tools



PART #	Description	Uses
SSRIVET	Hand Rivet Nut Gun	Inserting Rivet Nut into Posts.



SSRIVETCM6	M6 Rivet Nut Collet (Metric)	Inserting Rivet Nut into Posts.
SSRIVETCM8	M8 Rivet Nut Collet (Metric)	Inserting Rivet Nut into Posts.
SSRIVETC38	3/8" Rivet Nut Collet (Imperial)	Inserting Rivet Nut into Posts.



Stub Drill - Drill Press

PART #	Description	Uses
134-648	1 1/64"	For SSPH12X34 Stainless Steel / Steel.
134-656	5.0mm M6 x 1	Stainless Steel / Steel.
134-679	6.8mm M8 x 1.25	Stainless Steel / Steel.
134-416	8.5mm M10 x 1.5	Stainless Steel / Steel.
134-700	8.5mm M10 x 1.5	Stainless Steel / Steel.
128346	#7 0.2010	(Use with TAP1/4-20-3) Steel.



Jobber Drill - Hand Tool

PART #	Description	Uses
133-993	#7 for 1/4-20 Tap	(Also for Drill Press) Stainless Steel / Steel.
134-502	13/64" for 1/4" Tap	Stainless Steel / Steel.
134-517	1/4"	Stainless Steel / Steel.

Jobber Drill - Drill Press

PART #	Description	Uses
128136	#7 0.2010	(Use with TAP1/4-20-3) Steel.
144-110	6.8mm for M8	Steel.
118-011	7/32" HSS & Cobalt general purpose Drill Bit	(Use with TAP1/4-20-3) Steel.

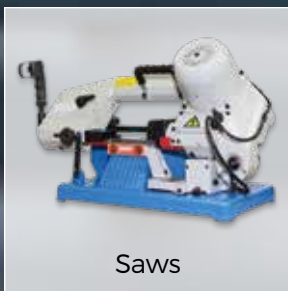


Taps - Drill Press

PART #	Description	Uses
123-116	Hand Tap 1/4 - 20	Stainless Steel / Steel.
123-498	Hand Tap 4 Flute M6 x 1	Stainless Steel / Steel.
123-499	Hand Tap 4 Flute M8 x 1.25	Stainless Steel / Steel.
123-500	Hand Tap 4 Flute M10 x 1.25	Stainless Steel / Steel.
124-675	Hss Roll Form Tap 1/4 - 20	Stainless Steel / Steel.
124-765	Hss Roll Form Tap M6 x 1	Stainless Steel / Steel.
124-770	Hss Roll Form Tap M8 x 1.25	Stainless Steel / Steel.
TAP1/4-20-3	Hsse-V3 Spiral Flute Tap 1/4 20 x 3	Steel.

Metal Machinery / Tools & Accessories





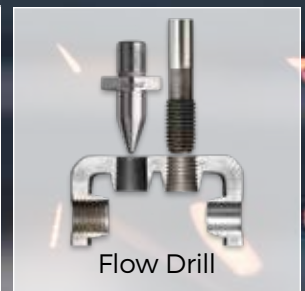
Saws



Grinding Tools



Polishing Tools



Flow Drill











FEMI NG120XL PROFESSIONAL BENCHTOP MITRING BANDSAW

Part # 69908030047

“NG” SYSTEM: Opposite Blade Rotation Direction provides a more efficient & cleaner cut than traditional blade cutting systems. Up to **60% faster** cutting using this patented reverse cutting technology.

NG120XL Technical Data

 WATT	 mm	 Z/t*	 m/min	 a x b x h (mm)	 Kg
1300 	1440x13x0.65	14*	35 ÷ 80	900 x 400 x 520	18




*Standard bimetal cobalt blade  110 Volt - Hz 50 single-phase motor



BB4825121014
Bandsaw Blades available. Contact us to inquire.

Scan QR code to see our demo video.

NG120XL Cutting Capacity




			
@ 0°	120 x 102 mm	120mm	112 x 112mm
@ 45°	78 x 78 mm	80mm	78 x 78mm
@ 60°	50 x 43 mm	50mm	48 x 48mm




G4510WA-2 EURO 4" PORTABLE BANDSAW

Part # G4510WA-2

G4510WA-2 Technical Data

 WATT	 mm	 Z/t*	 m/min	 a x b x h (mm)	 Kg
370	1440x13x0.65	14*	45@50HZ 54@60HZ	730 x 360 x 450	27

*Standard bimetal cobalt blade  110 Volt - Hz 50 single-phase motor



BB4978121014
Bandsaw Blades available. Contact us to inquire.

Scan QR code to see our demo video.

G4510WA-2 Cutting Capacity

		
@ 90°	100 x 150 mm	100mm
@ 45°	60 x 100 mm	60mm



Special Order Only

7 1/4" METAL CUTTING SAW

Includes: Case, Wrench, 7 1/4" Mild Steel Blade, Guide, Internal Laser Guide, Safety Protection.

PART #	Motor HP	Input Power	Max RPM	Max Depth Of Cut
69908120000	1.9	12A(1,400W)	3,800	2 3/8" (60mm)

7 1/4" Saw Blades

PART #	Used For	Capacity
63502007200	Mild Steel	5/16" (8mm)
63502007210	Aluminum	3/8" (9.5mm)
63502007220	Stainless Steel	1/4" (6mm)
69908120450	Thin Steel	1/4" (6mm)



Special Order Only

9" METAL CUTTING SAW

Includes: Case, Wrench, 9" Mild Steel Blade, Guide, Internal Laser Guide, Safety Protection.

PART #	Motor HP	Input Power	Max RPM	Max Depth Of Cut
69908120001	2.4	15A(1,400W)	2,300	3 1/8" (80mm)

9" Saw Blades

PART #	Used For	Capacity
63502009540	Mild Steel	1/2" (12.7mm)
63502009550	Aluminum	5/8" (15.9mm)
63502009560	Stainless Steel	5/16" (8mm)
69908120448	Thin Steel	1/4" (6mm)



Special Order Only

14" METAL CUTTING SAW

Features: Unique Auto-retracting Blade Guard, Quick release vise, & Ability to Bevel up to 45 degrees.

Includes: Case, Wrench, 14" Mild Steel Blade, Guide, Internal Laser Guide, Safety Protection.

PART #	Motor HP	Input Power	Max RPM	Max Depth Of Cut
72905361120	3.0	15A (1,800 W)	1,300	5 1/8" (130mm) Round 4 3/4" (120mm) Square

14" Saw Blades

PART #	Used For	Capacity
63502014600	Mild Steel	1/2" (12.7mm)
63502014610	Aluminum	5/8" (15.9mm)
63502014620	Stainless Steel	5/16" (8mm)
63502014630	Thin Steel	1/4" (6mm)



BOSCH
Invented for life



**Bosch 1375A
Electric Grinder**

Wheel Diameter: 4 1/2"
Amps: 6
RPM: 11,000



**Fein WSG11-125
Electric Grinder**

Wheel Diameter: 5"
Watts: 11,000
RPM: 11,000



Einhell



**Einhell 4431122
Cordless Grinder**

Wheel Diameter: 4 1/2"
RPM: 8,500
2.5 Ah Battery recommended.
Batteries sold separately.



**Einhell 4512131
2.5 Ah Battery & Charger Kit**



Cut Off Wheel Zip Cut (25Pcs/Pack)

PART #	Dimensions	Peripheral Speed (m/s)	Max RPM (1/min)
SS412116	4 1/2" x 1/16" x 7/8"	80	13,300
SS412132U	4 1/2" x 1/32" x 7/8"	80	13,300
SS5116	5" x 1/16" x 7/8"	80	12,250
SS5132U	5" x 1/32" x 7/8"	80	12,250
SS6116	6" x 1/16" x 7/8"	80	10,200
SS7116	7" x 1/16" x 7/8"	80	8,500



Cut Off Wheel Zip Cut Depressed (25Pcs/Pack)

PART #	Dimensions	Peripheral Speed (m/s)	Max RPM (1/min)
SS412116DP	4 1/2" x 1/16" x 7/8"	80	13,300
SS5116DP	5" x 1/16" x 7/8"	80	12,250
SS7116DP	7" x 1/16" x 7/8"	80	8,500



Fine Finishing Disc

PART #	Dimensions	Peripheral Speed (m/s)	Max RPM (1/min)
POL412F	4 1/2" x 7/8"	80	13,300
POL512F	5" x 7/8"	80	12,200



Medium Finishing Disc

PART #	Dimensions	Peripheral Speed (m/s)	Max RPM (1/min)
POL412M	4 1/2" x 7/8"	80	13,300
POL512M	5" x 7/8"	80	12,200



FEIN PIPE POLISHER/SANDER PROFESSIONAL SET

RS12-70E

Includes:

- 1 RS12-70E Pipe Polisher/Sander.
- Sanding Belts 20 x 815mm - 120 Grit (x10) + 180 Grit (x10).
- Sanding Belts 40 x 815mm - 120 Grit (x10) + 180 Grit (x10).
- Fleece Belts 20 x 815mm - 280 Grit (x5).
- 1 Carrying Case.

Additional Accessories Sold Separately



Sanding Belts (Sold in packs of 10)

- 69908034025 20 x 815mm 80 Grit ★
- 63714050015 20 x 815mm 120 Grit
- 63714051014 20 x 815mm 180 Grit
- 63714052017 20 x 815mm 320 Grit
- 63714053011 20 x 815mm 400 Grit
- 69908034234 20 x 815mm 600 Grit
- 69908034253 40 x 815mm 60 Grit
- 69908036109 40 x 815mm 80 Grit ★
- 63714054019 40 x 815mm 120 Grit
- 63714055013 40 x 815mm 180 Grit
- 69908034235 40 x 815mm 280 Grit ★



Fleece Belts (Sold in packs of 5)

- 63714056016 40 x 815mm 80 Grit ★
- 63714057010 40 x 815mm 120 Grit
- 63714058018 40 x 815mm 280 Grit
- 69908034252 40 x 815mm Coarse
- 69908036110 40 x 815mm Medium
- 69908036135 40 x 815mm Fine



Ceramic Belts (Sold in packs of 10)

- 63714130010 20 x 815mm 80 Grit ★
- 63714131010 40 x 815mm 80 Grit



Polishing Belts (Sold in packs of 3)

- 63726010018 20 x 815mm

★ SPECIAL ORDER ITEMS
For Technical Specifications, visit our Website.



FEIN WP014-25E METAL FINISHER

69908030010

High performance Metal Finisher for processing of Stainless Steel surfaces.

Features:

- Soft-start.
- Soft-start lock.
- FEIN high-performance motor.
- Spindle lock.
- 1,200 Watts.
- 2,500 Max RPM.
- 9" (230mm) Polishing Disc.



FEIN SS FINISHING KIT

63721050020

Perfect, blemish-free Satin finishing with extremely low head build-up.

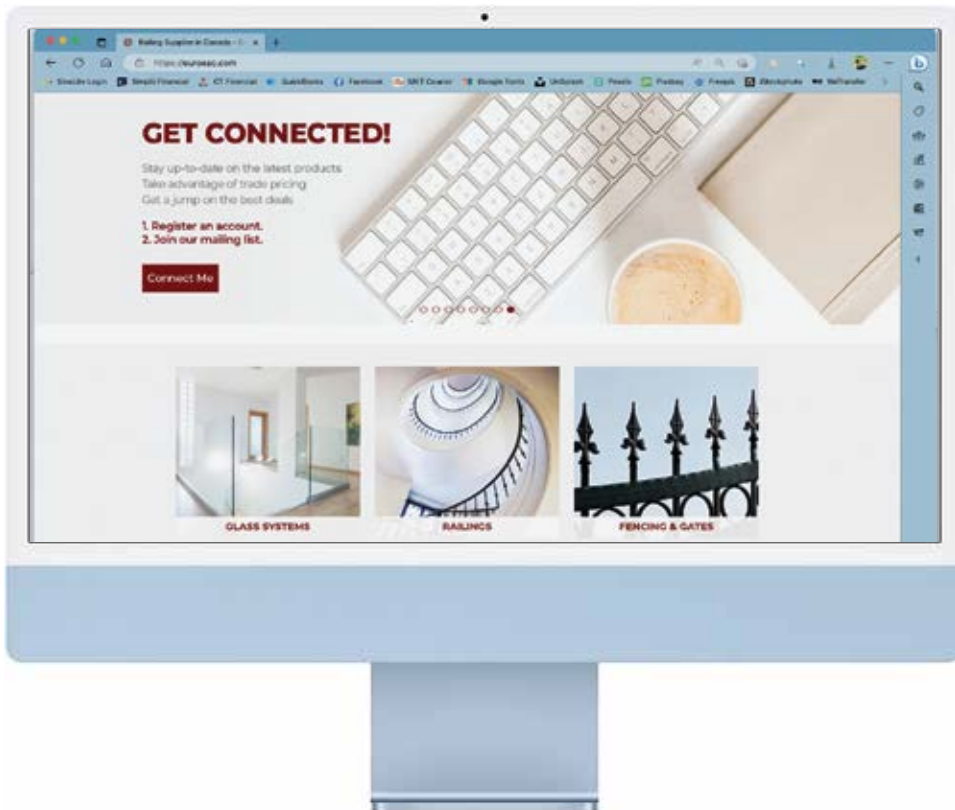
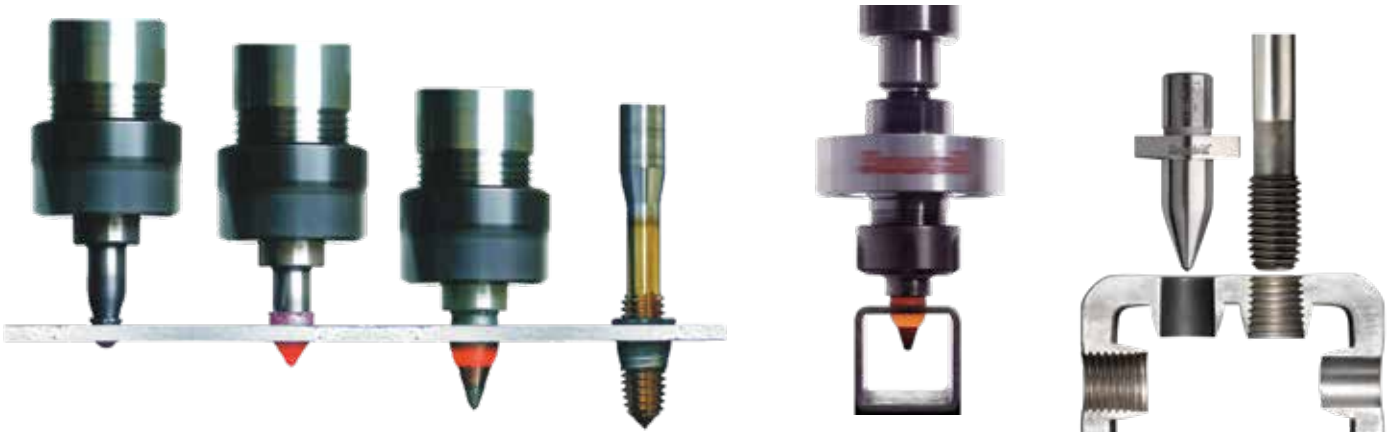
Includes:

- 60 Grit medium gum wheel (1pc).
- 180 Grit fine gum wheel (1pc).
- 180 Grit fine sinus fleece wheel (1pc).

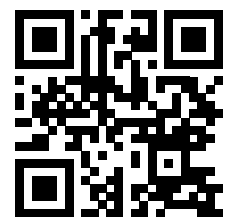
Flowdrill®



A Flowdrill is a lobed, conical tungsten carbide tool. When rotated at high speed and pressed with high axial force into sheet Metal or thin Walled Tube, generated heat softens the Metal and allows the Drill to feed forward, produce a hole and simultaneously form a Bushing from the displaced material. Contact us for more information.



Please scan the code to see more machinery, tools, and hardware on our Website.



Cleaners, Protectors, & Silicone



CHOOSE THE RIGHT PROTECTIVE COATING

Painted, Anodized or Architectural Metal

A clear, protective UV coating formulated to restore color and luster to dull, faded, oxidized metal of any color. Add years of protection from tarnish, oxidation, and corrosion.

The logo for EVERBRITE, featuring the word "EVERBRITE" in a bold, red, sans-serif font with a white outline and a slight shadow effect.

Stainless Steel High Use & Abuse Mirror Polish

A tough, thin, clear coating for high touch surfaces providing protection from salt damage, tarnish, corrosion, and oxidation.

The logo for PROTECTA Clear, with "PROTECTA" in a bold, blue, sans-serif font and "Clear" in a smaller, blue, cursive font.

Antimicrobial Protection

A clear coating providing protection for most surfaces from environmental damage, while helping to prevent the spread and growth of bacteria.

The logo for CROBIAL COAT MICROBAN, featuring the words "CROBIAL COAT" in a bold, green, sans-serif font with a white outline, and "MICROBAN" in a smaller, black, sans-serif font below it, all enclosed in a circular border.

Everbrite Protective Coating

EVERBRITE™



Everbrite Protective Coating

- Has more UV blockers and anti-oxidants in it than ProtectaClear.
- One-part coating; no mixing, no waste.
- Has UV protection to protect painted metals from fading and chalking on painted or exterior metal.
- Remains flexible; will not crack, chip, or peel when garage doors roll up and down.
- Protects from fading and oxidation; has additional UV protection to protect exterior metal from tarnishing.
- Will seal rusted metal: bronze sculptures, architectural metal, or other metal.
- Will not yellow; remains crystal clear.
- Self-Leveling: application marks level out.
- Excellent adhesion on metal, even polished metals.
- Self-annealing: will blend to itself so repairs are easy.
- Will last 4-5 years if cleaned properly and 2 coats applied.

Everbrite Uses

- Painted Metals: Metal Sidings, Storage Doors, Metal Roofs, Garage Doors, and Gutters.
- Metal Buildings: Sheds and more.
- Garage Doors or Storage Roll-up Doors.
- Copper Gutters.
- Copper Roofs.
- Cupolas.
- Finials.
- Weathervanes.
- FiberGlass.
- COR-TEN® Metals (Rusty).
- Marine Grade Metals: Brass, Copper, Bronze, and Zinc.

PART #	Size	Coverage (Sq.Ft.)	Finish
SSEVEVER1	4 oz.	25	Clear
SSEVEVER2	Pint	125	Clear
SSEVEVER2S	Pint	125	Satin
SSEVEVER3	Quart	250	Clear
SSEVEVER4	Gallon	1,000	Clear
SSEVEVER6	12 oz. Spray	60	Clear

Contact us for additional sizes.

5 Gallon size of Everbrite, and any size in Satin finish are available as a special order.



Everbrite Protective Coating

PROTECTA Clear



Protectaclear Protective Coating

- Is thinner and tougher than Everbrite Protective Coating; solvent-based.
- Designed for use on unpainted metal.
- One-part coating; no mixing, no waste.
- Has excellent salt and chlorine resistance and superior adhesion to Stainless Steel and Polished Metal.
- Has extra salt protection for Marine applications or coastal environments or metal around pools.
- Is more scratch-resistant than Everbrite Protective Coating.
- Remains flexible; will not crack, chip, or peel.
- Will not yellow; remains crystal clear.
- Self-Leveling: application marks level out.
- Excellent adhesion on metal, even polished metals.
- Safe for use on jewellery or in kitchens. Food safe after cured.
- Self-annealing: will blend to itself so repairs are easy.

Protectaclear Uses

- Unpainted Metals: Railings, Doorknobs, or KickPlates.
- Unpainted Metals (Marine): Stainless Steel, Brass, Copper, etc.
- Jewellery: Copper, Brass, Silver, Plated Metals, and more.
- Stainless Steel or other metals around pools: e.g., sculptures.
- Engine: Motorcycle Parts, Wheels, and any Boat.
- Marine Grade Metals: Brass, Copper, Bronze, and Zinc.

PART #	Size	Coverage (Sq.Ft.)	Finish
SSEVPROTECT1	4 oz.	25	Clear
SSEVPROTECT2	Pint	125	Clear
SSEVPROTECT8	Pint	125	Satin
SSEVPROTECT3	Quart	250	Clear
SSEVPROTECT4	Gallon	1,000	Clear
SSEVPROTECT5	6 oz. Spray	60	Clear
SSEVPROTECT6	12 oz. Spray	60	Clear

Contact us for additional sizes.

5 Gallon size of ProtectaClear, and any size in Satin finish are available as a special order.



Crobial Coat Protection



CrobialCoat™ Antimicrobial is a durable, clear protective coating that provides protection for most surface rust, salt damage, tarnish, corrosion, and oxidation. CrobialCoat™ has built-in Microban® Antimicrobial technology for an added level of protection against the growth of microbes. It is our most durable and scratch-resistant coating. Ideal for high-touch surfaces where cleanliness matters.

- Combines the tough protection of ProtectaClear® with the antimicrobial product protection of Microban®, keeping coated surfaces 99% cleaner by inhibiting the growth of bacteria and microbes.
- Clear coating specifically designed for protection of metals (even highly polished metals), ceramics, hard plastic, and hardwoods.
- Ideal for use in high-touch environments where cleanliness matters such as schools, hospitals, kitchens, and restrooms in both home and commercial environments.
- Will not wash off - antimicrobial protection remains effective for the life of the coating.
- Surfaces stay cleaner longer, show less fingerprints, and are much easier to maintain with less effort and time.
- Helps prevent odours due to odour-causing bacteria.
- Sealed surfaces clean easily with mild soap and water.
- Contains powerful antioxidants to protect against tarnish, oxidation, and corrosion.
- Remains flexible - will not crack, chip, peel, or discolour.
- Self-Leveling and self-annealing - blends to itself, making touch-ups easy. Easily adds an extra layer of antimicrobial protection to surfaces already coated with ProtectaClear® without additional prep.
- One-part coatings - no mixing or waste.
- Suitable for marine and ocean environments - highly salt-resistant.
- Excellent adhesion - even to highly polished metals.

PART #	Size	Coverage (Sq.Ft.)
SSEVPROCOAT1	4 oz.	25
SSEVPROCOAT2	Pint	125
SSEVPROCOAT3	Quart	250

Not recommended for use on soft plastic, rubber, or silicon.



Stainless Steel Cleaning Kits

Stainless Steel Cleaning Kits clean and restore rusted or corroded Stainless Steel and protect it from rust, corrosion, salts, chlorines, and more. The 4 oz. Kit cleans 25 sq. ft. and the Pint kit cleans 125 sq. ft.

Each Kit includes: Stainless Steel Rust Remover, EZ PREP Cleaner & Neutralizer, ProtectaClear, Prep Pad Scrubber, Applicator Pad, and Nitrile Gloves.

***NOT INCLUDED:** Solvent for final wipe. Xylene or Denatured Alcohol are recommended. ProtectaClear can be removed with Xylene.



PART # Size
SSEVSSKIT1 4oz.



PART # Size
SSEVSSKIT2 Pint

Garage Door Cleaning Kits

Garage Door Cleaning Kits restore the original colour and luster of your garage door. Available in 1-Door and 2-Door Kits.

Each Kit includes: Everbrite, EZ PREP Cleaner & Neutralizer, Prep Pads, Applicator Pad(s), Microfiber Cleaning Towel, and Nitrile Gloves.

Advantages:

- Less mess than painting.
- Much easier than painting.
- Less expensive than painting.
- No masking or taping necessary.
- Protect the door hardware at the same time.
- Everbrite lasts much longer than repainting.
- Coated surface is much easier to keep clean. Repels dirt.



PART # Size
SSEVDOOR1 1-Door



PART # Size
SSEVDOOR2 2-Door

Additional Everbrite Cleaning Products



EZ Prep Cleaner & Neutralizer

SSEVACC1 4 oz. bottle

- Highly concentrated, biodegradable, free-rinsing cleaner and neutralizer; emulsifies.
- Does NOT remove tarnish or rust from Copper, Brass, Stainless Steel, or other metal.
- Works exceptionally well for cleaning chalky oxidation on Metal Siding, Storage Doors, or other painted metal.



HD Copper Cleaning Gel

SSEVACC2 16 oz. jar

- Environmentally friendly, heavy-duty Copper Cleaner. Unique solution blended specifically to remove tarnish and oxides from Copper-based Metals.
- Use on Copper Roofs (will cling), Gutters, Hoods, Fireplaces, and other Copper that is difficult to clean.



Midas Touch Metal Polishing Cream

SSEVACC7 4.5 oz. Tube

- Gently removes tarnish, film, and hairline scratches from ALL metal surfaces while restoring them to their original luster and shine.
- Wiping with a solvent is still required to ensure proper adhesion.
- Does NOT contain any acid, so there is NO neutralizing necessary before coating with Everbrite or ProtectaClear.



Stainless Steel Rust Remover

SSEVACC5 8 oz. bottle

- Non-abrasive cleaner for cleaning Stainless Steel to remove rust, tea-staining, and iron deposits.
- FREE of Oxalic Acid - uses new technology. Very quick and effective.
- Thickly foams, so it clings - easy to use. Easily applied by brush or spray.
- Stays wet for a long time. Leaves surfaces clean, streak-free, and shiny.
- Effective in hard or soft water. Does not form white deposit with hard water.

Everbrite Prep Pad

SSEVACC6 1 piece

- Flexible, non-woven Pad acts as a great substitute for Steel Wool.
- Will not rust, shred, or splinter.
- Washable, reusable, and can be cut and folded.
- Use to remove chalk, oxidation, and stains from Painted Metal.
- Clean Anodized Aluminum, Storage Doors, Metal Buildings, Stainless Steel, Window Frames, Shutters, and more.
- Do NOT use on Mirror Finish Stainless Steel or anything that is highly polished!



Additional Cleaners & Accessories



**Sprayway
Glass
Cleaner**

GCCLEANER
539g / 16 fl.oz.



**Richelieu
Stainless Steel
Cleaner**

SSCLEANER
425g / 15 fl.oz.



**Weicon
Stainless Steel
Spray Paint**

SSSPRAYPAINT
500mL



**Weicon
2-Part
Adhesive Kit**

SSRK-1500
60g

**Scotch-Brite
Scouring Pads**

3MASB7447B
Sold in packs of 5.

Silicone



General Purpose

G.E. Silicone

GESCS1200
299mL Clear.

GESCS1200W
299mL White.



CS Silicone

SILICONE1
300mL Clear.



Mold &
Mildew
Resistant.

Sanitary

G.E. Silicone

GESCS1700
299mL Clear.



Richelieu Silicone

SILICONE2
300mL Clear.

DEEP CLEAN YOUR GLASS.



GLASS SCRUB®

Water Spot & Stain Remover

GGCLEANER2 (500 mL / 16 fl. oz.)

Glass SCRUB® removes the toughest Stains, Soap Scum, Rust, and Hard Water Mineral Deposits in Kitchens, Baths, and throughout the home.

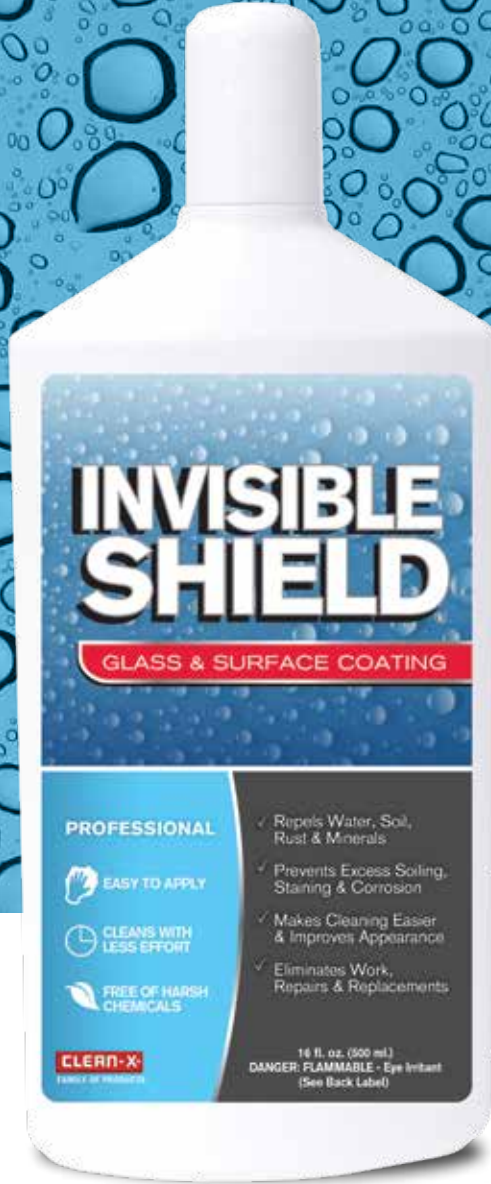
Glass SCRUB® deep cleans Sinks, Tubs, Showers, and Counters to a sparkling shine without scratching or dulling the surface. Perfect for Glass, Porcelain, Ceramics, and other hard surfaces such as Granite and Tile.

Used by professionals. The ultimate stain and build-up remover... guaranteed!

Properties

- Active Ingredients: Finely-divided Crystalline Silica, Soap, and Detergent.
- Flash Point: Non-flammable – Water-based.
- Odour: Mild (Wintergreen).
- Colour: White to Off-white.
- pH: 3.0.
- Viscosity: Consistency of Cream.
- Specific Gravity: 1.15.
- Storage Stability: Minimum 2 years.
- Weight per Gallon: 4.34 kg / 9.56 lbs.
- Freeze/Thaw Stability: Good.

PROTECT YOUR GLASS.



INVISIBLE SHIELD®

Protective Glass & Surface Coating

GCCLEANER3 (500 mL / 16 fl. oz.)

INVISIBLE SHIELD® seals, polishes, and protects Glass Windows, Patio Doors, Shower Doors & Enclosures, Porcelain Sinks & Bathtubs, and Ceramic Tile Walls & Counters.

INVISIBLE SHIELD® protects surfaces with a water, soil, and stain repellent finish that dramatically reduces the adhesion and build-up of Dirt, Grime, Water Spots, Limescale, Rust, Soap Scum, and Hard Water Minerals for easier next-time cleaning.

Long-lasting and resists Soaps, Solvents, and Detergents. Infinitely renewable!

Properties

- Active Ingredient: Dimethyl Polysiloxanes.
- Flash Point: 19°C / 66°F (TAG Open Cup).
- Odour: Mild (Ethyl Alcohol).
- Colour: Clear, colourless liquid.
- Acid Number: About 1.
- Viscosity: Consistency of Alcohol.
- Specific Gravity: 0.802.
- Abrasives: None.
- Storage Stability: Minimum 5 years.
- Weight per Gallon: 3.5 kg / 7.7 lbs.

Index

PART#	PAGE#	PART#	PAGE#	PART#	PAGE#	PART#	PAGE#
128136	202	BSST1662316	107	GCT124650	163	PWS516VP	201
128346	202	FKAS1234VP	197	GCT124652	163	PWZ12CT	201
4431122	207	FR5-10MX	40, 44, 198	GCT124654	163	PWZ14VP	201
4512131	207	G4510WA-2	205	GCT124654G2	163	PWZ39VP	201
63502007200	206	GESCS1200	218	GCT124656	163	PWZ516VP	201
63502007210	206	GESCS1200W	218	GCT124658	163	ROCKITE	198
63502007220	206	GESCS1700	218	GCT124660	163	RS12-70E	208
63502009540	206	GGCLEANER	164, 218	GCT124660G2	163	SILICONE1	218
63502009550	206	GGCLEANER2	164	GCT124662	163	SILICONE2	218
63502009560	206	GGCLEANER3	164	GCT124664	163	SLE12214-BX	201
63502014600	206	GGT123530	163	GCT124666	163	SLE123-BX	201
63502014610	206	GGT123532	163	GCT124668	163	SLE124-BX	201
63502014620	206	GGT123534	163	GCT124670	163	SLE34414-BX	201
63502014630	206	GGT123536	163	GCT124672	163	SLE34614-BX	201
63714050015	209	GGT123538	163	GCTTROLLEY	164	SLE383-BX	201
63714051014	209	GGT123540	163	GCTTROLLEYS	164	SLE384-BX	201
63714052017	209	GGT123542	163	HB12312	199	SS412116	208
63714053011	209	GGT123544	163	HB124SS	199	SS412116DP	208
63714054019	209	GGT123546	163	HB125	199	SS412132U	208
63714055013	209	GGT123548	163	HB125SS	199	SS5116	208
63714056016	209	GGT123550	163	HBD12	199	SS5116DP	208
63714057010	209	GGT123554	163	HBD38	199	SS5132U	208
63714058018	209	GGT123560	163	HBM10100	199	SS6116	208
63714130010	209	GGT123572	163	HBM1050	199	SS7116	208
63714131010	209	GGT124112	163	HBM1080	199	SS7116DP	208
63721050020	209	GGT124116	163	HBM12120	199	SSB5844TG	156
63726010018	209	GGT124118	163	HBM8100	199	SSB5844TGB	156
69908030010	209	GGT124120	163	HBM850	199	SSB5844TSB	156
69908030047	205	GGT124122	163	HBM880	199	SSBSQ1244TG	155
69908034025	209	GGT124124	163	HLS384CT	200	SSBSQ1244TGB	155
69908034234	209	GGT124126	163	HLS385-BX	200	SSBSQ1244TSB	155
69908034235	209	GGT124128	163	HLS385CT	200	SSCB18100	142
69908034252	209	GGT124130	163	HLZ384L	200	SSCB18250	142
69908034253	209	GGT124132	163	HLZ385L	200	SSCBBW3834	136, 142
69908036109	209	GGT124134	163	ISS12234	200	SSCBBW93234	136, 142
69908036110	209	GGT124136	163	ISS12334	40, 200	SSCBCONBIW	144
69908036135	209	GGT124138	163	ISS12412	40, 200	SSCBCONBWS	144
69908120000	206	GGT124140	163	ISS12512	200	SSCBCONCRKIT	144
69908120001	206	GGT124142	163	ISS34512	200	SSCBCONCRT	144
69908120448	206	GGT124144	163	ISS38214	200	SSCBCONECBL	144
69908120450	206	GGT124146	163	ISS38234	200	SSCBCONECSS	144
72905361120	206	GGT124148	163	ISS383	200	SSCBCONFWL	144
118-011	202	GGT124150	163	ISS38334	40, 200	SSCBCONKIT10	144
123-116	202	GGT124152	163	ISS385	200	SSCBCONKIT15	144
123-498	202	GGT124154	163	LAG123SS	200	SSCBCONKIT20	144
123-499	202	GGT124156	163	LAG124SS	200	SSCBCONKIT25	144
123-500	202	GGT124158	163	LAG125	200	SSCBCONKIT30	144
124-675	202	GGT124160	163	LAG125SS	200	SSCBCONKIT5	144
124-765	202	GGT124162	163	LAG383	200	SSCBCONSTAR	144
124-770	202	GGT124164	163	LAG383SS	200	SSCBCEBL	135, 142
133-993	202	GGT124166	163	LAG384	200	SSCBCESSCH	135, 142
134-416	202	GGT124168	163	LAG384SS	200	SSCBCESSDO	135, 142
134-502	202	GGT124172	163	LAG385	200	SSCBIB14516	136
134-517	202	GGT124624	163	LAG385SS	200	SSCBIB31614	136
134-648	202	GGT124628	163	MLSPS2L	171	SSCBIB381532	136
134-656	202	GGT124632	163	PA100	44, 198	SSCBKIT41410	135
134-679	202	GGT124632G1	163	POL412F	208	SSCBKIT41415	135
134-700	202	GGT124632G2	163	POL412M	208	SSCBKIT41420	135
1375A	207	GGT124636	163	POL512F	208	SSCBKIT41425	135
144-110	202	GGT124640	163	POL512M	208	SSCBKIT41430	135
3MASB7447	218	GGT124642	163	PSMC112SSSG	155	SSCBKIT41440	135
683RSS58G	156	GGT124644	163	PSMC112SSSSGB	155	SSCBKIT4145	135
683RSS58GB	156	GGT124646	163	PSMC112SSSSB	155	SSCBKIT41450	135
683RSS58SB	156	GGT124648	163	PWS12CT	40, 201	SSCBKIT41470	135
BB4825121014	205	GGT124648G1	163	PWS14VP	201	SSCBKIT71210	135
BB4978121014	205	GGT124648G2	163	PWS38VP	40, 201	SSCBKIT71215	135

PART#	PAGE#	PART#	PAGE#	PART#	PAGE#	PART#	PAGE#
SSCBKIT71220	135	SSEB4020116S	108	SSEVPROTECT6	214	SSGF10GM16S	122
SSCBKIT71225	135	SSEB4040304S	108	SSEVPROTECT8	214	SSGF10GX16S	122
SSCBKIT71230	135	SSEB4120116S	108	SSEVSSKIT1	216	SSGF1GM16B	122
SSCBKIT71240	135	SSEB4140316S	108	SSEVSSKIT2	216	SSGF1GM16GB	122
SSCBKIT7125	135	SSEB7020104S	108	SSFBO012216S	118	SSGF1GM16S	121, 122
SSCBKIT71250	135	SSEB7040304S	108	SSFBO022216S	118	SSGF1GM17B	122
SSCBNE18	136	SSEB8020116S	108	SSFBO032216S	118	SSGF1GM17S	122
SSCBQC18	142	SSEB8040316S	108	SSFBB212304	106	SSGF1GM18B	122
SSCBQCLAG	142	SSEB8050316S	108	SSFL12X2	197	SSGF1GM18S	122
SSCBQCLAG1	142	SSEB8100216S	110	SSFL14X2	197	SSGF12GM16S	125
SSCBQCP18	142	SSEB8110116S	110	SSFL8X1	197	SSGF13GM16S	125
SSCBQCPST18	142	SSEB9020116S	110	SSFLPK1	40, 197	SSGF14GM16S	125
SSCBRG18	136	SSEB9040316S	110	SSFLPK2	40, 197	SSGF200X16S	124
SSCBRT18	136	SSEB9050316S	110	SSFLPK3	40, 197	SSGR10001RBN	83
SSCBSL1478	136	SSEBLNDFLUSH	108	SSFP0012116S	118	SSGR10002RBN	83
SSCBTG	136	SSEBLNDLEFT	108	SSFP0012216S	118	SSGR10003RBN	83
SSCBTT	136	SSEBLNDRIGHT	108	SSFP0022116S	118	SSGR20001RBN	83
SSCBWCUT18	136	SSEBREC2101	112	SSFP0022216S	118	SSGR20002RBN	83, 89
SSCLEANER	218	SSEBREC2102	112	SSFP0112216S	118	SSGR20003RBN	83, 89
SSDRAIBINT	151	SSEBREC2103	112	SSFPM6TOM8	198	SSGR20004RBN	83, 89
SSDRAIBQC	151	SSEBREC211B	112	SSFPM8TOM10	198	SSGR30001RBN	84
SSDRAIBQCS	151	SSEBREC212B	112	SSFSRND100	78	SSGR30002RBN	84
SSDRAIBSCIS	151	SSEBREC213B	112	SSFSSQR100	79	SSGR30003RBN	84
SSDRAIBTT	151	SSEBREC501	113	SSGC014XX16S	89	SSGR41001RBN	84, 85
SSDRAIBTTS	151	SSEBREC502	113	SSGC015XX16S	89	SSGR41001RBN	86
SSDRAIPAD	151	SSEBREC503	113	SSGC101XX16S	83	SSGR41002RBN	84, 85
SSDRAPAINTB	151	SSEBREC504	113	SSGC103XX16S	83	SSGR41002RBN	86
SSDRAPCB	151	SSEPO010216S	59, 109	SSGC106XX16S	83	SSGR41003RBN	84, 85
SSDRAPCTB	151	SSEPO01021B	109	SSGC201XX16S	83	SSGR41003RBN	86
SSDRARCLVL	151	SSEPO012416S	109	SSGC201XXZMS	83	SSGR41004RBN	84, 85, 86
SSDRARCSTR	151	SSEPO012516S	109	SSGC203XX16S	59, 83	SSGR513RBN	86
SSDRKIN36	149	SSEPO020216S	109	SSGC203XXZMS	83	SSGR515RBN	86
SSDRKIN42	149	SSEPO022404S	109	SSGC206XX16S	83	SSGR517RBN	86
SSDRKINS36	150	SSEPO030216S	109	SSGC206XXZMS	83	SSGR519RBN	86
SSDRKLR36	150	SSEPO032416S	109	SSGC207XX16S	83	SSGR521RBN	86
SSDRKLR42	150	SSEPO032504S	109	SSGC207XXZMS	83	SSGS0010016S	123
SSDRKNL36	150	SSEPO070216S	109	SSGC301XX16B	84	SSGWCH112B	185
SSDRKNL42	150	SSEPO072416S	109	SSGC301XX16S	54, 84	SSGWCH112BN	185
SSDRKNP36	150	SSEPO072516S	109	SSGC301XXZMB	84	SSGWCH112CA	185
SSDRKNP42	150	SSEPREC11212	112	SSGC301XXZMS	84	SSGWCH112CP	185
SSDRKNR36	150	SSEPREC21	112	SSGC303XX16S	84	SSGWCH112E	185
SSDRKNR42	150	SSEPREC212	112	SSGC306XX16S	84	SSGWCH11B	185
SSDRKQC36	149	SSEPREC21B	112	SSGC411XX16B	85	SSGWCH11BN	185
SSDRKQC42	149	SSEPREC501	113	SSGC411XX16S	85	SSGWCH11CA	185
SSDRKQCS36	150	SSEPREC502	113	SSGC411XXZMB	85	SSGWCH11CP	185
SSDRKSC36	149	SSEVACC1	217	SSGC411XXZMS	85	SSGWCH11E	185
SSDRKSC42	149	SSEVACC2	217	SSGC413XX16S	85	SSGWCH12B	185
SSDRKSR36	150	SSEVACC5	217	SSGC417XX16S	85	SSGWCH12BN	185
SSDRKTT36	149	SSEVACC6	217	SSGC431XX16B	56, 84	SSGWCH12CA	185
SSDRKTT42	149	SSEVACC7	217	SSGC431XX16S	63, 84	SSGWCH12CP	185
SSDRKTT536	150	SSEVDOOR1	216	SSGC431XXSET	84	SSGWCH12E	185
SSDS110	189	SSEVDOOR2	216	SSGC431XXZMB	84	SSGWCH200A	182
SSDS111	189	SSEVEVER1	213	SSGC431XXZMS	84	SSGWCH200B	182
SSDS112	190	SSEVEVER2	213	SSGC433XX16S	84	SSGWCH200ECA	183
SSDS113	190	SSEVEVER2S	213	SSGC437XX16S	84	SSGWCH200ECB	183
SSEB1020116S	107	SSEVEVER3	213	SSGC451XX16S	86	SSGWCHSEAL1	186
SSEB1040316S	107	SSEVEVER4	213	SSGC461XX16S	86	SSGWCHSEAL2	186
SSEB1320116S	107	SSEVEVER6	213	SSGCH40116S	86	SSGWCHSEAL3	186
SSEB1340316S	107	SSEVPROCOAT1	215	SSGF0010016B	123	SSGWLEGG	180
SSEB1350316S	107	SSEVPROCOAT2	215	SSGF0010016G	123	SSGWLEGW	180
SSEB2020116S	107	SSEVPROCOAT3	215	SSGF0010016S	123	SSGWLM1	179
SSEB2040316S	107	SSEVPROTECT1	214	SSGF0010016B	123	SSGWLM2	179
SSEB3020116S	107	SSEVPROTECT2	214	SSGF0020016S	124	SSGWLM3	179
SSEB3021116S	107	SSEVPROTECT3	214	SSGF100X16B	123	SSGWLM4	179
SSEB3040316S	107	SSEVPROTECT4	214	SSGF100X16G	123	SSGWLM5	179
SSEB3050316S	107	SSEVPROTECT5	214	SSGF100X16GB	123	SSGWLM6	179

Index

PART#	PAGE#	PART#	PAGE#	PART#	PAGE#	PART#	PAGE#
SSGWPF90	175, 176	SSHPZAC05	72	SSKF5161	44, 198	SSPE36STLM	51, 52, 53
SSGWPFNH	175, 176	SSHPZAC06	72	SSKFHB38212	44, 199	SSPE42LNDE	51, 54
SSGWPFPIVOT	175	SSHPZAC07	74	SSKFHB38314	44, 199	SSPE42LNDL	51, 54
SSGWPFSTOP	176, 177	SSHPZAC08	74	SSKFHB384	44, 199	SSPEFT36LNC	55, 56
SSGWPFX1	175, 176	SSHPZAC09	73	SSKFHB5161	44, 199	SSPEFT36LNE	55, 56
SSGWPFX2	175, 176	SSHPZAC09	74	SSKFHBI3835	44, 199	SSPEFT36LNL	55, 56
SSGWPFX3	175, 176	SSHPZAC10	74	SSKFHBI384	44, 199	SSPEFT36SBE	55, 56
SSGWPFX4	175, 176	SSHPZAC11	74	SSKFW382	44, 198	SSPEFT36SL	55, 56
SSGWPFX5	176	SSHPZAC12	73	SSKFW38234	40, 44, 198	SSPEFT36T42	57, 58
SSGWPFX5B	177	SSHPZAC13	73	SSLIKITGB	160	SSPEFT36TL	57, 58
SSGWPFX5SA	177	SSHPZAC14	73	SSLIKITS	160	SSPEFT36TR	57, 58
SSGWPFX5SS	177	SSJ112	200, 201	SSLIWBI00GB	160	SSPEFT42BL	57, 58
SSGWPFX6	175, 177	SSJ112112	37, 40, 197	SSLIWBI00S	160	SSPEFT42LNC	57, 58
SSGWPFX7B	177	SSJ112114	37, 40, 197	SSLIWBI01GB	160	SSPEFT42LNE	57, 58
SSGWPFX7SA	177	SSJ1122	37, 40, 197	SSLIWBI01S	160	SSPEFT42LNL	57, 58
SSGWPFX7SS	177	SSJ2112	37, 40	SSL2KITELEC	160	SSPFEB1801	88
SSGWPFX8B	177	SSJ22	37, 40	SSL2LED1	160	SSPFEB1802	88
SSGWPFX8SA	177	SSJHBI24SS	40, 199	SSL2LED2	160	SSPFEB180B	87
SSGWPFX8SS	177	SSJQ112	38, 40, 197	SSL2LED3	160	SSPFEB180C	87
SSGWPFX9B	177	SSJT1	39	SSL2LED4	160	SSPFEB180GB	87
SSGWPFX9SA	177	SSK1121124B	42	SSL2LED5	160	SSPFEB180MB	87
SSGWPFX9SS	177	SSK1121126GB	42	SSLIFTELITE	164	SSPFEB180S	87
SSGWPFY12B	178	SSK1121126S	42	SSLIFTELITE2	164	SSPFEB901	88
SSGWPFY12S	178	SSK1121146S	42	SSM10100SET	198	SSPFEB902	88
SSGWPFY24B	178	SSK112126S	42	SSM1060SET	198	SSPFEB90B	87
SSGWPFY24S	178	SSK1121346S	42	SSM1080SET	198	SSPFEB90G	87
SSGWPFY36B	178	SSK11214B	42	SSM10ROD	198	SSPFEB90GB	87
SSGWPFY36S	178	SSK11216GB	42	SSM12ROD	198	SSPFEB90MB	87
SSGWPFY48B	178	SSK11216S	42	SSM4	197	SSPFEB90S	87
SSGWPFY48S	178	SSK11224B	42	SSM505	198	SSPFEBADJ1	88
SSGWPFY60B	178	SSK11226GB	42	SSM58	197	SSPFEBADJ2	88
SSGWPFY60S	178	SSK11226S	42	SSM612BX	197	SSPFEBADJB	87
SSGWPFY72B	178	SSK112SQR	43	SSM616BX	197	SSPFEBADJG	87
SSGWPFY72S	178	SSK112SQRB	43	SSM620BX	197	SSPFEBADJGB	87
SSGWPFZ48S	178	SSK112SQRGB	43	SSM625	197	SSPFEBADJMB	87
SSHD0010404S	130	SSK114126S	42	SSM8100SET	198	SSPFEBADJS	87
SSHD0030404S	130	SSK21124B	42	SSM812	197	SSPFEBTS	87
SSHD0060404S	130	SSK21126GB	42	SSM816	197	SSPFEBWALL1	88
SSHDADJUST	130	SSK21126S	42	SSM820	82, 197	SSPFEBWALL2	88
SSHDEND12	130	SSK21146S	42	SSM850SET	198	SSPFEBWALLB	87
SSHDGLASS	130	SSK2126S	42	SSM8ROD	198	SSPFEBWALLG	87
SSHDSQR04S	130	SSK21346S	42	SSNUT1213	40, 201	SSPFEBWALLGB	87
SSHPRND50B	72	SSK214B	42	SSNUT3816	40, 201	SSPFEBWALLMB	87
SSHPRND50C	72	SSK216GB	42	SSPC0600116S	78	SSPFEBWALLS	87
SSHPRND50E	72	SSK216S	42	SSPC0761316S	78	SSPFGL180B	168
SSHPRND50L	72	SSK224B	42	SSPC0850416S	78	SSPFGL180S	164, 168
SSHPRND50X1	74	SSK226GB	42	SSPC1050116S	78	SSPFGL180SSS	164, 168
SSHPRND50X2	72	SSK226S	42	SSPC1050216S	78	SSPFGL601G	164
SSHPRND50X3	72	SSK2346S	42	SSPC1051316S	78	SSPFGL601GB	171
SSHPRND50X4	72	SSKCAP1124B	42	SSPC1051416S	78	SSPFGL601GS	171
SSHPRND50X5	72	SSKCAP1126GB	42	SSPC1251416S	78	SSPFGL601W	164
SSHPRND50X6	72	SSKCAP1126S	42	SSPE36BPBEB	51, 52, 53	SSPFGL601WB	171
SSHPSQR50B	72	SSKCAP112GAS	42	SSPE36BPBEP	51, 52, 53	SSPFGL601WS	171
SSHPSQR50C	72	SSKCAP112GAX	42	SSPE36BPBEM	51, 52, 53	SSPFGL90SSS	164, 168
SSHPSQR50E	72	SSKCAP1146S	42	SSPE36LNDB	51, 54	SSPFGLWB	168
SSHPSQR50L	72	SSKCAP114GAS	42	SSPE36LNDC	51, 54	SSPFGLWS	164, 168
SSHPSQR50X1	74	SSKCAP24B	42	SSPE36LNDE	51, 52, 54	SSPFGLWSSS	164, 168
SSHPSQR50X2	72	SSKCAP26GB	42	SSPE36LNDL	51, 51, 54	SSPFH125G	164
SSHPSQR50X3	72	SSKCAP26S	42	SSPE36STBB	51, 53	SSPFH125GB	169
SSHPSQR50X4	72	SSKCAP2GAS	42	SSPE36STBF	51, 53	SSPFH125GS	169
SSHPSQR50X5	72	SSKCAP2GAX	42	SSPE36STBM	51, 53	SSPFH125RPB	169
SSHPSQR50X6	72	SSKF121	40, 44, 198	SSPE36STEB	51, 52, 53	SSPFH125RPS	169
SSHPZAC01	72	SSKF381	40, 44, 198	SSPE36STEF	51, 52, 53	SSPFH125SPB	169
SSHPZAC02	72	SSKF382	44, 198	SSPE36STEM	51, 52, 53	SSPFH125SPS	169
SSHPZAC03	72	SSKF383	42, 44, 198	SSPE36STLB	51, 52, 53	SSPFH125W	164
SSHPZAC04	72	SSKF384	42, 44, 198	SSPE36STLF	51, 52, 53	SSPFH125WB	169

PART#	PAGE#	PART#	PAGE#	PART#	PAGE#	PART#	PAGE#
SSPFH125WS	169	SSRIVET	201	SSSM3SHIM1	12	SSSPANNER2	44
SSPFH130G	164	SSRIVET38	201	SSSM3SHIM2	12	SSSPANNER3	44
SSPFH130GB	170	SSRIVETC38	201	SSSM3SHOE10	10	SSSPIGOT10B	34
SSPFH130GS	170	SSRIVETCM6	201	SSSM3SHOE10A	10	SSSPIGOT10GB	34
SSPFH155GB	170	SSRIVETCM8	201	SSSM3SHOE10B	10	SSSPIGOT10S	34
SSPFH155GS	170	SSRIVETM6	201	SSSM3SHOE10S	10	SSSPIGOTADJ	27
SSPFH155WB	170	SSRIVETM8	201	SSSM3SHOE20	10	SSSPIGOTADJB	27
SSPFH155WS	170	SSRK-1500	218	SSSM3SHOE20A	10	SSSPIGOTADJN	28
SSPFH156B	170	SSROD12304	106	SSSM3SHOE20S	10	SSSPIGOTADJP	28
SSPFHHGGS	164, 167	SSRODSQ12304	106	SSSM3SIDE10A	10, 197	SSSPIGOTAGB	27
SSPFHHGWS	164, 167	SSSH1239G	155	SSSM3SIDE10B	10	SSSPIGOTAMB	27
SSPFHSLGGS	167	SSSH1239GB	155	SSSM3TCC10A	11, 15, 19	SSSPIGOTBOLT	27, 29, 197
SSPFHSLGWS	167	SSSH1239SB	155	SSSM3TCC10B	11, 15, 19	SSSPIGOTEDB	29
SSPFSTOP7B	172	SSSHRD58G	156	SSSM4CCSHOEI	15	SSSPIGOTEDGE	29, 197
SSPFSTOP7S	172	SSSHRD58GB	156	SSSM4CCSHOE0	15	SSSPIGOTEGB	29
SSPG1540	62	SSSHRD58SB	156	SSSM4DRAINT	16	SSSPIGOTEMB	29
SSPG16640	62	SSSM2CCKITA	7	SSSM4ENDCAP1	16	SSSPIGOTS6B	31
SSPG16642	62	SSSM2CCKITB	7	SSSM4ENDCAP2	16	SSSPIGOTS6G	31
SSPG166L36C	60	SSSM2CCKITS	7	SSSM4ENDCAP3	16	SSSPIGOTS6GB	31
SSPG166L36E	60	SSSM2CCSHOEI	7	SSSM4GAP	16	SSSPIGOTS6MB	31
SSPG166L36L	60	SSSM2CCSHOE0	7	SSSM4GLASS1	14	SSSPIGOTS6S	31
SSPG166L42C	60	SSSM2CLADA	7	SSSM4GLASS2	14	SSSPIGOTS8B	32
SSPG166L42E	60	SSSM2CLADB	7	SSSM4GLASS3	14	SSSPIGOTS8G	32
SSPG166L42L	60	SSSM2CLADS	7	SSSM4GRIPS	16	SSSPIGOTS8GB	32
SSPG166S40C	60	SSSM2DRAINT	7	SSSM4SHIM1	16	SSSPIGOTS8P	32, 33
SSPG166S40E	60	SSSM2ENDCAP1	8	SSSM4SHIM2	16	SSSPIGOTS8S	32
SSPG166S40L	60	SSSM2ENDCAP2	8	SSSM4SHOE10	14	SSSPIGOTSIDB	30
SSPG166X36E	67	SSSM2ENDCAP3	8	SSSM4SHOE10A	14	SSSPIGOTSIDE	30
SSPG166X36L	67	SSSM2ENDCPIX	8	SSSM4SHOE10B	14	SSSPIGOTSIDT	30
SSPG166X42E	67	SSSM2ENDCP2X	8	SSSM4SHOE10S	14	SSSPIGOTSIGB	30
SSPG166X42L	67	SSSM2ENDCP3X	8	SSSM5CCSHOEI	19	SSSPIGOTSIMB	30
SSPG240	62	SSSM2GAP	8	SSSM5CCSHOE0	19	SSSPRAYPAINT	218
SSPH12X34PK	197	SSSM2GRIPS	8	SSSM5DRAINT	20	SST11215304	106, 107
SSPH620X38	197	SSSM2SHIM	8	SSSM5ENDCAP1	20	SST11215316	106, 107
SSPLO800616S	77	SSSM2SHOE10	6	SSSM5ENDCAP2	20	SST1215304	106, 107
SSPL1000116S	77	SSSM2SHOE10A	6	SSSM5ENDCAP3	20	SST1662304	106, 107
SSPRI66L36	61	SSSM2SHOE10B	6	SSSM5GAP	20, 21, 22	SST1662304B	106, 107
SSPSQ4040	65	SSSM2SHOE10S	6	SSSM5GLASS1	18	SST1662316	106
SSPSQ40403	65	SSSM3CCKITA	11, 15, 19	SSSM5GLASS2	18	SST215304	106, 107
SSPSQ4042	65	SSSM3CCKITB	11, 15, 19	SSSM5GRIPS	20	SST3415304	106, 107
SSPSQ40L36C	64	SSSM3CCKITS	11, 15, 19	SSSM5SHIM1	20	SST5815304	106, 107
SSPSQ40L36E	64	SSSM3CCSHOEI	11	SSSM5SHIM2	20	SST583048	131
SSPSQ40L36L	64	SSSM3CCSHOE0	11	SSSM5SHOE10	18	SSTF0030016S	119
SSPSQ40L42C	64	SSSM3CLADA	11, 15, 19	SSSM5SHOE10A	18	SSTF1050016S	119
SSPSQ40L42E	64	SSSM3CLADA1	11, 15, 19	SSSM5SHOE10B	18	SSTF1060004S	119
SSPSQ40L42L	64	SSSM3CLADB	11, 15, 19	SSSM5SHOE10S	18	SSTF2030016S	59, 119
SSPSQ40S40C	64	SSSM3CLADC	11, 15, 19	SSSM6DRAINL	21	SSTF2050016S	119
SSPSQ40S40E	64	SSSM3CLADM	11, 15, 19	SSSM6DRAINY	22	SSTF2060016S	119
SSPSQ40S40L	64	SSSM3CLADS	11, 15, 19	SSSM6GLASS1	21, 22	SSTLMPAB	46
SSPSQ40X36E	68	SSSM3CLADS1	11, 15, 19	SSSM6GLASS2	21, 22	SSTLMPSS	46
SSPSQ40X36L	68	SSSM3CLADXA	11	SSSM6GLASS3	21, 22	SSTLMPVAB	46
SSPSQ40X42E	68	SSSM3CLADXB	11	SSSM6GLASS4	21, 22	SSTLMPVSS	46
SSPSQ40X42L	68	SSSM3DRAINS	11	SSSM6SHIM1	21, 22	SSTREC11212	106, 112
SSPSQ42C	64	SSSM3DRAINT	11	SSSM6SHIM2	21, 22	SSTREC21	106, 112
SSPSQ42E	64	SSSM3ENDCAP1	12	SSSM6SHOE1A	21	SSTREC212	106, 112
SSPSQ42L	64	SSSM3ENDCAP2	12	SSSM6SHOE1B	21	SSTREC21B	106, 112
SSPSQ5042	65	SSSM3ENDCAP3	12	SSSM6SHOE1S	21	SSTREC5010	106, 113
SSPSQ5048	65	SSSM3ENDCAP5	12	SSSM6SHOE1YA	22	SSTS0030016S	119
SSPW0581516S	77	SSSM3ENDCAP7	12	SSSM6SHOE1YB	22	SSTS1060016S	117, 119
SSPW0701516S	77	SSSM3ENDCPIX	12	SSSM6SHOE1YS	22	SSTS1070004S	119
SSPW0801116S	77	SSSM3ENDCP2X	12	SSSMCLADTAPE	7, 11, 15, 19	SSTS2030016S	59, 119
SSPW1001216S	77	SSSM3ENDCP3X	12	SSSP0012116S	118	SSTS2050016S	119
SSPW1001616S	77	SSSM3ENDCP4X	12	SSSP0012216S	118	SSTS2060016S	119
SSPW1071316N	77	SSSM3GAP	12	SSSP0022116S	118	SSTSQ1215304	106
SSPW44216S	77	SSSM3GRIPS	12	SSSP0122016S	118	SSTSQ123048	131
SSPW45016S	77	SSSM3JOINPIN	8, 12, 16, 20	SSSPANNER1	44	SSTSQ22304	106, 111

Index

PART#	PAGE#	PART#	PAGE#	PART#	PAGE#	PART#	PAGE#
SSTSQ3415304	106	SSUTCH212	104	SSWB231116S	121	SSZT0404016S	63, 120
SSTSQ402304	106, 111	SSUTCH217	104	SSWB3116B	122	SSZT1404016S	63, 120
SSTSQ402304B	106, 111	SSUTCH221	104	SSWB3116GB	122	SSZT24016S	120
SSTSQ402316	106, 111	SSUTCH230A	104	SSWB3116S	122	SSZT34016S	120
SSUA0010116B	117	SSUTCH230B	104	SSWB3216B	122	SSZW1000316N	80
SSUA0010116G	117	SSUTCH231A	104	SSWB3216GB	122	SSZW1000416N	80
SSUA0010116S	63, 117	SSUTCH231B	104	SSWB3216S	122	SSZW1000516N	79
SSUA0010116B	117	SSUTCH232A	104	SSWB3316S	122	SUA0010116S	121
SSUA0010316B	117	SSUTCH232B	104	SSWF0010016B	123	TAPI/4-20-3	202
SSUA0010316S	59, 117	SSUTCH233A	104	SSWF0010016G	123	UTBI4214BX	199
SSUA0010316B	117	SSUTCH233B	104	SSWF0010016S	123	UTBI43BX	199
SSUA0010616B	117	SSUTCH300	102	SSWF0010016B	123	UTB38212	199
SSUA0010616S	117	SSUTCH301	102	SSWF0020016S	124	UTB384	199
SSUA0010616B	117	SSUTCH302	102	SSWF100X16B	123	WC315011BR	196
SSUA0010716S	117	SSUTCH303	102	SSWF100X16G	123	WC315011CP	196
SSUA0012116B	117	SSUTGASKET1	96, 102	SSWF100X16GB	123	WC315011ORB	196
SSUA0012116G	117	SSUTGASKET2	96, 102	SSWF100X16S	123	WC315011SN	196
SSUA0012116S	63, 117	SSUTGASKET2A	96, 102	SSWF20016B	124	WC315016BR	196
SSUA0012116B	117	SSUTGASKET3	96, 102	SSWF20016S	124	WC315016CP	196
SSUA0012316S	59, 117	SSUTGASKET3A	96, 102	SSWF20116B	124	WC315016ORB	196
SSUA0012616S	117	SSUTGASKET4	96, 102	SSWF20116S	124	WC315016SN	196
SSUA0012716S	117	SSUTREC400	95, 159	SSWF20216B	124	WC315018CP	196
SSUC0010316S	78	SSUTREC401	95	SSWF20216S	124	WC315018ORB	196
SSUC0010616S	78	SSUTREC402	95	SSWRENCH1	8, 12, 16, 20	WC315018SN	196
SSUC601	67	SSUTREC403	95	SSWRENCH3	8, 12, 16, 20	WC318708D10	196
SSUC701	68	SSUTREC404	95	SSWS0010016S	123	WC318712D10	196
SSUTALROB	98, 159	SSUTREC405	95	SSZC0814016S	79	WC345011CP	196
SSUTALROCA	98, 159	SSUTREC406	95	SSZC0914004B	80	WC345011ORB	196
SSUTALR1B	99	SSUTREC407	95	SSZC0914004S	80	WC345011SN	196
SSUTALR1CA	99	SSUTREC600	96, 159	SSZC0914005B	80	WC400010A	193
SSUTALR2B	99	SSUTREC601	96	SSZC0914005S	80	WC400165G	193
SSUTALR2CA	99	SSUTREC602	96	SSZC091504S	54, 80	WC400900B	193
SSUTALREC0B	98	SSUTREC603	96	SSZC091616S	56, 80	WC500010A	193
SSUTALREC0CA	98	SSUTRND4240	93, 159	SSZC1054016S	79	WC500165G	193
SSUTALREC0SB	98	SSUTRND4240B	93	SSZC1085016S	79	WC500900B	193
SSUTALREC1B	99	SSUTRND4241	93	SSZE0404016B	111	WC601010A	194
SSUTALREC1CA	99	SSUTRND4242	93	SSZE0404016S	111	WC601165G	194
SSUTALREC1SB	99	SSUTRND4243	93	SSZE0404116B	111	WC601900B	194
SSUTALREC2B	99	SSUTRND4245	93	SSZE0404116S	111	WC602010A	194
SSUTALREC2CA	99	SSUTRND4246	93	SSZE1404016B	111	WC602165G	194
SSUTALREC2SB	99	SSUTRND4246B	93	SSZE1404016S	111	WC602900B	194
SSUTALS0B	98, 159	SSUTRND4247	93	SSZH0070100S	127	WC603010A	194
SSUTALS0CA	98, 159	SSUTSQ40000	94, 159	SSZH0070101S	127	WC603165G	194
SSUTALS0SB	98	SSUTSQ40001	94	SSZH0070116S	127	WC603900B	194
SSUTALS1B	99	SSUTSQ40002	94	SSZH0071115S	127	WCCID323051	195
SSUTALS1CA	99	SSUTSQ40003	94	SSZH0071116S	127	WCCID484551	195
SSUTALS1SB	99	SSUTSQ40004	94	SSZH0072116S	127	WCCID643051	195
SSUTALS2B	99	SSUTSQ40005	94	SSZH007216GB	127	WCCID964551	195
SSUTALS2CA	99	SSUTSQ401B	94	SSZH0073116S	128	WCCIS124551	195
SSUTALS2SB	99	SSUTSQ40B	94	SSZH0073216S	128	WCIDIA363051	195
SSUTALT1CA	100	SSWB0100016B	121	SSZH1071116S	127	WED12234-BX	200
SSUTALT2CA	100	SSWB0100016S	121	SSZH1071116B	127	WED12334-BX	200
SSUTALT3CA	100	SSWB0100016GB	121	SSZH21216S	127	WED12412-BX	200
SSUTALT4CA	100	SSWB0100116S	125	SSZH31216B	127	WED12512-BX	200
SSUTALT5	100, 159, 160	SSWB0100216S	125	SSZH31216GB	127	WED34512-BX	200
SSUTCH100	101	SSWB0100316S	125	SSZH31216S	127	WED38214-BX	200
SSUTCH101	101	SSWB1109016S	121	SSZH31226B	127	WED38234-BX	200
SSUTCH102	101	SSWB111216B	122	SSZH31226GB	127	WED38334-BX	200
SSUTCH103	101	SSWB111216GB	122	SSZH31226S	127	WED383-BX	200
SSUTCH104	101	SSWB111216S	122	SSZH40116S	128	WED385-BX	200
SSUTCH105	101	SSWB111416B	122	SSZH40216S	128	WH4134324GO	159
SSUTCH106	101	SSWB111416GB	122, 160	SSZP0404016S	63, 111	WSC11-125	207
SSUTCH107	101	SSWB111416S	122, 160	SSZP040401B	111		
SSUTCH108	101	SSWB111426S	122	SSZP0505016S	111		
SSUTCH109	101	SSWB1301116S	121	SSZP0600116S	111		

GET CONNECTED!

Stay up-to-date on the latest products.

Take advantage of trade pricing.

Get a jump on the best deals.

It's as easy as 1, 2... not even 3.

- 1. Register an account.**
- 2. Join our mailing list.**





DISCLAIMER:

Euro Architectural Components carefully reviewed to ensure that the content in this catalogue was accurate at the time of print. We are not responsible for misinformation due to human error. Images or colours may not be exact due to rendering, photographic, or printing procedures. Consult your local authorities to ensure your design complies with all building code requirements. For our complete terms & conditions scan here, or copy the following link: <https://euroeac.com/terms-conditions/>.

