

A WORD ABOUT EPCO...

Elevator Products Corporation is dedicated to the elevator industry and offers the finest selection of elevator accessories available. For over fifty years, we've provided architects and consultants with the right products to meet their special requirements.

The EPCO staff includes highly skilled engineers and technicians, cost conscious buyers and extremely capable and dedicated sales and customer service personnel.

Strict control is maintained over all aspects of manufacturing. Every phase of design and fabrication follows our stringent quality process. EPCO has been ISO-9001 Certified since 1995, ensuring the highest standards of quality.

No matter what your needs are, our flexibility in design, expertise in custom equipment and innovative atmosphere will assure complete satisfaction for every order. EPCO offers the highest quality service in our industry. Our company is continuously developing new products to serve a variety of applications. Our complete line of elevator accessories will meet or exceed even the tightest specification, and can stand up to the abuse often found in many installations.

The technical information contained herein is included to assist you in choosing the correct elevator parts for the job. If there is a requirement not outlined within these pages, please contact our office at: 973-341-8000. Our highly trained sales professionals are available to assist with any questions.

*ELEVATOR PRODUCTS CORPORATION
ISO 9001 CERTIFIED SINCE 1995*



**ELEVATOR PRODUCTS
CORPORATION**



ELEVATOR PRODUCTS
CORPORATION

Table of Contents

Index for Buttons

NAME	PAGE #
SPR-S/SPR-M	1-2
SPS-S/SPS-M	1-2
SPR-SPC/SPR-MPC	3-4
SPS-SPC/SPS-MPC	3-4
SPR-W/SPR-WPC	5-6
SPR-SSPC/SPR-SMPC	7-8
SPR-SSL/SPR-MML	9-10
SPR-SSLPC/SPR-MMLPC	9-10
CL Series	11-12
SA-C/MA-C Series	13-14
SSL/MML	15-16
SSL-P/MML-P	17-18
SSL-PC/MML-PC	19-20
SSL-H/MML-H	21-22
SSL-HPC/MML-HPC	21-22
SSL-HC/MML-HC	23-24
SSL-HSE/MML-HSE	25-26
SSL-SH/MML-SH Housing	27-28
WA Series	29-30
WA-PC Series	31-32
WB Series	33-34
WS Series	35-36
FL Series	37-38
PEPS-SPR/PEPM-SPR	39-40
PEPS-SPRPC/PEPM-SPRPC	39-40
PEPS-AS/PEP-AM	41-42
PEP-ASPC/PEP-AMPC	41-42
Survivor	43-44
Survivor-PC	43-44
Survivor-SM (Surface Mount Style)	45-46
Survivor-SMPC (Surface Mount Style)	45-46
SURVPL-S/SURVPL-M	47-48
SURVPL-SPC/SURVPL-MPC	47-48
Designer	49-50



ELEVATOR PRODUCTS
CORPORATION

Table of Contents (Cont'd)

Index for Buttons (Cont'd)

NAME	PAGE #
Designer-PC	49-50
Designer2	51-52
Designer2-PC	51-52
Designer-SM (Surface Mount Style)	53-54
Designer-SMPC (Surface Mount Style)	53-54
Designer2-SM (Surface Mount Style)	55-56
Designer2-SMPC (Surface Mount Style)	55-56
Classic	57-58
Classic-PC	57-58
Classic2	59-60
Classic2-PC	59-60
Classic-SM (Surface Mount Style)	61-62
Classic-SMPC (Surface Mount Style)	61-62
Classic2-SM (Surface Mount Style)	63-64
Classic2-SMPC (Surface Mount Style)	63-64
WGH Series	65-66
WGH-PC Series	67-68
WGH-S/WGH-M	69-70
WGH-SPC/WGH-MPC	71-72
WN-PC Series	73-74
WNR-PC Series	75-76
MRB Series	77-78
RB Series	79-80



ELEVATOR PRODUCTS CORPORATION

Buttons

5-pin Connection

Ref. DWG. 12A85

LED LIGHT	RESISTOR
25 VAC ONLY	10A RESISTIVE
40 VAC/100S	3000 1A
54 VAC/100C	5000 1A (ALL)
12 VAC	5000 1A (ALL)

NOTE: WHEN CONVEYING WIRE, ALWAYS ATTACH TO THE COVER OF MICRO SWITCH (NOT SIGNAL)

8-pin Connection

Ref. DWG. 13A26

LED LIGHT	RESISTOR
0 VAC/100C	(1) 10A
12 VAC/100C	20 SERVICIS
24 VAC/100C	20 SERVICIS
40 VAC/100C	(1) LED 2
12 VAC	(2) 10A 2
13 VAC	(2) 10A 2
120 VAC	(2) 2.2 K

NOTE: WHEN CONVEYING WIRE, ALWAYS ATTACH TO THE COVER OF MICRO SWITCH (NOT SIGNAL)

4-5-2 Style Connection

Ref. DWG. 10M16

RESISTOR	RESISTOR
10A RESISTIVE	10A RESISTIVE
3000 1A	3000 1A
5000 1A (ALL)	5000 1A (ALL)
5000 1A (ALL)	5000 1A (ALL)

NOTE: WHEN CONVEYING WIRE, ALWAYS ATTACH TO THE COVER OF MICRO SWITCH (NOT SIGNAL)

Terminal Block

Ref. DWG. 25A12

RESISTOR	RESISTOR
10A RESISTIVE	10A RESISTIVE
3000 1A	3000 1A
5000 1A (ALL)	5000 1A (ALL)
5000 1A (ALL)	5000 1A (ALL)

NOTE: WHEN CONVEYING WIRE, ALWAYS ATTACH TO THE COVER OF MICRO SWITCH (NOT SIGNAL)

Reliably Engineered Elevator Accessories 1-877-CALL-EPCO (1-877-225-5372)



Buttons

ELEVATOR PRODUCTS CORPORATION

SPR-S/SPR-M

SPS-S/SPS-M

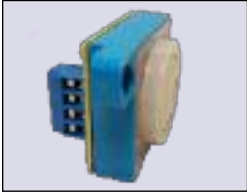

Model: SPR-S Light-up
 Model: SPR-S Non Light-up
 Halo: 1.375" Dia.
 Button: 1.125" Dia.
 St/St metal insert button cap.
 Button flush with halo.
 Available in #4 brushed circular finish, or #8 mirror finish.
 Buttons available with or without markings.



Model: SPS-S Light-up
 Model: SPS-S Non Light-up
 Halo: 1.375" Sq.
 Button: 1.125" Sq.
 St/St metal insert button cap.
 Button flush with halo.
 Available in #4 brushed finish, or #8 mirror finish.
 Buttons available with or without markings.



Model: SPR-M Light-up
 Model: SPR-M Non Light-up
 Halo: 1.375" Dia.
 Button: 1.125" Dia.
 Mz/Bz metal insert button cap.



Model: SPS-M Light-up
 Model: SPS-M Non Light-up
 Halo: 1.375" Sq.
 Button: 1.125" Sq.
 Mz/Bz metal insert button cap.

ORDER INFORMATION:

Please advise the following - model number, markings, LED lamp style and voltages.

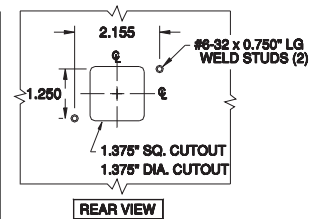
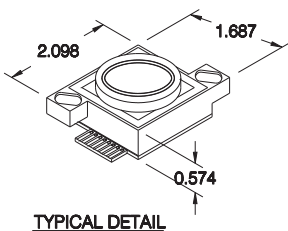



ELEVATOR PRODUCTS CORPORATION

Buttons (Cont'd)



Halo:
 1.375" Dia. Outside
 1.125" Dia. Inside
 To be used with 0.125" - 0.187" thick covers.
 Milkwhite and Clear (light-up)



Button Cap & Cam:
 1.125" Dia. button cap.
 St/St or Mz/Bz metal insert.
 Available in #4 brushed circular finish, or #8 mirror finish.
 Markings engraved on button cap.

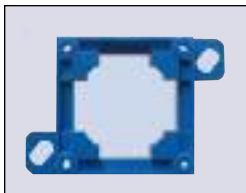

Housing:
 Made from high strength Lexan.
 1.687" Sq. x 0.50" deep



Harness:
 Color coded with plug in connector for easy installation.



Halo:
 1.375" Sq. Outside
 1.125" Sq. Inside
 To be used with 0.125" - 0.187" thick covers.
 Milkwhite and clear (light-up)



Button Cap & Cam:
 1.125" Sq. button cap.
 St/St or Mz/Bz metal insert.
 Available in #4 brushed, or #8 mirror finish.
 Markings engraved on button cap.

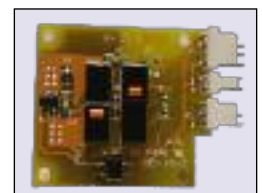

Button LED:
 Multi-volt available
 Part #: SB612LED (color)
 Part #: SB24120LED (color)
 Colors available in Red, White, Amber, Blue, Green.
 Also available in terminal block.

SPS/SPR Items	Part #
Complete Button Assembly	SPS-S/SPS-M / SPR-S/SPR-M
Halo-Round	15B52P01 (milkwhite)15B52P02 (clear)
Halo-Square	13B09P01 (milkwhite)13B09P02 (clear)
Button Cap & Cam	C&C-SPS-S/SPS-M / C&C-SPR-S/SPR-M
Housing	12C75P01



Buttons (Cont'd)

ELEVATOR PRODUCTS CORPORATION

SPR-SPC/SPR-MPC

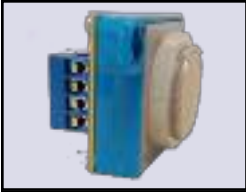

Model: SPR-SPC Light-up
 Model: SPR-SPC Non Light-up
 Halo: 1.375" Dia.
 Button: 1.125" Dia.
 St/St metal insert button cap.
 Button projects 0.125" from halo.
 Available in #4 brushed circular finish, or #8 mirror finish.
 Buttons available with or without markings.



Model: SPR-MPC Light-up
 Model: SPR-MPC Non Light-up
 Halo: 1.375" Dia.
 Button: 1.125" Dia.
 Mz/Bz metal insert button cap.

SPS-SPC/SPS-MPC



Model: SPS-SPC Light-up
 Model: SPS-SPC Non Light-up
 Halo: 1.375" Sq.
 Button: 1.125" Sq.
 St/St metal insert button cap.
 Button projects 0.125" from halo.
 Available in #4 brushed finish, or #8 mirror finish.
 Buttons available with or without markings.



Model: SPS-MPC Light-up
 Model: SPS-MPC Non Light-up
 Halo: 1.375" Sq.
 Button: 1.125" Sq.
 Mz/Bz metal insert button cap.

Note: Complies with title 24 California Code

ORDER INFORMATION:

Please advise the following - model number, markings, LED lamp style and voltages.

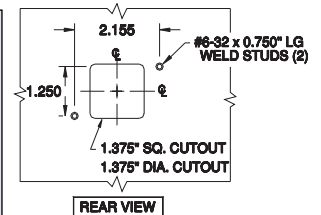
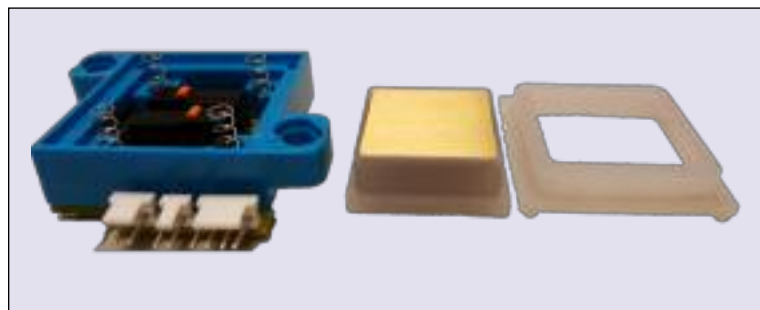
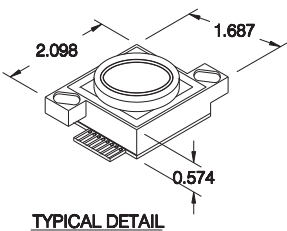



ELEVATOR PRODUCTS CORPORATION

Buttons (Cont'd)



Halo:
 1.375" Dia. Outside
 1.125" Dia. Inside
 To be used with 0.125" - 0.187" thick covers.
 Milkwhite and Clear (light-up)



Button Cap & Cam:
 1.125" Dia. button cap.
 St/St or Mz/Bz metal insert.
 Available in #4 brushed circular finish, or #8 mirror finish.
 Markings engraved on button cap.

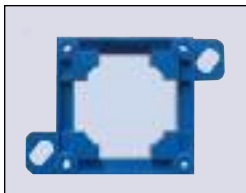

Housing:
 Made from high strength Lexan.
 1.687" Sq. x 0.50" deep



Harness:
 Color coded with plug in connector for easy installation.

Halo:
 1.375" Sq. Outside
 1.125" Sq. Inside
 To be used with 0.125" - 0.187" thick covers.
 Milkwhite and clear (light-up)



Button Cap & Cam:
 1.125" Sq. button cap.
 St/St or Mz/Bz metal insert.
 Available in #4 brushed, or #8 mirror finish.
 Markings engraved on button cap.



Button LED:
 Multi-volt available
 Part #: SB612LED (color)
 Part #: SB24120LED (color)
 Colors available in Red, White, Amber, Blue, Green.
 Also available in terminal block.

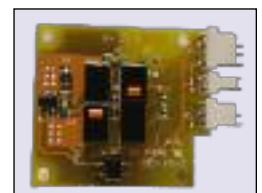

SPS-PC/SPR-PC Items	Part #
Complete Button Assembly	SPS-SPC/SPS-MPC / SPR-SPC/SPR-MPC
Halo-Round	15B52P01 (milkwhite)15B52P02 (clear)
Halo-Square	13B09P01 (milkwhite)13B09P02 (clear)
Button Cap & Cam	C&C-SPS-S/SPS-M / C&C-SPR-S/SPR-M
Housing	12C75P01



ELEVATOR PRODUCTS CORPORATION

Buttons (Cont'd)

SPR-W



Model: SPR-W
Model: SPR-WA with arrow
Button: 1.000" Dia.
Black or White Lexan Button.
Halo: 1.375" Dia. Milkwhite Lexan.

SPR-WPC

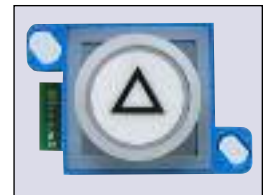

Model: SPR-WPC
Model: SPR-WAPC with arrow
Button: 1.000" Dia.
Black or White Lexan Button.
Halo: 1.375" Dia.. Milkwhite Lexan.
Button projects 0.125" from halo.
(California Code)

ORDER INFORMATION:

Please advise the following - model number, mounting orientation, markings, LED color and voltages.





ELEVATOR PRODUCTS CORPORATION

Buttons (Cont'd)



Halo:
 1.375" Dia. Outside
 1.125" Dia. Inside
 To be used with 0.125" - 0.187" thick covers.
 Milkwhite (light-up) only

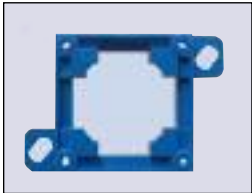

Housing:
 Made from high strength Lexan.
 1.687" Sq. x 0.50" deep.

Button Cam & Insert:
 Button Cam, Insert, & Arrow:
 1.125" Dia. button cap.
 Solid milkwhite lexan cap
 To be used with 0.125" th. covers.
 Markings engraved on button cap and flushcast with epoxy.



Harness:
 Color coded with plug in connector for easy installation.



Button LED:
 Multi-volt available
 Part #: SB612LED (color)
 Part #: SB24120LED (color)
 Colors available in Red, White, Amber, Blue, Green.
 Also available in terminal block.

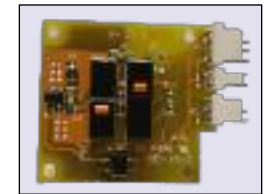

SPR-B / SPR-W Items	Part #
Complete Button Assembly	SPR-B / SPR-W
Halo	13B43P01
Button Cam & Insert (w/ arrow)	C&C-SPR-B (A) C&C-SPR-W (A)
Housing	12C75P01

SPR-BPC / SPR-WPC Items	Part #
Complete Button Assembly	SPR-BPC / SPR-WPC
Halo	13B43P01
Button Cam & Insert (w/ arrow)	C&C-SPR-BPC (A) C&C-SPR-WPC (A)
Housing	12C75P01



ELEVATOR PRODUCTS CORPORATION

Buttons (Cont'd)

SPR-SSPC

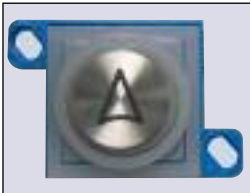
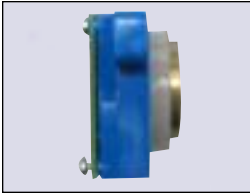

Model: SPR-SSPC
Model: SPR-SSPCA with arrow
Button: 1.125" Dia.
Solid St. Steel.
Halo: 1.375" Dia. Clear Lexan.
Button projects 0.125" from halo.
(California Code)

SPR-SMPC

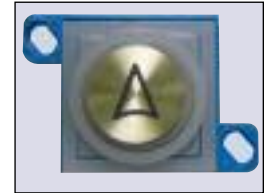
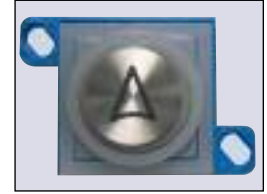

Model: SPR-SMPC
Model: SPR-SMPCA with arrow
Button: 1.125" Dia.
Solid Muntz Bronze
Halo: 1.375" Dia. Clear Lexan.
Button projects 0.125" from halo.
(California Code)

ORDER INFORMATION:

Please advise the following - model number, mounting orientation, markings, lamp style, LED color and voltages.

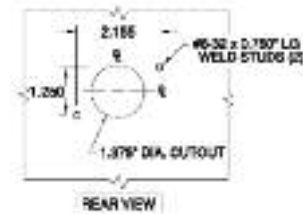



ELEVATOR PRODUCTS CORPORATION

Buttons (Cont'd)



Halo:
1.375" Dia. Outside
1.125" Dia. Inside
To be used with 0.125" - 0.187" thick covers.
Milk white (light-up) only

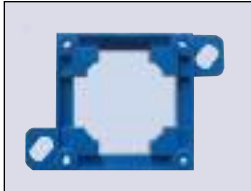

Housing:
Made from high strength Lexan.
1.687" Sq. x 0.50" deep.

Button Cap & Cam:
1.125" Dia. button cap.
Convex St/St cap.
To be used with 0.125" th. covers.
Available in #4 brushed circular finish, or #8 mirror finish.
Markings engraved on button cap and flushcast with epoxy.



Harness:
Color coded with plug in connector for easy installation.



Button LED:
Multi-volt available
Part #: SB612LED (color)
Part #: SB24120LED (color)
Colors available in Red, White, Amber, Blue, Green.
Also available in terminal block.

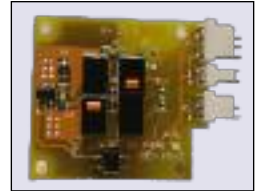

SPR-SSPC / SPR-SMPC Items	Part #
Complete Button Assembly	SPR-SSPC / SPR-SMPC
Halo - Clear	15B52P02
Button Cap & Cam	C&C-SPR-SSPC C&C-SPR-SMPC
Housing	12C75P01



ELEVATOR PRODUCTS CORPORATION

Buttons (Cont'd)

SPR-SSL/SPR-MML

SPR-SSLPC/SPR-MMLPC

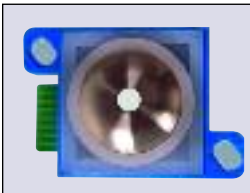
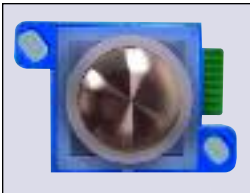
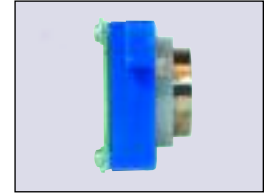
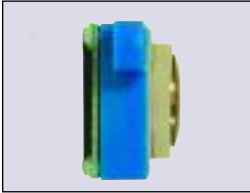

Model: SPR-SSL light-up
 Model: SPR-MML light-up
 Model: SPR-SSN non light-up
 Model: SPR-MMN non light-up
 Halo: None (Spacer only)
 Button: 1.125" Dia.
 Solid convex St/St. or Mz/Bz. button cap
 with 0.250" Dia. Lexan jewel
 Avail. in #4 brushed circular finish,
 or #8 mirror finish.
 Buttons avail. without markings.

Model: SPR-SSLPC light-up
 Model: SPR-MMLPC light-up
 Model: SPR-SSNPC non light-up
 Model: SPR-MMNPC non light-up
 Halo: None (Spacer only)
 Button: 1.125" Dia.
 Solid flat St/St. or Mz/Bz. button cap
 with 0.250" Dia. Lexan jewel
 Button projects 0.125" from halo.
 (California Code)
 Avail. in #4 brushed circular finish,
 or #8 mirror finish.
 Buttons avail. without markings.

ORDER INFORMATION:

Please advise the following - model number, mounting orientation, markings, lamp style and voltages.

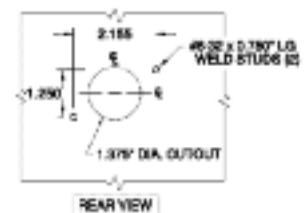



ELEVATOR PRODUCTS CORPORATION

Buttons (Cont'd)

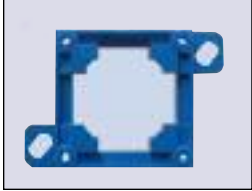

Housing:
Made from high strength Lexan.
1.687" Sq. x 0.50" deep.

Button Cap & Cam:
1.125" Dia. button cap.
Solid convex Mz/Bz cap
To be used with 0.125" th. covers.
Available in #4 brushed circular finish, or #8 mirror finish.
Markings engraved thru on button cap and flushcast with epoxy.



Harness:
Color coded with plug in connector for easy installation.



Button LED:
Multi-volt available
Part #: SB612LED (color)
Part #: SB24120LED (color)
Colors available in Red, White, Amber, Blue, Green.
Also available in terminal block.

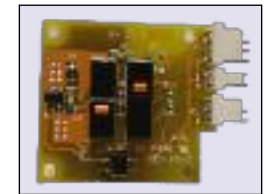

SPR-SSL / SPR-MML Items	Part #
Complete Button Assembly	SPR-SSL /SPR-MML
Button Cap & Cam	C&C-SPR-SSL C&C-SPR-MML
Housing	12C75P01

SPR-SSLPC / SPR-MMLPC Items	Part #
Complete Button Assembly	SPR-SSLPC /SPR-MMLPC
Button Cap & Cam	C&C-SPR-SSLPC C&C-SPR-MMLPC
Housing	12C75P01



ELEVATOR PRODUCTS CORPORATION

Buttons (Cont'd)

CL Series

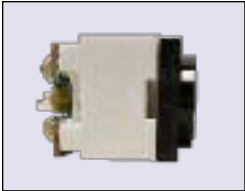

Model: CL Light-up
Model: CN Non Light-up
Halo: 1.375" Dia.
Button: 1.125" Dia.
Button projects 0.125" at center.
Clear convex window magnifies the legend for easy reading.
Buttons available with or without markings.

NOTE: These buttons do not comply with California Code (i.e. 1/8" proj. square shoulder)
Refer to "WA-PC" See Button Index.

ORDER INFORMATION:

Please advise the following - Model number, markings, lamp style, LED color and voltages.

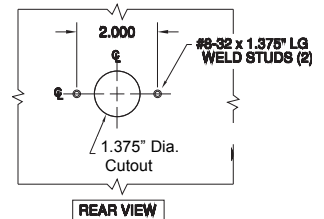
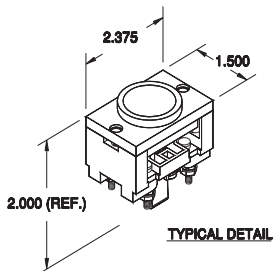



ELEVATOR PRODUCTS
CORPORATION

Buttons (Cont'd)



Halo:
1.375" Dia. Outside
1.125" Dia. Inside
To be used with 0.125" th.covers.
Color - black only.



Cam:
The pushbutton cam is made of high strength Lexan to ensure durability. Acts as a fixing mechanism to deter rotation of button cap.



Bulb Carrier:
Bulb carriers are made of high strength Lexan. Copper contacts assure positive conductivity. Pull handle in rear of carrier makes for easy lamp replacement.



Button LED:
Multi-volt available
Part #: BEA612LED (color)
Part #: BEA24120LED (color)
Colors available in Red, White, Amber, Blue, Green.

Button Cap & Insert:
1.125" Dia. clear button cap
1.375" Dia. milkwhite insert
Markings hot stamped on insert. Milkwhite cap available without markings only.
Color - white only (Insert).

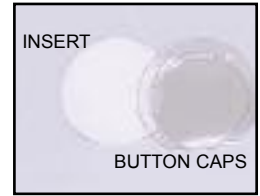

Button Base:
The pushbutton base is made of high strength Lexan with silver tipped self-cleaning contacts. The base is available in various contact configurations.



Harness:
Color coded with plug in connector for easy installation.



CL Items	Part #
Complete Button Assembly	CL
Halo	12C03P01
Button Cam & Insert	C&I-CL
Cam	10C04P04
Button Base (light-up)	10D01G01
Button Base (non light-up)	10D01G02
Bulb Carrier	10M25G01



Buttons (Cont'd)

ELEVATOR PRODUCTS CORPORATION

SA-C Series

MA-C Series



Model: SA-5C Light-up
 Model: SNA-12C Non Light-up
 Halo: 1.375" Dia.
 Button: 1.125" Dia.
 St/St metal insert under clear cap.
 Button flush with halo. Special 0.125" projection also available.
 Available in #4 brushed circular finish, or #8 mirror finish.
 Buttons available with or without markings. Standard is blank.

Model: MA-5C Light-up
 Model: MNA-12C Non Light-up
 Halo: 1.375" Dia.
 Button: 1.125" Dia.
 Mz/Bz metal insert under clear cap



NOTE: Complies with Title 24 California Code when ordering 1/8" projection.

ORDER INFORMATION:

Please advise the following - Model number, mounting orientation, markings, lamp style, LED color and voltages.

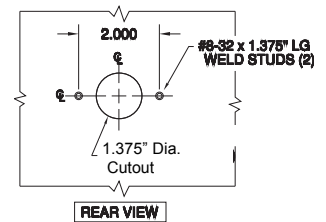
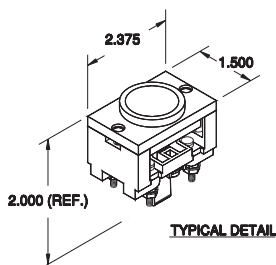



ELEVATOR PRODUCTS
CORPORATION

Buttons (Cont'd)



Halo:
1.375" Dia. Outside
1.125" Dia. Inside
To be used with 0.125" - 0.187"
thick covers.
Color - clear (light-up) only.



Bulb Carrier:
Bulb carriers are made of high
strength Lexan. Copper contacts
assure positive conductivity.
Pull handle in rear of carrier
makes for easy lamp
replacement.



Button LED:
Multi-volt available
Part #: BEA612LED (color)
Part #: BEA24120LED (color)
Colors available in Red, White,
Amber, Blue, Green.

Button Cap & Cam:
1.125" Dia. button cap.
St/St or Mz/Bz metal insert
mounted under clear crystal cap.
Available in #4 brushed circular
finish, or #8 mirror finish.
Markings engraved on insert and
flushcast with epoxy.



Button Base:
The pushbutton base is made of
high strength Lexan with silver
tipped self-cleaning contacts.
The base is available in various
contact configurations.



Harness:
Color coded with plug in
connector for easy installation.



SA-C/MA-C Items	Part #
Complete Button Assembly	SA-C/MA-C
Halo	11C38P02
Button Cap & Cam	C&C-SA-C C&C-MA-C
Button Base (light-up)	10D01G01
Button Base (non light-up)	10D01G02
Bulb Carrier	10M25G01



Buttons (Cont'd)

ELEVATOR PRODUCTS CORPORATION

SSL

MML



Model: SSL Light-up
 Model: SSN Non Light-up
 Halo: None
 Cutout: 1.125" Dia.
 Button: 1.125" Dia.
 Solid convex St/St button cap.
 Button flush with cover.
 Available in #4 brushed circular finish, or #8 mirror finish.
 Buttons available with or without markings.

Model: MML Light-up
 Model: MMN Non Light-up
 Halo: None
 Cutout: 1.125" Dia.
 Button: 1.125" Dia.
 Solid convex Mz/Bz button cap.



NOTE:
FOR REPLACEMENT PARTS ONLY

ORDER INFORMATION:

Please advise the following - model number, mounting orientation, markings, lamp style, LED color and voltages.

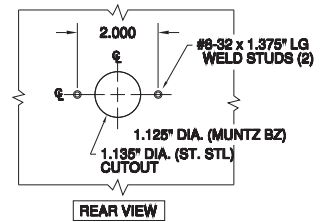
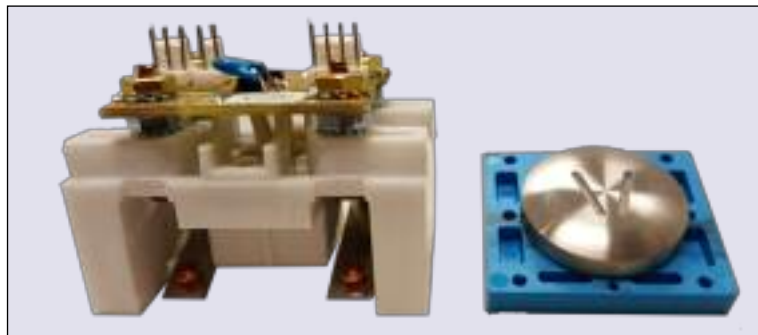
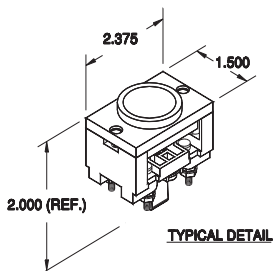



ELEVATOR PRODUCTS CORPORATION

Buttons (Cont'd)



Button Cap & Cam:
 1.125" Dia. button cap.
 0.235" th. solid convex St/St cap
 To be used with 0.125" th. covers.
 Available in #4 brushed circular finish, or #8 mirror finish.
 Markings engraved thru on button cap and flushcast with epoxy.



Bulb Carrier:
 Bulb carriers are made of high strength Lexan. Copper contacts assure positive conductivity. Pull handle in rear of carrier makes for easy lamp replacement.



Button LED:
 Multi-volt available
 Part #: BEA612LED (color)
 Part #: BEA24120LED (color)
 Colors available in Red, White, Amber, Blue, Green.

Button Cap & Cam:
 1.125" Dia. button cap.
 0.235" th. solid convex Mz/Bz cap
 To be used with 0.125" th. covers.
 Available in #4 brushed circular finish, or #8 mirror finish.
 Markings engraved thru on button cap and flushcast with epoxy.



Button Base:
 The pushbutton base is made of high strength Lexan with silver tipped self-cleaning contacts. The base is available in various contact configurations.



Harness:
 Color coded with plug in connector for easy installation.



SSL/MML Items	Part #
Complete Button Assembly	SSL/MML
Button Cap & Cam	C&C-SSL C&C-MML
Button Base (light-up)	10D01G01
Button Base (non light-up)	10D01G02
Bulb Carrier	10M25G01



Buttons (Cont'd)

ELEVATOR PRODUCTS CORPORATION

SSL-P

MML-P

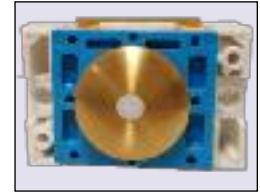
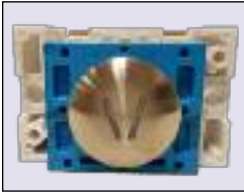

Model: SSL -P Light-up
 Model: SSN -P Non Light-up
 Halo: None
 Cutout: 1.125" Dia.
 Button: 1.125" Dia.
 Solid convex St/St button cap.
 Button projects 0.125" from cover.
 Available in #4 brushed circular finish, or #8 mirror finish.
 Buttons available with or without markings.

Model: MML -P Light-up
 Model: MMN -P Non Light-up
 Halo: None
 Cutout: 1.125" Dia.
 Button: 1.125" Dia.
 Solid convex Mz/Bz button cap.

NOTE:
FOR REPLACEMENT PARTS ONLY

ORDER INFORMATION:

Please advise the following - model number, mounting orientation, markings, lamp style, LED color and voltages.

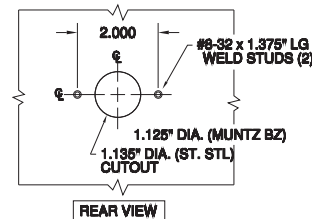
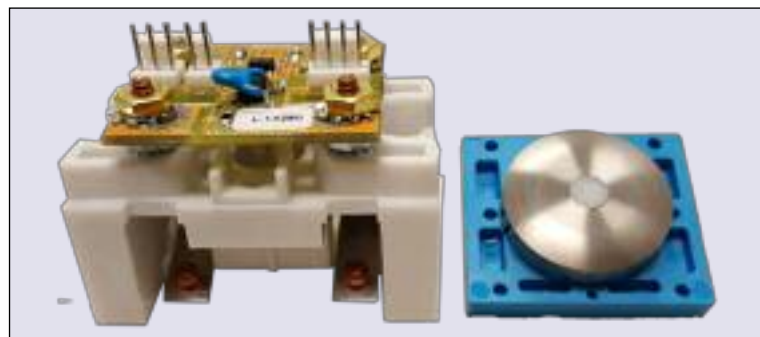
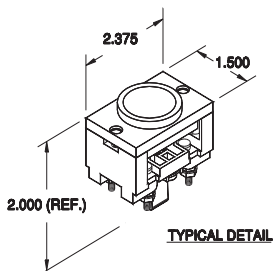



ELEVATOR PRODUCTS CORPORATION

Buttons (Cont'd)



Button Cap & Cam:
 1.125" Dia. button cap.
 0.281" th. solid convex St/St cap.
 To be used with 0.125" th. covers.
 Available in #4 brushed circular finish, or #8 mirror finish.
 Markings engraved thru on button cap and flushcast with epoxy.



Bulb Carrier:
 Bulb carriers are made of high strength Lexan. Copper contacts assure positive conductivity. Pull handle in rear of carrier makes for easy lamp replacement.



Button LED:
 Multi-volt available
 Part #: BEA612LED (color)
 Part #: BEA24120LED (color)
 Colors available in Red, White, Amber, Blue, Green.

Button Cap & Cam:
 1.125" Dia. button cap.
 0.281" th. solid convex Mz/Bz cap.
 To be used with 0.125" th. covers.
 Available in #4 brushed circular finish, or #8 mirror finish.
 Markings engraved thru on button cap and flushcast with epoxy.



Button Base:
 The pushbutton base is made of high strength Lexan with silver tipped self-cleaning contacts. The base is available in various contact configurations.



Harness:
 Color coded with plug in connector for easy installation.



SSL-P/MML-P Items	Part #
Complete Button Assembly	SSL-P/MML-P
Button Cap & Cam	C&C-SSL-P C&C-MML-P
Button Base (light-up)	10D01G01
Button Base (non light-up)	10D01G02
Bulb Carrier	10M25G01



Buttons (Cont'd)

ELEVATOR PRODUCTS CORPORATION

SSL-PC

MML-PC

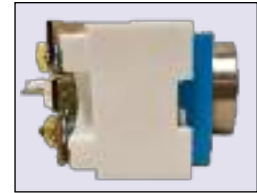

Model: SSL-PC Light-up
 Model: SSN-PC Non Light-up
 Halo: None
 Cutout: 1.125" Dia.
 Button: 1.125" Dia.
 Solid flat St/St button cap.
 Button projects 0.125" from cover.
 Available in #4 brushed circular finish, or #8 mirror finish.
 Buttons available without markings. Markings optional.

Model: MML-PC Light-up
 Model: MMN-PC Non Light-up
 Halo: None
 Cutout: 1.125" Dia.
 Button: 1.125" Dia.
 Solid flat Mz/Bz button cap.

NOTE: Complies with Title 24 California Code.

ORDER INFORMATION:

Please advise the following - model number, mounting orientation, markings, lamp style, LED color and voltages.

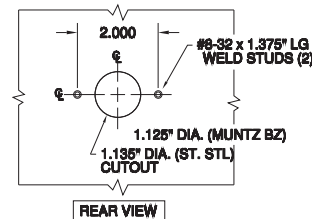
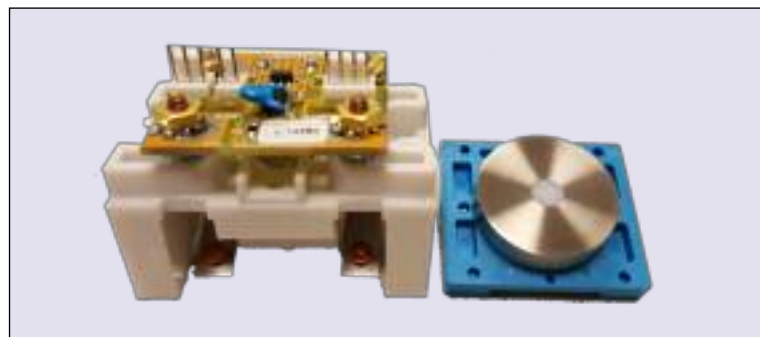
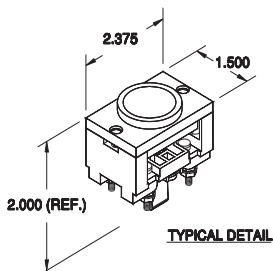



ELEVATOR PRODUCTS CORPORATION

Buttons (Cont'd)



Button Cap & Cam:
 1.125" Dia. button cap.
 0.281" th. solid flat St/St cap.
 To be used with 0.125" th. covers.
 Available in #4 brushed circular finish, or #8 mirror finish.
 Markings engraved thru on button cap and flushcast with epoxy.

Button Cap & Cam:
 1.125" Dia. button cap.
 0.281" th. solid flat Mz/Bz cap.
 To be used with 0.125" th. covers.
 Available in #4 brushed circular finish, or #8 mirror finish.
 Markings engraved thru on button cap and flushcast with epoxy.



Bulb Carrier:
 Bulb carriers are made of high strength Lexan. Copper contacts assure positive conductivity. Pull handle in rear of carrier makes for easy lamp replacement.

Button Base:
 The pushbutton base is made of high strength Lexan with silver tipped self-cleaning contacts. The base is available in various contact configurations.



Button LED:
 Multi-volt available
 Part #: BEA612LED (color)
 Part #: BEA24120LED (color)
 Colors available in Red, White, Amber, Blue, Green.

Harness:
 Color coded with plug in connector for easy installation.



SSL-PC/MML-PC Items	Part #
Complete Button Assembly	SSL-PC/MML-PC
Button Cap & Cam	C&C-SSL-PC C&C-MML-PC
Button Base (light-up)	10D01G01
Button Base (non light-up)	10D01G02
Bulb Carrier	10M25G01



ELEVATOR PRODUCTS CORPORATION

Buttons (Cont'd)

SSL-H/MML-H

SSL-HPC/MML-HPC

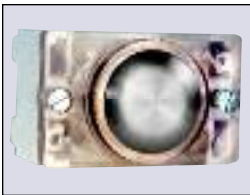
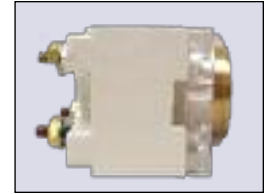
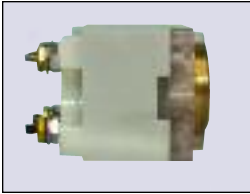

Model: SSL-H light-up
 Model: MML-H light-up
 Model: SSN-H non light-up
 Model: MMN-H non light-up
 Halo: 1.375" Dia. Clear
 Button: 1.125" Dia.
 Solid convex St/St.or Mz/Bz. button cap
 Avail. in #4 brushed circular finish,
 or #8 mirror finish.

Model: SSL-HPC light-up
 Model: MML-HPC light-up
 Model: SSN-HPC non light-up
 Model: MMN-HPC non light-up
 Halo: 1.375" Dia. Clear
 Button: 1.125" Dia.
 Solid flat St/St.or Mz/Bz. button cap
 Button projects 0.125" from halo.
 (California Code)
 Avail. in #4 brushed circular finish,
 or #8 mirror finish.

ORDER INFORMATION:

Please advise the following - model number, mounting orientation, LED color, lamp style and voltages.

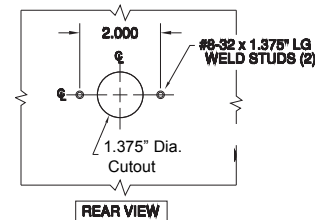



ELEVATOR PRODUCTS CORPORATION

Buttons (Cont'd)



Halo:
 1.375" Dia. Outside
 1.125" Dia. Inside
 To be used with 0.125" - 0.187"
 thick covers.
 Color - clear (light-up) only.



Bulb Carrier:
 Bulb carriers are made of high strength Lexan. Copper contacts assure positive conductivity. Pull handle in rear of carrier makes for easy lamp replacement.



Button LED:
 Multi-volt available
 Part #: BEA612LED (color)
 Part #: BEA24120LED (color)
 Colors available in Red, White, Amber, Blue, Green.

Button Cap & Cam:
 1.125" Dia. button cap.
 Solid St/St or Mz/Bz metal cap.
 Available in #4 brushed circular finish, or #8 mirror finish.
 Markings engraved on insert and flushcast with epoxy.



Button Base:
 The pushbutton base is made of high strength Lexan with silver tipped self-cleaning contacts. The base is available in various contact configurations.



Harness:
 Color coded with plug in connector for easy installation.



SSL-H / MML-H Items	Part #
Complete Button Assembly	SSL-H / MML-H
Halo	11C38P02
Button Cap & Cam	C&C-SSL-H C&C-MML-H
Button Base (light-up)	10D01G01
Button Base (non light-up)	10D01G02
Bulb Carrier	10M25G01

SSL-HPC / MML-HPC Items	Part #
Complete Button Assembly	SSL-HPC / MML-HPC
Halo	11C38P02
Button Cap & Cam	C&C-SSL-HPC C&C-MML-HPC
Button Base (light-up)	10D01G01
Button Base (non light-up)	10D01G02
Bulb Carrier	10M25G01



ELEVATOR PRODUCTS CORPORATION

Buttons (Cont'd)

SSL-HC



Model: SSL-HC light-up
 Model: SSN-HC non light-up
 Halo: 1.375" Dia. Clear Lexan
 Button: 1.125" Dia.
 Solid flat St/St. button cap,
 Button flush with halo
 Available in #4 brushed circular finish or
 #8 mirror finish
 Buttons avail. with or without markings.

MML-HC

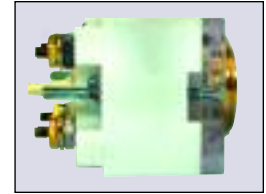

Model: MML-HC light-up
 Model: MMN-HC non light-up
 Halo: 1.375" Dia. Clear Lexan
 Button: 1.125" Dia.
 Solid flat Mz/Bz.button cap
 Button flush with halo
 Available in #4 brushed circular finish or
 #8 mirror finish
 Buttons avail. with or without markings.

ORDER INFORMATION:

Please advise the following - model number, mounting orientation, markings, lamp style, LED color and voltages.

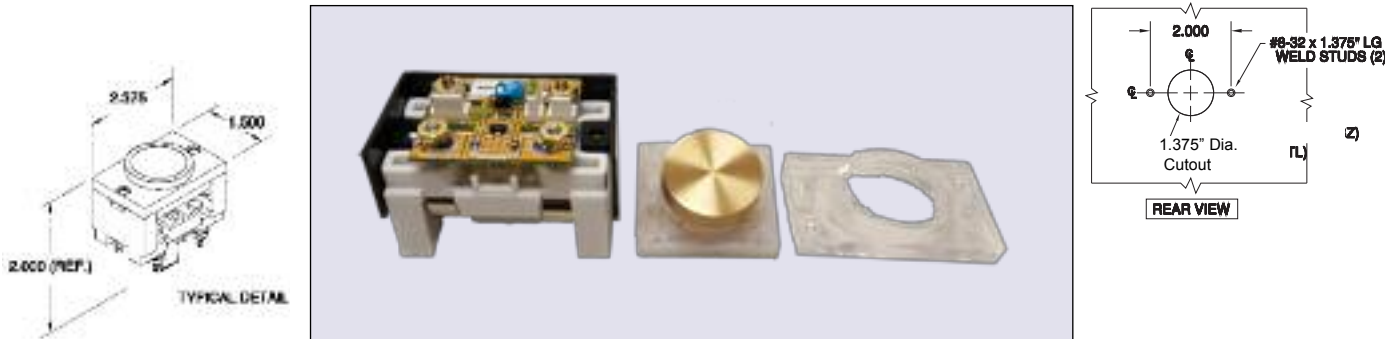



ELEVATOR PRODUCTS CORPORATION

Buttons (Cont'd)



Halo:
 1.375" Dia. Outside
 1.125" Dia. Inside
 To be used with 0.125" - 0.187" thick covers.
 Color - clear (light-up) only.



Bulb Carrier:
 Bulb carriers are made of high strength Lexan. Copper contacts assure positive conductivity. Pull handle in rear of carrier makes for easy lamp replacement.



Button LED:
 Multi-volt available
 Part #: BEA612LED (color)
 Part #: BEA24120LED (color)
 Colors available in Red, White, Amber, Blue, Green.

Button Cap & Cam:
 1.125" Dia. button cap.
 Available in #4 brushed circular finish, or #8 mirror finish.
 Blank markings optional.



Button Base:
 The pushbutton base is made of high strength Lexan with silver tipped self-cleaning contacts. The base is available in various contact configurations.



Harness:
 Color coded with plug in connector for easy installation.



SSL-HC / MML-HC Items	Part #
Complete Button Assembly	SSL-HC / MML-HC
Halo	11C38P02
Button Cap & Cam	C&C-SSL-HC C&C-MML-HC
Button Base (light-up)	10D01G01
Button Base (non light-up)	10D01G02
Bulb Carrier	10M25G01



Buttons (Cont'd)

ELEVATOR PRODUCTS CORPORATION

SSL-HSE

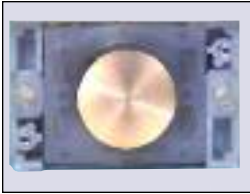

Model: SSL-HSE light-up
 Model: SSN-HSE non light-up
 Halo: 1.125" Dia. Clear
 Button: 1.000" Dia.
 Solid flat St/St. button cap,
 Available in #4 brushed circular finish or #8 mirror finish
 Button standard is blank. Markings optional.

MML-HSE

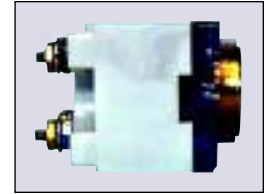

Model: MML-HSE light-up
 Model: MMN-HSE non light-up
 Halo: 1.125" Dia. Clear
 Button: 1.000" Dia.
 Solid flat Mz/Bz.button cap,
 Available in #4 brushed circular finish or #8 mirror finish
 Button standard is blank. Markings optional.

ORDER INFORMATION:

Please advise the following - model number, mounting orientation, markings, lamp style, LED color and voltages.

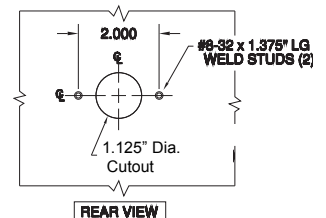
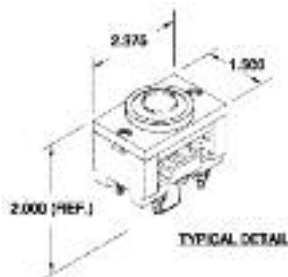



ELEVATOR PRODUCTS CORPORATION

Buttons (Cont'd)



Halo:
 1.125" Dia. Outside
 1.100" Dia. Inside
 To be used with 0.125" - 0.187"
 thick covers.
 Color - clear (light-up) only.



Bulb Carrier:
 Bulb carriers are made of high strength Lexan. Copper contacts assure positive conductivity. Pull handle in rear of carrier makes for easy lamp replacement.



Button LED:
 Multi-volt available
 Part #: BEA612LED (color)
 Part #: BEA24120LED (color)
 Colors available in Red, White, Amber, Blue, Green.

Button Cap & Cam:
 1.000" Dia. button cap.
 Available in #4 brushed circular finish, or #8 mirror finish.
 Markings engraved on insert and flushcast with epoxy.



Button Base:
 The pushbutton base is made of high strength Lexan with silver tipped self-cleaning contacts. The base is available in various contact configurations.



Harness:
 Color coded with plug in connector for easy installation.



SSL-HC / MML-HC Items	Part #
Complete Button Assembly	SSL-HSE / MML-HSE
Halo	11C38P02
Button Cap & Cam	C&C-SSL-HSE C&C-MML-HSE
Button Base (light-up)	10D01G01
Button Base (non light-up)	10D01G02
Bulb Carrier	10M25G01



ELEVATOR PRODUCTS CORPORATION

Buttons (Cont'd)

SSL-SH Housing

MML-SH Housing

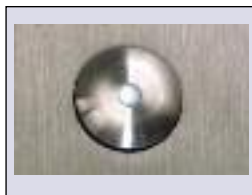
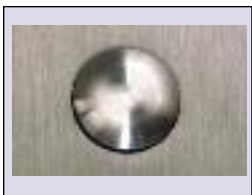
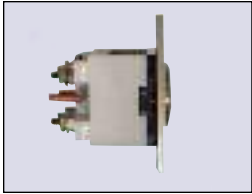

Model: SSL-SH light-up
 Model: SSN-SH non light-up
 Halo: None
 Cutout: 1.125" Dia. (see rear view)
 Button: 1.110" Dia.
 Jewel: 0.250" Dia.
 Solid Convex St/St. blank button cap
 Button projects 0.125" from cover.
 Available in #4 brushed circular finish or #8 mirror finish

Model: MML-SH light-up
 Model: MMN-SH non light-up
 Halo: None
 Cutout: 1.125" Dia. (see rear view)
 Button: 1.110" Dia.
 Jewel: 0.250" Dia.
 Solid convex Mz/Bz. blank button cap
 Button projects 0.125" from cover.
 Available in #4 brushed circular finish or #8 mirror finish

NOTE: Approved by the New York City Housing Authority.

ORDER INFORMATION:

Please advise the following - Model number, LED color, lamp style and voltages.

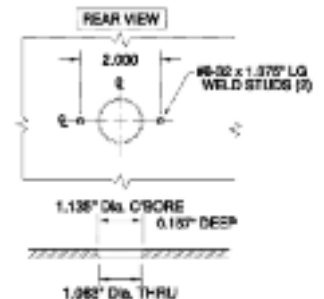
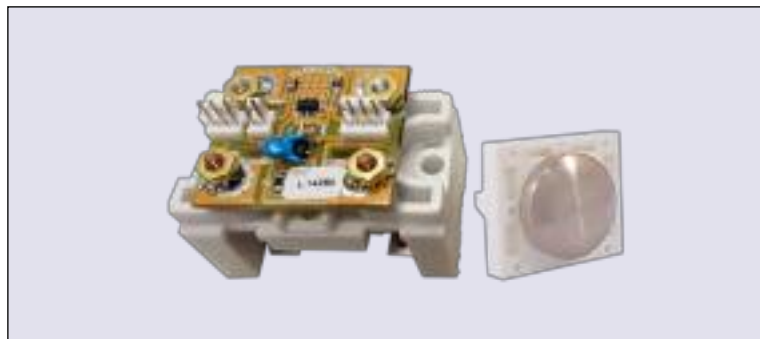
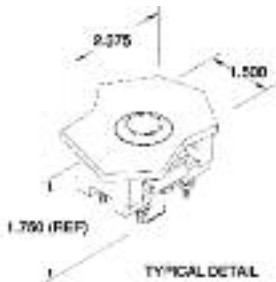



ELEVATOR PRODUCTS CORPORATION

Buttons (Cont'd)



Retainer Clip:
Alloy spring steel securly holds button cap to cover.



Bulb Carrier:
Bulb carriers are made of high strength Lexan. Copper contacts assure positive conductivity. Pull handle in rear of carrier makes for easy lamp replacement.



Button LED:
Multi-volt available
Part #: BEA612LED (color)
Part #: BEA24120LED (color)
Colors available in Red, White, Amber, Blue, Green.

Button Cap & Cam:
1.125" Dia. button cap. Solid convex St/St or Mz/Bz metal cap. Available in #4 brushed circular finish, or #8 mirror finish. Markings engraved on insert and flushcast with epoxy.



Button Base:
The pushbutton base is made of high strength Lexan with silver tipped self-cleaning contacts. The base is available in various contact configurations.



Harness:
Color coded with plug in connector for easy installation.



SSL-SH / MML-SH Items	Part #
Complete Button Assembly	SSL-SH / MML-SH
Button Cap & Cam	C&C-SSL-SH C&C-MML-SH
Button Base (light-up)	10D01G01
Button Base (non light-up)	10D01G02
Bulb Carrier	10M25G01
Lamps *	
LED	15B03P [x]
Incandescent	10M12P [x]
Contact Springs	see hardware section
Hardware	see hardware section



ELEVATOR PRODUCTS CORPORATION

Buttons (Cont'd)

WA Series



Model: WA-9 Light-up
Model: NA-16 Non Light-up
Halo: 1.375" Dia.
Button: 1.125" Dia.
Button flush with halo. * Special button projections are available - call for information.
Buttons available with or without markings.

ORDER INFORMATION:

Please advise the following - model number, mounting orientation, markings, lamp style, LED color and voltages.

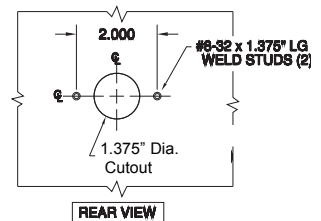
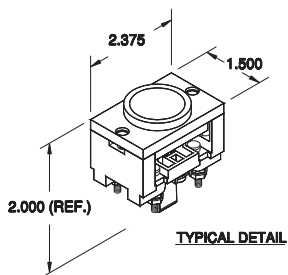



ELEVATOR PRODUCTS CORPORATION

Buttons (Cont'd)



Halo:
 1.375" Dia. Outside
 1.125" Dia. Inside
 To be used with 0.125" - 0.187" thick covers.



Bulb Carrier:
 Bulb carriers are made of high strength Lexan. Copper contacts assure positive conductivity. Pull handle in rear of carrier makes for easy lamp replacement.



Button LED:
 Multi-volt available
 Part #: BEA612LED (color)
 Part #: BEA24120LED (color)
 Colors available in Red, White, Amber, Blue, Green.

Button Cap & Cam:
 1.125" Dia. button cap.
 Markings engraved on solid Lexan button caps.
 Colors available - see chart.



Button Base:
 The pushbutton base is made of high strength Lexan with silver tipped self-cleaning contacts. The base is available in various contact configurations.



Harness:
 Color coded with plug in connector for easy installation.



WA Series Items	Part #
Complete Button Assembly	WA
Button Cap & Cam	C&C-WA
Halo +	10C07P [y]
Button Base (light-up)	10D01G01
Button Base (non light-up)	10D01G02
Bulb Carrier	10M25G01



ELEVATOR PRODUCTS CORPORATION

Buttons (Cont'd)

WA-PC Series



Model: WA-9PC Light-up
Model: NA-16PC Non Light-up
Halo: 1.375" Dia.
Button: 1.125" Dia.
Button projects 0.125" from halo - with square shoulders.
Buttons available with or without markings.

NOTE: Complies with Title 24 California Code

ORDER INFORMATION

Please advise the following - model number, mounting orientation, markings, lamp style, LED color and voltages.

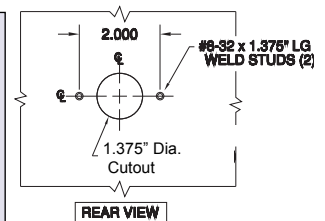
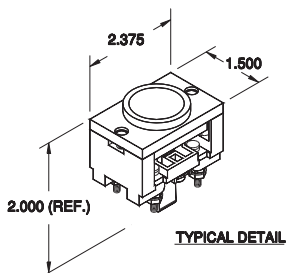



ELEVATOR PRODUCTS
CORPORATION

Buttons (Cont'd)



Halo:
1.375" Dia. Outside
1.125" Dia. Inside
To be used with 0.125" - 0.187"
thick covers.



Bulb Carrier:
Bulb carriers are made of high
strength Lexan. Copper contacts
assure positive conductivity.
Pull handle in rear of carrier
makes for easy lamp
replacement.



Button LED:
Multi-volt available
Part #: BEA612LED (color)
Part #: BEA24120LED (color)
Colors available in Red, White,
Amber, Blue, Green.

Button Cap & Cam:
1.125" Dia. button cap.
Milkwhite Lexan insert under clear
crystal square shoulder cap.
Markings hot-stamped on insert.
Colors - white only.



Button Base:
The pushbutton base is made of
high strength Lexan with silver
tipped self-cleaning contacts.
The base is available in various
contact configurations.



Harness:
Color coded with plug in
connector for easy installation.



WA-PC Series Items	Part #
Complete Button Assembly	WA-PC
Button Cap & Cam	C&C-WA-PC
Halo +	11C38P01
Button Base (light-up)	10D01G01
Button Base (non light-up)	10D01G02
Bulb Carrier	10M25G01



ELEVATOR PRODUCTS CORPORATION

Buttons (Cont'd)

WB Series



Model: WB-10 Light-up
Model: NB-6 Non Light-up
Halo: 1.000" Dia.
Button: 0.875" Dia.
Button flush with halo. * Special button projections are available - call for information.
Button available with or without markings.

NOTE:
FOR REPLACEMENT PARTS ONLY

ORDER INFORMATION:

Please advise the following - model number, mounting orientation, markings, lamp style and voltages.

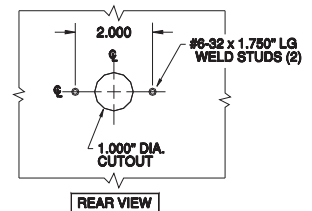
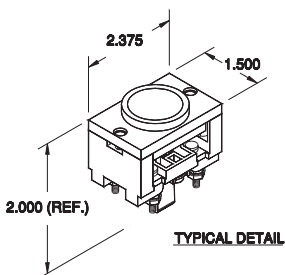



ELEVATOR PRODUCTS CORPORATION

Buttons (Cont'd)



Halo:
 1.000" Dia. Outside
 0.875" Dia. Inside
 To be used with 0.125" th. covers.



Bulb Carrier:
 Bulb carriers are made of high strength Lexan. Copper contacts assure positive conductivity. Pull handle in rear of carrier makes for easy lamp replacement.



Button LED:
 Multi-volt available
 Part #: BEA612LED (color)
 Part #: BEA24120LED (color)
 Colors available in Red, White, Amber, Blue, Green.

Button Cap & Cam:
 0.875" Dia. button cap.
 Markings engraved on solid Lexan button caps.
 Color available - see chart.



Button Base:
 The pushbutton base is made of high strength Lexan with silver tipped self-cleaning contacts. The base is available in various contact configurations.



Harness:
 Color coded with plug in connector for easy installation.



WB Series Items	Part #
Complete Button Assembly	WB
Button Cap & Cam	C&C-WB
Halo +	10C08P [y]
Halo - White Opaque	10C08P02
Button Base (light-up)	10D01G01
Button Base (non light-up)	10D01G02
Bulb Carrier	10M25G01



ELEVATOR PRODUCTS CORPORATION

Buttons (Cont'd)

WS Series



Model: WS-9 Light-up
Model: NS-16 Non Light-up
Halo: 1.375" Dia.
Button: 0.875" Dia.
Button slightly recessed from halo. * Special button projections are available - call for information.
Buttons available with or without markings.

NOTE: These buttons do not meet U.S. ADA Code
Special button projections are available.
Call for information

NOTE:
FOR REPLACEMENT PARTS ONLY

ORDER INFORMATION:

Please advise the following - model number, mounting orientation, markings, lamp style and voltages.

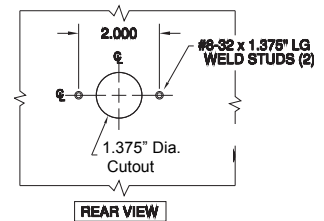
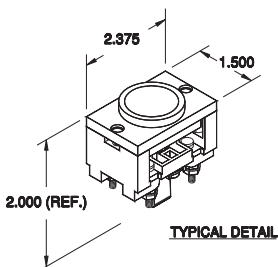



ELEVATOR PRODUCTS CORPORATION

Buttons (Cont'd)



Halo:
 1.375" Dia. Outside
 0.875" Dia. Inside
 To be used with 0.125" th. covers.



Bulb Carrier:
 Bulb carriers are made of high strength Lexan. Copper contacts assure positive conductivity. Pull handle in rear of carrier makes for easy lamp replacement.

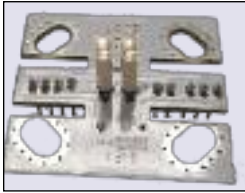

Button LED:
 Multi-volt available
 Part #: BEA612LED (color)
 Part #: BEA24120LED (color)
 Colors available in Red, White, Amber, Blue, Green.

Button Cap & Cam:
 0.875" Dia. button cap.
 Markings engraved on solid Lexan button caps.
 Colors available - see chart.



Button Base:
 The pushbutton base is made of high strength Lexan with silver tipped self-cleaning contacts. The base is available in various contact configurations.



Harness:
 Color coded with plug in connector for easy installation.



WS Series Items	Part #
Complete Button Assembly	WS
Button Cap & Cam	C&C-WS
Halo +	10C09P [y]
Button Base (light-up)	10D01G01
Button base (non light-up)	10D01G02
Bulb Carrier	10M25G01



ELEVATOR PRODUCTS CORPORATION

Buttons (Cont'd)

FL Series

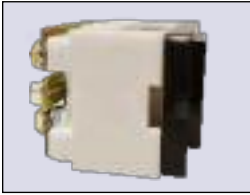

Model: FL Light-up
Model: FN Non Light-up
Halo: 1.250" Sq.
Button: 0.875" Sq.
Milkwhite insert under clear cap.
Button recessed from halo.
Buttons available with or without markings.

NOTE: These buttons do not meet U.S. ADA Code.

ORDER INFORMATION:

Please advise the following - model number, markings, lamp style and voltages.

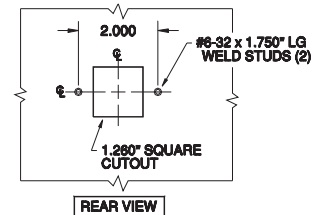
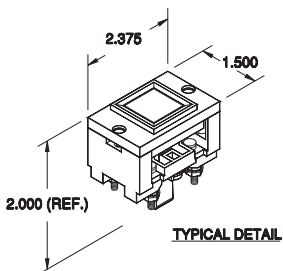



ELEVATOR PRODUCTS
CORPORATION

Buttons (Cont'd)



Halo:
1.250" Sq. Outside
0.875" Sq. Inside
To be used with 0.125" th. covers.



Cam:
The pushbutton cam is made of high strength Lexan to ensure durability. Acts as a fixing mechanism to deter rotation of button cap.



Bulb Carrier:
Bulb carriers are made of high strength Lexan. Copper contacts assure positive conductivity. Pull handle in rear of carrier makes for easy lamp replacement.



Button LED:
Multi-volt available
Part #: BEA612LED (color)
Part #: BEA24120LED (color)
Colors available in Red, White, Amber, Blue, Green.

Button Cap & Insert:
0.875" Sq. clear button cap.
0.875" Sq. milkwhite button cap.
1.250" Sq. milkwhite insert.
Markings hot stamped on insert.
Markings engraved on solid milkwhite cap.
Color - white only.



Button Base:
The pushbutton base is made of high strength Lexan with silver tipped self-cleaning contacts. The base is available in various contact configurations.



Harness:
Color coded with plug in connector for easy installation.



FL Series Items	Part #
Complete Button Assembly	FL
Button Cap & Insert	C&I-FL
Halo +	10C06P [y]
Cam	
Button Base (light-up)	10D01G01
Button Base (non light-up)	10D01G02
Bulb Carrier	10M25G01



Buttons (Cont'd)

ELEVATOR PRODUCTS CORPORATION

PEPS-SPR/PEPM-SPR

PEPS-SPRPC/PEPM-SPRPC

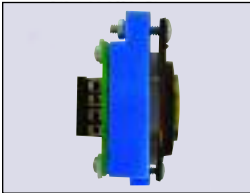

Model: PEPS-SPR light-up only
 Model: PEPM-SPR light-up only
 Pep Braille: Oblong 2.500"W x 1.375"H
 Oval black steel with St/St. or Mz/Bz. finish braille & character.
 Button: 1.000" Dia. St/St. or Mz/Bz. cap with 1.135" Dia. clear ferrule ring.
 Button flush with halo.

Model: PEPS-SPRPC light-up only
 Model: PEPM-SPRPC light-up only
 Pep Braille: Oblong 2.500"W x 1.375"H
 Oval black steel with St/St. or Mz/Bz. finish braille & character.
 Button: 1.000" Dia. St/St. or Mz/Bz. cap with 1.135" Dia. clear ferrule ring.
 Button projects 0.125" from halo.
 (California Code)

ORDER INFORMATION:

Please advise the following - model number, mounting orientation, markings, lamp style and voltages.

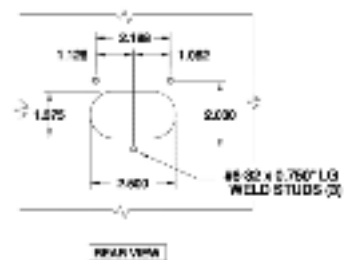
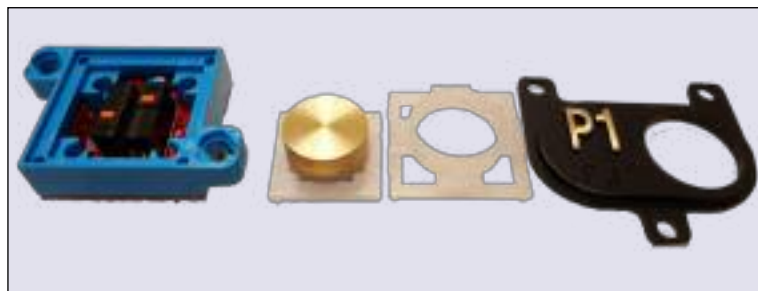



ELEVATOR PRODUCTS CORPORATION

Buttons (Cont'd)



Pep braille: 2.5" w x 1.375" h
 1.375" Dia. Outside
 1.125" Dia. Inside
 To be used with 0.063" or 0.125" thick covers.

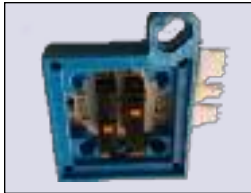

Housing:
 Made from high strength Lexan.
 1.687" Sq. x 0.50" deep.

Button Cap & Cam:
 0.937" Dia. button cap.
 Solid St/St or Mz/Bz metal cap.
 Available in #4 brushed circular finish, or #8 mirror finish.
 Markings engraved on insert and flushcast with epoxy.



Harness:
 Color coded with plug in connector for easy installation.



Button LED:
 Multi-volt available
 Part #: SB612LED (color)
 Part #: SB24120LED (color)
 Colors available in Red, White, Amber, Blue, Green.
 Also available in terminal block.

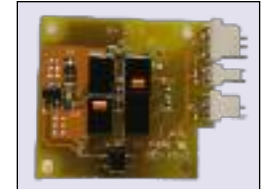

PEPS-SPR / PEPM-SPR Items	Part #
Complete Button Assembly	PEPS-SPR/PEPM-SPR
Pep Braille +	
St. Steel	65X46 [x]
Mz. Bronze	65X47 [x]
White	65X48 [x]
Button Cap & Cam	C&C-PEPS-SPR C&C-PEPM-SPR

PEPS-SPRPC / PEPM-SPRPC Items	Part #
Complete Button Assembly	PEPS-SPRPC/PEPM-SPRPC
Pep Braille +	
St. Steel	65X46 [x]
Mz. Bronze	65X47 [x]
White	65X48 [x]
Button Cap & Cam	C&C-PEPS-SPRPC C&C-PEPM-SPRPC

+ [x] is dependent upon braille marking, please specify when ordering.



Buttons (Cont'd)

ELEVATOR PRODUCTS CORPORATION

PEP-AS/PEP-AM

PEP-ASPC/PEP-AMPC

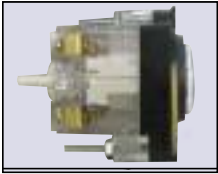

Model: PEP-ASPC light-up
 Model: PEP-NASPC non light-up
 Halo: Oblong 2.500"W x 1.375"H
 Black steel with integrated raised characters and Braille, St/St finish
 Button: 1.125" Dia. White
 Projection: 0.125"
 Buttons avail. with or without markings.

Model: PEP-ASPC light-up
 Model: PEP-AMPC non light-up
 Halo: Oblong 2.500"W x 1.375"H
 black steel with integrated raised characters and Braille, Mz/Bz. finish
 Button: 1.125" Dia. White
 Projection: 0.125"
 Buttons avail. with or without markings.

ORDER INFORMATION:

Please advise the following - model number, mounting orientation, markings, lamp style and voltages.

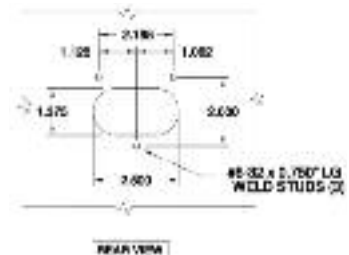
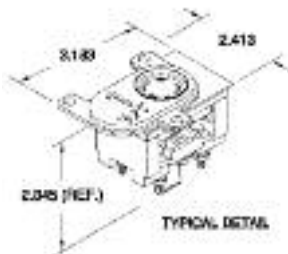



ELEVATOR PRODUCTS CORPORATION

Buttons (Cont'd)



Pep Braille:
 Oblong 2.500"W x 1.375"H with mounting ears.
 1.125" Dia. Hole Inside
 To be used with 0.125" thick covers only.



Harness:
 Color coded with plug in connector for easy installation.

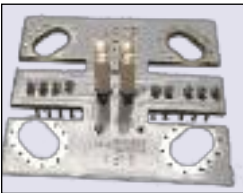

Button LED:
 Multi-volt available
 Part #: BEA612LED (color)
 Part #: BEA24120LED (color)
 Colors available in Red, White, Amber, Blue, Green.

Button/Cap: 1.125" Dia. clear cap over white Lexan button. Avail. blank or with character



Button Base:
 The pushbutton base is made of high strength Lexan with silver tipped self-cleaning contacts. The base is available in various contact configurations.



PEPS-AS / PEPM-AS Items	Part #
Complete Button Assembly	PEPS-AS/PEPM-AS
Pep Braille *	
St. Steel	65X46P [x]
Mz. Bronze	65X47P [x]
White	65X48P [x]
Button Cap & Cam	C&C-PEPS-AS C&C-PEPM-AS
Contact Base for LED	AS451A-02

* [x] is dependent upon braille marking, please specify when ordering.



ELEVATOR PRODUCTS CORPORATION

Buttons (Cont'd)

Survivor

Survivor-PC

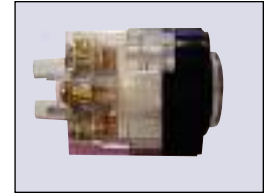
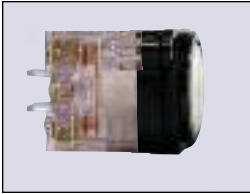

Model: SURVIVOR (light up)
 Model: SURVIVORN (non light up)
 Halo: 1.375" Dia. Black Lexan
 Button/Cap: 1.125" Dia. clear cap over white Lexan button.
 Legend: Engrave on button, flushcast epoxy.

Model: SURVIVOR-PC (light up)
 Model: SURVIVORN-PC (non light up)
 Halo: 1.375" Dia. Black Lexan
 Button/Cap: 1.125" Dia. clear cap over white Lexan button.
 Button projects 0.125" from halo.
 (California Code)
 Legend: Engrave on button, flushcast epoxy.

NOTE: Buttons also available with 0.250" deep halos
 (typically used for swing front applications.)

ORDER INFORMATION:

Please advise the following - model number, mounting orientation, markings, lamp style and voltages.





ELEVATOR PRODUCTS CORPORATION

Buttons (Cont'd)



Halo: 1.375" Dia. outside, 1.125" Dia. inside
Black Lexan.



Halo Adapter:
High Strength Black Lexan.
Joins base to base



Button LED:
Multi-volt available
Part #: BEA612LED (color)
Part #: BEA24120LED (color)
Colors available in Red, White, Amber, Blue, Green.

Button/Cap: 1.125" Dia. clear cap over white Lexan button.
Avail. blank or with character



Button Base:
The pushbutton base is made of high strength Lexan with silver tipped self-cleaning contacts.
The base is available in various contact configurations.



Harness:
Color coded with plug in connector for easy installation.



SURVIVOR Items	Part #
Button, Halo, Cap, & Adaptor *	ASA452A-[x]
Button & Clear Cap	ASA452W-BL
Halo	AS450H21
Halo Adapter	AS470-20B
Contact Base for LED	AS451A-02

SURVIVOR PC Items	Part #
Button, Halo, Cap, & Adaptor *	ASC452A-[x]
Button & Clear Cap	ASC452W-BL
Halo	AS450H21
Halo Adapter	AS470-20B
Contact Base for LED	AS451A-02

NOTE: Please specify color, marking and voltage when ordering.

* [x] is dependent upon marking.



ELEVATOR PRODUCTS CORPORATION

Buttons (Cont'd)

Survivor-SM Surface Mount Style

Survivor-SMPC Surface Mount Style



Model: SURVIVOR-SM
Halo: 1.375" Dia. Black Lexan
Button/Cap: 1.125" Dia. Clear cap over white Lexan button.
Legend: Engrave on button, flushcast epoxy

Model: SURVIVOR-SMPC
Halo: 1.375" Dia. Black Lexan
Button/Cap: 1.125" Dia. Clear cap over white Lexan button.
Button projects 0.125" from halo.
(California Code)
Legend: Engrave on button, flushcast epoxy

ORDER INFORMATION:

Please advise the following - model number, mounting orientation, markings, lamp style and voltages.

For old style survivor buttons, please contact. SLC.





ELEVATOR PRODUCTS
CORPORATION

Buttons (Cont'd)



Halo: 1.375" Dia. outside,
1.125" Dia. inside
Black Lexan.

Button/Cap: 1.125" Dia. clear
cap over white Lexan button.
Avail. blank or with character

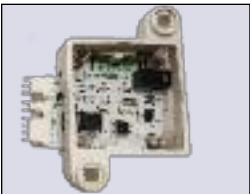

Surface mount button base:
Unique 3/4" shallow base.
For all survivor button caps.

Harness:
Color coded with plug in
connector for easy installation.

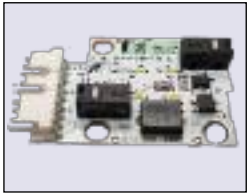

Button LED:
Multi-volt available
Part #: B612LED (color)
Part #: B24120LED (color)
Colors available in Red, White,
Amber, Blue, Green.

Sold as complete button only.

NOTE: Please specify color, marking and voltage when ordering.



Buttons (Cont'd)

ELEVATOR PRODUCTS CORPORATION

SURVPL-S/SURVPL-M

SURVPL-SPC/SURVPL-MPC

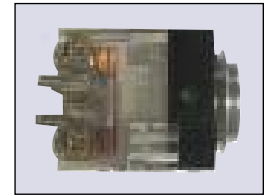
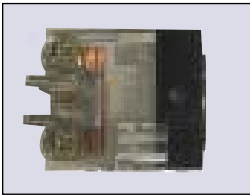

Model: SURVPL-S (light-up) (St/St.)
 Model: SURVPL-M (light-up) (Mz/Bz.)
 Model: SURVPL-SN (non light-up) (St/St.)
 Model: SURVPL-SN (non light-up) (Mz/Bz.)
 Halo: 1.250" Dia. St/St. or Mz/Bz.
 Vandal-resistant
 Button: 0.931" Dia. St/St. or Mz/Bz.
 Jewel: 0.250" Dia. insert (if applicable)
 Legend: Engrave on cover, flushcast epoxy.

Model: SURVPL-SPC (light-up) (St/St.)
 Model: SURVPL-MPC (light-up) (Mz/Bz.)
 Model: SURVPL-SNPC (non light-up) (St/St.)
 Model: SURVPL-MNPC (non light-up) (Mz/Bz.)
 Halo: 1.250" Dia. St/St. or Mz/Bz.
 Vandal-resistant
 Button: 0.931" Dia. St/St. or Mz/Bz.
 Jewel: 0.250" Dia. insert (if applicable)
 Button projects 0.125" from halo.
 (California Code)
 Legend: Engrave on cover, flushcast epoxy.

ORDER INFORMATION:

Please advise the following - model number, mounting orientation, markings, lamp style and voltages.

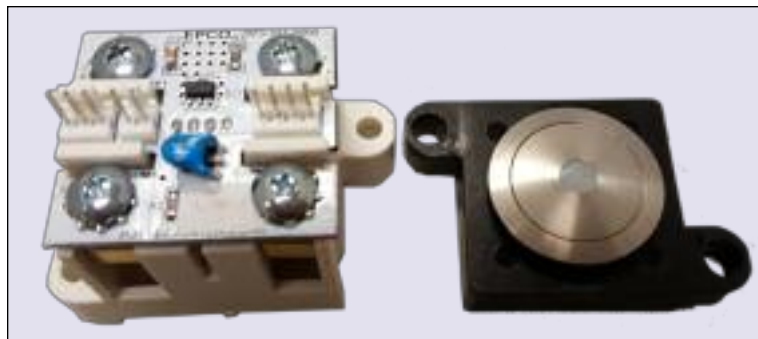



ELEVATOR PRODUCTS CORPORATION

Buttons (Cont'd)



Harness:
Color coded with plug in connector for easy installation.



Button LED:
Multi-volt available
Part #: BEA612LED (color)
Part #: BEA24120LED (color)
Colors available in Red, White, Amber, Blue, Green.

Button:
0.931" Dia.
St/St or Mz/Bz

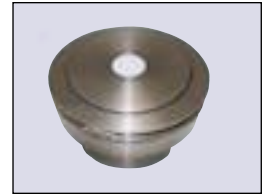

Button Base:
The pushbutton base is made of high strength Lexan with silver tipped self-cleaning contacts. The base is available in various contact configurations.



SURVPL-S Items	Part#
Complete Button Assembly (2 N/O) *	AS458 [x]
Contact Base for LED	AS451A-02
Spring Clips (1) each	AS458-05 & 06
LED +	15B03P [y]

SURVPL-SPC Items	Part#
Complete Button Assembly (2 N/O) *	AS458 [x]
Contact Base for LED	AS451A-02
Spring Clips (1) each	AS458-05 & 06
LED +	15B03P [y]

[x] is dependent upon illumination, finish, and color.



ELEVATOR PRODUCTS CORPORATION

Buttons (Cont'd)

Designer

Designer-PC



Model: DESIGNER (light up)
 Model: DESIGNERN (non light up)
 Halo: 1.500" Square black Lexan
 Button/Cap: 1.250" Square clear cap over white Lexan button.
 Legend: Engrave on button, flushcast epoxy.

Model: DESIGNER-PC (light up)
 Model: DESIGNERN-PC (non light up)
 Halo: 1.500" Square black Lexan
 Button/Cap: 1.250" Square clear cap over white Lexan button.
 Button projects 0.125" from halo.
 (California Code)
 Legend: Engrave on button, flushcast epoxy.

NOTE: Buttons also available with 0.250" deep halos
 (typically used for swing front applications.)

ORDER INFORMATION:

Please advise the following - model number, mounting orientation, markings, lamp style and voltages.

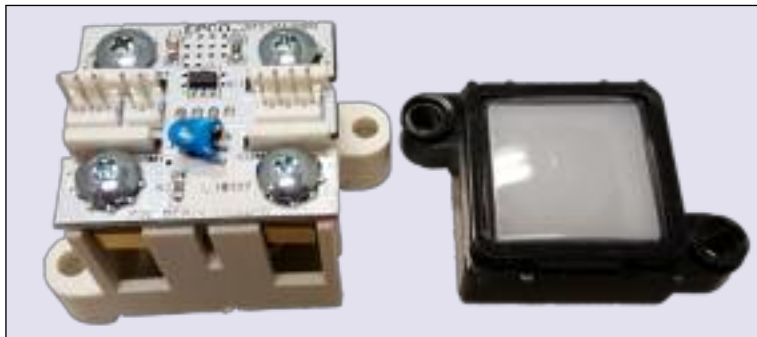



ELEVATOR PRODUCTS CORPORATION

Buttons (Cont'd)

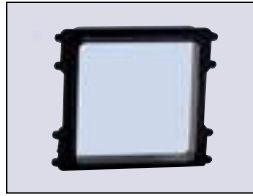

Halo: 1.500" Square Black Lexan



Halo Adapter:
High Strength Black Lexan.
Joins base to Base



Button LED:
Multi-volt available
Part #: BEA612LED (color)
Part #: BEA24120LED (color)
Colors available in Red, White, Amber, Blue, Green.

Button Cap: 1.250" Square clear cap over white Lexan button.
Available blank or with character.



Button Base:
The pushbutton base is made of high strength Lexan with silver tipped self-cleaning contacts.
The base is available in various contact configurations.



Harness:
Color coded with plug in connector for easy installation.



DESIGNER Items	Part#
Buton, Halo, Cap & Adaptor *	ASA472 [x]
Button	AS472-05W
Clear Cap	AS472-03
Halo	AS472-10B
Halo Adapter Square Black	AS470-20B
Contact Base for LED	AS451A-02
LED +	15B03P [y]

DESIGNER PC Items	Part#
Buton, Halo, Cap & Adaptor *	ASC472 [x]
Button	AS472-05W
Clear Cap	AS472-04
Halo	AS472-10B
Halo Adapter Square Black	AS470-20B
Contact Base for LED	AS451A-02
LED +	15B03P [y]

* [x] is dependent upon markings.



ELEVATOR PRODUCTS CORPORATION

Buttons (Cont'd)

Designer2

Designer2-PC

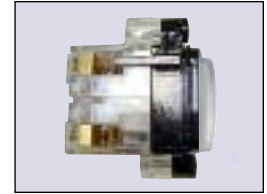

Model: DESIGNER2 (light up)
 Model: DESIGNER2N (non light up)
 Halo: 2.875" x 1.500" Black Lexan w/ integral handicap plate.
 Button/Cap 1.250" Square Clear Cap over white Lexan Button.
 Legend: Engrave on button, flushcast epoxy.

Model: DESIGNER2-PC (light up)
 Model: DESIGNER2N-PC (non light up)
 Halo: 2.875" x 1.500" Black Lexan w/ integral handicap plate.
 Button/Cap 1.250" Square Clear Cap over white Lexan Button.
 Button projects 0.125" from halo.
 (California Code)
 Legend: Engrave on button, flushcast epoxy.

ORDER INFORMATION:

Please advise the following - model number, mounting orientation, markings, lamp style and voltages.

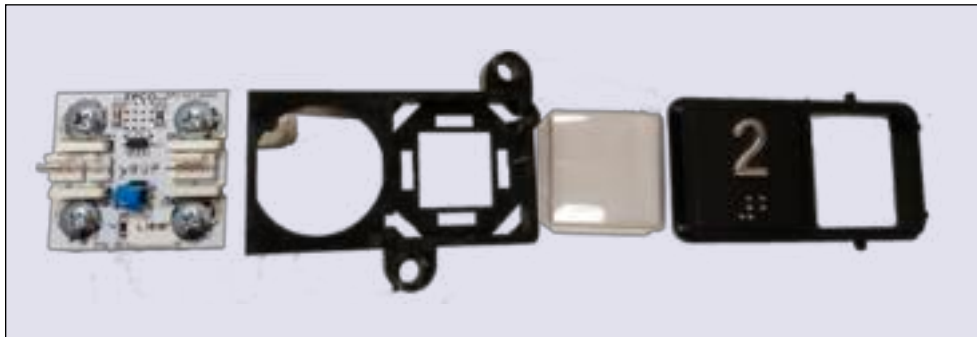



ELEVATOR PRODUCTS CORPORATION

Buttons (Cont'd)



Halo:
2.875 x 1.500" Black Lexan.
1.250" Square Button
1.250" Square Braille Plate
Integral Mounting

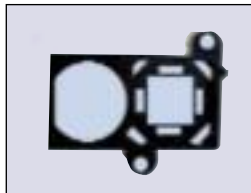

Halo Adapter:
High Strength Black Lexan.
joins base to halo and
provides cantilevered
support for braille.

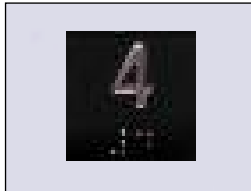

Braille:
Available with St.
Steal, Mz. Bronze,
and white characters.



Button LED:
Multi-volt available
Part #: BEA612LED (color)
Part #: BEA24120LED (color)
Colors available in Red, White,
Amber, Blue, Green.

Button Cap: 1.250" Square clear
cap over white Lexan
button.
Available blank or with character.
California Projecting: 0.125" Dia.
square shoulder.



Button Base:
The pushbutton base is made of
high strength Lexan with silver
tipped self-cleaning contacts.
The base is available in various
contact configurations.

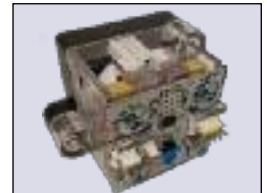

Harness:
Color coded with plug in
connector for easy installation.



DESIGNER2 Items	Part#
Buton, Halo, Cap & Adaptor *	ASA472 [x]
Button	AS472-05W
Clear Cap	AS472-03
Halo	AS472-11B
Halo Adapter Black	AS450-23B
Contact Base for LED	AS451A-02
Braille	see braille section

DESIGNER2 PC Items	Part#
Buton, Halo, Cap & Adaptor *	ASC472 [x]
Button	AS472-05W
Clear Cap	AS472-04
Halo	AS472-11B
Halo Adapter Black	AS450-23B
Contact Base for LED	AS451A-02
Braille	see braille section

* [x] is dependent upon markings.



ELEVATOR PRODUCTS CORPORATION

Buttons (Cont'd)

Designer-SM Surface Mount Style

Designer-SMPC Surface Mount Style

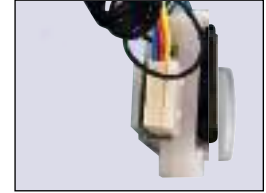
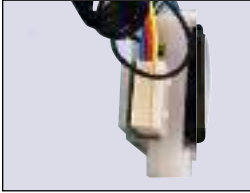

Model: DESIGNER-SM (light up)
Halo: 1.500" Square Black Lexan w/ integral handicap plate.
Button: 1.250" Dia. Square Flat white Plexi
Legend: Engrave on button, flushcast epoxy.

Model: DESIGNER-SMPC (light up)
Halo: 1.500" Square Black Lexan w/ integral handicap plate.
Button: 1.250" Dia. Square Flat white Plexi
Button projects 0.125" from halo.
(California Code)
Legend: Engrave on button, flushcast epoxy.

NOTE: Surface Mount Style Button Available in light up only.

ORDER INFORMATION:

Please advise the following - model number, mounting orientation, markings, lamp style and voltages.

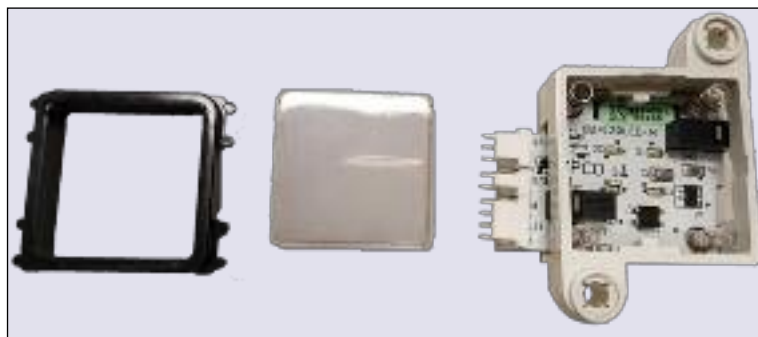



ELEVATOR PRODUCTS
CORPORATION

Buttons (Cont'd)

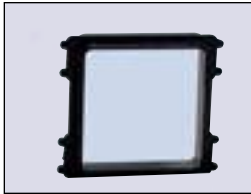

Halo: 1.5" Square Black
Lexan.



Halo Adapter:
High Strength Black
Lexan.
Joins base to Base

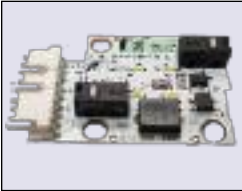

Button LED:
Multi-volt available
Part #: B612LED (color)
Part #: B24120LED (color)
Colors available in Red, White,
Amber, Blue, Green.

Button Cap: 1.125" Dia. flat
white plexi.
Legend: engrave on button,
flushcast epoxy.



Surface mount button base:
Unique 3/4" shallow base.
For all survivor button caps.

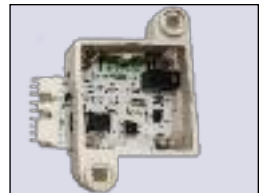

Harness:
Color coded with plug in
connector for easy installation.



Sold as complete button only.

NOTE: Please specify color, marking and voltage when ordering.



ELEVATOR PRODUCTS CORPORATION

Buttons (Cont'd)

Designer2-SM Surface Mount Style

Designer2-SMPC Surface Mount Style

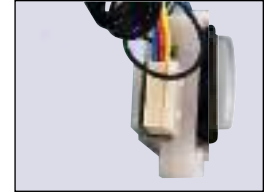
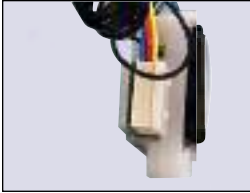

Model: DESIGNER2-SM (light up)
Halo: 2.875" x 1.500" Black Lexan w/ integral handicap plate.
Button/Cap: 1.250" Square clear cap over white Lexan button.
Legend: Engrave on button, flushcast epoxy.

Model: DESIGNER2-SMPC (light up)
Halo: 2.875" x 1.500" Black Lexan w/ integral handicap plate.
Button/Cap: 1.250" Square clear cap over white Lexan button.
Button projects 0.125" from halo.
(California Code)
Legend: Engrave on button, flushcast epoxy.

NOTE: Surface Mount Style Button Available in light up only.

ORDER INFORMATION:

Please advise the following - model number, mounting orientation, markings, lamp style and voltages.





ELEVATOR PRODUCTS
CORPORATION

Buttons (Cont'd)

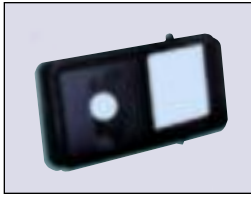

Halo: 2.875 x 1.500"
Black Lexan.



Surface mount button base:
Unique 3/4" shallow base.
For all survivor button caps.

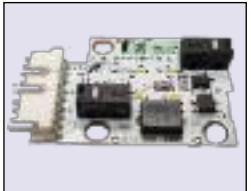

Button LED:
Multi-volt available
Part #: B612LED (color)
Part #: B24120LED (color)
Colors available in Red, White,
Amber, Blue, Green.

Button Cap: 1.250" Square clear
cap over white Lexan
button.
Available blank or with character.
California Projecting: 0.125" Dia.
square shoulder.



Braille: J-125
Available with St.
Steal, Mz. Bronze,
and white characters.

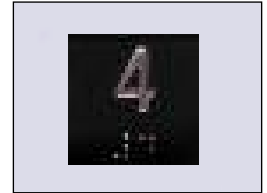

Harness:
Color coded with plug in
connector for easy installation.



Sold as complete button only.

NOTE: Please specify color, marking when ordering.



ELEVATOR PRODUCTS CORPORATION

Buttons (Cont'd)

Classic

Classic-PC



Model: CLASSIC (light up)
 Model: CLASSICN (non light up)
 Halo: 1.500" Dia. Black Lexan
 Button/Cap: 1.250" Dia. clear cap over white Lexan button.
 Legend: Engrave on button, flushcast epoxy.

Model: CLASSIC (light up)
 Model: CLASSICN (non light up)
 Halo: 1.500" Dia. Black Lexan
 Button/Cap: 1.250" Dia. clear cap over white Lexan button.
 Button projects 0.125" from halo.
 (California Code)
 Legend: Engrave on button, flushcast epoxy.

ORDER INFORMATION:

Please advise the following - model number, mounting orientation, markings, lamp style and voltages.





ELEVATOR PRODUCTS CORPORATION

Buttons (Cont'd)



Halo:
1.500" Dia. outside,
1.250" Dia. inside
Black Lexan.

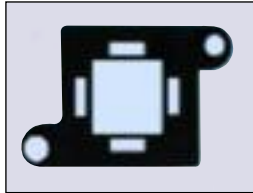

Halo Adapter:
High Strength Black Lexan.
Joins base to Base



Button LED:
Multi-volt available
Part #: BEA612LED (color)
Part #: BEA24120LED (color)
Colors available in Red, White,
Amber, Blue, Green.

Button/Cap: 1.250" Dia. clear
cap over white Lexan button.
Avail. blank or with character



Button Base:
The pushbutton base is made of
high strength Lexan with silver
tipped self-cleaning contacts.
The base is available in various
contact configurations.



Harness:
Color coded with plug in
connector for easy installation.



CLASSIC Items	Part#
Cap	AS480-01
Button	AS480-02W
Halo	AS480-11B
Halo Adaptor	AS472-10B
Contact Base for LED	AS451A-02

CLASSIC-PC Items	Part#
Cap	AS481-01
Button	AS480-02W
Halo	AS480-11B
Halo Adaptor	AS472-10B
Contact Base for LED	AS451A-02



ELEVATOR PRODUCTS CORPORATION

Buttons (Cont'd)

Classic2

Classic2-PC



Model: CLASSIC2 (light up)
 Model: CLASSIC2N (non light up)
 Halo: 1.500" Dia. x 2.875" Lg Black Lexan
 Button/Cap: 1.250" Dia. Clear cap over
 White Lexan Disk
 Braille: 1.250" Dia. Crescent Shaped
 Legend: Engrave on button, flushcast epoxy.

Model: CLASSIC2-PC (light up)
 Model: CLASSIC2N-PC (non light up)
 Halo: 1.500" Dia. x 2.875" Lg Black Lexan
 Button/Cap: 1.250" Dia. Clear cap over
 White Lexan Disk
 Braille: 1.250" Dia. Crescent Shaped
 Button projects 0.125" from halo.
 (California Code)
 Legend: Engrave on button, flushcast epoxy.

ORDER INFORMATION:

Please advise the following - model number, mounting orientation, markings, lamp style and voltages.





ELEVATOR PRODUCTS CORPORATION

Buttons (Cont'd)

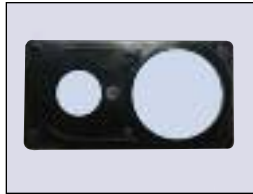

Classic2 Black Halo:
2.875 x 1.500" Black Lexan.
1.250" Square Button
1.250" Square Braille Plate
Integral Mounting

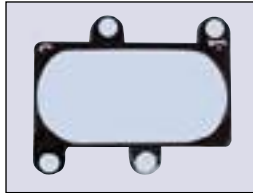

Classic2 Shim:
0.125" thickness
High strength Black Lexan
Attaches to the front of halo
to adjust thickness.

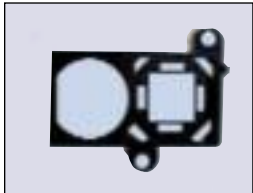

Classic2 Black Halo adapter:
High Strength Black Lexan.
Joins base to halo and
provides cantilevered
support for braille.



Button LED:
Multi-volt available
Part #: BEA612LED (color)
Part #: BEA24120LED (color)
Colors available in Red, White,
Amber, Blue, Green.

Button/Cap: 1.250" Dia. clear
cap over white Lexan button.
Avail. blank or with character



Braille:
Available with St.
Steel, Mz. Bronze,
and white characters.



Button Base:
The pushbutton base is made of
high strength Lexan with silver
tipped self-cleaning contacts.
The base is available in various
contact configurations.

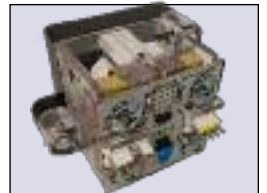

Harness:
Color coded with plug in
connector for easy installation.



CLASSIC2 Items	Part#
Cap	AS480-01
Button	AS480-02W
Halo	AS480-13B
Halo Adaptor	AS450-23B
Contact Base for LED	AS451A-02
Shim	AS480-21
Braille	005A

CLASSIC2-PC Items	Part#
Cap	AS481-01
Button	AS480-02W
Halo	AS480-13B
Halo Adaptor	AS450-23B
Contact Base for LED	AS451A-02
Shim	AS480-21
Braille	005A



ELEVATOR PRODUCTS CORPORATION

Buttons (Cont'd)

Classic-SM Surface Mount Style

Classic-SMPC Surface Mount Style

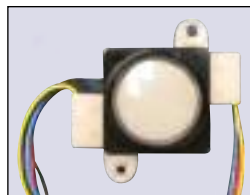
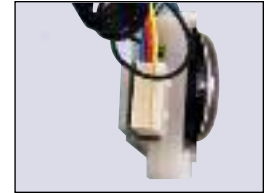
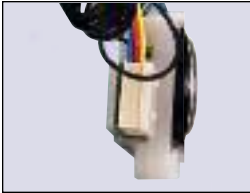

Model: CLASSIC-SM (light up)
Halo: 1.500" Dia. Black Lexan
Button/Cap: 1.250" Dia. clear cap over white Lexan button.
Legend: Engrave on button, flushcast epoxy.

Model: CLASSIC-SMPC
Halo: 1.500" Dia. Black Lexan
Button/Cap: 1.250" Dia. clear cap over white Lexan button.
Button projects 0.125" from halo.
(California Code)
Legend: Engrave on button, flushcast epoxy.

NOTE: Surface Mount Style Button Available in light up only.

ORDER INFORMATION:

Please advise the following - model number, mounting orientation, markings, lamp style and voltages.





ELEVATOR PRODUCTS
CORPORATION

Buttons (Cont'd)



Halo:
1.500" Dia. outside,
1.250" Dia. inside
Black Lexan.



Surface mount button base:
Unique 3/4" shallow base.
For all survivor button caps.

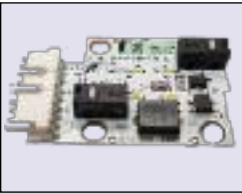

Button LED:
Multi-volt available
Part #: B612LED (color)
Part #: B24120LED (color)
Colors available in Red, White,
Amber, Blue, Green.

Button/Cap: 1.250" Dia. clear
cap over white Lexan button.
Avail. blank or with character

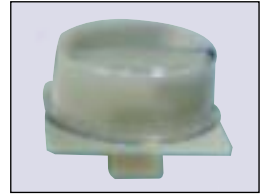

Harness:
Color coded with plug in
connector for easy installation.



Sold as complete button only.

NOTE: Please specify color, marking when ordering.



ELEVATOR PRODUCTS CORPORATION

Buttons (Cont'd)

Classic2-SM Surface Mount Style

Classic2-SMPC Surface Mount Style

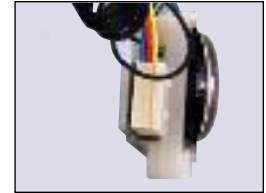
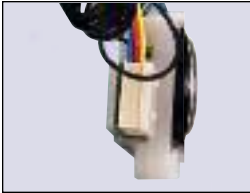

Model: CLASSIC2-SM
Halo: 1.500" Oblong black Lexan
Button: 1.250" Dia. Flat white Plexi
Legend: Engrave on button, flushcast epoxy

Model: CLASSIC2-SMPC
Halo: 1.500" Oblong black Lexan
Button: 1.250" Dia. Flat white Plexi
Button projects 0.125" from halo.
(California Code)
Legend: Engrave on button, flushcast epoxy

ORDER INFORMATION:

Please advise the following - model number, mounting orientation, markings, lamp style and voltages.





ELEVATOR PRODUCTS
CORPORATION

Buttons (Cont'd)

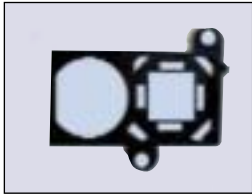

Classic2 Black Halo adapter:
High Strength Black Lexan.
Joins base to halo and
provides cantilevered
support for braille.



Braille: 005A
Available with St.
Steel, Mz. Bronze,
and white characters.

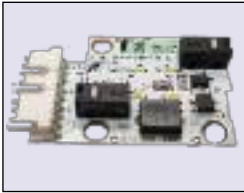

Button LED:
Multi-volt available
Part #: B612LED (color)
Part #: B24120LED (color)
Colors available in Red, White,
Amber, Blue, Green.

Button/Cap: 1.250" Dia. clear
cap over white Lexan button.
Avail. blank or with character

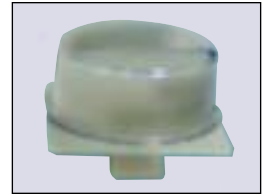

Surface mount button base:
Unique 3/4" shallow base.
For all survivor button caps.

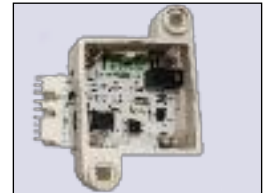

Harness:
Color coded with plug in
connector for easy installation.



Sold as complete button only.

NOTE: Please specify color, marking when ordering.



ELEVATOR PRODUCTS CORPORATION

Buttons (Cont'd)

WGH Series



Model: WGH-9 Light-up
Model: NGH-16 Non Light-up
Halo: 2.625"W x 1.375"H Oblong
Button: 1.125" Dia.
Button flush with halo.
Integral braille plate available with St/St or Mz/Bz characters.
Buttons available with or without markings.

Model: WGH-9 Light-up
Model: NGH-16 Non Light-up



ORDER INFORMATION:

Please advise the following - Model number, markings, lamp style, LED color and voltages.

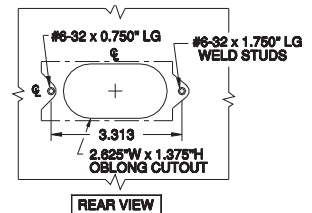
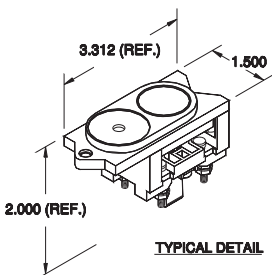



ELEVATOR PRODUCTS
CORPORATION

Buttons (Cont'd)



Halo:
2.625"Wx1.375"H Oblong Outside.
1.125" Dia. Inside
1.250" Dia. braille plate.
St/St or Mz/Bz characters.
To be used with 0.125" - 0.187"
thick covers.
Color - black only.



Cam:
The pushbutton cam is made of high strength Lexan to ensure durability. Acts as a fixing mechanism to deter rotation of button cap.



Bulb Carrier:
Bulb carriers are made of high strength Lexan. Copper contacts assure positive conductivity. Pull handle in rear of carrier makes for easy lamp replacement.



Button LED:
Multi-volt available
Part #: BEA612LED (color)
Part #: BEA24120LED (color)
Colors available in Red, White, Amber, Blue, Green.

Button Cap & Cam:
1.125" Dia. button cap.
Markings engraved on solid Lexan button caps.
Color - white only.



Button Base:
The pushbutton base is made of high strength Lexan with silver tipped self-cleaning contacts. The base is available in various contact configurations.



Harness:
Color coded with plug in connector for easy installation.



WGH Items	Part #
Complete Button Assembly	WGH
Halo	12C23P01
Button Cap & Cam	C&C-WGH
Button Base (light-up)	10D01G01
Button base (non light-up)	10D01G02
Bulb Carrier	10M25G01
Braille	JR-25



ELEVATOR PRODUCTS CORPORATION

Buttons (Cont'd)

WGH-PC Series



Model: WGH -9PC Light-up
Model: NGH -16PC Non Light-up
Halo: 2.625"W x 1.375"H Oblong
Button: 1.125" Dia.
Button projects 0.125" from halo with square shoulders.
Integral braille plate available with St/St or Mz/Bz characters.
Buttons available with or without markings.

Model: WGH -9PC Light-up
Model: NGH -16PC Non Light-up



NOTE: Complies with Title 24 California Code

ORDER INFORMATION:

Please advise the following - model number, markings, lamp style, LED color and voltages.

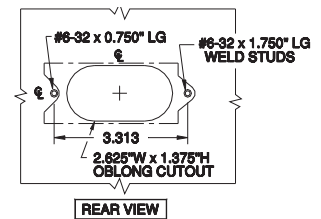
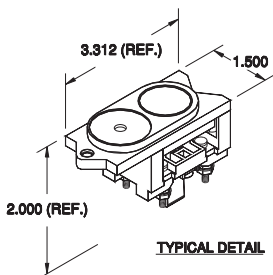



ELEVATOR PRODUCTS
CORPORATION

Buttons (Cont'd)



Halo:
2.625"Wx1.375"H Oblong Outside.
1.125" Dia. Inside
1.250" Dia. braille plate.
St/St or Mz/Bz characters.
To be used with 0.125" - 0.187"
thick covers.
Color - black only.



Bulb Carrier:
Bulb carriers are made of high
strength Lexan. Copper contacts
assure positive conductivity.
Pull handle in rear of carrier
makes for easy lamp
replacement.



Button LED:
Multi-volt available
Part #: BEA612LED (color)
Part #: BEA24120LED (color)
Colors available in Red, White,
Amber, Blue, Green.

Button Cap & Cam:
1.125" Dia. button cap.
Milkwhite Lexan insert under clear
crystal square shoulder cap.
Markings hot stamped on insert.
Color - white only



Button Base:
The pushbutton base is made of
high strength Lexan with silver
tipped self-cleaning contacts.
The base is available in various
contact configurations.



Harness:
Color coded with plug in
connector for easy installation.



WGH-PC Items	Part #
Complete Button Assembly	WGH-PC
Halo	12C23P01
Button Cap & Cam	C&C-WGH-PC
Button Base (light-up)	10D01G01
Button base (non light-up)	10D01G02
Bulb Carrier	10M25G01
Braille	JR-25

* [x] is dependent upon voltage and LED color choices, please specify when ordering.



Buttons (Cont'd)

ELEVATOR PRODUCTS CORPORATION

WGH-S

WGH-M



Model: WGH-9S Light-up
 Model: NGH-16S Non Light-up
 Halo: 2.625"W x 1.375"H Oblong
 Ferrule: 1.125" Dia. clear
 Button: .9375" Dia. St/St
 Integral braille plate
 Button flush with halo.
 Available in #4 brushed circular finish, or #8 mirror finish.
 Buttons available with or without markings - standard are blank.

Model: WGH-9M Light-up
 Model: NGH-16M Non Light-up
 Halo: 2.625"W x 1.375"H Oblong
 Ferrule: 1.125" Dia. clear
 Button: .9375" Dia. Mz/Bz
 Integral braille plate



ORDER INFORMATION:

Please advise the following - model number, markings, lamp style, LED color and voltages.

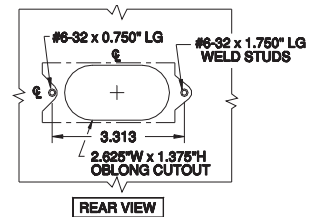
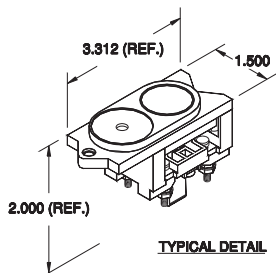

Buttons (Cont'd)



Halo:
2.625" Wx1.375"H Oblong Outside
1.125" Dia. Inside
1.250" Dia. braille plate
St/St or Mz/Bz characters
To be used with 0.125" - 0.187"
thick covers.
Color - black only.



Cam:
The pushbutton cam is made of
high strength Lexan to ensure
durability. Acts as a fixing
mechanism to deter rotation of
button cap.



Bulb Carrier:
Bulb carriers are made of high
strength Lexan. Copper contacts
assure positive conductivity.
Pull handle in rear of carrier
makes for easy lamp
replacement.

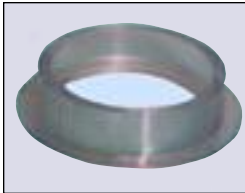

Clear Ferrule:
1.135" Outside Dia.
The Ferrule halo lights up and is
made of clear Lexan.

Button Cap & Cam:
0.937" Dia. 0.250" th. button cap
Button cap St/St or Mz/Bz
Available in #4 brushed circular
finish, or #8 mirror finish.
Standard is without markings.
Markings available engraved on
cap and flushcast with epoxy.



Button Base:
The pushbutton base is made of
high strength Lexan with silver
tipped self-cleaning contacts.
The base is available in various
contact configurations.



Harness:
Color coded with plug in
connector for easy installation.



Button LED:
Multi-volt available
Part #: BEA612LED (color)
Part #: BEA24120LED (color)
Colors available in Red, White,
Amber, Blue, Green.



WGH-S/WGH-M Items	Part #
Complete Button Assembly	WGH-S/WGH-M
Halo	12C23P01
Button Cap & Cam	C&C-WGH-S C&C-WGH-M
Clear Ferrule	13A30P01
Button Base (light-up)	10D01G01
Button base (non light-up)	10D01G02
Bulb Carrier	10M25G01
Braille	JR-25

* [x] is dependent upon voltage and LED color choices, please specify when ordering.



ELEVATOR PRODUCTS CORPORATION

Buttons (Cont'd)

WGH-SPC

WGH-MPC



Model: WGH-9SPC Light-up
 Model: NGH-16SPC Non Light-up
 Halo: 2.625"W x 1.375"H Oblong
 Ferrule: 1.125" Dia. clear
 Button: .9375" Dia. St/St
 Integral braille plate.
 Button projects 0.125" from halo.
 Available in #4 brushed circular finish, or #8 mirror finish.
 Buttons available with or without markings - standard are blank.

Model: WGH-9MPC Light-up
 Model: NGH-16MPC Non Light-up
 Halo: 2.625"W x 1.375"H Oblong
 Ferrule: 1.125" Dia. clear
 Button: .9375" Dia. Mz/Bz
 Integral braille plate.



NOTE: Complies with Title 24 California Code

ORDER INFORMATION:

Please advise the following - model number, markings, lamp style, LED color and voltages.

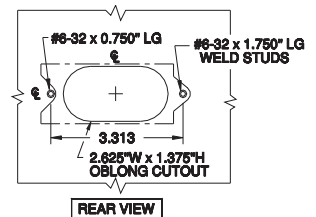
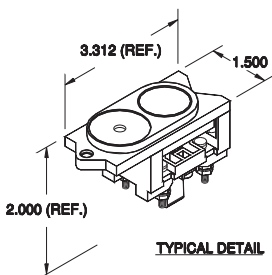



ELEVATOR PRODUCTS CORPORATION

Buttons (Cont'd)



Halo:
 2.625" Wx1.375"H Oblong Outside
 1.125" Dia. Inside
 1.250" Dia. braille plate
 St/St or Mz/Bz characters
 To be used with 0.125" - 0.187"
 thick covers.
 Color - black only.



Cam:
 The pushbutton cam is made of high strength Lexan to ensure durability. Acts as a fixing mechanism to deter rotation of button cap.



Bulb Carrier:
 Bulb carriers are made of high strength Lexan. Copper contacts assure positive conductivity. Pull handle in rear of carrier makes for easy lamp replacement.



Button LED:
 Multi-volt available
 Part #: BEA612LED (color)
 Part #: BEA24120LED (color)
 Colors available in Red, White, Amber, Blue, Green.

Button Cap & Cam:
 0.937" Dia. 0.250" th. button cap
 Button cap St/St or Mz/Bz
 Available in #4 brushed circular finish, or #8 mirror finish.
 Standard is without markings.
 Markings available engraved on cap and flushcast with epoxy.



Button Base:
 The pushbutton base is made of high strength Lexan with silver tipped self-cleaning contacts. The base is available in various contact configurations.



Harness:
 Color coded with plug in connector for easy installation.



WGH-SPC/WGH-MPC Items	Part #
Complete Button Assembly	WGH-SPC/WGH-MPC
Halo	12C23P01
Button Cam & Insert	C&C-WGH-SPC C&C-WGH-MPC
Button Base (light-up)	10D01G01
Button base (non light-up)	10D01G02
Bulb Carrier	10M25G01
Braille	JR-25



ELEVATOR PRODUCTS CORPORATION

Buttons (Cont'd)

WN-PC Series

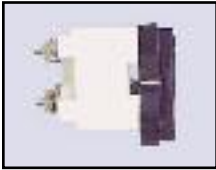

Model: WN-9PC Light-up
Model: NN-16PC Non Light-up
Halo: 2.875"W x 1.50"H Rectang..
Button: 1.250" Sq.
Button projects 0.125" from halo with square shoulders.
Integral braille plate available in St/St or Mz/Bz characters.
Buttons available with or without markings.

Model: WN-9PC Light-up
Model: NN-16PC Non Light-up



NOTE: Complies with Title 24 California Code

ORDER INFORMATION:

Please advise the following - model number, markings, lamp style, LED color and voltages.

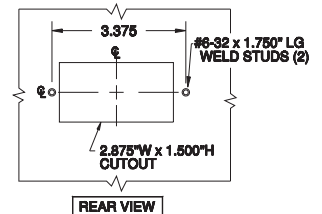
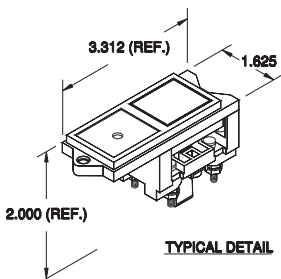



ELEVATOR PRODUCTS
CORPORATION

Buttons (Cont'd)



Halo:
2.875"W x 1.500"H Rectang.
Outside
1.250" Sq. Inside
1.250" Sq. braille plate
St/St or Mz/Bz characters
To be used with 0.125" - .0187"
thick covers.
Colors - black only.



Cam:
The pushbutton cam is made of high strength Lexan to ensure durability. Acts as a fixing mechanism to deter rotation of button cap.



Bulb Carrier:
Bulb carriers are made of high strength Lexan. Copper contacts assure positive conductivity. Pull handle in rear of carrier makes for easy lamp replacement.



Button LED:
Multi-volt available
Part #: BEA612LED (color)
Part #: BEA24120LED (color)
Colors available in Red, White, Amber, Blue, Green.

Button Cap & Cam:
1.250" Sq. button cap
Milkwhite Lexan insert under clear crystal square shoulder cap.
Markings hot stamped on insert.
Colors - white only.



Button Base:
The pushbutton base is made of high strength Lexan with silver tipped self-cleaning contacts. The base is available in various contact configurations.



Harness:
Color coded with plug in connector for easy installation.



WN-PC Items	Part #
Complete Button Assembly	WN-PC
Halo	12C24P01
Button Cap & Cam	C&C-WN-PC
Button Base (light-up)	10D01G01
Button base (non light-up)	10D01G02
Bulb Carrier	10M25G01
Braille	J-125



ELEVATOR PRODUCTS CORPORATION

Buttons (Cont'd)

WNR-PC Series

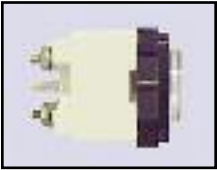

Model: WNR-9PC Light-up
 Model: NNR-16PC Non Light-up
 Halo: 2.687"W x 1.375"H Rectang.
 Button: 1.125" Dia.
 Button projects 0.125" from halo with square shoulder.
 Integral braille plate available in St/St or Mz/Bz characters.
 Buttons available with or without markings.

Model: WNR-9PC Light-up
 Model: NNR-16PC Non Light-up



NOTE: Complies with Title 24 California Code

ORDER INFORMATION:

Please advise the following - model number, markings, lamp style, LED color and voltages.

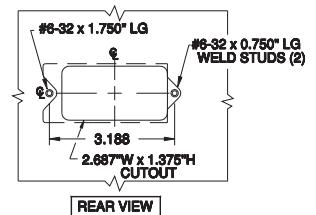
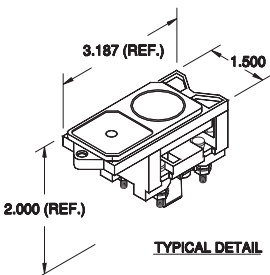



Buttons (Cont'd)

ELEVATOR PRODUCTS CORPORATION



Halo:
2.687"Wx1.375"H Rectang. Outside
1.125" Dia. Inside
1.250" Sq. braille plate
St/St or Mz/Bz characters
To be used with 0.125" th. covers.
Colors - black only.



Cam:
The pushbutton cam is made of high strength Lexan to ensure durability. Acts as a fixing mechanism to deter rotation of button cap.



Bulb Carrier:
Bulb carriers are made of high strength Lexan. Copper contacts assure positive conductivity. Pull handle in rear of carrier makes for easy lamp replacement.



Button LED:
Multi-volt available
Part #: BEA612LED (color)
Part #: BEA24120LED (color)
Colors available in Red, White, Amber, Blue, Green.

Button Cap & Cam:
1.125" Dia. button cap
Milkwhite Lexan insert under clear crystal square shoulder cap.
Markings hot stamped on insert.
Colors - white only.



Button Base:
The pushbutton base is made of high strength Lexan with silver tipped self-cleaning contacts. The base is available in various contact configurations.



Harness:
Color coded with plug in connector for easy installation.



WNR-PC Items	Part #
Complete Button Assembly	WNR-PC
Halo	20A06P10
Button Cap & Cam	C&C-WNR-PC
Button Base (light-up)	10D01G01
Button base (non light-up)	10D01G02
Bulb Carrier	10M25G01
Braille	CO8



ELEVATOR PRODUCTS CORPORATION

Buttons (Cont'd)

MRB Series

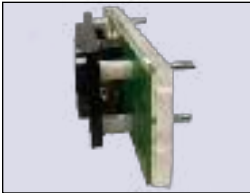

Model: MRB-9 Light-up
Model: MRB-16 Non Light-up
Halo: 4.000"W x 1.375"H Oblong
Button: 3.750"W x 1.125"H Oblong
Button flush with halo.
Buttons available with or without markings.

NOTE: FOR REPLACEMENT PARTS ONLY.
Custom Applications including St/St., Mz/Bz., color coded available.

ORDER INFORMATION:

Please advise the following - model number, markings, LED color and voltages.

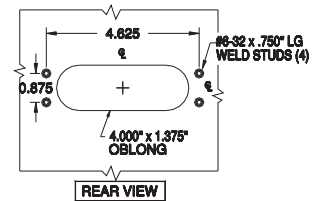
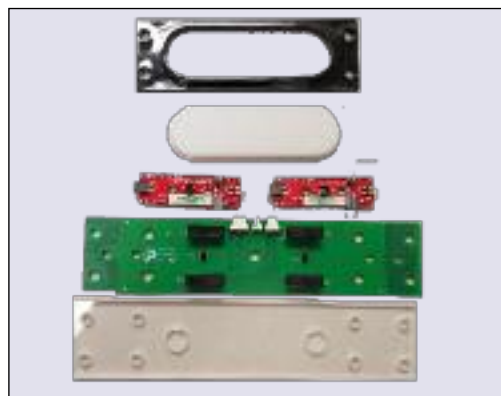
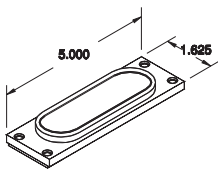



ELEVATOR PRODUCTS
CORPORATION

Buttons (Cont'd)

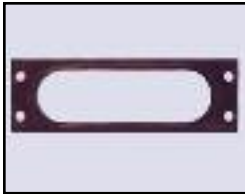

Halo:
4.000"W x 1.375"H Oblong Outside
3.750"W x 1.125"H Oblong Inside
To be used with 0.125" - 0.187"
thick covers.
Colors available - see chart.



Button LEDs:
Part# ML24120LED "Color"
Multi-volt
Colors available - Red, White,
Amber, Blue, Green.

Button Cap:
3.750"W x 1.125"H Oblong cap
Markings engraved on button cap
and enamel filled.
Colors - white only.



Button Board Module:
Part# BBSWPCB



Harness:
Color coded with plug in
connector for easy installation.



MRB Items	Part #
Complete Button Assembly	MRB
Halo *	11B40P [y]
Button Cam & Insert	C&C-MRB
Button Base (light-up)	10D01G01
Button base (non light-up)	10D01G02



ELEVATOR PRODUCTS CORPORATION

Buttons (Cont'd)

RB Series

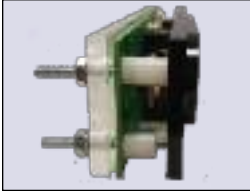

Model: RB-9 Light-up
Model: RB-16 Non Light-up
Halo: 5.000"W x 1.375"H Oblong
Button: 4.750"W x 1.125"H Oblong
Button flush with halo.
Buttons available with or without markings.

NOTE: FOR REPLACEMENT PARTS ONLY.
Custom Applications including St/St., Mz/Bz., color coded available.

ORDER INFORMATION:
Please advise the following - model number, markings, and voltages.

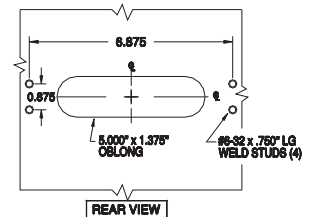
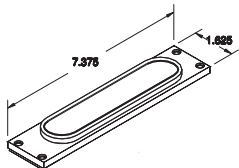



ELEVATOR PRODUCTS CORPORATION

Buttons (Cont'd)



Halo:
 5.000"W x 1.375"H Oblong. Outside
 4.750"W x 1.125"H Oblong. Inside
 To be used with 0.125" - 0.187"
 thick covers



Button LEDs:
 Part# ML24120LED "Color"
 Multi-volt
 Colors available - Red, White,
 Amber, Blue, Green.

Button Cap:
 4.750"W x 1.125"H Oblong. cap
 Markings engraved on button cap
 and enamel filled.
 Colors available - see chart.



Button Board Module:
 Part# BBSWPCB

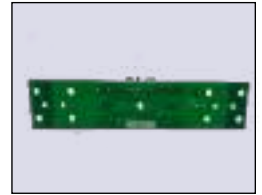

Harness:
 Color coded with plug in
 connector for easy installation.



RB Items	Part #
Complete Button Assembly	RB
Halo *	11B20P [y]
Button Cap	Cap-RB
Button Base (light-up)	10D01G01
Button base (non light-up)	10D01G02



ELEVATOR PRODUCTS CORPORATION

Illuminating Devices

CL - Series



Model: CLI-F

Typical Side View



Model: CLI-H



Model: CLI-C

Indicator: 1.125" Dia. Clear convex window over milkwhite insert with hot stamped markings.
Special engraved markings available.
Halo: 1.375" Dia. Black Lexan. To be used with 0.125" Thk. covers.
Markings: Fire hat, red epoxy filled.

All other engraved markings are available in black or red epoxy.

A - Series



Model: RLI-F

Typical Side View



Model: RLI-H



Model: RLI-C

Indicator: 1.125" Dia. Milkwhite Lexan insert under clear crystal square shoulder cap with hot stamped markings.
Special engraved markings available.
Halo: 1.375" Dia. Black Lexan. To be used with 0.125" - 0.187" thk covers.
Markings: Fire hat, red epoxy filled.

All other engraved markings are available in black or red epoxy.

NOTE: Refer to push button section for spare parts.

ORDER INFORMATION:
Please advise the following - Model number.



ELEVATOR PRODUCTS CORPORATION

Illuminating Devices (Cont'd)

Adams Style



Survivor Style Indicator

Indicator: 1.125" Dia. Clear convex window over milkwhite insert with hot stamped markings.
Special engraved markings available.
Halo: 1.375" Dia. Black Lexan.
To be used with 0.125" thk. covers.
Markings: All markings are available in black or red epoxy.

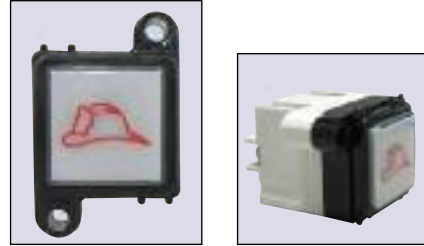

Designer Style Indicator

Indicator: 1.125" Square. Clear convex window over milkwhite insert with hot stamped markings.
Special engraved markings available.
Halo: 1.5" Square with radius corners.
To be used with 0.125" thk. covers.
Markings: All markings are available in black or red epoxy.

IDI LED PILOT LIGHTS



See Chart for Part Numbers

MODEL #	PART #	LED COLOR	VOLTAGE
IDI LED	X46PS3H30	BLUE	28 Volt
IDI LED	X46PS3H33	WHITE	24 Volt
IDI LED	X46PS3H22	AMBER	28 Volt
IDI LED	X46PS3H20	RED	28 Volt
IDI LED	X46PS3H21	GREEN	28 Volt
IDI 125V	X46PS3H25	AMBER	125 Volt
IDI 125V	X46PS3H23	RED	125 Volt
IDI 125V	X46PS3H31	BLUE	125 Volt

LIGHT UP INDICATIONS



LIGHT-UP INDICATORS - Snap in Type		
MODEL #	PART #	DESCRIPTION
OSLI (FM)	12B15P01	Light-up Indicator - "Fire Hat" Jewel (Red) 28V
OSLI (FM)	12B15P03	Light-up Indicator - "Fire Hat" Jewel (Red) 125V
OSLI (MG)	12B15P02	Light-up Indicator - "MG" Jewel (Black) 28V
OSLI (MG)	12B15P04	Light-up Indicator - "MG" Jewel (Black) 125V

- * All Halos are black
- * Indications: .75" Sq clear cap (Sonic welded to button) over white button.
- * Devices are Illuminated.

Special marking available upon request. Please contact our Sales department for further information.

ORDER INFORMATION:

Please advise the following - Model number.



ELEVATOR PRODUCTS CORPORATION

Keyswitches

Circleline-CL



ACE



Model: CKR-22 with Rotary
Halo: 1.375" Dia. Outside
Lock: Ace 0.875" Dia.
Various markings available See standard marking chart

Side View



Model: CKS-22 with toggle
Halo: 1.375" Dia. Outside
Lock: Ace 0.875" Dia.

Side View



Model: CKM-22 with micro
Halo: 1.375" Dia. Outside
Lock: Ace 0.875" Dia.

ILLINOIS



Model: ICKS-22 with toggle
Halo: 1.375" Dia. Outside
Lock: Illinois 0.875" Dia.
Various markings available See standard marking chart

Side View



Model: ICKS-22 with toggle
Halo: 1.375" Dia. Outside
Lock: Illinois 0.875" Dia.

Side View



Model: ICKM-22 with micro
Halo: 1.375" Dia. Outside
Lock: Illinois 0.875" Dia.

ORDER INFORMATION:

Please advise the following - Model number, function, mounting orientation, key pulls, lock and key number, plate thickness.

* NOTE: Please specify lock and key numbers when ordering

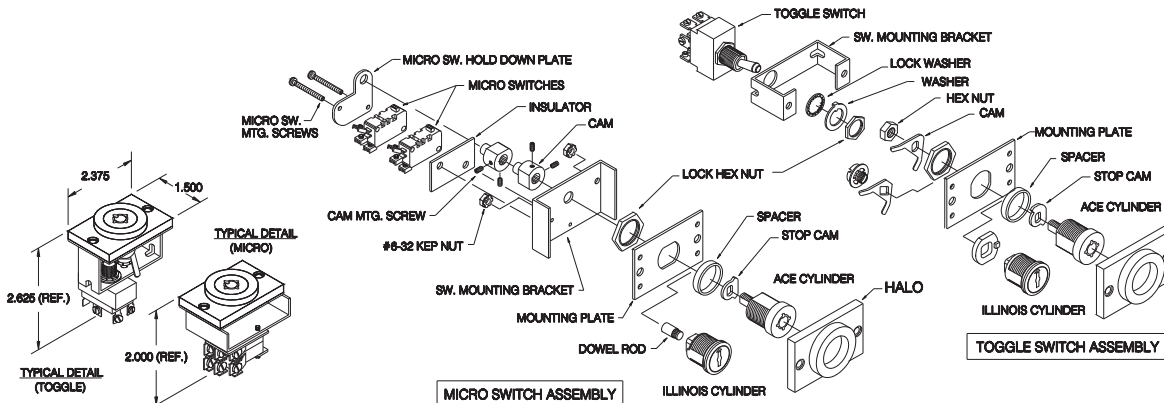



Keyswitches (Cont'd)

ELEVATOR PRODUCTS CORPORATION



Cylinder & Keys:
 Cylinder Part #: 10K61P [x]
 Key Part #: 20A03P [x]
 Ace 0.875" Dia.
 Available in stainless steel or bronze. Available in various finishes.
 Keys available in Key#1,2; 11-45 MFD-1, BFD-1

[x] is dependent upon finish and key #.



Toggle Switch:
 Mechanical toggle
 Available in various configurations



Ace Mtg. Bracket:
 Made from Aluminum
 Specify mounting orientation



Illinois Mtg. Bracket:
 Made from Aluminum
 Specify mounting orientation

Cylinder & Keys:
 Cylinder w/ Key Part #: 20K01P[x]
 Illinois 0.875" Dia.
 Available in stainless steel or bronze. Available in various finishes.
 Keys available in Key#J200, J222 J211-45, H-341



[x] is dependent upon finish and key #.

Halo:
 1.375" Dia. Outside
 0.875" Dia. Inside
 To be used with 0.125" thick covers. "Special thicknesses available".
 Colors available - see chart



Micro Switch:
 Heavy duty micro switch



Cams:
 Made from Lexan or Galvanized steel

PARTS LISTING						
ITEM	DESCRIPTION	PART #	DESCRIPTION	PART #	DESCRIPTION	PART #
Cylinders	Ace Cyl. SS / Brass	* Epc-lock #	Illinois Cyl. SS / Brass	* ILL-lock #		
Toggle Switch	2 Position	10Z23P01	3 Position	20K04P01		
Halo	Black - #15	10C12P01	Red - #15K	10C12P02		
Mtg. Bracket Horiz.	Ace Lock Mtg. Plate	11A02P02	Illinois Lock Mtg. Plate	11A02P04		
Mtg. Bracket Vert.	Ace Lock Mtg. Plate	11A02P01	Illinois Lock Mtg. Plate	11A02P03		
Micro Switch	Single Pole, Throw	40Z15P00				
Cams (Toggle)	2-Hole Latch Cam	13A52(P01 ver.P01 hor)	Ace 2-Ear Latch Cam	11A01P01	Illinois 2-Ear Latch Cam	12A98P01
Cams (Micro Sw.)	Nylon White E600	11A08P01	E-595 CAM (To be used with both Ace and Illinois locks) 11A37P01			

OPERATING DEVICES

ACE CYLINDERS		ILLINOIS CYLINDERS	
MODEL #	DESCRIPTION	MODEL #	DESCRIPTION
CKR-22	Rotary, 2 Position	ICKR-22	Rotary, 2 Position
CKR-22R	Rotary, OFF-ON, Spring Return to "OFF"	ICKR-22R	Rotary, OFF-ON, Spring Return to "OFF"
CKR-3	Rotary, 3 Position	ICKR-3	Rotary, 3 Position
CKR-4	Rotary, 4 Position	ICKR-4	Rotary, 4 Position
CKS-32A	Toggle Switch 3PDT, 3 Position, Spring Return to "OFF"	ICKS-32A	Toggle Switch 3PDT, 3 Position, Spring Return to "OFF"
CKS-22	Toggle Switch DPDT, OFF-ON	ICKS-22	Toggle Switch DPDT, OFF-ON
CKS-22R	Toggle Switch DPDT, OFF-ON, Spring Return to "OFF"	ICKS-22R	Toggle Switch DPDT, OFF-ON, Spring Return to "OFF"
CKM-22	2-Micro Switch DPDT, 2 Position	ICKM-22	2-Micro Switch DPDT, 2 Position
CKM-3	2-Micro Switch 3 Position	ICKM-3	2-Micro Switch 3 Position
CKM-4	3-Micro Switch 3 & 4 Positions Available	ICKM-4	3-Micro Switch 3 & 4 Positions Available



ELEVATOR PRODUCTS CORPORATION

Keyswitches (Cont'd)

Flushline-FL



ACE



Model: KR-22 with rotary
Halo: 1.250" Sq. Outside
Lock: Ace 0.875" Dia.
Various markings available

Side View



Model: KS-22 with toggle
Halo: 1.250" Sq. Outside
Lock: Ace 0.875" Dia.
Various markings available

Side View



Model: KM-22 with micro
Halo: 1.250" Sq. Outside
Lock: Ace 0.875" Dia.

ILLINOIS



Model: IKR-22 with rotary
Halo: 1.250" Sq. Outside
Lock: Ace 0.875" Dia.
Various markings available

Side View



Model: IKS-22 with toggle
Halo: 1.250" Sq. Outside
Lock: Illinois 0.875" Dia.
Various markings available

Side View



Model: IKM-22 with micro
Halo: 1.250" Sq. Outside
Lock: Illinois 0.875" Dia.

ORDER INFORMATION:

Please advise the following - Model number, function, mounting orientation, key pulls, lock and key number, plate thickness.

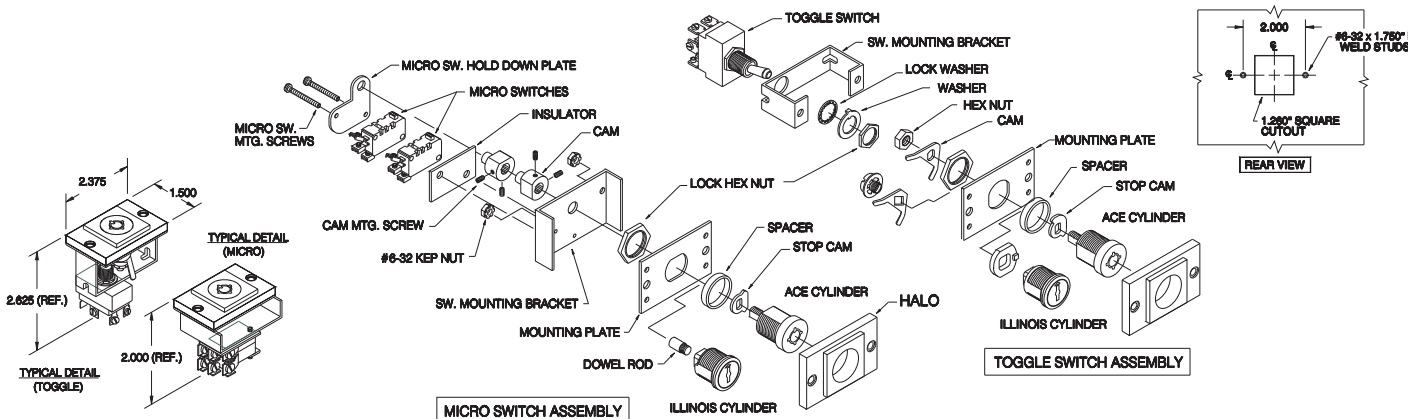



Keyswitches (Cont'd)

ELEVATOR PRODUCTS CORPORATION



Cylinder & Keys:
 Cylinder Part #: 10K61P [x]
 Key Part #: 20A03P [x]
 Ace 0.875" Dia.
 Available in stainless steel or bronze. Available in various finishes.
 Keys available in Key#1,2; 11-45 MFD-1, BFD-1

[x] is dependent upon finish and key #.



Toggle Switch:
 Mechanical toggle
 Available in various configurations



Ace Mtg. Bracket:
 Made from Aluminum
 Specify mounting orientation



Illinois Mtg. Bracket:
 Made from Aluminum
 Specify mounting orientation

Cylinder & Keys:
 Cylinder w/ Key Part #: 20K01P[x]
 Illinois 0.875" Dia.
 Available in stainless steel or bronze. Available in various finishes.
 Keys available in Key#J200, J222 J211-45, H-341



[x] is dependent upon finish and key #.

Halo:
 1.250" Sq. Outside
 0.875" Dia. Inside
 To be used with 0.125" thick covers. "Special thicknesses available".
 Colors available - see chart



Micro Switch:
 Heavy duty micro switch



Cams:
 Made from Lexan or Galvanized steel

PARTS LISTING						
ITEM	DESCRIPTION	PART #	DESCRIPTION	PART #	DESCRIPTION	PART #
Cylinders	Ace Cyl. SS / Brass	* Epc-lock #	Illinois Cyl. SS / Brass	* ILL-lock #		
Toggle Switch	2 Position	10Z23P01	3 Position	20K04P01		
Halo	Black - #11F	10C11P01	Red - #11F	10C11P02		
Mtg. Bracket Horiz.	Ace Lock Mtg. Plate	11A02P02	Illinois Lock Mtg. Plate	11A02P04		
Mtg. Bracket Vert.	Ace Lock Mtg. Plate	11A02P01	Illinois Lock Mtg. Plate	11A02P03		
Micro Switch	Single Pole, Throw	40Z15P00				
Cams (Toggle)	2-Hole Latch Cam	13A52(P01 ver.P01 hor)	Ace 2-Ear Latch Cam	11A01P01	Illinois 2-Ear Latch Cam	12A98P01
Cams (Micro Sw.)	Nylon White E600	11A08P01	E-595 CAM (To be used with both Ace and Illinois locks)		11A37P01	

OPERATING DEVICES

ACE CYLINDERS		ILLINOIS CYLINDERS	
MODEL #	DESCRIPTION	MODEL #	DESCRIPTION
KR-22	Rotary, 2 Position	IKR-22	Rotary, 2 Position
KR-22R	Rotary, OFF-ON, Spring Return to "OFF"	IKR-22R	Rotary, OFF-ON, Spring Return to "OFF"
KR-3	Rotary, 3 Position	IKR-3	Rotary, 3 Position
KR-4	Rotary, 4 Position	IKR-4	Rotary, 4 Position
KS-32A	Toggle Switch 3PDT, 3 Position, Spring Return to "OFF"	IKS-32A	Toggle Switch 3PDT, 3 Position, Spring Return to "OFF"
KS-22	Toggle Switch DPDT, OFF-ON	IKS-22	Toggle Switch DPDT, OFF-ON
KS-22R	Toggle Switch DPDT, OFF-ON, Spring Return to "OFF"	IKS-22R	Toggle Switch DPDT, OFF-ON, Spring Return to "OFF"
KM-22	2-Micro Switch DPDT, 2 Position	IKM-22	2-Micro Switch DPDT, 2 Position
KM-3	2-Micro Switch 3 Position	IKM-3	2-Micro Switch 3 Position
KM-4	3-Micro Switch 3 & 4 Positions Available	IKM-4	3-Micro Switch 3 & 4 Positions Available



ELEVATOR PRODUCTS CORPORATION

Keyswitches (Cont'd)

Tamper-SSL



ACE



Model: SSKR-22 with rotary
Halo: None (Spacer only)
Lock: Ace 0.875" Dia.
Various markings available See standard marking chart

Side View



Model: SSKS-22 with toggle
Halo: None (Spacer only)
Lock: Ace 0.875" Dia.
Various markings available

Side View



Model: SSKM-22 with micro
Halo: None (Spacer only)
Lock: Ace 0.875" Dia.



ILLINOIS



Model: ISSKR-22 with rotary
Halo: None (Spacer only)
Lock: Illinois 0.875" Dia.
Various markings available

Side View



Model: ISSKS-22 with toggle
Halo: None (Spacer only)
Lock: Illinois 0.875" Dia.
Various markings available

Side View



Model: ISSKM-22 with micro
Halo: None (Spacer only)
Lock: Illinois 0.875" Dia.

ORDER INFORMATION:

Please advise the following - Model number, function, mounting orientation, key pulls, lock and key number, plate thickness.

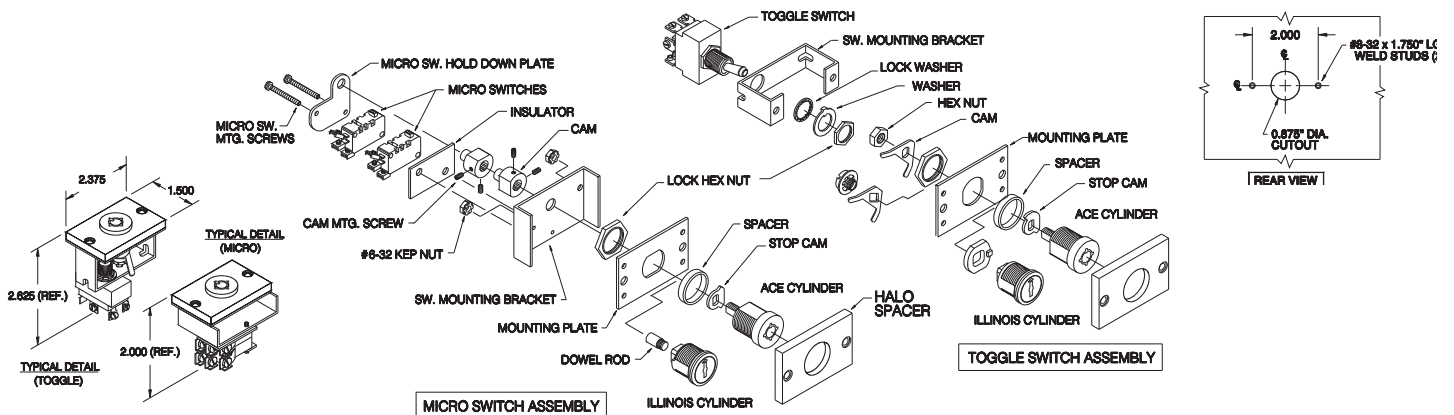



Keyswitches (Cont'd)

ELEVATOR PRODUCTS CORPORATION



Cylinder & Keys:
 Cylinder Part #: 10K61P [x]
 Key Part #: 20A03P [x]
 Ace 0.875" Dia.
 Available in stainless steel or bronze. Available in various finishes.
 Keys available in Key#1,2; 11-45 MFD-1, BFD-1

[x] is dependent upon finish and key #.



Toggle Switch:
 Mechanical toggle
 Available in various configurations



Ace Mtg. Bracket:
 Made from Aluminum
 Specify mounting orientation



Illinois Mtg. Bracket:
 Made from Aluminum
 Specify mounting orientation



Micro Switch:
 Heavy duty micro switch



Cylinder & Keys:
 Cylinder w/ Key Part #: 20K01P[x]
 Illinois 0.875" Dia.
 Available in stainless steel or bronze. Available in various finishes.
 Keys available in Key#J200, J222 J211-45, H-341

[x] is dependent upon finish and key #.

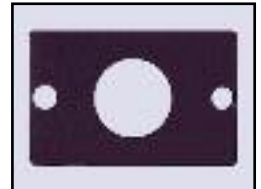

Spacer Halo:
 0.875" Dia. hole
 To be used with 0.125" thick covers. "Special thicknesses available".



Cams:
 Made from Lexan or Galvanized steel

PARTS LISTING						
ITEM	DESCRIPTION	PART #	DESCRIPTION	PART #	DESCRIPTION	PART #
Cylinders	Ace Cyl. SS / Brass	* Epc-lock #	Illinois Cyl. SS / Brass	* ILL-lock #		
Toggle Switch	2 Position	10Z23P01	3 Position	20K04P01		
Spacer Halo	Black	15C72P01				
Mtg. Bracket Horiz.	Ace Lock Mtg. Plate	11A02P02	Illinois Lock Mtg. Plate	11A02P04		
Mtg. Bracket Vert.	Ace Lock Mtg. Plate	11A02P01	Illinois Lock Mtg. Plate	11A02P03		
Micro Switch	Single Pole, Throw	40Z15P00				
Cams (Toggle)	2-Hole Latch Cam	13A52(P01 ver.P01 hor)	Ace 2-Ear Latch Cam	11A01P01	Illinois 2-Ear Latch Cam	12A98P01
Cams (Micro Sw.)	Nylon White E600	11A08P01	E-595 CAM (To be used with both Ace and Illinois locks) 11A37P01			

OPERATING DEVICES

ACE CYLINDERS		ILLINOIS CYLINDERS	
MODEL #	DESCRIPTION	MODEL #	DESCRIPTION
SSKR-22	Rotary, 2 Position	ISSKR-22	Rotary, 2 Position
SSKR-22R	Rotary, OFF-ON, Spring Return to "OFF"	ISSKR-22R	Rotary, OFF-ON, Spring Return to "OFF"
SSKR-3	Rotary, 3 Position	ISSKR-3	Rotary, 3 Position
SSKR-4	Rotary, 4 Position	ISSKR-4	Rotary, 4 Position
SSKS-32A	Toggle Switch 3PDT, 3 Position, Spring Return to "OFF"	ISSKS-32A	Toggle Switch 3PDT, 3 Position, Spring Return to "OFF"
SSKS-22	Toggle Switch DPDT, OFF-ON	ISSKS-22	Toggle Switch DPDT, OFF-ON
SSKS-22R	Toggle Switch DPDT, OFF-ON, Spring Return to "OFF"	ISSKS-22R	Toggle Switch DPDT, OFF-ON, Spring Return to "OFF"
SSKM-22	2-Micro Switch DPDT, 2 Position	ISSKM-22	2-Micro Switch DPDT, 2 Position
SSKM-3	2-Micro Switch 3 Position	ISSKM-3	2-Micro Switch 3 Position
SSKM-4	3-Micro Switch 3 & 4 Positions Available	ISSKM-4	3-Micro Switch 3 & 4 Positions Available



ELEVATOR PRODUCTS CORPORATION

Keyswitches (Cont'd)

Haloline-WB



ACE



Model: BKR-22 with rotary
Halo: 1.000" Dia. Outside
Lock: Ace 0.875" Dia.
Markings on Cover Plate

Side View



Model: BKS-22 with toggle
Halo: 1.000" Dia. Outside
Lock: Ace 0.875" Dia.
Markings on Cover Plate

Side View



Model: BKM-22 with micro
Halo: 1.000" Dia. Outside
Lock: Ace 0.875" Dia.

ILLINOIS



Model: IBKR-22 with rotary
Halo: 1.000" Dia. Outside
Lock: Illinois 0.875" Dia.
Markings on Cover Plate

Side View



Model: IBKS-22 with toggle
Halo: 1.000" Dia. Outside
Lock: Illinois 0.875" Dia.
Markings on Cover Plate

Side View



Model: IBKM-22 with micro
Halo: 1.000" Dia. Outside
Lock: Illinois 0.875" Dia.

ORDER INFORMATION:

Please advise the following - Model number, function, mounting orientation, key pulls, lock and key number, plate thickness.

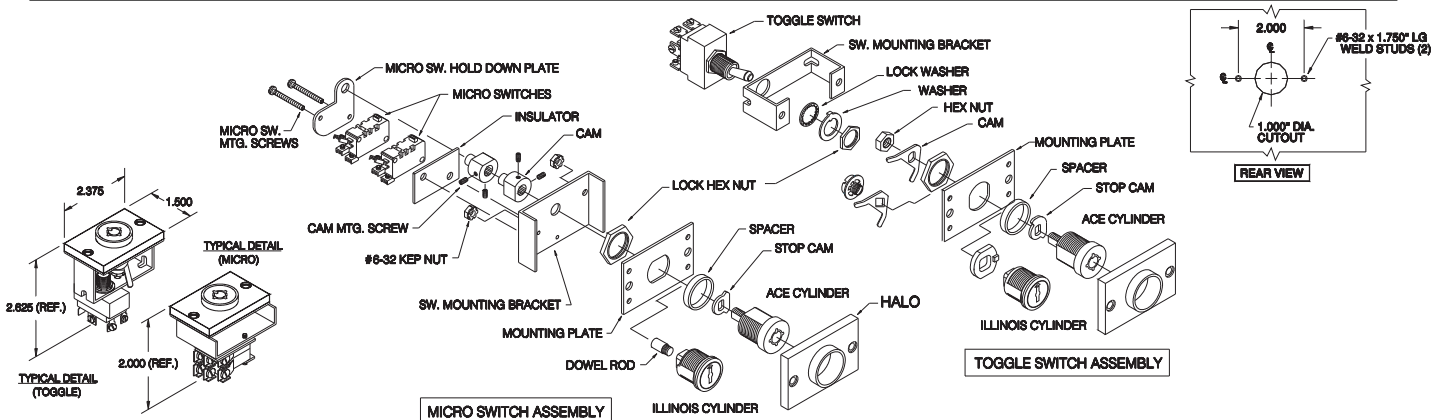



Keyswitches (Cont'd)

ELEVATOR PRODUCTS CORPORATION



Cylinder & Keys:
 Cylinder Part #: 10K61P [x]
 Key Part #: 20A03P [x]
 Ace 0.875" Dia.
 Available in stainless steel or bronze. Available in various finishes.
 Keys available in Key#1,2; 11-45 MFD-1, BFD-1

[x] is dependent upon finish and key #.



Toggle Switch:
 Mechanical toggle
 Available in various configurations



Ace Mtg. Bracket:
 Made from Aluminum
 Specify mounting orientation



Illinois Mtg. Bracket:
 Made from Aluminum
 Specify mounting orientation

Cylinder & Keys:
 Cylinder w/ Key Part #: 20K01P[x]
 Illinois 0.875" Dia.
 Available in stainless steel or bronze. Available in various finishes.
 Keys available in Key#J200, J222 J211-45, H-341

[x] is dependent upon finish and key #.



Halo:
 1.000" Dia. Outside
 0.875" Dia. Inside
 To be used with 0.125" thick covers. "Special thicknesses available".



Micro Switch:
 Heavy duty micro switch



Cams:
 Made from Lexan or Galvanized steel

PARTS LISTING						
ITEM	DESCRIPTION	PART #	DESCRIPTION	PART #	DESCRIPTION	PART #
Cylinders	Ace Cyl. SS / Brass	* Epcoc-lock #	Illinois Cyl. SS / Brass	* ILL-lock #		
Toggle Switch	2 Position	10Z23P01	3 Position	20K04P01		
Halo	Black - #4	10C08P01		-		
Mtg. Bracket Horiz.	Ace Lock Mtg. Plate	11A02P02	Illinois Lock Mtg. Plate	11A02P04		
Mtg. Bracket Vert.	Ace Lock Mtg. Plate	11A02P01	Illinois Lock Mtg. Plate	11A02P03		
Micro Switch	Single Pole, Throw	40Z15P00				
Cams (Toggle)	2-Hole Latch Cam	13A52(P01 ver.P01 hor)	Ace 2-Ear Latch Cam	11A01P01	Illinois 2-Ear Latch Cam	12A98P01
Cams (Micro Sw.)	Nylon White E600	11A08P01	E-595 CAM (To be used with both Ace and Illinois locks) 11A37P01			

OPERATING DEVICES

ACE CYLINDERS			ILLINOIS CYLINDERS		
MODEL #	DESCRIPTION		MODEL #	DESCRIPTION	
BKR-22	Rotary, 2 Position		IBKR-22	Rotary, 2 Position	
BKR-22R	Rotary, OFF-ON, Spring Return to "OFF"		IBKR-22R	Rotary, OFF-ON, Spring Return to "OFF"	
BKR-3	Rotary, 3 Position		IBKR-3	Rotary, 3 Position	
BKR-4	Rotary, 4 Position		IBKR-4	Rotary, 4 Position	
BKS-32A	Toggle Switch 3PDT, 3 Position, Spring Return to "OFF"		IBKS-32A	Toggle Switch 3PDT, 3 Position, Spring Return to "OFF"	
BKS-22	Toggle Switch DPDT, OFF-ON		IBKS-22	Toggle Switch DPDT, OFF-ON	
BKS-22R	Toggle Switch DPDT, OFF-ON, Spring Return to "OFF"		IBKS-22R	Toggle Switch DPDT, OFF-ON, Spring Return to "OFF"	
BKM-22	2-Micro Switch DPDT, 2 Position		IBKM-22	2-Micro Switch DPDT, 2 Position	
BKM-3	2-Micro Switch	3 Position	IBKM-3	2-Micro Switch	3 Position
BKM-4	3-Micro Switch	3 & 4 Positions Available	IBKM-4	3-Micro Switch	3 & 4 Positions Available



ELEVATOR PRODUCTS CORPORATION

Keyswitches (Cont'd)

Haloline-WR



ACE



Model: RKR-22 with rotary
Halo: None (Spacer only)
Lock: Ace 0.875" Dia.
Various markings available See standard marking chart

Side View



Model: RKS-22 with toggle
Halo: 1.375" Sq. Outside
Lock: Ace 0.875" Dia.
Various markings available

Side View



Model: RKM-22 with micro
Halo: 1.375" Sq. Outside
Lock: Ace 0.875" Dia.

ILLINOIS



Model: IRKR-22 with rotary
Halo: 1.375" Sq. Outside
Lock: Illinois 0.875" Dia.

Side View



Model: IRKS-22 with toggle
Halo: 1.375" Sq. Outside
Lock: Illinois 0.875" Dia.
Various markings available

Side View



Model: IRKM-22 with micro
Halo: 1.375" Sq. Outside
Lock: Illinois 0.875" Dia.

ORDER INFORMATION:

Please advise the following - Model number, function, mounting orientation, key pulls, lock and key number, plate thickness.

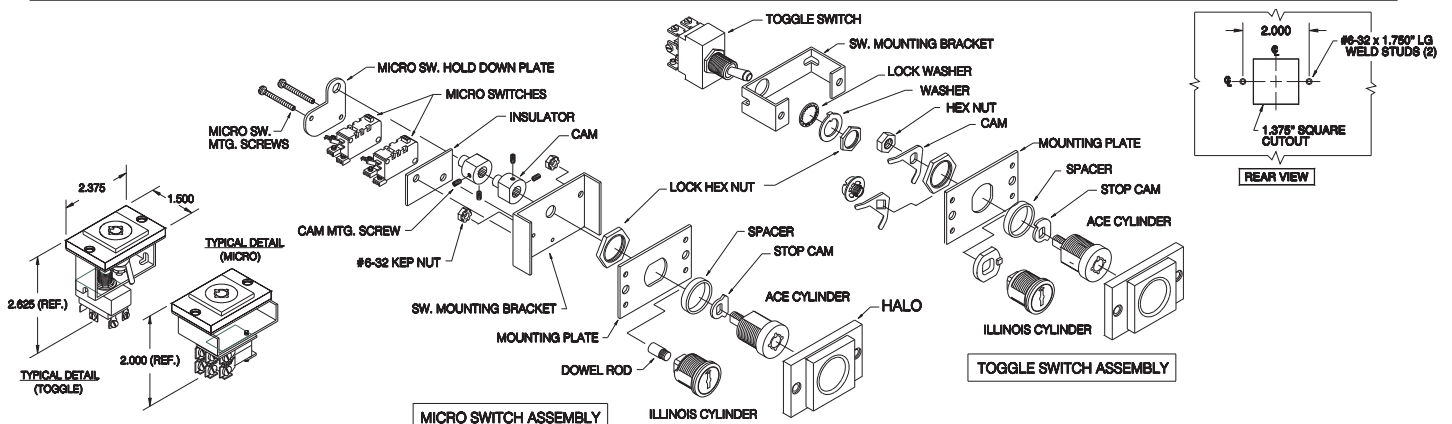



Keyswitches (Cont'd)

ELEVATOR PRODUCTS CORPORATION



Cylinder & Keys:
 Cylinder Part #: 10K61P [x]
 Key Part #: 20A03P [x]
 Ace 0.875" Dia.
 Available in stainless steel or bronze. Available in various finishes.
 Keys available in Key#1,2; 11-45 MFD-1, BFD-1

[x] is dependent upon finish and key #.



Toggle Switch:
 Mechanical toggle
 Available in various configurations



Ace Mtg. Bracket:
 Made from Aluminum
 Specify mounting orientation



Illinois Mtg. Bracket:
 Made from Aluminum
 Specify mounting orientation

Cylinder & Keys:
 Cylinder w/ H-341 Part #: 20K01P[x]
 Cylinder w/ J200 Part #: 10K70P[x]
 Illinois 0.875" Dia.
 Available in stainless steel or bronze. Available in various finishes.
 Keys available in Key#J200, J222 J211-45, H-341

[x] is dependent upon finish and key #.

Halo:
 1.375" Sq. Outside
 0.875" Dia. Inside
 To be used with 0.125" - 0.187" thick covers. "Special thicknesses available".



Micro Switch:
 Heavy duty micro switch



Cams:
 Made from Lexan or Galvanized steel

PARTS LISTING						
ITEM	DESCRIPTION	PART #	DESCRIPTION	PART #	DESCRIPTION	PART #
Cylinders	Ace Cyl. SS / Brass	* Epc-lock #	Illinois Cyl. SS / Brass	* ILL-lock #		
Toggle Switch	2 Position	10Z23P01	3 Position	20K04P01		
Halo	Black - #3	10C12P01				
Mtg. Bracket Horiz.	Ace Lock Mtg. Plate	11A02P02	Illinois Lock Mtg. Plate	11A02P04		
Mtg. Bracket Vert.	Ace Lock Mtg. Plate	11A02P01	Illinois Lock Mtg. Plate	11A02P03		
Micro Switch	Single Pole, Throw	40Z15P00				
Cams (Toggle)	2-Hole Latch Cam	13A52(P01 ver,P01 hor)	Ace 2-Ear Latch Cam	11A01P01	Illinois 2-Ear Latch Cam	12A98P01
Cams (Micro Sw.)	Nylon White E600	11A08P01	E-595 CAM (To be used with both Ace and Illinois locks) 11A37P01			

OPERATING DEVICES

ACE CYLINDERS		ILLINOIS CYLINDERS	
MODEL #	DESCRIPTION	MODEL #	DESCRIPTION
RKR-22	Rotary, 2 Position	IRKR-22	Rotary, 2 Position
RKR-22R	Rotary, OFF-ON, Spring Return to "OFF"	IRKR-22R	Rotary, OFF-ON, Spring Return to "OFF"
RKR-3	Rotary, 3 Position	IRKR-3	Rotary, 3 Position
RKR-4	Rotary, 4 Position	IRKR-4	Rotary, 4 Position
RKS-32A	Toggle Switch 3PDT, 3 Position, Spring Return to "OFF"	IRKS-32A	Toggle Switch 3PDT, 3 Position, Spring Return to "OFF"
RKS-22	Toggle Switch DPDT, OFF-ON	IRKS-22	Toggle Switch DPDT, OFF-ON
RKS-22R	Toggle Switch DPDT, OFF-ON, Spring Return to "OFF"	IRKS-22R	Toggle Switch DPDT, OFF-ON, Spring Return to "OFF"
RKM-22	2-Micro Switch DPDT, 2 Position	IRKM-22	2-Micro Switch DPDT, 2 Position
RKM-3	2-Micro Switch 3 Position	IRKM-3	2-Micro Switch 3 Position
RKM-4	3-Micro Switch 3 & 4 Positions Available	IRKM-4	3-Micro Switch 3 & 4 Positions Available



ELEVATOR PRODUCTS
CORPORATION

Keyswitches (Cont'd)

Adams Style

NOTE: Please specify markings and key number when ordering.

[X] is dependent upon halo style and markings.



Side view for all key switches with contact base.



**Classic Style
with Rotary**
Part #: AS469 [x]
1.500" Dia.
Available in St/St. or
Mz/Bz. finishes.



**Designer Style
with Rotary**
Part #: AS469 [x]
1.500" Square
Available in St/St. or
Mz/Bz. finishes.



**Survivor Style
with Rotary**
Part #: AS469 [x]
1.375" Dia.
Available in St/St. or
Mz/Bz. finishes.



ELEVATOR PRODUCTS CORPORATION

Keyswitches (Cont'd)

Best & Medeco Style

Best Style

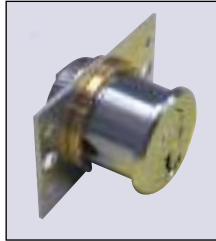

Best Lock

Part #: 10K59P[x]

[x] is dependent on function and finish.

Available in: SPST, DPDT, DPDT Momentary
All Best Locks are supplied with removable construction cores.

Medeco Small Face Style

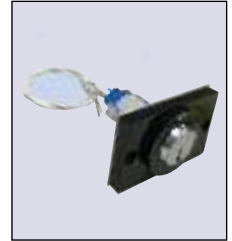

Medeco Small Face Lock

Massachusetts EMT and NYC Housing Top of Car Inspection Switch

Massachusetts EMT Models

St/St. Part #: 10K68P10

Mz/Bz. Part #: 10K68P09

NYC Housing Top of Car Inspection Switch Models

St/St. Part #: 10K68P12

Mz/Bz Part #: 10K68P11

Medeco Large Face Style

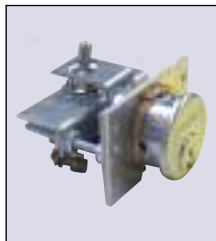

Medeco Large Face Lock

Available Custom Order Only

St/St Part #: 10K60P02

Mz/Bz Part #: 10K60P01

Please contact your sales representative with lock function, when placing an order.

Medeco Small Face Style



Medeco Small Face Lock

Available Custom Order Only

Part #: 10K68P[x]

[x] is dependent on function and finish.

Please contact your sales representative with lock function, when placing an order.

NOTE: EPCO carries a large variety of custom order locks.
Please contact your sales representative for more information.



Toggle Switches

ELEVATOR PRODUCTS CORPORATION

"CL" Series



Side View



Model: CT-22B
 Halo: 1.375" Dia. Outside
 Markings are engraved on halo
 Various markings available See standard marking chart

"FL" Series



Side View

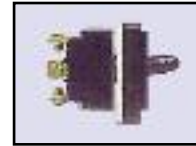

Model: T-22B
 Halo: 1.250" Sq. Outside
 Markings are engraved on halo.
 Various markings available See standard marking chart

"WR" Series



Side View



Model: RT-22B
 Halo: 1.375" Sq. Outside
 Markings are engraved on the face plate.

"WB" Series



Side View



Model: BT-22B
 Halo: 1.000" Dia. Outside
 Markings are engraved on the face plate.

"SSL" Series



Side View



Model: SST-22B
 Halo: None
 Markings are engraved on the face plate.

ORDER INFORMATION:

Please advise the following - Model number, mounting orientation and markings.

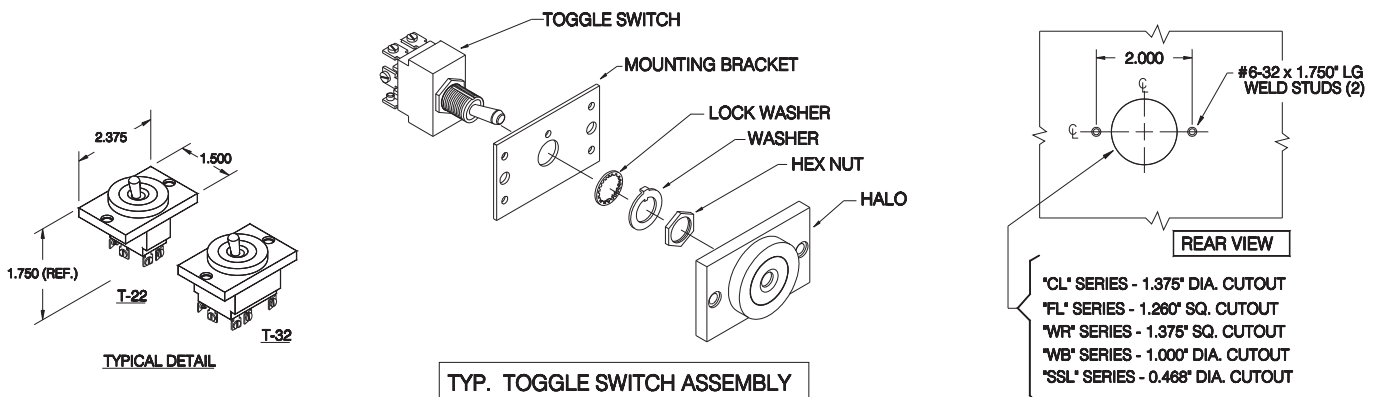



ELEVATOR PRODUCTS CORPORATION

Toggle Switches (Cont'd)



Halo: "CL" Series
1.375" Dia. Outside
to be used with 0.125"
thick covers.
Colors available - see chart



Halo: "FL" Series
1.250" Sq. Outside
to be used with 0.125"
thick covers.
Colors available - see chart

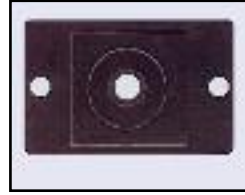

Halo: "WR" Series
1.375" Sq. Outside
to be used with 0.125"
thick covers.
Colors available - see chart



Halo: "WB" Series
1.000" Dia. Outside
to be used with 0.125"
thick covers.
Colors available - see chart

Toggle Switch
Mechanical Toggle
Available in various
configurations



Mtg. Bracket:
Made from Aluminum
Specify mounting
orientation

Parts Listing					
DESCRIPTION	"CL" Series PART #	"FL" Series PART #	"WR" Series PART #	"WB" Series PART #	"SSL" SERIES PART #
Halo Black	CT-HALO-B	T-HALO-B	RT-HALO-B	BT-HALO-B	NONE
Halo Red	CT-HALO-R	T-HALO-R	RT-HALO-R	BT-HALO-R	NONE
Halo White	CT-HALO-W	T-HALO-W	RT-HALO-W	BT-HALO-W	NONE
Mounting Bracket	TOG-BRK	TOG-BRK	TOG-BRK	TOG-BRK	TOG-BRK
Toggle Sw. (Standard)	10Z23P01 (DPDT)	TS-DPDT	TS-DPDT	TS-DPDT	TS-DPDT
Toggle Sw. (Momentary)	TS-DPDT-M	TS-DPDT-M	TS-DPDT-M	TS-DPDT-M	TS-DPDT-M
Toggle Sw. (Center Off)	10Z23P02 (DPDT-C)	TS-DPDT-C	TS-DPDT-C	TS-DPDT-C	TS-DPDT-C
Toggle Sw. (Momm. & Center)	10Z23P03(DPDT-MC)	TS-DPDT-MC	TS-DPDT-MC	TS-DPDT-MC	TS-DPDT-MC
Toggle Sw. (3-pole)	TS-3PDT	TS-3PDT	TS-3PDT	TS-3PDT	TS-3PDT

DESCRIPTION	"CL" Series PART #	"FL" Series PART #	"WR" Series PART #	"WB" Series PART #	"SSL" SERIES PART #
DPDT	CT-22B	T-22B	RT-22B	BT-22B	SST-22B
DPDT - Momentary	CT-22R	T-22R	RT-22R	BT-22R	SST-22R
DPDT - Center Off	CT-22CB	T-22CB	RT-22CB	BT-22CB	SST-22CB
DPDT - Momentary Ctr. Off	CT-22CB-M	T-22CB-M	RT-22CB-M	BT-22CB-M	SST-22CB-M
3PDT - Momentary Ctr, Off	CT-32A	T-32A	RT-32A	BT-32A	SST-32A



ELEVATOR PRODUCTS CORPORATION

Emergency Stop Switches

Push Pull

STANDARD

SAP #: ARW471A6 Horiz. Mtg. SAP #: ARW471V6 Vert. Mtg.
Switch only, please specify from halos below when ordering.



Model: BEP
Halo: 1.000" Dia. Outside
Spindle: 0.875" Dia. Red



Model: CEP
Halo: 1.375" Dia. Outside
Spindle: 0.875" Dia. Red



Model: EP
Halo: 1.250" Sq. Outside
Spindle: 0.875" Dia. Red



Model: REP
Halo: 1.375" Sq. Outside
Spindle: 0.875" Dia. Red

ANODIZED ALUM. SPINDLE

SAP #: ARW471A7 Horiz. Mtg. SAP #: ARW471V6 Vert. Mtg.
Switch only, please specify from halos below when ordering.



Model: SSEP
Halo: 1.000" Dia. Outside
Spindle: 0.875" Dia. Red



Model: SSEP-C
Halo: 1.375" Dia. Outside
Spindle: 0.875" Dia. Red



Model: SSEP-E
Halo: 1.250" Sq. Outside
Spindle: 0.875" Dia. Red



Model: SSEP-R
Halo: 1.375" Sq. Outside
Spindle: 0.875" Dia. Red

Solid Stainless Steel or Muntz Bronze spindles available.
Please contact our sales office for further information.



Halo: 1.000" Dia.
Black-Halo #SSEP-B
SAP #: A450H6B
White-Halo #SSEP-W
SAP #: A450H6W
Halo: 1.375" Dia.
Black-Halo #SSEP-C
SAP #: A450H4B



Halo: 1.375" Dia.
Black-Halo #CEP-B
SAP #: A450H4B



Halo: 1.375" Dia.
0.250" Projection
Black-Halo #PCEP-B
SAP #: A450H2B
White-Halo #PCEP-W
SAP #: A450H2W



Halo: 1.250" SQ.
Black-Halo #EP-B
SAP #: A450H5B
White-Halo #EP-W
SAP #: A450H5W

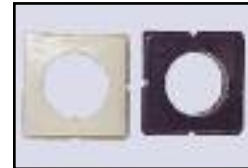

Halo: 1.375" SQ.
0.250" Projection
Black-Halo #REP-B
SAP #: A450H3B
White-Halo #REP-W
SAP #: A450H3W

ORDER INFORMATION:

Please advise the following - Model number, mounting orientation.

ADAMS STYLE



Adams Pull to Stop
Emergency Stop Switch
Survivor Style
Model: AS459A2
2NC, 1NO
Halo: 1.375" Dia. Outside
Spindle: 0.875" Dia. Red



Adams Push to Stop
Emergency Stop Switch
Survivor Style
Model: AS459A1
2NC, 1NO
Halo: 1.375" Dia. Outside
Spindle: 0.875" Dia. Red

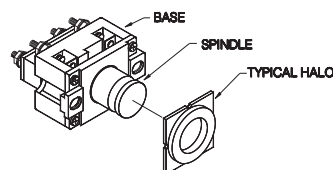
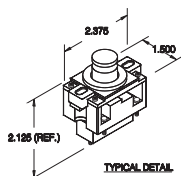

STOP PUSH-PULL SWITCH ASSEMBLY

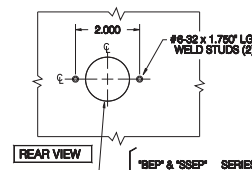

"REP" & "SSEP" SERIES - 1.000" DIA. CUTOUT
"CEP" & "C-SSEP" SERIES - 1.375" DIA. CUTOUT
"EP" & "E-SSEP" SERIES - 1.250" SQ. CUTOUT
"REP" & "R-SSEP" SERIES - 1.375" SQ. CUTOUT



ELEVATOR PRODUCTS CORPORATION

Emergency Stop Switches (Cont'd)

Key Switches



Model: CKR-22 (ES)
Halo: 1.375" Dia. Outside
Lock; Ace 0.875" Dia.



Model: KR-22 (ES)
Halo: 1.250" SQ. Outside
Lock; Ace 0.875" Dia.



Model: CKR-22 (ES)
Halo: 1.375" Dia. Outside
Lock; Ace 0.875" Dia.



Model: KR-22 (ES)
Halo: 1.250" SQ. Outside
Lock; Ace 0.875" Dia.



Model: ICKS-22 (ES)
Halo: 1.375" Dia. Outside
Lock; Illinois 0.875" Dia.



Model: IKS-22 (ES)
Halo: 1.250" SQ. Outside
Lock; Illinois 0.875" Dia.



Model: ICKS-22 (ES)
Halo: 1.375" Dia. Outside
Lock; Illinois 0.875" Dia.



Model: IKS-22 (ES)
Halo: 1.250" SQ. Outside
Lock; Illinois 0.875" Dia.

Halo:
Black Part #: 10C12P01
Red Part #: 10C12P02
1.375" Dia. Outside
0.875" Dia. Inside
To be used with 0.125" thick cover.
Available in Red & Black only



Halo:
Black Part #: 10C11P01
Red Part #: 10C11P02
1.250" SQ. Outside
0.875" Dia. Inside
To be used with 0.125" thick cover.
Available in Red & Black only

NOTE: All Key Switches available with Micro, Toggle, and Rotary Switches.

ORDER INFORMATION:

Please advise the following - Model number, mounting orientation and halo color.

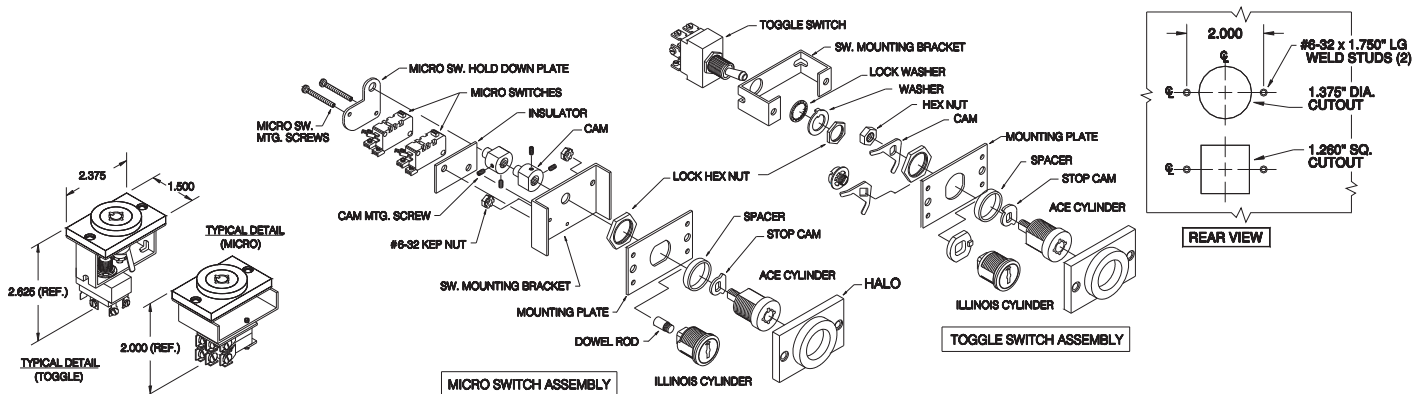



Rocker Switches

ELEVATOR PRODUCTS CORPORATION



Model: R-22B (IS)
Auto-Inspection Switch

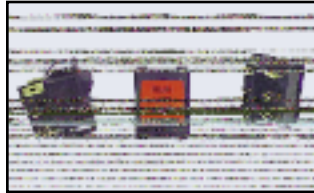

Model: R-22R
Run-Stop Switch

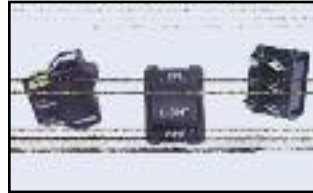

Model: R-22B (L)
On-Light-Off Switch



Model: R-22CB (F2)
Lo-Fan-Hi Switch

MODEL #	PART #	DESCRIPTION	CONTACT CONFIG.
R-22B	12B14P17	Rocker Switch - "Blank"	DPDT
R-22B (IS) PRE 2000	12B14P07	Rocker Switch - "Inspection"	DPDT
R-22B (IS) POST 2000	12B14P12	Rocker Switch - "Inspection"	DPDT
R-22R	7257C63H10	Rocker Switch - "Run-Stop"	DPDT
R-22B (L)	12B14P02	Rocker Switch - "Light"	DPDT
R-22CB (F1)	12B14P13	Rocker Switch - "Fan 1-Speed"	DPDT
R-22CB (F2)	7257C63H16	Rocker Switch - "Fan 2-Speed"	DPDT
R-22CB (F3)	12B14P14	Rocker Switch - "Fan 3-Speed"	DPDT
R-22B (G)	12B14P11	Rocker Switch - "Generic" Off/On	DPDT
R-22B (A)	12B14P09	Rocker Switch - "Access"	DPDT
r-22B (TS)	12B14P10	Rocker Switch - "Traffic Sentinel"	DPDT
R-22B (AT)	12B14P03	Rocker Switch - "Attendant"	DPDT
R-22B (ID)	12B14P04	Rocker Switch - "Independent"	DPDT
R-22B (MG)	12B14P05	Rocker Switch - "MG"	DPDT
R-22B (PO)	12B14P06	Rocker Switch - "Power"	DPDT
R-22CBM	12B14P15	Rocker Switch - Momentary Center Off	DPDT

- * All Halos are black
- * All Halo Legends are white. Rocker switch legends are white
- * Devices are Non-Illuminated

Special markings available upon request. Please contact our Sales department for further information



Typical Attendant Cabinet - SUB-PLATE

Plate with standard operating devices (shown).
Other devices available to suit any application.
See chart above.

ORDER INFORMATION:

Please advise the following - Model number, application and voltage.



ELEVATOR PRODUCTS
CORPORATION

Rocker Indicators & Buttons

LIGHT UP INDICATIONS

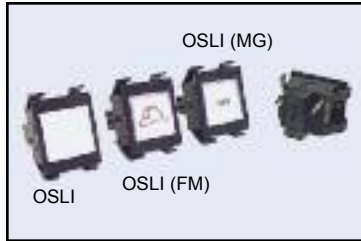

LIGHT-UP INDICATORS - Snap in Type		
MODEL #	PART #	DESCRIPTION
OSLI (FM)	12B15P01	Light-up Indicator - "Fire Hat" Jewel (Red) 28V
OSLI (FM)	12B15P03	Light-up Indicator - "Fire Hat" Jewel (Red) 125V
OSLI (MG)	12B15P02	Light-up Indicator - "MG" Jewel (Black) 28V
OSLI (MG)	12B15P04	Light-up Indicator - "MG" Jewel (Black) 125V

- * All Halos are black
- * Indications: .75" Sq clear cap (Sonic welded to button) over white button
- * Devices are Illuminated

Special markings available upon request. Please contact our Sales department for further information

PUSH BUTTONS



PUSH BUTTONS - Snap in Type			
MODEL #	PART #	DESCRIPTION	CONTACT CONFIG.
OSEM	7257C63H27	Button - "Emerg Light Test 115V"	DPST
OSL	12B17P05	Button - Light-up 24V Blank	DPST
OSL	12B16P02	Button - Light-up 125V Blank	DPST
OSN (EN)	12B17P07	Button - Non Light-up "Enable"	DPST
OSN (UP)	12B17P01	Button - Non Light-up "Up"	DPST
OSN (DN)	12B17P02	Button - Non Light-up "Down"	DPST
OSN (P)	12B17P03	Button - Non Light-up "Pass"	DPST
OSN (S)	12B17P04	Button - Non Light-up "Safety"	DPST

- * All Halos are black
- * Push Button: .75" Sq clear cap (Sonic welded to button) over white button
- * All button markings are black

Special markings available upon request. Please contact our Sales department for further information

ORDER INFORMATION:

Please advise the following - Model number, application.



ELEVATOR PRODUCTS CORPORATION

Miscellaneous Switches

LOCK SWITCHES

* Special Lock Switches and Key Numbers available upon request. Please contact our sales department for special orders.



ACE/ BARREL
Type Key Switch

Model: LS-22R

Part #: 20K13P01
St/St. EPCO Key # 1
1-pos. momentary. Key pull at 12 O'Clock only.

Part #: 20K13P02
St/St. EPCO Key # 2
1-pos. momentary. Key pull at 12 O'Clock only.

Model: LS-22

Part #: 20K13P04
St/St. EPCO Key # 1
2-position. Key pull in 12 & 6 O'Clock only.

Part #: 20K13P03
St/St. EPCO Key #2
2-position. Key pull in 12 & 6 O'Clock only.



ILLINOIS
Type Key Switch (Flat Key)

Model: LSI-22R

Part #: 20K09P01
St/St. Key # J200
2-Position (DPDT)momentary.
Key pull at 12:00 O'clock only.

Model: LSI-22

Part #: 20K08P02 St/St.
Key # J200

Part #: 20K08P01 Mz/Bz.
Key # J200
2-Position (DPDT)
Key pull in "Off" & "On."

ORDER INFORMATION:

Please advise the following - Model Number.



ELEVATOR PRODUCTS CORPORATION

Fire Service Switches

Boston Code

CAR - PHASE II

YALE



Side View



Model: BOSCKR-4

Key Pull = Off, Hold Key# 3502
Halo: 1.375" Dia. Outside
Cutout: 1.375" Dia.

HALL - PHASE I



Side View



Model: BOSCKR-3

Key Pull = Off, On Key# 3502
Halo: 1.375" Dia. Outside
Cutout: 1.375" Dia.

NOTE: - Switch shown with Adams Style vertical mounting, not available in Adams horizontal mounting.
- Please specify EPCO horizontal or vertical mounting, and finish.
- Available in 2 position for alternate floor/remote applications.
- Also available with rotary.

Replacement Parts Only

CAR - PHASE II

YALE



Side View



Model: BOSCKM-4
Key Pull = Off, Hold, On Key# 3502
Halo: 1.375" Dia. Outside
Cutout: 1.375" Dia.

HALL - PHASE I



Side View



Model: BOSCKM-3
Key Pull = Off, On Key# 3502
Halo: 1.375" Dia. Outside
Cutout: 1.375" Dia.

NOTE: Refer to Key switch section for available components.

ORDER INFORMATION:

Please advise the following - Model number and mounting orientation.



ELEVATOR PRODUCTS
CORPORATION

Fire Service Switches (Cont'd)



Cylinder & Keys:
Yale: 0.468" Dia.
Available in stainless steel or
bronze. Available in various
finishes.

Cylinder & Keys:
Illinois 1.000" Dia.
Available in stainless steel or
bronze. Available in various
finishes.



Yale Mtg. Bracket:
Made from Aluminum
Specify mounting
orientation



Illinois Mtg. Bracket:
Made from Aluminum
Specify mounting
orientation



Halo: Yale
Part #: 12C65P01
1.375" Dia. Outside
1.000" Dia. Inside
To be used with 0.125" thick
covers.
Available in Red only.
Please advise code year.
Please specify markings when ordering.



Halo: Yale
Part #: 10C59P01
1.375" Dia. Outside
0.468" Dia. Inside
To be used with 0.125" thick
covers.
Available in Red only.
Please advise code year.
Please specify markings when ordering.

NOTE: Legends are available for Local Codes.



ELEVATOR PRODUCTS CORPORATION

Fire Service Switches (Cont'd)

National Code & Other Replacement Parts Only

CAR - PHASE II ACE



Side View



Model: CKM-4
Key Pull = Off, Hold, On Key# MFD-1
Halo: 1.375" Dia. Outside
Cutout: 1.375" Dia.

FLAT BLADE



Side View



Model: ICKM-4
Key Pull = Off, Hold, On Key# H-341
Halo: 1.375" Dia. Outside
Cutout: 1.375" Dia.

ALTERNATE FLOOR / REMOTE

ACE



Side View



Model: CKM-22
Key Pull = Off, On Key# MFD-1
Halo: 1.375" Dia. Outside
Cutout: 1.375" Dia.

HALL - PHASE I



Model: CKM-3
Key Pull = Off, On Key# MFD-1
Halo: 1.375" Dia. Outside
Cutout: 1.375" Dia.



Model: ICKM-3
Key Pull = Off, On Key# H-341
Halo: 1.375" Dia. Outside
Cutout: 1.375" Dia.

ALTERNATE FLOOR / REMOTE

FLAT BLADE



Side View



Model: ICKM-22
Key Pull = Off, On Key# WD01, AS100, H-341
Halo: 1.375" Dia. Outside
Cutout: 1.375" Dia.

NOTE: Refer to Key switch section for available components.

ORDER INFORMATION:

Please advise the following - Model number, finish and mounting orientation.



ELEVATOR PRODUCTS
CORPORATION

Fire Service Switches (Cont'd)



Cylinder & Keys:
Ace 0.875" Dia.
Available in stainless steel or bronze. Available in various finishes.

Cylinder & Keys:
Illinois 0.875" Dia.
Available in stainless steel or bronze. Available in various finishes.



Ace Mtg. Bracket:
Made from Aluminum
Specify mounting orientation



Illinois Mtg. Bracket:
Made from Aluminum
Specify mounting orientation



"U" Mtg. Bracket &
Micro switch hold down
Bracket:
Made from Galvanized
Steel.



Micro Switch:
Heavy duty micro switch



Cams:
Made from Lexan



Halo: Ace & Illinois
Part #: 10C12P02
1.375" Dia. Outside
0.875" Dia. Inside
To be used with 0.125" thick covers.
Available in Red only
Please specify markings when ordering.



Halo: Ace & Illinois
Part #: 10C11P02
1.250" SQ. Outside
0.875" Dia. Inside
To be used with 0.125" thick covers.
Available in Red only
Please specify markings when ordering.

NOTE: Legends are available for Local Codes.



ELEVATOR PRODUCTS
CORPORATION

Fire Service Switches (Cont'd)

National Code

Rotary Style

CAR - PHASE II

ACE



Side View



Shown as 1998 Code

Model: CKR-4

Key Pull = Off, Hold, On 1998 Code Key# MFD-1, FEOK1

Key Pull = Off, On 2000 Code

Halo: 1.375" Dia. Outside

Cutout: 1.375" Dia.

HALL - PHASE I



Side View



Shown as 2000 Code

Model: CKR-3

Key Pull = Off, On Key# MFD-1, FEOK1

Halo: 1.375" Dia. Outside

Cutout: 1.375" Dia.

Bypass, Off, On 1998 Code

Reset, Off, On 2000 Code

FLAT/BLADE



Side View



Model: ICKR-4

Key Pull = Off, Hold Key# H-341, AS100

Halo: 1.375" Dia. Outside

Cutout: 1.375" Dia.



Side View



Model: ICKR-3

Key Pull = Off, On Key# H-341, WD01, AS100

Halo: 1.375" Dia. Outside

Cutout: 1.375" Dia.

ALTERNATE FLOOR / REMOTE

ACE



Side View



Model: CKR-22

Key Pull = Off, On Key# MFD-1, FEOK1

Halo: 1.375" Dia. Outside

Cutout: 1.375" Dia.

ALTERNATE FLOOR / REMOTE

FLAT BLADE



Side View



Model: ICKR-22

Key Pull = Off, On Key# WD01, AS100

Halo: 1.375" Dia. Outside

Cutout: 1.375" Dia.

ORDER INFORMATION:

Please advise the following - Model number, finish and mounting orientation.

Fire Service Switches Schindler Style

PEP Style

CAR - PHASE II

SHOWN AS: YALE

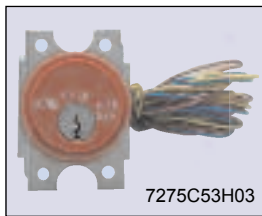

Side View

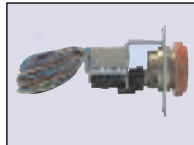

Model: 7275C53 [x]
Halo: 1.375" Dia. Outside
Cutout: 1.375" Dia.

HALL - PHASE I

SHOWN AS: YALE

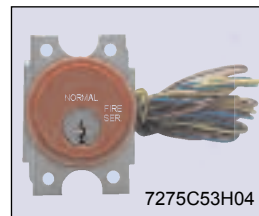

Side View

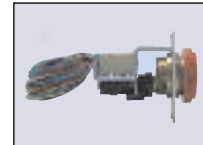

Model: 7275C53 [x]
Halo: 1.375" Dia. Outside
Cutout: 1.375" Dia.

NOTE: [x] is dependent upon location, positions, key pull, and key number. Please specify when ordering.

MTA Style

CAR - PHASE II

SHOWN AS: YALE

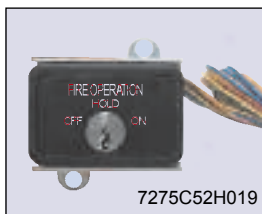

Side View

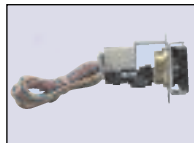

Model: 7275C52 [x]
Size: 2.300"W x 1.500" H x 2.625" Deep

HALL - PHASE I

SHOWN AS: YALE



Side View



Model: 7275C52 [x]
Size: 2.300"W x 1.500" H x 2.625" Deep

NOTE: [x] is dependent upon location, positions, key pull, and key number. Please specify when ordering.

ORDER INFORMATION:

Please advise the following - Model number, finish and mounting orientation.



ELEVATOR PRODUCTS CORPORATION

Fire Service Switches (Cont'd)

NYC Code

CAR - PHASE II

YALE



Side View



Model: NYCKM-4
Key Pull = Normal & Hold Key# 2642
Halo: 1.375" Dia. Outside
Cutout: 1.375" Dia.

HALL - PHASE I



Side View



Model: NYCKM-22
Key Pull = Normal & Fire Serv. Key# 2642
Halo: 1.375" Dia. Outside
Cutout: 1.375" Dia.

NOTE: - Switch shown with Adams Style vertical mounting, not available in Adams horizontal mounting.
- Please specify EPCO horizontal or vertical mounting, and finish.
- Available in 2 position for alternate floor/remote applications.

Replacement Parts Only

CAR - PHASE II

YALE



Side View



Model: NYCKM-4
Key Pull = Normal & Hold Key# 2642
Halo: 1.375" Dia. Outside
Cutout: 1.375" Dia.

HALL - PHASE I



Side View



Model: NYCKM-22
Key Pull = Normal & Fire Serv. Key# 2642
Halo: 1.375" Dia. Outside
Cutout: 1.375" Dia.

NOTE: Refer to Key switch section for available components.

ORDER INFORMATION:

Please advise the following - Model number and mounting orientation.



ELEVATOR PRODUCTS CORPORATION

Fire Service Switches (Cont'd)



Cylinder & Keys:
Yale: 0.468" Dia.
Available in stainless steel or bronze. Available in various finishes.

Cylinder & Keys:
Illinois 1.000" Dia.
Available in stainless steel or bronze. Available in various finishes.



Yale Mtg. Bracket:
Made from Aluminum
Specify mounting orientation



Illinois Mtg. Bracket:
Made from Aluminum
Specify mounting orientation



Halo: Illinois
Part #: 12C65P01
1.375" Dia. Outside
1.000" Dia. Inside
To be used with 0.125" thick covers.
Available in Red only
Please specify markings when ordering.



Halo: Yale
Part #: 10C59P01
1.375" Dia. Outside
0.468" Dia. Inside
To be used with 0.125" thick covers.
Available in Red only
Please specify markings when ordering.

NOTE: Legends are available for Local Codes.



ELEVATOR PRODUCTS CORPORATION

Fire Service Switches (Cont'd)

Connecticut Code

CAR - PHASE II

ACE



Side View



Model: CKR-4
Key Pull = Off, Hold, On Key# BFD-1
Halo: 1.375" Dia. Outside
Cutout: 1.375" Dia.

HALL - PHASE I



Side View



Model: CKR-3
Key Pull = Off, On Key# BFD-1
Halo: 1.375" Dia. Outside
Cutout: 1.375" Dia.

NOTE: - Switch shown with EPCO Style horizontal mounting, available in EPCO vertical.
- Available in 2 position for alternate floor/remote applications.
- Please specify finish.

Replacement Parts Only

CAR - PHASE II

ACE



Side View



Model: CKM-4
Key Pull = Off, Hold, On Key# BFD-1
Halo: 1.375" Dia. Outside
Cutout: 1.375" Dia.

HALL - PHASE I



Side View



Model: CKM-3
Key Pull = Off, On Key# BFD-1
Halo: 1.375" Dia. Outside
Cutout: 1.375" Dia.

NOTE: Refer to Key switch section for available components.

ORDER INFORMATION:

Please advise the following - Model number and mounting orientation.



ELEVATOR PRODUCTS
CORPORATION

Fire Service Switches (Cont'd)



Cylinder & Keys:
Ace 0.875" Dia.
Available in stainless steel or
bronze. Available in various
finishes.



Ace Mtg. Bracket:
Made from Aluminum
Specify mounting
orientation

Micro Switch:
Heavy duty micro switch



Halo: Ace
Part #: 10C12P02
1.375" Dia. Outside
0.875" Dia. Inside
To be used with 0.125" thick
covers.
Available in Red only
Please specify markings when ordering.



NOTE: Legends are available for Local Codes.



ELEVATOR PRODUCTS CORPORATION

Fire Service Switches (Cont'd)

South Carolina Code Post 2000

CAR - PHASE II

FLAT/BLADE



Side View



Model: ICKR-4
Key Pull = Off, Hold, On Key# SC1000
Halo: 1.375" Dia. Outside
Cutout: 1.375" Dia.

HALL - PHASE I



Side View



Model: ICKR-3
Key Pull = Off, On Key# SC1000
Halo: 1.375" Dia. Outside
Cutout: 1.375" Dia.

NOTE: - Switch shown with EPCO Style horizontal mounting, available in EPCO vertical, and Adams style.
- Available in 2 position for alternate floor/remote applications.
- Please specify finish.

Replacement Parts Only

CAR - PHASE II

FLAT/BLADE



Side View



Model: ICKM-4
Key Pull = Off, Hold, On Key# SC1000
Halo: 1.375" Dia. Outside
Cutout: 1.375" Dia.

HALL - PHASE I



Model: ICKM-3
Key Pull = Off, On Key# SC1000
Halo: 1.375" Dia. Outside
Cutout: 1.375" Dia.

NOTE: Refer to Key switch section for available components.

ORDER INFORMATION:

Please advise the following - Model number and mounting orientation.



ELEVATOR PRODUCTS CORPORATION

Fire Service Switches (Cont'd)

White Plains Code

CAR - PHASE II

YALE



Side View



Model: IWPCKM-4
Key Pull = Off, Hold, On 1998 Code Key# 255
Key Pull = Off, Hold 2000 Code Key # 255
Halo: 1.375" Dia. Outside
Cutout: 1.375" Dia.

HALL - PHASE I



Side View



Model: IWPCKM-3
Key Pull = Off, On Key# 255
Halo: 1.375" Dia. Outside
Cutout: 1.375" Dia.

NOTE: - Switch shown with Adams Style vertical mounting, not available in Adams horizontal mounting.
- Please specify EPCO horizontal or vertical mounting, and finish.
- Available in 2 position for alternate floor/remote applications.

Replacement Parts Only

CAR - PHASE II

YALE



Side View



Model: WPCKM-4
Key Pull = Off, Hold, On Key# 255
Halo: 1.375" Dia. Outside
Cutout: 1.375" Dia.

HALL - PHASE I



Side View



Model: WPCKM-3
Key Pull = Off, On Key# 255
Halo: 1.375" Dia. Outside
Cutout: 1.375" Dia.

NOTE: Refer to Key switch section for available components.

ORDER INFORMATION:

Please advise the following - Model number and mounting orientation.



ELEVATOR PRODUCTS CORPORATION

Fire Service Switches (Cont'd)

Arizona Code

CAR - PHASE II

ACE



Side View



Model: CKR-4
Key Pull = Off, Hold Key# AZFS
Halo: 1.375" Dia. Outside
Cutout: 1.375" Dia.

HALL - PHASE I



Side View



Model: CKR-3
Key Pull = Off, On Key# AZFS
Halo: 1.375" Dia. Outside
Cutout: 1.375" Dia.

NOTE: - Switch shown with EPCO Style horizontal mounting, available in EPCO vertical.
- Available in 2 position for alternate floor/remote applications.
- Please specify finish.

Chicago Code

*** PRE - 1999 CODE ***

*** FOR 1999 AND BEYOND REFER TO NATIONAL CODE.**

PHASE I & II

ACE



Side View



Model: CKM-22
Key Pull = Off only Key# MFD-1
Halo: 1.375" Dia. Outside
Cutout: 1.375" Dia.

ORDER INFORMATION:

Please advise the following - Model number, finish and mounting orientation.



ELEVATOR PRODUCTS
CORPORATION

Fire Service Cabinet Lock

Spring Latch



Available in stainless steel or
bronze. Available in J200.
Ask to see if your key is available.

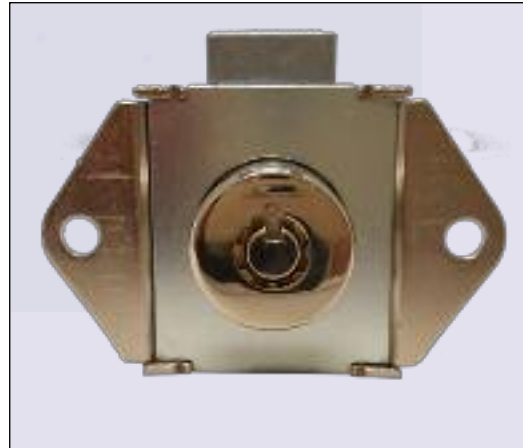

Available in stainless steel or
bronze. Available in MFD1, BFD1, FE0K1, etc.
Ask to see if your key is available.



Fire Stations

ELEVATOR PRODUCTS CORPORATION



CAR (PHASE II)

- * Available in St. Steel or Muntz Bronze
- * Available in #4 Brushed or #8 Mirror Finishes
- * STANDARD SIZE: 4-1/4"W x 10-1/2"H
- * Fixture can be supplied with your choice of components.



HALL (PHASE I)

- * Available in St. Steel or Muntz Bronze
- * Available in #4 Brushed or #8 Mirror Finishes
- * STANDARD SIZE: 3-1/4"W x 10-1/2"H
- Also Available in 4-1/4"W x 10-1/2"H
- * Fixture can be supplied with additional components (Push buttons, Jewels, Buzzer) Maximum of 3 total components.

NOTE: Refer to Fire Key switch and Pushbutton Section for available components.

ORDER INFORMATION:

Please advise the following - Model number, finish, fire switch and voltage.

Parts Listing				
Model #	Description	Cover Size	Box Size	Cutout
C-45F-S	St. Steel #4 with Fire Key Switch, Door Open	4-1/4" W x 10-1/2" H	3-1/2" W x 9-1/8" H x 3" DP.	3-5/8" W x 9-1/4" H
	Door Close, Call Cancel, Fire Light, Buzzer			
C-45F-M	Muntz Bz. #4 with Fire Key Switch, Door Open,			
	Door Close, Call Cancel, Fire Light, Buzzer			
C-43F-S	St. Steel #4 with Fire Key Switch, Call Cancel	3-1/4" W x 10-1/2" H	2-3/4" W x 9-1-8" H x 3" DP	2-7/8" W x 9-1/4" H
	Fire Light, Buzzer			
C-43F-M	Muntz Bz. #4 with Fire Key Sw. Call Cancel			
	Fire Light, Buzzer			
H-31F-S	St. Steel #4 with Fire Key Switch	3-1/4" W x 10-1/2" H	2-3/4" W x 9-1-8" H x 3" DP	2-7/8" W x 9-1/4" H
H-31F-M	Muntz Bz. #4 with Fire Key Switch			
H-32FJ-S	St. Steel #4 with Fire Key Switch, Fire Light			
H-32FJ-M	Muntz BZ. #4 with Fire Key Switch, Fire Light			

NOTE: PLEASE SPECIFY TYPE OF FIRE KEY SWITCH WHEN ORDERING.



ELEVATOR PRODUCTS CORPORATION

Fire Service Control Cabinet



Shown in St. Steel

Fire Service Control Cabinet:

- Contains: visual signal, Call/Cancel button, Push/Pull stop switch, Door Open/Door Close buttons; Available with Door Open Rear and Door Close Rear if required.
- Complies with A17.1-2004 Safety Code.
- Safety locked door only accessible to Fire Fighters with fire service key; available with WD01, H-341, AS-100, MFD-1, BFD-1, 2642, and 3502 keys.
- Meet 2004 requirements, Section 2.26.2.33, 2.27.3.3-2.27.3.3.8.
- Available in Mz. Bronze and St. Steel finishes.

NOTE: Please contact sales department for orders.

Fire Key Boxes

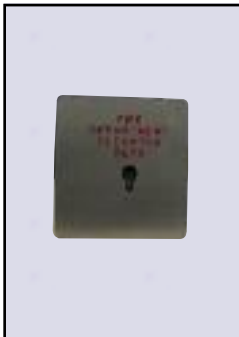

MODEL #: FKB-1-S
 Part #: 1304D60H01
 3.5" x 3.5"
 Meets Washington DC codes.



MODEL #: FKB-1-S-SMCA
 Part #: 1304D99G02
 3" X 9"
 Surface Mounted.



MODEL #: FKB-1-S-SM
 Part #: 1304D99G05
 3" X 9"
 Surface Mounted.

ORDER INFORMATION:

Please advise the following - Model number



ELEVATOR PRODUCTS
CORPORATION

Emergency Light Fixtures

These fixtures are designed for installation in elevator cabs and provide Emergency Illumination exceeding the requirements as outlined in the A17.1 Elevator Safety Code when used with EPCO Emergency Light Power Pack.



Ceiling Surface Mounted



Wall Recess Mounted



Wall Surface Mounted



Car Station Mounted



O.E.M. Installation



Drop Ceiling Mounted
(Sealed Beam)

Refer to back page for model numbers.

ORDER INFORMATION:

Please advise the following - Model number, material: stainless steel or muntz bronze and voltages.

Emergency Light Fixtures (Cont'd)

FIXTURE	MODEL # 6V	PART # 6V	MODEL # 12V	PART # 12V
Ceiling Surface Mounted 10-3/4"L x 4-1/2"W x 2"D	1001-43-00	10M69G01	1001-22-00	10M69G02
Car Station Mounted 4-1/4"L x 4-3/8"W x 1-7/8"D	1004-43-00	10K05G01	1004-22-00	10K05G02
O.E.M. Installation 4"L x 2"W Mounting Plate	1005-43-00	20B04G01	1005-22-00	20B04G02
Drop Ceiling Mounted (Sealed Beam) 10-5/8"L x 4-13/16"W x 2"D	1006-33-00	10C24G01	Not Available	Not Available
Wall Recessed Mounted Mz/Bz #4 10-5/8"L x 4-9/16"W Pan Cover 9-3/8"L x 3-11/16"W x 1-5/8" Box	1002-43-00	10K04G03	1002-22-00	10K04G04
Wall Recessed Mounted Mz/Bz #8 10-5/8"L x 4-9/16"W Pan Cover 9-3/8"L x 3-11/16"W x 1-5/8" Box	1002-43-00	10K04G07	1002-22-00	10K04G08
Wall Recessed Mounted St/St #4 10-5/8"L x 4-9/16"W Pan Cover 9-3/8"L x 3-11/16"W x 1-5/8" Box	1002-43-00	10K04G01	1002-22-00	10K04G02
Wall Recessed Mounted St/St #8 10-5/8"L x 4-9/16"W Pan Cover 9-3/8"L x 3-11/16"W x 1-5/8" Box	1002-43-00	10K04G05	1002-22-00	10K04G06
Wall Surface Mounted Mz/Bz #4 10-1/2"W x 4-1/4"H x 1-5/8"D	1003-43-00	10K12G03	1003-22-00	10K12G04
Wall Surface Mounted Mz/Bz #8 10-1/2"W x 4-1/4"H x 1-5/8"D	1003-43-00	10K12G07	1003-22-00	10K12G08
Wall Surface Mounted St/St #4 10-1/2"W x 4-1/4"H x 1-5/8"D	1003-43-00	10K12G01	1003-22-00	10K12G02
Wall Surface Mounted St/St #8 10-1/2"W x 4-1/4"H x 1-5/8"D	1003-43-00	10K12G05	1003-22-00	10K12G06

Replacement Lamps



Replacement Lens

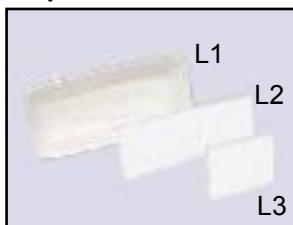

For convenience: Emergency light fixtures can be ordered together with the power pack. Refer to our Emergency Light Power Supply page for model numbers.

PART #	MODEL #
37X10P16	82 Bayonet Dbl Cont 6V
37X16P31	1651 Bayonet Sql Cont 5V
37X10P17	12V 90 Bayonet Dbl 12V
37X10P10	GE454

NOTE: Please see lamp section.

NAME	MODEL #	PART #	MOUNTING
L1	1001-LN	20B20P01	Ceiling Surface
L2	1002-LN	35B21P01	Wall Recess & Surface
L3	CELG-LN	11B95P01	Car Station



ELEVATOR PRODUCTS CORPORATION

Emergency Light Power Supplies



POWER PACK WITH ALARM BELL AND TOP OF CAR LIGHT



POWER PACK WITH ALARM BELL

MODEL #	PART #	VOLTAGE	DESCRIPTION
1000-03-01	10M44G01	6V	Plain Power Pack
1000-03-03	10M44G02	6V	Power Pack with Bell
1000-03-04	10M44G03	6V	Power pack with Bell and Top of Car Light
1000-02-01	10M55G01	12V	Plain Power Pack
1000-02-03	10M55G02	12V	Power Pack with Bell
1000-02-04	10M55G03	12V	Power pack with Bell and Top of Car Light

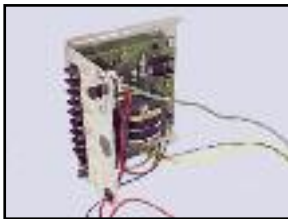

Circuit Board and Chassis



Battery



Bell



Lamp Guard

MODEL #	PART #	VOLTAGE	DESCRIPTION
6VGB	66B30G03	6V	Circuit Board and Chassis
12VGB	66B30G04	12V	Circuit Board and Chassis
EP-695	10Z01P03	6V	Battery
1000-03-10	66B20G01	6V	Bell
1000-02-10	66B20G02	12V	Bell
LG-1	10M65P04	None	Lamp Guard

ORDER INFORMATION:

Please advise the following - Model number and voltages.

Emergency Light Power Supplies (Cont'd)

- Designed expressly for use with EpcO emergency light fixtures
- Exceeds Elevator Safety Code A17.1
- Approved by CSA
- Certified by the State of California
- Designed for Tamperproof, Remote Installation on Cab Top
- Engineered Reliability in Maximum Temperature Range
- Independent circuitry for each of two incandescent lamps
- Unit shipped wired for 110/120 VAC, 60 Hz (Other voltages available on special order)
- Automatically recovers maximum power after use

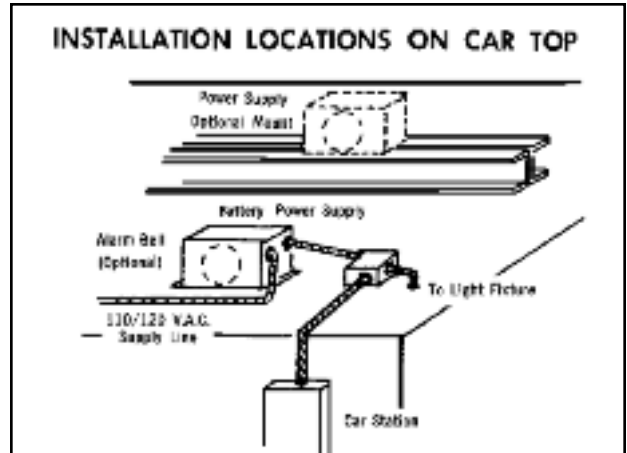



ELEVATOR PRODUCTS CORPORATION

Emergency Lighting

Self Contained



NICAD



Surface mounted NSMS



Bell

MODEL #	PART #	DESCRIPTION	TYPE	DIMENSIONS
1009-11-00-S (NSMS)	10M70G01	Stainless Steel Cover with Milkwhite Diffuser Window	Surface Mounted	10-1/2"W x 4-1/4"H x 2-1/4"D
1009-11-00-M (NSMS)	10M70G02	Muntz Bronze Cover with Milkwhite Diffuser Window	Surface Mounted	10-1/2"W x 4-1/4"H x 2-1/4"D
NICAD	10Z01P15	Nickel Cadmium Battery	Surface and Recessed	Not Available
BELL	66B20G01	Alarm Bell 6" Black with Lable	6 Volt	Not Available

* STANDARD FIXTURES ARE FURNISHED WITH BRUSHED STAINLESS STEEL COVERS. OTHER MATERIALS ARE AVAILABLE

- Exceeds Elevator Safety Code A17.1
- Certified by the State of California
- Self-contained - only 1 unit to install
- Engineered to perform in Maximum Temperature Range
- Provides 1.2 Candlepower but like most Nicads, it must be located close to car station to fully meet code
- Battery fully recharged within 8 hours after emergency use
- Alarm Bell available for remote installations
- Unit shipped to connect to 120V AC supply

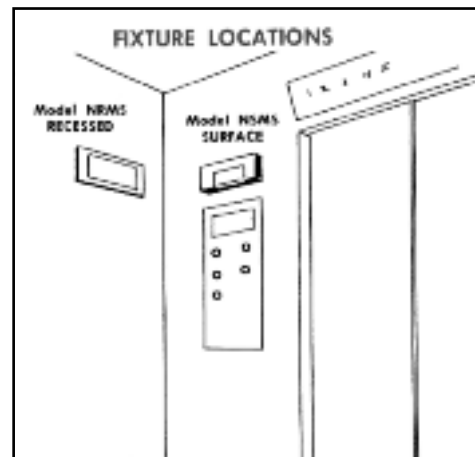

ORDER INFORMATION:

Please advise the following - Model number, material: stainless steel or muntz bronze.



Emergency Lighting

ELEVATOR PRODUCTS CORPORATION

TCEL



TCEL



TCEL/Charger Unit

PART #	DESCRIPTION
10M43G60	TCEL Top of Car Emer. Lite-No Bell
10M43G61	TCEL Top of Car Emer. Lite W/ 12V Bell
10M43G62	TCEL Top of Car Emer. Light-W/6V Bell
10M43G63	TCEL Top of Car Emer. Lite-No Battery

– Inverter and Charger boards are different (can not be interchanged with an old system, so new inverter board does not replace old inverter board and same for the charger board)

– Battery configuration is for 24V

New Features

- Fully CSA certified
- Can run fans
- Incandescent, fluorescent, compact fluorescent, most LED lighting
- Custom programming available for things like converting this to an Emergency only lighting system

TCEL Field Wiring

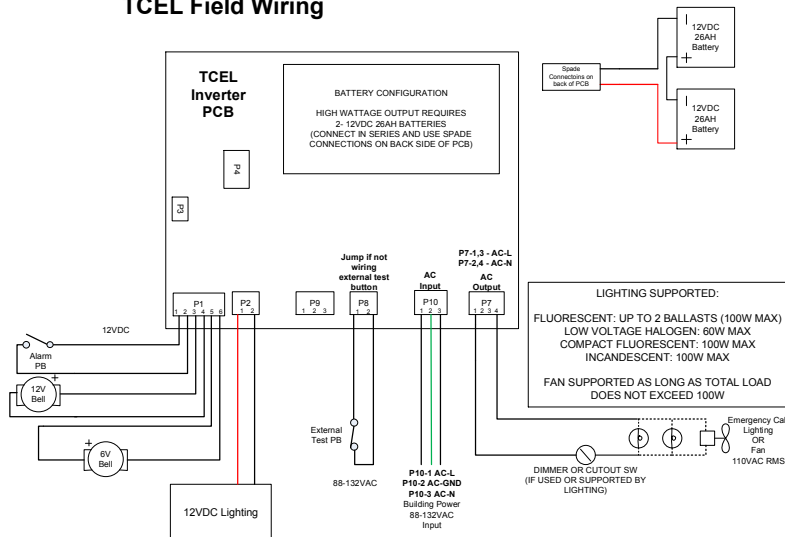

10M84P02



ELEVATOR PRODUCTS
CORPORATION

Emergency Lighting (Cont'd)

Flexilite

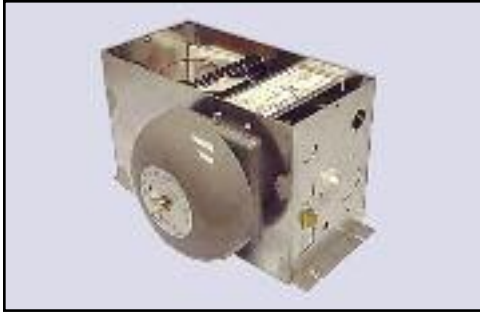

Charger Unit
Part #: 10M37G01
Model # - EFP-1-120C



Battery Pack
Part #: 10M43G01
Model # - EFP-1-120P

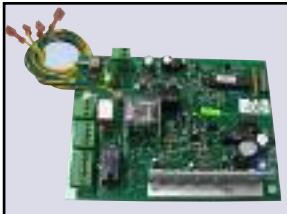

Circuit Board
Part #: 22C16P01
Model # - EFP-1-120B



Battery: 12-VDC
Part #: 10Z01P01
Model # - NP24-12B
(2-Batteries required)



Bell
Part # for 24V: 66B20G03

FLEXILITE EFP FLEXIBLE EMERGENCY LIGHTING

The EFP is a unique system which, when required, converts normal cab lighting of either incandescent or fluorescent lamps to emergency lighting.

The Flexilite EFP-1 will, under emergency conditions, light either two incandescent lamps, or two fluorescent lamps - up to 100 watts at 115 VAC.

The Flexilite system meets or exceeds the ANSI code requirements for elevator emergency lighting.

The Flexilite is CSA approved.

The Flexilite EFP can also be used as emergency power for a ventilation fan, or even a combination light and fan. This capability is especially useful for outside glass elevators exposed to sunlight.

ORDER INFORMATION:

Please advise the following - Model number, lamp style, voltage, lamp wattage and type of ballast (if used).



ELEVATOR PRODUCTS
CORPORATION

Emergency Lighting (Cont'd)

Mini Fluorescent

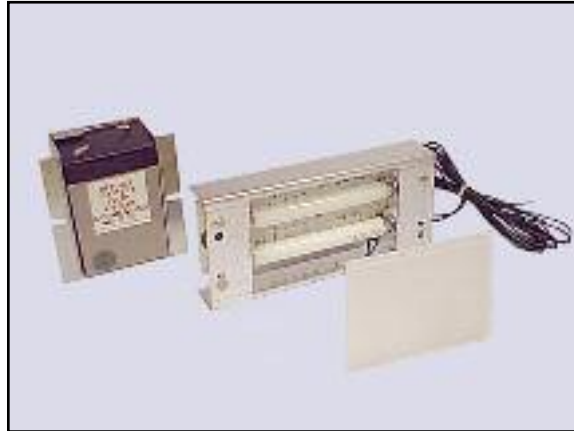

Mini - Fluorescent
Model #: ELU4
Part #: 10M78G01



Gel Cell Battery
Model #: EP-640
Part #: 10Z01P04



Diffuser Lens
Model #: ELU-LN



Battery Bracket
Model #: EP-640-BRK
Part #: 13B04P01
Board Bracket
Model #: ELU-4-BRK
Part #: 12B35P01

- Exceeds Elevator Safety Code A17.1
- Designed for Tamperproof, Remote Installation on Cab Top
- Engineered to perform in Maximum Temperature Range
- Alarm bell available for remote installation
- Optional pilot light available upon request

- Designed for integral use in car stations, or swing front return panels
- Uses two miniature fluorescent lamps, which provide more light than traditional incandescent systems



ELEVATOR PRODUCTS CORPORATION

Emergency Lighting (Cont'd)

Adams & EpcO Style



Adams Style
Part #: A911KIT



Lexan Lens
Part #: A911L-02

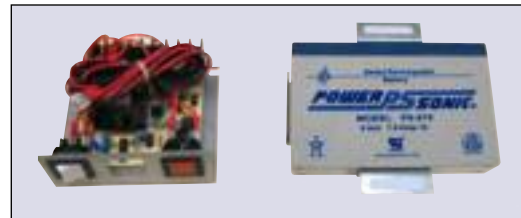

Charger and Battery
with Bracket
Part #: 223408

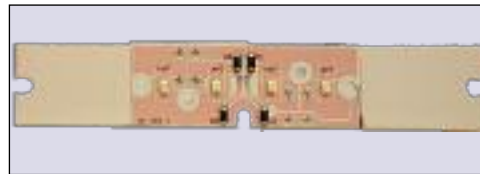

A911 LED
Part #: 695B319H01



EpcO Style
Part #: E911KIT



Lexan Lens
Part #: A911L-02



E911 LED
Part #: E911



Rechargeable Battery with
Bracket
Part #: 10Z01P08



ELEVATOR PRODUCTS CORPORATION

Adjustable Gibs

Nylon Door Gibs

GIBS

MODEL	PART #	COLOR CODE	DESCRIPTION
C	10B13P01	WHITE	15/32" W
T	10B13P02	BLUE	1/2" W
A	10B13P04	BROWN	5/8" W
H	10B13P03	GREEN	17/32" W
S	10B13P05	YELLOW	23/64" W
MG	10B13P07	BLACK	7/16" W
CG*	10B13P06	BLACK	15/32" W

* Model CG Door Gib is molded of Molybdenum Disulfide filled Nylon. When ordering give Gib model followed by chassis model; i.e. C-D3



CHASSIS

MODEL	PART #	DESCRIPTION
D-3	10B26P02	1" Wide - 8 Gib Adjustments
D-4	10B26P01	1-1/8" w - 10 Gib Adjustments
D-5	10B25P01	1-1/4" w - 12 Gib Adjustments

STANDARD PACKAGE - 100 sets per carton

Carton contains:

100 Nylon Gibs, 100 Chassis, 200 Sems (1-box)

200 Safety Studs (1-box), 300 Mounting Screws (1-box)

200 - Sems XS8P01

200 - Safety Studs XS8P02

300 - Mounting Screws XS8P03

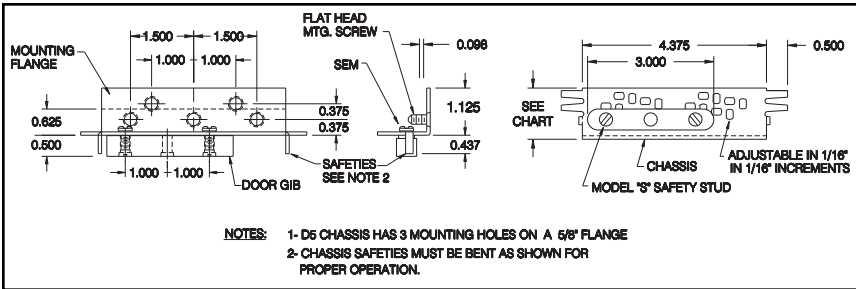
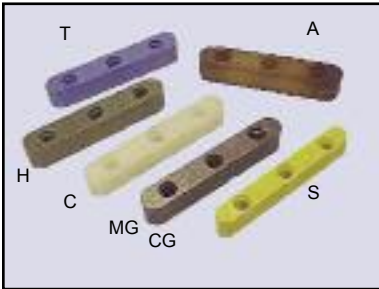

CHASSIS, GIBS, STUDS, SEMS AND MOUNTING SCREWS ARE AVAILABLE SEPARATELY AS REPLACEMENTS PARTS.

NOTE: Epco's powerful locking mechanism you won't find anywhere else.

SPECIAL NYLON FORMULATION DOOR SADDLE INSERTS

PRESSURE FITS - 1/2" or 9/16" tracks. Available in 6', 7' or 9' lengths.
 RELINES WORN TRACKS - eliminates expensive door saddle replacements.
 PROTECTS new tracks during construction. When installed upside-down reduces costly clean-up labor and time.
 EASILY REMOVED for cleaning.
 REDUCES FRICTION for easier, smoother, quieter door operation.
 Adds longer life to Door Gibs.

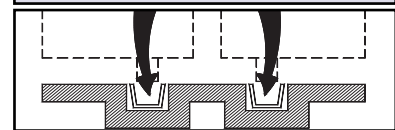

MODEL NO. 500
 SIZE 6', 7', or 9'.FT.
 FITS 1/2" to 9/16" Track Size.

NOTE
 Uses Model S Door Gib



ELEVATOR PRODUCTS CORPORATION

Adjustable Gibs (Cont'd)

Roller Bearing Gibs

EPCO'S FULLY ADJUSTABLE ROLLER BEARING DOOR GIB....

- * ACTUAL STEEL ROLLER BEARING
- * PROVIDES SAFE AND SURE OPERATION
- * EXTENDS DOOR OPERATION LIFE
- * ELIMINATES DOOR SILL WEAR
- * ASSURES PROPER ALIGNMENT
- * ELIMINATES DOOR SIDE PLAY



MODEL BR GIB

ROLLER BEARING DOOR GIB

- * Nylon outer face provides quiet, smooth operation. Reduces door operation torque requirements by 20%, thereby extending door operation life.
- * 75% Friction reduction
- * Special bearing configuration is engineered to compensate for groove variation, reduce friction and eliminate door sill wear.

CHASSIS

- * Broad range of designs engineered for variable door thickness and relationship to sill center line.
- * Choice of 4 chassis sizes
- * Cadmium plated steel construction
- * Permanent/ adjustable chassis safeties - 3 position.

- * Two door mounting locations - for different door styles.
- * Designed with integral safety stud - square shank mates with rectangular chassis hole in such a manner that no amount of vibration can loosen it.
- * Roller Bearing Gibs are mounted to chassis with 0.062" offset to provide rolling contact on both sides of the sill groove.

CHASSIS

MODEL	PART #	DESCRIPTION
D-3	10B26P02	1" Wide - 8 Gib Adjustments
D-4	10B26P01	1-1/8" w - 10 Gib Adjustments
D-5	10B25P01	1-1/4" w - 12 Gib Adjustments

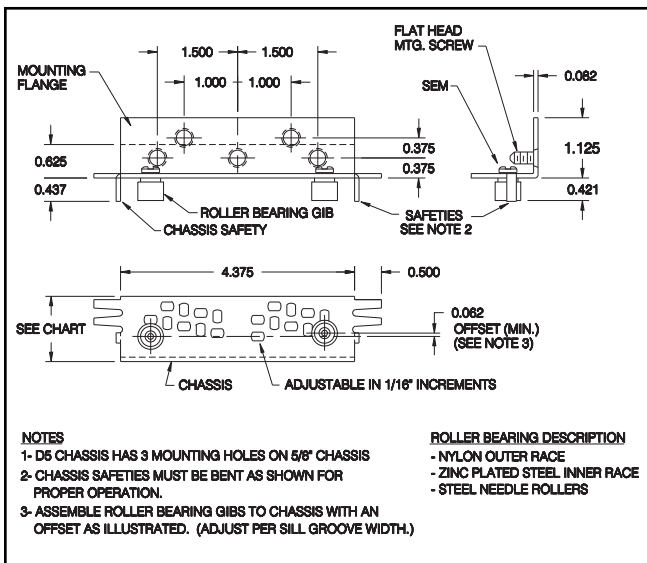

Available in individual sets or packaged 100 sets per carton.
 EACH SET CONTAINS:
 1 Chassis, 2 Roller Bearing Gibs, 2 Sems, 3 Mounting Screws

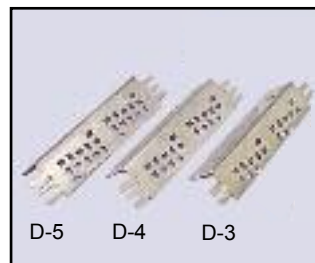

Hardware

PART #
10B14P01

ORDER INFORMATION:

Please advise the following - Give roller bearing GIB model number followed by chassis model (ie: BR-D3)



ELEVATOR PRODUCTS CORPORATION

Gibs

Rail Gibs



ZYTEL NYLON



BLACK NYLATRON

The same engineered design and quality construction as the Nylatron-GS Gibs...differs only in material. The finest pure NYLON Rail Gib available...guaranteed to provide a maximum of trouble free, efficient service in all applications.

- * EPCO Slipper Guide Rail Gibs are molded of Nylon, which contains a small percentage of Molybdenum Disulfide.
- * Nylatron-GS permits operation in higher temperatures, velocity and pressure ranges than pure nylon.
- * Nylatron Gibs are designed and engineered with the exclusive Truss-ribbed construction and equal wall thickness to better sustain continuous operational requirements of load, pressure and velocity. Every Gib is subjected to a "go-no-go" inspection prior being shipped.

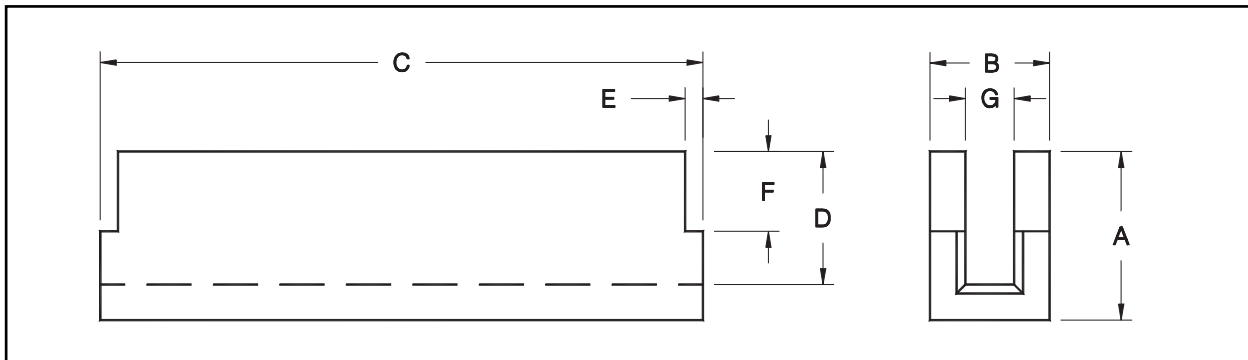

MATERIAL	TYPE	MODEL	PART #	A	B	C	D	E	F	G
MOLYBDENUM DISULFIDE Filled	8 # RAIL	RG	O902	1-1/2	1.677	8-1/2	1	1/4	1/4	.640
	15 # RAIL	RHG	O906	2-3/8	1.677	8-1/2	1-7/8	1/4	1/4	.640
NYLON (Black)	COUNTERWEIGHT	RWG	O904	1-3/8	1.400	5-1/2	7/8	1/4	1/4	.640
100% VIRGIN NYLON DUPONT	8 # Rail	R	O901	1-1/2	1.677	8-1/2	1	1/4	1/4	.640
	15 # Rail	RH	10C71P01	2-3/8	1.677	8-1/4	1-7/8	1/4	1/4	.640
ZYTEL (White)	COUNTERWEIGHT	RW	O903	1-3/8	1.400	5-1/2	7/8	1/4	1/4	.640

ORDER INFORMATION:

Please advise the following - Model number



ELEVATOR PRODUCTS
CORPORATION

Fire Door Retainers



4" Z BRACKET

PART #	OFFSET FOR 4"
15C65P01	OFFSET 0.375"
15C65P02	OFFSET 0.500"
15C65P03	OFFSET 0.563"
15C65P04	OFFSET 0.625"
15C65P05	OFFSET 0.750"
15C65P06	OFFSET 1.125"



8" Z BRACKET

PART #	OFFSET FOR 8"
15C48P01	OFFSET 0.375"
15C48P02	OFFSET 0.500"
15C48P03	OFFSET 0.563"
15C48P04	OFFSET 0.625"
15C48P05	OFFSET 0.750"
15C48P06	OFFSET 1.125"



ELEVATOR PRODUCTS
CORPORATION

Fans & Grilles

Designed to fit any equipment....

4 models in standard and shallow type fans available with blower or exhaust blades.

Self-lubricating motor with welded steel housing

Moves 375 cubic feet of air per minute.

Motor and housing are rubber mounted for sound-vibration isolation.

Motor wired for 115 V two speed.

Uses EPCO standard Grilles. (order separately)

FANS



GRILLES



Engineered for maximum air distribution.

Wide choices of finishes:

Simulated Stainless Steel

Simulated Muntz Bronze

Simulated St. Steel w/ white finish

Mounted independent of fan.

Available in two sizes:

12" and 16" diameter.



LIGHTED GRILLES

Combination glare free light and air distribution grille.

Choice of lighting designs:

INCANDESCENT -- four 40 Watts lamps

FLUORESCENT -- one 40 Watts Circleline lamp.

Incandescent design fulfills local codes requiring more than one lamp.

Both designs utilize durable plexiglass light diffuser.

Mounted independent of fan.



ORDER INFORMATION:

Please advise the following - Model number and cross - beam clearance.



Fans & Grills (Cont'd)

ELEVATOR PRODUCTS CORPORATION

MODEL	PART #	TYPE	SPEED
E 1420	22C02G03	Exhaust-Standard	Two
E 1424	22C01G03	Exhaust-Shallow	Two

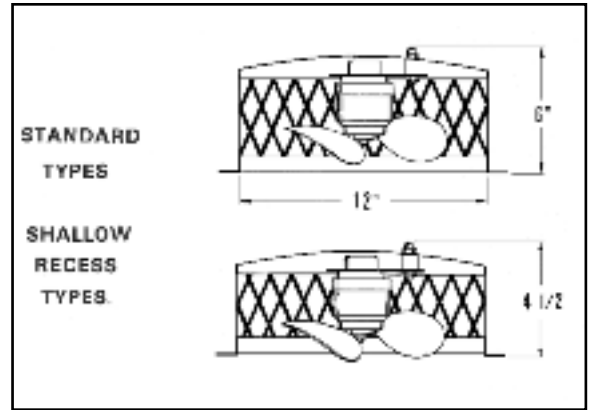

GRILLES

MODEL	PART #	FINISH	CUTOUT	OUTSIDE Dia..
125-S	"SPECIAL"	Simulated St. Steel	8.5"	12"
145-S	10D12P01	Simulated St. Steel	14-3/8"	12"

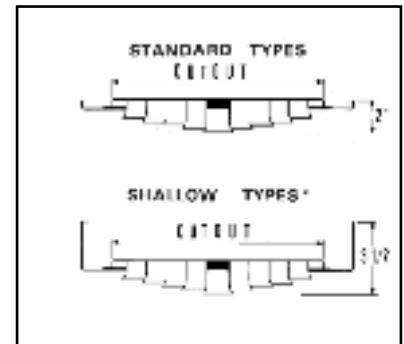

* SHALLOW TYPE GRILLES must be used with SHALLOW TYPE FANS

LIGHTED GRILLES

INCANDESCENT MODEL NUMBER	INCANDESCENT PART NUMBERS	FLUORESCENT MODEL NUMBER	FLUORESCENT MODEL NUMBER	GRILLE FINISH
145-S-I	22C36G01	145-S-FL	22C36P01	Simulated St. Steel

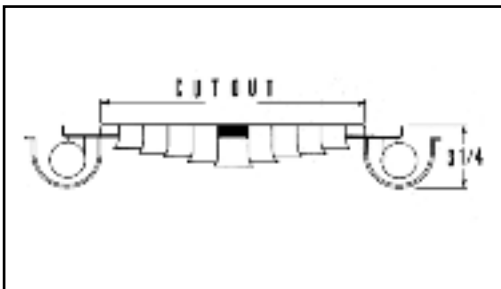

NOTE: Milkwhite diffuser available for replacement.
Part #: 22B01P01

Lighted Grilles Ballast:
Model: FNBAL
Utility box size: 2-3/4 x 9-1/8 x 3-1/2 deep



ELEVATOR PRODUCTS
CORPORATION

Car Top Inspection Station



- * Engineered for maximum safety. Cannot be accidentally activated.
- * UP and DOWN buttons operate only when SAFETY button is simultaneously pressed.
- * Model TCIG
Part # 10M65G02 24V
Part # 10M65G01 120V



Lamp Guard
Model: LG-1
Part #: 10M65P04

Pit Switches



Pit Stop Switch
Model: PS-2
Part #: 7284C97G01
2-5/8"W x 4-7/16"H x 1-1/2" Deep

- * Convenient size is designed for hand-held as well as stationary use.
- * Designed for maximum safety and durability.
- * Inspection switch is clearly marked and fully protected against accidental operation.

ORDER INFORMATION:
Please advise the following - Model Number.



ELEVATOR PRODUCTS CORPORATION

Hands Free Phones

RATH-MICROTECH



Speaker Phone System
Model: 2100957
Part #: 22X01P06

EMS



SpeakerPhone System
Model: PNB
Part #: 22X01P41
OEM Style ADA Phone

K-TECH



SpeakerPhone System
Model: ET901A-OEMU-D
Part #: 22X01P05

- Ready for mounting behind a speaker pattern.
in the Car, Hall or Lobby Stations.
 - Built in Dialer.
 - Pushbutton and light or jewel supplied separately.
- * Please contact our sales department for pricing and delivery.**

Adams Style



ADAMS PART #	DESCRIPTION	FACEPLATE		ELECTRICAL BOX			MOUNTING LOCATION
A931P3T	#4 St. Steel faceplate, gray galvanized box	12 1/2" H	9 3/4" W	11" H	8 3/4" W	3 1/2" D	Anywhere in cab
A931P4T	Mz. Bronze faceplate, gray galvanized box	12 1/2" H	9 3/4" W	11" H	8 3/4" W	3 1/2" D	Anywhere in cab
A931P5T	#4 St. Steel faceplate, vandal-resistant	12 1/2" H	9 3/4" W	11" H	8 3/4" W	3 1/2" D	Anywhere in cab

ORDER INFORMATION:
Please advise the following - Model number.



Certificate Frames

ELEVATOR PRODUCTS CORPORATION

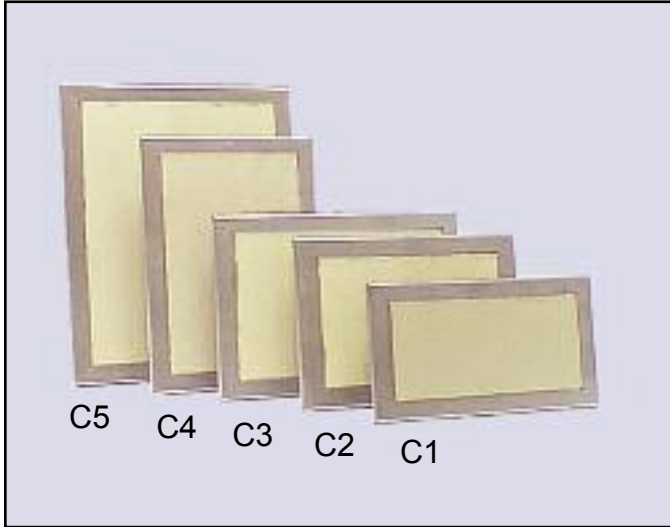

Five standard inspection card window sizes will meet virtually any local requirement. Special sizes can be manufactured to your exact specifications and requirements.

- * Available in Stainless Steel or Muntz Bronze.
- * Available in #4 and #8 finishes.
- * Contact our Sales department for special finishes.
- * Engraving available on special order.

All models constructed of 0.060" gage pan designs

PARTS LISTING						
CODE	MODEL #	PART #	DESCRIPTION	LOCALE	WINDOW SIZE	OVERALL SIZE
C1	CFCAL-S4	45B01G01	Stainless Steel #4	California, Washington, D.C.	7-3/4" W x 3-3/4" H	9" W x 5" H
C1	CFCAL-S8	45B01G02	Stainless Steel #8			
C1	CFCAL-M4	45B01G03	Muntz Bronze #4			
C1	CFCAL-M8	45B01G04	Muntz Bronze #8			
C2	CFGSA-S4	45B04G01	Stainless Steel #4	G.S.A. Standard Baltimore, MD	7-1/2"W x 5" H	9" W x 6-1/2" H
C2	CFGSA-S8	45B04G02	Stainless Steel #8			
C2	CFGSA-M4	45B04G03	Muntz Bronze #4			
C2	CFGSA-M8	45B04G04	Muntz Bronze #8			
C3	CFPA-S4	45B05G01	Stainless Steel #4	Pennsylvania	8-3/4" W x 5-3/4" H	10" W x 7" H
C3	CFPA-S8	45B05G02	Stainless Steel #8			
C3	CFPA-M4	45B05G03	Muntz Bronze #4			
C3	CFPA-M8	45B05G04	Muntz Bronze #8			
C4	CFNY-S4	45B03G01	Stainless Steel #4	New York	5-3/4" W x 8-3/4" H	7" W x 10" H
C4	CFNY-S8	45B03G02	Stainless Steel #8			
C4	CFNY-M4	45B03G03	Muntz Bronze #4			
C4	CFNY-M8	45B03G04	Muntz Bronze #8			
C5	CFL-S4	45B02G01	Stainless Steel #4	Letter Size	8-1/4" W x 10-3/4" H	9-3/4" W x 12-1/4" H
C5	CFL-S8	45B02G02	Stainless Steel #8			
C5	CFL-M4	45B02G03	Muntz Bronze #4			
C5	CFL-M8	45B02G04	Muntz Bronze #8			

CERTIFICATE FRAMES ARE SHIPPED WITH ALL MOUNTING HARDWARE

ORDER INFORMATION:

Please advise the following - Model number, mounting orientation, materials, and finishes.



ELEVATOR PRODUCTS
CORPORATION

Telephone Cabinets

- * Available in stainless steel or muntz bronze
- * Available finishes: #4 satin or #8 mirror
- * Two standard styles: TFL - solid 0.125" th. cover
TR - pan 0.080" th. cover
- * Special finishes available - call for information
- * Telephone symbol engraved on handle or cover, or "PHONE" engraved on handle
- * Pan styles available with 6 standard inspection card windows - meets virtually all local codes
- * Special engraving available - call for information



SOLID COVER DESIGN - "TFL"

ORDER INFORMATION:

Please advise the following - Model number, material and finishes.

Plain Cover Design			
MODEL #	PART #	DESCRIPTION	COVER SIZE
TFL-S	10M77G01	Solid 1/8" Stainless Steel #4 Cover	9.750"W x 12.750"H
TFL-M	10M77G03	Solid 1/8" Muntz Bronze #4 Cover	9.750"W x 12.750"H
TFL-S8	10M77G02	Solid 1/8" Stainless Steel #8 Cover	9.750"W x 12.750"H
TFL-M8	10M77G04	Solid 1/8" Muntz Bronze #8 Cover	9.750"W x 12.750"H
TR-[x]	"SPECIAL"	0.080" Thick Pan Cover	9.750"W x 12.750"H

[x] is dependent upon finish. Please specify when ordering.

SCISSOR HINGES:

Part # for LH: 12C95G03

Part # for RH: 12C95G04

* Please advise if you require replacement for 0.125" th. covers, or 0.080" pan design covers.

* Please advise hinge location: either Right Hand or Left Hand



HANDLES:

Part #: A464C

* Meets ADA Code



ELEVATOR PRODUCTS CORPORATION

Escalator Control Fixtures



ESN-1SF SHOWN

ESCALATOR STOP STATION

- Readily accessible to concerned riders.
- Easy to locate and use in case of an emergency.
- Available in Stainless Steel or Muntz Bronze (special order) finish with liftable lexan cover.
- Trim Frame supplied with Newel Mounted Units.
- All stations come with audible signal device.
- All stations meet New York City code.



Escalator Stop Replacement Button
Part #: 35X03P10

MODEL #	PART #	FINISH	DESCRIPTION (3.250" WIDE)
ESN-1S	46B12G01	Stainless Steel	Escalator Stop Station Newel Mtd.
ESN-1M	46B12G02	Muntz Bronze	Escalator Stop Station Newel Mtd.
ESN-1SF	46B12G03	Stainless Steel	Escalator Stop Station Newel Mtd. with Frame
ESN-1MF	46B12G04	Muntz Bronze	Escalator Stop Station Newel Mtd. with Frame
ESP-1S	46B12G05	Stainless Steel	*Escalator Stop Station Pedestal Mtd.
ESP-1M	46B12G06	Muntz Bronze	*Escalator Stop Station Pedestal Mtd.

* Pedestal sold separately, Please refer to Pedestal page.
Note: Also available in 2.500" Wide by Special Order.



ELEVATOR PRODUCTS CORPORATION

Escalator Control Fixtures (Cont'd)



ESN-2SF SHOWN

ESCALATOR START STATION

- Restarting your escalator couldn't be any easier using the ESN-2SF.
- The same key is used to unlock the clear lexan door and the directional keyswitch creating hassle free access to the button plate.
- Heavy duty and long lasting design.
- Available in Stainless Steel or Muntz Bronze (special order) finish with liftable lexan cover.
- All stations come with audible signal device.
- All stations meet New York City code.



Escalator Start Replacement Button
Part #: 35X03P11

MODEL #	PART #	FINISH	DESCRIPTION (3.250" WIDE)
ESN-2S	46B16P01	Stainless Steel	Escalator Stop Station Newel Mtd.

Note: Also available in 2.500" Wide by Special Order.



ELEVATOR PRODUCTS
CORPORATION

Escalator Control Fixtures (Cont'd)



ESCALATOR COMBINATION START / STOP STATION

- This heavy duty long lasting product combines the Stop Station and the Run Station all in one.
- The unit can be easily mounted in the newel of the deck with a trim frame.
- Available in Stainless Steel or Muntz Bronze (special order) finish with liftable lexan cover.
- All stations come with audible signal device.
- All stations meet New York City code.

MODEL #	PART #	FINISH	DESCRIPTION (3.250" WIDE)
ESN-3S	46B01G01	Stainless Steel	Escalator Stop Station Newel Mtd.
ESN-3M	46B01G02	Muntz Bronze	Escalator Stop Station Newel Mtd.
ESN-3SF	46B01G03	Stainless Steel	Escalator Stop Station Newel Mtd. with Frame
ESN-3MF	46B01G04	Muntz Bronze	Escalator Stop Station Newel Mtd. with Frame
ESP-3S	46B01G05	Stainless Steel	*Escalator Stop Station Pedestal Mtd.
ESP-3M	46B01G06	Muntz Bronze	*Escalator Stop Station Pedestal Mtd.

* Pedestal sold separately, Please refer to Pedestal page.
Note: Also available in 2.500" Wide by Special Order.

Escalator Control Fixtures (Cont'd)

Fujitec Style



ESCALATOR STOP STATION

Model #: FESN-1SF

- Available in Stainless Steel or Muntz Bronze (special order) finish with liftable lexan cover.
- All stations come with audible signal device.
- All stations meet New York City code.

Schindler Style



Escalator Direction Key Switch Assy. Complete. (OEM-NYC)

Part #: 12C41G01
Schindler Part #: CLQ0439
16 Ga. St. Steel #4 brushed finish
Box: 8.0"W x 3.125"H x 3.375" Deep tapered to 2.563"H



ESCALATOR DIRECTION
KEY SWITCH

Part #: 20K05P01
Model: ESC-KS-22



ESCALATOR FIXTURE DOOR

Part #: 12C98G01
Supplied with complete fixture,
shipped loose.
Door Size: 6.50"W x 3.50" H x 0.250"
Thick clear plexiglass.



REPLACEMENT LOCK W/ HATCH

Part #: 20K06P01
Key #: T112
Different key #'s available.



ELEVATOR PRODUCTS
CORPORATION

Escalator Control Fixtures (Cont'd)



ESCALATOR START STATION

- For applications with glass balustrades and or for a special, unique touch, consider mounting any of Epcos escalator safety stations on a custom manufactured pedestal.
- Built using weld construction from the inside to provide an attractive and durable look and feel.
- All that Epcos needs is a few dimensions from the existing escalator to provide a unit that will mount adjacent to the handrail in a code compliant position.
- Available in Stainless Steel or Muntz Bronze (special order) finish with liftable lexan cover.
- All stations come with audible signal device.
- All stations meet New York City code.



ELEVATOR PRODUCTS
CORPORATION

LED Segmented Position Indicator Replacement Boards



Remote Display Indicator
Part #: 10L21P03
Model: MV105-X
1/2" Characters with direction arrows.
For use in Hall Stations.
Available in Red (standard) or Green

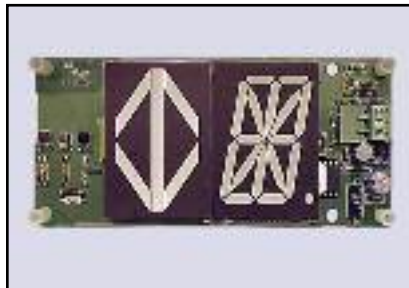

Remote Display Indicator
Part #: 10L15P06
Model: MH122-XX
2.2" Characters with direction arrows.
For use in Car Stations and stand-
alone Position Indicators.
Available in Red only.



Remote Display Indicator
Part #: 10L20P03
Model: MSV21-X
1" Characters with direction arrows.
For use in Hall Stations and
Surface Mounted Hall Stations.
Available in Red (standard), Green
or Amber

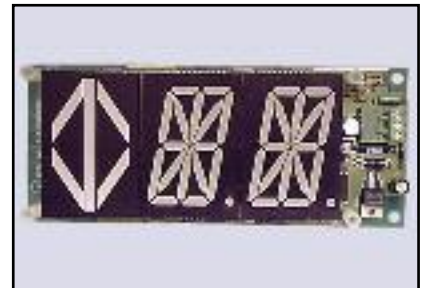

Remote Display Indicator
Part #: 10L15P01
Model: MH222-XX
2.2" Characters with direction arrows.
For use in Car Stations and stand-
alone Position Indicators.
Available in Red only.

- NOTES: 1- Above units require a **CENTRAL CONTROL BOARD**.
2- All units require 3-wire hook up.
3- DOT MATRIX units also available - Please call for more information.

ORDER INFORMATION:

Please advise the following - Model number, markings, controller type, voltage, and character color.



ELEVATOR PRODUCTS
CORPORATION

Audible Devices



TG Lantern Chime

PART #	DESCRIPTION
70B07P09	24-125VAC/DC Bi-Polar single and double stroke



TONER - Floor Passing
Part # for 24V: 70B08P10
Part # for 125V: 70B08P12
Model: ETE
available in a variety of voltages.



BUZZER - AC
Part # for 24V: 70B08P13
Fire, Alarm and
door nudging



PASSING CHIME BOARD
Part #: 70B09P02
Model: MPCB-1
to be used with Digital
Position Indicators



ELEVATOR PRODUCTS CORPORATION

Miscellaneous Electronic Components

LAMP SOCKETS



PUSH BUTTON
BULB CARRIER

Part #: 10M25G01
Model: BC-PB

ESSEX-STYLE LED LAMP

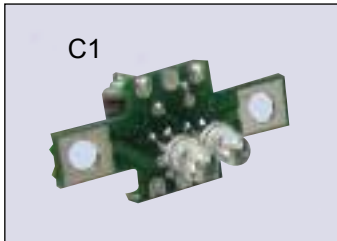

C1

Part #: 15B04P02

Types: LED.
Only available in 120
Amber.

NOTE: Fits EPCO and
Adams pushbutton
bases.

GFI OUTLETS



Ground fault interrupter
Outlet
Part #: 37X01P01
Model: GFI

PHONE JACKS



Insulated
Part #: 22X01P21
Model: PH JACK-1
Non-Insulated

ORDER INFORMATION:
Please advise the following - Model Number.



ELEVATOR PRODUCTS CORPORATION

Residential Fixtures



Rectangular

Rectangular panels in stainless or bronze with Homelift-style buttons.

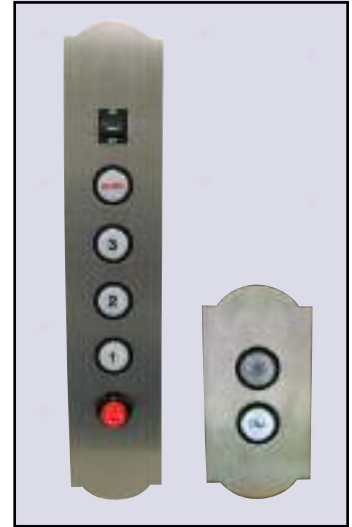

Victorian

Rounded-crown panels in stainless or bronze with round Survivor buttons.

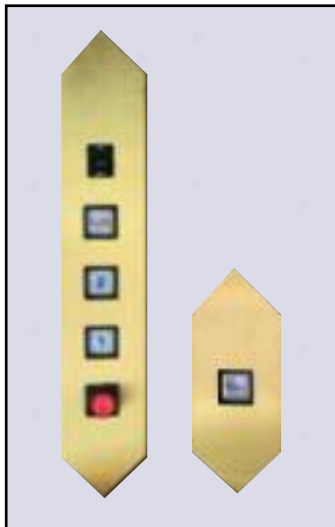

Apex

Diamond shaped panels in stainless or bronze with Homelift-style buttons.

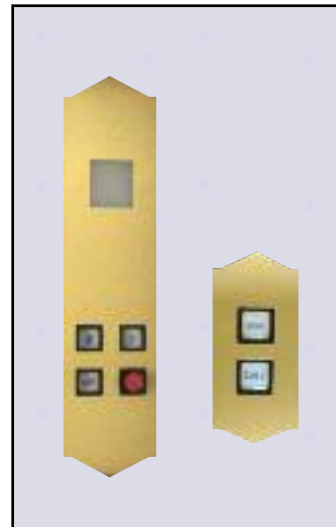

Gothic

Tapered-crown panels in stainless or bronze with Homelift-style buttons.



ELEVATOR PRODUCTS
CORPORATION

Residential Fixtures (Cont'd)

Now residential lift customers can enjoy the same styles of metal finishes and patterns available in upscale commercial elevators. Leading the market in residential fixtures, EPCO allows you to choose your specific style. From conventional rectangular to personalizing your system by specifying a unique style and finish.

Every Homelift fixture features the patented, CSA-approved Survivor pushbutton base...the most durable and reliable elevator pushbutton in the world.

- controls

full assortment of floor call buttons and switches, from 2-5 stops, depending on COP

- appearance

choose from a wide assortment of selective finished and metal patterns

- lighting

emergency light is standard in all car panels

- voltage

can be ordered for 24v or 120v systems

- box depth

electrical boxes are 2.75" deep

- illumination

standard LED illumination

- material

choose stainless steel or bronze #4 brushed or #8 mirror finish



ELEVATOR PRODUCTS CORPORATION

Hall Stations

Incline Surface Mounted

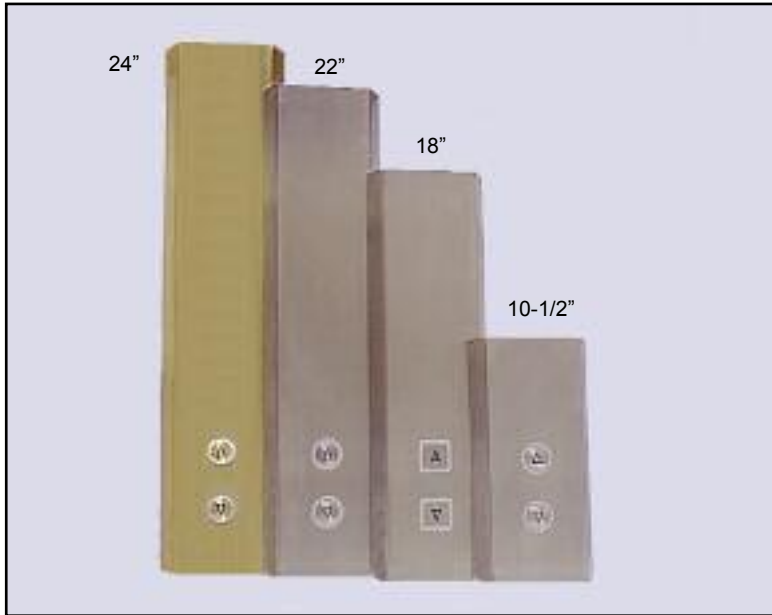

Epcos **Incline** Hall Stations Feature:

- * Surface mounted - no box required
- * Mounts directly to the wall
- * Durable cover construction
- * Elegant design
- * Mere 1.125" projection from wall to cover plate
- * Reliable and rugged stainless steel or muntz bronze push buttons - with LED lamps
- * Easy installation - ideal for both modernization and new construction.

Incline Hall Station:

Cover: 4.25"W (front) 5.50"W (back)

4 Standard Heights : 10.5", 18", 22" and 24"

Non-standard sizes and custom designs also available - call for information

Available in Stainless Steel or Muntz Bronze with either a #4 satin, or #8 mirror finish.



Wide Incline Hall Station:

Cover: 5.25"W (front) 6.50"W (back)

Special engraving or etching available.

Appendix "H" (shown)



Custom Incline Hall Station:

Available with special graphics

Available with relieved edges on all 4 sides (shown)

ORDER INFORMATION:

Please advise the following - Model number, material, finish, graphics if required, and voltages.



ELEVATOR PRODUCTS CORPORATION

Hall Stations (Cont'd)



Singapore - Round
SPR-W Series
Micro-Movement
Refer to Button Section

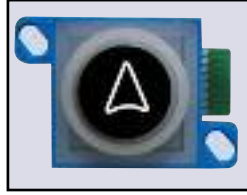

Singapore - Round
SPR-B Series
Micro-Movement
Refer to Button Section



Singapore - Round
SPR-S Series
Micro-Movement
Refer to Button Section



Singapore - Square
SPS-S Series
Micro-Movement
Refer to Button Section

Cover Size: 5.404"W x 10.500"			
Description	Button Style	St/St #4 Finish Model #	Mz/Bz #4 Finish Model #
Terminal	Singapore - Round Flush	IH-51 SR-S	IH-51 SR-M
Terminal	Singapore - Square Flush	IH-51 S-S	IH-51 S-M
Intermediate	Singapore - Round Flush	IH-52 SR-S	IH-52 SR-M
Intermediate	Singapore- Square Flush	IH-52 S-S	IH-52 S-M
Cover Size: 5.404"W x 18.000"			
Terminal	Singapore - Round Flush	IH-1801 SR-S	IH-1801 SR-M
Terminal	Singapore - Square Flush	IH-1801 S-S	IH-1801 S-M
Intermediate	Singapore - Round Flush	IH-1802 SR-S	IH-1802 SR-M
Intermediate	Singapore- Square Flush	IH-1802 S-S	IH-1802 S-M
Cover Size: 5.404"W x 22.000"			
Terminal	Singapore - Round Flush	IH-2201 SR-S	IH-2201 SR-M
Terminal	Singapore - Square Flush	IH-2201 S-S	IH-2201 S-M
Intermediate	Singapore - Round Flush	IH-2202 SR-S	IH-2202 SR-M
Intermediate	Singapore- Square Flush	IH-2202 S-S	IH-2202 S-M
Cover Size: 5.404"W x 24.00"H			
Terminal	Singapore - Round Flush	IH-2401 SR-S	IH-2401 SR-M
Terminal	Singapore - Square Flush	IH-2401 S-S	IH-2401 S-M
Intermediate	Singapore - Round Flush	IH-2402 SR-S	IH-2402 SR-M
Intermediate	Singapore- Square Flush	IH-2402 S-S	IH-2402 S-M



ELEVATOR PRODUCTS CORPORATION

Hall Stations (Cont'd)

Standard Flush Design

CIRCLELINE Design



MODEL H-31-S



MODEL H-31-M

TAMPER RESISTANT Design



MODEL H-31-S



MODEL H-31-M

- * Standard Covers of Solid 1/8" Stainless Steel or Muntz Bronze with #4 Finish.
- * Also Available with Covers of #8 mirror and lacquered Muntz Bronze, Oxidized Bronze and #8 mirror Stainless Steel. Contact our sales office for further information.
- * Fixtures with Key switches and other devices are available. Contact our sales office for further information.
- * Tamper Resistant mounting screws are provided for Tamper Design and Phillips Head Mounting screws for Circleline design.

- Notes:**
- 1) Refer to chart below for additional model numbers.
 - 2) Refer to Pushbutton & Indicators section for component information.
 - 3) These fixture sizes will accept all pushbutton models except the following:
WGH/ WGH-PC, WGV-PC, WGH-S / WGH-SPC, WN-PC, WNR-PC, MRB and RB Series.

HALL STATIONS				
MODEL #	NUMBER OF DEVICES	COVER W x H	BOX W x H x D	CUTOUT W x H
H-11D	1	2-1/2" x 5-1/4"	2" x 3-7/8" x 2.50"	2-1/8" x 4"
H-21D to H-22D	1 to 2	2-1/2" x 8"	2" x 6-5/8" x 2.50"	2-1/8" x 6-3/4"
H-31 to H-34	1 to 4	3-1/4" x 10-1/2"	2-3/4" x 9-1/8" x 2.50"	2-7/8" x 9-1/4"
USED FOR DUPLEX ELEVATOR INSTALLATIONS WITH ALL DEVICES.				
H-41 to H-46	1 to 4	4-1/4" x 10-1/2"	3-1/2" x 9-1/8" x 2.50"	3-5/8" x 9-1/4"

Note: In model number "S" is for Stainless Steel, "M" is for Muntz Bronze
 With Phase I or Access Switch Box is 3.50" Deep

ORDER INFORMATION:

Please advise the following - Model number, type of fixture and material.



ELEVATOR PRODUCTS
CORPORATION

Access Stations

ROUND COVER ACCESS STATION - Existing Entrance Jamb



- * Mounts directly to the wall with two screws.
- * Easy Installation - ideal for both new construction and Modernization
- * Also available with Rocker Switch.

Model # H-S-1A-S .125" thick St/Steel #4 circular brushed finish
Model # H-S-1A-M .125" Thick Muntz Bronze #4 circular brushed finish

Cover Size: 2.875" Dia. O.D.
Box Size: 2.00" Dia. Aluminum tubing x 3.312" deep
Cutout: 2.125" Dia. hole

STANDARD COVER ACCESS STATION



Model: H-31A-S .125" Thick St/Steel #4 finish
Model: H-31A-M .125" Thick Muntz Bronze #4 finish

Cover Size 3-1/4"W x 10-1/2"H
Box Size: 2-3/4"W x 9-1/8"H x 3.50" D.
Cutout: 2-7/8"W x 9-1/4"H

COVERLESS ACCESS STATION - New Entrance Jamb



Model: H-S-31A No Cover Plate
Box Size: 2-3/4"W x 9-1/8"H x 3.50" D.
Cutout: For Switch in jamb 1.375" Dia.

- Mounts directly behind door jambs or walls
- The box is mounted with two "L" shape brackets at top & bottom of the box.
- Back cover is removable for servicing and mounting.

Note: Key switches are available in "Ace" barrel type and "Illinois" Flat key style. See Key switch section



ELEVATOR PRODUCTS
CORPORATION

Lanterns

Incline Surface Mounted



Model: IL-1VCLC (Vertical)
Model: IL-1HCLC (Horizontal)
Standard Incline Hall Lantern:
5"W x 11"H x 1-1/4" Deep
5"W x 11"H x 1.875" Deep with
MicroComm Unit
Lens: 2-3/4"W x 4-1/4"H



Model: IL-1NVCLC (Vertical Only)
Narrow Incline Car Lantern:
3-7/8"W x 14-1/2"H x 1-1/4" Deep
Lens: 2-3/4"W x 4-1/4"H

- * **Surface** mounted - no box required. Mounts directly to the wall.
- * The digital lantern has a unique LED display which is easily visible even from acute angles.
- * The lantern comes with a built-in one and or two stroke module... no controller changes or extra gong modules are required.
- * The covers are available in Stainless Steel or Muntz Bronze with either a #4 or #8 mirror finish.

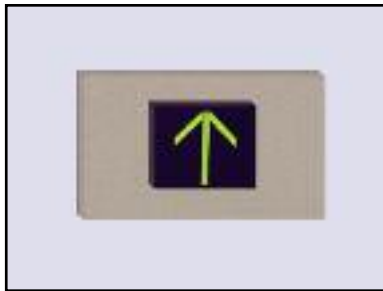

Model: IL-1HCLSB
Standard Incline Hall Lantern:
11"W x 5"H x 1-1/4" Deep
Lens: 4-1/8"W x 3-1/4"H



Model: IL-VCLSB
Incline Hall Lantern with side
view arrow:
5"W x 11"H x 1-1/4" Deep
Lens: 4-1/8"W x 3-1/4"H

- * **Surface** mounted - no box required. Mounts directly to the wall.
- * The digital lantern has a unique LED display which provides a side view arrow.
- * The covers are available in Stainless Steel or Muntz Bronze with either a #4 or #8 mirror finish.

ORDER INFORMATION:

Please advise the following - Model number, mounting orientation, material, finish and voltages.



ELEVATOR PRODUCTS CORPORATION

Lanterns (Cont'd)

Complete Fixtures			
Part#	Description	Part#	Description
IL-1VCL-S	New Style Segmented Arrow - Vertical Flush - St. Steel	IL-1HCLSB-S	New Style Seg. Side Bar Arrow- Horiz. Flush - St. Steel
IL-1VCL-M	New Style Segmented Arrow - Vertical Flush - Muntz Bz	IL-1HCLSB-M	New Style Seg. Side Bar Arrow- Horiz. Flush - Muntz Bz
IL-1HCL-S	New Style Segmented Arrow - Horiz. Flush - St. Steel	IL-1VCLSB-S	New Style Seg. Side Bar Arrow- Vert. Flush - St. Steel
IL-1HCL-M	New Style Segmented Arrow - Horiz. Flush - Muntz Bz	IL-1VCLSB-M	New Style Seg. Side Bar Arrow- Vert. Flush - Muntz Bz
IL-1NVCL-S	New Style Segm. Arrow Narrow -Vert. Flush - St.Steel		
IL-1NVCL-M	New Style Segm. Arrow Narrow -Vert. Flush - Muntz Bz		

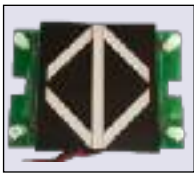

New style -
Model #: SA-130V
Part #: 10L16P [x]
Standard Incline
lantern board



New style -
Model #: ASB-30
Part #: 10L19P [x]
Incline lantern board
for side view fixture



New style Chime
Model #: TG-1
Part #: 70B07P09 [x]



Ruby Red Lens
Part#: IL-LENS-C
for standard incline
lantern



Standard lens
Part#: IL-LENS
for side view Incline
lantern

[x] is dependent upon a combination of voltages, sizes, finishes, and colors.
Please specify when ordering.

Parts Listing	
Part#	Description
SA-130	New Style Segmented Board - Flush Type. Please Specify Voltage
ASB-30	New Style Lantern Board - Side View. Please Specify Voltage
IL-LENS-C	New Style Ruby Red Lens - Flush
TG-1	New Style Chime - Please specify Voltage and Common Polarity

Incline Surface Mounted Position Indicators



11"W x 5"H x 1.250" Deep
Lens: 5.875"W x 3.125"H
Violet Lexan

- * **Surface** mounted - no box required. Mounts directly to the wall.
- * Segmented bar LED - 2"H characters with direction arrow.
- * Covers available in Stainless Steel or Muntz Bronze ,with #4 satin, or #8 mirror finish.
- * Indicators require a Central Control Unit per elevator to drive the LED.
- * Model# IPD-510-S St. Steel #4 Brushed Finished
- * Model# IPD-510-M Muntz Bz. #4 Brushed Finished.

ORDER INFORMATION:

Please advise the following - Model number, material, finish, markings, controller, and voltages.



ELEVATOR PRODUCTS CORPORATION

Lanterns (Cont'd)

Standard Flushline Design

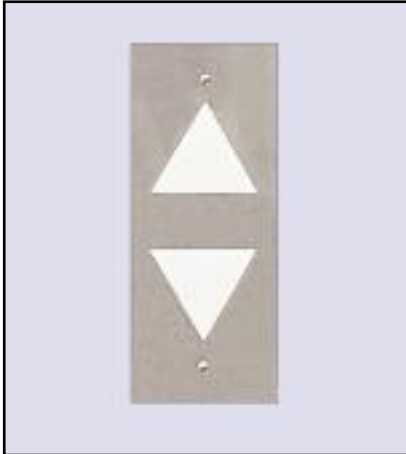

MODEL L-E42VCH



MODEL L-E42HCH

- * Covers are Solid 1/8" Stainless Steel with #4 Brushed Finish.
- * Also Available with Covers of Polished and Lacquered Muntz Bronze, Oxidized Bronze and Anodized Aluminum.
- * Broad Flexibility in Engineering Special Signal Designs. Contact sales office for further information.

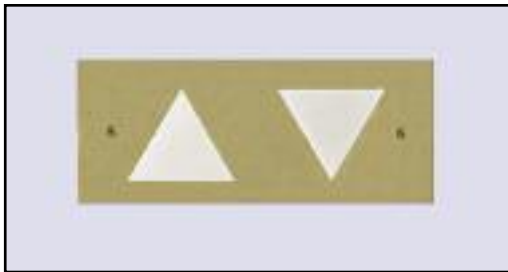

MODEL L-E42HCH

- * Wide Range of Standard Lens Designs - refer to back page
- * Model numbers shown are with chime.
- * High Brightness LED Lamps in white, red, or amber.
- * Variable Voltage and Electronic Chime with Volume Control

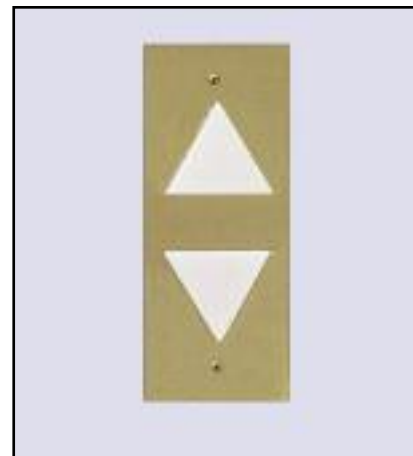

MODEL L-E42VCH

ORDER INFORMATION:

Please advise the following - Model number, mounting orientation, material, finish, chime and voltages.



Lanterns (Cont'd)

ELEVATOR PRODUCTS CORPORATION

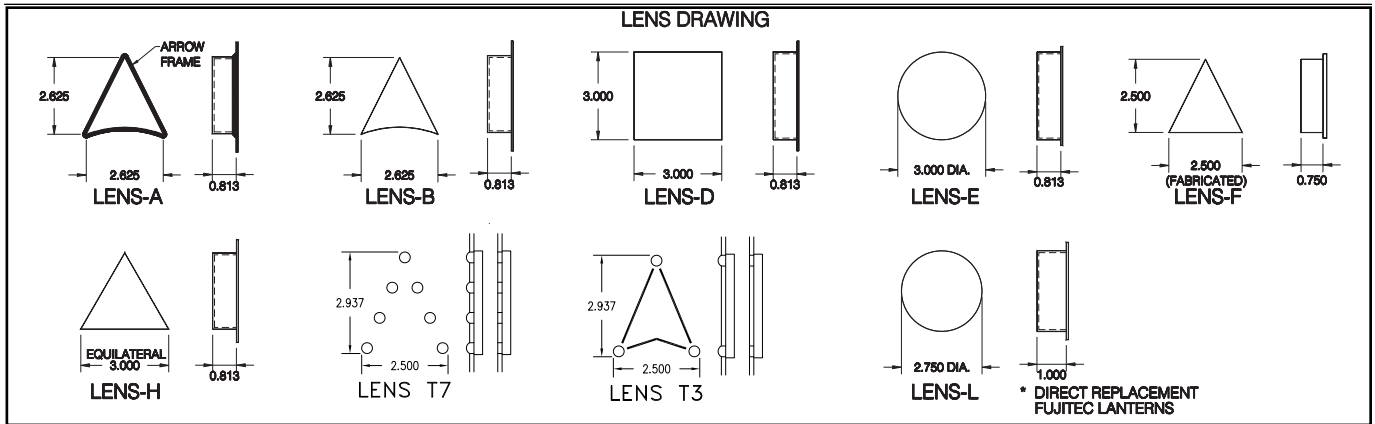

PARTS LISTING					
TYPE	MODEL #	LENS A	TYPE	MODEL #	LENS B
TERMINAL	L-E41HCA	MOLDED MILKWHITE LEXAN ARROW WITH BLACK BEZEL. PROJECTS 3/4" - FILTERED RED, GREEN OR WHITE.	TERMINAL	L-E41HCB	MOLDED MILKWHITE LEXAN PROJECTS 3/4" - FILTERED RED, GREEN OR WHITE.
INTERMEDIATE	L-E42HCA		INTERMEDIATE	L-E42HCB	
TERMINAL	L-E41VCA		TERMINAL	L-E41VCB	
INTERMEDIATE	L-E42VCA		INTERMEDIATE	L-E42VCB	
TYPE	MODEL #	LENS D	TYPE	MODEL #	LENS E
TERMINAL	L-E41HCD	MOLDED MILKWHITE LEXAN PROJECTS 3/4" - FILTERED RED, GREEN OR WHITE.	TERMINAL	L-E41HCE	MOLDED MILKWHITE LEXAN PROJECTS 3/4" - FILTERED RED, GREEN OR WHITE.
INTERMEDIATE	L-E42HCD		INTERMEDIATE	L-E42HCE	
TERMINAL	L-E41VCD		TERMINAL	L-E4EVCE	
INTERMEDIATE	L-E42VCD		INTERMEDIATE	L-E42VCE	
TYPE	MODEL #	LENS F	TYPE	MODEL #	LENS H
TERMINAL	L-E41HCF	MILKWHITE PLEXIGLASS PROJECTS 3/4" - FILTERED RED, GREEN OR WHITE.	TERMINAL	L-E41HCH	MOLDED MILKWHITE LEXAN PROJECTS 3/4" - FILTERED RED, GREEN OR WHITE.
INTERMEDIATE	L-E42HCF		INTERMEDIATE	L-E42HCH	
TERMINAL	L-E41VCF		TERMINAL	L-E41VCH	
INTERMEDIATE	L-E42VCF		INTERMEDIATE	L-E42VCH	
TYPE	MODEL #	LENS T7	TYPE	MODEL #	LENS T3
TERMINAL	L-E41HCT7	MOLDED MILKWHITE LEXAN JEWELS DOMED OR FLUSH - FILTERED RED, GREEN OR WHITE.	TERMINAL	L-E41HCT3	MOLDED MILKWHITE LEXAN JEWELS DOMED OR FLUSH, WITH 1/16" BLACK ENGRAVED LINES - FILTERED RED, GREEN OR WHITE.
INTERMEDIATE	L-E42HCT7		INTERMEDIATE	L-E42HCT3	
TERMINAL	L-E41VCT7		TERMINAL	L-E41VCT3	
INTERMEDIATE	L-E42VCT7		INTERMEDIATE	L-E42VCT3	

FIXTURES WILL BE SUPPLIED WITH TYPE "H" LENS UNLESS OTHERWISE SPECIFIED.



New style Chime
Model #: TG-1
Part #: 70B07P09
Multi Volt



LED Board
Part #: 7J24120LED [x]
Multi Voltage 24V-125V
Available colors: Amber, Red, White, Blue, and Green.

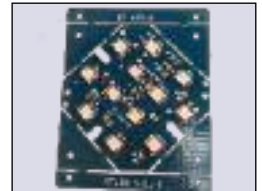

LED Board
Part #: M1CL204120 [x]
Multi Voltage 24V-125V
Available colors: Amber, Red, White, Blue, and Green.

[x] is dependent upon voltage and color choices, please specify when ordering.

	COVER	BOX	CUTOUT
HORIZONTAL FIXTURES	4-1/4" H x 10-1/2" L	3-5/8" H x 9-1/2" L x 2.5" Deep	3-3/4" H x 9-5/8" L
VERTICAL FIXTURES	10-1/2" H x 4-1/4" L	9-1/2" H x 3-5/8" L x 2.5" Deep	9-5/8" H x 3-3/4" L



ELEVATOR PRODUCTS CORPORATION

Lanterns (Cont'd)

Standard Incline Design

Surface Mounted Lanterns... No Cutout required



MODEL IL-2VCH



MODEL IL-2HCH

- * Covers are Stainless Steel with #4 Brushed Finish.
- * Also Available with Covers of Polished and Lacquered Muntz Bronze, Oxidized Bronze and Anodized Aluminum.
- * All Covers are 0.063" Gauge Die-Formed Design
- * Broad Flexibility in Engineering Special Signal Designs. Contact sales office for further information.



MODEL IL-2HCH



MODEL IL-2HCH

- * Surface Mounted Design Requires **No Cutout**. Fixture Projects Only 1-1/4" From Mounting Surface.
- * Wide Range of Standard Lens Designs - refer to back page.
- * Model numbers shown are with chime.
- * High Brightness LED Lamps in white, red, or amber.
- * Variable Voltage and Electronic Chime with Volume Control.

ORDER INFORMATION:

Please advise the following - Model number, mounting orientation, material, finish, and voltages.



ELEVATOR PRODUCTS CORPORATION

Lanterns (Cont'd)

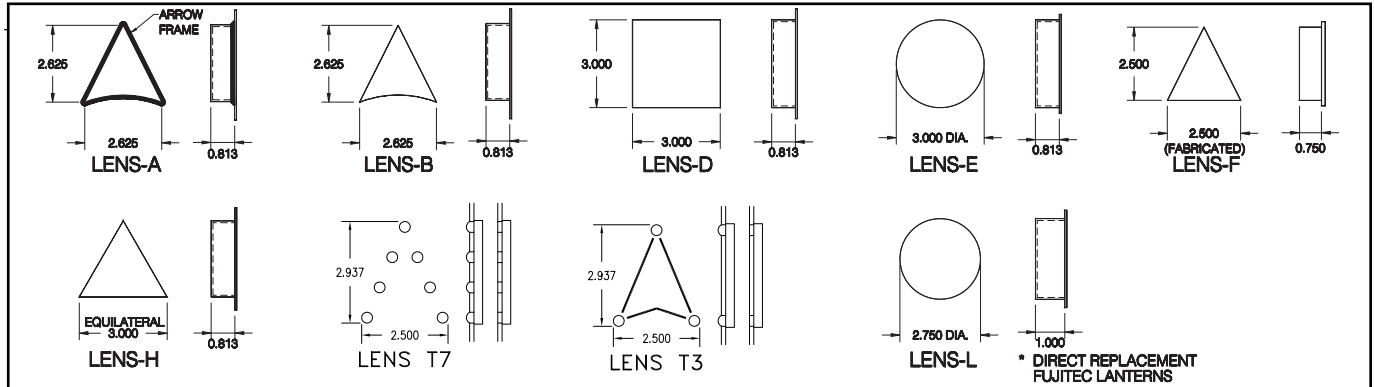

PARTS LISTING

TYPE	MODEL #	LENS A	TYPE	MODEL #	LENS B
TERMINAL	IL-1HCA	MOLDED MILKWHITE LEXAN ARROW WITH BLACK BEZEL. PROJECTS 3/4" - FILTERED RED, GREEN OR WHITE.	TERMINAL	IL-1HCB	MOLDED MILKWHITE LEXAN PROJECTS 3/4" - FILTERED RED, GREEN OR WHITE.
INTERMEDIATE	IL-2HCA		INTERMEDIATE	IL-2HCB	
TERMINAL	IL-1VCA		TERMINAL	IL-1VCB	
INTERMEDIATE	IL-2VCA		INTERMEDIATE	IL-2VCB	
TYPE	MODEL #	LENS D	TYPE	MODEL #	LENS E
TERMINAL	IL-1HCD	MOLDED MILKWHITE LEXAN PROJECTS 3/4" - FILTERED RED, GREEN OR WHITE.	TERMINAL	IL-1HCE	MOLDED MILKWHITE LEXAN PROJECTS 3/4" - FILTERED RED, GREEN OR WHITE.
INTERMEDIATE	IL-2HCD		INTERMEDIATE	IL-2HCE	
TERMINAL	IL-1VCD		TERMINAL	IL-1VCE	
INTERMEDIATE	IL-2VCD		INTERMEDIATE	IL-2VCE	
TYPE	MODEL #	LENS F	TYPE	MODEL #	LENS H
TERMINAL	IL-1HCF	MILKWHITE PLEXIGLASS PROJECTS 3/4" - FILTERED RED, GREEN OR WHITE.	TERMINAL	IL-1HCH	MOLDED MILKWHITE LEXAN PROJECTS 3/4" - FILTERED RED, GREEN OR WHITE.
INTERMEDIATE	IL-2HCF		INTERMEDIATE	IL-2HCH	
TERMINAL	IL-1VCF		TERMINAL	IL-1VCH	
INTERMEDIATE	IL-2VCF		INTERMEDIATE	IL-2VCH	
TYPE	MODEL #	LENS T7	TYPE	MODEL #	LENS T3
TERMINAL	IL-1HCT7	MOLDED MILKWHITE LEXAN JEWELS DOMED OR FLUSH - FILTERED RED, GREEN OR WHITE.	TERMINAL	IL-1HCT3	MOLDED MILKWHITE LEXAN JEWELS DOMED OR FLUSH, WITH 1/16" BLACK ENGRAVED LINES - FILTERED RED, GREEN OR WHITE.
INTERMEDIATE	IL-2HCT7		INTERMEDIATE	IL-2HCT3	
TERMINAL	IL-1VCT7		TERMINAL	IL-1VCT3	
INTERMEDIATE	IL-2VCT7		INTERMEDIATE	IL-2VCT3	

FIXTURES WILL BE SUPPLIED WITH TYPE "H" LENS UNLESS OTHERWISE SPECIFIED.

Note: In model number "H" is for Horizontal mount, "V" is for Vertically mount. (Please specify mounting requirements)



New style Chime
Model #: TG-1
Part #: 70B07P09
Multi Volt



LED Board
Part #: 7J24120LED [x]
Multi Voltage 24V-125V
Available colors: Amber, Red, White, Blue, and Green.

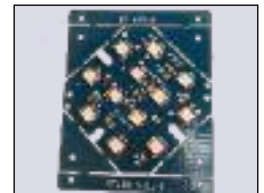

LED Board
Part #: M1CL204120 [x]
Multi Voltage 24V-125V
Available colors: Amber, Red, White, Blue, and Green.

		COVER
IL	HORIZONTAL FIXTURES	5" H x 11" L
	VERTICAL FIXTURES	11" H x 5" L



ELEVATOR PRODUCTS CORPORATION

Lanterns (Cont'd)

Standard Hall Pan Cover Design



MODEL RL-E42VCH



MODEL RL-E42HCH

- * Covers are Stainless Steel with #4 Brushed Finish.
- * Also Available with Covers of Polished and Lacquered Muntz Bronze, Oxidized Bronze and Anodized Aluminum.
- * All Covers are 0.080" Gauge Die-Formed Pan Design with 3/8" Flanges
- * Broad Flexibility in Engineering Special Signal Designs. Contact sales office for further information.

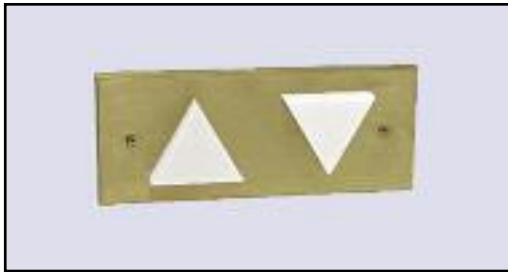

MODEL RL-E42HCH



MODEL RL-E42VCH

- * Wide Range of Standard Lens Designs - refer to back page.
- * Model numbers shown are with chime, gong available.
- * High Brightness Incandescent Lamps.
- * Variable Voltage and Electronic Chime with Volume Control.

ORDER INFORMATION:

Please advise the following - Model number, mounting orientation, material, finish, gong or chime and voltages.



Lanterns (Cont'd)

ELEVATOR PRODUCTS CORPORATION

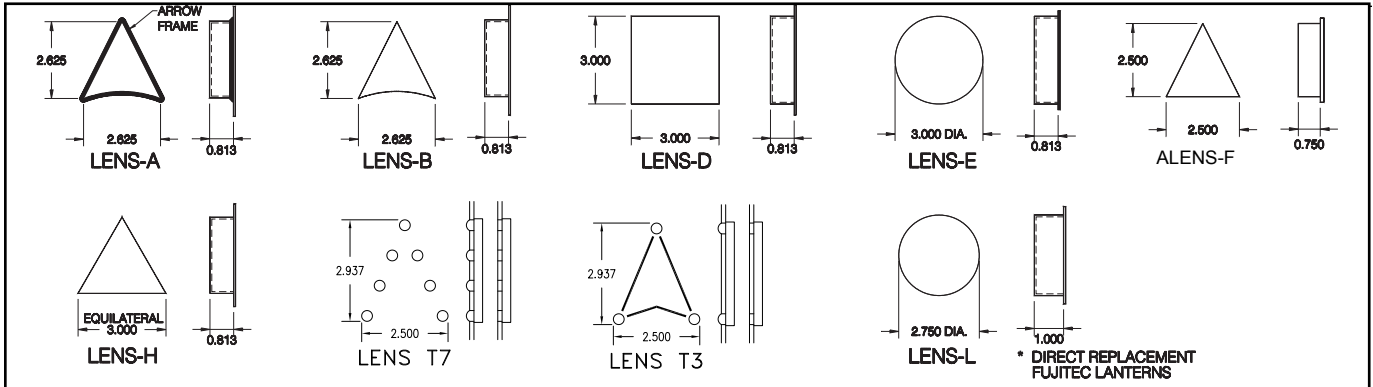

PARTS LISTING

TYPE	MODEL #	LENS A	TYPE	MODEL #	LENS B
TERMINAL	RL-E41HCA	MOLDED MILKWHITE LEXAN ARROW WITH BLACK BEZEL. PROJECTS 3/4" - FILTERED RED, GREEN OR WHITE.	TERMINAL	RL-E41HCB	MOLDED MILKWHITE LEXAN PROJECTS 3/4" - FILTERED RED, GREEN OR WHITE.
INTERMEDIATE	RL-E42HCA		INTERMEDIATE	RL-E42HCB	
TERMINAL	RL-E41VCA		TERMINAL	RL-E41VCB	
INTERMEDIATE	RL-E42VCA		INTERMEDIATE	RL-E42VCB	
TYPE	MODEL #	LENS D	TYPE	MODEL #	LENS E
TERMINAL	RL-E41HCD	MOLDED MILKWHITE LEXAN PROJECTS 3/4" - FILTERED RED, GREEN OR WHITE.	TERMINAL	RL-E41HCE	MOLDED MILKWHITE LEXAN PROJECTS 3/4" - FILTERED RED, GREEN OR WHITE.
INTERMEDIATE	RL-E42HCD		INTERMEDIATE	RL-E42HCE	
TERMINAL	RL-E41VCD		TERMINAL	RL-E41VCE	
INTERMEDIATE	RL-E42VCD		INTERMEDIATE	RL-E42VCE	
TYPE	MODEL #	LENS F	TYPE	MODEL #	LENS H
TERMINAL	RL-E41HCF	MILKWHITE PLEXIGLASS PROJECTS 3/4" - FILTERED RED, GREEN OR WHITE.	TERMINAL	RL-E41HCH	MOLDED MILKWHITE LEXAN PROJECTS 3/4" - FILTERED RED, GREEN OR WHITE.
INTERMEDIATE	RL-E42HCF		INTERMEDIATE	RL-E42HCH	
TERMINAL	RL-E41VCF		TERMINAL	RL-E41VCH	
INTERMEDIATE	RL-E42VCF		INTERMEDIATE	RL-E42VCH	
TYPE	MODEL #	LENS T7	TYPE	MODEL #	LENS T3
TERMINAL	RL-E41HCT7	MOLDED MILKWHITE LEXAN JEWELS DOMED OR FLUSH - FILTERED RED, GREEN OR WHITE.	TERMINAL	RL-E41HCT3	MOLDED MILKWHITE LEXAN JEWELS DOMED OR FLUSH, WITH 1/16" BLACK ENGRAVED LINES - FILTERED RED, GREEN OR WHITE.
INTERMEDIATE	RL-E42HCT7		INTERMEDIATE	RL-E42HCT3	
TERMINAL	RL-E41VCT7		TERMINAL	RL-E41VCT3	
INTERMEDIATE	RL-E42VCT7		INTERMEDIATE	RL-E42VCT3	

FIXTURES WILL BE SUPPLIED WITH TYPE "H" LENS UNLESS OTHERWISE SPECIFIED.

Note: In model number "H" is for Horizontal mount, "V" is for Vertical mount. (Please specify mounting requirements)



New style Chime
Model #: TG-1
Part #: 70B07P09
Multi Volt



LED Board
Part #: 7J24120LED [x]
Multi Voltage 24V-125V
Available colors: Amber, Red, White, Blue, and Green.

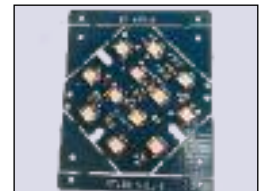

LED Board
Part #: M1CL204120 [x]
Multi Voltage 24V-125V
Available colors: Amber, Red, White, Blue, and Green.

[x] is dependent upon voltage and color choices, please specify when ordering.

		COVER	BOX	CUTOUT
RL-E4	HORIZONTAL FIXTURES	4-1/4" H x 10-1/2" L	3-5/8" H x 9-1/2" L x 2.5" D	3-3/4" H x 9-5/8" L
	VERTICAL FIXTURES	10-1/2" H x 4-1/4" L	9-1/2" H x 3-5/8" L x 2.5" D	9-5/8" H x 3-3/4" L



ELEVATOR PRODUCTS CORPORATION

Lanterns (Cont'd)

Standard Hall Soffit Design



MODEL St-2HCF-S

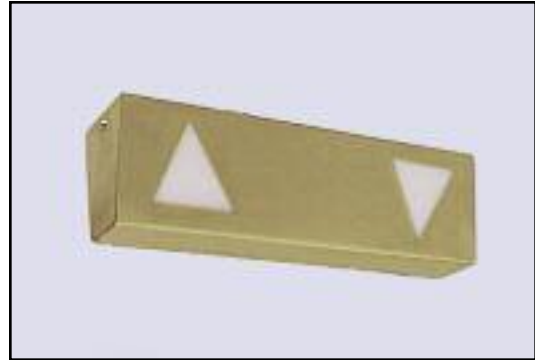

MODEL St-2HCF-M

- * Model numbers shown with chime, gong available.
- * Stainless Steel Covers (0.060" gage) with #4 Brushed Finish. Size: 12.00"W x 3.50"H (Proj.) x 3.00" Deep (2.00" at narrow end). Lens centerline: 7.50"
- * Also Available in Muntz Bronze with #4 Brushed Finish and Clear Epoxy Lacquer.
- * Special Finishes are Available.
- * High Brightness Incandescent Lamps.
- * Surface Mounted Design Eliminates Need for Cutout - Allows quick inexpensive Installation.
- * Broad Flexibility in Engineering - Designs available with integral rear projection readout Position Indicator
- * Complies with ANSI Codes.
- * Arrows visible from both Cab and Hall.
- * Arrows are 2-1/2" x 2-1/2" Milk-White Plexiglas - available filtered Red, Green and White.



New style Chime
Model #: TG-1
Part #: 70B07P09
Multi Volt



LED Board
Part #: 7J24120LED [x]
Multi Voltage 24V-125V
Available colors: Amber, Red, White, Blue, and Green.

[x] is dependent upon voltage and color choices, please specify when ordering.

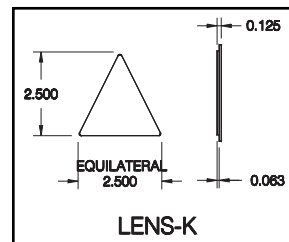
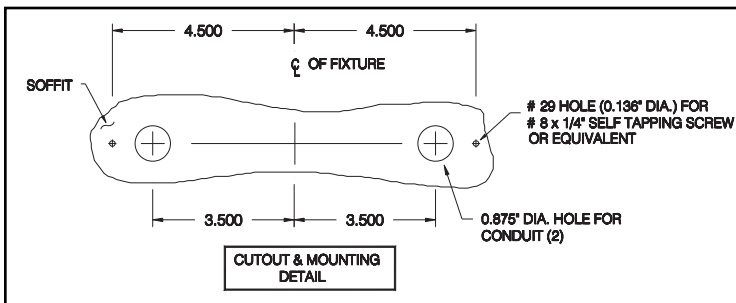

Lens:

ORDER INFORMATION:

Please advise the following - Model number, material, finish, gong or chime and voltages.



ELEVATOR PRODUCTS CORPORATION

Lanterns (Cont'd)

Standard Hall Coverless Design



WL-2 VCR - Intermediate
 WL-1 VCR - Terminal Box: 4.50"W x 13"H x 2.500" Deep
 Lens centerline: 6.0". Coverless Lantern with 4" Dia. Lenses
 Custom lenses available - call for information.
 Wall cutout: 3.500" Dia.

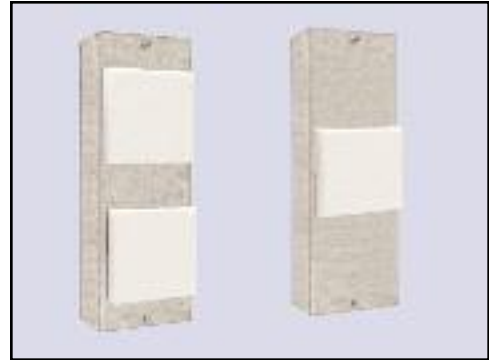

WL-2 VCS - Intermediate
 WL-1 VCS - Terminal Box: 4.50"W x 13"H x 2.500" Deep
 Lens centerline: 6.0".
 Coverless Lantern with 4" Sq. Lenses
 Custom lenses available - call for information.
 Wall cutout: 3.500" Sq.

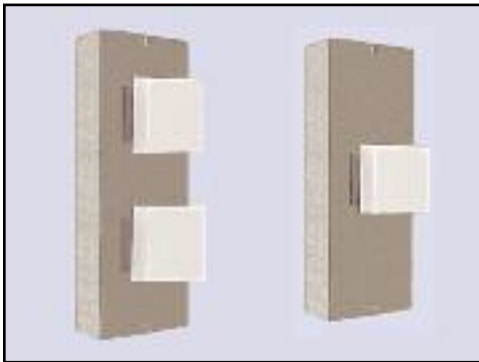

WLP-2 VCS - Intermediate
 WLP-1 VCS - Terminal Box: 4.50"W x 13"H x 2.50 Deep
 Lens centerline: 6.0". Coverless Lantern with 4" Sq. Lenses
 and Plaster ring (1.250" long) for dry wall applications.
 Custom lenses available - call for information.
 Wall cutout: 3.562" Sq.

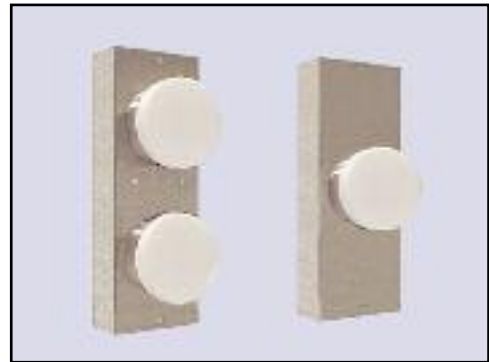

WLP-2 VCR - Intermediate
 WLP-1 VCR - Terminal Box: 4.50"W x 13"H x 2.50 Deep
 Lens centerline: 6.0".
 Coverless Lantern with 4" Dia. Lenses
 and Plaster ring (1.250" long) for dry wall applications.
 Custom lenses available - call for information.
 Wall cutout: 3.562" Dia.

* Variable Voltage and Electronic Chime with Volume Control.

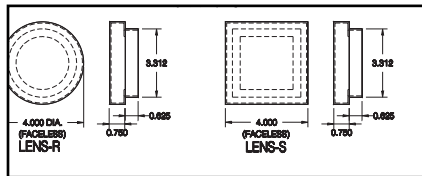

New style Chime
 Model #: TG-1
 Part #: 70B07P09
 Multi Volt



LED Board
 Part #: MICLE204120 [x]
 Multi Voltage 24V-125V
 Available colors: Amber, Red, White, Blue, and Green.



LED Board
 Part #: HICLE204120 [x]
 Multi Voltage 24V-125V
 Available colors: Amber, Red, White, Blue, and Green.

[x] is dependent upon voltage and color choices, please specify when ordering.

ORDER INFORMATION:

Please advise the following - Model number, gong or chime and voltages.



ELEVATOR PRODUCTS CORPORATION

Lanterns (Cont'd)

Standard Car Flushline Design



MODEL L-32VCF-S

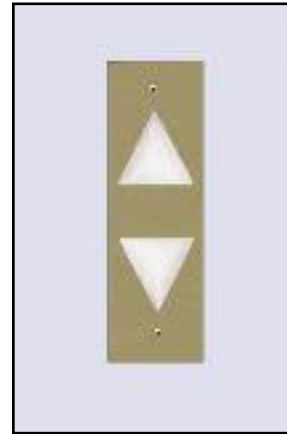

MODEL L-32VCF-M

- * Covers are Solid 1/8" Stainless Steel or Muntz Bz with #4 Brushed Finish.
- * Also Available with Covers of #8 mirror and lacquered Muntz Bronze, Oxidized Bronze and #8 mirror Stainless Steel. Contact our sales office for further information.
- * High Brightness Incandescent AND LED Lamps
- * Variable Voltages available, please specify when ordering.

PARTS LISTING					
TYPE	MODEL #	LENS F	COVER SIZE W x H	BOX SIZE W x H x D	CUTOUT W x H
STANDARD CAR LANTERN					
INTERMEDIATE	L-32VCF-S (St. Steel)	MILKWHITE PLEXIGLASS PROJECTS 3/8". FILTERED	3-1/4" x 10-1/2"	2-3/4" x 9-1/8" x 2.50"	2-7/8" x 9-1/4"
INTERMEDIATE	L-32VCF-M (Muntz Bz)	RED, GREEN OR WHITE			

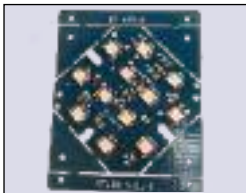

LED Board
Part #: MICL204120 [x]
Multi Voltage 24V-125V
Available colors: Amber, Red, White, Blue, and Green.



New style Chime
Model #: TG-1
Part #: 70B07P09
Multi Volt



LED Board
Part #: 7J24120LED [x]
Multi Voltage 24V-125V
Available colors: Amber, Red, White, Blue, and Green.

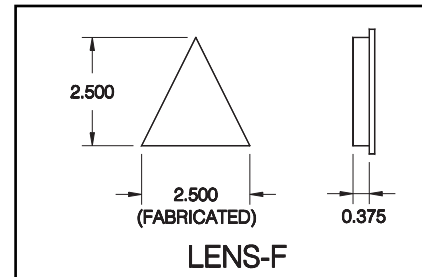

Part #: A474CL

[x] is dependent upon voltage and color choices, please specify when ordering.

ORDER INFORMATION:

Please advise the following - Model number, mounting orientation, material, finish, and voltages.



ELEVATOR PRODUCTS CORPORATION

Handicap Braille Plates

Handicap Plates are available in various finishes, sizes and thickness.

- * **Finishes:**
St/St Characters, Muntz Bronze Characters and White Characters (for California Code).
- * **Sizes:**
Various sizes available, depending on the application required. (see below)
- * **Thickness:**
Thickness varies from 0.031" thick to approximately 0.130" thick. Depending on the application and type of handicap plate used.
- * **Applications:**
Applied - mounted on the surface of the cover plate.
Recessed - mounted in a swaged pocket in the cover plate. The handicap plate is flush with the surface of the cover plate.
- * Special Order available. Please call the office.



MODEL #	PART #	FINISH	DIMENSIONS	MOUNTING
J-100-S4	65X01P [x]	Stainless Steel #4	1.00"W x 1.250"H x 0.030" TH	A) Double sided tape & 1-#6-32 x 3/8" stud B) 2- 0.104" Dia. mounting holes.
J-100-S8	65X04P [x]	Stainless Steel #8	1.00"W x 1.250"H x 0.030" TH	A) Double sided tape & 1-#6-32 x 3/8" stud B) 2- 0.104" Dia. mounting holes.
J-100-M4	65X02P [x]	Muntz Bronze #4	1.00"W x 1.250"H x 0.030" TH	A) Double sided tape & 1-#6-32 x 3/8" stud B) 2- 0.104" Dia. mounting holes.
J-100-M8	"Special"	Muntz Bronze #8	1.00"W x 1.250"H x 0.030" TH	A) Double sided tape & 1-#6-32 x 3/8" stud B) 2- 0.104" Dia. mounting holes.
J-100-W	65X03P [x]	White (CALIF. CODE)	1.00"W x 1.250"H x 0.030" TH	A) Double sided tape & 1-#6-32 x 3/8" stud B) 2- 0.104" Dia. mounting holes.

[x] is dependent upon markings.
For usage in Car Stations and Hall Stations.



MODEL #	PART #	FINISH	DIMENSIONS	MOUNTING
J-125-S4	65X06P [x]	Stainless Steel #4	1.250" Square x 0.030" TH	A) Double sided tape & 1-#6-32 x 3/8" stud B) 2- 0.104" Dia. mounting holes.
J-125-S8	65X09P [x]	Stainless Steel #8	1.250" Square x 0.030" TH	A) Double sided tape & 1-#6-32 x 3/8" stud B) 2- 0.104" Dia. mounting holes.
J-125-M4	65X07P [x]	Muntz Bronze #4	1.250" Square x 0.030" TH	A) Double sided tape & 1-#6-32 x 3/8" stud B) 2- 0.104" Dia. mounting holes.
J-125-M8	65X10P [x]	Muntz Bronze #8	1.250" Square x 0.030" TH	A) Double sided tape & 1-#6-32 x 3/8" stud B) 2- 0.104" Dia. mounting holes.
J-125-W	65X08P [x]	White (CALIF. CODE)	1.250" Square x 0.030" TH	A) Double sided tape & 1-#6-32 x 3/8" stud B) 2- 0.104" Dia. mounting holes.

[x] is dependent upon markings.
For usage in Car Stations and Hall Stations.

ORDER INFORMATION:

Please advise the following - Model number, size and mounting type.



ELEVATOR PRODUCTS
CORPORATION

Handicap Braille Plates (Cont'd)



MODEL #	PART #	FINISH	DIMENSIONS	MOUNTING
JR-38-S	65X21P [x]	Stainless Steel #4	1.350" Dia. x 0.030" TH.	A) Double sided tape & 1-#6-32 x 3/8" stud B) 2- 0.104" Dia. mounting holes.
JR-38-M	65X22P [x]	Muntz Bronze #4	1.350" Dia. x 0.030" TH.	A) Double sided tape & 1-#6-32 x 3/8" stud B) 2- 0.104" Dia. mounting holes.
JR-38-W	65X23P [x]	White (CALIF. CODE)	1.350" Dia. x 0.030" TH.	A) Double sided tape & 1-#6-32 x 3/8" stud B) 2- 0.104" Dia. mounting holes.

[x] is dependent upon markings.
For usage in Car Stations and Hall Stations.

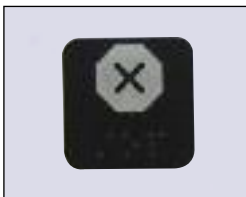

MODEL #	PART #	FINISH	DIMENSIONS	MOUNTING
SS-12-S	65X61P [x]	Stainless Steel #4	1.250" Square x 0.030" TH	A) Double sided tape & 1-#6-32 x 3/8" stud B) 2- 0.104" Dia. mounting holes.
SS-12-M	65X62P [x]	Muntz Bronze #4	1.250" Square x 0.030" TH	A) Double sided tape & 1-#6-32 x 3/8" stud B) 2- 0.104" Dia. mounting holes.
SS-12-W	65X63P [x]	White (CALIF. CODE)	1.250" Square x 0.030" TH	A) Double sided tape & 1-#6-32 x 3/8" stud B) 2- 0.104" Dia. mounting holes.

[x] is dependent upon markings.
For usage in Car Stations and Hall Stations.



MODEL #	PART #	FINISH	DIMENSIONS	MOUNTING
JR-25-S4	65X11P [x]	Stainless Steel #4	1.250" Round x 0.030" TH	A) Double sided tape & 1-#6-32 x 3/8" stud B) 2- 0.104" Dia. mounting holes.
JR-25-S8	65X14P [x]	Stainless Steel #8	1.250" Round x 0.030" TH	A) Double sided tape & 1-#6-32 x 3/8" stud B) 2- 0.104" Dia. mounting holes.
JR-25-M4	65X12P [x]	Muntz Bronze #4	1.250" Round x 0.030" TH	A) Double sided tape & 1-#6-32 x 3/8" stud B) 2- 0.104" Dia. mounting holes.
JR-25-M8	65X15P [x]	Muntz Bronze #8	1.250" Round x 0.030" TH	A) Double sided tape & 1-#6-32 x 3/8" stud B) 2- 0.104" Dia. mounting holes.
JR-25-W	65X13P [x]	White (CALIF. CODE)	1.250" Round x 0.030" TH	A) Double sided tape & 1-#6-32 x 3/8" stud B) 2- 0.104" Dia. mounting holes.

[x] is dependent upon markings.
For usage in Car Stations and Hall Stations.

ORDER INFORMATION:

Please advise the following - Model number, size and mounting type.



Handicap Braille Plates (Cont'd)

ELEVATOR PRODUCTS CORPORATION



MODEL #	FINISH	DIMENSIONS	MOUNTING
CC5	Stainless Steel #4	1.375" round	Front Mechanical or Back Flange Mounting



MODEL #	FINISH	DIMENSIONS	MOUNTING
CC2	Stainless Steel #4	1.250" x 1.250" Corners: 0.125" radius	Front Mechanical or Back Flange Mounting

[x] is dependent upon markings.

For usage in Car Stations and Hall Stations. Available in Stainless, Bronze, and White.



MODEL #	PART #	FINISH	DIMENSIONS	MOUNTING
PEP-S	65X46P [x]	Stainless Steel #4	1.375" Dia. x 2.490" Oblong	A) 3-0.234" Dia. mounting holes.
PEP-M	65X47P [x]	Muntz Bronze #3	1.375" Dia. x 2.490" Oblong	A) 3-0.234" Dia. mounting holes.
PEP-W	65X48P [x]	White (CALIF. CODE)	1.375" Dia. x 2.490" Oblong	A) 3-0.234" Dia. mounting holes.

[x] is dependent upon markings.

For usage in Car Stations and Hall Stations.



MODEL #	PART #	FINISH	DIMENSIONS	MOUNTING
J-325-S	"SPECIAL"	Stainless Steel #4	3.50"W x 1.0"H x 0.031"TH	A) Double sided tape & 1-#6-32 x 3/8" stud B) 2- 0.104" Dia. mounting holes.
J-325-M	"SPECIAL"	Muntz Bronze #4	3.50"W x 1.0"H x 0.031"TH	A) Double sided tape & 1-#6-32 x 3/8" stud B) 2- 0.104" Dia. mounting holes.
J-325-W	"SPECIAL"	White (CALIF. CODE)	3.50"W x 1.0"H x 0.031"TH	A) Double sided tape & 1-#6-32 x 3/8" stud B) 2- 0.104" Dia. mounting holes.

For usage in Phone Compartments and Phone Boxes.



MODEL #	PART #	FINISH	DIMENSIONS	MOUNTING
CO8-S	"SPECIAL"	Stainless Steel #4	1.25" Square Corners: 0.125" radius	A) Double sided Tape B) 2- #6-32 x 3/8" stud
CO8-M	"SPECIAL"	Muntz Bronze #4	1.25" Square Corners: 0.125" radius	A) Double sided Tape B) 2- #6-32 x 3/8" stud
CO8-W	"SPECIAL"	White (CALIF. CODE)	1.25" Square Corners: 0.125" radius	A) Double sided Tape B) 2- #6-32 x 3/8" stud



ELEVATOR PRODUCTS CORPORATION

Handicap Braille Plates (Cont'd)



MODEL #	PART #	FINISH	DIMENSIONS	MOUNTING
J-432-S4	66X11P [x]	Stainless Steel #4	3.250"W x 3.250"H x 0.042"TH Corners: 0.062" radius	A) Double sided Tape B) 2- #6-32 x 3/8" stud C) 4-0.104" Dia. mounting holes.
J-432-S8	"SPECIAL"	Stainless Steel #8	3.250"W x 3.250"H x 0.042"TH Corners: 0.062" radius	A) Double sided Tape B) 2- #6-32 x 3/8" stud C) 4-0.104" Dia. mounting holes.
J-432-M4	66X12P [x]	Muntz Bronze #4	3.250"W x 3.250"H x 0.042"TH Corners: 0.062" radius	A) Double sided Tape B) 2- #6-32 x 3/8" stud C) 4-0.104" Dia. mounting holes.
J-432-M8	"SPECIAL"	Muntz Bronze #8	3.250"W x 3.250"H x 0.042"TH Corners: 0.062" radius	A) Double sided Tape B) 2- #6-32 x 3/8" stud C) 4-0.104" Dia. mounting holes.
J-432-W	66X13P [X]	White (CALIF. CODE)	3.250"W x 3.250"H x 0.042"TH Corners: 0.062" radius	A) Double sided Tape B) 2- #6-32 x 3/8" stud C) 4-0.104" Dia. mounting holes.

[x] is dependent upon markings.
For usage in Jamb.

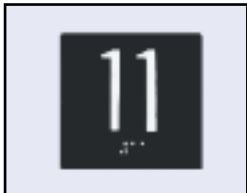

MODEL #	PART #	FINISH	DIMENSIONS	MOUNTING
J200-S4	66X01P [x]	Stainless Steel #4	3.250"W x 3.250"H x 0.042"TH Corners: 0.062" radius	A) Double sided Tape B) 2- #6-32 x 3/8" stud C) 4-0.104" Dia. mounting holes.
J200-S8	66X04P [x]	Stainless Steel #8	3.250"W x 3.250"H x 0.042"TH Corners: 0.062" radius	A) Double sided Tape B) 2- #6-32 x 3/8" stud C) 4-0.104" Dia. mounting holes.
J200-M4	66X02P [x]	Muntz Bronze #4	3.250"W x 3.250"H x 0.042"TH Corners: 0.062" radius	A) Double sided Tape B) 2- #6-32 x 3/8" stud C) 4-0.104" Dia. mounting holes.
J200-M8	"SPECIAL"	Muntz Bronze #8	3.250"W x 3.250"H x 0.042"TH Corners: 0.062" radius	A) Double sided Tape B) 2- #6-32 x 3/8" stud C) 4-0.104" Dia. mounting holes.
J200-W	66X03P [X]	White (CALIF. CODE)	3.250"W x 3.250"H x 0.042"TH Corners: 0.062" radius	A) Double sided Tape B) 2- #6-32 x 3/8" stud C) 4-0.104" Dia. mounting holes.

[x] is dependent upon markings.
For usage in Jamb.



ELEVATOR PRODUCTS CORPORATION

Hardware

Screws

PHILLIPS OVAL HEAD MACHINE SCREWS



PHILLIPS



8-32X1 (PS) / (PB)
#8-32 x 1" Phillips Oval HD
Mtl: St/St & Brass



8-32X3 (PS)
#8-32 x 3" Phillips Oval HD
Mtl: St/St



10-32X2 (PS) / (PB)
#10-32 x 2" Phillips Oval HD
Mtl: St/St & Brass

MODEL #	DESCRIPTION	MATL. FINISH:
8-32X1 (PS)	#8-32 x 1" Phillips Oval HD	St/St
8-32X1 (PB)	#8-32 x 1" Phillips Oval HD	Brass
8-32X2 (PB)	#8-32 x 2" Phillips Oval HD	Brass
8-32X2 1/2 (PS)	#8-32 x 2-1/2" Phillips Oval HD	St/St
8-32X3 (PS)	#8-32 x 3" Phillips Oval HD	St/St
10-32X1 (PS)	#10-32 x 1" Phillips Oval HD	St/St
10-32X1 (PB)	#10-32 x 1" Phillips Oval HD	Brass
10-32X2 (PS)	#10-32 x 2" Phillips Oval HD	St/St
10-32X2 (PB)	#10-32 x 2" Phillips Oval HD	Brass
10-32X2 1/2 (PS)	#10-32 x 2-1/2" Phillips Oval HD	St/St

PHILLIPS FLAT HEAD MACHINE SCREWS



PHILLIPS



6-32x1 (PFZ)
#6-32 x 1" Phillips Flat HD
Undercut Mtl: Zinc Plated Steel

6-32X1(PFB)
#6-32 x 1" Phillips Flat HD
Mtl: Brass



10-32x1/2 (PFZ)
#10-32 x 1/2" Phillips Flat HD
Undercut Type "F"
Self tapping Mtl: Zinc
Plated Steel

Note: Can also be used
with Gibs



6-32x1/2 (PFZ)
#6-32 x 1/2" Phillips Flat HD
Undercut Mtl: Zinc
Plated Steel

ORDER INFORMATION:

Please advise the following - Screw head type, length, type of screw and material.



ELEVATOR PRODUCTS CORPORATION

Hardware (Cont'd)

Screws

SPANNER OVAL HEAD MACHINE SCREWS



SPANNER



8-32X1 (SS) / (SB)
#8-32 x 1" Spanner HD
Mtl: St/St & Brass



8-32X2 1/2 (SB)
#8-32 x 2-1/2" Spanner HD
Mtl: Brass



10-32X2 (SS) / (SB)
#10-32 x 2" Spanner HD
Mtl: St/St & Brass

MODEL #	DESCRIPTION	MATL. FINISH
8-32X1(SS)	# 8-32 x 1" Spanner Oval HD	St/Steel
8-32X1(SB)	# 8-32 x 1" Spanner Oval HD	Brass
8-32X2 (SS)	# 8-32 x 2" Spanner Oval HD	St/Steel
8-32X2-1/2 (SB)	# 8-32 x 2-1/2" Spanner Oval HD	Brass
8-32X1 (SS)18-8	# 8-32 x 1" Spanner Oval HD 18-8	St/Steel
8-32X1 (SB)	# 8-32 x 1" Spanner Oval HD	Brass
8-32X2 (SS)18-8	# 8-32 x 2" Spanner Oval HD 18-8	St/Steel
8-32X3 (SS)	# 8-32 x 3" Spanner Oval HD	St/Steel
10-32X1 (SS)	#10-32 x 1" Spanner Oval HD	St/Steel
10-32X1 (SB)	#10-32 x 1" Spanner Oval HD	Brass
10-32X2 (SS)	#10-32 x 2" Spanner Oval HD	St/Steel
10-32X2 (SB)	#10-32 x 2" Spanner Oval HD	Brass

PHILLIPS PAN HEAD & SLOTTED SELF-TAPPING SCREWS



PHILLIPS



SLOTTED



4X3/4 (PZ)
#4 x 3/4" Phillips Pan HD
Thread Forming
Mtl: Zinc Plated
(Sheet Metal Screw)



8-32X3/4 (PZ)
#8-32 x 3/4" Phillips Pan HD
Thread Forming
Mtl: Zinc Plated



4X3/8 (PZ)
#4 x 3/8" Phillips Pan HD
Thread Forming
Mtl: Zinc Plated
(Sheet Metal Screw)



10-32X1/2 (SFZ)
10-32 x 1/2" Slot Flat HD
Type "F" Thread Forming
Mtl: Zinc Plated

ORDER INFORMATION:

Please advise the following - Screw head type, length, type of screw, and material.



ELEVATOR PRODUCTS CORPORATION

Hardware (Cont'd)

Screws

SLOTTED FLAT HEAD MACHINE SCREWS



SLOTTED



4-40x1/4 (SFS)
#4-40 x 1/4" Slot Flat HD
Mtl: Zinc Plated Steel



4-40x7/16 (SFS)
#4-40 x 7/16" Slot Flat HD
M/S 18-8 Mtl: St/St

MODEL #	DESCRIPTION	MATL. FINISH:
4-40X1/4 (SFZ)	#4-40 x 1/4" Slot Flat HD	Zinc Plated
4-40X3/16 (SFZ)	#4-40 x 3/16" Slot Flat HD	Zinc Plated
4-40X3/8 (SFZ)	#4-40 x 3/8" Slot Flat HD	Zinc Plated
4-40x7/16 (SFS)	#4-40 x 7/16" Slot Flat HD 18-8	St/St
6-32X1/4 (SFS)	#6-32 x 1/4" Slot Flat HD 18-8	St/St
6-32X1/2 (SFZ)	#6-32 x 1/2" Slot Flat HD	Zinc Plated
6-32X1 3/4 (SFB)	#6-32 x 1-3/4" Slot Flat HD	Brass
6-32X1 3/4 (SFZ)	#6-32 x 1-3/4" Slot Flat HD	Zinc Plated

SLOTTED PAN/ ROUND HEAD MACHINE SCREWS



SLOTTED



8-32x1/4 (SRZ)
#8-32 x 1/4" Slot Round HD
M/S 18-8 Mtl:St/St



4-40X2 (SPS)
#4-40 x 2" Slot Pan HD
M/S 18-8 Mtl: St/St



6-32X3/8 (SPZ)
#6-32 x 3/8" Slot Pan HD
"F" type Mtl: Zinc Plated

MODEL #	DESCRIPTION	MATL. FINISH
4-40X1 (SPZ)	#4-40 x 1" Slot Round HD	Zinc Plated
4-40X2 (SPS)	#4-40 x 2" Slot Pan HD 18-8	St/St
4-40X1 1/2 (SPB)	#4-40 x 1-1/2" Slot Pan HD	Brass
4-40X1 1/2 (SPS)	#4-40 x 1-1/2" Slot Pan HD	St/St/ Zinc
6-32X3/8 (SPZ)	#6-32 x 3/8" Slot Pan HD	Zinc Plated
6-32X5/8 (SPZ)	#6-32 x 5/8" Slot Pan HD	Zinc Plated
8-32X1/4 (SRZ)	#8-32 x 1/4" Slot Round HD	Zinc Plated

ORDER INFORMATION:

Please advise the following - Screw head type, length, type of screw and material.



ELEVATOR PRODUCTS CORPORATION

Hardware (Cont'd)

Screws

GIB HARDWARE



SLOTTED



SEMS #6
#6-32 x 3/8" Binding Head SEMS
for Epco Door Gib
Quantity: 200/ box



SAFETY STUD #S
#6-32 Safety Stud
for Epco Door Gib
Quantity: 200/ box



SCREWS #10
#10-32 x 1/2" Flat HD Type "F"
Screw for Epco Door Gib
Quantity: 300/ box

GROUND SCREWS



SLOTTED



10-32X1/2 (GSZ)
#10-32 x 1/2" Slot Washer Hex
Mtl: Zinc Plated Green



6-32X3/8 (GSFZ)
#6-32 x 3/8" Slot Washer Hex
HD "F" type
Mtl: Zinc Plated Steel

SOCKET SET SCREWS (ALLEN HEAD)



SOCKET SET



6-32X1/4 (AH)
#6-32 X 1/4" Cup Point
Socket Set Screw



6-32X1/8 (AH)
#6-32 x 1/8" Cup Point
Socket Set Screw

MODEL #	DESCRIPTION	MATL. FINISH
6-32X1/8 (AH)	#6-32 x 1/8" Lg. Cup Point Socket Set screw	Alloy Steel
6-32X1/4 (AH)	#6-32 x 1/4" Lg. Cup Point Socket Set screw	Alloy Steel
6-32X3/8 (AH)	#6-32 x 3/8" Lg. Cup Point Socket Set screw	Alloy Steel
6-32X1/2 (AH)	#6-32 x 1/2" Lg. Cup Point Socket Set screw	Alloy Steel
6-32X5/8 (AH)	#6-32 x 5/8" Lg. Cup Point Socket Set screw	Alloy Steel
6-32X3/4 (AH)	#6-32 x 3/4" Lg. Cup Point Socket Set screw	Alloy Steel
8-32X3/8 (AH)	#8-32 x 3/8" Lg. Cup Point Socket Set screw	Alloy Steel
8-32X5/8 (AH)	#8-32 x 5/8" Lg. Cup Point Socket Set screw	Alloy Steel
8-32X1 (AH)	#8-32 x 1" Lg. Cup Point Socket Set screw	Alloy Steel

ORDER INFORMATION:

Please advise the following - Screw head type, length, type of screw and material.



ELEVATOR PRODUCTS CORPORATION

Hardware (Cont'd)

Nuts & Spacers

HEX NUTS



10-32 (HNZ)
#10-32 (5/16 x 7/64)
Machine Screw Nut
Mtl: zinc Plated

MODEL #	DESCRIPTION
4-40 (HNZ)	#4-40 (1/4 x 3/32) Hex Mach. Screw Nut
6-32 (HNZ)	#6-32 (1/4 x 3/32) Hex Mach. Screw Nut
10-32 (HNZ)	#10-32 (5/16 x 7/64) Hex Mach. Screw Nut

KEP NUTS



8-32 (KNZ)
#8-32 (11/32 x 3/8)
Kep Nut with washer
Mtl: Zinc Plated

MODEL #	DESCRIPTION
4-40 (KNZ)	#4-40 (1/4 x 9/32) Mach. Screw Nut w/ washer
6-32 (KNZ)	#6-32 (1/4 x 9/32) Small Mach. Scr Nut w/ washer
6-32 (KNZ)	#6-32 (3/16 x 11/32) Mach. Screw Nut w/ washer
8-32 (KNZ)	#8-32 (11/32 x 3/8) Mach. Screw Nut w/ washer
10-32 (KNZ)	#10-32 (3/8 x 13/32) Mach. Screw Nut w/ washer

NYLON WASHER/ SPACERS



MODEL #	DESCRIPTION
3/8 (NYLK)	.375" OD x .184 ID x .375" Thk (ref #21A04-P01)
5/16 (NYLS)	5/16" OD x .175 ID x .062" Thick Flat Washer
346 (NYLK)	#346 5/16" OD x .145" ID x .050" Thk Flat Washer

ORDER INFORMATION:

Please advise the following - Screw head type, length, type of screw and material.



ELEVATOR PRODUCTS CORPORATION

Hardware (Cont'd)

Washers, Retainers, & Clips

WASHER & RETAINERS



6 (ITWZ)
#6 Internal Tooth Washer
Mtl: Zinc Plated



6 (FWZ)
#6 M/S Flat Washer
Mtl: Zinc Plated



6 (PNZ)
#6 Push Nut Bolt Retainer
Mtl: Zinc plated



10 (PNRO)
#10 Push Nut Bolt Retainer
Mtl: Black oxide

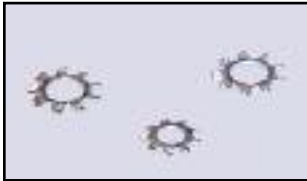

10 (ETWZ)
#10 External Tooth Washer
Mtl: Zinc Plated

MODEL #	DESCRIPTION	MATL. FINISH
6 (ITWZ)	#6 Internal Tooth Washer	Zinc Plated
10 (ITWZ)	#10 Internal Tooth Washer	Zinc Plated
6 (FWZ)	#6 Machine Screw Flat Washer	Zinc Plated
10-SAE (FWZ)	#10 SAE Flat Washer	Zinc Plated
1/4-VSS (FWZ)	1/4" VSS Flat Washer	Zinc Plated
6 (PNRZ)	#6 Push Nut Bolt Retainer	Zinc Plated
8 (PNRZ)	#8 Push Nut Bolt Retainer	Zinc Plated
10 (PNRO)	#10 Push Nut Bolt Retainer	Black oxide
6 (ETWZ)	#6 External Tooth Washer	Zinc Plated
10 (ETWZ)	#10 External Tooth Washer	Zinc Plated

CLIP NUTS - TINNEMAN



8-32S (CNO)
#8-32 U-Style Standard Nut
Short Mtl: Black oxide



8-32 (CNO)
#8-32 U-Style Standard Nut
Mtl: Black oxide



8-32T (CNO)
#8-32 U-Style Tapped Hole Nut
Mtl: Black oxide

MODEL #	DESCRIPTION	MATL. FINISH
6-32 (CNO)	#6-32 U-Style Nut Standard for Mach. screws	Black oxide
8-32S (CNO)	#8-32 U-Style Nut Standard - Short for Mach.screws	Black oxide
8-32 (CNO)	#8-32 U-Style Nut Standard for Mach. screws	Black oxide
10-32 (CNZ)	#10-32 U-Style Nut Standard for Mach. screws	Zinc Plated
8-32T (CNO)	#8-32 U-Style Tapped Hole Nut for Mach. screws	Black oxide

ORDER INFORMATION:

Please advise the following - Screw head type, length, type of screw and material.



ELEVATOR PRODUCTS CORPORATION

Hardware (Cont'd)

Hinges

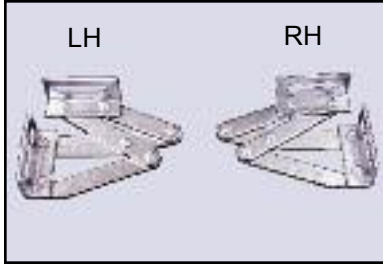

SCISSOR - Hinge
Single Strip
Flushline.

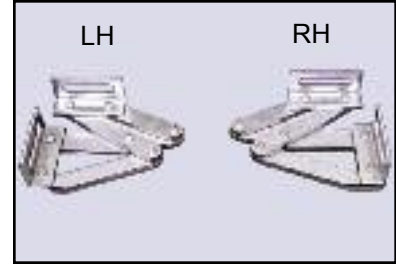

SCISSOR - Hinge
Double Strip
Heavy Duty
Flushline.

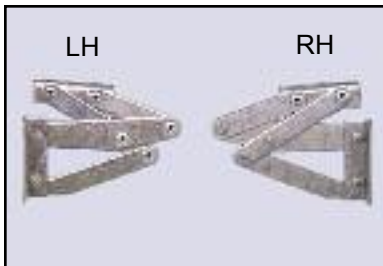

SCISSOR - Hinge
Single Strip
Haloline.



SOSS - Hinge



CONCEALED
FASTENER
with mounting
brackets.



SELBY Hinge



MAGNETIC CATCH
with mounting
brackets.



BULLET CATCH
with mounting
brackets.

Parts Listing		
Item	Part#	Typical Application
Scissor Hinge Single Flushline	SCISSOR1	Phone Cabinets, Car Stations (Specify Left or Right Hand)
Scissor Hinge Double Flushline	SCISSOR2	Otis - Replacement, Car Stations (Specify Left or Right Hand)
Scissor Hinge Single Haloline	SCISSOR3	Pan Type Phone Cabinets (Specify Left or Right Hand)
SOSS - Hinge	SOSS-S	Attendant Cabinets, Car Stations
Concealed (Hidden) Fastener	CONCFAST	Hall Stations, Hall Lanterns, Position Indicators
Selby Hinge	SELBY	Car Stations
Magnetic Catch	MAGCAT	Phone Cabinets
Bullet Catch	BULLCAT	All Fixtures



ELEVATOR PRODUCTS
CORPORATION

Index

NAME / PART	PAGE #
Access Stations	154
Audible Devices	146
Buttons	1-80
SPR-S/SPR-M	1-2
SPS-S/SPS-M	1-2
SPR-SPC/SPR-MPC	3-4
SPS-SPC/SPS-MPC	3-4
SPR-W/SPR-WPC	5-6
SPR-SSPC/SPR-SMPC	7-8
SPR-SSL/SPR-MML	9-10
SPR-SSLPC/SPR-MMLPC	9-10
CL Series	11-12
SA-C/MA-C Series	13-14
SSL/MML	15-16
SSL-P/MML-P	17-18
SSL-PC/MML-PC	19-20
SSL-H/MML-H	21-22
SSL-HPC/MML-HPC	21-22
SSL-HC/MML-HC	23-24
SSL-HSE/MML-HSE	25-26
SSL-SH/MML-SH Housing	27-28
WA Series	29-30
WA-PC Series	31-32
WB Series	33-34
WS Series	35-36
FL Series	37-38
PEPS-SPR/PEPM-SPR	39-40
PEPS-SPRPC/PEPM-SPRPC	39-40
PEPS-AS/PEP-AM	41-42
PEP-ASPC/PEP-AMPC	41-42
Survivor	43-44
Survivor-PC	43-44
Survivor-SM (Surface Mount Style)	45-46
Survivor-SMPC (Surface Mount Style)	45-46
SURVPL-S/SURVPL-M	47-48



ELEVATOR PRODUCTS
CORPORATION

Index (Cont'd)

NAME / PART	PAGE #
Buttons (Cont'd)	
SURVPL-SPC/SURVPL-MPC	47-48
Designer	49-50
Designer-PC	49-50
Designer2	51-52
Designer2-PC	51-52
Designer-SM (Surface Mount Style)	53-54
Designer-SMPC (Surface Mount Style)	53-54
Designer2-SM (Surface Mount Style)	55-56
Designer2-SMPC (Surface Mount Style)	55-56
Classic	57-58
Classic-PC	57-58
Classic2	59-60
Classic2-PC	59-60
Classic-SM (Surface Mount Style)	61-62
Classic-SMPC (Surface Mount Style)	61-62
Classic2-SM (Surface Mount Style)	63-64
Classic2-SMPC (Surface Mount Style)	63-64
WGH Series	65-66
WGH-PC Series	67-68
WGH-S/WGH-M	69-70
WGH-SPC/WGH-MPC	71-72
WN-PC Series	73-74
WNR-PC Series	75-76
MRB Series	77-78
RB Series	79-80



ELEVATOR PRODUCTS
CORPORATION

Index (Cont'd)

NAME / PART	PAGE #
Car Top Inspection Station	135
Certificate Frames	137
Emergency Light Fixtures	119-120
Emergency Light Power Supplies	121-122
Emergency Lighting	123-128
Self Contained	123
TCEL	124
Flexilite	125
Mini Flourescent	127
Adams Style	128
EPCO Style	128
Emergency Stop Switches-Key Switches	98
Emergency Stop Switches-Push Pull	97
Escalator Control Fixtures	139-143
Fujitec Style	142
Schindler Style	142
All Others	139-143
Fans & Grills	133-134
Fire Door Retainers	132
Fire Key Boxes	118
Fire Service Control Cabinet	118
Fire Service Switches	103-115
Boston Code	103-104
National Code & Other (Replacement Parts)	105-106
National Code Rotary Style	107
PEP Style	108
MTA Style	108
NYC Code	109-110
Connecticut Code	111-112
South Carolina Code Post 2000	113



ELEVATOR PRODUCTS
CORPORATION

Index (Cont'd)

NAME / PART	PAGE #
Fire Service Switches (Cont'd)	
White Plains Code	114
Arizona Code	115
Chicago Code	115
Fire Service Cabinet Lock	116
Fire Stations	117
Gibs	129-131
Nylon Door Gibs	129
Roller Bearing Gibs	130
Rail Gibs	131
Hall Stations	151-153
Incline Surface Mounted	151-152
Standard Flush Design	153
Handicap Braille Plates	167-170
J-100	167
J-125	167
JR-38	168
SS-12	168
SP3	168
JR-25	168
PEP	169
J-325	169
CO8	169
J-432	170
VP-2	170
J200	170
Hands Free Phones	136
Hardware	171-177
Screws	171-174
Nuts & Spacers	175
Washers, Retainers, & Clips	176
Hinges	177
Illuminating Devices	81-82
Indicators	81-82



ELEVATOR PRODUCTS
CORPORATION

Index (Cont'd)

NAME / PART	PAGE #
Keyswitches	83-94
Circleline-CL	83-84
Flushline-FL	85-86
Tamper-SSL	87-88
Haloline-WB	89-90
Haloline-WR	91-92
Adams Style	93
Best Style	94
Medeco Style	94
Lanterns	155-165
Incline Surface Mounted	155-156
Incline Surface Mounted Position Indicators	156
Standard Flushline Design	157-158
Standard Incline Design	159-160
Standard Hall Pan Cover Design	161-162
Standard Hall Soffit Design	163
Standard Hall Coverless Design	164
Standard Car Flushline Design	165
LED Segmented Position Indicator Replacement Boards	145
Miscellaneous Electronic Components	147
Miscellaneous Switches	101
Pit Switches	135
Residential Fixtures	149-150
Rocker Indicators & Buttons	100
Rocker Switches	99
Telephone Cabinets	138
Toggle Switches	95-96