

---

neurochirurgie  
neurosurgery  
neurocirugía  
neurochirurgie  
neurochirurgia

nopa<sup>®</sup> instruments

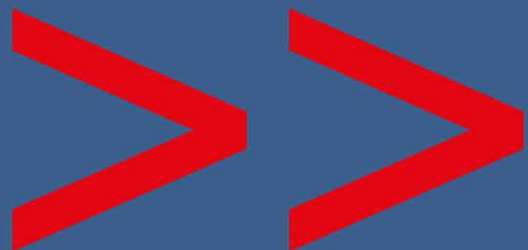

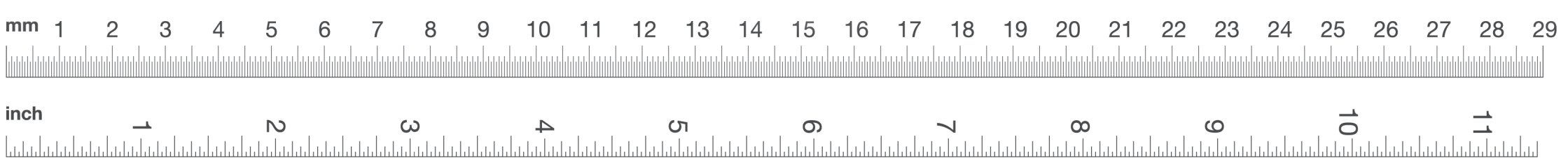

Dies ist unser Katalog, er bleibt unser ausschließliches Eigentum. Es gelten unsere allgemeinen Lieferbedingungen. Sie finden diese auf unserer Internetseite: [www.nopa-instruments.com](http://www.nopa-instruments.com).

This is our Catalogue. It remains our exclusive property. Please find our "General Terms of Sale" on our corporate website: [www.nopa-instruments.com](http://www.nopa-instruments.com).

Esto es nuestro catálogo queda nuestra propiedad.

Nuestros condiciones generales de venta se encuentran en nuestra página web: [www.nopa-instruments.com](http://www.nopa-instruments.com).

Voilà notre catalogue et il demeure notre propriété.

Veillez consulter nos conditions générales de vente sur notre page Internet: [www.nopa-instruments.com](http://www.nopa-instruments.com).

Questo è nostro catalogo e rimane nostra proprietà.

Trovano applicazione le nostre condizioni generali di fornitura, che sono disponibili sul nostro sito: [www.nopa-instruments.com](http://www.nopa-instruments.com).

Modelländerungen vorbehalten. Nachdruck, auch auszugsweise, verboten.

Change of design and pattern reserved. Re-printing, even in extracts, not permitted.

Nos reservamos el derecho de modificaciones sin aviso previo. Reimpresión, también parcialmente, está prohibido.

Tous droits réservés aux changements de modèle. Réimprimer, également partiellement, est interdit.

Noi riserviamo il diritto di effettuare delle modificazioni. Ristampa di divieto anche parziale.

Printed in Germany 110902





nopa<sup>®</sup>

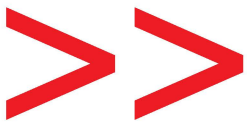



thank you for choosing  
**nopa** instruments...

...you obviously  
good taste have





# nopa<sup>®</sup> instruments

neurochirurgie

## neurosurgery

neurocirugía

neurochirurgie

neurochirurgia

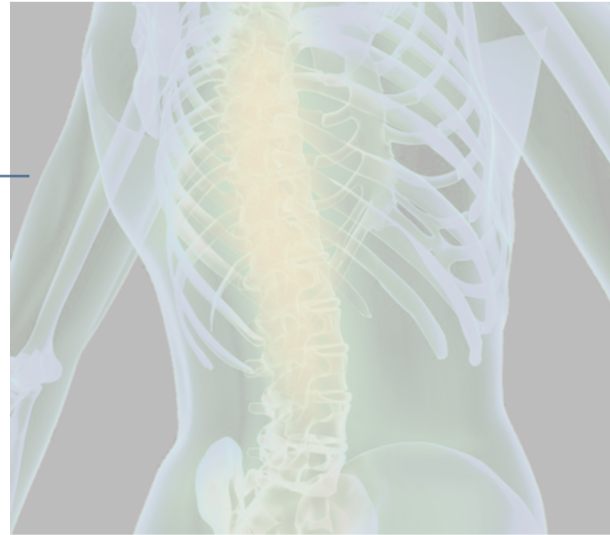
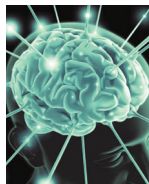
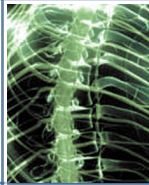
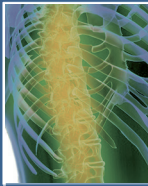

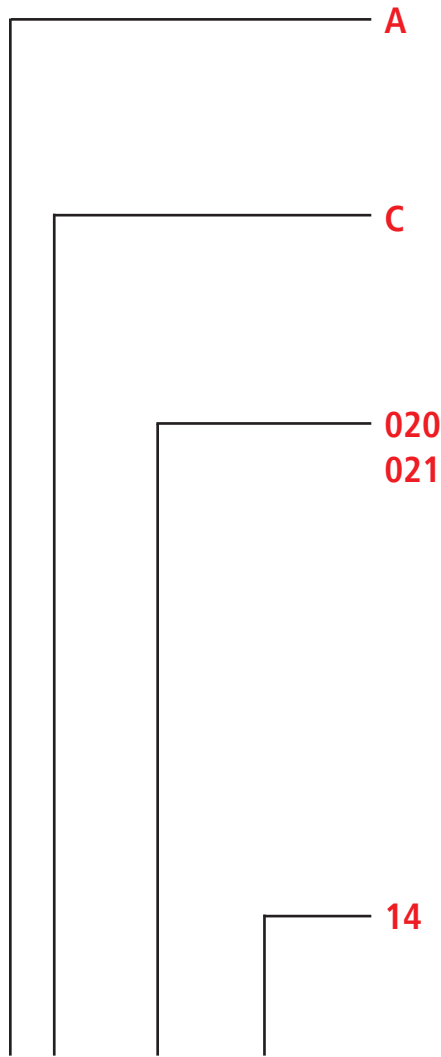

Artikelcode **AC 020/14**

#### Allgemeines Instrumentarium

General Instruments  
Instrumental Général  
Instruments Générales  
Strumenti generali

#### Scheren

Scissors  
Tijeras  
Ciseaux  
Forbici

#### Fortlaufende Nummern

Gerade Ziffer = gerades Instrument  
Ungerade Ziffer = gebogenes Instrument

#### Continuous number

Even number = straight instrument  
Odd number = curved instrument

#### Número de orden

números pares = instrumento derecho  
números impares = instrumento curvado

#### Numéros d'ordre

numéro pair = instrument droit  
numéro impair = instrument courbe

#### Numeri progressivamente

numero pari = strumento retto  
numero dispari = strumento curvo

#### Länge oder Figur

Length or Figure  
Longitud o figura  
Longueur ou figure  
Lunghezza o figura



INDEX

>> Klemmen >> Hemostats >> Pinzas hemostáticas >> Pincas hémostatiques >> Pinze emostatiche	11–14	AA
>> Pinzetten >> Forceps >> Pinzas >> Pincas >> Pinze	15–24	AB
>> Scheren >> Scissors >> Tijeras >> Ciseaux >> Forbici	24–38	AC
>> Naht >> Suture >> Sutura >> Suture >> Sutura	39–46	AE
>> Wundhaken >> Retractors >> Separadores >> Ecarteurs >> Divaricatori	47–58	AK
>> Punktion/Kanülen >> Puncture/Special Needles >> Punción/Agujas especiales >> Punction/Aiguilles spéciales >> Puntura/Aghi speciali	59–60	AO
>> Diagnostik >> Diagnostics >> Diagnóstico >> Diagnostic >> Diagnostica	61–64	AR
>> Orthopädie >> Orhtopaedics >> Ortopedia >> Orthopédie >> Ortopedia	65–84	KA
>> Neurochirurgie >> Neurosurgery >> Neurocirugía >> Neurochirurgie >> Neurochirurgia	85–170	KS
>> Endoskopie >> Endoscopy >> Endoscopia >> Endoscopie >> Endoscopia	171–174	XR
>> Endoskopie >> Endoscopy >> Endoscopia >> Endoscopie >> Endoscopia	175–180	XT

>> our catalogues and products are available on website [www.nopa.de](http://www.nopa.de) and CD-Rom



Shop - Microsoft Internet Explorer provided by Tiscali

nopa<sup>®</sup> instruments

Deutsch english français español italiano info Contact

Quick search >> enter search string Unit cm

Products Shopping Trolley Shop > Catalogues > A - General Instruments > AA - Hemostats > Artery Forceps

### Artery Forceps

Article number	Description / Name	Product size	Form / Figure
AA 11013	SPENCER-WELLS ARTERY FORCEPS	13 cm	straight
AA 11014	SPENCER-WELLS ARTERY FORCEPS	14 cm	str AA 11113
AA 11015	SPENCER-WELLS ARTERY FORCEPS	15,5 cm	str
AA 11018	SPENCER-WELLS ARTERY FORCEPS	18 cm	str
AA 11020	SPENCER-WELLS ARTERY FORCEPS	20 cm	str
AA 11113	SPENCER-WELLS ARTERY FORCEPS	13 cm	cu
AA 11114	SPENCER-WELLS ARTERY FORCEPS	14 cm	cu
AA 11115	SPENCER-WELLS ARTERY FORCEPS	15,5 cm	cu
AA 11118	SPENCER-WELLS ARTERY FORCEPS	18 cm	cu
AA 11120	SPENCER-WELLS ARTERY FORCEPS	20 cm	cu
AA 11410	HARTMANN ARTERY FORCEPS	10 cm	str
AA 11510	HARTMANN ARTERY FORCEPS	10 cm	cu
AA 11808	CARREL ARTERY FORCEPS	8,5 cm	straight
AA 11808	TERRIER ARTERY FORCEPS 1X2 T.	8,5 cm	straight

Medizintechnik GmbH • Weillatten 7 • 78532 Tuttlingen • Germany • [www.nopa.de](http://www.nopa.de)



---

KLEMMEN  
HEMOSTATS  
PINZAS HEMOSTATICAS  
PINCES HEMOSTATIQUES  
PINZE EMOSTATICHE

AA

nopa<sup>®</sup> instruments



Kopfhautklemmen  
 Scalp Flap Forceps  
 Pinzas hemostáticas para pericráneo  
 Pincés hémostatiques pour le cuir chevelu  
 Pinze emostatiche per il cuoio capelluto

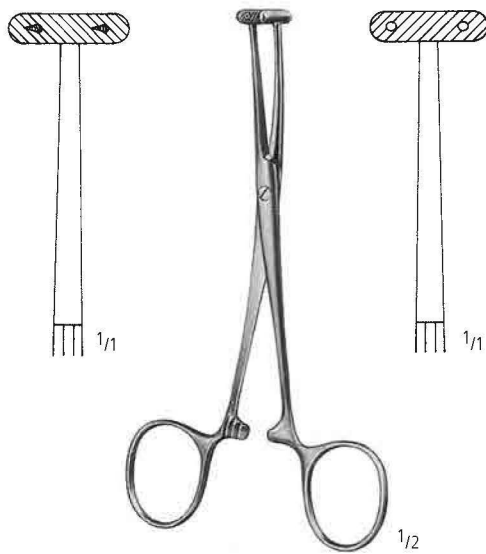

**MARTEL**  
 AA 078/14  
 14,0 cm/5½"

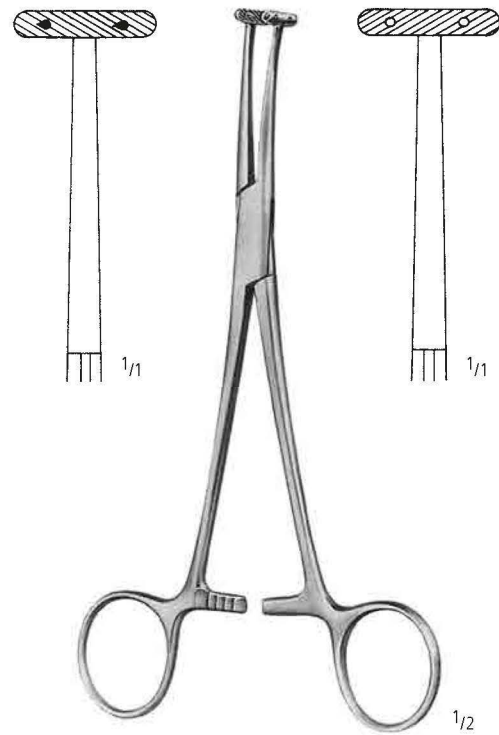

**WILLET-MARTEL**  
 AA 078/19  
 19,0 cm/7½"

Feine Arterienklemmen  
 Fine Artery Forceps  
 Pinzas hemostáticas finas  
 Pincas hémostatiques fines  
 Pinze emostatiche fine

AA  
 AB  
 AC  
 AE  
 AK  
 AO  
 AR  
 KA  
 KS  
 XR  
 XT

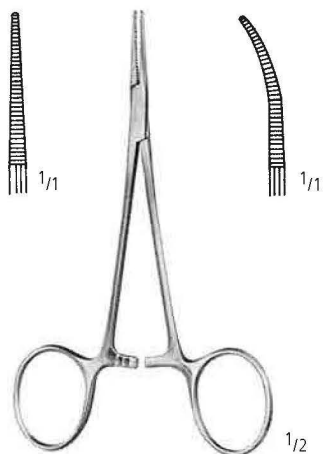

**MICRO-MOSQUITO**

AA 130/10      AA 131/10  
 AA 130/12      AA 131/12

10,0 cm/4"  
 12,0 cm/4<sup>3</sup>/<sub>4</sub>"

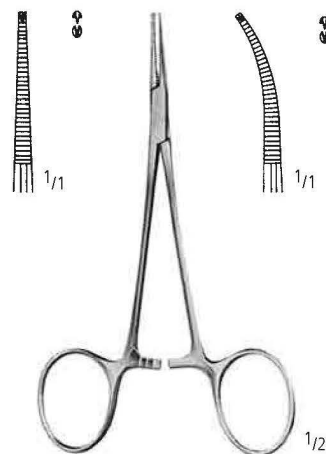

**MICRO-MOSQUITO 1:2**

AA 132/10      AA 133/10  
 AA 132/12      AA 133/12



**BABY-OVERHOLT**

AA 225/13  
 13,5 cm/5<sup>1</sup>/<sub>4</sub>"



**BABY-ADSON**

AA 235/14  
 14,0 cm/5<sup>1</sup>/<sub>2</sub>"

**AA** KLEMMEN HEMOSTATS PINZAS HEMOSTATICAS PINCES HEMOSTATIQUES PINZE EMOSTATICHE

Präparierklemmen  
Dissecting Forceps  
Pinzas para preparaciones  
Pincès à dissection  
Pinze per preparazione

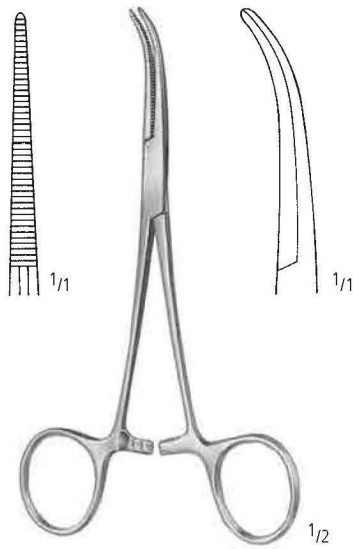

**DANDY**  
AA 291/14  
14,0 cm/5 1/2"

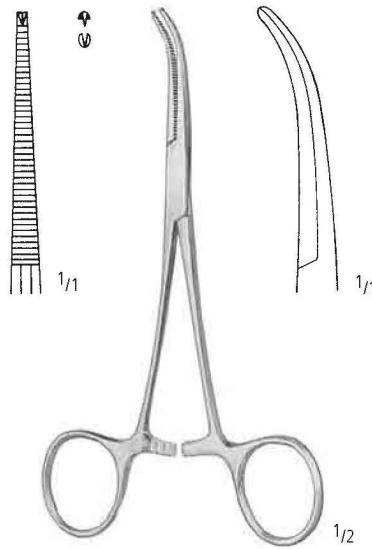

**DANDY 1:2**  
AA 293/14  
14,0 cm/5 1/2"

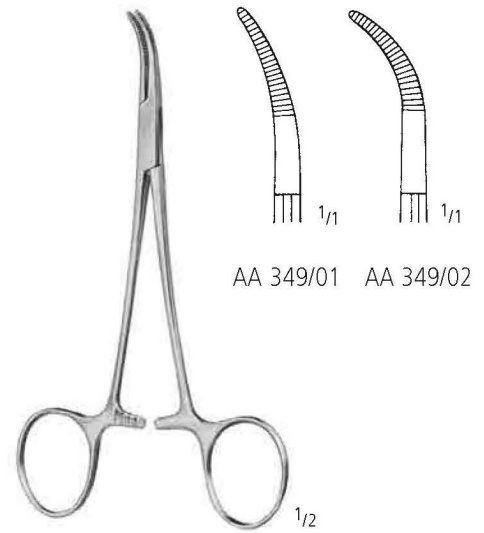

**BABY-MIXTER**  
14,0 cm/5 1/2"



**GEMINI**

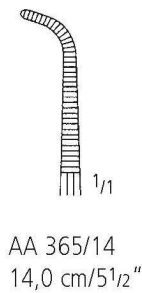

AA 365/14  
14,0 cm/5 1/2"

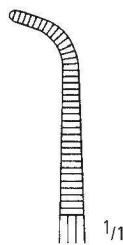

AA 365/18  
18,0 cm/7"

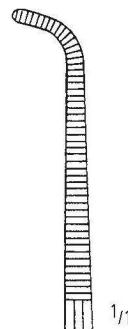

AA 365/22  
22,0 cm/8 3/4"

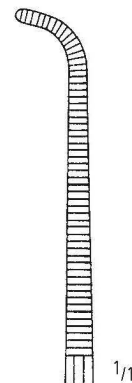

AA 365/25  
25,0 cm/10"

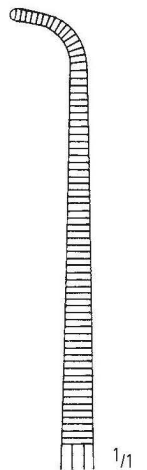

AA 365/28  
28,0 cm/11"

Weitere Klemmen siehe Katalog A 7-51 und Gruppe KS.  
For further hemostats see catalogue A 7-51 and section KS.  
Para otras pinzas hemostáticas ver catálogo A 7-51 y sección KS.  
D'autres pincès hémostatiques voir notre catalogue A 7-51 et groupe KS.  
Per altre pinze emostatiche consultare il nostro catalogo A 7-51 e gruppo KS.

---

PINZETTEN  
FORCEPS  
PINZAS  
PINCES  
PINZE

AB

nopa<sup>®</sup> instruments



**AB** PINZETTEN FORCEPS PINZAS PINCES PINZE

Anatomische Pinzetten, Chirurgische Pinzetten  
 Dressing Forceps, Tissue Forceps  
 Pinzas de disección, Pinzas de disección con dientes  
 Pincers à dissection, Pincers à griffes  
 Pinze anatomiche per dissezione, Pinze chirurgiche a denti di topo

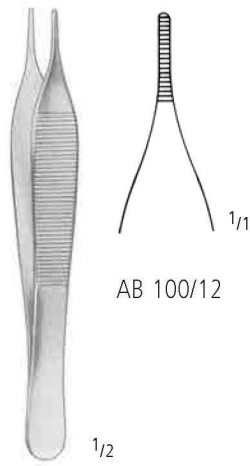

AB 100/12



AB 102/12

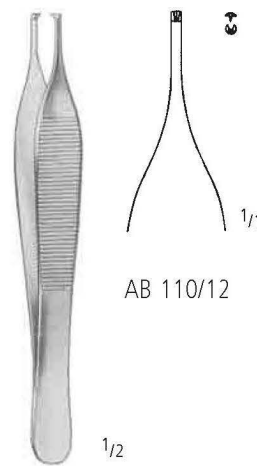

AB 110/12

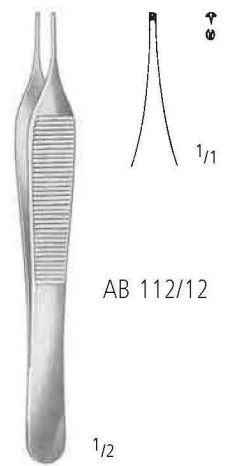

AB 112/12

12,0 cm/4<sup>3</sup>/<sub>4</sub>"  
 15,0 cm/6"

**ADSON**  
 AB 100/12  
 AB 100/15

**MICRO-ADSON**  
 AB 102/12  
 AB 102/15

**ADSON 1:2**  
 AB 110/12  
 AB 110/15

**MICRO-ADSON 1:2**  
 AB 112/12  
 AB 112/15

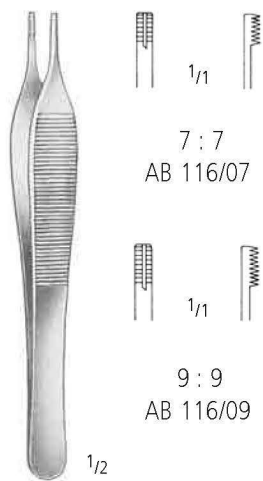

7 : 7  
 AB 116/07

1/1

9 : 9  
 AB 116/09

**ADSON-BROWN**

12,0 cm/4<sup>3</sup>/<sub>4</sub>"

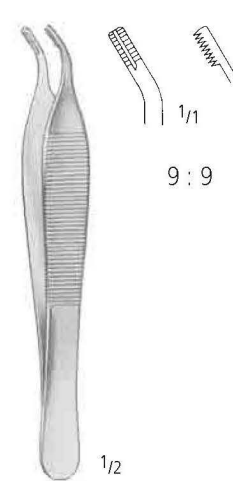

9 : 9

**ADSON-BROWN**

AB 117/09  
 12,0 cm/4<sup>3</sup>/<sub>4</sub>"



PINZETTEN FORCEPS PINZAS PINCES PINZE

Anatomische Pinzetten, Chirurgische Pinzetten  
 Dressing Forceps, Tissue Forceps  
 Pinzas de disección, Pinzas de disección con dientes  
 Pincés à dissection, Pincés à griffes  
 Pinze anatomiche per dissezione, Pinze chirurgiche a denti di topo

AA

AB

AC

AE

AK

AO

AR

KA

KS

XR

XT



**CUSHING**  
 AB 180/17 17,5 cm/7"



**CUSHING**  
 AB 181/17

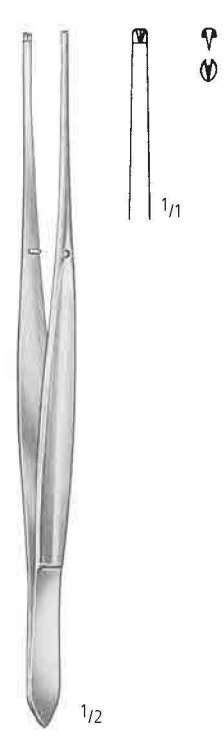

**CUSHING 1:2**  
 AB 190/17 17,5 cm/7"

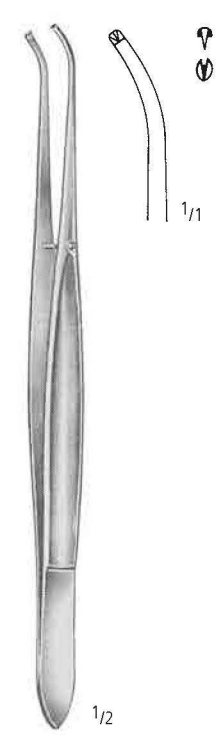

**CUSHING 1:2**  
 AB 191/17

**AB** PINZETTEN FORCEPS PINZAS PINCES PINZE

Uhrmacherpinzetten  
 Jeweler's Forceps  
 Pinzas de relojero  
 Pincès d'horloger  
 Pinze da orologiaio



No. 1 AB 501/01  
 12,0 cm/4<sup>3</sup>/<sub>4</sub>"



No. 2 AB 501/02  
 12,0 cm/4<sup>3</sup>/<sub>4</sub>"



No. 3 AB 501/03  
 12,0 cm/4<sup>3</sup>/<sub>4</sub>"



No. 4 AB 501/04  
 11,0 cm/4<sup>1</sup>/<sub>2</sub>"



No. 5 AB 501/05  
 11,0 cm/4<sup>1</sup>/<sub>2</sub>"



No. 5a AB 501/15  
 11,0 cm/4<sup>1</sup>/<sub>2</sub>"



No. 5/45° AB 501/45  
 10,5 cm/4"



No. 5/90° AB 501/90  
 10,5 cm/4"



No. 7 AB 502/07  
 11,5 cm/4<sup>1</sup>/<sub>2</sub>"

PINZETTEN FORCEPS PINZAS PINCES PINZE

Fasspinzetten  
Grasping Forceps  
Pinzas para coger  
Pinces pour saisir les tissus  
Pinze per afferrare tessuti

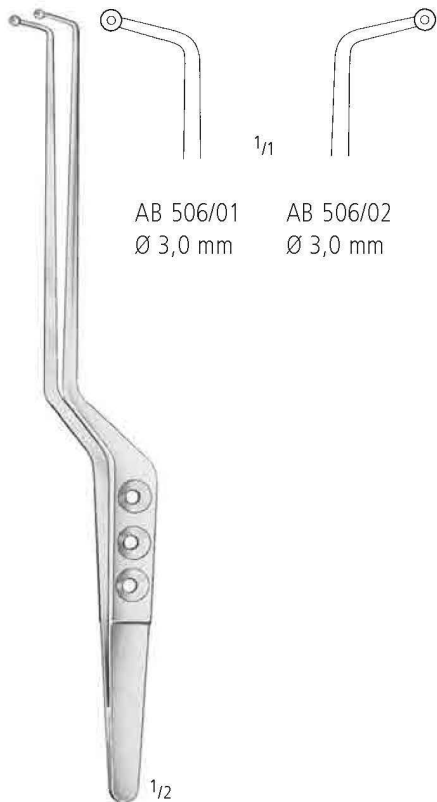

AB 506/01  
Ø 3,0 mm

AB 506/02  
Ø 3,0 mm

**SAMII**  
24,0 cm/9 1/4"



AB 507/01  
Ø 3,0 mm

AB 507/02  
Ø 5,0 mm

Löffel  
spoon  
cucharilla  
cuiller  
cucchiaio

AB 508/01  
Ø 3,0 mm

AB 508/02  
Ø 5,0 mm

flach  
flat  
plano  
plat  
piatto

22,0 cm/8 3/4"



AB 509/01  
Ø 3,0 mm

AB 509/02  
Ø 5,0 mm

Kürette  
curette  
cureta  
curette  
curetta

**HEIFETZ**  
22,0 cm/8 3/4"

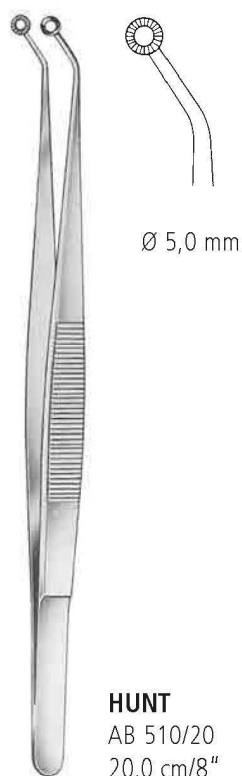

Ø 5,0 mm

**HUNT**  
AB 510/20  
20,0 cm/8"



16,0 cm/6 1/4"	AB 515/16	AB 516/16	
18,0 cm/7"	AB 515/18	AB 516/18	AB 517/18
20,0 cm/8"	AB 515/20	AB 516/20	
22,0 cm/8 3/4"	AB 515/22	AB 516/22	
24,0 cm/9 1/2"	AB 515/24	AB 516/24	

0,6 mm      0,9 mm      1:2

AC  
AE  
AK  
AO  
AR  
KA  
KS  
XR  
XT

**AB** PINZETTEN FORCEPS PINZAS PINCES PINZE

Mikro-Pinzetten, Knüpfpinzetten mit Plateau  
 Micro Forceps, Suture Tying Forceps with platform  
 Micro-Pinzas, Pinzas de ligadura con plataforma  
 Micro-Pinces, Pinces à ligature avec plate-forme  
 Micro-Pinze, Pinze per ligature con piattaforma

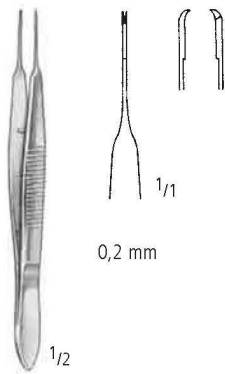

**AB 530/09 1:2**  
 9,5 cm/3<sup>3</sup>/<sub>4</sub>"

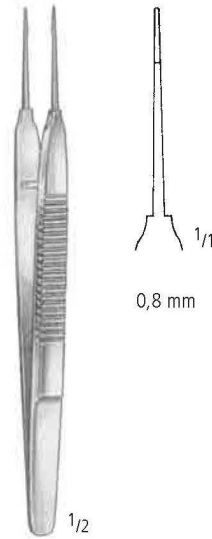

**AUSTIN**  
**AB 532/14**  
 14,0 cm/5<sup>1</sup>/<sub>2</sub>"

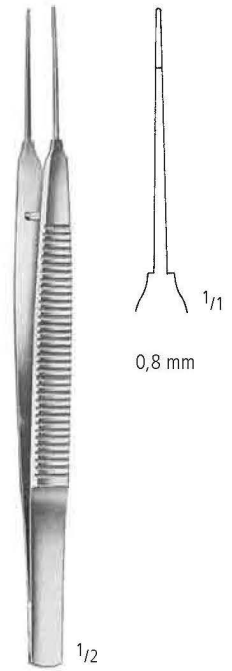

**AUSTIN**  
**AB 532/18**  
 18,0 cm/7"

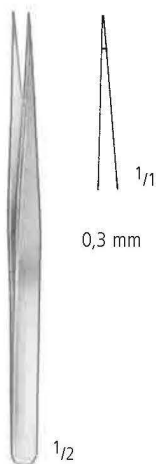

**AB 534/12**  
 12,0 cm/4<sup>3</sup>/<sub>4</sub>"



**WISE**  
**AB 534/13**  
 13,5 cm/5<sup>1</sup>/<sub>4</sub>"

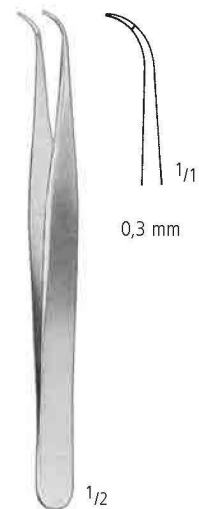

**WISE**  
**AB 535/13**  
 13,5 cm/5<sup>1</sup>/<sub>4</sub>"

PINZETTEN FORCEPS PINZAS PINCES PINZE

Mikro-Pinzetten, Knüpfpinzetten mit Plateau  
 Micro Forceps, Suture Tying Forceps with platform  
 Micro-Pinzas, Pinzas de ligadura con plataforma  
 Micro-Pinces, Pinces à ligature avec plate-forme  
 Micro-Pinze, Pinze per ligature con piattaforma

AA

AB

AC

AE

AK

AO

AR

KA

KS

XR

XT



AB 536/14  
 14,0 cm/5 1/2"



AB 538/14 **1:2**  
 14,0 cm/5 1/2"



AB 540/14 **1:2**  
 14,0 cm/5 1/2"

**AB** PINZETTEN FORCEPS PINZAS PINCES PINZE

Mikro-Pinzetten  
 Micro Forceps  
 Micro-Pinzas  
 Micro-Pinces  
 Micro-Pinze



12,0 cm/4<sup>3</sup>/<sub>4</sub>"  
 15,0 cm/6"



0,3 mm

AB 542/12  
 AB 542/15



0,3 mm

AB 543/12  
 AB 543/15



18,0 cm/7"



AB 544/18

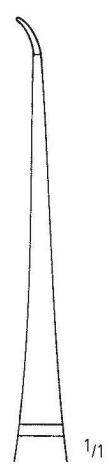

AB 545/18

Weitere Mikro-Pinzetten siehe Gruppe KS.  
 For further micro forceps see section KS.  
 Para otras micro-pinzas ver sección KS.  
 D'autres micro-pinces voir groupe KS.  
 Altre micro-pinze vedi gruppo KS.

PINZETTEN FORCEPS PINZAS PINCES PINZE

Atraumatische Pinzetten  
 Non-traumatic Vascular Tissue Forceps  
 Pinzas Atrauma  
 Pincas Atrauma  
 Pinze Atrauma

AA

AB

AC

AE

AK

AO

AR

KA

KS

XR

XT

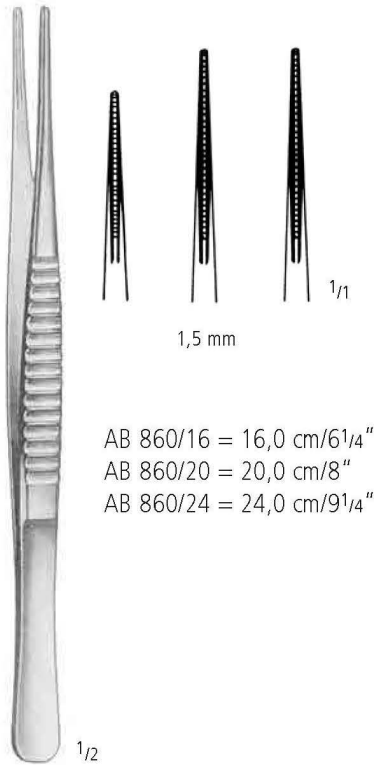

1,5 mm

AB 860/16 = 16,0 cm/6<sup>1</sup>/<sub>4</sub>"  
 AB 860/20 = 20,0 cm/8"  
 AB 860/24 = 24,0 cm/9<sup>1</sup>/<sub>4</sub>"

DE BAKEY

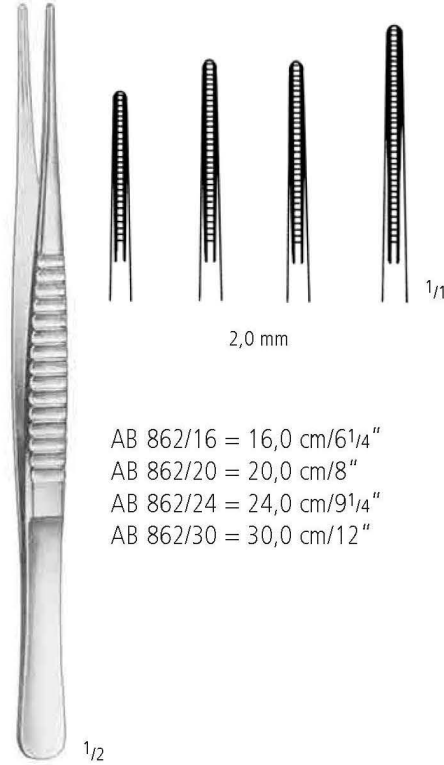

2,0 mm

AB 862/16 = 16,0 cm/6<sup>1</sup>/<sub>4</sub>"  
 AB 862/20 = 20,0 cm/8"  
 AB 862/24 = 24,0 cm/9<sup>1</sup>/<sub>4</sub>"  
 AB 862/30 = 30,0 cm/12"

DE BAKEY

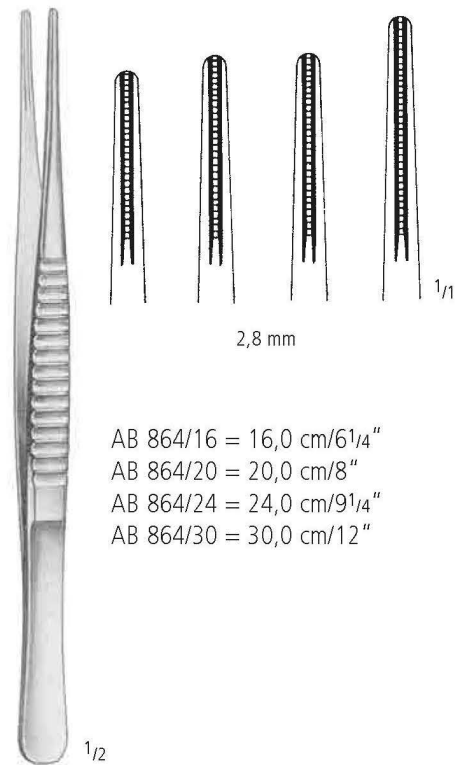

2,8 mm

AB 864/16 = 16,0 cm/6<sup>1</sup>/<sub>4</sub>"  
 AB 864/20 = 20,0 cm/8"  
 AB 864/24 = 24,0 cm/9<sup>1</sup>/<sub>4</sub>"  
 AB 864/30 = 30,0 cm/12"

DE BAKEY

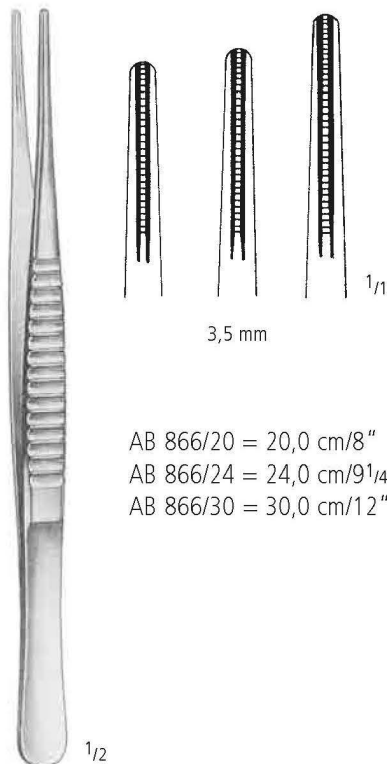

3,5 mm

AB 866/20 = 20,0 cm/8"  
 AB 866/24 = 24,0 cm/9<sup>1</sup>/<sub>4</sub>"  
 AB 866/30 = 30,0 cm/12"

DE BAKEY

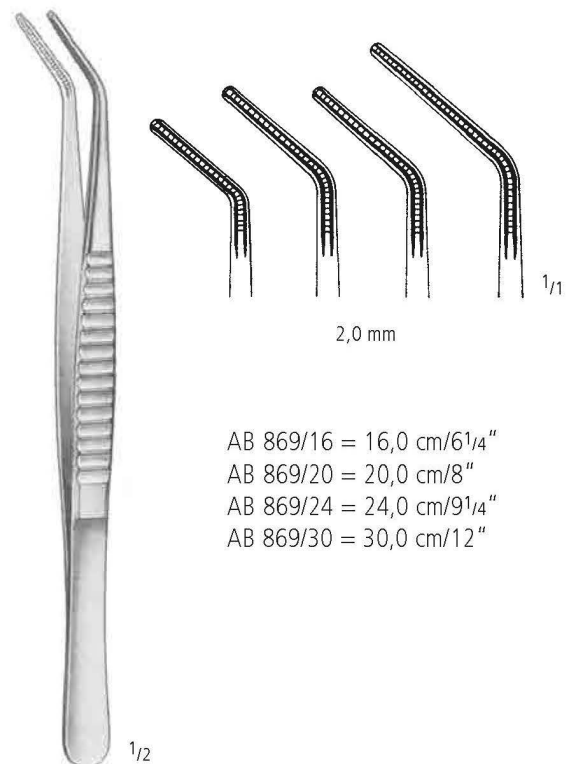

2,0 mm

AB 869/16 = 16,0 cm/6<sup>1</sup>/<sub>4</sub>"  
 AB 869/20 = 20,0 cm/8"  
 AB 869/24 = 24,0 cm/9<sup>1</sup>/<sub>4</sub>"  
 AB 869/30 = 30,0 cm/12"

DE BAKEY

**AB** PINZETTEN FORCEPS PINZAS PINCES PINZE

Pinzetten mit Hartmetalleinsätzen  
 Dissecting Forceps with Tungsten Carbide Inserts  
 Pinzas de disección con bocas de carburo de tungsteno  
 Pincas à dissection avec mors en carbure de tungstène  
 Pinze per dissezione con punte di carburo di tungsteno

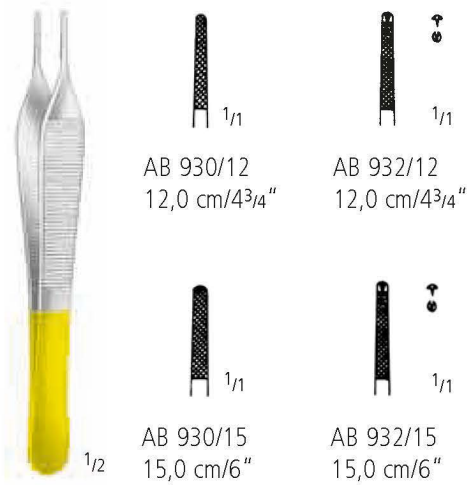

**ADSON**

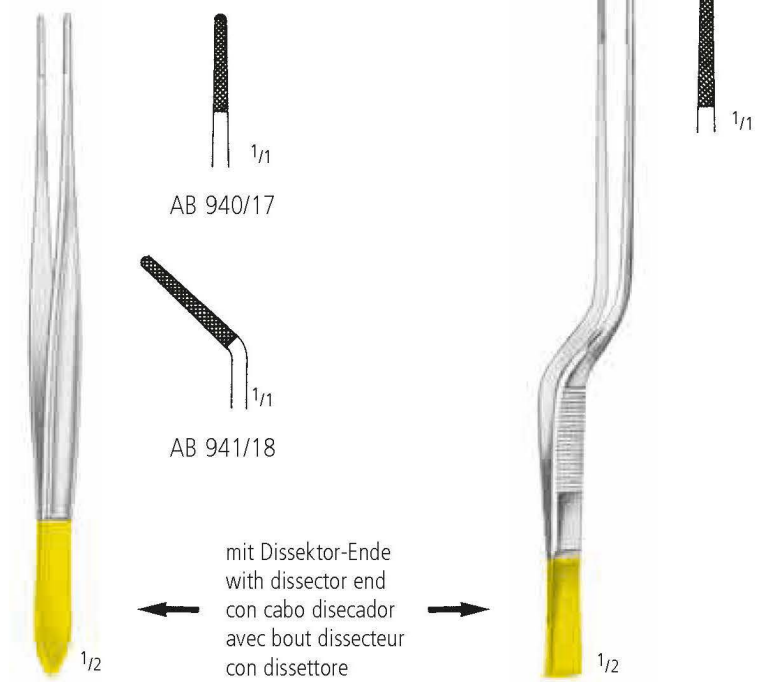

**CUSHING**  
17,5 cm/7"

**CUSHING-TAYLOR**  
AB 943/18  
18,0 cm/7"

mit Dissektor-Ende  
 with dissector end  
 con cabo disecador  
 avec bout dissecteur  
 con dissettore



---

SCHEREN  
SCISSORS  
TIJERAS  
CISEAUX  
FORBICI

AC

nopa<sup>®</sup> instruments



**AC** SCHEREN SCISSORS TIJERAS CISEAUX FORBICI

Scheren für Neurochirurgie  
 Scissors for Neuro Surgery  
 Tijeras para neurocirugía  
 Ciseaux pour neurochirurgie  
 Forbici per neurochirurgia

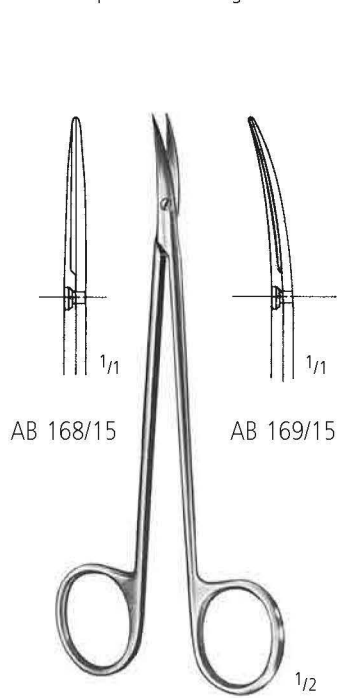

AB 168/15

AB 169/15

15,0 cm/6"

Nerv-Präparierschere  
 Nerve dissecting scissors  
 Tijeras para nervios  
 Ciseaux pour nerfs  
 Forbici per nervi



geknöpft  
 probe pointed  
 con botón  
 boutonné  
 bottenuto

AC 231/22  
 22,0 cm/8<sup>3</sup>/<sub>4</sub>"

**STRULLY**



AC 232/22  
 22,0 cm/8<sup>3</sup>/<sub>4</sub>"

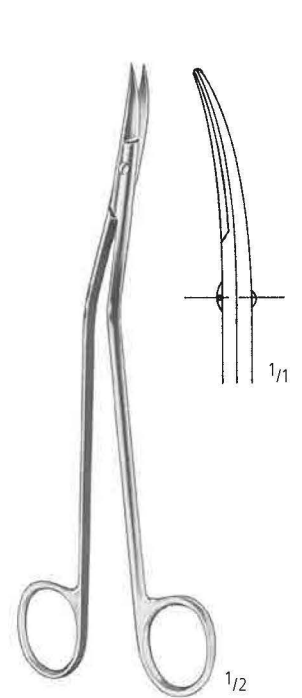

**DANDY**  
 AC 233/17  
 17,0 cm/6<sup>3</sup>/<sub>4</sub>"

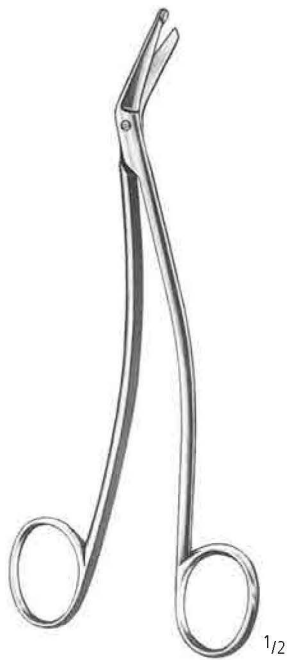

**SCHMIEDEN-TAYLOR**

14,5 cm/5<sup>1</sup>/<sub>2</sub>"      AC 241/15  
 17,0 cm/6<sup>3</sup>/<sub>4</sub>"      AC 241/17

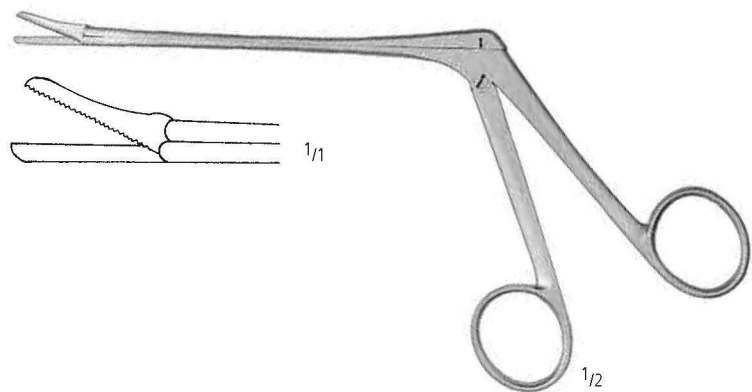

**OLIVECRONA**

AC 259/23  
 23,0 cm/9"

SCHEREN SCISSORS TIJERAS CISEAUX FORBICI

Mikroschere  
Micro Scissors  
Micro Tijeras  
Micro Ciseaux  
Micro Forbici

- >> Alle unsere Mikroschere werden von Fachkräften mit jahrelanger Erfahrung hergestellt. Die Endkontrolle findet unter dem Mikroskop statt. Um Ihnen ein ermüdungsfreies Arbeiten zu ermöglichen, wird dem Federdruck größte Aufmerksamkeit gewidmet.
- >> Bitte wählen Sie unter Rund- oder Flachgriffschere.

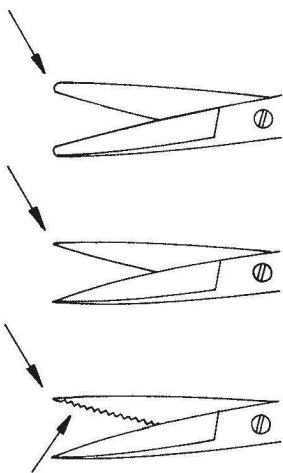

**Dissection:** **Gebogene Blätter, abgerundete Spitzen** ermöglichen eine gute und sichere Dissektion, ohne Nerven und Blutgefäße zu beschädigen.

**Adventitia:** **Gerade Blätter, sehr scharfe Spitzen** gewährleisten präzises Anfrischen von Gefäßenden.

**Nerve:** Ein Blatt ist **fein gezahnt**, um ein Herausgleiten des Nerven zu vermeiden.

- >> All our Micro Scissors are manufactured by skilled craftsmen with many years of experience. Final inspection is carried out under a microscope. Careful attention is paid to the closing pressure of the spring handle, to ensure precise work during surgeries, without fatigue.
- >> Round or flat handle scissors according to your preference.

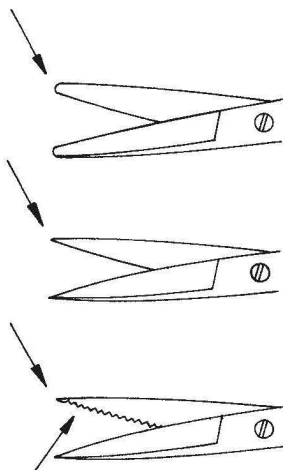

**Dissection:** **Curved blades, slightly rounded tips** ensure safe dissection without damage to nerves and vessels.

**Adventitia:** **Straight blades, very sharp tips** for finest trimming of vessel ends.

**Nerve:** One blade is **fine-toothed** to avoid slipping of the nerve.

AA

AB

AC

AE

AK

AO

AR

KA

KS

XR

XT

**AC** SCHEREN SCISSORS TIJERAS CISEAUX FORBICI

Mikroscheren  
Micro Scissors  
Micro Tijeras  
Micro Ciseaux  
Micro Forbici



14,5 cm/5 1/2"

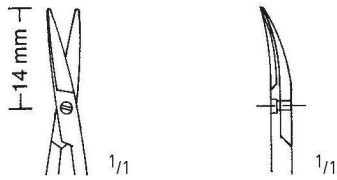

**Dissection**  
AC 801/15

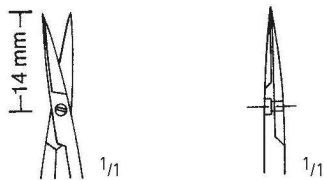

**Adventitia**  
AC 803/15



18,0 cm/7"

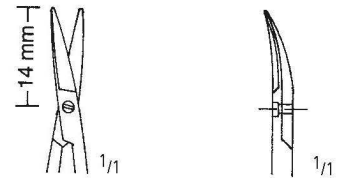

**Dissection**  
AC 801/18

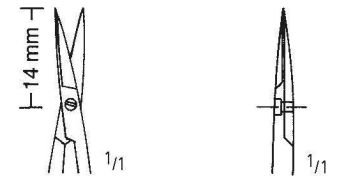

**Adventitia**  
AC 803/18

SCHEREN SCISSORS TIJERAS CISEAUX FORBICI

Mikroscheren  
Mikro Scissors  
Micro Tijeras  
Micro Ciseaux  
Micro Forbici

AA

AB

AC

AE

AK

AO

AR

KA

KS

XR

XT

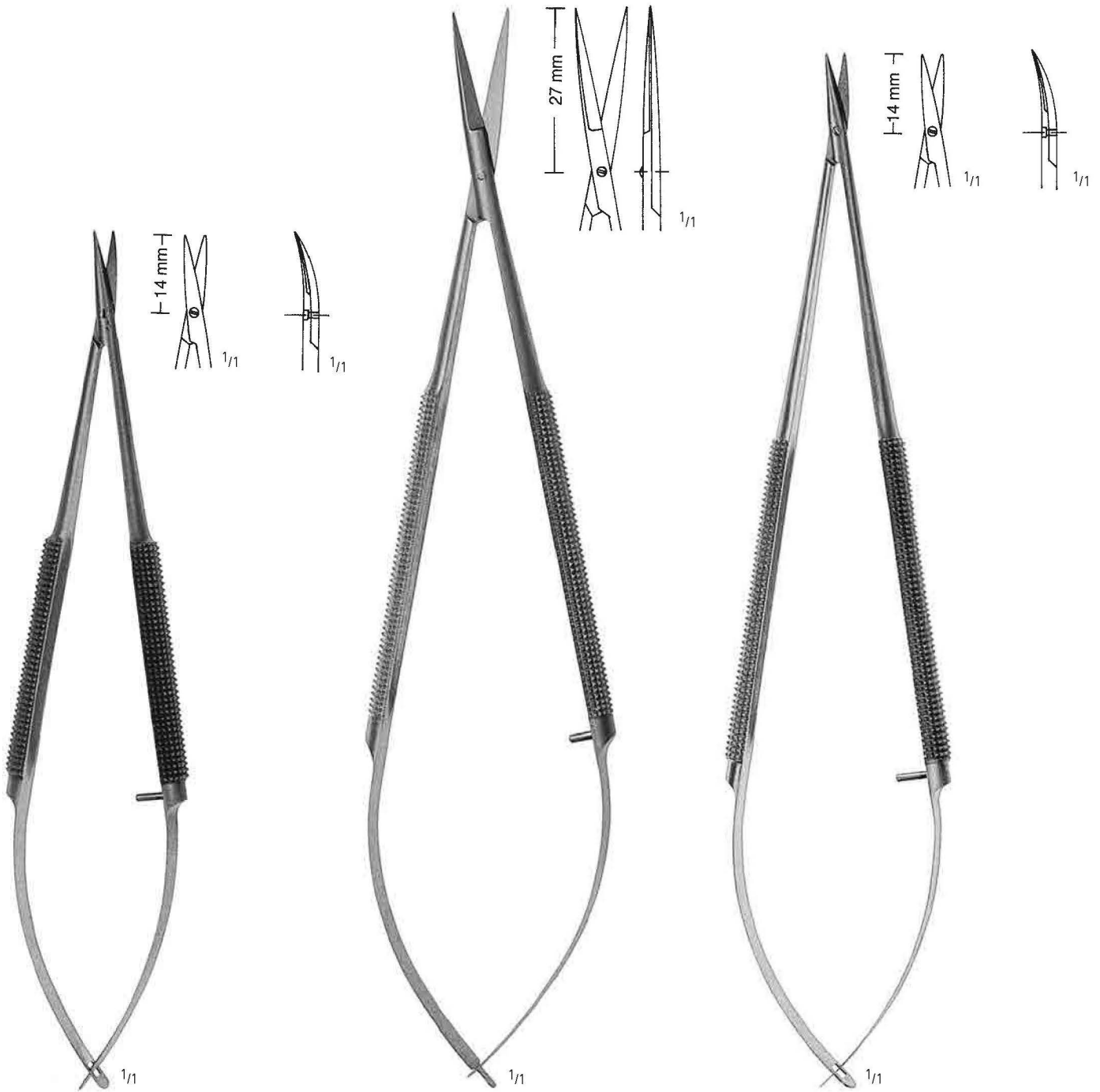

AC 807/14  
14,5 cm/5 1/2"

AC 812/18  
18,0 cm/7"

AC 817/18  
18,0 cm/7"

**AC** SCHEREN SCISSORS TIJERAS CISEAUX FORBICI

Mikroscheren  
Micro Scissors  
Micro Tijeras  
Micro Ciseaux  
Micro Forbici



11,0 cm/4 1/2"

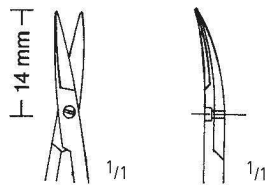

**Dissection**  
AC 821/11

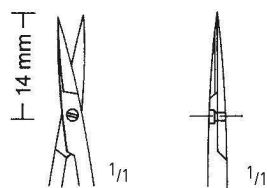

**Adventitia**  
AC 830/11

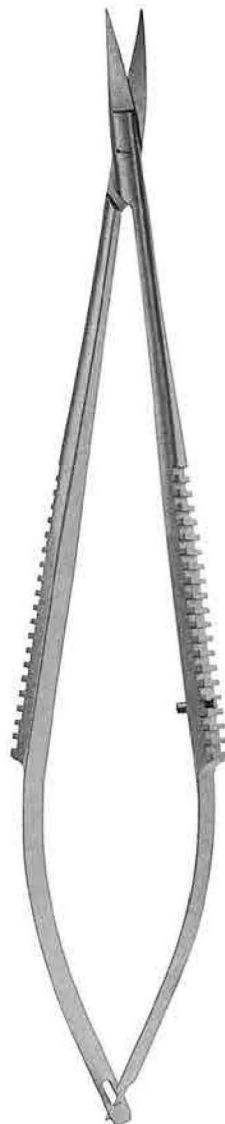

15,0 cm/6"

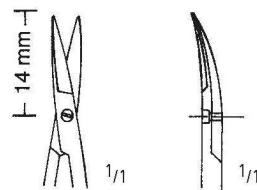

**Dissection**

AC 823/15

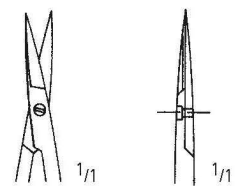

**Adventitia**

AC 832/15

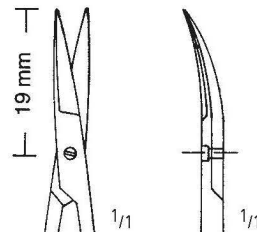

**Dissection**

AC 825/15

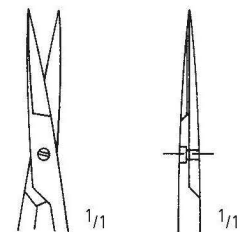

**Adventitia**

AC 834/15

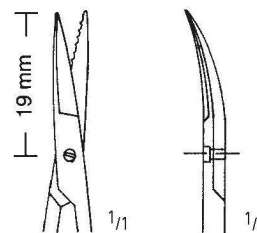

**Dissection**

AC 827/15

**>> Nerve >> Adventitia**

AC 836/15

SCHEREN SCISSORS TIJERAS CISEAUX FORBICI

Mikroscheren  
Micro Scissors  
Micro Tijeras  
Micro Ciseaux  
Micro Forbici

AA

AB

AC

AE

AK

AO

AR

KA

KS

XR

XT

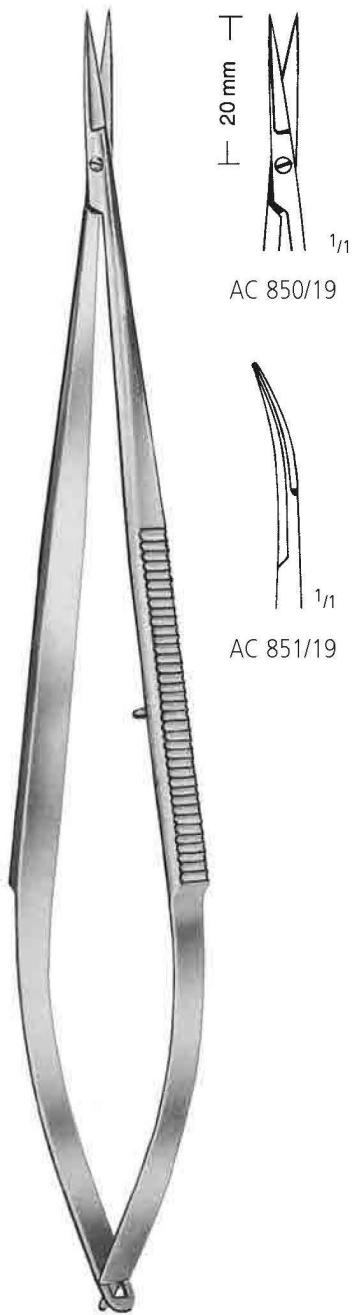

18,5 cm/7<sup>1</sup>/<sub>4</sub>"

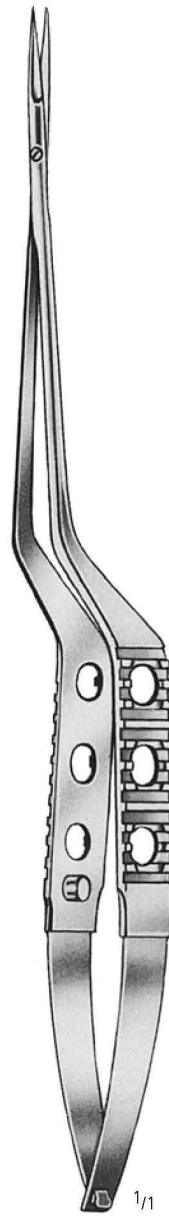

16,0 cm/6<sup>1</sup>/<sub>4</sub>"  
20,0 cm/8"  
22,5 cm/9"

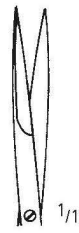

AC 860/16  
AC 860/20  
AC 860/22

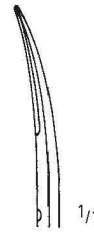

AC 861/16  
AC 861/20  
AC 861/22



AC 862/16  
AC 862/20  
AC 862/22



AC 863/16  
AC 863/20  
AC 863/22



AC 864/16  
AC 864/20  
AC 864/22



AC 865/16  
AC 865/20  
AC 865/22

AC SCHEREN SCISSORS TIJERAS CISEAUX FORBICI

Mikroscheren  
Micro Scissors  
Micro Tijeras  
Micro Ciseaux  
Micro Forbici



18,0 cm/7"

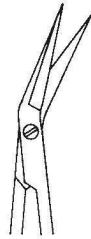

AC 870/01  
25°



AC 870/02  
45°

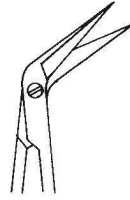

AC 870/03  
60°

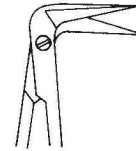

AC 870/04  
90°

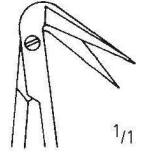

AC 870/05  
125°



18,0 cm/7"

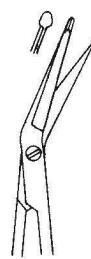

AC 871/01  
25°

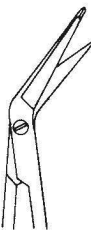

AC 871/02  
45°

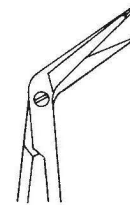

AC 871/03  
60°

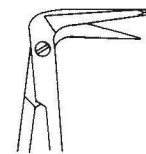

AC 871/04  
90°

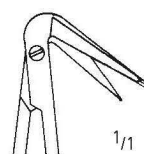

AC 871/05  
125°



SCHEREN SCISSORS TIJERAS CISEAUX FORBICI

Scheren mit Hartmetalleinlagen  
 Scissors with Tungsten Carbide Inserts  
 Tijeras con filos de carburo de tungsteno  
 Ciseaux avec plaquettes en carbure de tungstène  
 Forbici con taglio al carburo di tungsteno

AA

AB

AC

AE

AK

AO

AR

KA

KS

XR

XT

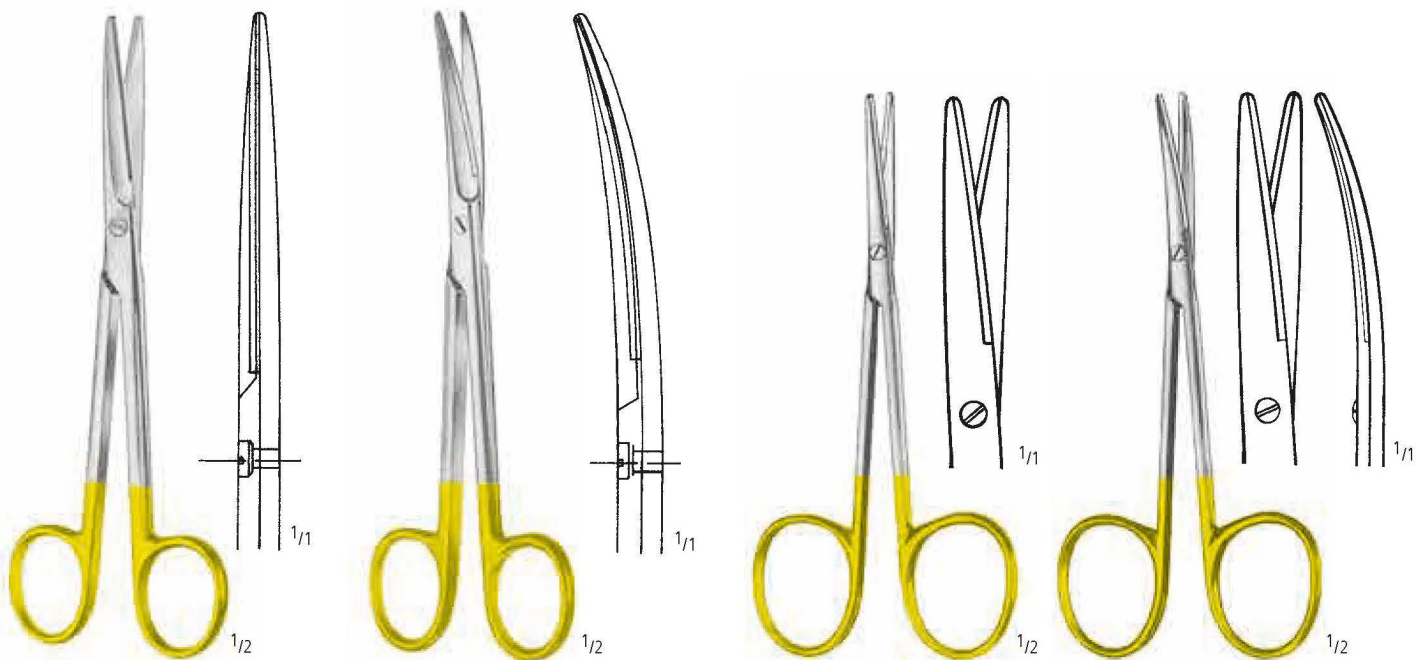
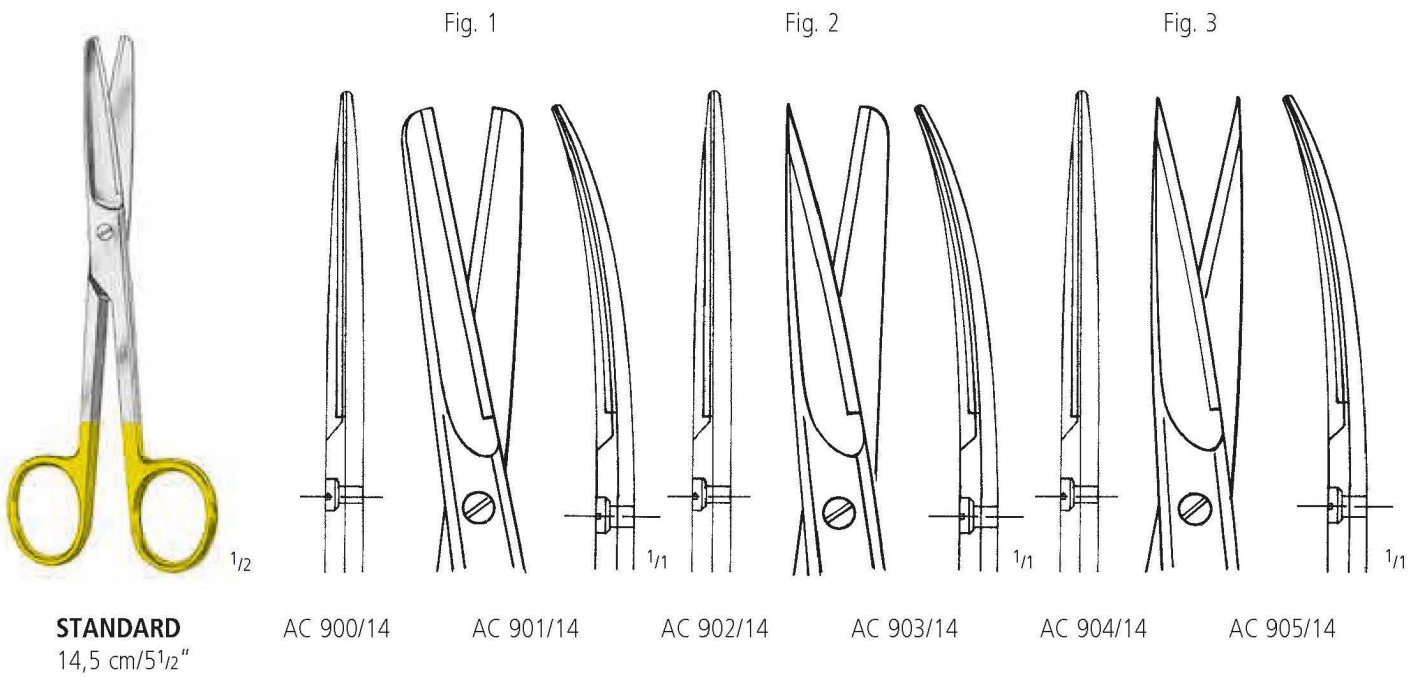

**MAYO**  
 AC 910/14 14,5 cm/5 1/2"  
 AC 910/17 17,0 cm/6 3/4"  
 AC 910/23 23,0 cm/9"

**MAYO**  
 AC 911/14  
 AC 911/17  
 AC 911/23

**METZENBAUM**  
 AC 930/14 14,5 cm/5 1/2"  
 AC 931/14 14,5 cm/5 1/2"

**AC** SCHEREN SCISSORS TIJERAS CISEAUX FORBICI

Scheren mit Hartmetalleinlagen  
 Scissors with Tungsten Carbide Inserts  
 Tijeras con filos de carburo de tungsteno  
 Ciseaux avec plaquettes en carbure de tungstène  
 Forbici con taglio al carburo di tungsteno

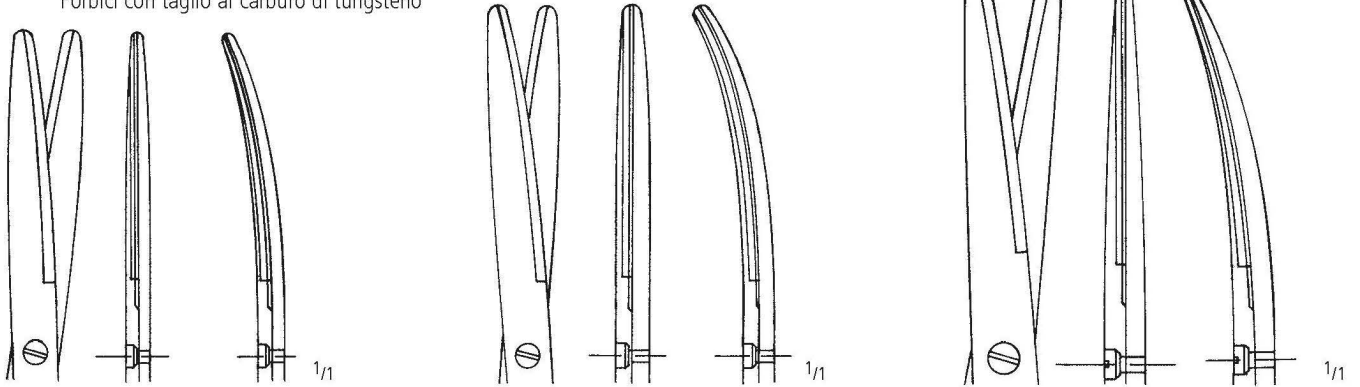

Original 18,0 cm

Original 20,0 cm

Original 23,0 cm



**METZENBAUM**



gerade  
 straight  
 rectas  
 droits  
 retta

gebogen  
 curved  
 curvas  
 courbes  
 curva

AC 940/18	18,0 cm/7"	AC 941/18
AC 940/20	20,0 cm/8"	AC 941/20
AC 940/23	23,0 cm/9"	AC 941/23
AC 940/25	25,0 cm/10"	AC 941/25
AC 940/28	28,0 cm/11"	AC 941/28
AC 940/30	30,0 cm/12"	AC 941/30

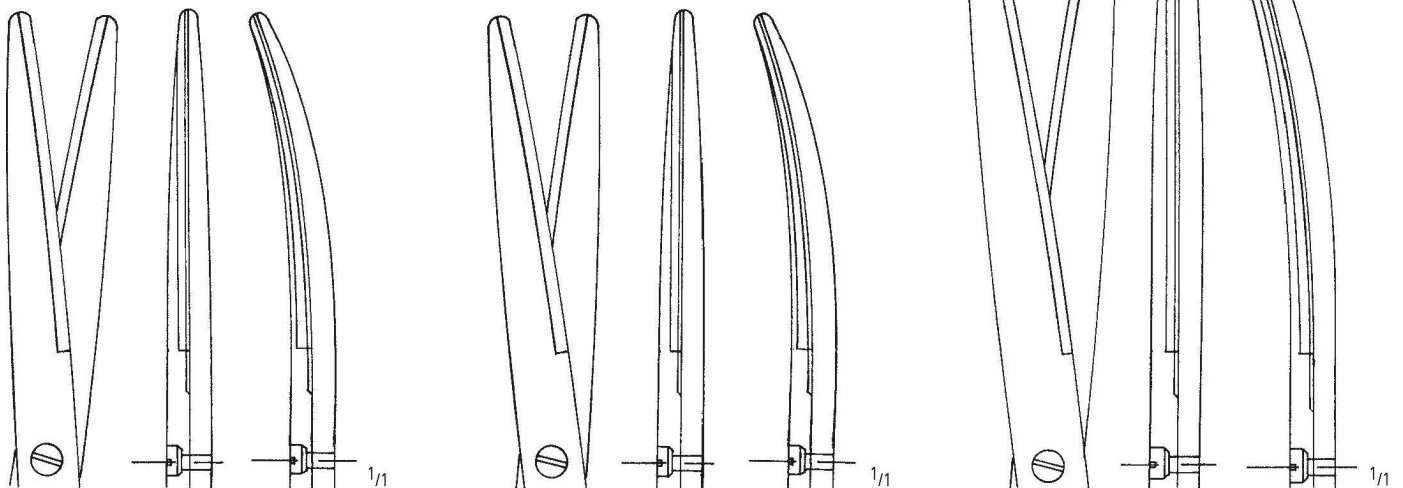

Original 25,0 cm

Original 28,0 cm

Original 30,0 cm

SCHEREN SCISSORS TIJERAS CISEAUX FORBICI

Scheren mit Hartmetalleinlagen  
 Scissors with Tungsten Carbide Inserts  
 Tijeras con filos de carburo de tungsteno  
 Ciseaux avec plaquettes en carbure de tungstène  
 Forbici con taglio al carburo di tungsteno

AA

AB

AC

AE

AK

AO

AR

KA

KS

XR

XT

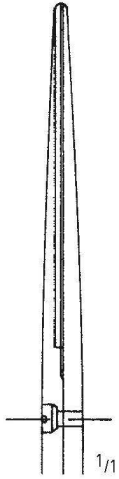

**LEXER**  
 AC 952/16  
 16,0 cm/6<sup>1</sup>/<sub>4</sub>"

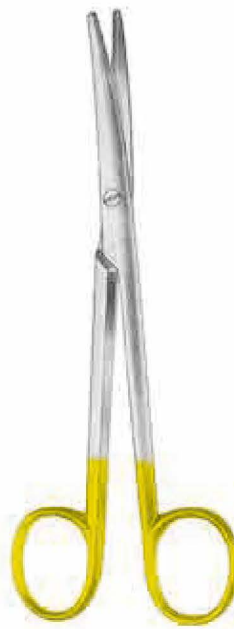
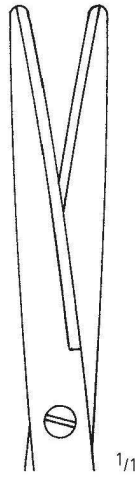

**LEXER**  
 AC 953/16  
 16,0 cm/6<sup>1</sup>/<sub>4</sub>"

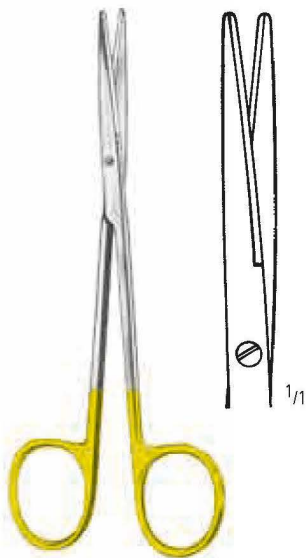

AC 960/14  
 14,5 cm/5<sup>1</sup>/<sub>2</sub>"  
 /5<sup>1</sup>/<sub>2</sub>"

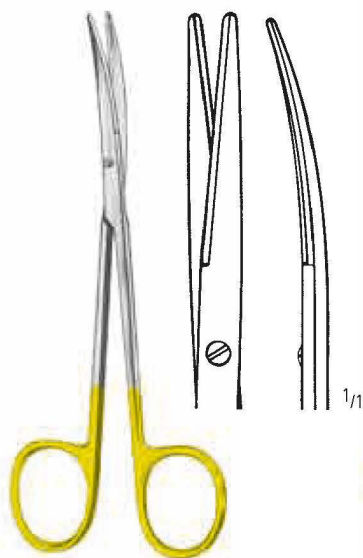

AC 961/14  
 14,5 cm/5<sup>1</sup>/<sub>2</sub>"

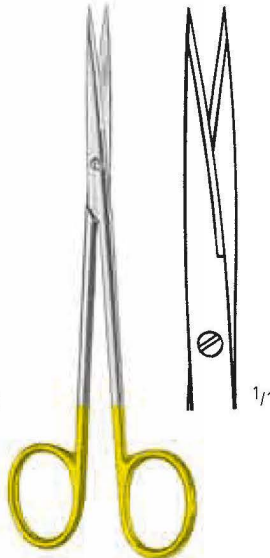

AC 962/14  
 14,5 cm/5<sup>1</sup>/<sub>2</sub>"

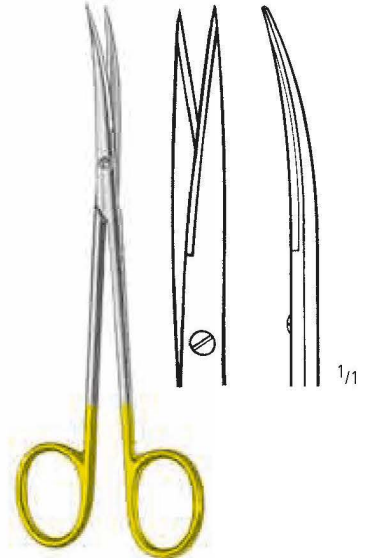

AC 963/14  
 14,5 cm

**METZENBAUM-DELICATE**

**AC** SCHEREN SCISSORS TIJERAS CISEAUX FORBICI

Scheren mit Hartmetalleinlagen  
 Scissors with Tungsten Carbide Inserts  
 Tijeras con filos de carburo de tungsteno  
 Ciseaux avec plaquettes en carbure de tungstène  
 Forbici con taglio al carburo di tungsteno

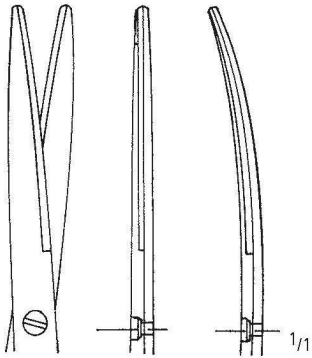

Original 18,0 cm

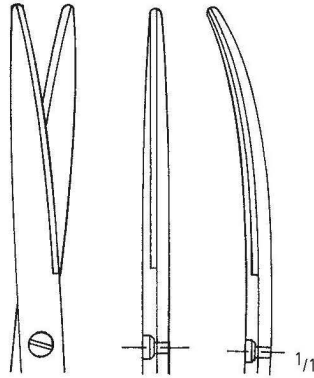

Original 20,0 cm

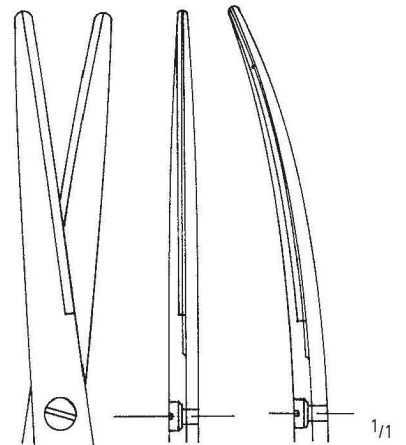

Original 23,0 cm



**METZENBAUM-DELICATE**



gerade  
 straight  
 rectas  
 droits  
 retta

gebogen  
 curved  
 curvas  
 courbes  
 curva

AC 970/18	18,0 cm/7"	AC 971/18
AC 970/20	20,0 cm/8"	AC 971/20
AC 970/23	23,0 cm/9"	AC 971/23
AC 970/25	25,0 cm/10"	AC 971/25
AC 970/28	28,0 cm/11"	AC 971/28

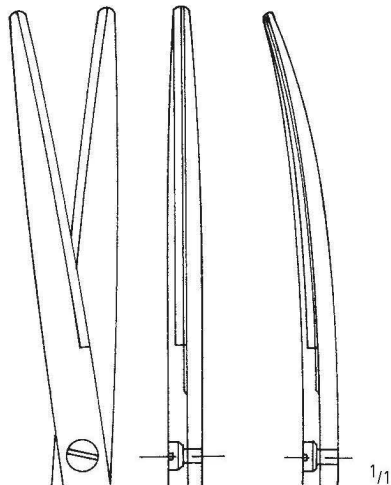

Original 25,0 cm

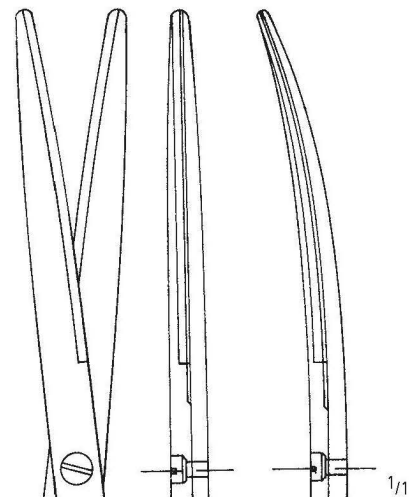

Original 28,0 cm

SCHEREN SCISSORS TIJERAS CISEAUX FORBICI

Scheren mit Hartmetalleinlagen  
 Scissors with Tungsten Carbide Inserts  
 Tijeras con filos de carburo de tungsteno  
 Ciseaux avec plaquettes en carbure de tungstène  
 Forbici con taglio al carburo di tungsteno

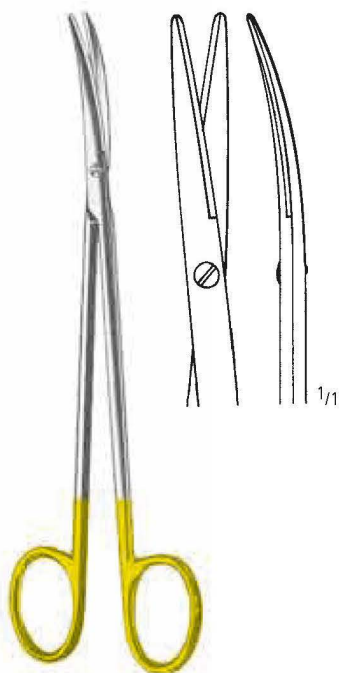

**TOENNIS-ADSON-DELICATE**

AC 977/17  
 17,5 cm/7"

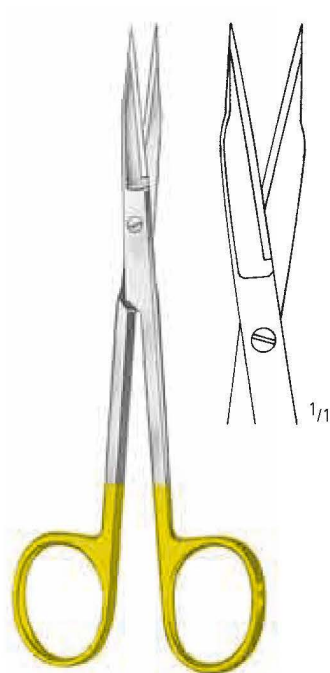

**GOLDMAN-FOX**

AC 980/13  
 13,0 cm/5"

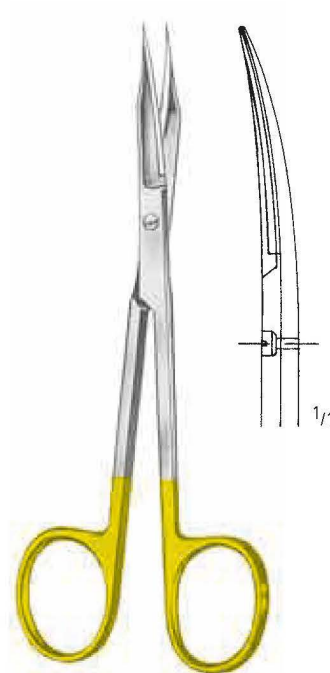

AC 981/13  
 13,0 cm/5"



Weitere Scheren siehe Katalog A 98-157.  
 For further scissors see catalogue A 98-157.  
 Para otras tijeras ver catálogo A 98-157.  
 D'autres ciseaux voir notre catalogue A 98-157.  
 Altre forbici consultare il nostro catalogo A 98-157.

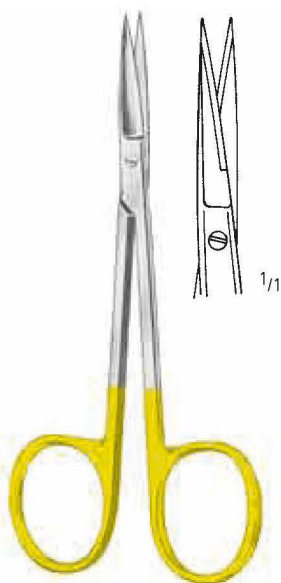

AC 984/11  
 11,5 cm/4 1/2"

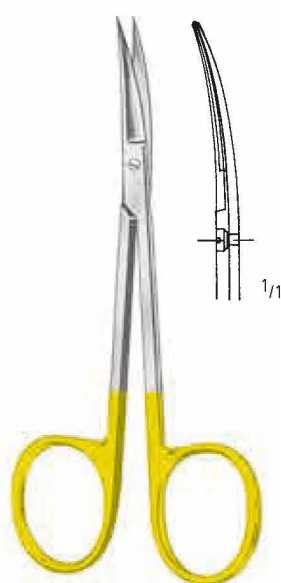

AC 985/11  
 11,5 cm/4 1/2"

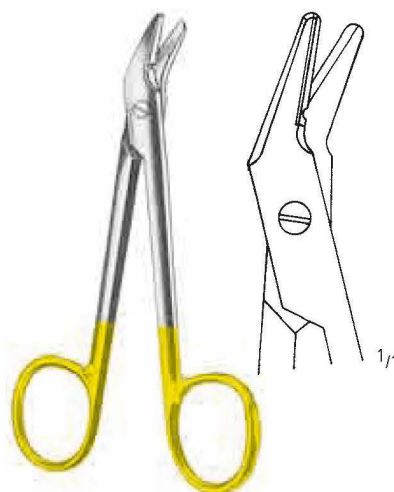

**UNIVERSAL**

AC 987/12  
 12,0 cm/4 3/4"



**LISTER**

AC 999/18  
 18,0 cm/7"

AA  
 AB  
 AC  
 AE  
 AK  
 AO  
 AR  
 KA  
 KS  
 XR  
 XT



NAHT  
SUTURE  
SUTURA  
SUTURE  
SUTURA

AE

nopa<sup>®</sup> instruments



**AE** NAHT SUTURE SUTURA SUTURE SUTURA

Nadelhalter mit Hartmetalleinsätzen  
 Needle Holders with Tungsten Carbide Inserts  
 Porta-agujas con bocas de carburo de tungsteno  
 Porte-aiguilles à mors en carbure de tungstène  
 Portaghi con placche di carburo di tungsteno



1/2

**MAYO-HEGAR**



AE 400/14  
14,0 cm/5 1/2"



AE 400/16  
16,0 cm/6 1/4"



AE 400/18  
18,0 cm/7"



AE 400/20  
20,0 cm/8"



AE 400/24  
24,0 cm/9 1/2"

1/1



AE 400/26  
26,0 cm/10 1/4"



AE 400/30  
30,0 cm/12"

1/1



1/2

**DE BAKEY  
 (MAYO-HEGAR-DELICATE)**



AE 420/18  
18,0 cm/7"



AE 420/20  
20,0 cm/8"



AE 420/23  
23,0 cm/9"



AE 420/26  
26,0 cm/10 1/4"



AE 420/31  
31,0 cm/12 1/4"

1/1



NAHT SUTURE SUTURA SUTURE SUTURA

Nadelhalter mit Hartmetalleinsätzen  
 Needle Holders with Tungsten Carbide Inserts  
 Porta-agujas con bocas de carburo de tungsteno  
 Porte-aiguilles à mors en carbure de tungstène  
 Portaghi con placche di carburo di tungsteno



**MICRO RYDER**



AE 434/13  
13,0 cm/5"



AE 434/15  
15,0 cm/6"



AE 434/18  
18,0 cm/7"



AE 434/20  
20,0 cm/8"



AE 434/23  
23,0 cm/9"



AE 434/26  
26,0 cm/10<sup>1</sup>/<sub>4</sub>"

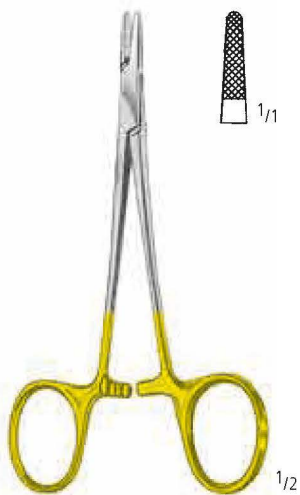

**CONVERSE**  
AE 452/12  
12,5 cm/5"

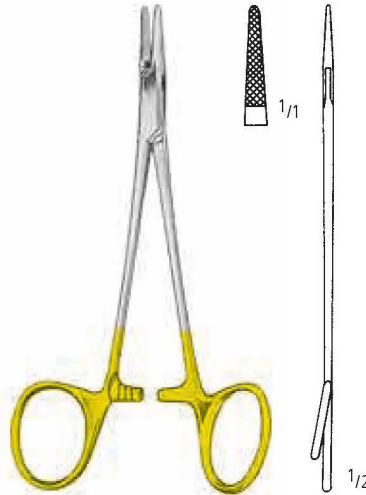

**NEIVERT**  
AE 456/13  
13,0 cm/5"

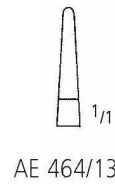

AE 464/13

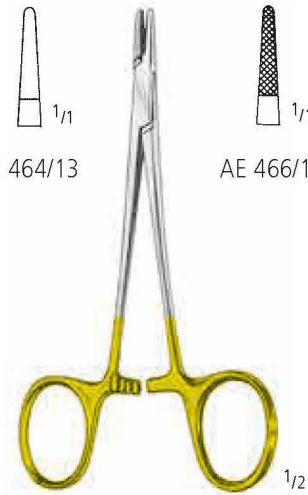

**HALSEY**  
13,0 cm/5"



AE 466/13

AA  
AB  
AC  
AE  
AK  
AO  
AR  
KA  
KS  
XR  
XT

**AE** NAHT SUTURE SUTURA SUTURE SUTURA

Nadelhalter mit Hartmetalleinsätzen  
 Needle Holders with Tungsten Carbide Inserts  
 Porta-agujas con bocas de carburo de tungsteno  
 Porte-aiguilles à mors en carbure de tungstène  
 Portaghi con placche di carburo di tungsteno



**BABY-CRILE-WOOD**  
 AE 468/15  
 15,0 cm/6"



**CRILE-WOOD**  
 AE 469/15  
 15,0 cm/6"

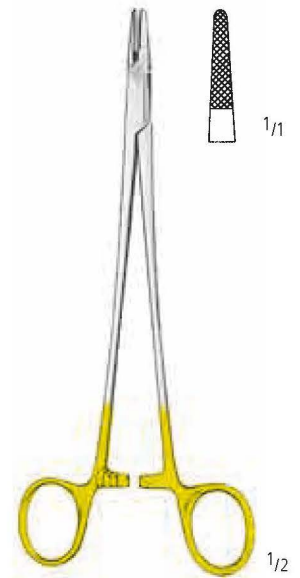

**CRILE-WOOD**  
 AE 470/15  
 15,0 cm/6"



**CRILE-WOOD**



AE 470/18  
 18,0 cm/7"



AE 470/20  
 20,0 cm/8"



AE 470/23  
 23,0 cm/9"



AE 471/18  
 18,0 cm/7"



AE 471/23  
 23,0 cm/9"







NAHT SUTURE SUTURA SUTURE SUTURA

Nadelhalter mit Hartmetalleinsätzen  
 Needle Holders with Tungsten Carbide Inserts  
 Porta-agujas con bocas de carburo de tungsteno  
 Porte-aiguilles à mors en carbure de tungstène  
 Portaghi con placche di carburo di tungsteno

AA  
 AB  
 AC  
**AE**  
 AK  
 AO  
 AR  
 KA  
 KS  
 XR  
 XT





MATHIEU

-  1/1  
 AE 500/14  
 14,0 cm/5 1/2"
-  1/1  
 AE 500/17  
 17,0 cm/6 3/4"
-  1/1  
 AE 500/20  
 20,0 cm/8"
-  1/1  
 AE 500/24  
 24,0 cm/9 1/2"





MATHIEU-DELICATE

-  1/1  
 AE 504/14  
 14,0 cm/5 1/2"
-  1/1  
 AE 504/17  
 17,0 cm/6 3/4"
-  1/1  
 AE 504/20  
 20,0 cm/8"





MATHIEU-RYDER MICRO

-  1/1  
 AE 512/17  
 17,0 cm/6 3/4"
-  1/1  
 AE 512/20  
 20,0 cm/8"
-  1/1  
 AE 512/24  
 24,0 cm/9 1/2"



LANGENBECK

-  1/1  
 AE 540/16  
 16,0 cm/6 1/4"
-  1/1  
 AE 540/18  
 18,0 cm/7"
-  1/1  
 AE 540/20  
 20,0 cm/8"

**AE** NAHT SUTURE SUTURA SUTURE SUTURA

Nadelhalter mit Hartmetalleinsätzen  
 Needle Holders with Tungsten Carbide Inserts  
 Porta-agujas con bocas de carburo de tungsteno  
 Porte-aiguilles à mors en carbure de tungstène  
 Portaghi con placche di carburo di tungsteno

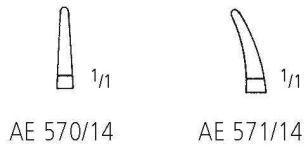

**CASTROVIEJO**  
 14,0 cm/5 1/2"

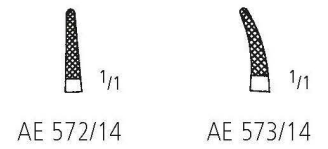

**CASTROVIEJO**  
 14,0 cm/5 1/2"

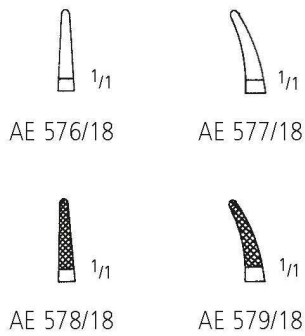

18,0 cm/7"



**JACOBSON**  
 21,0 cm/8 1/4"

NAHT SUTURE SUTURA SUTURE SUTURA

Mikro-Nadelhalter mit Rundgriff  
 Micro-Needle Holders with pen-type handle  
 Micro-porta-agujas con mango redondo  
 Micro-porte-aiguilles à manches rondes  
 Micro-portaghi con manici rotondi



AE 630/18  
 18,0 cm/7 1/4"



AE 631/18  
 18,0 cm/7 1/4"



AE 632/18  
 18,0 cm/7 1/4"



AE 633/18  
 18,0 cm/7 1/4"

AA  
 AB  
 AC  
**AE**  
 AK  
 AO  
 AR  
 KA  
 KS  
 XR  
 XT

**AE** NAHT SUTURE SUTURA SUTURE SUTURA

Mikro-Nadelhalter  
 Micro-Needle-Holders  
 Micro-porta-agujas  
 Micro-porte-aiguilles  
 Micro-portaghi

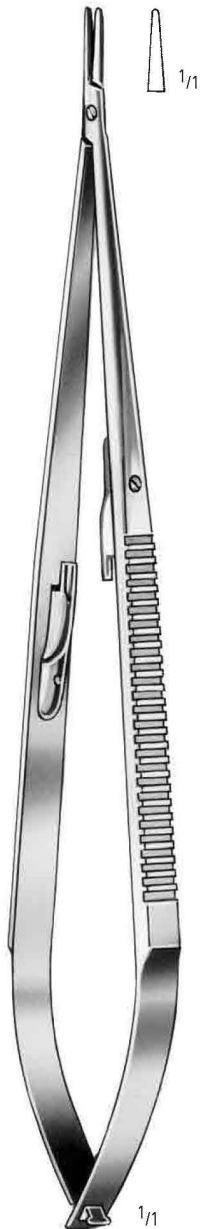

**JACOBSON**  
 AE 678/18  
 18,0 cm/7"

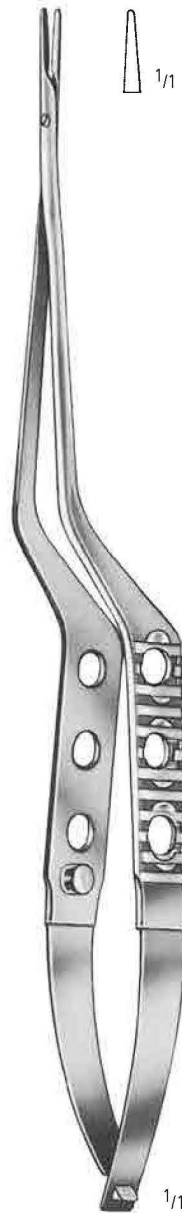

AE 680/16	16,0 cm/6 1/2"
AE 680/18	18,0 cm/7"
AE 680/20	20,0 cm/8"
AE 680/22	22,0 cm/9"

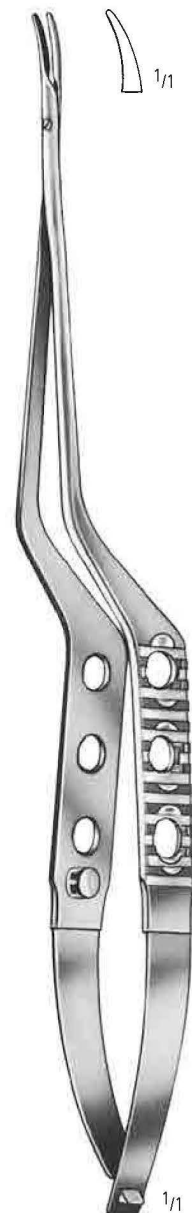

AE 681/16
AE 681/18
AE 681/20
AE 681/22

Weitere Nadelhalter siehe Katalog A 176-209 und Gruppe KS.  
 For further needle holders see catalogue A 176-209 and section KS.  
 Para otras porta-agujas ver catálogo A 176-209 y sección KS.  
 D'autres porte-aiguilles voir notre catalogue A 176-209 et groupe KS.  
 Per altri portaghi consultare il nostro catalogo A 176-209 e gruppo KS.

---

WUNDHAKEN  
RETRACTORS  
SEPARADORES  
ECARTEURS  
DIVARICATORI

**AK**

**nopa**<sup>®</sup> instruments



Feine Wundhaken  
 Delicate Hooks  
 Ganchos  
 Crochets très fins  
 Divaricatori sottili



**GILLIES**  
 AK 020/01  
 18,0 cm/7"



**GILLIES**  
 AK 020/02  
 18,0 cm/7"



**KILNER**  
 AK 022/15  
 15,0 cm/6"



**FRAZIER**  
 AK 024/13  
 13,0 cm/5"



AK 026/01



**KLEINERT-KUTZ**  
 AK 026/02  
 16,0 cm/6¼"



AK 026/03



WUNDHAKEN RETRACTORS SEPARADORES ECARTEURS DIVARICATORI

Feine Wundhaken  
Delicate Hooks  
Ganchos  
Crochets très fins  
Divaricatori sottili

AA

AB

AC

AE

AK

AO

AR

KA

KS

XR

XT



**CUSHING**  
28,0 cm/11"



AK 034/01



AK 034/02



AK 036/01



AK 036/02



**MOLDESTAD**  
AK 038/13  
13,0 cm/5"



1/1



AK 040/05  
5 mm



AK 040/07  
7 mm

17,0 cm/6<sup>3</sup>/<sub>4</sub>"



AK 042/10  
Ø 1,0 mm



AK 042/12  
Ø 1,2 mm

18,5 cm/7<sup>1</sup>/<sub>4</sub>"

Weitere feine Wundhaken siehe Gruppe KS.  
For further delicate hooks see section KS.  
Para otros ganchos ver sección KS.  
D'autres crochets très fins voir groupe KS.  
Per altri divaricatori sottili vedi gruppo KS.



AK 044/11  
11,0 cm/4<sup>1</sup>/<sub>4</sub>"

1/1

Spinalhaken  
 Spinal Retractors  
 Separadores espinales  
 Ecarteurs spinals  
 Divaricatori spinali



**CUSHING**  
 AK 130/20  
 20,0 cm/8"

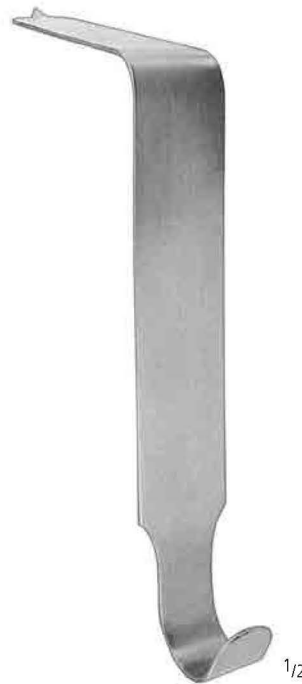

**TAYLOR**  
 16,5 cm/6 1/2"

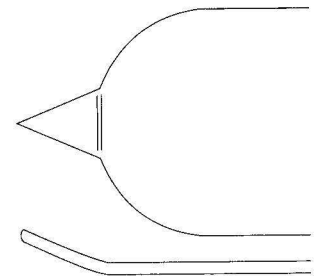

AK 132/07  
 75 x 30 mm

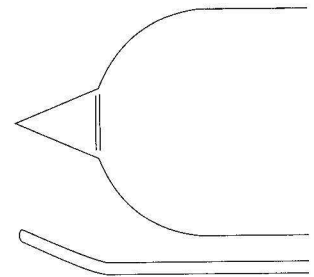

AK 132/10  
 100 x 30 mm

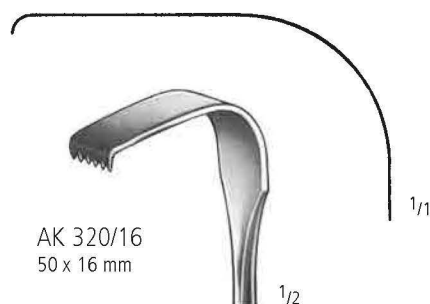

AK 320/16  
50 x 16 mm

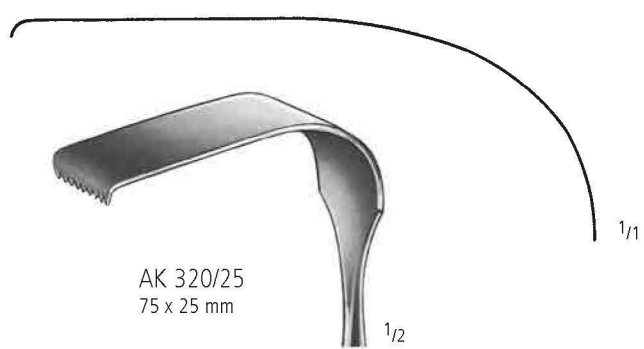

AK 320/25  
75 x 25 mm



AK 320/50  
90 x 50 mm



**MEYERDING**  
22,5 cm/9"

18 x 200 mm AK 456/18  
20 x 200 mm AK 456/20  
23 x 200 mm AK 456/23

**AK** WUNDHAKEN RETRACTORS SEPARADORES ECARTEURS DIVARICATORI

Selbsthaltende Wundsperrer  
 Selfretaining Retractors  
 Separadores autoestaticos  
 Ecarteurs autostatiques  
 Divaricatori autostatici

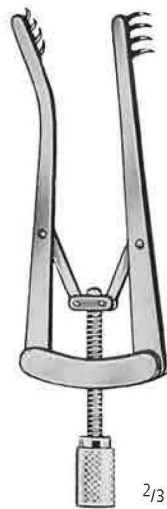

**ALM**

- |   |            |  |            |
|---|------------|--|------------|
| ∧ | 7,0 cm/2¾" |  | 10,0 cm/4" |
|   | AK 506/07  |  | AK 506/10  |
| ∩ | AK 507/07  |  | AK 507/10  |



**JANSEN**

- |            |           |   |           |
|------------|-----------|---|-----------|
| ∧          | AK 510/10 | ∩ | AK 511/10 |
| 10,0 cm/4" |           |   |           |



**JANSEN**

- |            |           |   |           |
|------------|-----------|---|-----------|
| ∧          | AK 512/10 | ∩ | AK 513/10 |
| 10,0 cm/4" |           |   |           |



**SNITMAN**

- |             |           |   |           |
|-------------|-----------|---|-----------|
| ∧           | AK 514/10 | ∩ | AK 515/10 |
| 10,5 cm/4¼" |           |   |           |

WUNDHAKEN RETRACTORS SEPARADORES ECARTEURS DIVARICATORI

Selbsthaltende Wundsperrer  
Selfretaining Retractors  
Separadores autoestaticos  
Ecarteurs autostatiques  
Divaricatori autostatici

AA  
AB  
AC  
AE  
AK  
AO  
AR  
KA  
KS  
XR  
XT

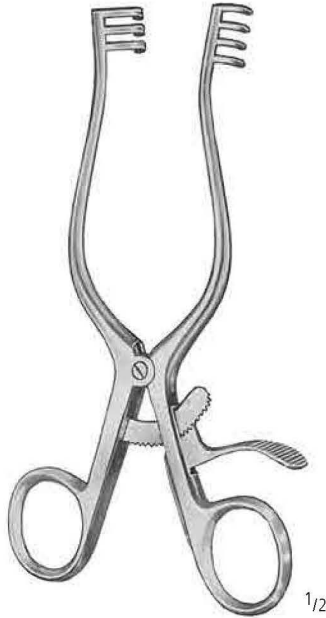

**WEITLANER**

10,5 cm/4 1/4"  
13,0 cm/5"  
16,5 cm/6 1/2"  
20,0 cm/8"  
25,0 cm/10"  
26,0 cm/10 1/2"

2 x 3  
3 x 4  
3 x 4  
3 x 4  
3 x 4  
5 x 6

AK 522/10  
AK 524/13  
AK 526/16  
AK 528/20  
AK 530/25  
AK 532/26

AK 523/10  
AK 525/13  
AK 527/16  
AK 529/20  
AK 531/25  
AK 533/26



**ANDERSON-ADSON**

AK 556/20      AK 557/20  
20,0 cm/8"

Selbsthaltende Wundsperrer  
 Selfretaining Retractors  
 Separadores autoestáticos  
 Ecarteurs autostatiques  
 Divaricatori autostatici



**ADSON**

AK 560/27  
 27,0 cm/10<sup>1</sup>/<sub>2</sub>"

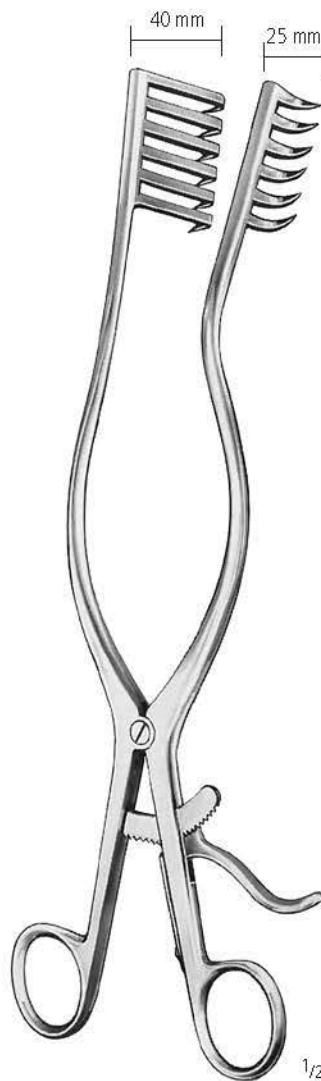

**ADSON - R**

AK 561/01  
 27,0 cm/10<sup>1</sup>/<sub>2</sub>"



**ADSON - L**

AK 561/02  
 27,0 cm/10<sup>1</sup>/<sub>2</sub>"

WUNDHAKEN RETRACTORS SEPARADORES ECARTEURS DIVARICATORI

Selbsthaltende Wundsperrer  
Selfretaining Retractors  
Separadores autoestaticos  
Ecarteurs autostatiques  
Divaricatori autostatici



CONE

13,0 cm/5"  
16,5 cm/6 1/2"  
20,0 cm/8"  
25,0 cm/10"

3 x 4  
3 x 4  
3 x 4  
3 x 4

^  
AK 564/13  
AK 564/16  
AK 564/20  
AK 564/25

∩  
AK 565/13  
AK 565/16  
AK 565/20  
AK 565/25

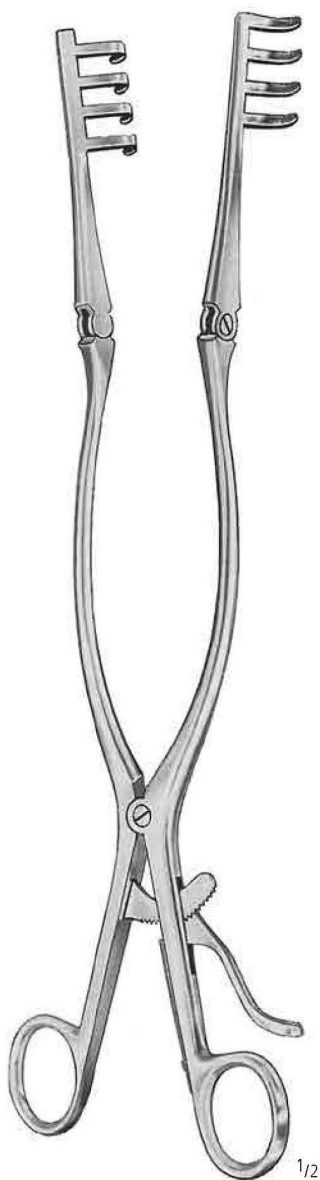

BECKMANN

31,0 cm/12"  
33,0 cm/13"

4 x 4  
4 x 5

^  
AK 566/31  
AK 568/33

∩  
AK 567/31  
AK 569/33

AA  
AB  
AC  
AE  
AK  
AO  
AR  
KA  
KS  
XR  
XT

Selbsthaltende Wundsperrer  
 Selfretaining Retractors  
 Separadores autoestaticos  
 Ecarteurs autostatiques  
 Divaricatori autostatici

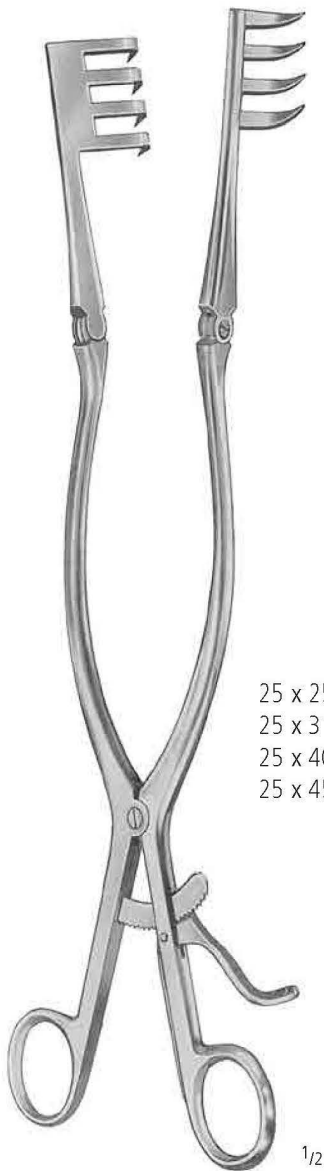

25 x 25 mm  
 25 x 31 mm  
 25 x 40 mm  
 25 x 45 mm



AK 570/01  
 AK 570/02  
 AK 570/03  
 AK 570/04



AK 571/01  
 AK 571/02  
 AK 571/03  
 AK 571/04

**BECKMANN-ADSON**  
 31,0 cm/12"



**BECKMANN-EATON**  
 AK 572/33      AK 573/33  
 33,0 cm/13"



Selbsthaltende Wundsperrer  
Selfretaining Retractors  
Separadores autoestáticos  
Ecarteurs autostatiques  
Divaricatori autostatici



#### SCALP-CONTOUR

AK 574/14

AK 575/14

14,0 cm/5 1/2"

Weitere Wundhaken siehe Katalog A 239-294 und Gruppe KS.  
For further retractors see catalogue A 239-294 and section KS.  
Para otros separadores ver catálogo A 239-294 y sección KS.  
D'autres écarteurs voir notre catalogue A 239-294 et groupe KS.  
Per altri divaricatori consultare il nostro catalogo A 239-294 e gruppo KS.

AA

AB

AC

AE

AK

AO

AR

KA

KS

XR

XT

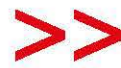



instruments **nodou**<sup>®</sup>

**A0**

PUNKTION/KANÜLEN  
PUNCTURE/SPECIAL NEEDLES  
PUNCIÓN/AGUJAS ESPECIALES  
PUNCTION/AIGUILLES SPECIALES  
PUNTURA/AGHI SPECIALI

Saugrohre  
Suction Tubes  
Tubos de aspiración  
Canules d'aspiration  
Cannule di aspirazione



complete with suction tube  
+ cannula 0,4 mm  
+ cannula 0,6 mm  
+ cannula 0,8 mm

**FRAZIER**  
6 Charr. AO 430/06  
8 Charr. AO 430/08  
10 Charr. AO 430/10  
12 Charr. AO 430/12

**PLESTER**  
1,5 mm AO 432/15  
2,0 mm AO 432/20  
2,5 mm AO 432/25  
3,0 mm AO 432/30

**FERGUSSON**  
5 Charr. AO 434/05  
6 Charr. AO 434/06  
7 Charr. AO 434/07  
8 Charr. AO 434/08  
9 Charr. AO 434/09  
10 Charr. AO 434/10  
12 Charr. AO 434/12

**WULLSTEIN MICRO**  
AO 438/00

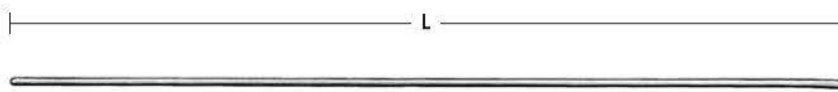

	L	L	L	L
	130 mm	150 mm	180 mm	220 mm
Ø 1,5 mm	AO 440/13	AO 440/15	AO 440/18	AO 440/22
Ø 2,0 mm	AO 441/13	AO 441/15	AO 441/18	AO 441/22
Ø 2,5 mm	AO 442/13	AO 442/15	AO 442/18	AO 442/22
Ø 3,5 mm	AO 443/13	AO 443/15	AO 443/18	AO 443/22



**ADSON**  
AO 450/04  
21,0 cm/8 1/4"  
4,0 mm

ORTHOPÄDIE  
ORTHOPAEDICS  
ORTOPEDIA  
ORTHOPEDIE  
ORTOPEDIA

KA

nopa<sup>®</sup> instruments



Handbohrapparate  
Hand Drills  
Perforadores de mano  
Perforateurs à main  
Perforatori a mano



← KA 060/90

**STILLE**  
KA 060/00  
20,0 cm/8"

komplett mit  
complete with  
completo con  
complet avec  
completo con

Fig. 1-9  
Fig. 1-9  
Fig. 1-9  
Fig. 1-9  
Fig. 1-9



Fig. 1  
KA 060/01  
Ø 2,5 mm



Fig. 2  
KA 060/02  
Ø 3,0 mm



Fig. 3  
KA 060/03  
Ø 3,5 mm



Fig. 4  
KA 060/04  
Ø 4,0 mm



Fig. 5  
KA 060/05  
Ø 10,0 mm



Fig. 6  
KA 060/06  
Ø 5,0 mm



Fig. 7  
KA 060/07  
Ø 8,0 mm



Fig. 8  
KA 060/08  
Ø 12,0 mm



Fig. 9  
KA 060/09  
Ø 16,0 mm



Fig. 10  
KA 060/10  
Ø 1,0 mm



Fig. 11  
KA 060/11  
Ø 1,5 mm



Fig. 12  
KA 060/12  
Ø 2,0 mm

Handbohrapparate  
Hand Drills  
Perforadores de mano  
Perforateurs à main  
Perforatore a mano



**RALK**  
KA 100/00



Ø 1,0 mm	KA 102/10
Ø 1,5 mm	KA 102/15
Ø 2,0 mm	KA 102/20
Ø 2,7 mm	KA 102/27
Ø 3,0 mm	KA 102/30
Ø 3,2 mm	KA 102/32
Ø 3,5 mm	KA 102/35
Ø 4,0 mm	KA 102/40
Ø 4,5 mm	KA 102/45
Ø 5,0 mm	KA 102/50
Ø 6,0 mm	KA 102/60
Ø 7,0 mm	KA 102/70
Ø 8,0 mm	KA 102/80
Ø 9,0 mm	KA 102/90
Ø 10,0 mm	KA 102/99

AA

AB

AC

AE

AK

AO

AR

**KA**

KS

XR

XT





Maßtabelle  
 Scale  
 Tabla de medida  
 Tableau de la mesure  
 Scala

AA

AB

AC

AE

AK

AO

AR

**KA**

K5

XR

XT



2,0 mm



3,0 mm



4,0 mm



5,0 mm



6,0 mm



8,0 mm



10,0 mm



12,0 mm



14,0 mm



16,0 mm

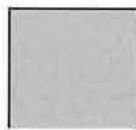

18,0 mm

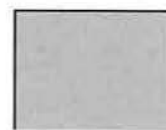

20,0 mm



25,0 mm



30,0 mm



35,0 mm



40,0 mm



45,0 mm



50,0 mm

Meißel und Osteotome  
 Chisels, Gouges and Osteotomes  
 Cinceles y Gubias  
 Ciseaux-Burins et Ostéotomes  
 Scalpelli, Osteotomi, Sgorbie



**MINI-LEXER**  
 18,0 cm/7"



**MINI-LEXER**  
 18,0 cm/7"



**LEXER**  
 22,0 cm/8<sup>3</sup>/<sub>4</sub>"



**LEXER**  
 22,0 cm/8<sup>3</sup>/<sub>4</sub>"

mm  
 4  
 6  
 7  
 8  
 10  
 12  
 15  
 20  
 25  
 30

KA 470/04  
 KA 470/06  
 KA 470/08  
 KA 470/10  
 KA 470/12  
 KA 470/15  
 KA 470/20

KA 471/04  
 KA 471/06  
 KA 471/08  
 KA 471/10  
 KA 471/12  
 KA 471/15  
 KA 471/20

KA 472/07  
 KA 472/10  
 KA 472/15  
 KA 472/20  
 KA 472/25  
 KA 472/30

KA 473/07  
 KA 473/10  
 KA 473/15  
 KA 473/20  
 KA 473/25  
 KA 473/30

Ferrozellgriff  
 Hartpress-Handle  
 Mango en "Ferrozell"  
 Manche en "Ferrozell"  
 Manico in "Ferrozell"

Meißel und Osteotome  
 Chisels, Gouges and Osteotomes  
 Cinceles y Gubias  
 Ciseaux-Burins et Ostéotomes  
 Scalpelli, Osteotomi, Sgorbie

AA  
 AB  
 AC  
 AE  
 AK  
 AO  
 AR  
 KA  
 KS  
 XR  
 XT



1/2

**LEXER**  
 27,5 cm/10<sup>3</sup>/<sub>4</sub>"



1/2

**LEXER**  
 27,5 cm/10<sup>3</sup>/<sub>4</sub>"



1/2

**LEXER**  
 25,0 cm/10"



1/2

**LEXER**  
 25,0 cm/10"

mm

- 5 KA 474/10
- 10 KA 474/15
- 15

- KA 476/05
- KA 476/10
- KA 476/15

- KA 477/05
- KA 477/10
- KA 477/15

Ferrozellgriff  
 Hartpress-Handle  
 Mango en "Ferrozell"  
 Manche en "Ferrozell"  
 Manico in "Ferrozell"

Meißel und Osteotome  
 Chisels, Gouges and Osteotomes  
 Cinceles y Gubias  
 Ciseaux-Burins et Ostéotomes  
 Scalpelli, Osteotomi, Sgorbie

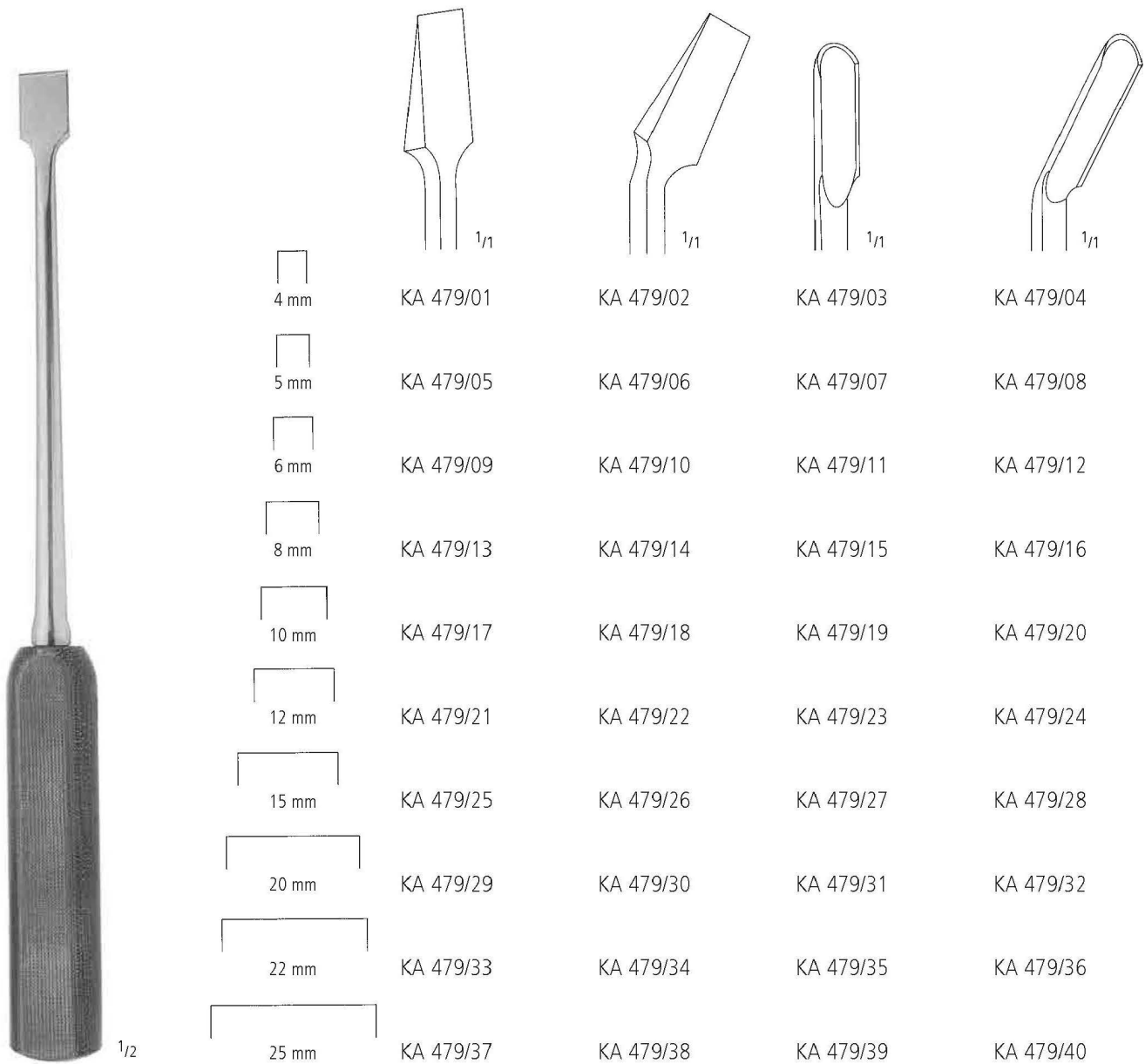

**DAHMEN**

30,0 cm/12"

Ferrozellgriff  
 Hartpress-Handle  
 Mango en "Ferrozell"  
 Manche en "Ferrozell"  
 Manico in "Ferrozell"

Hämmer  
Mallets  
Martillos  
Marteaux  
Martelli

AA

AB

AC

AE

AK

AO

AR

KA

KS

XR

XT

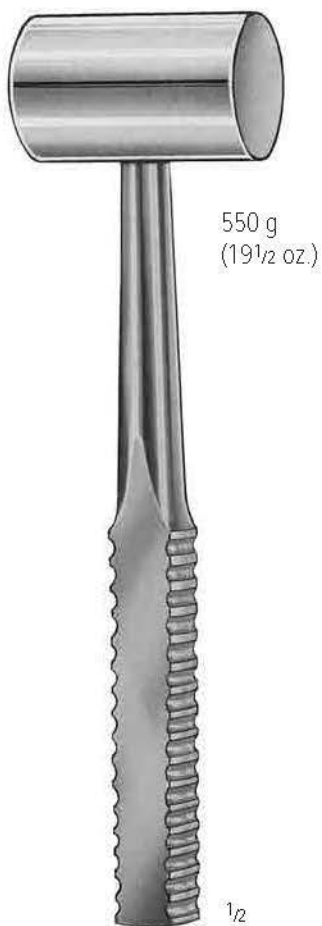

**OMBREDANNE**

KA 519/55  
24,0 cm/9 1/2"

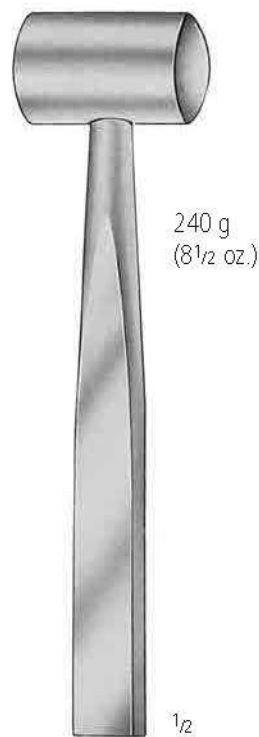

**COTTLE**

KA 531/24  
19,0 cm/7 1/2"



KA 534/14  
18,0 cm/7"

Hämmer  
Mallets  
Martillos  
Marteaux  
Martelli



KA 554/90

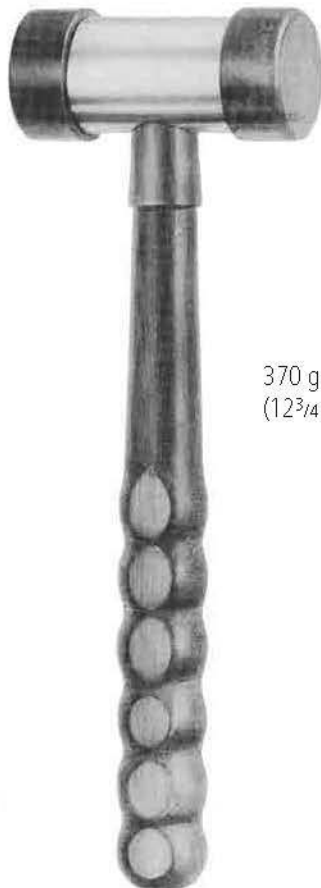

370 g  
(12<sup>3</sup>/<sub>4</sub> oz.)

KA 554/37  
Ferrozell



125 g  
(4<sup>1</sup>/<sub>4</sub> oz.)

KA 555/13  
Ferrozell

Scharfe Löffel  
 Bone Curettes  
 Cucharillas cortantes  
 Curettes tranchantes  
 Curette taglienti

AA  
 AB  
 AC  
 AE  
 AK  
 AO  
 AR  
 KA  
 KS  
 XR  
 XT

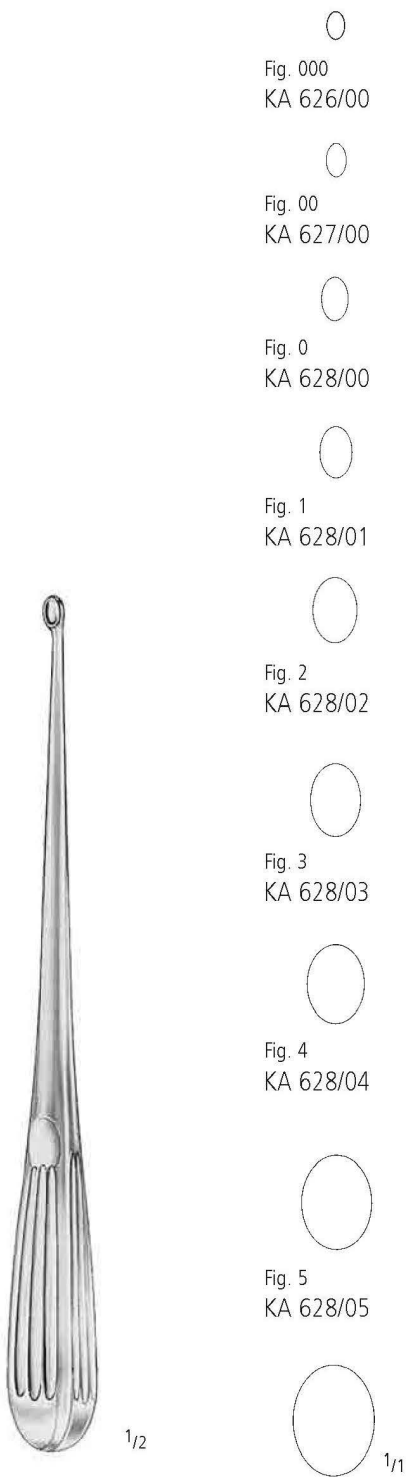

**CLOWARD  
 HIBBS SPRATT  
 SPINAL FUSION**  
 22,5 cm/9"

Fig. 000  
 KA 626/00  
 Fig. 00  
 KA 627/00  
 Fig. 0  
 KA 628/00  
 Fig. 1  
 KA 628/01  
 Fig. 2  
 KA 628/02  
 Fig. 3  
 KA 628/03  
 Fig. 4  
 KA 628/04  
 Fig. 5  
 KA 628/05  
 Fig. 6  
 KA 628/06

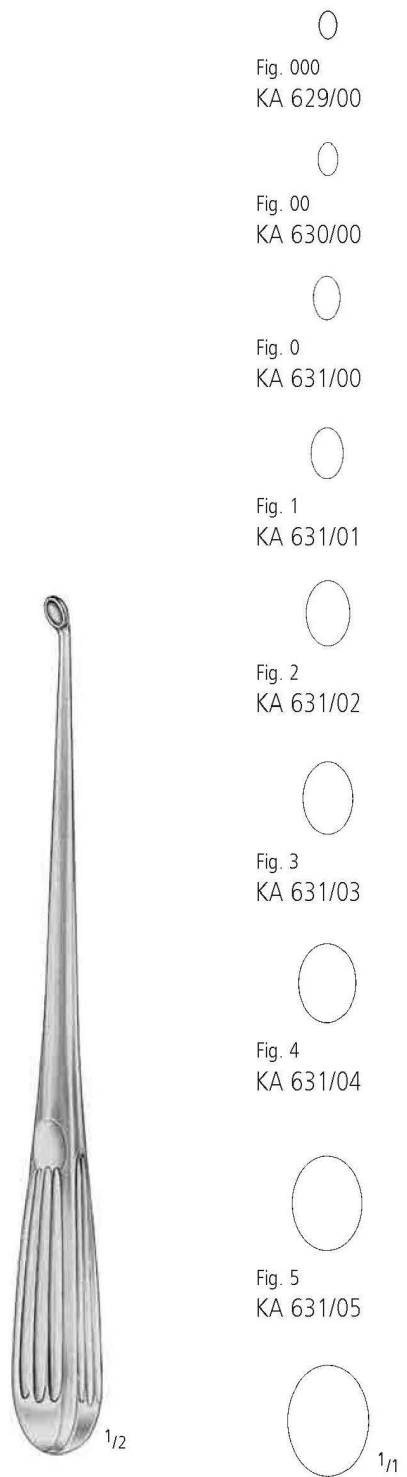

**CLOWARD  
 HIBBS SPRATT  
 SPINAL FUSION**  
 22,5 cm/9"

Fig. 000  
 KA 629/00  
 Fig. 00  
 KA 630/00  
 Fig. 0  
 KA 631/00  
 Fig. 1  
 KA 631/01  
 Fig. 2  
 KA 631/02  
 Fig. 3  
 KA 631/03  
 Fig. 4  
 KA 631/04  
 Fig. 5  
 KA 631/05  
 Fig. 6  
 KA 631/06

Elevatoren  
Elevators  
Elevadores  
Elévateurs  
Elevatori

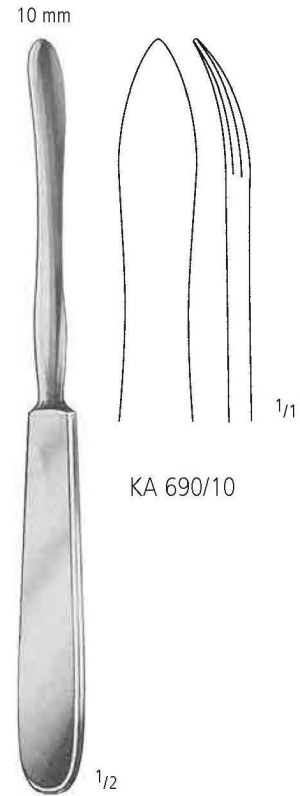
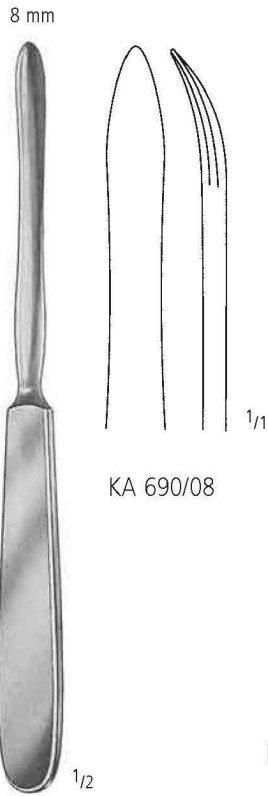

**LANGENBECK**  
19,5 cm/7<sup>3</sup>/<sub>4</sub>"



**FREER**  
19,0 cm/7<sup>1</sup>/<sub>2</sub>"



**FREER**  
KA 703/18

18,0 cm/7"



Elevatori  
Elevators  
Elevadores  
Elévateurs  
Elevatori

AA  
AB  
AC  
AE  
AK  
AO  
AR  
KA  
KS  
XR  
XT



**HOEN**

7 mm

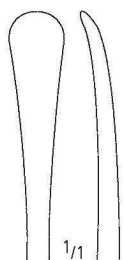

KA 704/07  
16,0 cm/6<sup>1</sup>/<sub>4</sub>"

15 mm

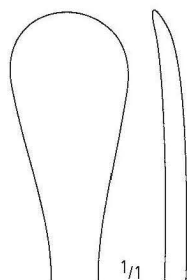

KA 704/15  
19,0 cm/7<sup>1</sup>/<sub>2</sub>"

20 mm

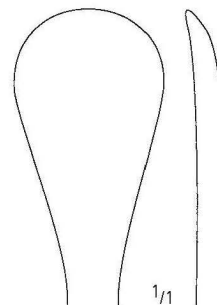

KA 704/20  
19,0 cm/7<sup>1</sup>/<sub>2</sub>"



**ADSON**  
17,0 cm/6<sup>3</sup>/<sub>4</sub>"



KA 705/01



KA 705/02



KA 705/03



KA 705/04

Hohlmeisselzangen  
 Bone Rongeurs  
 Pinzas-gubias  
 Pincès-gouges  
 Pinze-sgorbie

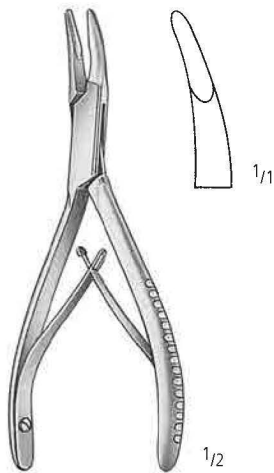

**MINI-FRIEDMAN**

KA 800/12

12,0 cm/5"

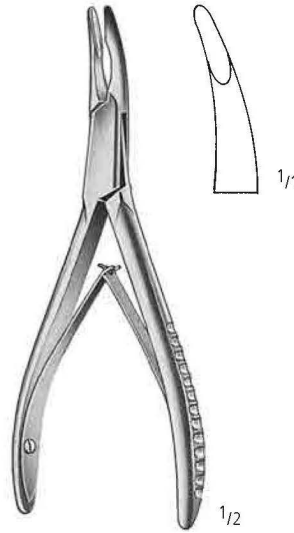

**FRIEDMAN**

KA 800/14  
 14,0 cm/5 1/2"

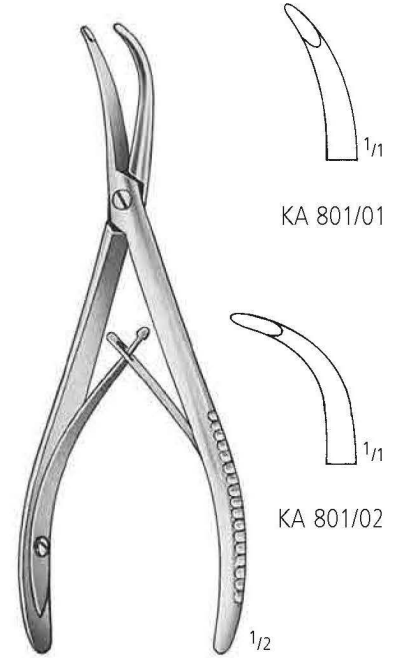

**STELLBRINK**

17,0 cm/6 3/4"

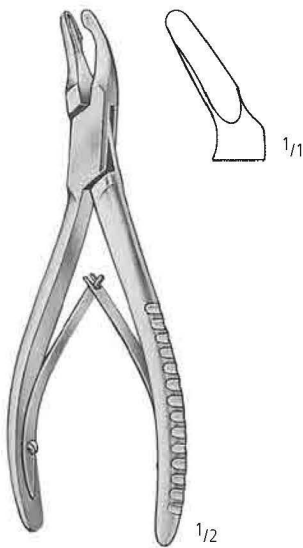

**CLEVELAND**

KA 802/14

14,0 cm/5 1/2"

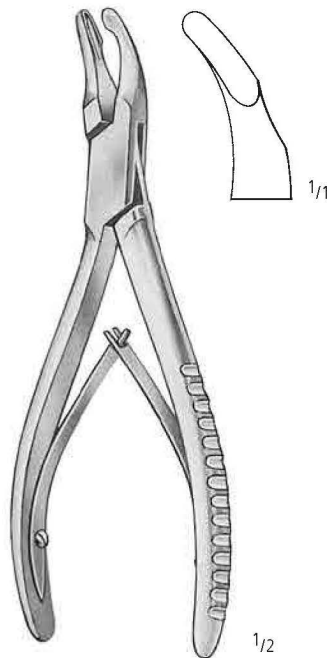

**CLEVELAND**

KA 802/17  
 17,0 cm/6 3/4"

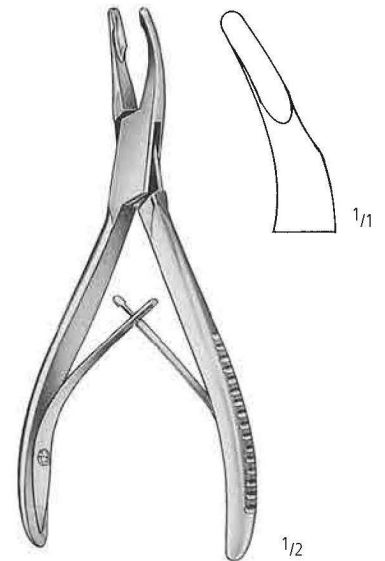

**UNIVERSAL**

KA 803/13  
 13,5 cm/5 1/4"

Hohlmeisselzangen  
 Bone Rongeurs  
 Pinzas-gubias  
 Pincès-gouges  
 Pinze-sgorbie

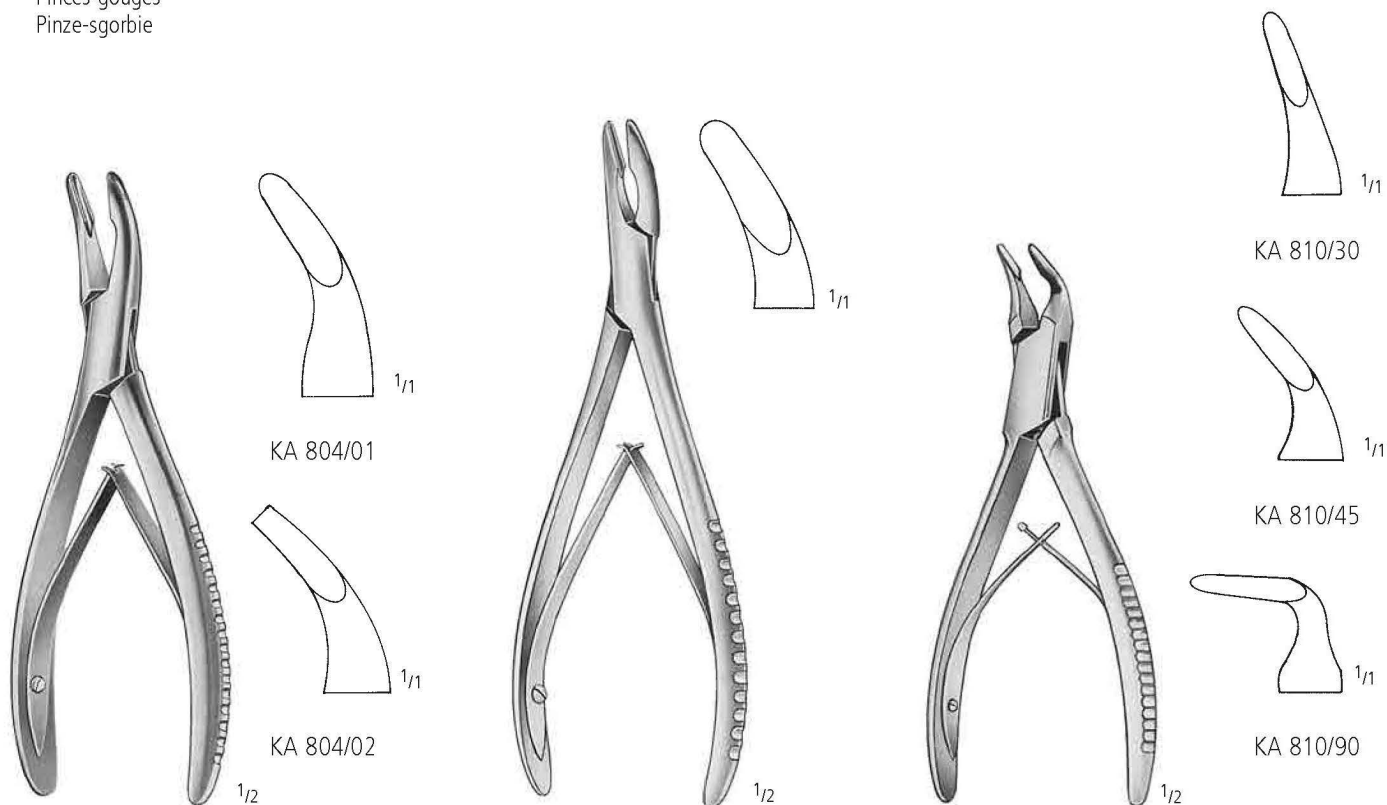

**MEAD**  
 16,5 cm/6<sup>1</sup>/<sub>2</sub>"

**HARTMANN**  
 KA 807/18  
 18,5 cm/7<sup>1</sup>/<sub>4</sub>"

**BLUMENTHAL**  
 15,5 cm/6"

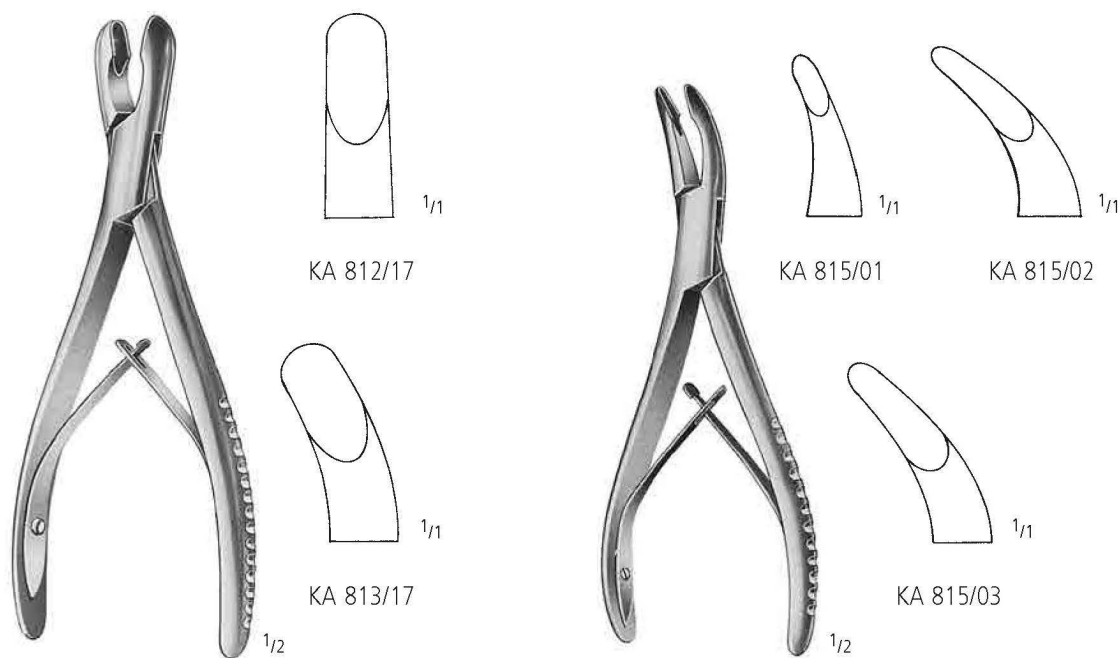

**LUER**  
 17,0 cm/6<sup>3</sup>/<sub>4</sub>"

**LUER**  
 15,0 cm/6"

AA  
 AB  
 AC  
 AE  
 AK  
 AO  
 AR  
 KA  
 KS  
 XR  
 XT

Hohlmeisselzangen  
 Bone Rongeurs  
 Pinzas-gubias  
 Pincés-gouges  
 Pinze-sgorbie



**LEMPERT**  
 KA 816/19  
 19,0 cm/7 1/2"



**BACON**  
 KA 819/20  
 20,0 cm/8"



**MARQUARDT**  
 KA 821/20  
 20,0 cm/8"

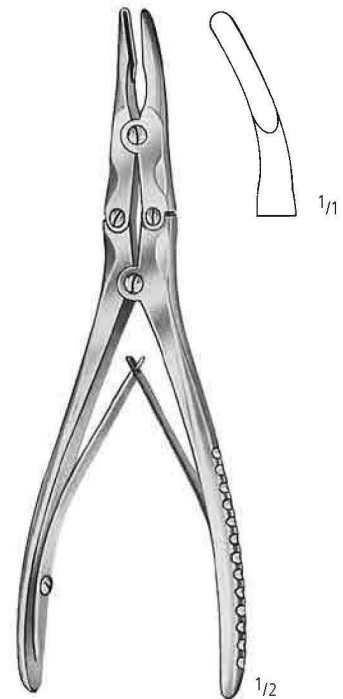

**MAYFIELD**  
 KA 823/17  
 17,0 cm/6 3/4"

Hohlmeisselzangen  
 Bone Rongeurs  
 Pinzas-gubias  
 Pinces-gouges  
 Pinze-sgorbie

AA

AB

AC

AE

AK

AO

AR

KA

KS

XR

XT

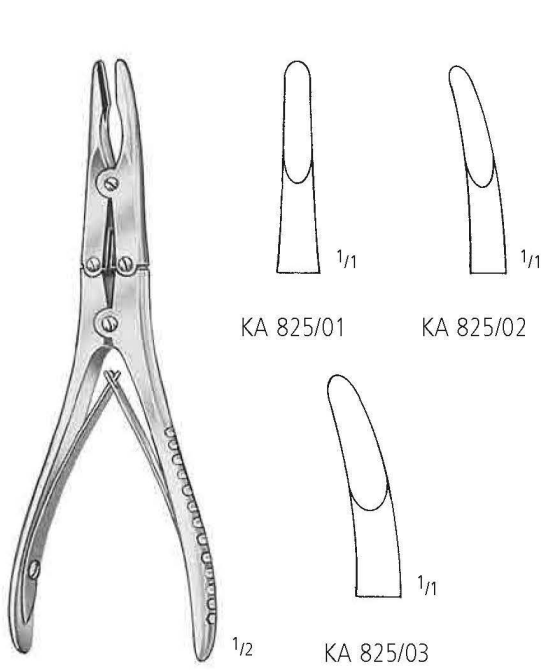

**BÖHLER**  
 15,0 cm/6"

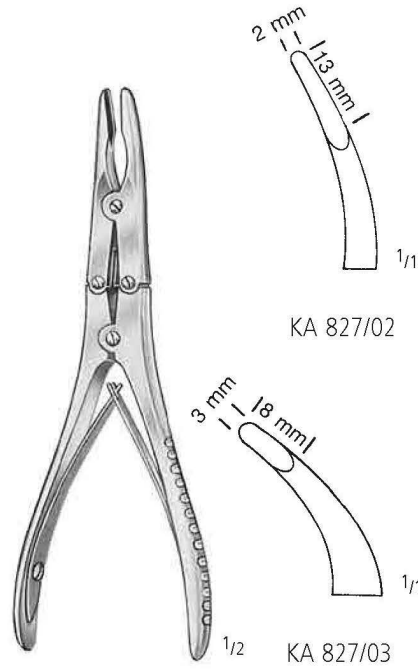

**KLEINERT-KUTZ**  
 15,0 cm/6"

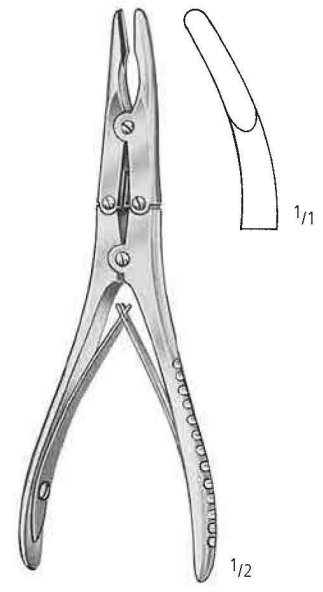

**RUSKIN-MINI**  
 KA 829/15  
 15,0 cm/6"

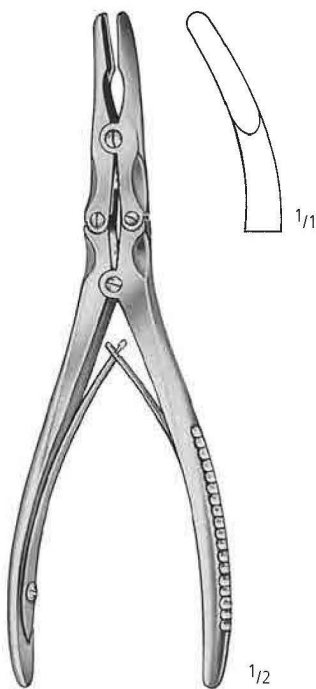

**BEYER**  
 KA 830/18  
 18,0 cm/7"



**ZAUFAL-JANSEN**  
 KA 835/18  
 18,0 cm/7"

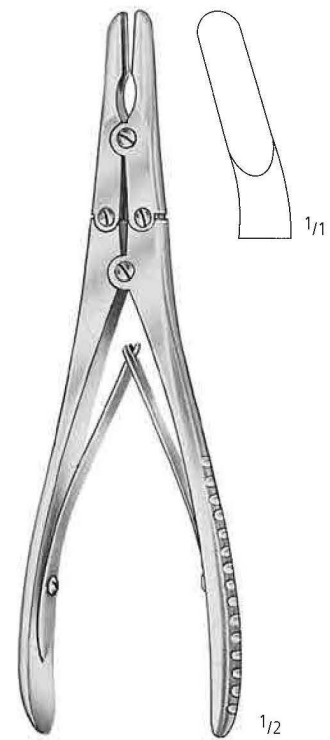

**RUSKIN**  
 KA 836/18  
 18,0 cm/7"

Hohlmeisselzangen  
 Bone Rongeurs  
 Pinzas-gubias  
 Pincés-gouges  
 Pinze-sgorbie

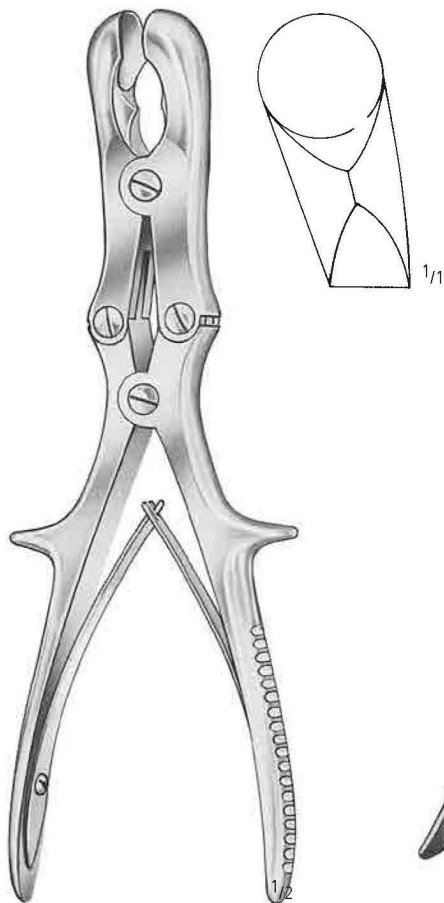

**SEMB**  
 KA 838/22  
 22,5 cm/9"

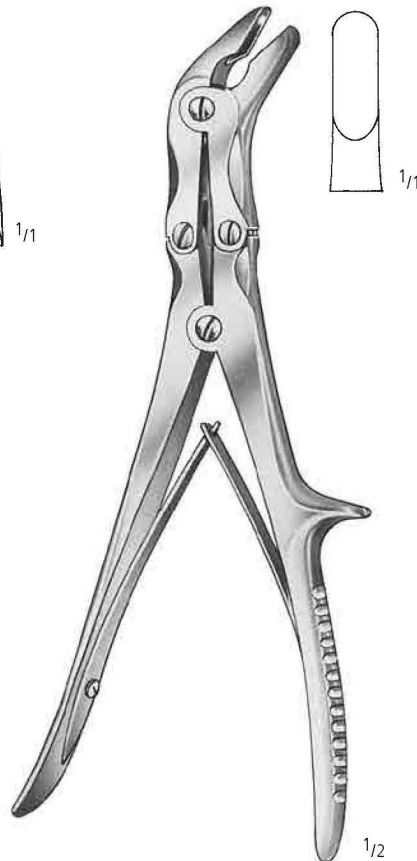

**STILLE**  
 KA 840/23  
 23,0 cm/9"



**STILLE-RUSKIN**  
 KA 841/23  
 23,0 cm/9"

Hohlmeisselzangen  
 Bone Rongeurs  
 Pinzas-gubias  
 Pincès-gouges  
 Pinze-sgorbie

AA

AB

AC

AE

AK

AO

AR

KA

KS

XR

XT

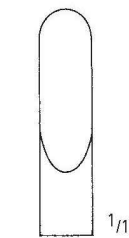
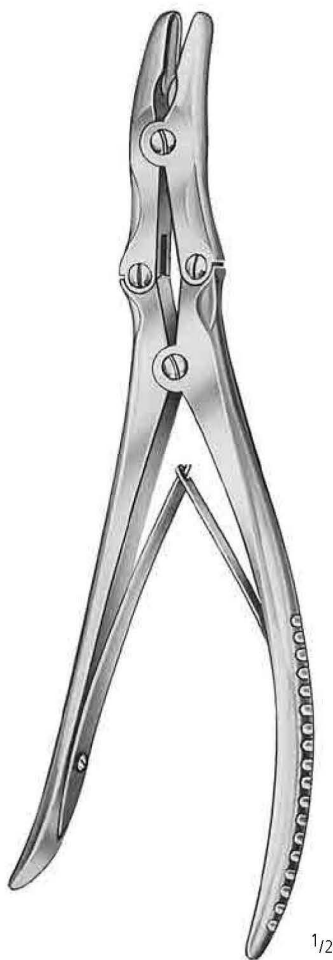

KA 848/01  
8 mm

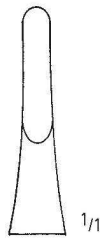

KA 848/02  
4 mm

**LEKSELL-STILLE**  
24,0 cm/9 1/2"

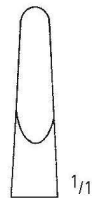

**FRYKHOLM**  
KA 859/23  
23,0 cm/9"

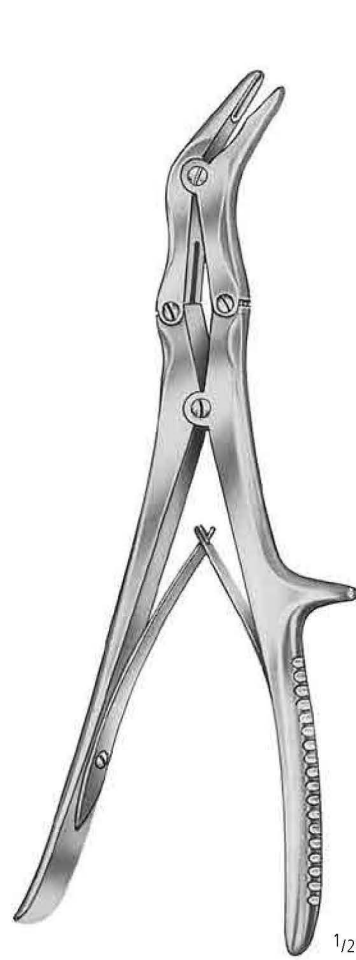

KA 860/01  
2 x 10 mm



KA 860/02  
3 x 10 mm

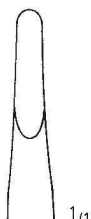

KA 860/03  
4 x 10 mm

**ECHLIN**  
23,0 cm/9"

Hohlmeisselzangen  
 Bone Rongeurs  
 Pinzas-gubias  
 Pincas-gouges  
 Pinze-sgorbie



**RUSKIN**  
 KA 862/23  
 23,0 cm/9"



**SMITH-PETERSON**  
 24,0 cm/9 1/2"

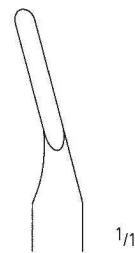

3,0 mm  
 KA 863/03

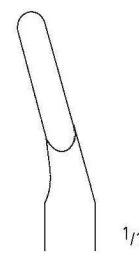

4,0 mm  
 KA 863/04

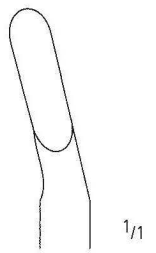

5,0 mm  
 KA 863/05

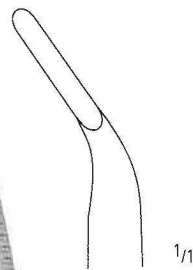

3,0 mm  
 KA 863/13

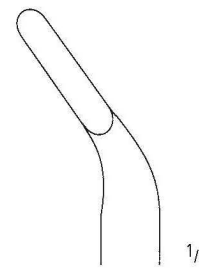

4,0 mm  
 KA 863/14

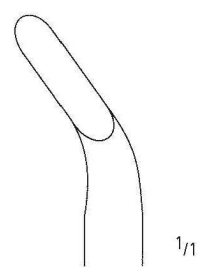

5,0 mm  
 KA 863/15



NEUROCHIRURGIE  
NEUROSURGERY  
NEUROCIRUGIA  
NEUROCHIRURGIE  
NEUROCHIRURGIA

KS

nopa<sup>®</sup> instruments





Feine Arterienklemmen  
 Fine Artery Forceps  
 Pinzas hemostáticas finas  
 Pinces hémostatiques fines  
 Pinze emostatiche fine

AA

AB

AC

AE

AK

AO

AR

KA

KS

XR

XT



**HOEN**  
 KS 001/13  
 13,5 cm/5<sup>1</sup>/<sub>4</sub>"

<sup>1</sup>/<sub>2</sub>



**RAIMONDI**  
 KS 003/13  
 12,5 cm/5"

<sup>1</sup>/<sub>2</sub>

Präparierklemmen  
 Dissecting Forceps  
 Pinzas para preparaciones  
 Pinces à dissection  
 Pinze per preparazione



KS 011/01  
 19,5 cm/8"



KS 011/02  
 19,5 cm/8"

Mikro-Instrumente  
 Micro Instruments  
 Instrumentos para microcirugía  
 Instruments pour la chirurgie micro  
 Strumenti per la chirurgia micro

AA

AB

AC

AE

AK

AO

AR

KA

**KS**

XR

XT



18,5 cm/7<sup>1</sup>/<sub>4</sub>"



KS 014/01

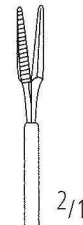

KS 014/02

Mikro-Pinzetten  
 Micro Forceps  
 Micro-Pinzas  
 Micro-Pinces  
 Micro-Pinze

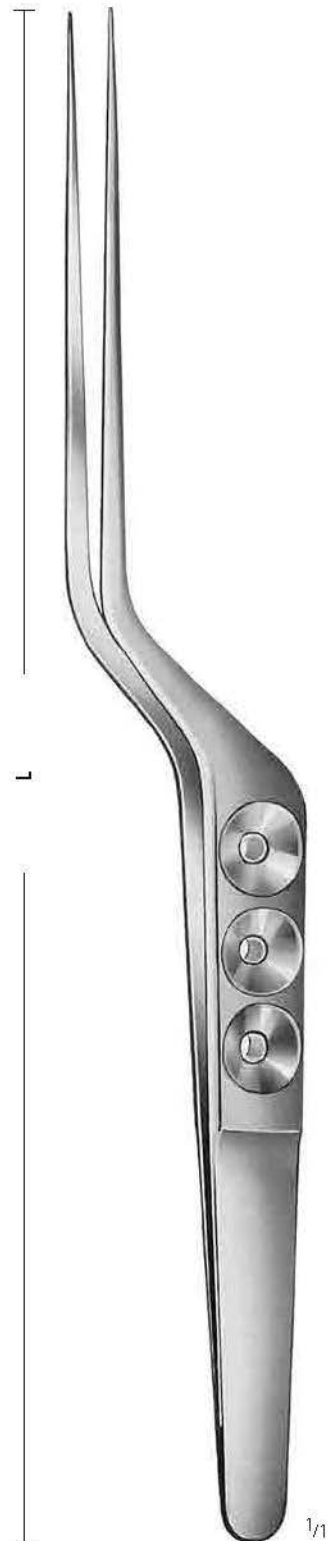

L	TIP	
18,0 cm/7"	0,6 mm	KS 020/06
18,0 cm/7"	0,9 mm	KS 020/09
18,0 cm/7"	1 : 2	KS 020/20
20,0 cm/8"	0,6 mm	KS 022/06
20,0 cm/8"	0,9 mm	KS 022/09
22,0 cm/8 <sup>3</sup> / <sub>4</sub> "	0,6 mm	KS 024/06
22,0 cm/8 <sup>3</sup> / <sub>4</sub> "	0,9 mm	KS 024/09
24,0 cm/9 <sup>1</sup> / <sub>2</sub> "	0,6 mm	KS 026/06
24,0 cm/9 <sup>1</sup> / <sub>2</sub> "	0,9 mm	KS 026/09

Mikro-Pinzetten, Nahtpinzetten  
 Micro Forceps, Suture Forceps  
 Micro-Pinzas, Pinzas para sutura  
 Micro-Pinces, Pinces pour sutures  
 Micro-Pinze, Pinze per sutura

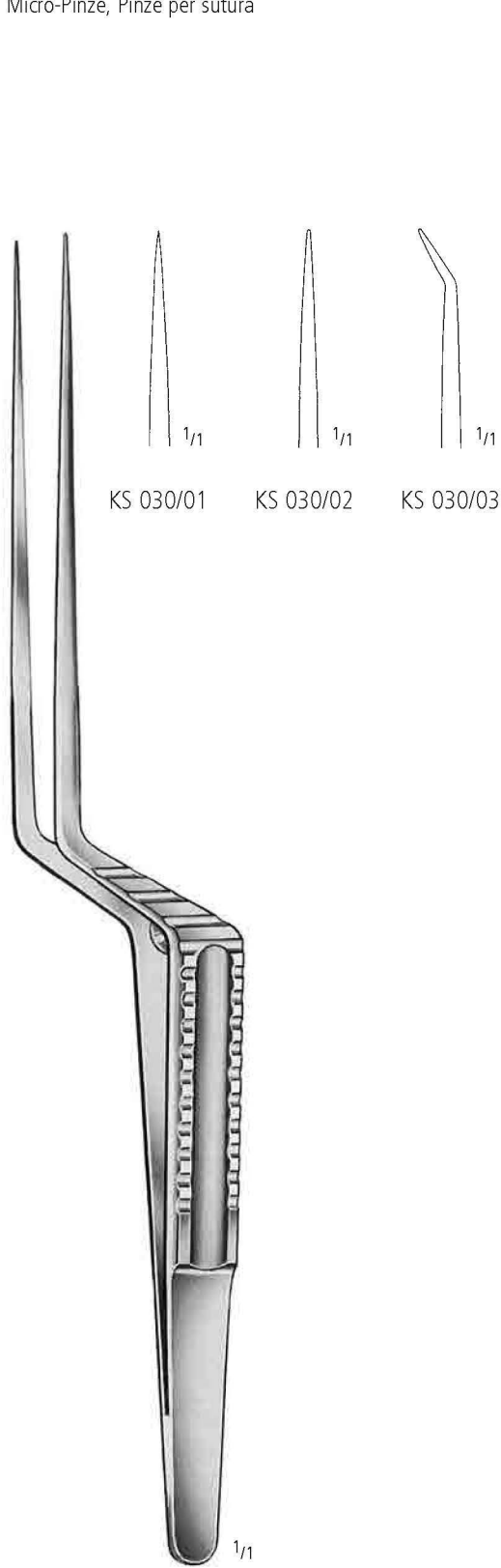

KS 030/01

KS 030/02

KS 030/03

18,5 cm/7 1/4"



KS 032/22  
 22,0 cm/8 3/4"



KS 036/18  
 18,5 cm/7 1/4"

Mikro-Pinzetten  
 Micro Forceps  
 Micro-Pinzas  
 Micro-Pinces  
 Micro-Pinze

## TITANIUM



**DIETRICH**

1,5 mm



1/1

2,0 mm



1/1

2,8 mm



1/1

15,0 cm/6"

KS 040/15

KS 040/20

KS 040/28

20,0 cm/8"

KS 041/15

KS 041/20

KS 041/28

24,0 cm/9<sup>3</sup>/<sub>4</sub>"

KS 042/15

KS 042/20

KS 042/28



Mikroscheren  
Micro Scissors  
Micro Tijeras  
Micro Ciseaux  
Micro Forbici



20,0 cm/8"

45°

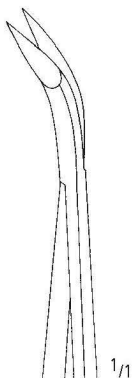

**NAGEL**  
KS 050/20

45°



KS 051/20

125°

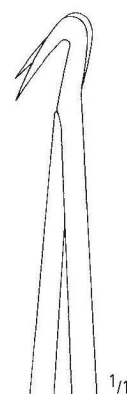

KS 052/20

AA

AB

AC

AE

AK

AO

AR

KA

**KS**

XR

XT

Mikroscheren  
Micro Scissors  
Micro Tijeras  
Micro Ciseaux  
Micro Forbici

gezahnt  
saw edge  
dentadas  
dentelés  
dentata

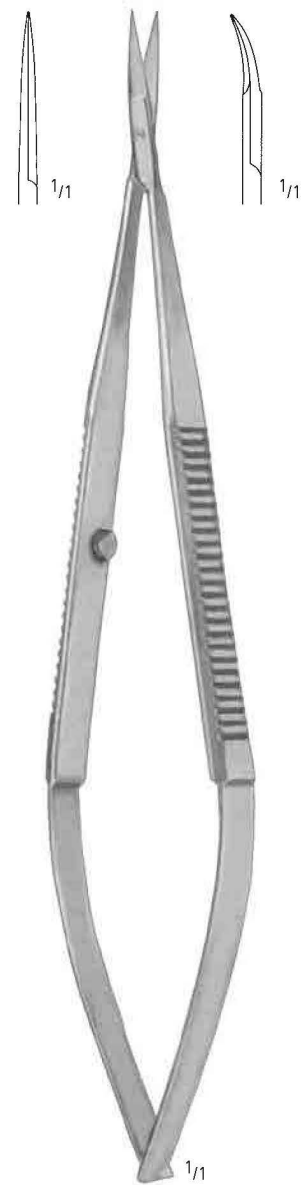

16,0 cm/6 1/4"

KS 060/16  
gerade  
straight  
rectas  
droits  
retta

KS 061/16  
gebogen  
curved  
curvas  
courbes  
curva

**VANNAS**  
16,0 cm/6 1/4"

KS 062/16  
gerade  
straight  
rectas  
droits  
retta

KS 063/16  
gebogen  
curved  
curvas  
courbes  
curva

**MILLES**  
16,0 cm/6 1/4"

KS 064/16  
gerade  
straight  
rectas  
droits  
retta

KS 065/16  
gebogen  
curved  
curvas  
courbes  
curva

Mikroscheren  
 Micro Scissors  
 Micro Tijeras  
 Micro Ciseaux  
 Micro Forbici

AA

AB

AC

AE

AK

AO

AR

KA

**KS**

XR

XT



KS 068/00  
 18,5 cm/7<sup>1</sup>/<sub>4</sub>"



KS 069/19  
 19,0 cm/7<sup>1</sup>/<sub>2</sub>"

Mikro-Nadelhalter mit Rundgriff  
 Micro-Needle Holders with pen-type handle  
 Micro-porta-agujas con mango redondo  
 Micro-porte-aiguilles à manches rondes  
 Micro-portaghi con manici rotondi



Tip 0,3 mm

Tip 0,3 mm

14,0 cm/5 1/2"  
 18,0 cm/7"

KS 070/14  
 KS 070/18

KS 071/14  
 KS 071/18

Tip 0,8 mm

Tip 0,8 mm

14,0 cm/5 1/2"  
 18,0 cm/7"

KS 072/14  
 KS 072/18

KS 073/14  
 KS 073/18

1/1

**BARRAQUER**



Tip 0,3 mm

Tip 0,3 mm

14,0 cm/5 1/2"  
 18,0 cm/7"

KS 074/14  
 KS 074/18

KS 075/14  
 KS 075/18

Tip 0,8 mm

Tip 0,8 mm

14,0 cm/5 1/2"  
 18,0 cm/7"

KS 076/14  
 KS 076/18

KS 077/14  
 KS 077/18

1/1

**BARRAQUER**

Nadelhalter  
Needle Holders  
Porta-agujas  
Porte-aiguilles  
Portaghi

nopa® DIAMOND

		Tip 0,3 mm			Tip 0,3 mm
	14,0 cm/5 1/2"	KS 080/14		14,0 cm/5 1/2"	KS 081/14
		Tip 0,8 mm			Tip 0,8 mm
	14,0 cm/5 1/2"	KS 082/14		14,0 cm/5 1/2"	KS 084/14
	18,0 cm/7"	KS 082/18		18,0 cm/7"	KS 084/18
	21,0 cm/8 1/4"	KS 082/21		21,0 cm/8 1/4"	KS 084/21
	23,0 cm/7"	KS 082/23		23,0 cm/7"	KS 084/23
25,0 cm/10"	KS 082/25	25,0 cm/10"	KS 084/25		
		Tip 0,8 mm			Tip 0,8 mm
	14,0 cm/5 1/2"	KS 083/14		14,0 cm/5 1/2"	KS 085/14
	18,0 cm/7"	KS 083/18		18,0 cm/7"	KS 085/18
	21,0 cm/8 1/4"	KS 083/21		21,0 cm/8 1/4"	KS 085/21
	23,0 cm/7"	KS 083/23		23,0 cm/7"	KS 085/23
25,0 cm/10"	KS 083/25	25,0 cm/10"	KS 085/25		

AA  
AB  
AC  
AE  
AK  
AO  
AR  
KA  
XR  
XT

KS



Nadelhalter  
Needle Holders  
Porta-agujas  
Porte-aiguilles  
Portaghi

nopa® DIAMOND

Length	Tip	Model
14,0 cm / 5 1/2"	0,3 mm	KS 080/14
14,0 cm / 5 1/2"	0,3 mm	KS 081/14
14,0 cm / 5 1/2"	0,8 mm	KS /14
18,0 cm / 7"	0,8 mm	KS 080/18
18,0 cm / 7"	0,8 mm	KS /18
21,0 cm / 8 1/4"	0,8 mm	KS /21
21,0 cm / 8 1/4"	0,8 mm	KS 081/21
23,0 cm / 7"	0,8 mm	KS 080/23
23,0 cm / 7"	0,8 mm	KS /23
23,0 cm / 7"	0,8 mm	KS 081/23
25,0 cm / 10"	0,8 mm	KS /25
25,0 cm / 10"	0,8 mm	KS 081/25

AA  
AB  
AC  
AE  
AK  
AO  
AR  
KA  
XR  
XT

KS

Nadelhalter  
Needle Holders  
Porta-agujas  
Porte-aiguilles  
Portaghi

nopa<sup>®</sup> DIAMOND

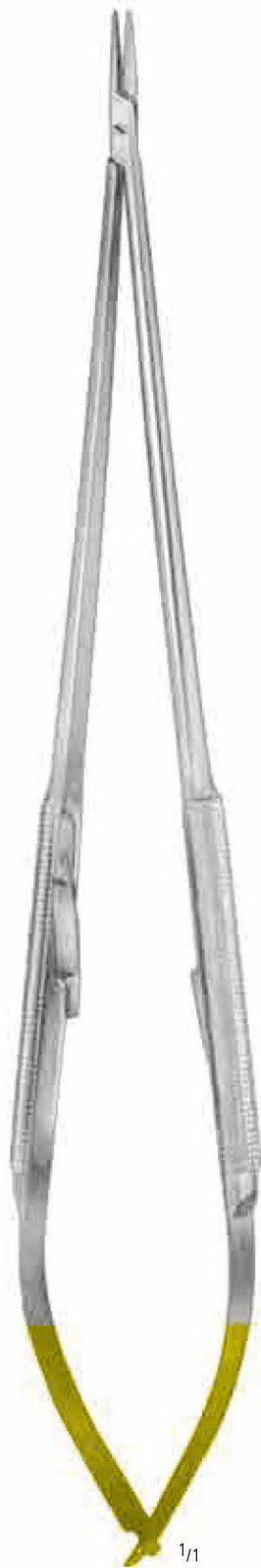

1/1

21,0 cm/8 1/4"



1/1

KS 082/21



1/1

KS 083/21



Nadelhalter  
Needle Holders  
Porta-agujas  
Porte-aiguilles  
Portaghi

AA

AB

AC

AE

AK

AO

AR

KA

**KS**

XR

XT

nopa<sup>®</sup> **DIAMOND**



15,0 cm/6"  
18,0 cm/7"  
23,0 cm/9"

KS 084/15  
KS 084/18  
KS 084/23

Instrumente zur Schädelöffnung  
 Instruments for Cranial Opening  
 Instrumentos para abertura craneana  
 Instruments pour l'ouverture du crâne  
 Strumenti per l'apertura del cranio

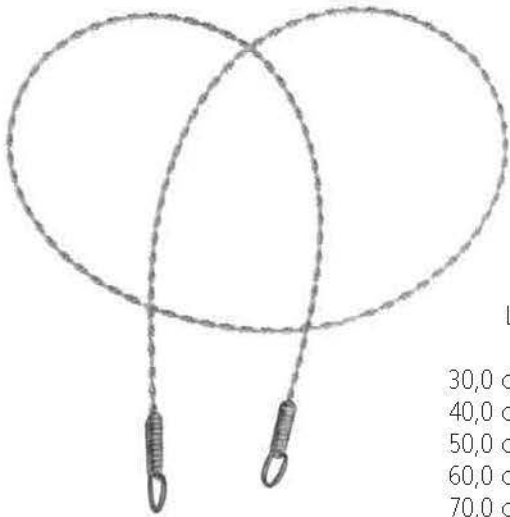

L	2x	3x
30,0 cm/12"	KS 102/30	KS 103/30
40,0 cm/16"	KS 102/40	KS 103/40
50,0 cm/20"	KS 102/50	KS 103/50
60,0 cm/24"	KS 102/60	KS 103/60
70,0 cm/28"	KS 102/70	KS 103/70

**OLIVECRONA-GIGLI**



KS 120/00  
 Paar / pair / pareja / paire / paio

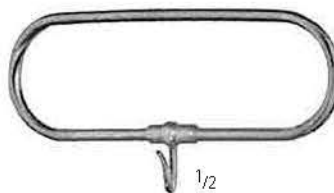

KS 122/00  
 Paar / pair / pareja / paire / paio



**MARTEL**  
 KS 130/33  
 33,0 cm/13"

Instrumente zur Schädelöffnung  
 Instruments for Cranial Opening  
 Instrumentos para abertura craneana  
 Instruments pour l'ouverture du crâne  
 Strumenti per l'apertura del cranio

AA

AB

AC

AE

AK

AO

AR

KA

**KS**

XR

XT



**DE VILBISS**  
 KS 160/21  
 21,0 cm/8<sup>1</sup>/<sub>4</sub>"

1/2



**DAHLGREEN**  
 KS 162/20  
 20,0 cm/8"

1/2

Schädelhalter  
 Cervical Traction Tongs  
 Pinzas de tracción craneal  
 Pinces de traction crânienne  
 Pinze per trazione craniale



**CRUTCHFIELD**  
 KS 200/01



**CRUTCHFIELD**  
 KS 200/02



KS 201/04  
 Ø 3,5 mm



KS 201/05  
 Ø 5,0 mm



KS 210/00



KS 210/01

Ersatzdorn  
 Spare Pin  
 Punta de repuesto  
 Pointe de rechange  
 Punta da scorta

Himnretraktor  
Brain Retractor  
Separadores cerebrales  
Ecarteurs cérébrales  
Divaricatori cerebrali

AA

AB

AC

AE

AK

AO

AR

KA

KS

XR

XT

# LEYLA



KS 220/01 = 1 x KS 220/10  
+ 1 x KS 220/21  
+ 1 x KS 220/45

**LEYLA - 1**  
KS 220/01



KS 220/02 = 2 x KS 220/10  
+ 1 x KS 220/22  
+ 2 x KS 220/45

**LEYLA - 2**  
KS 220/02

Hirnretraktor  
Brain Retractor  
Separadores cerebrales  
Ecarteurs cérébrales  
Divaricatori cerebrali

# LEYLA



KS 220/10



KS 220/21



KS 220/22

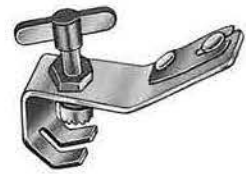

KS 220/30



KS 220/40



KS 220/45

Himnretraktor  
Brain Retractor  
Separadores cerebrales  
Ecarteurs cérébrales  
Divaricatori cerebrali

# LEYLA

Satz  
Set  
KS 222/00 = 1 x KS 222/10  
+ 1 x KS 222/20  
+ 1 x KS 222/25



9 x 32 mm KS 222/09  
10 x 25 mm KS 222/10



KS 222/20



KS 222/25



KS 222/40

AA  
AB  
AC  
AE  
AK  
AO  
AR  
KA  
KS  
XR  
XT

Hirnspatel  
Brain Spatulas  
Espátulas cerebrales  
Spatules cérébrales  
Spatoli cerebrali

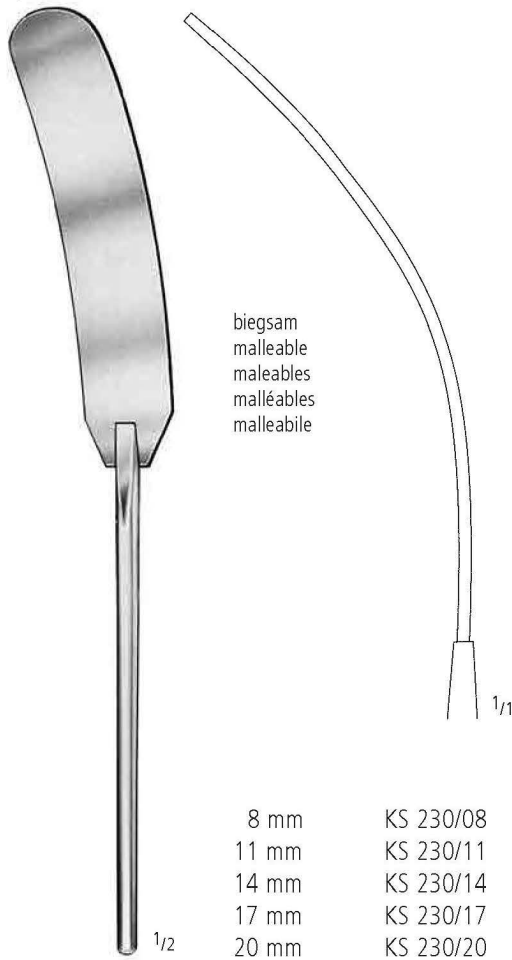

biegsam  
malleable  
maleables  
malléables  
malleabile

8 mm	KS 230/08
11 mm	KS 230/11
14 mm	KS 230/14
17 mm	KS 230/17
20 mm	KS 230/20

**HEIFETZ**  
20,0 cm/8"

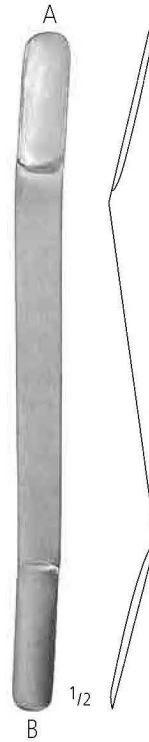

konkav  
concave  
cóncavas  
concaves  
concave

konvex  
convex  
convexas  
convexes  
convesso

	A mm	B mm	
KS 232/01	7	9	KS 233/01
KS 232/02	11	13	KS 233/02
KS 232/03	15	18	KS 233/03
KS 232/04	18	22	KS 233/04

**OLIVECROWNA**  
18,0 cm/7"

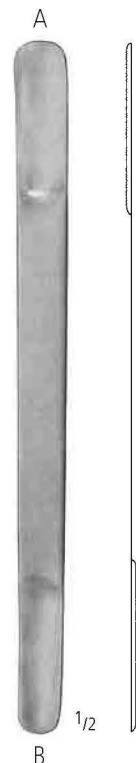

biegsam  
malleable  
maleables  
malléables  
malleabile

A mm	B mm	
7	9	KS 236/01
11	13	KS 236/02
15	18	KS 236/03
18	22	KS 236/04

18,0 cm/7"



biegsam  
malleable  
maleables  
malléables  
malleabile





12 mm	KS 237/12
17 mm	KS 237/17

20,0 cm/8"

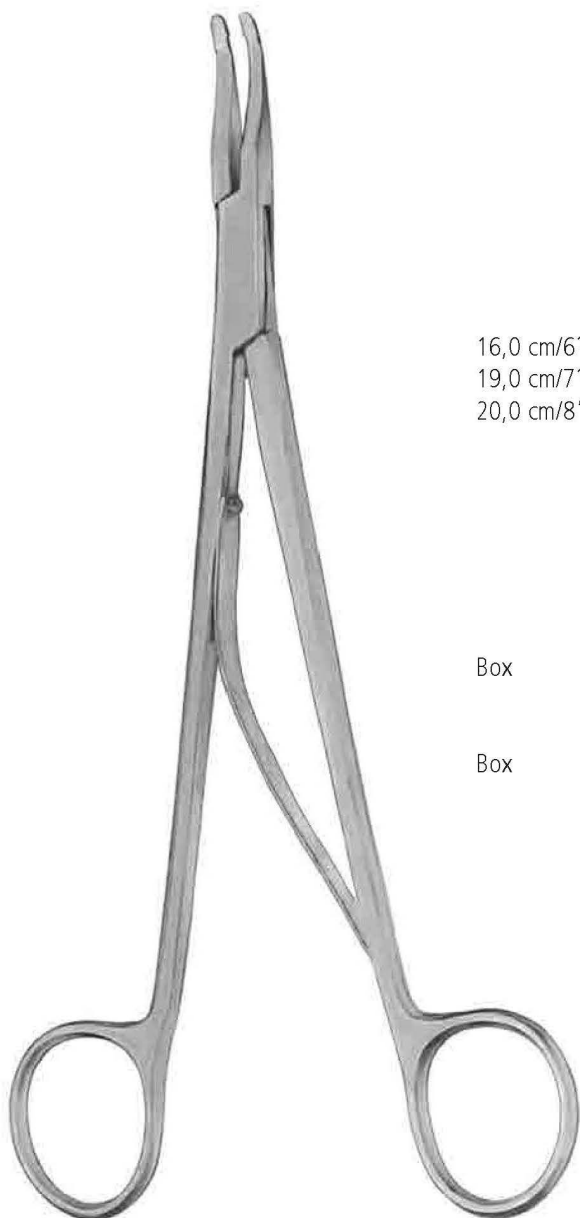

Anlegezangen, Clips  
 Applying Forceps, Clips  
 Pinzas aplicadoras, Clips  
 Pincas pour le cuir chevelu, Clips  
 Pinze al cuoio capelluto, Clips



	klein small	mittel medium	mittel-groß medium-large	groß large
	16,0 cm/6 <sup>1</sup> / <sub>4</sub> "			
	19,0 cm/7 <sup>1</sup> / <sub>2</sub> "		KS 241/01	
	20,0 cm/8"			KS 242/03
	KS 240/01	KS 240/02		
	KS 242/01	KS 242/02		
	 1/1	 1/1	 1/1	 1/1
Box	12 x 25 clips KS 244/01	10 x 25 clips KS 245/01	16 x 10 clips KS 246/01	10 x 15 clips KS 247/01
Box	24 x 10 clips KS 244/02	20 x 10 clips KS 245/02		12 X 10 clips KS 247/02

AA

AB

AC

AE

AK

AO

AR

KA

KS

XR

XT

Anlegezangen  
 Applying Forceps  
 Pinzas aplicadoras  
 Pincès pour le cuir chevelu  
 Pinze al cuoio capelluto

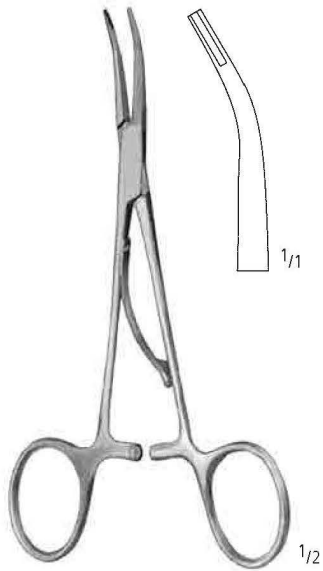

**MC KENZIE**

15,0 cm/6"            KS 250/15  
 19,0 cm/7 1/2"      KS 250/19

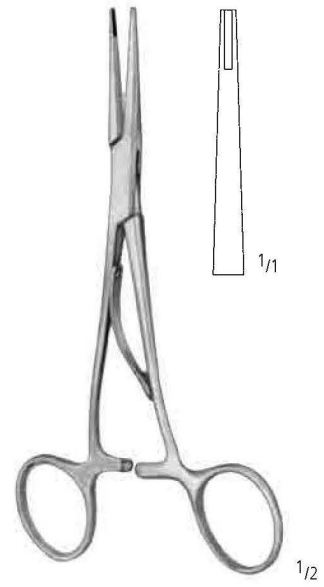

**MC KENZIE**

15,0 cm/6"            KS 255/15  
 19,0 cm/7 1/2"      KS 255/19

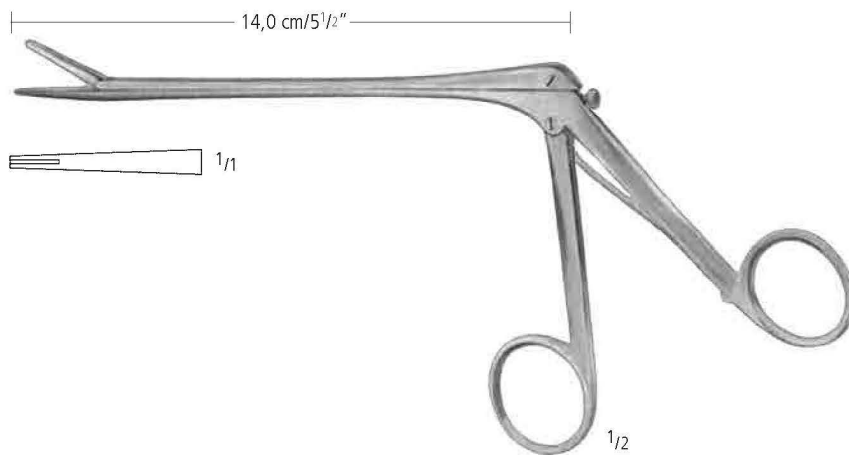

**OLIVECRONA-TOENNIS  
 (SCOVILLE)**

KS 258/00

Klammern und Anlegezangen  
 Clips and Applying Forceps  
 Grapas y pinzas aplicadoras  
 Clips et pinces pour le cuir chevelu  
 Agrafes e pinze al cuoio capelluto

AA

AB

AC

AE

AK

AO

AR

KA

KS

XR

XT



**MC KENZIE**  
 148 x 40 x 6 mm  
 KS 275/01



**MC KENZIE**  
 190 x 48 x 13 mm  
 KS 275/02

Verkaufseinheit: 100 Stück  
 Unit for Sale: 100 pieces  
 Unidad de venta: 100 piezas  
 Unité de vente: 100 pièces  
 Unità di vendita: 100 pezzi

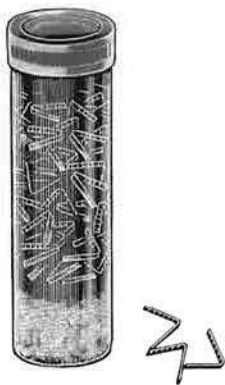

KS 277/00

Verkaufseinheit: 10 Stück  
 Unit for Sale: 10 pieces  
 Unidad de venta: 10 piezas  
 Unité de vente: 10 pièces  
 Unità di vendita: 10 pezzi



**KÖLNER**  
 KS 282/00



**RANEY**  
 KS 286/00  
 16,0 cm/6 1/4"



**RANEY**  
 KS 288/00

Galeahaken  
 Galea Hooks  
 Gancho para Galea  
 Crochets à Galea  
 Uncini per Galea

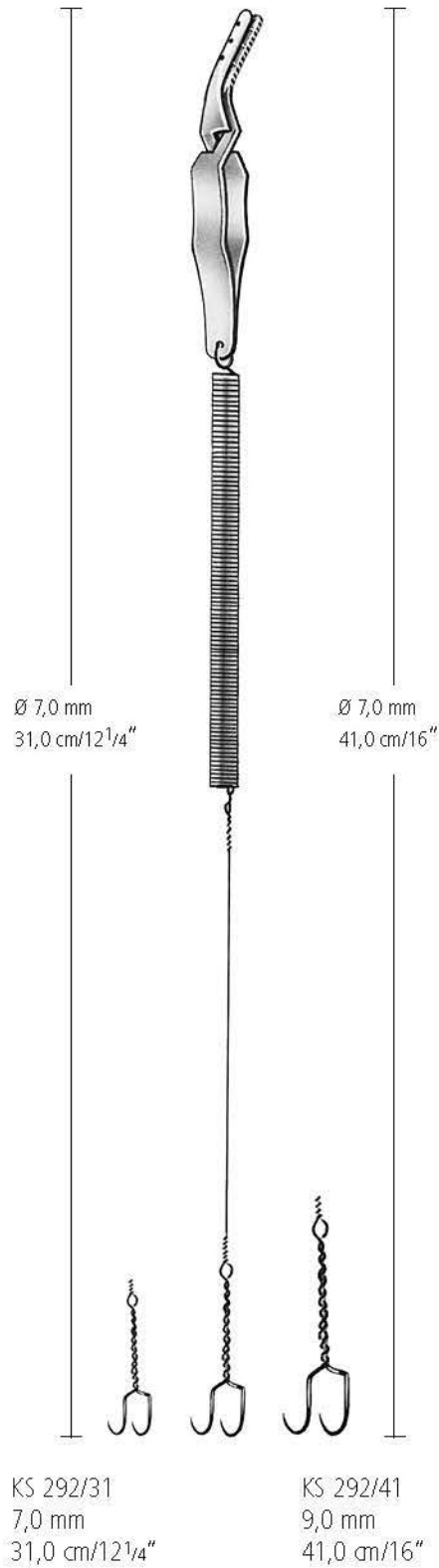

NEUROCHIRURGIE NEUROSURGERY NEUROCIRUGIA NEUROCHIRURGIE NEUROCHIRURGIA

Aneurysmen- und Gefäßclips  
 Aneurysm- and Vessel Clips  
 Clips de Aneurisma  
 Clips pour Aneurisme  
 Clips per Aneurismi

Also available in  
**TITANIUM**

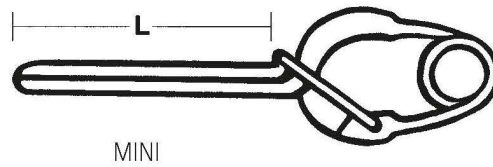

B Maulöffnung  
 Opening  
 Abertura  
 Overture  
 Apertura

F Schließkraft  
 Closing Force  
 Presión  
 Pression  
 Pressione

Permanent	KS 300/01	KS 302/01	KS 304/01	KS 306/01	KS 308/01
Temporary	KS 300/02	KS 302/02			KS 308/02

Permanent	KS 301/01	KS 303/01	KS 305/01	KS 307/01	KS 309/01
Temporary		KS 303/02		KS 307/02	

Permanent	KS 311/01	KS 313/01	KS 315/01	KS 317/01	KS 319/01
Temporary		KS 313/02			

	L (mm)	B (mm)	F (g)
KS 300/01	3,0	3,3	110
KS 300/02	3,0	3,3	50
KS 301/01	3,0	3,2	110
KS 302/01	5,0	4,0	110
KS 302/02	5,0	4,0	50
KS 303/01	5,0	3,8	110
KS 303/02	5,0	3,8	50
KS 304/01	3,0	3,3	110
KS 305/01	5,0	3,8	110
KS 306/01	5,0	4,0	110
KS 307/01	7,0	4,4	110

Also available in  
**TITANIUM**

	L (mm)	B (mm)	F (g)
KS 307/02	7,0	4,4	70
KS 308/01	7,0	4,6	110
KS 308/02	7,0	4,6	70
KS 309/01	5,0	3,6	110
KS 311/01	5,0	3,5	110
KS 313/01	7,0	4,0	110
KS 313/02	7,0	4,0	70
KS 315/01	5,0	3,5	130
KS 317/01	7,0	5,7	130
KS 319/01	7,0	4,5	130

AA  
AB  
AC  
AE  
AK  
AO  
AR  
KA  
KS  
XR  
XT

Aneurysmen- und Gefäßclips  
 Aneurysm- and Vessel Clips  
 Clips de Aneurisma  
 Clips pour Aneurisme  
 Clips per Aneurismi

Also available in  
**TITANIUM**

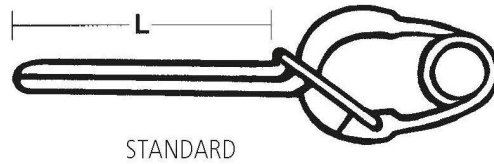

STANDARD

B  
 Maulöffnung  
 Opening  
 Abertura  
 Overture  
 Apertura

F  
 Schließkraft  
 Closing Force  
 Presión  
 Pression  
 Pressione

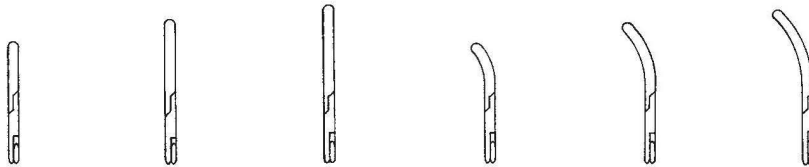

Permanent Temporary KS 330/01 KS 332/01 KS 332/02 KS 334/01 KS 331/01 KS 333/01 KS 333/02 KS 335/01

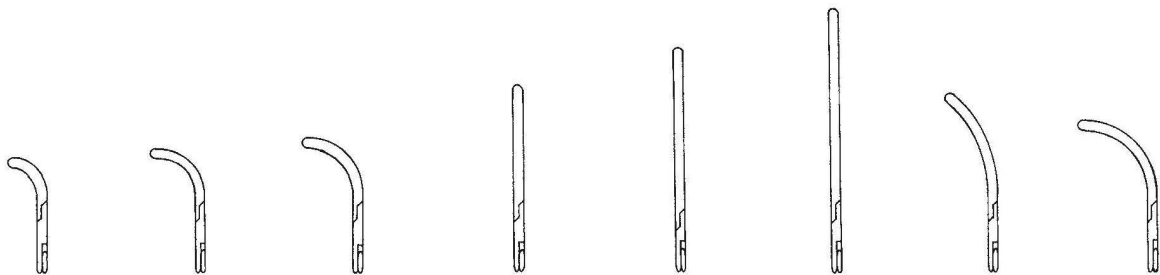

Permanent Temporary KS 337/01 KS 339/01 KS 339/02 KS 341/01 KS 342/01 KS 342/02 KS 344/01 KS 344/02 KS 346/01 KS 347/01 KS 347/02 KS 349/01 KS 349/02

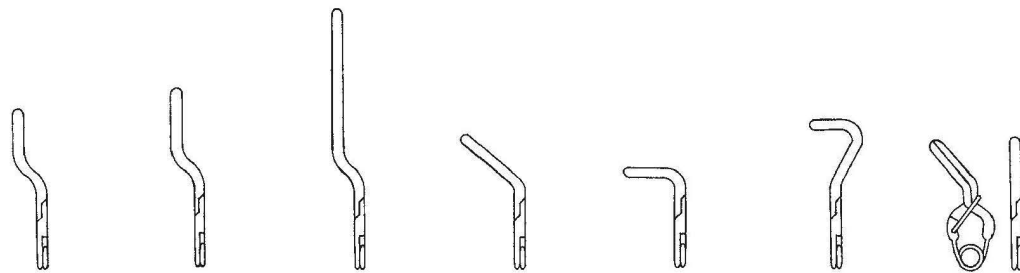

Permanent KS 351/01 KS 353/01 KS 355/01 KS 357/01 KS 359/01 KS 361/01 KS 363/01

	L (mm)	B (mm)	F (g)
KS 330/01	7,0	6,2	150
KS 331/01	7,0	6,0	150
KS 332/01	9,0	7,0	180
KS 332/02	9,0	7,0	70
KS 333/01	9,0	6,8	180
KS 333/02	9,0	6,8	70
KS 334/01	11,0	7,8	180
KS 335/01	11,0	7,5	180
KS 337/01	7,0	5,5	150
KS 339/01	9,0	6,1	180
KS 339/02	9,0	6,1	70
KS 341/01	11,0	6,5	180
KS 342/01	15,0	9,2	200
KS 342/02	15,0	9,2	70

Also available in  
**TITANIUM**

	L (mm)	B (mm)	F (g)
KS 344/01	20,0	11,4	200
KS 344/02	20,0	11,4	90
KS 346/01	25,0	13,3	180
KS 347/01	15,0	8,7	200
KS 347/02	15,0	8,7	70
KS 349/01	15,0	7,4	200
KS 349/02	15,0	7,4	70
KS 351/01	7,0	7,9	200
KS 353/01	9,0	8,7	200
KS 355/01	20,0	13,0	180
KS 357/01	9,0	6,5	200
KS 359/01	7,0	4,5	200
KS 361/01	7,0	7,2	200
KS 363/01	7,0	5,7	200

NEUROCHIRURGIE NEUROSURGERY NEUROCIRUGIA NEUROCHIRURGIE NEUROCHIRURGIA

Aneurysmen- und Gefäßclips  
 Aneurysm- and Vessel Clips  
 Clips de Aneurisma  
 Clips pour Aneurisme  
 Clips per Aneurismi

Also available in  
**TITANIUM**

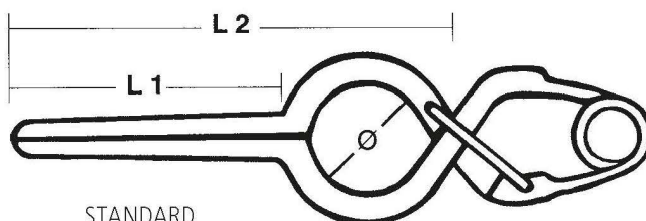

STANDARD  
 PERMANENT

B	F
Maulöffnung	Schließkraft
Opening	Closing Force
Abertura	Presión
Overture	Pression
Apertura	Pressione

Ø 3,5 mm

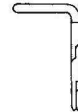
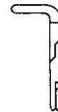
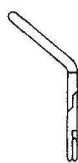

KS 370/01

KS 370/02

KS 370/03

KS 371/01

KS 371/02

KS 371/03

KS 372/01

KS 372/02

KS 372/03

Ø 5,0 mm

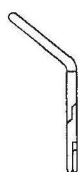

KS 374/01

KS 374/02

KS 374/03

KS 375/01

KS 375/02

KS 375/03

Also available in  
**TITANIUM**

Ø 5,0 mm

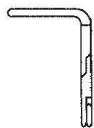
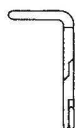

KS 376/01

KS 376/02

KS 376/03

KS 377/01

KS 377/02

KS 377/03

	L1/L2 (mm)	B (mm)	F (g)
KS 370/01	6,0/11,0	7,4	150
KS 370/02	9,0/14,0	8,4	150
KS 370/03	12,0/17,0	9,6	180
KS 371/01	5,0/ 9,0	5,8	150
KS 371/02	7,5/11,5	6,5	150
KS 371/03	10,0/14,0	7,2	180
KS 372/01	5,0/ 9,6	4,9	150
KS 372/02	7,5/12,1	4,9	150
KS 372/03	10,0/14,6	4,9	180
KS 374/01	6,0/12,7	7,9	150
KS 374/02	9,0/15,7	9,1	150
KS 374/03	12,0/18,7	10,3	180

Also available in  
**TITANIUM**

	L1/L2 (mm)	B (mm)	F (g)
KS 375/01	5,0/10,5	6,5	150
KS 375/02	7,5/13,0	7,2	150
KS 375/03	10,0/15,5	7,8	180
KS 376/01	5,0/11,0	5,5	150
KS 376/02	7,5/13,5	5,5	150
KS 376/03	10,0/16,0	5,5	180
KS 377/01	5,0/14,8	7,9	150
KS 377/02	7,5/17,3	8,8	150
KS 377/03	10,0/19,8	10,0	180

AA  
 AB  
 AC  
 AE  
 AK  
 AO  
 AR  
 KA  
 KS  
 XR  
 XT

Anlegezangen für Aneurysmen-Clips  
 Applying Forceps for Aneurysm Clips  
 Pinza para juntar clips de Aneurisma  
 Pince pour poser les clips de Aneurisme  
 Pinze per applicare clips Aneurismi

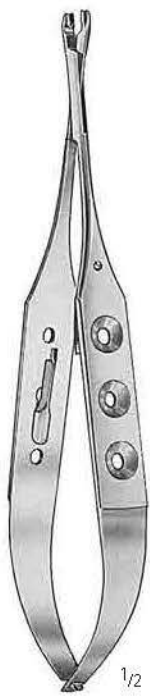

18,0 cm/7" <sup>1/2</sup>



17,0 cm/6<sup>3</sup>/<sub>4</sub>" <sup>1/2</sup>

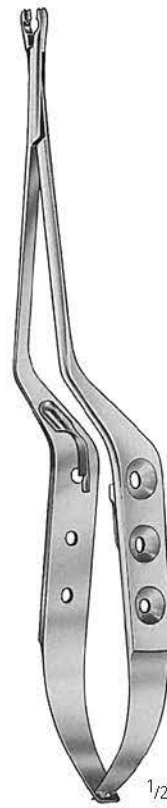

20,5 cm/8" <sup>1/2</sup>

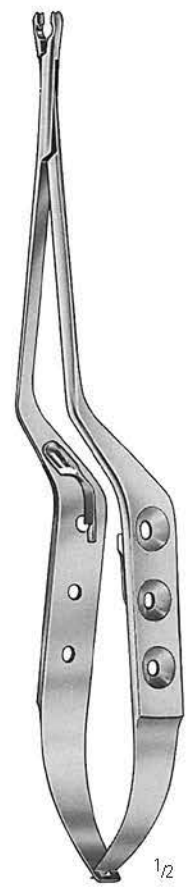

22,5 cm/9" <sup>1/2</sup>

MINI KS 390/01  
 STANDARD KS 390/02

KS 391/01  
 KS 391/02

KS 392/01  
 KS 392/02

KS 393/01  
 KS 393/02



Anlegezangen für Aneurysmen-Clips  
 Applying Forceps for Aneurysm Clips  
 Pinza para juntar clips de Aneurisma  
 Pince pour poser les clips de Aneurisme  
 Pinze per applicare clips Aneurismi

AA  
AB  
AC  
AE  
AK  
AO  
AR  
KA  
KS  
XR  
XT

# FLEXIBLE

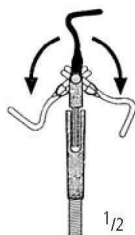

Beispiel für Drehmechanismus  
 Example for rotation  
 Ejemplo para la rotación  
 Exemple pour la rotation  
 Esempio per la rotazione

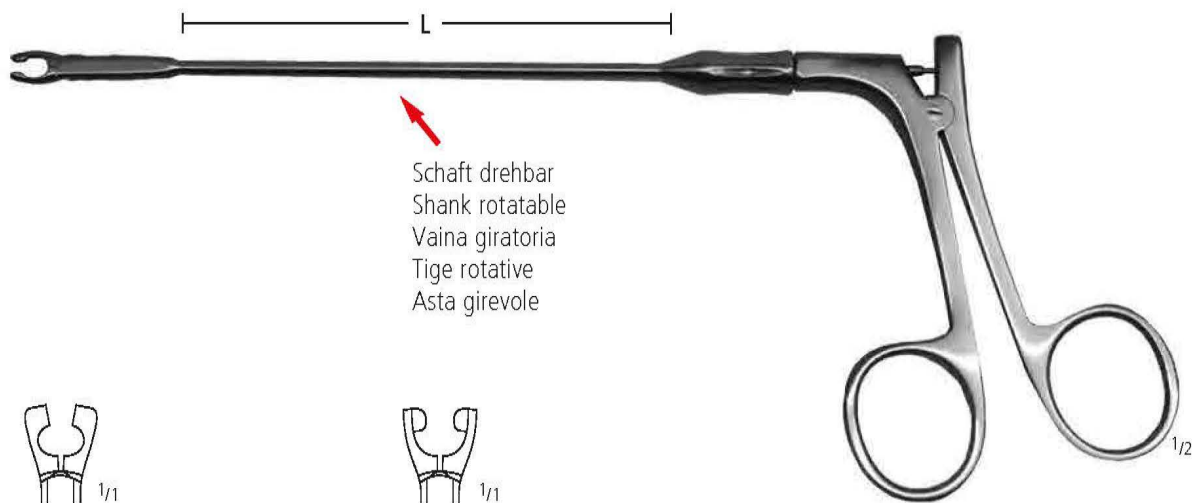

Schaft drehbar  
 Shank rotatable  
 Vaina giratoria  
 Tige rotative  
 Asta girevole

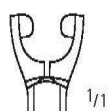
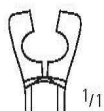

	MINI	STANDARD	MINI	STANDARD
70mm/2 <sup>3</sup> / <sub>4</sub> "	KS 396/11	KS 396/21	KS 397/11	KS 397/21
90mm/3 <sup>1</sup> / <sub>2</sub> "	KS 396/12	KS 396/22	KS 397/12	KS 397/22
110mm/4 <sup>1</sup> / <sub>4</sub> "	KS 396/13	KS 396/23	KS 397/13	KS 397/23
130mm/5"	KS 396/14	KS 396/24	KS 397/14	KS 397/24

nicht drehbar  
 non rotating  
 non rotatif  
 non rotativo  
 non rotatorio

drehbar  
 rotating  
 rotatif  
 rotativo  
 rotatorio

Muskelspreizer  
 Dissectomy Retractors  
 Separadores para músculos  
 Ecarteurs musculaire  
 Divaricatori muscolari



KS 520/01



1/1

20 x 50 mm

20 x 60 mm

20 x 70 mm

△ KS 520/50

KS 520/60

KS 520/70

∩ KS 520/51

KS 520/61

KS 520/71

**HEY**

- KS 520/00 = 1 x KS 520/01
- + 1 x KS 520/50
- + 1 x KS 520/60
- + 1 x KS 520/70
- + 1 x KS 520/37
- + 1 x KS 520/53
- + 1 x KS 520/62

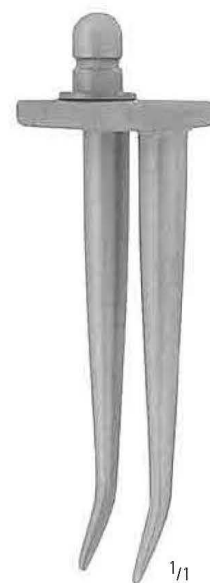

1/1

KS 520/37  
37 mm

KS 520/53  
53 mm

KS 520/62  
62 mm

Muskelspreizer  
 Disectomy Retractors  
 Separadores para músculos  
 Ecarteurs musculaire  
 Divaricatori muscolari



KS 521/51 - KS 521/72  
 17,0 cm/6<sup>3</sup>/<sub>4</sub>"



KS 522/51 - KS 522/72  
 17,0 cm/6<sup>3</sup>/<sub>4</sub>"

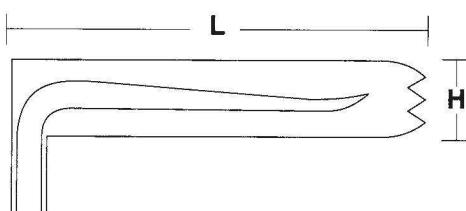

L	H	Linksmodell Left-type	Rechtsmodell Right-type
50 mm x 10 mm		KS 521/51	KS 522/51
60 mm x 10 mm		KS 521/61	KS 522/61
70 mm x 10 mm		KS 521/71	KS 522/71
50 mm x 20 mm		KS 521/52	KS 522/52
60 mm x 20 mm		KS 521/62	KS 522/62
70 mm x 20 mm		KS 521/72	KS 522/72

AA

AB

AC

AE

AK

AO

AR

KA

**KS**

XR

XT

Wundspreizer Wirbelsäule  
 Cervical Retractors  
 Separadores vertebrales  
 Ecarteurs cervicaux  
 Divaricatori vertebrali

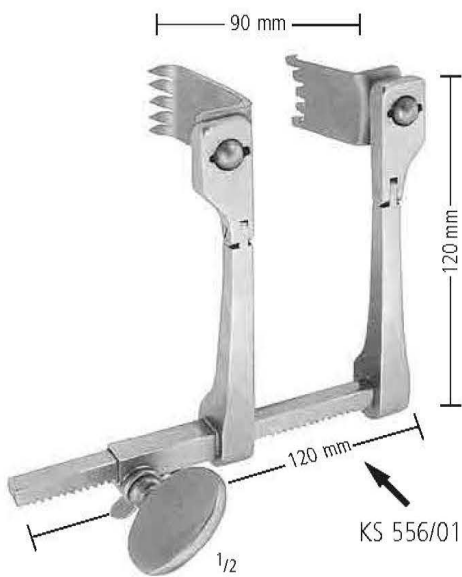

**CASPAR**  
 KS 556/00  
 Transversal



**CASPAR**  
 KS 557/00

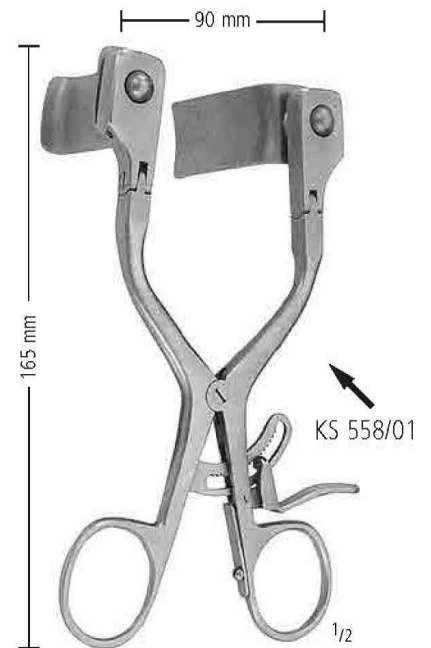

**CASPAR**  
 KS 558/00

- KS 556/00 = 1 x KS 556/01
- + 1 x KS 559/01
- + 1 x KS 559/02
- + 1 x KS 559/03
- + 1 x KS 559/04
- + 1 x KS 559/05
- + 1 x KS 559/11
- + 1 x KS 559/12
- + 1 x KS 559/13
- + 1 x KS 559/14
- + 1 x KS 559/15

- KS 557/00 = 1 x KS 557/01
- + 1 x KS 559/21
- + 1 x KS 559/22
- + 1 x KS 559/23
- + 1 x KS 559/24
- + 1 x KS 559/25

- KS 558/00 = 1 x KS 558/01
- + 1 x KS 559/21
- + 1 x KS 559/22
- + 1 x KS 559/23
- + 1 x KS 559/24
- + 1 x KS 559/25

Wundspreizer Wirbelsäule  
 Cervical Retractors  
 Separadores vertebrales  
 Ecarteurs cervicales  
 Divaricatori vertebrali



40 x 23 mm KS 559/01  
 45 x 23 mm KS 559/02  
 50 x 23 mm KS 559/03  
 55 x 23 mm KS 559/04  
 60 x 23 mm KS 559/05



40 x 23 mm KS 559/11  
 45 x 23 mm KS 559/12  
 50 x 23 mm KS 559/13  
 55 x 23 mm KS 559/14  
 60 x 23 mm KS 559/15

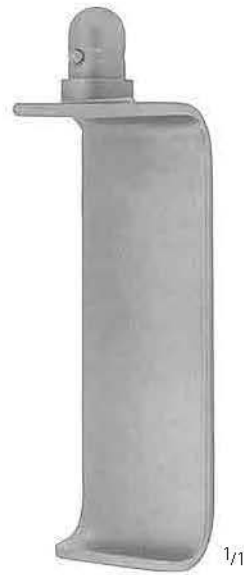

45 x 23 mm KS 559/21  
 50 x 23 mm KS 559/22  
 55 x 23 mm KS 559/23  
 60 x 23 mm KS 559/24  
 65 x 23 mm KS 559/25



50 x 25 mm KS 559/50  
 60 x 25 mm KS 559/60



KS 564/00  
 11,5 cm/4 1/2"

AA  
 AB  
 AC  
 AE  
 AK  
 AO  
 AR  
 KA  
 KS  
 XR  
 XT

Wundspreizer Wirbelsäule  
 Cervical Retractors  
 Separadores vertebrales  
 Ecarteurs cervicaux  
 Divaricatori vertebrali

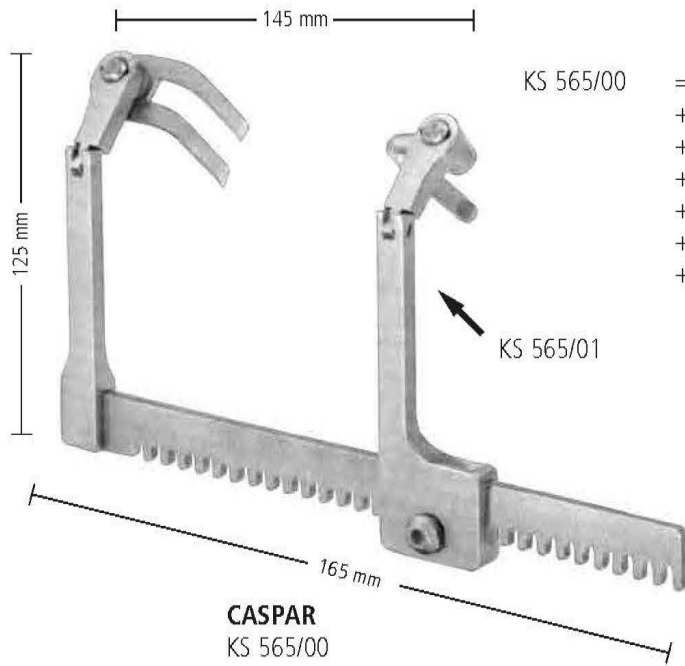

- KS 565/00 = 1 x KS 565/01  
 + 1 x KS 565/99  
 + 1 x KS 566/21  
 + 1 x KS 566/22  
 + 1 x KS 566/23  
 + 1 x KS 566/24  
 + 1 x KS 566/25



KS 565/99



38 mm  
KS 566/01



58 mm  
KS 566/02

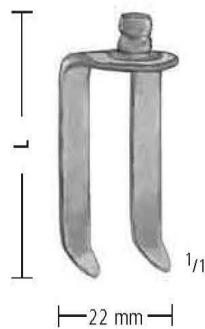

- |          |           |
|----------|-----------|
| <b>L</b> | KS 566/20 |
| 32 mm    | KS 566/21 |
| 37 mm    | KS 566/22 |
| 43 mm    | KS 566/23 |
| 47 mm    | KS 566/24 |
| 52 mm    | KS 566/25 |
| 57 mm    | KS 566/26 |
| 62 mm    | KS 566/27 |
| 67 mm    |           |

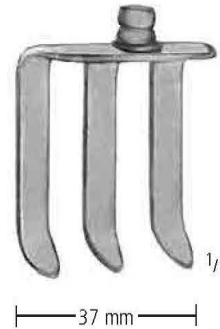

- |           |
|-----------|
| KS 566/30 |
| KS 566/31 |
| KS 566/32 |
| KS 566/33 |
| KS 566/34 |
| KS 566/35 |
| KS 566/36 |
| KS 566/37 |

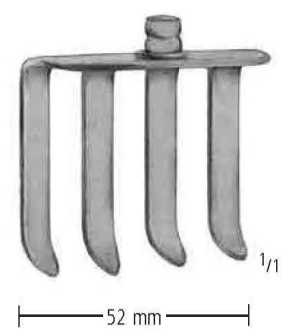

- |           |
|-----------|
| KS 566/40 |
| KS 566/41 |
| KS 566/42 |
| KS 566/43 |
| KS 566/44 |
| KS 566/45 |
| KS 566/46 |
| KS 566/47 |

Wundspreizer  
Retractors  
Separadores  
Ecarteurs  
Divaricatori

AA

AB

AC

AE

AK

AO

AR

KA

KS

XR

XT

Oberfläche geschwärzt  
Surface black-finish



L	
40 mm	KS 568/40
45 mm	KS 568/45
50 mm	KS 568/50
55 mm	KS 568/55
60 mm	KS 568/60

CASPAR



CASPAR

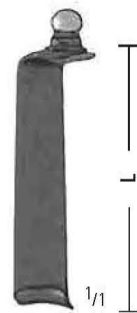

L	
35 mm	KS 569/35
40 mm	KS 569/40
45 mm	KS 569/45
50 mm	KS 569/50
55 mm	KS 569/55
60 mm	KS 569/60

KS 569/00	=	1 x KS 569/01
	+	1 x KS 569/35
	+	1 x KS 569/40
	+	1 x KS 569/45
	+	1 x KS 569/50
	+	1 x KS 569/55
	+	1 x KS 569/60

Wundspreizer  
 Retractors  
 Separadores  
 Ecarteurs  
 Divaricatori

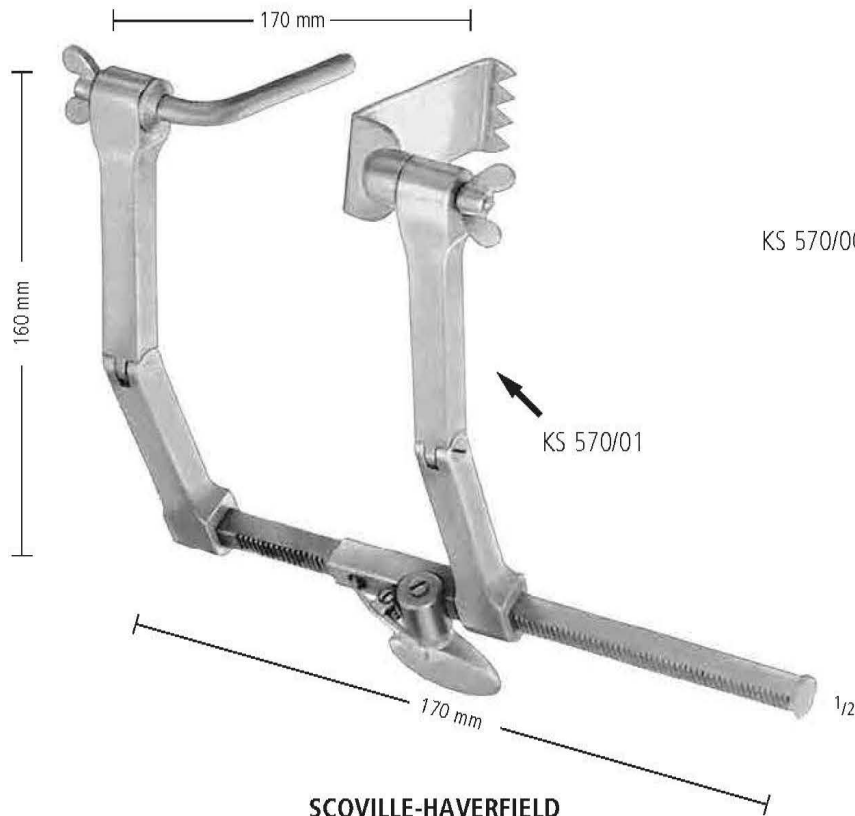

KS 570/00 = 1 x KS 570/01  
 + 1 x KS 570/02  
 + 1 x KS 570/10

**SCOVILLE-HAVERFIELD**  
 KS 570/00



**SCOVILLE**  
 KS 570/02  
 5,5 cm/2"



**SCOVILLE**  
 63 x 25 mm KS 570/10  
 63 x 51 mm KS 570/11  
 67 x 32 mm KS 570/12  
 89 x 25 mm KS 570/13



**TAYLOR**  
 47 X 37 mm KS 570/33



**TAYLOR**  
 63 X 51 mm KS 570/44



Wundspreizer  
Retractors  
Separadores  
Ecarteurs  
Divaricatori

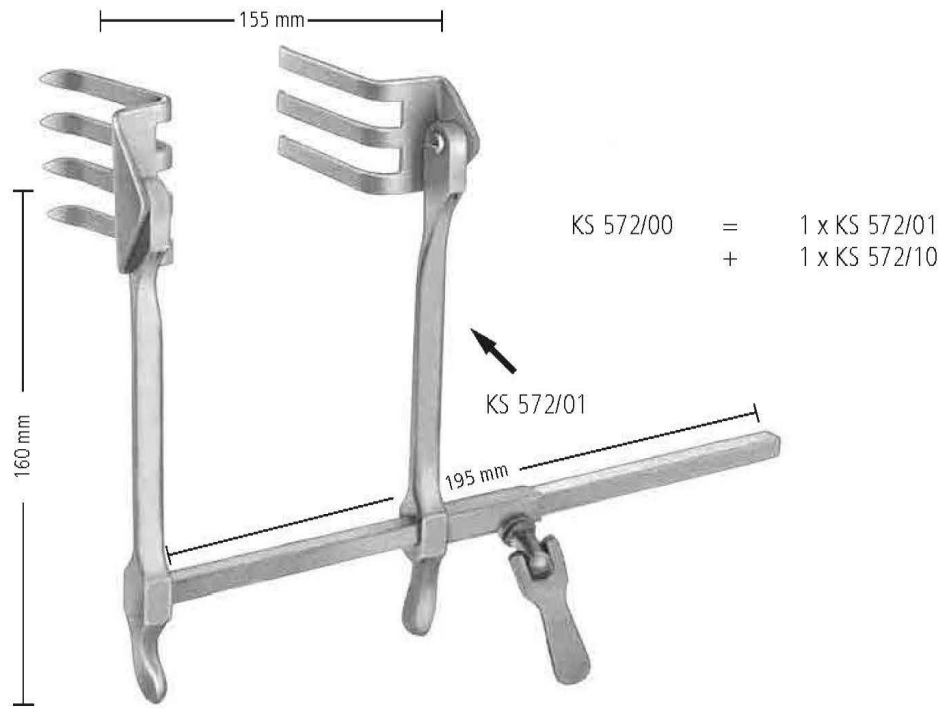

**SCOVILLE-RICHTER**  
KS 572/00



KS 572/10 (Paar/Pair)  
62 x 52 mm      62 x 37 mm



KS 572/20  
47 x 51 mm



KS 572/30  
30 x 40 mm



KS 572/40  
37 x 62 mm

AA  
AB  
AC  
AE  
AK  
AO  
AR  
KA  
KS  
XR  
XT

Wundspreizer  
 Retractors  
 Separadores  
 Ecarteurs  
 Divaricatori



**CLOWARD modif.**  
 KS 580/00  
 25,0 cm/10"

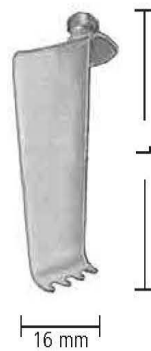

- |          |           |
|----------|-----------|
| <b>L</b> |           |
| 40 mm    | KS 580/10 |
| 45 mm    | KS 580/11 |
| 50 mm    | KS 580/12 |
| 55 mm    | KS 580/13 |
| 60 mm    | KS 580/14 |



- |          |           |
|----------|-----------|
| <b>L</b> |           |
| 40 mm    | KS 580/20 |
| 45 mm    | KS 580/21 |
| 50 mm    | KS 580/22 |
| 55 mm    | KS 580/23 |
| 60 mm    | KS 580/24 |

- |           |   |               |
|-----------|---|---------------|
| KS 580/00 | = | 1 x KS 580/01 |
|           | + | 1 x KS 580/10 |
|           | + | 1 x KS 580/11 |
|           | + | 1 x KS 580/12 |
|           | + | 1 x KS 580/13 |
|           | + | 1 x KS 580/14 |

Wundspreizer  
Retractors  
Separadores  
Ecarteurs  
Divaricatori

AA

AB

AC

AE

AK

AO

AR

KA

KS

XR

XT



KS 582/00

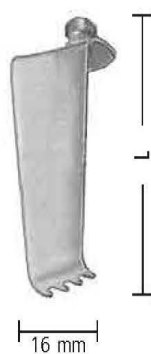

L	
40 mm	KS 580/10
45 mm	KS 580/11
50 mm	KS 580/12
55 mm	KS 580/13
60 mm	KS 580/14

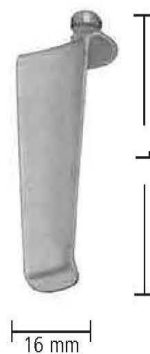

L	
40 mm	KS 580/20
45 mm	KS 580/21
50 mm	KS 580/22
55 mm	KS 580/23
60 mm	KS 580/24

KS 582/00	=	1 x KS 582/01
	+	1 x KS 580/10
	+	1 x KS 580/11
	+	1 x KS 580/12
	+	1 x KS 580/13
	+	1 x KS 580/14

Wirbelkörperspreizer  
 Lamina Spreaders  
 Separadores para cuerpos vertebrales  
 Ecarteurs pour corps vertébraux  
 Separatori per vertebre



**CLOWARD**  
 KS 587/08  
 T = 70 mm

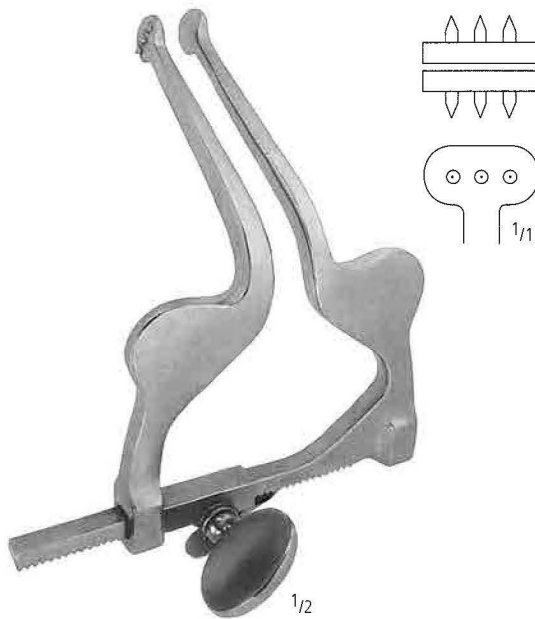

**CLOWARD**  
 KS 588/09      KS 588/11  
 9,0 cm/3<sup>3</sup>/<sub>4</sub>"      11,0 cm/4<sup>1</sup>/<sub>4</sub>"

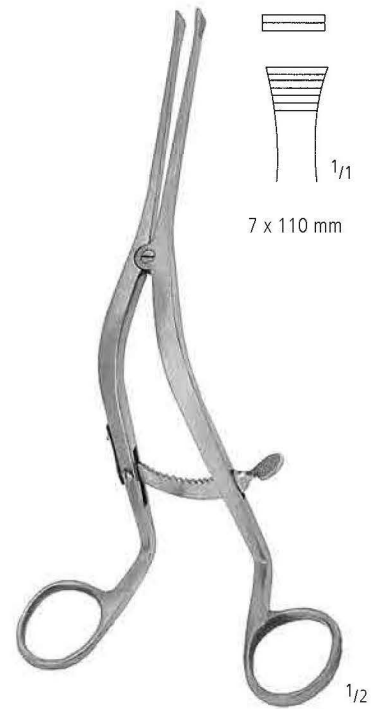

**CLOWARD**  
 KS 589/00  
 21,0 cm/8<sup>1</sup>/<sub>4</sub>"

Wirbelkörperspreizer  
 Lamina Spreaders  
 Separadores para cuerpos vertebrales  
 Ecarteurs pour corps vertébraux  
 Separatori per vertebre

AA

AB

AC

AE

AK

AO

AR

KA

**KS**

XR

XT



**HARMS**  
 KS 590/01  
 18,0 cm/7"



**HARMS**  
 KS 590/02  
 18,0 cm/7"

Wirbelkörperspreizer  
 Lamina Spreaders  
 Separadores para cuerpos vertebrales  
 Ecarteurs pour corps vertébraux  
 Separatori per vertebre



**CLOWARD**  
 KS 592/16  
 16,0 cm/6<sup>1</sup>/<sub>2</sub>"

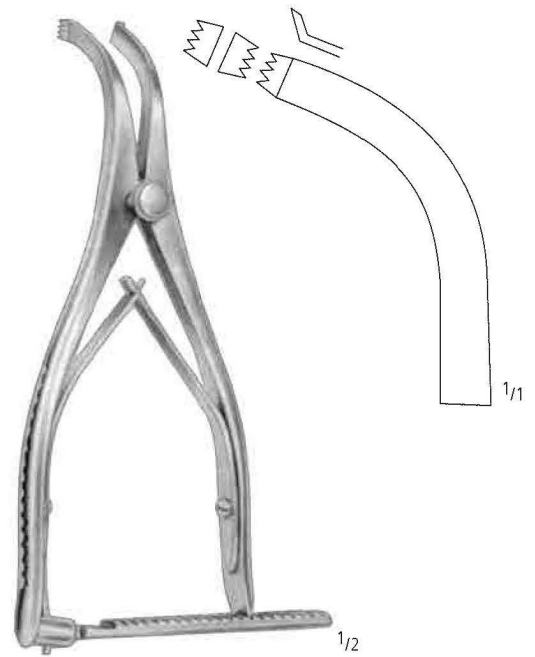

**INGE**  
 KS 593/17  
 16,5 cm/6<sup>1</sup>/<sub>2</sub>"

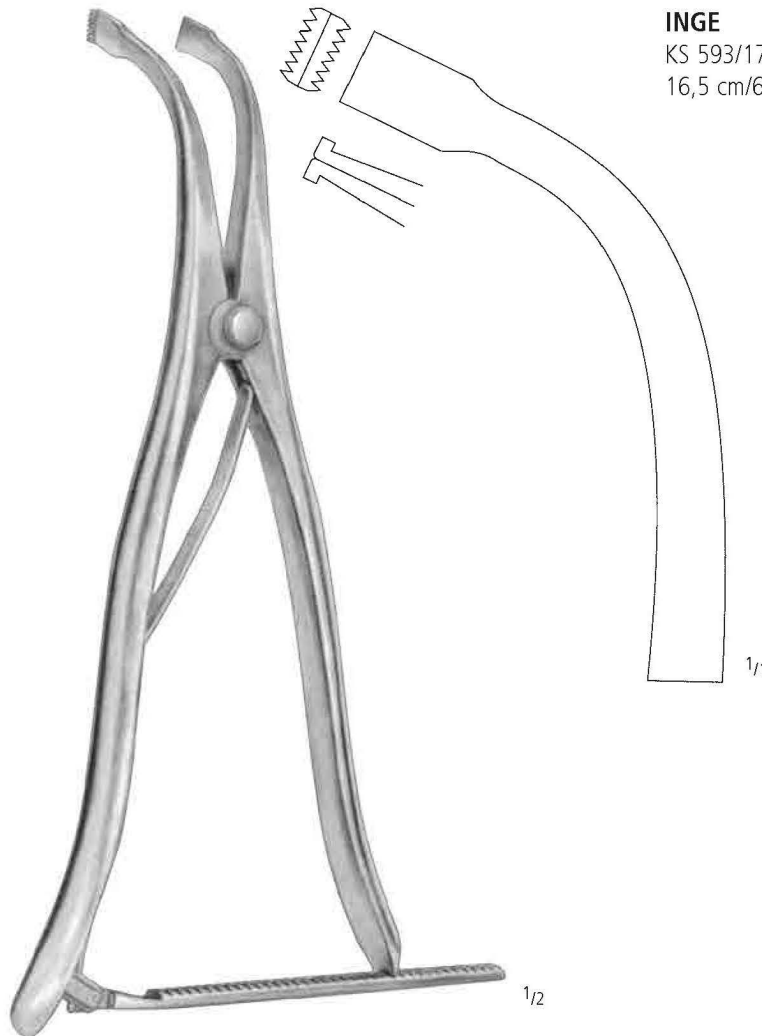

**INGE**  
 KS 594/27  
 27,0 cm/10<sup>3</sup>/<sub>4</sub>"

Nervwurzelnhaken  
 Nerve Root Retractors  
 Separadores de raiz de nervios  
 Rétracteurs pour racines nerveuses  
 Uncini per le radici dei nervi

AA

AB

AC

AE

AK

AO

AR

KA

**KS**

XR

XT

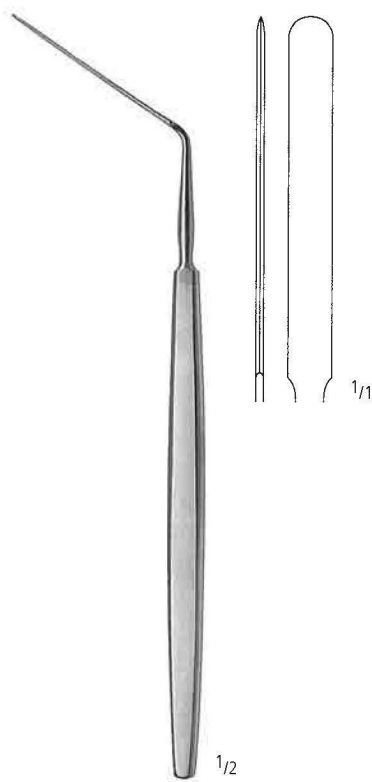

**HORSLEY**  
 KS 607/20  
 20,0 cm/8"

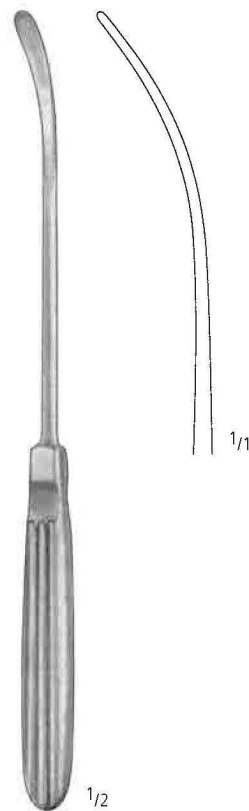

**SACHS**  
 KS 608/21  
 21,0 cm/8 1/2"



**SCOVILLE**  
 KS 609/23  
 23,0 cm/9 1/4"

Nervwurzelhaken  
 Nerve Root Retractors  
 Separadores de raiz de nervios  
 Rétracteurs pour racines nerveuses  
 Uncini per le radici dei nervi

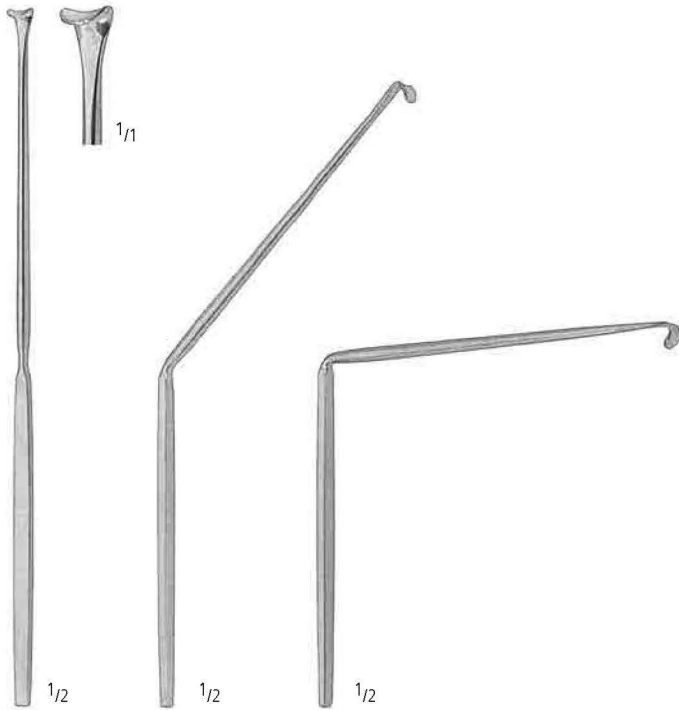

**LOVE**

	45°	90°
KS 610/01	KS 610/02	KS 610/03
19,0 cm/7 <sup>1</sup> / <sub>2</sub> "	19,0 cm/7 <sup>1</sup> / <sub>2</sub> "	19,0 cm/7 <sup>1</sup> / <sub>2</sub> "



**LOVE modif.**

Tip	L	L
3 mm	7,0 cm/3"	10,0 cm/4"
5 mm	KS 610/12	KS 610/22
7 mm	KS 610/13	KS 610/23

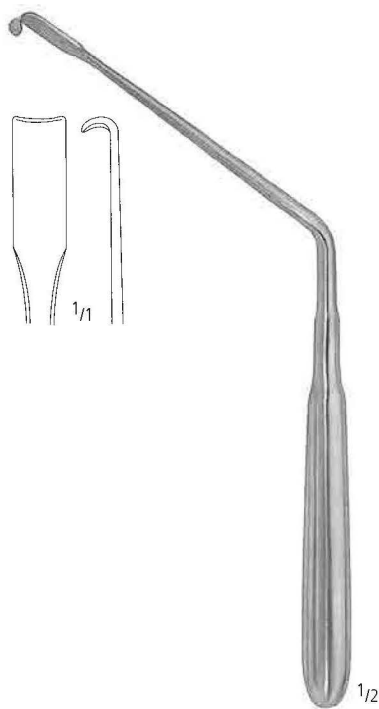

KS 611/20  
 20,0 cm/8"

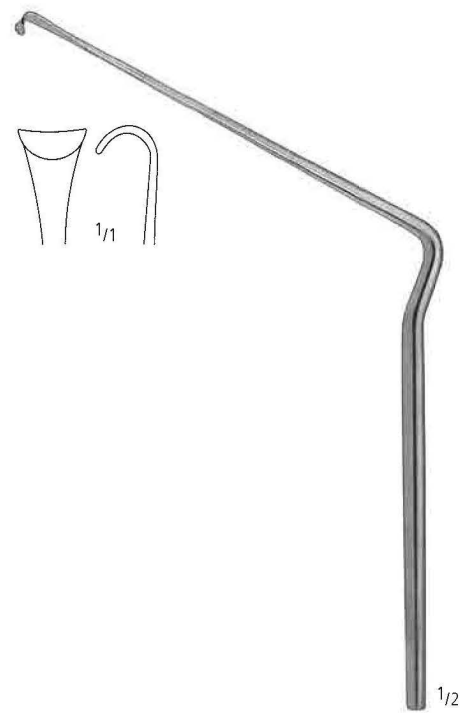

**MARTIN**  
 KS 612/21  
 21,0 cm/8<sup>1</sup>/<sub>4</sub>"



Nervhaken  
Nerve Hooks  
Ganchos para nervios  
Crochets à nerfs  
Uncini per nervi

AA

AB

AC

AE

AK

AO

AR

KA

**KS**

XR

XT



**GRONINGEN**  
26,0 cm/10<sup>1</sup>/<sub>4</sub>"

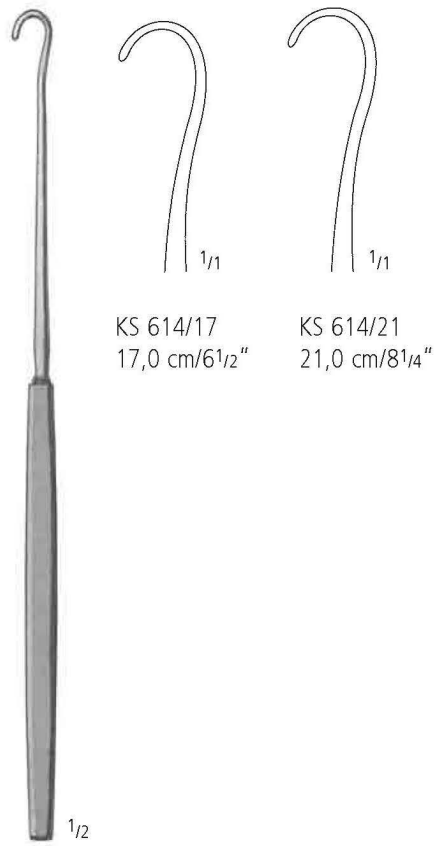

**SMITHWICK**



**DANDY**  
KS 615/20  
20,0 cm/8"

Nervhaken  
Nerve Hooks  
Ganchos para nervios  
Crochets à nerfs  
Uncini per nervi



1/1

**KRAYENBÜHL**  
18,5 cm/7<sup>1</sup>/<sub>4</sub>"

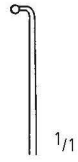

1/1

KS 616/01



1/1

KS 616/02



1/1

KS 616/03



1/1

KS 616/04

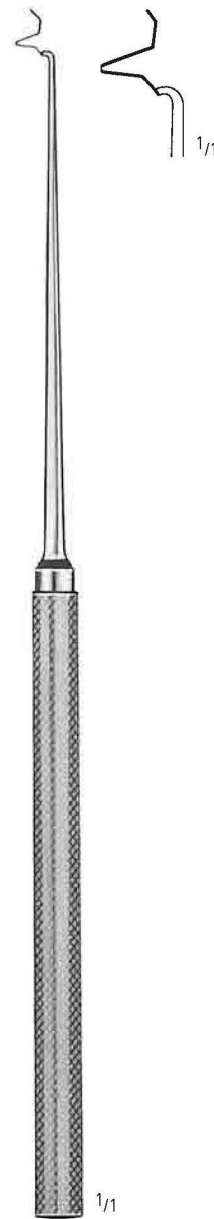

1/1

**BIEMER**  
KS 617/16  
16,0 cm/6<sup>1</sup>/<sub>4</sub>"



1/1

**FISCH**  
18,5 cm/7<sup>1</sup>/<sub>4</sub>"



1/1

KS 618/01



1/1

KS 618/02

Durahaken  
 Dura Hooks  
 Ganchos para dura-madre  
 Crochets à dure-mère  
 Uncini per dura-madre

AA  
 AB  
 AC  
 AE  
 AK  
 AO  
 AR  
 KA  
 KS  
 XR  
 XT

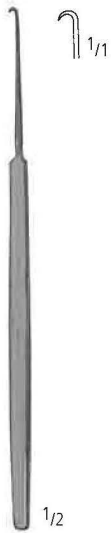

**CUSHING**  
 KS 620/14  
 14,0 cm/5 1/2"



**ADSON**  
 KS 621/20  
 20,0 cm/8"



**GRAHAM**  
 KS 622/16  
 16,5 cm/6 1/2"

Dura Dissektoren  
 Dura Dissectors  
 Disecadores para dura-madre  
 Dissecteurs à dure-mère  
 Dissetori per dura-madre

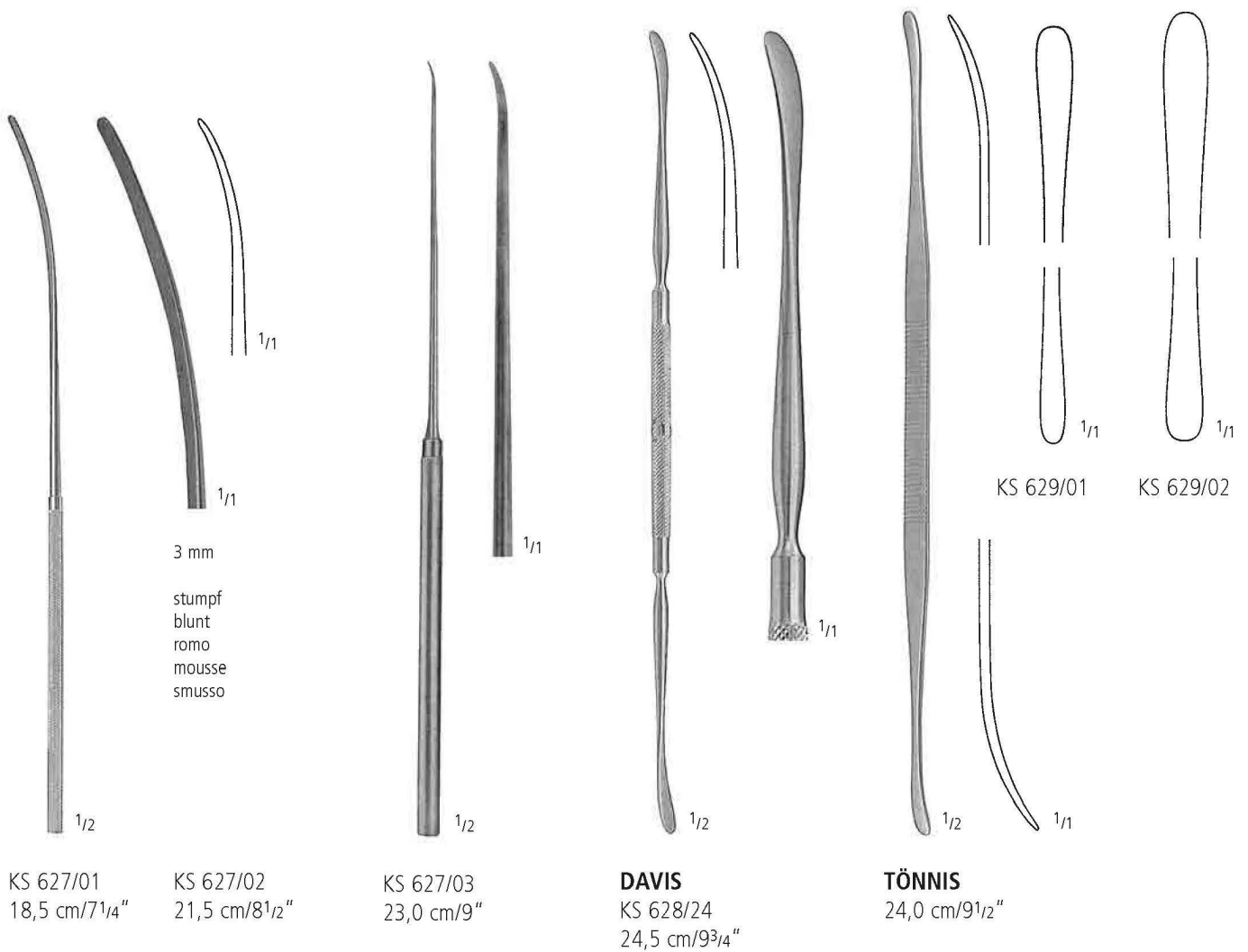

Dura Dissektoren  
 Dura Dissectors  
 Disecadores para dura-madre  
 Dissecteurs à dure-mère  
 Dissettori per dura-madre

AA

AB

AC

AE

AK

AO

AR

KA

KS

XR

XT



**SACHS**  
 KS 631/21  
 21,0 cm/8<sup>1</sup>/<sub>4</sub>"



**SACHS**  
 KS 632/21  
 21,0 cm/8<sup>1</sup>/<sub>4</sub>"



**FRAZIER**  
 KS 633/01  
 15,0 cm/6"



**HOEN**  
 KS 633/02  
 15,0 cm/6"

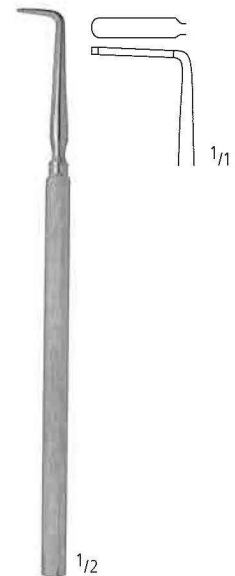

**HOEN**  
 KS 633/03  
 15,0 cm/6"

Dura Dissektoren  
 Dura Dissectors  
 Disecadores para dura-madre  
 Dissecteurs à dure-mère  
 Dissetori per dura-madre

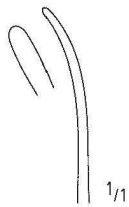

1/1



1/1

KS 634/18  
 18,0 cm/7"

KS 635/20  
 19,5 cm/7<sup>3</sup>/<sub>4</sub>"

KS 634/24  
 24,0 cm/9<sup>1</sup>/<sub>2</sub>"

KS 635/24  
 24,0 cm/9<sup>1</sup>/<sub>2</sub>"

1/2

**OLIVECRONA**

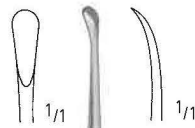

1/1

1/1

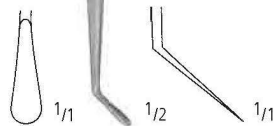

1/1

1/2

1/1

**MILLIGAN**

KS 636/21  
 21,0 cm/8<sup>1</sup>/<sub>4</sub>"

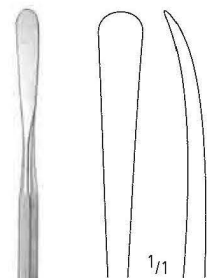

1/1

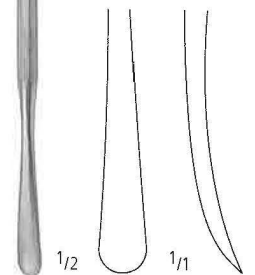

1/2

1/1

KS 637/22  
 22,0 cm/8<sup>3</sup>/<sub>4</sub>"

Dura Dissektoren  
 Dura Dissectors  
 Disecadores para dura-madre  
 Dissecteurs à dure-mère  
 Dissetori per dura-madre

AA  
 AB  
 AC  
 AE  
 AK  
 AO  
 AR  
 KA  
**KS**  
 XR  
 XT



**PENFIELD**  
 KS 638/01  
 17,5 cm/7"



**PENFIELD**  
 KS 638/02  
 19,5 cm/7<sup>3</sup>/<sub>4</sub>"



**PENFIELD**  
 KS 638/03  
 19,5 cm/7<sup>3</sup>/<sub>4</sub>"



**PENFIELD**  
 KS 638/04  
 20,5 cm/8"



**PENFIELD**  
 KS 638/05  
 29,0 cm/11<sup>1</sup>/<sub>2</sub>"

Mikro-Instrumente  
 Micro Instruments  
 Instrumentos para microcirugía  
 Instruments pour la chirurgie micro  
 Strumenti per chirurgia micro



1/1 23,0 cm/9"

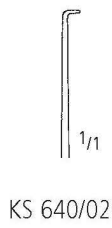
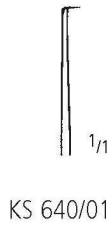

1/1 23,0 cm/9"

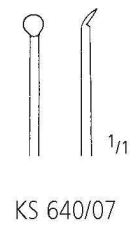
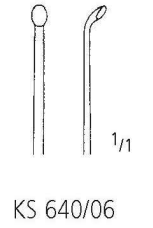
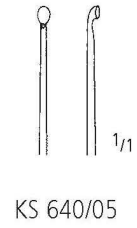
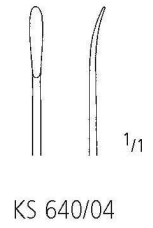
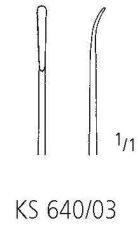



Mikro-Instrumente  
 Micro Instruments  
 Instrumentos para microcirugía  
 Instruments pour la chirurgie micro  
 Strumenti per chirurgia micro

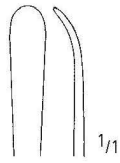

KS 642/01  
 23,0 cm/9"

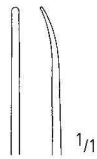

KS 642/02  
 20,0 cm/8"

<sup>1/1</sup> CASPAR

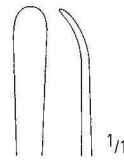

KS 642/03  
 23,0 cm/9"

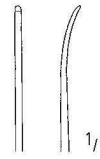

KS 642/05  
 21,0 cm/8<sup>1</sup>/<sub>4</sub>"

<sup>1/1</sup> CASPAR

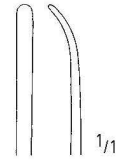

KS 642/04  
 23,0 cm/9"

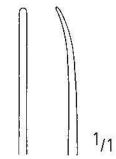

KS 642/06  
 21,0 cm/8<sup>1</sup>/<sub>4</sub>"

AA  
 AB  
 AC  
 AE  
 AK  
 AO  
 AR  
 KA  
 KS  
 XR  
 XT



Mikro-Instrumente  
 Micro Instruments  
 Instrumentos para microcirugía  
 Instruments pour la chirurgie micro  
 Strumenti per chirurgia micro

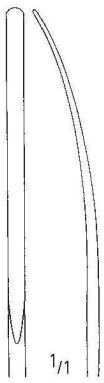

KS 643/19  
 18,5 cm / 7 1/4"

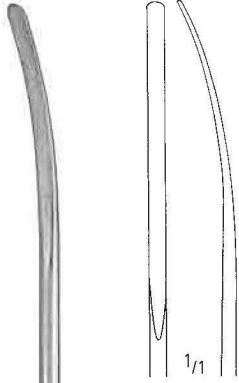

KS 643/22  
 21,5 cm / 8 1/2"



KS 644/01  
 24,5 cm / 9 3/4"

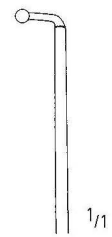

KS 644/02  
 24,5 cm / 9 3/4"

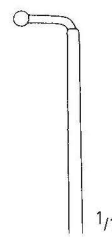

KS 644/03  
 24,5 cm / 9 3/4"

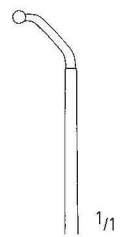

KS 644/04  
 24,5 cm / 9 3/4"



1/1



1/1

CASPAR

Mikro-Instrumente  
 Micro Instruments  
 Instrumentos para microcirugía  
 Instruments pour la chirurgie micro  
 Strumenti per chirurgia micro

AA  
 AB  
 AC  
 AE  
 AK  
 AO  
 AR  
 KA  
 KS  
 XR  
 XT



20,0 cm/8" KS 647/01  
 23,0 cm/9 1/4" KS 648/01

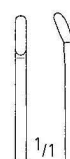

KS 647/02  
 KS 648/02



KS 647/03  
 KS 648/03

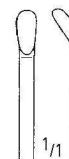

KS 647/04  
 KS 648/04

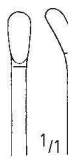

20,0 cm/8" KS 647/05  
 23,0 cm/9 1/4" KS 648/05



KS 647/06  
 KS 648/06

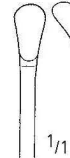

KS 647/07  
 KS 648/07

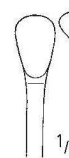

KS 647/08  
 KS 648/08

1/1 SAMII

Mikro-Instrumente  
 Micro Instruments  
 Instrumentos para microcirugía  
 Instruments pour la chirurgie micro  
 Strumenti per chirurgia micro



18,5 cm/7 1/4"

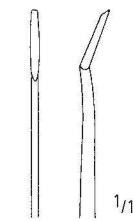

KS 650/01

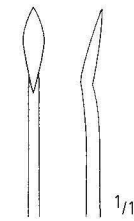

KS 650/02

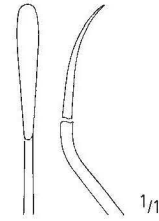

KS 650/06

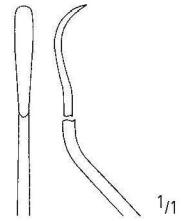

KS 650/07

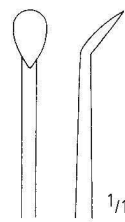

KS 650/03

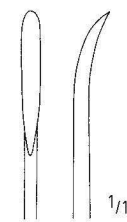

KS 650/04

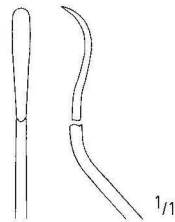

KS 650/08

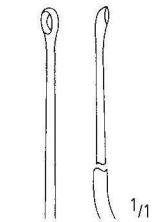

KS 650/09

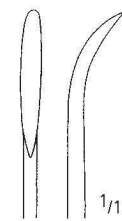

KS 650/05

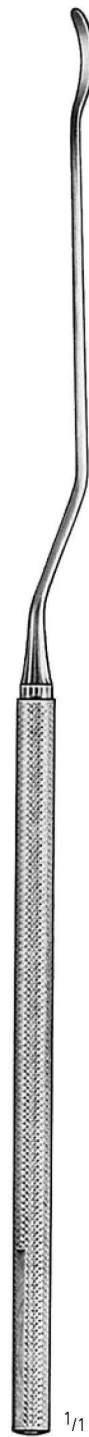

18,5 cm/7 1/4"

Mikro-Instrumente  
 Micro Instruments  
 Instrumentos para microcirugía  
 Instruments pour la chirurgie micro  
 Strumenti per chirurgia micro

AA  
 AB  
 AC  
 AE  
 AK  
 AO  
 AR  
 KA  
**KS**  
 XR  
 XT

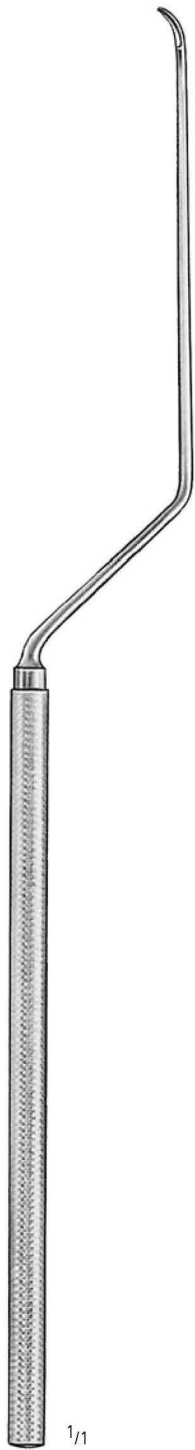

**KOOS**  
 19,0 cm/7 1/2"



KS 652/01



KS 652/02



KS 652/03



KS 652/04



KS 652/05

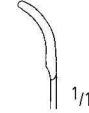

KS 652/06

Mikro-Instrumente  
 Micro Instruments  
 Instrumentos para microcirugía  
 Instruments pour la chirurgie micro  
 Strumenti per chirurgia micro

Schneide seitlich  
 Lateral cutting edge  
 Filo de corte lateral  
 Trachant latéral  
 Taglio laterale



**KRAUS**  
 KS 653/19  
 19,0 cm/7 1/2"



KS 654/01  
 19,0 cm/7 1/2"



KS 654/02  
 19,0 cm/7 1/2"

Mikro-Instrumente  
 Micro Instruments  
 Instrumentos para microcirugía  
 Instruments pour la chirurgie micro  
 Strumenti per chirurgia micro



**JACOBSON**  
 19,0 cm/7 1/2"



**JACOBSON**  
 18,5 cm/7 1/4"

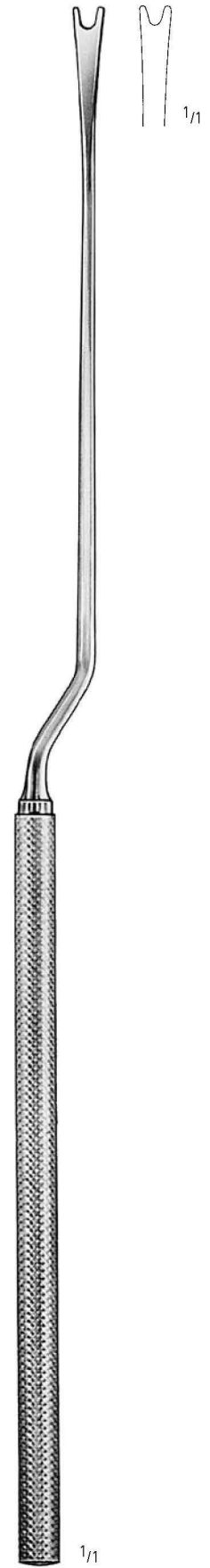

**CASPAR**  
 KS 659/23  
 23,0 cm/9"

AA  
 AB  
 AC  
 AE  
 AK  
 AO  
 AR  
 KA  
 KS  
 XR  
 XT

Mikro-Instrumente  
 Micro Instruments  
 Instrumentos para microcirugía  
 Instruments pour la chirurgie micro  
 Strumenti per chirurgia micro



**OKONEK**  
 1/1 23,0 cm/9"

3 mm



KS 660/03

4 mm



KS 660/04

5 mm



KS 660/05

8 mm

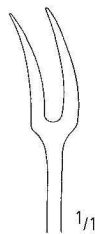

KS 660/08



1/1 19,0 cm/7 1/2"

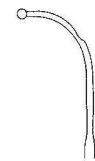

KS 665/01

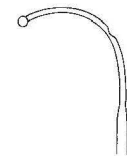

KS 665/02



KS 665/03

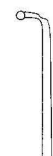

KS 665/04



Mikro-Instrumente  
 Micro Instruments  
 Instrumentos para microcirugía  
 Instruments pour la chirurgie micro  
 Strumenti per chirurgia micro

AA

AB

AC

AE

AK

AO

AR

KA

**KS**

XR

XT

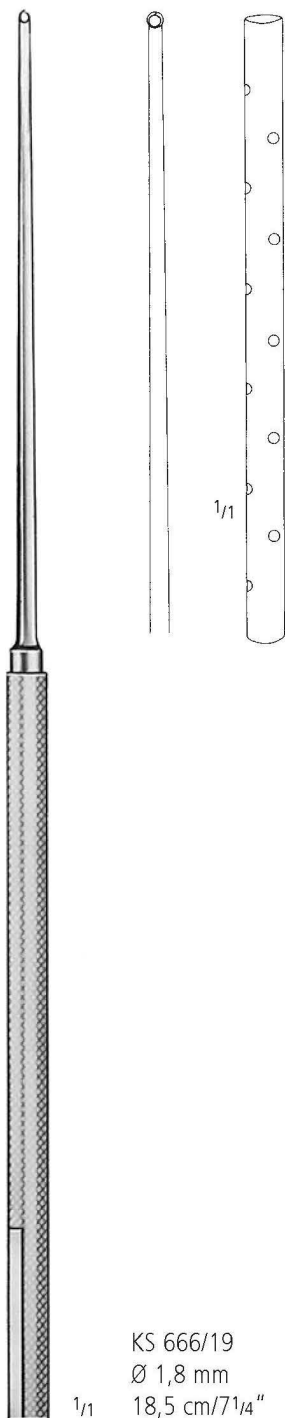

KS 666/19  
 Ø 1,8 mm  
 18,5 cm/7 1/4"



KS 670/00

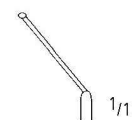

KS 670/01

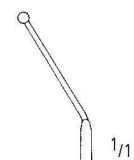

KS 670/02

1/1 12,5 cm/5"

Rhoton Mikro Dissektoren  
 Rhoton Micro Dissectors  
 Rhoton micro disecadores  
 Rhoton micro dissecteurs  
 Rhoton micro dissectori



KS 680/01



KS 680/02



KS 680/03



KS 680/04



KS 680/05



KS 680/06



KS 680/07



KS 680/08



KS 680/09

**RHOTON**

Rhoton Mikro Dissektoren  
 Rhoton Micro Dissectors  
 Rhoton micro disecadores  
 Rhoton micro dissecteurs  
 Rhoton micro dissetori



KS 680/10



KS 680/11



KS 680/12

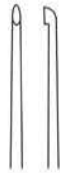

KS 680/13



KS 680/14



KS 680/15

**KS 680/00** = KS 680/01 - KS 680/15

Set komplett, 15 Dissektoren  
 Set complete, 15 dissectors  
 Set completo, 15 disecadores  
 Jeu complet, 15 dissecteurs  
 Set completo, 15 dissetori

**RHOTON**

AA  
 AB  
 AC  
 AE  
 AK  
 AO  
 AR  
 KA  
 KS  
 XR  
 XT

Mikro-Instrumente  
 Micro Instruments  
 Instrumentos para microcirugia  
 Instruments pour la chirurgie micro  
 Strumenti per la chirurgia micro

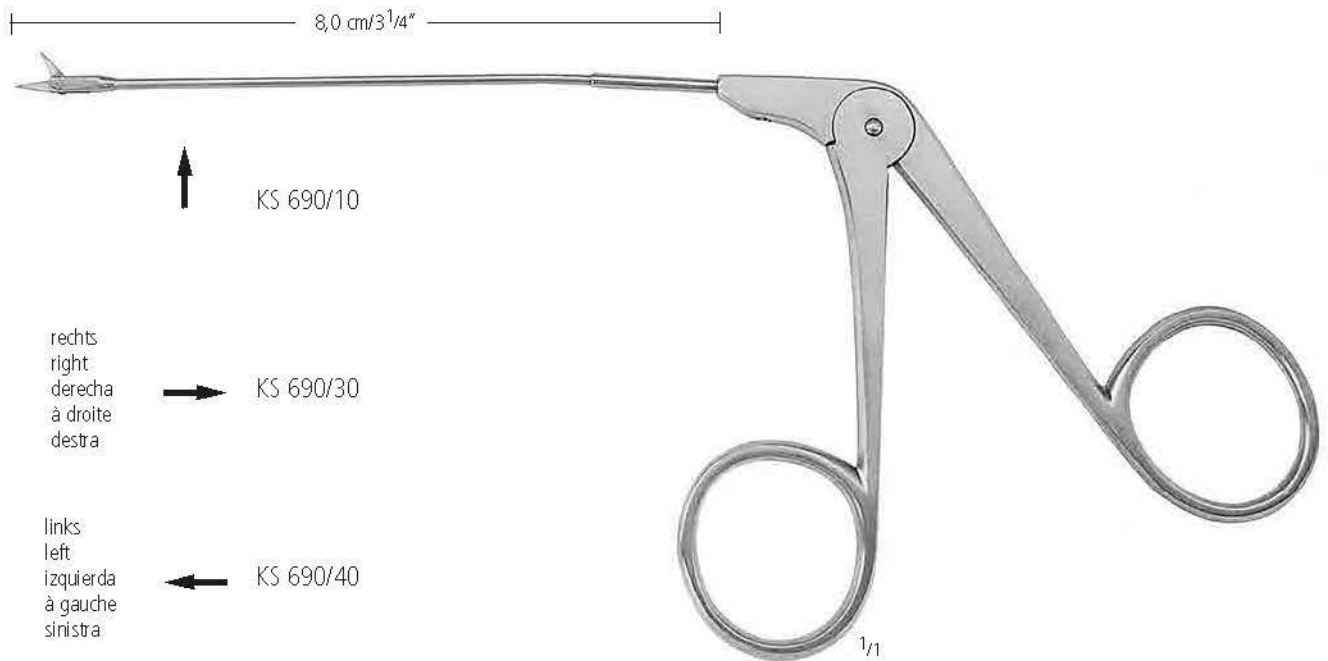

**BELLUCCI**

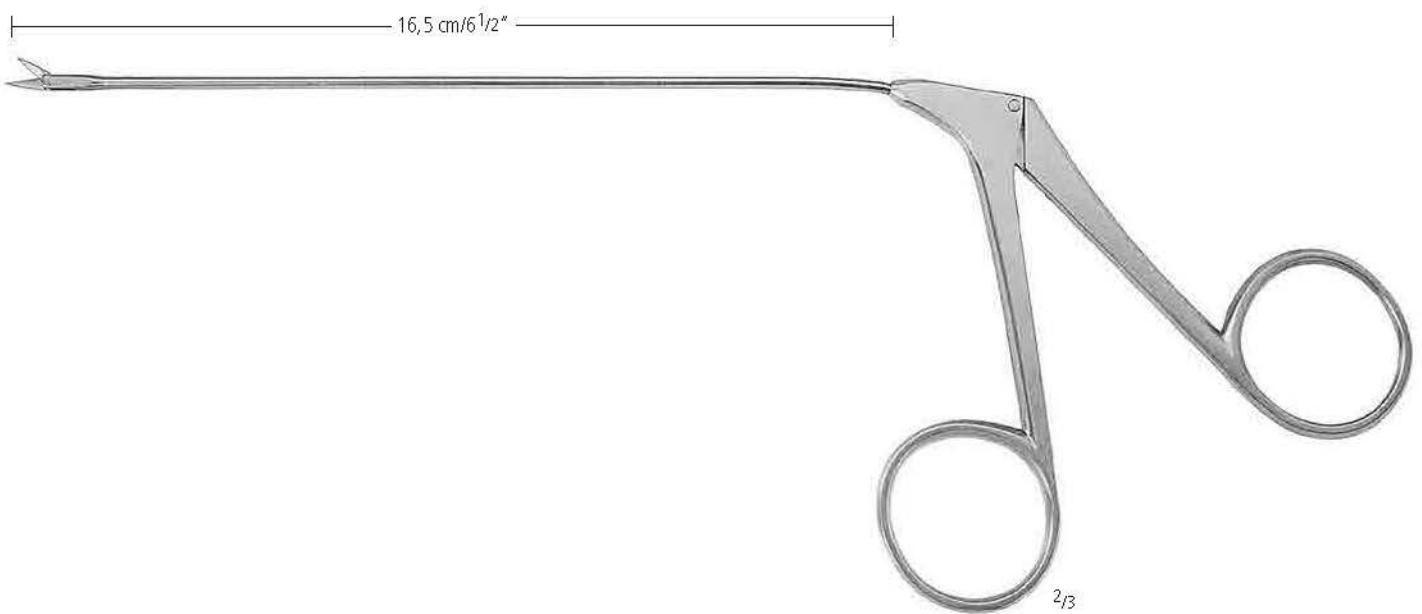

**FAHLBUSCH**  
 KS 693/17

Mikro-Instrumente  
 Micro Instruments  
 Instrumentos para microcirugía  
 Instruments pour la chirurgie micro  
 Strumenti per la chirurgia micro

AA  
 AB  
 AC  
 AE  
 AK  
 AO  
 AR  
 KA  
 KS  
 XR  
 XT

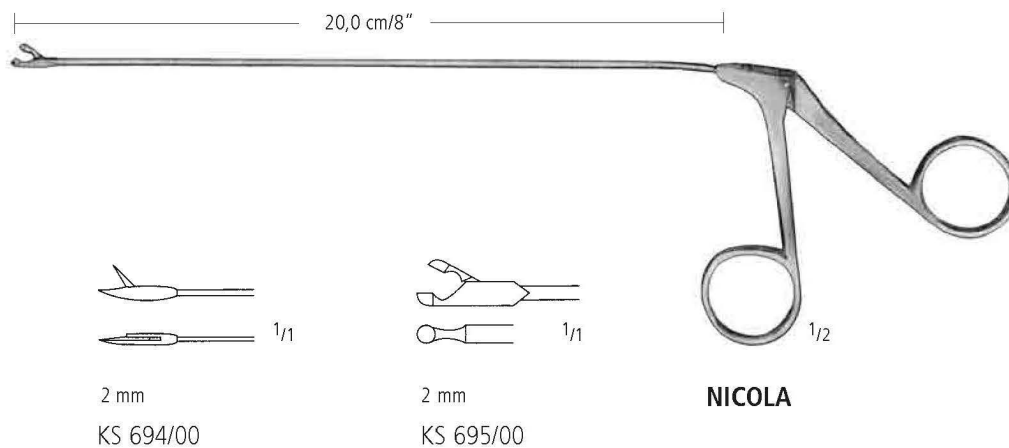

↑ 30° KS 694/10 KS 695/10

rechts  
 right  
 derecha  
 à droite  
 destra → KS 694/30 KS 695/30

links  
 left  
 izquierda  
 à gauche  
 sinistra ← KS 694/40 KS 695/40

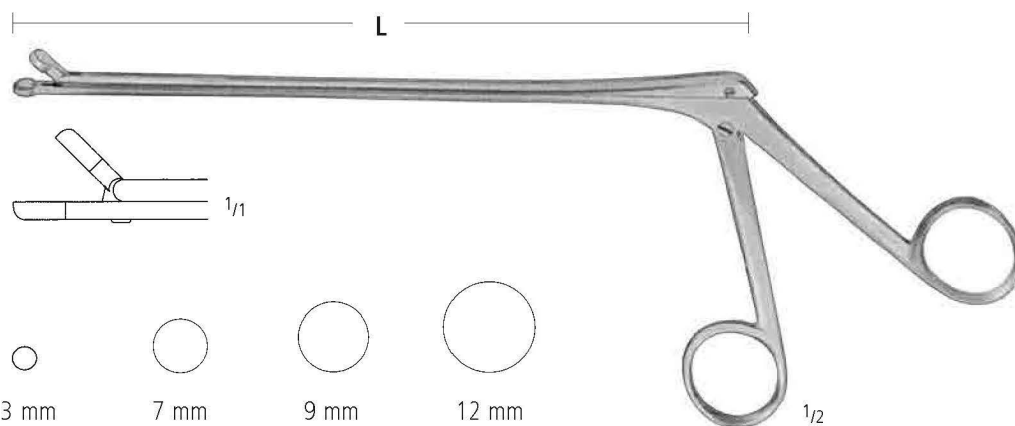

	<b>L = 14,0 cm / 5 1/2"</b>	<b>L = 18,0 cm / 7"</b>
∅ 3 mm	KS 696/03	KS 697/03
∅ 7 mm	KS 696/07	KS 697/07
∅ 9 mm	KS 696/09	KS 697/09
∅ 12 mm	KS 696/12	KS 697/12

Laminektomie-Stanzen  
 Laminectomy Punches  
 Pinzas cortantes para discos intervertebrales  
 Pincas emporte-pièces pour lames intervertébrales  
 Pinze taglienti per dischi intervertebrali



**KERRISON**

Also available in  
**TITANIUM**



	15,0 cm/6"	18,0 cm/7"	20,0 cm/8"
1 mm	KS 700/01	KS 701/01	KS 702/01
2 mm	KS 700/02	KS 701/02	KS 702/02
3 mm	KS 700/03	KS 701/03	KS 702/03
5 mm	KS 700/05	KS 701/05	KS 702/05

Also available in  
**TITANIUM**

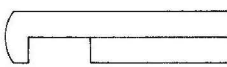

	15,0 cm/6"	18,0 cm/7"	20,0 cm/8"
1 mm	KS 706/01	KS 707/01	KS 708/01
2 mm	KS 706/02	KS 707/02	KS 708/02
3 mm	KS 706/03	KS 707/03	KS 708/03
5 mm	KS 706/05	KS 707/05	KS 708/05

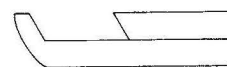

	15,0 cm/6"	18,0 cm/7"	20,0 cm/8"
1 mm	KS 712/01	KS 713/01	KS 714/01
2 mm	KS 712/02	KS 713/02	KS 714/02
3 mm	KS 712/03	KS 713/03	KS 714/03
5 mm	KS 712/05	KS 713/05	KS 714/05

Laminektomie-Stanzen  
 Laminectomy Punches  
 Pinzas cortantes para discos intervertebrales  
 Pincas emporte-pièces pour lames intervertébrales  
 Pinze taglienti per dischi intervertebrali

AA

AB

AC

AE

AK

AO

AR

KA

KS

XR

XT



easyClean®

ZERLEGBAR  
 DETACHABLE  
 DESMONTABLE  
 DEMONTABLE  
 SMONTABILE

	1 mm	18,0 cm/7"	20,0 cm/8"
	2 mm	KS 701/11	KS 702/11
	3 mm	KS 701/12	KS 702/12
	4 mm	KS 701/13	KS 702/13
	5 mm	KS 701/14	KS 702/14
	2 mm	18,0 cm/7"	20,0 cm/8"
	3 mm	KS 707/12	KS 708/12
	4 mm	KS 707/13	KS 708/13
	5 mm	KS 707/14	KS 708/14
	5 mm	KS 707/15	KS 708/15
	1 mm	18,0 cm/7"	20,0 cm/8"
	2 mm	KS 713/11	KS 714/11
	3 mm	KS 713/12	KS 714/12
	4 mm	KS 713/13	KS 714/13
	5 mm	KS 713/14	KS 714/14
	5 mm	KS 713/15	KS 714/15

Laminektomie-Stanzen  
 Laminectomy Punches  
 Pinzas cortantes para discos intervertebrales  
 Pincas emporte-pièces pour lames intervertébrales  
 Pinze taglianti per dischi intervertebrali

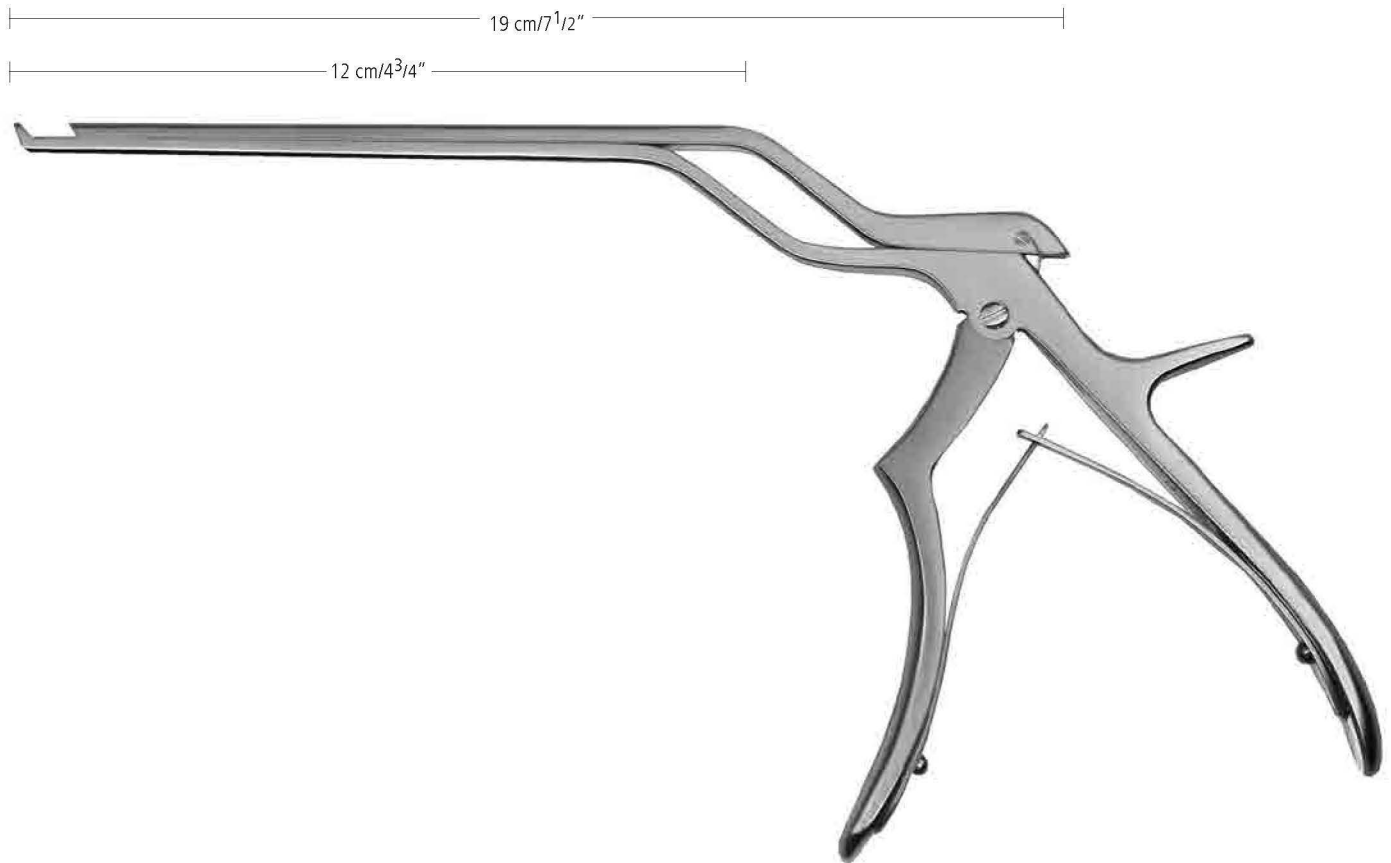

**KERRISON-BAJONETT**

12,0 cm / 4 3/4"

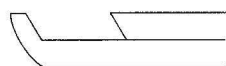

- 2 mm
- 3 mm
- 4 mm
- 5 mm

- KS 715/12
- KS 715/13
- KS 715/14
- KS 715/15



Laminektomie-Stanzen  
 Laminectomy Punches  
 Pinzas cortantes para discos intervertebrales  
 Pincas emporte-pièces pour lames intervertébrales  
 Pinze taglianti per dischi intervertebrali

AA  
AB  
AC  
AE  
AK  
AO  
AR  
KA  
KS  
XR



großer Griff  
 large handle  
 mango grande  
 branche grande  
 impugnatura grande

KERRISON-COLCLOUGH

Also available in  
**TITANIUM**

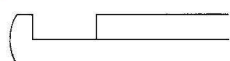

	15,0 cm/6"	18,0 cm/7"	20,0 cm/8"	30,0 cm/12"
2 mm	KS 720/02	KS 721/02	KS 722/02	KS 725/02
3 mm	KS 720/03	KS 721/03	KS 722/03	KS 725/03
4 mm	KS 720/04	KS 721/04	KS 722/04	KS 725/04
5 mm	KS 720/05	KS 721/05	KS 722/05	KS 725/05

Also available in  
**TITANIUM**

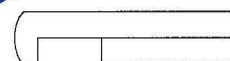

	15,0 cm/6"	18,0 cm/7"	20,0 cm/8"	30,0 cm/12"
2 mm	KS 726/02	KS 727/02	KS 728/02	KS 731/02
3 mm	KS 726/03	KS 727/03	KS 728/03	KS 731/03
4 mm	KS 726/04	KS 727/04	KS 728/04	KS 731/04
5 mm	KS 726/05	KS 727/05	KS 728/05	KS 731/05

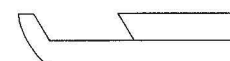

	15,0 cm/6"	18,0 cm/7"	20,0 cm/8"	30,0 cm/12"
2 mm	KS 732/02	KS 733/02	KS 734/02	KS 737/02
3 mm	KS 732/03	KS 733/03	KS 734/03	KS 737/03
4 mm	KS 732/04	KS 733/04	KS 734/04	KS 737/04
5 mm	KS 732/05	KS 733/05	KS 734/05	KS 737/05

XT

Laminektomie-Zangen  
 Laminectomy Rongeurs  
 Pinzas cortantes para laminectomía  
 Pincas emporte-pièces à laminectomie  
 Pinze taglianti per laminectomia

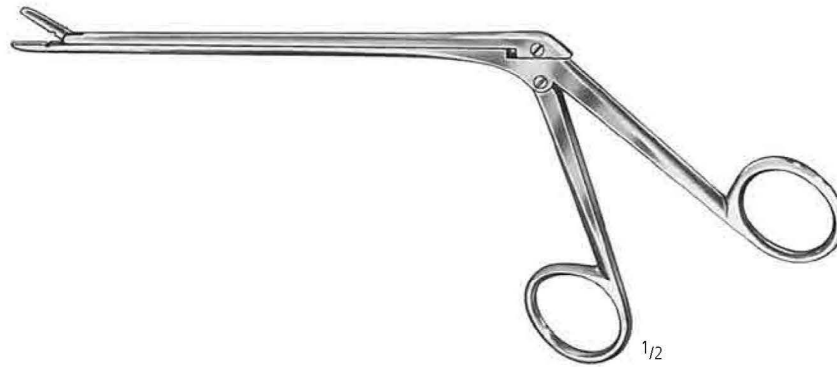

Also available in  
**TITANIUM**

**CUSHING**  
**LOVE-GRUENWALD**  
**SPURLING**

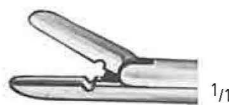

**CUSHING**  
 2 x 10 mm



13,0 cm/5"	KS 742/00
15,0 cm/6"	KS 742/04
18,0 cm/7"	KS 742/08
20,0 cm/8"	KS 742/12
25,0 cm/10"	KS 742/16
30,0 cm/12"	KS 742/20

KS 742/01
KS 742/05
KS 742/09
KS 742/13
KS 742/17
KS 742/21

KS 742/03
KS 742/07
KS 742/11
KS 742/15
KS 742/19
KS 742/23

**LOVE-GRUENWALD**  
 3 x 10 mm



13,0 cm/5"	KS 743/00
15,0 cm/6"	KS 743/04
18,0 cm/7"	KS 743/08
20,0 cm/8"	KS 743/12
25,0 cm/10"	KS 743/16
30,0 cm/12"	KS 743/20

KS 743/01
KS 743/05
KS 743/09
KS 743/13
KS 743/17
KS 743/21

KS 743/03
KS 743/07
KS 743/11
KS 743/15
KS 743/19
KS 743/23

**SPURLING**  
 4 x 10 mm



13,0 cm/5"	KS 744/00
15,0 cm/6"	KS 744/04
18,0 cm/7"	KS 744/08
20,0 cm/8"	KS 744/12
25,0 cm/10"	KS 744/16
30,0 cm/12"	KS 744/20

KS 744/01
KS 744/05
KS 744/09
KS 744/13
KS 744/17
KS 744/21

KS 744/03
KS 744/07
KS 744/11
KS 744/15
KS 744/19
KS 744/23

Laminektomie-Zangen  
 Laminectomy Rongeurs  
 Pinzas cortantes para laminectomía  
 Pincas emporte-pièces à laminectomie  
 Pinze taglienti per laminectomia

AA

AB

AC

AE

AK

AO

AR

KA

**KS**

XR

XT

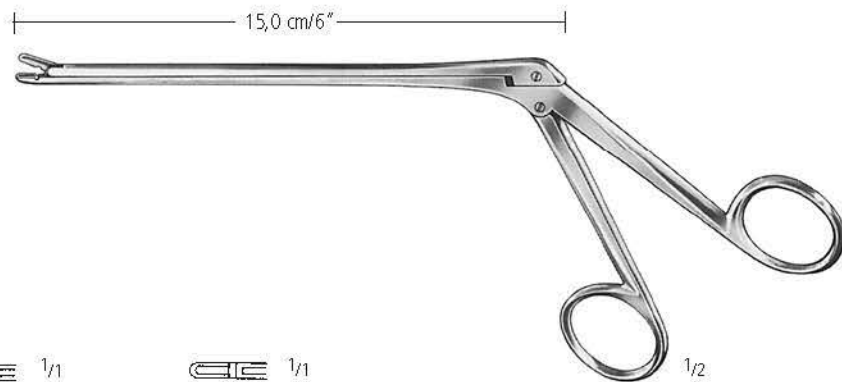

2 x 3 mm  
 KS 750/03



2 x 5 mm  
 KS 750/05



**SELVERSTONE**

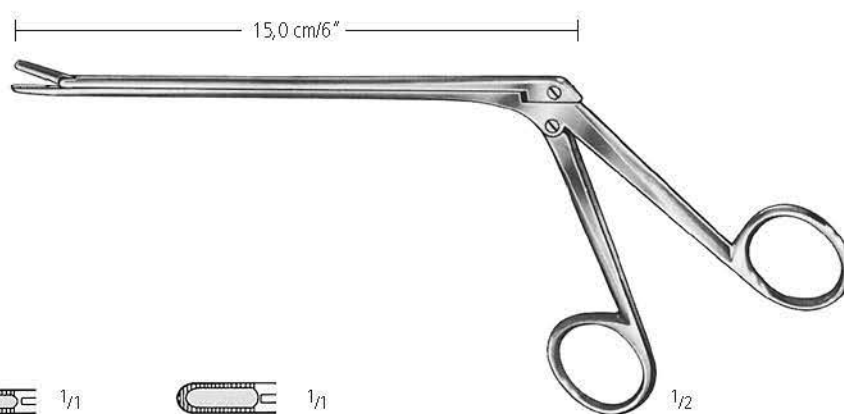

2 x 10 mm  
 KS 752/02



3 x 10 mm  
 KS 752/03

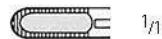

4 x 10 mm  
 KS 752/04



**SCHLESINGER**

Laminektomie-Zangen  
 Laminectomy Rongeurs  
 Pinzas cortantes para laminectomía  
 Pincas emporte-pièces à laminectomie  
 Pinze taglianti per laminectomia

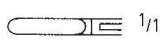
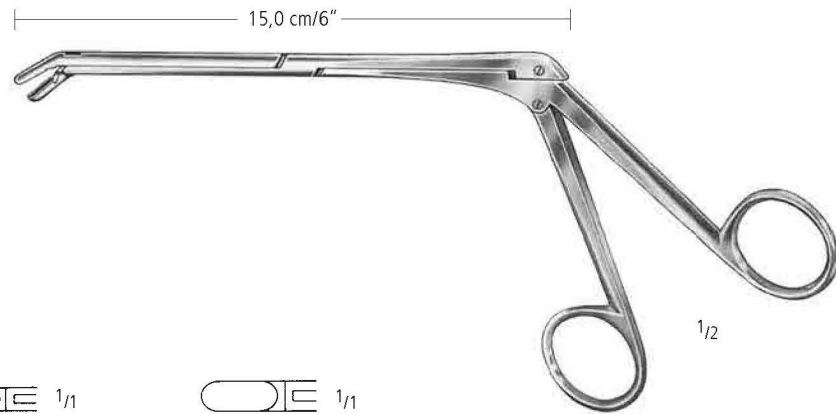

2 x 10 mm  
 KS 754/02



3 x 10 mm  
 KS 754/03



4 x 10 mm  
 KS 754/04

**CASPAR**

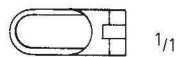

6 x 10 mm

**CLOWARD**



KS 756/01



KS 756/02







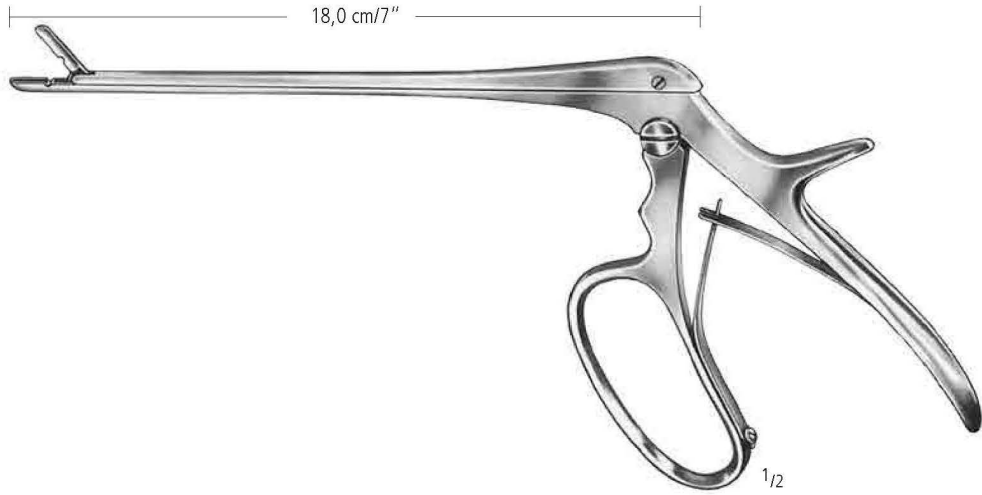

KS 756/03

Laminektomie-Zangen  
 Laminectomy Rongeurs  
 Pinzas cortantes para laminectomía  
 Pincas emporte-pièces à laminectomie  
 Pinze taglianti per laminectomia

AA  
AB  
AC  
AE  
AK  
AO  
AR  
KA  
KS  
XR  
XT

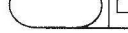

**FERRIS-SMITH-CUSHING**

	 1/1	 1/1	 1/1	 1/1
 1/1	2 x 10 mm KS 762/00	3 x 10 mm KS 763/00	4 x 10 mm KS 764/00	6 x 12 mm KS 766/00
 1/1	KS 762/01	KS 763/01	KS 764/01	KS 766/01
 1/1	KS 762/03	KS 763/03	KS 764/03	KS 766/03

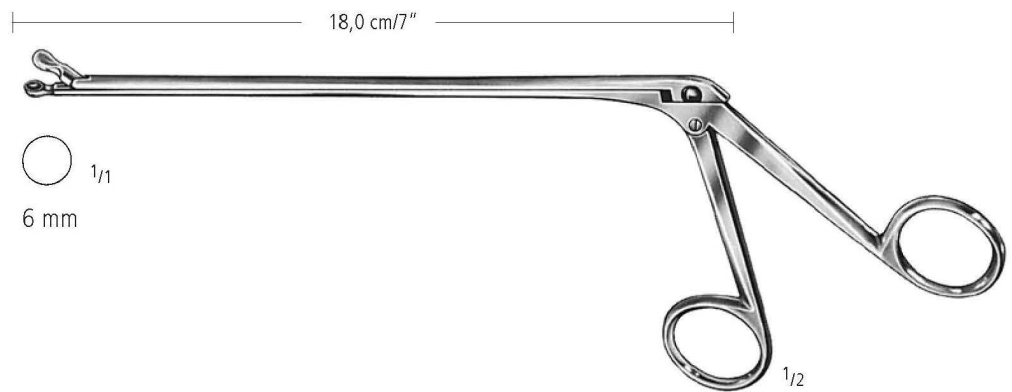

**OLDBERG**  
KS 770/00

Laminektomie-Stanzen  
 Laminectomy Punches  
 Pinzas cortantes para discos intervertebrales  
 Pincas emporte-pièces pour lames intervertébrales  
 Pinze taglianti per dischi intervertebrali

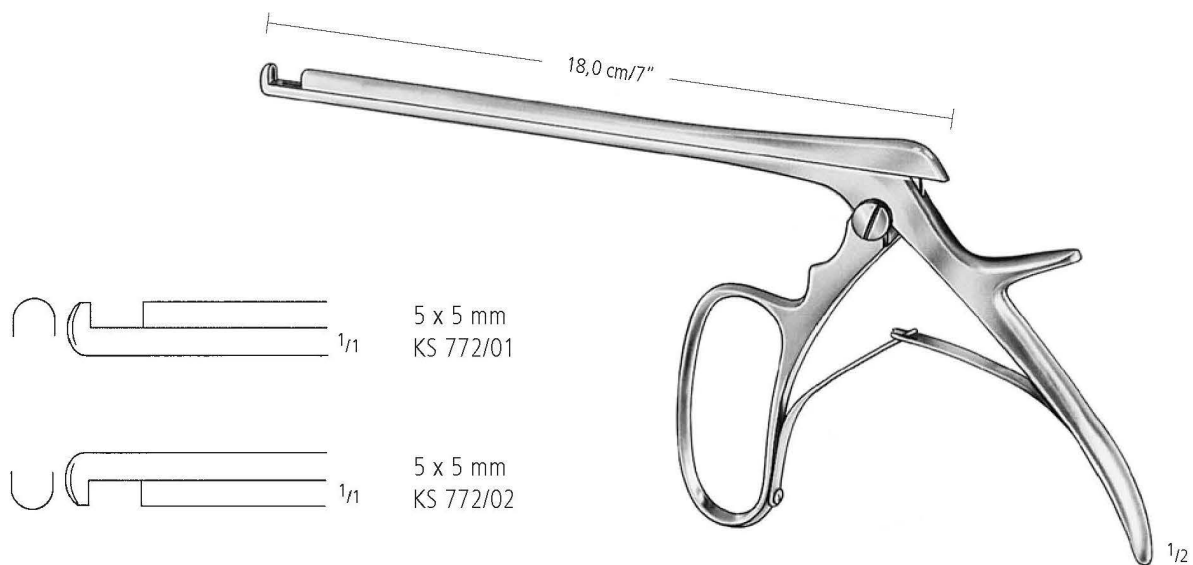

**FERRIS-SMITH**

Laminektomie-Stanzen  
 Laminectomy Punches  
 Pinzas cortantes para discos intervertebrales  
 Pinces emporte-pièces pour lames intervertébrales  
 Pinze taglienti per dischi intervertebrali

AA  
AB  
AC  
AE  
AK  
AO  
AR  
KA  
KS  
XR  
XT

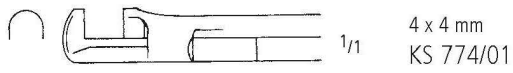

4 x 4 mm  
KS 774/01

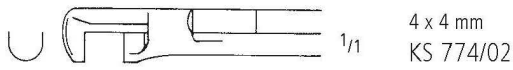

4 x 4 mm  
KS 774/02

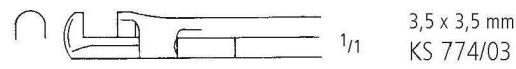

3,5 x 3,5 mm  
KS 774/03



3,5 x 3,5 mm  
KS 774/04



**HAJEK-KOFFLER**

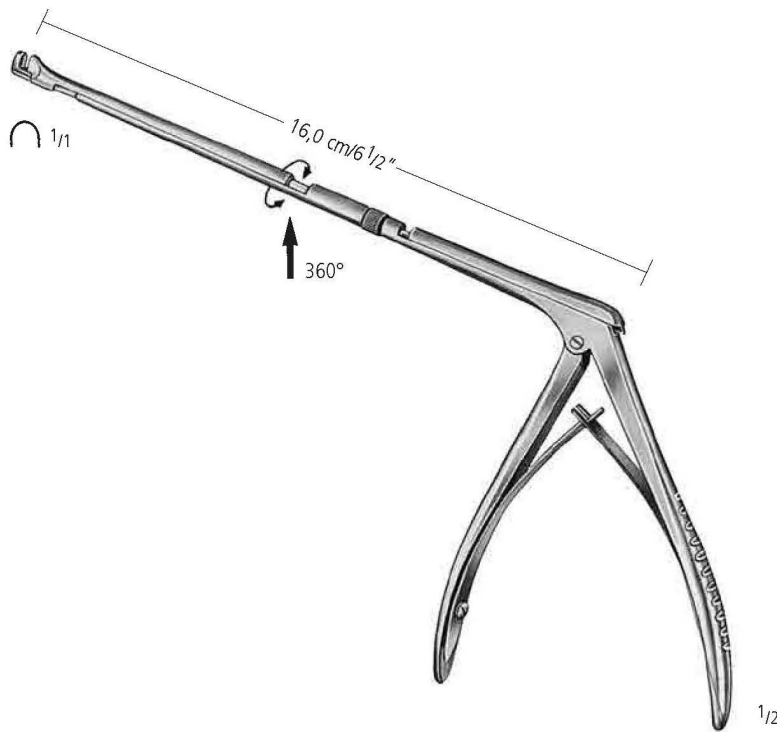

**HAJEK-KOFFLER**  
KS 774/16

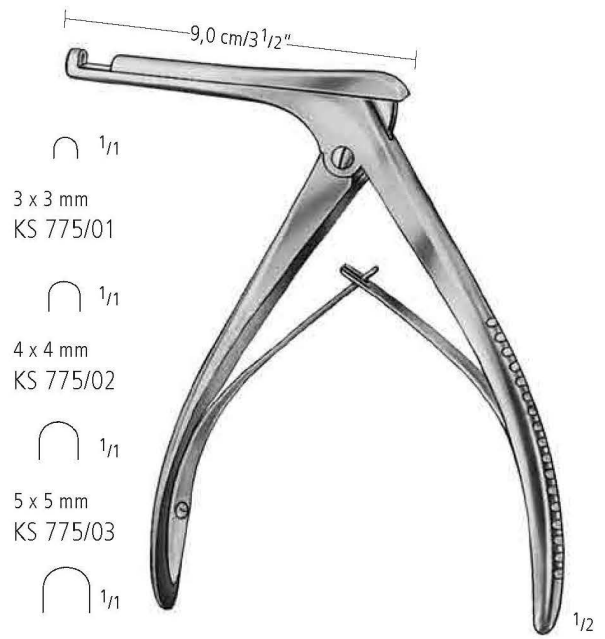

**KERRISON**

1/1  
3 x 3 mm  
KS 775/01

1/1  
4 x 4 mm  
KS 775/02

1/1  
5 x 5 mm  
KS 775/03

1/1  
6 x 6 mm  
KS 775/04

Laminektomie-Stanzen  
 Laminectomy Punches  
 Pinzas cortantes para discos intervertebrales  
 Pincas emporte-pièces pour lames intervertébrales  
 Pinze taglienti per dischi intervertebrali

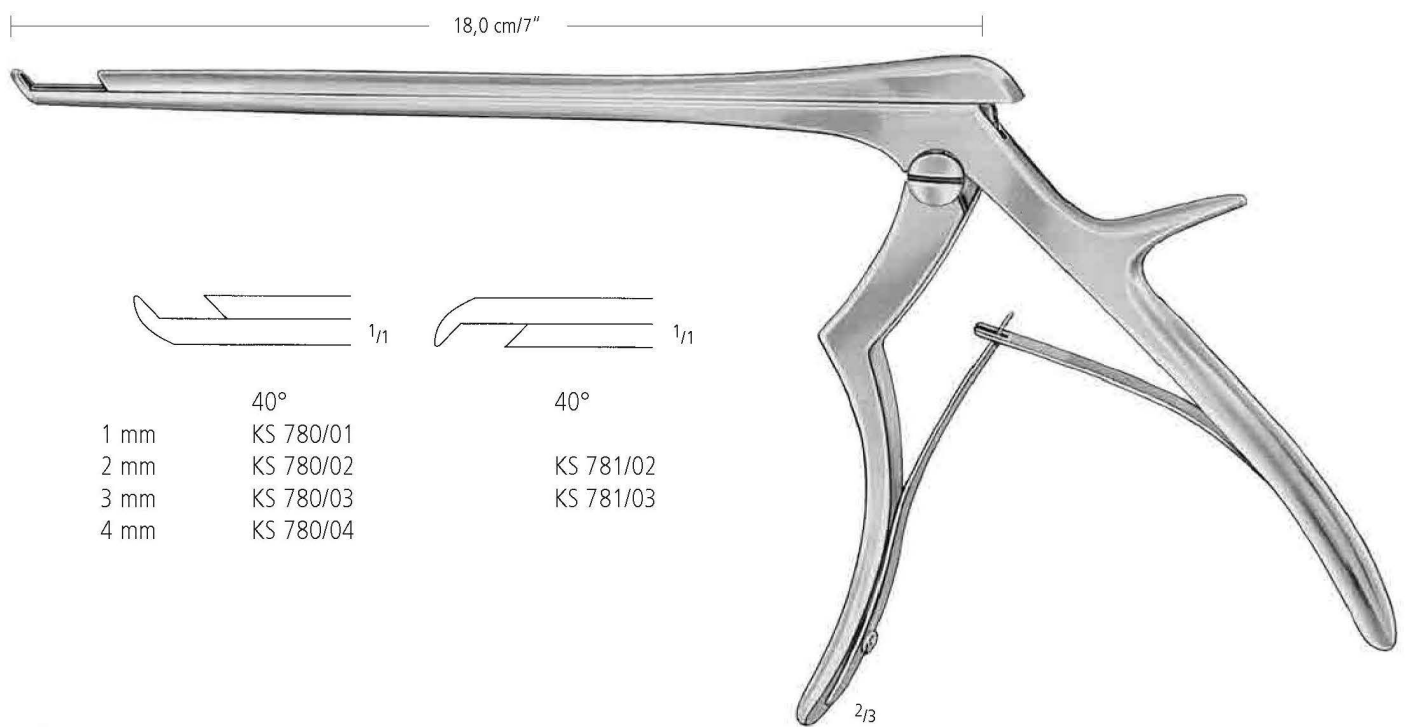

**PLATTFUSS**



Hypophysen-Instrumente  
 Pituitary Instruments  
 Instrumentos para hipófisis  
 Instruments pour la chirurgie pituitaire  
 Strumenti per ipofisi cerebrale

AA

AB

AC

AE

AK

AO

AR

KA

**KS**

XR

XT

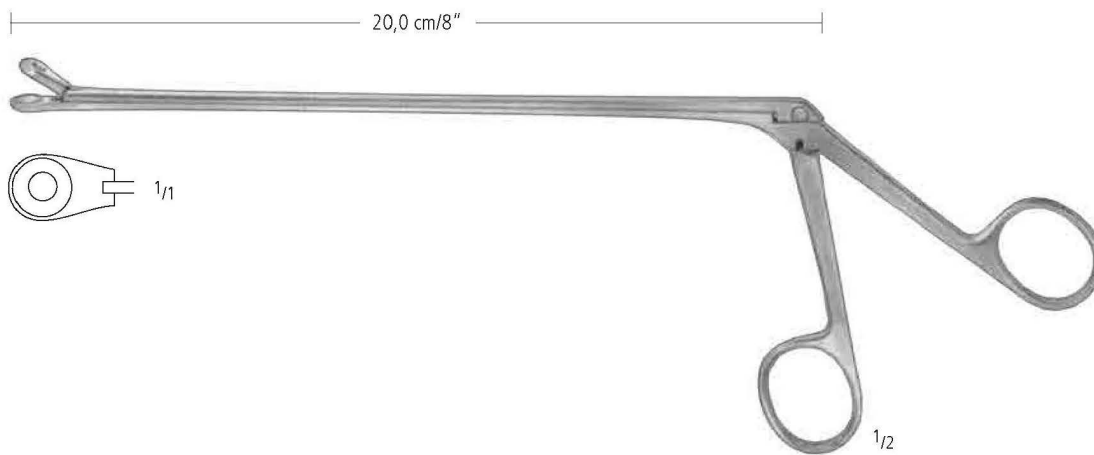
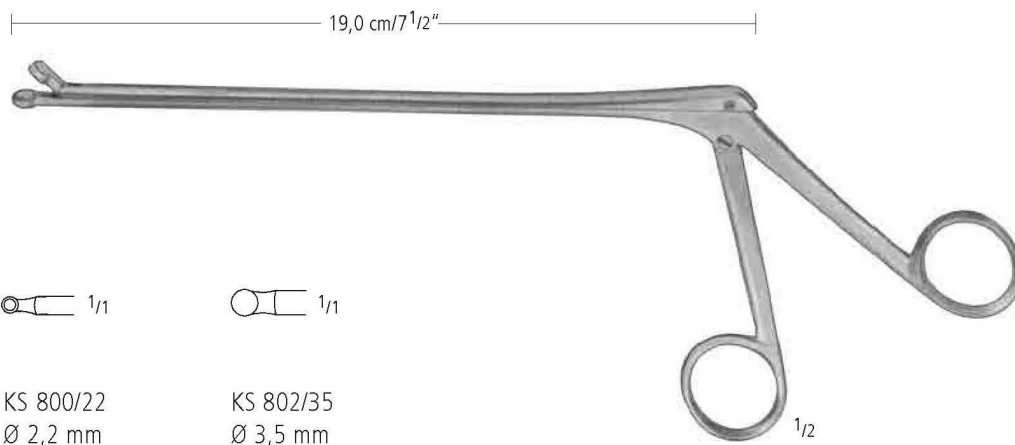

**LANDOLT**  
 KS 804/09  
 Ø 9 mm

Hypophysen-Instrumente  
 Pituitary Instruments  
 Instrumentos para hipófisis  
 Instruments pour la chirurgie pituitaire  
 Strumenti per ipofisi cerebrale



**CUSHING-LANDOLT**

<b>L</b>	
70 x 15 mm	KS 820/01
90 x 15 mm	KS 820/02
110 x 15 mm	KS 820/03



**LANDOLT**  
 KS 821/21  
 21,5 cm/8 1/2"

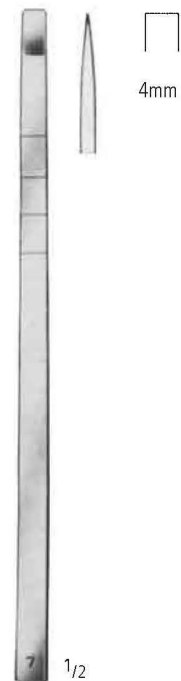

**COTTLE**  
 KS 822/04  
 18 cm/7"

Hypophysen-Instrumente  
 Pituitary Instruments  
 Instrumentos para hipófisis  
 Instruments pour la chirurgie pituitaire  
 Strumenti per ipofisi cerebrale

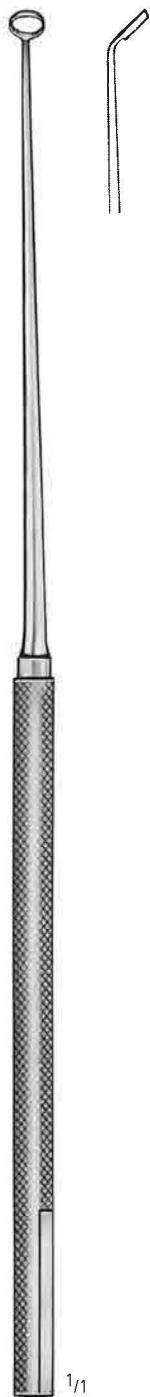

**RAY**  
 18,0 cm/7<sup>1</sup>/<sub>4</sub>"

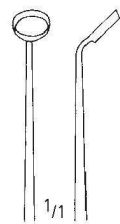

Ø 4 mm  
 KS 830/18

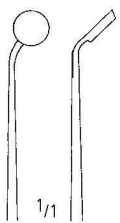

Ø 4 mm  
 KS 831/18

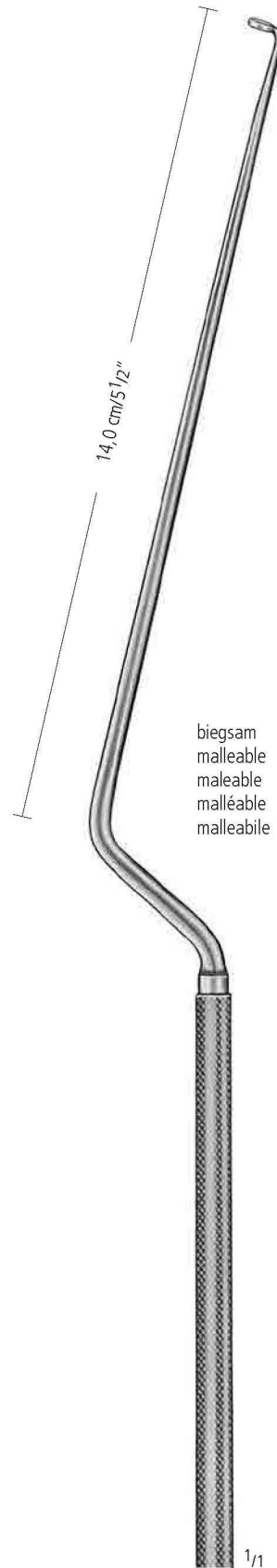

**HARDY**  
 26,0 cm/10<sup>1</sup>/<sub>4</sub>"



Ø 4 mm  
 KS 832/04



Ø 6 mm  
 KS 832/06

biegsam  
 malleable  
 maleable  
 malléable  
 malleabile

Hypophysen-Instrumente  
 Pituitary Instruments  
 Instrumentos para hipófisis  
 Instruments pour la chirurgie pituitaire  
 Strumenti per ipofisi cerebrale

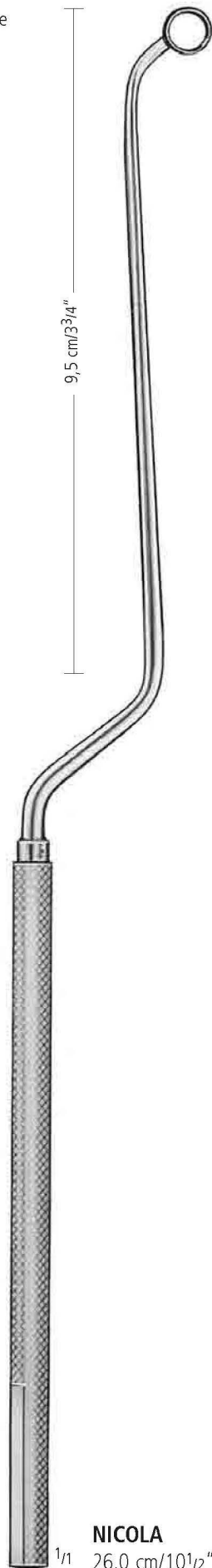

9,5 cm / 3 3/4"

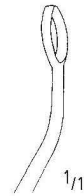

1/1

KS 834/01  
 biegsam  
 malleable  
 maleable  
 malléable  
 malleabile



1/1

KS 834/02  
 biegsam  
 malleable  
 maleable  
 malléable  
 malleabile



1/1

KS 835/22

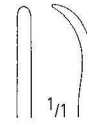

1/1

KS 836/22

**NICOLA**  
 1/1 26,0 cm / 10 1/2"

Hypophysen-Instrumente  
 Pituitary Instruments  
 Instrumentos para hipófisis  
 Instruments pour la chirurgie pituitaire  
 Strumenti per ipofisi cerebrale

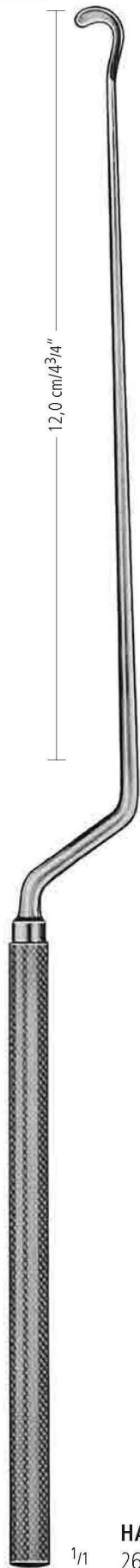

**HARDY**  
 1/1 26,0 cm / 10 1/4"



**KS 837/01**  
 stumpf  
 blunt  
 romo  
 mousse  
 smusso



**KS 837/02**  
 stumpf  
 blunt  
 romo  
 mousse  
 smusso

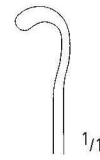

**KS 837/03**  
 scharf  
 sharp  
 cortante  
 tranchante  
 tagliente



**KS 837/04**  
 scharf  
 sharp  
 cortante  
 tranchante  
 tagliente



**HARDY**  
 KS 838/25



**HARDY-FAHLBUSCH**  
 KS 839/01  
 scharf  
 sharp  
 cortante  
 tranchante  
 tagliente



**HARDY-FAHLBUSCH**  
 KS 839/02  
 scharf  
 sharp  
 cortante  
 tranchante  
 tagliente

AA  
 AB  
 AC  
 AE  
 AK  
 AO  
 AR  
 KA  
 KS  
 XR  
 XT



Hypophysen-Instrumente  
 Pituitary Instruments  
 Instrumentos para hipófisis  
 Instruments pour la chirurgie pituitaire  
 Strumenti per ipofisi cerebrale

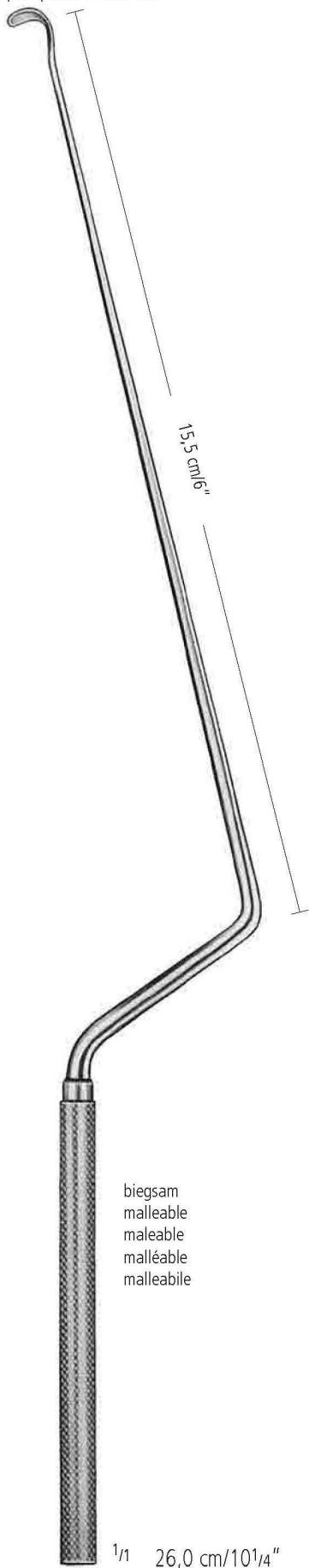

biegsam  
 malleable  
 maleable  
 malléable  
 malleabile

<sup>1/1</sup> 26,0 cm/10<sup>1</sup>/<sub>4</sub>"

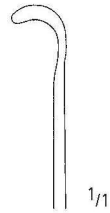

**LANDOLT**  
 KS 840/01



**LANDOLT**  
 KS 840/02

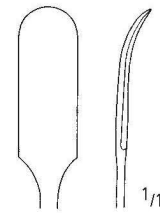

**LANDOLT**  
 KS 841/26

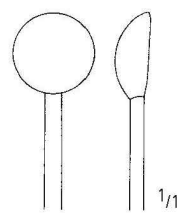

**LANDOLT**  
 KS 842/26



**LANDOLT**  
 KS 843/26



**FAHLBUSCH**  
 KS 844/26



**FAHLBUSCH**  
 KS 845/26

Hypophysen-Instrumente  
 Pituitary Instruments  
 Instrumentos para hipófisis  
 Instruments pour la chirurgie pituitaire  
 Strumenti per ipofisi cerebrale

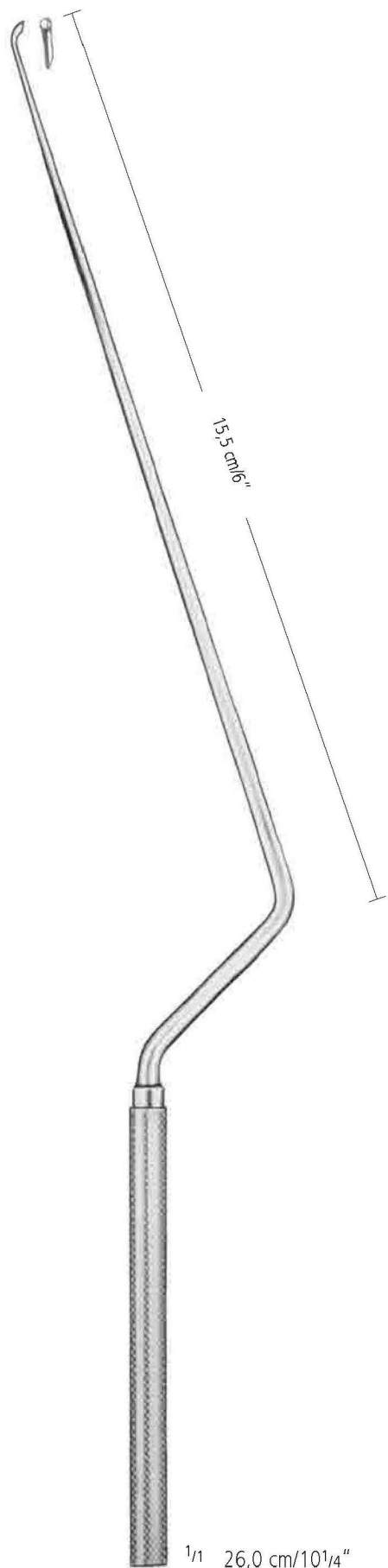

<sup>1/1</sup> 26,0 cm/10<sup>1</sup>/<sub>4</sub>\"

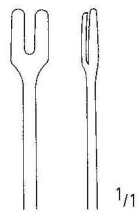

**HOSOBUCHI**  
 KS 846/26

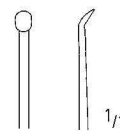

**LANDOLT-REULEN**  
 Ø 2,2 mm  
 KS 847/22

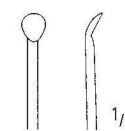

**LANDOLT-REULEN**  
 Ø 3,2 mm  
 KS 847/32

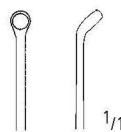

**LANDOLT-REULEN**  
 Ø 2,5 mm  
 KS 848/25



**LANDOLT-REULEN**  
 Ø 1,7 mm  
 KS 849/17

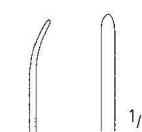

**LANDOLT-REULEN**  
 Ø 2,0 mm  
 KS 850/20

AA

AB

AC

AE

AK

AO

AR

KA

**KS**

XR

XT





ENDOSKOPIE  
ENDOSCOPY  
ENDOSCOPIA  
ENDOSCOPIE  
ENDOSCOPIA

**XR**

**nopa**<sup>®</sup> instruments

Unser komplettes **Endoskopie**-Programm finden Sie in Katalog **X - ENDOSKOPIE**.

For our complete program in **endoscopy** please refer to catalogue **X - ENDOSCOPY**.

Para nuestro programa completo de **endoscopia** vea el catálogo **X - ENDOSCOPIA**.

Pour notre programme complet d'**endoscopie** voir le catalogue **X - ENDOSCOPIE**.

Per la nostra gamma completa di **endoscopia** la preghiamo di consultare il catalogo **X - ENDOSCOPIA**.



Anschlußkabel  
 Connection Cords  
 Cables de connexion  
 Câbles de raccordement  
 Cavi da connessione

monopolar

bipolar



**MARTIN/BERCHTOLD**

300 cm XR 827/03  
 500 cm XR 827/05

XR 828/03  
 XR 828/05

XR 830/03  
 XR 830/05

monopolar

bipolar

monopolar

bipolar



**ERBE**  
 300 cm XR 831/03  
 500 cm XR 831/05  
 (ACC/ICC)

**ERBE**  
 XR 831/13  
 XR 831/15  
 (T-Serie)

**ERBE/SELECT**  
 XR 832/03  
 XR 832/05

**ERBE**  
 XR 833/03  
 XR 833/05

**VALLEYLAB**  
 XR 834/03  
 XR 834/05  
 (in D nicht zulässig  
 nach MedGV)

ENDOSKOPIE ENDOSCOPY ENDOSCOPIA ENDOSPIE ENDOSCOPIA

Bi-Koagulations-Pinzetten  
 Bi-Coagulation-Forceps  
 Pinzas para la Bi-Coagulación  
 Pince pour la Bi-Coagulation  
 Pinze per la Bi-Coagulazione



16,0 cm/6 <sup>1</sup> / <sub>4</sub> "	XR 890/16 A	XR 891/16 C	XR 894/16 C		
16,0 cm/6 <sup>1</sup> / <sub>4</sub> "	XR 890/16 C	XR 891/16 D	XR 894/16 D		
16,0 cm/6 <sup>1</sup> / <sub>4</sub> "	XR 890/16 E	XR 891/16 E	XR 894/16 E		
20,0 cm/8"	XR 890/20 A	XR 891/20 A	XR 894/20 A		
20,0 cm/8"	XR 890/20 C	XR 891/20 C	XR 894/20 C	XR 895/20 C	XR 896/20 C
20,0 cm/8"	XR 890/20 E	XR 891/20 F	XR 894/20 E		
20,0 cm/8"			XR 894/20 F		
22,0 cm/8 <sup>3</sup> / <sub>4</sub> "	XR 890/22 A	XR 891/22 C	XR 894/22 D		

A=2,0 mm

C=1,0 mm



D=0,5 mm

E=Nadel

F=Profil



11,0 cm/4 <sup>1</sup> / <sub>4</sub> "	XR 898/11 D	XR 899/11 D
11,0 cm/4 <sup>1</sup> / <sub>4</sub> "	XR 898/11 E	XR 899/11 E

AA  
AB  
AC  
AE  
AK  
AO  
AR  
KA  
KS  
XR  
XT



ENDOSKOPIE  
ENDOSCOPY  
ENDOSCOPIA  
ENDOSCOPIE  
ENDOSCOPIA

**XT**

**nopa**<sup>®</sup> instruments

Unser komplettes **Endoskopie**-Programm finden Sie in Katalog **X - ENDOSKOPIE**.

For our complete program in **endoscopy** please refer to catalogue **X - ENDOSCOPY**.

Para nuestro programa completo de **endoscopia** vea el catálogo **X - ENDOSCOPIA**.

Pour notre programme complet d'**endoscopie** voir le catalogue **X - ENDOSCOPIE**.

Per la nostra gamma completa di **endoscopia** la preghiamo di consultare il catalogo **X - ENDOSCOPIA**.





Kaltlichtkabel  
Fibre optic cable  
Cable fibra óptica  
Câble fibre optique  
Cavo fibra ottica

AA

AB

AC

AE

AK

AO

AR

KA

KS

XR

XT



**Kaltlichtkabel-Grundkabel**  
**Basic fibre optic cable**

XT 035/18 Ø 3,5 mm, 180 cm  
XT 035/23 Ø 3,5 mm, 230 cm  
XT 035/30 Ø 3,5 mm, 300 cm

XT 045/18 Ø 4,5 mm, 180 cm  
XT 045/23 Ø 4,5 mm, 230 cm  
XT 045/30 Ø 4,5 mm, 300 cm

XT 060/18 Ø 6,0 mm, 180 cm  
XT 060/23 Ø 6,0 mm, 230 cm  
XT 060/30 Ø 6,0 mm, 300 cm



XT 070/18 Ø 3,5 mm, 180 cm  
XT 070/23 Ø 3,5 mm, 230 cm  
XT 070/30 Ø 3,5 mm, 300 cm

- >> **Zusätzliche Isolierung**
- >> **Metallspirale**
- >> **Silikonmantel**
- >> **Sterilisierbar**

- >> **Additionally insulated**
- >> **Metal spiral**
- >> **Silicon tube**
- >> **Autoclavable**

Adapter  
Adapter  
Adaptador  
Connexion  
Adattatore

**Projektor-Seite  
Projector side**

**Endoskop-Seite  
Endoscope side**

XT 100/01



**STORZ**



XT 100/11

**STORZ/WINTER + IBE  
OLYMPUS/STRYKER**

XT 100/02



**WOLF/HENKE-SASS**



XT 100/12

**WOLF/HENKE-SASS**

XT 100/03



**ACM/HEINE**



XT 100/13

**ACM/HEINE**

XT 100/04



**WINTER + IBE**

XT 100/05



**OLYMPUS**

**Bestellinformation / Ordering information**

**>> Bitte bestellen Sie Kaltlicht-  
grundkabel mit 2 Adaptern**

**>> Please order the basic fibre  
optic cable and two adapters**



Källichtquellen  
Cold Light Sources  
Fuente de luz fría  
Source à lumière froide  
Sorgente luce fredda

## nopa<sup>®</sup> light halogen 2 x 250W future 100



XT 170/00 = 110 - 230 VAC

XT 169/00 = Ersatzlampe  
Spare bulb  
Bombilla de recambio  
Lampe de rechange  
Lampadina di ricambio

### nopalight halogen 2 x 250W

#### Beschreibung XT 170/00

Die nopalight halogen 2 x 250 W Lichtquelle kann bei allen Einsätzen angewendet werden, besonders dann, wenn eine starke Ausleuchtung oder eine Videoaufzeichnung notwendig ist.

Alle modernen Autoshutter-Videokameras werden mit ausreichender Lichtzufuhr versorgt. Die zweite Lampe wird als Reserve bei Lampendefekten oder Lampenausfall durch sofortiges Umschalten während den Einsätzen aktiviert.

Spezielle Wärmeschutzfilter sorgen für eine Schonung der Lichtleiter und eine optimale Lichtfiltrierung. Das Gerät ist MedGV-geprüft.

#### Technische Daten

Elektr. Versorgung:	100-240 VAC/50-60Hz Weltnetzteil
Farbtemperatur:	über 3500° K
Lichtregelung:	automatisch, stufenlos
Maße (B x H x T):	355 x 110 x 320 mm
Gewicht:	ca. 8,5 kg

#### Zubehör

Lampe XT 169/00: 250 Watt Halogen

### nopalight halogen 2 x 250W

#### Description XT 170/00

The nopalight halogen 2 x 250 W lightsource can be utilized in all procedures, especially if a strong illumination or video-monitoring is required.

All modern autoshutter-videocameras will be supplied with sufficient light-intensity, the second lamp serves as stand-by. Simply switch-over.

Special temperature-filters guarantee long life of light cables and optimal light output. The nopalight halogen 2 x 250 W lightsource is approved by MedGV.

#### Technical data

Power supply:	100-240 VAC/50-60Hz world power supply
Color temperature:	more than 3500° K
Light control:	automatic
Measurements (W x H x D):	355 x 110 x 320 mm
Weight:	approx. 8,5 kg

#### Accessories

Bulb XT 169/00: 250 Watt Halogen

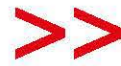

**nopa**<sup>®</sup> instruments

**nopa instruments**  
Medizintechnik GmbH  
Weilatten 7-9  
D - 78532 Tuttlingen

Tel. +49.7462.9490-0  
Fax +49.7462.9490-90  
info@nopa.de  
www.nopa.de

Herstellung und Verkauf chirurgischer  
und endoskopischer Instrumente.  
Manufacture and Sales of Surgical  
and Endoscopic Instruments.