



FLEX-6000 SIGNATURE SERIES

MAESTRO USER GUIDE

SmartSDR Version **3.7.3**

March 6, 2024



TABLE OF CONTENTS

1	How to Request Technical Support and Assistance	1
2	Key Contacts	2
3	Getting to Know Your Maestro	3
3.1	Identifying Your Maestro Model	3
3.1.1	Maestro “C” Maestro Version	3
3.1.2	Maestro “B” Maestro Version	3
3.1.3	Maestro “A” Maestro Version	3
3.2	Front Panel Controls.....	4
3.3	Rear Panel Connectors	5
3.3.1	Maestro “C” Rear Panel Layout	5
3.3.2	Maestro “A” and “B” Rear Panel Layout	6
4	Setting Up Your Maestro	7
4.1	External DC Power Requirements	7
4.1.1	Maestro “C” External Power Requirements	7
4.1.2	Maestro “A” and “B” External Power Requirements	7
4.2	Battery Packs and Banks	8
4.2.1	Battery Pack Selection for the Maestro “C”	8
4.2.2	Battery Pack Installation for the Maestro “C”	9
4.2.3	Battery Pack Operating Instructions for the Maestro “C”	11
4.2.4	USB Power Banks for Maestro “A” and “B”	12
4.2.5	USB Power Bank Installation for the Maestro “A” and “B”	14
4.3	Network Interface.....	16
4.4	Input Devices.....	17
4.4.1	Maestro “C” External Monitor Port.....	17
4.4.2	Straight Key and Paddles Connection.....	17
4.4.3	Powered Speaker Connection	18
4.4.4	Line Out Connection.....	18
4.4.5	Maestro “A” and “B” Phones Connection	18
4.4.6	PTT Connection	19
4.4.7	Maestro “C” HDST Combo Microphone and Headphone Connection	19
4.4.8	Maestro “A” and “B” Mic 2 Connection	19
4.4.9	Maestro “A” and “B” Mic 1 Connection	20
4.4.10	Maestro “A” and “B” Line In Connection	20
4.4.11	Ethernet Connection.....	21

4.4.12	Maestro “C” 24 VDC Power Connection	21
4.4.13	Maestro “A” and “B” 10-15 VDC Coaxial Power Connection	22
4.5	Starting/Stopping the Maestro.....	22
4.6	WiFi Network Setup.....	22
4.7	Network Status	25
5	multiFlex.....	27
6	Connecting to a Radio.....	29
7	How to Select Maestro and Radio Software	31
7.1	Selecting a SmartSDR Version and installing it	31
7.2	Licensing SmartSDR Version 2	32
8	SmartLink	34
8.1	SmartLink Overview	34
8.2	SmartLink Setup.....	35
8.2.1	Create a SmartLink Account.....	35
8.2.2	Register the Radio in SmartLink.....	38
8.2.3	Test the Radio in SmartLink	40
8.3	Using SmartLink	41
9	SmartControl.....	45
9.1	SmartControl brings the best of both worlds to your shack.....	45
9.2	Why Would You Want to Use SmartControl Instead of the Mouse in SmartSDR?.....	45
9.3	Who Will Find SmartControl Valuable?.....	45
9.4	Getting Started - Activating SmartControl.....	46
9.5	Operating with SmartControl	47
9.5.1	Additional SmartControl functions:.....	48
9.5.2	Accessing the Various Meters	48
9.5.3	Accessing the Maestro Main Menu	49
9.5.4	Accessing the individual Slice Controls	49
9.5.5	Exiting SmartControl	51
9.5.6	Changing to a Different Radio in Your Network.....	51
9.5.7	Changing from SmartControl mode to “Regular” Maestro Mode.....	52
9.5.8	Changing from “Regular” or Multi-Flex mode to SmartControl mode.....	52
9.5.9	What you Cannot Do in SmartControl.....	52
10	Maestro Overview.....	53
10.1	Theory of Operation	53
10.2	Key System Components.....	53
10.2.1	Spectral Capture Unit (SCU)	53

10.2.2	Slice Receiver	53
10.2.3	Panadapter	54
10.2.4	Waterfall	54
10.2.5	Panafall	55
11	How to Operate a Slice Receiver	56
11.1	How to Create and Delete a Slice Receiver	56
11.2	How to Tune a Slice Receiver	56
11.3	Making a Slice Receiver Active	57
11.4	How to Change the Demodulation Mode	58
11.5	How to Adjust the Speaker and Headphone Volume of a Slice Receiver	58
11.6	How to Change the RX filter of a Slice Receiver	58
11.7	Recording and Playback of Slice Receiver Audio	59
12	How to Operate the Panadapter / Waterfall	60
12.1	How to Create / Delete a Panadapter / Waterfall	60
12.2	How to Create / Delete a Slice Receiver in the Second Panadapter	60
12.3	How to Change the Panadapter Frequency (Tune)	60
12.4	How to Zoom a Panadapter	60
12.5	How to Change the Signal Magnitude Scale of a Panadapter	62
12.6	Adjusting the Panadapter and Waterfall Controls	62
13	Noise Mitigation	63
14	How to Configure Noise Mitigation	64
14.1	AGC Threshold	64
14.2	DSP Noise Mitigation Features	65
14.3	Wideband Noise Blanker (WNB)	65
14.4	Slice Specific Noise Blanker (NB)	66
14.5	Noise Reduction (NR)	66
15	How to use Tracking Notch Filters	67
15.1	Tracking Notch Filter Theory	67
15.2	Creating and Adjusting a Tracking Notch Filter	67
15.3	Turning all Tracking Notch Filters On or Off	69
15.4	Automatic Notch Filter (ANF)	70
16	How to Use Profiles	71
16.1	MIC Profiles	71
16.2	Transmit Profiles	72
16.3	Global Profiles	73
16.4	Saving and Deleting Profiles	73

16.5	Loading Profiles	75
16.6	Default Profiles	75
16.7	Comparing Profiles and Persistence	75
17	How to Operate Maestro Audio	79
17.1	Playing Slice Audio Using the Default Playback Device.....	79
17.2	Transmitting Using a Connected Recording Device	79
17.3	Configuring the Audio Output Devices	80
17.4	PTT Override when Operating via Maestro	80
17.5	Operating CW when Operating via Maestro	80
17.6	Monitoring Remote Audio and Network Performance	80
17.6.1	Network Health Indicator	81
17.6.2	Network Diagnostics.....	82
18	How to Operate multiFlex	83
18.1	Shared Resources.....	83
18.1.1	Single Transmitter.....	83
18.1.2	Available SCUs.....	84
18.1.3	Total Available Slices and Panadapters	84
18.1.4	Hardware PTT Inputs – Introducing Local PTT.....	84
19	How to Operate CW Mode	86
19.1	How to Operate CW in Split Mode	87
19.2	CW Transmitting	88
19.2.1	Straight Key and Paddles	Error! Bookmark not defined.
19.3	Using the Built-in Keyer.....	90
19.4	How to Operate QRQ (high speed) CW with QSK.....	91
19.5	How to Connect an External Keyer using the FSK/Key Input on the Accessory Connector.....	91
19.6	Using CW with a Contest Logger.....	91
20	How to Operate Single Sideband mode (SSB)	92
20.1	How to Select the SSB RX Filter Bandwidth.....	92
20.2	Selecting RX Filter Favorites	92
20.3	How to Operate SSB in Split Mode.....	93
20.4	How to Configure the Audio Controls for Phone Modes.....	94
20.4.1	Setting the Transmit Filter Bandwidth.....	94
20.4.2	Operating the Speech Processor.....	95
20.4.3	How to Configure the Equalizer (EQ)	96
20.4.4	How to Configure VOX.....	96

20.4.5	Monitor Mode Operation	97
20.4.6	How to Configure the Downward Expander (DEXP)	97
20.4.7	DAX TX Channel and Microphone Interaction.....	97
20.5	Monitoring your Transmitted Audio	98
20.6	Recommended Audio Adjustment Steps for Phone Modes	99
21	How to Operate AM and SAM Modes	100
22	How to Operate FM Mode.....	101
22.1	Operating FM Repeaters.....	101
22.2	Memory Channels.....	102
23	How to Operate Diversity Reception (FLEX-6600(M) and 6700 Only).....	104
24	How to Operate the ATU	106
24.1	Modes of Operation	106
24.2	ATU Match Frequency Range.....	106
24.3	Manual Mode.....	107
24.4	Memory Mode	107
25	How to Configure Antennas	109
25.1	Getting Started.....	109
25.2	Selecting the Transmit Antenna for a Slice Receiver.....	109
25.3	Antenna Options for PIN Diode QSK Operation	109
25.4	Using a Common Receive Antenna with Separate Transmit Antennas	110
25.5	Using Two Transceive Antennas on the FLEX-6700	111
25.6	Using a Dedicated Receive Antenna	112
25.7	Receive-only Antenna Operation	112
25.8	Antenna Selection for Transverter Operation.....	113
25.9	Using the Receiver RF Gain/Preamplifiers	114
25.10	Setting the RF Gain/Preamplifiers.....	115
25.11	Antenna Configuration Basic Terms and Rules	116
26	Displaying Spots in SmartSDR for Maestro.....	118
27	How to Configure Transverters	121
27.1	Using a Transverter	123
27.2	Multiple Copies of a Band.....	124
27.3	Transverter Power Settings.....	124
27.4	Transmitting on a Transverter	125
27.5	Weak Signal Considerations.....	125
28	Using the FlexRadio Power genius XL Amplifier.....	126
29	How to Connect an External Amplifier	128

30	USB Cables.....	129
30.1	USB Cables Overview.....	129
30.2	Cable management	130
30.2.1	CAT Cables.....	131
30.2.2	BIT Cables	133
30.2.3	BCD Cables	134
30.2.4	LDPA Cables	136
31	How to Operate in Digital Modes.....	137
31.1	PTT Override when Operating Digital Modes	137
31.2	RTTY Mode	138
31.3	DIGI Mode Audio Offsets.....	139
32	How to Operate in Full Duplex (FDX) Mode.....	140
32.1	FDX Requirements.....	140
32.2	FDX Applications.....	140
32.3	FDX Capabilities by Radio Model.....	141
32.3.1	FLEX-6600(M) and FLEX-6700 SO2R Operation	141
32.3.2	FLEX-6300 and FLEX-6500 Full Duplex.....	142
32.4	SCU Overload Fundamentals	142
32.4.1	Preselection Band Filter Block	143
32.4.2	Preamplifier / Attenuator Block.....	143
32.4.3	High-Performance Analog to Digital Converter Block (ADC).....	144
32.5	Full Duplex Antenna Isolation Requirements	144
33	Main Menu.....	145
33.1	Introduction	145
33.2	Maestro Tab.....	145
33.3	Radio Tab	146
33.4	Function F1-F6 Tab.....	148
33.5	Network Tab.....	149
33.6	Audio Tab.....	152
33.7	Transmit Tab.....	153
33.8	TX Band Settings Tab	155
33.9	Phone/CW Tab	157
33.9.1	Straight Key and Paddles	Error! Bookmark not defined.
33.10	XVTR Tab	159
33.11	Profiles Tab.....	159
33.12	Memory Tab	159

33.13	USB Cables Tab	159
33.14	Spots Tab	160
33.15	multiFlex Tab	160
33.16	GPS Tab.....	161
34	Slice Receiver	163
34.1	Definition.....	163
34.2	Carrier Frequency	163
34.3	Receive Filter.....	163
34.4	Dynamic Filter Depth	164
35	Front Panel Display.....	165
35.1	Introduction	165
35.2	Display Upper Bar	165
35.2.1	Slice Receiver Flags.....	165
35.2.2	Slice Receiver Menu	167
35.2.3	Power and Network Indicators – Maestro “C”	170
35.2.4	Power and Network Indicators – Maestro “A” and “B”	171
35.3	Display Panadapters	171
35.3.1	Panadapter Definition	171
35.3.2	Waterfall Definition	172
35.3.3	Waterfall Time Machine	172
35.3.4	Panadapter Display Menu	173
35.3.5	Horizontal Zoom.....	175
35.3.6	Vertical Zoom	176
35.3.7	Panning Method	176
35.3.8	Add / Remove the Second Panadapter	176
35.3.9	Auxiliary Meters	177
36	Front Panel Knobs and Buttons	178
36.1	Slice Receiver Activation Buttons.....	178
36.2	Slice Receiver Tuning Knobs and Buttons.....	180
36.3	Slice Receiver Audio Knobs.....	181
36.4	Slice Receiver Bandwidth Knobs	182
36.5	Transmitter Knobs and Buttons	183
36.6	TX Menu.....	184
36.6.1	Audio Modes Transmitter Menu.....	184
36.6.2	CW Mode Transmitter Control Panel	186
36.7	Function Buttons.....	187

37	Restoring to Factory Defaults	188
38	Error and Status Messages	189
38.1	Thermal Over Temperature	189
38.2	Reverse RF Power Detected	189
38.3	Interlock is Preventing Transmission	189
38.4	Transmit Slice Has Not Been Selected.....	189
38.5	Max Power Set Too Low For ATU	189
39	Troubleshooting Tips	190
39.1	FLEX-6000 Does Not Show Up in the Radio Chooser.....	190
39.1.1	Physical Layer Issues	190
39.1.2	Firewalls Preventing Network Access from the FLEX-6000	190
39.1.3	MAC Address Filtering.....	190
39.2	Maestro Becomes Unresponsive	191
39.3	Radio Will Not BOOT, or SmartSDR-Win will not Completely Load.....	191
39.4	FLEX-6000 Not Performing Well after an Upgrade to New Firmware.....	191
39.5	RF Spectrum Not Displayed Properly after Selecting a FLEX-6000 or Audio Stuttering 191	
39.6	Amber front panel light stuck on.....	192
39.7	Maestro starts up in portrait mode.....	192
39.8	I purchased a license, but it doesn't show up On the radio.	192
39.9	SmartLink Troubleshooting.....	192
39.9.1	Radio not shown in the <i>Select Radio</i> screen	192
39.9.2	My radio shows up on the <i>Select Radio</i> screen, but when I try to connect, it doesn't work. 193	
39.9.3	Running the Network Settings Test, I do not get a green response.	193
39.9.4	My router doesn't support UPnP. How can I set up my radio to reliably connect to remote clients?	193
39.9.5	When I use public WiFi, sometimes my Panadapter hangs or my audio has gaps in it. How do I fix this?	194
40	Legal Notice.....	195
41	Copyright Information	197
41.1	User Guide Copyright.....	197
41.2	Software Copyrights	197
42	Software Licence Agreements	198
42.1	FlexRadio Software License.....	198
42.2	GPL Information.....	208

1 HOW TO REQUEST TECHNICAL SUPPORT AND ASSISTANCE

If you encounter any issues installing or operating your Maestro with a FlexRadio Signature Series FLEX-6000 software defined radio, please use our online [Community](#) to search for information about SmartSDR and the FLEX-6000. If you need assistance using the Community, please refer to the [Community Message Board](#) for additional information.

If you are unable to find an existing answer to your issue via the Community, please contact FlexRadio Technical Support by opening a [HelpDesk support ticket](#) online.

For details on how to submit a HelpDesk support ticket, please refer to the HelpDesk article How to Submit a [Request for Technical Support](#).

Hours of Operation: Our Technical Support engineers are available Monday-Friday from 7:00 AM-4:00 PM Central Time. If you open a HelpDesk ticket after business hours, on a holiday, or weekend, we will respond to your request for assistance during regular business hours in the order your HelpDesk ticket was received.

2 KEY CONTACTS

FlexRadio, Inc. - U.S.A

4616 W. Howard Lane, Suite 8-860

Austin, TX 78728

U.S.A.

Phone: +1 (512) 535-4713

Email: sales@flexradio.com

HelpDesk: <https://helpdesk.flexradio.com>

User-Provided Support: <https://community.flexradio.com>

Outside of the USA

Please contact your local distributor. <https://www.flexradio.com/about/distributors/>

3 GETTING TO KNOW YOUR MAESTRO

Maestro is a self-contained hardware and software system designed to operate FLEX-6000 Signature Series radios. It can operate in a fixed mode connected to external power, or in a portable mode using internal battery power. In either mode, the network connection can be wired Ethernet or a WiFi connection.

3.1 IDENTIFYING YOUR MAESTRO MODEL

There are three (3) Maestro Models designated as “A”, “B” and “C” which have slightly different physical layouts. The location of the power button is the quickest way to identify the Maestro version.

3.1.1 Maestro “C” Version

The power button for the Maestro “C” is located on the **front of the left-hand side of the chassis**. They are also identified by the third set of numbers in the serial number as being 0102.

3.1.2 Maestro “B” Version

The power button for the Maestro “B” is located on the **side of the left-hand side of the chassis**. They are also identified by the third set of numbers in the serial number as being 0101.

3.1.3 Maestro “A” Version

The power button for the Maestro “A” is located on the **top of the left-hand side of the chassis**. They are also identified by the third set of numbers in the serial number as being 0100.

3.2 FRONT PANEL CONTROLS



All three versions of the Maestro have the same front panel controls and control layout.

1. Power On/Off button (the locations of the power button are Maestro model dependent. See the description above)
2. Eight-inch multi-touch sensitive full-color high-resolution display
3. Slice Receiver A multi-function control for audio level, AGC Threshold, Squelch, and Solo audio operation
4. Slice Receiver A multi-function control for receiver filter width and position
5. Slice Receiver B multi-function control for audio level, AGC Threshold, Squelch, and Solo audio operation
6. Slice Receiver B multi-function control for receiver filter width and position
7. Manual transmit (**MOX**) button
8. Manual tune (**TUNE**) button
9. Automatic Tuning Unit (**ATU**) button
10. Microphone level, key speed, transmitter power, and **TX Menu** multi-function control
11. Programmable function buttons, 1 – 6
12. Slice Receiver A enable button
13. Slice Receiver A transmitter enable button
14. Slice Receiver B enable button
15. Slice Receiver B transmitter enable button
16. A>B button
17. Slice Receiver A RIT/XIT indicator
18. Slice Receiver A tuning knob, menu / clear control
19. Slice Receiver B tuning knob, menu / clear control

- 20. Slice Receiver A and B step control buttons
- 21. Slice Receiver A and B tuning lock buttons
- 22. Slice Receiver B RIT/XIT indicator

3.3 REAR PANEL CONNECTORS

The Maestro “A” and “B” share the same rear panel layout. The Maestro “C” rear panel layout is different. Please refer to the correct layout for your Maestro model.

3.3.1 Maestro “C” Rear Panel Layout

Maestro “C” Rear Panel Layout

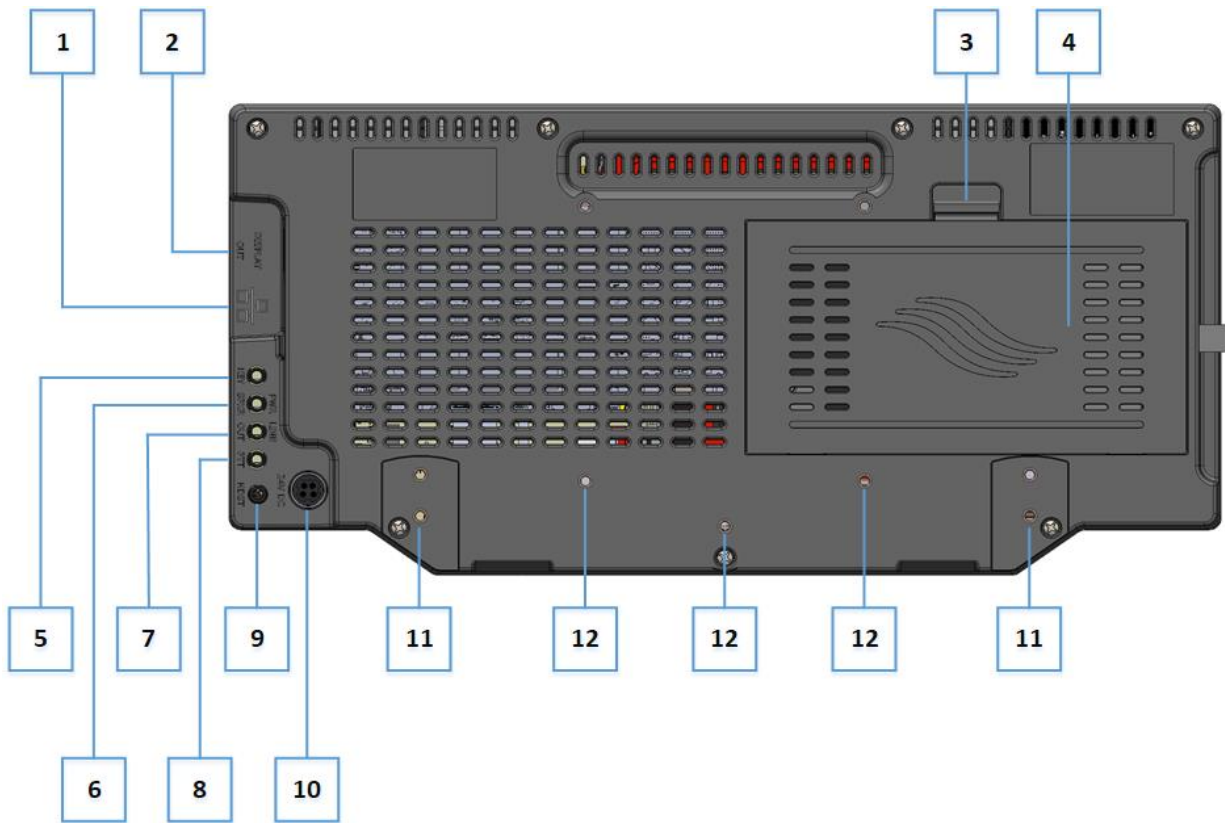

The components of the Maestro “C” back panel are:

1. Wired Ethernet port	7. Line Out socket
2. External monitor port	8. Push-To-Talk socket
3. Battery Compartment Release tab	9. Microphone and Headphone socket
4. Battery Compartment	10. External power port
5. Morse key socket	11. Tilt leg mounting points
6. Powered speakers socket	12. Fixed leg mounting points

3.3.2 Maestro “A” and “B” Rear Panel Layout

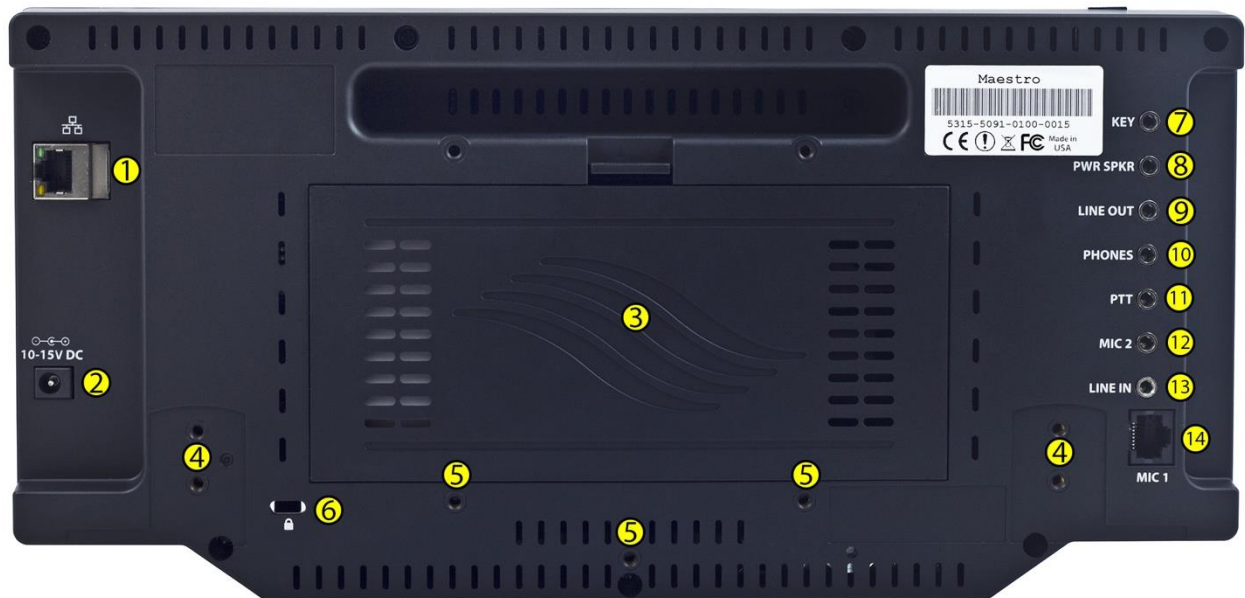

The components of the Maestro “A” and “B” back panel are:

1. Wired Ethernet port
2. External power port
3. Battery compartment
4. Tilt leg mounting points
5. Fixed leg mounting points
6. Physical security point
7. Morse key socket
8. Powered speakers socket
9. Line Out socket
10. Headphones socket
11. Push-To-Talk socket
12. Microphone 2 socket
13. Line In socket
14. Microphone 1 socket

4 SETTING UP YOUR MAESTRO

To operate your Signature Series Flex 6000 transceiver with your Maestro, you must provide power, an Ethernet connection, and an input device to the Maestro. Other equipment such as speakers, headphones, line-level signals, and push-to-talk switches are optional.

4.1 EXTERNAL DC POWER REQUIREMENTS

The Maestro can be powered using an external DC source. Additionally, the Maestro may be powered by a battery placed in the battery compartment on the back of the Maestro for untethered operation.

4.1.1 Maestro “C” External Power Requirements

The Maestro “C” utilizes a 24-volt DC 4-pin DIN external DC power adapter supplied with the Maestro.

4.1.2 Maestro “A” and “B” External Power Requirements

The Maestro “A” and “B” utilize 10 to 15-volt DC external DC coaxial power adapters such as the one supplied by the wall power adapter that is provided with the Maestro, or a supply such as is required to run the FLEX-6000 radio.

Note: Maestro “A” models must be connected to DC power for 15 to 30 minutes every 4 to 6 weeks of non-use to ensure that the internal display battery does not completely discharge.

4.2 BATTERY PACKS AND BANKS

The Maestro may be powered by an external battery bank placed in the battery compartment on the back of the Maestro. This section details the external battery installation and operation for the Maestro.

4.2.1 Battery Pack Selection for the Maestro “C”

IMPORTANT: Maestro “C” models are **ONLY** compatible with RRC Power Solutions Battery Pack, model RRC2054-2.

Battery Specs:
Voltage: 14.40 V
Discharge Current: 8.50 A
Capacity: 6.9 Ah

It is recommended that before using your battery pack with your Maestro “C” device you read the manufacturer's instruction manual for use included in your battery shipment. These *smart* battery packs are off-the-shelf batteries and adhere to worldwide certifications and approvals.

More information on RRC Smart Battery Packs can be found here: https://www.rrc-ps.com/fileadmin/Dokumente/Manuals/Manual_RRC2054-2.pdf

It is normal for a battery installed in a Maestro “C” to slowly drain while it is power is off. A recommended best operating practice calls for removing the battery from the unit when left off for multiple days. A fully charged battery will be depleted after a few weeks when stored inside the Maestro “C” without AC applied.

BATTERY PACK CAUTIONS:

Refer to the battery pack safety precautions as to its use and charging cautions included with your battery shipment and provided by the manufacturer. These documents can be found here: https://www.rrc-ps.com/fileadmin/Dokumente/Shipment/SDS_RRC_Batteries_N_2022-11-16.pdf

4.2.2 Battery Pack Installation for the Maestro “C”



This section details the battery pack installation steps:

1. Depress the latch and remove the battery compartment cover plate.
2. Orient the battery pack in the Maestro “C” as shown below.

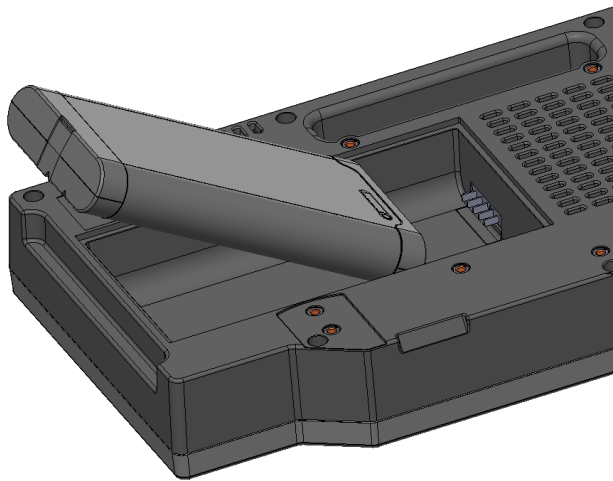

3. Slide battery pack into place so connectors make contact.

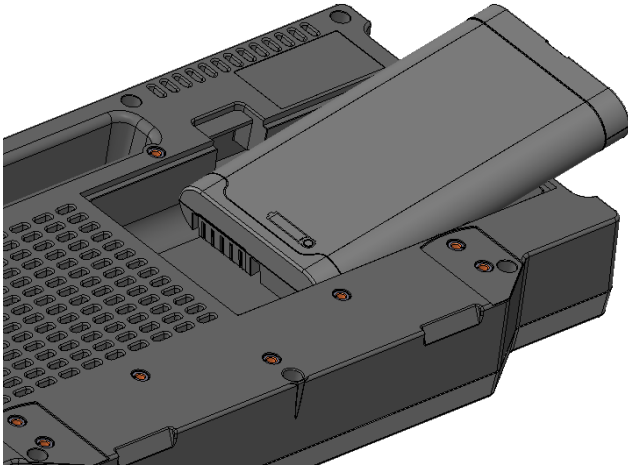

4. Hold down until the battery latches into place as shown below.

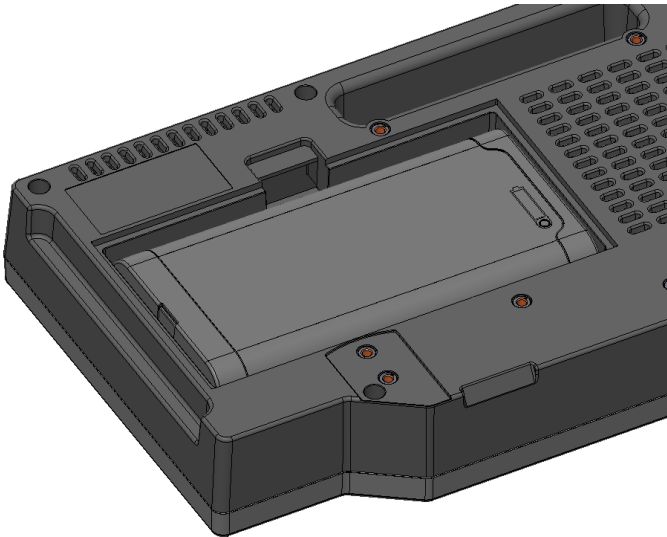

5. Replace the battery cover and secure it as shown below.

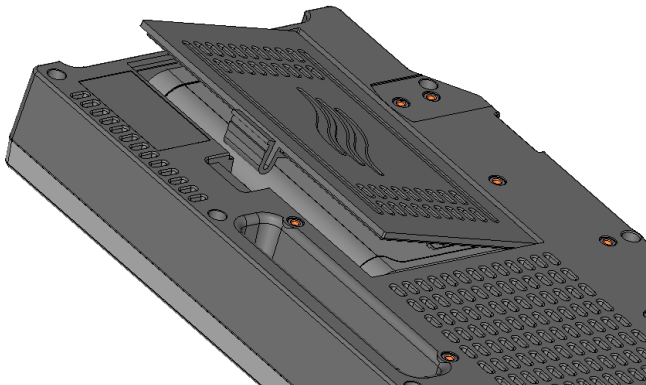

4.2.3 Battery Pack Operating Instructions for the Maestro “C”

The RRC-SMB-MBC external charger is provided with the RRC2054-2 battery pack.



The RRC-SMB-MBC charger is optimized for faster charging and longer charging cycle lifetimes.

To charge the battery, simply plug in the charger to an AC power outlet and place the battery pack in the charger until it is completely seated. The Charge Status LED on the charger will initially indicate green and transition quickly from blinking red to solid orange as the battery begins charging. The Charge Status LED will turn solid green when the battery is completely charged.

If the charge status LED stays solid red for a prolonged time, then the battery is not within the charging temperature range (0 to 40C or 32 to 104F) or the battery pack is defective.

It is a best practice to recharge the battery pack after it has completely discharged.

Note: When the RRC2054-2 battery pack is installed in the Maestro “C” and is being powered from the external 24-volt power supply, if needed, the battery pack will be charged.

The RRC2054-2 battery pack has a graphical charge level indicator located on the front right-hand side. Pressing the circle at the bottom of the battery graphic will momentarily show the battery charge level in five (5) steps as shown below.

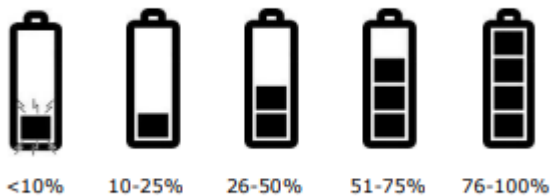

4.2.4 USB Power Banks for Maestro “A” and “B”

Maestro “A” and “B” may be powered by a user-supplied 5-volt battery placed in the battery compartment on the back of the Maestro.

Supplemental batteries used for charging cellular phones and other electronics are plentiful and relatively inexpensive. The capacity and functionality of these batteries vary across manufacturers and models. FlexRadio has found that it is not uncommon for the advertised capacities to vary from actual measured capacities.

Specifications for batteries that are suitable for Maestro:
Maximum size: 6" x 3" x 0.75"
USB-A Female connector for battery drain (5V output)
Minimum output current of 2.1A
Auto-start preferred (will start on load without depressing a button – see below)

Most of these batteries contain an internal Lithium-Ion battery that has a nominal operating voltage of 3.7V. Typically, the output voltage is produced with a boost regulator that raises the voltage to 5V DC.

Maestro “A” and “B” are designed to place a load on the battery when it loses power from the wall charger and most batteries will automatically turn on and begin supplying power in this case (autostart). If your battery does not supply power when the external supply is removed, Maestro will display a message indicating that you have two minutes to replace or turn on the battery. If your battery has an on switch and will not auto start, simply press the on switch and Maestro will detect the battery voltage, remove the message, and continue normal operation.

For the Maestro “A” and “B” to operate properly, it requires the average voltage from the battery to be above 4.5V. If the battery voltage falls below 4.25V for an extended period, Maestro will display the following message:

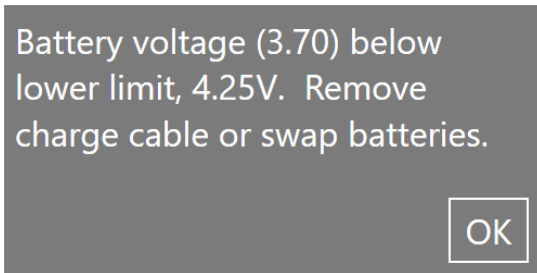

This message generally indicates one of two possibilities if the battery has been fully charged:

1. The battery has drained beyond its normal capacity and needs to be replaced. Typically, the battery voltage will be around the 4.25V range and falling. In this case, the battery should be replaced or charged.
2. There is another issue with the battery, such as a failure, a design issue, or an inability to provide the necessary power, which requires a replacement of the battery.

If the battery being used cannot supply the required power for Maestro “A” or “B” but does not fall below 4.25V, it will cause a slow drain of the Maestro “A” and “B” internal battery. If the internal

battery is completely drained, the Maestro “A” and “B” will shut off and will require charging through the wall charger port on the back of the Maestro (up to 15 minutes may be required before the Maestro will restart in this condition). Maestro can detect a loss of internal charge on the battery, and if detected will show this message:

Insufficient battery power. Please replace battery or use wall charger.

OK

If you receive this message, you should plug in your Maestro “A” or “B” using the supplied wall charger or switch to a battery that can supply sufficient energy to both run the Maestro “A” and “B” and charge the internal battery.

Note: In some circumstances, the Maestro “A” and “B” can demand more power from the battery than it can supply. This may cause Maestro to produce a power supply error and stop. Known circumstances that can lead to this error include running the built-in speaker at high volume with AGC turned off. The current demand of the speaker and the display may exceed the battery’s maximum rated output current. This in turn may lead to the battery shutting down or decreasing voltage below Maestro “A” and “B” minimum. In this case, running the radio with AGC on may reduce the power peaks and prevent the error.

In summary, not all battery banks will function the same in Maestro “A” or “B”, and batteries age and fail over time. For best results, check the FlexRadio Community for recommendations on batteries from FlexRadio employees and other FlexRadio owners. Good batteries should provide reliable operation over many charge/discharge cycles.

4.2.5 USB Power Bank Installation for the Maestro “A” and “B”

This section details the installation steps:

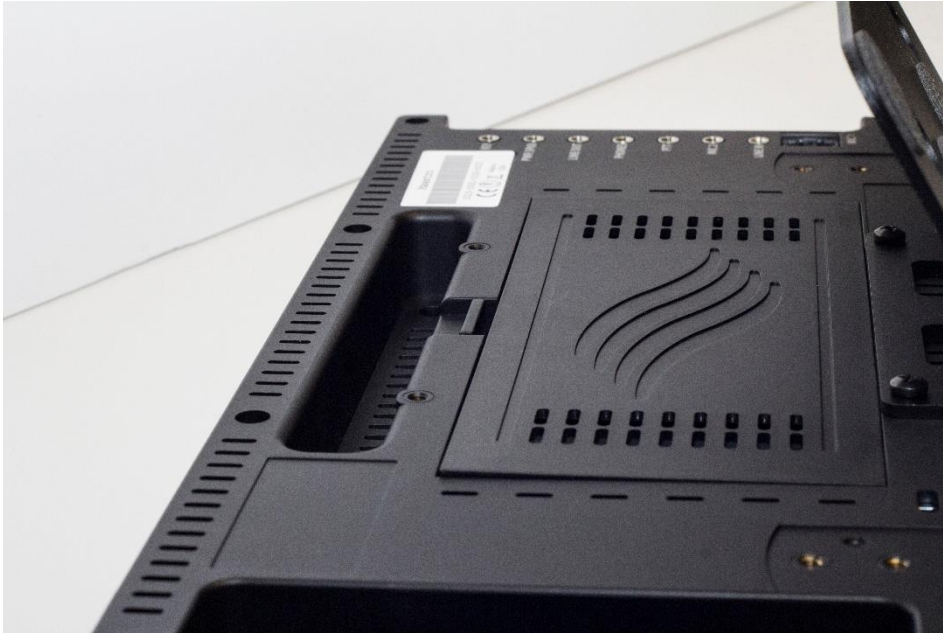

The door to the battery compartment is located in the middle of the back panel of the Maestro.



Depress the latch and open the battery compartment. Remove the door.



Insert a battery of a suitable size. Secure the battery using the self-adhesive straps.



Make the battery power connection with the USB Type A plug to the battery drain connector.



Close the battery door and press the latch until it engages. Make sure the battery and the connected battery power cable fit completely inside the compartment and do not interfere with the door as it is closed.

4.3 NETWORK INTERFACE

Maestro requires a network connection to your FLEX-6000 radio. This connection can take one of two forms:

- A wired connection using the RJ-45 Ethernet port on the back of the Maestro. This connection can take two forms
 - A “point-to-point” connection between the Maestro and the FLEX-6000 transceiver using a single Ethernet cable. In this configuration, the Maestro and the radio set up a two-node ad hoc network and communicate across it.
 - A connection through an Ethernet switch. Many configurations are possible, but typically the Maestro is connected to a port on the switch, and the FLEX-6000 transceiver is connected to a similar port. A third agent, such as an ISP-supplied router-modem connected to the same Ethernet switch provides IP addresses to the network components via a DHCP service.

Note: When a Maestro “A” and “B” are operated on battery power, the wired Ethernet port is disabled.

- A WiFi (wireless) connection using the built-in wireless adapter. On start-up, Maestro will attempt to make a WiFi connection using information from earlier sessions, or if no recognized network is available, Maestro will present the *Choose a WiFi Network* screen showing available networks. Select a network by tapping its name, then tapping the *Connect* button. You may be required to enter a password to access the network.
 - The Maestro “C” is compatible with WiFi6 (802.11ax) and below.
 - The Maestro “A” and “B” are compatible with WiFi5 (802.11n) and below.

4.4 INPUT DEVICES

A microphone or key is required to operate the transmitter in your FLEX-6000 transceiver. A straight key or paddles can be plugged into the Key port on the back panel of the Maestro. A microphone can be plugged into one of the available microphone inputs.

The following sections describe, in detail, the connections that can be made on the back panel of the Maestro.

4.4.1 Maestro “C” External Monitor Port

The external monitor port is provided to connect an external monitor to your Maestro device. The Maestro screen is then "mirrored" to the external monitor providing a larger viewing field.



4.4.2 Straight Key and Paddles Connection

For CW operation, the 1/8 inch (3.5mm) TRS KEY connector accepts a TRS plug for operating a keyer with paddles or a straight key.

When Connecting a CW straight key, a TRS plug must be used for proper connectivity to the Maestro. Connect the key to the Tip and Sleeve, and leave the Ring unconnected.

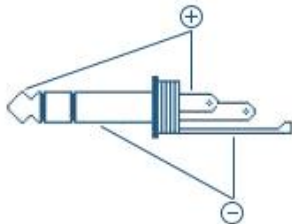

When connecting a CW paddle and using the internal electronic keyer, connect the Dot to the Tip, the Dash to the Ring, and the paddle common to the Sleeve.

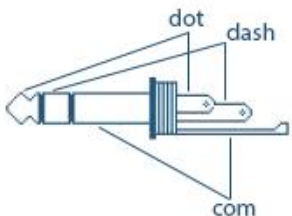

4.4.3 Powered Speaker Connection

The **PWR SPKR** connector accepts a 1/8-inch (3.5mm) stereo (TRS) plug and provides stereo line level output for amplified PC speakers. **CAUTION: Do not use a mono (TS) plug as this will short-circuit the right channel signal to ground.**

Note: Connecting powered speakers to a Maestro “C” will mute the front panel speaker.

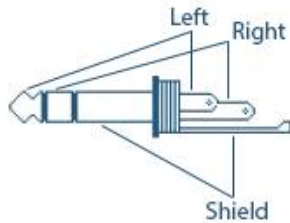

4.4.4 Line Out Connection

The **LINE OUT** connector accepts a 1/8-inch (3.5mm) stereo (TRS) plug and provides stereo consumer (-10 dBV) line-level output. **CAUTION: Do not use a mono (TS) plug as this will short-circuit the right channel to the ground.**

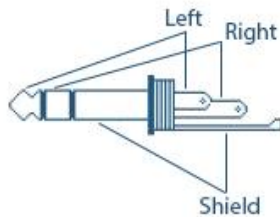

4.4.5 Maestro “A” and “B” Phones Connection

Note: Only the Maestro “A” and “B” have a dedicated headphone connector. The Maestro “C” utilizes a combination of headphone and mic HDST adapter (see below).

The **PHONES** connector accepts headphones with a standard 1/8-inch (3.5mm) stereo (TRS) plug. Recommended ratings for headphones are 25mW into a 16-ohm load or 13mW into a 32-ohm load. **CAUTION: Do not use a mono (TS) plug as this will short-circuit the right channel signal to the ground.**

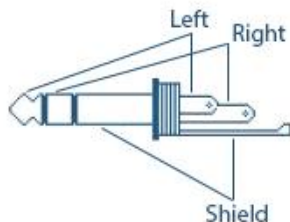

4.4.6 PTT Connection

The **PTT** connector accepts a 1/8-inch (3.5mm) stereo (TRS) plug or mono (TS) plug. Grounding the PTT line through an external switch keys the transmitter.

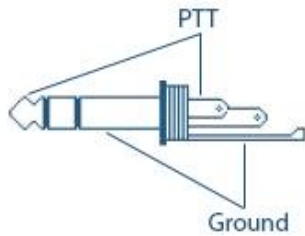

4.4.7 Maestro “C” HDST Combo Microphone and Headphone Connection

The **HDST** connector accepts a 1/8-inch (3.5mm) TRRS plug which provides a stereo headphone output and a microphone input. **The connector utilizes the TRRS CTIA standard for the pinout.** The other competing standard is OMTP, used by older Smartphones such as Nokia and old Samsung model cellphones.

Note: Apple headphones with a microphone adhere to the CTIA TRRS standard. Using headphones that are compliant with the older OMTP standard may not provide optimal audio fidelity.

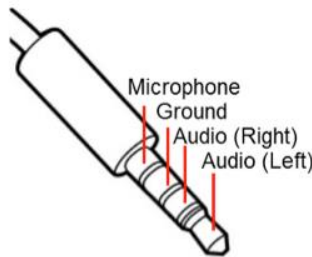

4.4.8 Maestro “A” and “B” Mic 2 Connection

The **MIC 2** connector accepts a 1/8-inch (3.5mm) stereo (TRS) plug and provides an unbalanced microphone input with optional push-to-talk input. The connector may be used with dynamic or electret microphone elements. A software-enabled 2.5V bias voltage may be applied to the Mic (+) line for electret microphones. **CAUTION: Failure to enable bias on some consumer electret microphones may cause the PTT line to be asserted and key the transmitter.**

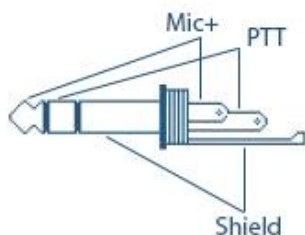

4.4.9 Maestro “A” and “B” Mic 1 Connection

The 8-pin RJ-45 **MIC 1** connector offers the ability to connect a microphone and to key the radio via a PTT line. The RJ-45 pin-out is shown below. To engage PTT, pin 6 must be grounded to pin 7 (Shield Ground) and not to pin 4, which is the microphone ground.

Pin #	Signal	Diagram
1	Frequency Down	
2	Frequency Up (Ground)	
3	+5 VDC (470 Ohm)	
4	Microphone Ground	
5	Microphone Input	
6	PTT Input	
7	Chassis Ground for	
8	Fast Step Tuning	

To prevent ground loops and RF ingress into the microphone circuit, the MIC (-) wire should be connected to pin-4 only and NOT be connected to the pin-7 chassis ground. The microphone circuit is wired as pseudo-differential and can thus be used with balanced or unbalanced microphones as long as the MIC (-) wire connects only to pin-4. Bias for electret microphones may be derived from the +5 VDC output on pin-3.

Although Maestro will work well with many types of microphones, it is wired for the convenient use of microphones such as the FlexRadio FMH-3-RJ45. The FHM-3-8P hand microphone supplied with the FLEX-6000 Series Radios uses an 8-pin Foster connector. This microphone may be adapted to Maestro with either the ACC-ADM817 RJ45 to 8-pin Male Foster Adapter cable or the ACC-CLV-310 RJ45 to RJ45 coiled cable replacement.

4.4.10 Maestro “A” and “B” Line In Connection

The **LINE-IN** connector accepts a 1/8-inch (3.5mm) stereo (TRS) plug and provides a pseudo-differential line level input to the transmitter.

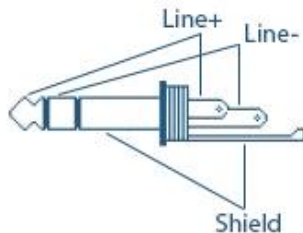

4.4.11 Ethernet Connection

To use wired Ethernet communications, connect a CAT5 or greater Ethernet cable from the RJ-45 connector marked with the network symbol as shown below. The connector is compatible with 10, 100 (Fast Ethernet) and 1000 (Gigabit Ethernet) Ethernet switches and interfaces.

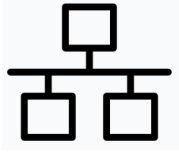

Note: On the Maestro “A” and B”, to operate using the Ethernet connection, the unit must be powered using an external 13.8 VDC power source.

Note: On the Maestro “A” and B”, the connector is located above the 10-15 VDC power connector on the left side of the Maestro back panel. Be careful not to plug the Ethernet cable into the MIC 1 connector located on the rear right side of the back panel.

4.4.12 Maestro “C” 24 VDC Power Connection

The 4-pin DIN (PD-40V) power connector accepts a 4-pin DIN power plug to provide 24 VDC at 5 amps (120W). The Maestro “C” is supplied with an AC/DC power supply with a 24 VDC output. Note that the connector has a “key” to ensure the plug is inserted in the PD-40V connector with the correct orientation.

As you look at the 4-pin DIN (PD-40V) power connector on the Maestro, the pins on the bottom are positive, and the pins on the top are negative.

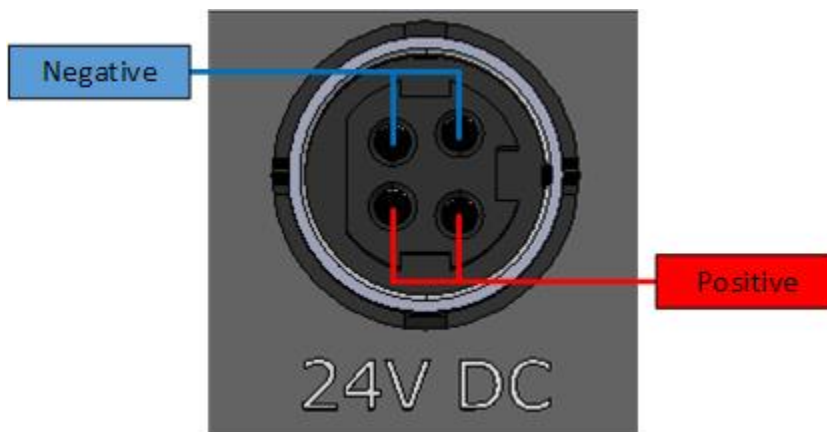

Note: Only use external power supplies provided by FlexRadio. Using a power supply with the incorrect voltage or polarity may result in certain features not working correctly and can damage the Maestro, voiding the warranty.

4.4.13 Maestro “A” and “B” 10-15 VDC Coaxial Power Connection

The power connector accepts a 2.1mm coaxial power plug to provide 10-15 VDC at 2 amps (25W). Maestro “A” and “B” are supplied with an AC/DC power supply with a 12V output. Also included is a DC power cable with a 2.1mm plug and pigtails on respective ends. This cable may be used to connect to the station power supply bus.



4.5 STARTING/STOPPING THE MAESTRO

The Maestro “C” is started by momentarily pressing and releasing the power button.

Maestro “A” and “B” are started by pressing and holding the Power button for approximately 5 to 6 seconds before releasing the button. It may take 15 more seconds before you see any screen display (flash) or the Maestro controls begin to illuminate and it may take an additional 45 seconds before the Maestro splash screen is displayed.

The Maestro “C” is stopped by pressing and releasing the power button. The power button LED will turn yellow just before completing the shutdown process. Please allow the Maestro “C” to fully shut down before removing its power source.

The Maestro “A” and “B” are stopped by pressing the Power button for a moment and then releasing it. In normal circumstances, it can take as long as 10 to 15 seconds for the unit to completely shut down after the screen goes blank. If a momentary press of the power button does not shut down Maestro, press and hold the power button until the unit shuts off. This procedure should seldom be necessary.

4.6 WIFI NETWORK SETUP

Maestro surveys the computer networks available to it at start-up. If it finds a usable network connection, either a wired Ethernet connection or a known WiFi connection, the first screen displayed to the user will be the *Select Radio* screen. But if it finds no wired Ethernet connection and no useable WiFi connection, it displays the *Choose a WiFi Network* screen.

Maestro supports WPA/WPA2 WiFi security and can also connect to open (unsecured) WiFi networks, but does not support WEP-secured WiFi networks. Wireless Protected Setup (WPS) is not supported.

Maestro surveys the 2.4 and 5.0 GHz WiFi radio frequencies for available WiFi networks. This survey may take a few minutes to complete. The survey results are displayed on the *Choose a WiFi Network* screen as shown below:

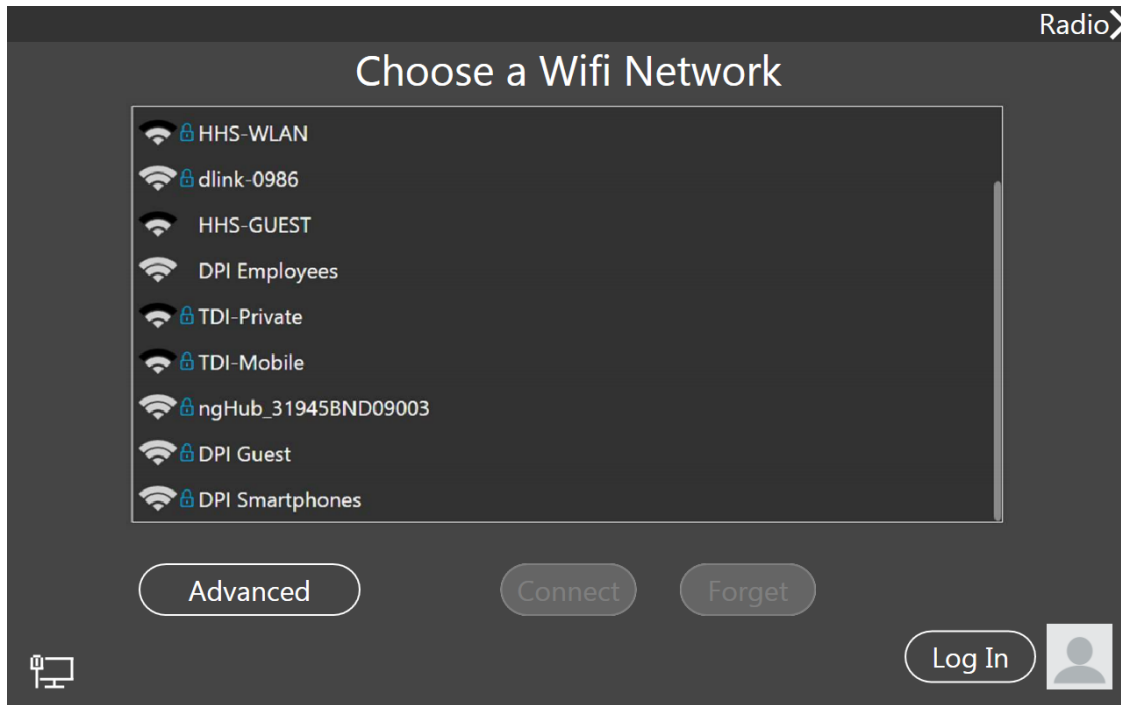

Select a network by tapping on it, then tapping the **Connect** button. If the network requires a password to complete a connection, you will be shown the *Enter WiFi Password* screen. Enter the password using the software keyboard provided on the screen, then tap **Connect**.

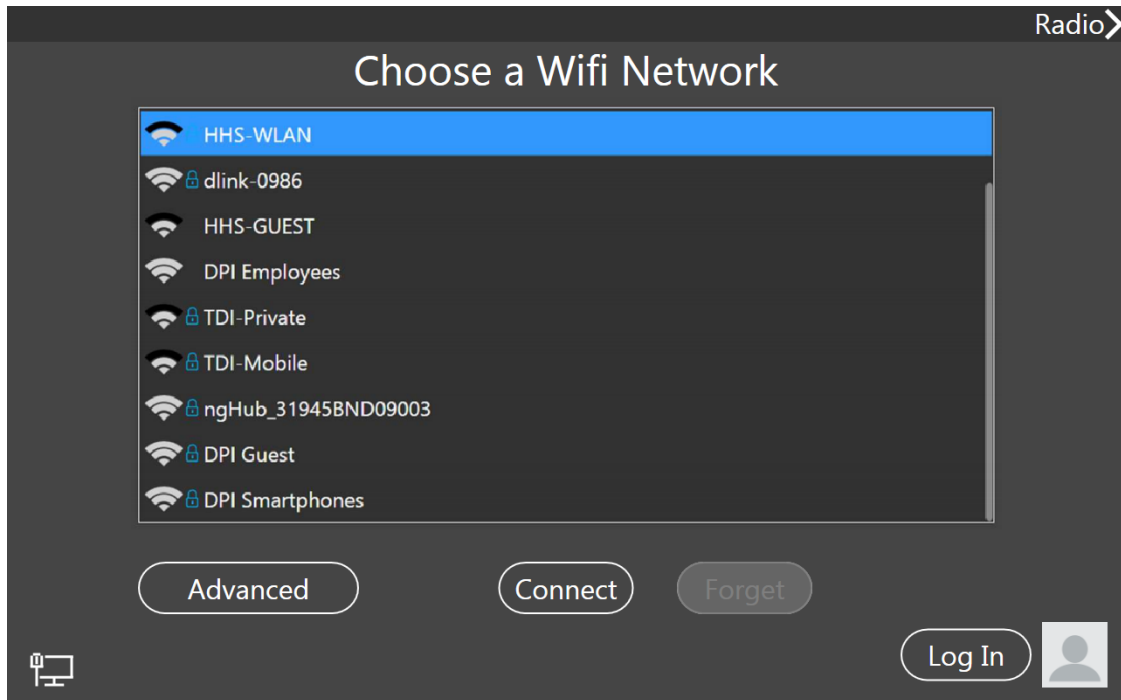

If the Maestro can make a connection to the network, the WiFi network setup is complete, and the Maestro continues to the *Select Radio* screen. You can return to the *Choose a WiFi Network* screen any time during the Maestro startup process by using the navigation buttons in the upper left and right corners of the startup screens. The *Select Radio* screen offers a “< WiFi” button to take you back to the *Choose a WiFi Network* screen.

Maestro treats WiFi network connections as secondary to wired network connections. At startup, it will use a wired Ethernet connection when it is available and will not connect to a WiFi network, even if a known WiFi network is available. If the wired connection is lost while the radio is in operation, Maestro will attempt to make a connection to the radio using a known WiFi connection. However, when operated on battery power, Maestro disables the wired Ethernet port and uses only the WiFi network connection.

Some users may want to use a WiFi connection for software updates but avoid using it to operate the radio. A metered WiFi connection might be an example of this situation. To operate Maestro in this fashion, start Maestro and use the WiFi connection to update the software, then start the desired version of the software. Enter the **Main Menu** then tap the **Network** tab. Tap the **WiFi Settings** button. Maestro will break its connection to the radio and then return to the *Choose a WiFi Network* setup screen. On this screen, you can select the WiFi network and use the **Forget** button to break the connection.

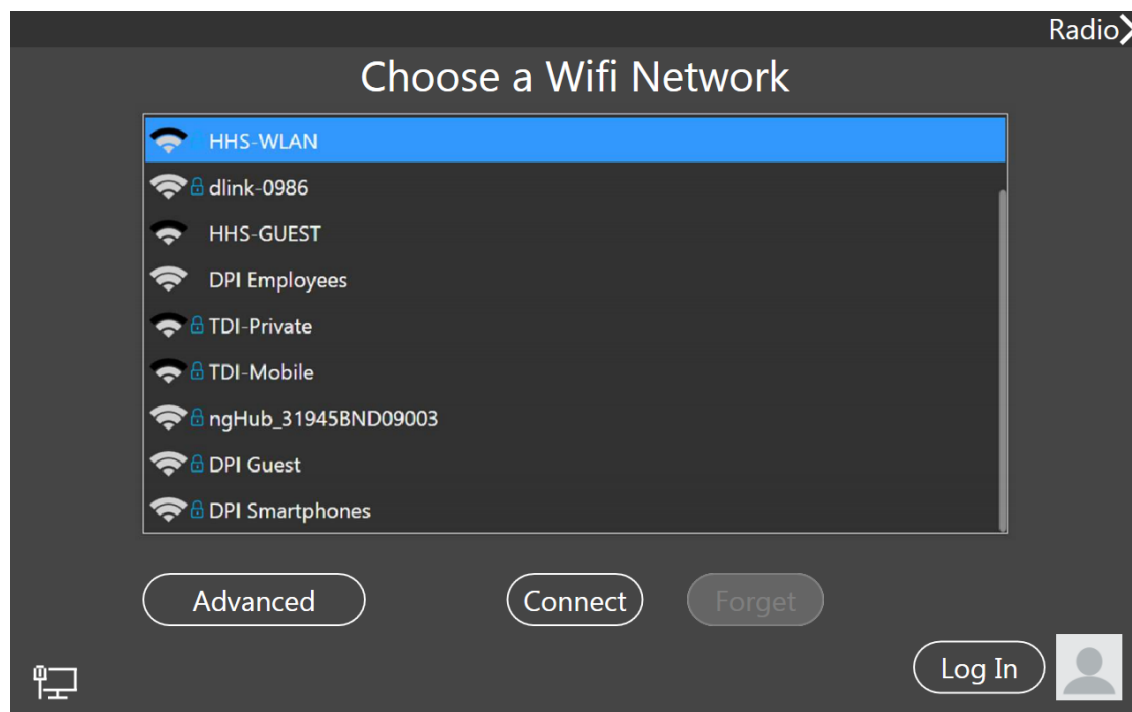

Maestro will clear any information it has stored about making a connection to that network. Subsequent Maestro startups will not connect to that WiFi network until it is manually selected by the user.

Tapping the **Advanced** button opens a screen that is used to configure details of the Maestro WiFi and wired Ethernet connections.

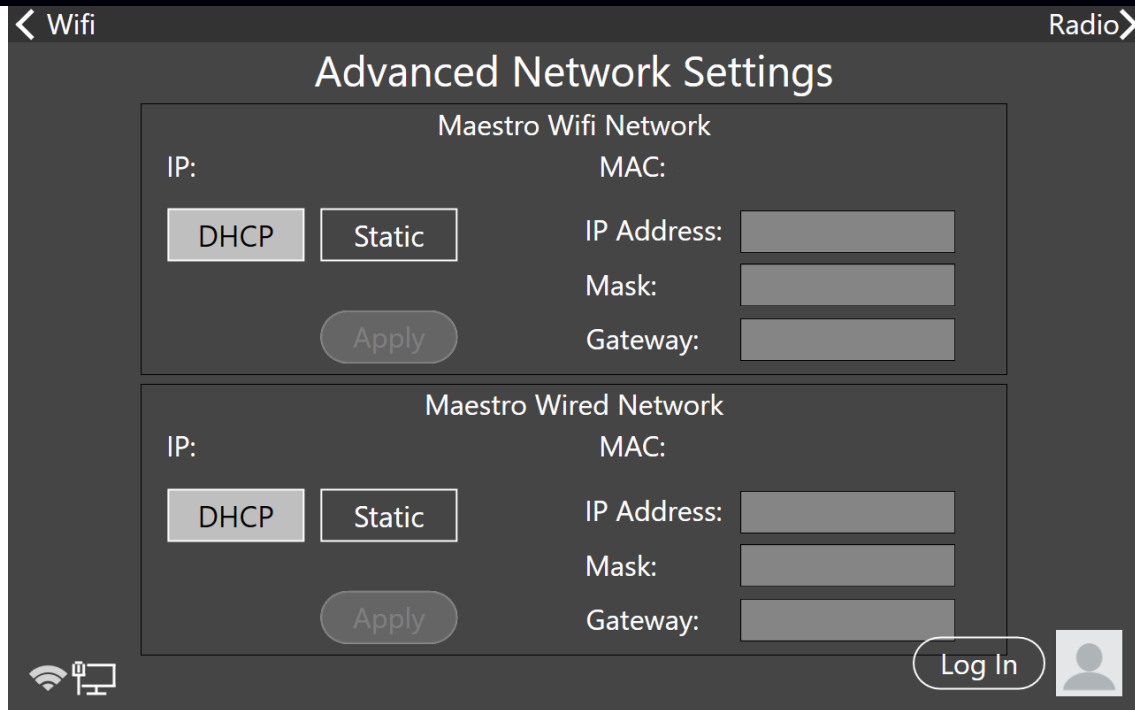

The configuration details of the WiFi and wired network interfaces are displayed. The default configuration for each interface is to use Dynamic Host Control Protocol (DHCP) to configure the interface. If a static configuration is needed, tap the **Static** button and enter the parameters in the **IP Address**, **Mask**, and **Gateway** fields, then tap **Apply**. Each interface can be configured independently.

See section **33.5, Network Tab** for more information about Maestro network connections and the **WiFi Settings** button.

4.7 NETWORK STATUS

When Maestro starts, the user has a choice of the *Choose a WiFi Network*, *Select Radio*, and *Select a Version* startup screens. Each of these screens includes information about the network connection that Maestro has made or is attempting to make. This information is shown by an icon in the lower-left corner of each of these screens.

The icon provides status information about a wired Ethernet connection, a wireless WiFi connection, and the Maestro server (which provides Maestro software for installation). Tap the icon to display text that provides more information. Some examples of the network status icon follow:





Connected to Ethernet, Maestro server unavailable



Connected to Wifi



Connected to Ethernet and Wifi



Connected to Ethernet and Wifi, Internet unavailable

5 MULTIFLEX

multiFLEX™ allows more than one operating position for each radio. In SmartSDR v3.0+, up to two operating positions may connect to a single radio. The operators may be in the same vicinity, or they may be accessing the radio via SmartLink from anywhere in the world (with internet access). In either case, the same familiar easy-to-use interface is used to drive the radio. Each operating position is considered a Station and can have its independent Slices¹, Panadapters¹, transmit settings, and active profiles. This allows the sharing of a radio with two users at the same time as if they each had their radio although there can only be one active transmitter at a time and receive resources must be shared.

multiFLEX introduces several new paradigms to the FlexRadio ecosystem that each needs their definitions. These definitions are given assuming a single radio with two operators connected to the same radio at the same time.

Station and Station Name: The Station is the main program being used to operate the radio. This can include Maestro, SmartSDR for iOS, SmartSDR for Windows, and other programs that display panadapter and waterfall data. Each of these programs is considered a Station and is assigned a Station Name which can be changed by the user. This Station Name is then used in DAX, CAT, and other third-party programs to track slices, panadapters, streams, and other information that is unique to a Station. Each Station can have its own TX Slice and different TX/Mic profiles loaded independently from other Stations. It can be thought of as an operating position.

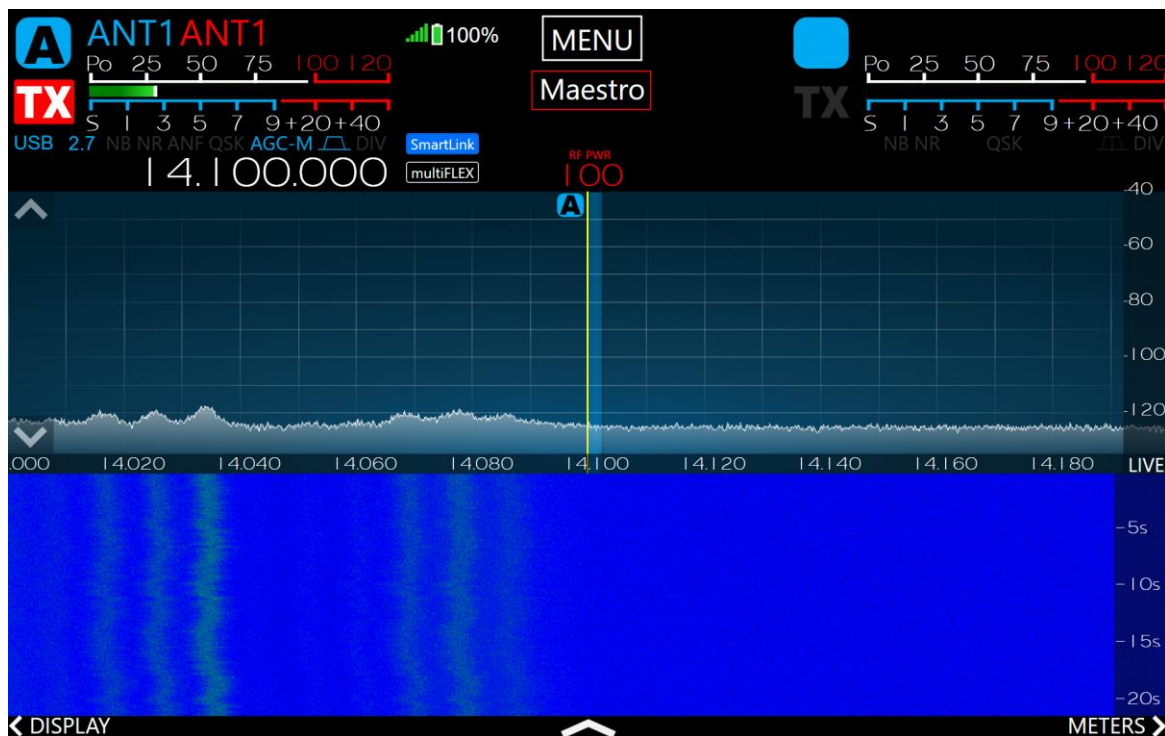

¹ Subject to resource availability based on model (e.g. FLEX-6700 has 8 Slices and Panadapters, FLEX-6600/FLEX-6500 has 4 each, and the FLEX-6400 and FLEX-6300 have 2 each).

Local PTT: Local PTT is assigned to a single Station. Since there can be multiple TX slices, the radio must know where to transmit whenever a physical input to the radio (RCA/ACC PTT, CW Key, Mic PTT) is pressed. The Local PTT is how the radio decides where to transmit whenever any of these physical inputs are pressed. For example.

Station 1 is on 20m. Station 2 is on 40m. A footswitch is plugged into the RCA PTT of the radio.

Station 1 is the Local PTT Station. If the footswitch (hardware PTT) is pressed the radio will transmit on 20M

If Station 2 presses the MOX button (non-hardware PTT), then the radio will transmit on 40M

To set the Local PTT, use the multiFLEX Dashboard (see section **33.15, multiFlex Tab**).

6 CONNECTING TO A RADIO

After Maestro starts, a screen is displayed showing radios found on your local network. Maestro locates these radios using a network broadcast protocol that is limited to the local subnet that Maestro is connected to. If your radio is running and is connected to your local network, it should appear in the *Select Radio* screen as shown below:

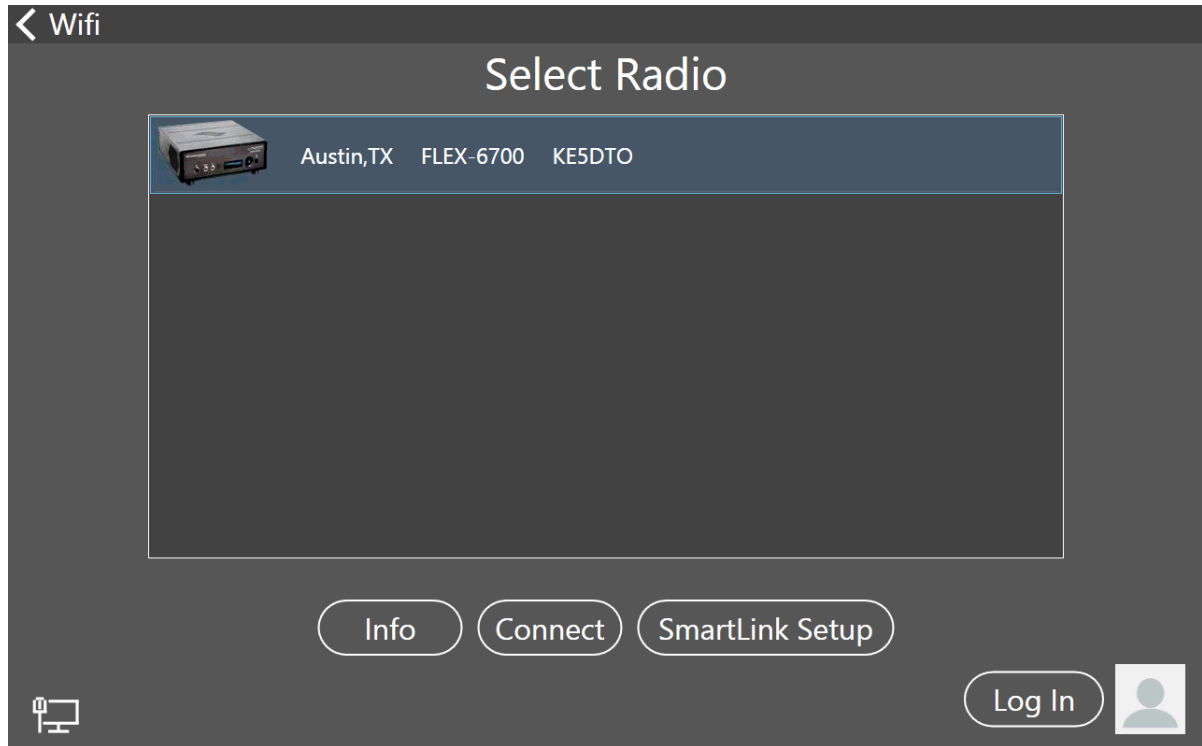

Select a radio in the *Select Radio* screen by tapping it. If the radio is not in use, it will be shown as above. If it has one client already attached, the word “multiFlex” and the name of the attached station will be shown in parenthesis under the name of the radio, as shown below. If all of the available multiFlex connections are in use, you will see “In Use” under the radio’s name.

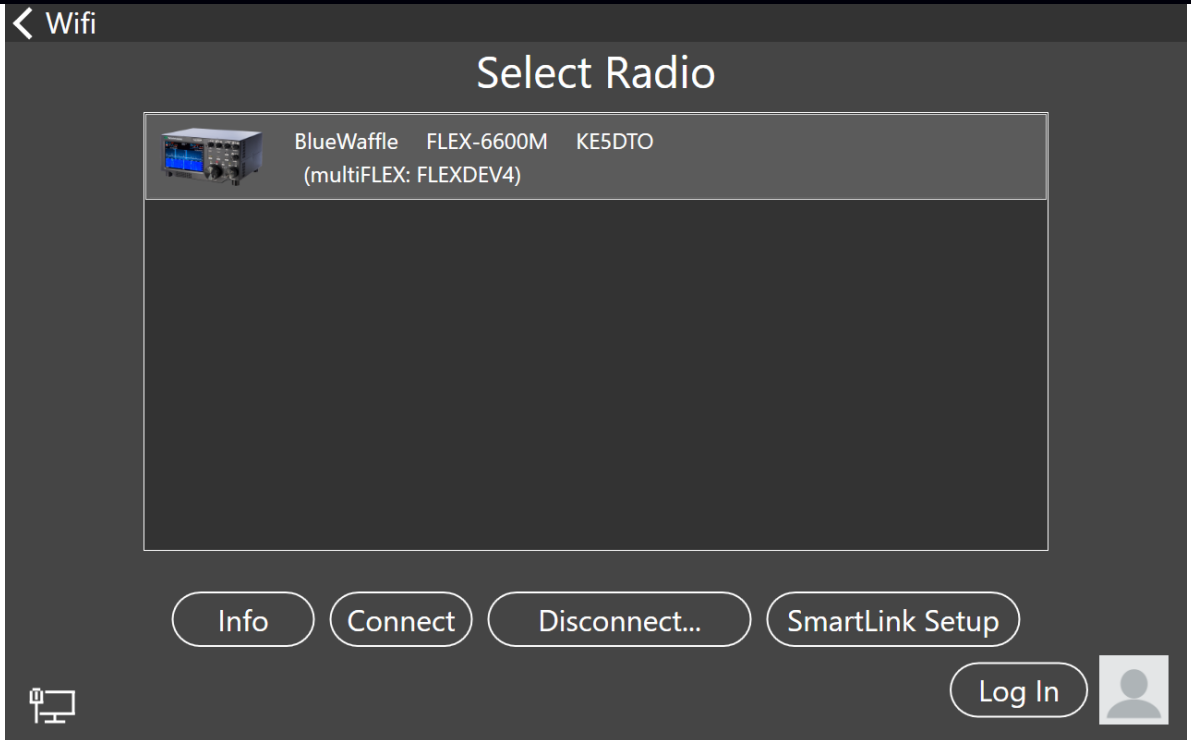

To connect to a radio that is in use by another client, select the radio by tapping it. A **Disconnect User** button will appear to the right of the **Connect** button. Tap this button to disconnect the other client. The radio will then be available for use.

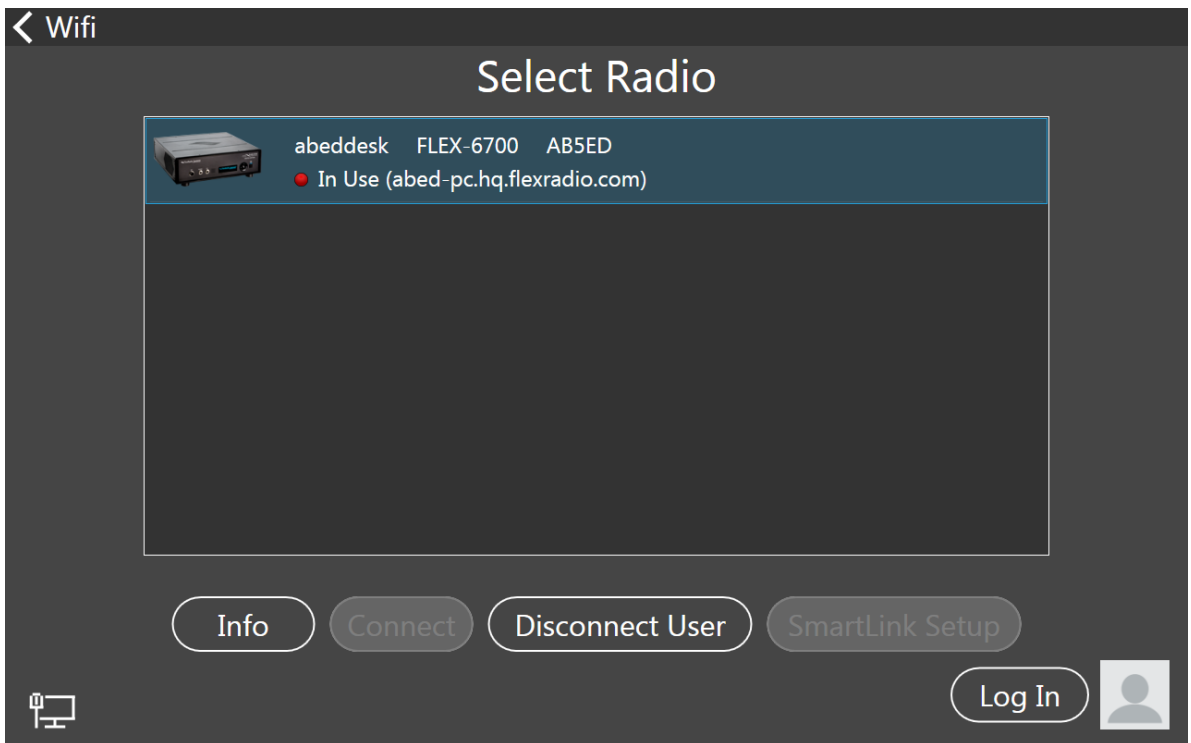

7 HOW TO SELECT MAESTRO AND RADIO SOFTWARE

After a radio is selected, Maestro will display the *Select a Version* screen, and a list of available versions of Maestro software and radio firmware.

Maestro manages software versions automatically. Each time Maestro is started It checks for new versions of the software and displays them on the *Select a Version* screen. When a new version is available, you will have the option to download and install it. If a new version requires a change to the radio firmware, this is also downloaded and made ready to install on the radio. Several versions of the software will usually be available for installation, giving you the option to move forward or backward through the versions. The newest software is listed at the top of the screen, the oldest at the bottom.

7.1 SELECTING A SMARTSDR VERSION AND INSTALLING IT

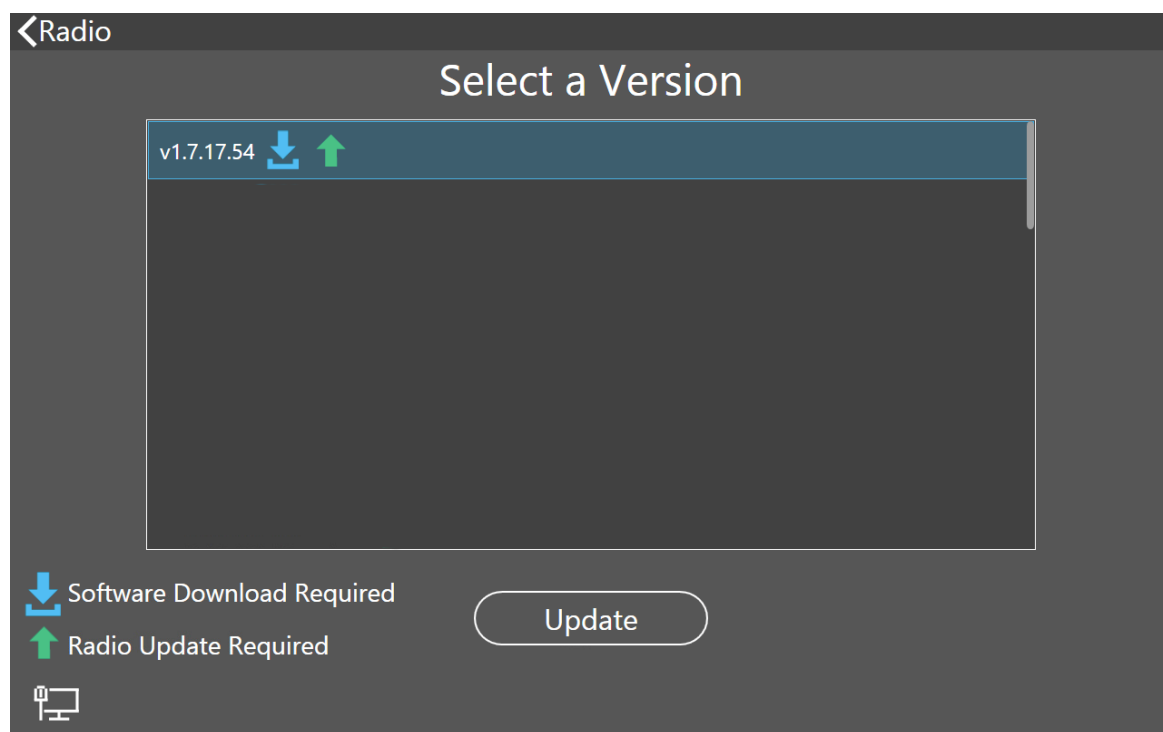

From the *Select a Version* screen, select a software version to run by tapping the version, then tap **Update** to proceed.

Maestro will download and install the software for itself and the radio, as needed. If the version you select has been downloaded before, it is not downloaded again. A single version of SmartSDR for Maestro is installed on Maestro at any one time, but up to five are kept on Maestro for later installation. Any time a different version is selected, a short installation process will reinstall the

selected software on Maestro. The *Select a Version* screen displays an  if a change is required in the radio firmware. In most cases, the radio will stop and restart once or twice as the radio firmware is installed.

Once the installation process has started you will see a progress bar showing the approximate completion status. Firmware updates are usually complete in a few minutes. If a progress bar goes

all of the way to the right and stops, and the update does not complete within a few minutes, restart the radio and Maestro and try again.

Note: Some firmware updates make changes to the radio's processor that regulates the radio's internal temperature. When this happens, the radio's fans will run at full speed as a safety precaution until the update is finished. This and other unusual occurrences during firmware updates should not be considered problems unless they persist after the update is complete.

7.2 LICENSING SMARTSDR VERSION 2

Version 2 of SmartSDR for Windows is licensed software. FlexRadio makes the Version 2 software available under license to owners and users of FlexRadio 6000 Series radios. Most 6000 Series owners will need to purchase a license as part of the version 2 installation process. Limited Edition Flex 6000 Signature Series radios, Flex 6000 Signature Series radios purchased on or after May 19, 2017, and certain other radios are already licensed for version 2. No additional license purchase is required for these radios.

When SmartSDR for Maestro is started on a radio that has not been licensed for Version 2, you will see a screen like this:

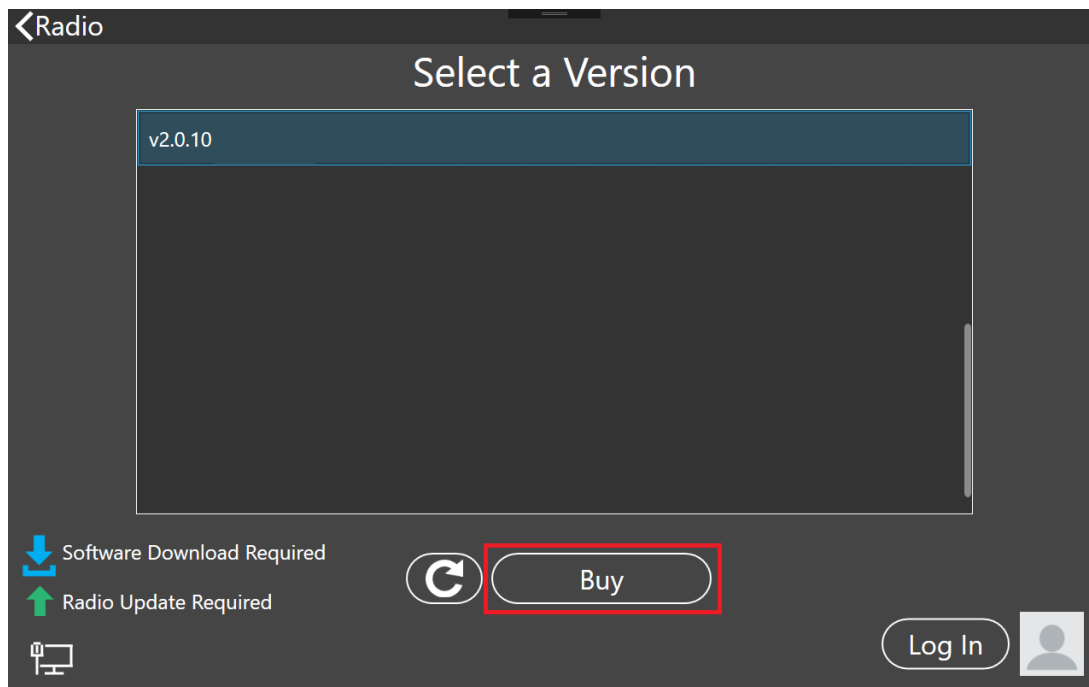

You will not be able to connect to the radio and operate it until a Version 2 license is installed on the radio. Tap the **Buy** button (outlined in red) to generate and show a shortened URL that must be plugged into a browser manually. This URL is case-sensitive and unique for each radio.

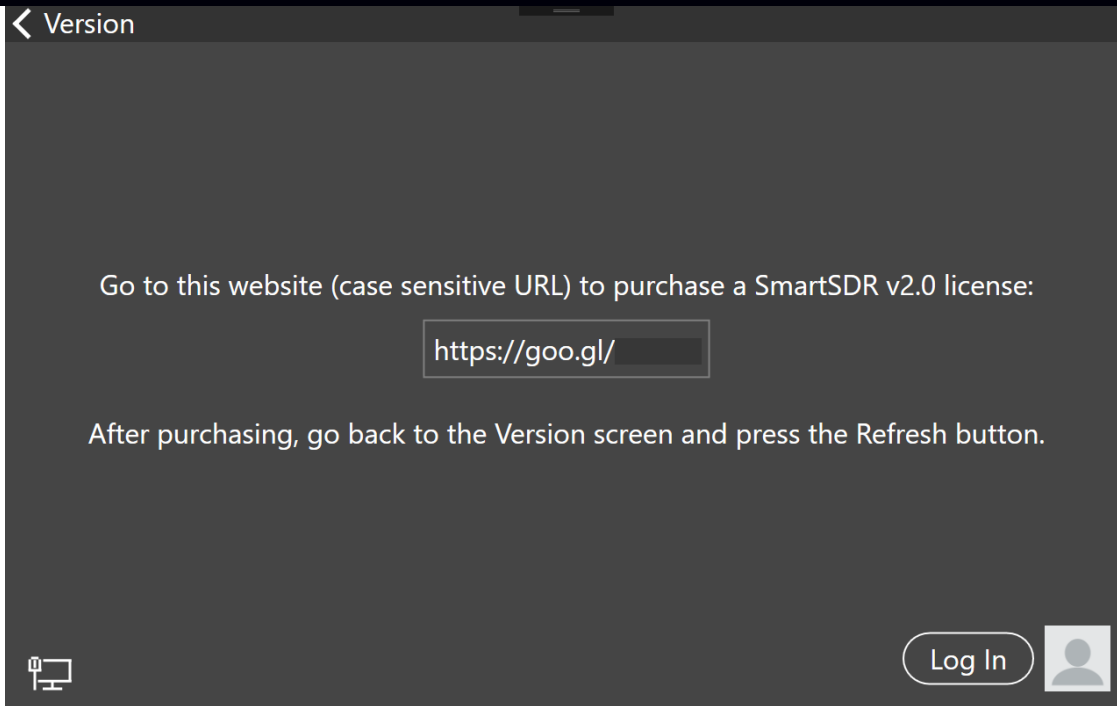

Note: Do not use this URL in a mobile device browser. The URL may be corrupted leading to errors in the licensing process that may require technical support to correct. Use the URL in a desktop computer browser.

When the purchase is complete, return to the *Select a Version* screen and tap the  button. The radio will search for a new license and install it when it is found. It may take up to a minute after the purchase completes for the license to become available for installation. Note that the radio must have access to the Internet for this step to be completed.

The license applies to the radio it was purchased for, not to the owner of the radio or any instance of SmartSDR for Windows, SmartSDR for Maestro, SmartSDR for iOS, or any other radio client. Each radio has a unique identifier that is associated with the license. Only one license is required for any radio, regardless of the number of instances of SmartSDR that may use the radio.

Licenses are not transferable to other radios. If the ownership of a radio changes, the license moves with the radio.

Once the radio has found and installed the license, it does not need to be connected to the Internet to run SmartSDR Version 2. In addition to the license stored on the radio, a copy is stored securely online. When the radio is connected to the Internet, it periodically checks its license status and updates it as appropriate. In the very unlikely event it needs to be restored to the radio, simply return to this screen and tap the  button.

8 SMARTLINK

8.1 SMARTLINK OVERVIEW

Use SmartLink™ with a Maestro connected to the Internet to operate your Flex 6000 Series radio at a remote location. SmartLink provides authenticated, secure access to the radio over the Internet at effective data transfer speeds.

It is not necessary to use SmartLink when connecting to radios that are local to Maestro. They will appear in the *Select Radio* screen when Maestro is started. Simply tap the desired radio, then tap the **Connect** button.

SmartLink has been designed with four main goals in mind: simplicity, security, performance, and expandability.

Simplicity: For most operators, setting up and using SmartLink will be plug-and-play. Simply upgrade your radio software to SmartSDR version 2 (or later), create a SmartLink account, register your radio in your SmartLink account, and enjoy remote access from anywhere with Internet access. Once a radio is registered, it will appear in SmartSDR's radio chooser when you are operating at a remote location just as if SmartSDR were running in the radio's local area network.

Security: We know that keeping your data and access to your radio secure is of utmost importance. To ensure this, all communication between SmartSDR clients, radios, and SmartLink servers is encrypted and authenticated using the TLS protocol (the successor of SSL). SmartLink provides secure and safe authentication using the latest token-based sign-in methods while still allowing the flexibility of signing in with Facebook or Google credentials or a username and password of your choice.

Performance: Our goal is to provide the same level of performance with a SmartSDR SmartLink connection that operators have come to expect from SmartSDR locally. Although there is a recommended minimum connection bandwidth, the FLEX-6000 architecture will perform well using slower Internet connections than other radio architectures.

Expandability: SmartLink is designed to scale as more operators and features are added. Third-party developers will be able to implement programs on the SmartLink API to bring remote connectivity to other applications.

8.2 SMARTLINK SETUP

8.2.1 Create a SmartLink Account

SmartLink requires an online user account to store the SmartLink user credentials and connection information about the radios that users are authorized to use. To create your SmartLink account or log into an existing account, start Maestro, go to the *Select Radio* screen, and tap the **Log In** button near the bottom right of the screen.



The following screen will appear.

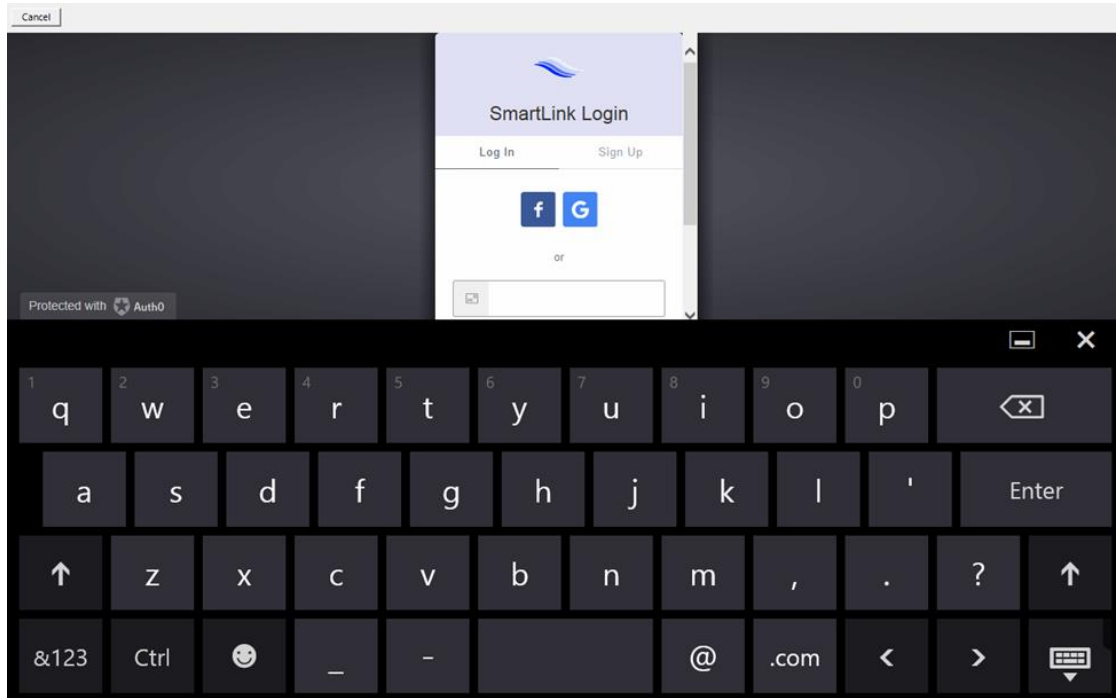

If you do not have a SmartLink account, tap **Sign Up** in the **SmartLink Login** screen to create an account using either an email address and password of your choice, or the credentials of an existing **Google** or **Facebook** account. You can use finger swipes on the Maestro touch screen to scroll the **SmartLink Login** screen up and down. Follow the instructions to create the account, then fill in the Name and Callsign fields and tap the **Save** button as shown below.

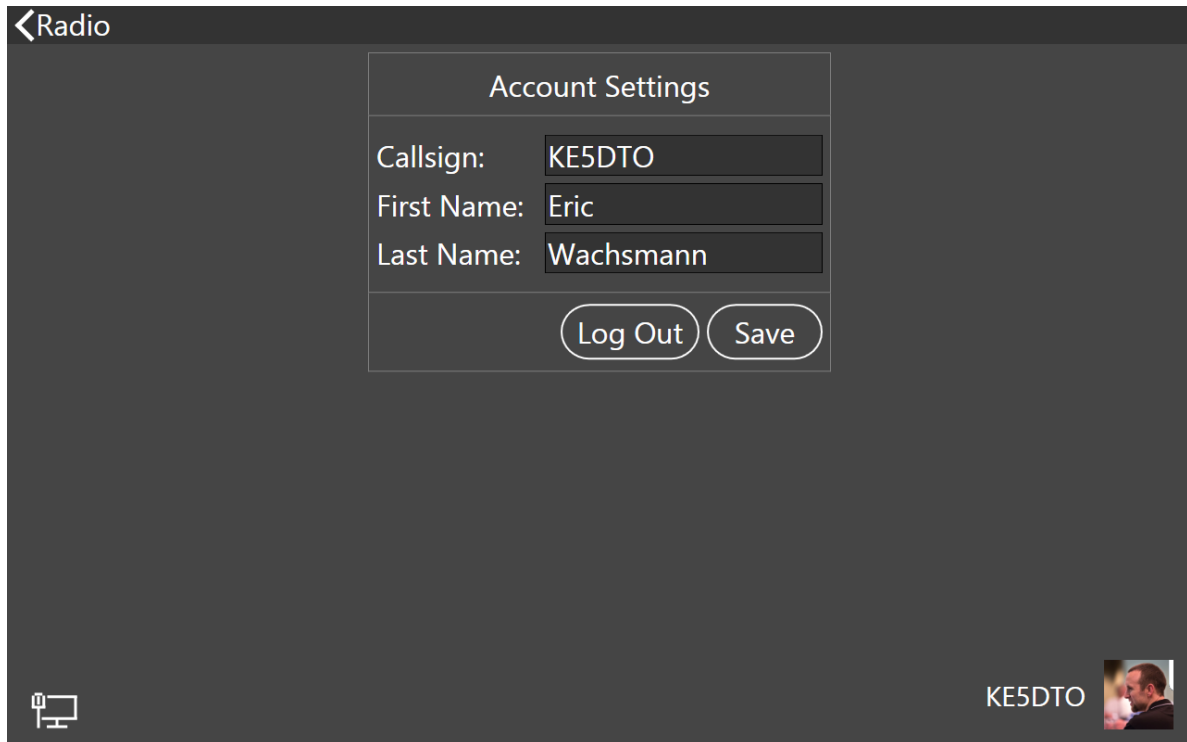

If you already have a SmartLink account, tap **login** on the **SmartLink Login** screen and then enter your email address and password.

Note: You will remain logged into your SmartLink account until you explicitly log out, even if Maestro is restarted.

Note: Be careful to note which type of credentials you used to create your SmartLink account as you will need to use the same credentials to access your radio from a remote location. Using different credentials may result in your radio not showing up in your connection list when trying to connect from a remote location.

8.2.2 Register the Radio in SmartLink

The next step is to register your radio in your SmartLink account. At the *Select Radio* screen, tap the radio to select it. **Connect** and **SmartLink Setup** buttons will appear at the bottom of the screen. Tap the **SmartLink Setup** button.

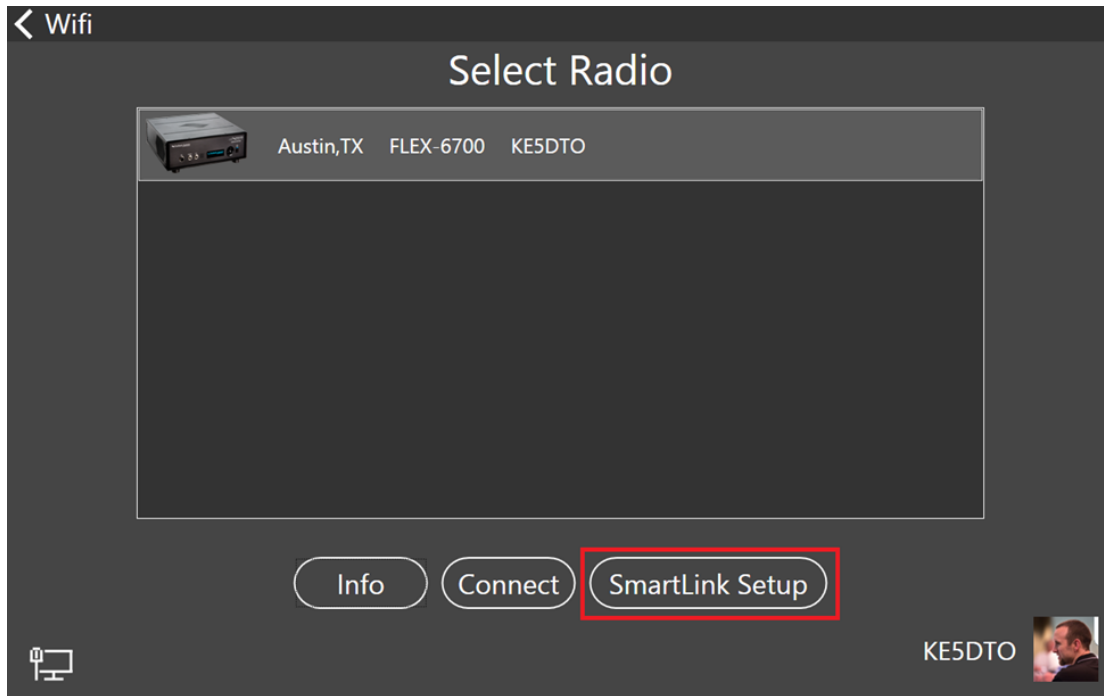

The following window will appear. Tap the **Register** button.

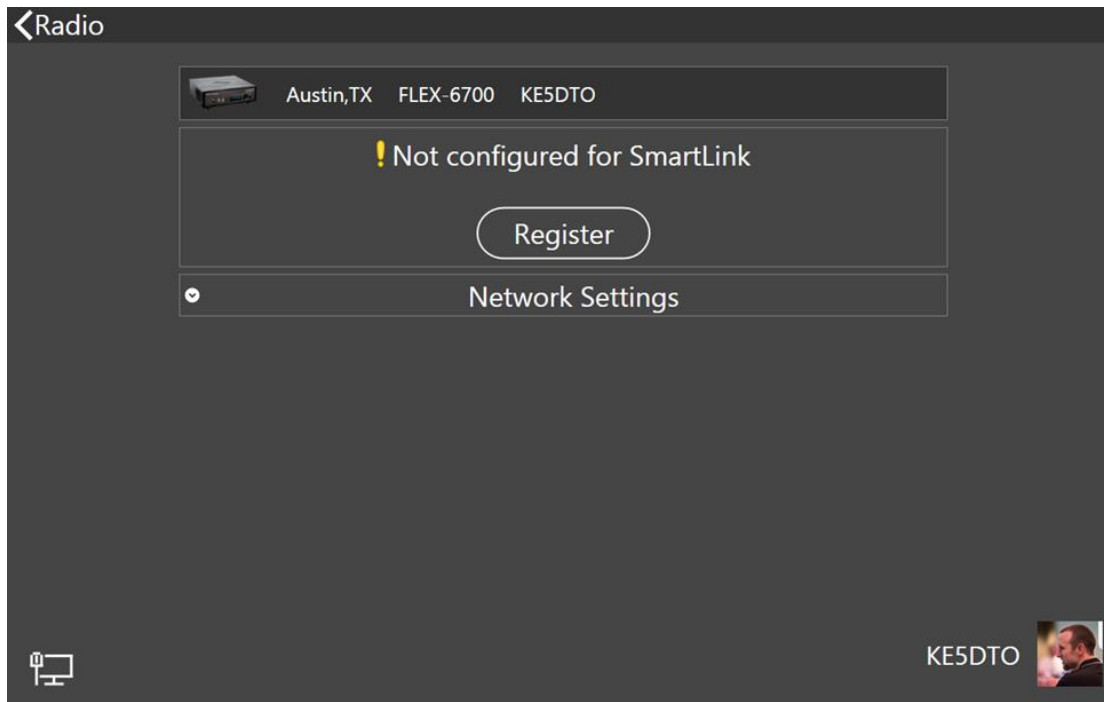

After a brief period to establish a secure connection, a prompt to key the radio will be shown.

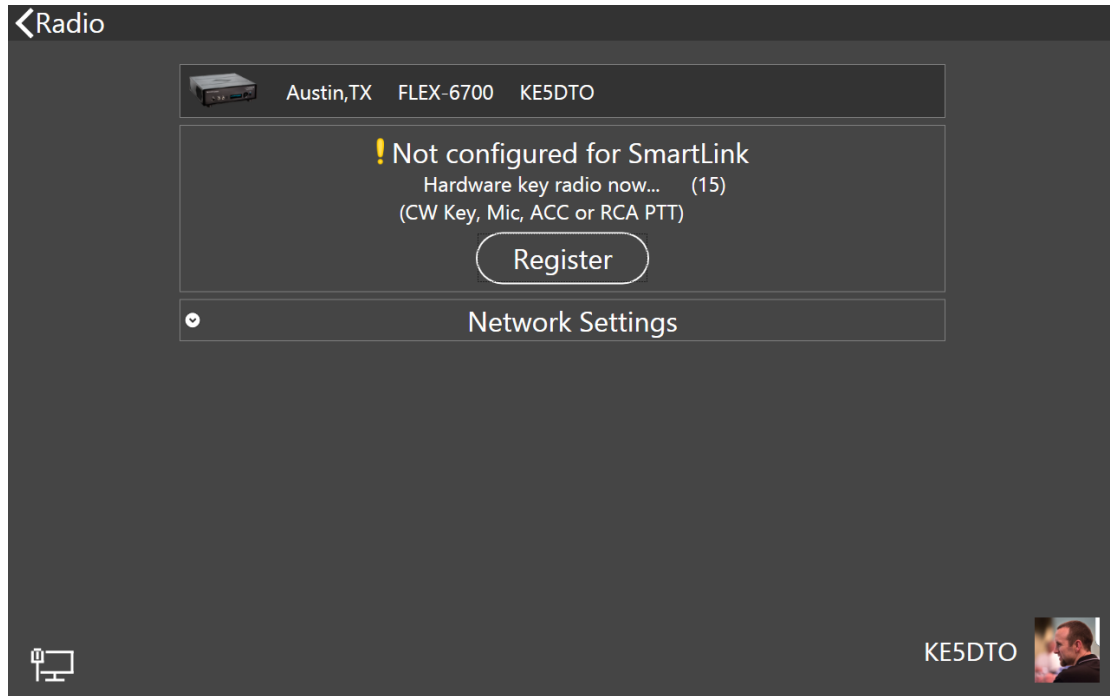

Use a Hand Mic, CW Paddles, or an RCA PTT input to key the radio. This cannot be done via the Maestro MOX button or any remote keying input. This step ensures that you the radio owner, having physical access to the radio, authorize it to be associated with your SmartLink account. Similar measures are required should you need to unregister your radio from the SmartLink account.

Note: You will not be able to connect to the radio from a remote network until this step is completed. This step must be done on the local network.

When the radio is registered, the screen will update to indicate the registered status as shown below.

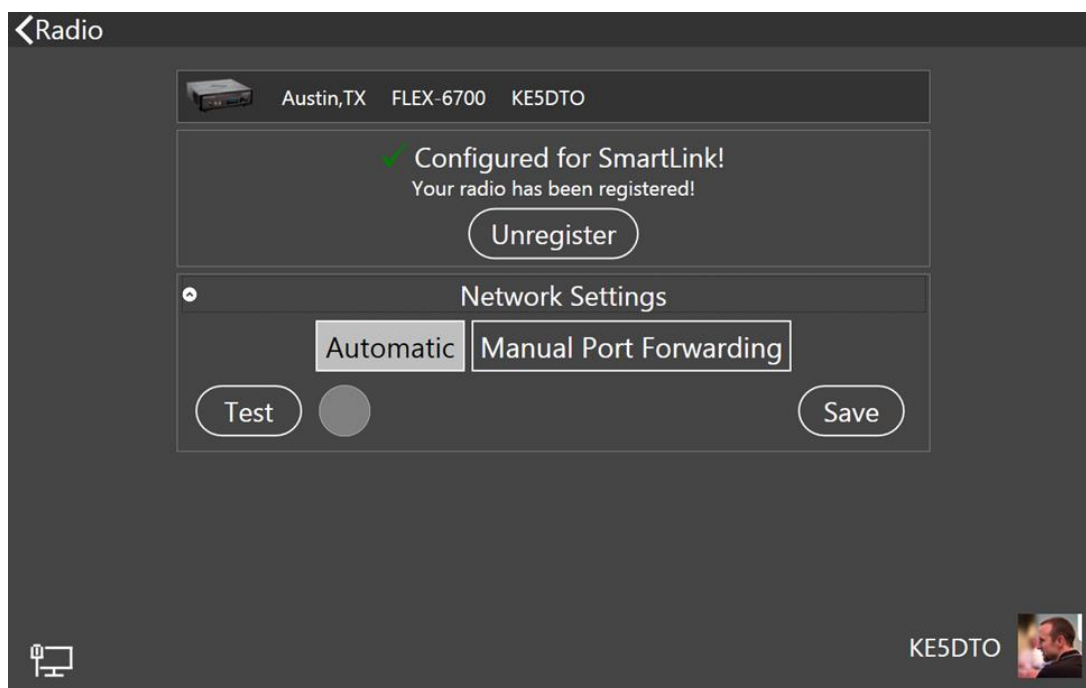

The final configuration step is to map communication ports in the radio to the outside world. Open the **Network Settings** pane as shown above and select **Automatic** mode. Tap the **Test** button. If the indicator turns green, the SmartLink configuration for your radio is complete.

Automatic mode should work for most networks. If it doesn't, it may be necessary to enable UPnP (Universal Plug n Play) in your router or to manually configure port forwarding, also in your router. Refer to the following HelpDesk article for more information:

<https://helpdesk.flexradio.com/hc/en-us/articles/115003365503-What-is-Port-Forwarding-and-How-do-you-do-it>

8.2.3 Test the Radio in SmartLink

Referring to the figure above, open the **Network Settings** pane and tap the **Test** button. SmartLink will send a request to the online SmartLink server to test the connection to the radio using the information configured in section 8.2.2. If the SmartLink configuration is correct, the indicator next to the **Test** button will turn green. Tapping the indicator will reveal configuration information about the SmartLink connection.

8.3 USING SMARTLINK

Use SmartLink with a Maestro connected to the Internet to operate your Flex 6000 Series radio at a remote location. SmartLink provides authenticated, secure access to the radio over the Internet at effective data transfer speeds.

It is not necessary to log into SmartLink when connecting to radios that are local to Maestro. They will appear in the *Select Radio* screen when Maestro is started. Simply tap the desired radio, then tap the **Connect** button.

When you start Maestro at a remote location, you will see a window similar to this:

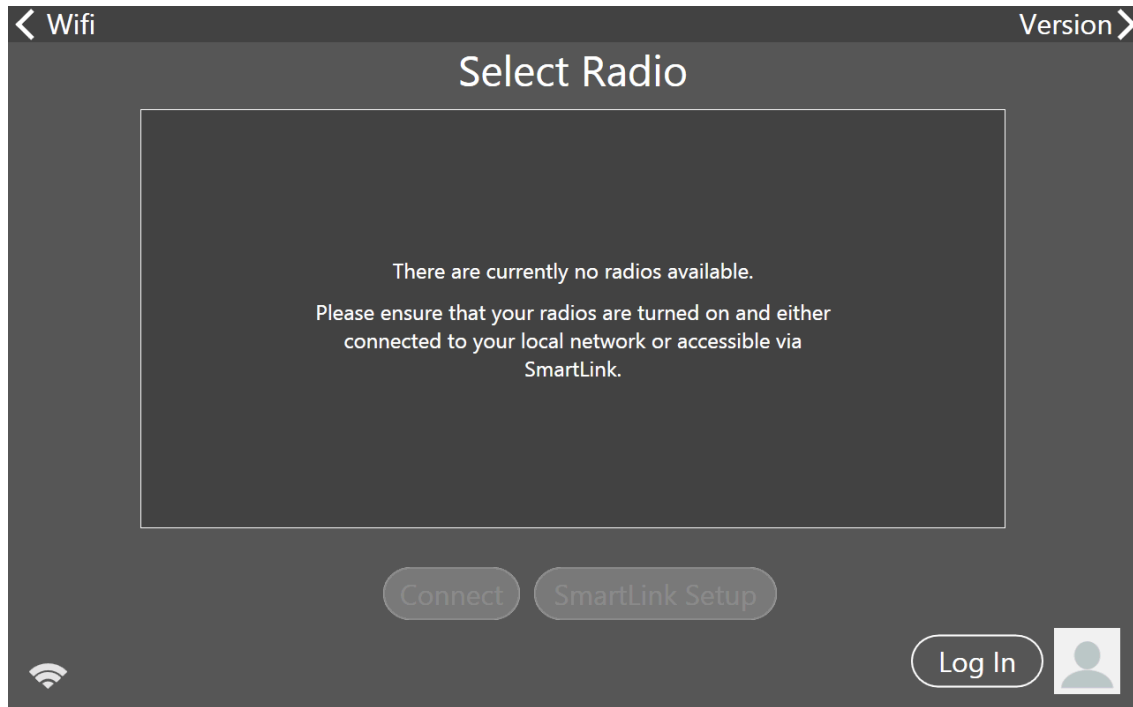

Tap the **Log In** button and follow the screens to log into your SmartLink account. Use the credentials you used to create the SmartLink account (see section **8.2.1, Create a SmartLink Account**).

When the login is complete, return to the SmartSDR start screen, which will now look similar to the following:

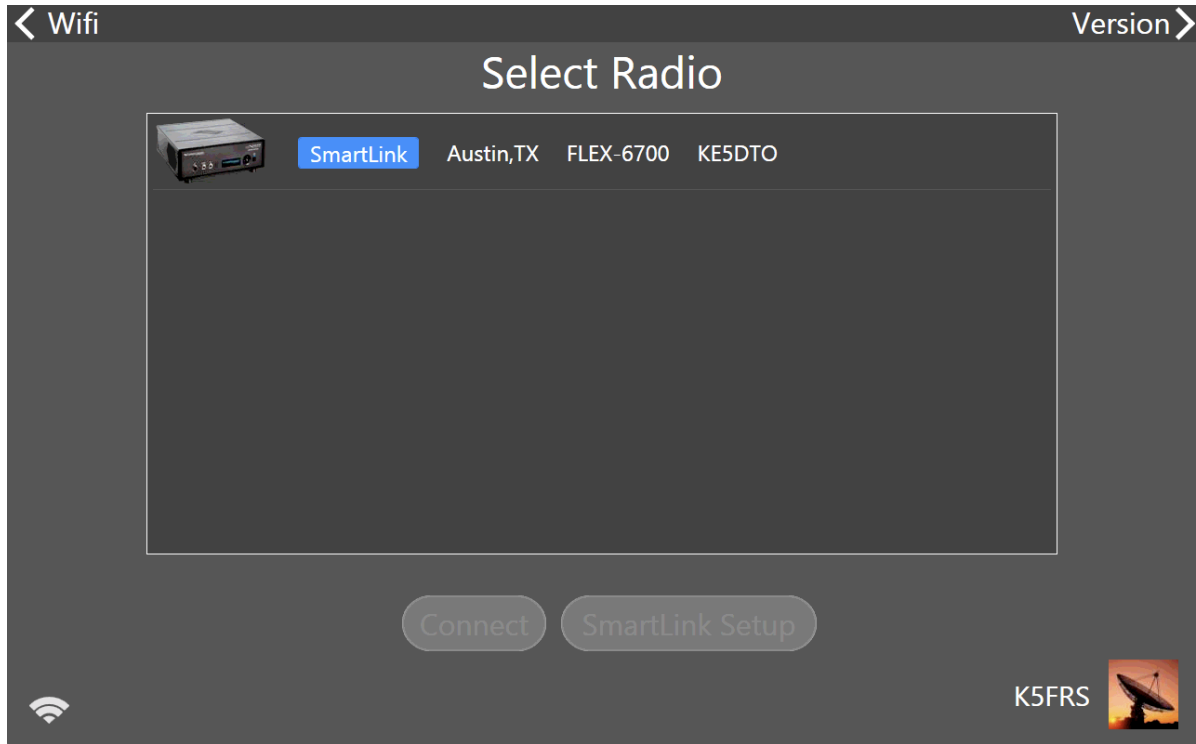

Radios available through SmartLink are shown in the list with the **SmartLink** logo.

Tap the desired radio to select it. **Info**, **Connect** and **SmartLink Setup** buttons will appear at the bottom of the screen.

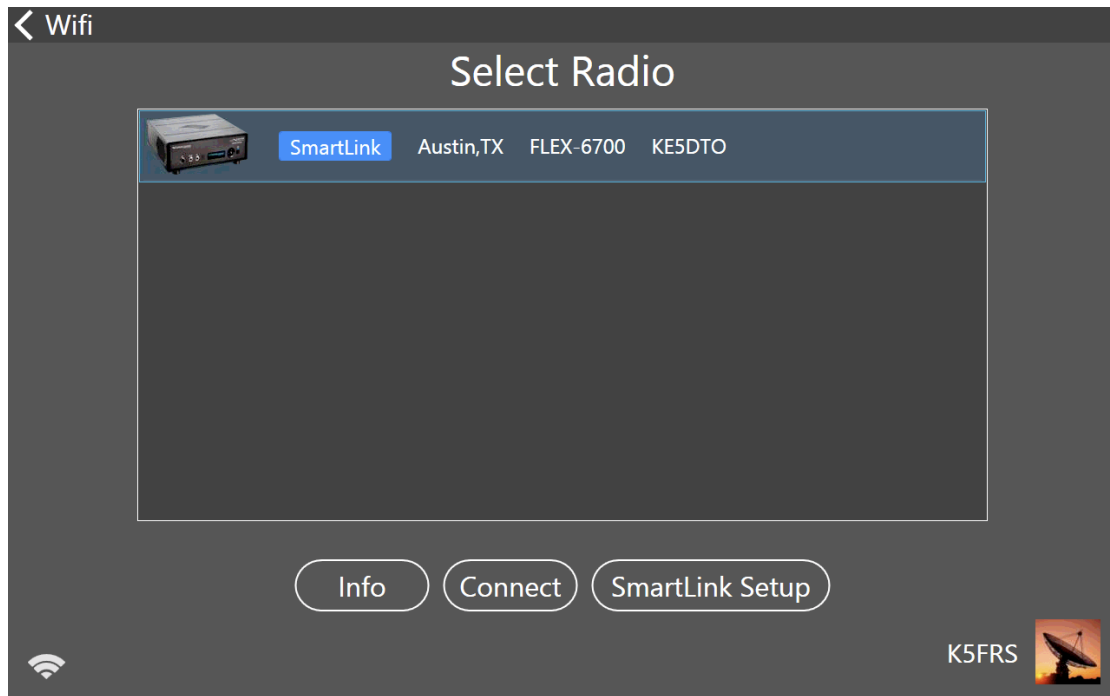

Tap the **Connect** button to connect to the radio. The *Select a Version* screen will appear.

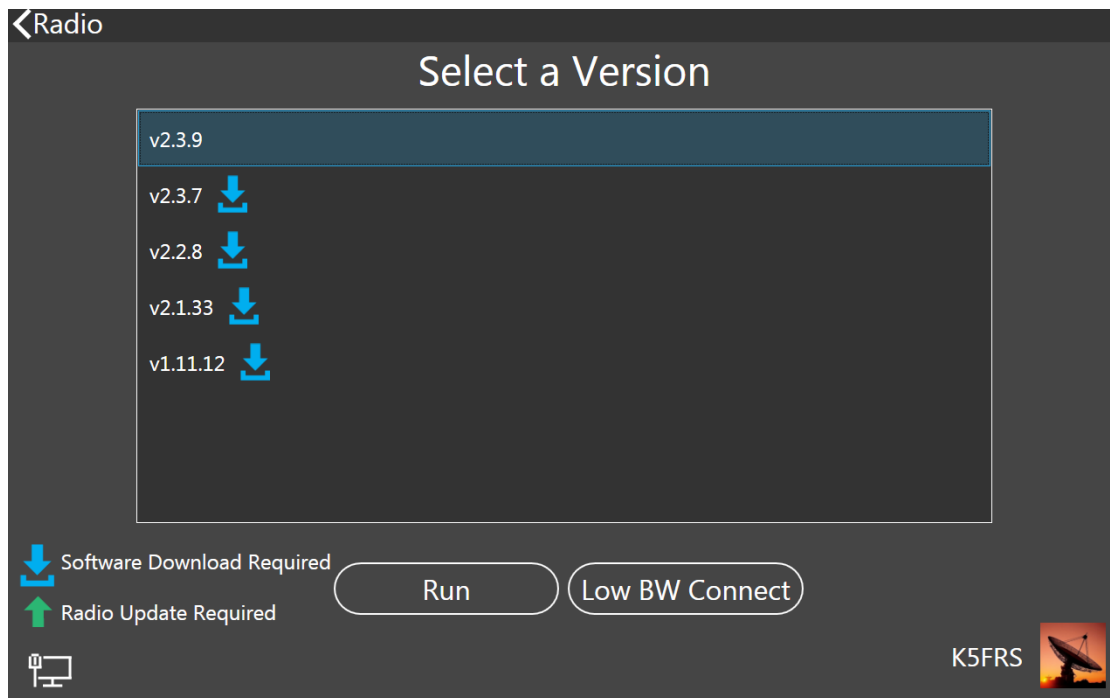

Select the version of SmartSDR to use then tap **Run**. The radio will start, using the same settings (number of panadapters, panadapter frame rates, etc.) it would have used if operated locally.

If the data rate from the radio to Maestro is higher than can be supported by the radio's Internet connection use the **Low BW Connect** button to start the radio using panadapter settings that minimize the Internet data transfer rate. These are temporary settings for the session that are not retained in the radio's persistence database.

SmartLink remains logged in after operating sessions have finished, so it is usually not necessary to repeat the login process to start another session. However, there are circumstances when it is desirable to log out at the end of an operating session. When a session is not in progress, start Maestro and navigate to the *Select Radio* screen, tap the logged-in SmartLink user icon in the lower right corner of the screen, then tap **Logout** in the **Account Settings** screen. If a session is in progress, use the **Switch Radio** button on the **Radio tab** of the **Main Menu** to end the session and return to the *Select Radio* screen, tap the logged-in SmartLink user icon in the lower right corner of the screen, then tap **Logout** in the **Account Settings** screen.

The SmartLink status indicator is shown on the front panel. When the indicator is blue, the Maestro is accessing a remote radio via a SmartLink connection.

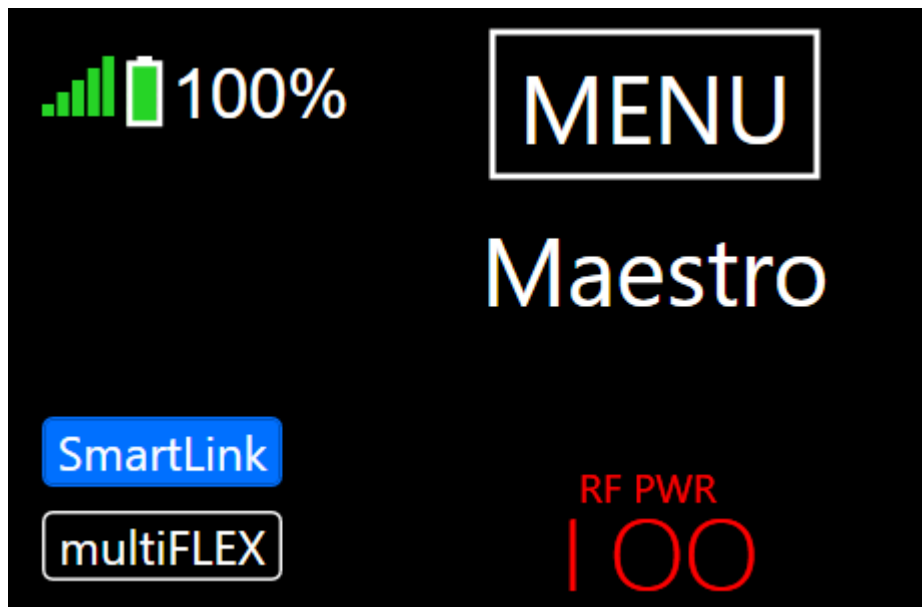

9 SMARTCONTROL

SmartControl is a new feature for FLEX-6000 series radios.

Many users prefer the power, flexibility, and display capabilities of SmartSDR for Windows. Others appreciate the Maestro and M Model control heads for their ability to use knobs, buttons, and touch-screen menus to control important functions on their radios.

9.1 SMARTCONTROL BRINGS THE BEST OF BOTH WORLDS TO YOUR SHACK.

SmartControl allows you to connect to your radio using SmartSDR for Windows to enjoy all the benefits of a mouse and keyboard interface, plus the power and size of the graphics display, and use your Maestro or M Model control surfaces at the same time.

This is similar to using multiFLEX, except that with SmartControl, the Maestro/M-model surface controls the same slices that are in use via SmartSDR.

Note: In multiFLEX, both “Clients” actually control different slices on the radio at the same time. This is an important difference: multiFLEX lets two people control different slices on the same radio. SmartControl lets one person control the same slice or slices from two different control surfaces at the same time.

9.2 WHY WOULD YOU WANT TO USE SMARTCONTROL INSTEAD OF THE MOUSE IN SMARTSDR?

- You may simply prefer to use knobs, buttons, and menus to control your radio. You may not like using a mouse, but you love the high-definition panadapter and other flexibility of SmartSDR for Windows.
- Some functions are quicker and easier to control with a knob or menu, such as AGC-T, Mic Gain, RX Filters, Band Changes, etc.
- You might not want to divert your attention or your computer’s screen or mouse “focus” away from your logging or contesting program to make changes to your radio with a mouse. Having SmartControl saves time and effort when seconds may make a difference in your operation.

9.3 WHO WILL FIND SMARTCONTROL VALUABLE?

- Casual operators who love the Display of SmartSDR but prefer a more traditional method of controlling their rig.
- Net operators want an easy way to use RIT or XIT. It is simple with the Maestro/M-Control Surface. Or you can use Split Slices and tune for that station that you moved off frequency, while still listening to Net Control.
- DXers will discover that using the Maestro or the Flex 6000M Series Control Surface is the easiest way to open and operate “Splits.” Using SmartControl while watching the panadapter in SmartSDR gives you the ability to “zoom in” on the DX station and the pileup and quickly discern where and when to transmit to break the pileup. Using the twin tuning knobs for Slice A and B makes split operating a joy!

- Contesters will find that SmartControl makes the contesting session a lot more powerful, and a lot less stressful! SmartControl gives you easy, intuitive access to all of the main controls that contest operators crave.
- EMA/Public Service operators may find that it is easier to teach volunteer operators how to use the Maestro/M-Series Control Surface than it is to teach them how to click through the menus of SmartSDR.
- VHF/UHF operators who wish to tune two different bands at the same time will find it easy to set up one band on Slice A in one panadapter and another band on Slice B in a different panadapter. Now you can have a tuning knob to control each band. And you have easy access to control functions without grabbing the mouse.
- Hams with a visitor in their shack can set up SmartControl and let your visitor/trainee control your rig while you can monitor what they are doing and stay in control. You could call this “Driver’s Ed mode.”

9.4 GETTING STARTED - ACTIVATING SMARTCONTROL

To activate the SmartControl you first need to be connected to your FlexRadio via SmartSDR for Windows, The 6000 M Series, SmartSDR-IOS, or SmartSDR-Mac.

From the Maestro:

- Power up your Maestro.
- At the “Select Radio” screen, highlight the radio you wish to control with SmartControl. (You may have more than one radio on the network)

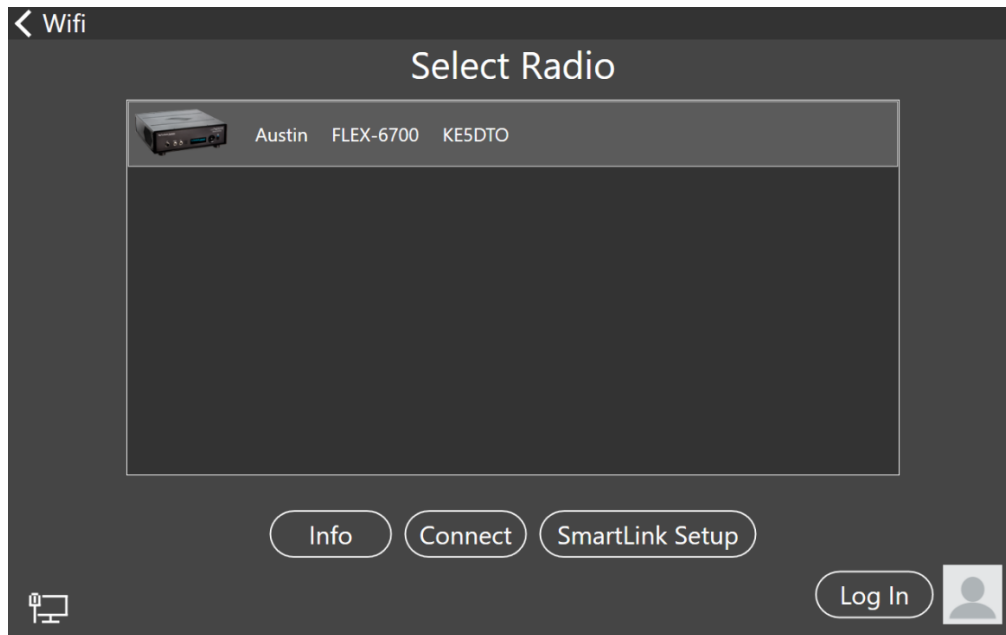

- Select the **Connect** button. This will open the “Select a Version” menu screen.

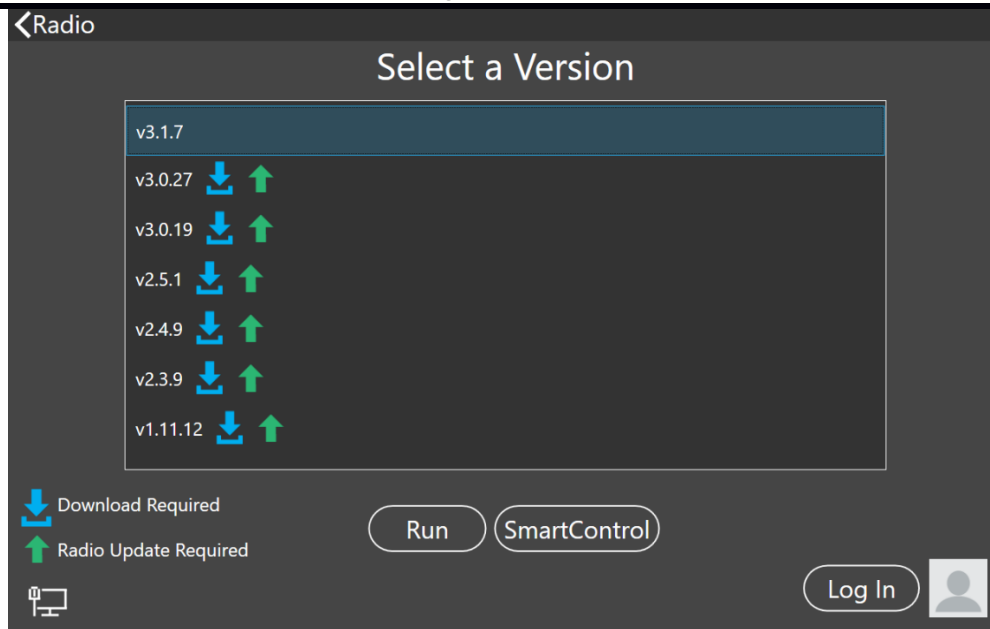

- At the “Select a Version” screen, select the version of the software that you wish to use with this radio. (The current version in use will not have an up arrow or down arrow next to the version number.)
- You will now be given the option to select either **Run** or **SmartControl**.

Select the SmartControl button.

- The screen will flash “Loading” and bring you to the SmartControl interface screen.
- Enjoy operating with SmartControl

Note: If you have been using your Maestro to operate a radio either locally or via SmartLink that was using a SmartSDR version before v3.1, you must first select and install SmartSDR v3.1+ from the Maestro/M “Select a Version” menu before the SmartControl option will show up on your Menu. The first time you do this after changing software versions, your Maestro/M will connect in Regular or multiFLEX mode. To use SmartControl mode you will need to follow the procedure above to change back to SmartControl mode.

Note: You cannot use SmartControl mode on a radio that does not have SmartSDR v3.1+ installed on the radio.

9.5 OPERATING WITH SMARTCONTROL

Now you have complete control of your rig from BOTH the Maestro AND the other client you have connected.....Now what?

Try it! Use your mouse to change the frequency on slice A and observe that the frequency changes on both your SmartSDR Window and the Maestro Slice indicator panel!

Next, use your Maestro tuning knob and change the frequency. The same happens on your SmartSDR screen.

You can open and close a second slice from your Maestro, or your other client, and use the smaller tuning knob to control Slice B.

It is just like using your Maestro, except that your Maestro Display doesn't show a Panadapter or Waterfall. Those are on your main client's window. If you want to open a new Panadapter, not just a new slice, you need to do that from within SmartSDR for Windows.

9.5.1 Additional SmartControl functions:

You can change the volume of Slice A or B, adjust AGC-Threshold, change the RX filter settings, adjust Mic Gain or CW Keying Speed, use your F1-F6 button macros, etc. All of the controls on the front of your Maestro are active. These changes will also be reflected in your SmartSDR or other client's Window.

9.5.2 Accessing the Various Meters

From the Main SmartControl screen, tap the **Meters** menu on the lower right side. Your lineup of station meters will appear on the right side of the display.

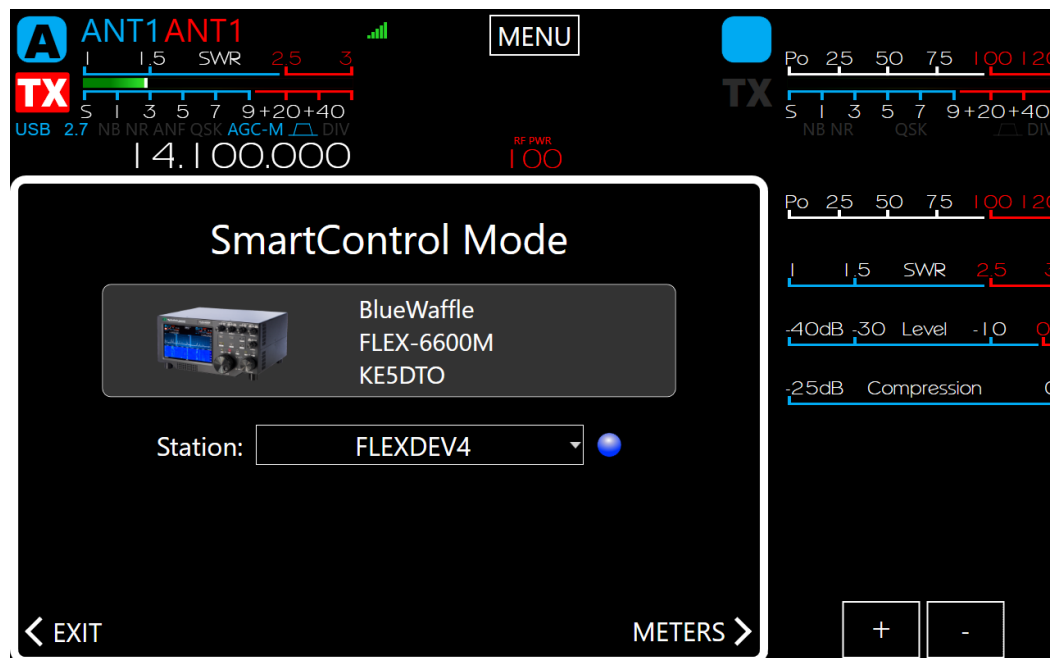

You can add or subtract additional meters, up to a total of 6, in addition to the slice "B" display.

You can tap any individual meter to toggle through different options, including:

- Power Output
- SWR
- Mic Level
- Compression Level
- ALC Level

Additional Meters if you have the PGXL Amplifier:

- Amp Power
- Amp SWR
- Amp Temp

If you wish to hide the meter display, just tap the **METERS** button again and they will be hidden by the main display.

9.5.3 Accessing the Maestro Main Menu

If you wish to access the main Maestro menu, tap the **Menu** button at the top center of the display.

The menu will appear, giving you access to almost all of the radio controls that the Maestro can control in regular use. The operation of these menu items is covered elsewhere in the Maestro User Guide.

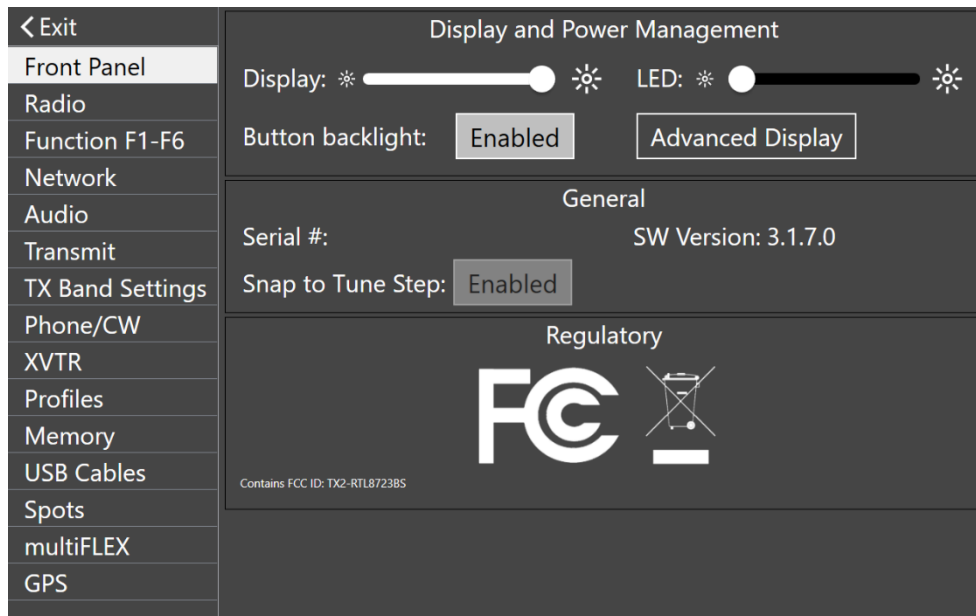

To close the menu, tap the **Exit** tab in the upper left-hand corner.

9.5.4 Accessing the individual Slice Controls

As with normal Maestro mode operation, you can control important parameters by tapping on different sections of the individual slice panels.

Antenna selection:

- Tap on the top of the slice panel. It will bring up an antenna selection menu. (The exact menu choices depend upon the model of your radio)
- Your Receive selection is highlighted in BLUE. (ANT1, ANT2, XVTR, XVTR1, XVTR2, RXA, RXB)
- Your Transmit selection is highlighted in RED. (ANT1, ANT2, XVTR, XVTR1, XVTR2)
- Select a different antenna/port by tapping on your desired RX or TX port.

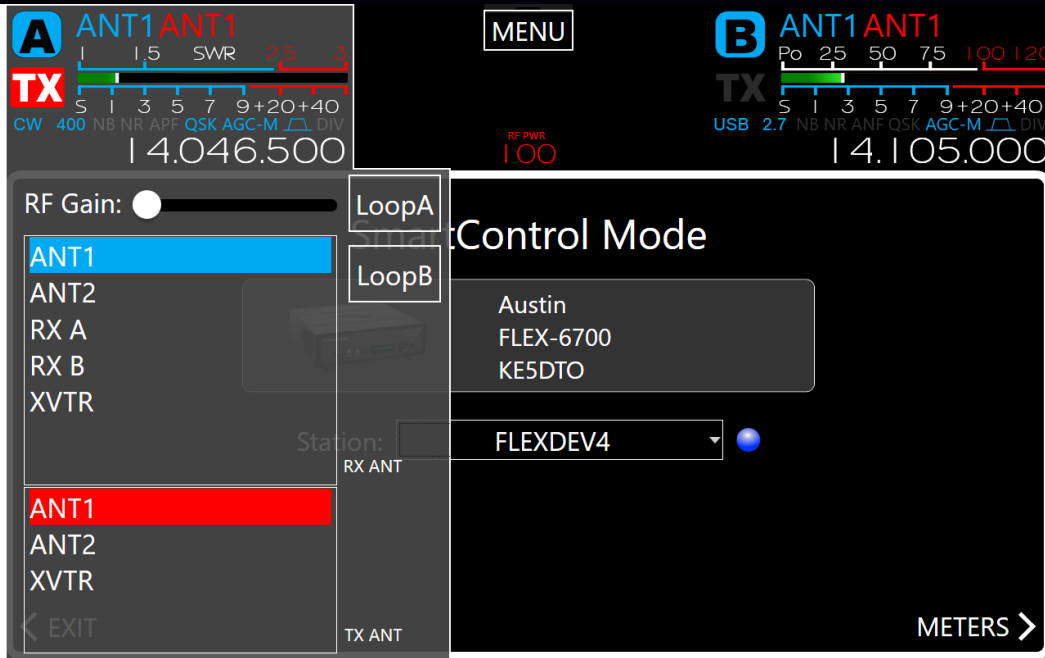

Meter Selection:

- If you tap on the meter section of the Slice Panel, you can toggle through several different metering options for the top section of the meter.
- The same choices are available that are available in the larger metering panel.
- The lower section of the meter remains as a signal strength meter at all times.

Other Slice Control Functions:

There are two ways to open the additional slice control menus:

- If you tap the frequency display section of the Slice A or Slice B Panel, you will open up a larger panel that gives you control over a large number of options for that slice.
- If you Press and Hold the tuning knob for either slice A or B, it will open up the Control Menu for that slice.

The menu display will highlight either the A or B frequency display to remind you which slice you are controlling in this menu.

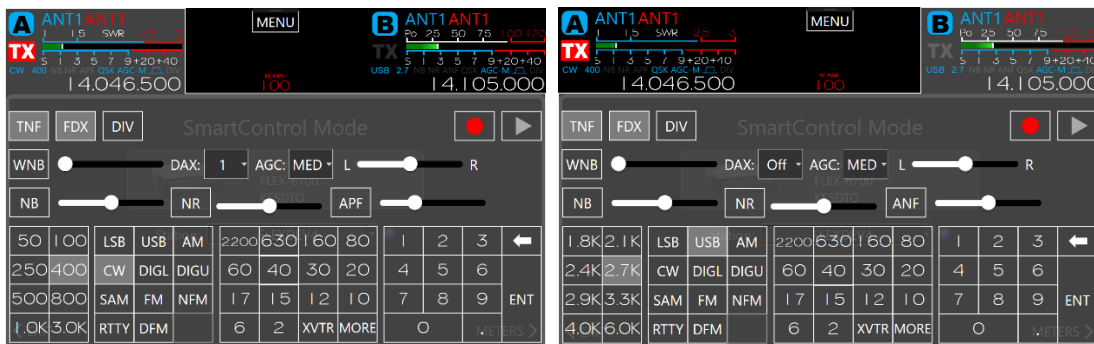

Functions available for the active slice include:

- Band Selection
- Direct Frequency Entry
- RX filter presets
- TNF
- FDX
- DSP functions such as WNB, NB, NR, ANF, APF, AGC Speed, and Threshold.
- Record and Playback of received and transmitted signals

When you are ready to return to the main control screen, you can either tap on the upper section of the screen or press and hold the tuning knob for that slice.

9.5.5 Exiting SmartControl

To exit SmartControl mode, simply tap the **EXIT** button on the lower left corner of the main screen. This will return you to the “Select Radio” screen.

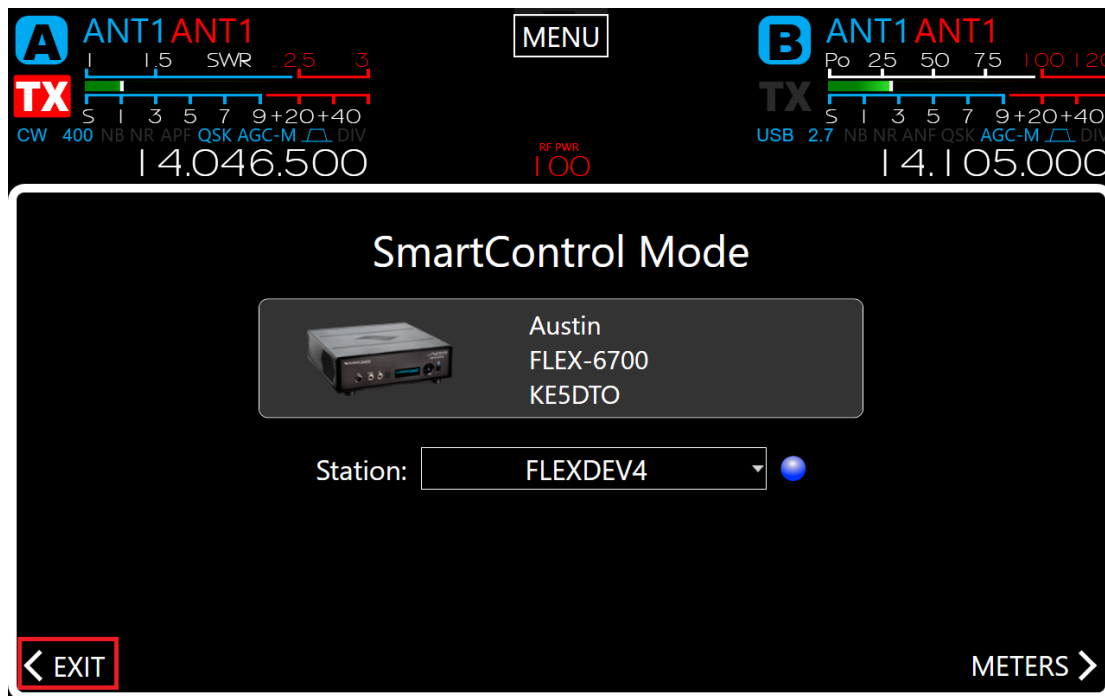

NOTE: If you wish to turn your Maestro OFF and have it return in SmartControl mode, you do not need to tap “EXIT.” Simply turn the Maestro OFF. The next time you power up the Maestro, it will return to SmartControl mode.

9.5.6 Changing to a Different Radio in Your Network

If you have multiple radios in your network and want to change which radio to control with SmartControl, click the “Station” drop-down menu in the center near the bottom of the screen, and select a different radio to control. It may take a few seconds to negotiate the new connection. If it fails to negotiate a connection, simply return to the Radio Chooser and connect again to the desired radio as a SmartControl.

9.5.7 Changing from SmartControl mode to “Regular” Maestro Mode

- On the main SmartControl screen, tap the **EXIT** tab in the lower-left corner of the main screen. You will return to the “Select Radio” menu.
- At the “Select Radio” screen, highlight the radio you wish to control with SmartControl. (you may have more than one radio on the network)
- Select the **Connect** button.
- At the “Select a Version” screen, select the version of the software that you wish to use with this radio. (The current version in use will not have an up arrow or down arrow next to the version number.)
- You will now be given the option to select either **Run** or **SmartControl**.
- Select the **Run** button.
- The screen will flash “Loading” and connect you to the radio.

NOTE: If your radio already is connected to a client, such as SmartSDR for Windows or SmartSDR for IOS, then you will now be operating your Maestro in multiFLEX mode. Each client will control its own set of slices, up to the limit of the radio or the limit of the device. (Maestro and IOS at this point can only control two slices, no matter how many slices your radio is capable of operating. If there is no other client connected to your radio, then your Maestro will operate as the only client connected to the radio.

9.5.8 Changing from “Regular” or Multi-Flex mode to SmartControl mode

- Select the **MENU** button at the top center of the Maestro Screen.
- Select the “Radio” menu item.
- Tap the **Switch Radio** button. This will take you back to the “Select Radio” menu.
- At the “Select Radio” screen, highlight the radio you wish to control with SmartControl. (you may have more than one radio on the network)
- Select the **Connect** button.
- At the “Select a Version” screen, select the version of the software that you wish to use with this radio. (The current version in use will not have an up arrow or down arrow next to the version number.)
- You will now be given the option to select either **Run** or **SmartControl**.
- Select the **SmartControl** button.
- The screen will flash “Loading” and bring you to the SmartControl interface screen.
- Enjoy operating with SmartControl!

9.5.9 What you Cannot Do in SmartControl

- The Maestro Mic input is not available while in SmartControl Mode.
- The Maestro internal speaker is disabled when in SmartControl mode.

10 MAESTRO OVERVIEW

10.1 THEORY OF OPERATION

Maestro is a hardware and software system designed to operate FLEX-6000 Signature Series radios. FLEX-6000 radios perform wide-band sampling of the RF spectrum. How is wide-band sampling different from other radios?

In superheterodyne (also called “superhet” or “multiconversion”) radio systems, a series of down-conversions using local oscillators is performed on the RF input ultimately resulting in a baseband signal. This signal is generally only a few kilohertz wide and is ready to be demodulated and presented to the operator in the form of audio. In a superheterodyne architecture, generally only a single receiver is available at a time and the receiver has limited bandwidth.

In a wide-band sampling radio, a large portion of the spectrum is sampled (turned into digital information) all at once. This sampling provides the basis for the use of several analysis tools and receivers in the spectrum simultaneously, all from the one hardware sampler.

10.2 KEY SYSTEM COMPONENTS

10.2.1 Spectral Capture Unit (SCU)

Because the notion of a receiver is firmly established in both the amateur community and possibly the rest of the world, it seemed inappropriate to describe the functionality of a wide-band sampling system simply as a “receiver”. Instead, in the FLEX-6000 world there are one or more “Spectral Capture Units”, or SCUs, that are responsible for the collection of wide-band data from the RF spectrum. The SCU components are an antenna input, an optional set of receive pre-selectors, and an analog-to-digital converter (ADC). Each SCU in the radio system can be connected to only a single antenna at a time, but due to the sampling architecture, it may support any number of receivers and spectrum displays. The SCU enables listening to multiple bands at the same time on the same antenna. A hardware platform with multiple SCUs such as the FLEX-6700 allows for monitoring multiple bands on different antennas or the ability to perform more complex noise mitigation techniques that are available in multi-antenna systems.

10.2.2 Slice Receiver

Maestro can create two receivers out of the data collected from the SCU. How does this work? The characteristics of the SCU sampled data stream vary by radio model but are typically 1-4Gbps of data that contains all activity across a large section of the RF spectrum. In the FLEX-6700, for example, an SCU tuned to the HF band collects every signal present in the spectrum from 0-73MHz! This data is not directly observable or understandable by an operator, so several tools exist for understanding and using the SCU data, the first of which is the Slice Receiver. Each Slice Receiver is tuned to a specific frequency just as a Variable Frequency Oscillator (VFO) would be in a traditional radio. The Slice Receiver then takes this more manageable amount of data (typically describing 10-20kHz of the band) and performs operations to output the signals required by the operator.

For example, in the case of a single sideband receiver, the Slice Receiver will demodulate the upper (or lower) sideband of the data collected, will filter it according to the receiver filter settings, may perform noise mitigation techniques on the data, and then ultimately passes it to an audio system to become sound for the operator. Because the source of the Slice Receiver data is always the SCU data and each Slice Receiver uses the same techniques to demodulate, filter, and convert the signal into audio, each Slice Receiver shares the same base performance. For the operator, this means

that access to two receivers with the same top performance may be used interchangeably without concern for differing performance characteristics of each receiver often found in superheterodyne receivers.

10.2.3 Panadapter

The Panadapter uses the data available from the SCU and turns it into a visual representation of the radio frequency spectrum. The Panadapter display, pictured below, shows the level of signals present across a specific region of the spectrum just as a spectrum analyzer would. The higher the white line appears in the display, the stronger the signal is in that part of the band. A scale for the absolute signal level in dBm (decibels above or below one milliwatt) is provided on the right-hand side of the display. This allows the operator to quickly identify signals of interest where the operator can focus his/her efforts.

Each Panadapter is derived from the data from a single SCU so it is possible in multiple-SCU radios to show two different Panadapters tuned to the same region of the spectrum, each with data from a different SCU and ultimately a different antenna. The Panadapter shows the current state of the spectrum and can be adjusted to show various widths of the spectrum. A Panadapter can be seen below:

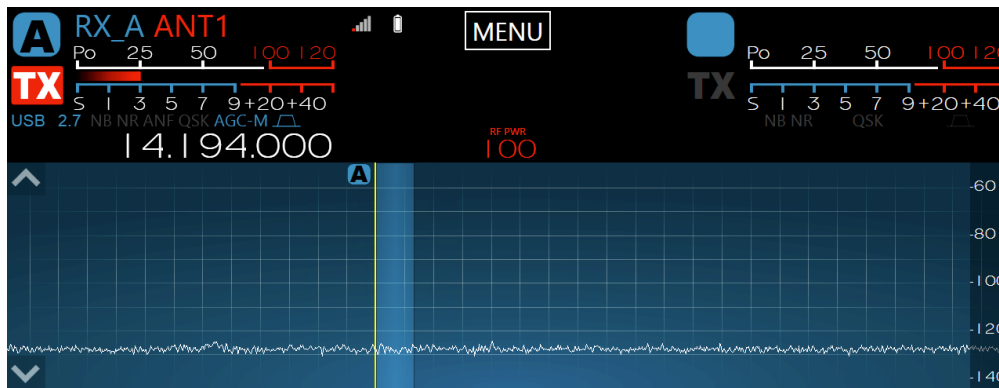

10.2.4 Waterfall

The Waterfall uses the same data from the SCU as the Panadapter and turns it into a time-based visual representation of the spectrum. In the Waterfall, the intensity of the signal is represented by a change in color in a similar way as water density is shown in weather radar. The vertical position in the Waterfall represents the time that the information on the spectrum was obtained. The Waterfall owes its name to the way that it continually moves downward like a Waterfall as time passes. The Waterfall can be useful for understanding how signals are distributed in the spectrum over time, locating where stations have recently transmitted and even locating “holes” where operation will not interfere with other stations. A Waterfall can be seen below:

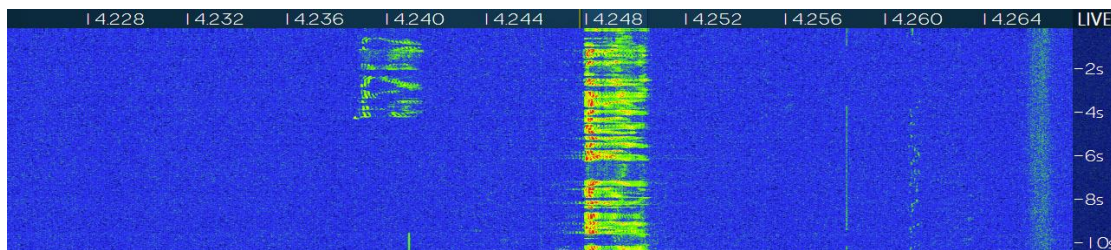

10.2.5 Panafall

The Panafall display is simply a Panadapter and a Waterfall that are joined such that the horizontal axis has the same frequency location. In this way, the Panadapter portion of the display will show the current state of the spectrum and the Waterfall portion will show a historical perspective.

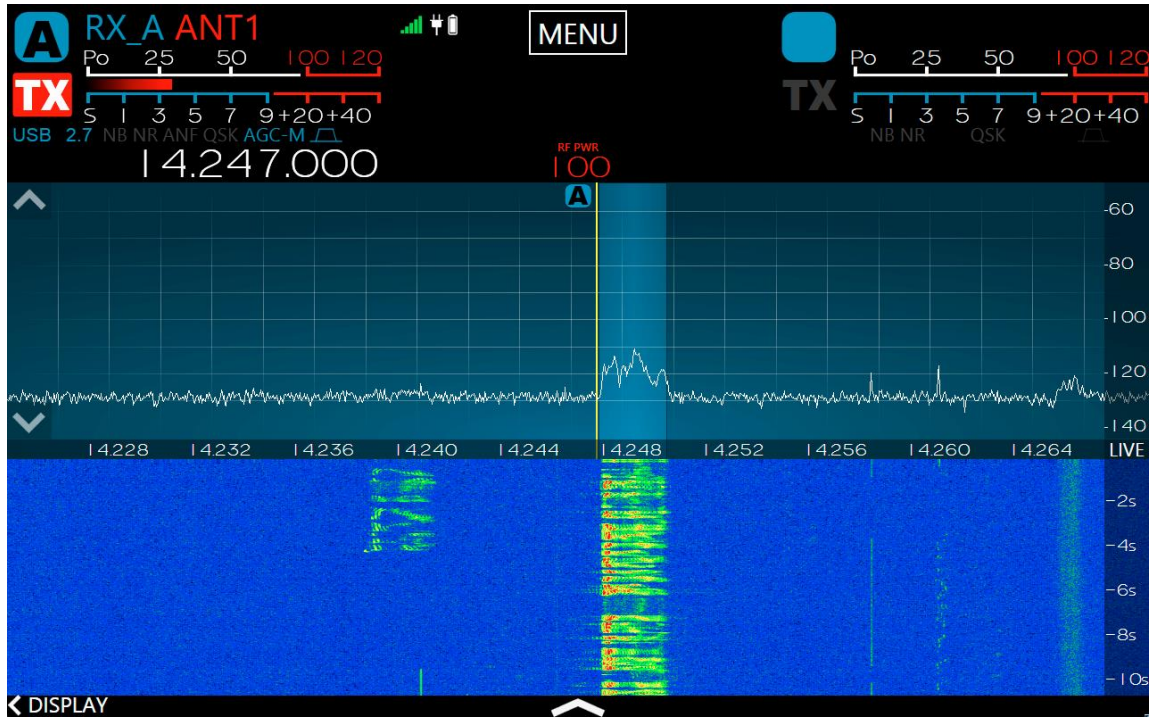

11 HOW TO OPERATE A SLICE RECEIVER

11.1 HOW TO CREATE AND DELETE A SLICE RECEIVER

Maestro can control two Slice Receivers labeled A and B. The first two columns of knobs and buttons on the Maestro front panel control the A Slice, and the second two columns control the B Slice. When the A Slice Receiver is operating, the A **RX** button will be illuminated green. When the B Slice Receiver is operating the B **RX** button will be illuminated green. Press the **RX** buttons to turn the A and B Slice Receivers on and off.

Pressing the A or B **RX** button will place a Slice Receiver inside the corresponding Panadapter. A Slice Receiver will be created in the center of the Panadapter if none exists. If a Slice Receiver is already present in the Panadapter, the new Slice Receiver will be created with the same basic characteristics (mode, DSP settings, etc.) as the active Slice Receiver, or with the characteristics of the Slice Receiver closest to the center of the Panadapter. Please see section **12.2, How to Create / Delete a Slice Receiver in the Second Panadapter** for an explanation of how Slice Receivers are created when a second Panadapter is open.

The various models of the Signature Series transceivers support different numbers of Slice Receivers, varying from two to eight. The Maestro supports a fixed number of two Slice Receivers.

When a Slice Receiver is active, pressing its **RX** button will deactivate it and remove it from the Panadapter display. It is possible to disable both Slice Receivers so that only the panafall display remains. With no Slice Receivers, no signals will be audible from Maestro or the radio.

Note: If the removed Slice Receiver was enabled for transmission, the radio will be unable to transmit until another Slice Receiver is selected for transmission.

If a Slice has moved off-screen outside the bounds of a Panadapter, the Slice Receiver display will

change to indicate where the Slice is tuned relative to the Panadapter.  Double tapping

on the indicator will center the Slice in the Panadapter display. The  indicator also will show if the transmitter is enabled in the off-screen Slice.

An off-screen Slice can be closed by pressing its **RX** button to disable it.

If a Slice Receiver moves too far beyond the bounds of the Panadapter, it will be put into a detached state and will no longer produce audio. Moving the Slice back into the bounds of the Panadapter will put the Slice Receiver back into a normal state which produces audio. The bounds of the Panadapter are determined by the radio hardware and vary by radio model.

11.2 HOW TO TUNE A SLICE RECEIVER

Knob Tuning: Use the front panel tuning knobs to adjust the frequency of the A Slice Receiver (larger knob) or the B Slice Receiver (smaller knob). The knobs are weighted and spin freely to provide rapid tuning. Each full revolution of a knob creates 64 pulses each of which maps to one step change in frequency, up or down. Turning the knob quickly enables acceleration to traverse more of the band faster. The size of the steps, in Hertz, is controlled by the A and B Step buttons. See section **36.2, Slice Receiver Tuning Knobs and Buttons** for full details.

Drag Tuning: Drag Tuning is one of the more common tuning methods. By touching the Receive Filter (lighter blue area of the Slice Receiver) or the carrier (the vertical yellow or red line of the Slice Receiver), and moving your finger left or right, the Slice will move up or down in frequency while the Panadapter remains stationary. This tuning occurs in increments of the currently selected step size. Once the Slice reaches the edge of the Panadapter the Slice will stop and the Panadapter will begin to move behind the Slice. This is called Pan Edge Tuning and allows rapid tuning above or below the Panadapter’s current frequency range.

Tap Tuning: Double tapping anywhere in the Panadapter grid will initiate a Tap Tune. Tap Tune will move the Active Slice to the frequency where the tap occurred. The Active Slice is designated by a yellow carrier line and a yellow triangle at the top of the carrier line (see section **11.3, Making a Slice Receiver Active**).

Direct Frequency Entry: Direct Frequency entry for any Slice Receiver is a tuning option. Simply tap on the Slice Receiver’s frequency display to open the **Slice Receiver Menu** and use the ten-digit touchpad to enter the frequency in megahertz using a single separator specific to your country (for the US it is a period, for other countries, it may be a comma). For example, entering “14.0705” will tune to 14.070.500. You can also enter some frequency ranges using kilohertz, but the data entered is limited to 4 or 5 digits and you cannot use a country-specific separator. For example, entering “7250” will tune the Slice Receiver to 7.250.000 megahertz.

Tune Step Size: The tuning knobs generate 64 pulses per revolution. The amount of frequency change caused by one pulse from a tuning knob or by dragging the Slice Receiver is determined by the Active Slice Tune Step Size. Tune Step Size is mode-specific and can be set with the A or B Slice Step Button. A single press of the button increases the step size by an amount appropriate to the Slice Receiver’s mode. The new value is shown in a pop-up display. A longer press of the button decreases the step similarly.

11.3 MAKING A SLICE RECEIVER ACTIVE



A Slice Receiver consists of a center Carrier Frequency displayed by a solid yellow or red vertical bar. A yellow bar indicates the Slice is “Active,” indicating that this is the Slice that you are currently manipulating. Moving the A or B Tuning knob makes the corresponding Slice Receiver active. Tapping a Slice Receiver’s receive filter display makes that Slice active. When a new Slice Receiver is selected as the Active Slice, the old Active Slice will become inactive and its carrier line will change to red. There can only be one Slice active at a time.

11.4 HOW TO CHANGE THE DEMODULATION MODE



When a Slice Receiver is active, the Slice Receiver Flag shows the mode and receive filter width in use. To change the mode, tap the frequency display or depress the slice receiver’s tuning knob for two seconds or more. The **Slice Receiver Menu** will be displayed. Tap on the desired mode in the mode sub-menu. The Slice Receiver will change to that mode and values in the Slice Flag will change accordingly. To close the pop-up menu, tap on the Slice Receiver’s frequency display or anywhere outside of the pop-up menu or depress the slice receiver’s tuning knob for two or more seconds.

The position of the Receive Filter relative to the Carrier Frequency will correspond to the conventions of the current mode. A Receive Filter to the right of the Carrier indicates Upper Sideband mode. A Receive Filter to the left indicates Lower Sideband mode. A Receive Filter that spans both the left and right of the Carrier will indicate a double sideband mode.

11.5 HOW TO ADJUST THE SPEAKER AND HEADPHONE VOLUME OF A SLICE RECEIVER

Speaker and headphone audio levels are controlled by the AF/AGCT/SQL multi-function controls on the Maestro front panel. The speaker and headphone audio level is controlled with the inner knob. The Automatic Gain Control Threshold is adjusted with the outer knob. When the Slice is operating in an FM mode, the outer knob controls the audio squelch level. A short press of the inner knob mutes the other Slice, placing the audio in Solo mode (and making the Slice the Active Slice). A long press of the inner knob mutes or unmutes the corresponding Slice. When a Slice is muted, a mute indicator appears superimposed on the Slice Flag.

Controls for left-to-right audio balance and AGC decay rate can be found in the **Slice Receiver Menu**. Tap the Slice Receiver’s frequency display to bring up this menu. See section **14.1, AGC Threshold** for detailed information about the use of the AGC.

11.6 HOW TO CHANGE THE RX FILTER OF A SLICE RECEIVER

Surrounding the Carrier Frequency bar in a Slice Receiver is a blue Receive Filter bar which represents the filtered receive audio. The portion of the RF spectrum that is highlighted by the Receive Filter bar will be output as audio.



The Receive Filter width can be adjusted manually with the RX filter multi-function control. The control has two modes. In the High/Low mode, the inner knob controls the position of the lower frequency edge of the RX filter and the outer knob controls the position of the higher frequency edge. In the Center/Width mode, the inner knob controls the frequency of the center of the RX filter and the outer knob controls the width of the filter. A pop-up display shows the frequency of the filter parameter, relative to the Slice Receiver’s tuned frequency as the filter is adjusted.

Information about the Receive Filter's width and the knob mode is shown in the Slice Flag's Annunciator area.

A short press of the inner knob cycles the RX filter through a series of preset filter configurations that are determined by the selected mode. A long press of the knob toggles the knob's function between High/Low and Center/Width modes. See section **36.4, Slice Receiver Bandwidth Knobs** for more details.

Mode-specific RX filter presets are also available in the **Slice Receiver Menu**, which can be reached by tapping the Slice Receiver's frequency display.

11.7 RECORDING AND PLAYBACK OF SLICE RECEIVER AUDIO

Slice Receivers may be recorded, and the recording played back over the air using the Quick Record/Playback feature of the Maestro. The controls for these functions are located in the **Slice Receiver Menu**. Tap the Slice Receiver's frequency display to raise this menu. The controls are in the upper right corner of the menu and consist of a record button (red circle) and a play button (green triangle):



On startup, there is no recorded audio in the playback buffer so the play button will be disabled (greyed out). To record audio from the Slice Receiver, press the record button (red circle) once. While recording, the record button will pulsate.

Recording will continue until the record button is pressed again or until two minutes have passed. The recording will include any received audio while in receive mode and also any transmit audio when the radio switches to transmit mode. Once the recording is stopped, the record button will return to a solid red circle and the play button (green triangle) will be active.

To playback the audio, press the play button. If the play button is pressed while the radio is in receive mode, the playback audio will be routed to the speakers and headphones. If play is pressed while the radio is in transmit mode, the audio recording will also play through the transmitter.

To stop playing audio, press the play button a second time or wait for the recorded audio to finish playing.

To record or play again, press the appropriate button. Only one audio recording per Slice Receiver is saved. The audio played during transmission can originate in any Slice Receiver regardless of whether the Slice Receiver that recorded the audio is the Slice Receiver now transmitting. For example, you may record audio using Slice Receiver A and then playback that audio over the air using Slice Receiver B. To do this, make Slice Receiver B the transmitter by selecting it using the red TX selection below the letter B, or by pressing the Slice Receiver's TX button. Press the **MOX** button, PTT on the microphone, footswitch, or other PTT source, and then press the play button on Slice Receiver A.

12 HOW TO OPERATE THE PANADAPTER / WATERFALL

12.1 HOW TO CREATE / DELETE A PANADAPTER / WATERFALL

Maestro runs with a minimum of one and a maximum of two Panadapters. To add the second Panadapter, tap the upward pointing arrow at the bottom center of the display. To remove the second Panadapter, tap the downward pointing arrow in the middle of the display.

12.2 HOW TO CREATE / DELETE A SLICE RECEIVER IN THE SECOND PANADAPTER

When a second Panadapter is added to the radio, a Slice Receiver may also be added by Maestro if either the A or B Slice is not in use at the time the Panadapter is added. If both Slices are active in the first Panadapter, no Slice Receiver will be added when the second Panadapter is created. The user can move either the A or B Slice Receiver to either the first or second Panadapter by repeated presses of the A or B RX button.

12.3 HOW TO CHANGE THE PANADAPTER FREQUENCY (TUNE)

Each Panadapter can perform a pan function to adjust the frequency range that is displayed. Touching and dragging within the Panadapter grid will reorient the frequencies being viewed on the Panadapter in the direction that your finger moves. By moving your finger to the right, lower frequencies are displayed, and vice-versa.

Opening a **Slice Receiver Menu** opens a band selection menu. Selecting a band from this list will adjust the Panadapter to display all or part of the corresponding amateur radio band. Selecting band buttons allows for rapid switching between views of the amateur radio bands. Tapping on the **XVTR** button in the lower right swaps the buttons to a list of XVTR bands. Tap the **HF** button to swap back.

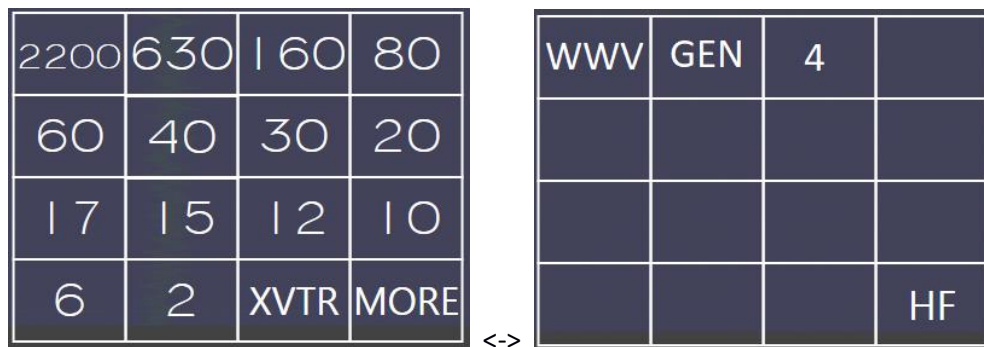

When switching between bands any Slice Receivers defined in the Panadapter are removed. If Slice Receivers were present in the new band the last time the band was active on the radio, they will be recreated. If no Slice Receivers were present, none are created.

12.4 HOW TO ZOOM A PANADAPTER

Each Panadapter has a zoom range up to a maximum of 14 MHz for the FLEX-6500 and FLEX-6700 or 7 MHz for the FLEX-6300 and down to a minimum of 1.5 kHz in bandwidth for the FLEX-6700 and 6kHz in bandwidth for the FLEX-6500 and FLEX-6300. There are multiple methods for adjusting the zoom of the Panadapter.

Tapping the Panadapter reveals plus and minus magnifying glass buttons located in the upper left corner of the Panadapter. Tap these buttons to zoom the Panadapter in or out. Zooming out (-) will double the bandwidth presented in the Panadapter while zooming in (+) will halve the bandwidth. The frequency at the center of the Panadapter will remain the same after each change in bandwidth, except in the case where the Active Slice Receiver is not in the center of the panadapter. In this case, the panadapter will be re-centered on the slice before the zoom operation.

For more precise control of the zoom, touch and drag anywhere on the frequency labels located at the bottom of the Panadapter.



14.020 14.040 14.060

Dragging the frequency labels to the right zooms in, dragging to the left zooms out. With this method, the frequency at the point where your finger was located will remain stationary in the Panadapter.

Next to the plus and minus buttons located in the upper right corner of the Panadapter display, you will see the **B** control. Tapping this control changes the zoom level so that the entire band that contains the Active Slice Receiver is displayed on the Panadapter. Tapping the control again returns the Panadapter zoom to its previous level.

Next to the **B** control, the **S** control performs a “zoom to segment”. When activated, the Panadapter zoom is adjusted so that the segment (CW/Phone) of the band that contains the Active Slice Receiver is displayed on the Panadapter. This control is available as part of the set of controls that can be mapped to function buttons. See section **33.4, Function F1-F6 Tab** for more details.



When zooming out of a Panadapter there are certain points where the amount of data needed to create the display must be doubled. As this occurs more noise will be included in the FFT bins comprising the display which will cause a noticeable increase in the noise floor. The reverse occurs when zooming in on a Panadapter. Each time one of these thresholds is crossed, either zooming in or out, the noise floor will increase or decrease by about 3 dB. If the displayed spectrum after the zoom operation exceeds the width of band pre-selectors in the FLEX-6500 or FLEX-6700 the radio will switch to wideband mode, which causes the radio to open the Bandpass Filters to their maximum bandwidth. When this occurs, any Panadapters using that antenna will display **WIDE** in the top right corner to indicate that they are in wideband mode.

Note: The FLEX-6300 is always in WIDE mode and will not show this indicator.

Just to the left of the WIDE indicator is an indicator that shows if the preamplifier is active and if so, at what level. A complete description of the preamplifier control can be found starting in section **25.9, Using the Receiver RF Gain/Preamplifiers**.

If the Panadapter is on a Transverter (XVTR) band, an indicator appears to the left of the preamplifier indicator. A complete description of how to set up the Maestro for transverter operation can be found in section **27, How to Configure Transverters**.

12.5 HOW TO CHANGE THE SIGNAL MAGNITUDE SCALE OF A PANADAPTER

The maximum and minimum amplitude displayed in each Panadapter may be adjusted. Tapping the up  or down  arrows displayed along the left edge of the Panadapter increases or decreases, respectively, in 10 dB increments, the maximum amplitude displayed. You may also adjust the minimum amplitude by touching and dragging the vertical axis on the right side of the panadapter. This will effectively adjust where the noise floor is positioned within the Panadapter. The radio remembers these settings by band so that future switches to the band will restore these settings.

The vertical scale is calibrated in dBm, showing the signal strength as measured at the antenna terminal.



12.6 ADJUSTING THE PANADAPTER AND WATERFALL CONTROLS

Touching the Display control at the bottom of the first Panadapter opens the display controls. When one Panadapter is active, the upper half of the control panel is populated, and the lower half is blank. When both Panadapters are active the upper and lower halves of the control panel are populated.

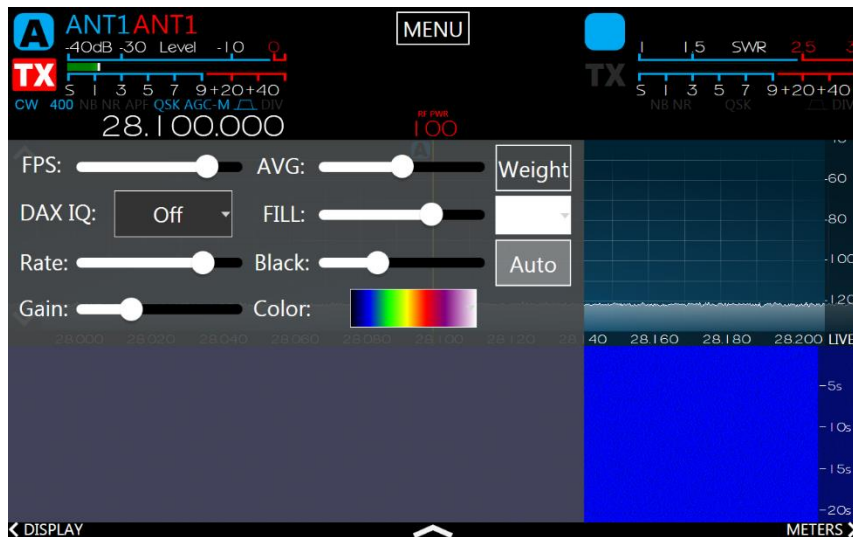

Complete details about the use of this screen are found in section **35.3.4, Panadapter Display Menu**.

13 NOISE MITIGATION

To properly utilize the DSP noise reduction features of the Flex 6000 Series radios, it is important to understand the type of noise causing interference. There is no single solution for noise mitigation since different types of noise require different algorithms. Two primary types of noise can be minimized using DSP techniques: white noise and impulse noise.

White noise is defined as random or uncorrelated noise with a uniform frequency spectrum over a wide range of frequencies. The sound of rain is an example of white noise. Three techniques are best used to improve the signal-to-noise ratio in the presence of white noise:

- Reduced filter bandwidth
- Optimized AGC threshold (**AGC-T**) setting
- DSP Noise Reduction (**NR**)

Reducing filter bandwidth and optimizing the AGC threshold can significantly improve the SNR without adding distortion or “coloring” the signal so long as the desired signal is not at the antenna noise floor. However, DSP noise reduction (**NR**) can provide significant intelligibility improvement on weak signals that may be near or below the atmospheric noise floor.

Impulse noise is a category of noise that includes almost instantaneous impulse-like sharp sounds generated by voltage spikes from arcing power lines, automotive ignition systems, electric fences, etc. Impulse noise can raise the wideband noise floor received at the antenna by tens of dB and thus completely mask signals that would otherwise be readable.

Traditionally, “noise blankers” have been utilized to mitigate this type of impulse noise. These techniques detect the noise pulses and turn off the receiver during the time of the impulse. The problem with traditional noise blanking techniques is that they have no way to tell strong signals on the band from impulse noise and can thus “mix” impulses with the strong signals to cause unwanted interference. The Flex 6000 Series radios incorporate a Wideband Noise Blanking (WNB) algorithm that can differentiate between modulated signals and impulse noise, virtually eliminating the “mixing” problem found in traditional blankers. This WNB algorithm operates in real time over the entire Spectral Capture Unit (SCU) bandwidth to detect and replace impulses with an estimate of the desired signal.

14 HOW TO CONFIGURE NOISE MITIGATION

The FLEX-6000 Series radios have several digital signal processing functions that enhance reception in noisy environments.

14.1 AGC THRESHOLD

Automatic Gain Control (AGC) is a feature that automatically adjusts the Slice Receiver's audio gain (volume) based on the strength of signals in the receiver's passband filter. The goal of AGC is to amplify weak signals and attenuate strong signals so that they all lie within a comfortable listening range.

The receiver Automatic Gain Control Threshold (**AGC-T**) can be adjusted for optimum performance in noisy or quiet environments. The **AGC-T** sets the maximum gain applied under any circumstances. Since the noise floor is relatively constant on a given band at a given time, the AGC can be adjusted using the threshold control so that the AGC never applies gain to noise, but it will apply gain to signals just out of the noise. In doing so, the AGC can *reduce* the level of noise you hear, and help signals pop out of the noise.

The AGC system is a dual-track system, meaning that it can track both slow and fast increases in signal strength, making appropriate gain correction decisions in the presence of each. The speed of the AGC (FAST, MED, SLOW) determines how quickly or slowly the AGC recovers after attenuating a strong signal. You can easily hear this by tuning to a CW signal and going through the three settings. On FAST with a strong signal, you can hear the gain pump up and down while on SLOW it recovers after a longer pause once the signal stops. When the signal stops, you will hear the noise floor increase as the gain returns.

How to Set AGC for Different Operating Conditions

If you are listening to a loud voice signal, AGC SLOW will resist increasing the gain between syllables and therefore reject most of the noise which is at a level far below the signal. FAST and MED provide faster levels of recovery for situations when you want the system to closely follow the dominant signal in the passband. Any time you have a very strong signal that causes the gain in the AGC to be reduced, you could experience a loss of gain to a weak signal you are listening to. The filter passband edges, which are continuously adjustable, and TNFs can be used to eliminate signals that might interfere with AGC operation.

The operator might prefer to use SLOW settings when rag chewing in a high signal-to-noise environment where there isn't much QRN and the noise floor is stable. This keeps the gain at more of a constant level that is less distracting. If the operator is trying to pull a weak CW signal out of the noise, they may prefer to use FAST mode to quickly ensure that the long-term average of the noise floor doesn't overcome the signal and prevent it from being heard. MEDIUM is a reasonable compromise.

When AGC is set to OFF, a *fixed* amount of gain determined by the **AGC-T** setting will be applied to both fast and slow signals regardless of their level. The more you increase the **AGC-T**, the more gain is applied and the louder the signal *and noise* will be. The benefits of increasing SNR with AGC are lost in this mode. Another disadvantage of turning AGC off is that the operator must adjust the 'RF Gain manually to avoid distortion due to overload by strong signals.

Operating with AGC turned OFF may be desired by operators who want to avoid having a strong signal drive a weak nearby signal into the noise floor resulting from AGC audio attenuation. Digital mode operation may benefit from this configuration.

To adjust the AGC Threshold, tune to a quiet spot between stations. Starting with the **AGC-T** at a high value decrease the **AGC-T** until the background noise just begins to decrease. This is the **AGC-T** "sweet spot" or the "knee" of the AGC algorithm. Depending on band conditions, if the **AGC-T** is set below 50, you may have to compensate for the loss in audio gain (volume) by increasing the Slice volume to a higher value. When you get the knee and AF volume adjustment correct for the band conditions, it will keep the volume of strong signals constant which will allow weaker signals to be heard even with AGC in FAST mode. Thus **AGC-T** is one of the most important adjustments, and often overlooked, to achieve the maximum weak signal receive performance out of the FLEX-6000 series SDRs.

The Automatic Gain Control Threshold (**AGC-T**) adjustment is located on the AF/AGCT/SQL multi-function control. Each Slice Receiver has its unique settings for the AGC timing and threshold.

The AGC attack/release time is controlled by the AGC button on the **Slice Receiver Menu**. You can choose FAST, MEDium, SLOW, or OFF.

14.2 DSP NOISE MITIGATION FEATURES

The **Slice Receiver Menu** contains the enable buttons and threshold adjustments for the Wideband Noise Blanker, Slice Specific Noise Blanker, Noise Reduction, and Automatic Notch Filter. The midrange settings of the threshold controls are good starting points for adjustments.



14.3 WIDEBAND NOISE BLANKER (WNB)

The Wideband Noise Blanker (WNB) is used to combat fast rise time pulse-type noise such as power line hash and car ignitions. To enable the Wideband Noise Blanker, tap the WNB button, then adjust the threshold control for the best noise suppression. In general, the default setting is adequate, but depending on the noise characteristics, some adjustments can help. The WNB Threshold control adjusts the level at which a sample is considered to be impulse noise. The general rule of thumb for this adjustment is to use the lowest level that is effective. For large impulse noise (meaning the noise floor jumps are large) a lower level should be used. If the impulse noise is causing only small jumps in the noise floor, a higher level can be used.

Large signals, both in the passband and around it, can result in distorted audio if the WNB threshold control is set too high.

Since the Wideband Noise Blanker operates at the Panadapter level rather than at the Slice level easy detection of wideband correlated noise pulses is possible. The algorithm employs an automatic slider normalization function to make the WNB work consistently on different bandwidths and signal levels. This unique architecture allows pulse removal with far less distortion than many traditional noise blankers.

Given the wideband nature of this feature, the threshold slider controls an entire Panadapter, which may have several Slice Receivers attached to it. This means that the WNB can positively impact not only the audio of Slice Receivers but also the panafall visual display. For convenience, the slider is available in each Slice and each Panadapter. Adjusting any one of them adjusts an entire Panadapter, and all related slider controls are updated. Enabling and disabling the WNB function is available separately for each Panadapter.

When the WNB detects a significant change in signal level or bandwidth, it attempts to normalize the slider value. During this time, blanking will be momentarily bypassed, and the WNB indicator in the Panadapter will start to flash (blink). Once a suitable normalized slider range has been re-established, the noise blanking action will resume, and the WNB indicator will return to a solid color.

It is possible for certain WNB-level settings to distort with certain types of signals. For example, in the proximity of very large signals, noise may become worse with aggressive settings of WNB. If this is the case, either lower the WNB level setting or disable WNB on that Panadapter.

14.4 SLICE SPECIFIC NOISE BLANKER (NB)

The Slice Specific Noise Blanker (NB) is used to combat fast rise time pulse-type noise such as power line hash and car ignitions, on an individual Slice Receiver basis. To enable the Noise Blanker, tap the **NB** button in the **Slice Receiver Menu**, then adjust the threshold control for the best noise suppression. In general, the default setting is adequate, but depending on the noise characteristics, some adjustments can help. The **NB Threshold** control adjusts the level at which a sample is considered to be impulse noise. The general rule of thumb for this adjustment is to use the lowest level that is effective. For large impulse noise (meaning the noise floor jumps are large) a lower level should be used. If the impulse noise is causing only small jumps in the noise floor, a higher level can be used.

Unlike the Wideband Noise Blanker, the Slice Specific Noise Blanker algorithm considers only 24kHz of the RF spectrum, centered on the Slice Receiver's tuned frequency, not the entire SCU RF spectrum, as is the case with WNB. The NB algorithm complements the WNB algorithm and may be used with or without WNB. It may be more effective than WNB, less effective, or do not affect specific examples of impulse noise. The Slice Specific Noise Blanker may be turned on or off and adjusted for each Slice Receiver.

14.5 NOISE REDUCTION (NR)

The Noise Reduction processor (NR) will reduce random ("white") noise making signals more readable which are buried in the noise. It is best to adjust the AGC threshold first, and then enable the Noise Reduction.

The Noise Reduction algorithm uses a correlation-based adaptive filter. Noise Reduction increases the correlation between input and output with the assumption that noise is uncorrelated and should be canceled out. The threshold adjustment controls the adaptation rate of the filter, so in the case of Noise Reduction, there will be very little audible change while adjusting the threshold unless the noise is changing rapidly or dramatically. The most aggressive settings of Noise Reduction increase the signal-to-noise ratio but will tend to "color" the signal. The slider should be set for the optimal tradeoff between signal-to-noise ratio and minimal distortion of the desired signal.

15 HOW TO USE TRACKING NOTCH FILTERS

15.1 TRACKING NOTCH FILTER THEORY

With the notch filters found on most receivers, the notch removes an audio frequency after the AGC. When you hear a carrier in the middle of a sideband transmission, you can enable the notch and adjust it to remove the objectionable carrier. The weakness of this type of filter is apparent when the dial frequency is changed. Since the notch is on an audio frequency offset, as the dial frequency is changed the audio frequency of the undesirable frequency is changed and it falls out of the notch, requiring a readjustment of the notch.

With the Tracking Notch Filter™ (TNF), once the frequency has been notched the filter remembers the RF frequency of the objectionable signal. When the dial frequency is changed, the filter is automatically adjusted to maintain the notch on the objectionable frequency. With SmartSDR, you can create many Tracking Notch Filters to notch out local problem carriers or birdies across all bands covered by SmartSDR. The TNFs may be temporary, for only the current session, or they may be remembered permanently.

Note: Individual TNFs are disabled when in the audio passband of a Slice Receiver that is configured for demodulating FM. Because of the frequency-dependent nature of FM, a "notch" in the FM passband severely distorts the demodulation.

15.2 CREATING AND ADJUSTING A TRACKING NOTCH FILTER

To create a TNF, press and hold your finger on either the Panadapter or the Waterfall, near the frequency to create the TNF. A menu will appear. Touch "Create TNF" to create a TNF at this location.

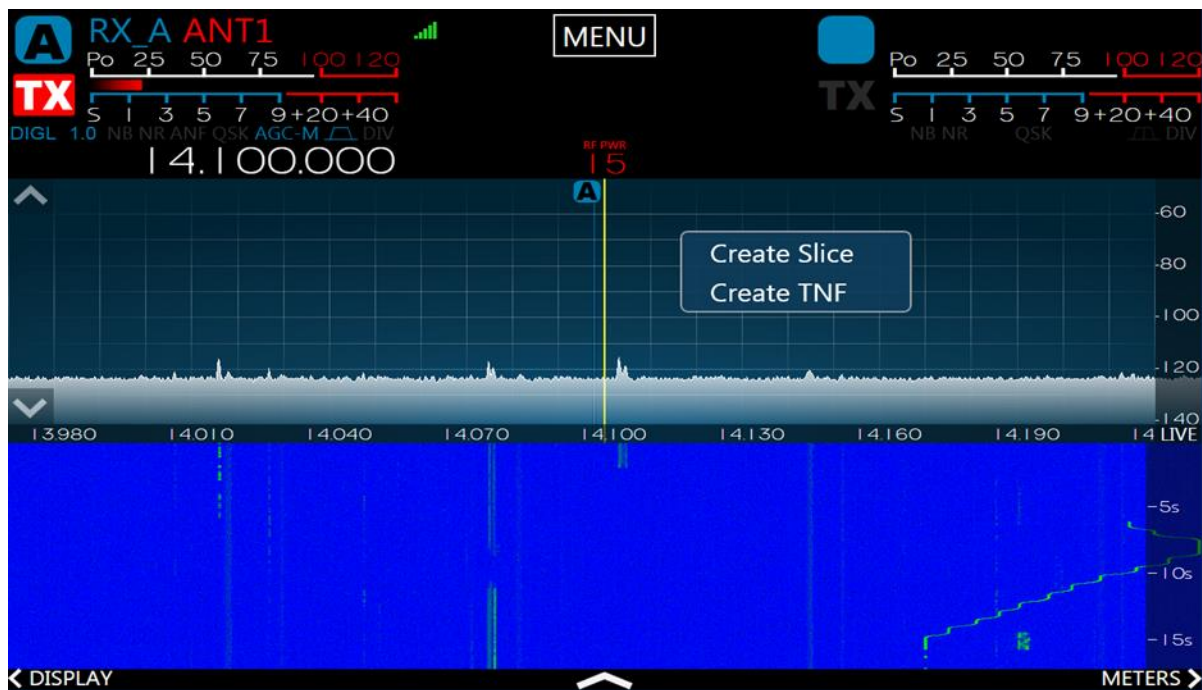

A TNF will be shown by a greenish vertical line with diagonal yellow stripes.

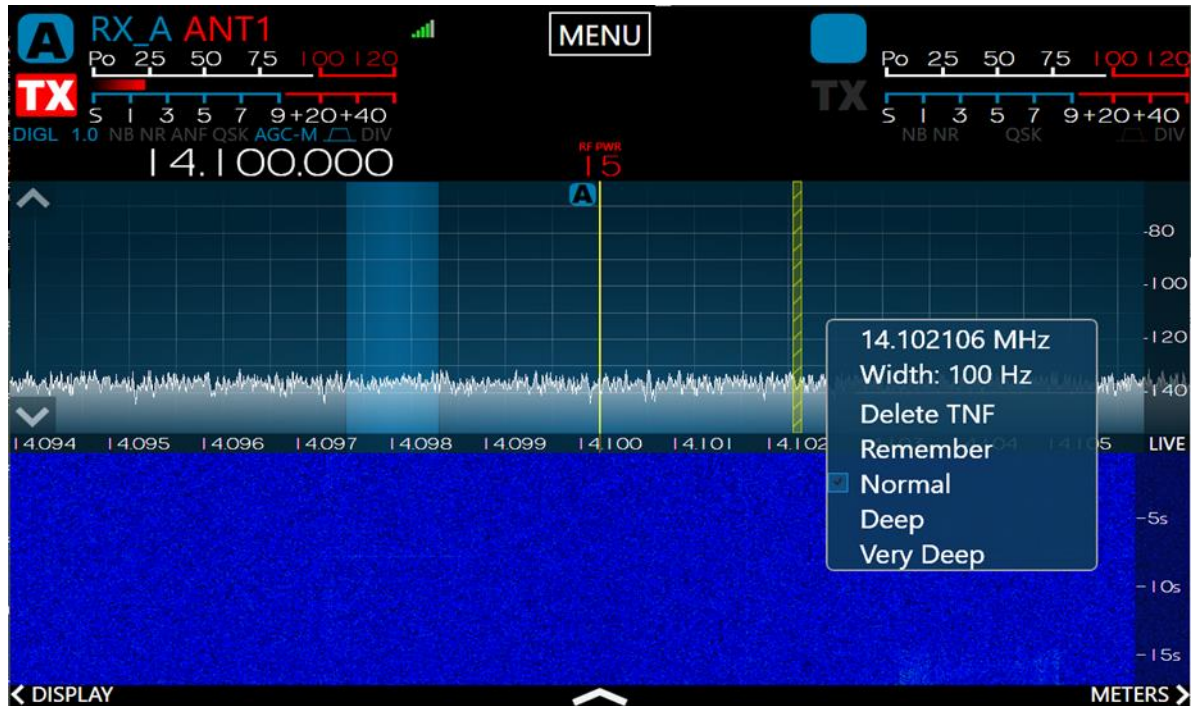

The TNF can be moved by dragging it (just like a slice), and the width can be adjusted by sliding your finger up and down. Tapping a TNF once will put it in Edit Mode, causing the options to reappear. While in this mode you can also fine-tune the frequency and width of the TNF using the BW Select knob.

15.3 TURNING ALL TRACKING NOTCH FILTERS ON OR OFF

To disable all TNFs at the same time, touch the TNF button in the top-left corner of the Slice menu.

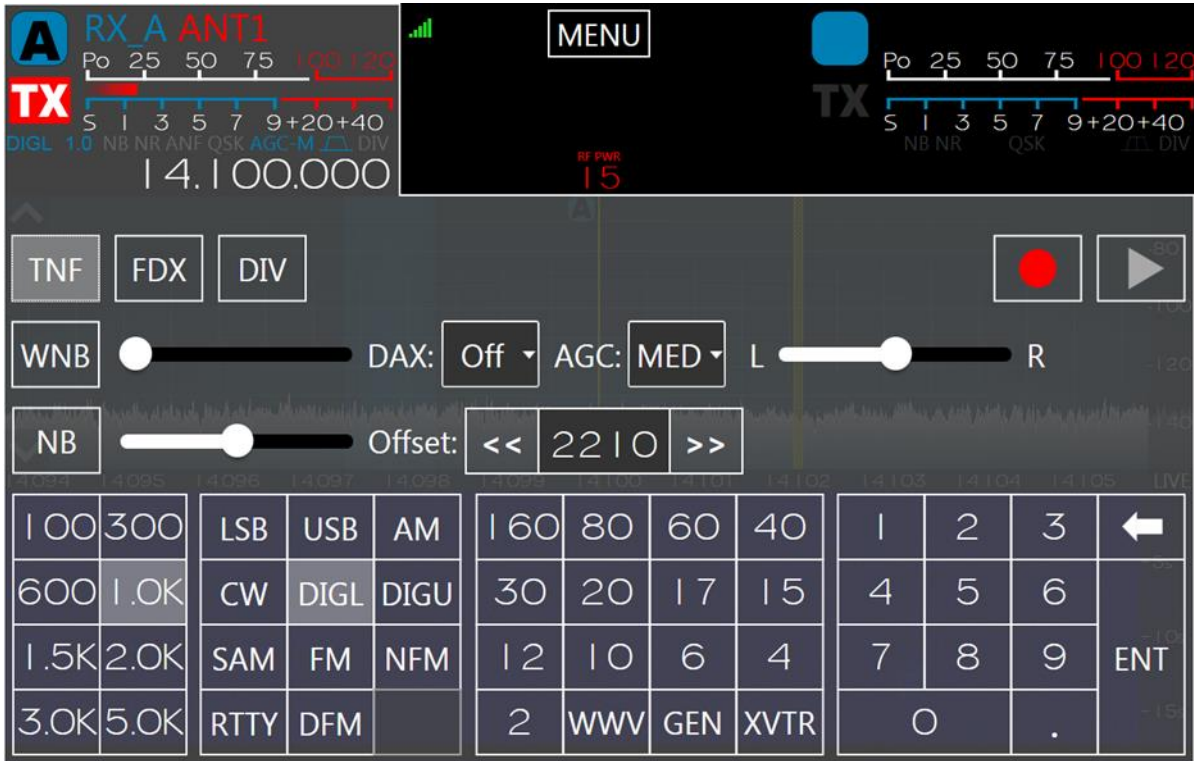

To remove all TNFs, tap and hold the TNF button. The **Remove All TNFs** option will appear as shown below. Tap the option to remove all TNFs.



15.4 AUTOMATIC NOTCH FILTER (ANF)

The Automatic Notch Filter automatically applies a Tracking Notch Filter, as described above, to remove constant tones such as carriers and heterodynes from the received audio passband. These filters can be applied to each Slice Receiver as needed.

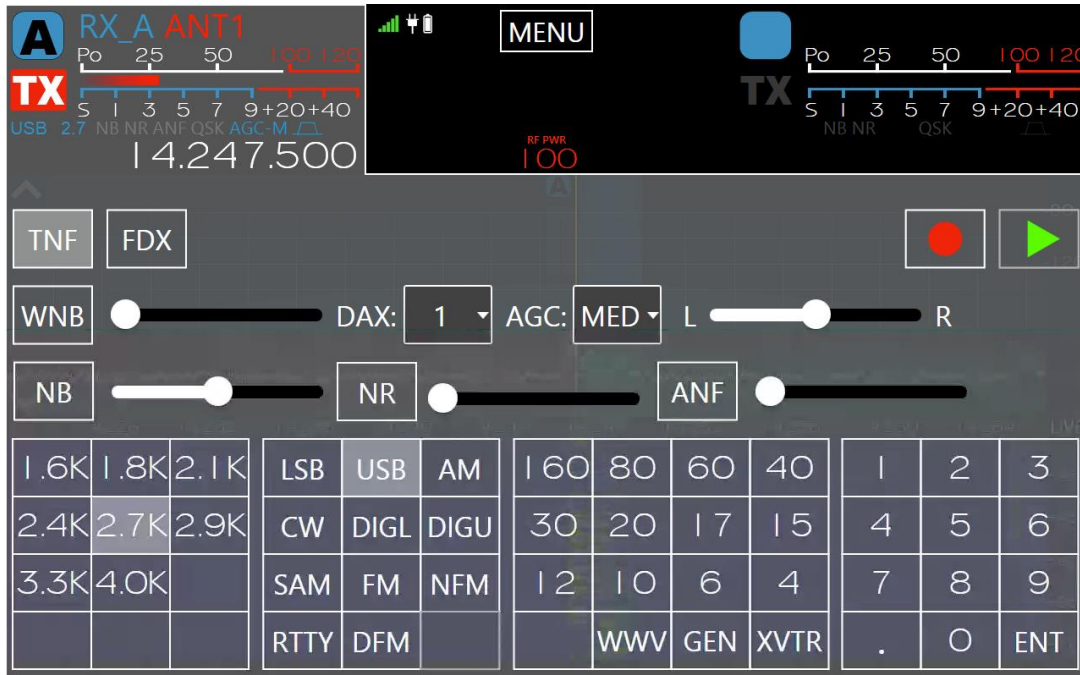

The slider to the right of the ANF button controls the depth and sensitivity of the filter. Automatic Notch Filters are not affected by the setting of the global Tracking Notch Filter control, section 15.3, **Turning all Tracking Notch Filters On or Off.**

The Automatic Notch Filter algorithm uses a correlation-based adaptive filter. The filter decreases the correlation of the input and output since a constant tone is highly correlated and should be canceled out. The threshold adjustment controls the adaptation rate of the filter. If a loud tone is present and you move the receive filter around it, you should hear the tone get canceled at different rates depending on the threshold control setting.

16 HOW TO USE PROFILES

Profiles allow the user to name and save the state of the radio and recall it later. Profiles can even be exported and restored on another FLEX-6000 Series radio. This facilitates convenient backup of radio configurations and also helps IT managers of DXpeditions or contest super-stations test configurations and then install or restore them at a site. Individual operators can also save their favorite settings and then, after others have operated, restore the state of the radio.

There are three types of profiles: GLOBAL, TRANSMIT, and MIC. Global profiles store the state of the radio including the Panadapters and Slices that are open, the mode associated with each Slice, and all of the settings for noise blankers, AGC, filters, etc. This can be thought of as a snapshot in time. Transmit profiles save the transmitter power level, tune power level, transverter power level, and the various transmitter delay parameters. MIC profiles save a configuration for a specific microphone or audio source, including the TX filter settings, the MIC selection and level, and the DEXP, PROC, DAX, VOX, and EQ settings. Both Transmit and MIC profiles are automatically saved when the related controls are changed.

Profiles are far superior to traditional "band stacking" in that you can save as many different configurations as desired and give them a meaningful name for recall.

16.1 MIC PROFILES

MIC profiles manage a set of radio parameters associated with microphones and other audio sources. These include TX filter settings, MIC selection and level, and DEXP, PROC, DAX, and VOX settings. A complete list of the parameters is provided in section **16.7, Comparing Profiles and Persistence**.

The MIC profile can be selected from the **Profiles** control panel in the Maestro **Main Menu**. Tap the name of the desired profile, then tap the **Load** button. See section **16.4, Saving and Deleting Profiles** for more details about using the control panels.

MIC profiles can be associated with the mode of a Slice Receiver. The MIC profile in effect at any point in time is determined by the mode of the transmit Slice, or by a Global profile. Two Slice Receivers may exist, set to different modes, but only one controls the transmitter (for each Station), the active Slice determines the MIC profile selection.

To associate a MIC profile with a mode, mode groups are used. LSB and USB are considered to be a single mode group (SSB), as are DIGU and DIGL (Digital), FM, NFM, DFM (FM), and AM and SAM (AM). RTTY and each Waveform installed in the radio are treated as a separate mode.

To associate or link a Mic profile to a particular mode group, set the transmit Slice to the mode you wish to link, then load or save a Mic profile while the transmit Slice is in that mode. From then on, whenever the transmit Slice is set to that mode the linked Mic profile will be loaded. For example:

- Slice A – Mode is USB
- Load **Default FHM-1** Mic profile. (This Mic profile is now linked to the USB/LSB mode group)
- Change Slice A to SAM (This loads the default linked MIC profile Default)
- Load **Default PR781** Mic profile. (This Mic profile is now linked to the AM/SAM mode group)

- Change Slice A to LSB or USB. (This loads the **Default FHM-1** Mic profile)
- Change Slice A to AM or SAM. (This loads the **Default PR781** Mic profile)

These MIC profile mode group associations are saved/restored within the Preferences.

Because the MIC profiles are automatically saved when changes are made to the associated settings, some users may want to save a separate profile with known good settings they can use to return to after testing different settings. Use the Profile Manager (section **33.11, Profiles Tab**) to create a new profile based on the current settings.

MIC profiles are band-independent. A MIC profile that is associated with a mode will invoke the same values in any band in which it is used.

The active MIC profile selection is saved per Station. When operating multiFLEX, it is important that if the devices have unique settings each Station uses its own MIC profile. For example, consider a FLEX-6500 that has 2 Stations connected, one running SmartSDR for Windows and another running a Maestro. If both Stations have the Default MIC profile selected, this will result in confusion when trying to transmit from the Maestro. Consider if the M-MIC1 (Maestro Microphone 1 input) option is selected on the Maestro as that is where your microphone is connected to the Maestro. Since the SmartSDR for Windows Station also has the Default MIC profile selected and it doesn't have an M-MIC1 option, it will set the Mic Input selection back to something like R-Mic (Radio's microphone input). To correct this, create a new Maestro MIC profile and use this on the Maestro with the M-MIC1 setting.

NOTE: If a MIC profile is modified, the change will affect all MODES and Global profiles with which the MIC profile is associated.

16.2 TRANSMIT PROFILES

Transmit profiles manage the transmitter power and interlock settings. The power settings are saved by band, while the interlock settings apply to all bands. The power settings include the transmitter power level, tune power level, and ALC. The interlock settings include the TX Delay, PTT Timeout, and the controls for the various transmitter-engaged signals. A complete list of the settings is provided in section **16.7, Comparing Profiles and Persistence**.

NOTE: Power settings are saved for every band in a Transmit profile. To save the appropriate power settings set a Slice as the TX Slice, then open the TX Band Settings tab (section 33.8) to make adjustments.

The Transmit profile can be selected from the **Profiles** control panel in the Maestro **Main Menu**. Tap the name of the desired profile, then tap the Load button.

Transmit profiles are linked to the TX Antenna setting in the transmit Slice. When the antenna used by the transmit Slice is changed, the Transmit profile associated with the new antenna selection is invoked. For example:

- Slice A is the transmit Slice. TX ANT is ANT1
- Slice B is NOT the transmit Slice. TX ANT is ANT2
- Load SO2R_TX1 Transmit profile. (This Transmit profile is now automatically linked to ANT1)
- Set Slice B as the transmit Slice.

- Load SO2R_TX2 Transmit profile. (This Transmit profile is now automatically linked to ANT2)
- Set Slice A as the transmit Slice. (This loads the SO2R_TX1 Transmit profile)
- Change Slice A TX ANT to ANT2. (This loads the SO2R_TX2 Transmit profile)

To associate a Transmit profile with a TX antenna, select the TX Antenna you wish to associate in the transmit Slice, then load or save a Transmit profile using the **Profiles** control panel in the **Main Menu**, or select an existing Transmit profile using the menu.

Each Transmit profile saves a set of power settings, one setting for each band. To save power settings for each band, select the Transmit profile from the drop-down menu, then tune to each band and adjust the power settings. As the adjustments are made, an asterisk should appear before the Transmit profile name in the drop-down menu, indicating that the Transmit profile has been modified. When all bands of interest have been set, save the modified Transmit profile using the **Profiles** control panel in the **Main Menu**.

***NOTE:** If a Transmit profile is modified, the change will affect all Global profiles with which the Transmit profile is associated.*

16.3 GLOBAL PROFILES

Global profiles manage the state of Panadapters and Slice Receivers and the layout of these components on the Maestro display. Panadapter settings saved in Global profiles include the number of Panadapters on the Maestro display, frequency ranges, bandwidth, and scaling and display parameters. Slice Receiver parameters include the frequency, mode, MIC profile, RX and TX filter settings, DAX channel, audio gain, and many others. See section **16.7, Comparing Profiles and Persistence** for details.

In addition, Global profiles also record the linking of each TX Antenna in each Slice to a Transmit profile and each Slice Receiver's mode. Invoking a Global profile therefore creates a set of Panadapters and Slices, selects a Slice to control the transmitter, then invokes the Transmit profile indicated by the selected TX antenna and the MIC profile. The selection of a different Slice to control the transmitter may change the selected Transmit and MIC profiles depending on the TX Antenna and Mode selected in the new TX Slice. Similarly, changes to the selected TX antenna or mode within the transmit Slice may change the selected Transmit or MIC profiles.

To create or save a Global profile, configure all Panadapters and Slice Receivers to the desired settings. TX Antennas and modes should be set to the desired values. Each TX Antenna that will be used in the Global profile should be selected and then linked to a Transmit profile by selecting the profile in the **Profiles** control panel. Select the mode and MIC profile in each Slice Receiver. When these adjustments are complete, save the Global profile using the **Profiles** control panel.

***Note:** Changes made to Panadapters and Slices are not automatically saved to a loaded Global profile. Changes to existing Global profiles can only be made by manually re-saving the profile using the Profile control panel.*

16.4 SAVING AND DELETING PROFILES

The Profiles control panel is reached by tapping on the **Menu** button on the main display, then on the **Profiles** tab on the **Main Menu**. On the Profiles control panel tap the **Global**, **TX**, or **MIC** option

appropriate for the profile you wish to save or delete. This will bring up one of the following Profiles control panels:

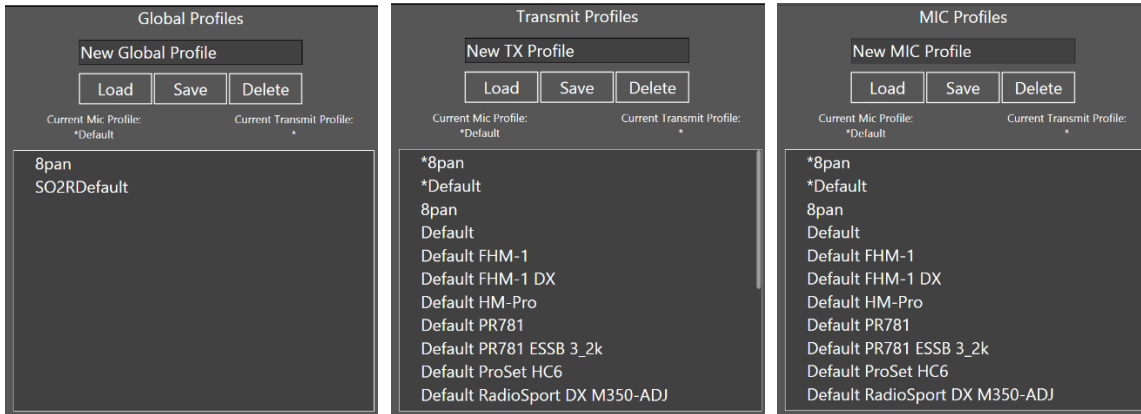

To save a new profile, tap the *New Global Profile*, *New TX Profile*, or *New MIC Profile* text box. A keyboard will appear. Type the desired name into the text box and tap **Save**. Saving a Global profile saves the Panadapter settings, the CWX settings, and the Slice Receiver configuration. Saving a Transmit or MIC profile will save only the settings related to the transmitter or microphone. See section 16.7, **Comparing Profiles and Persistence**, for details.

Note: When creating a new global profile, it must have a TX and MIC profile associated with it. At the time the new global profile is saved, if there isn't a TX or MIC profile associated with the global profile, new TX and MIC profiles are created having the same profile name as the global profile.

Take care when creating a new MIC profile to ensure that the Slice Receiver that is selected to control the transmitter also selects the mode to be associated with the new MIC profile. If this is not the case, the new MIC profile will become associated with the current mode unintentionally.

To create a MIC profile, LSB and USB are considered to be a single mode (SSB), as are DIGU and DIGL (Digital), FM, NFM, DFM (FM), and AM and SAM (AM). Each Waveform installed in the radio is treated as a separate mode.

To delete a profile, select the appropriate profile name and tap the delete button.

Note: Performing a database reset from the front panel of the radio will delete all non-default profiles. It is recommended that you export your profiles with all options selected before performing a database reset.

16.5 LOADING PROFILES

To load a profile from the **Profiles** control panel, select the desired profile and tap **Load**.

Note: You can load profiles created by different FLEX-6000 models without any adverse interactions.

16.6 DEFAULT PROFILES

Several default profiles are included in the radio software. These profiles provide a basic level operation for the radio and are listed in the illustrations in section **16.4, Saving and Deleting Profiles** above.

A default global profile, *SO2RDefault*, provides an example setup of the radio for SO2R operation. See section **32.3.1, FLEX-6600(M) and FLEX-6700 SO2R Operation** for more information. The default Transmit profiles provide common transmitter settings for “barefoot” operation. The default MIC profiles provide example values for microphone level, transmit filters, DEXP settings, voice processor settings, equalization settings, and other settings for several popular microphones and headsets.

Default profiles can be modified or deleted from the radio using the **Profiles** control panel, but will be restored if the radio is reset to the factory defaults (see section **37, Restoring to Factory Defaults**).

Note: Default profiles can be modified, but the modifications cannot be saved using the default profile name. A new profile name has to be entered.

16.7 COMPARING PROFILES AND PERSISTENCE

Profiles are different from persistence. As described above, profiles are a way to save and restore a complete radio configuration and then return to that configuration later. Global Profiles require action on your part to both save and restore but are a very quick way to put the radio in exactly the state you want. MIC and Transmit profiles both save automatically as settings are changed.

Persistence, always enabled on your Signature Series radio, remembers settings from band to band without your direct action so that when you return to a band your settings are restored. For example, if you are operating on 20m and set the Slice frequency to 14.185, then go to 10m and set the Slice frequency to 28.1 MHz, and then go back to 20m, persistence will return your Slice to 14.185 MHz. Resetting the radio to the factory settings (see section **37, Restoring to Factory Defaults**) will clear the persistence settings.

Persistence remembers a large number of settings as shown in the following table:

Radio	
PTT Timeout	Show mic meter in receive
TX1/2/3/Acc enabled and delay	Show transmit signals in the Waterfall
TXREQ enabled and polarity (RCA & ACC)	DAX transmit enabled
Speaker volume and mute	Hardware ALC enabled
Headphone volume and mute	Transmit inhibit setting
PC Audio enabled	VOX Level and hang time
Processor enabled and setting	Raw I/Q mode enabled
Selected microphone	Transmit filter passband (low, high)
CW/CWX Keyer speed	AM Carrier Level
CW/CWX break-in delay	CW Sideband (CWL or CWU)
CW Pitch	CW Iambic mode / straight key
CW Monitor enabled / level/pan	CW/CWX synchronize settings enable
SSB monitor enabled / level/pan	Reference calibration offset
Mode	
Selected microphone	
Microphone	
Bias enabled	Level
Boost enabled	Compander settings
Accessory Mix enabled	
Slice	
Frequency	AGC Mode
Filter limits	AGC-Threshold / AGC Off Level
Mode (USB, CW, etc.)	Mute state
RX Antenna	Audio level, pan
TX Antenna	WNB, NR, ANF, APF states and levels
TX state (is this the transmit Slice?)	Diversity state / Slice
DAX channel	FM tone mode
Squelch settings (for FM)	FM repeater offset
Panadapter	
Center Frequency and Bandwidth	DAX I/Q Channel
RX Antenna and Loop settings	Display frames per second
Preamplifier setting	Display averaging settings
Display min/max dBm	
Waterfall	
Auto-black enable and level	Gradient selection
Scroll speed (line duration)	Color gain

Global Profile Fields			
PANADAPTER	CWX	SLICE	Global
Center Frequency	CWX Macro 1	Frequency	RX EQ Enable
XVTR Frequency	CWX Macro 2	XVTR Frequency	RX EQ Levels (all frequencies)
XVTR Key	CWX Macro 3	XVTR Key	Full Duplex ON/OFF
Bandwidth	CWX Macro 4	Diversity	
RX Antenna	CWX Macro 5	Mode	
Loop A Enabled	CWX Macro 6	RX Filter Low	
Loop B Enabled	CWX Macro 7	RX Filter High	
RF Gain	CWX Macro 8	RX Ant	
Min dBm	CWX Macro 9	TX Ant	
max dBm	CWX Macro 10	Parent Panadapter	
FPS	CWX Macro 11	Is this Slice the TX Slice	
Averaging ON/OFF	CWX Macro 12	DAX Channel	
Weighted average ON/OFF		Is muted?	
DAX IQ Channel		Audio Gain	
Waterfall black level		Audio Pan	
Waterfall color gain		Is locked?	
Waterfall line duration level		AGC Mode	
Waterfall autoblack ON/OFF		AGC Threshold	
Waterfall gradient		AGC Off Level	
Waterfall Type		NR Enabled	
Show TX in Waterfall		NR Level	
		NB Enabled	
		NB Level	
		ANF Enabled	
		ANF Level	
		APF Enabled	
		APF Level	
		Squelch Enabled	
		Squelch Level	
		FM Tone Mode	
		FM Tone Value	
		FM Repeater Offset	
		TX Offset Frequency	
		FM Repeater Offset Direction	
		Diversity Child AGC Mode	
		Diversity Child AGC Level	
		Diversity Child Audio Gain	
		Diversity Child RX Ant	

TX Profile Fields	
Interlock	Power
TX Delay	Hardware ALC Enabled
PTT Timeout	Tune Level
PTT Inhibit	Power Level
ACC TX Request Enable	XVTR Tune Level
RCA TX Request Enable	XVTR Power Level
ACC Polarity	
RCA Polarity	
ACC TX Relay Enable	
ACC TX Relay Delay	
TX Relay 1 Enable	
TX Relay 1 Delay	
TX Relay 2 Enable	
TX Relay 2 Delay	
TX Relay 3 Enable	
TX Relay 3 Delay	

MIC Profile Fields
TX Filter Low
TX Filter High
Mic Selection
Mic Level
Mic Boost
Mic Bias On/Off
DEXP Enable
DEXP Level
PROC Enable
PROC Level
Monitor Enable
Monitor Level
Monitor Pan (L/R)
DAX Input Enable
VOX Enable
VOX Level
VOX Delay
Show MIC Meter in RX Enable
AM Carrier Level
TX EQ Enable
TX EQ Levels (all frequencies)

17 HOW TO OPERATE MAESTRO AUDIO

Maestro can be operationally “decoupled” from the radio hardware by playing Slice Receiver audio through the Maestro speaker (or another attached playback device) and using a connected microphone or other audio input device to make phone QSOs. This feature streams compressed audio over the Ethernet connection between the radio and the Maestro, eliminating the need for the speakers and microphone to be directly connected to the radio hardware. Although from the perspective of the radio the audio is remote, from the perspective of Maestro, this is the conventional way audio is handled.

To provide diagnostic capabilities for the Maestro audio feature, monitors are included in the Maestro software. The Network Quality Monitor and Audio Streaming Monitor provide a visual indication of a network’s capability to adequately stream audio to Maestro, which is essential when using a wireless link between Maestro and the radio hardware.

Maestro audio uses a compressed audio format suitable for transmission over the local area network. Compression is accomplished with the Opus codec. Opus is an audio coding format developed by the Internet Engineering Task Force (IETF) and has been standardized in RFC 6716. Although technically lossy, Opus provides excellent fidelity with minimal bandwidth usage.

17.1 PLAYING SLICE AUDIO USING THE DEFAULT PLAYBACK DEVICE

As noted above, Maestro audio uses the playback and recording devices available to Maestro. Tapping the **Main Audio Out** button located in the **Audio** tab of the Maestro **Main Menu** enables streaming of Slice audio from the radio to the Maestro playback device (speakers or headphones). When Maestro audio streaming is enabled the **Main Audio Out** button will be highlighted.

17.2 TRANSMITTING USING A CONNECTED RECORDING DEVICE

To transmit using a microphone connected to the Maestro you will need to select from the M-MIC1, M-MIC2, or M-LINE inputs in the TX control panel. Press the inner knob of the transmitter multi-function control to open this control panel and tap the desired input device.



Transmit can be triggered using the MOX button on the transmit panel or using VOX, or any PTT input.

Note: Maestro has an override feature that allows microphones other than the selected microphone to be used during a transmission. This is discussed in section 17.4.

17.3 CONFIGURING THE AUDIO OUTPUT DEVICES

The Maestro provides several audio output options. A speaker is built into the front panel of the Maestro. The **Front Speaker** button in the **Audio** control panel of the **Main Menu** enables and disables the speaker. Plugging a headphone or similar device into the back-panel **Phone** connector disables the front-panel speaker regardless of the **Front Speaker** button state.

The back panel of the Maestro provides a connector for the connection of powered speakers and a similar connector that provides a line-level output. Plugging devices into these connectors does not affect the front panel speaker.

17.4 PTT OVERRIDE WHEN OPERATING VIA MAESTRO

When operating in a non-DIGx mode, using a hardware PTT such as the RCA PTT input on the transceiver back panel or the transceiver front panel microphone PTT will override the Maestro PTT. This feature is provided to allow an operator at the transceiver to override the Maestro input with a PTT switch connected directly to the radio.

17.5 OPERATING CW WHEN OPERATING VIA MAESTRO

A key or paddles can be connected to the Maestro back panel **Key** connector. CW signals generated by the internal Winkeyer 3 module are transmitted from Maestro to the transceiver across the network connection. Sidetone from the keyer is generated inside Maestro and played out of the speaker, headphones, or powered speaker output. CW operation, especially in contest and DX environments, tends to be fast-paced and relatively intolerant of delays which can add confusion.

Many issues can affect the LAN performance of Maestro including, but not limited to, the wireless router used, the congestion on local wireless channels, settings inside the router such as packet coalescing and duplex modes, cabling issues such as interference from florescent light ballasts on the wired connection to the router, etc. The network diagnostics in Maestro can help diagnose these, but if network issues are suspected, a thorough investigation of the network may be in order.

Generally, wired networks will perform better than wireless networks. In many cases, the Internet will have better packet latency and jitter performance than a wireless network with some degree of congestion. For this reason, FlexRadio recommends using wired networks for CW as there tend to be fewer issues that require troubleshooting on wired networks. Maestro will always attempt to compensate for any jitter or latency caused by any kind of network, but the mechanism for compensation is to add latency to ensure a steady stream of CW at the radio transmitter.

17.6 MONITORING REMOTE AUDIO AND NETWORK PERFORMANCE

There are two ways to monitor the performance of the network while using Maestro. The first is with a convenient Network Health Indicator display in the top middle of the Maestro display. The second is a detailed Network Diagnostics display.

17.6.1 Network Health Indicator

The network health indicator provides a quick way to determine if your network connection is performing well enough to properly operate your radio for both remote and local modes of operation. As shown below, the indicator is a series of “bars”, usually green, indicating error-free streaming at a sufficient rate.

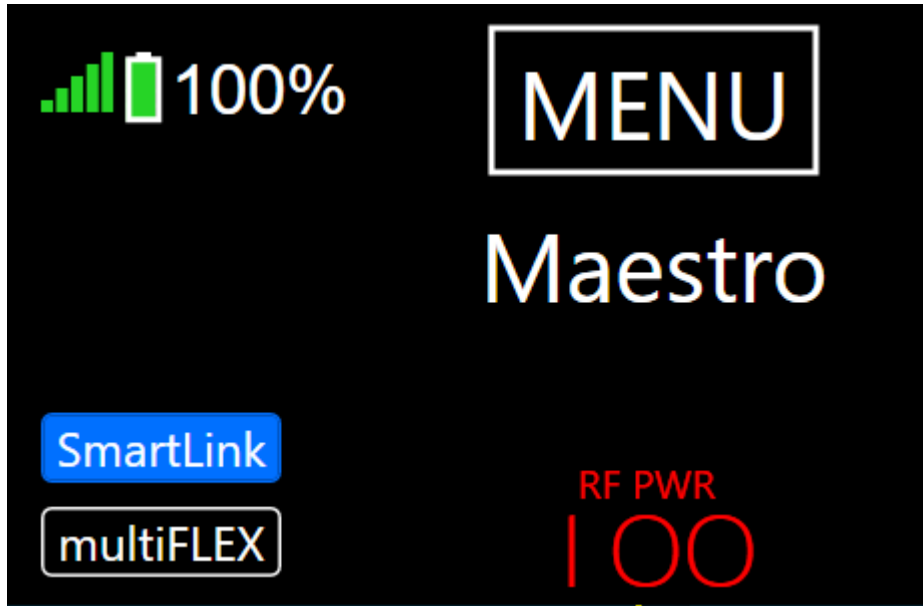

If network errors do occur, the number of illuminated bars in the indicator will decrease. As long as the indicator is green, the radio should perform properly. If the indicator changes to yellow, occasional audio dropouts and screen freezes may occur, but the radio will continue to operate. Once the health indicator drops to red bars or no bars, the link is not reliable enough to maintain communications.

17.6.2 Network Diagnostics

When LAN issues occur with Maestro, it is useful to have additional details to aid in diagnosing the problem. A Network Diagnostics feature provides this information. To access this information, open the **Network** tab in the **Main Menu**.

The Network Diagnostics shows several types of diagnostic data. There is a **Network Status** indicator that describes a summary of the quality of your network connection. **Latency (RTT)** is the round-trip time in milliseconds for a keep-alive packet to be sent between the Maestro and the radio hardware. A lower number indicates better network quality. On a LAN, **Latency (RTT)** should be no more than a few milliseconds and should not vary greatly. For a wireless network link, this number may be much higher and can vary depending on factors inherent to wireless network links such as signal attenuation and multipath reflections. **Max Latency (RTT)** is the greatest observed value of **Latency (RTT)**. If this number is much higher than the real-time **Latency (RTT)** values, this indicates a network link that has a lot of quality variability, which in general is not desirable.

The **Remote RX** and **TX Rates** are the rates, in kilobits per second, of all data sent over the LAN including audio, control commands, and display information for panadapters and Waterfalls.

Additionally, there is a listing of the number of dropped packets and the total number of data packets sent between the radio and the Maestro since the Network Diagnostic data was reset or since the Maestro started. On a healthy LAN connection with sufficient bandwidth, you should not experience any dropped packets. When using a wireless network connection, dropped packets cannot be avoided and you may observe the occasional dropped packet. However, if you observe a rising number of dropped packets, greater than 0.10% after the radio has been running for several minutes, this is an indication that your network lacks sufficient capacity or throughput to provide error-free operation. You can reset this count by tapping on the Reset Stats button.

Diagnostics

Network Status:	Excellent	Remote RX Rate:	76	kbps
Latency (RTT):	< 1 ms	Remote TX Rate:	0	kbps
Max Latency (RTT):	< 1 ms	<input style="border: 1px solid #fff; padding: 2px 10px;" type="button" value="Reset Stats"/>		

Dropped 0 out of 12500 packets (0.00%)

18 HOW TO OPERATE MULTIFLEX

As discussed in the introduction to multiFLEX (section 5), multiFLEX allows multiple operating positions called Stations to operate the radio concurrently. Because multiFLEX offers each user their unique view of the radio, the operating experience is familiar. The stations may be on the same LAN or SmartLink or a combination.

Operating in CW, SSB, AM, FM or Digital works virtually the same as it does with a single operator as described in the following sections. To use multiFLEX, you simply connect more than one Station to the Radio. Each Station will have its own Slice A/B/etc. and its own TX Slice on its own Panadapter.

18.1 SHARED RESOURCES

Because several of the key resources in the radio such as the Transmitter, SCUs, Slices, and Panadapters are finite in number, some means of coordination may be helpful when operating multiple Stations concurrently with multiFLEX.

18.1.1 Single Transmitter

There is a single transmitter on the radio. This means that only a single Station can transmit at a time. Conflicts are resolved using a First One Wins system. This means that if you have Station 1 and Station 2 connected to the same Radio if Station 1 begins to transmit, Station 2 must wait until Station 1's transmission is complete to make a transmission. The same is then true for Station 1 while Station 2 is transmitting – it must wait until Station 2 is finished transmitting before it can transmit again.

To indicate when another Station is transmitting, we have added an inverted TX icon:

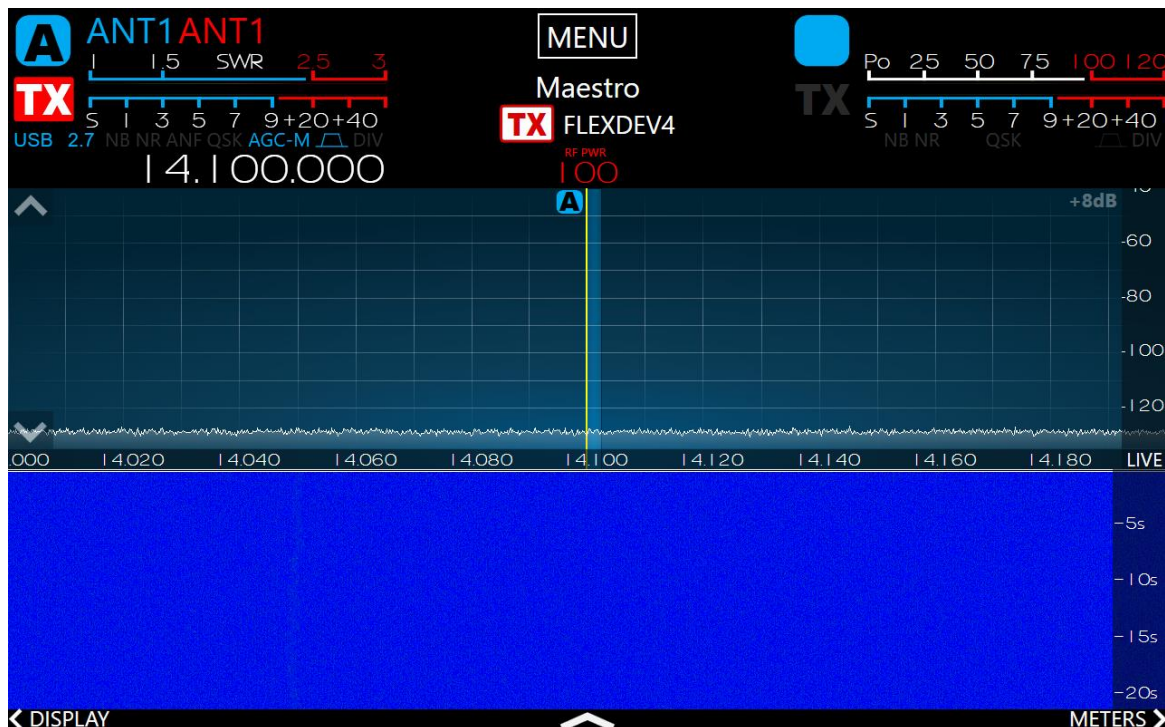

18.1.2 Available SCUs

The total available number of SCUs (Spectral Capture Units – see section 10.2.1) is determined by the radio model according to the following table:

Model	FLEX-6700	FLEX-6600	FLEX-6500	FLEX-6400	FLEX-6300
SCUs	2	2	1	1	1

When the RX Antenna selection is made on a Slice or Panadapter, this associates that Antenna Port (such as ANT1, ANT2, RX A, etc.) with an SCU. If there is no available SCU when changing Antenna Ports, an existing SCU must be moved to the newly selected RX Antenna. Put another way, a single SCU radio can only listen on a single RX Antenna Port at a time. This means that if two Stations are connected to a FLEX-6500 and both of them are using ANT1 for RX, if one of the Stations changes the RX Antenna to ANT2, all Panadapter and Slice resources on both Stations will move to ANT2.

The situation is easier to handle when using a dual SCU model like the FLEX-6600 or FLEX-6700. This allows up to 2 RX Antennas to be in use at a time. Even with two SCUs, they can still run into situations where both SCUs are in use, and changing an antenna may switch resources on any Stations that were using the original Antenna Port that is being changed. This sharing will likely be familiar to those who have operated a FLEX-6000 radio, but it can be confusing if your RX Antenna settings change as a result of settings that another Station has chosen.

Similarly, the Gain setting (Preamp/Attenuator) for the SCU is shared just as it is in a single Station setup. However, it may not be as obvious why the Gain setting is changing when another Station changes it unless it is understood that the SCUs are a shared resource.

18.1.3 Total Available Slices and Panadapters

The total available number of Slices and Panadapters is determined by the radio model according to the following table:

Model	FLEX-6700	FLEX-6600	FLEX-6500	FLEX-6400	FLEX-6300
Panadapters	8	4	4	2	2
Slices	8	4	4	2	2

multiFLEX allows these resources to be split across multiple Stations flexibly. One station on a FLEX-6600 might have 3 Slices in use while another has 1 Slice. When all of the Slices are in use, a Slice must be closed before another will be allowed to be opened. The same rules apply to Panadapters and Waterfall displays. This means that on a FLEX-6500 if two Stations are connected and Station 1 opens four Panadapters, Station 2 will not be able to open any Panadapters until one or more Panadapters on Station 1 are closed thus freeing up those shared resources.

18.1.4 Hardware PTT Inputs – Introducing Local PTT

In a system with multiple Stations connected, it isn't immediately clear what should happen when a Hardware PTT is used with the Radio. Take for example a FLEX-6600 with 2 Stations connected: Station 1 using SmartSDR for Windows is called FLEXDEV4 and Station 2 is using his FLEX-6600M Front Panel. In this scenario, both of these Stations are being operated by the same person in the

vicinity of the radio. Let's say that the operator reaches over and keys his CW paddle. Where should the radio begin transmitting? Remember that each of the Stations has its own concept of a TX Slice.

To help resolve such conflicts, we have added a Local PTT designation in the multiFLEX Dashboard (see section **33.15, multiFlex Tab**).

NOTE: When there is only a single Station active, it will automatically be set as the Local PTT.

19 HOW TO OPERATE CW MODE

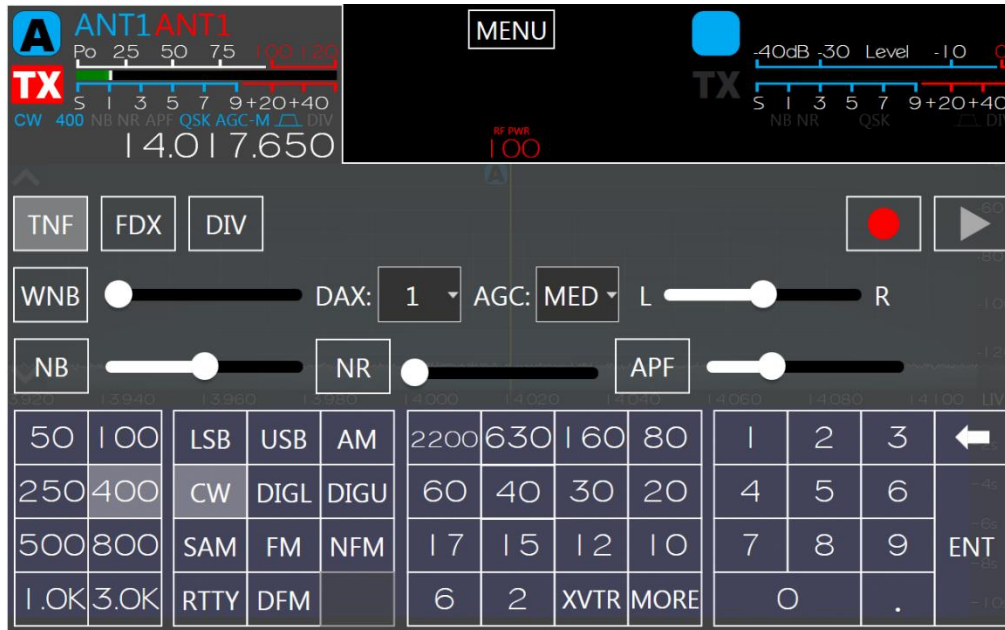

To use Maestro in CW mode, select CW in the **Slice Receiver Menu**. This shows the narrower CW receive filter presets in the **Slice Receiver Menu** and brings up the CW-specific controls in the **TX Menu**.

The CW display is slightly different from the SSB display. In CW mode, the Slice carrier indicator line is in the center of the receiver passband. This coincides with the CW carrier frequency. It shows exactly the location of your transmitted carrier. The pitch of received CW signals depends on the value of the Pitch control in the CW Transmit Control Panel (see section **36.6.2, CW Mode Transmitter Control Panel**) and the distance of the CW carrier from the tuned frequency.

19.1 HOW TO OPERATE CW IN SPLIT MODE

Many DXpeditions prefer to operate in split mode, in which they transmit on one frequency but listen on another, up or down a few kilohertz. To do this with Maestro, the A Slice must be set to the DX station's transmitting frequency, and the B Slice must be inactive. Press the B slice TX button. The B Slice will become active, its frequency will be set to a value 1 KHz higher than the A Slice Receiver's frequency and the transmitter control will move to the B Slice. Your Panadapter display should look similar to this:

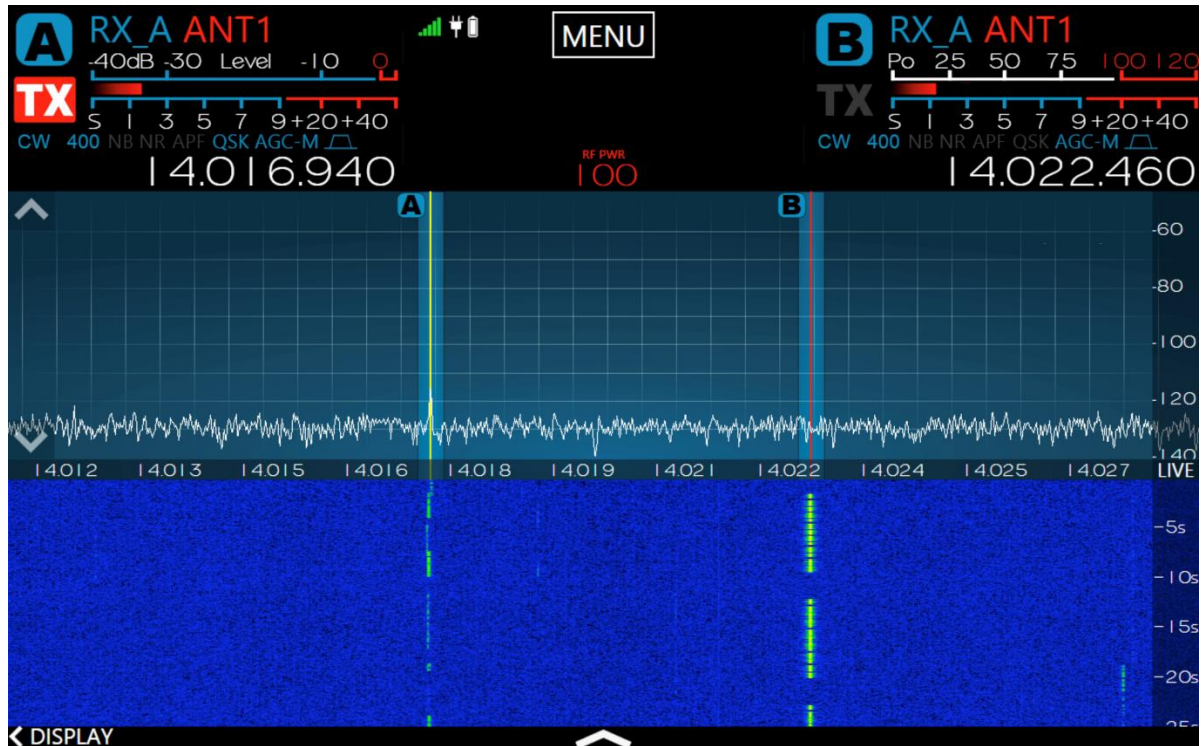

If you prefer, you can use the Slice audio controls to pan the Slice audio so one receiver is in your left ear and the other is in your right ear. Touch and drag the L/R control in the **Slice Receiver Menu** to move that Slice Receiver's audio to the left or right ear.

To leave split mode and disable the transmitter, press the B-RX button to remove the B slice. Press the A-TX button to restore the transmitter to the A slice receiver

If you have configured one of the function buttons (F1 – F6) as a **Split** button (see section 33.4, **Function F1-F6 Tab**), and if the B slice is inactive, then a single press of the function button will create the split configuration. The B slice will control the transmitter. Pressing the button a second time will disable the B slice and return the transmitter to the A slice receiver.

19.2 CW TRANSMITTING

To transmit in CW mode using the keyer built into the FLEX-6000 radio, you will need either a straight key or an iambic paddle. Refer to the FLEX-6000 Hardware Reference Manual in section 0,

Maestro “C” External Monitor Port

The external monitor port is provided to connect an external monitor to your Maestro device. The Maestro screen is then "mirrored" to the external monitor providing a larger viewing field.

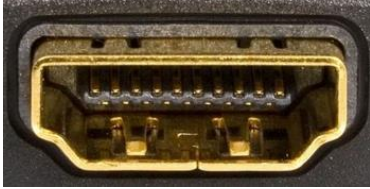

19.2.1 Straight Key and Paddles Connection

For CW operation, the 1/8 inch (3.5mm) TRS KEY connector accepts a TRS plug for operating a keyer with paddles or a straight key.

of this document for wiring instructions.

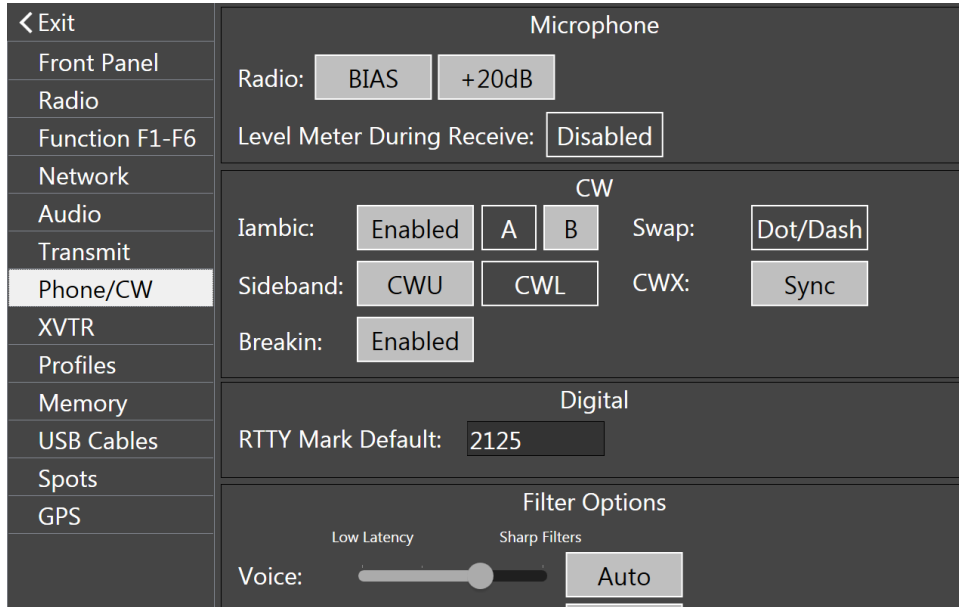

Main Menu, Phone/CW tab

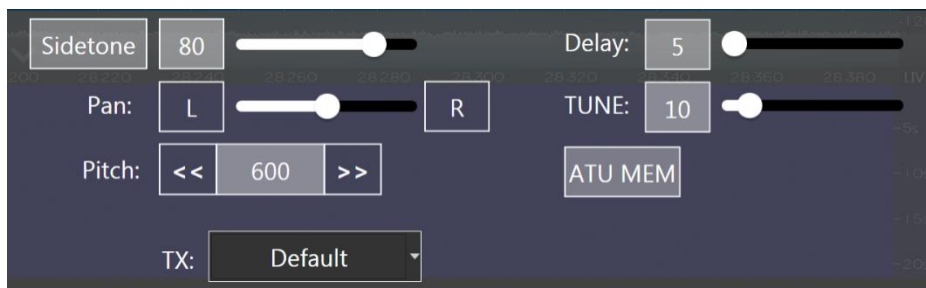
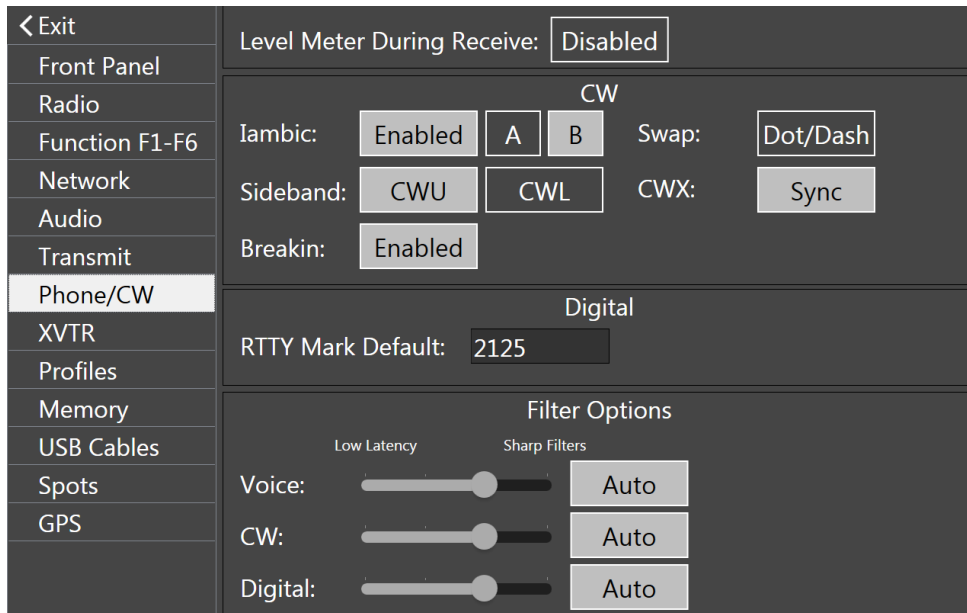

TX Menu, CW Mode

To use a straight key, disable the **Iambic** control and enable **Dot/Dash Swap** in the Phone/CW control panel in the Maestro **Main Menu**. Connect the straight key to the tip and sleeve of a 1/8th inch TRS plug and connect it to the **Key** input on the back panel of the Maestro. When **Breakin** is enabled, the transmitter is engaged when the key contact is closed. When **Breakin** is disabled, the transmitter must be engaged with one of the PTT inputs before using the key. The **Delay** slider in the **TX Menu** sets the PTT hold time for a break-in in milliseconds. It can be set anywhere from zero (full QSK), to 2000 milliseconds (2 seconds). See section **36.6.2, CW Mode Transmitter Control Panel** for details about these controls.

19.3 USING THE BUILT-IN KEYER

Maestro has a built-in iambic keyer that can be used either as iambic “A” or iambic “B”. Controls for the keyer are found on the **Phone/CW** tab of the Maestro **Main Menu**. See section **33.9, Phone/CW Tab** for details about these controls.

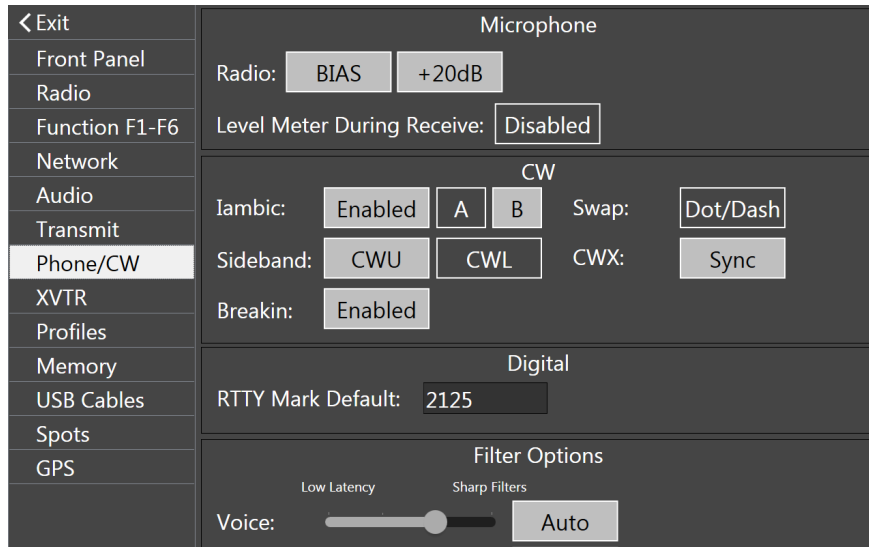

The keyer speed can be set between 5 and 100 WPM using the **Speed** control (inner knob) on the Transmitter multi-function control. The **IAMBIC** selector must be enabled to use the built-in keyer. The **Sidetone** control will increase or decrease the Sidetone volume in the speakers and headphones. Note that the sidetone button to the left of the slider should be illuminated to enable sidetone output.

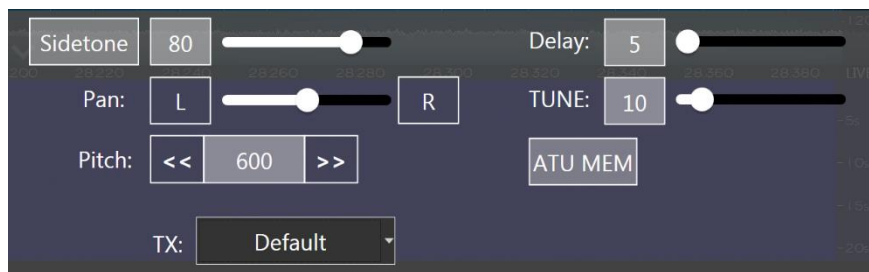

19.4 HOW TO OPERATE QRQ (HIGH SPEED) CW WITH QSK

All FLEX-6000 radios are capable of full QSK operation. To achieve the full benefit of QSK, the **Delay** control on the CW TX Menu must be set to zero. This will allow the transmit/receive switching to occur immediately upon release of the key. In QSK mode the FLEX-6000s use a very fast reed relay for CW T/R switching, but at higher CW speeds (above 30 WPM) better inter-element receiving results are obtained by using two antennas, one for transmitting and another for receiving. Refer to section **25, How to Configure Antennas** for information on how to configure separate transmit and receive antennas. Full break QRQ is available only in the FLEX-6600/M and FLEX-6700 models.

19.5 HOW TO CONNECT AN EXTERNAL KEYSER USING THE FSK/KEY INPUT ON THE ACCESSORY CONNECTOR

In CW mode, the FSK/Key input on the FLEX-6000 rear panel accessory connector (pin 4) can be used as a straight key input. This is useful if you wish to attach an external keyer, such as a K1EL WinKeyer, microHAM microKEYER, or another contest-oriented interface. This input is always active and is not affected by the FLEX-6000 internal keyer settings. It's therefore possible to use both the external keyer and the internal keyer at the same time.

19.6 USING CW WITH A CONTEST LOGGER

At the time of this writing, SmartSDR for Maestro v1.7 has certain limitations concerning CW contesting that should be considered if you will be using a logger in conjunction with the Maestro and a FLEX-6000. A typical contesting setup would include a logger, such as Logger+ from N1MM, that is connected to the FLEX-6000 via a CAT interface. An additional Winkeyer emulation interface is provided in CAT (see the *SmartSDR for Windows Software Manual*) which will allow Logger+ to send CW through the radio using Winkeyer commands. Using this method will only produce CW sidetone in the radio speaker and headphone outputs. This limitation, which is likely to be lifted in the future, may conflict with using the Winkeyer inside of Maestro because the sidetone for the Winkeyer is only output through the Maestro speaker and headphone connections, to avoid unnecessary network delay in the sidetone which can affect keying comfort in the CW operator.

Because of this limitation, it is recommended that headphones and CW paddles be connected to the radio when Maestro is used for CW operation in conjunction with a logger. Again, this limitation will likely be removed in a future release of SmartSDR for Maestro.

20 HOW TO OPERATE SINGLE SIDEBAND MODE (SSB)

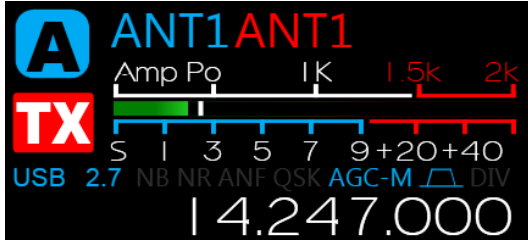

To use the Maestro in SSB mode, select either USB or LSB in the **Slice Receiver Menu**. This brings up the SSB receive filter presets and shows the SSB-specific controls in the transmit panel. Conventional USB or LSB settings are automatically selected for each band when the band selection panel is used.

In SSB modes, the Slice carrier indicator line will be located to the left of the receiver passband for USB and to the right for LSB. It shows exactly the location of your transmitted SSB suppressed carrier frequency. If the Slice is the Active Slice, the carrier indicator line will be displayed in yellow. If the other Slice is active, it will be displayed with a red carrier indicator.

20.1 HOW TO SELECT THE SSB RX FILTER BANDWIDTH

1.8K	2.1K
2.4K	2.7K
2.9K	3.3K
4.0K	6.0K

Standard SSB receiver filter bandwidths from 1.6K to 6.0K can be selected from the **Slice Receiver Menu**. Custom bandwidths can be adjusted by use of the High/Low Shift/Width multi-function control. When the control is in High/Low mode, adjusting the inner knob moves the location of the lower frequency margin of the filter while adjusting the outer knob moves the location of the higher frequency margin. Pop-up displays provide detailed information as the adjustments are made.

20.2 SELECTING RX FILTER FAVORITES

A favorites function allows the selection of the most commonly used filter bandwidths and provides a convenient way to toggle between these filters. To select a favorite, press and hold the square containing the favorite filter. A small triangle will be added to the filter square. Do this for as many favorites as desired.

A short press of the BW Select knob will cycle through the filters chosen as favorites.

20.3 HOW TO OPERATE SSB IN SPLIT MODE

Many DXpeditions prefer to operate in split mode, in which they transmit on one frequency but listen on another, up or down a few kilohertz. To do this with Maestro, the A Slice must be set to the DX station's transmitting frequency, and the B Slice must be inactive. Press the B Slice TX button. The B Slice will become active, its frequency will be set to a value 5 KHz higher than the A Slice Receiver's frequency and the transmitter control will move to the B Slice. Your Panadapter display should look similar to this:

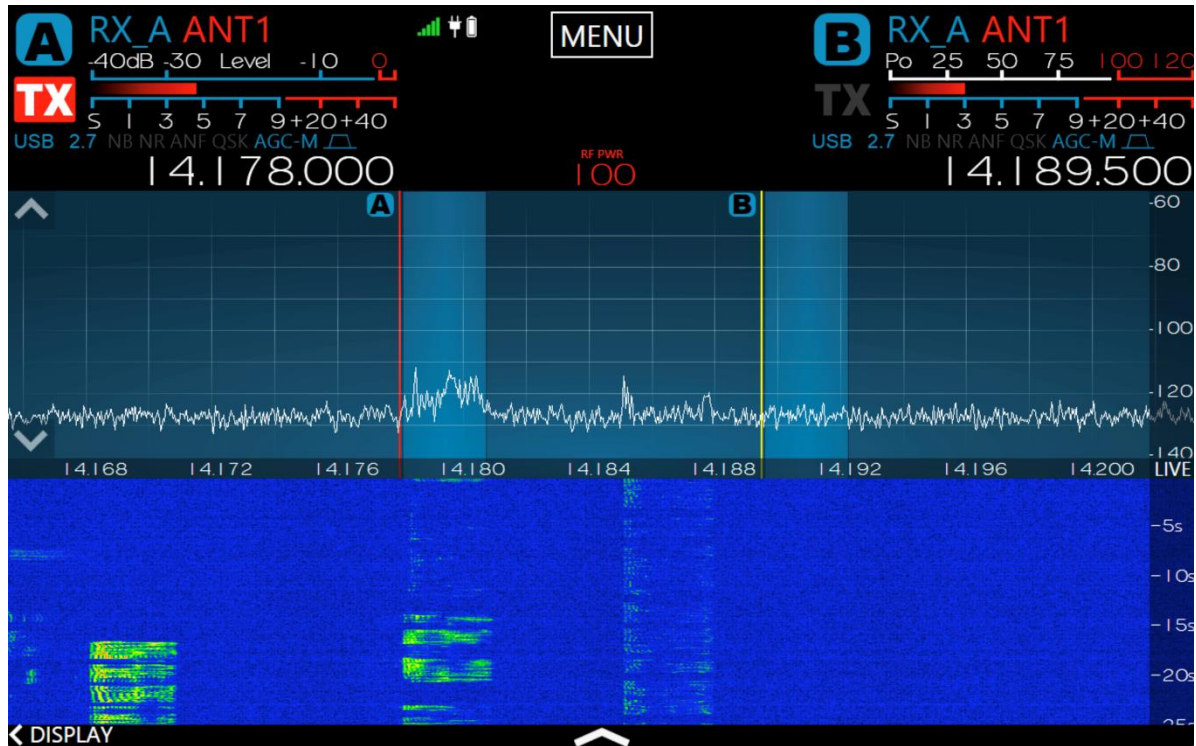

If you prefer, you can use the Slice audio controls to pan the Slice audio so one receiver is in your left ear and the other is in your right ear. Touch and drag the L/R control in the **Slice Receiver Menu** to move that Slice Receiver's audio to the left or right ear.

To leave split mode and disable the transmitter, press the B-RX button to remove the B slice. Press the A-TX button to restore the transmitter to the A slice receiver.

If you have configured one of the function buttons (F1 – F6) as a **Split** button (see section 33.4, **Function F1-F6 Tab**), and if the B slice is inactive, then a single press of the function button will create the split configuration. The B slice will control the transmitter. Pressing the button a second time will disable the B slice and return the transmitter to the A slice receiver.

20.4 HOW TO CONFIGURE THE AUDIO CONTROLS FOR PHONE MODES



Connect a suitable microphone to the RJ45 MIC1 connector or the 1/8th inch TRS MIC2 connector on the back panel of the Maestro. Press the Maestro **TX Menu** button to bring up the **TX Menu**, then select the appropriate microphone from the microphone list at the left side of the menu. See section **36.6.1, Audio Modes Transmitter Menu** for a description of the inputs. See section **20.4.7, DAX TX Channel and Microphone Interaction** for information about coordinating DAX TX channel usage with microphones.

Note: With multiFLEX, the microphone PTT (and all other hardware PTT sources) will use the Local PTT Station to transmit (see section 33.15, multiFlex Tab)

20.4.1 Setting the Transmit Filter Bandwidth

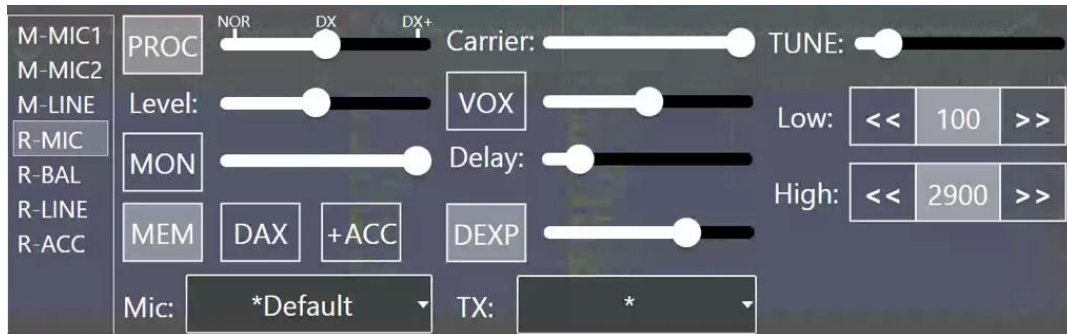

The bandwidth of a single sideband transmission is determined by the **Low** and **High** bandwidth controls found on the **TX Menu**. The bandwidth is adjustable up to 10 KHz in 50 Hz steps. The transmit bandwidth is double for symmetric sideband modes such as AM.

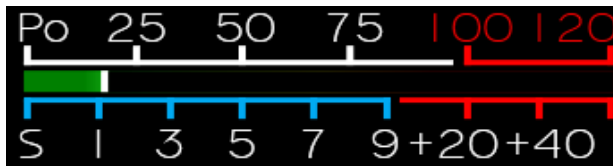

Each Slice Receiver can display an input level meter. Tap the Slice Receiver meter display to cycle through the available meters. There are two indicator components of the microphone or input Level meter that show the actual audio input level. The leftmost component is a solid bar

indicating the average input level and the smaller box-like component farther to the right of the average input level bar is the peak level indicator. The Level meter indicator bars also utilize three colors to visually indicate the input level range. Signals up to -10 dB are shown in green. Signal levels between -10 and 0 dB are shown in yellow. Any signal level greater than 0 dB is shown in red.

When setting up your microphone audio for optimal modulation, adjust the input gain so that the peak level indicator is peaking just BELOW 0 dBFS on voice peaks. Your peak level indicator must never exceed 0 dBFS and turn red at any time. A red peak level indicator indicates over-driven or “clipped” input audio levels resulting in audio distortion. The input ALC is active, but excessive input signal levels may result in input signals that can exceed 0 dBFS. If you see the peak level indicator turn red at any time, turn down the audio input level until you no longer see the peak level indicator turn red.

The compression meter indicates the amount of compression provided by the speech processor based on the PROC setting and the input gain level. This meter is informational only and is not used in setting microphone levels.

20.4.2 Operating the Speech Processor

The speech processor implements the W9GR Controlled Envelope Single Sideband (CESSB) peak limiting algorithm in SSB, AM, and FM modes. The processor may be on or off and has three different settings when enabled. In the NOR or normal setting, the processor provides minimal additional gain and simply prevents audio peaks from clipping or producing power over the set level. In the DX setting, some compression is provided to the audio to increase the overall sideband envelope which results in a stronger signal that may be more readily heard at a distance. The DX+ setting adds even more compression increasing your talk power or “punch” without incurring significant audio distortion. DX+ is most effective if you increase the low-cut TX filter to between 200-400 Hz to concentrate your talk power in the audio frequency range that has the greatest intelligibility.

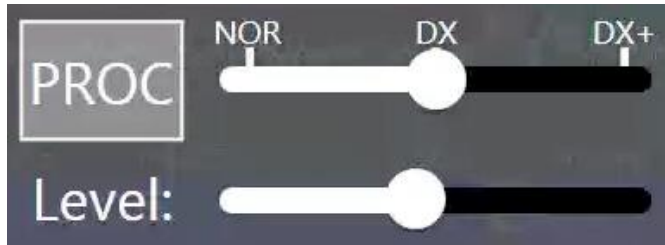

The recommended setting is to leave the speech processor enabled and in the NORmal or DX position.

20.4.3 How to Configure the Equalizer (EQ)

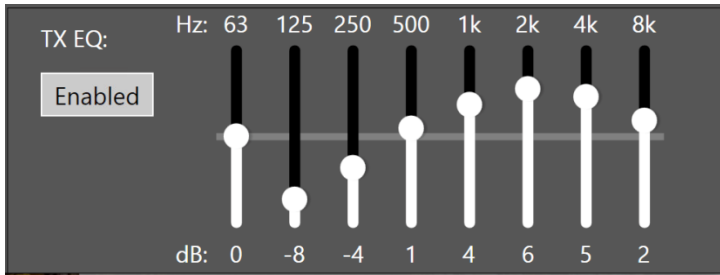

The Transmit Equalizer control panel is found on the **Transmit** tab of the **Main Menu** as shown above. When enabled, the graphic equalizer can be optimized for different microphones and operating styles such as DX, contesting, and SSB. The sliders provide a +/- 10 dB adjustment range over eight octaves. The settings shown above provide very good audio quality for many dynamic microphones.

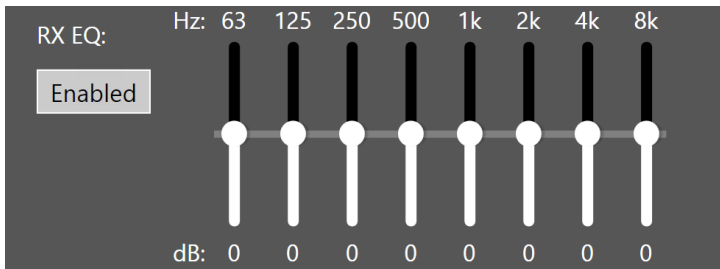

Similarly, the Receive Equalizer is found on the **Audio** tab of the **Main Menu** as shown above. When enabled, the graphic equalizer can be optimized for different listening conditions and operating styles. The sliders provide a +/- 10 dB adjustment range over eight octaves.

20.4.4 How to Configure VOX



The VOX controls are found in the **TX Menu**. Tap the VOX button to enable voice-operated transmit operation and adjust the VOX gain slider to adjust the VOX sensitivity. The sensitivity should be adjusted to the minimum that allows reliable keying by the voice without keying from other room noises. **VOX Delay** sets the hang time before the transmitter unkeys after you stop speaking. The delay should be set to be comfortable for the style of operation desired. See section **20.4.7, DAX**

TX Channel and Microphone Interaction for details concerning the interaction of VOX and the DAX TX channel.

20.4.5 Monitor Mode Operation

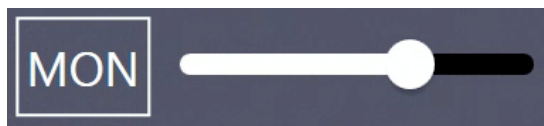

The Monitor controls are found in the **TX Menu**. Monitor mode is enabled by tapping the MON button. The monitor level may be controlled by the adjacent slider.

Note: The MON feature allows for monitoring of the processed audio before the final brick wall filtering and ALC limiting, compression, and equalization, allowing the operator to listen to the transmitted audio in “real-time” with minimal latency or delay. However, since the monitor audio bypasses the signal processing stages, the audio heard in the monitor is not the same as what is being transmitted and therefore is not suitable for determining the over-the-air quality of your transmitted signal.

NOTE: When operating in multiFLEX with multiple Stations connected, when the MON is on, the transmit audio will be heard from whichever Station is transmitting. This is mutually exclusive with Full Duplex operation.

20.4.6 How to Configure the Downward Expander (DEXP)



The Downward Expander controls are found in the **TX Menu**. The Downward Expander reduces the microphone input gain during the quiet periods between spoken words, eliminating extraneous background noise. This improves the apparent signal-to-noise ratio of your transmitted audio by “soft gating” ambient room noise between words.

To adjust the Downward Expander, enable **DEXP** and move the DEXP Threshold slider to 0. While transmitting and listening with MON without speaking, adjust the DEXP Threshold until you can no longer hear the background or ambient noise at your operating position. In most cases, a DEXP threshold level of 60-70 should be sufficient.

20.4.7 DAX TX Channel and Microphone Interaction

When the DAX TX channel has been selected to provide audio for the transmitter (DAX button in the **TX Menu**), the radio will still accept audio from the selected microphone as long as the DAX TX stream contains no data. As soon as data appears, the DAX TX channel becomes the transmitted audio.

This feature is provided to support voice keyer configurations. The user can enable both the DAX TX channel and a microphone and use the microphone normally as long as the voice keyer program is not sending a message. When a voice keyer message is desired, the associated program simply

plays the audio into the DAX TX channel and the transmitter automatically switches to it, overriding the microphone.

Similarly, VOX can be triggered from either the DAX TX channel or the selected microphone audio. If the DAX TX channel information is above the VOX triggering level, DAX will key the radio.

20.5 MONITORING YOUR TRANSMITTED AUDIO

The Quick Record and Playback feature in Maestro can be used to monitor your transmitted audio. The audio recorded in this manner represents transmitted audio using all of the enabled signal processing features so that adjustments can be made to optimize your transmitted audio.

- Connect your radio to a dummy load and switch the transmit antenna to the appropriate antenna connector or turn down the power output to 1W (a setting of 0W will not transmit any audio).
- Open the control panel for the Slice Receiver that controls the transmitter.
- Press **MOX** or press a PTT to enable the transmitter.
- Tap the RECORD icon (red dot) on the control panel. It will flash when recording.



- Talk normally into the microphone.
- When done, tap the RECORD icon to stop recording.
- Tap the PLAY icon to play back the transmitted audio.

See section **11.7, Recording and Playback of Slice Receiver Audio** for complete details on the usage of this feature.

20.6 RECOMMENDED AUDIO ADJUSTMENT STEPS FOR PHONE MODES

The use of a second receiver to monitor your transmitted audio in real-time is the preferred method for making the adjustments listed below. Otherwise, use the Quick Record and Playback procedure described above for monitoring your transmitted audio and making the following adjustments.

- Select the desired microphone input from the list in the **TX Menu**.
- Select the desired transmit filter width on the **TX Menu**.
- Turn the speech processor off by pressing the PROC button in the **TX Menu** so that it is not highlighted.
- Adjust the TX Equalizer to compensate for the microphone and operating conditions. The default setting is a good starting point for most microphones. The TX EQ is located after the processor in the signal chain, so it should typically be adjusted before engaging the processor. Minor adjustments can be made after engaging the processor, but care is needed to avoid excessive peaks.
- Speak into the microphone at the loudest voice level you would normally use.
- Adjust the microphone gain control so that the peak indicator hovers near 0 VU on the Level meter. **Most microphones will require the +20 dB gain preamp to be enabled** on the Phone/CW tab of the **Main Menu**.
- Turn on the speech processor with the PROC button. The adjacent slider sets the Compression setting. In most cases use the NORM (normal) setting. Selecting DX and DX+ adds additional compression without distorting the audio.
- Readjust the transmit equalizer to optimize the audio for your voice characteristics, the desired operating style, and microphone response once PROC is enabled.
- Enable the DEXP, setting it for your operating position's ambient background noise. Ideally, any device that generates background noise should be on so that the DEXP is optimally configured.
- If VOX operation is desired, enable the VOX button and adjust the VOX gain/delay for proper operation.

The settings described above are included in MIC profiles. After the controls are adjusted, their settings can be saved for future use by storing a MIC profile. See section **16.1, MIC Profiles**.

21 HOW TO OPERATE AM AND SAM MODES



To use the Maestro in Amplitude Modulation (AM) or Synchronous AM (SAM) mode, select either AM or SAM in the **Slice Receiver Menu**. In selective fading conditions, SAM mode may provide better detection of AM signals. The carrier frequency indicator is shown at the center of the filter passband.

Standard AM receive filter bandwidths from 5.6K to 20K can be selected from the **Slice Receiver Menu**. Custom bandwidths can be adjusted by use of the High/Low Shift/Width multi-function control. When the control is in High/Low mode, adjusting the inner knob moves the location of the lower frequency margin of the filter while adjusting the outer knob moves the location of the higher frequency margin. Pop-up displays provide detailed information as the adjustments are made.



The AM Carrier control is found on the **TX Menu**. It allows the carrier level to be set while maintaining a constant overall PEP output of the transmitter. With the AM Carrier control set to maximum, standard 25% carrier operation is provided. When both the RF Power and AM Carrier controls are set to maximum, the carrier level will be approximately 25W, and the PEP output will be approximately 100W. Reducing the RF Power control will reduce the carrier level and PEP in proportion. By reducing the AM Carrier level, the percentage of carrier relative to total PEP can be reduced to increase talk power in the AM sidebands. This is called Reduced Carrier AM.

22 HOW TO OPERATE FM MODE

To use the Maestro in Frequency Modulation (FM), Narrow FM (NFM) mode, or Digital FM (DFM) mode, select either FM, NFM, or DFM in the **Slice Receiver Menu**.

Wide FM is the standard FM mode used by commercial radio stations and provides 5kHz deviation FM modulation and demodulation with pre-emphasis and de-emphasis, CTCSS tone encoding, and memories.

NFM is the same basic mode but with a 2.5kHz deviation for narrower channel spacing.

DFM is a digital FM mode providing 5kHz of deviation, but no pre-emphasis and de-emphasis. This mode can be used for modulation of digital data that prefers a flat bandpass such as 9600 baud packet data.

When an FM mode is selected, controls specific to FM modes are displayed in the **Slice Receiver Menu**, as shown below.



22.1 OPERATING FM REPEATERS

From left to right, the first of the FM-specific controls enables and disables CTCSS tones in transmissions. The second control selects the CTCSS tone value. The repeater controls, “-”, “SIMP”, and “+” set the repeater offset direction or enable simplex mode (no offset). The REV button enables a quick frequency change to the repeater split or transmit frequency. The Offset control selects the frequency offset or “split” in MHz for repeater operation.

22.2 MEMORY CHANNELS

FM settings can be stored in the Memory form accessible on the **Memory** tab of the **Main Menu**. The memory form, as shown below, stores the memory frequency along with other settings such as the mode, CTCSS tone, etc. Although this feature is optimized for use in FM mode, it can be used in any mode.

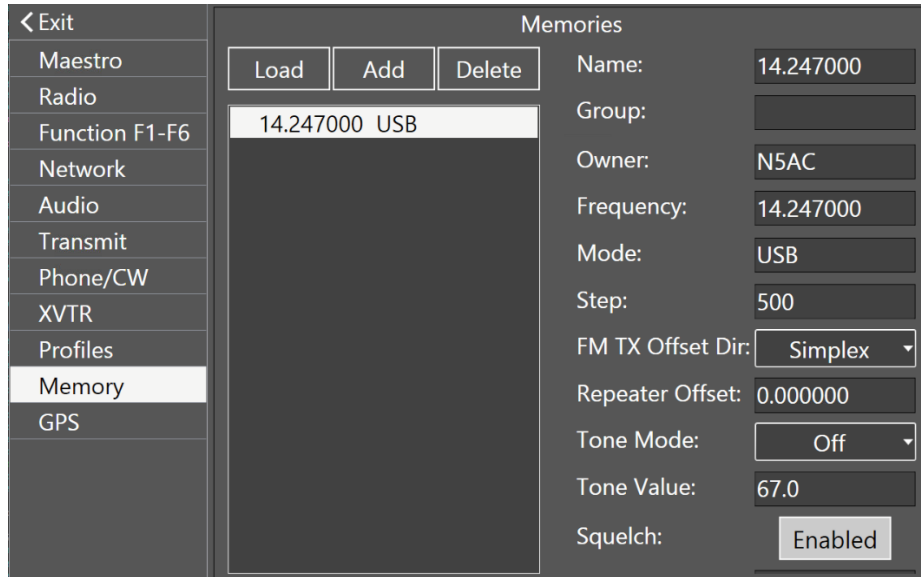

The memory form allows individuals to create lists that can be shared with others. For example, your local club may produce a list of frequencies all with a common "group" name. This group of channels can be independently exported and imported using *SmartSDR for Windows*.

To create a memory entry, adjust the settings of the radio as you want them to be recorded, then click the **Add** button. The new entry will appear on the memory screen.

To invoke a stored setting, open the Memory screen, click on the desired entry, then click the **Load** button.

To delete a stored setting, open the Memory screen, click on the entry to be deleted, and then click on the **Delete** button.

The fields in a memory entry are defined as follows:

- **Name** - A unique name for this memory - Initially blank.
- **Group** - The combination of Group/Owner identifies a set for import when using *SmartSDR for Windows*. When importing, the existing Group/Owner memories will be removed before importing the new fields. This makes it easy for a user to keep a master list of memories and distribute them and not have to worry about merging existing old data - initially blank.
- **Owner** - This is important for importing files and is typically the callsign of the person creating the memory. This will be populated automatically when creating a new memory if a callsign has been entered in Maestro.
- **Frequency** - The frequency to tune the Slice when selecting the memory. This will initially be set to the Active Slice frequency when adding a memory.

- **Mode** - The Modulation/Demodulation mode for the Slice (e.g. USB, CW, FM, etc.). Initially set to the Active Slice mode.
- **Step** – The frequency step size in Hertz, associated with this setting.
- **OffsetDirection** - If in FM mode, this sets the direction for the repeater transmitter offset. Options are Down, Simplex, and Up. Initially, this will be set to the matching setting in the Active Slice.
- **RepeatersOffset** - The offset in MHz. Initially, this will be set to the matching setting in the Active Slice.
- **ToneMode** - In FM transmit, this can be set to Off or CTCSS TX for PL tones. Initially, this will be set to the matching setting in the Active Slice.
- **ToneValue** - The tone value in Hz to use for CTCSS TX

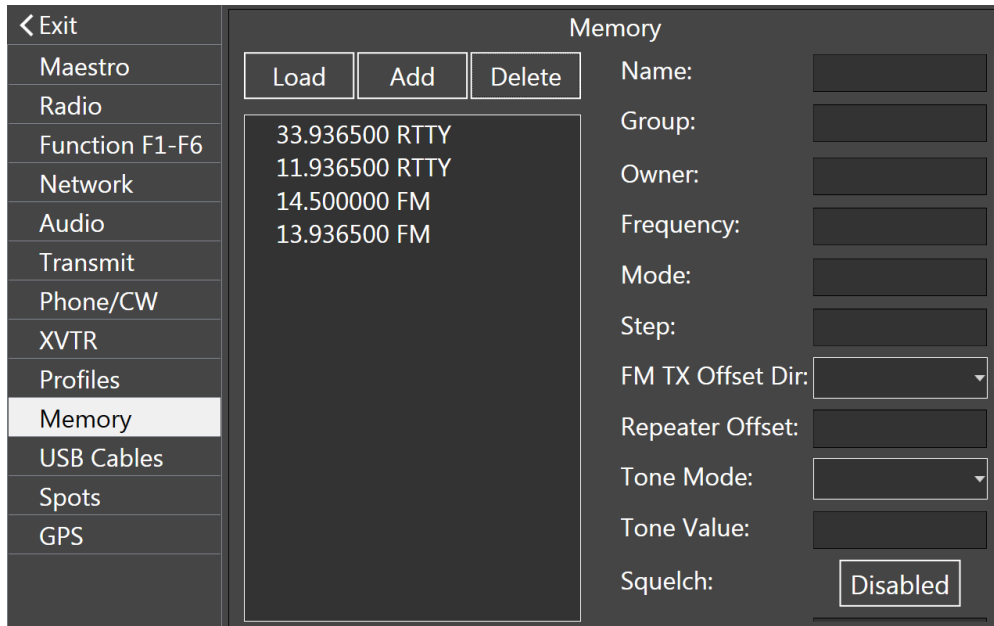

- **Squelch** – Turns FM Squelch on or off.
- **Squelch Level** – The Squelch threshold value.
- **RF Power** - The power setting from 0-100 to use for this memory.
- **RX Filter Low** - The Receive Filter Low Cut in Hz
- **RX Filter High** - the Receive Filter High Cut in Hz
- **RTTY Mark** - The mark frequency when using RTTY mode
- **RTTY Shift** - The shift frequency when using RTTY mode
- **DIGL Offset** - The offset when using DIGL mode
- **DIGU Offset** - The offset when using DIGU mode

Note: Memories and Profiles are two separate features that may appear similar. However, memories record a relatively small number of radio configuration parameters, as listed above, while Profiles record many more parameters.

23 HOW TO OPERATE DIVERSITY RECEPTION (FLEX-6600(M) AND 6700 ONLY)

Diversity reception is a powerful method for improving the readability of a signal by using two or more communication channels with different characteristics. Diversity reception is very useful for aiding reception in weak and fading (QSB) signal conditions. With optimally configured antennas, weak signal QSB copy can be improved by as much as 75%.

Two common diversity reception methods are space and polarization. These methods use separate antennas to receive different versions of the same signal. The FLEX-6700 incorporates two fully independent Spectral Capture Units (SCUs) that allow two separate antennas to be simultaneously digitized. The analog-to-digital converters (ADCs) in the respective SCUs are driven from a single clock source to provide stable synchronous reception.

Note: Since the FLEX-6500 and FLEX-6300 use a single SCU, they are not capable of diversity reception.

For best results, antennas should be de-correlated in some way so that fading on one antenna is likely to be seen as increased signal strength on the other antenna. De-correlation can be accomplished by using different types of antennas (dipole and vertical), using the same type of antenna at wide spacing (e.g. multiple wavelengths), or using the same antenna with different polarizations (horizontal and vertical or right and left). The more de-correlated the antennas the better, but even small amounts can be beneficial. One interesting example of the application of circular polarization diversity on HF is discussed in the December 2010 QST article, “Gimme an X, Gimme an O, What’s that Spell? – Radio.”

The diversity reception implementation provided in Maestro is intended for use only with headphones. Two Slice Receivers attached to separate antennas are automatically routed to the left and right ears so that the brain can provide discrimination between the signals. Speakers are not recommended because they allow the audio signals to combine in the space between the speakers to cause undesirable peaks and nulls in the sound.

To enable diversity reception, tap the DIV button in the **Slice Receiver Menu** as shown below. This will create a diversity slave Slice locked to the same frequency as the master Slice of the diversity pair.

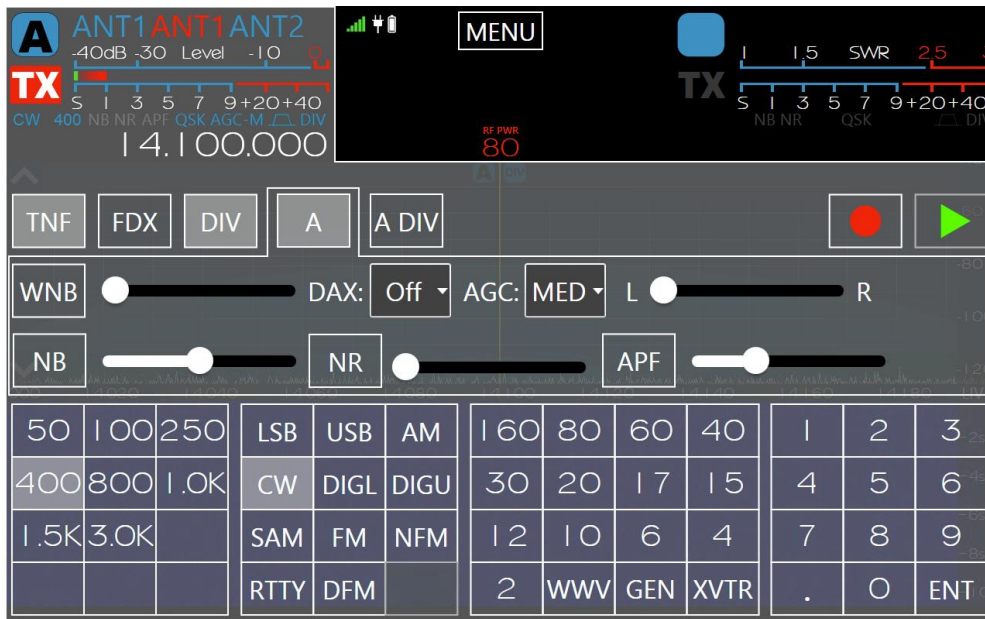

As seen in the image below, after diversity reception has been enabled a weak SSB signal has been tuned on Slice A attached to ANT1, and the slaved diversity Slice on ANT2 is locked to the same frequency.

Note: The RXA, RXB, and XVTR ports are also available for receiver inputs.

Maestro automatically sets the Slice audio faders to place the two antennas in the left and right ears respectively. Your brain does the rest. Remember that the sound will be very different from normal reception since you are listening in “stereo” to the same signal on two different antennas. Adjustments made to the AF knob raise and lower both slice receivers in unison.

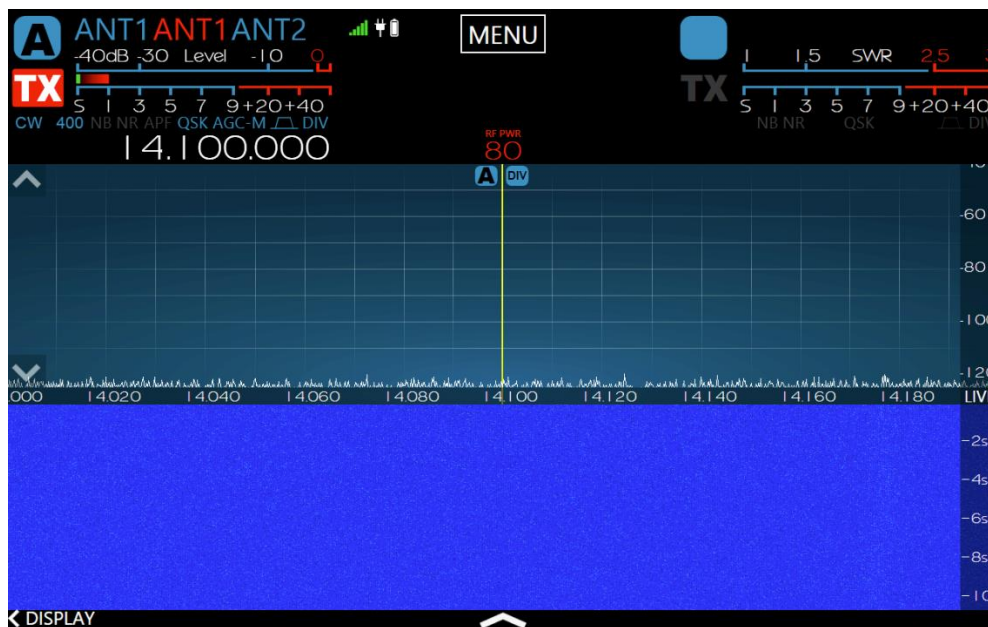

24 HOW TO OPERATE THE ATU

The antenna tuning unit (ATU) is a device in the RF signal path that improves power transfer from the transmitter to the antenna by transforming the apparent antenna impedance seen by the transmitter to a value compatible with the transceiver's power amplifier (PA). An ATU is useful when the antenna's feedline impedance is unknown, complex, or otherwise different from the transceiver's. It's important to remember that the ATU does not affect the actual SWR of the antenna and feedline. It does however change the impedance presented to the transmitter by the ATU.

Note that the radio software automatically folds back transmitter power so that the power reflected by the antenna and tuner system does not exceed 25 watts. This feature protects the Power Amplifier but should not be relied upon when operating with a mismatched antenna. Use of the ATU or an external tuner is recommended to match the transmitter to the antenna and minimize power reflected to the Power Amplifier.

The FLEX-6000 ATU is a standard feature of the FLEX-6700 and FLEX-6500 and an option for the FLEX-6300. The operation of the ATU is controlled by the Maestro software.

24.1 MODES OF OPERATION

There are two modes of ATU operation, Manual and Memory. In Manual mode, the user initiates an ATU tuning operation to attempt to find a better match between the PA and the antenna system, but the inductance (L) and capacitance (C) values that are found are not retained and the ATU will revert to Bypass mode if the frequency or band is changed. Memory mode is an extension of Manual mode in which the L/C values are retained and automatically used when the frequency of the transmit Slice is within the ATU Match Frequency Range.

The ATU will try to impedance match the load to as close to a 1.1:1 SWR as possible. If the ATU measures an SWR of 1.1:1 or better at the beginning of the matching process, the ATU stops searching and remains in Bypass mode.

A successful ATU tuning on 6m occurs when the SWR is improved from the initial SWR determined in the Bypass state and is better than 2.32:1. On other bands, a successful ATU match is one where the SWR is improved from the bypass SWR reading and is better than 1.7:1.

The ATU will stay enabled but the **ATU** button will not be lit if the SWR improves from Bypass but does not meet the SWR criteria described above. If the resulting SWR after an ATU tuning operation is not better than when in Bypass and the above SWR criteria are not met, the ATU goes into Bypass mode and the **ATU** button will not be lit.

24.2 ATU MATCH FREQUENCY RANGE

After the ATU has found a successful match, the inductance (L) and capacitance (C) values are valid for a 200 kHz frequency span centered at the frequency the ATU tuning operation was initiated, or +/- 100 KHz. Once you tune the frequency of the transmit Slice beyond that range, the ATU will be put into Bypass mode unless there is a previously saved ATU memory at the new frequency.

24.3 MANUAL MODE

To operate the ATU in Manual mode, make sure the **ATU MEM** button in the **TX Menu** is unlit by tapping it. ATU memories are enabled by default.

Tune the transmitter to the desired frequency. Press the **ATU** button to initiate an ATU tuning operation. The ATU will set the power output to approximately 2W on 6m and 10W on all other bands during the tuning operation. The ATU will tune until it either achieves a successful impedance match or finishes in Bypass mode. Note that if the ATU determines that Bypass provides the best match, and the resulting SWR is less than the criteria for success, this is considered a successful tuning operation.

Tuning the transmit Slice to a frequency outside of the ATU Match Frequency Range or to a different band will disable the ATU, putting it into Bypass mode. The **ATU** button will be off.

The **ATU** button will illuminate in red immediately after it is pressed, while the tuning operation is in progress.

The **ATU** button will illuminate in green when a match is found resulting in an SWR less than the match criteria for the band. This includes Bypass mode when the antenna system is well-matched.

If a good match cannot be found, the **ATU** button will be off. If a partial match is found – the ATU can improve the match but can't meet the criteria for a good match -- the ATU will remain engaged with the partial match and the **ATU** button will be off.

24.4 MEMORY MODE

To operate the ATU in Memory mode, make sure the **ATU MEM** button in the **TX Menu** is lit by tapping it. ATU memories are enabled by default.

Tune to the desired frequency. If the ATU has successfully tuned the selected antenna at or near this frequency in the past, the **ATU** button will illuminate in green indicating the stored result has been applied. This includes Bypass when Bypass is best. If the button is not lit, an acceptable match is not stored, and the transmitter should not be used until the problem is corrected.

Pressing the **ATU** button will start a new tuning cycle and the results will replace the previously stored results for that frequency. The ATU will set the power output to approximately 2W on 6m and 10W on all other bands during the tuning operation. The ATU will tune until it either achieves a successful impedance match or finishes in Bypass mode. Note that if the ATU determines that Bypass provides the best match, and the resulting SWR is less than the criteria for success, this is considered a successful tuning operation.

The **ATU** button will illuminate in green when a match is found resulting in an SWR less than the match criteria for the band.

If a good match cannot be found, the **ATU** button will be off. If a partial match is found – the ATU can improve the match but can't meet the criteria for a good match -- the ATU will remain engaged with the partial match and the **ATU** button will be off.

Regardless of the outcome, when in Memory mode, the ATU will update its stored settings so that they can be reapplied when the transmitter is tuned to the frequency again.

For high Q antennas that have a very narrow low SWR range, ATU memories may be saved every 10 kHz for a very granular ATU memory profile for that particular antenna.

To clear the ATU memories, tap and hold the **ATU MEM** button until the **Clear ATU Memories** option appears, as shown below. Tap the option to clear the memories.



25 HOW TO CONFIGURE ANTENNAS

25.1 GETTING STARTED

When Maestro starts, it loads a single Panadapter and Slice Receiver with Antenna 1 (ANT1) selected by default. Transmit and receive operations are then functional on ANT1 with no further setup or adjustment required.

25.2 SELECTING THE TRANSMIT ANTENNA FOR A SLICE RECEIVER

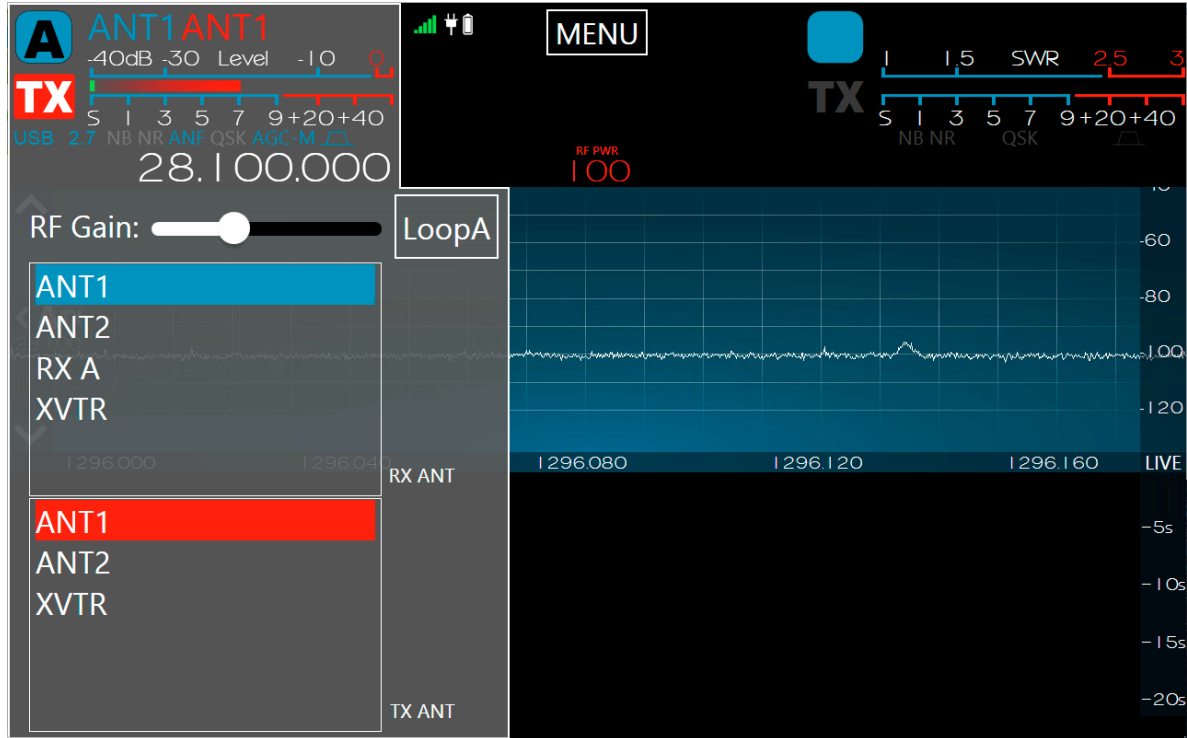

The transmit antenna for each Slice is selected from the **Antenna Menu** shown on Slice A above. The transmit antenna selector offers the same ANT1, ANT2, and XVTR options on both the FLEX-6500 and FLEX-6700 models. Each Slice may have its own designated transmit antenna. Open the menu by tapping on the antenna indicators in the Slice Flag.

Loop selection is provided in the Slice Receiver **Antenna Menu** and is indicated next to the receive antenna selector on each Slice. The example shown above indicates that the RX A loop is active and connected to ANT1.

25.3 ANTENNA OPTIONS FOR PIN DIODE QSK OPERATION

Full QSK operation with reception between individual CW elements is supported on a single antenna at speeds up to 30 WPM. QRQ QSK is supported at 100+ WPM when a separate receive antenna is used on the RX A, RX B, or XVTR inputs. The QSK annunciator located just above the frequency display on each Slice Receiver Flag indicates that QSK is possible in the selected mode. QSK is not supported with a separate receive antenna if that antenna is connected to ANT1 or ANT2.

25.4 USING A COMMON RECEIVE ANTENNA WITH SEPARATE TRANSMIT ANTENNAS

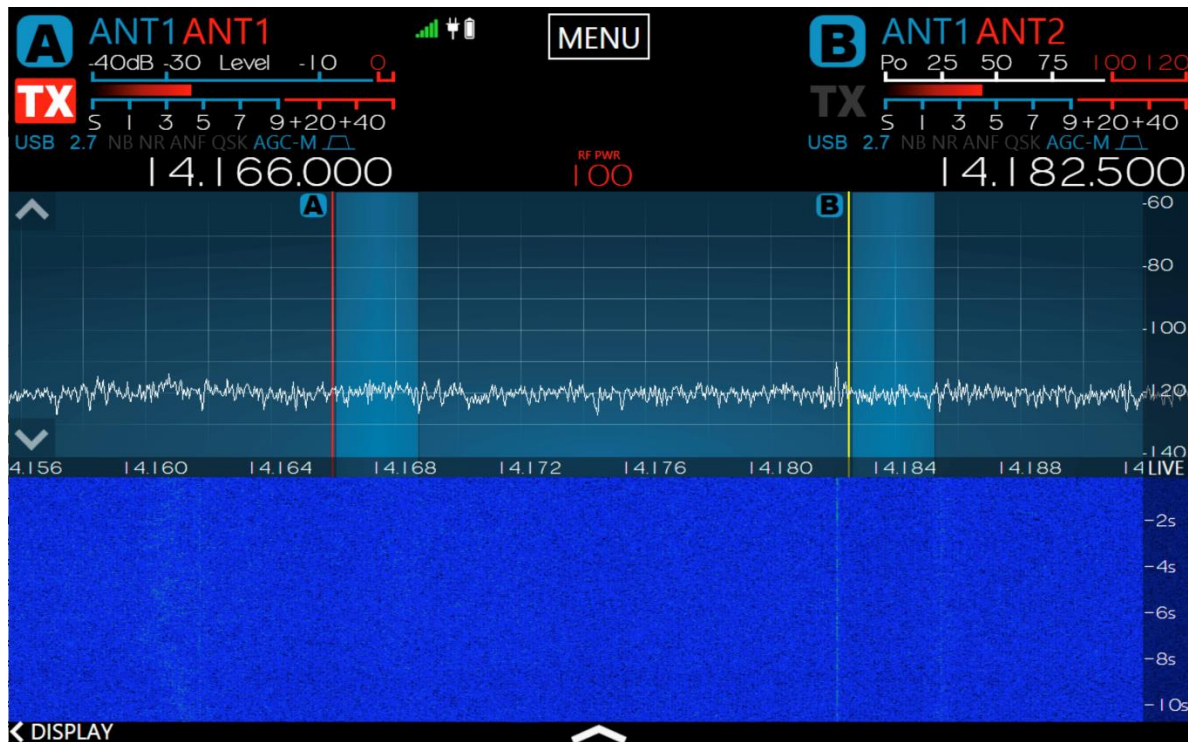

The image above illustrates two Slice Receivers using a single receive antenna (ANT1) but using separate transmit antennas on ANT1 and ANT2 respectively. Both Slice A and B have ANT1 selected. Slice A has ANT1 selected as the TX antenna and Slice B has ANT2 selected as the TX antenna. Tapping the TX indicator in the Slice Flag changes the TX indicator to red and activates the Slice as the transmitter with its TX antenna.

25.5 USING TWO TRANSCEIVE ANTENNAS ON THE FLEX-6700

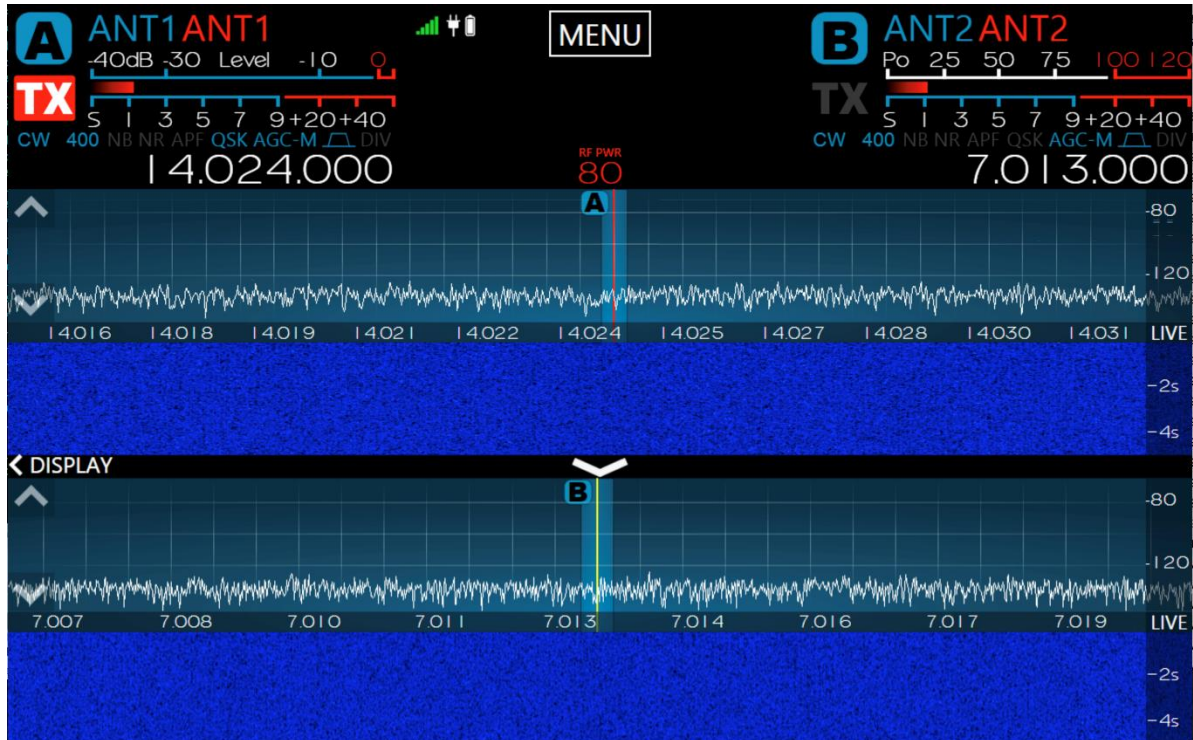

In the image above, Slice A is set to receive and transmit on ANT1. Slice B is set to receive and transmit on ANT2. Slice B is selected as the active transmit frequency of 7.033 MHz on ANT2 as indicated by the red TX button. To move the transmit frequency to 14.225 MHz on ANT1, simply tap the TX button on Slice A, or press the TX A button.

25.6 USING A DEDICATED RECEIVE ANTENNA

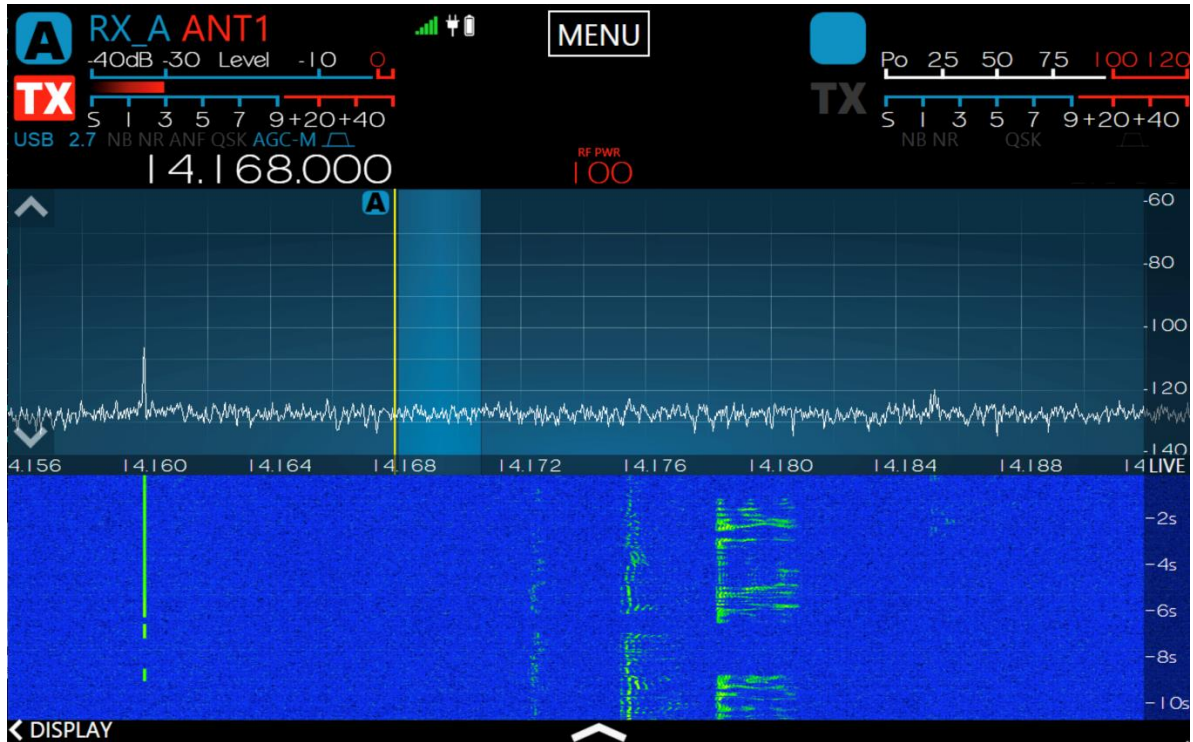

In the image above, Slice A has a dedicated receive antenna on RX A and is transmitting on ANT1. The FLEX-6700/6700R models have the option of using separate receive antennas on RX A and RX B respectively. The FLEX-6500 has only the RX A option. The FLEX-6300, FLEX-6500, and FLEX-6700 all have the option of receiving from the XVTR port. *The XVTR port is not recommended as a receive antenna port if an external preamp is used on its antenna. Transmission on the XVTR port could put up to +10 dBm of reverse power into the connected preamp.*

25.7 RECEIVE-ONLY ANTENNA OPERATION

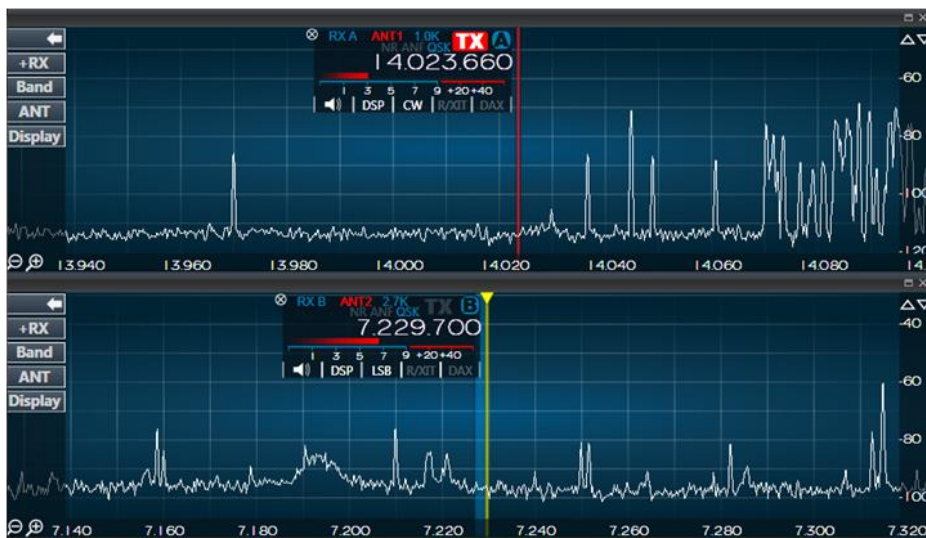

In the image above, a FLEX-6700 is configured so that the Slice A receive antenna is set to RX A and the Slice B antenna to RX B. ANT1 is selected as the transmit antenna for Slice A and ANT2 for Slice B. This configuration allows separate receive antennas on the two independent SCUs. This configuration is not available on the single SCU FLEX-6500 or FLEX-6300.

25.8 ANTENNA SELECTION FOR TRANSVERTER OPERATION

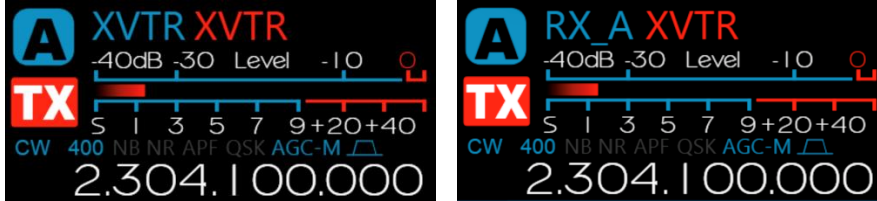

The Slice Flag shown above on the left shows XVTR selected for both receive and transmit antennas. This provides typical transverter port transceiver operation. The Slice Flag on the right illustrates the configuration in which RX A is set as the receive antenna and XVTR as the transmit antenna. This configuration supports split transmit/receive transverter operation.

25.9 USING THE RECEIVER RF GAIN/PREAMPLIFIERS

Each Spectral Capture Unit (SCU) in the FLEX-6000 includes a preamplifier with adjustable gain. The RF gain selector is located near the top of the ANT menu.

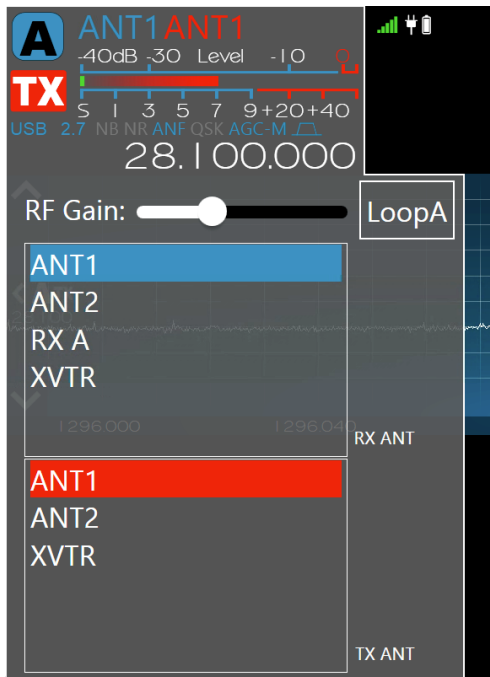

The FLEX-6300 can be set to 0dB (default) and +20dB

Note: Since the FLEX-6300 always operates in wideband mode, the preamplifier incorporates a tapered gain with a -3db cutoff located at ~14 MHz. This technique is optimized so that preamp gain and an improved noise figure are provided above 14 MHz, and the gain is tapered below 14 MHz to offset the rising noise levels below 14 MHz. At very low frequencies, the preamp will function as an attenuator when enabled.

The FLEX-6500 can be set to -10dB, 0dB (default), +10dB, and +20 dB.

The FLEX-6700 can be set to -10dB, 0dB (default), +10dB, +20dB, +30dB, and +40 dB.

Note: In some cases, the preamp of the FLEX-6700 may overload at the 20dB setting but not at the 30dB setting with the same input signal. This is caused by differences in the hardware implementation of the two preamp settings. If the 20dB setting is overloading, the 30dB setting should be tried before changing to the 10dB setting.

25.10 SETTING THE RF GAIN/PREAMPLIFIERS

Each Spectral Capture Unit in a FLEX-6000 receiver includes an RF preamplifier with adjustable gain. The RF gain selector is in the ANT menu on the left side of the screen. The gain range is selectable in 10 dB steps from -10 dB to +40 dB on the FLEX-6700, 8 dB steps from -8 dB to +32 dB on the FLEX-6400 and FLEX-6600, -10 dB to +20 dB on the FLEX-6500 and 0dB to +20dB on the FLEX-6300. The default setting is 0 dB. For typical HF operations below 12m, the 0 dB setting provides the highest dynamic range and is recommended for most locations. Even in quiet rural locations, gain is not needed or desired unless a low gain/low noise antenna is utilized.

The best way to determine the amount of gain needed for a given antenna and band condition is to disconnect the antenna and measure the receiver noise floor with the Slice Receiver’s signal level meter, then connect the antenna. If the band noise measurement without a signal present in the passband is 8 dB or more than that with no antenna, additional gain is not needed. If a directional antenna is used, it should be pointed toward the band opening for this measurement because noise propagates with the opening.

Note: Although the RF gain slider is present in every Panadapter, the gain setting controls the RF preamplifier associated with SCU. If you adjust the preamp settings for one Panadapter, all other Panadapters associated with that SCU will also be changed since the change is made to the SCU. For operational purposes, this equates to a “per antenna” basis. In the case of the FLEX-6500 and FLEX-6300 with a single SCU, the preamplifier settings affect all Panadapters and receivers.

The preamp indicator in the upper right corner of each Panadapter will be lit whenever the preamp/attenuator is turned on for the band. It will show the requested gain for a FLEX-6500 or FLEX-6700 (such as +20dB). On the 6300, the preamp provides different levels of gain by frequency. If there is a net +5dB or better gain, the indicator will show PRE. If there is a net -5dB or less gain (attenuation) then the indicator will read ATTN. If it is in between these two values, it will read ---- to indicate that the preamp is on, but not providing much change in the band of interest. This means on a 6300 that one Panadapter could have PRE and the other ATTN.

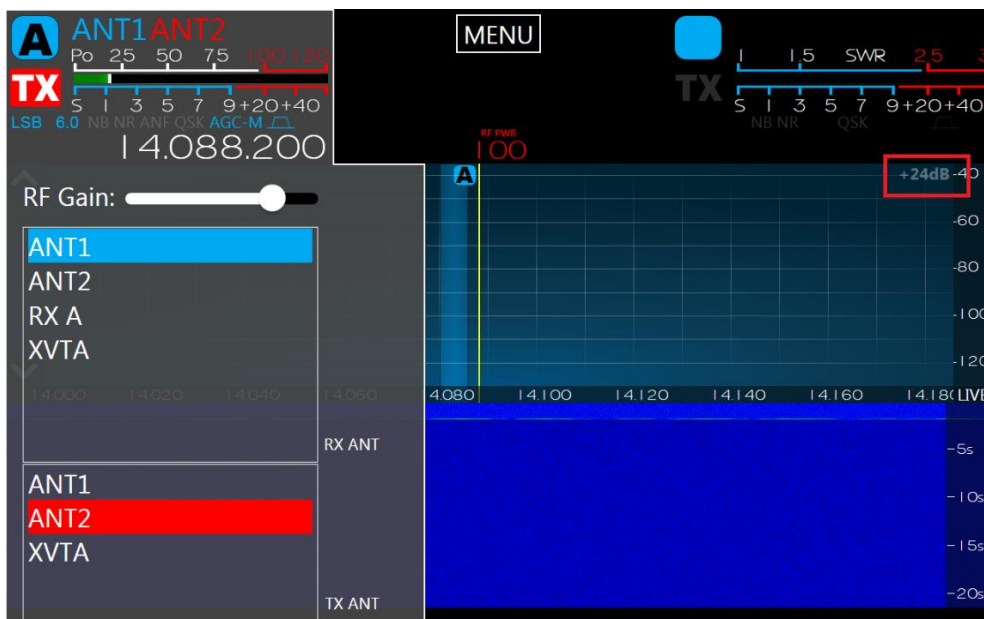

25.11 ANTENNA CONFIGURATION BASIC TERMS AND RULES

For more advanced antenna configurations, it is helpful to define terms used to describe the FLEX-6000 Signature Series architecture and the rules associated with its configuration.

- A Spectral Capture Unit (SCU) is a direct sampling, wideband digitizer that captures the entire RF spectrum within its input filter limits.
- The FLEX-6700, 6700R, and 6600(M) models contain two fully equivalent but independent SCUs. The FLEX-6500, 6400(M), and FLEX-6300 contain a single SCU.
- The FLEX-6700, 6700R, and 6600(M) models can simultaneously digitize RF from two separate antennas, one for each SCU, while the FLEX-6500, 6400(M) and FLEX-6300 digitize RF from a single antenna.
- Each Panadapter spectral display requires the selection of an associated receive antenna. The default association for the first Panadapter is ANT1.
- One or more Slice Receivers may be placed on one or more Panadapters.
- Multiple Slices and Panadapters can share a single receive antenna.
- Maestro implements at most two Panadapters and two Slice Receivers.
- In single SCU radios, all Slices must use the same receive antenna. Changing the receive antenna for a single Slice will change the receive antenna for all Slice Receivers, regardless of the number of Panadapters.
- In dual SCU radios, all Slices placed on a Panadapter must use the same receive antenna as the Panadapter. Changing the receive antenna for a single Slice will change the receive antenna for its host Panadapter and all Slices within.
- The receive RF Gain control located on the Slice Receiver's **Antenna Menu** is tied to its respective SCU/ receive antenna combination.
- Transmit antenna selection is completely independent of the receive antenna. Only one transmit Slice can be active at one time.
- The transmit Slice is selected by tapping the large "TX" button on the Slice Flag, which will illuminate the button in red, or by pressing the corresponding TX button.
- ANT1 and ANT2 ports allow transmission at 100W on 160m through 6m amateur bands. The XVTR port allows continuous coverage low power (+10 dBm max) transverter IF from 100 KHz to 165 MHz.
- Each Slice can have its own transmit antenna selection, which may be the same as or different from the assigned receive antenna.
- Each SCU on the FLEX-6700 and 6600(M) has the option of a dedicated receive-only antenna designated RX A and RX B respectively. These inputs are hard-wired to their respective SCUs and may not be switched between SCUs.

Note: This does not preclude using RX A with ANT2 or RX B with ANT1.

- A single SCU radio has the option of the dedicated receive-only antenna input RX A.
- LoopA and LoopB on the FLEX-6500 and FLEX-6700 are provided to allow connection of external preamplifiers or pre-selectors. The internal relay switching is identical to RX A and RX B respectively. However, LoopA and LoopB is a logical designation that assumes that their input is from one or both ANT1 and ANT2 ports. This means that a preamplifier installed in LoopA will be functional if either LoopA or RX A is selected. Logically RX A will assume a receive-only antenna connected to RX A and LoopA will assume that a device is connected between RX A IN and RX A OUT.

- The XVTR input/output port may be used on the FLEX-6000s as another receive-only input or may be used as a transverter transmit or common receive port. RX A and/or RX B may be used for split transmit-receive operation when selected as the receive antenna and XVTR as the transmit antenna.
- PIN diode silent CW QSK operation on ANT1 and ANT2 require that both receive and transmit be on the same antenna or that a dedicated receive-only antenna be used on RX A, RX B, or XVTR. If ANT1 and ANT2 are used separately as receive and transmit antennas, the transmitter reverts to mechanical relay TR switching. Each Slice has a QSK annunciator that indicates when PIN diode TR switching is engaged.

26 DISPLAYING SPOTS IN SMARTSDR FOR MAESTRO

SmartSDR v2.3 for Maestro introduced a feature that allows spots, supplied by third-party programs, to be displayed directly in the Panadapter window. Some of these programs include N1MM, FRStack, Slicemaster, DXLabs, and Logger32. While there is no capability in SmartSDR to directly connect to a cluster server via telnet, spots can be provided using these programs as well as any other third-party program that uses the Spot API commands in the radio. This section explains the various Spot controls that are available in SmartSDR.

When enabled, spots will appear in the panadapter display as shown below:

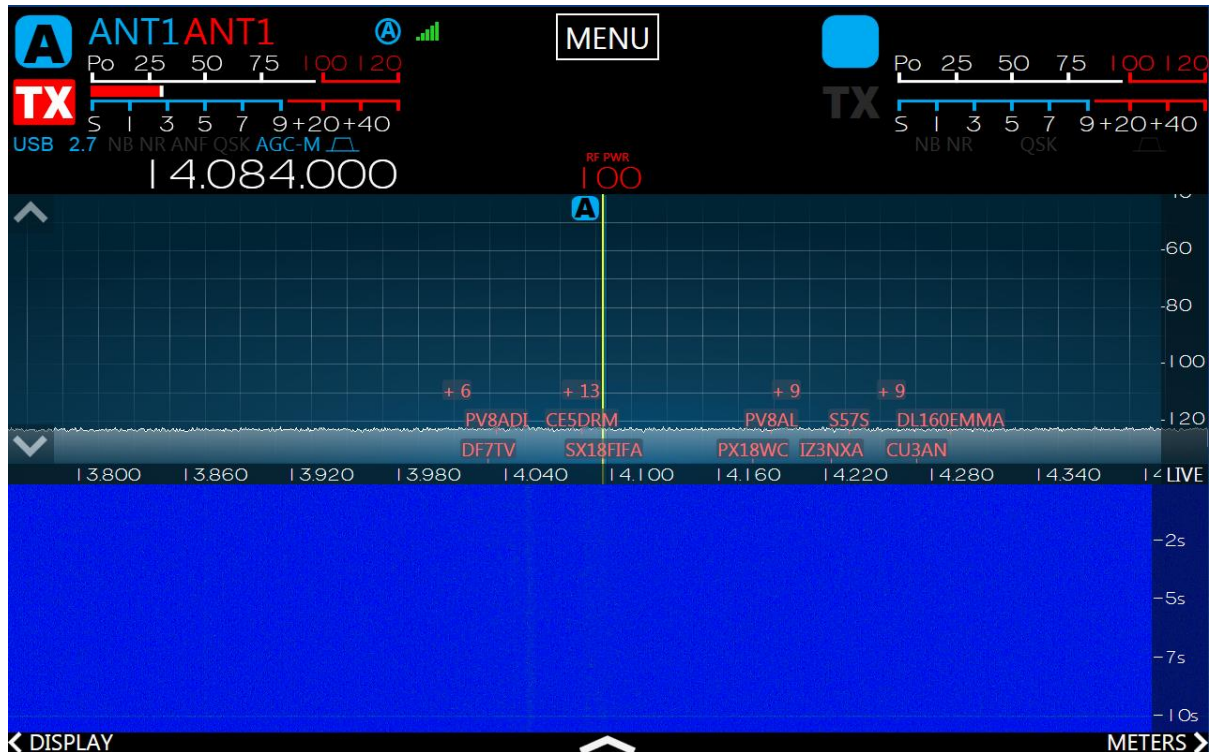

When a spot is tapped, the Active Slice will automatically tune to the spot frequency. When there are many spots in a single area, they collapse into a number value. In the image below, the “+3” is such a collection of spots. When this collection is tapped, the list of the spots expands, showing the spots in the area. Clicking any of these spots will tune the Active Slice to the spot frequency.

To see the timestamp, additional comments, and deletion option, simply touch and hold a spot. A menu will appear, as shown below:

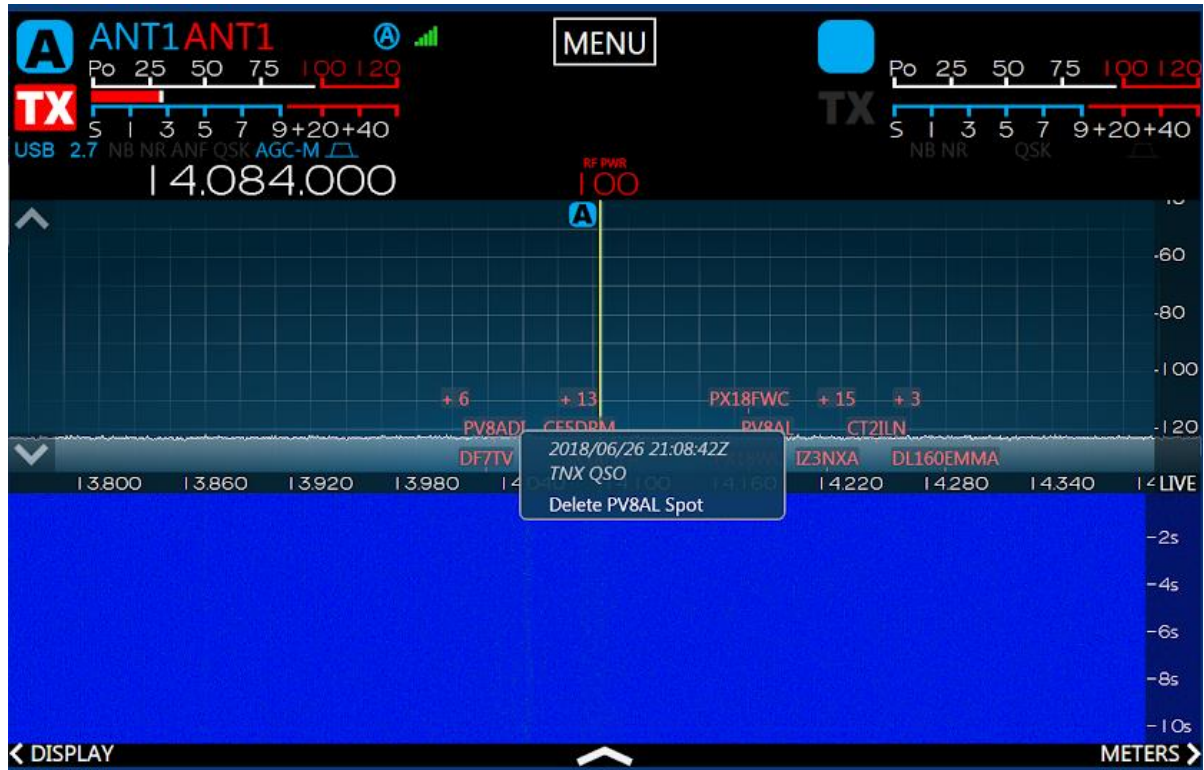

The Spot settings tab can be reached by going to **Menu → Spots**.

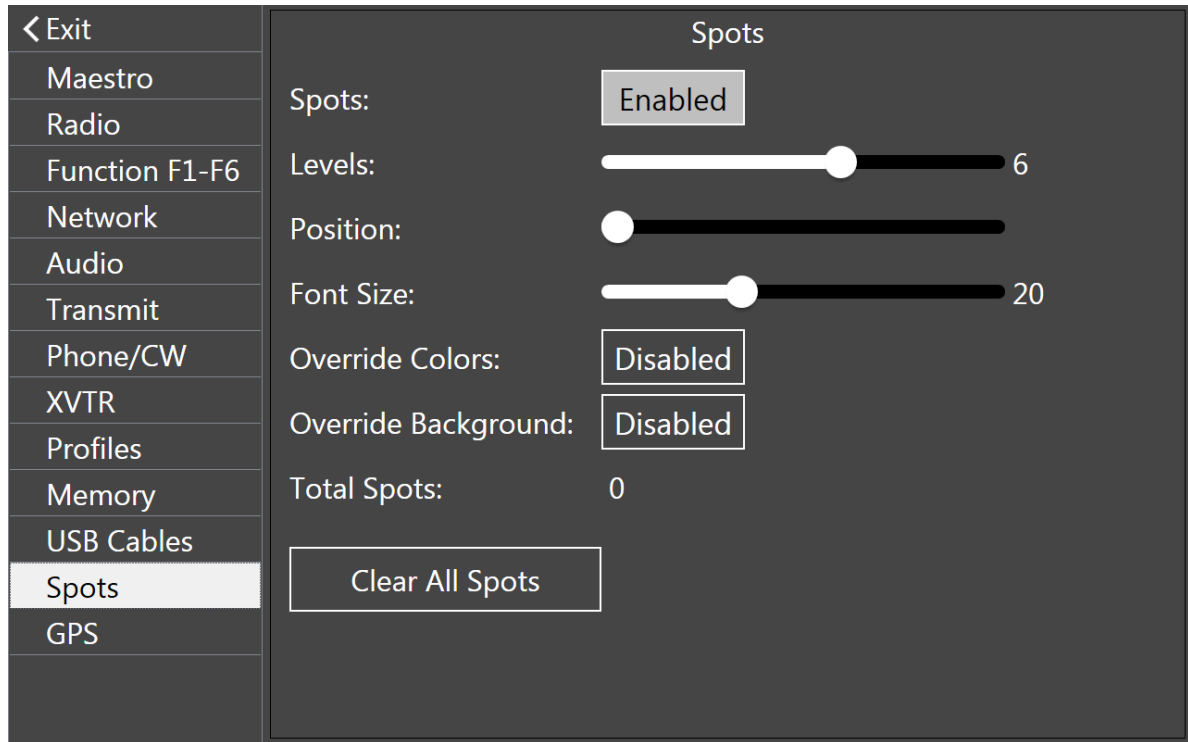

The **Spots** button enables or disables the Spots feature.

The **Levels** slider changes the depth of the displayed spots before collapsing them into a list of spots.

The **Position** slider determines the location in the Panadapter where spots will be rendered. The lowest setting places spots at the bottom of the Panadapter. Increasing this value will raise the starting position closer to the top of the Panadapter. This setting can be useful for users who prefer that spots appear above signals that appear in the Panadapter.

The **Size** slider changes the font size of the spots.

Enabling **Override Colors** will provide an option to set the colors of all spots to the color of the user’s choice, as opposed to colors specified by the application providing the spots.

Enabling **Override Background** provides an option to change the color of the spot backgrounds. The **Auto** option picks a color that contrasts well with the spot color.

Pressing the **Clear All Spots** button clears all currently collected spots on the radio.

27 HOW TO CONFIGURE TRANSVERTERS

To configure transverters, open the transverter control panel on the **XVTR** tab of the Maestro **Main Menu**. The transverter setup panel should look like this:

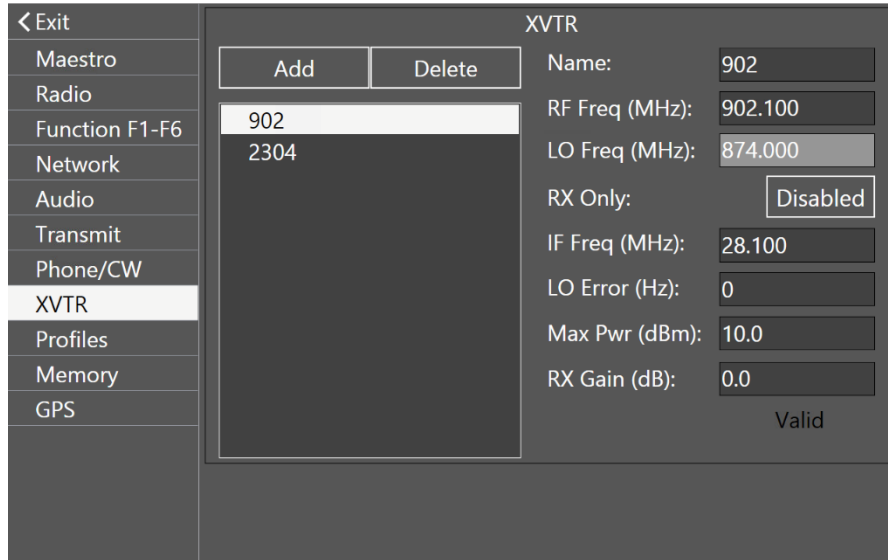

To add a transverter band, tap the **Add** button. A new transverter band tab will appear which has blanks that need to be filled in with information about your transverter. The first blank holds the name of the transverter or transverter band. Generally, you would enter something like "1296" for 1296MHz or "10G" for 10.368GHz, but you may enter any 4-character descriptor for the band that suits you. Next, the RF frequency in MHz is entered followed by the IF frequency in MHz. This is followed by any error in your local oscillator, maximum output power from the radio, and then any IF gain in your transverter. Here's a detailed description of each field and what you would input or see in the field:

Name: holds the name of the transverter, generally a reference to the RF frequency of the transverter. This name must be 4 characters or less. The name will be displayed in the Panadapter during transverter use as a reminder that RF will be passing through the transverter. The name is also used on the transverter band selection panel discussed later.

RF Freq (MHz): the output RF frequency of your transverter. This is the frequency that the final antenna will work on. Note that the RF frequency and the IF frequency are directly related to the LO frequency. You must enter an RF frequency that will be directly translated to the IF frequency. For example, if you enter "1296" for a 1296 to 28MHz transverter, you must enter "28" in the IF frequency. Do not use "1296.1" for one and "28.0" for the other unless this is the way your transverter is configured. If you have any doubts, be sure that the LO frequency calculated by Maestro matches the LO frequency of your transverter.

LO Freq (MHz): the calculated value of the local oscillator in your transverter. This number should match the transverter manufacturer's specifications. If it does not, check the RF and IF entries again and make corrections.

RX Only: Enable this if you do not want to transmit through your transverter. It will lock out the transmit capabilities in Maestro.

IF Freq (MHz): the IF frequency that corresponds to the RF frequency previously entered. Currently, Maestro only understands high-side injection, so the IF frequency must be below the LO frequency of your transverter.

LO Error (Hz): If your radio's local oscillator is off-frequency by a known amount, enter that amount here and Maestro will make the proper adjustments to properly read transmit, and receive frequencies in Maestro. If you are using a GPS or 10MHz locked transverter, this number should be set to zero.

Max Power (dBm): Enter the IF input power level to the transverter to achieve maximum output power of the transverter. This will limit the output power that Maestro allows to be provided to the transverter. This value may be up to +15dBm for IF frequencies below 80MHz and up to +8dBm for IF frequencies above 135MHz (default: 0dBm). The value set in this field should match the power output when the RF Power slider is set to 100. The lower end (values near 1 on the RF Power slider) will be approximately 20dB lower than the Max Power setting.

Note: This power range may be different than using the IF frequency directly (i.e. not using the XVTR RF frequency).

RX Gain (dB): this field is optional but will correct the receive signal level reading in the Panadapter and Slice Receivers. To properly set this, you should enter the IF gain for the transverter. If you do not know this value, ask your transverter manufacturer. If you do not have this number available, it may still be calculated by inputting a known value signal into the transverter, reading the receive level in Maestro, and then adjusting the RX Gain until the values are equal.

Valid indicates that Maestro has enough information to use the transverter which will be set automatically by Maestro and the FLEX-6000.

When operating in a Transverter band the Transverter name will appear in the top right corner of the Panadapter as shown below:

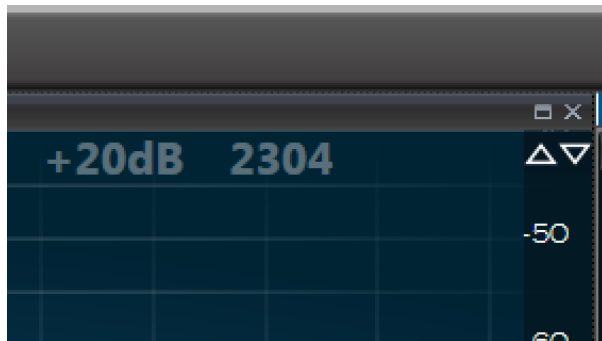

27.1 USING A TRANSVERTER

There are two ways to tune to a transverter. The first way is to use the band select panel in the **Slice Receiver Menu**. Open the control panel and then tap the XVTR button at the lower right of the band selection buttons. The band selection buttons will change to a set of buttons that correspond to the defined transverter bands, as shown below. Tap the transverter band you wish to use. The buttons in the panel use the name of each transverter specified in the transverter setup form.

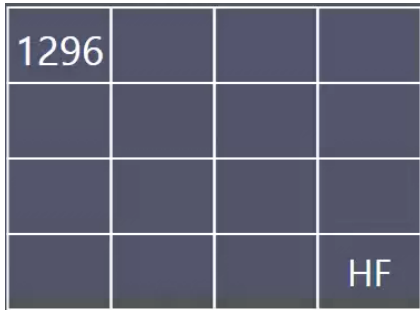

When the band button for a transverter is tapped, the radio will change the frequency of the Panadapter to the transverter frequency. In the image below (taken from a *SmartSDR for Windows* session) you can see that we are now on 1296.0MHz and there is now a band indicator in the upper left of the Panadapter that indicates that we are on the 1296 transverter.



The FLEX-6000 will receive on the programmed IF frequency and perform a frequency translation in the Slice and the Panadapter to indicate the frequency being listened to.

If you have more than one transverter on the same band, you can name them differently and then access them with different transverter buttons. Each transverter band behaves just like an HF band in that it remembers the settings used for that band. If you were to change the frequency to 1296.1, Maestro would remember that this is the last frequency used on the 1296 transverter

band. All other features of Maestro including multiple Slices, wide bandwidth views of the spectrum, etc. are all available on the transverter band.

The second way to select a transverter band is to directly enter the frequency of the desired operation into the Slice Receiver. For example, entering “1296.” (don’t forget the decimal point to tell Maestro that we want to go to 1296MHz) will move the Panadapter and Slice to 1296MHz.

To return to an HF band, simply enter the HF frequency that you wish to change or select the HF bands with the **HF** band button.

27.2 MULTIPLE COPIES OF A BAND

In some situations, it may be desirable to have multiple copies of a signal frequency on the radio. For example, if you have a high power 144 to 28MHz transverter in use on a FLEX-6700, the radio will not know whether to tune to the internal 144MHz band or the external transverter. This ambiguity is resolved in two ways: First, if the band is selected using the band buttons, the radio will always know which band to switch to. If direct frequency entry is used, the following rules are used to select the band of operation:

- If the Panadapter is currently in a band that would match the entered frequency, Maestro remains in the current band.
- The most recently used band that matches the frequency entered will be selected.

Example:

- The current Panadapter is tuned to 50.125MHz
- There is an external 144 to 28MHz transverter on a FLEX-6700 with an internal 2m band
- The most recently used 144MHz band is the external 144-28MHz transverter
- A direct frequency entry of “144.2” is typed
- The radio will select the external 144-28MHz transverter and tune it to 144.200MHz
- The Panadapter will indicate the selected band by placing a “144” (or whatever name was given to the transverter band) in the upper right of the Panadapter. If this is not the desired result -- if you intended to switch to the internal 2m band -- just use the Band selection to switch to this band in the Panadapter. At this point, the radio will switch to the correct band and it will become the “favorite” band the next time a direct frequency is entered.

27.3 TRANSVERTER POWER SETTINGS

The operation of the RF power slider in Maestro is set by the **Max Power** setting in the transverter setup. Setting the RF power slider to 100 will set the power to the **Max Power** setting. The zero setting will shut off all RF power from the transverter port. A setting of 1 results in a power level of 20 dB below the maximum power. For example, if a Max Power setting of +5dBm was configured, the slider “0” position would have no power, and “1” would be +5dBm - 20dB = -15dBm. The 50% setting on the slider will be +5dBm - 10dB = -5dBm.

27.4 TRANSMITTING ON A TRANSVERTER

When transmissions occur on the transverter, the radio will reconfigure internal relays to connect the exciter in the FLEX-6000 to the XVTR port on the radio. If a split IF is in use, the RXA or RXB port may continue to be used for receiving provided that your transverter continues to receive RF (check with the transverter manufacturer).

When a common IF transverter is used, the XVTR port normally being used for transmitting will be switched away from the FLEX-6000 SCU and connected to the exciter. As a side-effect, the relay may connect the SCU to one of the HF antenna ports which causes the Panadapter to show HF signals in the HF IF band in addition to the transverter band when transmitting.

In addition, when transmitting on a split IF transverter configuration, because the transverter RF output is low power it will not be dramatically visible on the transverter Panadapter like it is shown when transmitting on HF at high power.

Both of these conditions during transmission can be quite confusing as they do not accurately represent the transmitting state of the radio properly. For this reason, the Panadapter will pause when using IF transverters while transmitting.

27.5 WEAK SIGNAL CONSIDERATIONS

When using Maestro for weak signal operations, three kinds of receiver resources will be in use: Panadapters, Waterfalls, and Slice Receivers. The noise floor of the Panadapter may be changed to facilitate seeing signals that are weaker than the “noise floor.” Amateurs generally refer to the noise floor as the noise floor in a 500Hz bandwidth receiver. For a Maestro Panadapter, the receiver is variable width for a single “bin” or pixel in your display. The further you zoom in on the Panadapter, the lower the bin size in use and the lower the noise floor. The processing gain achieved in this way is 3dB for each reduction in the bandwidth of a bin by two --- or each time the magnifying glass ‘+’ is depressed. To show this control, tap on the panadapter and it will appear in the upper right of the panadapter.

On a FLEX-6700 fully zoomed in, the bin size will be 1.5Hz. This represents a 25dB gain over the 500Hz noise floor. The Waterfall and Panadapter both derive data from the same receiver so for best weak signal viewing, zoom the Panadapter to one of the last few zoom levels. On a FLEX-6500 or FLEX-6300, the minimum bin size is 5.9Hz.

The noise floor of the Slice Receiver is independent of the Panadapter and is adjustable by adjusting the filter width of the Slice Receiver. Your ears and brain provide a type of signal processing so the Slice Receiver volume should be adjusted for the best listening experience. In general, the **AGC-T** should be set to a fairly low value for best listening on transverter bands. In other words, it should be adjusted for a relatively quiet receiver.

28 USING THE FLEXRADIO POWER GENIUS XL AMPLIFIER

The FlexRadio **Power Genius XL™** linear amplifier is fully integrated with SmartSDR for Maestro. When the amplifier is installed in the same Local Area Network (LAN) as the FLEX-6000 transceiver, all of the amplifier’s operational controls can be manipulated using Maestro. This allows the amplifier to be located somewhere other than at the operating position if desired.

Using the LAN connection to the amplifier, SmartSDR for Maestro sends information about the band and mode of the Slice Receiver that controls the transmitter. The Power Genius XL uses this information to configure the low-pass filters and operational modes of the amplifier. Full details can be found in the *Power Genius XL User Guide*, available from the FlexRadio website.

The only configuration change needed to operate the Power Genius XL amplifier from SmartSDR for Maestro is to configure the correct transmit time delay. The amplifier needs at least 20 milliseconds of settling time between receiving the keying signal and the arrival of the RF signal to be amplified. This can be achieved by setting the TX Delay value to 20 or more. See sections **33.7, Transmit Tab**, and **16.2, Transmit Profiles** for more details. The TX Delay setting applies to both LAN and direct PTT signaling.

When a Power Genius XL is connected to the radio, Maestro makes three additional auxiliary meters available.



Forward Power: The output power of the amplifier, in watts, measured at the active output terminal.



SWR: The standing wave ratio, calculated by the amplifier from the forward and reverse power values. Note that the smallest value reported by this meter is

1.2:1.

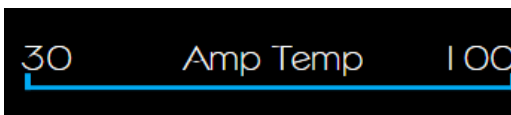

Temp: The output power transistor heatsink temperature, in degrees Celsius.

The last component of the Power Genius XL integration with the Maestro controls is the amplifier state control button. This button is found in the top center portion of the main display and has four values:



When the button is missing, the amplifier is not connected to the radio. The amplifier auxiliary meters are not available.



When the button is dimmed and reads “AMP Standby”, the amplifier is connected to the radio but is in standby mode. If a signal is transmitted, the amplifier will not amplify it. Tap on the button to change the amplifier state to “Operate”.



When the button reads “AMP Operate”, the amplifier is connected to the radio and ready to accept and amplify an RF signal. Tap on the button to change the amplifier state to “Standby”.

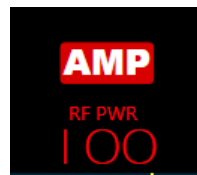

When the button is red, the amplifier is engaged and amplifies the RF signal sent by the transceiver.

Adjust the output power of the amplifier by adjusting the FLEX-6000’s output power. Use the **RF Power** control described in section **36.5, Transmitter Knobs and Buttons**. The transmitter’s output power needs to be about 30 to 40 watts to drive the Power Genius XL. The amplifier presents a very low SWR to the transceiver, so in general, use of the FLEX-6000 ATU is not recommended.

29 HOW TO CONNECT AN EXTERNAL AMPLIFIER

The FLEX-6000 has hardware interfaces for connecting an external power amplifier. There are four PTT outputs on the FLEX-6700 and FLEX-6500 and two outputs on the FLEX-6300, each with independently configurable time delays, a transmit hold-off input for amplifiers that have QSK hold-off outputs, and a standard zero to negative four Volt hardware ALC input. These interfaces are controlled from the **Transmit** tab in the Maestro **Main Menu**. (Left: FLEX-6700/6500 Right: FLEX-6300)

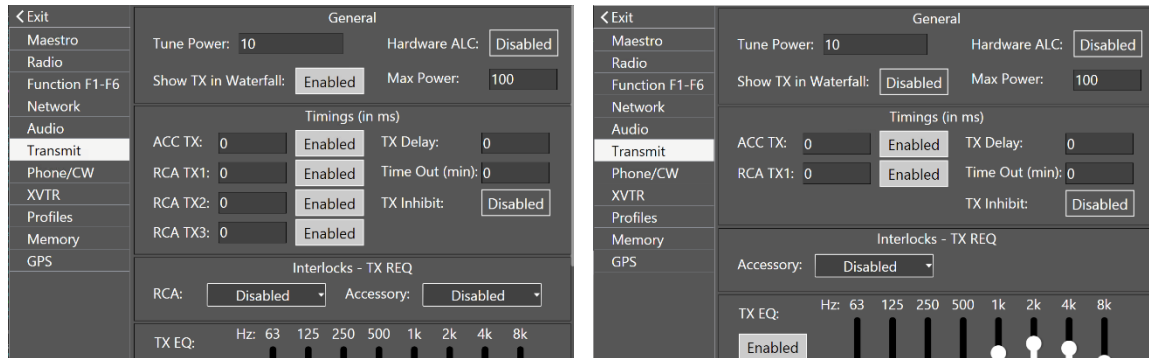

On the FLEX-6700 and FLEX-6500, there are four PTT outputs. Three are RCA jacks on the rear panel, labeled TX1, TX2, and TX3. The FLEX-6300 has one RCA jack labeled TX. On each of the radios, there is an output on Pin 11 of the Accessory connector on the rear panel as well. These outputs are isolated, and each one can have a specific delay. Some users will want to utilize the delay settings to sequentially switch external equipment.

For external amplifier use, the delay should be set to zero for any output that keys the external amplifier.

The TX Delay setting can be used if the external amplifier has slow T/R relays and requires a longer time between PTT and RF Emission. Unless you are noticing problems with the radio-emitting RF before the amplifier has switched to transmit mode, you should leave the TX Delay set to zero.

The TX Delay will negatively impact QSK operation. If the intent is to operate QSK then Delay should be set to zero.

The Interlocks settings are used for amplifiers that have a hold-off output for QSK CW. There are two interlock inputs. One is an RCA jack on the rear panel, and the other is Pin 13 of the Accessory connector on the rear panel. On the FLEX-6300 this is only available on the Accessory connector

If your amplifier does not have one of these outputs, or you do not use it in your station, leave these settings disabled. If you need to use the hold-off, select Active High or Active Low to enable the interlock and set the proper polarity of the signal provided by the amplifier.

30 USB CABLES

30.1 USB CABLES OVERVIEW

The USB Cables feature provides a means to control external devices such as amplifiers, antenna controllers, and tuners via USB to Serial data cables connected to the USB ports on the back panel of the radio. Band data generated by SmartSDR appears on the cable in a form acceptable to the external device.

This feature is limited to FTDI USB cables which contain embedded circuitry that translates the USB signals and protocol to one of several serial or parallel data protocols. In some cases, data flow is bidirectional with a wide selection of speeds and signaling levels.

FlexRadio carries two FTDI cables that can be used to interface with many devices:

- FTDI USB to Serial Cable DB9M (UT232R-200). For most configurations, only Pins 2, 3, and 5 will be used.
- FTDI C232HM (C232HM-EDHSL-0). This parallel data cable has an output of 10 pins that can be used for interfacing with other devices in BIT and BCD modes (described below).

The cable that is used to interface with an external device will vary for each device. One of the above cables may be sufficient for operation in many cases, while for other devices a proprietary cable or custom-made cable may also be needed. Detailed information for many commonly used devices is provided in the **USB Cables Interface Guide** available in the **Downloads** section of the Flex Radio Systems website.

Three main types of cables are supported, CAT, BIT, and BCD, described below. In addition, a preconfigured cable type is provided for Down East Microwave 2 and 4-meter Low Drive Power Amplifiers: See <http://www.downeastmicrowave.com/product-p/2mldpa.htm> for more information.

30.2 CABLE MANAGEMENT

USB Cables are managed in the **USB Cables** tab in the Maestro **Main Menu**:

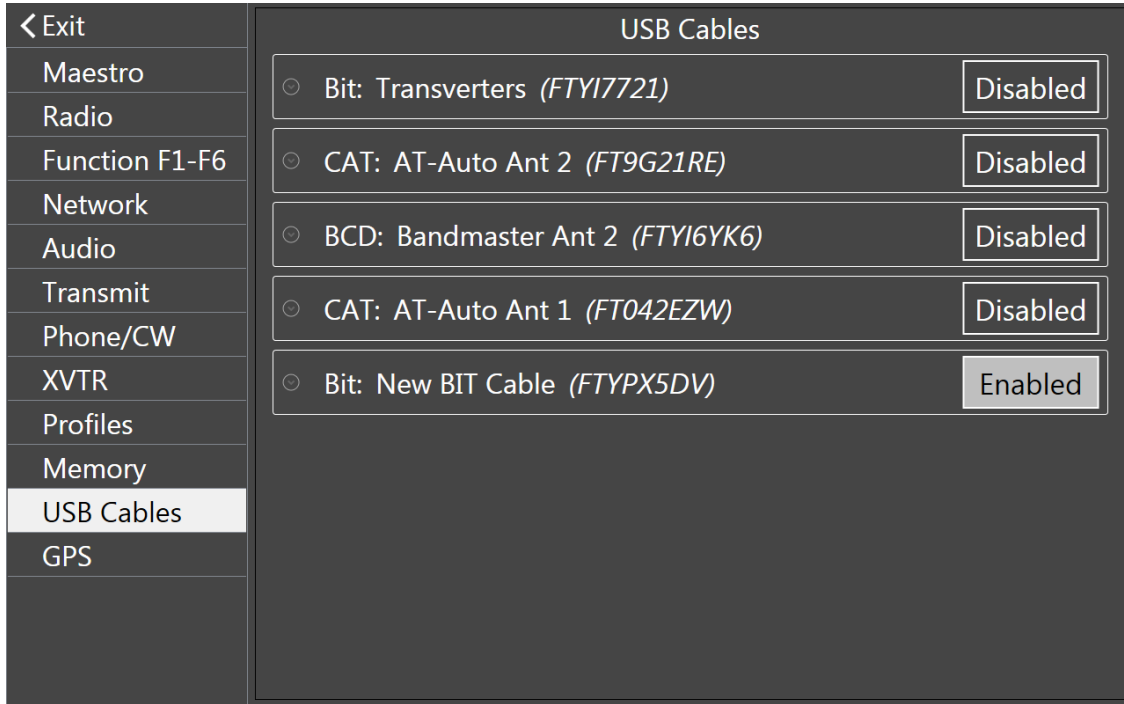

Using the **USB Cables** window, cables can be selected, activated and deactivated, modified, logged, and removed. The information in the window includes:

- **Name** – The name given to the USB Cable. Newly installed cables get a default name. The name can be changed by tapping the name field and typing a new name.
- **Serial Number** – The serial number of the USB Cable, read from the FTDI chip embedded in the cable.
- **Type** – The type of the USB Cable. This field is limited to one of the following:
 - CAT
 - BIT
 - BCD
 - LDPA
 - DSTAR
- **Enabled** – Enables or disables the USB Cable.

Cable parameters can be edited by tapping on the cable, which opens a window in which values can be changed. Tapping on the value opens a menu of available values or opens a keyboard. Tapping **Logging** opens an additional window that enables logging for a cable and displays the log. Logging allows the user to see and monitor all traffic going across the cable. For BIT and BCD cables the log indicates the bits written out to a cable as a hexadecimal number. Tapping **Remove** removes the cable from SmartSDR management. Note that cables can be removed only when they are unplugged.

30.2.1 CAT Cables

CAT cables are serial data communication cables on which a small subset of the CAT command set is implemented. Most of the functions implemented on these cables are frequency reporting functions. Each cable has an associated source device in the radio which supplies the frequency information communicated across the cable.

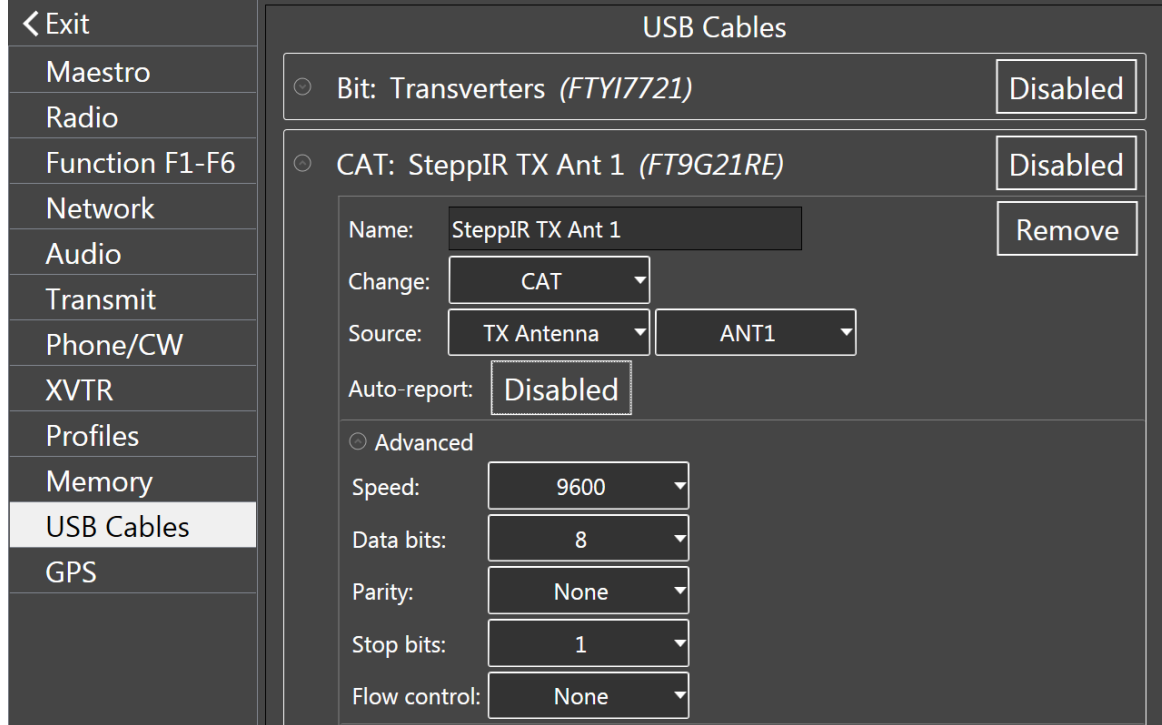

The sources are:

- **TX Slice** - The cable will report the frequency of the slice receiver that holds the Transmit Indicator.
- **Active Slice** - The cable will report the frequency of the active slice receiver (the slice that has the yellow cursor).
- **TX Panadapter** - The cable will report the center frequency of the panadapter that contains the transmit slice
- **Specific Slice** - The cable will report the frequency of the specified slice (A, B, C, D, E, F, G, H)
- **RX Antenna** - The cable will report the frequency of the specified receive antenna (ANT1, ANT2, XVTR, RXA, RXB). *Note: If multiple slices are on the same RX Antenna then the frequency of the last tuned slice will be reported.*
- **TX Antenna** - The cable will report the frequency of the specified transmit antenna (ANT1, ANT2, XVTR). *Note: This frequency is only changed/reported when the TX Slice is connected to the specified antenna.*

The **Advanced** menu provides configuration for link speed, number of data bits, parity, stop bits, and flow control.

The CAT commands supported on CAT cables are:

- **FA** and **ZZFA**: Report the source frequency, **Get/Read Only**
- **FB** and **ZZFB**: Report the source frequency, **Get/Read Only**. FA and FB report the same information.
- **FR**: Reports which slice is the receiver (0 or 1) which corresponds to the slice that is NOT the transmitter.
- **FT**: Report or set the transmit slice.
- **SP**: Report the status of split mode or enter split mode.
- **SB**: Report the status of a “sub-band receiver”. This command will report “SB0” when a single SCU is in use, or “SB1” when more than one SCU is in use.
- **IF** and **ZZIF**: Report the source frequency as well as mode and other parameters, **Get/Read Only**
- **AI** and **ZZAI**: Set 'auto-report' enabled/disabled
 - If **Auto-report** is FALSE, then the external device must poll by sending a command through the USB Cable. If **Auto-report** is TRUE, then anytime the source frequency changes it is automatically sent on the CAT cable
- **PC**: Used to set and get the current power level

30.2.2 BIT Cables

BIT cables provide a means to map the tuned frequency of the radio to a set of individual signals/wires at the end of the cable. These cables are designed to control external devices when the radio is tuned to specific bands or frequency ranges, and for external keying or sequencing that is triggered when the transmitter becomes active.

The signal that appears on each bit/pin of a BIT cable is configured by use of the controls in the **USB Cables** menu:

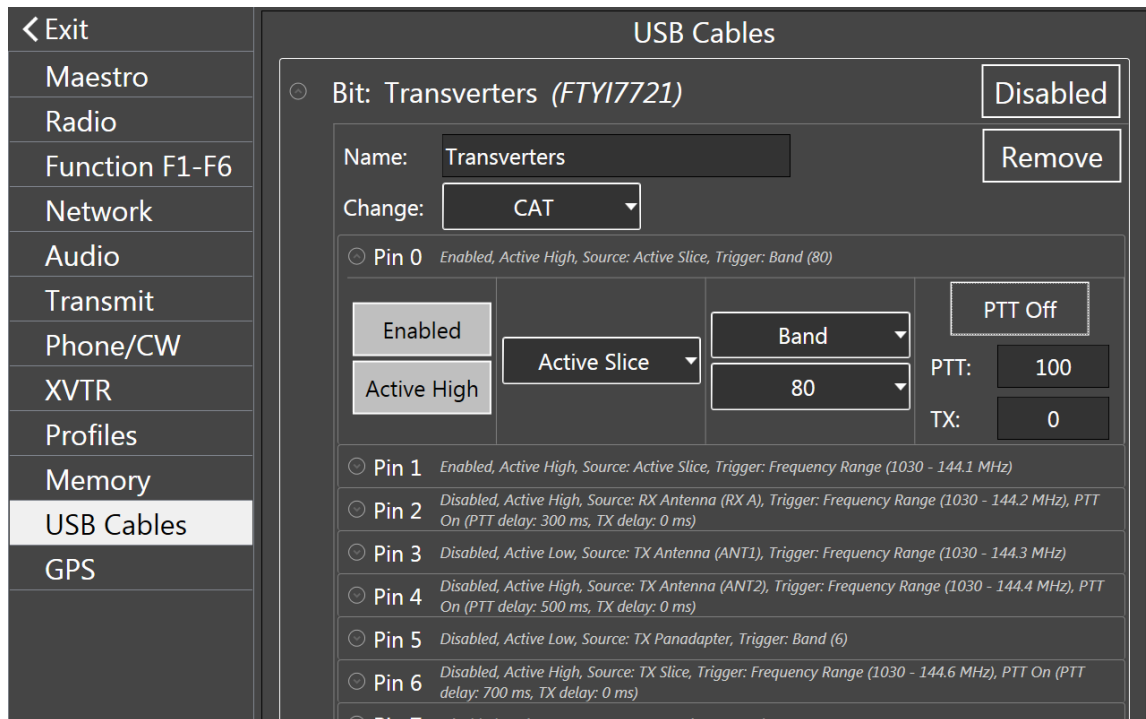

- **Enabled/Disabled** – Enables/disables each pin/bit individually
- **Active High/Active Low** - Controls whether the pin/bit is high or low when triggered
- **Source** - Determines which source is used as the frequency check for this bit/pin. The sources are the same as for the **CAT** cables, listed above.
- **Band/Frequency Range** - Determines the band/frequency range that the source must be within for this bit/pin to be active.
- **PTT On/PTT Off** - When on, the pin/bit will become active only when the radio is in transmit mode and the source frequency is within the output band/frequency range. Individual pin/bit PTT and TX Delays can be set and will be used by the radio when keyed.

30.2.3 BCD Cables

BCD cables provide a means to map the tuned frequency of the radio to a 4 or 5-bit Binary Coded Decimal output representing specific bands.

The BCD signal that appears on the cable is configured by use of the controls in the **USB Cables** menu:

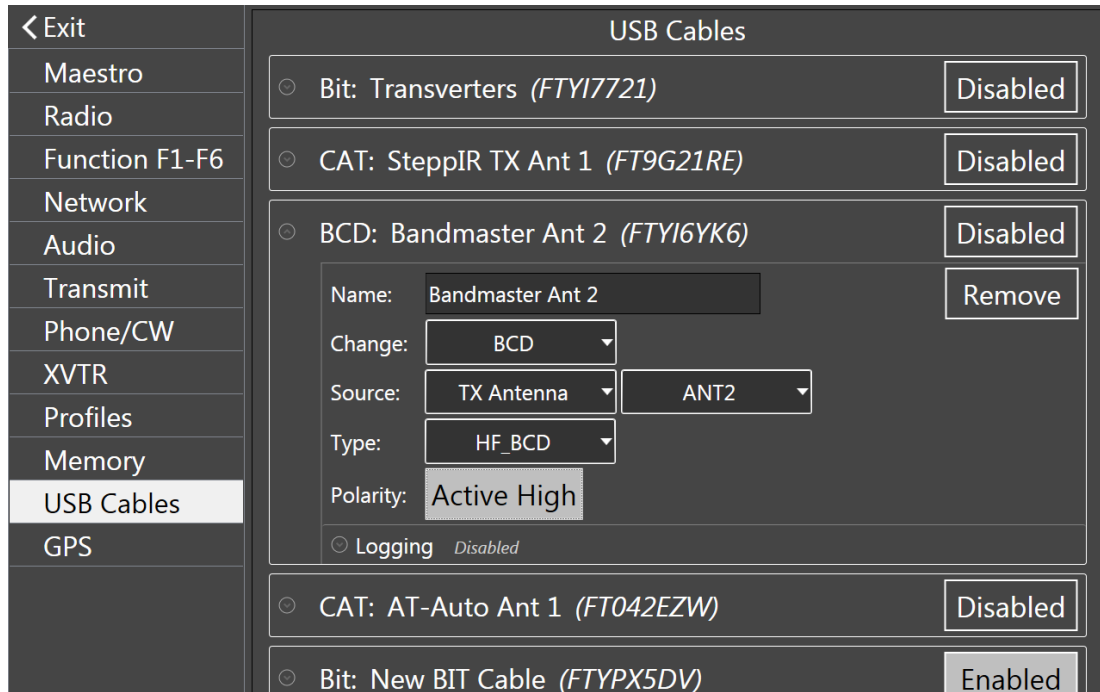

- **Source** - Determines which source is used as the frequency check. The sources are the same as for the **CAT** cables, listed above.
- **Type** – Specifies which of several available BCD mappings are generated by the cable:
 - **HF_BCD** - Yaesu/Elecraft BCD band output
 - **VHF_BCD** - Similar to HF_BCD but for VHF and higher bands
 - **HF_VHF_BCD** - Combined HF and VHF output

BCD Output					
Band	Bit 4	Bit 3	Bit 2	Bit 1	Bit 0
160	0	0	0	0	1
80	0	0	0	1	0
60	0	0	0	0	0
40	0	0	0	1	1
30	0	0	1	0	0
20	0	0	1	0	1
17	0	0	1	1	0
15	0	0	1	1	1
12	0	1	0	0	0
10	0	1	0	0	1
6	0	1	0	1	0
2	0	1	0	1	1
432	0	1	1	0	0

VHF VBCD Output					
Band	Bit 4	Bit 3	Bit 2	Bit 1	Bit 0
6	0	0	0	0	1
2	0	0	0	1	0
222	0	0	0	1	1
432	0	0	1	0	0
902	0	0	1	0	1
1296	0	0	1	1	0
2304	0	0	1	1	1
3456	0	1	0	0	0
5760	0	1	0	0	1
10368	0	1	0	1	0
24048	0	1	0	1	1
47088	0	1	1	0	0
4	0	1	1	0	1

HF + VHF Output					
Band	Bit 4	Bit 3	Bit 2	Bit 1	Bit 0
160	0	0	0	0	1
80	0	0	0	1	0
60	0	0	0	0	0
40	0	0	0	1	1
30	0	0	1	0	0
20	0	0	1	0	1
17	0	0	1	1	0
15	0	0	1	1	1
12	0	1	0	0	0
10	0	1	0	0	1
6	1	0	0	0	1
2	1	0	0	1	0
222	1	0	0	1	1
432	1	0	1	0	0
902	1	0	1	0	1
1296	1	0	1	1	0
2304	1	0	1	1	1
3456	1	1	0	0	0
5760	1	1	0	0	1
10368	1	1	0	1	0
24048	1	1	0	1	1
47088	1	1	1	0	0
4	1	1	1	0	1

30.2.4 LDPA Cables

Control cables for Low Drive Power Amplifiers for the 2 and 4-meter bands produced by Down East Microwave Inc. are supported by the LDPA option in the **USB Cables** menu. The functions supported by the amplifiers are determined by the manufacturer, so the options for this type of cable are limited to selecting the model of the amplifier and turning the pre-amplifier on and off. As with all USB cables, the entire cable can be enabled or disabled.

31 HOW TO OPERATE IN DIGITAL MODES

Digital modes such as FT8, JT65, and PSK31 are implemented in third-party programs that must run on a computer separate from Maestro. The recommended configuration uses DAX and CAT on a PC to connect the digital mode program to the FLEX-6000. This is accomplished in the same way that CAT and DAX are used with *SmartSDR for Windows*, with the noted exception that SmartSDR and Maestro perform the same basic functions and cannot be running simultaneously.

The DAX channel for audio output from the radio can be selected in Maestro in the **Slice Receiver Menu**. This audio channel, the **DAX TX Audio** channel, and a CAT port are generally required for each band where the digital mode will be run. When using this method, Maestro may be used to tune the radio, observe the spectrum for likely operating locations, etc., but the DAX and CAT software communicate directly to the radio. Maestro is designed to operate in conjunction with a digital mode program operating in this manner.

When running digital modes, the computer screen can be effectively extended by running the FLEX-6000 transceiver with Maestro instead of with *SmartSDR for Windows*. The computer screen can be dedicated to running the digital mode programs.

31.1 PTT OVERRIDE WHEN OPERATING DIGITAL MODES

When operating in a non-DIGx mode, the use of a hardware PTT such as the RCA PTT input on the back panel will override the DAX channel input. This feature allows the user to override the DAX input with a PTT switch connected directly to the radio, or Maestro.

***NOTE:** With multiFLEX, hardware PTT inputs always key using the Local PTT Station (see section 33.15, multiFlex Tab).*

31.2 RTTY MODE

RTTY mode is a variant of DIGL mode, optimized to facilitate tuning and reporting of an RTTY Mark frequency via CAT or the FlexLib API. In RTTY mode two controls appear in the **Slice Receiver Menu**. These are the RTTY Mark and RTTY Shift values:



These values default to 2125 and 170 Hz respectively for operating at 45.5 baud, the standard for HF RTTY. The RTTY Mark is an IF shift of the Slice Receiver indicated frequency which allows knob tuning and spot frequency reporting to third-party programs that expect the reported frequency to be the RTTY Mark frequency. For knob tuning, move the frequency centerline (the higher frequency yellow line) on the Mark frequency (higher of the two tones). RTTY mode can also be tuned by double tapping on the Panadapter display at the desired Mark frequency. To the user, the IF shift at the RTTY Mark frequency is transparent since the Slice seems to be tuned to the RTTY Mark. The Slice Receiver filter is also IF-shifted and the default filter presets are centered between the RTTY Mark and Space frequencies.

31.3 DIGI MODE AUDIO OFFSETS

When operating the radio in DIGU or DIGL mode a receive filter Offset control is available in the **Slice Receiver Menu**. This control allows the operator to set the audio offset in Hertz of the center of the receiver’s bandpass preset filters. When Tap Tuning a Slice Receiver with an Offset set to a non-zero value, the Slice Receiver’s frequency will be adjusted so that the center of the receiver’s bandpass filter will be tuned to the frequency that was Tap Tuned. The default offset for DIGU is 1500Hz and the default for DIGL is 2210 Hz.

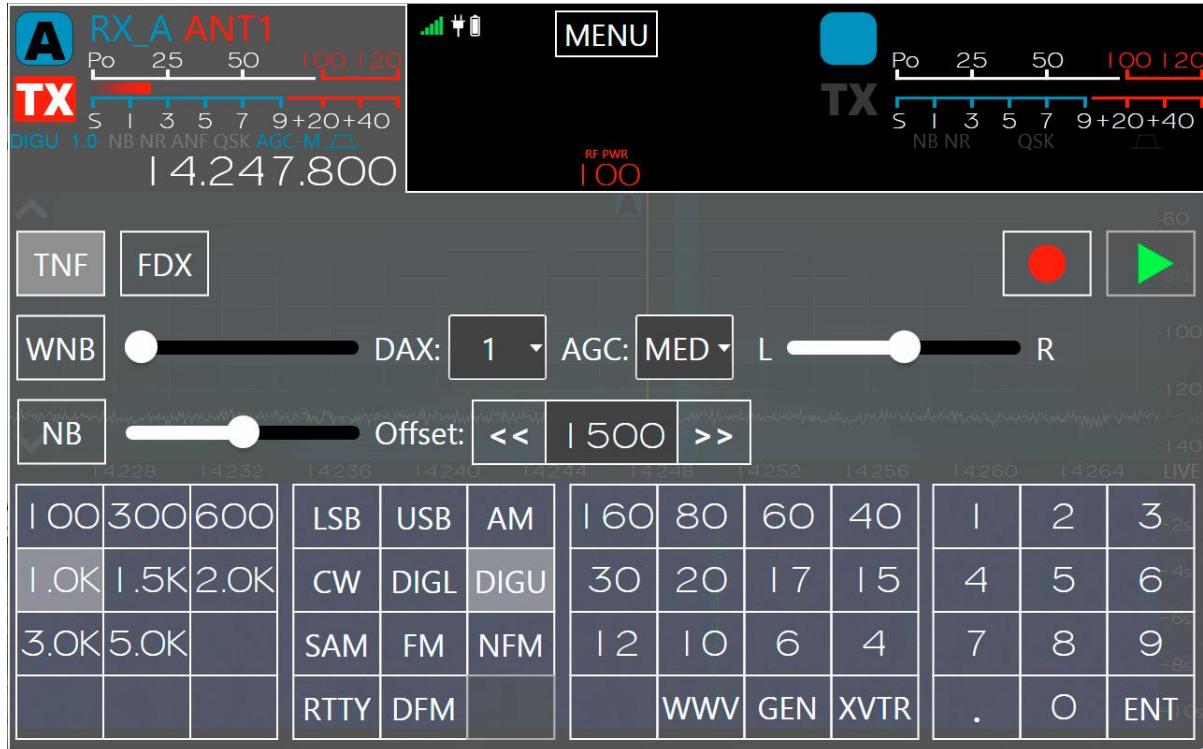

This feature allows the operator to configure a narrow filter in DIGU or DIGL mode, and then conveniently drop it over a signal of interest by simply double tapping on the signal.

32 HOW TO OPERATE IN FULL DUPLEX (FDX) MODE

All FLEX-6000 Signature Series Transceivers are inherently capable of full duplex operation. In normal simplex operation, all Slice Receivers are muted when transmitting. When Full Duplex (FDX) is enabled, the transmitting Slice Receiver is muted along with all other Slice Receivers on the same antenna. Receivers located on *different antennas* from the transmitter are not muted during transmission.

FDX is only possible if the two Slice Receivers are using separate physically isolated antennas. Since two receivers are used, two signals may be heard simultaneously when in receive. When the radio is switched to transmit, the transmitting Slice Receiver will no longer emit receive audio, but the other receiver will continue to receive.

The transmitting Slice Receiver is muted primarily because it contains a delayed version of the radio's transmit signal. This delayed transmit signal results in operator confusion if heard at the same time transmit audio is being produced. If hearing this signal is the desired goal, another Slice Receiver may be placed on the same frequency as the transmit Slice. This receiver will not be muted and delayed transmit audio can be heard provided that the receiver's receiving antenna is different from the transmit antenna.

Select Full Duplex mode by tapping the **FDX** button in a **Slice Receiver Menu**.

32.1 FDX REQUIREMENTS

To use FDX mode, the following requirements must be met:

- The transmitting antenna and receiving antenna must be different
- The transmitting Slice Receiver and receiving Slice Receivers must be different (two or more receivers must be used)
- The radio must be placed into FDX mode
- The signal level of the received transmit signal coming into the receive antenna must be below the overload threshold of the Spectral Capture Unit (SCU, details below)

The first three steps involve setting up the radio properly, but the fourth step requires understanding your antenna system and signal-level environment in detail by performing the necessary calculations to ensure proper operation. A detailed explanation of this and working examples are provided below.

32.2 FDX APPLICATIONS

There are two initial applications of FDX mode:

- FLEX-6700 Single Operator Two Radio (SO2R) operation
- Full Duplex amateur satellite operation using appropriate transverters

SO2R mode is used by single operator contesters to boost scores by listening on two bands simultaneously and alternating the transmit band, interleaving listening and transmitting tasks. As always, consult the contest rules for any requirements or restrictions on operating in this manner. Presently, SO2R operation is only possible on the FLEX-6600M and FLEX-6700.

32.3 FDX CAPABILITIES BY RADIO MODEL

The capabilities and rules for FDX operation vary by model as defined by its respective hardware capabilities. Specifics for each model are as follows.

32.3.1 FLEX-6600(M) and FLEX-6700 SO2R Operation

The FLEX-6600(M) and FLEX-6700 incorporate two independent, full-performance Spectral Capture Units (SCUs), each with its bandpass filter pre-selectors. This means that these radios can simultaneously receive on two separate antennas. With FDX engaged, it is possible to listen on one antenna/band while transmitting on another - given sufficient antenna isolation is provided.

Alternatively, RX A, RX B, or XVTR may be used as receive-only ports. The internal pre-selectors on the FLEX-6700 provide a minimum of 20 dB band-to-band rejection. With antenna isolation of at least 40 dB, cross-band SO2R operation without external filtering is practical. For high power operation and sites with less antenna isolation, external transmit band pass filters must be added to increase isolation.

Please refer to the [SO2R Mode with N1MM for the FLEX-6600\(M\) or FLEX-6700 How to Guide](#) for step-by-step setup instructions for operating a FLEX-6700 with N1MM in SO2R mode.

A default Global profile, *SO2RDefault*, provides a starting point for configuring the radio for SO2R operation.

The image below illustrates an example SO2R configuration using the FLEX-6700.

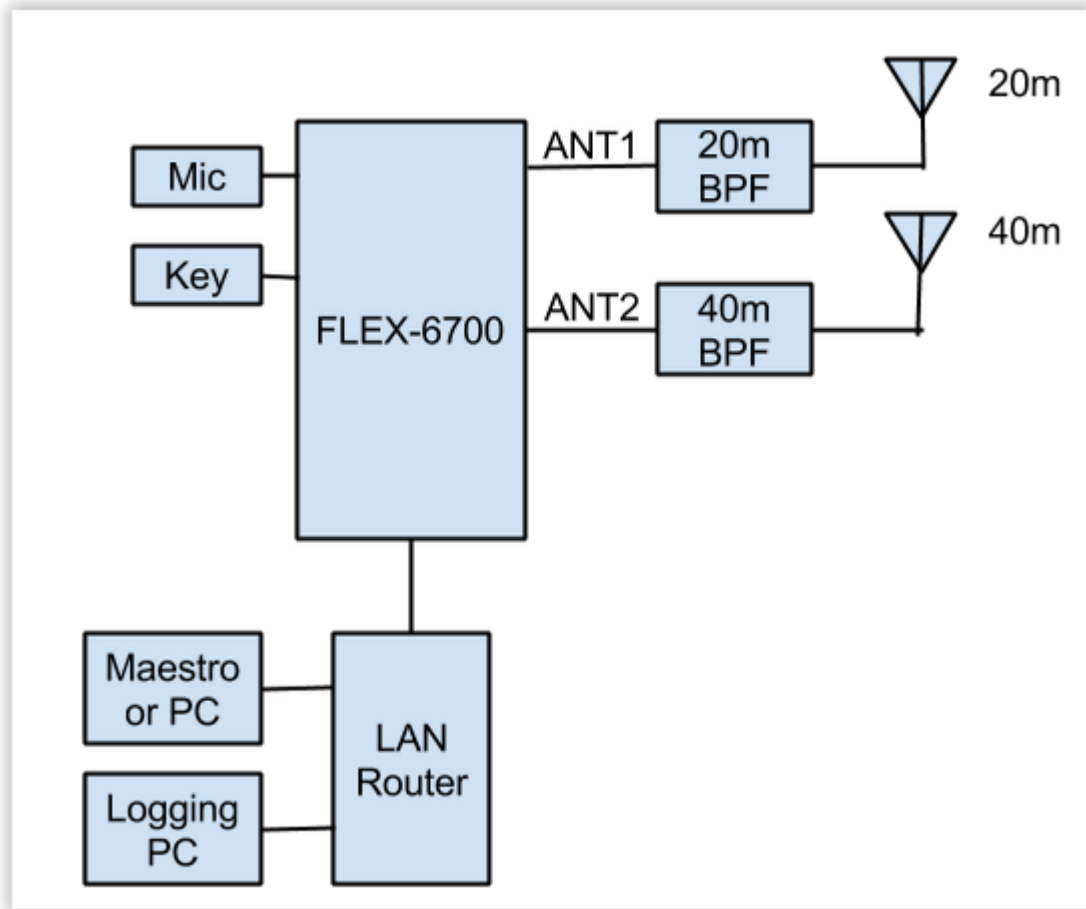

32.3.2 FLEX-6300 and FLEX-6500 Full Duplex

Both the FLEX-6300 and FLEX-6500 models are enabled for full duplex operation using XVTR as a receive-only port so long as at least 70 dB of port-to-port isolation is provided for a 100W station. This may be provided through a combination of antenna isolation and external bandpass filtering for cross-band operation. RX A may alternately be used on the FLEX-6500. This feature can also be used for satellite operation with suitable transverter support.

32.4 SCU OVERLOAD FUNDAMENTALS

All radios are susceptible to overload. Overload conditions caused by a signal level that is too high can result in compromised performance, the inability to receive, or even receiver damage. An understanding of how overload occurs and methods to avoid it is required for the proper operation of a radio in full duplex mode.

The Spectral Capture Units (SCU) in the FLEX-6000 transceivers contain three primary component blocks:

- Preselection band filters (except in FLEX-6300)
- A preamplifier/attenuator
- A high-performance analog-to-digital converter (ADC) also known as a digitizer

Each of these blocks plays a role in receiver performance and must be considered when planning full duplex operation.

32.4.1 Preselection Band Filter Block

Preselection band filters, when present and active, can reduce out-of-band signal levels by 20dB or more. Preselection band filters are enabled by default in the FLEX-6500 and FLEX-6700 any time the radio is not in the WIDE mode. An indicator in the upper right corner of the Panadapter will show when the radio is in the WIDE mode and pre-selectors are not enabled. The FLEX-6300 is always in WIDE mode since it does not have preselection band filters, but this is not indicated in the Panadapter.

As an example, assume a 20dB reduction in out-of-band signals when the preselection band filters are enabled.

Example 1: FLEX-6500 with two Slice Receivers on 20m in a single Panadapter. Both receivers are set to listen on RXA and transmit on ANT1. The WIDE indicator is not present in the Panadapter. In this case, the pre-selector filter for 20m is enabled, but the receiver and transmitter are on the same band. The pre-selector will not reduce the transmit signal (it is in-band) and no 20dB reduction in signal can be used for calculations.

Example 2: FLEX-6500 with two Slice Receivers, one on 20m, one on 40m in two Panadapters. Both Slice Receivers are set to receive on RXA and transmit on ANT1. Because two different bands are received on the same antenna, WIDE mode is indicated in both Panadapters. Preselection band filters are not used and a 20dB reduction in signal cannot be used for calculations.

Example 3: FLEX-6700 with two Slice Receivers, one listening on 20m and one on 40m in two Panadapters. Slice A is set to receive on RXA and transmit on ANT1. Slice B is set to receive on RXB and transmit on ANT1. Neither Panadapters indicate WIDE. In this case, preselection band filters are enabled on both bands and a 20dB reduction can be used in calculations.

32.4.2 Preamplifier / Attenuator Block

The preamplifier/attenuator block can raise or reduce signals before they are sampled in the ADC block. The overload limit of the SCU is reduced by any gain that is added by the preamplifier. For example, if 10dB of gain is selected using the preamplifier selection under the antenna controls in the Panadapter, this 10dB addition must be factored into the overload calculations. The same holds for other amplification levels: if +20dB or +30dB are selected, the respective value must be added to overload calculations. You should only use pre-amplification when necessary and only what is required to raise the noise level in the receiver by 8-10dB over the noise level when the antenna is disconnected.

The preamplifier has protection circuitry to prevent damage above levels of +10dBm. This protection circuitry will distort received signals if the level exceeds 10dBm. For this reason, pre-amplification should not be used when the input signal level meets or exceeds +10dBm. When performing all testing of a full duplex configuration, it is highly recommended that the preamplifier be disengaged until it can be determined that the power level from the transmitter will not reach +10dBm in any operating scenario.

32.4.3 High-Performance Analog to Digital Converter Block (ADC)

The ADC block, or digitizer, converts the received signals into digital data. All ADCs have overload points and damage points, but there is some variability in overload symptoms. With the FLEX-6000 Signature Series radios, the ADC overload point varies from +7dBm (FLEX-6300) to +9dBm (FLEX-6500 and FLEX-6700). This overload point is a “soft overload” meaning that at this point the receiver will begin to show a performance drop. The ADC generally functions better with increasing signal levels up to this point. At the soft overload point, the receiver will begin to develop spurs that will appear in the Panadapter, and these spurs will grow as power is increased. A digital overload point will be reached around +12dBm, but varying by the receiver, at which point the receiver will cease to function normally, producing substantial distortion in received signals and rendering reception difficult.

At levels above +15dBm, the ADC can be damaged so the FLEX-6000 contains circuitry to disengage the ADC from the SCU. While circuitry should protect the radio from a damaging signal, it is highly recommended that station configuration be designed such that signal levels above the soft overload point are prevented from entering the antenna connector of the radio. FlexRadio assumes no responsibility for damage incurred from high signal levels entering the receiver.

32.5 FULL DUPLEX ANTENNA ISOLATION REQUIREMENTS

For successful FDX operation, it is essential to understand and plan for sufficient transmit-to-receive antenna isolation to prevent receiver overload and/or damage. The [FLEX-6000 FDX Power Calculation Worksheet](#) can aid in the calculation of antenna isolation and power levels that are suitable for a specific station.

The FLEX-6000 Signature Series transceivers are designed to disconnect the receiver from the antenna when signal levels are +18 dBm to +22 dBm depending on frequency. The front-end protection circuits will begin to engage at approximately +15 dBm. Front-end overload of the SCU will occur with a single tone in the range of +8 dBm with the preamp-off. Increasing preamp gain will lower the overload point by the amount of the added gain.

To provide suitable headroom to prevent SCU overload, we recommend that transmit-to-received signal strength be limited to a worst-case of -20 dBm or lower at the antenna input. With 20 dB of preamp gain, this would provide a single tone input of 0 dBm to the A/D converter leaving about 8 dB of headroom. More isolation is better.

One of the best resources for information on achieving antenna isolation is:

"Managing Interstation Interference, Revised Second Edition" by George Cutsogeorge, W2VJN.

33 MAIN MENU

33.1 INTRODUCTION

A button that opens the Maestro **Main Menu** is located at the top center of the Maestro display. Tapping this button opens the **Main Menu**. A list of menu tabs appears down the left side of the menu. When tapped, each of these tabs opens a sub-menu that can be used to configure some aspect of Maestro operation.

33.2 MAESTRO TAB

Located in the **Maestro** tab are basic controls for the display and LED button backlight levels. The serial number and software version information is shown.

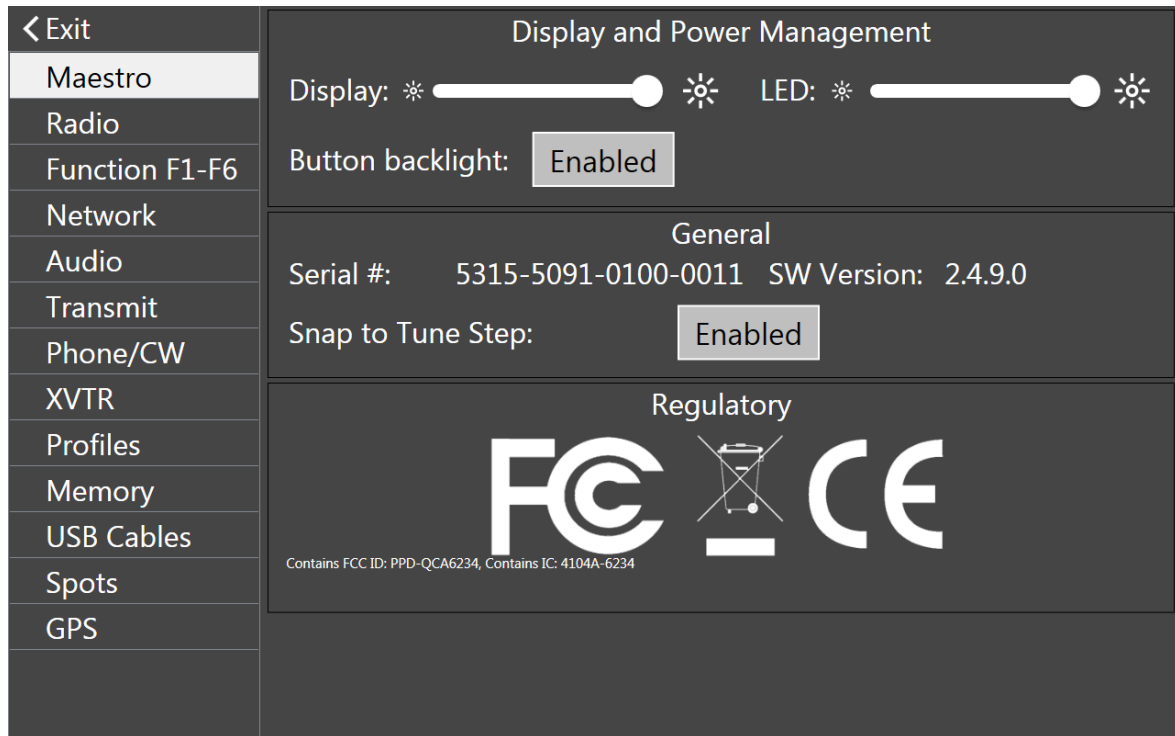

The **Button backlight** button controls the white backlight of the Maestro front panel buttons. Turning the backlight off does not affect the button colors that are displayed as various functions change.

The **Snap to Tune Step** button controls the Drag Tune and Tap Tune behavior. When enabled, tuning operations will round to the nearest tune step size. For example, if the tune step is set to 10Hz then the Slice Receiver will snap to every 10 Hz (i.e. 14.100.000, 14.100.010, 14.100.020) increment regardless of the tuning method when tuning outside of the Slice Receiver passband. When this feature is disabled it will allow the receiver to be tuned in 1 Hz steps.

The **Use VFO B Knob** button changes the RIT/XIT behavior. See section **36.1, Slice Receiver Activation Buttons** for details.

33.3 RADIO TAB

Located in the **Radio** tab is basic information about the selected radio. The tab contains the radio **Hardware Version** and installed **Options** of the radio.

< Exit	Radio	
Maestro	Serial #: 5017-7826-6601-1768	Region: USA
Radio	HW Version: v2.1.25.524	Model: FLEX-6600M
Function F1-F6	Options: None	Nickname: <input type="text"/>
Network	Switch Radio	Callsign: <input type="text"/>
Audio		Remote On: Disabled
Transmit	Frequency Offset	
Phone/CW	Cal Frequency (MHz): 10	Start
XVTR	Offset (in ppb): -385	
Profiles	10 MHz Reference	
Memory	Source: <input type="text" value="TCXO"/>	Locked ✓
USB Cables		
GPS		

The **Region** indicator displays the country on which the radio’s transmit capabilities are based.

A set of three buttons provides a means to change the contents of the OLED front panel display on Flex-6500 and Flex-6700 transceivers. When the **Model** button is selected, the radio’s model name is displayed. When the **Nickname** button is selected, the nickname text is displayed. Tapping on the nickname field opens a keyboard so that the nickname can be changed. When the **Callsign** button is selected, the call sign text is displayed. Tapping on the call sign field opens a keyboard so that the call sign can be changed.

Next is the **Remote On** enable/disable control. Tap the button to enable and disable this feature. When enabled, closing the circuit in the RCA connector on the rear panel of the radio will power up the radio. Opening the circuit will power down the radio.

Tapping the **Switch Radio** button disconnects Maestro from the radio, ending the operating session, and returns control to the *Select Radio* screen.

The backlight section controls the intensity of the radio’s front panel backlight on those models that have this feature.

The **Frequency Offset** controls are used to compensate for the error in the radio’s local oscillator.

Calibrate the local oscillator by performing the following steps:

1. Select a signal of known frequency, with strength greater than S6. In the US, WWV is a good choice.
2. Enter the known frequency in the **Calibration Frequency** field
3. Click **Start**

The radio will tune to the signal and compare its tuned frequency to the declared frequency. The difference will appear in the **Offset** field. You can also enter a value directly into the **Offset** field.

NOTE: When running the frequency calibration, the radio uses Slice A and ANT-1 regardless of the radio's slice/antenna configuration.

NOTE: When running the frequency calibration, the radio uses Slice A and ANT-1 regardless of the radio's slice/antenna configuration. The frequency calibration should be run in a single Station configuration (as opposed to multiple connected Stations via multiFLEX) for best results.

The **10 MHz Reference** section offers a selection of 10 MHz signal sources that synchronize the local 10 MHz master oscillator. This feature is not available in the FLEX-6300, FLEX-6500, or FLEX-6700.

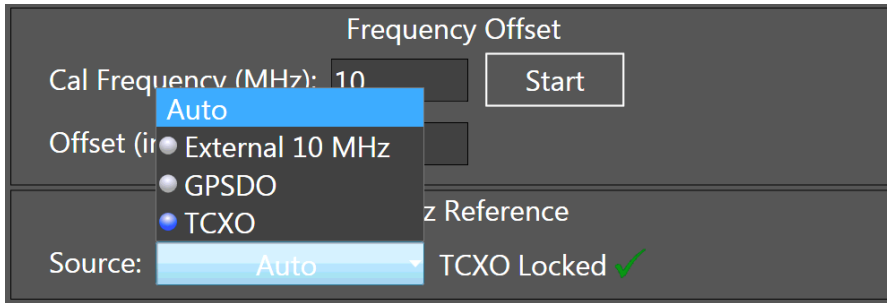

The radio monitors each of the inputs and indicates which has a signal present with the blue marker. The Temperature Compensated Crystal Oscillator (TCXO) is part of the radio hardware and is always available. When one of the three inputs is selected, using the menu shown above, the radio will use that input regardless of the presence of a signal. The master oscillator status is shown to the right of the selection list. When the master oscillator is trying to lock to the selected input, the status message will say “searching”. When it is locked, it will say “Locked”.

In **Auto** mode, the radio monitors each of the inputs and selects an input that offers a signal in priority order. The highest priority signal is the External 10 MHz signal (optional), followed by the GPSDO signal (optional), followed by the TCXO signal (always provided). The radio will track changes in the availability of the signals. For instance, if the External 10 MHz signal appears, the radio will switch to it from the GPSDO or TCXO signal.

33.4 FUNCTION F1-F6 TAB

The **Function** tab contains controls used to assign functions to the six front panel function buttons.

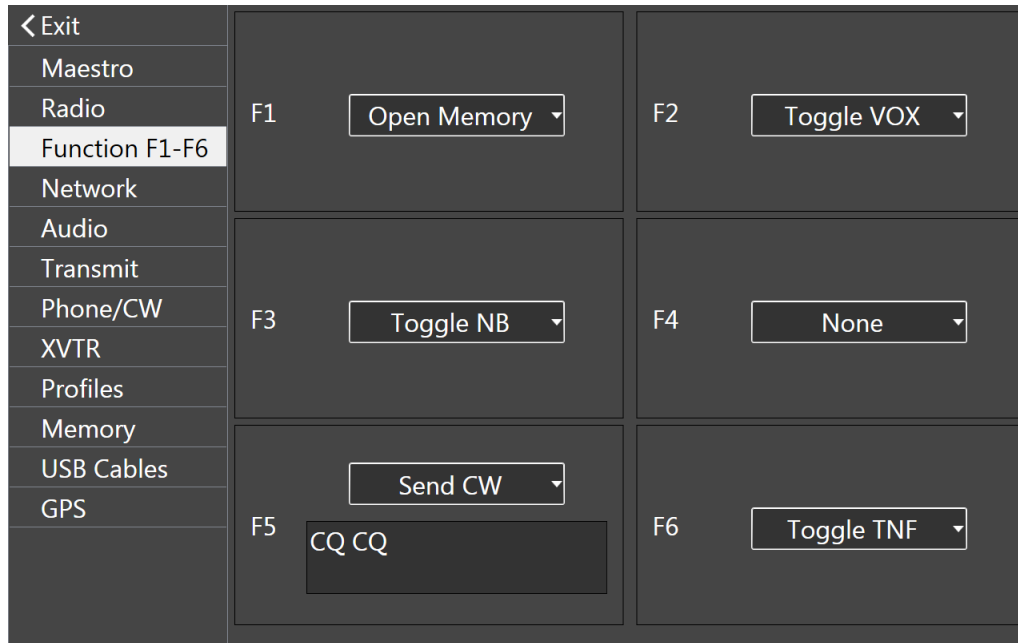

To assign a function to a function button, tap the appropriate drop-down menu box, move the selections up and down with a finger swipe, and then tap on the desired function. When the drop-down menu closes, the function is assigned.

Functions that can be assigned to the buttons include:

- Band Zoom: Change the zoom in the Panadapter so that the entire band is displayed.
- Segment Zoom: Change the zoom in the Panadapter so that the segment containing the Active Slice Receiver is displayed.
- Toggle WNB: Toggle the Wide Noise Blanker
- Toggle NB: Toggle the Slice Specific Noise Blanker
- Toggle NR: Toggle Noise Reduction
- Toggle ANF: Toggle the Automatic Notch Filter
- Toggle APF: Toggle the CW mode Audio Peaking Filter
- Toggle TNF: Toggle the Tracking Notch Filters
- Toggle FDX: Toggle Full Duplex operation
- Toggle DIV: Toggle diversity reception
- Toggle VOX: Toggle Voice Operated Transmission
- Toggle Iambic: Toggle iambic keying mode

- Set Mode: Change the Active Slice Receiver mode to a new value
- Send CW: Send a short message in CW mode
- Split: Invoke split operation on the Active Slice Receiver
- Open Memory: Open the memory tab on the display

See section 36.7, **Function Buttons** for a discussion of the use of the Function buttons.

33.5 NETWORK TAB

The **Network** tab contains information about Maestro’s connection to the communication network, the attached radio’s network connection, and network diagnostics.

< Exit	Maestro	
Maestro	Wifi IP: -	Ethernet IP:
Radio	Wifi MAC:	Ethernet MAC:
Function F1-F6	Wifi:	
Network	<input type="button" value="Wifi Settings"/> This will disconnect your radio	
Audio	Radio	
Transmit	IP Address:	Mask:
Phone/CW	MAC Address:	<input type="button" value="Advanced"/>
XVTR	Diagnostics	
Profiles	Network Status: Excellent	Total RX Rate: 2216 kbps
Memory	Latency (RTT): < 1 ms	Total TX Rate: 3 kbps
GPS	Max Latency (RTT): 1 ms	<input type="button" value="Reset Stats"/>
	Dropped 0 out of 46900 packets (0.00%)	

The **Maestro** and **Radio** sections of this tab show the IP addresses of the Maestro wireless and wired Ethernet interfaces, the radio’s wired Ethernet interface, and other associated information. When a WiFi connection has been made, the **WiFi IP** field will contain the IP address associated with that connection. When the field is empty, no WiFi connection has been made. Similarly, when a wired Ethernet connection has been made, the **Ethernet IP** field will contain the IP address associated with that connection. When the field is empty, no Ethernet connection has been made.

Pressing the **WiFi Settings** button terminates Maestro’s connection to the radio and returns user control to the *Choose a WiFi Network* startup screen. The user can choose a WiFi network and connect to it or can choose to break a WiFi connection using the **Forget** button. See section 4.6, **WiFi Network Setup** for more information.

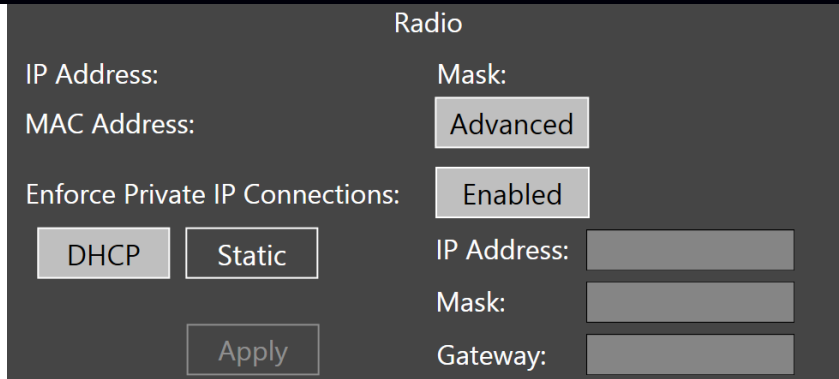

Pressing the **Advanced** button reveals controls that allow the user to assign a fixed IP address to the radio.

The **MTU** setting (industry standard default 1500) can be used in situations where connecting via SmartLink will not pass Panadapter or Waterfall data as a result of larger packets being dropped. Try using incrementally smaller values until it works.

Press the **Static** button then tap the **IP Address** field to bring up a keyboard. Enter the desired IP address, subnet mask, and gateway address, then press **Apply**. Maestro will disconnect from the radio; the radio will reboot, and Maestro will return to the *Select Radio* screen. The radio can be returned to dynamic IP address assignment by use of the **DHCP** button. Note that the **Advanced** controls are not available when accessing the radio via SmartLink.

The **Enforce Private IP Connections** button enables and disables a network security feature. When enabled, only private network IP addresses may connect to the radio when the radio is connected to a private network. These are the 10.0.0.0 - 10.255.255.255, 172.16.0.0 - 172.31.255.255 and 192.168.0.0 - 192.168.255.255 address blocks. When disabled, any address may connect.

***NOTE:** This is not recommended for most users and puts your radio at risk of being accessed from outside your network without authentication such as SmartLink. This should only be used if you understand network security and the associated risks.*

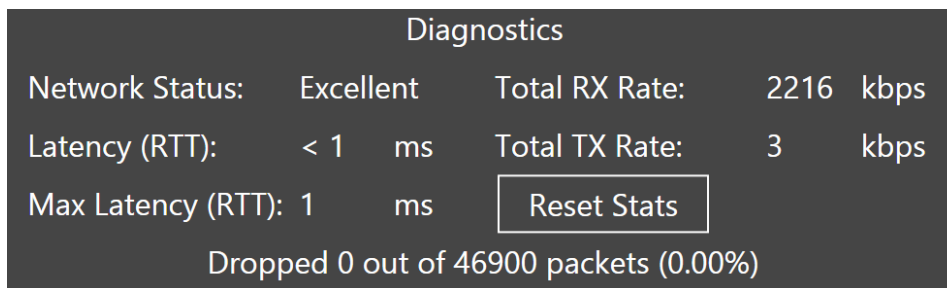

The **Diagnostics** section shows several types of diagnostic data.

The **Network Status** indicator describes a summary of the quality of the network connection to the radio.

Latency (RTT) is the round-trip time in milliseconds for a keep-alive packet to be sent between the Maestro and the radio. A smaller number indicates better network quality. On a wired LAN,

Latency (RTT) should be no more than a few milliseconds and should not vary greatly. On a wireless network link, this number may be much higher and can vary depending on factors inherent to wireless networks such as signal attenuation and multipath reflections.

Max Latency (RTT) is the greatest observed value of **Latency (RTT)**. If this number is much higher than the real-time **Latency (RTT)** values, this indicates a network link that has a lot of quality variability, which in general is not desirable.

Remote RX Rate and **Remote TX Rate** show the rate of information flow between Maestro and the radio, in thousands of bits per second.

Tapping the **Reset Stats** button resets the network performance statistics shown in the next line.

The network statistics show the number of lost network data packets from the radio to Maestro. Loss of packets may cause interruptions in the receiver audio stream. On a wired LAN, packet losses should be very small, if any. On a wireless LAN, packets may occasionally be lost due to factors such as signal attenuation and multipath reflections.

Total packets and lost packets are tracked by the type of stream, Audio, Waterfall, Panadapter, Meters, etc. When a Panadapter is closed, its packet statistics contribution is removed from the displayed statistics. This can make the statistics appear to “go backward”.

33.6 AUDIO TAB

The **Audio** tab provides several controls for audio output.

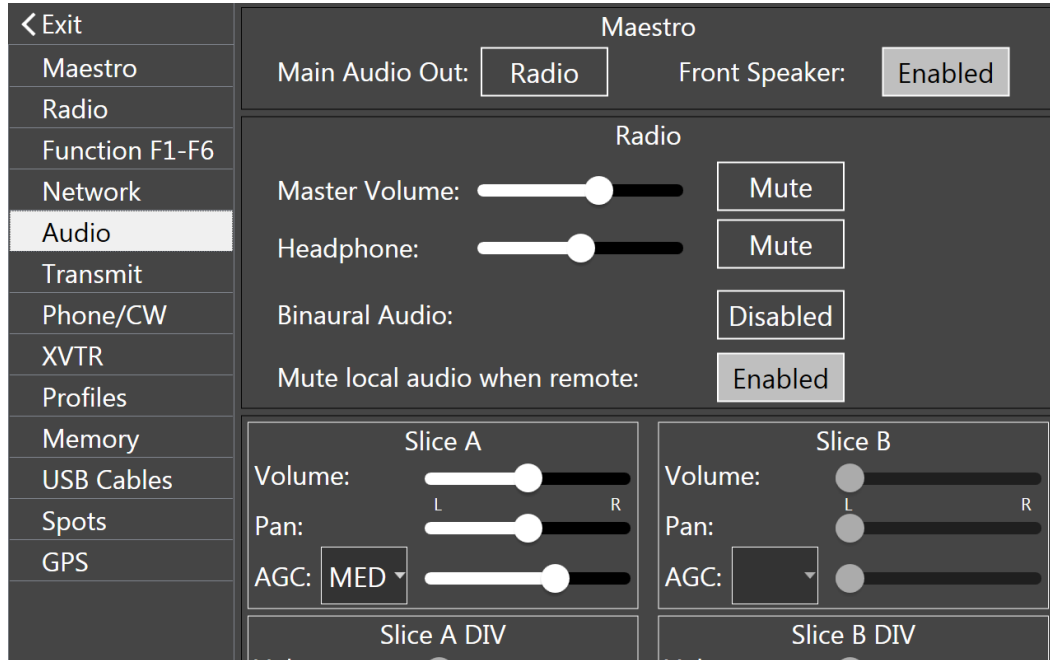

The **Main Audio Out** button controls Maestro’s access to audio from the radio. When enabled, audio is sent to Maestro for reproduction in speakers or headphones. When disabled, audio is kept on the radio where it may be sent to attached speakers or headphones.

The **Front Speaker** button turns Maestro’s front panel speaker on and off.

The **Binaural Audio** button controls the production of a virtual 3D spatial depth-of-field listening experience by shifting the phase of the recovered audio relative to one channel of the speakers or headphones. The effect may enhance weak signal reception. This effect can only be heard in headphones attached to Maestro.

The **Mute local audio when remote** button mutes the speaker and audio outputs of the radio when the radio is controlled by a remote client via SmartLink.

The **Slice A** and **Slice B** sections of the tab contain controls reproduced from the A and B Slice front panel knobs and display controls. **Volume**, left to right **Pan**, **AGC** recovery rate, and threshold are available for adjustment by tapping and sliding the controls. When the Slice is in FM mode, the AGC controls are replaced with a Squelch enable button and Squelch level. Changes made to these values are reflected throughout Maestro.

When Maestro is connected to a FLEX-6600 or FLEX-6700, diversity mode controls appear between the Slice A and Slice B volume controls and the Radio section. These controls provide adjustments for audio volume and AGC for each of the Slices in diversity mode.

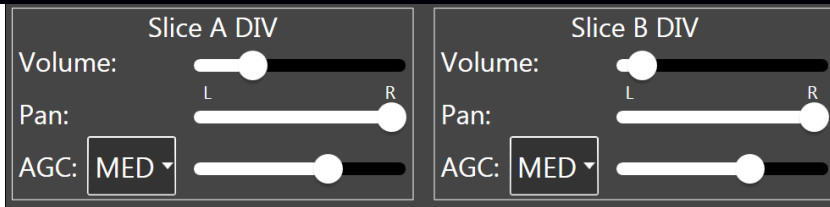

The **Radio** section sliders and buttons control the audio volume at the radio when the **Main Audio Out** control is set to **Radio**. When it is set to **Maestro**, these controls have no effect.

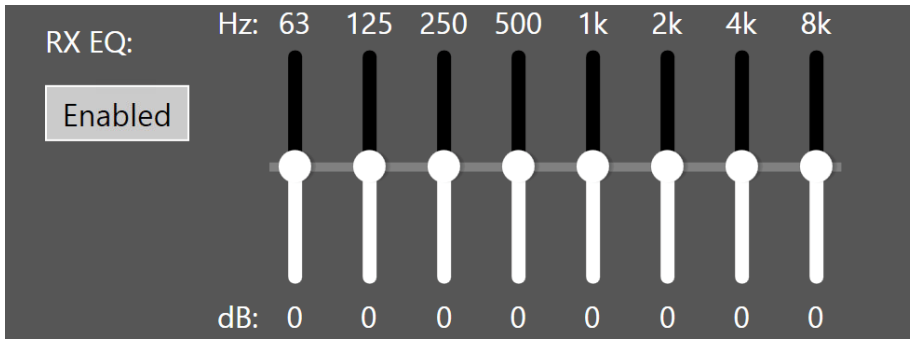

The **Receiver Equalizer** can be used to optimize the reproduced audio for different listening conditions and operating styles. The sliders provide a +/- 10 dB adjustment range over eight octaves. A button is available to enable and disable the equalizer. Note that a separate **Transmit Equalizer** is available on the **Transmit** tab.

33.7 TRANSMIT TAB

The **Transmit** tab offers adjustments for many parameters associated with the transmitter.

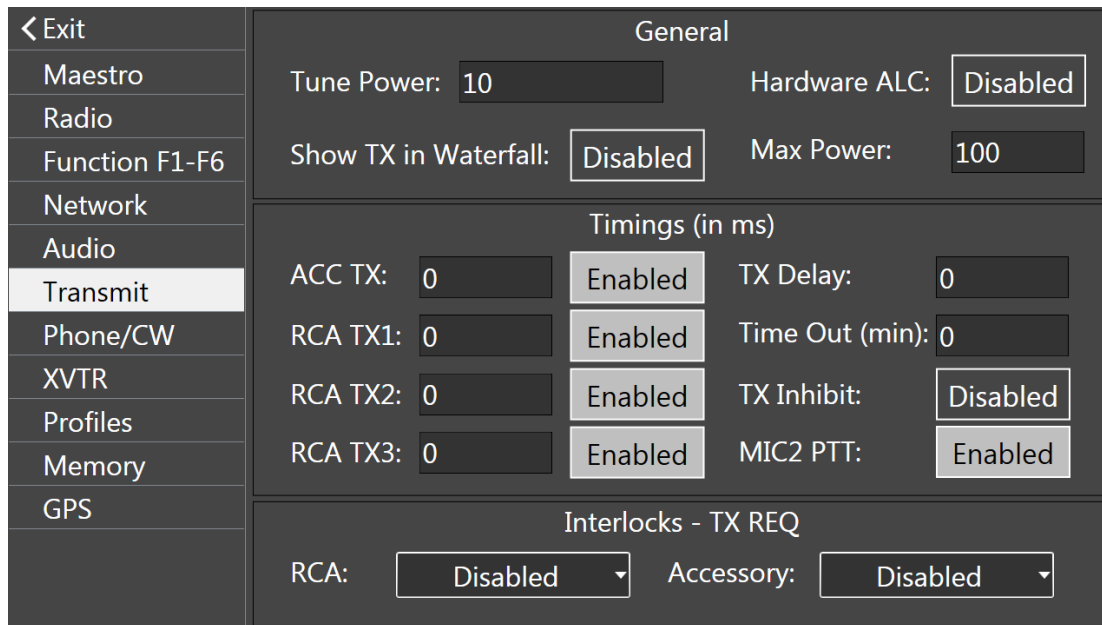

In the **General** section, the **Tune Power** control sets a limit on the transmitter power level when the **TUNE** button is pressed on the front panel. Tapping this field opens a keyboard so the value can be changed.

The hardware ALC can be enabled and disabled by tapping on the **Hardware ALC** button.

Δ – Please note this input is provided as a safety measure for external amplifiers. It is NOT meant to be used in regular operation as an active power control input or to modify the “attack” of an external amplifier. Almost all modern HF amplifier manufacturers discourage the use of ALC in normal operation. Many amplifiers do not have ALC implemented.

The **Show Tx in Waterfall** button enables and disables the display of the transmitted signal in the Panadapter Waterfall. When disabled, a single white line is added to the Waterfall when transmitting. When enabled, the transmission data is added to the Waterfall.

The **Max Power** control allows the user to manually set the radio’s maximum output power on ANT1 and ANT2 when using the PA. This control sets the maximum value of the RF Power front panel knob. Transmit power set by third-party programs will be limited to this value.

The **Timings** section has adjustments for RCA TX1, TX2, and TX3 (only TX1 on FLEX-6300) as well as the Accessory TX, TX Delay, and TX Timeout. Each of these controls is measured in Milliseconds (ms). Each of the TX1, 2, and 3 timings acts independently and starts measuring from the moment a microphone PTT switch is depressed, a CW paddle is keyed, etc. RF is transmitted as soon as the largest of the TX1, 2, 3, and ACC_TX delays have elapsed if the TX Delay is set to zero. Otherwise, the TX Delay value is added to the maximum of TX1, 2, 3, and ACC_TX. Note that each of these timing settings is global to the radio. Whether the fields are active is set by band on the TX Band Settings tab. See section **33.8**.

When **TX Inhibit** is enabled, the transmitter is prevented from operating, regardless of other settings and inputs.

The **MIC2 PTT** button allows the user to disable the PTT input on the MIC2 back panel jack. This is useful when a microphone without a PTT switch is used.

The **Interlocks** section offers three settings for **RCA** and **Accessory** timings: **Disabled**, **Active High**, and **Active Low**. The FLEX-6300 does not have interlock settings for RCA.

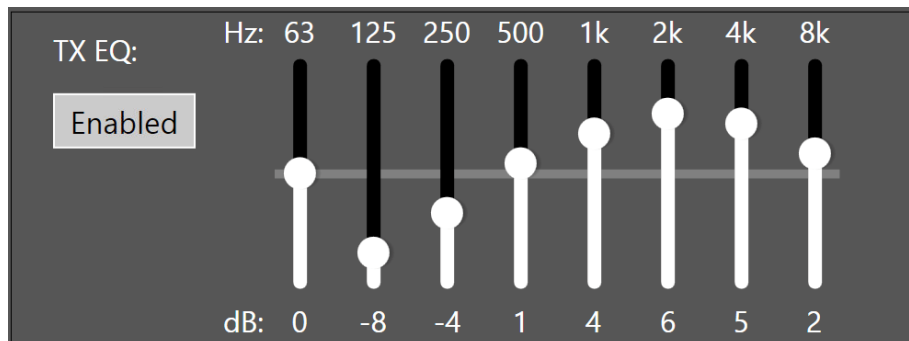

When the **Transmit Equalizer** is enabled, the transmitted audio can be optimized for different microphones and operating styles such as DX, contesting, and SSB. The sliders provide a +/- 10 dB adjustment range over eight octaves. The settings shown above provide very good audio quality for many dynamic microphones.

33.8 TX BAND SETTINGS TAB

The TX Band Settings tab, introduced in SmartSDR v3.0, is a one-stop shop for all of the by-band Transmit settings. This makes it easy to see all of the settings for each band (including XVTRs) and to compare them visually in one place.

TX Band Settings											
Current TX Profile: Default											
Band	RF PWR	Tune PWR	PTT Inhibit	ACC TX	RCA TX Req	ACC TX Req	RCA TX1	RCA TX2	RCA TX3	HWALC	
160	100	10	<input type="checkbox"/>	<input type="checkbox"/>	<input type="checkbox"/>	<input type="checkbox"/>	<input type="checkbox"/>	<input type="checkbox"/>	<input type="checkbox"/>	<input type="checkbox"/>	<input type="checkbox"/>
80	100	10	<input type="checkbox"/>	<input type="checkbox"/>	<input type="checkbox"/>	<input type="checkbox"/>	<input type="checkbox"/>	<input type="checkbox"/>	<input type="checkbox"/>	<input type="checkbox"/>	<input type="checkbox"/>
60	100	10	<input type="checkbox"/>	<input type="checkbox"/>	<input type="checkbox"/>	<input type="checkbox"/>	<input type="checkbox"/>	<input type="checkbox"/>	<input type="checkbox"/>	<input type="checkbox"/>	<input type="checkbox"/>
40	100	10	<input type="checkbox"/>	<input type="checkbox"/>	<input type="checkbox"/>	<input type="checkbox"/>	<input type="checkbox"/>	<input type="checkbox"/>	<input type="checkbox"/>	<input type="checkbox"/>	<input type="checkbox"/>
30	100	10	<input type="checkbox"/>	<input type="checkbox"/>	<input type="checkbox"/>	<input type="checkbox"/>	<input type="checkbox"/>	<input type="checkbox"/>	<input type="checkbox"/>	<input type="checkbox"/>	<input type="checkbox"/>
20	100	10	<input type="checkbox"/>	<input type="checkbox"/>	<input type="checkbox"/>	<input type="checkbox"/>	<input type="checkbox"/>	<input type="checkbox"/>	<input type="checkbox"/>	<input type="checkbox"/>	<input type="checkbox"/>
17	100	10	<input type="checkbox"/>	<input type="checkbox"/>	<input type="checkbox"/>	<input type="checkbox"/>	<input type="checkbox"/>	<input type="checkbox"/>	<input type="checkbox"/>	<input type="checkbox"/>	<input type="checkbox"/>
15	100	10	<input type="checkbox"/>	<input type="checkbox"/>	<input type="checkbox"/>	<input type="checkbox"/>	<input type="checkbox"/>	<input type="checkbox"/>	<input type="checkbox"/>	<input type="checkbox"/>	<input type="checkbox"/>
12	100	10	<input type="checkbox"/>	<input type="checkbox"/>	<input type="checkbox"/>	<input type="checkbox"/>	<input type="checkbox"/>	<input type="checkbox"/>	<input type="checkbox"/>	<input type="checkbox"/>	<input type="checkbox"/>
10	100	10	<input type="checkbox"/>	<input type="checkbox"/>	<input type="checkbox"/>	<input type="checkbox"/>	<input type="checkbox"/>	<input type="checkbox"/>	<input type="checkbox"/>	<input type="checkbox"/>	<input type="checkbox"/>
6	100	10	<input type="checkbox"/>	<input type="checkbox"/>	<input type="checkbox"/>	<input type="checkbox"/>	<input type="checkbox"/>	<input type="checkbox"/>	<input type="checkbox"/>	<input type="checkbox"/>	<input type="checkbox"/>
GEN	100	10	<input type="checkbox"/>	<input type="checkbox"/>	<input type="checkbox"/>	<input type="checkbox"/>	<input type="checkbox"/>	<input type="checkbox"/>	<input type="checkbox"/>	<input type="checkbox"/>	<input type="checkbox"/>
2200	100	10	<input type="checkbox"/>	<input type="checkbox"/>	<input type="checkbox"/>	<input type="checkbox"/>	<input type="checkbox"/>	<input type="checkbox"/>	<input type="checkbox"/>	<input type="checkbox"/>	<input type="checkbox"/>

The settings on the TX Band Settings show the active settings for the current TX Profile (shown in the title bar). Changes to the form are saved immediately to the profile. Below you will find a description of each field:

Band: The settings across each row apply to the band in the first column.

RF PWR²: The RF Power output setting. Sets the output power for typical transmissions.

Tune PWR²: The Tune Power output setting. Sets the output power to use when using TUNE.

PTT Inhibit: Inhibits transmission on the band when selected.

ACC TX: When selected, the ACC TX Pin on the ACC connector (back panel) is pulled to ground during transmit.

² *The control on the front panel will modify this value for the current band (and vice versa).*

RCA TX Req: Enables the RCA TX Request line when selected. When active, the RCA TX Req line must be in the appropriate state (depending on the polarity set on the Settings -> TX Tab) to allow for transmission.

ACC TX Req: Enables the ACC TX Request line when selected. When active, the ACC TX Req line must be in the appropriate state (depending on the polarity set on the Settings -> TX Tab) to allow for transmission.

RCA TX1/2/3: When selected, the TX1/2/3 RCA output is pulled to ground during transmission.

HWALC: Enables the RCA Hardware ALC circuit when selected.

Note: For the timing settings for several of these controls which apply to all bands, see the Transmit Tab, section 33.7.

33.9 PHONE/CW TAB

The **Phone/CW** tab provides several controls for managing the microphone and CW key interfaces.

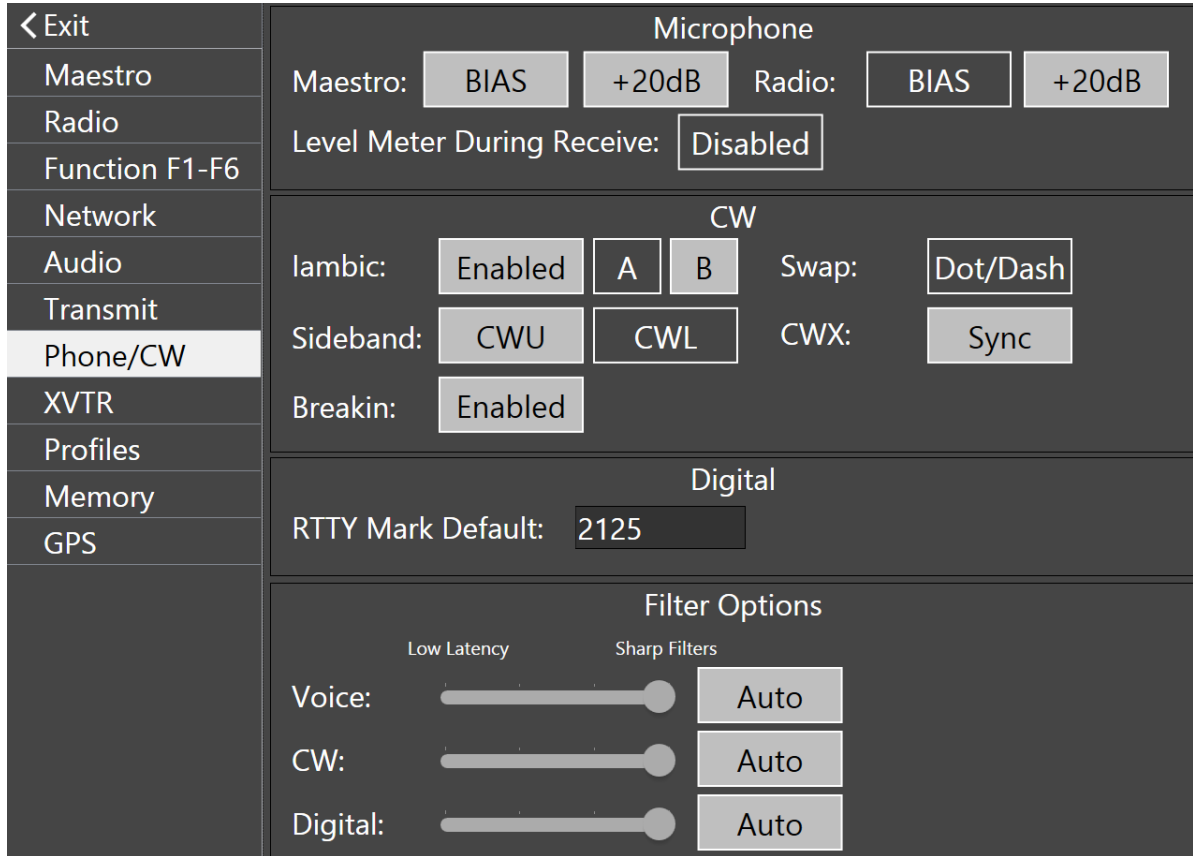

In the **Microphone** section, the **Maestro BIAS** button enables the +5 VDC microphone bias voltage on the Maestro **MIC 2** connector. Enable this bias voltage only if required by the microphone. The **Radio Bias** button enables the bias voltage on the radio's front panel microphone connector.

The **Maestro +20dB button** enables the 20 dB gain microphone preamp on the MIC connector. The **Radio +20 dB** button enables the 20 dB gain microphone preamp on the radio's front panel microphone connector.

Note: The +20 dB microphone preamp option should always be enabled whenever a microphone is directly connected to the FLEX-6000. This option is not available when LINE is selected as the audio input.

The **Level Meter During Receive** button enables or disables the display of the microphone signal level on the microphone signal level meter when the transmitter is not engaged. This can be used to set the microphone level without transmitting.

In the **CW** section, the **Iambic** and **Swap** buttons control how signals from a connected straight key or paddle set are interpreted. To use a paddle set in Iambic mode, enable the **Iambic** button and select either the **A** or **B** Iambic mode.

A paddle set can be used as a “bug” by disabling the **Iambic** control. In this mode, one paddle will key the transmitter continuously, the other will create a string of dots. In both of these configurations, the **Swap** control reverses the paddle assignments.

To use a straight key, disable the **Iambic** control and enable the **Swap** control. The key should be wired as shown in section 0,

Maestro “C” External Monitor Port

The external monitor port is provided to connect an external monitor to your Maestro device. The Maestro screen is then “mirrored” to the external monitor providing a larger viewing field.



33.9.1 Straight Key and Paddles Connection

For CW operation, the 1/8 inch (3.5mm) TRS KEY connector accepts a TRS plug for operating a keyer with paddles or a straight key.

The **CWU** and **CWL** buttons alter CW tone pitch with tune direction in a similar way to upper and lower sideband decoding.

When the **Breakin** button is selected, the transmitter is engaged by a key or paddle closure rather than a PTT signal.

In the Digital section, the RTTY Mark Default control sets the default value of the RTTY IF offset when new RTTY slice receivers are created. See section 31.2, **RTTY Mode** for more information about RTTY operation.

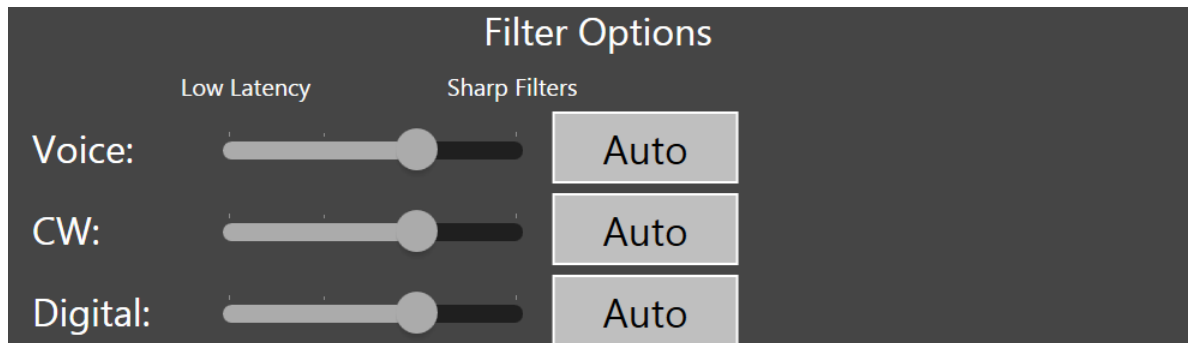

The three sliders in the Filter Options section control the RX filter sharpness/latency for the three mode groups, Voice (USB/LSB/AM/SAM/FM), CW, and Digital (DIGU, DIGL, DFM, RTTY). The processing time, or latency, of the digital RX filters, increases as the slider is moved to the right.

Sharper filters require more processing time. In applications requiring fast turnaround of signals (e.g. certain contest environments), faster filtering of the received signal may be more desirable than adjacent signal rejection.

When Auto is selected for a mode group, the sharpness of the filter depends on the bandwidth of the filter. In general, the filter gets sharper, but slower, as the bandwidth narrows. In the following, Level 0 is the lowest latency (least sharp) and Level 3 is the highest latency (most sharp).

- DIGU/DIGL
 - Bandwidth from zero to 500 Hz: Level 3
 - Bandwidth from 500 to 1000 Hz: Level 2
 - Bandwidth from 1000 to 2000 Hz: Level 1
 - Bandwidth from 2000 to 10000 Hz: Level 0
- RTTY
 - Bandwidth from zero to 400 Hz: Level 3
 - Bandwidth from 400 to 1000 Hz: Level 2
 - Bandwidth from 1000 to 1200 Hz: Level 0
- CW
 - Bandwidth from zero to 400 Hz: Level 3
 - Bandwidth from 400 to 1000 Hz: Level 2
 - Bandwidth from 1000 to 1500 Hz: Level 1
 - Bandwidth from 1500 to 10000 Hz: Level 0
- USB/LSB/AM/SAM
 - Level 3 for all bandwidths
- FM/NFM/DFM
 - Level 0 for all bandwidths

All TX filtering is performed with low latency (less sharp) filters.

33.10 XVTR TAB

The XVTR Tab allows the user to set up transverter bands for the FLEX-6000. Tapping the **Add** button creates a new tab for a new transverter band definition. Refer to section **27, How to Configure Transverters** for detailed information on configuring transverters.

33.11 PROFILES TAB

The **Profiles** tab loads, saves, and deletes global, transmit, and microphone profiles. See section **16, How to Use Profiles**, for full details.

33.12 MEMORY TAB

The **Memory** tab loads, adds and deletes sets of radio configuration information for rapid recall. See section **22.2, Memory Channels** for full details. While section **22.2** describes the use of Memories with the FM modes, Memories can be used with any mode.

33.13 USB CABLES TAB

The **USB Cables** tab is described in detail in section **30.1, USB Cables Overview**

33.14 SPOTS TAB

The Spots tab is described in section 26, **Displaying Spots in SmartSDR for Maestro**.

33.15 MULTIFLEX TAB

The multiFLEX tab shows the connected Stations and which one is set as the Local PTT.

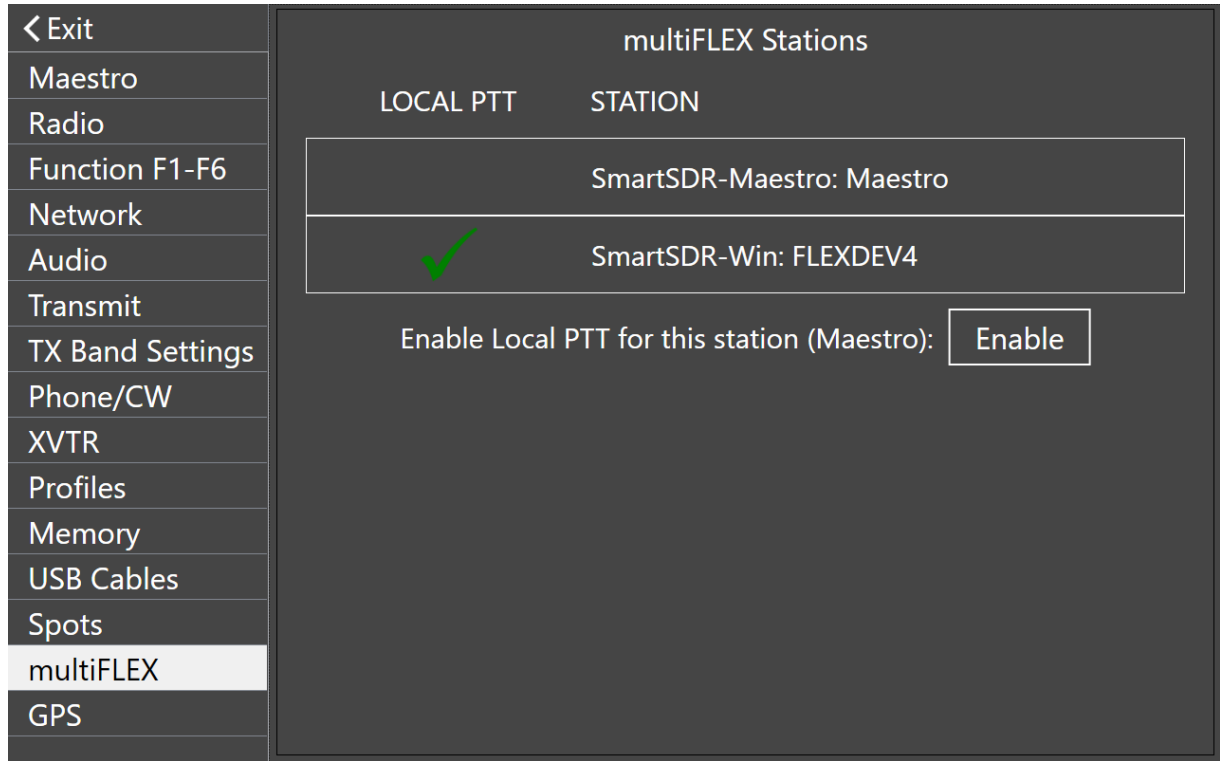

Each Station application is listed along with the Station Name for easy identification.

Local PTT: The Local PTT Station is the chosen Station context to use when using a hardware PTT such as a footswitch or CW paddles. The Local PTT Station is identified with the checkmark. This setting is a conflict resolver and is necessary since multiple Stations can be connected to the radio at once.

33.16 GPS TAB

The **GPS** tab provides controls to manage a GPS Disciplined Oscillator. This option is not available in Flex-6300 models.

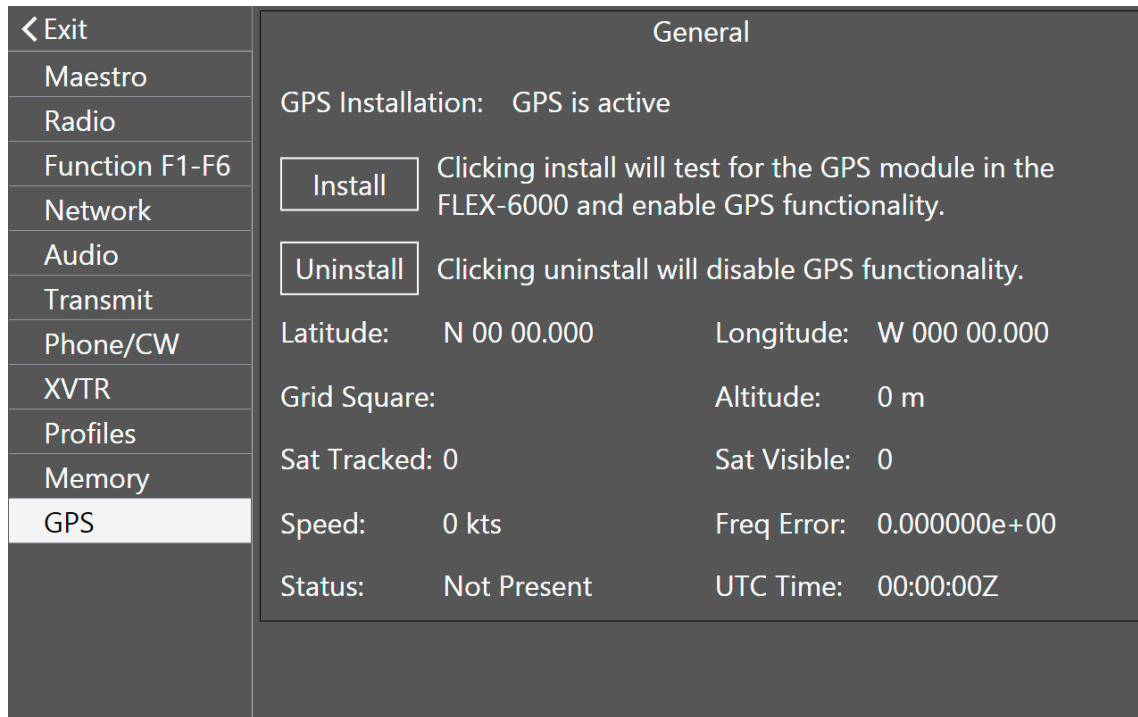

If your radio has a factory-installed GPS module, this tab should display data from the GPS module and no further changes should be needed.

If you are installing the GPS module, tap the **Install** button to test for the GPS module and enable its operation. If the installation was successful, **GPS is active** and should be displayed at the top of the panel. When removing the GPS or bypassing the module, tap the **Uninstall** button to disable GPS functionality.

If no GPS device is present in the radio, the **Install** and **Uninstall** buttons have no effect.

The lower portion of the GPS tab displays information collected from the GPS module. This information includes:

- **Latitude**
- **Longitude**
- **Grid Square**
- **Altitude**
- **Sat Tracked** - Number of Satellites being tracked by the GPS
- **Sat Visible** - Total number of satellites that should currently be visible to the GPS
- **Speed** - Speed of your radio in knots along the surface of the Earth
- **Freq Error** – The average error in the frequency of the 10MHz output from the GPS. The radio’s frequency error is this value multiplied by the currently tuned frequency.
- **UTC Time**
- **Status** - Displays the current status of the GPS Module. One of six modes will be displayed:

- Not Present
- Holdover
- Locking
- Locked
- Holdphase
- Warm-up

34 SLICE RECEIVER

34.1 DEFINITION

A Slice Receiver is a software resource that represents an independent, full-performance, receiver. Maestro can operate a maximum of two Slices at one time, with fully independent controls. Each Slice is designated by a letter indicator  which increments with each additional Slice.

34.2 CARRIER FREQUENCY



A Slice consists of a center Carrier Frequency displayed by a solid yellow  or red/vertical bar. A yellow bar indicates the Slice is “Active”, suggesting that this is the Slice that you are currently manipulating. The Active Slice will have the control of radio features that are applied to Slice Receivers.

34.3 RECEIVE FILTER



Surrounding the Carrier Frequency bar is a blue Receive Filter bar  which represents the filtered receive audio. The portion of the spectrum that is highlighted by the Receive Filter bar will be output as audio.

The position of the Receive Filter relative to the Carrier Frequency will correspond to the selected mode. A Receive Filter to the right of the Carrier indicates an Upper Sideband mode. A Receive Filter to the left indicates a Lower Sideband mode. A Receive Filter that spans both the left and right of the Carrier will indicate a double sideband mode.

The Receive Filter width can be adjusted manually by use of the associated bandwidth front panel control. The lower frequency limit and higher frequency limit can be adjusted in several ways.

34.4 DYNAMIC FILTER DEPTH

In most SDR systems, the number of filter taps employed to carry out the filtering task is set by a buffer size in the system. To change the filter tap depth, the system must be stopped before the adjustment can be made. As more taps are added, filtering is better, but latency also increases. In Maestro, the number of filter taps employed changes based on the mode and filter width to achieve the best compromise between latency and filtering for the task at hand. Ultimately, the filtering capability and the latency are a function of the total duration of samples inside the filter at any time. The table below shows based on mode and filter size how many samples are used in the filter. The more samples (and consequently time) inside the filter, the greater the filter and the higher the latency.

Mode	Filter Width	Filter time	Filtering	Latency
USB / LSB	Any	85ms	Excellent	Highest
CW	<= 400Hz	85ms	Excellent	Highest
	<= 1kHz	43ms	Very Good	Medium
	<= 1.5kHz	21ms	Good	Low
	> 1.5kHz	11ms	Good	Very Low
AM	Any	85ms	Excellent	Highest
FM	Any	11ms	Good	Very Low
DIGU / DIGL	<= 500Hz	85ms	Excellent	Highest
	<= 1kHz	43ms	Very Good	Medium
	<= 2kHz	21ms	Good	Low
	> 2kHz	11ms	Good	Very Low
Waveform Mode	Any	43ms	Very Good	Medium

When using low latency ARQ mode digital programs such as PACTOR, a filter width greater than 2kHz is recommended to avoid adding extra latency inside the radio to the demodulation time.

35 FRONT PANEL DISPLAY

35.1 INTRODUCTION

The Front Panel Display is a full color high-resolution touch-sensitive device. In operation, Maestro displays one or two Panadapters and one or two Slice Receivers. The user can interact with and control the radio by touching graphic elements of the display such as the **Main Menu** button, Slice Receiver Antenna control panels, Slice Receiver meters, **Slice Receiver Menus**, and Slice Receiver tuned positions.

35.2 DISPLAY UPPER BAR



Located in the upper bar of the display are the two Slice Receiver Flags, the A Slice on the right and the B Slice on the left. In the center of the bar are the **Main Menu** button, the RF power level indicator, the power supply indicators, and the network signal strength indicator. When a Power Genius XL amplifier is configured with the radio, its control appears above the RF power level.

35.2.1 Slice Receiver Flags

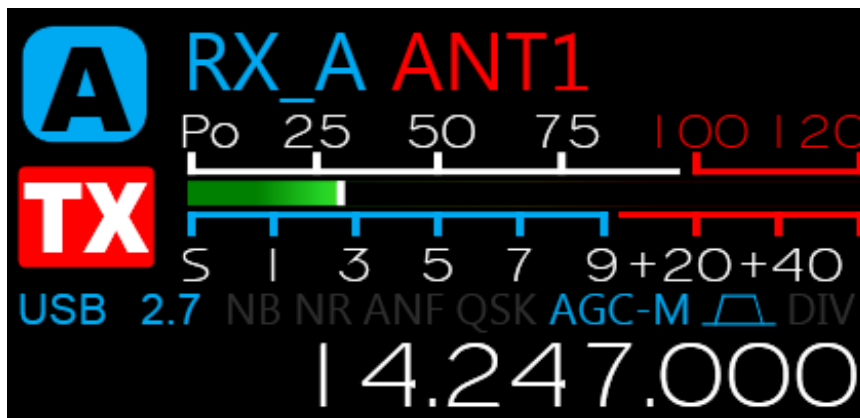

The Slice Receiver Flags contain many controls and annunciators associated with the operation of a Slice Receiver. These include a basic on/off control, an antenna selection menu, transmitter assignment, multiple meters, operational mode, tuned frequency and annunciators for filter width, noise reduction options, CW options, and AGC state.



Elements of the Slice Flag, top to bottom, left to right:

- 
 The Slice Receiver identifier, A or B. When the Slice Receiver is active, A or B will be displayed. When the Slice is inactive a vacant blue background is shown. Tap the identifier to turn the Slice on or off. The corresponding front panel **RX** buttons will illuminate indicating that the Slice is receiving.

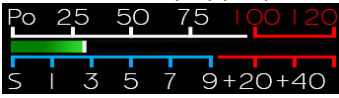
If two Panadapters are active in the Maestro display, tapping a Slice Receiver identifier button creates a Slice Receiver in the upper Panadapter if it doesn't already exist. Tapping the button again removes the Slice Receiver from the upper Panadapter and creates it in the lower Panadapter. Another tap removes the Slice Receiver altogether. Either the A or B Slice Receiver can be moved to either Panadapter this way.

-  The Slice Receiver **Antenna Menu**. Tap this indicator to open the antenna control panel. Using this panel, choices can be made for reception and transmit antennas. Tap the indicator again to close the control panel. A complete discussion of the control panel is found in section **25, How to Configure Antennas**.
-  Transmitter indicator. Tap this indicator to move control of the transmitter to or from the associated Slice Receiver. The front panel TX buttons will illuminate as the changes are made. Note that it is possible to assign the transmitter to Slice A, Slice B, or to neither Slice by appropriate taps of the indicator.
-  Signal Meters. A choice of several meters is available in the middle of the Slice Flag. An "S" meter showing the received signal strength is always displayed in the lower half of the meter. A sliding white marker shows the recent peak value on the scale. Tapping the meter reveals a choice of meters for the upper half of the meter display. Choices include transmitted power level, SWR, microphone level, audio signal compression level, and ALC signal level. See section **35.3.9, Auxiliary Meters** for more information.
-  Annunciators. Below the signal meter is a row of annunciators. From left to right, these show the Slice Receiver operational mode (LSB, USB, CW, etc.), the receiver filter width in kHz, and a list of annunciators for options such as noise blanking (NB), noise reduction (NR), automatic notch filters (ANF), QSK mode and AGC recovery rate. At the right of the list, a graphic indicates the mode of the bandwidth control. When the graphic appears as it does above, the bandwidth control is in Low/Hi mode. When a vertical bar appears in the middle of the graphic, the control is in Center/Width mode. See section **11.6, How to Change the RX filter of a Slice Receiver** for more details.
-  The tuned frequency. The bottom element of the Slice Flag shows the tuned frequency. Tapping this element opens the **Slice Receiver Menu** which covers the entire Panadapter portion of the display.



35.2.2 Slice Receiver Menu



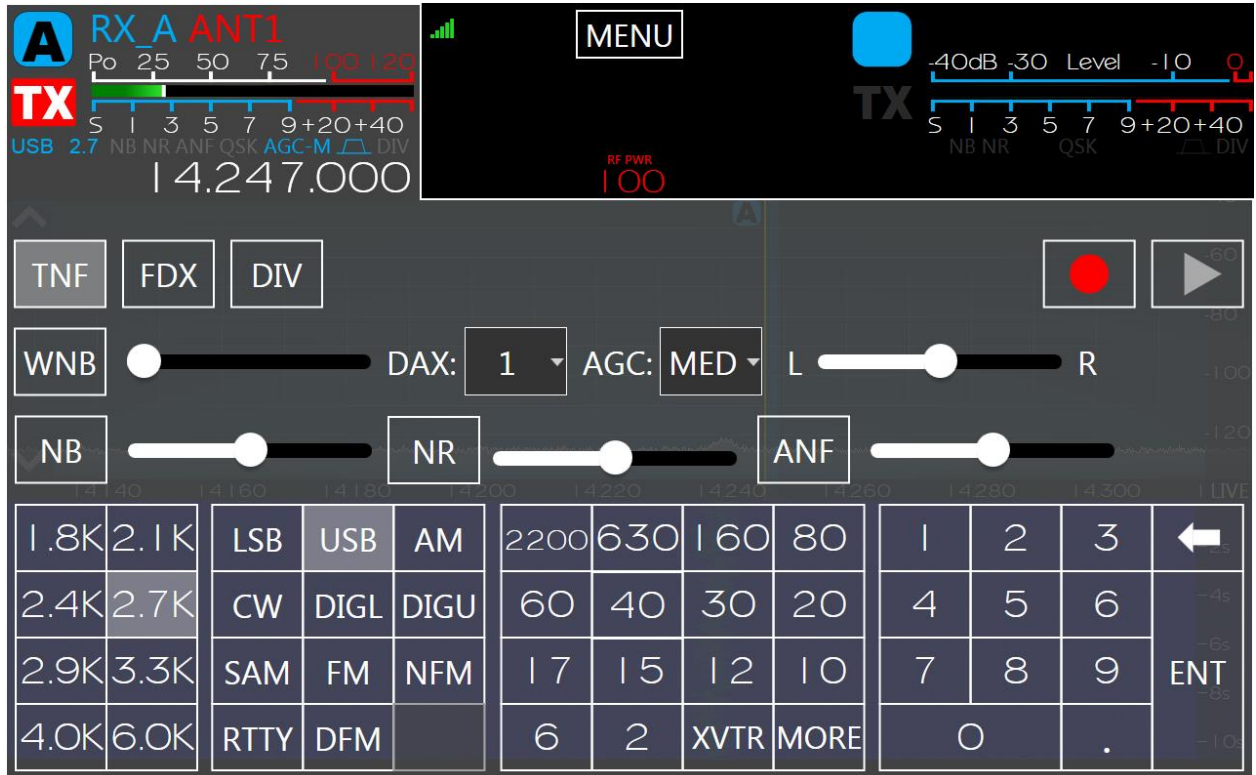



The **Slice Receiver Menu** contains the controls associated with a Slice Receiver. These include the receiver mode, band, frequency, filter width, noise reduction, DAX channel assignment, AGC recovery time, and others.

Open the control panel by tapping on the frequency in the Slice Flag, or by pressing the tuning knob inward until it clicks. The control panel covers the Slice Flag and all of the Panadapter. Close the control panel by tapping the frequency display, tapping outside of the control panel, or by another tuning knob press.

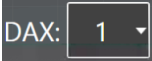
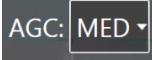

The elements of the control panel from top to bottom, left to right are:

-  Tracking Notch Filter button. Enables and disables tracking notch filters.
-  Full Duplex button. When enabled, allows certain receivers to operate in full duplex mode. See section 32, **How to Operate in Full Duplex (FDX) Mode** for details on using this mode.
-  The red Quick Record button records the received or transmitted audio of the Slice Receiver. Pressing the green Quick Play button will play back the recorded audio. When the radio is transmitting, the recorded audio will be played through the transmitter.

-  Wideband Noise Blanker. Enables the wideband noise blanker. Note that this noise reduction feature operates on the entire RF spectrum captured by the SCU, so enabling this feature in one Slice may enable it in another. See section **14.3, Wideband Noise Blanker (WNB)** for full details.
-  DAX channel assignment. It assigns the audio produced by the Slice Receiver to the indicated DAX channel. The **Off** setting disconnects the Slice from the DAX system.
-  AGC recovery rate. Controls the speed that the Automatic Gain Control recovers from sudden changes in the audio level. See section **14.1, AGC Threshold** for full details.
-  L/R pan. Adjusts the audio level in stereo headphones from left to right. Each Slice Receiver can be set independently so it is possible to listen to a different Slice with each ear.
-  Slice Specific Noise Blanker. Enables the Slice-specific noise blanker and sets its threshold level. See section **14.4, Slice Specific Noise Blanker (NB)** for full details.
-  Noise Reduction. Enables the noise reduction system for the Slice and sets its threshold level. See section **14.5, Noise Reduction (NR)** for full details.
-  Automatic Notch Filter. Enables the Automatic Notch Filter and sets its threshold level. When the Slice is in CW mode the ANF button and slider will switch to an APF button and slider. See section **15.4, Automatic Notch Filter (ANF)** for full details.
-  When operating a FLEX-6700 an additional control will appear to enable Diversity Reception. See section **23, How to Operate Diversity Reception (FLEX-6600(M) and 6700 Only)** for complete details.

Across the bottom of the control panel are four menus for receiver filter selection, receiver mode, band, and frequency input.

1.8K	2.1K
2.4K	2.7K
2.9K	3.3K
4.0K	6.0K

The Receiver Filter menu provides several commonly used filter widths, coordinated with the mode of the Slice Receiver. Tap a filter button to select a filter. Note that custom adjustments can be made with the front panel bandwidth knobs.

LSB	USB	AM
CW	DIGL	DIGU
SAM	FM	NFM
RTTY	DFM	

The Mode menu provides a selection of the available operational modes. Sideband, AM, CW, digital, FM, and RTTY modes are available. Tap a mode button to invoke the mode in the receiver.

2200	630	160	80	WWV GEN 4 HF
60	40	30	20	
17	15	12	10	
6	2	XVTR	MORE	

Selecting a band from this menu will adjust the Panadapter to display all or part of the corresponding amateur radio band. Selecting band buttons allows for rapid switching between views of the amateur radio bands. Tapping on the **XVTR** button in the lower right swaps the buttons to a list of **XVTR** bands. When the **XVTR** bands are shown an **HF** button will also be shown. Tap the **HF** button to swap back.

1	2	3	←
4	5	6	ENT
7	8	9	
0	.		

The tuned frequency of the Slice Receiver can be controlled with the keypad. Tap the number buttons to enter a frequency in MHz, and tap ENT to enter the value into the Slice Receiver.

35.2.3 Power and Network Indicators – Maestro “C”

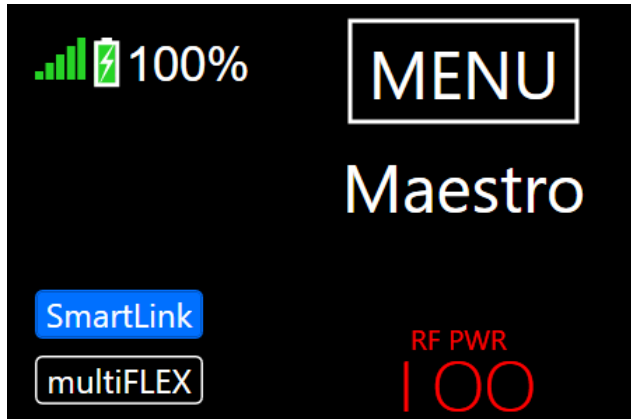

The center of the Maestro display’s upper bar features indicators showing the quality of the network connection (wired or wireless), the power source in use (external 12VDC or 14.4 VDC battery pack), the RF Power Amplifier output level, SmartLink and MultiFlex status indicators and a button to open the **Main Menu**. See section **33, Main Menu** for full details about the **Main Menu**.

Battery Icons:

- Plug icon = Power supply connected
- Battery icon = Battery connected without power supply
- Battery icon with charge (lightning bolt indicator) icon = Battery and power source connected

Battery Levels:

- 0 - 5% Red empty battery icon
- 5 - 14% Red
- 15 - 49% Yellow
- 50 - 100% Green

Low Battery Management

At a 3% charge level, the battery-low warning appears and the Power LED flashes yellow.

The warning message can be cleared by selecting OK. It is advised to shut down Maestro or connect the external power supply.

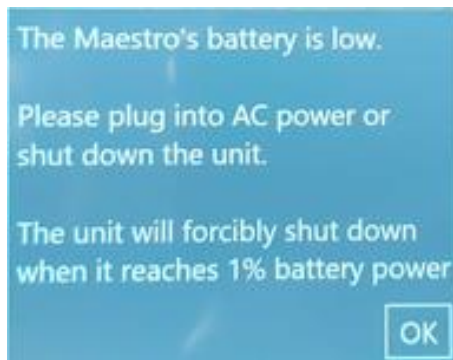

At 1% the Maestro is forcibly powered off.

35.2.4 Power and Network Indicators – Maestro “A” and “B”



The center of the Maestro display’s upper bar features indicators showing the quality of the network connection (wired or wireless), the power source in use (external 12VDC or battery), the RF Power Amplifier output level, and a button to open the **Main Menu**. See section **33, Main Menu** for full details about the **Main Menu**.

Important Note: Maestro “A” models (those with serial numbers in the form xxxx-xxxx-0100-xxxx) must be connected to DC power for 15 to 30 minutes every 4 to 6 weeks of non-use to ensure that the internal display battery does not completely discharge. If the display battery discharges, the Maestro will not boot, and a HelpDesk ticket will have to be opened to resolve the issue.

Tapping the RF output level indicator opens the Transmitter Control Panel.

35.3 DISPLAY PANADAPTERS

35.3.1 Panadapter Definition

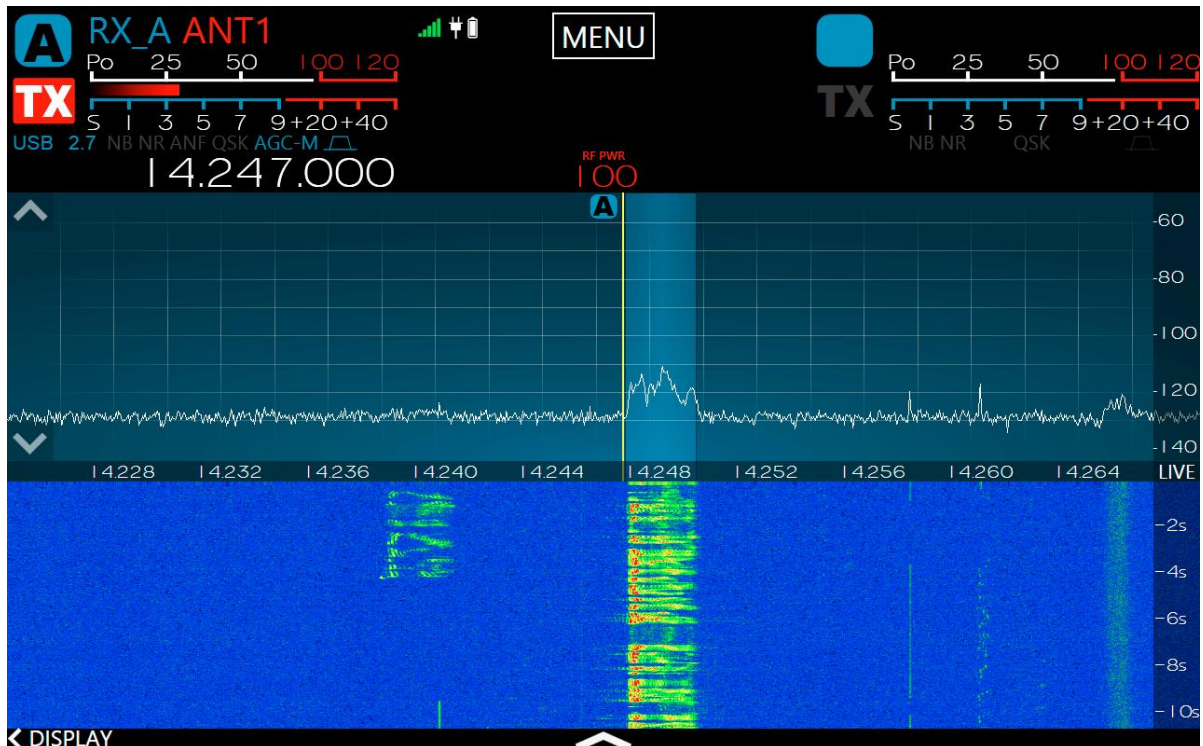

A Panadapter is a visual spectrum display of radio frequencies (RF). Frequency is listed along the horizontal axis from lower to higher frequency, from left to right, measured in Megahertz (MHz). Amplitude is shown on the vertical axis measured in decibels (dBm). The moving white line represents RF coming into the radio at the indicated frequency. The Panadapter is where the majority of typical operations occur. Maestro is capable of displaying two Panadapters simultaneously, each with its unique frequency and bandwidth.

35.3.2 Waterfall Definition

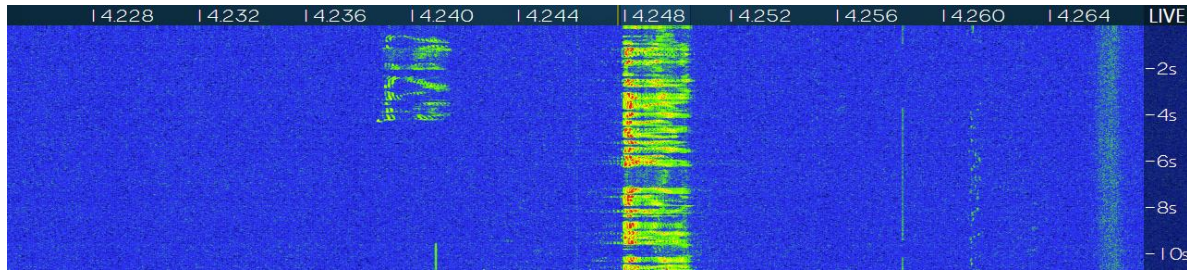

A Waterfall is a historical representation of RF data over time. Frequency is listed along the horizontal axis from lower to higher frequency, from left to right, measured in Megahertz (MHz). Time is measured on the vertical axis where the most recent data is at the top and the oldest data is at the bottom.

35.3.3 Waterfall Time Machine

Tapping in the time scale at the right margin of the Waterfall changes the mode of operation from real-time to recent history. In the recent history mode, the Waterfall displays selected data from the most recent several minutes. The displayed data can be moved up and down with finger swipes along the right edge of the display.

While the stored information is being displayed, Maestro continues to record the live Waterfall and add it to the top of the stored information. Depending on the amount of information stored, the oldest information at the bottom may be lost.

Tap the **Live** button at the top right of the Waterfall to return to the real-time display.

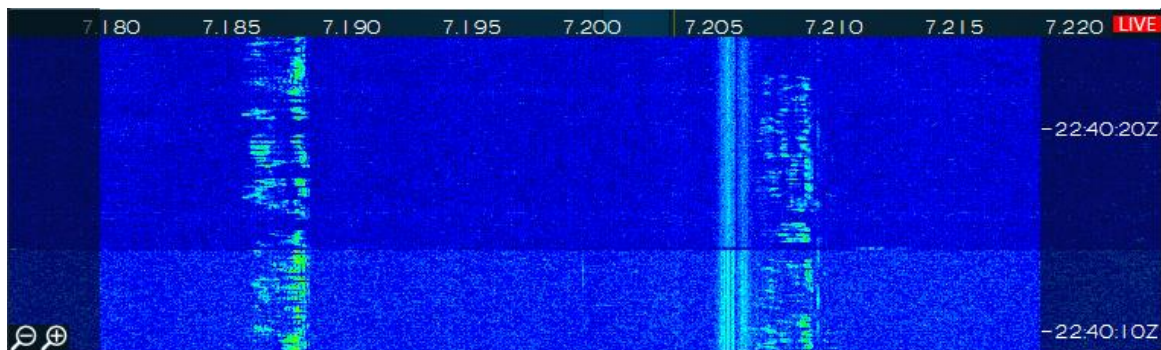

35.3.4 Panadapter Display Menu

Tapping the **Display** menu button on the left side of the Panadapter will expose the display control panel.

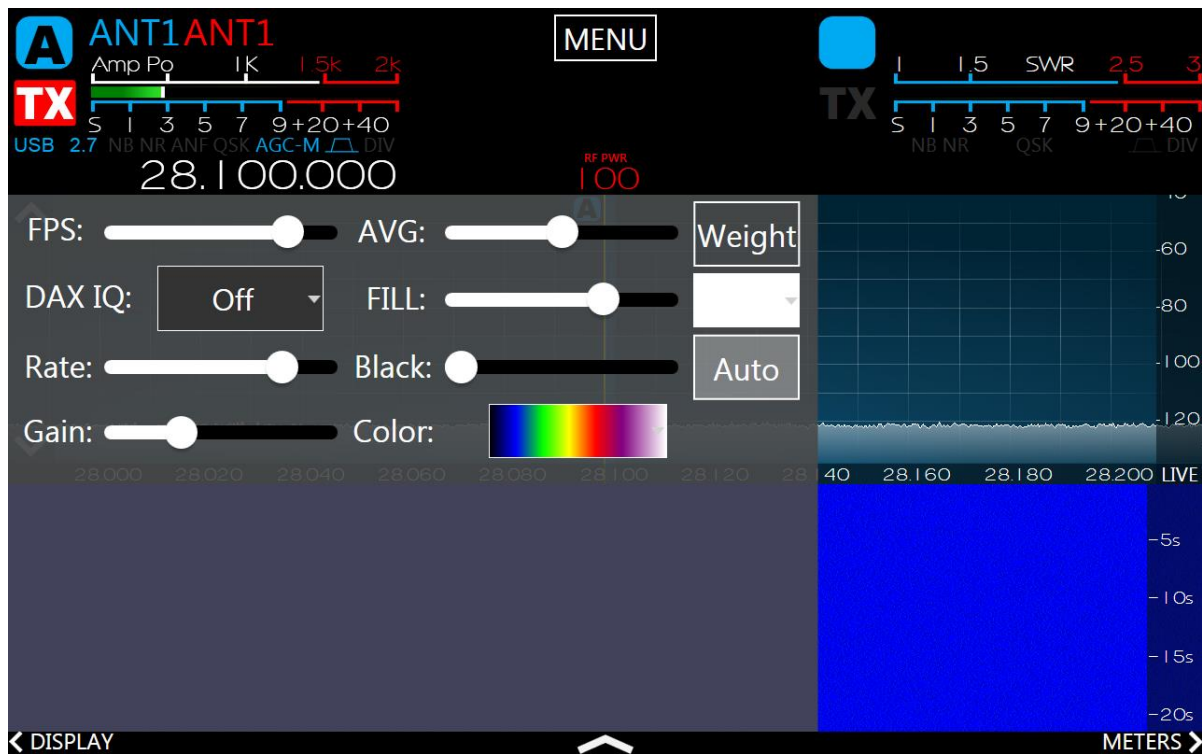

Each Panadapter has its own controls. When one Panadapter is active, the upper half of the control panel is populated with controls, the lower half is blank. The controls are superimposed on the Panadapter they are associated with.

The **FPS** slider controls the rate at which the Frequency Spectrum is presented on the Panadapter, in frame per second. Lowering the **FPS** control has several effects:

- It reduces the rate at which both the Panadapter and the Waterfall are updated.
- It reduces the network bandwidth required for data sent from the radio to the client, which may be important in situations in which limited bandwidth is available.
- As the framerate is reduced, the extra data not displayed is averaged and so the variance of the data is lowered, making both the Panadapter and the Waterfall smoother.

If you prefer a faster updating display, but a more averaged or smoother one, adjust the **FPS** setting for the update speed you prefer and then raise the **AVG** (averaging) control. The **AVG** control increases the number of frames that are averaged, lowering the variance and smoothing the display.

The weighted average control, **Weight**, emphasizes signals that are increasing in amplitude over those that are declining. This tends to continue to show locations where signals have been and show a more precise view of their full amplitude when they first appear.

The **DAXIQ** control allows the user to select the DAXIQ channel (1-4) that will stream IQ data from the Panadapter. Tap this control to display a selection of channels, or **Off**.

The **Fill** control adjusts the amount of shading that is applied to the portion of the spectrum display below the signal line. The fill color can be chosen from the drop-down menu to the right of the **Fill** control.

The **Rate** control adjusts how quickly the Waterfall advances on the screen. At the lowest setting, many minutes of data can be displayed. At its highest setting, the Waterfall displays a rapidly changing spectrum in the most detail.

The **Gain**, **Black**, and **Auto** controls work together to adjust how different signal levels are displayed in the Waterfall. The **Black** control sets the level below which all pixels will render as black. In other words, it sets the level at which signals are no longer of interest. The **Auto** control automatically sets the black level to just below the noise level as band conditions, preamplifier changes or antenna changes alter the noise floor.

The **Gain** control adjusts how rapidly the Waterfall will advance through the color spectrum for minimal changes in signal level. Lowering the gain gives the Waterfall a broader dynamic range but lessens its ability to show small variations signals. Raising the gain lowers the dynamic range but provides more detail in the variances in smaller signals' magnitudes.

In most cases, **Auto Black** properly adjusts the background color or black level for the display's zoom factor and its relative noise floor. However, you can manually adjust the Waterfall's settings to display weak signals at or near the noise floor. If the **Black Level** is set too low, many of the "in the noise" FFT bins will be zero, regardless of the **Gain** setting. To achieve an ideal setting for the **Black Level**, do the following:

- Adjust the **Gain** to maximum.
- Adjust the **Black Level** to a point where the Waterfall is primarily white, but there are approximately 2-5% black areas displayed.
- Decrease the **Gain** until the background is deep blue.

This ensures that small signals in the noise will be easily seen.

The **Color** control offers options for the color scheme used in the Waterfall.

35.3.5 Horizontal Zoom

The FLEX-6500, FLEX-6600(M), and FLEX-6700 Panadapters support a display range of a few KHz to a maximum of 14 MHz. The FLEX-6300 and FLEX-6400M Panadapters support a display range of a few KHz to a maximum of 7 MHz. There are five methods for adjusting the zoom of the Panadapter.

- The first is by use of the plus and minus buttons located in the upper right corner of the Panadapter. Tap on the upper half of a Panadapter display to reveal the buttons. Zooming out (-) will double the bandwidth presented in the Panadapter while zooming in (+) will halve the bandwidth. The frequency at the center of the Panadapter will remain the same after tapping a zoom button. The buttons are removed from the display a few seconds after their last use.



- The second is the “pinch zoom” method. Touch the panadapter with two fingers at once. Move them apart to zoom in, move them together to zoom out.
- The third is a tap-and-drag method using the horizontal axis for more precise zooming.  The tap-and-drag method will zoom in by dragging to the right and vice-versa. With this method, the frequency at the point where your finger was located at the tap event will remain stationary in the Panadapter.
- The fourth is the “zoom to band” method. Next to the plus and minus buttons located in the upper right corner of the Panadapter display, you will see the **B** control as shown in the image above. Tapping this control changes the zoom level so that the entire band that contains the Active Slice Receiver is displayed on the Panadapter. Tapping the control again returns the Panadapter zoom to its previous level. This control is available as part of the set of controls that can be mapped to function buttons. See section **33.4, Function F1-F6 Tab** for more details.
- The fifth is the “zoom to segment” method. Next to the plus and minus buttons located in the upper right corner of the Panadapter display, you will see the **S** control as shown in the image above. Tapping this control changes the zoom level so that the entire segment (CW/Phone) of the band that contains the Active Slice Receiver is displayed on the Panadapter. Tapping the control again returns the Panadapter zoom to its previous level. This control is available as part of the set of controls that can be mapped to function buttons. See section **33.4, Function F1-F6 Tab** for more details.

When zooming out with a FLEX-6000 radio there are certain points where the size of the data used to create the display on the screen will need to be doubled. As this occurs there will be more noise taken into account while processing the display which will cause a noticeable increase in the noise floor. The reverse occurs when zooming in on a Panadapter. After zooming out to a certain point, the hardware will switch to wideband mode. When this occurs, any Panadapters that are affected by this change will display  in the top right corner to indicate that it is in wideband mode. In Wideband mode, the radio will open the Bandpass Filters to their maximum for any Panadapter using the associated antenna.

35.3.6 Vertical Zoom

Each Panadapter allows you to adjust the maximum and minimum amplitude displayed. Tapping the up or down arrows  displayed at the left edge of the Panadapter will increase or decrease respectively the maximum amplitude displayed, in 10 dBm increments. You may also adjust the minimum amplitude by tapping and dragging the vertical axis at the right edge. This will effectively adjust where the noise floor is positioned within the Panadapter.

35.3.7 Panning Method

Each Panadapter can be panned left or right to adjust the frequency range that is viewed. Tapping and dragging within the Panadapter grid will reorient the frequencies being viewed on the Panadapter in the direction that your finger moves. By moving your finger to the right, you will display lower frequencies and vice-versa.

35.3.8 Add / Remove the Second Panadapter

When a single Panadapter is displayed on Maestro, a second Panadapter can be added by tapping the up-arrow symbol at the bottom of the Maestro display.

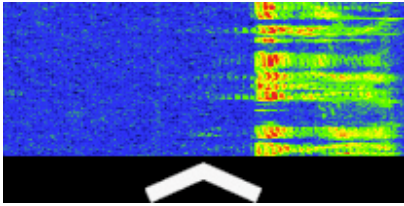

If both Slice Receivers are active when the second Panadapter is added, it is created without a Slice Receiver. If either the A or B Slice Receiver is inactive, it will be activated in the new Panadapter.

When two Panadapters are displayed, the second (lower) Panadapter can be removed by tapping the down-arrow symbol between the upper and lower Panadapters.

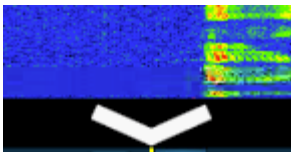

Maestro supports at most two Panadapters.

35.3.9 Auxiliary Meters

A set of auxiliary meters can be displayed on the Maestro display by tapping the **Meters** button at the bottom right corner of the display. When two panadapters are displayed, the button is found on the right side of the display between the panadapters.

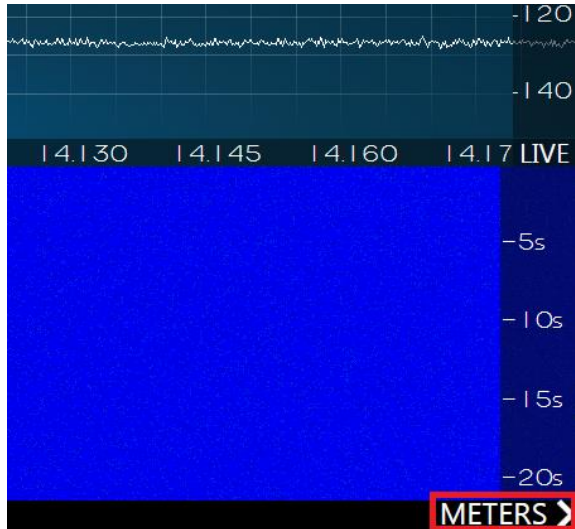

When the meters are displayed, the panadapter(s) are made narrower and move to the left side of the display; the meters are displayed on the right. “Plus” and “minus” buttons are displayed below the meters. Tapping the “plus” button adds a meter, and tapping a “minus” button removes a meter. The value displayed in each meter can be selected by tapping on the meter. A selection of values is available that depends on the equipment connected to the radio.

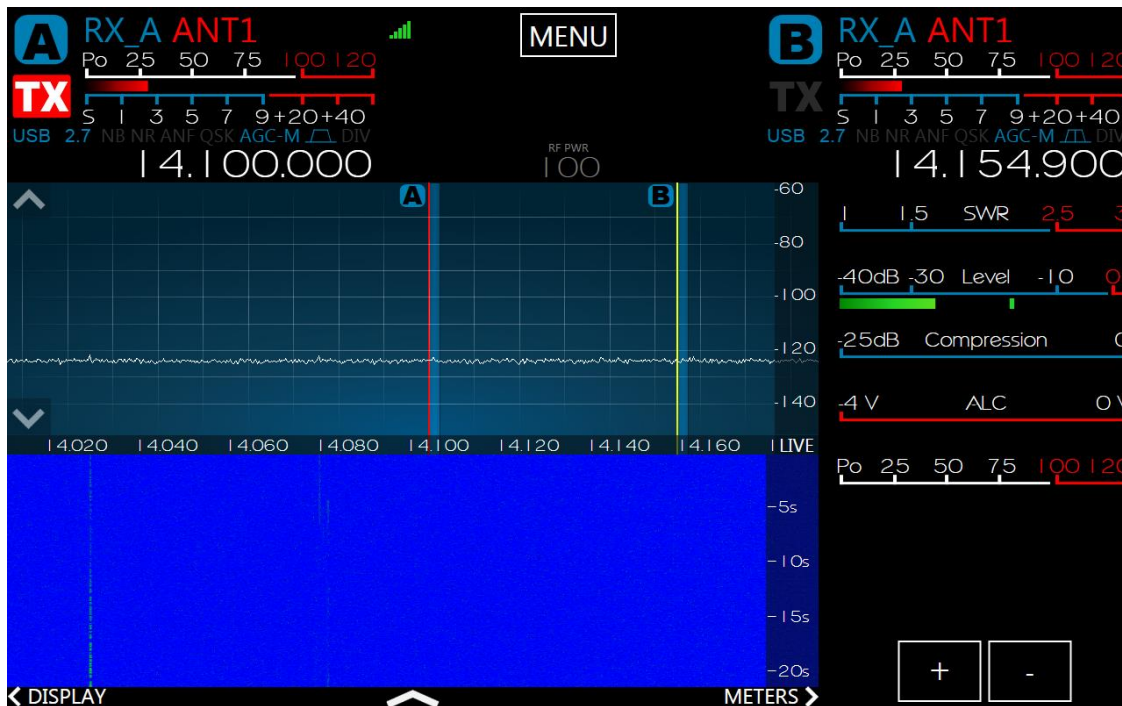

36 FRONT PANEL KNOBS AND BUTTONS

36.1 SLICE RECEIVER ACTIVATION BUTTONS

The Maestro front panel provides two sets of buttons that activate and deactivate the Slice Receivers.



Pressing an **RX** button when the corresponding Slice is inactive causes the Slice Receiver to become active. The button will illuminate green. Pressing the button again causes the Slice Receiver to become inactive. With appropriate button presses, zero, one, or two Slice Receivers can be active.

Pressing a TX button causes the transmitter control to move to the corresponding Slice Receiver if the receiver is active. If the Slice Receiver is inactive, the transmitter cannot be assigned to it. At most one of the Slice Receivers can control the transmitter.

If two Panadapters are active in the Maestro display, pressing an **RX** button creates a Slice Receiver in the upper Panadapter. Pressing the button again removes the Slice Receiver from the upper Panadapter and creates it in the lower Panadapter. Another press removes the Slice Receiver altogether. Either the A or B Slice Receiver can be moved to either Panadapter this way.

Note that when no Slice Receiver is active, pressing the B **RX** button will not create the B Slice Receiver. When no Slice Receiver is active, the A Slice Receiver must be created first.

As a special case, if the A Slice is active and the B Slice is inactive, pressing the B TX button creates a conventional “split operation” configuration. The B Slice is created at a higher frequency, appropriate to the mode, and in the same mode as the A Slice. The transmitter control is moved to the B Slice.

A long press of either **RX** button, when the Slice is active, and the button is green, activates the **RIT** (Receiver Incremental Tuning) feature. **RIT** allows the Slice Receiver’s reception frequency to be adjusted up and down with the tuning knob while holding the transmit frequency constant. In this

mode, the reception bandpass is shown on the Panadapter as a light blue band while the transmit bandpass is shown as a light red band. If the transmitter is not assigned to the Slice, a vertical dotted red line marks the transmit frequency. The **RIT** indicator is green when **RIT** is active. Another long press of the **RX** button disables **RIT**.

Similarly, a long press of the **TX** button in an Active Slice activates the **XIT** (Xmit Incremental Tuning) feature. **XIT** allows the Slice Receiver's transmit frequency to be adjusted up and down with the tuning knob while holding the reception frequency constant. In this mode, the reception bandpass is shown on the Panadapter as a light blue band while the transmit bandpass is shown as a light red band. The **XIT** indicator is red when **XIT** is active. Another long press of the **TX** button disables **XIT**.

The **RIT/XIT** step size is dependent on the mode assigned to the slice receiver. In AM/LSB/USB/FM modes, **RIT** and **XIT** adjustments occur on 10Hz steps. In CW/RTTY/DIGU/DIGL modes, **RIT/XIT** adjustments occur on 5Hz steps.

The **Use VFO B Knob for VFO A RIT/XIT** button on the **Maestro** tab of the **Main Menu** (see section **33.2, Maestro Tab**) controls the details of **RIT/XIT** operation. When the option is not selected, the VFO A and VFO B controls operate independently as described above. When the option is selected, and when Slice B is not active (**RX** button is off), then adjusting the Slice B **Tuning** knob will move the Slice A transmit or receive frequency while holding the other constant. Adjusting the Slice A **Tuning** knob moves both frequencies while holding the difference between them constant. When in **RIT** mode, pressing the VFO B knob resets the received frequency to the transmit frequency. Similarly, when in **XIT** mode, pressing the VFO B knob resets the transmit frequency to the received frequency.

The **A>B** button copies the settings of the A Slice to the B Slice. If no B Slice exists when the button is pressed, a B Slice is created in the same mode as the A Slice but at a higher frequency determined by the mode. In AM and FM modes, the new slice is located 10 KHz higher, in sideband modes, it is 5 KHz higher, in CW and RTTY modes, it is 1 KHz higher and in DIGU mode it is 500 Hz higher. If a B Slice exists when the button is pressed, its frequency is set to the same value as the A Slice, but its mode does not change. A second short press of the button causes the frequency of Slice B to be set to Slice A. On the display, Slice B will cover Slice A until one of the slices is moved.

If two panadapters are displayed, and Slice A is in one while Slice B is in the other, then a short press of the **A>B** button will change the frequency of Slice B to that of Slice A.

A long press of the **A>B** button (**A>>B**) activates the constant frequency difference feature. The A and B Slices are locked together so that a change to the frequency of one of them changes the other by the same amount in the same direction. The difference in the frequencies remains constant. Another long press of this button disables this feature. The two Slices do not have to be located in the same panadapter, or on the same band.

36.2 SLICE RECEIVER TUNING KNOBS AND BUTTONS

The Maestro front panel provides two knobs and two sets of buttons for tuning Slice Receivers.



The larger of the knobs, to the left, tunes the A Slice Receiver while the smaller of the knobs, to the right, tunes the B Slice Receiver. Tuning is completely independent. Each knob generates 64 tuning pulses per rotation and each pulse moves the frequency by an amount determined by the Slice Receiver's frequency step size and the direction of rotation of the knob.

Pressing the **A** or **B Step** button pops up a display of the step size in Hertz. Repeated presses cycle through a range of steps appropriate to the Slice Receiver's mode. Pressing and holding the button causes the step size to cycle in reverse.

The **A** and **B Lock** buttons lock the frequency of the corresponding Slice Receivers so that any attempt to change the frequency is ignored. When the frequency is locked, the button illuminates in red.

36.3 SLICE RECEIVER AUDIO KNOBS

The Maestro front panel provides two sets of knobs for managing the audio levels of Slice Receivers.



These multi-function knobs control audio level, AGC threshold, and solo channel operation.

The inner knob controls the audio level of the associated Slice Receiver. This signal is produced either at the Maestro front panel speaker or in headphones plugged into the back panel jack. When headphones are plugged in, the speaker is muted. Note that audio from both of the Slice Receivers can be mixed into the speaker or headphones.

When operating on battery power, the audio level is limited to a lower level than when operating on external power. This is done to increase battery life.

The outer knob controls the AGC-Threshold in SSB, digital, and AM modes and the squelch level in FM modes. See section **14.1, AGC Threshold** for full details.

Pressing the inner knob activates the solo channel/mute feature. When two Slice Receivers are active, a short press of the knob mutes the opposite Slice Receiver. Another short press returns Maestro to two-channel audio operation. A longer press of the knob mutes the Slice Receiver. Changing the audio level unmutes the Slice Receiver.

36.4 SLICE RECEIVER BANDWIDTH KNOBS

The Maestro front panel provides two sets of knobs for managing receive filters.



These multi-function knobs control the Slice Receiver filter lower and upper bounds and how they are changed.

The controls operate in two modes, High/Low mode and Center/Width mode:

- In High/Low mode, the inner knob controls the lower frequency bound of the filter and the outer knob controls the upper frequency bound.
- In Center/Width mode, the inner knob controls the center frequency of the filter and the outer knob controls the width of the filter.

In both cases, pop-up displays show the filter edge and center values as they are changed.

Pressing the inner knob inward performs one of two functions:

- A short press cycles the filter through the list of preset filters, appropriate to the Slice Receiver's mode.
- A long press changes the knob mode from High/Low to Center/Width and back. When the knob mode changes, the annunciator in the Slice Flag changes accordingly.

36.5 TRANSMITTER KNOBS AND BUTTONS

The Maestro front panel provides several knobs and buttons to control the transmitter.



The multi-function knob at the right side of the front panel controls the microphone level, CW keyer speed, and transmitter power level and opens the **TX Menu**:

The inner knob controls the microphone audio level when the transmitter is operating in a voice mode. When the transmitter is operating in CW mode, the inner knob controls the keyer speed. A pop-up display shows the microphone level or keyer speed as it is adjusted.

The outer knob controls the transmitter power level. A pop-up display shows the power level, as a percentage of full power, as it is adjusted.

Pressing the inner knob inward opens the **TX Menu**. Pressing the knob a second time closes the menu. Note that the menu can also be opened and closed by tapping the RF PWR annunciator in the middle of the upper bar of the main display.

Pressing the **MOX** button keys the transmitter. The button does not operate like a Push-To-Talk button. Press the button and release it to engage the transmitter. Press and release again to disengage the transmitter. The button illuminates in red when the transmitter is active.

Pressing the **TUNE** button causes the transmitter to output a low-power sinusoidal tone useful for adjusting external antenna tuners and amplifiers. The power level is controlled by the **TUNE** slider on the **TX Menu**. Like the **MOX** button, the **TUNE** button does not operate like a Push-To-Talk button. Press the button and release it to engage the transmitter. Press and release again to disengage the transmitter. The button illuminates in red when the transmitter is active.

The **ATU** button engages and disengages the Automatic Tuning Unit. Please see section **24, How to Operate the ATU** for complete details on the usage of this device.

36.6 TX MENU

The Maestro **TX Menu** contains the controls and metering required for optimal FLEX-6000 RF transmission. The menu is displayed in several configurations depending on the demodulation mode of the Slice Receiver that controls the transmitter.

To display the **TX Menu**, press the inner knob of the transmitter multi-function knob inward, or tap the RF PWR annunciator in the middle of the upper bar of the main display. Press or tap again to remove the menu.

36.6.1 Audio Modes Transmitter Menu

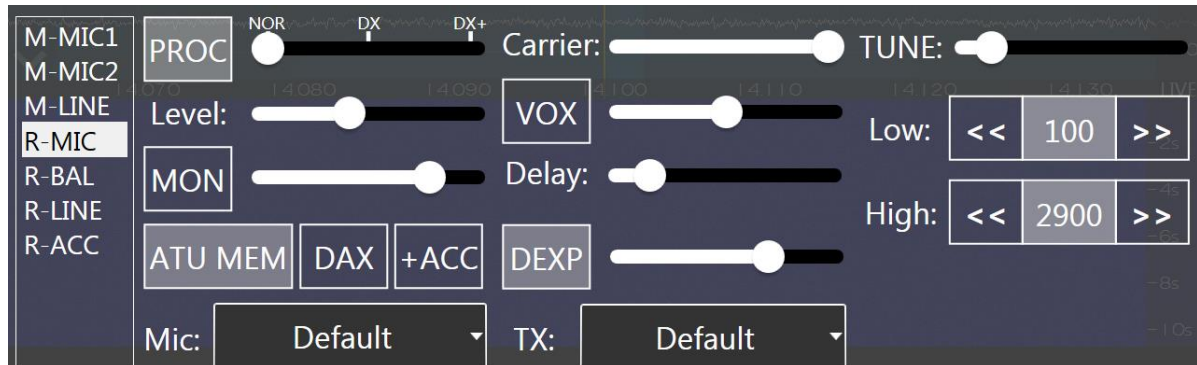

In the audio modes configuration, the transmitter menu contains microphone selections, audio processor, monitor, DAX, VOX, Downward Expansion, bandwidth filter, and other controls:

- The **Microphone Selection Menu** at the left of the transmitter menu provides the operator with a choice of microphone inputs on the Maestro device and the FLEX-6000 transceiver. Tap on a choice to select it.
 - **M-MIC1** is the RJ45 **MIC 1** input on the back panel of the Maestro.
 - **M-MIC2** is the 1/8th inch TRS **MIC 2** input on the back panel of the Maestro.
 - **M-Line** is the 1/8th inch TRS **Line Input** on the back panel of the Maestro.
 - **R-MIC** is the 8-pin Foster microphone input on the front panel of the FLEX-6000 transceiver.
 - **R-BAL** is the balanced XLR input on the back panel of the FLEX-6000 transceiver.
 - **R-LINE** is the balanced ¼ inch TRS input on the back panel of the FLEX-6000 transceiver.
 - **R-ACC** is the line-level input that is part of the D-Sub accessory connector on the back panel of the FLEX-6000 transceiver.
- **Processor (PROC) button:** Tapping this button will enable the W9GR Controlled Envelope Single Sideband (CESSB) DSP algorithm resulting in additional talk power. The speech processor may be on or off and has three different settings when on. In the NOR or normal setting, the processor provides minimal additional gain and simply prevents audio peaks from clipping or producing power more than the set level. In the DX setting, some compression is provided to the audio to increase the overall sideband envelope which results in a stronger signal that may be more readily heard at a distance. The DX+ setting adds even more compression increasing your talk power or “punch” without incurring significant audio distortion. DX+ is most effective if you increase the low-cut TX filter to between 200-400 Hz to concentrate your talk power in the audio frequency range that has the greatest intelligibility. This feature is available only in SSB, AM, and FM modes.

- **Level control:** Moving the slider to the right increases the amount of transmitter audio input gain. Moving the slider to the left decreases the audio input gain. This level can also be adjusted using the inner knob of the transmitter multi-function control.
- **MON button and Slider:** Tapping this button enables the audio input monitor while transmitting, allowing the operator to hear the audio signal being sent to the transmitter in real time. Moving the slider to the right increases the monitor volume of the transmit audio. Moving the slider to the left decreases the monitor volume.
- **ATU MEM button:** Enables the ATU memories. See section **24, How to Operate the ATU** for complete details.
- **DAX Button:** Tapping the DAX button enables audio input from the Digital Audio eXchange (DAX) channel in place of the microphone or other audio source. See section **20.4.7, DAX TX Channel and Microphone Interaction** for more information on the coordination of DAX and microphones.
- **ACC button:** Tapping this button enables audio input and output on the ACC connector on the rear panel of the FLEX-6000 at the same time as a different primary audio source.
- **Carrier:** This slider adjusts the level of the AM carrier generated by the radio. Sliding the control to the right will increase the carrier level while sliding to the left will decrease the level.
- **Voice-Operated Transmit (VOX) button and slider:** When VOX mode is enabled, the operator's voice will automatically switch the transceiver into transmit mode. When moved to the right, the slider increases the audio level at which the transmitter is engaged and reduces the level when moved to the left.
- **Delay slider:** This slider adjusts the delay between the end of the voice input and the point in time when the radio switches back to receive mode. Sliding the control to the right increases the delay while sliding to the left decreases it.
- **Downward Expander (DEXP):** A downward expander variably attenuates the mic gain by a certain percentage below a threshold setting rather than gating it on and off. This results in filtering out background noise without the abrupt on/off or chattering of a noise gate. The effect of a downward expander is to increase the *apparent* dynamic range of the system by decreasing the gain during the relatively quiet times thereby moving the apparent noise floor downward. See section **20.4.6, How to Configure the Downward Expander (DEXP)** for full details.
- **Tune Pwr Slider:** The Tune Pwr (Power) slider sets the output power level when **TUNE** is enabled. Moving the slider to the right increases the RF power output. A value of 0 will not produce any RF output. The scale, from 0 – 100 approximates RF output wattage.
- **TX Low Cut and High Cut:** allows the user to set the low-end cutoff and the high-end cutoff of the transmit bandwidth.
- **Mic and TX Profiles:** The operator may choose from a list of microphone and transmit profiles defined in the radio. See section **16, How to Use Profiles** for complete details.

36.6.2 CW Mode Transmitter Control Panel

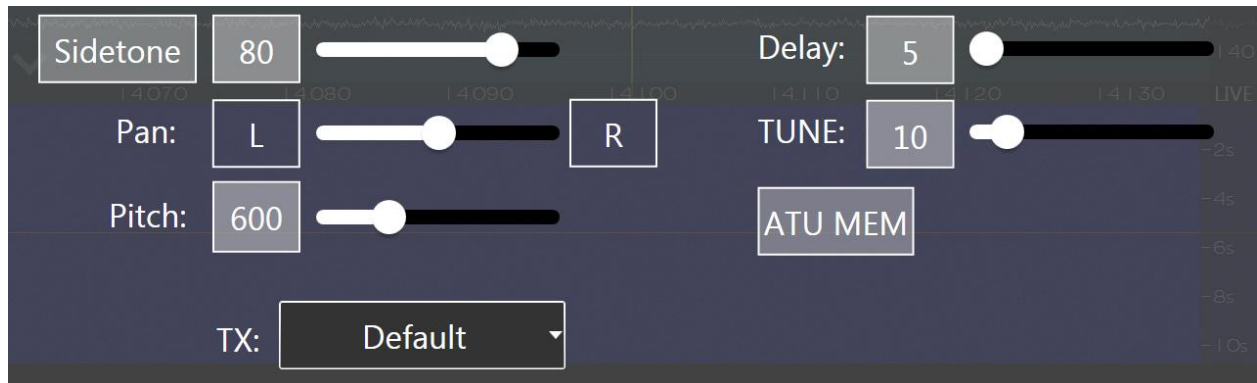

In the CW configuration, the transmitter control panel contains controls for:

- **Sidetone Button:** Tapping this button enables or disables the CW Sidetone.
- **Sidetone Slider:** Adjusts the volume (or amplitude) of the CW note. Moving the slider to the right increases the volume. Moving the slider to the left decreases the volume.
- **Sidetone Pan Slider:** Moving the Sidetone Pan Slider adjusts the sidetone from left to right channel audio, for use with headphones or stereo speakers.
- **Pitch control:** The pitch slider adjusts the pitch of the CW signal in 10Hz steps.
- **Delay Slider:** Moving the control to the right increases the time delay in milliseconds (ms) between the end of a keying element and the point in time when the radio transitions from transmit to receive. This effectively controls the QSK characteristics of the radio, where a value of 0ms is full-break QSK. Increasing this value will allow different degrees of QSK (semi-break), such as listening between letters or words while sending.
- **Tune Pwr Slider:** The Tune Pwr (Power) slider sets the output power level when **TUNE** is enabled. Moving the slider to the right increases the RF power output. A value of 0 will not produce any RF output. The scale, from 0 – 100 approximates RF output wattage.
- **ATU MEM button:** When illuminated, this button turns on the ATU memories. See section **24, How to Operate the ATU** for complete details.
- **TX Profiles:** The operator may choose from a list of transmit profiles defined in the radio. See section **16, How to Use Profiles** for complete details.

36.7 FUNCTION BUTTONS



The function buttons provide a means to map a selection of radio operations to front panel buttons for convenient access. Mapping of the operations to the buttons is performed on the **Main Menu** Function Buttons tab. See section **33.4, Function F1-F6 Tab** for complete details.

A short press of the F1, F2, or F3 button invokes the function mapped to F1, F2 or F3 respectively. A longer press of one of the buttons invokes the function mapped to the F4, F5, or F6 buttons. A second long or short press reverses the action of the first press.

37 RESTORING TO FACTORY DEFAULTS

Restoring the radio to factory defaults will clear any installed waveform modules, persistence, and profile data in the radio and return it to its original state. Default profiles are restored if they have been deleted. It is recommended that you make a backup of your Global, Transmit, and MIC profiles before resetting the radio back to factory defaults.

NOTE: This should only be used as a last resort. If you are having trouble with your radio, please submit a HelpDesk support request.

FLEX-6700 and FLEX-6500 Reset Procedure

With the radio powered off, press and hold down the “OK” button on the front panel of the radio. Momentarily press and release the power button to power on the radio. Continue holding the OK button until the front display counts down to 0, the power LED starts blinking white and the “CALIBRATING...” message is displayed, then release the OK button. Allow the radio to continue booting normally.

FLEX-6300 Reset Procedure

With the radio powered off, press and hold down the power button until the Power LED blinks white, then release the power button. Allow the radio to continue booting normally.

38 ERROR AND STATUS MESSAGES

Various error and status messages regarding the operational state of your radio may be displayed to inform you of conditions that require attention. The following section describes these messages. If any of these errors occur frequently, immediately contact FlexRadio Support by submitting a HelpDesk support ticket for assistance.

38.1 THERMAL OVER TEMPERATURE

If the temperature of the FPGA exceeds 122F (50C) the following fatal error message will be displayed, and the radio will become unresponsive, requiring a reboot of the radio to recover. An FPGA over-temperature condition can be due to high ambient operating temperatures or insufficient cooling by the FPGA cooling fan.

38.2 REVERSE RF POWER DETECTED

When a large amount of RF power is detected coming into the receiver, the receiver will automatically be disconnected, and the transmitter will be unkeyed. Review your radio and antenna setup.

38.3 INTERLOCK IS PREVENTING TRANSMISSION

This message means that there is a certain interlock condition that is preventing transmission. Details on this interlock condition can be found near the bottom left corner of the Maestro display.

38.4 TRANSMIT SLICE HAS NOT BEEN SELECTED

A transmit Slice must be selected for the radio to transmit. To select a transmit Slice, press the **TX** button on the Slice Flag.

38.5 MAX POWER SET TOO LOW FOR ATU

This message indicates the Max Power setting for the radio is set too low for proper ATU operation. Refer to section **33.7, Transmit Tab** to increase this value.

39 TROUBLESHOOTING TIPS

If you encounter problems running your Maestro, please use the following troubleshooting tips. If these tips do not solve the problem, please submit a HelpDesk support ticket for assistance from FlexRadio.

39.1 FLEX-6000 DOES NOT SHOW UP IN THE RADIO CHOOSER

If the FLEX-6000 does not show up in the *Select Radio* screen, the most probable fault is network-related. Several network components can be at fault.

39.1.1 Physical Layer Issues

After connecting your FLEX-6000 to either a network router, an Ethernet switch, or directly connected to your Maestro, make sure the FLEX-6000 is properly connected to the network's physical layer.

Looking at the back of the FLEX-6000 at the Ethernet connection, below the connector on the left you will find the link state LED. It should be illuminated yellow when the radio is powered on. If not, you do not have a physical layer connection and you should check or try the following:

- Make sure the Ethernet cable is completely plugged in on both ends. A click should be heard when it is seated completely.
- Make sure the network router, Maestro, or Ethernet switch is powered on before powering up the FLEX-6000.
- Most network routers and Ethernet switches will have link state LEDs associated with the port to which the FLEX-6000 is connected. Make sure the link state LED for the port connected to the FLEX-6000 is illuminated. If the port connected to the FLEX-6000 is blinking at a steady rate, this can indicate that the port is partitioned. Please refer to your network hardware manual for additional information
- Power cycle the FLEX-6000 to re-initialize the Ethernet port.

39.1.2 Firewalls Preventing Network Access from the FLEX-6000

The FLEX-6000 broadcasts a network discovery packet (message) that is received by Maestro. Maestro uses this information to populate the *Select Radio* screen. If the FLEX-6000 is not displayed in the *Select Radio* screen, or, after connecting to a FLEX-6000 there is no spectrum displayed, a firewall running on a network router, which is referred to as a “hardware” firewall, may be the source of the problem.

The action to resolve this condition is to modify the firewall configuration to allow access from any host on your local network to Maestro by allowing all TCP and UDP port access to Maestro.

39.1.3 MAC Address Filtering

Some hardware firewall/router / Wireless access point products have a feature that restricts access to the network based on the connected device's media access control (MAC) address. If this feature has been enabled, failure to add the FLEX-6000 to the permitted MAC address access control list will prevent the FLEX-6000 from showing up in the *Select Radio* screen.

39.2 MAESTRO BECOMES UNRESPONSIVE

If your Maestro becomes unresponsive to button presses and turned knobs, power cycling the unit usually restores normal operation. Press the power button momentarily. If the unit shuts down, wait at least 10 seconds for all of the internal components to stop, then restart the Maestro.

If your Maestro does not respond to the momentary power button press, press, and hold the power button until the unit powers off. Wait at least 10 seconds after releasing the button before restarting Maestro.

39.3 RADIO WILL NOT BOOT, OR SMARTSDR-WIN WILL NOT COMPLETELY LOAD

If you get into a situation where the radio or Maestro will not boot or load properly, please open a HelpDesk ticket to resolve this. Alternatively, you can reset the Persistence database by doing a Factory Reset as described in section 37, **Restoring to Factory Defaults**. Before doing this procedure, it is recommended to export your current settings if possible, using the Import/Export menu in the SmartSDR-Win client.

39.4 FLEX-6000 NOT PERFORMING WELL AFTER AN UPGRADE TO NEW FIRMWARE

If you observe unexpected behavior or your radio is not performing well immediately after an upgrade to a new version of the Maestro software the first troubleshooting step is to “cold” boot the radio by turning the radio off using the power button. If the radio will not shut down, press and hold the power button until the radio turns off. Then remove all DC power from the radio for 10 to 15 seconds by unplugging the DC power cable. Replace the DC power cable and turn the radio back on. This will ensure a complete restart of all internal processors.

39.5 RF SPECTRUM NOT DISPLAYED PROPERLY AFTER SELECTING A FLEX-6000 OR AUDIO STUTTERING

After a FLEX-6000 has been selected, a default Panadapter is displayed showing an active RF spectrum. If no spectrum is displayed, the display is not updating properly, or remote audio is stuttering, check for the following problems:

- **Low bandwidth connection between the FLEX-6000 and Maestro** – If Maestro is connected to the FLEX-6000 via a wireless network connection, there is a possibility that a combination of low data streaming throughput and packet loss can result in a spectrum display that momentarily freezes or will not be displayed at all. If you experience this behavior, connect the FLEX-6000 directly to the Maestro via the Ethernet cable and reboot the system. If the direct connect method resolves the problem, then the wireless network cannot run the FLEX-6000.
- **Panadapter resource not available** – If a Panadapter resource is not available on the radio, power cycling the radio will free the locked Panadapter resource.

39.6 AMBER FRONT PANEL LIGHT STUCK ON

If the LED on the front panel of the radio stays amber after powering down the radio, the radio has been configured to hold power on a GPS device. This configuration can exist even if no GPS device is present. This situation can be corrected by uninstalling the GPS using the **Uninstall** button.

39.7 MAESTRO STARTS UP IN PORTRAIT MODE

Very rarely the Maestro software may start the display in “portrait mode”, with the image rotated 90 degrees left or right. This problem is easily corrected.

Press and hold the power button. Maestro will display the “slide down” screen. Continue to hold the power button down. Maestro will shut down, but the front panel buttons may remain lit. Continue to hold the power button down until the front panel lights turn off. Disconnect external power (if any) for 30 seconds or more. Reconnect external power and start Maestro in the usual way.

39.8 I PURCHASED A LICENSE, BUT IT DOESN'T SHOW UP ON THE RADIO.

If you have SmartSDR Version 2 running on your Maestro and your radio, and you purchased or are entitled to a Version 2 license, but you continue to see the **Buy** button, this issue cannot be resolved by reinstalling any software.

A common cause of this problem is the isolation of the radio from the Internet. The radio must be able to contact the FlexRadio server through the Internet to find and install the license. This step is done by the radio's firmware, not by the SmartSDR software running in Maestro. The most common reason for the radio being isolated from the Internet is connecting the radio directly to Maestro with an Ethernet wire. This configuration creates a “link-local” connection between Maestro and the radio, which works fine for everyday use by SmartSDR, but it does not support Internet communication for the radio. The radio will not be able to connect to the FlexRadio server and install the license.

A simple solution is to disconnect the radio from Maestro and reconnect the radio's Ethernet wire directly to the local area network (LAN) router. Turn the radio on, let it run for a minute, turn it off, and return the radio to its original location and wiring. The license should be installed.

If these suggestions don't solve the problem, open a HelpDesk support ticket.

39.9 SMARTLINK TROUBLESHOOTING

39.9.1 Radio not shown in the *Select Radio* screen

Here are some things to consider:

- Is the radio powered up?
- Does the radio have an Internet connection that is functioning?
- Does Maestro have a functioning Internet connection at the remote location?

Did you login to SmartLink on Maestro with the same account that you used to register your radio?

39.9.2 My radio shows up on the **Select Radio** screen, but when I try to connect, it doesn't work.

If trying to connect via SmartLink: The first step in diagnosing a remote connection problem is to run the test included in the SmartLink Setup -> Network Settings screen. See section **8.2.3, Test the Radio in SmartLink**. If the test passes (green), this verifies the connection between the SmartLink server and the radio. Further testing may be necessary to verify the client's connection to the radio and may be dependent on the client's network.

If not using SmartLink: If the Radio and the client are on different network subnets, the client will likely be able to see the broadcast radio discovery packets, and thus the radio will show up on the radio selection windows. However, the connection will fail due to not being able to route the TCP connection to the radio. The Radio IP address should be compared to the Client IP address. If one is 169.254.x.x (link-local) and the other is something like 192.168.x.x, 172.x.x.x, or 10.x.x.x), then this is likely the problem. In general, the beginning of the IP address should start the same way. The solution is to get the Radio and the Client onto the same network. See the following helpdesk article for more help on this: <https://helpdesk.flexradio.com/hc/en-us/articles/202118558-How-to-Connect-your-FLEX-6000-to-a-LAN>.

39.9.3 Running the Network Settings Test, I do not get a green response.

A yellow test result means that a remote connection might work depending on the configuration of the network at the remote end. Remote connections may work from some locations and not others. A red test result means that the connection will not work with the current configuration on the radio network. Tap the red result indicator to open a window containing details about the test failure. These details may help you to understand how to correct the problem. Take note of the details in case you need to open a Help Desk support ticket, as described at the end of this section.

To avoid connection issues and obtain a good test result (green), enable UPnP (Universal Plug n Play) on your router if it is supported or use the Manual Port Forwarding option. See the following section, **39.9.4**.

39.9.4 My router doesn't support UPnP. How can I set up my radio to reliably connect to remote clients?

For a reliable connection without UPnP, you will need to use Manual Port Forwarding. To use Manual Port Forwarding, you will need to pick one TCP port number (e.g. 4994) and one UDP port number (e.g. 4993) for SmartLink to use. Referring to section **8.2.2, Register the Radio in SmartLink**, by going to the **Network Settings** screen. Select **Manual Port Forwarding** then enter the port numbers you have chosen in the TCP and UDP Port fields. Tap the **Save** button. The remainder of this procedure is done to the configuration settings of your router. Details for setting up port forwarding on a wide variety of routers are beyond the scope of this document, but this document, <https://helpdesk.flexradio.com/hc/en-us/articles/115003365503-What-is-Port-Forwarding-and-How-do-you-do-it>, should provide a good starting point. In addition to port forwarding, your radio should be assigned a Static DHCP address by the router to avoid occasional breaks in the SmartLink connection caused by changes to the radio's IP address.

39.9.5 When I use public WiFi, sometimes my Panadapter hangs or my audio has gaps in it. How do I fix this?

As a network application, SmartLink can only perform as well as the networks to which it is connected. This means that even if your radio's Internet connection is good, connecting to it from a marginal network can impact your performance. Use the Network Health indicator on the SmartSDR main screen to learn if the network is the problem. As an aside, testing with 3G and LTE cell phone connection hotspots has fared well.

40 LEGAL NOTICE

©2013 - 2024 FlexRadio, Inc. All rights reserved. FlexRadio®, SmartSDR™, and related trademarks, names, and logos are the property of FlexRadio, Inc. and are registered and/or used in the U.S. and countries around the world.

All other trademarks are the property of their respective owners.

This documentation including all documentation incorporated by reference herein such as documentation provided or made available at www.flexradio.com is provided or made accessible "AS IS" and "AS AVAILABLE" and without condition, endorsement, guarantee, representation, or warranty of any kind by FlexRadio and FlexRadio assumes no responsibility for any typographical, technical, or other inaccuracies, errors, or omissions in this documentation. To protect FlexRadio's proprietary and confidential information and/or trade secrets, this documentation may describe some aspects of FlexRadio technology in generalized terms. FlexRadio reserves the right to periodically change information that is contained in this documentation; however, FlexRadio does not commit to providing any such changes, updates, enhancements, or other additions to this documentation to you promptly or at all.

This documentation might contain references to third-party sources of information, hardware or software, products or services including components and content such as content protected by copyright and/or third-party websites (collectively the "Third Party Products and Services"). FlexRadio does not control, and is not responsible for, any Third Party Products and Services including, without limitation the content, accuracy, copyright compliance, compatibility, performance, trustworthiness, legality, decency, links, or any other aspect of Third Party Products and Services. The inclusion of a reference to Third Party Products and Services in this documentation does not imply endorsement by FlexRadio of the Third Party Products and Services or the third party in any way.

EXCEPT TO THE EXTENT SPECIFICALLY PROHIBITED BY APPLICABLE LAW IN YOUR JURISDICTION, ALL CONDITIONS, ENDORSEMENTS, GUARANTEES, REPRESENTATIONS, OR WARRANTIES OF ANY KIND, EXPRESS OR IMPLIED, INCLUDING WITHOUT LIMITATION, ANY CONDITIONS, ENDORSEMENTS, GUARANTEES, REPRESENTATIONS, OR WARRANTIES OF DURABILITY, FITNESS FOR A PARTICULAR PURPOSE OR USE, MERCHANTABILITY, MERCHANTABILITY, NON-INFRINGEMENT, SATISFACTORY QUALITY, OR TITLE, OR ARISING FROM A STATUTE OR CUSTOM OR A COURSE OF DEALING OR USAGE OF TRADE, OR RELATED TO THE DOCUMENTATION OR ITS USE, OR PERFORMANCE OR NON-PERFORMANCE OF ANY SOFTWARE, HARDWARE, SERVICE, OR ANY THIRD PARTY PRODUCTS AND SERVICES REFERENCED HEREIN, ARE HEREBY EXCLUDED. YOU MAY ALSO HAVE OTHER RIGHTS THAT VARY BY STATE OR PROVINCE. SOME JURISDICTIONS MAY NOT ALLOW THE EXCLUSION OR LIMITATION OF IMPLIED WARRANTIES AND CONDITIONS. TO THE EXTENT PERMITTED BY LAW, ANY IMPLIED WARRANTIES OR CONDITIONS RELATING TO THE DOCUMENTATION TO THE EXTENT THEY CANNOT BE EXCLUDED AS SET OUT ABOVE, BUT CAN BE LIMITED, ARE HEREBY LIMITED TO NINETY (90) DAYS FROM THE DATE YOU FIRST ACQUIRED THE DOCUMENTATION OR THE ITEM THAT IS THE SUBJECT OF THE CLAIM.

TO THE MAXIMUM EXTENT PERMITTED BY APPLICABLE LAW IN YOUR JURISDICTION, IN NO EVENT SHALL FLEXRADIO BE LIABLE FOR ANY TYPE OF DAMAGES RELATED TO THIS DOCUMENTATION OR ITS USE, OR PERFORMANCE OR NON-PERFORMANCE OF ANY SOFTWARE, HARDWARE, SERVICE, OR ANY THIRD PARTY PRODUCTS AND SERVICES REFERENCED HEREIN INCLUDING WITHOUT LIMITATION ANY OF THE FOLLOWING DAMAGES: DIRECT, CONSEQUENTIAL, EXEMPLARY, INCIDENTAL, INDIRECT, SPECIAL, PUNITIVE, OR AGGRAVATED DAMAGES, DAMAGES FOR LOSS OF PROFITS OR REVENUES, FAILURE TO REALIZE ANY EXPECTED SAVINGS, BUSINESS INTERRUPTION, LOSS OF BUSINESS

INFORMATION, LOSS OF BUSINESS OPPORTUNITY, OR CORRUPTION OR LOSS OF DATA, FAILURES TO TRANSMIT OR RECEIVE ANY DATA, PROBLEMS ASSOCIATED WITH ANY APPLICATIONS USED IN CONJUNCTION WITH FLEXRADIO PRODUCTS OR SERVICES, DOWNTIME COSTS, LOSS OF THE USE OF FLEXRADIO PRODUCTS OR SERVICES OR ANY PORTION THEREOF OR OF ANY COST OF SUBSTITUTE GOODS, COSTS OF COVER, FACILITIES OR SERVICES, COST OF CAPITAL, OR OTHER SIMILAR PECUNIARY LOSSES, WHETHER OR NOT SUCH DAMAGES WERE FORESEEN OR UNFORESEEN, AND EVEN IF FLEXRADIO HAS BEEN ADVISED OF THE POSSIBILITY OF SUCH DAMAGES.

TO THE MAXIMUM EXTENT PERMITTED BY APPLICABLE LAW IN YOUR JURISDICTION, FLEXRADIO SHALL HAVE NO OTHER OBLIGATION, DUTY, OR LIABILITY WHATSOEVER IN CONTRACT, TORT, OR OTHERWISE TO YOU INCLUDING ANY LIABILITY FOR NEGLIGENCE OR STRICT LIABILITY.

THE LIMITATIONS, EXCLUSIONS, AND DISCLAIMERS HEREIN SHALL APPLY: (A) IRRESPECTIVE OF THE NATURE OF THE CAUSE OF ACTION, DEMAND, OR ACTION BY YOU INCLUDING BUT NOT LIMITED TO BREACH OF CONTRACT, NEGLIGENCE, TORT, STRICT LIABILITY OR ANY OTHER LEGAL THEORY AND SHALL SURVIVE A FUNDAMENTAL BREACH OR BREACHES OR THE FAILURE OF THE ESSENTIAL PURPOSE OF THIS AGREEMENT OR ANY REMEDY CONTAINED HEREIN; AND (B) TO FLEXRADIO AND ITS AFFILIATED COMPANIES, THEIR SUCCESSORS, ASSIGNS, AGENTS, AUTHORIZED FLEXRADIO DISTRIBUTORS AND THEIR RESPECTIVE DIRECTORS, EMPLOYEES, AND INDEPENDENT CONTRACTORS.

IN ADDITION TO THE LIMITATIONS AND EXCLUSIONS SET OUT ABOVE, IN NO EVENT SHALL ANY DIRECTOR, EMPLOYEE, AGENT, DISTRIBUTOR, SUPPLIER, INDEPENDENT CONTRACTOR OF FLEXRADIO OR ANY AFFILIATES OF FLEXRADIO HAVE ANY LIABILITY ARISING FROM OR RELATED TO THE DOCUMENTATION.

Before subscribing for, installing, or using any Third Party Products and Services, it is your responsibility to ensure that the supplier has agreed to support all of their features. Installation or use of Third Party Products and Services with FlexRadio System's products and services may require one or more patents, trademarks, copyright, or other licenses to avoid infringement or violation of third-party rights. You are solely responsible for determining whether to use Third Party Products and Services and if any third-party licenses are required to do so. If required, you are responsible for acquiring them. You should not install or use Third Party Products and Services until all necessary licenses have been acquired. Any Third Party Products and Services that are provided with FlexRadio's products and services are provided as a convenience to you and are provided "AS IS" with no express or implied conditions, endorsements, guarantees, representations, or warranties of any kind by FlexRadio and FlexRadio assumes no liability whatsoever, in relation thereto. Your use of Third Party Products and Services shall be governed by and subject to you agreeing to the terms of separate licenses and other agreements applicable thereto with third parties, except to the extent expressly covered by a license or other agreement with FlexRadio.

The terms of use of any FlexRadio product or service are set out in a separate license or other agreement with FlexRadio applicable thereto. **NOTHING IN THIS DOCUMENTATION IS INTENDED TO SUPERSEDE ANY EXPRESS WRITTEN AGREEMENTS OR WARRANTIES PROVIDED BY FLEXRADIO SYSTEMS FOR PORTIONS OF ANY FLEXRADIO PRODUCT OR SERVICE OTHER THAN THIS DOCUMENTATION.**

41 COPYRIGHT INFORMATION

41.1 USER GUIDE COPYRIGHT

Copyright © 2013 – 2024 FlexRadio, Inc.
All rights reserved

Information in this document is subject to change without notice and does not represent a commitment on behalf of FlexRadio. No part of this publication may be reproduced, stored in a retrieval system, or transmitted in any form or by any means, electronic, mechanical, photocopying, recording, or otherwise, for any purpose other than the purchaser's personal use, without the prior express written permission of FlexRadio.

41.2 SOFTWARE COPYRIGHTS

Copyright © 2013-2024 FlexRadio, Inc.
All rights reserved

Republication or redistribution of FlexRadio Software content is prohibited without the prior written consent of FlexRadio.

The software contains proprietary information of FlexRadio; it is provided under a license agreement containing restrictions on use and disclosure and is also protected by copyright law. Reverse engineering of the software is prohibited.

Due to continued product development, this information may change without notice. The information and intellectual property contained herein are confidential between FlexRadio and the client and remain the exclusive property of FlexRadio. If you find any problems in the documentation, please report them to us in writing. FlexRadio does not warrant that this document is error-free.

Disclaimers

THIS SOFTWARE AND DOCUMENTATION ARE PROVIDED "AS IS," AND COPYRIGHT HOLDERS MAKE NO REPRESENTATIONS OR WARRANTIES, EXPRESS OR IMPLIED, INCLUDING BUT NOT LIMITED TO, WARRANTIES OF MERCHANTABILITY OR FITNESS FOR ANY PARTICULAR PURPOSE OR THAT THE USE OF THE SOFTWARE OR DOCUMENTATION WILL NOT INFRINGE ANY THIRD PARTY PATENTS, COPYRIGHTS, TRADEMARKS OR OTHER RIGHTS.

COPYRIGHT HOLDERS WILL NOT BE LIABLE FOR ANY DIRECT, INDIRECT, SPECIAL, OR CONSEQUENTIAL DAMAGES ARISING OUT OF ANY USE OF THE SOFTWARE OR DOCUMENTATION.

The name and trademarks of copyright holders may NOT be used in advertising or publicity about the software without specific, written prior permission. Title to copyright in this software and any associated documentation will at all times remain with copyright holders.

42 SOFTWARE LICENCE AGREEMENTS

42.1 FLEXRADIO SOFTWARE LICENSE

Maestro End User License Agreement

Revised: June 10, 2019

Version: 1.3

Software components provided with Maestro including Windows software located on the included computer and embedded microprocessor software inside Maestro including all upgrades applied after the initial purchase (“the Software Product”) and accompanying documentation are licensed and not sold. The Software Product is protected by copyright laws and treaties, as well as laws and treaties related to other forms of intellectual property. FlexRadio, Inc., or its subsidiaries, affiliates, and suppliers (collectively “FlexRadio”, “Company”, “we” or “us”) own intellectual property rights in the Software Product. The Licensee’s (“you” or “your”) license to download, use, copy, or change the Software Product is subject to these rights and all the terms and conditions of this End User License Agreement (“Agreement”).

Acceptance

YOU ACCEPT AND AGREE TO BE BOUND BY THE TERMS OF THIS AGREEMENT BY SELECTING THE “ACCEPT” OPTION AND INSTALLING THE SOFTWARE PRODUCT OR BY DOWNLOADING, USING, OR COPYING THE SOFTWARE PRODUCT. YOU MUST AGREE TO ALL OF THE TERMS OF THIS AGREEMENT BEFORE YOU WILL BE ALLOWED TO INSTALL THE SOFTWARE PRODUCT. IF YOU DO NOT AGREE TO ALL OF THE TERMS OF THIS AGREEMENT, YOU MUST NOT INSTALL, USE, OR COPY THE SOFTWARE PRODUCT.

License Grant

FlexRadio, Inc. grants to you, and you accept, a limited, non-exclusive, and revocable license to use the Software Product, in machine-readable, object code form only. You shall use the Software Product only as authorized in this Agreement. This Agreement does not convey to you any ownership rights or any other interest in the Software Product. This Agreement entitles you to use the Software Product on any number of computers for exclusive use with FlexRadio, Inc. software defined radios (“SDRs”).

multiFLEX™

If more than one user desires to use the Software Product to connect to the SDR or otherwise, you must obtain a multiFLEX license, which may be subject to additional license fees based on various factors such as number of users, type of use, and whether or not such use is for profit. If you have obtained the appropriate multiFLEX license, you may allow only the number of people to access and use the Software Product and SDR corresponding to your multiFLEX license. You are not permitted to employ any device, whether hardware, software, or otherwise, designed to circumvent, or which has the effect of circumventing, the license restrictions set forth in this paragraph or which allows multiple users to access or use the Software Product or SDR without first obtaining the applicable multiFLEX license.

Term

This Agreement will become effective on the date you acquire the Software Product and will remain in force until terminated. You may terminate the license, at any time, by removing the Software Product from all of your computers and destroying the original Software Product. This License will automatically terminate if you breach any of the terms or conditions set out in this Agreement. Upon termination of this Agreement

for any reason, you shall immediately cease all use of the Software product, and either destroy the original Software Product and all copies of the Software or return the Software to FlexRadio, Inc.. at your own cost.

Restrictions on Transfer

Without first obtaining the express written consent of FlexRadio, Inc., you may not assign your rights and obligations under this Agreement, or redistribute, encumber, sell, rent, lease, sublicense, or otherwise transfer your rights to the Software Product.

Restrictions on Use

Except to the extent expressly permitted by applicable law, You may not decompile, “reverse-engineer”, disassemble, or otherwise attempt to derive the intellectual property or source code for the Software Product. The Software Product may only be used with unmodified FlexRadio, Inc. software defined radio (SDR) hardware. Use of the Software Product with any other hardware or in conjunction with any other non-FlexRadio, Inc. software product that interfaces, communicates, or emulates FlexRadio, Inc. SDR hardware is prohibited and constitutes a breach of the Agreement. You may not use the Software product in any manner to develop, or assist any third party in developing, any product that competes with the Software Product.

Restrictions on Alteration

You may not modify the Software Product or create any derivative work of the Software Product or its accompanying documentation. Derivative works include but are not limited to translations. You may not alter any files or libraries in any portion of the Software Product.

Legal Use

SmartLink, a software and service capability provided with the Software Product, includes the use of a Company computer network server ("Server") to broker a connection between an individual using SmartLink ("Operator") and a FlexRadio, Inc. receiver or transceiver ("Radio") in a location that may or may not be in a different legal jurisdiction from the Operator. SmartLink enables a network connection between the Operator and the Radio and provides the ability to receive and transmit signals, demodulated audio and complex intermediate frequency signals, spectrum plots, and other spectrum information under the control of the Operator. The legality of the use of SmartLink in any jurisdiction may vary by any number of factors including, but not limited to, the country where the Operator resides, the location or technology comprising the network, the location or technology used in the Server, the location of the Radio, and licenses or authorizations that may be required in one or more jurisdictions. You agree that your use of SmartLink will follow all applicable laws in the legal jurisdictions where you use SmartLink and that you are responsible for all actions that occur in regard to your use of SmartLink. You agree to indemnify and hold harmless the Company, its officers, employees, agents, and affiliates, for any cause of action arising from your use of Software or SmartLink.

Limited Software Product Warranty

For a period of thirty (30) days from the date of shipment or from the date that you download the Software Product, as applicable, FlexRadio, Inc. warrants that when properly installed and used under normal conditions, the Software Product will perform substantially as advertised. FlexRadio, Inc. warrants that it will use commercially reasonable efforts to maintain a 99.9% uptime for the network-based aspects of SmartLink; provided, however, that FlexRadio's warranty does not apply to any downtime resulting from (i)

a failure in a third party's or your network infrastructure or (ii) scheduled updates, upgrades or maintenance.

Disclaimer of Warranties and Limitation of Liability

UNLESS OTHERWISE EXPLICITLY AGREED TO IN WRITING BY FLEXRADIO, INC., FLEXRADIO, INC. MAKES NO OTHER WARRANTIES, EXPRESS OR IMPLIED, IN FACT OR IN LAW, INCLUDING, BUT NOT LIMITED TO, ANY IMPLIED WARRANTIES OF MERCHANTABILITY OR FITNESS FOR A PARTICULAR PURPOSE OTHER THAN AS SET FORTH IN THIS AGREEMENT OR IN THE LIMITED WARRANTY DOCUMENTS PROVIDED WITH THE SOFTWARE PRODUCT.

FlexRadio, Inc. makes no warranty that the Software Product will meet your requirements or operate under your specific conditions of use. FlexRadio, Inc. makes no warranty that the operation of the Software Product will be secure, error-free, or free from interruption. YOU MUST DETERMINE WHETHER THE SOFTWARE PRODUCT SUFFICIENTLY MEETS YOUR REQUIREMENTS FOR SECURITY AND UNINTERRUPTABILITY. YOU BEAR SOLE RESPONSIBILITY AND ALL LIABILITY FOR ANY LOSS INCURRED DUE TO FAILURE OF THE SOFTWARE PRODUCT TO MEET YOUR REQUIREMENTS. FLEXRADIO, INC. WILL NOT, UNDER ANY CIRCUMSTANCES, BE RESPONSIBLE OR LIABLE FOR THE LOSS OF DATA ON ANY COMPUTER, CONNECTED HARDWARE OR INFORMATION STORAGE DEVICE.

High-Risk Activities. The Software Product is not fault-tolerant and is not designed, manufactured, or intended for use or resale in hazardous environments requiring fail-safe performance, including without limitation the operation of nuclear facilities, aircraft navigation or communication systems, air traffic control, life support, ambulance, or search and rescue, in which the failure of the Software Product could lead directly to death, personal injury, or severe physical or environmental damage. FlexRadio, Inc. and its suppliers specifically disclaim any express or implied warranty or liability for such activities.

UNDER NO CIRCUMSTANCES SHALL FLEXRADIO, INC., ITS DIRECTORS, OFFICERS, EMPLOYEES OR AGENTS BE LIABLE TO YOU OR ANY OTHER PARTY FOR INDIRECT, CONSEQUENTIAL, SPECIAL, INCIDENTAL, PUNITIVE, OR EXEMPLARY DAMAGES OF ANY KIND (INCLUDING LOST REVENUES OR PROFITS OR LOSS OF BUSINESS) RESULTING FROM THIS AGREEMENT, OR FROM THE FURNISHING, PERFORMANCE, INSTALLATION, SUPPORT OR USE OF THE SOFTWARE PRODUCT, WHETHER DUE TO A BREACH OF CONTRACT, BREACH OF WARRANTY, OR THE NEGLIGENCE OF FLEXRADIO, INC. OR ANY OTHER PARTY, EVEN IF FLEXRADIO, INC. IS ADVISED BEFOREHAND OF THE POSSIBILITY OF SUCH DAMAGES. TO THE EXTENT THAT THE APPLICABLE JURISDICTION LIMITS FLEXRADIO, INC. ABILITY TO DISCLAIM ANY IMPLIED WARRANTIES, THIS DISCLAIMER SHALL BE EFFECTIVE TO THE MAXIMUM EXTENT PERMITTED.

Limitation of Remedies and Damages

Your remedy for a breach of this Agreement or of any warranty included in this Agreement is the correction or replacement of the Software Product. Selection of whether to correct or replace shall be solely at the discretion of FlexRadio, Inc.. FlexRadio, Inc. reserves the right to substitute a functionally equivalent copy of the Software Product as a replacement. If FlexRadio, Inc. is unable to provide a replacement or substitute Software Product or corrections to the Software Product, your sole alternate remedy shall be a refund of the purchase price for the Software Product exclusive of any costs for shipping and handling.

Any claim must be made within the applicable warranty period. All warranties cover only defects arising under normal use and do not include malfunctions or failure resulting from misuse, abuse, neglect, alteration, problems with electrical power, acts of nature, unusual temperatures or humidity, improper installation, or damage determined by FlexRadio, Inc. to have been caused by you. All limited warranties on the Software Product are granted only to you and are non-transferable. You agree to indemnify and hold

FlexRadio, Inc. harmless from all claims, judgments, liabilities, expenses, or costs arising from your breach of this Agreement and/or acts or omissions.

Privacy: Password and User ID

Upon registration, the Software Product automatically communicates with the Company's servers on the Internet. The Company will use any personally identifiable information (e.g., name, callsign, etc.) only for the purposes specified in its Privacy Policy, the terms of which are set forth below and incorporated herein by reference and, by your acceptance of this EULA, to which you agree to be bound.

Privacy Policy

Your privacy is important to FlexRadio, Inc., and we have implemented policies designed to protect your privacy, whether you are accessing our Software via traditional computers (desktops, laptops) or via mobile devices (such as smartphones and tablets) or via our client-enabled products (Maestro, FLEX-6400M, or FLEX-6600M). The following explains our online information-gathering practices and how that information is used by us.

Protection of Personal Information

We take appropriate precautions to protect any Personal Information that you submit to us. FlexRadio, Inc. uses industry-standard measures to protect data that is stored on our SmartLink server and restricts access to such user information to those who are responsible to operate and maintain the SmartLink server.

Data and Privacy

When you use the Software Product, we collect your IP address and network information for the purpose of facilitating SmartLink connections.

We may from time to time disclose data to third parties in the following circumstances: (1) to conform to legal requirements or to respond to a subpoena, search warrant, or other legal process received by the Company seeking such information, or (2) to enforce the terms of the End User License Agreement to which you are bound as a condition to use of the Software or otherwise to protect our rights in the Software or the rights of other customers to enjoy the benefits of the Software or (3) to our legal team or to a party that purchases Company or any of its businesses. We do not furnish any Personal Information to any affiliated or unaffiliated third parties.

Financial

Payment for use of our Software is handled by recognized third-party vendors. We do not collect or store any personal banking or credit card information.

Governing Law, Jurisdiction and Costs

This Agreement is governed by the laws of Texas, without regard to Texas's conflict or choice of law provisions. This Agreement shall not be governed by the United Nations Convention on Contracts for the International Sale of Goods, the application of which is expressly excluded. Any civil action or legal proceeding arising out of or relating to this Agreement shall be brought in the courts of record of the State of Texas in Travis County or the United States District Court, Western District of Texas, Austin Division. You and FlexRadio, Inc. consent to the jurisdiction of such court in any such civil action or legal proceeding and waive any objection to the laying of the venue of any such civil action or legal proceeding in such court.

Severability

If any provision of this Agreement shall be held to be invalid or unenforceable by a court of competent jurisdiction, the remainder of this Agreement shall remain in full force and effect. To the extent any express or implied restrictions are not permitted by applicable laws, these express or implied restrictions shall remain in force and effect to the maximum extent permitted by such applicable laws.

Complete Agreement

This Agreement constitutes the entire agreement between you and FlexRadio, Inc. with respect to the use of the Software Product licensed hereunder and supersedes all prior or contemporaneous understandings regarding such subject matter. No amendment to or modification of this Agreement will be binding unless in writing and signed by FlexRadio, Inc.. Any translation of this Agreement is done for local requirements and in the event of a dispute between the English and any non-English versions, the English version of this Agreement shall govern.

Compliance with Law.

You will comply with all applicable laws and regulations in Your use of the Software Product. In the event that You are located outside of the United States, or the computer You are operating is running on a network located outside of the United States, You agree to comply with any laws, rules, or regulations in your locale or in the location of your computer/server regarding online conduct and acceptable content, including laws regulating the export of data to the United States or your country of residence.

API License

This copy of the FlexRadio, Inc. API (the API”) and accompanying documentation is licensed and not sold. The API is protected by copyright laws and treaties, as well as laws and treaties related to other forms of intellectual property. FlexRadio, Inc. or its subsidiaries, affiliates, and suppliers (collectively “FlexRadio”) own intellectual property rights in the API. The Licensee’s (“you” or “your”) license to download and use the API is subject to these rights and to all the terms and conditions of this API License Agreement (“Agreement”).

Acceptance

YOU ACCEPT AND AGREE TO BE BOUND BY THE TERMS OF THIS AGREEMENT BY SELECTING THE “ACCEPT” OPTION AND/OR INSTALLING THE API AND/OR BY DOWNLOADING, USING, OR COPYING THE API. YOU MUST AGREE TO ALL OF THE TERMS OF THIS AGREEMENT BEFORE YOU INSTALL OR USE THE API. IF YOU DO NOT AGREE TO ALL OF THE TERMS OF THIS AGREEMENT, YOU WILL HAVE NO LICENSE TO, AND YOU MUST NOT INSTALL, USE, OR COPY, THE API.

1. THE APPLICATION

1. Overview of the FlexRadio, Inc. API Package and License Grant. The FlexRadio, Inc. API Package consists of a package or suite of different applications programmer’s interfaces (hereinafter referred to for convenience as “the API” whether You access one or multiple interfaces) that will allow third-party hardware or software to directly interface with FlexRadio transceiver hardware and/or FlexRadio, Inc. SmartSDR software. Subject to the terms and restrictions set forth in this Agreement, FlexRadio, Inc. grants You a limited, non-exclusive, non-transferable, and non-sublicensable license for the sole purpose of embedding the API and underlying content into your software so that Your software and/or application can interface directly with FlexRadio, Inc. devices and/or software. In order to use and access the API, You may

be required to register for an API account (“Account”) with FlexRadio. If registration is required, then (a) after completing your registration, which includes a description of your application and its value proposition, and agreeing to this Agreement, You will be issued an electronic Key that is uniquely assigned to You and associated with the application, (b) Your Application must import the FlexRadio API using an HTML “script” tag that contains this Key, And (c) FlexRadio, Inc. will block any requests with an invalid Key or invalid URL.

2. Updates and Modifications. FlexRadio, Inc. may, at its sole discretion, release subsequent versions of the FlexRadio API and underlying data and require You to obtain and use the most current version. FlexRadio may also release subsequent versions of the SmartSDR software, in which case the software programs You have created using the API may no longer operate and would require modifications by You in order to continue interoperation. In addition, FlexRadio may modify this Agreement at any time with or without notice. You can always review the most updated version of this Agreement online at <http://multiFLEX.flexradio.com/smartsdr-eula/>. If a subsequent version is unacceptable to You, You may cancel the API at any time by simply deleting the FlexRadio API from Your product. If You continue to use the API on Your product, You will be deemed to have accepted any modifications.

3. Restrictions on Use.

1. You have no rights with respect to the API or any portion thereof and shall not use the API or any portion thereof except as expressly set forth herein. Without limiting the generality of the foregoing, You agree not to (i) modify or create derivative works of the API; (ii) sublicense, lease, rent, assign, distribute, repackage, rebrand, or otherwise transfer or disclose the API, any portion thereof or any documentation to any third party; (iii) use the API on or in connection with any website or application other than the specific URL(s) and/or applications provided to FlexRadio at the time You registered for the API; or (iv) cause, assist or permit any third party (including an end-user) to do any of the foregoing.

2. Except to the extent expressly permitted by applicable law, You may not decompile, “reverse-engineer”, disassemble, or otherwise attempt to derive the intellectual property or source code for the API or the SmartSDR software. You may not use the API or the SmartSDR software in any manner to develop, or assist any third party in developing, any product that competes with the API or the SmartSDR software.

3. You will not use the API to create or disseminate, or assist in the creation or dissemination, of any virus, Trojan horse, back door, or other code that would permit unauthorized access to or use of other software or radios or otherwise cause harm, damage or interfere with the operation of any other software or radios.

4. Specifically excluded from the license set forth in this Agreement are any uses or operation of the API in connection with (i) any Internet site other than the URL(s) provided in Your registration; and (ii) any products, systems, applications or hardware other than devices manufactured by FlexRadio or any of its subsidiaries.

5. You agree to be fully responsible for your own conduct and content while using the API, and for any consequences thereof. You agree to use the API only for purposes that are legal, proper, and in accordance with this Agreement and any applicable policies or guidelines. By way of example, and not as a limitation, You agree that when using the API, You will not:

- upload, post, email, transmit, or otherwise make available any Content that infringes any patent, trademark, copyright, trade secret, or other proprietary right of any party unless You are the owner of the Rights or have the permission of the owner to post such Content;
- use the API for any illegal or unauthorized purpose;

- remove or alter any copyright, trademark, or other proprietary rights notices contained in the API or any other FlexRadio, Inc. content
- submit content that falsely expresses or implies that such content is sponsored or endorsed by FlexRadio, Inc.; or
- transmit any viruses, worms, defects, Trojan horses, or any items of a destructive nature.

You will comply with all applicable laws and regulations in Your use of the Software Product. In the event that You are located outside of the United States, or the computer You are operating is running on a network located outside of the United States, You agree to comply with any laws, rules, or regulations in your locale or in the location of your computer/server regarding online conduct and acceptable content, including laws regulating the export of data to the United States or your country of residence.

4. Termination of Use. FlexRadio, Inc. hereby reserves all rights to discontinue Your access to the API and the underlying content at any time, at FlexRadio's sole discretion, for any reason, with or without notice.

2. DISCLAIMER OF WARRANTIES

1. YOUR USE OF THE API IS AT YOUR SOLE RISK. THE API IS PROVIDED ON AN "AS IS" AND "AS AVAILABLE" BASIS. FLEXRADIO, INC. EXPRESSLY DISCLAIMS ALL WARRANTIES OF ANY KIND, WHETHER EXPRESS OR IMPLIED, INCLUDING, BUT NOT LIMITED TO THE IMPLIED WARRANTIES OF MERCHANTABILITY, FITNESS FOR A PARTICULAR PURPOSE AND NON-INFRINGEMENT.

2. FLEXRADIO MAKES NO WARRANTY THAT (i) THE API WILL MEET YOUR REQUIREMENTS, (ii) USE OF THE API WILL BE UNINTERRUPTED, TIMELY, SECURE, OR ERROR-FREE, AND/OR THAT (iii) ANY ERRORS IN THE SOFTWARE WILL BE CORRECTED.

3. ANY MATERIAL DOWNLOADED OR OTHERWISE OBTAINED THROUGH THE API IS DONE AT YOUR OWN DISCRETION AND RISK. YOU ARE SOLELY RESPONSIBLE FOR ANY DAMAGE TO YOUR COMPUTER SYSTEM/NETWORK, TRANSCEIVER OR ANY LOSS OF DATA THAT MAY RESULT FROM THE DOWNLOAD OF ANY SUCH MATERIAL OR THE USE OF THE API. YOU ARE SOLELY RESPONSIBLE FOR ANY DAMAGE TO ANY THIRD PARTY'S COMPUTER SYSTEM/NETWORK, TRANSCEIVER OR ANY LOSS OF DATA THAT MAY RESULT FROM ACCESS TO OR USE OF THE SOFTWARE YOU CREATE AS A RESULT OF YOUR USE OF THE API.

3. LIMITATION OF LIABILITY

YOU EXPRESSLY UNDERSTAND AND AGREE THAT FLEXRADIO, INC. SHALL NOT BE LIABLE TO YOU FOR ANY DIRECT, INDIRECT, INCIDENTAL, SPECIAL, CONSEQUENTIAL, EXEMPLARY, OR ANY OTHER DAMAGES, INCLUDING BUT NOT LIMITED TO, DAMAGES FOR LOSS OF PROFITS, GOODWILL, USE, DATA OR OTHER INTANGIBLE LOSSES (EVEN IF FLEXRADIO, INC. HAS BEEN ADVISED OF THE POSSIBILITY OF SUCH DAMAGES), RESULTING FROM: (i) THE USE OR THE INABILITY TO USE THE API; (ii) UNAUTHORIZED ACCESS TO OR ALTERATION OF YOUR TRANSMISSIONS OR DATA; OR (iii) ANY OTHER MATTER RELATING TO THE API, INCLUDING WITHOUT LIMITATION THIRD PARTY DAMAGES AS A RESULT OF SUCH THIRD PARTY'S USE OF YOUR SOFTWARE. Some jurisdictions do not allow the exclusion of certain warranties or the limitation or exclusion of liability for incidental or consequential damages. Accordingly, some of the above limitations of sections 3 and 4 may not apply to you.

4. INDEMNIFICATION

FlexRadio, Inc. shall indemnify, hold harmless, and defend You against any action brought by a third party against You to the extent that such action is based on a claim that the unmodified API, when used in

accordance with this Agreement, infringes a United States copyright and FlexRadio, Inc. shall pay all costs, settlements, and damages finally awarded as a result of such claim; provided, that You promptly notify FlexRadio, Inc. in writing of any claim, give FlexRadio sole control of the defense and settlement thereof and provide all reasonable assistance in connection therewith. If the API is finally adjudged to so infringe, or in FlexRadio's opinion is likely to become the subject of such a claim, FlexRadio shall, at its option, either:

- a. procure for You the right to continue using the API,
- b. modify or replace the API to make it non-infringing, or
- c. terminate this Agreement and Your rights to use the API.

FlexRadio, Inc. shall have no liability regarding any claim arising out of: (multiFLEX) use of other than a current, unaltered release of the API unless the infringing portion is also in the then current, unaltered release, (x) use of the API in combination with non-FlexRadio, Inc. software, data or equipment if the infringement was caused by such use or combination, (multiFLEX) any modification or derivation of the API not specifically authorized in writing by FlexRadio, or (z) use of third party software. THE FOREGOING STATES THE ENTIRE LIABILITY OF FLEXRADIO, INC. AND THE EXCLUSIVE REMEDY FOR LICENSEE RELATING TO INFRINGEMENT OR CLAIMS OF INFRINGEMENT OF ANY COPYRIGHT OR OTHER PROPRIETARY RIGHT BY THE API.

Except for the foregoing infringement claims, You shall indemnify and hold harmless FlexRadio, Inc. and their officers, agents, and employees from and against any claims, demands, or causes of action whatsoever, including without limitation those arising on account of Your use of or modification or enhancement of the API or otherwise caused by, or arising out of, or resulting from, the exercise or practice of the license granted hereunder by You, Your Subsidiaries or their officers, employees, agents or representatives, including without limitation any claims arising as a result of any software created by You using the API. In such a case, FlexRadio, Inc. will provide You with written notice of such claim, suit, or action.

5. INTELLECTUAL PROPERTY RIGHTS

1. "Intellectual Property Rights" shall mean any and all rights existing under patent law, copyright law, semiconductor chip protection law, moral rights law, trade secret law, trademark law, unfair competition law, publicity rights law, privacy rights law, and any and all other proprietary rights, and any and all applications, renewals, extensions, and restorations thereof, now or hereafter in force and effect worldwide. As between You and FlexRadio, Inc., You acknowledge that FlexRadio owns all rights, title, and interest, including without limitation all Intellectual Property Rights, in and to the API, including but not limited to the FlexRadio API and any data accessed by virtue of the FlexRadio API, and that You shall not acquire any right, title, or interest in or to the API, except the limited license expressly set forth in this Agreement.

2. Trademarks. Unless specifically agreed in writing, You have no right to use any Trademarks of FlexRadio, Inc. for any purpose; provided, however, that You are permitted to discuss, both verbally and in writing, your use of the API and the software you create that interoperates with the SmartSDS software. Notwithstanding the foregoing, statements implying endorsement of Your software by FlexRadio or disparaging statements about the API, SmartSDR, or FlexRadio are prohibited and would be deemed a breach of this Agreement. For purposes of this Agreement, "Trademarks" shall be defined as the trademarks, trade names, logos, and domain names, along with any other distinctive brand features of each party. Except as set forth in this Section 5, nothing in this Agreement shall grant or shall be deemed to grant to one party any right, title, or interest in or to the other party's Trademarks.

3. Attribution of FlexRadio System's Third-Party Data Providers. Some images accessible by You by virtue of the API may contain the trade names, trademarks, logos, domain names, and other distinctive brand features of FlexRadio and its third-party data providers. You may not delete or in any manner alter these trade names, trademarks, logos, domain names, and other distinctive brand features.

6. TERM AND TERMINATION

1. Term. The term of this Agreement shall commence on the date upon which You download the API and agree to this Agreement and shall continue in force thereafter unless terminated as provided herein.

2. Termination. FlexRadio, Inc. may change, suspend, or discontinue all or any aspect of the API, including its availability, at any time, and may suspend or terminate Your use of the API at any time. In addition, either party may terminate this Agreement at any time, for any reason, or for no reason including, but not limited to, if You engage in any action that reflects poorly on FlexRadio or otherwise disparages or devalues the FlexRadio trademarks or FlexRadio's reputation or goodwill. If You desire to terminate this Agreement, You must remove the API, and any code created therefrom, from Your product.

3. Effect of Termination. Upon the termination of this Agreement for any reason (i) all license rights granted herein shall terminate; (ii) You shall immediately delete any and all images and FlexRadio Trademarks; and (iii) You shall immediately cease all use of the API.

4. Survival. In the event of any termination or expiration of this Agreement for any reason, Sections 1.2, 1.3, and two through seven (2-7) shall survive termination. Neither party shall be liable to the other party for damages of any sort resulting solely from terminating this Agreement in accordance with its terms.

5. Equitable Remedies. You acknowledge that Your breach of API/license restrictions contained herein may cause irreparable harm to FlexRadio, Inc.. Accordingly, You agree that, in addition to any other remedies to which FlexRadio may be legally entitled, FlexRadio, Inc. shall have the right to seek immediate injunctive relief in the event of a breach of such sections by You, or any of Your officers, employees, consultants or other agents.

7. MISCELLANEOUS TERMS

1. Entire Agreement. This Agreement constitutes the entire agreement between You and FlexRadio, Inc. with respect to the subject matter hereof and governs your use of the API, superseding any prior agreements between You and FlexRadio related to the API. You also may be subject to additional terms and conditions that may apply when You use or purchase certain other FlexRadio products or applications, affiliate applications, third-party content, or third-party software.

2. Jurisdiction, Venue, and Choice of Law. This Agreement and the relationship between You and FlexRadio shall be governed by the laws of the State of Texas without regard to its conflict of law provisions. You and FlexRadio agree to submit to the personal and exclusive jurisdiction of the United States District Court for the District of Texas and the Texas state courts located in Travis County, Texas.

3. Severability and Waiver. The failure of FlexRadio, Inc. to exercise or enforce any right or provision of this Agreement shall not constitute a waiver of such right or provision. If any provision of this Agreement is found by a court of competent jurisdiction to be invalid, the parties nevertheless agree that the court should endeavor to give effect to the parties' intentions as reflected in the provision, and the other provisions of this Agreement remain in full force and effect.

4. Statute of Limitations. You agree that regardless of any statute or law to the contrary, any claim or cause of action arising out of or related to the use of the FlexRadio API or this Agreement must be filed within one (1) year after such claim or cause of action arose or be forever barred.

42.2 GPL INFORMATION

Portions of the software contained within the FLEX-6000 Signature Series transceiver are covered under the GNU General Public License (GPL).

GNU GENERAL PUBLIC LICENSE

Version 2, June 1991. Copyright (C) 1989, 1991 Free Software Foundation, Inc.

51 Franklin Street, Fifth Floor, Boston, MA 02110-1301, USA

Everyone is permitted to copy and distribute verbatim copies of this license document, but changing it is not allowed.

Preamble

The licenses for most software are designed to take away your freedom to share and change it. By contrast, the GNU General Public License is intended to guarantee your freedom to share and change free software--to make sure the software is free for all its users. This General Public License applies to most of the Free Software Foundation's software and to any other program whose authors commit to using it. (Some other Free Software Foundation software is covered by the GNU Lesser General Public License instead.) You can apply it to your programs, too.

When we speak of free software, we are referring to freedom, not price. Our General Public Licenses are designed to make sure that you have the freedom to distribute copies of free software (and charge for this service if you wish), that you receive source code or can get it if you want it, that you can change the software or use pieces of it in new free programs; and that you know you can do these things.

To protect your rights, we need to make restrictions that forbid anyone to deny you these rights or to ask you to surrender the rights. These restrictions translate to certain responsibilities for you if you distribute copies of the software, or if you modify it.

For example, if you distribute copies of such a program, whether gratis or for a fee, you must give the recipients all the rights that you have. You must make sure that they, too, receive or can get the source code. And you must show them these terms so they know their rights.

We protect your rights with two steps: (1) copyright the software, and (2) offer you this license which gives you legal permission to copy, distribute and/or modify the software.

Also, for each author's protection and ours, we want to make certain that everyone understands that there is no warranty for this free software. If the software is modified by someone else and passed on, we want its recipients to know that what they have is not the original, so that any problems introduced by others will not reflect on the original authors' reputations.

Finally, any free program is threatened constantly by software patents. We wish to avoid the danger that redistributors of a free program will individually obtain patent licenses, in effect making the program proprietary. To prevent this, we have made it clear that any patent must be licensed for everyone's free use or not licensed at all.

The precise terms and conditions for copying, distribution and modification follow.

TERMS AND CONDITIONS FOR COPYING, DISTRIBUTION AND MODIFICATION

0. This License applies to any program or other work which contains a notice placed by the copyright holder saying it may be distributed under the terms of this General Public License. The "Program", below, refers to any such program or work, and a "work based on the Program" means either the Program or any derivative work under copyright law: that is to say, a work containing the Program or a portion of it, either verbatim or with modifications and/or translated into another language. (Hereinafter, translation is included without limitation in the term "modification".) Each licensee is addressed as "you".

Activities other than copying, distribution and modification are not covered by this License; they are outside its scope. The act of running the Program is not restricted, and the output from the Program is covered only if its contents constitute a work based on the Program (independent of having been made by running the Program). Whether that is true depends on what the Program does.

1. You may copy and distribute verbatim copies of the Program's source code as you receive it, in any medium, provided that you conspicuously and appropriately publish on each copy an appropriate copyright notice and disclaimer of warranty; keep intact all the notices that refer to this License and to the absence of any warranty; and give any other recipients of the Program a copy of this License along with the Program.

You may charge a fee for the physical act of transferring a copy, and you may at your option offer warranty protection in exchange for a fee.

2. You may modify your copy or copies of the Program or any portion of it, thus forming a work based on the Program, and copy and distribute such modifications or work under the terms of Section 1 above, provided that you also meet all of these conditions:

a) You must cause the modified files to carry prominent notices stating that you changed the files and the date of any change.

b) You must cause any work that you distribute or publish, that in whole or in part contains or is derived from the Program or any part thereof, to be licensed as a whole at no charge to all third parties under the terms of this License.

c) If the modified program normally reads commands interactively when run, you must cause it, when started running for such interactive use in the most ordinary way, to print or display an announcement including an appropriate copyright notice and a notice that there is no warranty (or else, saying that you provide a warranty) and that users may redistribute the program under these conditions, and telling the user how to view a copy of this License. (Exception: if the Program itself is interactive but does not normally print such an announcement, your work based on the Program is not required to print an announcement.)

These requirements apply to the modified work as a whole. If identifiable sections of that work are not derived from the Program, and can be reasonably considered independent and separate works in themselves, then this License, and its terms, does not apply to those sections when you distribute them as separate works. But when you distribute the same sections as part of a whole which is a work based on the Program, the distribution of the whole must be on the terms of this License, whose permissions for other licensees extend to the entire whole, and thus to each and every part regardless of who wrote it.

Thus, it is not the intent of this section to claim rights or contest your rights to work written entirely by you; rather, the intent is to exercise the right to control the distribution of derivative or collective works based on the Program.

In addition, mere aggregation of another work not based on the Program with the Program (or with a work based on the Program) on a volume of a storage or distribution medium does not bring the other work under the scope of this License.

3. You may copy and distribute the Program (or a work based on it, under Section 2) in object code or executable form under the terms of Sections 1 and 2 above provided that you also do one of the following:

- a)** Accompany it with the complete corresponding machine-readable source code, which must be distributed under the terms of Sections 1 and 2 above on a medium customarily used for software interchange; or,
- b)** Accompany it with a written offer, valid for at least three years, to give any third party, for a charge no more than your cost of physically performing source distribution, a complete machine-readable copy of the corresponding source code, to be distributed under the terms of Sections 1 and 2 above on a medium customarily used for software interchange; or,
- c)** Accompany it with the information you received as to the offer to distribute corresponding source code. (These alternatives are allowed only for noncommercial distribution and only if you received the program in object code or executable form with such an offer, in accord with Subsection b above.)

The source code for a work means the preferred form of the work for making modifications to it. For an executable work, complete source code means all the source code for all modules it contains, plus any associated interface definition files, plus the scripts used to control compilation and installation of the executable. However, as a special exception, the source code distributed need not include anything that is normally distributed (in either source or binary form) with the major components (compiler, kernel, and so on) of the operating system on which the executable runs, unless that component itself accompanies the executable.

If distribution of executable or object code is made by offering access to copy from a designated place, then offering equivalent access to copy the source code from the same place counts as distribution of the source code, even though third parties are not compelled to copy the source along with the object code.

4. You may not copy, modify, sublicense, or distribute the Program except as expressly provided under this License. Any attempt otherwise to copy, modify, sublicense or distribute the Program is void, and will automatically terminate your rights under this License. However, parties who have received copies, or rights, from you under this License will not have their licenses terminated so long as such parties remain in full compliance.

5. You are not required to accept this License, since you have not signed it. However, nothing else grants you permission to modify or distribute the Program or its derivative works. These actions are prohibited by law if you do not accept this License. Therefore, by modifying or distributing the Program (or any work based on the Program), you indicate your acceptance of this License to do so, and all its terms and conditions for copying, distributing or modifying the Program or works based on it.

6. Each time you redistribute the Program (or any work based on the Program), the recipient automatically receives a license from the original licensor to copy, distribute or modify the Program subject to these terms and conditions. You may not impose any further restrictions on the recipients' exercise of the rights granted herein. You are not responsible for enforcing compliance by third parties to this License.

7. If, as a consequence of a court judgment or allegation of patent infringement or for any other reason (not limited to patent issues), conditions are imposed on you (whether by court order, agreement or otherwise) that contradict the conditions of this License, they do not excuse you from the conditions of this License. If you cannot distribute so as to satisfy simultaneously your obligations under this License and any other pertinent obligations, then as a consequence you may not distribute the Program at all. For example, if a patent license would not permit royalty-free redistribution of the Program by all those who receive copies directly or indirectly through you, then the only way you could satisfy both it and this License would be to refrain entirely from distribution of the Program.

If any portion of this section is held invalid or unenforceable under any particular circumstance, the balance of the section is intended to apply and the section as a whole is intended to apply in other circumstances.

It is not the purpose of this section to induce you to infringe any patents or other property right claims or to contest validity of any such claims; this section has the sole purpose of protecting the integrity of the free software distribution system, which is implemented by public license practices. Many people have made generous contributions to the wide range of software distributed through that system in reliance on consistent application of that system; it is up to the author/donor to decide if he or she is willing to distribute software through any other system and a licensee cannot impose that choice.

This section is intended to make thoroughly clear what is believed to be a consequence of the rest of this License.

8. If the distribution and/or use of the Program is restricted in certain countries either by patents or by copyrighted interfaces, the original copyright holder who places the Program under this License may add an explicit geographical distribution limitation excluding those countries, so that distribution is permitted only in or among countries not thus excluded. In such case, this License incorporates the limitation as if written in the body of this License.

9. The Free Software Foundation may publish revised and/or new versions of the General Public License from time to time. Such new versions will be similar in spirit to the present version, but may differ in detail to address new problems or concerns.

Each version is given a distinguishing version number. If the Program specifies a version number of this License which applies to it and "any later version", you have the option of following the terms and conditions either of that version or of any later version published by the Free Software Foundation. If the Program does not specify a version number of this License, you may choose any version ever published by the Free Software Foundation.

10. If you wish to incorporate parts of the Program into other free programs whose distribution conditions are different, write to the author to ask for permission. For software which is copyrighted by the Free Software Foundation, write to the Free Software Foundation; we

sometimes make exceptions for this. Our decision will be guided by the two goals of preserving the free status of all derivatives of our free software and of promoting the sharing and reuse of software generally.

NO WARRANTY

11. BECAUSE THE PROGRAM IS LICENSED FREE OF CHARGE, THERE IS NO WARRANTY FOR THE PROGRAM, TO THE EXTENT PERMITTED BY APPLICABLE LAW. EXCEPT WHEN OTHERWISE STATED IN WRITING THE COPYRIGHT HOLDERS AND/OR OTHER PARTIES PROVIDE THE PROGRAM "AS IS" WITHOUT WARRANTY OF ANY KIND, EITHER EXPRESSED OR IMPLIED, INCLUDING, BUT NOT LIMITED TO, THE IMPLIED WARRANTIES OF MERCHANTABILITY AND FITNESS FOR A PARTICULAR PURPOSE. THE ENTIRE RISK AS TO THE QUALITY AND PERFORMANCE OF THE PROGRAM IS WITH YOU. SHOULD THE PROGRAM PROVE DEFECTIVE, YOU ASSUME THE COST OF ALL NECESSARY SERVICING, REPAIR OR CORRECTION.

12. IN NO EVENT UNLESS REQUIRED BY APPLICABLE LAW OR AGREED TO IN WRITING WILL ANY COPYRIGHT HOLDER, OR ANY OTHER PARTY WHO MAY MODIFY AND/OR REDISTRIBUTE THE PROGRAM AS PERMITTED ABOVE, BE LIABLE TO YOU FOR DAMAGES, INCLUDING ANY GENERAL, SPECIAL, INCIDENTAL OR CONSEQUENTIAL DAMAGES ARISING OUT OF THE USE OR INABILITY TO USE THE PROGRAM (INCLUDING BUT NOT LIMITED TO LOSS OF DATA OR DATA BEING RENDERED INACCURATE OR LOSSES SUSTAINED BY YOU OR THIRD PARTIES OR A FAILURE OF THE PROGRAM TO OPERATE WITH ANY OTHER PROGRAMS), EVEN IF SUCH HOLDER OR OTHER PARTY HAS BEEN ADVISED OF THE POSSIBILITY OF SUCH DAMAGES.

END OF TERMS AND CONDITIONS

How to Apply These Terms to Your New Programs

If you develop a new program, and you want it to be of the greatest possible use to the public, the best way to achieve this is to make it free software which everyone can redistribute and change under these terms.

To do so, attach the following notices to the program. It is safest to attach them to the start of each source file to most effectively convey the exclusion of warranty; and each file should have at least the "copyright" line and a pointer to where the full notice is found.

One line to give the program's name and an idea of what it does.

Copyright (C) yyyy name of author

This program is free software; you can redistribute it and/or modify it under the terms of the GNU General Public License as published by the Free Software Foundation; either version 2 of the License, or (at your option) any later version.

This program is distributed in the hope that it will be useful, but WITHOUT ANY WARRANTY; without even the implied warranty of MERCHANTABILITY or FITNESS FOR A PARTICULAR PURPOSE. See the GNU General Public License for more details.

You should have received a copy of the GNU General Public License along with this program; if not, write to the Free Software Foundation, Inc., 51 Franklin Street, Fifth Floor, Boston, MA 02110-1301, USA.

Also add information on how to contact you by electronic and paper mail.

If the program is interactive, make it output a short notice like this when it starts in an interactive mode:

Gnomovision version 69, Copyright (C) *year name of author*

Gnomovision comes with ABSOLUTELY NO WARRANTY; for details type `show w'. This is free software, and you are welcome to redistribute it under certain conditions; type `show c' for details.

The hypothetical commands `show w' and `show c' should show the appropriate parts of the General Public License. Of course, the commands you use may be called something other than `show w' and `show c'; they could even be mouse-clicks or menu items--whatever suits your program.

You should also get your employer (if you work as a programmer) or your school, if any, to sign a "copyright disclaimer" for the program, if necessary. Here is a sample; alter the names:

Yoyodyne, Inc., hereby disclaims all copyright interest in the program `Gnomovision' (which makes passes at compilers) written by James Hacker.

Signature of Ty Coon, 1 April 1989

Ty Coon, President of Vice

This General Public License does not permit incorporating your program into proprietary programs. If your program is a subroutine library, you may consider it more useful to permit linking proprietary applications with the library. If this is what you want to do, use the GNU Lesser General Public License instead of this License.